

# IDAHO ADMINISTRATIVE BULLETIN

April 15, 2020 – Vol. 20-4SE

Office of the Governor  
Division of Financial Management  
Office of the Administrative Rules Coordinator



The Idaho Administrative Bulletin is published monthly by the Office of the Administrative Rules Coordinator, Division of Financial Management, Statehouse Mail, Boise, Idaho 83720-0306, pursuant to Title 67, Chapter 52, Idaho Code.

Brad Little, Governor  
Alex J. Adams, Administrator, Division of Financial Management  
Dennis Stevenson, Administrative Rules Coordinator  
Bradley A. Hunt, Administrative Rules Specialist  
Jason Shaw, Publishing Specialist

All Rights Reserved / Printed in the United States of America



State of Idaho  
DIVISION OF FINANCIAL MANAGEMENT  
Executive Office of the Governor

BRAD LITTLE  
Governor

ALEX J. ADAMS  
Administrator

April 15, 2020

**MEMORANDUM**

TO: **Members of the Public**

FROM: **Alex J. Adams, Administrator** 

**Dennis R. Stevenson, Rules Coordinator** 

SUBJECT: **Overview of April 15<sup>th</sup> Special Edition of Idaho Administrative Bulletin**

The Idaho Legislature adjourned *sine die* on March 20<sup>th</sup>. The Legislature did not pass a concurrent resolution rejecting any pending non-fee rules as specified under 67-5224, I.C. As a result, all non-fee rules that were reviewed by the legislature have taken an effect with an effective date of March 20, 2020. These non-fee rules will be printed as the official Idaho Code and available on the Rules Coordinator's website: <https://adminrules.idaho.gov/rules/current/index.html>.

The Legislature did not pass a concurrent resolution approving any pending fee rules as specified under 67-5224, I.C. As a result, the fee rules would not typically take effect. However, the proactive action taken by state agencies in February to conditionally re-approve fee rules upon *sine die* has ensured that they remain in effect as temporary rules. This special edition of the Idaho Administrative Bulletin republishes fee rules as temporary fee rules, with an effective date as of *sine die* (e.g., March 20).

In general, the temporary fee rules published herein are unchanged from those presented to (and previously approved by) the Legislature. In some rare cases, technical corrections were made, or changes designed to facilitate the state's response to the 2019 Novel Coronavirus (COVID-19) pandemic have been adopted by the agencies. Such changes are relatively infrequent and they are noted on the Notice of Adoption of a Temporary Rule in the rare instances they occurred.

For more information on this special bulletin, please contact:  
Alex Adams ([Alex.Adams@dfm.idaho.gov](mailto:Alex.Adams@dfm.idaho.gov); 208-334-3900); or  
Dennis Stevenson ([Dennis.Stevenson@dfm.idaho.gov](mailto:Dennis.Stevenson@dfm.idaho.gov); 208-854-3095).

# IDAHO ADMINISTRATIVE BULLETIN

## Table of Contents

April 15, 2020 – Vol. 20-4SE

<b>PREFACE</b> .....	14
<b>IDAPA 01 – BOARD OF ACCOUNTANCY</b>	
<i>Docket No. 01-0101-2000F (Fee Rule)</i>	
Notice of Omnibus Rulemaking – Adoption of Temporary Rule .....	21
01.01.01 – Idaho Accountancy Rules	
<b>IDAPA 02 – DEPARTMENT OF AGRICULTURE</b>	
<i>Docket No. 02-0000-2000F (Fee Rule)</i>	
Notice of Omnibus Rulemaking – Adoption of Temporary Rule .....	36
02.01.04 – Rules Governing the Idaho Preferred® Promotion Program	
02.01.05 – Rules Governing Certificates of Free Sale	
02.02.07 – Rules Governing Bulk Permits and Retail Sale of Potatoes	
02.02.11 – Rules Governing Eggs and Egg Products	
02.02.12 – Bonded Warehouse Rules	
02.02.13 – Commodity Dealers’ Rules	
02.02.14 – Rules for Weights and Measures	
02.02.15 – Rules Governing the Seed Indemnity Fund	
02.03.03 – Rules Governing Pesticide and Chemigation Use and Application	
02.04.03 – Rules Governing Animal Industry	
02.04.05 – Rules Governing Grade A Milk And Manufacture Grade Milk	
02.04.19 – Rules Governing Domestic Cervidae	
02.04.26 – Rules Governing the Public Exchange of Livestock	
02.04.32 – Rules Governing Poultry Operations	
02.06.01 – Rules Governing the Production and Distribution of Seed	
02.06.02 – Rules Governing Registrations And Licenses	
02.06.04 – Rules Governing Plant Exports	
02.06.05 – Rules Governing Plant Disease And Quarantines	
02.06.06 – Rules Governing the Planting of Beans	
02.06.09 – Rules Governing Invasive Species and Noxious Weeds	
02.06.10 – Rules Governing the Growing of Potatoes	
02.06.33 – Organic Food Products Rules	
<b>IDAPA 02.07 – IDAHO HOP GROWERS’ COMMISSION</b>	
<i>Docket No. 02-0701-2000F (Fee Rule)</i>	
Notice of Omnibus Rulemaking – Adoption of Temporary Rule .....	360
02.07.01 – Rules of the Idaho Hop Growers’ Commission	
<b>IDAPA 02.08 – IDAHO SHEEP AND GOAT HEALTH BOARD</b>	
<i>Docket No. 02-0801-2000F (Fee Rule)</i>	
Notice of Omnibus Rulemaking – Adoption of Temporary Rule .....	363
02.08.01 – Sheep and Goat Rules of the Idaho Sheep and Goat Health Board	

**IDAPA 07 – DIVISION OF BUILDING SAFETY*****Docket No. 07-0000-2000F (Fee Rule)***

Notice of Omnibus Rulemaking – Adoption of Temporary Rule .....	374
<i>07.01.01 – Rules of the Idaho Electrical board</i>	
<i>07.02.02 – Rules Governing Plumbing</i>	
<i>07.03.01 – Rules of Building Safety (Building Code Rules)</i>	
<i>07.03.03 – Rules for Modular Buildings</i>	
<i>07.03.11 – Rules Governing Manufactured/Mobile Home Industry Licensing</i>	
<i>07.03.12 – Rules Governing Manufactured or Mobile Home Installations</i>	
<i>07.04.02 – Safety Rules for Elevators, Escalators, and Moving Walks</i>	
<i>07.05.01 – Rules of the Public Works Contractors License Board</i>	
<i>07.07.01 – Rules Governing Installation of Heating, Ventilation, and Air Conditioning Systems</i>	
<i>07.10.01 – Rules Governing the Damage Prevention Board</i>	

**IDAPA 08 – STATE BOARD OF EDUCATION*****Docket No. 08-0000-2000F (Fee Rule)***

Notice of Omnibus Rulemaking – Adoption of Temporary Rule .....	483
<i>08.01.11 – Registration of Postsecondary Educational Institutions and Proprietary Schools</i>	
<i>08.02.02 – Rules Governing Uniformity</i>	
<i>08.02.03 – Rules Governing Thoroughness</i>	

**IDAPA 10 – BOARD OF PROFESSIONAL ENGINEERS  
AND PROFESSIONAL LAND SURVEYORS*****Docket No. 10-0101-2000F (Fee Rule)***

Notice of Omnibus Rulemaking – Adoption of Temporary Rule .....	494
<i>10.01.01 – Rules of the Idaho Board of Licensure of Professional Engineers and Professional Land Surveyors</i>	

**IDAPA 11 – IDAHO STATE POLICE*****Docket No. 11-0000-2000F (Fee Rule)***

Notice of Omnibus Rulemaking – Adoption of Temporary Rule .....	514
<i>11.05.01 – Rules Governing Alcohol Beverage Control</i>	
<i>11.10.02 – Rules Governing State Criminal History Records and Crime Information</i>	

**IDAPA 11 – IDAHO STATE POLICE –  
STATE BRAND BOARD*****Docket No. 11-0201-2000F (Fee Rule)***

Notice of Omnibus Rulemaking – Adoption of Temporary Rule .....	524
<i>11.02.01 – Rules of the Idaho State Brand Board</i>	

**IDAPA 11 – IDAHO STATE POLICE –  
RACING COMMISSION*****Docket No. 11-0400-2000F (Fee Rule)***

Notice of Omnibus Rulemaking – Adoption of Temporary Rule .....	537
<i>11.04.02 – Rules Governing Simulcasting</i>	
<i>11.04.03 – Rules Governing Licensing and Fees</i>	
<i>11.04.05 – Rules Governing Advanced Deposit Wagering</i>	
<i>11.04.07 – Rules Governing Racing Associations</i>	

- 11.04.11 – Rules Governing Equine Veterinary Practices, Permitted Medications,  
Banned Substances and Drug Testing of Horses*
- 11.04.15 – Rules Governing Controlled Substance and Alcohol Testing of Licensees and Applicants*

**IDAPA 11 – IDAHO STATE POLICE –  
IDAHO PUBLIC SAFETY AND SECURITY INFORMATION SYSTEM**

- Docket No. 11-1001-2000F (Fee Rule)*
- Notice of Omnibus Rulemaking – Adoption of Temporary Rule .....595
- 11.10.01 – Rules Governing Idaho Public Safety and Security Information System*

**IDAPA 11 – IDAHO STATE POLICE –  
PEACE OFFICER STANDARDS AND TRAINING COUNCIL**

- Docket No. 11-1101-2000F (Fee Rule)*
- Notice of Omnibus Rulemaking – Adoption of Temporary Rule .....607
- 11.11.01 – Rules of the Idaho Peace Officer Standards and Training Council*

**IDAPA 12 – IDAHO DEPARTMENT OF FINANCE**

- Docket No. 12-0000-2000F (Fee Rule)*
- Notice of Omnibus Rulemaking – Adoption of Temporary Rule .....643
- 12.01.08 – Rules Pursuant to the Uniform Securities Act (2004)*

**IDAPA 13 – DEPARTMENT OF FISH AND GAME**

- Docket No. 13-0000-2000F (Fee Rule)*
- Notice of Omnibus Rulemaking – Adoption of Temporary Rule .....678
- 13.01.02 – Rules Governing Mandatory Education and Mentored Hunting*
- 13.01.04 – Rules Governing Licensing*
- 13.01.08 – Rules Governing the Taking of Big Game Animals*
- 13.01.10 – Rules Governing the Importation, Possession,  
Release, Sale, or Salvage of Wildlife*
- 13.01.19 – Rules for Selecting, Operating, Discontinuing, and Suspending Vendors*

**IDAPA 15 – OFFICE OF THE GOVERNOR –  
IDAHO FOREST PRODUCTS COMMISSION**

- Docket No. 15-0300-2000F (Fee Rule)*
- Notice of Omnibus Rulemaking – Adoption of Temporary Rule .....686
- 15.03.01 – Rules of Administrative Procedure of the Idaho  
Forest Products Commission*

**IDAPA 15 – OFFICE OF THE GOVERNOR –  
IDAHO MILITARY DIVISION**

- Docket No. 15-0600-2000F (Fee Rule)*
- Notice of Omnibus Rulemaking – Adoption of Temporary Rule .....689
- 15.06.03 – Public Safety Communications Systems Installation and Maintenance Fee Rules*

**IDAPA 15 – OFFICE OF THE GOVERNOR –  
IDAHO STATE LIQUOR DIVISION**

- Docket No. 15-1000-2000F (Fee Rule)*
- Notice of Omnibus Rulemaking – Adoption of Temporary Rule .....691
- 15.10.01 – Rules of the Idaho State Liquor Division*

**IDAPA 16 – DEPARTMENT OF HEALTH AND WELFARE**

***Docket No. 16-0000-2000F (Fee Rule)***

Notice of Omnibus Rulemaking – Adoption of Temporary Rule .....700

16.01.07 – *Emergency Medical Services (EMS) – Personnel Licensing Requirements*

16.02.01 – *Idaho Time Sensitive Emergency System Council*

16.02.08 – *Vital Statistics Rules*

16.02.13 – *State of Idaho Drinking Water Laboratory Certification Program*

16.02.14 – *Construction and Operation of Public Swimming Pools*

16.02.25 – *Fees Charged by the State Laboratory*

16.02.26 – *The Idaho Children’s Special Health Program*

16.02.27 – *Idaho Radiation Control Rules*

16.03.03 – *Child Support Services*

16.03.18 – *Medicaid Cost-Sharing*

16.03.19 – *Certified Family Homes*

16.03.22 – *Residential Assisted Living Facilities*

16.04.07 – *Rules Governing Fees for State Hospital North*

16.05.06 – *Criminal History and Background Checks*

16.06.01 – *Child and Family Services*

16.06.02 – *Rules Governing Standards for Child Care Licensing*

16.07.01 – *Behavioral Health Sliding Fee Schedules*

**IDAPA 17 – INDUSTRIAL COMMISSION**

***Docket No. 17-0000-2000F (Fee Rule)***

Notice of Omnibus Rulemaking – Adoption of Temporary Rule .....1092

17.01.01 – *Administrative Rules Under the Worker's Compensation Law*

**IDAPA 18 – IDAHO DEPARTMENT OF INSURANCE**

***Docket No. 18-0000-2000F (Fee Rule)***

Notice of Omnibus Rulemaking – Adoption of Temporary Rule .....1123

18.01.02 – *Schedule of Fees, Licenses, and Miscellaneous Charges*

18.08.02 – *Fire Protection Sprinkler Contractors*

**IDAPA 19 – IDAHO STATE BOARD OF DENTISTRY**

***Docket No. 19-0101-2000F (Fee Rule)***

Notice of Omnibus Rulemaking – Adoption of Temporary Rule .....1134

19.01.01 – *Rules of the Idaho State Board of Dentistry*

**IDAPA 20 – IDAHO DEPARTMENT OF LANDS**

***Docket No. 20-0000-2000F (Fee Rule)***

Notice of Omnibus Rulemaking – Adoption of Temporary Rule .....1152

20.02.14 – *Rules for Selling Forest Products on State-Owned Endowment Lands*

20.03.01 – *Rules Governing Dredge and Placer Mining Operations in Idaho*

20.03.02 – *Rules Governing Mined Land Reclamation*

20.03.03 – *Rules Governing Administration of the Reclamation Fund*

20.03.04 – *Rules for the Regulation of Beds, Waters, and Airspace Over Navigable Lakes in the State of Idaho*

20.03.05 – *Riverbed Mineral Leasing in Idaho*

20.03.08 – *Easements on State-Owned Lands*

- 20.03.09 – *Easements on State-Owned Submerged Lands and Formerly Submerged Lands*
- 20.03.13 – *Administration of Cottage Site Leases on State Lands*
- 20.03.14 – *Rules Governing Grazing, Farming, Conservation, Noncommercial Recreation, and Communication Site Leases*
- 20.03.15 – *Rules Governing Geothermal Leasing on Idaho State Lands*
- 20.03.16 – *Rules Governing Oil and Gas Leasing on Idaho State Lands*
- 20.03.17 – *Rules Governing Leases on State-Owned Submerged Lands and Formerly Submerged Lands*
- 20.04.02 – *Rules Pertaining to the Idaho Forestry Act and Fire Hazard Reduction Laws*
- 20.06.01 – *Rules of the Idaho Board of Scaling Practices*
- 20.07.02 – *Rules Governing Conservation of Oil and Natural Gas in the State of Idaho*

**IDAPA 21 – IDAHO DIVISION OF VETERANS SERVICES**

- Docket No. 21-0000-2000F (Fee Rule)**
- Notice of Omnibus Rulemaking – Adoption of Temporary Rule .....1359
- 21.01.01 – *Rules Governing Admission, Residency, and Maintenance Charges in Idaho State Veterans Homes and Division of Veterans Services Administrative Procedure*
- 21.01.04 – *Rules Governing the Idaho State Veterans Cemetery*

**IDAPA 22 – BOARD OF MEDICINE**

- Docket No. 22-0000-2000F (Fee Rule)**
- Notice of Omnibus Rulemaking – Adoption of Temporary Rule .....1387
- 22.01.01 – *Rules of the Board of Medicine for the Licensure to Practice Medicine and Osteopathic Medicine in Idaho*
- 22.01.03 – *Rules for the Licensure of Physician Assistants*
- 22.01.07 – *Rules for the Licensure of Naturopathic Medical Doctors*
- 22.01.10 – *Rules for the Licensure of Athletic Trainers to Practice in Idaho*
- 22.01.11 – *Rules for Licensure of Respiratory Therapists and Permitting of Polysomnographers in Idaho*
- 22.01.13 – *Rules for the Licensure of Dietitians*

**IDAPA 23 – BOARD OF NURSING**

- Docket No. 23-0101-2000F (Fee Rule)**
- Notice of Omnibus Rulemaking – Adoption of Temporary Rule .....1413
- 23.01.01 – *Rules of the Idaho Board of Nursing*

**IDAPA 24 – DIVISION OF OCCUPATIONAL AND PROFESSIONAL LICENSES**

- Docket No. 24-0101-2000F (Fee Rule)**
- Notice of Omnibus Rulemaking – Adoption of Temporary Rule .....1456
- 24.01.01 – *Rules of the Board of Architectural Examiners*
- Docket No. 24-0201-2000F (Fee Rule)**
- Notice of Omnibus Rulemaking – Adoption of Temporary Rule .....1464
- 24.02.01 – *Rules of the State Athletic Commission*
- Docket No. 24-0301-2000F (Fee Rule)**
- Notice of Omnibus Rulemaking – Adoption of Temporary Rule .....1509
- 24.03.01 – *Rules of the State Board of Chiropractic Physicians*

<b>Docket No. 24-0401-2000F (Fee Rule)</b>	
Notice of Omnibus Rulemaking – Adoption of Temporary Rule .....	1525
24.04.01 – Rules of the Board of Registration for Professional Geologists	
<b>Docket No. 24-0501-2000F (Fee Rule)</b>	
Notice of Omnibus Rulemaking – Adoption of Temporary Rule .....	1533
24.05.01 – Rules of the Board of Drinking Water and Wastewater Professionals	
<b>Docket No. 24-0601-2000F (Fee Rule)</b>	
Notice of Omnibus Rulemaking – Adoption of Temporary Rule .....	1550
24.06.01 – Rules for the Licensure of Occupational Therapists and Occupational Therapy Assistants	
<b>Docket No. 24-0701-2000F (Fee Rule)</b>	
Notice of Omnibus Rulemaking – Adoption of Temporary Rule .....	1561
24.07.01 – Rules of the Idaho State Board of Landscape Architects	
<b>Docket No. 24-0801-2000F (Fee Rule)</b>	
Notice of Omnibus Rulemaking – Adoption of Temporary Rule .....	1566
24.08.01 – Rules of the State Board of Morticians	
<b>Docket No. 24-0901-2000F (Fee Rule)</b>	
Notice of Omnibus Rulemaking – Adoption of Temporary Rule .....	1577
24.09.01 – Rules of the Board of Examiners of Nursing Home Administrators	
<b>Docket No. 24-1001-2000F (Fee Rule)</b>	
Notice of Omnibus Rulemaking – Adoption of Temporary Rule .....	1583
24.10.01 – Rules of the State Board of Optometry	
<b>Docket No. 24-1101-2000F (Fee Rule)</b>	
Notice of Omnibus Rulemaking – Adoption of Temporary Rule .....	1594
24.11.01 – Rules of the State Board of Podiatry	
<b>Docket No. 24-1201-2000F (Fee Rule)</b>	
Notice of Omnibus Rulemaking – Adoption of Temporary Rule .....	1600
24.12.01 – Rules of the Idaho State Board of Psychologist Examiners	
<b>Docket No. 24-1301-2000F (Fee Rule)</b>	
Notice of Omnibus Rulemaking – Adoption of Temporary Rule .....	1622
24.13.01 – Rules Governing the Physical Therapy Licensure Board	
<b>Docket No. 24-1401-2000F (Fee Rule)</b>	
Notice of Omnibus Rulemaking – Adoption of Temporary Rule .....	1635
24.14.01 – Rules of the State Board of Social Work Examiners	
<b>Docket No. 24-1501-2000F (Fee Rule)</b>	
Notice of Omnibus Rulemaking – Adoption of Temporary Rule .....	1648
24.15.01 – Rules of the Idaho Licensing Board of Professional Counselors and Marriage and Family Therapists	
<b>Docket No. 24-1601-2000F (Fee Rule)</b>	
Notice of Omnibus Rulemaking – Adoption of Temporary Rule .....	1661
24.16.01 – Rules of the State Board of Dentistry	



**Docket No. 24-1701-2000F (Fee Rule)**  
 Notice of Omnibus Rulemaking – Adoption of Temporary Rule .....1671  
*24.17.01 – Rules of the State Board of Acupuncture*

**Docket No. 24-1801-2000F (Fee Rule)**  
 Notice of Omnibus Rulemaking – Adoption of Temporary Rule .....1679  
*24.18.01 – Rules of the Real Estate Appraiser Board*

**Docket No. 24-1901-2000F (Fee Rule)**  
 Notice of Omnibus Rulemaking – Adoption of Temporary Rule .....1694  
*24.19.01 – Rules of the Board of Examiners of Residential Care Facility Administrators*

**Docket No. 24-2101-2000F (Fee Rule)**  
 Notice of Omnibus Rulemaking – Adoption of Temporary Rule .....1699  
*24.21.01 – Rules of the Idaho State Contractors Board*

**Docket No. 24-2201-2000F (Fee Rule)**  
 Notice of Omnibus Rulemaking – Adoption of Temporary Rule .....1703  
*24.22.01 – Rules of the Idaho State Liquefied Petroleum Gas Safety Board*

**Docket No. 24-2301-2000F (Fee Rule)**  
 Notice of Omnibus Rulemaking – Adoption of Temporary Rule .....1708  
*24.23.01 – Rules of the Speech, Hearing, and Communication Services Licensure Board*

**Docket No. 24-2401-2000F (Fee Rule)**  
 Notice of Omnibus Rulemaking – Adoption of Temporary Rule .....1722  
*24.24.01 – Rules of the Genetic Counselors Licensing Board*

**Docket No. 24-2501-2000F (Fee Rule)**  
 Notice of Omnibus Rulemaking – Adoption of Temporary Rule .....1727  
*24.25.01 – Rules of the Idaho Driving Businesses Licensure Board*

**Docket No. 24-2601-2000F (Fee Rule)**  
 Notice of Omnibus Rulemaking – Adoption of Temporary Rule .....1741  
*24.26.01 – Rules of the Idaho Board of Midwifery*

**Docket No. 24-2701-2000F (Fee Rule)**  
 Notice of Omnibus Rulemaking – Adoption of Temporary Rule .....1754  
*24.27.01 – Rules of the Idaho State Board of Massage Therapy*

**Docket No. 24-2801-2000F (Fee Rule)**  
 Notice of Omnibus Rulemaking – Adoption of Temporary Rule .....1767  
*24.28.01 – Rules of the Barber and Cosmetology Services Licensing Board*

**Docket No. 24-2901-2000F (Fee Rule)**  
 Notice of Omnibus Rulemaking – Adoption of Temporary Rule .....1794  
*24.29.01 – Rules of Procedure of the Idaho Certified Shorthand Reporters Board*

**IDAPA 25 – IDAHO OUTFITTERS AND GUIDES LICENSING BOARD**

*Docket No. 25-0101-2000F (Fee Rule)*

Notice of Omnibus Rulemaking – Adoption of Temporary Rule .....1800

*25.01.01 – Rules of the Outfitters and Guides Licensing Board*

**IDAPA 26 – DEPARTMENT OF PARKS AND RECREATION**

*Docket No. 26-0000-2000F (Fee Rule)*

Notice of Omnibus Rulemaking – Adoption of Temporary Rule .....1833

*26.01.10 – Rules Governing the Administration of Temporary Permits on Lands Owned  
by the Idaho Department of Parks and Recreation*

*26.01.20 – Rules Governing the Administration of Park and Recreation Areas and Facilities*

*26.01.33 – Rules Governing the Administration of the Land and Water Conservation Fund Program*

**IDAPA 27 – IDAHO BOARD OF PHARMACY**

*Docket No. 27-0101-2000F (Fee Rule)*

Notice of Omnibus Rulemaking – Adoption of Temporary Rule .....1870

*27.01.01 – Rules of the Idaho State Board of Pharmacy*

**IDAPA 32 – ENDOWMENT FUND INVESTMENT BOARD**

*Docket No. 32-0101-2000F (Fee Rule)*

Notice of Omnibus Rulemaking – Adoption of Pending Fee Rule .....1897

*32.01.01 – Rules Governing the Credit Enhancement  
Program for School Districts*

**IDAPA 33 – REAL ESTATE COMMISSION**

*Docket No. 33-0101-2000F (Fee Rule)*

Notice of Omnibus Rulemaking – Adoption of Temporary Rule .....1901

*33.01.01 – Rules of the Idaho Real Estate Commission*

**IDAPA 34 – SECRETARY OF STATE**

*Docket No. 34-0000-2000F (Fee Rule)*

Notice of Omnibus Rulemaking – Adoption of Temporary Rule .....1907

*34.05.01 – Rules Governing Farm Products Central Filing System*

*34.05.02 – Rules Governing Liens in Crops for Seed or Liens in Crops for Farm Labor*

*34.05.03 – Requests for Information – Form UCC-4 – Fees*

*34.05.06 – Rules Governing Lien Filings Under the UCC*

**IDAPA 36 – IDAHO STATE BOARD OF TAX APPEALS**

*Docket No. 36-0101-2000F (Fee Rule)*

Notice of Omnibus Rulemaking – Adoption of Temporary Rule .....1944

*36.01.01 – Idaho Board of Tax Appeals Rules*

**IDAPA 37 – IDAHO DEPARTMENT OF WATER RESOURCES –  
IDAHO WATER RESOURCE BOARD**

*Docket No. 37-0000-2000F (Fee Rule)*

Notice of Omnibus Rulemaking – Adoption of Temporary Rule .....1961

*37.01.01 – Rules of Procedure of the Idaho Department of Water Resources*

*37.02.03 – Water Supply Bank Rules*

- 37.03.01 – *Adjudication Rules*
- 37.03.02 – *Beneficial Use Examination Rules*
- 37.03.03 – *Rules and Minimum Standards for the Construction and Use of Injection Wells*
- 37.03.04 – *Drilling for Geothermal Resources Rules*
- 37.03.05 – *Mine Tailings Impoundment Structures Rules*
- 37.03.06 – *Safety of Dams Rules*
- 37.03.07 – *Stream Channel Alteration Rules*
- 37.03.08 – *Water Appropriation Rules*
- 37.03.09 – *Well Construction Standards Rules*
- 37.03.10 – *Well Driller Licensing Rules*

**IDAPA 38 – DEPARTMENT OF ADMINISTRATION*****Docket No. 38-0000-2000F (Fee Rule)***

Notice of Omnibus Rulemaking – Adoption of Temporary Rule .....2168

38.04.04 – *Rules Governing Capitol Mall Parking*

**IDAPA 39 – IDAHO TRANSPORTATION DEPARTMENT*****Docket No. 39-0000-2000F (Fee Rule)***

Notice of Omnibus Rulemaking – Adoption of Temporary Rule .....2178

39.02.04 – *Rules Governing Manufacturer and New Vehicle Dealer Hearing Fees*

39.02.05 – *Rules Governing Issuance of Certificates of Title*

39.02.22 – *Rules Governing Registration and Permit Fee Administration*

39.02.26 – *Rules Governing Temporary Vehicle Clearance for Carriers*

39.02.41 – *Rules Governing Special Provisions Applicable to Fees for Services*

39.02.60 – *Rules Governing License Plate Provisions*

39.03.03 – *Rules Governing Special Permits – General Conditions and Requirements*

**IDAPA 41 – IDAHO PUBLIC HEALTH DISTRICTS  
(PANHANDLE HEALTH DISTRICT #1)*****Docket No. 41-0101-2000***

Notice of Omnibus Rulemaking – Adoption of Temporary Rule .....2225

41.01.01 – *Rules of Idaho Public Health District #1*

**IDAPA 42 – IDAHO WHEAT COMMISSION*****Docket No. 42-0101-2000F (Fee Rule)***

Notice of Omnibus Rulemaking – Adoption of Temporary Rule .....2254

42.01.01 – *Rules of the Idaho Wheat Commission*

**IDAPA 43 – IDAHO OILSEED COMMISSION*****Docket No. 43-0101-2000F (Fee Rule)***

Notice of Omnibus Rulemaking – Adoption of Temporary Rule .....2257

43.01.01 – *Rules Governing the Idaho Oilseed Commission*

**IDAPA 46 – IDAHO BOARD OF VETERINARY MEDICINE*****Docket No. 46-0101-2000F (Fee Rule)***

Notice of Omnibus Rulemaking – Adoption of Temporary Rule .....2260

46.01.01 – *Rules of the State of Idaho Board of Veterinary Medicine*

**IDAPA 48 – IDAHO GRAPE GROWERS AND WINE PRODUCERS COMMISSION**

*Docket No. 48-0101-2000F (Fee Rule)*

Notice of Omnibus Rulemaking – Adoption of Temporary Rule .....2286

*48.01.01 – Rules of the Idaho Grape Growers and Wine Producers Commission*

**IDAPA 51 – IDAHO BEEF COUNCIL**

*Docket No. 51-0101-2000F (Fee Rule)*

Notice of Omnibus Rulemaking – Adoption of Temporary Rule .....2288

*51.01.01 – Idaho Beef Council Rules*

**IDAPA 52 – IDAHO STATE LOTTERY COMMISSION**

*Docket No. 52-0103-2000F (Fee Rule)*

Notice of Omnibus Rulemaking – Adoption of Temporary Rule .....2291

*52.01.03 – Rules Governing Operations of the Idaho State Lottery*

**IDAPA 53 – IDAHO BARLEY COMMISSION**

*Docket No. 53-0101-2000F (Fee Rule)*

Notice of Omnibus Rulemaking – Adoption of Temporary Rule .....2341

*53.01.01 – Rules of the Idaho Barley Commission*

**IDAPA 57 – SEXUAL OFFENDER MANAGEMENT BOARD**

*Docket No. 57-0101-2000F (Fee Rule)*

Notice of Omnibus Rulemaking – Adoption of Temporary Rule .....2344

*57.01.01 – Rules of the Sexual Offender Management Board*

**IDAPA 58 – DEPARTMENT OF ENVIRONMENTAL QUALITY**

*Docket No. 58-0000-2000F (Fee Rule)*

Notice of Omnibus Rulemaking – Adoption of Temporary Rule .....2361

*58.01.01 – Rules for the Control of Air Pollution in Idaho*

*58.01.05 – Rules and Standards for Hazardous Waste*

*58.01.06 – Solid Waste Management Rules*

*58.01.07 – Rules Regulating Underground Storage Tank Systems*

*58.01.08 – Idaho Rules for Public Drinking Water Systems*

*58.01.09 – Rules Regulating Swine Facilities*

*58.01.11 – Ground Water Quality Rule*

*58.01.12 – Rules for Administration of Water Pollution Control Loans*

*58.01.13 – Rules for Ore Processing by Cyanidation*

*58.01.14 – Rules Governing Fees for Environmental Operating Permits, Licenses, and Inspection Services*

*58.01.18 – Idaho Land Remediation Rules*

*58.01.20 – Rules for Administration of Drinking Water Loan Program*

*58.01.25 – Rules Regulating the Idaho Pollutant Discharge Elimination System Program*

**IDAPA 60 – IDAHO STATE SOIL AND WATER CONSERVATION COMMISSION**

*Docket No. 60-0501-2000F (Fee Rule)*

Notice of Omnibus Rulemaking – Adoption of Temporary Rule .....2967

*60.05.01 – Rules of the Idaho State Soil And Water Conservation Commission*

**SECTIONS AFFECTED INDEX** ..... 2977

**LEGAL NOTICE - SUMMARY OF PROPOSED RULEMAKINGS** ..... 3131

**CUMULATIVE RULEMAKING INDEX  
OF IDAHO ADMINISTRATIVE RULES**..... 3132

**SUBJECT INDEX** ..... 3173

# PREFACE

The Idaho Administrative Bulletin is an electronic-only, online monthly publication of the Office of the Administrative Rules Coordinator, Department of Administration, that is published pursuant to Section 67-5203, Idaho Code. The Bulletin is a compilation of all official rulemaking notices, official rule text, executive orders of the Governor, and all legislative documents affecting rules that are statutorily required to be published in the Bulletin. It may also include other rules-related documents an agency may want to make public through the Bulletin.

State agencies are required to provide public notice of all rulemaking actions and must invite public input. This is done through negotiated rulemaking procedures or after proposed rulemaking has been initiated. The public receives notice that an agency has initiated proposed rulemaking procedures through the Idaho Administrative Bulletin and a legal notice (Public Notice of Intent) that publishes in authorized newspapers throughout the state. The legal notice provides reasonable opportunity for the public to participate when a proposed rule publishes in the Bulletin. Interested parties may submit written comments to the agency or request public hearings of the agency, if none have been scheduled. Such submissions or requests must be presented to the agency within the time and manner specified in the individual “Notice of Rulemaking - Proposed Rule” for each proposed rule that is published in the Bulletin.

Once the comment period closes, the agency considers fully all comments and information submitted regarding the proposed rule. Changes may be made to the proposed rule at this stage of the rulemaking, but changes must be based on comments received and must be a “logical outgrowth” of the proposed rule. The agency may now adopt and publish the pending rule. A pending rule is “pending” legislative review for final approval. The pending rule is the agency’s final version of the rulemaking that will be forwarded to the legislature for review and final approval. Comment periods and public hearings are not provided for when the agency adopts a temporary or pending rule.

## CITATION TO THE IDAHO ADMINISTRATIVE BULLETIN

The Bulletin is identified by the calendar year and issue number. For example, Bulletin **18-1** refers to the first Bulletin issued in calendar year **2018**; Bulletin **19-1** refers to the first Bulletin issued in calendar year **2019**. Volume numbers, which proceed from 1 to 12 in a given year, correspond to the months of publication, i.e.; Volume No. **19-1** refers to January 2019; Volume No. **19-2** refers to February 2019; and so forth. Example: The Bulletin published in January 2019 is cited as Volume **19-1**. The December 2019 Bulletin is cited as Volume **19-12**.

## RELATIONSHIP TO THE IDAHO ADMINISTRATIVE CODE

The **Idaho Administrative Code** is an electronic-only publication that is a compilation of all final and enforceable administrative rules of the state of Idaho that are of full force and effect. Any temporary rule that is adopted by an agency and is of force and effect is codified into the Administrative Code upon becoming effective. All pending rules that have been approved by the legislature during the legislative session, and any temporary rules that are extended, are codified into the Administrative Code upon becoming effective. Because proposed and pending rules are not enforceable, they are published in the Administrative Bulletin only and cannot be codified into the Administrative Code until approved as final.

To determine if a particular rule remains in effect or whether any amendments have been made to the rule, refer to the **Cumulative Rulemaking Index**. Link to it on the Administrative Rules homepage at [adminrules.idaho.gov](http://adminrules.idaho.gov).

## THE DIFFERENT RULES PUBLISHED IN THE ADMINISTRATIVE BULLETIN

Idaho’s administrative rulemaking process, governed by the Administrative Procedure Act, Title 67, Chapter 52, Idaho Code, comprises distinct rulemaking actions: negotiated, proposed, temporary, pending and final rulemaking. Not all rulemakings incorporate or require all of these actions. At a minimum, a rulemaking includes proposed, pending and final rulemaking. Many rules are adopted as temporary rules when they meet the required statutory criteria and agencies must, when feasible, engage in negotiated rulemaking at the beginning of the process to facilitate consensus building. In the majority of cases, the process begins with proposed rulemaking and ends with the final rulemaking. The following is a brief explanation of the rulemaking process and each type of rule.

## **1. NEGOTIATED RULEMAKING**

Negotiated rulemaking is a process in which all interested persons and the agency seek consensus on the content of a rule through dialogue. Agencies are required to conduct negotiated rulemaking whenever it is feasible to do so. The agency files a “Notice of Intent to Promulgate a Rule - Negotiated Rulemaking” for publication in the Administrative Bulletin inviting interested persons to contact the agency if interested in discussing the agency’s intentions regarding the rule changes. This process is intended to result in the formulation of a proposed rule and the initiation of regular rulemaking procedures. One result, however, may also be that regular (proposed) rulemaking is not initiated and no further action is taken by the agency.

## **2. PROPOSED RULEMAKING**

A proposed rulemaking is an action by an agency wherein the agency is proposing to amend or repeal an existing rule or to adopt a new rule. Prior to the adoption, amendment, or repeal of a rule, the agency must publish a “Notice of Rulemaking - Proposed Rule” in the Bulletin. This notice must include very specific information regarding the rulemaking including all relevant state or federal statutory authority occasioning the rulemaking, a non-technical description of the changes being made, any associated costs, guidance on how to participate through submission of written comments and requests for public hearings, and the text of the proposed rule in legislative format.

## **3. TEMPORARY RULEMAKING**

Temporary rules may be adopted only when the governor finds that it is necessary for:

- a) protection of the public health, safety, or welfare; or
- b) compliance with deadlines in amendments to governing law or federal programs; or
- c) conferring a benefit.

If a rulemaking meets one or more of these criteria, and with the Governor’s approval, the agency may adopt and make a temporary rule effective prior to receiving legislative authorization and without allowing for any public input. The law allows an agency to make a temporary rule immediately effective upon adoption. A temporary rule may not be made retroactively effective upon adoption but it may be made effective on a date other than the adoption date. The agency must specify what the effective date is in the rulemaking notice that publishes in the Bulletin. A temporary rule expires at the conclusion of the next succeeding regular legislative session unless the rule is extended by concurrent resolution, is replaced by a final rule, or expires under its own terms. Once adopted, a temporary rule must be published in the next available Bulletin.

## **4. PENDING RULEMAKING**

A pending rule is a rule that has been adopted by an agency under regular rulemaking procedures and remains subject to legislative review before it becomes a final, enforceable rule. When a pending rule is published in the Bulletin, the agency is required to include certain information in the “Notice of Rulemaking - Pending Rule.” This includes a statement giving the reasons for adopting the rule, a statement regarding when the rule becomes effective, a description of how it differs from the proposed rule, and identification of any fees being imposed or changed.

Agencies are required to republish the text of the pending rule when substantive changes have been made to the proposed rule. An agency may adopt a pending rule that varies in content from that which was originally proposed if the subject matter of the rule remains the same, the pending rule change is a logical outgrowth of the proposed rule, and the original notice was written so as to assure that members of the public were reasonably notified of the subject. It is not always necessary to republish all the text of the pending rule.

## **5. FINAL RULEMAKING**

A final rule is a rule that has been adopted by an agency under the regular rulemaking procedures and is of full force and effect.

## HOW TO USE THE IDAHO ADMINISTRATIVE BULLETIN

Rulemaking documents produced by state agencies and published in the **Idaho Administrative Bulletin** are organized by a numbering schematic. Each state agency has a two-digit identification code number known as the “**IDAPA**” number. (The “IDAPA” Codes are listed in the alphabetical/numerical index at the end of this Preface.) Within each agency there are divisions or departments to which a two-digit “TITLE” number is assigned. There are “CHAPTER” numbers assigned within the Title and the rule text is divided among major sections that are further subdivided into subsections. An example IDAPA number is as follows:

### **IDAPA 38.05.01.200.02.c.ii.**

“**IDAPA**” refers to Administrative Rules in general that are subject to the Administrative Procedures Act and are required by this act to be published in the Idaho Administrative Code and the Idaho Administrative Bulletin.

1. “**38.**” refers to the Idaho Department of Administration
- “**05.**” refers to Title **05**, which is the Department of Administration’s Division of Purchasing
- “**01.**” refers to Chapter **01** of Title 05, “Rules of the Division of Purchasing”
- “**200.**” refers to Major Section **200**, “Content of the Invitation to Bid”
- “**02.**” refers to Subsection 200.02.
- “**c.**” refers to Subsection 200.02.c.
- “**ii.**” refers to Subsection 200.02.c.ii.

## DOCKET NUMBERING SYSTEM

Internally, the Bulletin is organized sequentially using a rule docketing system. Each rulemaking that is filed with the Coordinator is assigned a “DOCKET NUMBER.” The docket number is a series of numbers separated by a hyphen “-”, (**38-0501-1401**). Rulemaking dockets are published sequentially by IDAPA number (the two-digit agency code) in the Bulletin. The following example is a breakdown of a typical rule docket number:

### **“DOCKET NO. 38-0501-1401”**

“**38-**” denotes the agency's **IDAPA** number; in this case the Department of Administration.

“**0501-**” refers to the **TITLE AND CHAPTER** numbers of the agency rule being promulgated; in this case the Division of Purchasing (TITLE **05**), Rules of the Division of Purchasing (Chapter **01**).

“**1401**” denotes the year and sequential order of the docket being published; in this case the numbers refer to the first rulemaking action published in **calendar year 2014**. A subsequent rulemaking on this same rule chapter in calendar year 2014 would be designated as “**1402**”. The docket number in this scenario would be 38-0501-**1402**.

Within each Docket, only the affected sections of chapters are printed. (See **Sections Affected Index** in each Bulletin for a listing of these.) The individual sections affected are printed in the Bulletin sequentially (e.g. Section “200” appears before Section “345” and so on). Whenever the sequence of the numbering is broken the following statement will appear:

**(BREAK IN CONTINUITY OF SECTIONS)**



**BULLETIN PUBLICATION SCHEDULE FOR CALENDAR YEAR 2019**

Vol. No.	Monthly Issue of Bulletin	ARRF Due to DFM	Closing Date for Agency Filing	Bulletin Publication Date	21-day Comment Period End Date
19-1	January 2019		<b>*November 30, 2018</b>	January 2, 2019	January 23, 2019
19-2	February 2019		January 4, 2019	February 6, 2019	February 27, 2019
19-3	March 2019		February 8, 2019	March 6, 2019	March 27, 2019
19-4	April 2019		March 8, 2019	April 3, 2019	April 24, 2019
19-5	May 2019	March 22, 2019	April 5, 2019	May 1, 2019	May 22, 2019
19-6	June 2019	April 19, 2019	May 3, 2019	June 5, 2019	June 26, 2019
19-7	July 2019	May 24, 2019	June 7, 2019	July 3, 2019	July 24, 2019
19-8	August 2019	June 21, 2019	July 5, 2019	August 7, 2019	August 28, 2019
19-9	September 2019	July 19, 2019	August 2, 2019	September 4, 2019	September 25, 2019
19-10	October 2019	August 16, 2019	<b>**August 30, 2019</b>	October 2, 2019	October 23, 2019
19-11	November 2019	September 20, 2019	October 4, 2019	November 6, 2019	November 27, 2019
19-12	December 2019	October 18, 2019	November 1, 2019	December 4, 2019	December 25, 2019

**BULLETIN PUBLICATION SCHEDULE FOR CALENDAR YEAR 2020**

Vol. No.	Monthly Issue of Bulletin	ARRF Due to DFM	Closing Date for Agency Filing	Publication Date	21-day Comment Period End Date
20-1	January 2020	November 15, 2019	<b>*November 29, 2019</b>	January 1, 2020	January 22, 2020
20-2	February 2020	December 20, 2019	January 3, 2020	February 5, 2020	February 26, 2020
20-3	March 2020	January 22, 2020	February 7, 2020	March 4, 2020	March 25, 2020
20-4	April 2020	February 21, 2020	March 6, 2020	April 1, 2020	April 22, 2020
20-5	May 2020	March 20, 2020	April 3, 2020	May 6, 2020	May 27, 2020
20-6	June 2020	April 24, 2020	May 1, 2020	June 3, 2020	June 24, 2020
20-7	July 2020	May 22, 2020	June 5, 2020	July 1, 2020	July 22, 2020
20-8	August 2020	June 19, 2020	July 3, 2020	August 5, 2020	August 26, 2020
20-9	September 2020	July 24, 2020	August 7, 2020	September 2, 2020	September 23, 2020
20-10	October 2020	August 21, 2020	<b>**August 28, 2020</b>	October 7, 2020	October 28, 2020
20-11	November 2020	September 18, 2020	October 2, 2020	November 4, 2020	November 25, 2020
20-12	December 2020	October 23, 2020	November 6, 2020	December 2, 2020	December 23, 2020

***\*Last day to submit a proposed rulemaking before moratorium begins and last day to submit a pending rule to be reviewed by the legislature.***

***\*\*Last day to submit a proposed rule in order to have the rulemaking completed and submitted for review by legislature.***

<b>ALPHABETICAL INDEX OF STATE AGENCIES AND CORRESPONDING IDAPA NUMBERS</b>	
<b>IDAPA 01</b>	<b>Accountancy</b> , Board of
<b>IDAPA 38</b>	<b>Administration</b> , Department of
<b>IDAPA 02</b>	<b>Agriculture</b> , Idaho Department of
<b>IDAPA 40</b>	<b>Arts</b> , Idaho Commission on the
<b>IDAPA 04</b>	<b>Attorney General</b> , Office of the
<b>IDAPA 53</b>	<b>Barley Commission</b> , Idaho
<b>IDAPA 51</b>	<b>Beef Council</b> , Idaho
<b>IDAPA 07</b>	<b>Building Safety</b> , Division of Electrical Board (07.01) Plumbing Board (07.02) Building Codes & Manufactured Homes (07.03) Building Code Advisory Board (07.03.01) Public Works Contractors License Board (07.05) Uniform School Building Safety (07.06) HVAC Board (07.07)
<b>IDAPA 55</b>	<b>Career Technical Education</b> , Division of
<b>IDAPA 28</b>	<b>Commerce</b> , Idaho Department of
<b>IDAPA 06</b>	<b>Correction</b> , Board of
<b>IDAPA 19</b>	<b>Dentistry</b> , Board of
<b>IDAPA 08</b>	<b>Education</b> , State Board of and State Department of
<b>IDAPA 10</b>	<b>Engineers and Land Surveyors</b> , Board of Professional
<b>IDAPA 58</b>	<b>Environmental Quality</b> , Department of
<b>IDAPA 12</b>	<b>Finance</b> , Department of
<b>IDAPA 13</b>	<b>Fish and Game</b> , Department of
<b>IDAPA 15</b>	<b>Governor</b> , Office of the Idaho Commission on Aging (15.01) Idaho Commission for the Blind and Visually Impaired (15.02) Idaho Forest Products Commission (15.03) Division of Human Resources and Personnel Commission 15.04) Idaho Liquor Division (15.10) Idaho Military Division (Division of Homeland Security) (15.06)
<b>IDAPA 48</b>	<b>Grape Growers and Wine Producers Commission</b> , Idaho
<b>IDAPA 16</b>	<b>Health and Welfare</b> , Department of

<b>ALPHABETICAL INDEX OF STATE AGENCIES AND CORRESPONDING IDAPA NUMBERS</b>	
<b>IDAPA 41</b>	<b>Health Districts, Public</b>
<b>IDAPA 45</b>	<b>Human Rights Commission</b>
<b>IDAPA 17</b>	<b>Industrial Commission</b>
<b>IDAPA 18</b>	<b>Insurance, Department of</b>
<b>IDAPA 05</b>	<b>Juvenile Corrections, Department of</b>
<b>IDAPA 09</b>	<b>Labor, Idaho Department of</b>
<b>IDAPA 20</b>	<b>Lands, Department of</b>
<b>IDAPA 30</b>	<b>Libraries, Commission for</b>
<b>IDAPA 52</b>	<b>Lottery Commission, Idaho State</b>
<b>IDAPA 22</b>	<b>Medicine, Board of</b>
<b>IDAPA 23</b>	<b>Nursing, Board of</b>
<b>IDAPA 43</b>	<b>Oilseed Commission, Idaho</b>
<b>IDAPA 24</b>	<b>Occupational Licenses, Board of (24.20)</b> Acupuncture, Board of (24.17) Athletic Commission (24.02) Architectural Examiners, Board of (24.01) Barber and Cosmetology Services Licensing Board (24.28) Chiropractic Physicians, Board of (24.03) Contractors Board, Idaho State (24.21) Counselors and Marriage and Family Therapists, Licensing Board of Professional (24.15) Dentistry, Board of (24.16) Drinking Water and Wastewater Professionals, Board of (24.05) Driving Businesses Licensure Board, Idaho (24.25) Genetic Counselors Licensing Board (24.24) Geologist, Board of Registration (24.04) Landscape Architects, Board of (24.07) Liquefied Petroleum Gas Safety Board (24.22) Massage Therapy, Board of (24.27) Midwifery, Board of (24.26) Morticians, Board of (24.08) Nursing Home Administrators, Board of Examiners of (24.09) Occupational Therapy Licensure Board (24.06) Optometry, Board of (24.10) Physical Therapy Licensure Board (24.13) Podiatry, Board of (24.11) Psychologist Examiners, Board of (24.12) Real Estate Appraiser Board (24.18) Residential Care Facility Administrators, Board of Examiners of (24.19) Shorthand Reporters, Board of Certified (24.29) Social Work Examiners, Board of (24.14) Speech, Hearing and Communication Services Licensure Board (24.23)
<b>IDAPA 25</b>	<b>Outfitters and Guides Licensing Board</b>

<b>ALPHABETICAL INDEX OF STATE AGENCIES AND CORRESPONDING IDAPA NUMBERS</b>	
<b>IDAPA 50</b>	<b>Pardons and Parole</b> , Commission for
<b>IDAPA 26</b>	<b>Parks and Recreation</b> , Department of
<b>IDAPA 27</b>	<b>Pharmacy</b> , Board of
<b>IDAPA 11</b>	<b>Police</b> , Idaho State
<b>IDAPA 29</b>	<b>Potato Commission</b> , Idaho
<b>IDAPA 61</b>	<b>Public Defense Commission</b> , State
<b>IDAPA 59</b>	<b>Public Employee Retirement System of Idaho (PERSI)</b>
<b>IDAPA 31</b>	<b>Public Utilities Commission</b>
<b>IDAPA 56</b>	<b>Rangeland Resources Commission</b> , Idaho
<b>IDAPA 33</b>	<b>Real Estate Commission</b> , Idaho
<b>IDAPA 34</b>	<b>Secretary of State</b> , Office of the
<b>IDAPA 57</b>	<b>Sexual Offender Management Board</b>
<b>IDAPA 60</b>	<b>Soil and Water Conservation Commission</b> , Idaho State
<b>IDAPA 36</b>	<b>Tax Appeals</b> , Board of
<b>IDAPA 35</b>	<b>Tax Commission</b> , State
<b>IDAPA 39</b>	<b>Transportation Department</b> , Idaho
<b>IDAPA 54</b>	<b>Treasurer</b> , Office of the State
<b>IDAPA 21</b>	<b>Veterans Services</b> , Division of
<b>IDAPA 46</b>	<b>Veterinary Medical Examiners</b> , Board of
<b>IDAPA 47</b>	<b>Vocational Rehabilitation</b> , Division of
<b>IDAPA 37</b>	<b>Water Resources</b> , Department of
<b>IDAPA 42</b>	<b>Wheat Commission</b>

# IDAPA 01 – BOARD OF ACCOUNTANCY

## DOCKET NO. 01-0101-2000F (FEE RULE)

### NOTICE OF OMNIBUS RULEMAKING – ADOPTION OF TEMPORARY RULE

**EFFECTIVE DATE:** The effective date of the temporary rule being adopted through this omnibus rulemaking is the adjournment date of the second regular session of the 65th Idaho State Legislature - March 20, 2020.

**AUTHORITY:** In compliance with Sections 67-5226, Idaho Code, notice is hereby given this agency has adopted a temporary rule. The action is authorized pursuant to Section 54-204(1), Idaho Code.

**DESCRIPTIVE SUMMARY:** The following is the required finding and concise statement of its supporting reasons for adopting the temporary rule:

This temporary rulemaking adopts the following chapter under IDAPA 01:

#### **IDAPA 01**

- 01.01.01, *Idaho Accountancy Rules* (Chapter 2, Title 54, Idaho Code).

**TEMPORARY RULE JUSTIFICATION:** Pursuant to Sections 67-5226(1) and 67-5226(2), Idaho Code, the Governor has found that temporary adoption of these rules is appropriate for the following reasons:

These temporary rules are necessary to protect the public health, safety, and welfare of the citizens of Idaho and confer a benefit on its citizens. The temporary rules implement the duly enacted laws of the state of Idaho, provide citizens with the detailed rules and standards for complying with those laws, and assist in the orderly execution and enforcement of those laws. The expiration of these temporary rules without due consideration and processes would undermine the public health, safety, and welfare of the citizens of Idaho and deprive them of the benefit intended by these rules.

**FEE SUMMARY:** Pursuant to Section 67-5226(2), the Governor has found that the fees or charges being imposed or increased are justified and necessary to avoid immediate danger and the fees are described herein:

The fees or charges, authorized in Section 54-212, Idaho Code, are part of the agency's 2021 budget that relies upon the existence of these fees or charges to meet the state's obligations and provide necessary state services. Failing to reauthorize these temporary rules would create immediate danger to the state budget, immediate danger to necessary state functions and services, and immediate danger of a violation of Idaho's constitutional requirement that it balance its budget.

The following is a specific description of the fees or charges: This rulemaking does not impose a fee or charge, or increase a fee or charge, beyond what was previously approved and codified in the prior rules. These fees cover Exam, Licensure and Firm Registration; Administrative Services such as the Interstate Exchange of Information to other jurisdictions and wall certificates for licensees; and Late Fees regarding licensing, CPE filing and firm registration.

**ASSISTANCE ON TECHNICAL QUESTIONS:** For assistance on technical questions concerning the temporary rules, contact Kent A. Absec, Executive Director at (208) 334-2490.

DATED this 13th day of February 2020.

Kent A. Absec, Executive Director  
Idaho State Board of Accountancy  
3101 W. Main St., Suite 210  
P.O. Box 83720  
Boise, Idaho 83720-0002  
Phone: (208) 334-2490  
Email: [kent.absec@isba.idaho.gov](mailto:kent.absec@isba.idaho.gov)

# IDAPA 01 – IDAHO BOARD OF ACCOUNTANCY

## 01.01.01 – IDAHO ACCOUNTANCY RULES

### 000. LEGAL AUTHORITY (RULE 000).

This chapter is adopted under the legal authority of Title 54, Chapter 2, Idaho Code. (3-20-20)T

### 001. TITLE AND SCOPE (RULE 001).

01. **Title.** These rules are titled IDAPA 01.01.01, “Idaho Accountancy Rules.” (3-20-20)T

02. **Scope.** These rules govern the administration of the certified public accountant examination, the issuance and renewal of licenses to practice as certified or licensed public accountants, the registration of firms, the regulation of individuals granted practice privileges, and the limitation of non-licensees. (3-20-20)T

### 002. -- 003. (RESERVED)

### 004. INCORPORATION BY REFERENCE (RULE 004).

The following documents are hereby incorporated by reference into IDAPA 01.01.01 and can be obtained at the Board office. Licensees are required to comply with the following standards when applicable. (3-20-20)T

01. **AICPA Standards.** The AICPA Professional Standards as applicable under the circumstances and at the time of the services, except as superseded by Section 54-206(8), Idaho Code. (3-20-20)T

02. **CPE Standards.** 2016 Statements on Standards for Continuing Professional Education Programs jointly approved by NASBA and AICPA. (3-20-20)T

03. **PCAOB Standards.** The Standards issued by the Public Company Accountability Oversight Board, as applicable under the circumstances and at the time of the services. (3-20-20)T

### 005. -- 009. (RESERVED)

### 010. DEFINITIONS (RULE 010).

The Idaho State Board of Accountancy adopts the definitions set forth in Section 54-206, Idaho Code. In addition, as used in this chapter: (3-20-20)T

01. **Administering Organization.** An entity that has met, and at all relevant times continues to meet, the standards specified by the Board for administering peer reviews. (3-20-20)T

02. **Board.** The Board or its designated representative. (3-20-20)T

03. **Candidate.** Applicants approved to sit for the CPA Examination. (3-20-20)T

04. **CPA Examination.** Uniform Certified Public Accountant Examination. (3-20-20)T

05. **CPE.** Continuing Professional Education. (3-20-20)T

06. **Ethics CPE.** Programs in ethics include topics such as ethical reasoning, state-specific statutes and rules, and standards of professional conduct, including those of other applicable regulatory bodies. (3-20-20)T

07. **NASBA.** The National Association of State Boards of Accountancy. (3-20-20)T

08. **National Candidate Database.** The National Association of State Boards of Accountancy database of all CPA Examination candidates. (3-20-20)T

09. **State-Specific Ethics for Idaho.** A minimum two-hour (2) CPE course on Idaho Accountancy Act and Rules, which is exempt from the Statements on Standards for CPE. (3-20-20)T

10. **Year of Review.** The calendar year during which a peer review is conducted. (3-20-20)T

11. **Year Under Review.** The twelve-month (12) period that is reviewed. (3-20-20)T

**011. -- 017. (RESERVED)**

**018. COMPLIANCE WITH THESE RULES (RULE 018).**

A licensee of the Board or an individual granted practice privileges is subject to the rules of the Board when rendering professional services. (3-20-20)T

**019. COMPUTATION OF TIME (RULE 019).**

The time in which any act provided by law, rule, order, or notice is to be done is computed by excluding the first day; and including the last day unless the last day is a Saturday, Sunday, or legal holiday and then it is also excluded. (3-20-20)T

**020. GOOD MORAL CHARACTER (RULE 020).**

**01. Demonstrating Good Moral Character.** Applicants have the burden of demonstrating good moral character as defined by Section 54-206(11), Idaho Code, in the manner specified by the Board in its application forms. (3-20-20)T

**02. Evidence.** Prima facie evidence of a lack of good moral character includes, but is not limited to: (3-20-20)T

**a.** Any deferred prosecution agreement involving an admission of wrongdoing, or any criminal conviction, including conviction following a guilty plea or plea of nolo contendere, for any felony or any crime, an essential element of which is fraud, dishonesty, or deceit, or any other crime that evidences an unfitness of the applicant to provide professional services in a competent manner and consistent with the public safety; (3-20-20)T

**b.** Revocation, suspension or the lapsing in lieu of discipline of any license or other authority to practice by or before any state, federal, foreign or other licensing or regulatory authority; or (3-20-20)T

**c.** Any act that would be grounds for revocation or suspension of a license if committed by a licensee of the Board. (3-20-20)T

**03. Rehabilitation.** The applicant may offer, and the Board may consider the following factors in determining whether the applicant's moral character has been rehabilitated as of the date the applicant is seeking licensure. These factors include, but are not limited to: (3-20-20)T

**a.** The applicant's completion of criminal probation, restitution, community service, military or other public service; (3-20-20)T

**b.** The passage of time without the applicant's commission of further crime or act demonstrating a lack of good moral character; and (3-20-20)T

**c.** The entry of an order by any state or federal court expunging any conviction, reducing a conviction from a felony to misdemeanor, or commuting, suspending, or withholding any judgment as provided by law. (3-20-20)T

**021. NOTIFICATION OF CHANGE OF ADDRESS, FELONY CHARGES, OR ACTIONS TAKEN (RULE 021).**

Per Section 54-211(3), Idaho Code, within thirty (30) days after its occurrence, a licensee or candidate will notify the Board, in writing, of: (3-20-20)T

**01. Address Change.** A change in the business address, residence address, or business connection, employer, or principal place of business; (3-20-20)T

**02. Felony Charge.** Any felony charges, or; (3-20-20)T

**03. Actions Taken.** The issuance, denial, disciplinary action, restriction, revocation, or suspension of a certificate, license, or permit by another state or by any federal agency. (3-20-20)T

**022. -- 099. (RESERVED)**

**100. CPA EXAMINATION (RULE 100).**

An applicant must pass the CPA Examination before applying for a CPA license. The CPA Examination is graded by the American Institute of Certified Public Accountants and subject to review and acceptance by the Board.

(3-20-20)T

**101. EXAM APPLICATIONS (RULE 101).**

Applications to take the CPA Examination are to be made as prescribed in accordance with Section 54-208, Idaho Code.

(3-20-20)T

**102. AUTHORIZATION TO TEST AND NOTIFICATION TO SCHEDULE (RULE 102).**

The Board will forward notification of eligibility in the form of an Authorization to Test (ATT) to NASBA. The ATT is issued for the test section(s) for which the candidate applied. Candidates must pay the fees charged by the AICPA, NASBA, and the test delivery service provider directly to NASBA. The ATT will expire ninety (90) days after it is issued if the candidate has not paid the appropriate fees. Eligible candidates will receive a Notice to Schedule (NTS) for the CPA Examination. The NTS is valid for six (6) months from the date issued. A candidate's ATT lasts as long as the NTS is valid, or until the candidate tests, whichever occurs first.

(3-20-20)T

**103. FAILURE TO APPEAR (RULE 103).**

A candidate who fails to appear for the CPA Examination forfeits all fees paid.

(3-20-20)T

**104. CPA EXAM EDUCATIONAL QUALIFICATIONS (RULE 104).**

A candidate for the CPA examination provides evidence of successful completion of a baccalaureate degree or its equivalent to include thirty (30) or more semester hours (or forty-five (45) or more quarter hours) in business administration subjects of which at least twenty (20) semester hours (or at least thirty (30) quarter hours) are in accounting subjects.

(3-20-20)T

**105. TESTING PERIOD AND CREDIT (RULE 105).**

**01. CPA Examination Credit.** Candidates are to pass all four (4) test sections of the CPA Examination with a grade of seventy-five (75) or higher within an eighteen-month period which begins on the date that the first test section is passed. Candidates who do not pass all four (4) sections of the CPA Examination within the eighteen-month period lose credit for any test section(s) passed outside the eighteen-month period and that test section(s) is to be retaken.

(3-20-20)T

**02. Extending the Term of Credit.** The Board may extend the term of credit validity upon demonstration by the candidate that the credit was lost by reason of circumstances beyond the candidate's control.

(3-20-20)T

**03. Transfer of Credit.** An applicant may submit the results of any test section of the CPA Examination taken by the applicant in any other state having standards at least equivalent to those of this state, and these results may be adopted by the Board in lieu of examination in this state on the same test section and in accordance with the provisions of Section 54-210, Idaho Code, and these rules.

(3-20-20)T

**106. CHEATING (RULE 106).**

**01. Actions.** Cheating by an applicant in applying for the CPA Examination or by a candidate in taking the CPA Examination will cause any grade otherwise earned on any part of the CPA Examination to be invalidated. Cheating may warrant summary expulsion from the examination room and disqualification from taking the CPA Examination for a specified period of time.

(3-20-20)T

**02. Hearings.** If the Board believes that it has evidence that a candidate has cheated on the examination or a candidate has been expelled from the examination, the candidate will be provided notice and opportunity for hearing. In such hearings, the Board decides:

(3-20-20)T



- a. Whether or not there was cheating, and if so what remedy should be applied; (3-20-20)T
- b. Whether the candidate will be given credit for any portion of the examination completed in that session; and (3-20-20)T
- c. Whether the candidate will be barred from taking the examination in future sittings, and if so, for how many sittings. (3-20-20)T

**03. Notice.** If a candidate is refused credit for any test section of an examination taken, disqualified from taking any test section, or barred from taking the examination in the future, the Board will provide information about findings and actions taken to the national candidate database and the board of any other state to which the candidate may apply for the examination. (3-20-20)T

**107. SECURITY AND IRREGULARITIES (RULE 107).**

Notwithstanding any other provisions under these rules, the Board may postpone scheduled examinations, the release of grades, or the issuance of certificates due to a breach of security, unauthorized acquisition or disclosure of the contents of an examination, suspected or actual negligence, errors, omissions, or irregularities in conducting an examination, or for any other reasonable cause or unforeseen circumstance. (3-20-20)T

**108. -- 199. (RESERVED)**

**200. INITIAL CERTIFIED PUBLIC ACCOUNTANT LICENSURE (RULE 200).**

Applications for initial licensure are to be made as prescribed in Section 54-207, Idaho Code, and are to comply with the following: (3-20-20)T

**01. Education.** (3-20-20)T

a. Applicants for licensure are to meet the provisions of Section 54-207(2), Idaho Code. An applicant for licensure who was accepted for the May 2000 CPA Examination or prior examination is exempt from additional educational requirements. (3-20-20)T

b. The Board will recognize: (3-20-20)T

i. Any college or university accredited by the Northwest Commission on Colleges or Universities or any other regional accrediting association having equivalent standards; (3-20-20)T

ii. Any independent senior college in Idaho certified by the State Department of Education for teacher training; and (3-20-20)T

iii. Accounting and business programs accredited by the Association to Advance Collegiate Schools of Business (AACSB) or any other accrediting agency having equivalent standards. (3-20-20)T

c. An applicant is deemed to have met the education requirement if, as part of the one hundred fifty (150) semester hours of education, the applicant has met any one (1) of the following conditions: (3-20-20)T

i. Earned a graduate degree with a concentration in accounting from a program that is accredited in accounting by an accrediting agency approved by the Board; (3-20-20)T

ii. Earned a graduate degree from a program that is accredited in business by an accrediting agency approved by the Board. Completion of at least twenty-four (24) semester hours in accounting at the undergraduate or fifteen (15) semester hours at the graduate level, or an equivalent combination thereof, including coverage of, but not necessarily separate courses in, the subjects of financial accounting, auditing, taxation, and management accounting; (3-20-20)T

iii. Earned a baccalaureate degree at an institution approved by the Board or from a program that is accredited in business by an accrediting agency approved by the Board. Completion of at least twenty-four (24) semester hours in business (other than accounting courses) and twenty-four (24) semester hours in accounting at the

undergraduate or graduate level including coverage of, but not necessarily separate courses in, the subjects of financial accounting, auditing, taxation, and management accounting. (3-20-20)T

**02. Experience.** (3-20-20)T

**a.** An applicant is to provide evidence of one (1) year of experience as prescribed in Section 54-209, Idaho Code, and these rules. Experience consists of full or part time employment that extends over a period of no less than twelve (12) months and no more than thirty-six (36) months with no fewer than two thousand (2,000) hours earned within the ten (10) year period immediately preceding the latest application for licensure. (3-20-20)T

**b.** An applicant completes and submits the Verification of Employment and Experience Evaluation form(s). An applicant may be called to appear before the Board to supplement or verify evidence of experience. (3-20-20)T

**c.** A licensee verifying experience will maintain supporting documentation of the applicant's experience until thirty (30) days after the applicant is granted a license. The licensee will permit the Board to inspect the supporting documentation prior to issuing a license to the applicant. Any licensee who has been requested by an applicant to submit to the Board evidence of the applicant's experience and has refused to do so will, upon request by the Board, explain in writing or in person the basis for such refusal. (3-20-20)T

**d.** A licensee who is responsible for supervising attest services, and signs or authorizes someone to sign the accountant's report on the financial statement on behalf of the firm, is to meet the experience requirement set out in the AICPA statements on quality control standards. (3-20-20)T

**03. Examination on Code of Professional Conduct.** Prior to licensure, applicants successfully complete a course in professional ethics that is acceptable to the Board. (3-20-20)T

**04. Initial License Application Fee.** As prescribed in Rule 600. (3-20-20)T

**201. ANNUAL LICENSE RENEWAL AND LATE FEE (RULE 201).**

**01. Renewal.** Licenses expire on June 30 of each year. (3-20-20)T

**02. Non-Renewal.** Individuals choosing not to renew their license are to notify the Board, on the renewal form by the expiration date. Individuals with lapsed licenses may not publicly display their wall certificates, use the title CPA or LPA, or provide services that are reserved to licensees. (3-20-20)T

**03. Late Fee.** Licenses renewed after July 1, but before August 1, are subject to the late renewal fee as prescribed in Rule 600. After August 1, any license not renewed is deemed lapsed and is subject to reinstatement pursuant to Section 54-211, Idaho Code. (3-20-20)T

**202. PRACTICE PRIVILEGES (RULE 202).**

**01. Substantially Equivalent.** As prescribed in Section 54-227, Idaho Code, and these rules. (3-20-20)T

**02. Internet Disclosures.** An individual entering into an engagement to provide professional services via a web site, pursuant to Idaho practice privileges, is to disclose on their web site: (3-20-20)T

**a.** Their principal state of licensure, license number, and address. (3-20-20)T

**b.** A means for regulators and the public to contact a responsible licensee in charge at the firm regarding complaints, questions, or regulatory compliance. (3-20-20)T

**203. RECIPROCAL LICENSURE (RULE 203).**

If the practice privilege standard set out in Section 54-227, Idaho Code, is not applicable, the Board will issue a license to an applicant provided that the applicant pays the application and licensure fees prescribed in Rule 600 and

meets one of the following:

(3-20-20)T

**01. Interstate Reciprocity.** The requirements for a reciprocal license under Section 54-210(2), Idaho Code. Notwithstanding anything to the contrary, an individual whose principal place of business is not in this state and who holds a valid license or permit with unrestricted practice privileges as a Certified Public Accountant from any state that the NASBA National Qualification Appraisal Service has verified to be in substantial equivalence with the CPA licensure requirements of the AICPA/NASBA Uniform Accountancy Act is presumed to have the qualifications substantially equivalent to this state's requirements. (3-20-20)T

**02. International Reciprocity.** The requirements for foreign reciprocal licensure under Section 54-210(5), Idaho Code, provided that the Board relies on the International Qualifications Appraisal Board for evaluation of foreign credential equivalency. Such licensees are to report any investigations undertaken, or sanctions imposed, by a foreign credentialing body against the licensee's foreign credential. The Board will participate in joint investigations with foreign credentialing bodies and rely on evidence supplied by such bodies in disciplinary hearings. (3-20-20)T

**204. -- 299. (RESERVED)**

**300. APPLICABILITY OF RULES (RULE 300).**

**01. Reliance.** A certified public accountant or licensed public accountant is to hold the affairs of his clients in strict confidence, observe the standards incorporated by reference, promote sound and informative financial reporting, and maintain high standards of personal conduct. (3-20-20)T

**02. Acceptance of Licensure.** Acceptance of practice privileges or licensure as a certified public accountant or licensed public accountant establishes an affirmative obligation by said individual to be diligent in the performance of professional services, and to be fair and honest in relations with clients, fellow practitioners and the public. (3-20-20)T

**03. Rules.** These rules do not comprise all acts that may be considered incompatible with the obligations and responsibilities imposed by professional status or discreditable or harmful even though not specifically mentioned or described in the rules. The Board may revoke, suspend, refuse to renew, administratively penalize, reprimand, restrict, or place on probation a licensee, individual granted practice privileges or other individual. The action will not be taken until the individual has been given notice and opportunity for hearing. (3-20-20)T

**04. Applicability.** These rules apply to all professional services offered or performed by licensees or individuals granted practice privileges, including tax and management advisory services. (3-20-20)T

**05. Responsibility.** A licensee is responsible for ensuring all persons associated with the licensee in the rendering of professional services, who are either under the licensee's supervision or who are the licensee's partners or shareholders in the practice comply with these rules. A licensee may not permit others to carry out, on his behalf, either with or without compensation, acts that, if carried out by the licensee, would place the licensee in violation of any laws. (3-20-20)T

**06. Interpretation of Rules.** In the interpretation and enforcement of these rules, the Board gives consideration, but not necessarily dispositive weight, to relevant interpretations, rulings and opinions issued by other states, and by appropriately authorized standard setting bodies. (3-20-20)T

**07. Investigative Committee.** The Board may appoint an investigative committee of not less than three (3) members consisting of active licensees in good standing. The committee duties are to direct the review and investigation of complaints of violations of the Idaho Accountancy Act and Rules, and to provide reports to the Board. (3-20-20)T

**301. COMMISSIONS AND CONTINGENT FEES (RULE 301).**

**01. Acceptance.** Licensees may accept commissions or contingent fees subject to Section 54-218,

Idaho Code, the AICPA Code of Professional Conduct, and these rules. (3-20-20)T

**02. Disclosures.** Any licensee who directly or indirectly accepts or agrees to accept such form of compensation is to disclose the terms of such compensation to the client. The disclosure is to be: (3-20-20)T

**a.** In writing, clear, and conspicuous; and state the amount of the compensation or basis on which it will be computed; (3-20-20)T

**b.** Made at or prior to the time of the recommendation or referral of the product or service for which the commission is paid, prior to the client retaining the licensee to whom the client has been referred for which a referral fee is paid, and prior to the time the licensee undertakes representation of or performance of the service upon which a contingent fee will be charged. (3-20-20)T

**302. CONFIDENTIAL CLIENT INFORMATION (RULE 302).**

**01. Confidentiality.** A licensee is to protect and not disclose confidential client information obtained in the course of performing professional services, unless the licensee has obtained the specific consent of the client, or of such client's heirs, successors or personal representatives, or others legally authorized to give such consent on behalf of the client. (3-20-20)T

**02. Exemptions.** Nothing in these rules is construed as prohibiting the disclosure of information that is required to be disclosed: (3-20-20)T

**a.** In reporting on the examination of financial statements; (3-20-20)T

**b.** In investigations by the Board or other accounting regulatory agency; (3-20-20)T

**c.** In ethical investigations conducted in private professional organizations; (3-20-20)T

**d.** In the course of peer reviews; (3-20-20)T

**e.** To other persons active in the organization performing services for that client on a need to know basis; (3-20-20)T

**f.** To persons in the entity who need this information for the sole purpose of assuring quality control; or (3-20-20)T

**g.** By any act of law. (3-20-20)T

**03. Disciplinary Proceedings.** Members of the Board and investigative officers may not disclose any confidential client information that comes to their attention from licensees in disciplinary proceedings or otherwise, except that they may furnish such information to an investigative or disciplinary body. (3-20-20)T

**303. RECORDS (RULE 303).**

A licensee is to furnish to his client or former client, upon request made within a reasonable time after original issuance of the document in question all client records, as that term is defined in the AICPA Code of Professional Conduct belonging to, or obtained from or on behalf of, the client that the licensee removed from the client's premises or received for the client's account. The licensee may make and retain copies of such documents when they form the basis for work performed by him. Client records are to be returned upon request by the client, whether the engagement has been terminated or the licensee has been paid for services rendered. (3-20-20)T

**01. Tax Return, Other Reports, Working Papers Including Audit Documentation Made Part of Client's Records.** A licensee who has been paid for the services rendered is to furnish to his client or former client, upon request, within a reasonable time after original issuance of the document in question the following records: (3-20-20)T

**a.** A copy of a tax return of a client. (3-20-20)T

b. A copy of any report, or other document, issued by the licensee to or for the client; and (3-20-20)T

c. A copy of the licensee's working papers, to the extent that such working papers include records that would ordinarily constitute part of the client's books and records and are not otherwise available to the client. This would include adjusting, closing, combining, or consolidating journal entries; information normally contained in books of original entry and general ledgers or subsidiary ledgers; and tax and depreciation carry forward information. The information should be provided in the medium in which it is requested, provided it exists in that medium. The licensee does not have to convert information that is not in electronic format to an electronic format. (3-20-20)T

**02. Working Papers Including Audit Documentation Not a Part of the Client's Records.** A licensee's working papers that do not become part of a client's records, which may include analyses and schedules prepared by the client at the request of the licensee, are the licensee's property, not client records, and need not be made available under any circumstances. (3-20-20)T

**03. Charges.** A licensee does not have to furnish records to a client or a former client more than once. A licensee may charge the client or former client actual costs for time and photocopying charges on subsequent requests. (3-20-20)T

### **304. FIRM NAMES (RULE 304).**

**01. General.** A licensee may only provide professional services under a firm name that is not misleading as to the description of the legal form of the firm, or as to the person or persons who are owner(s), partners, officers, shareholders or members of the firm. Names of one (1) or more past owners, partners, shareholders or members who were licensed may be included in the firm name. A partner surviving the death or withdrawal of all other partners may continue to practice under a partnership name for up to two (2) years after becoming a sole practitioner. (3-20-20)T

**02. Title.** A firm may designate itself as "Certified Public Accountant(s)," "Licensed Public Accountant(s)" or "Public Accountant(s)" when a majority of its partners, shareholders, or members are actively licensed certified public accountants or licensed public accountants under the provisions of the Idaho Accountancy Act and Rules. The firm name may not include the name of a non-licensee owner, except as allowed in Subsection 304.01 if the title "CPA(s)" or "LPA(s)" is included in the firm name. The firm name may not include the name of a person who is not a CPA or LPA if the title "Public Accountant(s)" is included in the firm name. (3-20-20)T

### **305. COMMUNICATIONS (RULE 305).**

**01. Response.** Unless otherwise specified, a licensee is to respond within thirty (30) calendar days of the mailing to any communication in which the Board requests a response. (3-20-20)T

**02. Complaints.** Upon the receipt or filing of a complaint against an individual over whom the Board has regulatory authority, the Board may transmit a copy of such complaint to the individual. Upon receipt of a transmitted complaint, the individual is to file a written answer to the complaint within twenty (20) calendar days of receipt, unless otherwise granted an extension of time by the Board. (3-20-20)T

### **306. -- 399. (RESERVED)**

### **400. CPE BASIC REQUIREMENTS (RULE 400).**

Demonstrate participation in a program of learning that meets the requirements as set forth in the Statement of Standards as referenced in Rule 004. CPE courses approved on NASBA's National Registry of CPE Sponsors, the AICPA, and state societies are deemed to meet the CPE requirements of this state. Responsibility for documenting the acceptability of the program and the validity of the credits rests with the licensee. (3-20-20)T

**01. Renewal.** Licensees seeking active license renewal are to demonstrate that during the two (2) calendar years immediately preceding the date the reporting form is due that no less than eighty (80) hours of CPE are recorded, of which at least four (4) hours are ethics with a minimum of thirty (30) hours in any one (1) calendar year, and a maximum of fifty (50) hours recorded in any one (1) calendar year. (3-20-20)T

**02. New and Reciprocal.** Completion of at least a two-hour (2) course on Idaho state-specific ethics during the calendar year that the license is issued. During the second calendar year of licensure, a minimum of thirty (30) hours is to be completed which may include an ethics component based on the prior year submission. (3-20-20)T

**401. CPE REPORTING, CONTROLS, AND LATE FEES (RULE 405).**

**01. Reporting.** No later than January 31 of each year, individuals renewing their licenses are to provide a signed reporting form either: (3-20-20)T

**a.** Disclosing the information pertaining to the educational programs submitted for qualification as prescribed in the CPE Standards; or (3-20-20)T

**b.** Applying for exception, extension, or exemption. (3-20-20)T

**02. CPE Late Fees.** A License will not be issued until the licensee files the reporting form with supporting documentation, pays the late filing as prescribed in Rule 600, license renewal fee and any other penalty the Board may impose. (3-20-20)T

**402. CPE EXCEPTIONS, EXTENSIONS, AND EXEMPTIONS (RULE 402).**

**01. Exceptions and Extensions.** The Board may make exceptions to the CPE requirements, or grant extensions of time for completion of the CPE requirements, where reasons of health as certified by a medical doctor prevent compliance by the licensee, or other good cause exists. (3-20-20)T

**a.** Licensees asking for exceptions or extensions under these conditions apply on the reporting form for the year in which the extension or exemption is sought, and within the time period set for CPE reporting, stating the reasons for asking for such exception or extension. Any request not filed timely is subject to the late fee prescribed in Rule 600, in addition to any administrative action. (3-20-20)T

**b.** A penalty of no more than fifty percent (50%) of the hours a licensee is short in meeting the calendar year CPE requirement may be assessed for extensions. In such cases, the licensee will be required to complete the CPE hours and any assessed penalty no later than April 30. The penalty for non-compliance with ethics CPE is to obtain the mandatory hours of ethics CPE plus fifty percent (50%) penalty hours in ethics CPE prior to April 30. The penalty for non-compliance with state-specific ethics for Idaho is to complete the course plus fifty percent (50%) penalty hours in ethics CPE prior to April 30. (3-20-20)T

**02. Inactive or Retired.** Licensees who elect inactive or retired status are exempt from any CPE requirements as prescribed by Sections 54-211(c) and (d), Idaho Code. A licensee who has elected inactive or retired status may provide the following volunteer, uncompensated services: tax preparation services, participating in a government-sponsored business mentoring program, serving on the board of directors for a nonprofit or governmental organization, or serving on a government-appointed advisory board. If the CPA provides the foregoing volunteer, uncompensated services, the CPA has a duty to ensure that they hold the professional competencies necessary to offer these services. (3-20-20)T

**403. REVIEW AND AUDIT OF CPE REPORTS (RULE 403).**

All signed CPE reports are subject to formal verification to determine qualification and sufficiency of hours reported. A formal audit of CPE reported may be performed to determine whether hours reported qualify for credit. If a reporting form is not approved, the licensee will be notified. (3-20-20)T

**404. NOTIFICATION (RULE 404).**

A licensee is served a notice of noncompliance when it is determined the CPE requirement has not been fulfilled. The notice advises and provides opportunity for the deficiencies to be addressed. If the deficiencies remain, administrative action may be taken. (3-20-20)T

**405. ACTION (RULE 405).**

Following notice and hearing, the Board may suspend the license or take other action pursuant to Section 54-219,

Idaho Code. (3-20-20)T

**406. REINSTATEMENT AND RE-ENTRY (RULE 406).**

An individual whose license has lapsed or is in a non-active status per Section 54-211, Idaho Code, is to complete no less than eighty (80) hours of CPE, of which at least four (4) hours are in ethics CPE with a minimum of two (2) hours to be in state specific ethics for Idaho, during the twelve (12) months immediately prior to applying for reinstatement or re-entry to an active license. The applicant is required to identify and complete a program of learning designed to demonstrate the currency of the applicant's competencies directly related to his area of service. Completion of the CPE will otherwise exempt the licensee from obtaining CPE hours during the calendar year of returning to an active license. If a licensee applies for re-entry during a license period and has already paid the fee for an inactive or retired license, the licensee is to pay the difference between the cost of an inactive or retired license and the annual license renewal fee. An individual who is applying for reinstatement to an inactive or retired license is not required to meet a CPE requirement. (3-20-20)T

**407. FORMERLY LICENSED (RULE 407).**

Any person who was licensed by the Board and who chose to let their license lapse, or had their license lapsed by the Board, may place the word "former" adjacent to their CPA or LPA title on any business card, letterhead, or any other document or device so long as at the time the license lapsed, the person was in good standing with the Board. (3-20-20)T

**408. CONTINUING PROFESSIONAL EDUCATION COMMITTEE (RULE 408).**

**01. Appointment.** The Board may appoint a continuing professional education committee. The committee consists of not less than five (5) members who are active licensees of this state, in good standing, and who need not be members of this Board. The committee performs the following duties and is authorized to take all actions necessary to perform these duties: (3-20-20)T

- a. To evaluate reported CPE to determine qualification. (3-20-20)T
- b. To consider applications for exceptions, extensions, and exemptions, and to assess penalties. (3-20-20)T
- c. To audit CPE reports and to consider other matters that may be assigned by the Board. (3-20-20)T

**02. Powers and Duties.** Any decision or ruling of this committee, in performance of these duties, will have the full power and effect of a ruling of the Board, but is subject to the Board's review and approval. (3-20-20)T

**409. -- 499. (RESERVED)**

**500. PURPOSE OF FIRM REGISTRATION AND PEER REVIEW (RULE 500).**

The purpose of the program is to monitor compliance with applicable accounting and auditing standards adopted by generally recognized standard setting bodies. The program emphasizes appropriate education programs or remedial procedures that may be recommended or required where the firm does not comply with appropriate professional standards. In the event a firm is unwilling or unable to comply with professional standards, or a firm's failure to comply with professional standards is so egregious as to warrant continuing action, the Board will take appropriate action to protect the public interest as authorized by Section 54-219, Idaho Code. (3-20-20)T

**501. ISSUANCE OF REPORTS AND FORM OF PRACTICE (RULE 501).**

A licensee can provide or offer to provide attest services or issue reports on compilations only in a firm as defined by Section 54-206(10), Idaho Code, except as provided under Section 54-221(4), Idaho Code. (3-20-20)T

**502. PEER REVIEW PROGRAM PARTICIPATION (RULE 502).**

**01. Participation.** Any firm that issues reports on accounting and auditing engagements, including audits, reviews, compilations, prospective financial information, engagements performed in accordance with the PCAOB, and any examination, review or agreed-upon procedures engagement performed in accordance with the statement on standards for attestation engagements. A licensee who issues compilation reports through any form of

business other than a firm is to participate in the peer review program. Such licensees are to meet the requirements for registration and peer review. (3-20-20)T

**02. Practice Privileges.** Individuals with practice privileges in Idaho are to comply with the peer review requirements in the state of their principal place of business. (3-20-20)T

**503. EXEMPTION FROM PARTICIPATION (RULE 503).**

**01. Firms.** A firm that does not perform any of the services in Rule 502 is exempt from peer review. The firm is to notify the Board of such exemption in writing at the time of renewal of its registration. A firm that begins providing these services is to commence a peer review within eighteen (18) months of the date of the issuance of its initial report. (3-20-20)T

**02. Licensees Not in Public Practice.** A licensee who does not perform any of the services in Rule 502 is exempt from firm registration and peer review. The licensee is to notify the Board of such exemption in writing at the time of initial CPA licensure and annually thereafter at the time of CPA or LPA license renewal. (3-20-20)T

**03. Licensees Not Issuing Reports.** A licensee who issues financial statements pursuant to Section 54-221(5), Idaho Code, is exempt from peer review. (3-20-20)T

**504. SCHEDULING OF THE PEER REVIEW (RULE 504).**

**01. Frequency.** A firm performing any of the services in Rule 502 undergoes, at its own expense, a peer review commensurate in scope with its practice, not less than once in each three (3) years. (3-20-20)T

**02. Currently Enrolled.** A firm currently enrolled in a program of an approved administering organization will use the year of review assigned by the administering organization. The firm will notify the Board of the deadlines set by the administering organization. (3-20-20)T

**03. Review Year.** Each firm is to enroll with one (1) of the approved administering organizations. Each firm adopts the review date assigned by the appropriate administering organization and notifies the Board of such date. (3-20-20)T

**04. New Firms.** Within one (1) year of registration with the Board, new firms are to enroll with an approved administering organization. The firm adopts the review date assigned and notifies the Board of such date. (3-20-20)T

**05. Mergers or Combinations.** In the event that two (2) or more firms are merged or combined, the resulting firm retains the peer review year of the firm with the largest number of accounting and auditing hours. (3-20-20)T

**06. Dissolutions or Separations.** In the event that a firm is divided, the new firm(s) retains the review year of the former firm. In the event that the year under review is less than twelve (12) months, a review year will be assigned so that the review occurs within eighteen (18) months of the commencement of the new firm(s). (3-20-20)T

**07. Multi-State Practices.** With respect to a multi-state firm, the Peer Review Oversight Committee may accept a peer review based solely upon work conducted outside of this state if the peer review is performed in accordance with requirements equivalent to those of this state. (3-20-20)T

**08. Report Issuance.** It is the responsibility of the firm to anticipate its need for peer review services in sufficient time to enable the reviewer to issue the report within six (6) months after the review date. (3-20-20)T

**09. Extensions.** The Board may accept an extension recommended by the administering organization for the conduct of a review, provided the Board is notified by the firm within thirty (30) days of the date of receipt of recommendation for such an extension. (3-20-20)T

**10. Just Cause.** The Board may change a firm's peer review year for just cause. (3-20-20)T



**505. MINIMUM STANDARDS (RULE 505).**

The minimum standards for peer review are contained in the Standards for Performing and Reporting on Peer Reviews section of the AICPA Standards. Peer reviews intended to meet the requirements of the AICPA peer review program are to be carried out in conformity with these standards under the supervision of an administering organization approved by the Board to administer peer reviews. Reviewed firms arrange and schedule their reviews in compliance with the procedures established by the administering organization and cooperate with the administering organization and with the Board in all matters related to the review. (3-20-20)T

**506. REPORTING TO THE BOARD (RULE 506).**

**01. Firm Registration Form.** All firms performing any of the peer reviewable services in Rule 502 annually file a firm registration no later than September 30. The registration is on a form prescribed by the Board. Firm registrations filed after September 30 are subject to penalty for non-compliance pursuant to Rule 600. (3-20-20)T

**02. Peer Review Documentation.** A firm that has undergone peer review will file a copy of the peer review report, letter of comments if any, letter of response if any, and letter accepting the review report issued by the administering organization. The letter will be filed within thirty (30) days after receipt. Additionally, firms are to notify the Board within thirty (30) days of the date the peer reviewer or a team captain advises the firm that a grade of fail will be recommended. The Board reserves the right to obtain all other information relating to the peer review. The Board also has the authority to exempt for good cause firms who would otherwise have to file peer review documentation. (3-20-20)T

**507. RETENTION OF DOCUMENTS RELATING TO PEER REVIEWS (RULE 507).**

Documents relating to peer reviews are to be retained as follows: (3-20-20)T

**01. Documents.** All documentation necessary to establish that each peer review was performed in conformity with peer review standards adopted by the Board. These documents may include the peer review working papers, the peer review report, comment letters and related correspondence indicating the firm's concurrence or non-concurrence, and any proposed remedial actions and related implementation. (3-20-20)T

**02. Retention Period.** Document retention is for a period of time corresponding to the designated retention period of the relevant administering organization and, upon request of the Committee, to be made available to it. In no event may the retention period be less than ninety (90) days from the date of acceptance of the review by the administering organization. (3-20-20)T

**508. CONFIDENTIALITY (RULE 508).**

The letter and any documentation submitted to the Board pursuant to Rule 506.02 is confidential as authorized by Title 74, Chapter 1, Idaho Code, unless an Order is issued by the Board pursuant to Section 54-219, Idaho Code. (3-20-20)T

**509. REMEDIES FOR FAILURE TO COMPLY (RULE 509).**

**01. Corrective Actions.** The Board will take appropriate action to protect the public interest if the Board determines, through the peer review process or otherwise, that a firm's performance or reporting practices, or both, are not, or may not be, in accordance with applicable professional standards, or that the firm does not comply with peer review program requirements or with all or some of the reporting, remedial action, or fee penalty requirements of this section. The Board's actions may include, but are not limited to: (3-20-20)T

**a.** The annual license of the principal(s) of a non-compliant firm will not be issued until the firm complies with all requirements of these rules, provided the licensee has met all licensing requirements; (3-20-20)T

**b.** Requiring the firm to develop quality control procedures to provide a reasonable assurance that similar occurrences will not occur in the future; (3-20-20)T

**c.** Requiring any individual licensee who had responsibility for, or who substantially participated in,

the engagement(s) to successfully complete specific courses or types of continuing education as specified by the Board; (3-20-20)T

**d.** Requiring the reviewed firm to engage a Board-approved licensee to conduct a Board-prescribed on-site field review of the firm's work product and practices or perform other investigative procedures to assess the degree or pervasiveness of nonconforming work product. The Board-approved licensee engaged by the firm will submit a report of the findings to the Board within thirty (30) days of the completion of the services. The cost of the Board-prescribed on-site review or other Board-prescribed procedures will be at the firm's expense; (3-20-20)T

**e.** Requiring the reviewed firm responsible for engagement(s) to submit all or specified categories of its compilation or attest working papers and reports to a preissuance evaluation performed by a Board-approved licensee in a manner and for a duration prescribed by the Board. Prior to the firm issuing the reports on the engagements reviewed, the Board-approved licensee submits to a designee of the Board for the purpose of recommending that the Board accept a report of the findings, including the nature and frequency of recommended actions for the firm. The cost of the Board-approved preissuance evaluation will be at the firm's expense; (3-20-20)T

**f.** Initiating an investigation to determine if additional discipline pursuant to Section 54-219, Idaho Code, is warranted. Notwithstanding the foregoing, absent an investigation the specific rating of a single peer review report is not a sufficient basis to warrant disciplinary action. (3-20-20)T

**02. Solicitation and Review of Other Sources.** The Board may solicit, and review licensee reports and other information covered by the reports from clients, public agencies, banks, and other users of such information. (3-20-20)T

**510. ADMINISTERING ORGANIZATIONS (RULE 510).**

Qualified administering organizations that register with, and are approved by the Board based on their adherence to the AICPA Peer Review minimum standards, include the peer review program of the American Institute of Certified Public Accountants (AICPA) and state CPA societies fully involved in the administration of the AICPA Peer Review Program and their successor organizations that meet the minimum standards. (3-20-20)T

**511. PEER REVIEW OVERSIGHT COMMITTEE (RULE 511).**

**01. Appointment.** The Board appoints an Oversight Committee consisting of no more than seven (7) members who are active licensees and possess extensive current experience in accounting and auditing services. No committee member may be a current member of the Board. (3-20-20)T

**02. Responsibilities.** The committee acts in an advisory capacity to the Board with the following duties: (3-20-20)T

**a.** Monitoring administering organizations to provide reasonable assurance that peer reviews are being conducted and reported in accordance with the peer review minimum standards. (3-20-20)T

**i.** Visit annually the administering organizations to examine their procedures for administering the peer review program and meet with the organization's peer review committee during the consideration of peer review documents. (3-20-20)T

**ii.** Review, on the basis of random selection, a number of reviews performed by the administering organization which include, at a minimum, a review of the peer review report, the letter of comments (if any), the firm's response to the matters discussed in the letter of comments, the organization's acceptance letter outlining any additional corrective or monitoring procedures, and working papers on the selected review. The review of documents may be expanded if significant deficiencies, problems, or inconsistencies are discovered. (3-20-20)T

**b.** Reports to the Board on conclusions reached and makes recommendations to the adherence to Peer Review Standards. Alternatively, for those organizations participating in the AICPA oversight program in connection with involved state societies, the committee may obtain and review the oversight program report to ensure that reviews are being conducted and reported on in accordance with the standards. Reports submitted may not contain information concerning specific firms or reviewers. (3-20-20)T

c. Based on the result of the foregoing procedures, the committee will make recommendation to the Board as to the continuing qualifications of the approved administering organizations. (3-20-20)T

**512. -- 599. (RESERVED)**

**600. FEES (RULE 600).**

**01. Examination and License.**

<b>Exam/License</b>	<b>Initial Fee</b>
Initial Exam	\$100
Re-Exam	\$50
Active License	\$120
Inactive or Retired License	\$100
Reciprocity	\$175 + license fee
International Reciprocity	\$175 + license fee
Transfer of Grades	\$175 + license fee
Reinstatement License	Sum of unpaid license fees for the preceding 3 license renewal cycles
Re-entry License	\$20
Firm Registration	\$20 firm plus \$5 per licensee up to \$200 maximum

(3-20-20)T

**02. Administrative Services.**

<b>Category</b>	<b>Fee</b>
Interstate Exchange of Information	\$10
Wall Certificate	\$20

(3-20-20)T

**03. Late Fees.**

<b>Category</b>	<b>Fee</b>
Late License Renewal	\$100
Non-compliance with CPE Filing:	
February	\$100
March	\$150
April	\$200
May	\$250
June	\$300
Non-compliance with Firm Registration	\$100 per licensee

(3-20-20)T

**701. -- 999. (RESERVED)**

## IDAPA 02 – DEPARTMENT OF AGRICULTURE

### DOCKET NO. 02-0000-2000F (FEE RULE)

#### NOTICE OF OMNIBUS RULEMAKING – ADOPTION OF TEMPORARY RULE

**EFFECTIVE DATE:** The effective date of the temporary rules being adopted through this omnibus rulemaking is the adjournment date of the second regular session of the 65th Idaho State Legislature - March 20, 2020.

**AUTHORITY:** In compliance with Sections 67-5226, Idaho Code, notice is hereby given this agency has adopted a temporary rule. The action is authorized pursuant to Sections 22-103(20), 22-107, 22-108, 22-112, 22-418, 22-505, 22-604, 22-702, 22-901, 22-911, 22-1103, 22-1907, 22-2004, 22-2006, 22-2013, 22-2204, 22-2303(5), 22-2403, 22-2412, 22-2511, 22-3418, 22-3421, 22-5129, 25-203, 25-207, 25-207B, 25-212, 25-305, 25-401, 25-601, 25-804, 25-1723(b), 25-2710, 25-3520, 25-3704, 25-4012, 37-303, 37-401, 37-402, 37-405, 37-516, 37-1521, 69-231, 69-524, 71-111, 71-121, 71-232, 71-233, 71-236, 71-241, and 71-408, Idaho Code.

**DESCRIPTIVE SUMMARY:** The following is the required finding and concise statement of its supporting reasons for adopting a temporary rule:

These temporary rules adopt and re-publish the following existing and previously approved and codified chapter(s) under IDAPA 02, rules of the Department of Agriculture. These rules are necessary to promote Idaho agricultural products and provide standards and regulations for Idaho agricultural products. These rules also protect the environment, prevent the spread of animal and plant diseases, noxious weeds, and invasive species. These rules also support programs for Idaho warehouses, commodity dealers, and producers.

This temporary rulemaking adopts the following chapters under IDAPA 02:

#### **IDAPA 02**

- 02.01.04 *Rules Governing the Idaho Preferred® Promotion Program*
- 02.01.05 *Rules Governing Certificates of Free Sale*
- 02.02.07 *Rules Governing Bulk Permits and Retail Sale of Potatoes*
- 02.02.11 *Rules Governing Eggs and Egg Products*
- 02.02.12 *Bonded Warehouse Rules*
- 02.02.13 *Commodity Dealers' Rules*
- 02.02.14 *Rules for Weights and Measures*
- 02.02.15 *Rules Governing the Seed Indemnity Fund*
- 02.03.03 *Rules Governing Pesticide and Chemigation Use and Application*
- 02.04.03 *Rules Governing Animal Industry*
- 02.04.05 *Rules Governing Grade A and Manufacture Grade Milk*
- 02.04.19 *Rules Governing Domestic Cervidae*
- 02.04.26 *Rules Governing the Public Exchange of Livestock*
- 02.04.32 *Rules Governing Poultry Operations*
- 02.06.01 *Rules Governing the Production and Distribution of Seed*
- 02.06.02 *Rules Governing Registrations and Licenses*
- 02.06.04 *Rules Governing Plant Exports*
- 02.06.05 *Rules Governing Plant Diseases and Quarantines*
- 02.06.06 *Rules Governing the Planting of Beans*
- 02.06.09 *Rules Governing Invasive Species and Noxious Weeds*
- 02.06.10 *Rules Governing the Growing of Potatoes*
- 02.06.33 *Organic Food Products Rules*

**TEMPORARY RULE JUSTIFICATION:** Pursuant to Section(s) 67-5226(1)(a-c) and 67-5226(2), Idaho Code, the Governor has found that temporary adoption of the rule is appropriate for the following reasons:

These temporary rules are necessary to protect the public health, safety, and welfare of the citizens of Idaho and confer a benefit on its citizens. These temporary rules implement the duly enacted laws of the state of Idaho, provide citizens with the detailed rules and standards for complying with those laws, and assist in the orderly execution and enforcement of those laws. The expiration of these rules without due consideration and processes would undermine the public health, safety and welfare of the citizens of Idaho and deprive them of the benefit intended by these rules. This docket also incorporates minor rule changes related to the COVID-19 response adopted in an open meeting.

**FEE SUMMARY:** Pursuant to Section 67-5226(2), the Governor has found that the fee(s) or charge(s) being imposed or increased is justified and necessary to avoid immediate danger and the fee(s) is described herein:

The fees or charges, authorized in various sections of Idaho Code (see chart below), are part of the agency’s 2021 budget that relies upon the existence of these fees or charges to meet the state’s obligations and provide necessary state services. Failing to reauthorize these temporary rules would create immediate danger to the state budget, immediate danger to necessary state functions and services, and immediate danger of a violation of Idaho’s constitutional requirement that it balance its budget.

The following is a specific description of the fees or charges:

<b>IDAPA</b>	<b>Specific Findings</b>	<b>Fee Summary</b>	<b>Authorization - Idaho Code</b>
02.01.04	Fee for voluntary participation in the Idaho Preferred promotion program	<b>IDAPA 02.01.04.110.01. -</b> Annual fees not to exceed \$1000	Section 22-112(1)
02.01.05	Certificates of Free Sale fees to provide producers with documentation that commodities were grown or processed in accordance with Idaho laws and rules	<b>IDAPA 02.01.05.300.01. -</b> Certification fees not to exceed \$50	Section 22-112
02.02.07	Fee for permits for first handler or shipper to ship bulk potatoes; Potato advertising tax to the Idaho Potato Commission	<b>IDAPA 02.02.07.120. -</b> Fees to cover the cost of inspections and the potato advertising tax	Sections 22-107 and 22-2207(8)
02.02.11	Assessment fee in lieu of seal sanitation, grading, handling, labeling and marketing of eggs sold in Idaho	<b>IDAPA 02.02.11.600.07. -</b> Assessment in lieu of seal at rate of 0.4 cent per dozen each month	Section 37-1523A
02.02.12	Bonded Warehouse Assessments	<b>IDAPA 02.02.12.480. and 483. -</b> 0.2% of total value at time of sale	Section 69-257
02.02.13	Commodity Indemnity Fund Assessments	<b>IDAPA 02.02.13.500. and 503. -</b> 0.2% gross dollar amount	Section 69-257
02.02.14	Weighing and measuring device licensing fees	<b>IDAPA Section 02.02.14.016. -</b> Fee schedule by device	Section 71-121
02.02.15	Seed Indemnity Fund Assessments and License Reinstatement fee	<b>IDAPA 02.02.15.070. -</b> Assessment based on categories of seed crops; <b>IDAPA 02.02.15.026.05. -</b> Reinstatement fee	Sections 22-5107, 22-5121 and 22-5122
02.03.03	Fees for pesticide registration, pesticide dealer’s license, private applicator’s license, professional applicator’s license, and examinations	<b>IDAPA 02.03.03.200. -</b> Fees for the previously described licenses and exams	Sections 22-3402 and 22-3404

<b>IDAPA</b>	<b>Specific Findings</b>	<b>Fee Summary</b>	<b>Authorization - Idaho Code</b>
02.04.03	Artificial insemination license-fee	<b>IDAPA 02.04.03.200.01.</b> - License application fee of \$25 annually; <b>IDAPA 02.04.03.200.07.</b> - License renewal \$5	Section 25-807
02.04.05	Fees in this chapter establishes a laboratory license fee, a permit fee for manufacturers/ distributors to produce and sell a new dairy product; and a bulk hauler’s permit fee	<b>IDAPA 02.04.05.221.03.</b> - Laboratory license fee of \$25; <b>IDAPA 02.04.05.395.02.</b> - New product permit fee of \$25; <b>IDAPA 02.04.05.380.01.</b> - Bulk milk hauler permit of \$25	Sections 37-407, 37-412, 37-503 and 37-511
02.04.19	Annual facility inspections, entry permits and disease surveillance; Domestic Cervidae annual assessment, import, export and movement fees	<b>IDAPA 02.04.19.090.</b> - \$10/head on elk, \$3/head on fallow deer	Section 25-3708
02.04.26	Fee for issuance, renewal, suspension, and revocation of market charters	<b>IDAPA 02.04.26.700.</b> - Charter fee of \$100	Section 25-1724
02.04.32	Annual fee assessed to each facility to cover twice annual facility inspection and nutrient management plan review	<b>IDAPA 02.04.32.140.01.</b> - Annual fee/assessment of no more than three cents (\$0.03) per square foot of containment area	Section 25-4010
02.06.01	Fees are for Seed Dealer’s Licenses and voluntary services provided through ISDA investigators and labs	<b>IDAPA 02.06.01.194.</b> - Seed dealer’s license fees; <b>IDAPA 02.06.01.190. and 191.</b> - Idaho Seed Laboratory testing services	Sections 22-108, 22-418, and 22-2006
02.06.02	Commercial Feed Product Registration Fee-	<b>IDAPA 02.06.02.020.</b> - \$40 per product	Section 25-2704
02.06.04	Phytosanitary certifications and inspections fee	<b>IDAPA 02.06.04.195.</b> - Certificate fees by category; <b>IDAPA 02.06.04.280.</b> - Nursery certification fees; <b>IDAPA 02.06.04.392.</b> - Ginseng export fees	Sections 22-107, 22-112, and 22-2305
02.06.05	Special permits require a specific fee for importation of hops	<b>IDAPA 02.06.05.190.</b> - Special permit and phytosanitary fee	Sections 22-107, 22-112, and 22-2006

<b>IDAPA</b>	<b>Specific Findings</b>	<b>Fee Summary</b>	<b>Authorization - Idaho Code</b>
02.06.06	Fees for inspections to ensure compliance with seed certification and export requirements	<b>IDAPA 02.06.06.550.01.</b> - \$0.18 for tags; <b>IDAPA 02.06.06.550.02.</b> - Field inspection fees of \$5; <b>IDAPA 02.06.06.550.03.</b> - Field inspections of \$3.50/acre/inspection; <b>IDAPA 02.06.06.04.</b> - Laboratory seed sampling	Section 22-2006
02.06.09	Fees for field inspections certify noxious weed free forage and straw for transportation and use of such in Idaho	<b>IDAPA 02.06.09.320.16.</b> - Certification fees of \$3/inspection for up to 10 acres and \$3/acre thereafter up to 99 acres. \$3/acre after 100 ac, plus \$30 annual fee	Section 22-2412
02.06.10	Fees for laboratory testing of bacterial ring rot in potatoes	<b>IDAPA 02.06.10.370.</b> - Lab testing sample fees for ring rot as charged by the approved lab	Section 22-505
02.06.33	Fee for inspection and certification of organic producers in Idaho	<b>IDAPA 02.06.33.300. and 301.</b> - Graduated gross sales fee structure	Section 22-1106

**ASSISTANCE ON TECHNICAL QUESTIONS:** For assistance on technical questions concerning the temporary rule, contact Brian Oakey, Deputy Director, at (208) 332-8552.

Dated this 19th day of February, 2020.

Brian Oakey  
Deputy Director  
Idaho Department of Agriculture  
2270 Old Penitentiary Road  
P.O. Box 7249  
Boise, Idaho 83707  
Phone: (208) 332-8552  
Fax: (208) 334-2170

## 02.01.04 – RULES GOVERNING THE IDAHO PREFERRED® PROMOTION PROGRAM

### 000. LEGAL AUTHORITY.

This chapter is adopted under the legal authority of Section 22-112, Idaho Code.

(3-20-20)T

### 001. TITLE AND SCOPE.

**01. Title.** The title of this chapter is IDAPA 02.01.04, “Rules Governing the Idaho Preferred® Promotion Program.”

(3-20-20)T

**02. Scope.** These rules govern the participation in, and product selection criteria for the Idaho Preferred® program. The program was developed by the Idaho State Department of Agriculture to identify and promote food and agricultural products from the state of Idaho, elevate consumer awareness of such products, and assist in developing opportunities for sale of such products. These rules establish the requirements for the use of the Idaho Preferred® logo and will define eligible products, application procedures, and participation fees.

(3-20-20)T

### 002. -- 009. (RESERVED)

### 010. DEFINITIONS.

The following definitions apply in the interpretation and enforcement of this chapter.

(3-20-20)T

**01. Agricultural Product.** Any fresh or processed apicultural, aquacultural, avicultural, beverage, cervidae, dairy, horticultural, livestock, forestry, viticultural, or other farm or garden product.

(3-20-20)T

**02. Apicultural Product.** Products produced from or related to honey bees or honey.

(3-20-20)T

**03. Aquacultural Product.** Products produced from or related to fish, reptiles, or other aquatic animals.

(3-20-20)T

**04. Avicultural Product.** Products produced from or related to birds, including but not limited to, ratites or poultry.

(3-20-20)T

**05. Beverage.** Drinks including but not limited to wine, beer, distilled spirits, bottled water, or flavored drinks.

(3-20-20)T

**06. Broker.** A sales and marketing agent employed to make bargains and contracts for compensation.

(3-20-20)T

**07. Cervidae Product.** Products produced from or related to fallow deer, elk, or reindeer owned by a person.

(3-20-20)T

**08. Dairy Product.** Products produced from or related to milk from cattle, goats, or sheep.

(3-20-20)T

**09. Florist Stock.** All cut flowers, foliage and ferns, all potted plants or cuttings or bedding plants, and all flowering bulbs and rooted herbaceous plants used for ornamental or decorative purposes and all corms, whether grown in boxes, benches, pots, under glass or other artificial covering, or in the field or open ground or cuttings therefrom.

(3-20-20)T

**10. Foodservice.** A person engaged in or related to the practice of commercial food preparation and service.

(3-20-20)T

**11. Forest Products.** All products made of wood fiber such as timber, wood chips, sawdust or shavings, including but not limited to lumber, paper, particleboard, fence or corral posts or rails, shingles, shakes, firewood or pellets, logs used in the construction of log homes or any other product sold commercially.

(3-20-20)T

**12. Fresh Produce, Commodities, and Fresh Meat.** Bulk or packaged agricultural products that have been cleaned, sorted, or otherwise prepared and are sold or distributed in an unprocessed or minimally processed condition.

(3-20-20)T

**13. Horticultural Products.** Plants, including but not limited to, fruits, vegetables, flowers, seeds, or ornamental plants.

(3-20-20)T



- 14. Livestock.** Domestic animals including but not limited to cattle, sheep, pigs, goats, domestic cervidae, domestic bison, camelids, or horses. (3-20-20)T
- 15. Livestock Product.** Products produced from or related to livestock. (3-20-20)T
- 16. Non-Food Agricultural Products.** Products not intended for human consumption, including but not limited to, animal feed, compost, hides, or skins. (3-20-20)T
- 17. Supporting Organization.** Any commission, association, or incorporated group supporting the efforts of the Idaho Preferred® program. (3-20-20)T
- 18. Nursery Stock.** All botanically classified plants or any part thereof, such as aquatic or herbaceous plants, bulbs, sod, buds, corms, culms, roots, scions, grafts, cuttings, fruit pits, seeds of fruits, forest and ornamental trees, and shrubs, berry plants, and all trees, shrubs, vines, and plants collected in the wild that are grown or kept for propagation or sale. Nursery stock does not include field and forage crops, seeds of grasses, cereal grains, vegetable crops and flowers, bulbs and tubers of vegetable crops, vegetables or fruit used for food or feed, cut trees or cut flowers unless stems or other portions thereof are intended for propagation. (3-20-20)T
- 19. Packer/Shipper.** A person who packages and ships food or agricultural products to wholesalers, retailers, and other outlets. (3-20-20)T
- 20. Participant.** A person who has applied to the Department and been approved for participation in the Idaho Preferred® program. (3-20-20)T
- 21. Processed Food.** Any food product which has been transformed from its natural state by methods including but not limited to freezing, cutting, heating, drying, treating, or adding ingredients. (3-20-20)T
- 22. Processor.** A person engaged in the manufacturing of processed food. (3-20-20)T
- 23. Producer.** A person engaged in the business of growing or raising food, fiber, feed, or other agricultural products. (3-20-20)T
- 24. Retailer.** A person engaged in making sales directly to consumers. (3-20-20)T
- 25. Viticultural Products.** Products produced from or related to grapes and wine. (3-20-20)T
- 26. Wholesaler.** A person who buys in comparatively large quantities and then resells, usually in smaller quantities, but never directly to the consumer. (3-20-20)T

**011. -- 014. (RESERVED)**

**015. VOLUNTARY PROGRAM.**  
The Idaho Preferred® program is a voluntary promotion program. (3-20-20)T

**016. -- 099. (RESERVED)**

**100. APPLICATION FOR PARTICIPATION.**

**01. Application Requirement.** Persons interested in becoming a participant in the Idaho Preferred® program shall do so by making application to the Department on forms established by the Director. New applications may be submitted at any time throughout the year. (3-20-20)T

**02. Application Review and Compliance Verification.** The Director, upon receipt of an application, will verify the applicant's compliance with this chapter and approve or deny the application. The Director will notify the applicant in writing of the approval or denial. (3-20-20)T

**101. PARTICIPATION DURATION AND RENEWAL.**

**01. Duration.** Participation is on an annual basis, coinciding with the fiscal year beginning July 1 and ending June 30, unless otherwise provided for in this chapter. (3-20-20)T

**02. Renewing Participation.** Renewals shall be submitted on forms established by the Director and will be due August 1. (3-20-20)T

**03. Reporting on Use of Logo.** Participants renewing with the Department will report their use of the Idaho Preferred® logo from the concluding program year. The report will include, but may not be limited to, information regarding how the Idaho Preferred® logo was used. (3-20-20)T

**102. -- 109. (RESERVED)**

**110. PARTICIPATION FEES.**

**01. Annual Fee.** Participation fees will be listed in the participation application and will not exceed one thousand dollars (\$1,000). (3-20-20)T

**02. Participation Categories:** (3-20-20)T

**a. Producer.** (3-20-20)T

**b. Packer/Shipper/Processor.** (3-20-20)T

**c. Supporting Organization.** (3-20-20)T

**d. Retail/Foodservice.** (3-20-20)T

**e. Broker/Distributor.** (3-20-20)T

**03. Pro-Rated Fees.** New participation agreements issued during the program year will be assessed one hundred percent (100%) of the annual fee if applying between July 1 and December 31 and fifty percent (50%) of the fee if applying between January 1 and June 30. (3-20-20)T

**04. Participation in Multiple Categories.** Persons qualifying in multiple participation categories shall be assessed the greater of participation fees. (3-20-20)T

**111. PARTICIPATION PRIVILEGES.**

Participants will benefit from privileges including: (3-20-20)T

**01. Use of the Idaho Preferred® Logo.** Use of the Idaho Preferred® Logo on product labels, advertising, signage, or other promotional materials as allowed by the department. (3-20-20)T

**02. Listing.** Listing In Idaho Preferred® Product Directories. (3-20-20)T

**03. Promotion.** Promotion through advertising, retail and foodservice promotions, consumer and education events, and the Idaho Preferred® website. (3-20-20)T

**04. Visibility.** Visibility from the department's promotion activities. (3-20-20)T

**112. -- 199. (RESERVED)**

**200. PRODUCT QUALIFICATION.**

**01. Authority of Determination.** The Director has sole authority in determining the eligibility of a product for participation in the program. (3-20-20)T

**02. General Product Qualifications.** Except as specified in this chapter, or by written order of the Director, products must meet or exceed the following criteria: (3-20-20)T

**a.** Fresh produce and commodities bearing the Idaho Preferred® logo shall be one hundred percent (100%) Idaho grown or raised. (3-20-20)T

**b.** Processed foods and beverages shall: (3-20-20)T

**i.** Contain a minimum of twenty percent (20%) agricultural content by weight that has been grown or raised in Idaho; and (3-20-20)T

**ii.** Be processed in the state of Idaho. (3-20-20)T

**c.** Non-food agricultural products must be at least twenty percent (20%) agricultural content by weight that has been grown or raised in Idaho and processing must occur in Idaho. (3-20-20)T

**03. Potatoes.** Only certification marks owned or administered by the Idaho Potato Commission may be branded on potatoes grown in Idaho unless prior Idaho Potato Commission approval in writing is secured and granted for the use of additional words or designs. Any person or participant applying to the Idaho Preferred® program, with the intention to promote Idaho-grown potatoes or products made from Idaho-grown potatoes, shall provide proof of such permission prior to making application with the Department. (3-20-20)T

**04. Wine.** Wines shall contain a minimum of ninety-five percent (95%) Idaho grapes. (3-20-20)T

**05. Beer.** Beer shall: (3-20-20)T

**a.** Be brewed in Idaho; and (3-20-20)T

**b.** Contain at least one (1) Idaho agricultural product such as Idaho malt, Idaho wheat or Idaho hops, or soluble remnant thereof, but excluding water. (3-20-20)T

**06. Water.** Water must be extracted from an Idaho water source. (3-20-20)T

**07. Nursery Stock.** Nursery stock shall have been grown in Idaho a minimum of one (1) growing season or growing cycle. (3-20-20)T

**08. Beef and Beef Products.** Beef and beef products shall come from cattle that: (3-20-20)T

**a.** Were born, raised and harvested in the United States. No cattle that originate from outside the United States may qualify for the Idaho Preferred® logo. (3-20-20)T

**b.** Are raised, fed, or processed in Idaho. (3-20-20)T

**c.** Are processed in federally inspected plants. (3-20-20)T

**09. Lamb and Lamb Products.** Lamb and lamb products shall come from sheep that: (3-20-20)T

**a.** Are born, raised and harvested in the United States. No lambs that originate from, or reside for any portion of their life outside the United States may qualify for the Idaho Preferred® logo. (3-20-20)T

**b.** Have grazed or been fed in Idaho at least three (3) months prior to harvest. The three (3) months need not be contiguous, but must be verifiable. (3-20-20)T

**c.** Are processed at approximately one (1) year of age or less and qualify as lamb or carcasses from older animals, identified as mutton by USDA inspectors, may qualify if they have met requirements in Subsection 200.07.b. (3-20-20)T

- 10. Pork and Pork Products.** Pork and pork products shall come from hogs that: (3-20-20)T
- a.** Are born, raised and harvested in the United States. No hogs that originate from, or reside for any portion of their life outside the United States may qualify for the Idaho Preferred® logo. (3-20-20)T
  - b.** Are raised in or processed in Idaho. (3-20-20)T
  - c.** Are processed at less than one (1) year of age unless used exclusively for ground pork or sausage products, and are processed in a federally inspected plant. (3-20-20)T
- 11. Poultry and Poultry Products.** Poultry and poultry products shall come from fowl that: (3-20-20)T
- a.** Are hatched, raised and harvested in the United States. No fowl that originate from, or reside for any portion of their life outside the United States may qualify for the Idaho Preferred® logo. (3-20-20)T
  - b.** Are raised and processed in Idaho. Fertile eggs, also known as hatching eggs, or chicks less than three (3) days of age that originate outside of Idaho, but are raised and processed in Idaho, may qualify for Idaho Preferred®. (3-20-20)T
  - c.** Are processed in a facility that is approved through a District Health Department for retail sales, or in a federally inspected plant. (3-20-20)T
- 12. Game Meat.** Game meat shall: (3-20-20)T
- a.** Come from domestic Cervidae that are born, raised and processed in Idaho and originate from a facility regulated by the Idaho State Department of Agriculture. (3-20-20)T
  - b.** Come from domestic buffalo that are born, raised and processed in Idaho. (3-20-20)T
  - c.** Be processed in a federally inspected plant. (3-20-20)T
- 13. Apicultural Products.** Products produced by honey bees including honey, wax, pollen, and propolis shall be one hundred percent (100%) Idaho origin. Processed honey shall be eighty percent (80%) Idaho origin. (3-20-20)T
- 14. Forest Products.** Forest products shall: (3-20-20)T
- a.** Contain a minimum of eighty percent (80%) of their wood fiber content from trees grown in Idaho; and (3-20-20)T
  - b.** Be manufactured in Idaho. (3-20-20)T
- 15. Exceptions.** The Director has the authority to establish product qualification requirements specific to individual products and commodities by written order. (3-20-20)T

**201. -- 299. (RESERVED)**

**300. LOGO.**

The Idaho Preferred® logo has been registered by the Department with the United States Library of Congress (Copyright registration), the United States Patent and Trademark Office (Certification Mark registration), the Idaho Secretary of State (Certificate of Trademark) and is afforded all protections provided for by law. The logo shall be used only by those participants in compliance with this chapter. The Director will establish by written order a logo style manual specifying approved colors, treatments, and fonts for the Idaho Preferred® logo. (3-20-20)T

**01. Description of the Idaho Preferred® Logo.** The Idaho Preferred® logo is an oval background containing a snow-capped mountain range topped with a sunburst. The word "IDAHO" appears in Brand Idaho

logotype, and a banner emblazoned with the word “PREFERRED” scrolls across the bottom of the logo. (3-20-20)T

**02. Graphic Depiction of the Idaho Preferred® Logo:**



(3-20-20)T

**03. Approval for Use of Logo.** Participants who wish to use the Idaho Preferred® logo on packaging, labels, flyers, promotional materials, or any other materials that will be viewed by the public must submit a proof of text and design to the Department for approval. Requests for approval must be submitted to the Idaho State Department of Agriculture, Marketing Division not less than five (5) working days prior to the proposed date of use. Written approval from the Department for logo use must be issued prior to use of the logo. (3-20-20)T

**301. SPECIAL PROMOTIONAL ACTIVITIES.**

**01. Activities.** The Department may engage in special promotional activities including, but not limited to, advertising, product demonstrations, events, publicity, and cooperative activities. The Department may invite participants in the Idaho Preferred® program to participate in any activities. (3-20-20)T

**02. Fees.** The Department may assess a separate fee for any special promotional activity. This fee will not exceed the actual cost of conducting the activity. (3-20-20)T

**302. OTHER IDAHO PROMOTION PROGRAMS.**

**01. Commodity-Specific Promotion Programs.** Commissions, boards, associations, or other organizations authorized by statute to promote or regulate agricultural products grown, packed, or processed in the state of Idaho shall be the primary and principal promotion and certification mark and trademark organizations for the particular commodity they are authorized to promote or regulate. (3-20-20)T

**02. Ownership of Marks.** Any trademarks, certification marks, brands, seals, logos or other identification marks, that are established, owned or used by such commissions, boards, associations or organizations shall remain their sole property. Any use or infringement of their ownership right is prohibited unless written permission is obtained from an authorized representative of the commission, board, association or organization. (3-20-20)T

**303. DISTRIBUTION OF PROMOTIONAL MATERIAL.**

**01. Authorized Use.** The Idaho Preferred® program has the authority to provide retail and food service outlets, farmers' markets, schools, media, fairs, and other such businesses, organizations, and venues the opportunity to promote Idaho food and agricultural products using the program logo and promotional materials. Open distribution of any and all point-of-sale materials, signage, advertising, identification placards, and other such promotional material, in accordance with this chapter and other applicable laws and precedent, is acceptable use and not considered an infringement on the ownership rights of any mark or seal of a supporting organization as defined in this chapter. (3-20-20)T

**02. Fees.** The Department may assess a fee for promotional materials such as, but not limited to,

banners, stickers, signs, aprons, shopping bags, etc. (3-20-20)T

**304. -- 309. (RESERVED)**

**310. SELF-CERTIFICATION.**

All participants shall self-certify that all products marked with the Idaho Preferred® logo meet the qualification criteria as set forth in this chapter. Self-certification is subject to verification through the application and compliance process. (3-20-20)T

**311. COMPLIANCE.**

**01. Authority of Director.** The Director has the authority to enter upon the premises of any participant to examine and copy any of the following items: (3-20-20)T

**a.** Books, papers, records, ledgers, journals, electronically or magnetically recorded data: (3-20-20)T

**b.** Computers and computer records or memoranda bearing on the usage of the Idaho Preferred® logo; and (3-20-20)T

**c.** To secure all other information concerned in the enforcement of these rules. (3-20-20)T

**02. Random Compliance Inspection.** The Director shall annually perform random compliance inspections. (3-20-20)T

**03. Samples.** The participant shall, upon the request of the Director, provide samples of the participant's labels, packaging, merchandising, and promotional materials featuring the Idaho Preferred® logo. (3-20-20)T

**312. -- 314. (RESERVED)**

**315. VIOLATION.**

Any person found in violation of these rules is subject to termination of participation privileges. (3-20-20)T

**316. -- 999. (RESERVED)**

## 02.01.05 – RULES GOVERNING CERTIFICATES OF FREE SALE

### 000. LEGAL AUTHORITY.

This chapter is adopted under the legal authority of Section 22-112, Idaho Code. (3-20-20)T

### 001. TITLE AND SCOPE.

01. **Title.** The title of this chapter is IDAPA 02.01.05, “Rules Governing Certificates of Free Sale.” (3-20-20)T

02. **Scope.** These rules govern the issuing of certificates of free sale and establish applicant procedures for obtaining Certificates of Free Sale. (3-20-20)T

### 002. -- 009. (RESERVED)

### 010. DEFINITIONS.

01. **Applicant.** Any person applying for certification under these rules. (3-20-20)T

02. **Certificate of Free Sale.** A certificate issued by the Department for products grown or processed in Idaho to certify that the products are distributed generally throughout the state of Idaho and the United States and are in accordance with Idaho health laws and sanitary regulations. (3-20-20)T

### 011. -- 099. (RESERVED)

### 100. APPLICATION FOR CERTIFICATION - PROCEDURES.

01. **Application.** Application must be made in writing (which includes electronic mail) and include, but will not be limited to, the following information: (3-20-20)T

a. Company name; (3-20-20)T

b. Physical address of packing or processing facility; and (3-20-20)T

c. List of products to be certified. (3-20-20)T

02. **Application Forms.** No application form(s) are necessary. (3-20-20)T

03. **Multiple Certificates.** Multiple certificates may be requested at one time. (3-20-20)T

### 101. -- 109. (RESERVED)

### 110. APPLICANT REQUIREMENTS.

01. **Applicant Health Inspection.** The Department may request a copy of an applicants’ most recent state, federal or third-party health inspection, if applicable. Such inspection records will be kept on file for one (1) year. (3-20-20)T

02. **Applicant Licenses or Registrations.** If the applicant is regulated by the Department, the applicant must meet all state laws and Department regulations. (3-20-20)T

### 111. -- 119. (RESERVED)

### 120. SPECIAL REQUESTS.

01. **Customized Certificates.** The applicant may request customized text for the certificate of free sale in order to meet the import requirements of a specific country. The Department will make every effort to comply with the request. (3-20-20)T

02. **Additional Charges.** There will be no additional charges for special requests. (3-20-20)T

### 121. -- 299. (RESERVED)

**300. FEES AND CHARGES.**

**01. Certification Fees.** The Director will establish certification fees annually under this chapter. Fees will not exceed fifty dollars (\$50) each. Fees will be set by July 1 of each year. (3-20-20)T

**02. Notary Charges.** Notary certification will be provided for each certificate at no additional charge. (3-20-20)T

**03. Shipping and Delivery Charges.** There will be no fees for mailing costs unless the applicant requests express mailing. (3-20-20)T

**04. Express Mailing.** The applicant will be responsible for express mailing charges. The applicant may provide an account number for the carrier, pre-paid air bill or be invoiced for the actual costs. (3-20-20)T

**05. Payment.** The applicant will be sent an invoice for fees and charges and will be responsible for payment. (3-20-20)T

**301. -- 999. (RESERVED)**



## 02.02.07 – RULES GOVERNING BULK PERMITS AND RETAIL SALE OF POTATOES

### 000. LEGAL AUTHORITY.

This chapter is adopted under the legal authority of Sections 22-901, 22-911, and 22-2006, Idaho Code. (3-20-20)T

### 001. TITLE AND SCOPE.

01. **Title.** The title of this chapter is IDAPA 02.02.07, “Rules Governing Bulk Permits and Retail Sale of Potatoes.” (3-20-20)T

02. **Scope.** These rules govern the application for a permit to ship bulk potatoes, permit fees, and marketing order requirements and specify the general requirements for the inspection, grading, marking and retail sales of potatoes in the state of Idaho. (3-20-20)T

### 002. -- 003. (RESERVED)

### 004. INCORPORATION BY REFERENCE.

The following document is incorporated by reference into this chapter: (3-20-20)T

01. **Federal Marketing Order Number 945 - U.S.D.A. Handling Regulations October 3, 2018, Until Revised.** Copies of this document may be obtained from the Idaho State Department of Agriculture. (3-20-20)T

### 005. -- 119. (RESERVED)

## SUBCHAPTER A – BULK PERMITS

### 120. PERMIT FEES.

The first handler or shipper shall apply through the nearest District Inspection Office for a permit to ship bulk potatoes. The permittee shall pay the potato advertising tax at combined grower-shipper rates for either fresh or processing potatoes, and inspection fees, if required, within thirty (30) days of shipment. Failure to pay either fee within the prescribed time is grounds for denial of future permits, so long as the fees remain outstanding. (3-20-20)T

### 121. APPLICATION FORM.

Application for permit is to be on a form furnished by the department. Acknowledgment of receipt of processing potatoes, when leaving the Federal Marketing Order area, shall be accomplished immediately by the processor upon receipt of the shipment and forwarded to the issuing office. A copy of each permit issued is to be forwarded to the Idaho Potato Commission by the issuing officer. (3-20-20)T

### 122. MARKETING ORDER.

Permits for shipment of processing potatoes require a Marketing Order Certificate of Privilege number, issued by the Marketing Order Manager, if leaving the Marketing Order area. Inspection of bulk shipments for processing is not required. Bulk shipments for repacking or fresh sale must be graded and meet all applicable minimum Marketing Order requirements. Each shipment requires a Federal-State inspection certificate, certifying minimum standards and include the percentage of U.S. No. 1 quality. (3-20-20)T

### 123. REQUEST FOR PERMIT.

Request for permits must be made forty-eight (48) hours prior to shipment, excluding weekends and Legal Holidays. Any violation or improper use of permits will invalidate the permit and may be grounds for denial of future permits. (3-20-20)T

### 124. -- 219. (RESERVED)

## SUBCHAPTER B – RETAIL SALES

### 220. INSPECTIONS, RESTRICTIONS, AND IDENTIFICATION REQUIRED.

All potatoes packed for resale to retail outlets in Idaho shall be inspected as outlined in Subsection 220.02 and meet the requirements of Federal Marketing Order number 945-USDA and the conditions outlined below: (3-20-20)T

01. **Certification and Markings.** Each shipment packed for resale to retail outlets in Idaho is to be

accompanied by a valid inspection certificate, numbered note sheet or be marked with a positive lot identification number (PLI) number. (3-20-20)T

**02. Inspections.** For other than Idaho or Oregon, inspections may be performed by any person or persons authorized under the USDA AMS Specialty Crop Inspection Program to inspect potatoes. (3-20-20)T

**03. Restrictions.** All potatoes packed for resale to retail outlets in Idaho under the provision of this rule are inspected as outlined in Subsection 220.02 and found free from: (3-20-20)T

a. Potato Tuberworm (*Phthorimaea operculella* (Zeller)). (3-20-20)T

b. Potato Wart (*Synchytrium endobioticum*). (3-20-20)T

**221. LOTS TAGGED NOT FOR SALE -- REMOVAL THEREOF.**

Retail outlets may be periodically checked by the Idaho State Department of Agriculture. Lots found failing to grade as marked or otherwise found out of compliance with the provisions of this rule will be tagged "Not For Sale" until removed from display and regraded, destroyed or remarked to a lower grade if feasible. (3-20-20)T

**222. COMPLIANCE OR NON-COMPLIANCE CERTIFICATE.**

Each inspection at the retail outlet will be acknowledged by an inspection report showing compliance or non-compliance. (3-20-20)T

**223. SECOND NOTICE ACTION -- NON-COMPLIANCE.**

A second inspection showing evidence of non-compliance in any calendar year will constitute sufficient grounds to proceed with prosecution in accordance with Sections 22-2020 or 22-912, Idaho Code. (3-20-20)T

**224. BULK LOTS LABELED NOT FOR SALE -- REMOVAL THEREOF.**

Bulk potatoes failing to meet the grade shown or otherwise found out of compliance with the provisions of this rule are labeled "Not For Sale" until removed. They may be regraded, destroyed or re-marked to a lower grade if feasible. (3-20-20)T

**225. RESPONSIBILITY OF PERMANENT AND CONDITION DEFECTS.**

Defects of condition are those of retailers' responsibility. Permanent grade defects are those of the original packer. (3-20-20)T

**226. RESTRICTING STANDARDS TO TABLESTOCK GRADES.**

Usable grades or standards are the entire spectrum of U.S. and Idaho Grades excluding processing grades. (3-20-20)T

**227. -- 999. (RESERVED)**

## 02.02.11 – RULES GOVERNING EGGS AND EGG PRODUCTS

### 000. LEGAL AUTHORITY.

This chapter is adopted under the legal authority of Section 37-1521, Idaho Code. (3-20-20)T

### 001. TITLE AND SCOPE.

**01. Title.** The title of this chapter is IDAPA 02.02.11, “Rules Governing Eggs and Egg Products.” (3-20-20)T

**02. Scope.** These rules govern the grades and standards for Idaho eggs and egg products, including tolerances, consumer grades, sanitation, storage, egg seals, tax, and cartons. (3-20-20)T

### 002. -- 011. (RESERVED)

### 012. GRADES AND STANDARDS.

**01. Classifications.** The following standards, grades and weight classifications are hereby established and adopted. (3-20-20)T

**a.** Except as otherwise provided in this subsection, all shell eggs sold for human consumption in the Idaho must be designated as one (1) of the following grades: “Idaho Consumer Grade AA,” “Idaho Consumer Grade A,” “Idaho Consumer Grade B.” (3-20-20)T

**b.** An Idaho producer of shell eggs may sell shell eggs produced on his premises in Idaho directly to consumers at the place of production of the eggs, without grade designations. (3-20-20)T

**c.** Idaho shell egg producers having three hundred (300) or less hens may sell ungraded shell eggs produced upon their premises to retailers, provided that each carton or other container of ungraded shell eggs sold must be clearly marked “Ungraded” and bear the name and address of the Idaho producer. (3-20-20)T

**02. Standards.** The following standards for individual shell eggs are used in determining the Idaho consumer grade designation applicable thereto. (3-20-20)T

**03. Application.** The Idaho standards for quality of individual shell eggs contained in this section are applicable only to eggs that are the product of the domesticated chicken hen and are in the shell. (3-20-20)T

**04. Interior Egg Quality Specifications.** Interior egg quality specifications for these standards are based on the apparent condition of the interior contents of the egg as it is twirled before the candling light. Any type or make of candling light may be used that will enable the particular grader to make consistently accurate determinations of the interior quality of shell eggs. It is desirable to break out an occasional egg and by determining the Haugh unit value of the broken-out egg, compare the broken-out and candled appearance, thereby aiding in correlating candled and broken-out appearance. (3-20-20)T

**05. AA Quality.** The shell must be clean, unbroken and practically normal. The air cell must not exceed one-eighth (1/8) inch in depth, may show unlimited movement and may be free or bubbly. The white must be clear and firm so that the yolk is only slightly defined when the egg is twirled before the candling light. The yolk must be practically free from apparent defects. (3-20-20)T

**06. A Quality.** The shell must be clean, unbroken and practically normal. The air cell must not exceed three-sixteenths (3/16) inch in depth, may show unlimited movement and may be free or bubbly. The white must be clear and at least reasonably firm so that the yolk outline is only fairly well defined when the egg is twirled before the candling light. The yolk must be practically free from apparent defects. (3-20-20)T

**07. B Quality.** The shell must be unbroken, may be abnormal, and may have slightly stained areas. Moderately stained areas are permitted if they do not cover more than one thirty-second (1/32) of the shell surface if localized, or one-sixteenth (1/16) of the shell surface if scattered. Eggs having shells with prominent stains or adhering dirt are not permitted. The air cell may be over three-sixteenths (3/16) inch in depth, may show unlimited movement, and may be free or bubbly. The white may be weak and watery so that the yolk outline is plainly visible when the egg is twirled before the candling light. The yolk may appear dark, enlarged and flattened and may show clearly visible germ development but no blood due to such development. It may show other serious defects that do not render the egg inedible. Small blood spots or meat spots (aggregating not more than one-eighth (1/8) inch in

diameter) may be present. (3-20-20)T

**08. Dirty.** An individual egg that has an unbroken shell with adhering dirt or foreign material, prominent stains or moderate stains covering more than one thirty-second (1/32) of the shell surface if localized, or one-sixteenth (1/16) of the shell surface if scattered. (3-20-20)T

**09. Check.** An individual egg that has a broken shell or crack in the shell but with its shell membranes intact and its contents do not leak. A “check” is considered to be lower in quality than a “dirty.” (3-20-20)T

**013. -- 049. (RESERVED)**

**050. TERMS DESCRIPTIVE OF SHELL.**

**01. Clean.** A shell that is free from foreign material and from stains or discolorations that are readily visible. An egg may be considered clean if it has only very small specks, stains or cage marks if such specks, stains or cage marks are not of sufficient number or intensity to detract from the generally clean appearance of the egg. Eggs that show traces of processing oil on the shell are considered clean unless otherwise soiled. (3-20-20)T

**02. Dirty.** A shell that is unbroken and that has dirt or foreign material adhering to its surface, that has prominent stains, or moderate stains covering more than one thirty-second (1/32) of the shell surface if localized or one-sixteenth (1/16) of the shell surface if scattered. (3-20-20)T

**03. Practically Normal (AA or A Quality).** A shell that approximates the usual shape and that is sound and is free from thin spots. Ridges and rough areas that do not materially affect the shape and strength of the shell are permitted. (3-20-20)T

**04. Abnormal (B Quality).** A shell that may be somewhat unusual or decidedly misshapen or that may show pronounced ridges or thin spots. (3-20-20)T

**051. -- 099. (RESERVED)**

**100. TERMS DESCRIPTIVE OF THE AIR CELL.**

**01. Depth of Air Cell.** The depth of the air cell (air space between shell membranes, normally in the large end of the egg) is the distance from its top to its bottom when the egg is held air cell upward. (3-20-20)T

**02. Free Air Cell.** An air cell that moves freely toward the uppermost point in the egg as the egg is rotated slowly. (3-20-20)T

**03. Bubbly Air Cell.** A ruptured air cell resulting in one (1) or more small separate air bubbles usually floating beneath the main air cell. (3-20-20)T

**101. -- 149. (RESERVED)**

**150. TERMS DESCRIPTIVE OF THE WHITE.**

**01. Clear.** A white that is free from discolorations or from any foreign bodies floating in it. (Prominent chalazas should not be confused with foreign bodies such as spots or blood clots). (3-20-20)T

**02. Firm (AA Quality).** A white that is sufficiently thick or viscous to prevent the yolk outline from being more than slightly defined or indistinctly indicated when the egg is twirled. With respect to a broken-out egg, a firm white has a Haugh unit value of seventy-two (72) or higher when measured at a temperature between forty-five (45) Degrees F and sixty (60) Degrees F. (3-20-20)T

**03. Reasonably Firm (A Quality).** A white that is somewhat less thick or viscous than a firm white. A reasonably firm white permits the yolk to approach the shell more closely that results in a fairly well defined yolk outline when the egg is twirled. With respect to a broken-out egg, a reasonably firm white has a Haugh unit value of

sixty (60) to seventy-two (72) when measured at a temperature between forty-five (45) Degrees F and sixty (60) Degrees F. (3-20-20)T

**04. Weak and Watery (B Quality).** A white that is weak, thin and generally lacking in viscosity. A weak and watery white permits the yolk to approach the shell closely, thus causing the yolk outline to appear plainly visible and dark when the egg is twirled. With respect to a broken-out egg, a weak and watery white has a Haugh unit value lower than sixty (60) when measured at a temperature between forty-five (45) Degrees F and sixty (60) Degrees F. (3-20-20)T

**05. Blood Spots or Meat Spots.** Small blood spots or meat spots (aggregating not more than one-eighth (1/8) inch in diameter), may be classified as "B" quality. If larger, or showing diffusion of blood into the white surrounding a blood spot, the egg must be classified as Loss. Blood spots must not be due to germ development. They may be on the yolk or in the white. Meat spots may be blood spots that have lost their characteristic red color or tissue from the reproductive organs. (3-20-20)T

**06. Bloody White.** An egg that has blood diffused through the white. Eggs with bloody whites are classed as Loss. Eggs with blood spots that show a slight diffusion into the white around the localized spot are not to be classified as bloody whites. (3-20-20)T

**151. -- 199. (RESERVED)**

**200. TERMS DESCRIPTIVE OF THE YOLK.**

**01. Outline Slightly Defined (AA Quality).** A yolk outline that is indistinctly indicated and appears to blend into the surrounding white as the egg is twirled (3-20-20)T

**02. Outline Fairly Well Defined (A Quality).** A yolk outline that is discernible but not clearly outlined as the egg is twirled. (3-20-20)T

**03. Outline Plainly Visible (B Quality).** A yolk outline that is clearly visible as a dark shadow when the egg is twirled. (3-20-20)T

**04. Enlarged and Flattened (B Quality).** A yolk in which the yolk membranes and tissues have weakened and moisture has been absorbed from the white to such an extent that it appears definitely enlarged and flat. (3-20-20)T

**05. Practically Free From Defects (AA or A Quality).** A yolk that shows no germ development but may show other very slight defects on its surface. (3-20-20)T

**06. Serious Defects (B Quality).** A yolk that shows well developed spots or areas and other serious defects, such as olive yolks, that do not render the egg inedible. (3-20-20)T

**07. Clearly Visible Germ Development (B Quality).** A development of the germ spot on the yolk of a fertile egg that has progressed to a point where it is plainly visible as a definite circular area or spot with no blood in evidence. (3-20-20)T

**08. Blood Due to Germ Development.** Blood caused by development of the germ in a fertile egg to the point where it is visible as definite lines or as a blood ring. Such an egg is classified as inedible. (3-20-20)T

**201. -- 249. (RESERVED)**

**250. GENERAL TERMS.**

**01. Loss.** An egg that is inedible, cooked, frozen, contaminated, or containing bloody whites, large blood spots, large unsightly meat spots, or other foreign material. (3-20-20)T

**02. Inedible Eggs.** Eggs of the following description are classed as inedible: black rots, yellow rots,

white rots, mixed rots (addled eggs), sour eggs, eggs with green whites, eggs with stuck yolks, moldy eggs, musty eggs, eggs showing blood rings, eggs containing embryo chicks (at or beyond the blood ring state), and any eggs that are adulterated as such term is defined pursuant to the Federal Food, Drug and Cosmetic Act. (3-20-20)T

**03. Leaker.** An individual egg that has a crack or break in the shell and shell membranes to the extent that the egg contents are exuding or free to exude through the shell. (3-20-20)T

**251. -- 299. (RESERVED)**

**300. CONSUMER GRADES FOR SHELL EGGS - GENERAL.**

**01. Applicability.** The consumer grade designations established by this act are applicable to edible shell eggs in "lot" quantities rather than on an "individual" egg basis. these standards to the term "case" means thirty (30) dozen egg cases as used in commercial practices in the United States. (3-20-20)T

**02. Substitution.** Substitution of higher qualities for the lower qualities specified is permitted. (3-20-20)T

**03. No Grade.** "No Grade" means eggs of possible edible quality that fail to meet the requirements of an Idaho Consumer Grade or that have been contaminated by smoke, chemicals or other foreign material that has seriously affected the character, appearance or flavor of the eggs. (3-20-20)T

**301. -- 349. (RESERVED)**

**350. GRADE STANDARDS - TOLERANCES.**

**01. Grade AA (At Origin).** Idaho Consumer Grade AA (at origin) consists of eggs that are at least eighty-seven percent (87%) AA quality. The maximum tolerance of thirteen percent (13%) that may be below AA quality may consist of A or B quality in any combination, except that within the tolerance of B quality not more than one percent (1%) may be B quality due to air cells over three-eighths (3/8) inch, blood spots (aggregating not more than one-eighth (1/8) inch in diameter), or serious yolk defects. Not more than five percent (5%) (seven percent (7%) for Jumbo size) Checks are permitted and not more than five-tenths of one percent (0.5%) Leakers, Dirties or Loss (due to meat or blood spots) in any combination, except that such Loss may not exceed three-tenths of one percent (0.3%). Other types of Loss are not permitted. (3-20-20)T

**02. Grade AA (At Destination).** Idaho Consumer Grade AA (destination) consists of eggs that are seventy-two percent (72%) AA quality. The remaining tolerance of twenty-eight percent (28%) must consist of at least ten percent (10%) A quality, and the remainder must be B quality, except that within the tolerance for B quality not more than one percent (1%) may be B quality due to air cells over three-eighths (3/8) inch, blood spots (aggregating not more than one-eighth (1/8) inch in diameter) or serious yolk defects. Not more than seven percent (7%) (nine percent (9%) for Jumbo size) Checks are permitted and not more than one percent (1%) Leakers, Dirties, or Loss (due to meat or blood spots) in any combination except that such Loss may not exceed three tenths of one percent (0.3%). Other types of Loss are not permitted. (3-20-20)T

**03. Grade A (At Origin).** Idaho Consumer Grade A (at origin) consists of eggs that are eighty-seven percent (87%) A quality or better. Within the maximum tolerance of thirteen percent (13%) that may be below A quality, not more than one percent (1%) may be B quality due to air cells over three-eighths (3/8) inch, blood spots (aggregating not more than one-eighth (1/8) inch in diameter) or serious yolk defects. Not more than five percent (5%) (seven percent (7%) for Jumbo size) Checks are permitted and not more than five-tenths of one percent (0.5%) Leakers, Dirties or Loss (due to meat or blood spots) in any combination except that such Loss may not exceed three-tenths of one percent (0.3%). Other types of Loss are not permitted. (3-20-20)T

**04. Grade A (At Destination).** Idaho Consumer Grade A (at destination) consists of eggs that are eighty-two percent (82%) A quality or better. Within the maximum tolerance of eighteen percent (18%) that may be below A quality, not more than one percent (1%) may be B quality due to air cells over three-eighths (3/8) inch, blood spots (aggregating not more than one-eighth (1/8) inch in diameter) or serious yolk defects. Not more than seven percent (7%) (nine percent (9%) for Jumbo size) Checks are permitted and not more than one percent (1%) Leakers,

Dirties, or Loss (due to meat or blood spots) in any combination, except that such Loss may not exceed three-tenths of one percent (0.3%). Other types of Loss are not permitted. (3-20-20)T

**05. Grade B (At Origin).** Idaho Consumer Grade B (at origin) consists of eggs that are ninety percent (90%) B quality or better, not more than ten percent (10%) may be Checks and not more than five-tenths of one percent (0.5%) Leakers, Dirties or Loss (due to meat or blood spots) except that such Loss may not exceed three-tenths of one percent (0.30%) in any combination. Other types of Loss are not permitted. (3-20-20)T

**06. Grade B (at Destination).** Idaho Consumer Grade B (at destination) consists of eggs that are ninety percent (90%) B quality or better, not more than ten percent (10%) may be Checks and not more than one percent (1%) Leakers, Dirties, or Loss (due to meat or blood spots) in any combination, except that such Loss may not exceed three-tenths of one percent (0.3%). Other types of Loss are not permitted. (3-20-20)T

**351. -- 399. (RESERVED)**

**400. ADDITIONAL TOLERANCES -- IN LOTS OF TWO OR MORE CASES.**

**01. Grade AA.** No individual case may exceed ten percent (10%) less AA quality eggs than the minimum permitted for the lot average. (3-20-20)T

**02. Grade A.** No individual case may exceed ten percent (10%) less A quality eggs than the minimum permitted for the lot average. (3-20-20)T

**03. Grade B.** No individual case may exceed ten percent (10%) less B quality eggs than the minimum permitted for the lot average. (3-20-20)T

**04. Single Egg Exemption.** For Grades AA, A, and B, no lot may be rejected or downgraded due to the quality of a single egg except for loss other than blood or meat spots. (3-20-20)T

**05. Lots of Two or More Cartons.** In lots of two (2) or more cartons, no individual carton may contain less than eight (8) eggs of the specified quality and no individual carton may contain less than ten (10) eggs of the specified quality and the next lower quality. The remaining two (2) eggs may consist of a combination of qualities below the next lower quality (i.e., in lots of grade A, not more than two (2) eggs of the qualities in individual cartons within the sample may be B or checks). (3-20-20)T

**401. -- 449. (RESERVED)**

**450. SUMMARY OF IDAHO CONSUMER GRADES FOR SHELL EGGS.**

**01. Grades for Shell Eggs -- Table 1.**

	TOLERANCE PERMITTED		
	QUALITY REQUIRED	Percent	Quality
<b>IDAHO CONSUMER GRADE (origin)</b>			
Grade AA	87 percent AA	Up to 13 Not over 5	A or B Checks
Grade A	87 percent A or Better	Up to 13 Not over 5	B Checks
Grade B	90 percent B or Better	Not over 10	Checks
<b>IDAHO CONSUMER GRADE (destination)</b>			
Grade AA	72 percent AA	Up to 28 Not over 7	A or B Checks

TOLERANCE PERMITTED			
	QUALITY REQUIRED	Percent	Quality
Grade A	82 percent A or Better	Up to 18 Not Over 7	B Checks
Grade B	90 percent B or Better	Not over 10	Checks

(3-20-20)T

**a.** In lots of two (2) or more cases or cartons, see Table 2 of Section 450 for tolerances for an individual case or carton within a lot. (3-20-20)T

**b.** For Idaho Consumer Grades (at origin) a tolerance of five-tenths of one percent (0.5%) Leakers, Dirties, or Loss (due to meat or blood spots) in any combination is permitted except that such Loss may not exceed three-tenths of one percent (0.3%). Other types of Loss are not permitted. (3-20-20)T

**c.** For Idaho Consumer Grades (destination) a tolerance of one percent (1%) Leakers, Dirties, or Loss (due to meat or blood spots) in any combination is permitted, except that such Loss may not exceed three-tenths of one percent (0.3%). Other types of Loss are not permitted. (3-20-20)T

**d.** For Idaho Consumer Grade AA at destination, at least ten percent (10%) must be A quality or better. (3-20-20)T

**e.** For Idaho Consumer grade AA and A at origin and destination within the tolerances permitted for B quality, not more than one percent (1%) may be B quality due to air cells over three-eighths (3/8) inch, blood spots (aggregating not more than one-eighth (1/8) inch in diameter) or serious yolk defects. (3-20-20)T

**f.** For Idaho Consumer Grades AA and A Jumbo size eggs, the tolerance for checks at origin and destination is seven percent (7%) and nine percent (9%) respectively. (3-20-20)T

**02. Tolerance for Individual Case or Carton Within a Lot -- Table 2.**

Idaho Consumer Grade	Case Minimum Quality	Origin Percent	Destination Percent	Carton Minimum Quality, No. of Eggs (Origin & Destination)
Grade AA	AA (Min)	77	62	8 eggs AA
	A or B	13	28	2 eggs A
	Check (Max)	10	10	2 eggs B, or Check
Grade A	A (Min)	77	72	8 eggs A
	B	13	18	2 eggs B
	Check (Max)	10	10	2 eggs Check
Grade B	B (Min)	80	80	10 eggs B
	Check	20	20	2 eggs Check

(3-20-20)T

**03. Summary of Standards for Quality of Individual Shell Eggs.** The Specifications for Each Quality Factor:



Quality Factor	AA Quality	A Quality	B Quality
Shell	Clean	Clean	Clean to Slightly Stained
	Unbroken Practically Normal	Unbroken Practically Normal	Unbroken Abnormal
Air Cell	1/8" or less in Depth. Unlimited movement and free or bubbly	3/16" or less in Depth. Unlimited movement and free and bubbly	Over 3/16" in Depth. Unlimited movement and free or bubbly
White	Clear Firm	Clear Reasonably Firm	Weak and Watery. Small Blood and Meat spots present
Yolk	Outline slightly defined. Practically free from defects	Outline fairly well defined. Practically free from defects.	Outline plainly visible. Enlarged and flattened. Clearly visible germ development but no blood. Other serious defects

(3-20-20)T

**a.** Moderately stained areas permitted (one thirty-second (1/32) of surface if localized or one-sixteenth (1/16) if scattered). (3-20-20)T

**b.** Blood and meat spots are allowed if they are small (aggregating not more than one-eighth (1/8) inch in diameter). (3-20-20)T

**04. Quality of Dirty or Broken Shell Eggs -- Table 5.** For eggs with dirty or broken shells, the standards of quality provide three additional qualities. These are:

Dirty	Check	Leaker
Unbroken Adhering dirt or foreign material, moderate stained areas in excess of B quality	Broken or cracked shell but membranes intact, not leaking	Broken or cracked shell and membranes and contents leaking or free to leak

(3-20-20)T

**05. Weight Classes.** The weight class for Idaho Consumer Grades for shell eggs is as indicated in the following table:

Size Or Weight Class	Minimum Net Weight Per Dozen	Minimum Net Weight Per 30 Dozen (Pounds)	Minimum Weight For Individual Eggs At Rate Per Dozen (Ounces)
Jumbo	30	56	29
Extra Large	27	50.5	26
Large	24	45	23
Medium	21	39.5	20
Small	18	34	17
Peewee	15	28	--

(3-20-20)T

**06. Lot Average Tolerance.** A lot average tolerance of three and three-tenths percent (3.3%) for individual eggs in the next lower weight class is permitted as long as no individual case within the lot exceeds five percent (5%). (3-20-20)T

**451. -- 499. (RESERVED)**

**500. EGG PRODUCTS AND BREAKING OPERATIONS.**

Anyone engaged in a breaking operation for the production of egg products may obtain a copy of the Federal "Regulations Governing Voluntary Inspection of Egg Products and Grading" (7 CFR Part 55) from the United States Department of Agriculture, AMS, Poultry Division, Washington, DC 20250, Revised May 1, 1991. This is a federally mandated program. The Department of Agriculture has entered into a cooperative agreement with the United States Department of Agriculture (USDA) to provide constant monitoring of these operations. Egg product plants in Idaho are monitored with state staff implementing federal regulations as contained in (7 CFR Part 55) including but not limited to: breaking, pasteurization, packaging, labeling, storage and plant sanitation. Copies of these federal regulations are on file at the Idaho Department of Agriculture located at 2270 Old Penitentiary Road, Boise, Idaho 83712. (3-20-20)T

**501. -- 549. (RESERVED)**

**550. SANITATION AND STORAGE.**

**01. Grading Room.** Animals, pets, livestock, etc., are not allowed in the grading and packing rooms, or any areas where eggs, cases, flats, and cartons are stored. (3-20-20)T

**02. Wash Water.** Wash water must be clean, potable and free of foreign material. Water must be changed as often as necessary so as to comply. (3-20-20)T

**03. Wash Water Temperature.** The minimum temperature of the wash water must be ninety (90) degrees F or higher, and must be at least twenty (20) degrees F warmer than the temperature of the eggs to be washed. These temperatures must be maintained through the cleaning cycle. (3-20-20)T

**04. Pre-Wetting or Soaking.** Pre-wetting or soaking of stained eggs may not exceed five (5) minutes. Water temperature must meet requirements of Subsection 550.03. (3-20-20)T

**05. Rest Period.** During any rest period, eggs must be removed from the washing and rinsing area of the egg washer and from the scanning area whenever there is a buildup of heat. (3-20-20)T

**06. Washing and Rinsing Compound.** Where washing and rinsing compounds are used, they must be approved by the United States Department of Agriculture or the State Department of Agriculture. (3-20-20)T

**07. Grading and Packing Rooms.** Grading and packing rooms must be kept reasonably clean during grading and packing operations and must be thoroughly cleaned at the end of each operating day. (3-20-20)T

**08. Weighing and Grading Equipment.** Weighing and grading equipment, whether manual or automatic, must be kept clean and be capable of ready adjustment. (3-20-20)T

**09. Adequate Lavatory and Toilet Accommodations Must Be Provided.** Toilet and locker rooms must be maintained in a clean and sanitary condition. Hot and cold running water must be provided. Signs must be posted in the rest rooms instructing employees to wash their hands before returning to work. (3-20-20)T

**10. Trash.** Trash accumulations must be removed from the grading room after each day of operation and removed from the premises on a regular basis. (3-20-20)T

**11. Thermometers.** Accurate thermometers must be provided in egg coolers. (3-20-20)T

**12. Sanitary Conditions.** Cooler rooms must be free from objectable odors and from mold, and maintained in a sanitary condition. (3-20-20)T

**13. Egg Handling and Transport.** (3-20-20)T

**a.** All eggs handled, stored or offered for sale by egg distributors, egg dealers and retailers must be held under refrigeration at a temperature of forty-five (45) degrees F or below. (3-20-20)T

**b.** Eggs must be transported from one facility to another facility in clean and sanitary vehicles that are refrigerated or capable of maintaining the ambient temperature of the eggs at forty-five (45) degrees F or below. (3-20-20)T

**14. Distributors or Dealers.** All sales areas where eggs are offered for sale by egg distributors or dealers must be maintained in a clean and sanitary condition. (3-20-20)T

**15. Case and Carton Storage.** Egg case and carton storage must be clean and dry, free from poultry house dust or any odorous material that could be absorbed by cases or cartons. (3-20-20)T

**16. Pesticides, Insecticides and Rodenticides.** Pesticides, insecticides and rodenticides must be handled in accordance with the manufacturers' instructions. Storage of these products must be away from the egg grading and packing area. These products must not be allowed to come in contact with the shell eggs being processed, stored, or with egg cases and cartons. (3-20-20)T

**17. Clean Clothing.** Personnel handling, packing and grading eggs must wear clean clothing. (3-20-20)T

**18. Cases and Packing Materials.** Egg cases and packing materials must be clean, free of mold, mustiness and any odors. (3-20-20)T

**551. -- 599. (RESERVED)**

**600. EGG SEALS, TAX AND CARTONS.**

**01. Cartons.** Each egg carton must display the following: (3-20-20)T

**a.** An official egg seal one and one-fourth (1 1/4") inches in diameter, black in color with white printing, containing the statement: "State of Idaho, Department of Agriculture - One Dozen Graded Eggs." These official gummed egg seals are available only through the Department and sold at the assessment rate established in this rule; or (3-20-20)T

**b.** A legible facsimile egg seal, as defined in Subsection 600.02 of these rules. (In lieu of the official or facsimile egg seal application for exemption from use of seals may be made to the Director under the provisions of Subsection 600.07 of these rules.) (3-20-20)T

**c.** Grade of the eggs contained in the carton. (3-20-20)T

**d.** Size of the eggs contained in the carton. (3-20-20)T

**e.** The name and address of the distributor, together with any desired business or corporation name. (e.g. John Doe, Boise, Idaho; or Produced for, Packed for, Distributed for X-Y-Z Stores, by John Doe, Boise, Idaho.) (3-20-20)T

**f.** The statement "Keep Refrigerated" or with a statement of similar meaning. (3-20-20)T

**g.** The items set forth in Subsections 600.01.a. or 600.01.b., and 600.01.c. and 600.01.d. must be contained on the top panel; items set forth in Subsections 600.01.e. and 600.01.f. may be contained anywhere on the lid portion of each egg carton to be used by any dealer or distributor. The items must be clearly and legibly displayed

in contrast to the color of the carton and surrounding colors so that they can be easily distinguished and read. Other coloring or printing that may appear on the top panel of each egg carton must not dominate the above listed items. No printed matter or design must separate or interfere with the clear legibility of the necessary items. (3-20-20)T

**02. Facsimile Idaho Egg Seal.** The Idaho facsimile egg seal must be one and one-fourth (1 1/4") inches in diameter, contain the wording "State of Idaho Department of Agriculture - One Dozen Graded Eggs." If there is to be any deviation in wording or size, written permission must be obtained from the Director prior to use of any such deviating seal. The color does not have to be black. The color of the facsimile Idaho Egg Seal must be in contrast to the color of the egg carton so that it can be easily distinguishable and read in either a good or a poor light and must not be smeared or smothered out or predominated over by other printing or coloring that may appear on the top panel of the carton. (3-20-20)T

**03. Distributor.** Distributor means the person whose name and address appear on the lid portion of the carton assuming responsibility for the size and grade of such eggs as any carton may be so labeled. (3-20-20)T

**04. Top Panel.** That portion of the egg carton that is the horizontal plane forming the top of the lid of the carton. (3-20-20)T

**05. Proofs.** Proofs of all cartons desired to be used may be submitted to the Director for approval prior to their use. (3-20-20)T

**06. Imprinting.** Procedure for the imprinting of the facsimile Idaho Egg Seal on cartons of eggs: (3-20-20)T

**a. Instructions for Dealer or Distributor:** (3-20-20)T

i. A person grading, candling or packing eggs for retail in Idaho must request authorization from the State Department of Agriculture prior to the printing of the facsimile Idaho Egg Seal on the egg cartons. (3-20-20)T

ii. The request must be accompanied by payment of four (4) mills per facsimile Idaho Egg Seal along with the name and address of the printer or supplier. (3-20-20)T

iii. It is unlawful to cause to be printed or to receive cartons printed with the facsimile Idaho Egg Seal other than as requested and paid for by the authorization request and/or allowed under the authorization permit. Section 37-1526, Idaho Code, provides a penalty for such act. (3-20-20)T

iv. There will be no refund of tax if the printer or supplier delivers short of the amount of the authorizing permit. (3-20-20)T

**b. Instructions for Printer or Supplier:** (3-20-20)T

i. The printer or supplier must be registered with the Department of Agriculture. (3-20-20)T

ii. To register, the printer or supplier must post a one thousand dollar (\$1,000) surety bond to the effect that only that amount of facsimile Idaho Egg Seals will be delivered for which the authorization permit has been granted. If overage is printed, then an additional authorization permit for the overage must be secured and the tax paid before the overage can be delivered. (3-20-20)T

iii. A copy of the printer's or supplier's delivery invoice must be submitted to the Department of Agriculture immediately upon completion and delivery of the order. (3-20-20)T

iv. It is unlawful for a printer or supplier to reproduce a facsimile Idaho Egg Seal without authorization of the Department of Agriculture. Section 37-1526, Idaho Code, provides a penalty for such act. (3-20-20)T

**07. Assessments in Lieu of Egg Seals.** Applications for exemption of egg seals must be made to the Director of Agriculture. This application will require the following information and facts. Upon application and approval by the Director, the assessment at the rate of four (4) mills or four-tenths (4/10) of a cent per dozen must be

paid on a monthly basis in lieu of egg seals. Such assessment is applicable to all eggs entering intrastate commerce. (3-20-20)T

- a.** Application must be made by person or firm that is billing or invoicing eggs sold within Idaho. (3-20-20)T
- b.** Applicant must hold a current shell egg distributor license. (3-20-20)T
- c.** Applicant must show a sound and accurate accounting procedure from which to prepare monthly reports. Accounting procedure subject to approval by the Director. (3-20-20)T
- d.** Reports must be made on a monthly basis on or before the twenty-fifth (25th) day following the month such eggs enter intrastate commerce. (3-20-20)T
- e.** Applicant who pays assessments in lieu of egg seals are subject to audit by the Director or person appointed by him on an annual basis or more frequently, if in the opinion of the Director, such audit is necessary. (3-20-20)T

**08. Divided Cartons Design.** Egg cartons designed to permit the division of such carton by the retail customer into two (2) portions of one-half (1/2) dozen eggs are permissible if the carton, when undivided, conforms to law and these rules. (3-20-20)T

**09. Reporting Form.** A reporting form will be made available to each dealer or distributor that must be completed by them accounting for all eggs entering intrastate commerce and mailed to the Department of Agriculture by the twenty-fifth (25th) day following the month such eggs entered intrastate commerce. (3-20-20)T

- a.** The reporting form must be signed by the owner, manager or authorized person of the business or corporation. stating the report is correct and accurate. (3-20-20)T
- b.** A check or money order covering the quantity of eggs sold in Idaho, reported at the rate of four (4) mills per dozen must accompany the report. (3-20-20)T
- c.** All records and invoices must be maintained for two (2) years and made available to authorized representatives of the Director for the purpose of auditing and to determine the correctness of monthly report forms as set forth in Section 37-1525, Idaho Code. (3-20-20)T

**601. -- 999. (RESERVED)**

## 02.02.12 – BONDED WAREHOUSE RULES

### 000. LEGAL AUTHORITY.

This chapter is adopted under the legal authority of Section 69-231, Idaho Code. (3-20-20)T

### 001. TITLE AND SCOPE.

**01. Title.** The title of this chapter is IDAPA 02.02.12, “Bonded Warehouse Rules.” (3-20-20)T

**02. Scope.** These rules clarify the procedure for licensing, collection and remittance of assessment, determining claim value, maintaining electronic records use of electronic scales and remedies of the Department for non-compliance. (3-20-20)T

### 002. -- 009. (RESERVED)

### 010. DEFINITIONS.

The definitions set forth in Section 69-202, Idaho Code, and the following apply: (3-20-20)T

**01. Cash Sale.** Payment to the producer by the warehouse or dealer contemporaneously with the transfer of commodity to the warehouse or dealer. (3-20-20)T

**02. Commodity Indemnity Fund (CIF).** Commodity Indemnity Fund is a trust fund. (3-20-20)T

**03. Credit-Sale Contract.** An agreement in writing containing the provisions of Section 69-249, Idaho Code, and where the producer transfers a specific quantity of commodity to a warehouse or dealer with a price or payment to the producer by the warehouse or dealer to be made at a later date or on the occurrence of a specific event expressed in the agreement. (3-20-20)T

**04. Dealer.** Is limited to dealers licensed by the state of Idaho. (3-20-20)T

**05. Deposit for Service.** Deposit of a commodity by a person for cleaning, processing, reconditioning or the rendering of other similar services by a warehouse, but does not include either a cash sale, credit-sale, or open storage. (3-20-20)T

**06. NPE.** (No price established contract) A contract containing no readily calculable sale value of the commodity for the producer. (3-20-20)T

**07. Open Storage.** The deposit of commodity by the producer for a period of time with the subsequent disposition of the same commodity or a fungible commodity as agreed to by the parties. (3-20-20)T

**08. Warehouse.** Is limited to warehouses licensed by the state of Idaho. (3-20-20)T

### 011. (RESERVED)

### 012. LICENSING.

**01. Posting of License.** Immediately upon receipt of the license or any renewal, extension or modification thereof under Title 69, Chapter 2, Idaho Code, the licensed warehouseman shall post the license in a conspicuous place in each place of business or in any other place as the Director may determine. The Department will issue a duplicate license for each additional facility as needed. (3-20-20)T

**02. Return of Suspended or Terminated License.** If a license issued to a warehouseman has lapsed or is suspended, revoked or canceled by the Director, the license shall be returned to the Department. (3-20-20)T

**03. Suspension Due to Neglect.** If, through inspection or other information, it is revealed or indicated that the commodities in storage are deteriorating due to the warehouseman’s or operator’s neglect, the license may be suspended until the matter has been corrected to the satisfaction of the Director. (3-20-20)T

**04. Loss of License.** Upon satisfactory proof of the loss or destruction of a license issued to a warehouseman, a duplicate may be issued under the same number or a new number at the discretion of the Director. (3-20-20)T

**05. Sign to Be Posted.** Each licensed warehouseman shall maintain suitable signs on the licensed property in such manner as will give ample public notice of his tenancy. These signs shall be painted on the warehouse or elevator in letters not less than six (6) inches in height and contain the following words: "State No. \_\_\_\_." The number of each warehouse will be assigned by the Director. (3-20-20)T

**06. Bins Labeled.** All storage areas licensed for the storage of agricultural commodities shall be numbered and have a diagram of the storage areas kept in the office showing the exact dimensions and the maximum capacity of the storage area. (3-20-20)T

**07. Insurance Calculations.** The director may approve a request to reduce the insurance calculation for a facility provided the request is in writing and evidence is supplied that all agricultural commodities that are stored at any given point in time are insured pursuant to Title 69, Chapter 2, Idaho Code. (3-20-20)T

**013. -- 049. (RESERVED)**

**050. RECEIPTING.**

**01. Every Warehouseman.** Every warehouseman shall issue a negotiable warehouse receipt when requested to do so by the depositor. All storage and handling charges are due and payable on or before July 1 following the date of the issuance of the receipt, or as agreed upon by the parties. (3-20-20)T

**02. Form of Nonnegotiable Warehouse Receipts.** Nonnegotiable warehouse receipts that contain the essential terms for warehouse receipts as set forth in Section 28-7-202, Idaho Code, and Section 69-223, Idaho Code, are deemed sufficient for all purposes. Copies of all nonnegotiable warehouse receipts shall be kept as permanent records by the warehouseman issuing them. (3-20-20)T

**03. Lost Negotiable Warehouse Receipt.** To cancel an outstanding warehouse receipt or issue a new warehouse receipt supplementing one that has been lost or destroyed, the licensed warehouseman shall require the depositor or other applicant to submit to the warehouseman: (3-20-20)T

**a.** An affidavit showing that he is lawfully entitled to the possession of the original receipt, that he has not negotiated or assigned it and how the original receipt was lost or destroyed; and (3-20-20)T

**b.** A bond in the amount double the market value of the agricultural commodity represented by the lost or destroyed receipt. The market value shall be determined at the time this bond is submitted for the lost receipt. A duplicate warehouse receipt shall clearly state that it is a duplicate receipt, the number of the receipt the duplicate is replacing, and the license number under which the original receipt was issued. (3-20-20)T

**04. Electronic Warehouse Receipts.** An electronic version of a warehouse receipt generated by a provider licensed and approved by the United States Department of Agriculture (USDA) that contains the same information as the paper version of a warehouse receipt may be issued instead of a paper document. The electronic version of a warehouse receipt carries the same rights and obligations as the paper version. At no time may a paper receipt and an electronic receipt represent the same lot of commodity. Electronic warehouse receipts shall be numbered and issued consecutively starting with the number specified to the provider by the department. (3-20-20)T

**05. Agreements.** Prior to entering into an agreement with an electronic warehouse receipt provider to issue such receipts, a warehouse licensee must provide a copy of the proposed agreement to the department for review and approval. A warehouse operator shall not issue electronic negotiable warehouse receipts until and unless the department approves its agreement with an electronic warehouse receipt provider and notifies the licensee of such approval. A provider shall be independent of any outside influence or bias in action or appearance. In order to be approved by the department, an electronic warehouse receipt provider agreement shall: (3-20-20)T

**a.** Only be with a provider that is first approved as an electronic warehouse receipt provider by the USDA pursuant to the provisions of 7 CFR Part 735. Upon department request, a provider shall provide a copy of the provider's executed USDA Form WA-460 and any addenda, and any other documentation requested by the department to confirm that the provider is a USDA-approved provider in good standing. (3-20-20)T

**b.** Provide for the department to become a joint holder on all open electronic negotiable warehouse receipts if the issuing warehouse operator's license is relinquished or revoked. (3-20-20)T

**c.** Require the provider to provide security as required by its provider agreement with the USDA regarding on-site security, data authorization, security plans, and facility vulnerability. (3-20-20)T

**d.** Prohibit the provider from deleting or altering any electronic negotiable warehouse receipts in the centralized filing system unless such actions are authorized by the department. (3-20-20)T

**e.** Allow the department unrestricted access to the central filing system for electronic warehouse receipts issued on behalf of warehouse operators licensed by the department. The electronic warehouse receipt data shall be maintained for six (6) years after cancellation of the receipts. Access shall be free of charge and made available in a manner that allows interaction with department warehouse examinations. (3-20-20)T

**f.** Require the provider, when a warehouse operator changes provider, to supply the new provider and the warehouse operator with a complete list of all the current holders of open electronic negotiable commodity warehouse receipts prior to the intended transfer date. (3-20-20)T

**06. Change in Provider.** A warehouse operator shall issue electronic warehouse receipts through only one (1) approved provider at a time. (3-20-20)T

**a.** A warehouse operator may change providers only once a year unless otherwise approved by the department. (3-20-20)T

**b.** A warehouse operator shall notify the department of the exact date of the proposed transfer thirty (30) calendar days prior to the intended date of any transfer to a new provider. The operator must also, thirty (30) days prior to the intended transfer date, send notices of the change to the holders of all open electronic negotiable warehouse receipts specifying the date and time period during which access to receipts will not be available. (3-20-20)T

**051. -- 079. (RESERVED)**

**080. FORWARDING AGRICULTURAL COMMODITIES.**

Warehouses licensed under Title 69, Chapter 2, Idaho Code, receiving agricultural commodities for shipment to terminals or to other warehouses for storage or processing within the state or outside the state shall have in their possession a statement authorizing the shipment of agricultural commodities to another location for storage or processing that is signed by the owner or producer of the agricultural commodity. The receiving warehouse shall be a state or federally licensed and bonded warehouse or have a Commodity Credit Corporation storage agreement. When requested to do so by an Idaho Warehouse Examiner, the shipping warehouse shall promptly procure from the terminal or storage warehouse a statement or negotiable warehouse receipt on a form approved by the director describing the quantity, class and grade of all agricultural commodities so shipped and in storage. The shipping warehouse shall have such forms promptly forwarded and returned to the Idaho Department of Agriculture, Bureau of Warehouse Control, within fifteen (15) days of issuance. (3-20-20)T

**081. -- 099. (RESERVED)**

**100. OFFICE RECORDS.**

A warehouseman shall maintain complete and sufficient records to show all deposits, purchases, sales contracts, storage obligations and loadouts of the warehouse in this state that are subject to Department inspection during normal business hours. Office records as set forth in Title 69, Chapter 2, Idaho Code, include, but not limited to, the following: (3-20-20)T

**01. Daily Position Record.** This shows the total quantity of each kind and class of agricultural commodity received and loaded out, the amount remaining in storage at the close of each business day, and the warehouseman's total storage obligation for each kind and class of agricultural commodity at the close of each business day. (3-20-20)T



**02. Storage Ledger.** This shows the name and address of the depositor, the date purchased, the terms of the sale, and the quality and quantity of the agricultural commodity purchased by the warehouseman. When applicable, the storage ledger shall also show the tare, grade, size, net weight, and unsold amount of agricultural commodities. (3-20-20)T

**03. Scale Weight Tickets.** Scale weight tickets, except tickets for electronic scales that are recorded and maintained electronically, shall be pre-numbered with one (1) copy of each ticket maintained in numerical order. All scale weight tickets shall show the time when the commodities were delivered, the quantities delivered, who delivered the commodities, the ownership of the commodities, and the condition of the commodities upon delivery. (3-20-20)T

**04. Receipts and Tickets.** Receipts and tickets in the warehouseman's possession that have not been issued. (3-20-20)T

**05. Receipts and Tickets Issued by the Warehouseman.** Receipts and tickets issued by the warehouseman. (3-20-20)T

**06. Receipts and Tickets Returned and Cancelled.** Receipts and tickets returned to and cancelled by the warehouseman. (3-20-20)T

**07. Insurance Documentation.** (3-20-20)T

**08. Electronic Records.** If any electronic records are maintained outside of the state of Idaho, the Department is entitled to examine them at any reasonable time and place as determined by the Department. (3-20-20)T

**101. -- 129. (RESERVED)**

**130. LICENSE APPLICATION AND CONDITIONS OF ISSUANCE.**

**01. License Application.** Application for a license to operate a warehouse under the provisions of Title 69, Chapter 2, Idaho Code, shall be on a form prescribed by the Department and include: (3-20-20)T

**a.** The full name of the person applying for the license and whether the applicant is an individual, partnership, association, corporation or other entity. (3-20-20)T

**b.** The full name of each member of the firm or partnership, or the names of the officers and directors of the company or limited liability company, association, or corporation. (3-20-20)T

**c.** The address of the principal place of business. (3-20-20)T

**d.** Information relating to any judgments against the applicants. (3-20-20)T

**e.** The location of each warehouse the applicant intends to operate and the commodities expected to be stored. (3-20-20)T

**f.** A current financial statement as specified by Section 69-206, Idaho Code. (3-20-20)T

**g.** A sketch or drawing as specified in Section 69-206, Idaho Code. (3-20-20)T

**h.** A bond as required by Section 69-208, Idaho Code. (3-20-20)T

**i.** Proof of insurance as required by Section 69-206, Idaho Code. (3-20-20)T

**j.** The license fee as prescribed by Section 69-211, Idaho Code. (3-20-20)T

**k.** Any other reasonable information the Department finds necessary to carry out the purpose and

provisions of Title 69, Chapter 2, Idaho Code. (3-20-20)T

**02. Modification.** If a licensee wishes to add additional capacity to an existing license, the Director may modify the license if all requirements of Section 69-206, Idaho Code, are met. (3-20-20)T

**131. AMOUNT OF BOND, IRREVOCABLE LETTER OF CREDIT, CERTIFICATE OF DEPOSIT, OR SINGLE BOND.**

**01. Bonding Requirement.** The amount of bond to be furnished shall be fixed at a rate pursuant to Section 69-208A, Idaho Code. (3-20-20)T

**02. Single Bond, Irrevocable Letter of Credit or Certificate of Deposit.** For the purposes of licensing as a warehouseman pursuant to Title 69, Chapter 2, Idaho Code and a seed buyer pursuant to Title 22, Chapter 51, Idaho Code a single bond, irrevocable letter of credit or certificate of deposit shall be fixed at whichever of the following amounts is greater: (3-20-20)T

**a.** Combined total indebtedness paid and owed to producers for agricultural commodity and seed crop, without any deductions, for the previous license year; or (3-20-20)T

**b.** The indebtedness owed and estimated to be owed to producers for agricultural commodity and seed crop, without any deductions, for the current license year. (3-20-20)T

**132. -- 149. (RESERVED)**

**150. WAREHOUSES TO BE KEPT CLEAN.**

Each warehouseman is required to use such precautions and surveillance as is necessary to provide for the safe and adequate storage of all commodities stored in his warehouse and to prevent these commodities from being contaminated in any way from chemicals, pesticides, fertilizers, adulterated seeds, animals, birds or any such thing as may contaminate or reduce the quality of stored goods. (3-20-20)T

**151. -- 179. (RESERVED)**

**180. WAREHOUSEMAN RESPONSIBILITIES.**

**01. Warehouse Receipts -- Quality.** A warehouseman licensed under Title 69, Chapter 2, Idaho Code, shall maintain in the facility of issuance of any negotiable warehouse receipt, for as long as the receipt is outstanding and has not been canceled, like variety, quantity, and quality of the agricultural commodity stated on the receipt. No warehouseman shall remove, deliver, direct or permit any person to remove or deliver any agricultural commodity from any warehouse for which warehouse receipts have been issued and are outstanding, without receiving and canceling the warehouse receipt that was issued for the commodity, except if the Director determines an emergency storage situation exists. A warehouseman may then forward agricultural commodities to other licensed warehouses for storage without canceling the outstanding warehouse receipt, provided the following conditions are met: (3-20-20)T

**a.** The warehouseman obtains written approval from the Department prior to forwarding agricultural commodities. (3-20-20)T

**b.** The warehouseman provides written guidelines to the Department establishing how he will be back in position within the time limits set and granted by the Department. (3-20-20)T

**c.** The warehouseman maintains and makes available to the Department records of positions concerning the forwarding of agricultural commodities. (3-20-20)T

**d.** The receiving warehouse is a state or federally licensed and bonded warehouse or have a Commodity Credit Corporation storage agreement. (3-20-20)T

**e.** The shipping warehouse has in its possession a statement signed by the bearer of the warehouse

receipt authorizing the shipment of agricultural commodities represented by such receipt to another location for storage. (3-20-20)T

**f.** When requested to do so by the Department, the shipping warehouseman shall promptly procure from the receiving warehouseman a statement describing the quantity, class and grade of all agricultural commodities so shipped and in storage on a form approved by the Director. The shipping warehouseman shall have such forms promptly forwarded to the receiving warehouseman for verification of quantity, class and grade of agricultural commodities forwarded and return the verification to the Department within fifteen (15) days of issuance. Failure to provide this statement to the Department in the above specified time, will result in a short position for the warehouseman with penalties as prescribed by law. (3-20-20)T

**02. Rights and Duties of Licensees -- Unlawful Practices.** It is unlawful for a warehouseman to: (3-20-20)T

**a.** Issue a warehouse receipt in excess of the amount of the agricultural commodity held in the licensee's warehouse to cover such receipt. (3-20-20)T

**b.** Sell, encumber, ship, transfer, remove or permit to be sold encumbered, shipped, transferred or removed from a warehouse any agricultural commodity received by him for deposit, shipment or handling for which scale weight tickets have been issued without the written approval of the holder of the scale weight ticket and such transfer shall be shown on the individual depositor's account and the inventory records of the warehouseman. (3-20-20)T

**c.** Remove or permit any person to remove any agricultural commodity from a warehouse when the amount of any fairly representative grade or class of an agricultural commodity in the warehouses of such licensee is reduced below the amount for which a warehouse receipt or scale weight ticket for the particular agricultural commodity is outstanding, except as provided for in Section 69-223(2), Idaho Code, and Rule 180.01. (3-20-20)T

**d.** Issue a warehouse receipt or scale weight ticket that exceeds the amount of agricultural commodities delivered for storage. (3-20-20)T

**e.** Issue a warehouse receipt showing a grade or description different from the grade or description of the agricultural commodities delivered and for which such warehouse receipt is issued. (3-20-20)T

**f.** Fail to deliver agricultural commodities as required by Section 28-7-402, Idaho Code. (3-20-20)T

**g.** Knowingly accept for storage any agricultural commodity destined for human consumption that has been contaminated, if such agricultural commodities are commingled with any uncontaminated agricultural commodity. (3-20-20)T

**h.** Terminate storage of an agricultural commodity in the warehouse without giving reasonable notice to the depositor as provided in Section 28-7-206, Idaho Code. (3-20-20)T

**i.** Alter, falsify, or withhold records from the warehouse examiner. (3-20-20)T

**181. -- 199. (RESERVED)**

**200. INSURANCE SETTLEMENT.**

When the commodities within a licensed warehouse have been damaged or destroyed, the warehouseman shall make complete settlement to all depositors having agricultural commodities stored in the warehouse within ten (10) days after a settlement with the insurance company. Failure of the warehouseman to make such settlement is grounds for revocation of the license. However, such settlement need not be made within the ten (10) days period if the warehouseman and the depositor agree to other terms. In the case of commingled agricultural commodities where only a portion is damaged, settlement may be made on a pro rata basis to the owners of all agricultural commodities stored within the warehouse. (3-20-20)T

**201. -- 229. (RESERVED)**

**230. AGRICULTURAL COMMODITIES -- WAREHOUSE OBLIGATIONS.**

Any agricultural commodity deposited for storage that is not sold by contract or otherwise, as shown by documentation, is open storage and shall be considered a warehouse obligation. (3-20-20)T

**231. -- 299. (RESERVED)**

**300. FINANCIAL STATEMENTS.**

In order to obtain a bonded warehouse license, the applicant shall submit a current financial statement that has been prepared not more than ninety (90) days prior to the date of application and conform to the applicable requirements of Title 69, Chapter 2, Idaho Code, as to annual financial statements. (3-20-20)T

**01. Statement Compliance.** Each licensed warehouseman shall submit to the Department an annual financial statement that has been audited or reviewed by an independent certified public accountant or independent licensed public accountant and be submitted to the Department no later than ninety (90) days after the end of the warehouseman's fiscal year. The warehouse license may be suspended or revoked for failure to comply with licensing requirements stated in Bonded Warehouse Rule Section 300 and Section(s) 69-206(6) and (7), Idaho Code. (3-20-20)T

**a.** The Department may grant an extension of no more than sixty (60) days, provided sufficient cause of an exceptional nature is provided, in writing, to the Department by a certified public accountant or a licensed public accountant and made prior to the date the financial statement is due. (3-20-20)T

**b.** The director may make exceptions to the financial statement requirements provided sufficient cause is provided and to do so would be in the best interest of the State. (3-20-20)T

**02. Statement Content.** The acceptable statement includes: (3-20-20)T

**a.** A balance sheet. (3-20-20)T

**b.** An income statement that includes annual gross sales of commodities purchased from producers covered under the act. (3-20-20)T

**c.** A statement of cash flows. (3-20-20)T

**d.** All accompanying notes to the financial statement. (3-20-20)T

**301. -- 329. (RESERVED)**

**330. AMENDING TARIFF.**

Tariffs may be amended by the licensed warehouseman by filing a new tariff with the Department. The previous tariff continues to apply on all commodities received prior to the effective date of the amended tariff until the anniversary date of deposit. The amended tariff applies to any commodities received after the effective date of the amendment and on any commodities stored under the previous tariff commencing on the anniversary date of the storage period. (3-20-20)T

**331. -- 379. (RESERVED)**

**380. LICENSE -- DURATION.**

Licenses issued under the provisions of Title 69, Chapter 2, Idaho Code, expire annually on April 30th. (3-20-20)T

**381. -- 399. (RESERVED)**

**400. INSURANCE DEDUCTIBLE.**

The maximum deductible allowed for insurance required by Section 69-206(1), Idaho Code, shall be five thousand dollars (\$5,000). However, a larger deductible may be allowed at the discretion of the Director. (3-20-20)T

**401. -- 429. (RESERVED)**

**430. ADDITIONAL BONDING REQUIREMENTS.**

If it appears the licensee does not have the ability to pay producers for commodities purchased, or when it appears the licensee does not have a sufficient net worth to outstanding financial obligations ratio, the Department may require the licensee to post a bond or other additional acceptable security in the amount of two thousand dollars (\$2,000) for each one thousand dollars (\$1,000) or fraction thereof of deficiency. (3-20-20)T

**431. -- 479. (RESERVED)**

**480. COMMODITY INDEMNITY FUND.**

The Commodity Indemnity Fund applies to entities governed by Chapter 2, Title 69, Idaho Code, and Chapter 5, title 69, Idaho Code, warehouses and dealers, respectively, unless otherwise specified. (3-20-20)T

**01. Rate of Assessment.** The rate of assessment is two-tenths of one percent (.2%) of the total value at the time of sale of the commodities pursuant to Section 69-257(2), Idaho Code. The maximum rate of assessment shall not exceed two-tenths of one percent (.2%) of the total gross dollar amount, without deductions, due the producer. The Director may establish a lower rate of assessment whenever he deems it advisable or as recommended by the advisory committee established by Section 69-261, Idaho Code. (3-20-20)T

**a.** The rate of assessment on commodity withdrawn by its producer from open storage is one cent (\$.01) per hundredweight (CWT) of commodity at the time of withdrawal. (3-20-20)T

**b.** If the amount of the assessment for a producer on all deposits made in a calendar year is calculated to be less than fifty cents (\$.50), no assessment will be collected. If deposits exceed the fifty cent (\$.50) limit, all assessments will be collected. (3-20-20)T

**02. Exemptions to Assessments.** Producers are not eligible to participate in CIF and no assessments can be collected in the following cases. (3-20-20)T

**a.** If a producer has a financial or management interest in a licensed warehouse or licensed commodity dealer, except members of a cooperative marketing association qualified under Title 22, Chapter 26, Idaho Code. (3-20-20)T

**b.** If a producer sells to another producer, none of which are a licensed warehouseman or a licensed commodity dealer. (3-20-20)T

**c.** If a producer deposits or delivers commodity to an unlicensed entity pursuant to Title 69, Chapters 2 or 5, Idaho Code. (3-20-20)T

**d.** Non-producers or producers delivering commodity that was grown on land not situated within the borders of the state of Idaho are exempt from paying assessments. (3-20-20)T

**481. HOW ASSESSMENTS ARE TO BE CALCULATED.**

Assessments shall be collected by all warehouses from all producers who deposit commodities for storage or sale. Assessments are calculated as follows: (3-20-20)T

**01. Cash Sale or Credit Sale Contract.** In a cash sale or credit sale contract on the contract price of the commodity at the time of sale. (3-20-20)T

**02. Open Storage or Deposit for Service.** When commodity is withdrawn from storage by the producer, the assessment will be one cent (\$.01) per hundred weight (CWT) at the time of withdrawal. (3-20-20)T

**03. Unpaid Assessments.** If any assessment is unpaid and a failure occurs, the amount of the unpaid assessment will be deducted from any CIF recovery paid to the producer. (3-20-20)T

**04. Incidental Costs and Expenses.** All incidental costs and expenses including, but not limited to

transportation, cleaning, in and out charges, insurance, taxes or additional services or charges are not included in the calculation to determine the assessment. (3-20-20)T

**482. RECORDKEEPING AND PAYMENT SCHEDULE.**

**01. Permanent Record.** Each warehouse and dealer shall maintain a permanent record showing producer's name and address, lot or identification number, date assessment collected, amount of assessment, commodity assessed, quantity of commodity, gross dollars of settlement and check number issued to producer. (3-20-20)T

**02. Payment Due Dates.** On or before the twentieth day of the month following the close of the quarter, on a form prescribed by the Department, the assessments imposed by Chapters 2 and 5 of Title 69, Idaho Code, collected by warehouses and dealers, are due and payable to the Department. A quarter (1/4) will consist of three (3) months beginning on the first day of January, April, July, and October. If assessment is paid by mail the payment must be postmarked not later than the twentieth day of the month following the close of the quarter to avoid interest and penalty charges. (3-20-20)T

**03. Notice.** The notice and rate of assessment or a copy of the official notice of suspension of assessment are to be posted in a conspicuous place in the warehouse or dealer facility. (3-20-20)T

**483. TRUST FUNDS.**

All assessments collected by warehouses and dealers in compliance with Chapters 2 and 5, Title 69, Idaho Code, shall, immediately upon payment to and collection by the warehouse or dealer, be trust fund money and held for payment to the Department for the CIF. Such money shall not, for any purpose, be considered to be a part of the proceeds of any transaction between a depositor and warehouse or dealer for which the collection and payment of the assessment was related and shall not be subject to an encumbrance, security interest, execution or seizure on account of any debt owed by the warehouse or dealer to any of their creditors. (3-20-20)T

**484. PENALTIES FOR FAILURE TO COLLECT, ACCOUNT FOR, OR REMIT ASSESSMENTS.**

Failure to collect, account for, or remit assessments, or violations of the statutory requirements of Chapters 2 and 5, Title 69, Idaho Code, as it relates to the CIF are grounds for the immediate demand on the warehouse, dealer bond, letter of credit, or certificate of deposit, and the undertaking by the Director of any other remedy provided by law. (3-20-20)T

**485. RETURN OF COMMODITY DUE TO FAILURE.**

In the event of failure the Department may: (3-20-20)T

**01. Identifiable Commodity.** Return specifically identifiable commodity or as much as is available to its producer in full or partial satisfaction of indebtedness; or (3-20-20)T

**02. Fungible Commodity.** If the commodity is fungible, an amount equal to the producer's original deposit or if insufficient fungible commodity is available, a pro-rata share to all producers of the commodity; and (3-20-20)T

**03. Shortfall in Commodity Distribution.** Any shortfall in commodity distribution may be submitted as a claim against the CIF. (3-20-20)T

**486. -- 500. (RESERVED)**

**501. NPE CONTRACT CLAIMS ON THE FUND.**

NPE contracts shall be executed in writing, dated, and signed by all parties to the contract. (3-20-20)T

**01. NPE Clause.** An NPE contract shall have the following statement: "No claim shall be paid from the CIF pursuant to Section 69-263, Idaho Code, if a producer files his claim more than one hundred eighty (180) days from the date the contract is executed." (3-20-20)T

**02. NPE Contract List.** A warehouseman shall maintain a list of all NPE contracts written in a

calendar year that reflects the producers name, contract number, agricultural commodity, and date of the contract.

(3-20-20)T

**03. NPE Contract Renewal Period.** A producer may renew an NPE contract; but no claim shall be paid from the CIF if a producer files his claim more than three hundred sixty-five (365) days from the date the original NPE contract was executed.

(3-20-20)T

**502. -- 999. (RESERVED)**

## 02.02.13 – COMMODITY DEALERS’ RULES

### 000. LEGAL AUTHORITY.

This chapter is adopted under the legal authority of Section 69-524, Idaho Code. (3-20-20)T

### 001. TITLE AND SCOPE.

01. **Title.** The title of this chapter is IDAPA 02.02.13, “Commodity Dealers’ Rules.” (3-20-20)T

02. **Scope.** These rules clarify the procedure for licensing, collection and remittance of assessments, determining claim value, maintaining electronic records, use of electronic scales and remedies of the Department for non-compliance. (3-20-20)T

### 002. -- 009. (RESERVED)

### 010. DEFINITIONS.

The Idaho State Department of Agriculture adopts the definitions set forth in Section 69-502, Idaho Code. In addition the following definitions apply to the interpretation and enforcement of this chapter. (3-20-20)T

01. **Cash Sale.** Payment to the producer by the warehouse or dealer contemporaneously with the transfer of commodity to the warehouse or dealer. (3-20-20)T

02. **Commodity Indemnity Fund.** Commodity Indemnity Fund is a trust fund. (3-20-20)T

03. **Credit-Sale Contract.** An agreement in writing containing the provisions of Section 69-514, Idaho Code, and where the producer transfers a specific quantity of commodity to a warehouse or dealer with a price or payment to the producer by the warehouse or dealer to be made at a later date or on the occurrence of a specific event expressed in the agreement. (3-20-20)T

04. **Dealer.** Is limited to dealers licensed by the state of Idaho. (3-20-20)T

05. **Seed Crops.** Means any seed crop regulated by Title 22, Chapter 4, Idaho Code. (3-20-20)T

06. **NPE.** (No price established contract) A contract containing no readily calculable sale value of the commodity for the producer. (3-20-20)T

07. **Warehouse.** Is limited to warehouses licensed by the state of Idaho. (3-20-20)T

### 011. ABBREVIATIONS.

01. **CIF.** Commodity Indemnity Fund. (3-20-20)T

02. **NPE.** No price established contract. (3-20-20)T

03. **SIF.** Seed Indemnity Fund. (3-20-20)T

### 012. LICENSING.

01. **Posting of License.** Immediately upon receipt of the license or any renewal, extension or modification thereof under Title 69, Chapter 5, Idaho Code, the licensed commodity dealer shall post the license in a conspicuous place in each place of business or in any other place as the director may determine. The Department will issue a duplicate license for each additional facility as needed. (3-20-20)T

02. **Return of Suspended or Terminated License.** If a license issued to a commodity dealer has lapsed or is suspended, revoked or cancelled by the Director, the license shall be returned to the Department. At the expiration of any period of suspension, revocation or cancellation the license will be returned to the commodity dealer to whom it was originally issued and be posted as prescribed by these rules. (3-20-20)T

03. **Loss of License.** Upon satisfactory proof of the loss or destruction of a license issued to a commodity dealer, a duplicate may be issued under the same number or a new number at the discretion of the Director. (3-20-20)T



**013. -- 099. (RESERVED)**

**100. OFFICE RECORDS.**

A commodity dealer shall maintain complete and sufficient records to show all purchases and sales, including all contracts relating to these transactions. A warehouse licensed as a commodity dealer under Title 69, Chapter 5, Idaho Code, must maintain complete and sufficient records to show all deposits, purchases, sales contracts, storage obligations and loadouts of the warehouse in this State. Office records as set forth in Title 69, Chapter 5, Idaho Code, include, but not be limited to, the following: (3-20-20)T

**01. Daily Position Record.** Record which shows the total quantity of each kind and class of agricultural commodity received and loaded out, the amount remaining in storage at the close of each business day and the warehouseman's total storage obligation for each kind and class of agricultural commodity at the close of each business day. (3-20-20)T

**02. Settlement Sheets/Storage Ledgers.** Every commodity dealer shall use settlement sheets showing the dealer's name and location in making settlement with the seller, unless otherwise approved by the Director. All settlement sheets/storage ledgers include, but are not limited to, the following information: (3-20-20)T

- a.** The seller's name and address. (3-20-20)T
- b.** The date of deliveries. (3-20-20)T
- c.** The scale ticket numbers. (3-20-20)T
- d.** The amount, kind and grade of commodity delivered. (3-20-20)T
- e.** The price per bushel or unit. (3-20-20)T
- f.** The date and amount of payment. (3-20-20)T
- g.** The contract number if a deferred payment, deferred pricing or other sale contract is used. A copy of each settlement sheet shall be maintained in alphabetical order by the commodity dealer as part of the pay records. (3-20-20)T
- h.** Electronic Records. If any electronic records are maintained outside of the state of Idaho, the Department must be allowed to examine them at any reasonable time and place as determined by the Department. (3-20-20)T

**03. Scale Weight Tickets.** Scale weight tickets, except tickets for electronic scales that are recorded and maintained electronically, shall be pre-numbered with one (1) copy of each ticket maintained in numerical order. All scale weight tickets shall show the time when the commodities were delivered, the quantities delivered, who delivered the commodities, the ownership of the commodities and the condition of the commodities upon delivery. (3-20-20)T

- a.** Tickets in the commodity dealer's possession that have not been issued. (3-20-20)T
- b.** Tickets issued by the commodity dealer. (3-20-20)T
- c.** Tickets returned to and cancelled by the commodity dealer. (3-20-20)T

**101. -- 149. (RESERVED)**

**150. INSPECTION.**

For the purpose of inspection the hours of 8 a.m. to 5 p.m., Monday through Friday, except holidays, are considered as ordinary business hours. All financial records, commodity records and payment records shall be available for inspection by the Department during ordinary business hours and any other reasonable time specified by the Department in writing. All records shall be made available within the state of Idaho upon request. (3-20-20)T

**151. -- 199. (RESERVED)**

**200. LICENSING APPLICATION FORMAT.**

**01. License -- Application.** Application for a license to operate as a commodity dealer under the provisions of Title 69, Chapter 5, Idaho Code, shall be on a form prescribed by the Department and include: (3-20-20)T

**a.** The full name of the person applying for the license and whether the applicant is an individual, partnership, association, corporation or other entity. (3-20-20)T

**b.** The full name of each member of the firm or partnership, or the names of the officers and directors of the company or limited liability company, association, or corporation. (3-20-20)T

**c.** The address of the principal place of business. (3-20-20)T

**d.** The names of any businesses previously owned or operated by the applicant or any members, officers or directors if the applicant is a corporation, partnership or association. (3-20-20)T

**e.** Information relating to any prior adjudication of bankruptcy relating to the business or any members, officers or directors thereof. (3-20-20)T

**f.** Information relating to any judgments against the applicants. (3-20-20)T

**g.** The location of each office the applicant intends to operate. (3-20-20)T

**h.** Any other reasonable information the Department finds necessary to carry out the purpose and provisions of Title 69, Chapter 5, Idaho Code. (3-20-20)T

**02. License Conditions of Issuance.** An application for license under Title 69, Chapter 5, Idaho Code, shall include: (3-20-20)T

**a.** Application on a form prescribed by the Director. (3-20-20)T

**b.** A current financial statement as specified by Section 69-503 and 69-521, Idaho Code. (3-20-20)T

**c.** A bond or bonds as required by Section 69-506, Idaho Code. (3-20-20)T

**d.** The license fee as prescribed by Section 69-508, Idaho Code. (3-20-20)T

**e.** Compliance with all rules adopted pursuant to Title 69, Chapter 5, Idaho Code. (3-20-20)T

**f.** Any other reasonable information the Department finds necessary to carry out the purpose and provisions of Title 69, Chapter 5, Idaho Code. (3-20-20)T

**03. License Modification.** At the request of the license holder a license may be modified to change existing license classification, providing all requirements of Section 69-508, Idaho Code, are met. (3-20-20)T

**201. -- 249. (RESERVED)**

**250. RECORDS -- SEPARATE.**

All records and accounts required under Title 69, Chapter 5, Idaho Code, shall be kept separate and distinct from all records and accounts of any other business and are subject to inspection by the Director at any reasonable time. (3-20-20)T

**251. -- 299. (RESERVED)**

**300. FINANCIAL STATEMENT.**

**01. Financial Statements.** In order to obtain a commodity dealer's license, the applicant shall submit a current financial statement prepared not more than ninety (90) days prior to the date of application and conform to the applicable requirements of Title 69, Chapter 5, Idaho Code, as to annual financial statements. (3-20-20)T

**02. Statement Compliance.** Each licensed commodity dealer shall submit to the Department an annual financial statement that has been audited or reviewed by an independent certified public accountant or independent licensed public accountant. The statement shall be submitted to the Department no later than ninety (90) days after the end of the commodity dealer's fiscal year. The commodity dealer license may be suspended or revoked for failure to comply with licensing requirements stated in Subsection 300.01 of these rules and Section(s) 69-503(6) and 69-521, Idaho Code. (3-20-20)T

**a.** The Department may grant an extension of no more than sixty (60) days, provided cause of an exceptional nature is provided, in writing, to the Department. (3-20-20)T

**b.** The request must be made by a certified public accountant or a licensed public accountant. (3-20-20)T

**c.** The request is made prior to the date the financial statement is due. (3-20-20)T

**d.** The director may make exceptions to the financial statement requirements provided sufficient cause is provided and to do so would be in the best interest of the state. (3-20-20)T

**03. Statement Content.** The statement shall include: (3-20-20)T

**a.** A balance sheet. (3-20-20)T

**b.** An income statement that includes annual gross sales of commodities purchased from producers covered under the act. (3-20-20)T

**c.** A statement of cash flows. (3-20-20)T

**d.** All accompanying notes to the financial statement. (3-20-20)T

**301. -- 349. (RESERVED)**

**350. SHIPPING RECORDS.**

Every dealer who ships by truck shall maintain a truck shipping record and every dealer who ships by rail must maintain a rail or car shipping record. Each shipping record includes, but is not limited to, the following: (3-20-20)T

**01. Name and Address.** The name and address of the seller or shipper. (3-20-20)T

**02. Buyer and Destination.** The buyer and destination of the commodity shipped. (3-20-20)T

**03. Date.** The date the agricultural commodities were shipped. (3-20-20)T

**04. Amount and Type.** The amount and type of agricultural commodities shipped. (3-20-20)T

**05. Identification Number.** The truck identification or car number. (3-20-20)T

**351. -- 399. (RESERVED)**

**400. SCALE TICKETS.**

If a dealer has access to a scale that can be used for weighing commodity, that dealer shall use pre-numbered scale tickets showing the dealer's name and location. A copy of each ticket shall be maintained in numerical order as part

of the commodity records. If a dealer does not have access to a scale and purchases commodity by having it custom weighed at various locations or at destination, the dealer shall maintain a copy of the scale ticket in chronological order as part of the commodity records. If agricultural commodities are settled on destination weights, copies of the destination weights are to be kept as part of the records. (3-20-20)T

**401. -- 450. (RESERVED)**

**451. AMOUNT OF BOND, IRREVOCABLE LETTER OF CREDIT, CERTIFICATE OF DEPOSIT, OR SINGLE BOND.**

**01. Bonding Requirement.** The amount of bond to be furnished for each class 1 dealer and each class 2 dealer is fixed at a rate pursuant to Section 69-506, Idaho Code. (3-20-20)T

**02. Single Bond, Irrevocable Letter of Credit or Certificate of Deposit.** For the purposes of licensing as a commodity dealer pursuant to Title 69, Chapter 5, Idaho Code, and a seed buyer pursuant to Title 22, Chapter 51, Idaho Code, a single bond, irrevocable letter of credit or certificate of deposit shall be fixed at whichever of the following amounts is greater: (3-20-20)T

**a.** Combined total indebtedness paid and owed to producers for agricultural commodity and seed crop, without any deductions, for the previous license year; or (3-20-20)T

**b.** The indebtedness owed and estimated to be owed to producers for agricultural commodity and seed crop, without any deductions, for the current license year. (3-20-20)T

**03. Additional Bonding Requirements.** If it appears the licensee does not have the ability to pay producers for commodities purchased, or when it appears the licensee does not have a sufficient net worth to outstanding financial obligations ratio, the licensee may be required to post a bond or other additional acceptable security in the amount of two thousand dollars (\$2,000) for each one thousand dollars (\$1,000) or fraction thereof of deficiency. (3-20-20)T

**452. -- 499. (RESERVED)**

**500. COMMODITY INDEMNITY FUND.**

The Commodity Indemnity Fund applies to entities governed by Chapter 2, Title 69, Idaho Code, and Chapter 5, Title 69, Idaho Code, warehouses and dealers, respectively, unless otherwise specified. (3-20-20)T

**01. Rate of Assessment.** The rate of assessment is two-tenths of one percent (.2%) gross dollar amount, without deductions, due the producer pursuant to Section 69-257(2), Idaho Code. The Director may establish a lower rate of assessment whenever he deems it advisable or as recommended by the advisory committee established by Section 69-261, Idaho Code. (3-20-20)T

**02. Exemptions to Assessment.** Producers are not eligible to participate in CIF and no assessments will be collected in the following cases. (3-20-20)T

**a.** If a producer has a financial or management interest in a licensed warehouse or licensed commodity dealer, except members of a cooperative marketing association qualified under Title 22, Chapter 26, Idaho Code. (3-20-20)T

**b.** If a producer sells to another producer, none of which are a licensed warehouseman or a licensed commodity dealer. (3-20-20)T

**c.** If a producer deposits or delivers commodity to an unlicensed entity pursuant to Title 69, Chapters 2 or 5, Idaho Code. (3-20-20)T

**d.** Non-producers or producers delivering commodity that was grown on land not situated within the borders of the state of Idaho are exempt from paying assessments. (3-20-20)T

**501. NPE CONTRACT CLAIMS ON THE FUND.**

NPE contracts shall be executed in writing, dated, and signed by all parties to the contract. (3-20-20)T

**01. NPE Clause.** An NPE contract shall have the following statement: "No claim shall be paid from the CIF pursuant to Section 69-263, Idaho Code, if a producer files his claim more than one hundred eighty (180) days from the date the contract is executed." (3-20-20)T

**02. NPE Contract List.** A commodity dealer shall maintain a list of all NPE contracts written in a calendar year that reflects the producers name, contract number, agricultural commodity and date of the contract. (3-20-20)T

**03. NPE Contract Renewal Period.** A producer may renew an NPE contract; but no claim shall be paid from the CIF if a producer files his claim more than three hundred sixty-five (365) days from the date the original NPE contract was executed. (3-20-20)T

**502. HOW ASSESSMENTS ARE TO BE CALCULATED.**

Assessments shall be collected by all warehouses licensed as commodity dealers from all producers who deposit commodities for storage or sale. Assessments are calculated as follows: (3-20-20)T

**01. Cash Sale or Credit Sale Contract.** In a cash sale or credit sale contract on the contract price of the commodity at the time of sale. (3-20-20)T

**02. Unpaid Assessments.** If any assessment is unpaid and a failure occurs, the amount of the unpaid assessment will be deducted from any CIF recovery paid to the producer. (3-20-20)T

**03. Incidental Costs and Expenses.** All incidental costs and expenses including, but not limited to, transportation, cleaning, in and out charges, insurance, taxes or additional services or charges are not included in the calculation to determine the assessment. (3-20-20)T

**503. RECORDKEEPING AND PAYMENT SCHEDULE.**

**01. Permanent Record.** Each warehouse and dealer shall maintain a permanent record showing producer's name and address, lot or identification number, date assessment collected, amount of assessment, commodity assessed, quantity of commodity, gross dollars of settlement and check number issued to producer. (3-20-20)T

**02. Payment Due Dates.** On or before the twentieth day of the month following the close of the quarter, on a form prescribed by the Department, the assessments imposed by Title 69, Chapters 2 and 5, Idaho Code, collected by warehouses and dealers, are due and payable to the Department. A quarter will consist of three (3) months beginning on the first day of January, April, July, and October. If assessment is paid by mail the payment must be postmarked not later than the twentieth day of the month following the close of the quarter to avoid interest and penalty charges. (3-20-20)T

**03. Notice.** The notice and rate of assessment or a copy of the official notice of suspension of assessment shall be posted in a conspicuous place in the warehouse or dealer facility. (3-20-20)T

**504. TRUST FUNDS.**

All assessments collected by warehouses and dealers in compliance with Title 69, Chapters 2 and 5, Idaho Code, immediately upon payment to and collection by the warehouse or dealer, are trust fund money held for payment to the Department for the CIF. Such money shall not, for any purpose, be considered to be a part of the proceeds of any transaction between a depositor and warehouse or dealer for which the collection and payment of the assessment was related and shall not be subject to an encumbrance, security interest, execution or seizure on account of any debt owed by the warehouse or dealer to any of their creditors. (3-20-20)T

**505. PENALTIES FOR FAILURE TO COLLECT, ACCOUNT FOR, OR REMIT ASSESSMENTS -- OTHER VIOLATIONS.**

Failure to collect, account for, or remit assessments, or violations of the statutory requirements of Title 69, Chapters 2

and 5, Idaho Code, as it relates to the CIF are grounds for the immediate demand on the warehouse, dealer bond, or certificate of deposit, and the undertaking by the Director of any other remedy provided by law. (3-20-20)T

**506. RETURN OF COMMODITY DUE TO FAILURE.**

In the event of failure the Department may: (3-20-20)T

**01. Identifiable Commodity.** Return specifically identifiable commodity or as much as is available to its producer in full or partial satisfaction of indebtedness; or (3-20-20)T

**02. Fungible Commodity.** If the commodity is fungible, an amount equal to the producer's original deposit or if insufficient fungible commodity is available, a pro-rata share to all producers of the commodity; and (3-20-20)T

**03. Shortfall in Commodity Distribution.** Any shortfall in commodity distribution may be submitted as a claim against the CIF. (3-20-20)T

**507. -- 599. (RESERVED)**

**600. UNLAWFUL PRACTICES.**

It is unlawful for a commodity dealer to alter, falsify or withhold records from the warehouse examiner. (3-20-20)T

**601. -- 999. (RESERVED)**

## 02.02.14 – RULES FOR WEIGHTS AND MEASURES

### 000. LEGAL AUTHORITY.

This chapter is adopted under the legal authority of Sections 71-111, 71-121, 71-232, 71-233, 71-236, 71-241, and 71-408, Idaho Code. (3-20-20)T

### 001. TITLE AND SCOPE.

01. **Title.** The title of this chapter is “Rules for Weights and Measures.” (3-20-20)T

02. **Scope.** This chapter has the following scope: to govern the checking, testing, and examination of weighing and measuring devices, packages and labels; to govern consumer and non-consumer packaging and labeling; to govern the registration of servicemen and service agencies for commercial weighing and measuring devices; to govern the licensing of weighmasters, and to govern the licensing of commercially used weighing and measuring devices and to set maximum annual license fees for weighing and measuring devices. (3-20-20)T

### 002. – 003. (RESERVED)

### 004. INCORPORATION BY REFERENCE.

01. **Required Reference Materials.** The 2019 edition of Handbook No. 44 of the National Institute of Standards and Technology, United States Department of Commerce, “Specifications, Tolerances, and Other Technical Requirements for Weighing and Measuring Devices,” hereby incorporated by reference, is the specifications, tolerances and other technical requirements for commercial weighing and measuring devices, unless otherwise stated in these rules. (3-20-20)T

02. **Required Reference Materials for Checking Prepackaged Commodities.** The 2019 edition of Handbook No. 133 of the National Institute of Standards and Technology, United States Department of Commerce, “Checking the Net Contents of Packaged Goods,” hereby incorporated by reference, is the authority in checking packaged commodities, unless otherwise stated in these rules. (3-20-20)T

03. **Specifications for Diesel Fuel and Biodiesel Fuel.** American Society of Testing and Materials (ASTM) D975-16a, “Standard Specification for Diesel Fuel Oils,” and ASTM D6751-15ce<sup>1</sup>, “Standard Specification for Biodiesel Fuel (B100) Blend Stock for Distillate Fuels,” intended for blending with diesel fuel are hereby incorporated by reference and are the specifications for diesel fuel and biodiesel fuel blend stock (B100 biodiesel). (3-20-20)T

04. **Specifications for Gasoline.** American Society of Testing and Materials (ASTM) D4814-16ce<sup>1</sup>, “Standard Specification for Automotive Spark-Ignition Engine Fuel”, dated November 15, 2016, is hereby incorporated by reference and is the specification for gasoline. (3-20-20)T

05. **Local Availability.** Copies of the incorporated documents are on file with the Idaho State Department of Agriculture, 2216 Kellogg Lane, Boise, Idaho 83712. Copies of NIST documents may be purchased from the Superintendent of Documents, Government Printing Office, Washington, D.C. 20402. Copies are available for downloading at <https://www.nist.gov/pml/weights-and-measures/publications>. Copies of ASTM specifications are on file with the Idaho State Department of Agriculture or may be purchased from <http://www.astm.org>, 100 Barr Harbor Drive, P.O. Box C700, West Conshohocken, PA, 19428. (3-20-20)T

### 005. -- 009. (RESERVED)

### 010. DEFINITIONS.

In addition to the definitions set forth in Sections 71-108 and 71-401, Idaho Code, the following definitions apply to this rule: (3-20-20)T

01. **Alcohol.** A volatile flammable liquid having the general formula  $C_nH_{(2n+1)}OH$  used or sold for the purpose of blending or mixing with gasoline for use in motor vehicles, and commonly or commercially known or sold as an alcohol, including ethanol and methanol. (3-20-20)T

02. **Biodiesel.** A fuel comprised of mono-alkyl esters of long chain fatty acids derived from vegetable oils or animal fats, designated B100. (3-20-20)T

03. **Biodiesel Blends.** A fuel comprised of a blend of biodiesel fuel with petroleum-based diesel fuel,

designated BXX. In the abbreviation BXX, the XX represents the volume percentage of biodiesel fuel in the blend.  
(3-20-20)T

**04. Certificate of Conformance.** A document issued by the National Institute of Standards and Technology based on testing in participating laboratories, said document constituting evidence of conformance of a type with the requirements of National Institute of Standards and Technology Handbooks 44, 105-1, 105-2, 105-3.  
(3-20-20)T

**05. Compressed Natural Gas (CNG).** Natural Gas which has been compressed and dispensed into fuel storage containers and is suitable for use as an engine fuel.  
(3-20-20)T

**06. Commercial Weighing and Measuring Device.** Any weight or measure or weighing or measuring device commercially used or employed in establishing the size, quantity, extent, area or measurement of quantities, things, product, or articles for distribution or consumption, purchased, offered or submitted for sale, hire, or award, or in computing any basic charge or payment for services rendered on the basis of weight or measure, and must also include any accessory attached to or used in connection with a commercial weighing or measuring device when such accessory is so designed or installed that its operation affects, or may affect, the accuracy of the device. (3-20-20)T

**07. Co-Solvent.** An alcohol or any other chemical with higher molecular weight than methanol or ethanol which is blended with either or both to prevent phase separation in gasoline.  
(3-20-20)T

**08. Diesel Gallon Equivalent (DGE).** Equivalent to six point three hundred eighty-four thousandths (6.384) pounds of compressed natural gas or six point fifty-nine thousandths (6.059) pounds of liquefied natural gas.  
(3-20-20)T

**09. Ethanol.** Ethyl alcohol, a flammable liquid having the formula C<sub>2</sub>H<sub>5</sub>OH used or sold for the purpose of blending or mixing with gasoline for use in motor vehicles, and commonly or commercially known or sold as ethanol or ethyl alcohol.  
(3-20-20)T

**10. Gasoline.** Any fuel sold for use in motor vehicles and commonly or commercially known or sold as gasoline whether leaded or unleaded.  
(3-20-20)T

**11. Gasoline Gallon Equivalent (GGE).** Equivalent to five point six hundred sixty thousandths (5.660) pounds (two point five hundred sixty- seven thousandths (2.567) kilograms) of compressed natural gas.  
(3-20-20)T

**12. Gasoline Liter Equivalent (GLE).** Equivalent to one point four hundred ninety-five thousandths (1.495) pounds (zero point six hundred seventy-eight thousandths (0.678) kilograms) of compressed natural gas.  
(3-20-20)T

**13. Gasoline-Oxygenate Blend.** For labeling purposes, any spark-ignition motor fuel containing one percent (1%) or more by volume of oxygenates or combination of oxygenates, such as but not restricted to ethanol, methanol, or methyl-tertiary-butyl ether.  
(3-20-20)T

**14. Label.** Any written, printed, or graphic matter affixed to, applied to, attached to, blown into, formed, molded into, embossed on, or appearing upon or adjacent to a consumer commodity or a package containing any consumer commodity, for purposes of branding, identifying, or giving any information with respect to the commodity or to the contents of the package, except an inspector's tag or other non-promotional matter affixed to or appearing upon a consumer commodity will not be deemed to be a label requiring the repetition of label information required by this rule.  
(3-20-20)T

**15. Liquefied Natural Gas (LNG).** Natural gas that has been liquefied at minus one hundred sixty-two degrees Celsius (-162 °C) (minus two hundred sixty degrees Fahrenheit (-260 °F)) and stored in insulated cryogenic tanks for use as an engine fuel.  
(3-20-20)T

**16. Methanol.** Methyl alcohol, a flammable liquid having the formula CH<sub>3</sub>OH used or sold for the purpose of blending or mixing with gasoline for use in motor vehicles, and commonly or commercially known or sold



as methanol or methyl alcohol. (3-20-20)T

**17. Motor Vehicles.** Include all vehicles, vessels, watercraft, engines, machines, or mechanical contrivances that are propelled by internal combustion engines or motors. (3-20-20)T

**18. Multi-Unit Package.** A package containing two (2) or more individual packages of the same commodity, in the same quantity, with the individual packages intended to be sold as part of the multi-unit package but capable of being individually sold in full compliance with all requirements of this rule. (3-20-20)T

**19. National Type Evaluation Program.** A program of cooperation between the National Institute of Standards and Technology, the National Conference on Weights and Measures, the states, and the private sector for determining, on a uniform basis, conformance of a type with the relevant provisions of the National Institute of Standards and Technology Handbook 44, "Specifications, Tolerances, and Other Technical Requirements for Weighing and Measuring Devices," National Institute of Standards and Technology Handbook 105-1, "Specifications and Tolerances for Reference Standards and Field Standard Weights and Measures, Specifications and Tolerances for Field Standard Weights (NIST Class F)," National Institute of Standards and Technology Handbook 105-2, "Specifications and Tolerances for Reference Standards and Field Standard Weights and Measures, Specifications and Tolerances for Field Standard Measuring Flask," or National Institute of Standards and Technology Handbook 105-3, "Specifications and Tolerances for Reference Standards and Field Standard Weights and Measures, Specifications and Tolerances for Graduated Neck Type Volumetric Field Standards." (3-20-20)T

**20. Package.** Any commodity put up or packaged in any manner in advance of sale in units suitable for either wholesale or retail sale. (3-20-20)T

**21. Participating Laboratory.** Any State Measurement Laboratory that has been certified by the National Institute of Standards and Technology, in accordance with its program for the Certification of Capability of State Measurement Laboratories, to conduct a type of evaluation under the National Type Evaluation Program. (3-20-20)T

**22. Principal Display Panel or Panels.** That part, or those parts, of a label that is, or are, so designed as to most likely be displayed, presented, shown, or examined under normal and customary conditions of display and purchase. Wherever a principal display panel appears more than once on a package, all requirements pertaining to the "principal display panel" shall pertain to all such "principal display panels." (3-20-20)T

**23. Random Package.** A package that is one (1) of a lot, shipment, or delivery of packages of the same consumer commodity with varying weights; that is, packages of the same consumer commodity with no fixed pattern of weight. (3-20-20)T

**24. Registered Service Agency.** Any agency, firm, company or corporation which, for hire, award, commission or any other payment of any kind, installs, services, repairs or reconditions a commercial weighing or measuring device, and which voluntarily registers itself as such with the Bureau of Weights and Measures. Under agency registration, identification of individual servicemen is required. (3-20-20)T

**25. Registered Serviceman.** Any individual who for hire, award, commission or any other payment of any kind, installs, services, repairs or reconditions a commercial weighing or measuring device, and who voluntarily registers himself as such with the Bureau of Weights and Measures. (3-20-20)T

**26. Retail Dealer.** Any person who owns, operates, controls, or supervises an establishment at which gasoline is sold or offered for sale to the public. (3-20-20)T

**27. Sale from Bulk.** The sale of commodities when the quantity is determined at the time of sale. (3-20-20)T

**28. Spark-Ignition Motor Fuel.** Gasoline and its blends with oxygenates such as co-solvent and ethers (also "spark-ignition engine fuel"). (3-20-20)T

**29. Type.** A model or models of a particular measurement system, instrument, element or a field

standard that positively identifies the design. A specific type may vary in its measurement ranges, size, performance, and operating characteristics as specified in the Certificate of Conformance. (3-20-20)T

**30. Type Evaluation.** The testing, examination, and evaluation of a type by a participating laboratory under the National Type Evaluation Program. (3-20-20)T

**31. Wholesale Dealer.** Any person engaged in the sale of gasoline to others who the seller knows or has reasonable cause to believe intends to resell the gasoline in the same or an altered form to another. (3-20-20)T

**011. ABBREVIATIONS.**

**01. ISDA.** Idaho State Department of Agriculture. (3-20-20)T

**02. NIST.** National Institute of Standards and Technology. (3-20-20)T

**012. LICENSE REQUIRED FOR COMMERCIALY-USED WEIGHING OR MEASURING INSTRUMENT OR DEVICE.**

Weighing or measuring instruments or devices used for commercial purposes in the State of Idaho must be licensed annually. (3-20-20)T

**01. Annual License.** No person may operate or use for commercial purposes within the state any weighing or measuring instrument or device specified in Section 71-113, Idaho Code, that is not licensed in accordance with the requirements of this rule. (3-20-20)T

**02. Specific Device.** Any license issued applies only to the instrument or device identified by Device Code, as listed in TABLE 1-A, and rated capacity on the application for license. The license is applicable to an equivalent replacement for the original instrument or device, within the annual license period. (3-20-20)T

**013. LICENSE APPLICATION.**

License application must be submitted on forms provided by ISDA and accompanied with the proper fee as established in this rule. The capacity of an instrument or device will be determined by the manufacturer's rated capacity. (3-20-20)T

**014. ANNUAL LICENSE PERIOD.**

Annual license applications and fees are due February 1 of each year and all licenses expire on January 31 of the following year. (3-20-20)T

**015. LICENSE RENEWALS.**

Any device or instrument will be considered rejected if the license for that device or instrument is not renewed thirty (30) days after expiration. A person failing to pay the annual license fee after forty-five (45) days following the expiration date, forfeits the right to use the instrument or device for commercial purposes, and the instrument or device may be taken out of service by the ISDA Bureau of Weights and Measures until the license fee is paid. (3-20-20)T

**016. MAXIMUM AND MINIMUM LICENSE FEE SCHEDULE FOR COMMERCIALY-USED WEIGHING AND MEASURING INSTRUMENTS AND DEVICES.**

The annual license fee for instruments and devices is based on manufacturer's rated capacity. The minimum annual license fee for commercially used instrument and device types is twelve dollars (\$12) when licensing a single device.

TABLE 1-A		
DEVICE CODE	KEY	FEE
A	Scales ≤ 50 lb	\$6.00
B	Scales > 50 ≤ 1,159 lb	\$12.00

TABLE 1-A		
DEVICE CODE	KEY	FEE
C	Scales $\geq 1,160 \leq 7,499$ lb	\$24.00
D	Scales $\geq 7,500 \leq 59,999$ lb	\$100.00
E & F	Scales 60,000 lbs or more	\$100.00
G	Meter $< 20$ gpm	\$6.00
H	Meter $\geq 30 < 150$ gpm	\$33.00
I	Meter $\geq 150$ gpm	\$40.00
J	LPG dispenser	\$40.00
K & L	LPG temperature compensated	\$60.00
M	Cordage or Fabric meter	\$5.00
N	Natural gas motor fuel devices	\$60.00
O	Bulk oil meter	\$35.00
T	Meter $> 20 \leq 30$ gpm or fuel additive metering devices	\$10.00

(3-20-20)T

**017. VOLUNTARY INSPECTION OF WEIGHING AND MEASURING INSTRUMENTS AND DEVICES, FEES.**

In addition to commercially used weighing and measuring instruments and devices, ISDA Bureau of Weights and Measures, at the request of an owner or user thereof, may inspect and test non-commercial weighing or measuring instruments or devices to ascertain if they are correct. Any entity making such special request must pay the Bureau of Weights and Measures the cost of the inspection as listed in Section 100. (3-20-20)T

**018. LICENSE DISPLAYED.**

Any owner or user of commercially used weighing and measuring instruments and devices must display the current annual license for those instruments and devices in a prominent place at the same physical location where those devices are installed or used. In the case of devices installed on vehicles, the license must be carried in the vehicle on which the device is installed. (3-20-20)T

**019. -- 099. (RESERVED)**

**100. CHARGES FOR SPECIAL REQUEST TESTING OR EXAMINATION.**

**01. Mileage Charges.** (3-20-20)T

**a.** Fifty-five cents (\$.55) a mile for car travel. (3-20-20)T

**b.** Seventy-five cents (\$.75) a mile for pickup and prower. (3-20-20)T

**c.** Two dollars and fifty cents (\$2.50) a mile for heavy capacity scale trucks. (3-20-20)T

**02. Fee Collection.** Such fees will be collected from place where working and back. Where more than one (1) request is to be handled on same trip, the mileage will be prorated between the parties requesting the service. (3-20-20)T

**03. Personnel Charges.** There will also be an hourly personnel charge of thirty dollars (\$30) per hour

per person for special request testing, chargeable during the time of the actual testing and examination of devices and for driving time. (3-20-20)T

**101. -- 149. (RESERVED)**

**150. PACKAGING AND LABELING RULES.**

The application of this rule applies to packages and to commodities in package form, but does not apply to: (3-20-20)T

**01. Inner Wrappings.** Inner wrappings not intended to be individually sold to the customer. (3-20-20)T

**02. Shipping Containers.** Shipping containers or wrapping used solely for the transportation of any commodities in bulk or in quantity to manufacturers, packers, or processors, or to wholesale or retail distributors, but in no event does this exclusion apply to packages of consumer or non-consumer commodities, as defined herein. (3-20-20)T

**03. Auxiliary Containers.** Auxiliary containers or outer wrappings used to deliver packages of such commodities to retail customers if such containers or wrappings bear no printed matter pertaining to any particular commodity. (3-20-20)T

**04. Retail Display Containers.** Containers used for retail tray pack displays when the container itself is not intended to be sold (e.g., the tray that is used to display individual envelopes of seasonings, gravies, etc., and the tray itself is not intended to be sold). (3-20-20)T

**05. Unpackaged Commodities.** Commodities put up in variable weights and sizes for sale intact and intended to be either weighed or measured at the time of sale, where no package quantities are represented, and where the method of sale is clearly indicated in close proximity to the quantity being sold. (3-20-20)T

**06. Open Carriers.** Open carriers and transparent wrappers or carriers for containers when the wrappers or carriers do not bear any written, printed, or graphic matter obscuring the label information required by this rule. (3-20-20)T

**151. -- 169. (RESERVED)**

**170. IDENTITY.**

**01. Declaration of Identity -- Consumer Package.** A declaration of identity on a consumer package must appear on the principal display panel, and positively identify the commodity in the package by its common or usual name, description, generic term, or the like. (3-20-20)T

**02. Parallel Identity Declaration -- Consumer Package.** A declaration of identity on a consumer package must appear generally parallel to the base on which the package rests as it is designed to be displayed. (3-20-20)T

**03. Declaration of Identity -- Non-Consumer Package.** A declaration of identity on a non-consumer package must appear on the outside of a package and positively identify the commodity in the package by its common or usual name, description, generic term, or the like. (3-20-20)T

**04. Declaration of Responsibility -- Consumer and Non-Consumer Packages.** (3-20-20)T

**a.** Any package kept, offered, or exposed for sale, or sold, at any place other than on the premises where packed must specify conspicuously on the label of the package the name and address of the manufacturer, packer, or distributor. The name must be the actual corporate name, or, when not incorporated, the name under which the business is conducted. The address must include street address, city, state, and zip code; however, the street address may be omitted if this is shown in a current city directory or telephone directory. The requirement for inclusion of the zip code must apply only to labels that have been developed or revised after July 1, 1970. (3-20-20)T

b. If a person manufactures, packs, or distributes a commodity at a place other than his principal place of business, the label may state the principal place of business in lieu of the actual place where the commodity was manufactured or packed or is to be distributed, unless such statement would be misleading. Where the commodity is not manufactured by the person whose name appears on the label, the name must be qualified by a phrase that reveals the connection such person has with such commodity, such as "Manufactured for and packed by," "Distributed by," or any other wording of similar import that expresses the facts. (3-20-20)T

**171. DECLARATION OF QUANTITY -- CONSUMER PACKAGES.**

**01. Largest Whole Unit.** Where this rule requires that the quantity declaration be in terms of the largest whole unit, the declaration must, with respect to a particular package, be in terms of the largest whole unit of weight or measure, with any remainder expressed in: (3-20-20)T

a. Common or decimal fractions of such largest whole unit; or (3-20-20)T

b. The next smaller whole unit, or units, with any further remainder in terms of common or decimal fractions of the smallest unit present in the quantity declaration. (3-20-20)T

**02. Net Quantity.** A declaration of net quantity of the commodity in the package, exclusive of wrappers and any other material packed with such commodity, must appear on the principal display panel of a consumer package and, unless otherwise specified in this rule (see Subsections 171.06 through 171.08) must be in terms of the largest whole unit. (3-20-20)T

**03. Use of "Net Weight."** The term "net weight" must be used in conjunction with the declaration of quantity in terms of weight; the term may either precede or follow the declaration of weight. (3-20-20)T

**04. Lines of Print or Type.** A declaration of quantity may appear on one (1) or more lines of print or type. (3-20-20)T

**05. Terms -- Weight, Liquid Measures, or Count.** The declaration of the quantity of a particular commodity must be expressed in terms of liquid measure if the commodity is liquid, or in terms of weight if the commodity is solid, semisolid, viscous, or a mixture of solid and liquid, or in terms of numerical count. However, if there exists a firmly established general consumer usage and trade custom with respect to the terms used in expressing a declaration of quantity of a particular commodity, such declaration of quantity may be expressed in its traditional terms, if such traditional declaration gives accurate and adequate information as to the quantity of the commodity. (3-20-20)T

**06. Combination Declaration.** (3-20-20)T

a. A declaration of quantity in terms of weight must be combined with appropriate declarations of the measure, count, and size of the individual units unless a declaration of weight alone is fully informative. (3-20-20)T

b. A declaration of quantity in terms of measure must be combined with appropriate declarations of the weight, count, and size of the individual units unless a declaration of measure alone is fully informative. (3-20-20)T

c. A declaration of quantity in terms of count must be combined with appropriate declarations of the weight, measure, and size of the individual units unless a declaration of count alone is fully informative. (3-20-20)T

**07. Units -- Weight, Measure.** A declaration of quantity must be as follows, however provided that in the case of a commodity packed for export shipment, the declaration of quantity may be in terms of the metric system of weight or measure. (3-20-20)T

a. In units of weight will be in terms of the avoirdupois pound or ounce; (3-20-20)T

b. In units of liquid measure will be in terms of the United States gallon of two hundred thirty-one

(231) cubic inches or liquid-quart, liquid-pint, or fluid-ounce subdivisions of the gallon, and shall express the volume at sixty-eight degrees (68 Degrees F), twenty degrees (20 Degrees C), except in the case of petroleum products, for which the declaration must express the volume at sixty degrees (60 Degrees F), fifteen point six degrees (15.6 Degrees C), and except also in the case of a commodity that is normally sold and consumed while frozen, for which the declaration must express the volume at the frozen temperature, and except also in the case of a commodity that is normally sold in the refrigerated state, for which the declaration must express the volume at forty degrees (40 Degrees F), four degrees (4 Degrees C); (3-20-20)T

- c. In units of linear measure must be in terms of the yard, foot, or inch; (3-20-20)T
- d. In units of area measure, must be in terms of the square yard, square foot, or square inch; (3-20-20)T
- e. In units of dry measure must be in terms of the United States bushel of two thousand one hundred fifty point forty-two (2,150.42) cubic inches, or peck, dry-quart, and dry-pint subdivisions of the bushel; (3-20-20)T
- f. In units of cubic measure must be in terms of the cubic yard, cubic foot, or cubic inch. (3-20-20)T

**08. Abbreviations.** Any of the following abbreviations, and none other, may be employed in the quantity statement on a package of commodity. (There normally are no periods following, nor plural forms of, these abbreviations. For example, “oz” is the abbreviation for both “ounce” and “ounces.”)

avoirdupois	-	avdp	quart	-	qt
cubic	-	cu	square	-	sq
feet or foot	-	ft	weight	-	wt
fluid	-	fl	yard	-	yd
gallon	-	gal	cubic centimeter	-	cc
inch	-	in	gram	-	g
liquid	-	liq	kilogram	-	kg
ounce	-	oz	microgram	-	mcg
pint	-	pt	milligram	-	mg
pound	-	lb	milliliter	-	ml

(3-20-20)T

**09. Units with Two or More Meanings.** When the term “ounce” is employed in a declaration of liquid quantity, the declaration must identify the particular meaning of the term by the use of the term “fluid”; however, such distinction may be omitted when, by association of terms (for example, as in “one (1) pint four (4) ounces”), the proper meaning is obvious. Whenever the declaration of quantity is in terms of the dry pint or dry quart, the declaration must include the word “dry.” (3-20-20)T

**172. PRESCRIBED UNITS.**

**01. Less Than One Foot, One Square Foot, One Pound, or One Pint.** The declaration of quantity must be expressed as follows, provided, that the quantity declaration appearing on a random package may be expressed in terms of decimal fractions of the largest appropriate unit, the fraction being carried out to not more than two (2) decimal places: (3-20-20)T

- a. In the case of length measure of less than one (1) foot, inches, and fractions of inches; (3-20-20)T
- b. In the case of area measure of less than one (1) square foot, square inches, and fractions of square

- inches; (3-20-20)T
- c. In the case of weight of less than one (1) pound, ounces, and fractions of ounces; (3-20-20)T
  - d. In the case of fluid measure of less than one (1) pint, ounces, and fractions of ounces; (3-20-20)T
- 02. Four Feet, Four Square Feet, Four Pounds, One Gallon, or More.** (3-20-20)T
- a. In the case of length measure of four (4) feet or more the declaration of quantity must be expressed in terms of feet, followed in parentheses by a declaration of yards and common or decimal fractions of the yard, or in terms of feet followed in parentheses by a declaration of yards with any remainder in terms of feet and inches. (3-20-20)T
  - b. In the case of area measure of four (4) square feet or more; (3-20-20)T
  - c. In the case of weight of four (4) pounds or more; (3-20-20)T
  - d. In the case of fluid measure of one (1) gallon or more the declaration of quantity must be expressed in terms of the largest whole unit. (3-20-20)T
- 03. Weight -- Dual Quantity Declaration.** On packages containing one (1) pound or more but less than four (4) pounds, the declaration must be expressed in ounces and, in addition, be followed by a declaration in parentheses, expressed in terms of the largest whole unit, provided, that the quantity declaration appearing on a random package may be expressed in terms of pounds and decimal fractions of the pound carried out to not more than two (2) decimal places. (3-20-20)T
- 04. Fluid Measure -- Dual Quantity Declaration.** On packages containing (1) one pint or more but less than one (1) gallon, the declaration must be expressed in ounces and, in addition, be followed by a declaration in parentheses, expressed in terms of the largest whole unit. (3-20-20)T
- 05. Length Measure -- Dual Quantity Declaration.** On packages containing (1) one foot but less than four (4) feet, the declaration must be expressed in inches and, in addition, be followed by a declaration in parentheses, expressed in terms of the largest whole unit. (3-20-20)T
- 06. Area Measure -- Dual Quantity Declaration.** On packages containing (1) one square foot but less than four (4) square feet, the declaration must be expressed in square inches and, in addition, be followed by a declaration in parentheses, expressed in terms of the largest whole unit. (3-20-20)T
- 07. Bidimensional Commodities.** For bidimensional commodities (including roll-type commodities) the quantity declaration must be expressed: (3-20-20)T
- a. If less than one (1) square foot, in terms of linear inches and fractions of linear inches; (3-20-20)T
  - b. If at least one (1) square foot but less than four (4) square feet, in terms of square inches followed in parentheses by a declaration of both the length and width, each being in terms of the largest whole unit, provided, that: (3-20-20)T
    - i. No square inch declaration is required for a bidimensional commodity of four (4) inches width or less; (3-20-20)T
    - ii. A dimension of less than two (2) feet may be stated in inches within the parenthetical; and (3-20-20)T
    - iii. Commodities consisting of usable individual units (except roll-type commodities with individual usable units created by perforations, see Subsection 173.03) require a declaration of unit area but not a declaration of total area of all such units. (3-20-20)T

**c.** If four (4) square feet or more, in terms of square feet followed in parentheses by a declaration of the length and width in terms of the largest whole unit, provided that: (3-20-20)T

**i.** No declaration in square feet is required for a bidimensional commodity with a width of four (4) inches or less; (3-20-20)T

**ii.** A dimension of less than two (2) feet may be stated in inches within the parenthetical; and (3-20-20)T

**iii.** No declaration in square feet is required for commodities for which the length and width measurements are critical in terms of end use (such as tablecloths or bedsheets) if such commodities clearly present the length and width measurements on the label. (3-20-20)T

**173. POLYETHYLENE SHEETING.**

**01. Packages.** All packages of polyethylene sheeting must be labeled as to quantity in accordance with the following: (3-20-20)T

**a.** Actual length; (3-20-20)T

**b.** Actual width; (3-20-20)T

**c.** Actual thickness; and (3-20-20)T

**d.** Actual weight of each individual unit. (3-20-20)T

**02. Bulk.** All polyethylene sold from bulk must be accompanied by a delivery ticket with the following information: (3-20-20)T

**a.** The identity; (3-20-20)T

**b.** Actual length, width, thickness, and weight of each individual unit; (3-20-20)T

**c.** The number of individual units; (3-20-20)T

**d.** The total weight of all the units; (3-20-20)T

**e.** The name and address of both the vendor and purchaser; and (3-20-20)T

**f.** The date delivered or the date shipped. (3-20-20)T

**03. Count -- Ply.** If the commodity is in individually usable units of one (1) or more components or ply, the quantity declaration must, in addition to complying with other applicable quantity declaration requirements of this rule, include the number of ply and the total number of usable units. Roll-type commodities, when perforated so as to identify individual usable units, must not be deemed to be made up of usable units; however, such roll-type commodities must be labeled in terms of: (3-20-20)T

**a.** Total area measurement; (3-20-20)T

**b.** Number of ply; (3-20-20)T

**c.** Count of usable units; and (3-20-20)T

**d.** Dimensions of a single usable unit. (3-20-20)T

**04. Fractions.** A statement of net quantity of contents of any consumer commodity may contain common or decimal fractions. A common fraction must be in terms of halves (1/2), quarters (1/4), eighths (1/8),



sixteenths (1/16), or thirty-seconds (1/32), except that: (3-20-20)T

**a.** If there exists a firmly established general consumer usage and trade custom of employing different common fractions in the net quantity declaration of a particular commodity, they may be employed; and (3-20-20)T

**b.** If linear measurements are required in terms of yards or feet, common fractions may be in terms of thirds (1/3). A common fraction must be reduced to its lowest terms; a decimal fraction must not be carried out to more than two (2) places. (3-20-20)T

**174. SUPPLEMENTARY DECLARATIONS.**

**01. Supplementary Quantity Declarations.** The required quantity declaration may be supplemented by one (1) or more accurate declarations of weight, measure, or count, such declaration appearing other than on a principal display panel. Such supplemental statement of quantity of contents must not include any terms qualifying a unit of weight, measure, or count that tends to exaggerate the amount of commodity contained in the package (e.g., “giant” quart, “full” gallon, “when packed,” “minimum,” or words of similar import). (3-20-20)T

**02. Metric System Declarations.** A separate statement of the net quantity of contents in terms of the metric system is not regarded as a supplemental statement, and a statement of quantity in terms of the metric system of weight or measure may also appear on the principal display panel or on other panels. The metric system may be used as provided for by Section 71-229, Idaho Code, in lieu of the traditional system of weights and measures by substituting the proper metric terms where applicable in these rules. (3-20-20)T

**03. Qualification of Declaration Prohibited.** In no case will any declaration of quantity be qualified by the addition of the words “when packed,” “minimum,” or “not less than,” or any words of similar import, nor any unit of weight, measure, or count be qualified by any term (such as “jumbo,” “giant,” “full,” or the like) that tends to exaggerate the amount of commodity. (3-20-20)T

**175. -- 179. (RESERVED)**

**180. DECLARATION OF QUANTITY -- NON-CONSUMER PACKAGES.**

**01. Location.** Non-consumer packages must bear on the outside a declaration of the net quantity of contents. Such declaration must be in terms of the largest whole unit (see Subsection 171.01 Largest Whole Unit). (3-20-20)T

**02. Terms -- Weight, Liquid Measure, or Count.** The declaration of the quantity of a particular commodity must be expressed in terms of liquid measure if the commodity is liquid, or in terms of weight if the commodity is solid, semisolid, viscous, or a mixture of solid and liquid, or in terms of numerical count. However, if there exists a firmly established general consumer usage and trade custom with respect to the terms used in expressing a declaration of quantity of a particular commodity, such declaration of quantity may be expressed in its traditional terms, if such traditional declaration gives accurate and adequate information as to the quantity of the commodity. (3-20-20)T

**03. Units -- Weight, Measure.** A declaration of quantity: (3-20-20)T

**a.** In units of weight must be in terms of the avoirdupois pound or ounce; (3-20-20)T

**b.** In units of liquid measure must be in terms of the United States gallon of two hundred thirty-one (231) cubic inches or liquid-quart, liquid-pint, or fluid-ounce subdivisions of the gallon, and must express the volume at sixty-eight (68) degrees F, twenty (20) degrees C, except in the case of petroleum products, for which the declaration must express the volume at sixty (60) degrees F, fifteen point six (15.6) degrees C, and except also in the case of a commodity that is normally sold and consumed while frozen for which the declaration must express the volume at the frozen temperature, and except also in the case of a commodity that is normally sold in the refrigerated state, for which the declaration must express the volume at forty (40) degrees F, four (4) degrees C; (3-20-20)T

**c.** In units of linear measure must be in terms of the yard, foot, or inch; (3-20-20)T

d. In units of area measure, must be in terms of the square yard, square foot, or square inch; (3-20-20)T

e. In units of dry measure shall be in terms of the United States bushel of two thousand one hundred fifty and forty-two one hundredths (2,150.42) cubic inches, or peck, dry-quart and dry-pint subdivisions of the bushel; (3-20-20)T

f. In units of cubic measure must be in terms of the cubic yard, cubic foot, or cubic inch, provided that nothing in this subsection prohibits the labeling of non-consumer packages in terms of units on the metric system. (3-20-20)T

**04. Abbreviations.** Any generally accepted abbreviation of a unit name may be employed in the quantity statement on a non-consumer package of commodity. (For commonly accepted abbreviations, see Subsection 171.08, Abbreviations.) (3-20-20)T

**05. Character of Declaration -- Average.** The average quantity of contents in the non-consumer package of a particular lot, shipment, or delivery must at least equal the declared quantity, and no unreasonable shortage in any package is permitted, even though overages in other packages in the same shipment, delivery, or lot compensate for such shortage. (3-20-20)T

**181. -- 199. (RESERVED)**

**200. PROMINENCE AND PLACEMENT -- CONSUMER PACKAGES.**

**01. General.** All information required to appear on a consumer package must appear thereon in the English language and be prominent, definite, and plain, and be conspicuous as to size and style of letters and numbers and as to color of letters and numbers in contrast to color of background. Any required information that is either in hand lettering or hand script must be entirely clear and equal to printing in legibility. (3-20-20)T

**02. Location.** The declaration or declarations of quantity of the contents of a package must appear in the bottom thirty percent (30%) of the principal display panel or panels, except as otherwise provided in Subsection 220.07, Cylindrical Containers. (3-20-20)T

**03. Style of Type or Lettering.** The declaration or declarations of quantity must be in such a style of type or lettering as to be boldly, clearly, and conspicuously presented with respect to other type, lettering, or graphic material on the package, except that a declaration of net quantity blown, formed or molded on a glass or plastic surface is permissible when all label information is blown, formed, or molded on the surface. (3-20-20)T

**04. Color Contrast.** The declaration or declarations of quantity must be in a color that contrasts conspicuously with its background, except that a declaration of net quantity blown, formed, or molded on a glass or plastic surface is not required to be presented in a contrasting color if no required label information is on the surface in a contrasting color. (3-20-20)T

**05. Free Area.** The area surrounding the quantity declaration must be free of printed information as follows: (3-20-20)T

a. Above and below, by a space equal to at least the height of the lettering in the declaration: and (3-20-20)T

b. To the left and right, by a space equal to twice the width of the letter "N" of the style and size of type used in the declaration. (3-20-20)T

**06. Parallel Quantity Declaration.** The quantity declaration must be presented in such a manner as to be generally parallel to the declaration of identity and to the base on which the package rests as it is designed to be displayed. (3-20-20)T

**07. Calculation of Area of Principal Display Panel for Purposes of Type Size.** The square-inch area of the principal display panel must be as follows: (3-20-20)T

**a.** In the case of a rectangular container, one (1) entire side, which properly can be considered to be the principal display panel, the product of the height times the width of that side; (3-20-20)T

**b.** In the case of a cylindrical or nearly cylindrical container, forty percent (40%) of the product of the height of the container times the circumference; or (3-20-20)T

**c.** In the case of any other shaped container, forty percent (40%) of the total surface of the container, unless such container presents an obvious principal display panel (e.g., the top of a triangular or circular package of cheese, or the top of a can of shoe polish), the area must consist of the entire such surface. (3-20-20)T

**d.** Determination of the principal display panel excludes tops, bottoms, flanges at tops and bottoms of cans, and shoulders and necks of bottles or jars. (3-20-20)T

**08. Minimum Height of Numbers and Letters.** The height of any letter or number in the required quantity declaration must be not less than that shown in Subsection 200.10, Table 1 with respect to the square-inch area of the panel, and the height of each number of a common fraction must meet one-half (1/2) the minimum height standards. (3-20-20)T

**09. Numbers and Letters -- Proportion.** No number or letter may be more than three (3) times as high as it is wide. (3-20-20)T

**10. Minimum Height of Numbers and Letters -- Table 1.**

Square-inch Area of Principal Display Panel	Minimum Height of Numbers and Letters	Minimum Height: Label Information Blown, Formed, or Molded on Surface of Container
5 square inches and less	1/16 inch	1/8 inch
Greater than 5 square inches and not greater than 25 square inches.	inch	3/16 inch
Greater than 25 square inches and not greater than 100 square inches.	3/16 inch	1/4 inch
Greater than 100 square inches and not greater than 400 square inches.	1/4 inch	5/16 inch
Greater than 400 square inches.	1/2 inch	9/16 inch

(3-20-20)T

**201. -- 209. (RESERVED)**

**210. PROMINENCE AND PLACEMENT -- NON-CONSUMER PACKAGES GENERAL.** All information required to appear on a non-consumer package must be definitely and clearly stated thereon in the English language. Any required information that is either in hand lettering or hand script must be entirely clear and equal to printing in legibility. (3-20-20)T

**211. -- 219. (RESERVED)**

**220. REQUIREMENTS -- SPECIFIC CONSUMER COMMODITIES, PACKAGES, CONTAINERS.**

**01. Display Card Package.** For an individual package affixed to a display card, or for a commodity and display card together comprising a package, the type size of the quantity declaration is governed by the

dimensions of the display card. (3-20-20)T

**02. Eggs.** When cartons containing twelve (12) eggs have been designed so as to permit division in half by the retail purchaser, the required quantity declaration must be so positioned as to have its context destroyed when the carton is divided. (3-20-20)T

**03. Aerosols and Similar Pressurized Containers.** The declaration of quantity on an aerosol package, and on a similar pressurized package, must disclose the net quantity of the commodity (including propellant), in terms of weight, that will be expelled when the instructions for use as shown on the container are followed. (3-20-20)T

**04. Multi-Unit Packages.** Any package containing more than one (1) individual “commodity in package form” (see Subsection 151.01) of the same commodity must bear on the outside of the package a declaration of the following: (3-20-20)T

**a.** The number of individual units; (3-20-20)T

**b.** The quantity of each individual unit; and (3-20-20)T

**c.** The total quantity of the contents of the multi-unit package, provided, that the requirement for a declaration of the total quantity of contents of a multi-unit package must be effective with respect to those labels revised after the effective date of this rule. Any such declaration of total quantity is not required to include the parenthetical quantity statement of a dual quantity representation. (3-20-20)T

**05. Combination Packages.** Any package containing individual units of dissimilar commodities (such as an antiquing kit, for example) must bear on the label of the package a quantity declaration for each unit. (3-20-20)T

**06. Variety Packages.** Any package containing individual units of reasonably similar commodities (such as, for example, seasonal gift packages, variety packages of cereal) must bear on the label of the package a declaration of the total quantity of commodity in the package. (3-20-20)T

**07. Cylindrical Containers.** In the case of cylindrical or nearly cylindrical containers, information required to appear on the principal display panel must appear within that forty percent (40%) of the circumference that is most likely to be displayed, presented, shown, or examined under customary conditions of display for retail sale. (3-20-20)T

**221. -- 229. (RESERVED)**

**230. MEASUREMENT OF CONTAINER-TYPE COMMODITIES, HOW EXPRESSED.**

**01. General.** Commodities designed and sold at retail to be used as containers for other materials or objects, such as bags, cups, boxes, and pans, must be labeled with the declaration of net quantity as follows: (3-20-20)T

**a.** For bag-type commodities, in terms of count followed by linear dimensions of the bag (whether packaged in a perforated roll or otherwise). (3-20-20)T

**b.** When the unit bag is characterized by two (2) dimensions because of the absence of a gusset, the width and length will be expressed in inches, except that a dimension of two (2) feet or more will be expressed in feet with any remainder in terms of inches or common or decimal fractions of the foot. (Example: “25 bags, 17 in x 20 in” or “100 bags, 20 in x 2 ft 6 in” or “50 bags, 20 in x 2-1/2 ft”). (3-20-20)T

**c.** When the unit bag is gusseted, the dimensions will be expressed as width, depth, and length, in terms of inches, except that any dimension of two (2) feet or more will be expressed in feet with any remainder in terms of inches or the common or decimal fractions of the foot. (Examples: “25 bags, 17 in x 4 in x 20 in” or “100 bags, 20 in x 12 in x 2-1/2 ft”). (3-20-20)T

**d.** For other square, oblong, rectangular, or similarly shaped containers, in terms of count followed by length, width, and depth, except depth need not be listed when less than two (2) inches. (Example: “2 cake pans, 8 in x 8 in” or “roasting pan, 12 in x 8 in x 3 in”). (3-20-20)T

**e.** For circular or other generally round-shaped containers, except cups, and the like in terms of count followed by diameter and depth, except depth need not be listed when less than two (2) inches. (Example: “4 pie pans, 8 in diameter x 4 in”). (3-20-20)T

**02. Capacity.** When the functional use of the container is related by label references in standard terms of measure to the capability of holding a specific quantity of substance or class of substances such references must be a part of the net quantity statement and must specify capacity as follows: (3-20-20)T

**a.** Liquid measure for containers that are intended to be used for liquids, semisolids, viscous materials, or mixtures of solids and liquids. The expressed capacity will be stated in terms of the largest whole unit (gallon, quart, pint, ounce), with any remainder in terms of the common or decimal fraction of that unit. (Example: Freezer Boxes “4 boxes, 1-qt capacity, 5 in x 4 in x 3 in”). (3-20-20)T

**b.** Dry measure for containers that are intended to be used for solids. The expressed capacity will be stated in terms of the largest whole unit (bushel, peck), with any remainder in terms of the common or decimal fraction of that unit. (Example: Leaf bags “8 bags, 6-bushel capacity, 3 ft x 5 ft”). (3-20-20)T

**c.** Where containers are used as liners for other more permanent containers, in the same terms as are normally used to express the capacity of the more permanent container. (Example: Garbage Can Liners “10 liners, 2 ft 6 in x 3 ft 9 in, fits up to 30-gallon cans”). (3-20-20)T

**d.** Notwithstanding the above requirements, the net quantity statement for containers such as cups will be listed in terms of count and liquid capacity per unit. (Example: “24 cups, 6 fl oz capacity”). For purposes of this section, the use of the terms “capacity,” “diameter,” and “fluid” is optional. (3-20-20)T

**231. -- 239. (RESERVED)**

**240. TEXTILE PRODUCTS, THREADS, AND YARNS.**

**01. Wearing Apparel.** Wearing apparel (including non-textile apparel and accessories such as leather goods and footwear) sold as single-unit items, or if normally sold in pairs (such as hosiery, gloves, and shoes) sold as single-unit pairs, is exempt from the requirements for a net quantity statement by count, as required by Subsection 171.05 of this rule. (3-20-20)T

**02. Textiles.** Bedsheets, blankets, pillowcases, comforters, quilts, bedspreads, mattress covers and pads, afghans, throws, dresser and other furniture scarfs, tablecloths and napkins, flags, curtains, drapes, dish towels, dish cloths, towels, face cloths, utility cloths, bath mats, carpets and rugs, pot holders, fixture and appliance covers, non-rectangular diapers, slip covers, etc., are be exempt from the requirements of Subsection 172.07 of this rule, provided that: (3-20-20)T

**a.** The quantity statement for fitted sheets and mattress covers must state, in inches, the length and width of the mattress for which the item is designed, such as “twin,” “double,” “king,” etc. (Example: “Twin Fitted Sheet for thirty-nine by seventy-five (39 x 75) inch mattress”) (3-20-20)T

**b.** The quantity statement for flat sheets must state the size designation of the mattress for which the sheet is designed, such as “twin,” “double,” “king,” etc. The quantity statement also must state, in inches, the length and width of the mattress for which the sheet is designed, followed in parentheses by a statement, in inches, of the length and width of the sheet before hemming. (Example: “Double Flat Sheet for fifty-four by seventy-five (54 x 75) inch mattress (eighty-one by one hundred four (81 x 104) inch before hemming”) (3-20-20)T

**c.** The quantity statement for pillowcases must state the size designation of the pillow for which the pillowcase is designed, such as “youth,” “standard,” and “queen,” etc. The quantity statement also must state, in inches, the length and width of the pillow for which the pillowcase is designed, followed in parentheses by a

statement, in inches, of the length and width of the pillowcase before hemming. (Example: “Standard Pillowcase for twenty by twenty-six (20 x 26) inch pillow (forty-two by thirty-six (42 x 36) inch before hemming”) (3-20-20)T

**d.** The quantity statement for blankets, comforters, quilts, bedspreads, mattress pads, afghans, and throws must state, in inches, the length and width of the finished item. The quantity statement also may state the length of any ornamentation and the size designation of the mattress for which the item is designed, such as “twin,” “double,” “king,” etc. (3-20-20)T

**e.** The quantity statement for tablecloths and napkins must state, in inches, the length and width of the finished item. The quantity statement also may state parenthetically, in inches, the length and width of the items before hemming and properly identified as such. (3-20-20)T

**f.** The quantity statement for curtains, drapes, flags, furniture scarfs, etc., must state, in inches, the length and width of the finished item. The quantity statement also may state parenthetically, in inches, the length of any ornamentation. (3-20-20)T

**g.** The quantity statement for carpets and rugs must state, in feet, with any remainder in common or decimal fractions of the foot or in inches, the length and width of the item. The quantity statement also may state parenthetically, in inches, the length of any ornamentation. (3-20-20)T

**h.** The quantity statement for woven dish towels, dish cloths, towels, face cloths, utility cloths, bath mats, etc., must state, in inches, the length and width of the item. The quantity statement for such items, when knitted, need not state the dimensions. (3-20-20)T

**i.** The quantity statement for textile products such as pot holders, fixture and appliance covers, non-rectangular diapers, slip covers, etc., must be stated in terms of count and may include size designations and dimensions. (3-20-20)T

**j.** The quantity statement for other than rectangular textile products identified in Subsections 240.02.a. through 240.02.h. must state the geometric shape of the product and the dimensions which are customarily used in describing such geometric shape. (Example: “Oval Tablecloth fifty-four by forty-two (54x42) inch” representing the maximum length and width in this case). (3-20-20)T

**k.** The quantity statement for packages of remnants of textile products of assorted sizes, when sold by count, must be accompanied by the term “irregular dimensions” and the minimum size of such remnants. (3-20-20)T

**03. Textiles -- Variations from Declared Dimensions.** (3-20-20)T

**a.** For an item with no declared dimension less than twenty-four (24) inches, a minus variation greater than three percent (3%) of a declared dimension and a plus variation greater than six percent (6%) of a declared dimension should be considered unreasonable. (3-20-20)T

**b.** For an item with a declared dimension less than twenty-four (24) inches, a minus variation greater than six percent (6%) of a declared dimension and a plus variation greater than twelve percent (12%) of a declared dimension should be considered unreasonable. (3-20-20)T

**04. Exemption -- Variety Textile Packages.** Variety packages of textiles which are required by reason of Subsection 171.06 to provide a combination declaration stating the quantity of each individual unit, are exempt from the requirements in this rule for the following: (3-20-20)T

**a.** Location (see Subsection 200.02); or (3-20-20)T

**b.** Free area (see Subsection 200.05); or (3-20-20)T

**c.** Minimum height of numbers and letters. (see Subsection 200.08). (3-20-20)T

**05. Sewing Threads, Handicraft Threads, and Yarns.** Sewing and handicraft threads are exempt

from the requirements of Subsections 172.02.a. through 172.02.d. of this rule, provided that: (3-20-20)T

- a. The net quantity statement for sewing and handicraft threads must be expressed in terms of yards. (3-20-20)T
- b. The net quantity statement for yarns must be expressed in terms of weight. (3-20-20)T
- c. Thread products may, in lieu of name and address, bear a trademark, symbol, brand, or other mark that positively identifies the manufacturer, packer, or distributor, provided that such marks, employed to identify the vendor, must be filed with the Director. (3-20-20)T
- d. Each unit of industrial thread must be marked to show its net measure in terms of yards or its net weight in terms of avoirdupois pounds or ounces, except that ready-wound bobbins which are not sold separately, shall not be required to be individually marked but the package containing such bobbins must be marked to show the number of bobbins contained therein and the net yards of thread on each bobbin. (3-20-20)T

**241. -- 249. (RESERVED)**

**250. EXEMPTIONS.**

**01. General.** Whenever any consumer commodity or package of consumer commodity is exempted from the requirements for dual quantity declaration, the net quantity declaration required to appear on the package must be in terms of the largest whole unit (except see Subsection 220.04.c., Multi-Unit Packages). (3-20-20)T

**02. Random Packages.** A random package bearing a label conspicuously declaring: (3-20-20)T

a. The net weight; (3-20-20)T

b. The price per pound, or other unit of weight, measure or count; and (3-20-20)T

c. The total price is exempt from the type size, dual declaration, placement, and free area requirements of this rule. In the case of a random package packed at one place for subsequent sale at another, neither the price per unit of weight nor the total selling price need appear on the package, provided the package label includes both such prices at the time it is offered or exposed for sale at retail. This exemption also applies to uniform weight packages of cheese and cheese products labeled in the same manner and by the same type of equipment as random packages exempted by this section. (3-20-20)T

**03. Small Confections.** Individually wrapped pieces of “penny candy” and other confectionery of less than one-half (1/2) ounce net weight per individual piece is exempt from the labeling requirements of this rule when the container in which such confectionery is shipped is in conformance with the labeling requirements of this rule. Similarly, when such confectionery items are sold in bags or boxes, such items are exempt from the labeling requirements of this rule including the required declaration of net quantity of contents, when the declaration of the bag or box meets the requirements of this rule. (3-20-20)T

**04. Individual Servings.** Individual-serving-size packages of foods containing less than one-half (1/2) ounce or less than one-half (1/2) fluid ounce for use in restaurants, institutions, and passenger carriers, and not intended for sale at retail, are exempt from the required declaration of net quantity of contents specified in this rule. (3-20-20)T

**05. Cuts, Plugs, and Twists of Tobacco and Cigars.** When individual cuts, plugs, and twists of tobacco and individual cigars are shipped or delivered in containers that conform to the labeling requirements of this rule, such individual cuts, plugs, and twists of tobacco and cigars are exempt from such labeling requirements. (3-20-20)T

**06. Reusable (Returnable) Glass Containers.** Nothing in this rule is deemed to preclude the continued use of reusable (returnable) glass containers; provide, that such glass containers ordered after the effective date of this rule must conform to all requirements of this rule. (3-20-20)T

**07. Cigarettes and Small Cigars.** Cartons of cigarettes and small cigars, containing ten (10) individual packages of twenty (20), labeled in accordance with the requirements of this rule are exempt from the requirements set forth in Subsection 200.02, Location, Subsection 200.08, Minimum Height of Numbers and Letters, and Subsection 220.04, Multi-Unit Packages, provided that such cartons bear a declaration of the net quantity of commodity in the package. (3-20-20)T

**08. Packaged Commodities with Labeling Requirements Specified in Federal Law.** Packages of meat and meat products, poultry and poultry products, tobacco and tobacco products, insecticides, fungicides, rodenticides, alcoholic beverages, and seeds are exempt from the requirements set forth in Subsection 172.03, Weight: Dual Quantity Declaration; Subsection 172.04, Fluid Measure: Dual Quantity Declaration; Subsection 172.05, Length Measure: Dual Quantity Declaration; Subsection 172.06, Area Measure: Dual Quantity Declaration; Subsection 200.02, Location; and Subsection 200.08, Minimum Height of Numbers and Letters, provided that quantity labeling requirements for such products are specified in Federal Law, so as to follow reasonably sound principles of providing consumer information. (3-20-20)T

**09. Fluid Dairy Products, Ice Cream, and Similar Frozen Desserts.** (3-20-20)T

**a.** When packaged in one-half (1/2) liquid pint and one-half (1/2) gallon containers, are exempt from the requirements for stating net contents of eight (8) fluid ounces and sixty-four (64) fluid ounces, which may be expressed as one-half (1/2) pint and one-half (1/2) gallon, respectively. (3-20-20)T

**b.** When packaged in one (1) liquid pint, one (1) liquid quart, and one-half (1/2) gallon containers, are exempt from the dual net contents declaration requirements of Subsection 172.04, Fluid Measure: Dual Quantity Declaration. (3-20-20)T

**c.** When measured by and packaged in one-half (1/2) liquid pint, one (1) liquid pint, one (1) liquid quart, one-half (1/2) gallon and one (1) gallon measure containers as defined in "Measure Container Code of National Bureau of Standards, or its successor organization, the National Institute of Standards and Technology, Handbook 44," are exempt from the requirement of Subsection 200.02, Location, that the declaration of net contents be located within the bottom thirty percent (30%) of the principal display panel. (3-20-20)T

**d.** Milk and milk products when measured by and packaged in glass or plastic containers of one-half (1/2) liquid pint, one (1) liquid pint, one (1) liquid quart, one-half (1/2) gallon, and one (1) gallon capacities are exempt from the placement requirement of Subsection 200.02, Location, that the declaration of net contents be located within the bottom thirty percent (30%) of the principal display panel, provided that other required label information is conspicuously displayed on the cap or outside closure, and the required net quantity of contents declaration is conspicuously blown, formed, or molded on, or permanently applied to that part of the glass or plastic container that is at or above the shoulder of the container. (3-20-20)T

**10. Single Strength and Less Than Single Strength Fruit Juice Beverages, Imitations Thereof, and Drinking Water.** (3-20-20)T

**a.** When packaged in glass, plastic, or fluid milk type paper containers of eight (8) and sixty-four (64) fluid ounce capacity, are exempt from the requirements of Subsection 171.07.b., Units: Weight, Measure, to the extent that net contents of eight (8) fluid ounces and sixty-four (64) fluid ounces (or two (2) quarts) may be expressed as one-half (1/2) pint (or half pint) and one-half (1/2) gallon (or half gallon), respectively. (3-20-20)T

**b.** When packaged in glass, plastic, or fluid milk type paper containers of one (1) pint, one (1) quart, and one-half (1/2) gallon capacities, are exempt from the dual net contents declaration requirements of Subsection 172.04, Fluid Measure: Dual Quantity Declaration. (3-20-20)T

**c.** When packaged in glass or plastic containers of one-half (1/2) pint, one (1) pint, one (1) quart, one (1/2) gallon, and one (1) gallon capacities, are exempt from the placement requirement of Subsection 200.02, Location, that the declaration of net contents be located within the bottom thirty percent (30%) of the principal display panel; provided that other required label information is conspicuously displayed on the cap or outside closure and the required net quantity of contents declaration is conspicuously blown, formed, or molded into or permanently



applied to that part of the glass or plastic container that is at or above the shoulder of the container. (3-20-20)T

**11. Soft-Drink Bottles.** Bottles of soft drinks are exempt from the placement requirements for the declaration of: (3-20-20)T

**a.** Identity, when such declaration appears on the bottle closure; and (3-20-20)T

**b.** Quantity, when such declaration is blown, formed, or molded on or above the shoulder of the container and when all other information required by this rule appears only on the bottle closure. (3-20-20)T

**12. Multi-Unit Soft Drink Packages.** Multi-unit packages of soft drinks are exempt from the requirement for a declaration of: (3-20-20)T

**a.** Responsibility, when such declaration appears on the individual units and is not obscured by the multi-unit packaging, or when the outside container bears a statement to the effect that such declaration will be found on the individual units inside; and (3-20-20)T

**b.** Identity, when such declaration appears on the individual units and is not obscured by the multi-unit packaging. (3-20-20)T

**13. Butter.** When packaged in four (4) ounce, eight (8) ounce, and one (1) pound units with continuous label copy wrapping, butter is exempt from the requirements that the statement of identity (Subsection 170.01) and the net quantity declaration (Subsection 200.06) be generally parallel to the base of the package. When packaged in eight (8) ounce and one (1) pound units, butter is exempt from the requirement for location (Subsection 200.02) of net quantity declaration and, when packaged in one (1) pound units, is exempt from the requirement for dual quantity declaration (Subsection 172.03). (3-20-20)T

**14. Eggs.** Carton containing twelve (12) eggs are exempt from the requirement for location (Subsection 200.02) of net quantity declaration. When such cartons are designed to permit division in half, each half (1/2) are exempt from the labeling requirements of this rule if the undivided carton conforms to all such requirements. (3-20-20)T

**15. Flour.** Packages of wheat flour packaged in units of two (2), five (5), ten (10), twenty-five (25), fifty (50), and one-hundred (100) pounds are exempt from the requirement in this rule or location (Subsection 200.02) of the net quantity declaration and, when packaged in units of two (2) pounds, are exempt also from requirement for a dual quantity declaration (Subsection 172.03). (3-20-20)T

**16. Small Packages.** On a principal display panel of five (5) square inches or less, the declaration of quantity need not appear in the bottom thirty (30%) of the principal display panel if that declaration satisfies the other requirements of this rule. (3-20-20)T

**17. Decorative Containers.** The principal display panel of a cosmetic marketed in a “boudoir-type” container including decorative cosmetic containers of the “cartridge,” “pill box,” “compact,” or “pencil” variety, and those with a capacity of one-fourth (1/4) ounce or less, may be a tear-away tag or tape affixed to the decorative container and bearing the mandatory label information as required by this rule. (3-20-20)T

**18. Combination Packages.** Combination packages are exempt from the requirements in this rule for: (3-20-20)T

**a.** Location (see Subsection 200.02); (3-20-20)T

**b.** Free area (see Subsection 200.05); and (3-20-20)T

**c.** Minimum height of numbers and letters (see Subsection 200.08). (3-20-20)T

**19. Margarine.** Margarine in one (1) pound rectangular packages, except for packages containing whipped or soft margarine or packages containing more than four (4) sticks, is exempt from the requirement in this

rule for location (see Subsection 200.02) of the net quantity declaration, and is exempt from the requirement for a dual quantity declaration (see Subsection 172.03). (3-20-20)T

**20. Corn Flour.** Corn flour packaged in conventional five (5), ten (10), twenty-five (25), fifty (50), and one-hundred (100) pound bags is exempt from the requirement in this rule for location (see Subsection 200.02) of the net quantity declaration. (3-20-20)T

**21. Prescription and Insulin Containing Drugs.** Prescription and insulin containing drugs subject to the provisions of Section 503(b)(1) or 506 of the Federal Food, Drug, and Cosmetic Act are exempt from the provisions of this rule. (3-20-20)T

**22. Camera Film.** Camera film packaged and labeled for retail sale is exempt from the net quantity statement requirements of this rule which specify how measurement of commodities should be expressed, provided that: (3-20-20)T

**a.** The net quantity of contents on packages of movie film and bulk still film is expressed in terms of the number of lineal feet of usable film contained therein. (3-20-20)T

**b.** The net quantity of contents on packages of still film is expressed in terms of the number of exposures the contents will provide. The length and width measurements of the individual exposures, expressed in millimeters or inches, are authorized as an optional statement. (Example: "36 exposures, 36 x 24 mm" or "12 exposures, 2-1/4 x 2-1/4 in"). (3-20-20)T

**23. Paints and Kindred Products.** Paints, varnishes, lacquers, thinners, removers, oils, resins, and solvents, when packed in one (1) liquid pint and one (1) liquid quart units are exempt from the dual quantity declaration requirements of Subsection 172.04. (3-20-20)T

**24. Automotive Cooling System Antifreeze.** Antifreeze, when packed in one (1) liquid quart units, in metal or plastic containers, is exempt from the dual quantity declaration requirements of Subsection 172.04. (3-20-20)T

**25. Motor Oils.** Motor oils, when packed in one (1) liquid quart units, are exempt from the dual quantity declaration requirements of Subsection 172.04. Additionally, motor oil in one (1) liquid quart, one (1) gallon, one and one-fourth (1-1/4) gallon, two (2) gallon, and two and one-half (2-1/2) gallon units, bearing the principal display panel on the body of the container, is exempt from the requirements of Subsection 170.01 through 170.03. Identity, to the extent that the SAE grade is required to appear on the principal display panel, provided the SAE grade appears on the can lid and is expressed in letters and numerals in type size of at least one-fourth (1/4) inch. (3-20-20)T

**251. -- 259. (RESERVED)**

**260. VARIATIONS TO BE ALLOWED.**

**01. Packaging Variations.** (3-20-20)T

**a.** Variations from Declared Net Quantity. Variations from the declared net weight, measure, or count are permitted when caused by unavoidable deviations in weighing, measuring, or counting the contents of individual packages that occur in good packaging practice, but such variations are not permitted to such extent that the average of the quantities in the packages of a particular commodity, or a lot of the commodity that is kept, offered, or exposed for sale, or sold, is below the quantity stated, and no unreasonable shortage in any package is permitted, even though overages in other packages in the same shipment, delivery, or lot compensate for such shortage. Variations above the declared quantity may not be unreasonably large. (3-20-20)T

**b.** Variations Resulting from Exposure. Variations from the declared weight or measure are permitted when caused by ordinary and customary exposure to conditions that normally occur in good distribution practice and that unavoidably result in change of weight or measure, but only after the commodity is introduced into intrastate commerce, provided that the phrase "introduced into intrastate commerce" as used in this paragraph must be

construed to define the time and the place at which the first sale and delivery of a package is made within the state, the delivery being either: (3-20-20)T

i. Directly to the purchaser or to his agent; or (3-20-20)T

ii. To a common carrier for shipment to the purchaser, and this paragraph must be construed as requiring that, so long as a shipment, delivery, or lot of packages of a particular commodity remains in the possession or under the control of the packager or the person who introduces the package into intrastate commerce, exposure variations are not permitted. (3-20-20)T

**02. Magnitude of Permitted Variations.** The magnitude of variations permitted under Section 260 of this rule must, in the case of any shipment, delivery, or lot, be determined by the facts in the individual case. (3-20-20)T

**261. -- 269. (RESERVED)**

**270. MISLEADING PACKAGES.**

No commodity in package form may be so wrapped, nor be in a container so made, formed, or filled as to mislead the purchaser as to the quantity of the package, and the contents of a container must not fall below such reasonable standard of fill as may have been prescribed for the commodity in question by the Director. (3-20-20)T

**271. ADVERTISING PACKAGES FOR SALE.**

Whenever a packaged commodity is advertised in any manner with the retail price stated, there must be closely and conspicuously associated with the retail price a declaration of quantity as is required by law or rule to appear on the package. Where a dual declaration is required, only the declaration that sets forth the quantity in terms of the smaller unit of weight or measure need appear in the advertisement. And provided further, that there must not be included as part of the package declaration required under this section such qualifying terms as "when packed," "minimum," "not less than," or any other terms of similar import, nor any term qualifying a unit of weight, measure, or count (for example, "jumbo," "giant," "full," and the like) that tends to exaggerate the amount of commodity in the package. (3-20-20)T

**272. -- 299. (RESERVED)**

**300. PETROLEUM PRODUCTS.**

**01. Liquefied Petroleum.** Liquefied petroleum gas is considered to be a petroleum product and must be sold only by weight or liquid measure as provided in Sections 71-232 and 71-241, Idaho Code, of the Idaho Weights and Measures Law. (3-20-20)T

**02. Metering System Installation.** A liquefied petroleum gas metering system installation must be complete, that is, so installed to insure that liquefied petroleum gas is maintained in a liquid state while being metered. This includes an adequate means for vapor elimination upstream of meter and a properly installed and functioning differential valve downstream from meter. (3-20-20)T

**03. Maintaining Scales.** Scales used for liquefied petroleum gas bottle filling must be maintained in an adequate and accurate functioning condition. This means the periodic checking by a competent scale repairman, and checked regularly by your company's serviceman for any foreign material and clearances around lever system and working parts. Scales must be installed so that they are protected against weather effects so that weight value indicating elements can be accurately read. (3-20-20)T

**04. Gauge Stick Measurement.** Petroleum products are not to be sold by gauge stick measurement. (3-20-20)T

**05. Single Meters.** Trucks with a single meter which are used to meter oils and gasolines must be calibrated and adjusted on one of the following only: furnace or heating oils, diesel fuels, kerosene and/or high flash solvents. (3-20-20)T

**06. Compressed Natural Gas.** All compressed natural gas kept, offered or exposed for sale and sold at retail as a vehicle fuel must be measured in terms of mass, and indicated in gasoline gallon equivalent (GGE), diesel gallon equivalent (DGE) units, or mass. (3-20-20)T

**07. Liquefied Natural Gas.** All liquefied natural gas kept, offered, or exposed for sale and sold at retail as a vehicle fuel must be measured in terms of mass, and indicated in diesel gallon equivalent (DGE) units, or mass. (3-20-20)T

**301. -- 349. (RESERVED)**

**350. SALE AND LABELING OF GASOLINE WHICH CONTAINS OXYGENATES.**

**01. Pump Labeling Requirements.** (3-20-20)T

**a.** All spark ignition engine fuel kept, offered, or exposed for sale, or sold, at retail containing at least one percent (1%) by volume and not more than ten percent (10%) by volume of any oxygenate or combination of oxygenates must be identified as “with” or “containing” (or similar wording) the specific type of oxygenate(s) in the engine fuel. For example, the label may read “contains ethanol” or “with MTBE/ETBE.” This information must be posted on the upper fifty percent (50%) of the dispenser front panel in a position clear and conspicuous from the driver’s position, in a type at least one half (1/2) inch in height, one-sixteenth (1/16) inch stroke (width of type). (3-20-20)T

**b.** The labels are to be furnished by the retail owner or operator. (3-20-20)T

**02. Oxygenates Content Labels.** (3-20-20)T

**a.** The label must have letters in bold face, block not less than one-half (1/2) inch high. The lettering must be in black on a contrasting background. Both colors must be non-fade. (3-20-20)T

**b.** The label must be displayed on both faces of the dispenser on the upper one-half (1/2) of the dispenser as near the unit price display as practical. (3-20-20)T

**03. Documentation for Dispenser Labeling Purposes.** The retailer must be provided, at the time of delivery of the fuel, on an invoice, bill of lading, shipping paper, or other documentation, a declaration of any oxygenate or combination of oxygenates present in concentrations of at least one percent (1%) by volume of the fuel. This documentation is only for dispenser labeling purposes; it is the responsibility of any potential blender to determine the total oxygen content of the engine fuel before blending. (3-20-20)T

**04. Fuel Specifications for Gasoline and Gasoline-Oxygenate Blends.** (3-20-20)T

**a.** The version of ASTM D 4814 “Standard Specification for Automotive Spark-Ignition Engine Fuel” incorporated by reference in this rule is the standard for gasoline and gasoline oxygenate blends, except the volatility standards for unleaded gasoline blended with ethanol must not be more restrictive than those adopted under the rules, regulations, and Clean Air Act waivers of the U.S. Environmental Protection Agency. Gasoline blended with ethanol must be blended under any of the following three (3) options. (3-20-20)T

**i.** The base gasoline used in such blends must meet the requirements of ASTM D 4814, or (3-20-20)T

**ii.** The blend must meet the requirements of ASTM D 4814, or (3-20-20)T

**iii.** The base gasoline used in such blends must meet all the requirements for gasoline of ASTM D 4814 except distillation, and the blend must meet the distillation requirements of the ASTM specification. (3-20-20)T

**b.** Blends of gasoline and ethanol must not exceed the ASTM D 4814 vapor pressure standard by more than one point zero (1.0) psi. (3-20-20)T

**351. BIODIESEL.**

Identification and labeling requirements for biodiesel.

(3-20-20)T

**01. Identification of Product.** Biodiesel and biodiesel blends must be identified by the capital letter B followed by the numerical value representing the volume percentage of biodiesel fuel. (Examples: B10, B20, B100).  
(3-20-20)T

**02. Labeling of Retail Dispensers.** Each retail dispenser of biodiesel or biodiesel blend containing more than five percent (5%) must be labeled with the capital letter B followed by the numerical value representing the volume percentage of biodiesel fuel and ending with the either “biodiesel” or “biodiesel blend.” (Examples: B10 biodiesel, B20 biodiesel blend).  
(3-20-20)T

**a.** The label must have letters in bold face block not less than one-half (1/2) inch high, with the lettering clearly legible on a contrasting background.  
(3-20-20)T

**b.** The label must be displayed on both faces of the dispenser on the upper one-half (1/2) of the dispenser as near the unit price display as practical.  
(3-20-20)T

**03. Documentation for Dispenser Labeling Purposes.** (3-20-20)T

**a.** The retailer must be provided a declaration of the volume percent of the biodiesel on an invoice, bill of lading, shipping paper, or other document, at the time of delivery of the fuel.  
(3-20-20)T

**b.** This documentation is for dispenser labeling purposes only; it is the responsibility of any potential blender to determine the amount of biodiesel in the diesel fuel prior to blending.  
(3-20-20)T

**04. Exemption.** Biodiesel blends containing five percent (5%) or less biodiesel by volume are exempted from the requirements of Section 351 of this rule.  
(3-20-20)T

**352. -- 399. (RESERVED)**

**400. UNATTENDED VENDING MACHINES.**

**01. Vending Machine Displays.** Any coin or currency operated device which automatically dispenses consumer commodities or consumer packages without a full-time attendant must clearly display a sign or signs showing the following facts:  
(3-20-20)T

**a.** The name of the commodity or commodities dispensed;  
(3-20-20)T

**b.** The brand name or names of the commodity or commodities dispensed;  
(3-20-20)T

**c.** A statement of the quantity of each commodity or package to be dispensed through the device, except that this paragraph does not apply to candy bars, gum, or cigarettes;  
(3-20-20)T

**d.** The name, city, street address, state, and telephone number of the local distributor or operator of such device.  
(3-20-20)T

**02. Units of Measurement.** The units of measure used on such sign in the statement of quantity are the standard units as prescribed by the Idaho Weights and Measures Law and the rules of this chapter.  
(3-20-20)T

**401. -- 449. (RESERVED)**

**450. REGISTRATION OF SERVICEMEN AND SERVICE AGENCIES FOR COMMERCIAL WEIGHING AND MEASURING DEVICES.**

**01. Policy.** It is the policy of the Director of the Department of Agriculture or the Director’s duly authorized agent, hereinafter referred to as “Director,” to accept voluntary registration of (a) an individual and (b) an

agency that provides acceptable evidence that he or it is fully qualified to install, service, repair or recondition a commercial weighing or measuring device; has a thorough working knowledge of all appropriate weights and measures laws, orders, rules; and has possession of, or available for use, weights and measures standards and testing equipment appropriate in design and adequate in amount. (An employee of government shall not be eligible for registration). This policy in no way precludes or limits the right and privilege of any qualified individual or agency not registered with the Director to install, service, repair, or recondition a commercial weighing or measuring device. (3-20-20)T

**02. Reciprocity.** The Director may enter into an informal reciprocal agreement with any other state or states that has or have similar voluntary registration policies. Under such agreement, the registered servicemen and the registered service agencies of the states party to the reciprocal agreement are granted full reciprocal authority, including reciprocal recognition of certification of standards and testing equipment, in all states party to such agreement. (3-20-20)T

**03. Voluntary Registration.** An individual or agency may apply for voluntary registration to service weighing devices or measuring devices on an application form supplied by the Director. Said form, duly signed and witnessed, must include certification by the applicant that the individual or agency is fully qualified to install, service, repair, or recondition whatever devices for the service of which competence is being registered; has in possession, or available for use, all necessary testing equipment and standards; and has full knowledge of all appropriate weights and measures laws, orders, rules and regulations. An applicant must also submit appropriate evidence or references as to qualifications. (3-20-20)T

**04. Certificate of Registration.** Upon receipt and acceptance of a properly executed application form, the Director will issue to the applicant a "Certificate of Registration," including an assigned registration number, which will remain effective until either returned by the applicant or withdrawn by the Director. (3-20-20)T

**05. Privileges of a Voluntary Registrant.** A bearer of a Certificate of Registration has the authority to remove an official rejection tag or mark placed on a weighing or measuring device by the authority of the Director; place in service, until such time as an official examination can be made, a weighing or measuring device that has been officially rejected; and place in service, until such time as an official examination can be made, a new or used weighing or measuring device. (3-20-20)T

**06. Placed in Service Report.** The Director will furnish each registered serviceman and registered service agency with a supply of report forms to be known as "Placed in Service Reports." Such a form will be executed in triplicate, include the assigned registration number, and be signed by a registered serviceman or by a serviceman representing a registered agency for each rejected device restored to service and for each newly installed device placed in service. Within twenty-four (24) hours after a device is restored to service, or placed in service, the original of the properly executed Placed in Service Report, together with any official rejection tag removed from the device, must be mailed to the Director at The Idaho State Department of Agriculture, Bureau of Weights and Measures, 2216 Kellogg Lane, Boise, Idaho, 83712. The duplicate copy of the report must be handed to the owner or operator of the device, and the triplicate copy of the report must be retained by the registered serviceman or agency. Also, a copy of a test report on the form used by the Bureau of Weights and Measures or a form approved by the Bureau of Weights and Measures must be submitted to the Bureau of Weights and Measures, 2216 Kellogg Lane, Boise, Idaho, 83712, on livestock, vehicle and mono-rail scales. (3-20-20)T

**07. Standards and Testing Equipment.** A registered serviceman and a registered service agency must submit, at least biennially, or as directed, to the Director, for his examination and certification, any standards and testing equipment that are used, or are to be used, in the performance of the service and testing functions with respect to weighing and measuring devices for which competence is registered. A registered serviceman or agency may not use in servicing commercial weighing or measuring devices any standards or testing equipment that have not been certified by the Director. (3-20-20)T

**08. Revocation of Certificate of Registration.** The Director may, for good cause, after careful investigation and consideration, suspend or revoke a Certificate of Registration. (3-20-20)T

**09. Publication of Lists of Registered Servicemen and Registered Service Agencies.** The Director will publish, from time to time as he deems appropriate, and may supply upon request, lists of Registered Servicemen

and Registered Service Agencies. (3-20-20)T

**451. -- 499. (RESERVED)**

**500. BREAD.**

Each loaf of bread kept, offered, or exposed for sale, whether or not the bread is packaged or sliced, must be sold by weight, as per Section 71-236 of Title 71, Chapter 2, Idaho Code. (3-20-20)T

**501. -- 599. (RESERVED)**

**600. SINGLE DRAFT VEHICLE WEIGHING.**

A highway vehicle or a coupled highway-vehicle or a coupled highway-vehicle combination must be commercially weighed on a vehicle scale only as a single draft. That is, the total weight of such a vehicle or combination may not be determined by adding together the results obtained by separately and not simultaneously weighing each end of such vehicle or individual elements of such coupled combination. However: (3-20-20)T

**01. Coupled Combination.** The weight of a coupled combination may be determined by uncoupling the various elements (tractor, semitrailer, trailer), weighing each unit separately as a single draft, and adding together the results. (3-20-20)T

**02. Vehicle.** The weight of a vehicle or coupled-vehicle combination may be determined by adding together the weights obtained while all individual elements are resting simultaneously on more than one (1) scale platform. (3-20-20)T

**601. -- 649. (RESERVED)**

**650. RULE FOR NATIONAL TYPE EVALUATION.**

**01. Application.** This rule applies to all classes of devices and equipment as covered in the National Institute of Standards and Technology Handbooks 44, 105-1, 105-2, and 105-3. (3-20-20)T

**02. Certificate of Conformance.** The Director may require any weight or measure, or any weighing or measuring instrument or device to be issued a Certificate of Conformance prior to use for commercial or law enforcement purposes. (3-20-20)T

**03. Participating Laboratory.** The Director is authorized to operate a participating laboratory as part of the National Type Evaluation Program. (3-20-20)T

**651. -- 999. (RESERVED)**

## 02.02.15 – RULES GOVERNING THE SEED INDEMNITY FUND

### 000. LEGAL AUTHORITY.

This chapter is adopted under the legal authority of Section 22-5129, Idaho Code. (3-20-20)T

### 001. TITLE AND SCOPE.

01. **Title.** The title of this chapter is IDAPA 02.02.15, “Rules Governing the Seed Indemnity Fund.” (3-20-20)T

02. **Scope.** These rules clarify the procedure for licensing, collection and remittance of assessments, determining claim value, maintaining electronic records, use of electronic scales and remedies of the ISDA for non-compliance. (3-20-20)T

### 002. -- 009. (RESERVED)

### 010. DEFINITIONS.

The Idaho State Department of Agriculture adopts the definitions set forth in Section 22-5102, Idaho Code. In addition, as used in this chapter, “type” means the class of seed (i.e. foundation, certified, registered, noncertified). (3-20-20)T

### 011. ABBREVIATIONS.

01. **GAAP.** Generally Accepted Accounting Principles. (3-20-20)T

02. **ISDA.** Idaho State Department of Agriculture. (3-20-20)T

03. **SIF.** The Idaho Seed Indemnity Fund. (3-20-20)T

04. **USPS.** United States Postal Service. (3-20-20)T

### 012. DELIVERY VOUCHER.

If there are no receipts or scale weight tickets issued at the time of seed crop delivery, a delivery voucher may be issued. A delivery voucher is a document that may be used as written evidence of transfer in accordance with Section 22-5102(16), Idaho Code, evidencing delivery of producer's seed crop to seed buyer and includes, but is not limited to: (3-20-20)T

01. **Producer.** The full name, address and phone number of the producer. (3-20-20)T

02. **Seed Buyer.** The full name, address and phone number of the seed buyer. (3-20-20)T

03. **Ship To.** The full name, address and phone number of the seed facility that the seed crop is to be transferred. (3-20-20)T

04. **Transportation Company.** The name, address and phone number of the transportation company delivering the seed crop to the seed facility. The truck, trailer and seal number, if applicable, driver name (printed), signature and date of transfer. (3-20-20)T

05. **Seed Crop Shipped.** For each seed crop delivery, the type, kind, variety, estimated volume or weight and date of shipment and container identification markings. (3-20-20)T

### 013. WAREHOUSE RECEIPTS.

The following information is required on each warehouse receipt: (3-20-20)T

01. **Name of Producer.** (3-20-20)T

02. **Name and Address of Seed Buyer.** (3-20-20)T

03. **Kind of Seed Crop.** (3-20-20)T

04. **Date of Delivery.** (3-20-20)T



- 05. Weight of Seed Crop Delivered.** (3-20-20)T
- 06. Lot Identification.** (3-20-20)T

**014. SCALE WEIGHT TICKETS.**

Scale weight tickets for electronic scales that are recorded and maintained electronically are exempt from the sequentially numbered and in triplicate requirement. (3-20-20)T

**01. Pre-Numbered Scale Tickets.** If a seed buyer has access to a scale that can be used for weighing seed, the seed buyer is to use pre-numbered scale tickets. (3-20-20)T

**02. Numerical Order Requirement.** A copy of each ticket must be maintained in numerical order. (3-20-20)T

**03. Custom Scale Requirement.** If a seed buyer does not have access to a scale and has seed crop custom weighed at various locations, the seed buyer must maintain a copy of the scale ticket in chronological order as part of the seed crop records. (3-20-20)T

**015. -- 025. (RESERVED)**

**026. LICENSE.**

**01. Posting of License.** Immediately upon receipt of the license or any renewal, extension or modification thereof under Title 22, Chapter 51, Idaho Code, the licensed seed buyer must post the license in a conspicuous place in each place of business or in any other place as the director may determine. The ISDA will issue a duplicate license for each additional seed facility. (3-20-20)T

**02. License Fee.** If an applicant is not licensed pursuant to the "Pure Seed Law," Title 22, Chapter 4, Idaho Code, the license fee is equal to the out-of-state license fees, pursuant to Title 22, Chapter 4, and will be deposited to the state treasury and credited to the SIF. (3-20-20)T

**03. Return of Suspended or Terminated License.** If a license issued to a seed buyer has lapsed or is suspended, revoked or canceled by the director, the license and all duplicates shall be returned to the ISDA. At the expiration of any period of suspension, revocation or cancellation, the license will be returned to the seed buyer to whom it was originally issued and be posted as prescribed by these rules. (3-20-20)T

**04. Loss of License.** Upon satisfactory proof of the loss or destruction of a license issued to a seed buyer, a duplicate may be issued under the same number or a new number at the discretion of the director. (3-20-20)T

**05. License Reinstatement Fee.** If license renewal material is received by the ISDA after the current license has expired, but no later than thirty (30) days past due, a reinstatement fee of one hundred dollars (\$100) will be assessed. If license renewal material is received after the thirty (30) day late period it will be considered an original license application and will be assessed a license fee equal to the requirements of Section 026. The exemption for license fees in Section 22-5103(3)(a), Idaho Code, will not apply to license renewals that have been received by the ISDA later than thirty (30) days. Fees collected by this subsection will be deposited in the state treasury and credited to the SIF account. (3-20-20)T

**06. Additional License Application Information.** The ISDA may request additional license information including, but not limited to: (3-20-20)T

- a.** Names of officers of corporations or limited liability companies. (3-20-20)T
- b.** Company information as required in the application form. (3-20-20)T
- c.** Outstanding producer financial obligations. (3-20-20)T
- d.** Name and address of banks that handle business accounts. (3-20-20)T

**07. License Duration.** Licenses issued under the provisions of Title 22, Chapter 51, Idaho Code, expire on the 30th day of June of each year. (3-20-20)T

**027. -- 035. (RESERVED)**

**036. AMOUNT OF BOND FOR SEED STORED FOR WITHDRAWAL.**

For the purpose of calculating the bond required pursuant to Section 22-5105, Idaho Code, the value for seed stored for withdrawal is calculated by either using the commonly accepted market price of similar seed crops within the same geographic location or equal to the average value of the same kind of seed crop owned by the seed buyer, whichever is greater, as determined by ISDA. (3-20-20)T

**037. AMOUNT OF BOND, IRREVOCABLE LETTER OF CREDIT, CERTIFICATE OF DEPOSIT, OR SINGLE BOND.**

**01. Bonding Requirement.** The amount of bond to be furnished will be fixed at a rate pursuant to Section 22-5105, Idaho Code. (3-20-20)T

**02. Single Bond, Irrevocable Letter of Credit or Certificate of Deposit.** For the purposes of licensing as a seed buyer pursuant to Title 22, Chapter 51, Idaho Code, and as a warehouseman pursuant to Title 69, Chapter 2, Idaho Code, or as a commodity dealer pursuant to Title 69, Chapter 5, Idaho Code, a single bond, irrevocable letter of credit or certificate of deposit will be fixed at whichever of the following amounts is greater: (3-20-20)T

**a.** Combined total indebtedness paid and owed to producers for seed crop and agricultural commodity, without any deductions, for the previous license year; or (3-20-20)T

**b.** The indebtedness owed and estimated to be owed to producers for seed crop and agricultural commodity, without any deductions, for the current license year. (3-20-20)T

**038. -- 046. (RESERVED)**

**047. MAINTENANCE OF RECORDS.**

All records and accounts required under Title 22, Chapter 51, Idaho Code, are kept separate and distinct from all records and accounts of any other business of the seed buyer and be subject to inspection by the Director at any reasonable time. Electronic records may be maintained outside of Idaho provided they are available for examination by the ISDA within the state at any reasonable time. (3-20-20)T

**048. -- 049. (RESERVED)**

**050. INSURANCE REQUIREMENTS.**

**01. Insurance Coverage.** Pursuant to Section 22-5114, Idaho Code, the seed buyer must maintain a commercial property policy for loss against, but not limited to: (3-20-20)T

**a.** Loss from fire; (3-20-20)T

**b.** Loss from internal explosion; (3-20-20)T

**c.** Loss from lightning; (3-20-20)T

**d.** Loss from tornado. (3-20-20)T

**02. Insurance Deductible.** The maximum deductible allowed for insurance required by Section 22-5114, Idaho Code, is fifty thousand dollars (\$50,000). However, a larger deductible may be allowed at the discretion of the director. The request must be submitted in writing and kept on file. (3-20-20)T

**03. Seed Stored for Withdrawal.** The amount of insurance coverage must be sufficient to cover the full replacement value of similar or better kind and quality of seed crop. (3-20-20)T

**04. Self-Insurance.** A request for self-insurance must be submitted to the ISDA in writing and signed by the seed buyer or his representative. Supporting evidence of ability to pay seed crop obligations, in the event of a loss due to fire, internal explosions, lightning, or tornadoes, must be attached to the self-insurance request. (3-20-20)T

**a.** The director may accept or reject the self-insurance request. The director's findings will be in writing and kept on file. (3-20-20)T

**b.** If a seed buyer is self-insured and the seed crop within the licensed seed buyer's facility has been damaged or destroyed, the seed buyer must make complete settlement to all producers within thirty (30) days of the loss. Failure of the seed buyer to make such settlement is cause to revoke the seed buyer's license. If the seed buyer and producer agree to other terms, set out in writing, the settlement does not need to be made within the thirty (30) day time period. If only a portion of the seed crop is damaged, settlement may be made on a pro-rata basis to the producer. (3-20-20)T

**05. Insurance Settlement.** When the seed crop within a licensed seed buyer's facility has been damaged or destroyed, the seed buyer must make complete settlement to all producers having seed crops transferred to the seed buyer or stored for withdrawal within ten (10) days after settlement with the insurance company. Failure of the seed buyer to make such settlement is cause to revoke the seed buyer's license. If the seed buyer and producer agree to other terms, set out in writing, the settlement does not need to be made within the ten (10) day time period. If only a portion of the seed crop is damaged, settlement may be made on a pro-rata basis to the producer. (3-20-20)T

**051. -- 059. (RESERVED)**

**060. NONCOMPLIANCE -- REQUIREMENTS.**

If a seed buyer is not meeting its obligations to producers, does not have the ability to pay producers, or refuses to submit records and papers for lawful inspection, the ISDA will give written notice to the seed buyer and direct the seed buyer to comply with all of the following requirements within ten (10) working days or as agreed to by the ISDA. (3-20-20)T

**01. Additional Security Requirements.** If it appears the licensee does not have the ability to pay producers for seed crops transferred, or when it appears the licensee does not have a sufficient net worth to outstanding financial obligations ratio, the ISDA may require the licensee to post a bond or other additional acceptable security in the amount of two thousand dollars (\$2,000) for each one thousand dollars (\$1,000) or fraction thereof of deficiency. (3-20-20)T

**02. Provide an Audited or Reviewed Financial Statement.** The ISDA may require the licensee to submit an audited or reviewed financial statement prepared for the current financial accounting year by an independent certified public accountant or licensed public accountant. The audited or reviewed financial statement is to be prepared in accordance with GAAP. The ISDA may request a follow-up review of the submitted financial statement. (3-20-20)T

**061. -- 069. (RESERVED)**

**070. HOW ASSESSMENTS ARE TO BE CALCULATED.**

Pursuant to Section 22-5121, Idaho Code, all seed buyers must collect assessments from producers who transfer seed crop or store for withdrawal. Assessments are calculated as follows: (3-20-20)T

**01. Contract.** Assessments are collected on the gross dollar amount, without any deduction, owed to, or paid, or to be paid, on behalf of the producer of the seed crop. (3-20-20)T

**02. Seed Stored for Withdrawal.** On the clean or estimated clean weight at the time the seed crop is withdrawn from the seed facility: (3-20-20)T

**a.** The initial rate of assessment for cereal grain, lentil, pea, and dry edible bean and oil seed stored for withdrawal is not to exceed one hundredth (1/100) cent per pound. (3-20-20)T

**b.** The initial rate of assessment for all seed crops stored for withdrawal other than seed crops pursuant to Section 070, is not to exceed one half (1/2) cent per pound. (3-20-20)T

**c.** The SIF advisory board will review the assessment rate annually and make recommendations for change, as necessary, to the director. (3-20-20)T

**d.** If the amount of assessment for a producer on all seed stored for withdrawal made in a calendar year is calculated to be less than fifty cents (\$.50), no assessment will be collected. (3-20-20)T

**03. Incidental Costs and Expenses.** All incidental costs and expenses including, but not limited to, transportation, cleaning, in and out charges, insurance, taxes and additional services or charges are not be included in the calculation to determine the assessment. (3-20-20)T

**04. Unpaid Assessments.** If any assessment is unpaid and a failure occurs, the amount of the unpaid assessment will be deducted from any SIF recovery paid to the producer. (3-20-20)T

**071. -- 079. (RESERVED)**

**080. COLLECTION AND REMITTANCE OF SIF ASSESSMENTS.**

SIF assessments are collected from obligations owed to the producer or at the time of withdrawal by the seed buyer and remitted to the ISDA. If assessment is paid by mail the payment must be postmarked no later than the twentieth day of the month following the close of the quarter to avoid interest and penalty charges. (3-20-20)T

**081. -- 089. (RESERVED)**

**090. CLAIM FORMS AND PAYMENT FROM THE FUND.**

**01. Claim Forms.** Claim forms will be provided either via the USPS, by electronic transfer by the ISDA, or other commercial means. (3-20-20)T

**02. Contract.** If the seed crop is contracted, the value of the contract price of the seed crop, at the time of payment, may be used to determine payment from the SIF. (3-20-20)T

**03. Not Contracted or Stored for Withdrawal.** If the seed crop is not contracted or stored for withdrawal, the value for payment from the SIF will be determined by a survey of prices, for similar seed crops and similar seed facilities, within the same geographic location as the failed seed buyer. (3-20-20)T

**091. -- 099. (RESERVED)**

**100. EXEMPTIONS.**

Producers are not eligible to participate in SIF and no assessments will be collected from: (3-20-20)T

**01. Producers With a Financial or Management Interest.** Producers that have a financial or management interest in a seed facility, except members of a cooperative marketing association qualified under Title 22, Chapter 26, Idaho Code. (3-20-20)T

**02. Producers That Sell or Transfer to Another Producer.** Producers that sell to another producer, none of which are seed buyers. (3-20-20)T

**03. Deliveries or Transfers to Unlicensed Seed Facilities.** Producers that deliver or transfer seed crops to an unlicensed facility. (3-20-20)T

**101. -- 999. (RESERVED)**

## 02.03.03 – RULES GOVERNING PESTICIDE AND CHEMIGATION USE AND APPLICATION

### 000. LEGAL AUTHORITY.

This chapter is adopted under the legal authority of Section 22-3421, Idaho Code. (3-20-20)T

### 001. TITLE AND SCOPE.

**01. Title.** The title of this chapter is IDAPA 02.03.03, “Rules Governing Pesticide and Chemigation Use and Application.” (3-20-20)T

**02. Scope.** This chapter governs the use and application of pesticides; licensing of pesticide applicators; registration of pesticides; and responsibilities for chemigation in Idaho. (3-20-20)T

### 002. WRITTEN INTERPRETATIONS.

There are no written interpretations of these rules. (3-20-20)T

### 003. ADMINISTRATIVE APPEAL.

There is no provision for administrative appeal before the Idaho Department of Agriculture under this chapter. Hearing and appeal rights are pursuant to Title 67, Chapter 52, Idaho Code. (3-20-20)T

### 004. INCORPORATION BY REFERENCE.

**01. Incorporated Document.** IDAPA 02.03.03 incorporates by reference 40 CFR Part 165 Subpart E - Standards For Pesticide Containment Structures, Sections 165.80 through 165.97 as published in the Federal Register, Volume 71, Number 158, on August 16, 2006. Copies of these documents may be viewed at the Idaho State Department of Agriculture, or at <https://www.federalregister.gov/documents/2006/08/16/06-6856/pesticide-management-and-disposal-standards-for-pesticide-containers-and-containment>. (3-20-20)T

### 005. ADDRESS, OFFICE HOURS, TELEPHONE, FAX NUMBERS, WEB ADDRESS.

The Idaho State Department of Agriculture central office is located at 2270 Old Penitentiary Road, Boise, ID 83712-8298. The office is open from 8 a.m. to 5 p.m., except Saturday, Sunday, and legal holidays. The mailing address is PO Box 7249, Boise, Idaho 83707. The phone number is (208) 332-8500 and the fax number is (208) 334-2170. The Department web address is <https://agri.idaho.gov/>. (3-20-20)T

### 006. PUBLIC RECORDS ACT COMPLIANCE.

These rules are public records available for inspection and copying at the Department. (3-20-20)T

### 007. -- 009. (RESERVED)

### 010. DEFINITIONS.

The Idaho Department of Agriculture adopts the definitions set forth in Section 22-3401, Idaho Code, and the following definitions: (3-20-20)T

**01. Air Gap.** A physical separation between the free flowing discharge end of a domestic water supply system pipeline and an open or non-pressure receiving vessel. (3-20-20)T

**02. Basin Irrigation.** Irrigation by flooding areas of level land surrounded by dikes. (3-20-20)T

**03. Border Irrigation.** Irrigation by flooding strips of land, rectangular in shape and cross leveled, bordered by dikes. (3-20-20)T

**04. Certification.** Passing one (1) or more examinations, to initially demonstrate an applicant’s competence, as required by the licensing provisions of this act, in order to use or distribute pesticides, or to act as a pesticide consultant. (3-20-20)T

**05. Check Valve.** A certified valve designed and constructed to close a water supply pipeline, chemical injection line, or other conduit in a chemigation system to prevent reverse flow in that line. (3-20-20)T

**06. Chemigator.** Any person engaged in the application of chemicals through any type of irrigation system. (3-20-20)T

**07. Cross-Connection.** Any connection that may have chemical injected or introduced into the

- domestic water supply system and has the potential of or is connected to the domestic water supply system. (3-20-20)T
- 08. Demonstration and Research.** The use of restricted use pesticides to demonstrate the action of the pesticide or conduct research. (3-20-20)T
- 09. Domestic Water Supply System.** Any system providing water for human use. (3-20-20)T
- 10. Drip Irrigation.** A method of microirrigation wherein water is applied as drops or small streams through emitters. (3-20-20)T
- 11. Flood Irrigation.** Method of irrigation where water is applied to the soil surface without flow controls, such as furrows, borders or corrugations. (3-20-20)T
- 12. Flow Rate.** The weight or volume of flowable material per unit of time. (3-20-20)T
- 13. Furrow Irrigation.** Method of surface irrigation where the water is supplied to small ditches or furrows for guiding the water across the field. (3-20-20)T
- 14. Hazard Area.** Cities, towns, subdivisions or densely populated areas. (3-20-20)T
- 15. High Volatile Esters.** Formulations of 2,4-D which contain methyl, ethyl, butyl, isopropyl, octylamyl and pentyl esters. (3-20-20)T
- 16. Injection Pump.** A pump that uses a gear, rotary, piston or diaphragm to develop the pressures exceeding the irrigation system pressure to inject a chemical. (3-20-20)T
- 17. Inspection Port.** An orifice or other viewing device from which the low pressure drain and check valve may be observed. (3-20-20)T
- 18. Low Volatile Esters.** Formulations of 2,4-D; 2,4-DP; MCPA and MCPB which contain butoxyethanol, propylene glycol, tetrahydrofurfuryl, propylene glycol butyl ether, butoxy propyl, ethylhexyl and isooctyl esters. (3-20-20)T
- 19. Mixer-Loader.** Any person who works under the supervision of a professional applicator in the mixing and loading of pesticides to prepare for, but not actually make, applications. (3-20-20)T
- 20. Pressure Switch.** A device which will stop the chemical injection pump when the water pressure decreases to the point where chemical distribution is adversely affected. (3-20-20)T
- 21. Recertification.** The requalification of a certified person through seminar attendance over a set period of time, or taking an examination at the end of a set period of time, to ensure that the person continues to meet the requirements of changing technology and maintains competence. (3-20-20)T
- 22. Reduced Pressure Principle Backflow Prevention Assembly (RP).** An assembly containing two (2) independently acting approved check valves together with a hydraulically operating, mechanically independent pressure differential relief valve located between the check valves and at the same time below the first check valve. The unit shall include properly located resilient seated test cocks and tightly closing resilient seated test cocks and tightly closing resilient seated shutoff valves at each end of the assembly. (3-20-20)T
- 23. Seminar.** Any Department-approved meeting or activity convened for the purpose of presenting pesticide recertification information. (3-20-20)T
- 24. Sprinkler Irrigation.** Method of irrigation in which the water is sprayed, or sprinkled, through the air to the ground surface. (3-20-20)T
- 25. System Interlock.** Safety equipment used to ensure that a chemical injection pump will stop if the

irrigation pumping plant stops to prevent the entire chemical mixture from emptying from the supply tank into the irrigation pipeline. The safety equipment may also be used to shut down the irrigation system if the injection system fails. (3-20-20)T

**26. Vacuum Relief Valve.** A device to automatically relieve or break a vacuum. (3-20-20)T

**27. Venturi.** A differential pressure injector that operates on a pressure difference between the inlet and outlet of the injector and creates a vacuum inside the body, which results in suction through the suction port. (3-20-20)T

**28. Venturi Injection System.** A chemical injection system which operates with a Venturi using the suction from the Venturi that can be used to inject and mix chemicals into the water. (3-20-20)T

**29. Working Pressure.** The internal operating pressure of a vessel, tank or piping used to hold or transport liquid. (3-20-20)T

**30. Waters of the State.** Any surface waters such as canals, ditches, laterals, lakes, streams, or rivers. (3-20-20)T

**011. -- 049. (RESERVED)**

**050. PRIVATE APPLICATOR LICENSING.**

**01. Applying for a Private Applicator's License.** To obtain a private applicator's license: (3-20-20)T

**a.** Fill out an application prescribed by the Department; and (3-20-20)T

**b.** Take an examination based on the Environmental Protection Agency (EPA) core manual and score a minimum of seventy percent (70%). For the purpose of becoming licensed, examination scores are valid for twelve (12) months from the date of the examination. The examination procedure is the same as for professional applicators (Subsection 100.03), except private applicators are not assessed an examination fee. (3-20-20)T

**02. License Categories.** (3-20-20)T

**a.** Private applicators are certified and licensed in one (1) or more of the following categories: (3-20-20)T

**i.** Restricted Use Pesticide (RU). For persons who use or supervise the use of restricted use pesticides to produce agricultural commodities or forest crops on land they or their employer(s) own(s) or operate(s). (3-20-20)T

**ii.** Chemigation (CH). For persons who apply chemicals through irrigation systems on land they or their employer(s) own(s) or operate(s). (3-20-20)T

**iii.** Soil Fumigation (SF). For persons who apply soil fumigants on land they or their employer(s) own(s) or operate(s). In order to be certified and licensed in this category, private applicators must pass both the RU examination and the SF examination. (3-20-20)T

**b.** Non-reading applicators may be certified to purchase and apply a single restricted use pesticide when they have demonstrated their competence in the safe and proper use of such pesticide to the Director or other designated agent. (3-20-20)T

**03. License Recertification.** In order for a private applicator's license to be renewed, the license holder must complete the recertification provisions of this section. Licenses belonging to private applicators with last names beginning with A through L, inclusive, shall expire on the last day of the month listed on the chart in Subsection 050.03.a. in every odd-numbered year, and licenses belonging to private applicators with last names beginning with M through Z, inclusive, shall expire on the last day of the month listed on the chart in Subsection

050.03.a., in every even-numbered year. The recertification period shall be concurrent with the licensing period. Any person with less than thirteen (13) months in the initial licensing period shall not be required to obtain recertification credits for the initial period. Recertification and relicensing may be accomplished by complying with either Subsection 050.03.b. or 050.03.c. (3-20-20)T

**a.** Licensing schedule.

Last Name		Month to License
Odd Year	Even Year	
A-D	M-P	March
E-H	Q-T	July
I-L	U-Z	October

(3-20-20)T

**b.** A person accumulates recertification credits by attending Department-accredited pesticide instruction seminars. (3-20-20)T

**i.** A minimum of six (6) credits shall be earned during each recertification period. (3-20-20)T

**ii.** Guidelines for obtaining recertification credits are described in Subsections 100.04.a.ii. through 100.04.a.v. Any credits accumulated beyond the required six (6) in a recertification period may not be carried over to the next recertification period. (3-20-20)T

**iii.** Upon earning the recertification credits, a person is eligible for license renewal for the next licensing period, provided that the license renewal application is submitted within twelve (12) months from the expiration date of the license. (3-20-20)T

**c.** A person passes the Department's private applicator recertification examination(s) for all categories in which the person intends to license with a minimum score of seventy percent (70%). (3-20-20)T

**i.** Recertification examinations may be taken by a person beginning the thirteenth (13th) month of the license period. (3-20-20)T

**ii.** The examination procedures as outlined in Subsection 100.03 shall be followed, except that examination fees are not assessed. (3-20-20)T

**iii.** Upon passing the recertification examinations, a person is eligible for license renewal for the next licensing period. For the purpose of becoming licensed, recertification examination scores are valid for twelve (12) months from the date of the examination. (3-20-20)T

**d.** The Department may issue variances for the requirements delineated in 050.03 in the recertification of private applicators' licenses. Issuance of variances shall not relieve the recipient from compliance with all other responsibilities under the Pesticide and Chemigation Act and Rules. The request will be on a Department-prescribed form and state fully the grounds for requesting a variance. (3-20-20)T

**051. -- 099. (RESERVED)**

**100. LICENSING PROFESSIONAL APPLICATORS AND PESTICIDE DEALERS.**

**01. Demonstration of Competence.** (3-20-20)T

**a.** Professional applicators may only recommend the application or make pesticide applications for any purpose for which they have demonstrated competence. Competence is demonstrated by passing Department



- examinations and becoming licensed in the Subsection 100.02 categories. (3-20-20)T
- b.** An applicant shall demonstrate competency in the following areas: (3-20-20)T

    - i.** Labels and labeling, including terminology, instructions, format, warnings and symbols. (3-20-20)T
    - ii.** Safety factors and procedures, including protective clothing and equipment, first aid, toxicity, symptoms of poisoning, storage, handling, transportation and disposal. (3-20-20)T
    - iii.** Laws, rules, and regulations governing pesticides. (3-20-20)T
    - iv.** Environmental considerations, including the effect of climate and physical or geographical factors on pesticides, and the effects of pesticides on the environment, and the animals and plants living in it. (3-20-20)T
    - v.** Mixing and loading, including interpretation of labels, safety precautions, compatibility of mixtures, and protection of the environment. (3-20-20)T
    - vi.** Methods of use or application, including types of equipment, calibration, application techniques, and prevention of drift and other types of pesticide migration. (3-20-20)T
    - vii.** Pests to be controlled, including identification, damage characteristics, biology and habitat. (3-20-20)T
    - viii.** Types of pesticides, including formulations, mode of action, toxicity, persistence, and hazards of use. (3-20-20)T
    - ix.** Chemigation practices involving the application of chemicals through irrigation systems, calibration, management, and equipment requirements. (3-20-20)T
    - x.** For use of the Livestock Protection Collar (LPC), in addition to the requirements of Subsection 100.01.b.i. through 100.01.b.viii., professional applicators shall have training in and knowledge of the following: (3-20-20)T

      - (1) Characteristics and habits of predatory animals, and particularly, coyotes. (3-20-20)T
      - (2) Properties of the collars and of Sodium Fluoroacetate (Compound 1080). (3-20-20)T
      - (3) Recordkeeping requirements set forth in Subsection 150.01 that will additionally include a record of each animal found poisoned or suspected of having been poisoned as a result of the use of Compound 1080, including target and non-target species. (3-20-20)T
      - (4) The requirement for immediate reporting of suspected poisonings of non-target species and suspected poisonings of humans or domestic animals by the use of Compound 1080 to the United States Environmental Protection Agency (US EPA) and the Idaho State Department of Agriculture (ISDA). (3-20-20)T
      - (5) How to properly dispose of animal remains, vegetation, or soil contaminated by a punctured LPC. (3-20-20)T
      - (6) Practical treatment of Compound 1080 poisonings in humans and domestic animals. (3-20-20)T
      - (7) Safe handling, attachment, and storage of LPC collars. (3-20-20)T
      - (8) The requirement to post and maintain bilingual (English/Spanish or other second language appropriate for the region) signs at logical points of access to areas where LPCs are in use. (3-20-20)T
      - (9) The requirement to perform inspections once every week to ensure that collars in use are accounted

- for, property positioned, and intact. (3-20-20)T
- (10) Knowledge of alternative controls of predation. (3-20-20)T
- xi. For use of the LPC, in addition to the requirements of Subsections 100.01.b.i. through 100.01.b.x., professional applicators shall have training in and the ability to: (3-20-20)T
- (1) Recognize potential hazards to humans, domestic animals, and non-target wildlife from the use of the LPC. (3-20-20)T
- (2) Read and understand the labeling specific to the LPC. (3-20-20)T
- (3) Recognize general symptoms of poisoning by Compound 1080 in humans and domestic animals and take appropriate action. (3-20-20)T
- (4) Recognize where the LPC can be used safely and effectively and, conversely, where alternative methods of control would be more appropriate. (3-20-20)T
- (5) Assess damaged LPCs to determine which can be repaired and which must be disposed of properly. (3-20-20)T
- (6) Properly dispose of the LPCs. (3-20-20)T
- 02. Certification.** A person is certified by passing Department examinations with a minimum of seventy percent (70%) in the applicable pesticide categories. For the purpose of becoming licensed, examination scores are valid for twelve (12) months from the date of the examination. (3-20-20)T
- a.** Professional applicators shall be certified and licensed in one (1) or more of the following categories: (3-20-20)T
- i. Law and Safety (LS). This includes general knowledge of pesticides including proper use and disposal, product characteristics, first aid, labeling, and laws. Certification in this category is required when certifying in Subsections 100.02.a.ii. through 100.02.a.ix. (3-20-20)T
- ii. Agriculture. For persons conducting field crop applications. Agriculture Herbicide (AH). Certification in this category also certifies a person to make herbicide applications in rights-of-way, forests, and rangelands. Agriculture Insecticide/Fungicide (AI). Certification in this category also certifies a person to make insecticide/fungicide applications in rights-of-way, forests, and rangelands. Soil Fumigation (SF). (3-20-20)T
- iii. Forest Environment (FE). For U.S. Forest Service and Bureau of Land Management personnel, contractors, and private industry personnel who control pests in forests and on rangelands. (3-20-20)T
- iv. Right-of-Way Herbicide (RW). For railroads, highway departments and others, for roadside weed control, soil sterilant herbicides, and weed control on public lands (non-crop). Certification in the Agricultural Herbicide category exempts the applicant from the need to certify in this category. (3-20-20)T
- v. Public Health Pest (PH). For abatement districts and others controlling mosquitoes and other public health pests. (3-20-20)T
- vi. Livestock Pest Control (LP). For persons treating livestock pests. (3-20-20)T
- vii. Ornamental Herbicide (OH). For persons conducting outside urban or residential herbicide applications, with the exception of soil sterilant applications (see Subsection 100.02.a.iv.). Ornamental Insecticide/Fungicide (OI). For persons doing outside urban or residential insecticide and fungicide applications, including exterior applications to residential, urban or commercial buildings, excluding structural destroying pests (see Subsection 100.02.a.ix.). (3-20-20)T

- viii. General Pest Control Operations (GP). For persons controlling pests in and around residential, commercial, or other buildings, excluding structural destroying pests. (3-20-20)T
- ix. Structural Destroying Pest (SP). For persons involved in the control of pests which destroy wooden structures, such as bridges, houses, offices, and warehouses. (3-20-20)T
- x. General Vertebrate Control (GV). For Wildlife Services (WS) personnel of the United States Department of Agriculture-Animal and Plant Health Inspection Service, for controlling vertebrates such as rodents, predators, and birds. (3-20-20)T
- xi. Rodent Control (RC). For rodent districts and others, for the control of field rodents. Certification in the General Pest Control category shall exempt the applicant from the need to certify in this category. (3-20-20)T
- xii. Aquatic Weed and Pest Control (AW). For irrigation districts, canal companies and others, for weed and pest control on aquatic sites. (3-20-20)T
- xiii. Seed Treatment (ST). For persons doing treatments to protect seeds used for plant reproduction. (3-20-20)T
- xiv. Commodity Pest Control (CP). For persons controlling pests in stored commodities. (3-20-20)T
- xv. Potato Cellar Pest Control (PC). For persons who apply sprout inhibitors in potato cellars. (3-20-20)T
- xvi. Wood Preservative (WP). For persons who apply wood preservatives. (3-20-20)T
- xvii. Pest Control Consultant-Statewide (SW). For persons who make recommendations or supply technical advice concerning the use of any pesticide for agricultural purposes. (3-20-20)T
- xviii. Demonstration and Research (DR). For persons who apply or supervise the use of restricted use pesticides at no charge to demonstrate the action of the pesticide or conduct research with restricted use pesticides. A person is eligible to license in this category by passing the Pest Control Consultant examination. (3-20-20)T
- xix. Chemigation (CH). For persons who apply chemicals through an irrigation system, excluding Aquatic Weed and Pest Control applicators (see Subsection 100.02.xii.). (3-20-20)T
- xx. Livestock Protection Collars (LPC). For use of Livestock Protection Collars (LPC) containing the restricted use pesticide Compound 1080 to control predatory coyotes. (3-20-20)T
- b.** Pesticide Dealers are certified and licensed in any category listed in Subsection 100.02 that pertains to the types of restricted use pesticides sold or distributed. (3-20-20)T
- c.** Mixer-Loaders. No person shall act as a mixer-loader for a professional applicator without first obtaining annual training. (3-20-20)T
- i. Training will be conducted and certified by the professional applicator who employs the mixer-loader. Certification of training shall be on a form prescribed by the Department and must include the signatures of both the mixer-loader and the professional applicator providing the training. (3-20-20)T
- ii. Training includes areas relevant to the pesticide mixing and loading operation and instruction on the interpretation of pesticide labels, safety precautions, first aid, compatibility of mixtures, and protection of the environment. (3-20-20)T
- 03. Department Examination Procedures.** (3-20-20)T
- a.** Examinations are administered by a designated agent. (3-20-20)T

**b.** Professional applicators and pesticide dealers pass a Department examination by obtaining a score of seventy percent (70%) or higher. (3-20-20)T

**c.** Payment of examination fees shall be received by the Idaho Department of Agriculture before examination results may be released. (3-20-20)T

**d.** A minimum waiting period of one (1) week is required before an applicant may retake an examination. (3-20-20)T

**04. Licensing Periods and Recertification.** Any professional applicator with less than thirteen (13) months in the licensing period is not required to obtain recertification credits during the initial licensing period. The recertification period for professional applicators shall be concurrent with their two (2) year licensing period. Recertification requirements may be accomplished by complying with either Subsection 100.04.a. or 100.04.b. (3-20-20)T

**a.** A person accumulates recertification credits by attending Department-accredited pesticide instruction seminars. (3-20-20)T

**i.** Professional applicators have a fifteen (15) credit minimum for each recertification period. (3-20-20)T

**ii.** A completed written request for accreditation of a seminar shall be received by the Department not less than thirty (30) days prior to the scheduled seminar submitted on a form prescribed by the Department. Under exceptional circumstances, as described in writing by the person requesting accreditation, the thirty (30) day requirement may be waived. (3-20-20)T

**iii.** Credit is given only for those parts of seminars that deal with pesticide subjects as listed in Subsection 100.01.b. No credit will be given for training given to persons to prepare them for initial certification. (3-20-20)T

**iv.** The number of credits assigned in advance for a seminar, or a part of a seminar, is tentative, and may be revised by the Department if it is later found that the training does not comply with Subsection 100.04.a.iii. (3-20-20)T

**v.** A recertification credit is based upon one (1) credit for each one (1) hour of instruction, as described in Subsection 100.04.a.iii. (3-20-20)T

**vi.** Verification of attendance at a seminar is accomplished by validating the attendee's pesticide license, using a stamp, sticker, or other method approved by the Department. A designated agent must ensure that such attendance records are properly completed. Verification of attendance must be submitted with the license renewal application. (3-20-20)T

**vii.** If a person has accumulated more than fifteen (15) credits during the recertification period, the excess credits may not be carried over to the next recertification period. (3-20-20)T

**viii.** Upon earning the recertification credits as described above, a person is recertified for the next recertification period corresponding with the next issuance of a license, provided that the license renewal application is submitted within twelve (12) months from the expiration date of the license. (3-20-20)T

**b.** A person shall pass the Department's recertification examinations for all categories in which a person intends to license. (3-20-20)T

**i.** Recertification examinations may be taken by a professional applicator beginning the thirteenth month of the recertification period. (3-20-20)T

**ii.** The examination procedures as outlined in Subsection 100.03 shall be followed. (3-20-20)T

- iii. In addition to examinations for categories listed under Subsections 100.02.a.ii. through 100.02.a.ix., a person must also pass a Law and Safety recertification examination. (3-20-20)T
- iv. Recertification shall not be achieved by passing an entry-level examination. (3-20-20)T
- v. Upon passing the recertification examination(s), a person is considered by the Department to be recertified for the next recertification period. (3-20-20)T
- c. Any person who fails to accumulate the required recertification credits prior to the expiration date of their license shall be required to pass the appropriate recertification examination(s) before being licensed. (3-20-20)T

**05. Licensed Professional Applicator.** Only a licensed professional applicator shall operate or supervise the operation of commercial application equipment by being present during the time of operation. Licensed professional applicators that start the application of chemicals through chemigation equipment do not have to be present during the entire application, but must return to monitor the proper application at least once every four (4) hours for the duration of the application. (3-20-20)T

**06. Licensing Variances.** The Department may grant variances in the recertification of professional applicators' and dealers' licenses. Issuance of variances shall not relieve the recipient from compliance with all other responsibilities under the Pesticide and Chemigation Act and Rules. The request will be on a Department-prescribed form and state fully the grounds for requesting a variance. (3-20-20)T

## **101. REGISTRATION AND LICENSING REQUIREMENTS FOR USE OF THE LPC.**

**01. Registration.** Use restricted to United States Department of Agriculture, Animal and Plant Health Inspection Service, wildlife services (USDA, APHIS, WS) employees, licensing, and recordkeeping requirements for the LPC. (3-20-20)T

- a. Only the USDA, APHIS, WS can register the LPC. USDA, APHIS, WS is hereinafter known as the registrant for the purpose of these rules. (3-20-20)T
- b. The LPC shall be transferred only by the registrant and only to professional applicators who are certified in the LC category and who are current employees of USDA, APHIS, WS. (3-20-20)T
- c. The LPC is used only by professional applicators with certification in the LC category who are current employees of the USDA, APHIS, WS. (3-20-20)T
- d. Before obtaining certification and licensing, LC applicants shall receive training and demonstrate competency in the areas listed in Subsection 100.01.b.x. and 100.01.b.xi. of these rules and satisfy Section 22-3404, Idaho Code. (3-20-20)T

e. Only the manufacturer or registrant is authorized to fill collars with Compound 1080. Certified professional applicators or any other person shall not fill collars or remove the pesticide from the collars. (3-20-20)T

**02. Use of the LPC (Compound 1080).** (3-20-20)T

- a. Coyotes may be taken by collar only. (3-20-20)T
- b. Warning signs shall be posted at all usual points of entry to the area, including any access roads, or footpath or other walking route that enters the area. When there are no usual points of entry, signs shall be posted in the corners of the area or in any other location affording maximum visibility. (3-20-20)T
  - i. The signs shall remain visible and legible throughout the collar use. (3-20-20)T
  - ii. All warning signs shall be posted and inspected once a week by the certified Wildlife Services employee to ensure their continued presence and legibility, and will be removed when all collars are removed and

accounted for. (3-20-20)T

iii. Warning signs shall be at least fourteen (14) inches by sixteen (16) inches with letters at least one (1) inch in height. (3-20-20)T

iv. All warning signs shall have a background color that contrasts with red and feature clearly legible wording. The words "DANGER" and "PELIGRO," plus "PESTICIDES" and "PESTICIDAS," shall be at the top of the sign, and the words "KEEP OUT" and "NO ENTRE" shall be at the bottom of the sign. A circle containing an upraised hand on the left and a stern face on the right shall be near the center of the sign. The inside of the circle shall be red, except that the hand and a large portion of the face shall be in a shade that contrasts with red. The length of the hand shall be at least twice the height of the smallest letters. The length of the face shall be only slightly smaller than the hand. (3-20-20)T

v. The name of the pesticide (Compound 1080) and the date collars were placed on the sheep or goats shall appear on the warning sign. (3-20-20)T

c. If a collar is found to have been punctured by a predator attacking a collared animal, an intensive search shall be conducted for the predator that punctured the collar. (3-20-20)T

i. Disposal of punctured or unserviceable collars and contaminated gloves, clothing, vegetation or soil shall be as prescribed by the 1080 LPC label and technical bulletin or through the ISDA pesticide disposal program. Disposal of animal remains shall be in accordance with label directions. (3-20-20)T

d. Prior to any intended use or application of the LPCs, the professional applicator is to submit to ISDA a written notice of intended use containing: (3-20-20)T

i. The professional applicator's license number issued by the ISDA; (3-20-20)T

ii. A list of the names and addresses of the owners or persons in charge of the areas to be treated and a map of the geographic location of such areas; (3-20-20)T

iii. The approximate size of the area where treatment will take place; (3-20-20)T

iv. The intended period of use; and (3-20-20)T

v. The number of collars to be used. (3-20-20)T

e. USDA, APHIS, WS shall accurately keep and maintain the following records and reports: (3-20-20)T

i. Records of all collars distributed; (3-20-20)T

ii. The name and address of each professional applicator receiving the collars; and (3-20-20)T

iii. The dates and the number of collars received by each professional applicator. (3-20-20)T

iv. These records shall be maintained by USDA, APHIS, WS for a period of three (3) years and made available to the ISDA for inspection, duplication, and verification upon request by the ISDA. (3-20-20)T

f. The professional applicator shall accurately keep and maintain the following records and reports: (3-20-20)T

i. Any suspected poisoning of humans, threatened or endangered species, domestic animals, or non-target wild animals shall be reported within seventy-two (72) hours or less to the ISDA and US EPA; (3-20-20)T

ii. The name and address of the person on whose property the LPC was used or, if different from the property owner, the same information for the person in charge of the area where the collars will be used; (3-20-20)T

- iii. A map of the geographic location and size of the area in which the LPCs were used; (3-20-20)T
  - iv. A summary report of the date each individual collar was obtained by the professional applicator, placed on sheep, punctured or ruptured (along with apparent cause), lost or unrecovered, or removed and put in storage, or disposed of through the ISDA Pesticide Disposal Program; (3-20-20)T
  - v. The species, date, and location of each animal found poisoned or suspected of having been poisoned as a result of the use of Compound 1080 in LPCs; (3-20-20)T
  - vi. The dates and results of each collar inspection; and (3-20-20)T
  - vii. A written description of any complete and intensive search for missing collars or poisoned animals conducted as specified in these rules. (3-20-20)T
  - viii. The records required by this rule shall be maintained by the professional applicator for a period of three (3) years and made available to the ISDA for inspection, duplication and verification upon request of the ISDA. (3-20-20)T
  - ix. A report of the records required by Subsection 101.02.g. shall be submitted to the ISDA as an annual summary report. (3-20-20)T
- g.** Collars may be used only upon sheep or goats within fenced pastures no larger than two thousand five hundred sixty (2,560) acres (four (4) square miles). Fenced pastures include all pastures that are enclosed by livestock fencing. In addition to wire livestock fences, and other man-made fences, such as rock walls, natural barriers such as escarpments, lakes, or large rivers may be used as fences, as long as they will prevent escape of sheep or goats. Fenced pastures and fences as herein defined are referred to elsewhere in this section as "area." Collars shall not be used on unfenced, open range. (3-20-20)T
- h.** All appropriate alternative control methods must be considered before implementing use of the LPC. (3-20-20)T
- i.** Each collar in use shall be inspected by the professional applicator once a week to ensure that it is properly positioned and unbroken. An inspection report on a form prescribed by the director shall be forwarded to ISDA following the conclusion of the project. (3-20-20)T
- i. If any collared animal is not accounted for in any two (2) consecutive checks, a complete search for the collared animal shall be conducted. (3-20-20)T
  - ii. If more than four (4) LPCs are unaccounted for during any thirty (30) day period, WS employees shall remove all LPCs from all animals and terminate their use. Use of collars shall not be resumed until WS employees have provided ISDA with a written protocol defining adequate steps they shall take to prevent any losses of LPCs. (3-20-20)T
- j.** Intact LPCs containing Compound 1080 shall be stored by USDA, APHIS, WS under lock and key in a dry place away from food, feed, domestic animals and corrosive chemicals, and in outbuildings or in outdoor storage areas attached to, but separate from, human living quarters. (3-20-20)T

**102. -- 149. (RESERVED)**

**150. RECORDS REQUIREMENTS.**

- 01. Applicator Records.** Professional applicators shall maintain pesticide application records for three (3) years, ready to be inspected, duplicated, or submitted when requested by the Director. The records shall be maintained in a location designated by the professional applicator. (3-20-20)T
- 02. Record Contents.** Such records shall contain: (3-20-20)T

- a. The name and address of the owner or operator of each property treated; and (3-20-20)T
  - b. The specific crop, animal, or property treated; and (3-20-20)T
  - c. The location by the address, general legal description (township, range, and section) or latitude/longitude of the specific crop, animal, or property treated; and (3-20-20)T
  - d. The size or amount of specific crop, animal, or property treated; and (3-20-20)T
  - e. The trade name or brand name of the pesticide applied; and (3-20-20)T
  - f. The total amount of pesticide applied; and (3-20-20)T
  - g. The dilution applied or rate of application; and (3-20-20)T
  - h. The EPA registration number of the pesticide applied; and (3-20-20)T
  - i. The date of application; and (3-20-20)T
  - j. The time of day when the pesticide is applied; and (3-20-20)T
  - k. The approximate wind velocity; and (3-20-20)T
  - l. The approximate wind direction; and (3-20-20)T
  - m. The full name of the person recommending the pesticide application; and (3-20-20)T
  - n. The full name of the professional applicator applying the pesticide; and (3-20-20)T
  - o. The license number of the professional applicator applying the pesticide; and (3-20-20)T
  - p. Worker protection information exchange, if required by the worker protection standard, prior to pesticide application, shall be documented by: (3-20-20)T
    - i. Date of contact; and (3-20-20)T
    - ii. Time of contact; and (3-20-20)T
    - iii. Name of grower or operator contacted. (3-20-20)T
- 03. Pesticide Dealer Records.** Pesticide dealers shall maintain restricted use pesticide distribution records for three (3) years, ready to be inspected, duplicated, or submitted when requested by the Director. The records shall be maintained in a location designated by the pesticide dealer. (3-20-20)T
- 04. Record Contents.** Such records shall contain: (3-20-20)T
- a. The name and address of the person purchasing or receiving the restricted use pesticide (RUP); and (3-20-20)T
  - b. The certified applicator name, license number, and expiration date of the license for the person certified to use the RUP; or (3-20-20)T
  - c. In the case of distribution of a RUP to another pesticide dealer, the name, license number, and expiration date of the license of the licensed pesticide dealer. (3-20-20)T
  - d. The brand name and Environmental Protection Agency (EPA) Registration Number for each RUP



- distributed; and (3-20-20)T
- e. Date of the distribution of each RUP; and (3-20-20)T
  - f. The quantity and size of each RUP container distributed and the total quantity of RUP distributed; and (3-20-20)T
  - g. The pesticide dealer's name, address, and pesticide dealer license number distributing the RUP. (3-20-20)T

**151. -- 199. (RESERVED)**

**200. FEES.**

- 01. Pesticide Registration.** One hundred sixty dollars (\$160) per product. (3-20-20)T
- 02. Professional Applicator's License.** One hundred twenty dollars (\$120) per licensing period of fourteen (14) months or more, sixty dollars (\$60) per licensing period of thirteen (13) months or less. (3-20-20)T
- 03. Pesticide Dealer's License.** One hundred dollars (\$100) per licensing period of fourteen (14) months or more, fifty dollars (\$50) per licensing period of thirteen (13) months or less. (3-20-20)T
- 04. Private Applicator's License.** A Restricted Use Category, ten dollars (\$10); a Chemigation Category, twenty dollars (\$20); or thirty dollars (\$30) for both categories. (3-20-20)T
- 05. Examination Fee per Examination Category.** Ten dollars (\$10). (3-20-20)T

**201. -- 249. (RESERVED)**

**250. FINANCIAL RESPONSIBILITY.**

- 01. Proof of Financial Ability.** A professional applicator's license will not be issued by the Department until an applicant submits written proof of financial responsibility by any of the following methods: (3-20-20)T
  - a. Liability insurance with an insurance company licensed to do business in Idaho and documented on a form approved by the Director; or (3-20-20)T
  - b. A bond that is approved by the Director; or (3-20-20)T
  - c. A cash certificate of deposit in escrow with a bank or trust company; or (3-20-20)T
  - d. An annuity; or (3-20-20)T
  - e. An irrevocable letter of credit. (3-20-20)T
  - f. Any certificate of deposit, annuity, or irrevocable letter of credit must be payable to the Director as trustee and shall remain on file with the Department until it is released, canceled or discharged by the Director. Any certificate of deposit, annuity, or irrevocable letter of credit must maintain a cash value equal to the requirements of Subsection 250.02, less any penalty for early withdrawal. Accrued interest upon a certificate of deposit or annuity shall be payable to the purchaser of the certificate or annuity. (3-20-20)T
  - g. Under the provisions of this chapter, an irrevocable letter of credit shall not be acceptable unless it is issued by a national bank in Idaho or by an Idaho state-chartered bank insured by the federal deposit insurance corporation. Under the provisions of this chapter, an annuity shall not be accepted by the Department unless it is issued by an insurance company, bank or other financial institution found acceptable by the Director. (3-20-20)T

**h.** Exclusions. Any exclusion to liability insurance, bond, cash certificate of deposit, annuity or irrevocable letter of credit coverage shall be listed on a form approved by the Director. (3-20-20)T

**02. Minimum Coverage Required.** (3-20-20)T

**a.** Professional applicators. (3-20-20)T

**i.** Bodily injury - fifty thousand dollars (\$50,000) per person/one hundred thousand dollars (\$100,000) per occurrence. (3-20-20)T

**ii.** Property damage - fifty thousand dollars (\$50,000) per occurrence. (3-20-20)T

**iii.** Maximum deductible - five thousand dollars (\$5,000). (3-20-20)T

**iv.** All new professional applicator licenses issued on or after September 1, 1997, shall require financial responsibility at or exceeding the coverage limits as specified in Subsections 250.02.a.i. and 250.02.a.ii. (3-20-20)T

**v.** In order to maintain an existing professional applicator license the coverage limits specified in Subsections 250.02.a.i. and 250.02.a.ii. shall be met or exceeded on or before December 31, 1998. (3-20-20)T

**03. Target Property Not Required to Be Covered.** The immediate property being treated is not required to be covered as prescribed in Subsection 250.02.a.ii. (3-20-20)T

**04. Cancellation or Reduction.** The Department shall be notified by the applicator in writing immediately after cancellation or reduction of the financial coverage. (3-20-20)T

**05. Coverage Waived.** Coverage waivers which have been issued prior to September 1, 1997, shall remain in effect until the first license expiration date subsequent to September 1, 1997. (3-20-20)T

**251. -- 299. (RESERVED)**

**300. DEVIATIONS FROM PESTICIDE LABELS AND LABELING.**

Any licensed professional or private applicator may deviate from pesticide label directions for use only as EPA or state laws, rules, and regulations permit. (3-20-20)T

**301. -- 320. (RESERVED)**

**321. CHANGE OF LICENSE STATUS.**

**01. Change Notification.** Any person who is licensed by this act shall immediately notify the Director, in writing, of any change of status of any person or agent so named, or of any change in the business name, organization, or any other information shown in the licensing application. (3-20-20)T

**02. Transferable.** Licenses are not transferable. (3-20-20)T

**322. (RESERVED)**

**323. PESTICIDE-FERTILIZER MIX RESTRICTIONS.**

No person shall distribute, sell, offer for sale, or hold for sale any dry pesticide incorporated in a dry blended bulk fertilizer mix. (3-20-20)T

**324. EXPERIMENTAL PERMITS.**

Any person who wishes to obtain an experimental permit to accumulate information necessary to register a pesticide for a special local need under Section 22-3402(5), Idaho Code, shall file an application with the Department which contains: (3-20-20)T

- 01. Name.** The company name. (3-20-20)T
- 02. Applicant.** The name, address, and telephone number of the applicant. (3-20-20)T
- 03. Shipment.** The proposed date of shipment or proposed shipping period not to exceed one (1) year. (3-20-20)T
- 04. Active Ingredient.** A statement listing the active ingredient. (3-20-20)T
- 05. Quantity Statement.** A statement of the approximate quantity to be tested. (3-20-20)T
- 06. Acute Toxicity.** Available data or information or reference to available data on the acute toxicity of the pesticide. (3-20-20)T
- 07. Statement of Scope.** A statement of the scope of the proposed experimental program, including the type of pests or organisms involved, the crops and animals for which the pesticide is to be used, the areas where the applicant proposes to conduct the program, and when requested by the Director, the results of previous tests. (3-20-20)T
- 08. Temporary Tolerance.** When the pesticide is to be used on food or feed, a temporary tolerance must be obtained from the EPA or evidence that the proposed experiment will not result in injury to humans or animals, or illegal residues entering the food chain. (3-20-20)T
- 09. Proposed Labeling.** Proposed labeling which must bear: (3-20-20)T
- a.** The prominent statement "For Experimental Use Only" on the container label and any labeling that accompanies the product. (3-20-20)T
- b.** An adequate caution or warning statement to protect those who may handle or be exposed to the experimental formulation. (3-20-20)T
- c.** The name and address of the applicant for the permit. (3-20-20)T
- d.** The name or designation of the formulation. (3-20-20)T
- e.** Directions for use. (3-20-20)T
- f.** A statement listing the name and percentage of each active ingredient and the total percentage of inert ingredients. (3-20-20)T
- 10. Quantity Limit.** The Director may limit the quantity of pesticide covered by the permit or make such other limitations as he may determine to be necessary for the protection of humans or the environment. (3-20-20)T
- 11. Experimental Use.** A pesticide for experimental use shall not be offered for sale unless a written permit has been obtained from the Director. (3-20-20)T

**325. -- 399. (RESERVED)**

**400. RESTRICTIONS TO PROTECT POLLINATORS.**

- 01. Bee Restrictions.** Any pesticide that is toxic to bees shall not be applied to any agricultural crop when such crop is in bloom or when bees are actively foraging on blooming weeds in the crop being sprayed except during the period beginning three (3) hours before sunset until three (3) hours after sunrise. (3-20-20)T
- 02. Green Pea Exception.** In the counties of Benewah, Bonner, Boundary, Clearwater, Idaho, Kootenai, Latah, Lewis, Nez Perce, and Shoshone: Green (white) pea crops may be sprayed or dusted at any time. (3-20-20)T

**03. Other Exceptions.** Pesticides may be applied at any time to sweet corn for processing, hops, potatoes, and beans other than lima beans, subject to all other applicable regulations. (3-20-20)T

**401. -- 449. (RESERVED)**

**450. STORAGE OF PESTICIDE CONTAINERS.**

**01. Protecting Humans and Environment.** No person shall handle, transport, display, or distribute pesticides in such a manner as to endanger humans and their environment, or to contaminate food, feed, or any other product that may be transported, stored, displayed, or distributed with such pesticides. (3-20-20)T

**02. Storage by Professional Applicators or Pesticide Dealers.** Storage of pesticide containers by professional applicators and pesticide dealers: (3-20-20)T

**a.** Empty or partially full pesticide containers which contain Class 1 - highly toxic pesticides (LD50 of 50 or below) and which require the skull and crossbones insignia and the words "Danger - Poison" on the label; and Class 2 (moderately toxic) pesticides (LD50 - 500) which carry a "Warning" statement on the label; and Class 3 (slightly toxic) pesticides (LD50 of 500-5000) and which carry a "Caution" statement on the label, shall be stored in one of the following enclosures which when unattended shall be locked to prevent unauthorized persons, livestock or animals from gaining entry: (3-20-20)T

- i. Closed vehicle; (3-20-20)T
- ii. Closed trailer; (3-20-20)T
- iii. Building or room; (3-20-20)T
- iv. Fenced area with a fence at least six (6) feet high; (3-20-20)T
- v. Truck or trailer with solid sideracks and secured tailgate at least six (6) feet above ground level. (3-20-20)T

**b.** Empty or partially full pesticide containers which contain Class 4 pesticides (LD50 over 5000) shall be stored in secured storage out of the reach of children in one of the above enclosures. (3-20-20)T

**c.** Warning notices, visible from any direction, shall be posted around all storage areas where partially full or empty containers which hold or have held pesticides required to be labeled with the signal words "Warning" or "Danger - Poison" are stored. Each warning notice shall be of such size that it is readable at a distance of twenty-five (25) feet and be substantially as follows:

**"D A N G E R"**

**"POISON STORAGE AREA  
ALL UNAUTHORIZED PERSONS  
KEEP OUT"**

The notice shall be repeated in an appropriate language other than English when it may be reasonably anticipated that persons who do not understand the English language will come to the enclosure. The notice shall also contain the name and telephone number of a person to contact in case of an emergency. (3-20-20)T

**03. Exceptions.** The provisions of Subsection 450.02 shall not apply to drums of petroleum oils, lime sulfur, and copper sulfate. (3-20-20)T

**04. Disposal.** Any person applying pesticides shall be responsible for the proper disposal of such empty containers. (3-20-20)T

**451. -- 499. (RESERVED)**

**500. NON-DOMESTIC PESTICIDES.**

**01. Home and Garden Restrictions.** The following pesticides are to be registered only when labeled, distributed, sold or held for sale and use other than home and garden use and are not be sold to home and garden users or applied by professional applicators around any home or garden. (3-20-20)T

- a. Bidrin (Foliar applications). (3-20-20)T
- b. Strychnine (one percent (1%) and above). (3-20-20)T
- c. Zinc Phosphide (two point one percent (2.1%) and above). (3-20-20)T

**02. Ester Restriction.** Low volatile liquid ester formulations of herbicides shall not be applied around any home or garden at any time when ambient air temperature exceeds or is forecasted to exceed eighty (80) degrees Fahrenheit during the day of application. (3-20-20)T

**501. -- 549. (RESERVED)**

**550. PHENOXY HERBICIDE RESTRICTIONS.**

**01. High Volatile Ester Restrictions.** No aircraft pilot shall apply high volatile ester formulations of 2,4-D: (3-20-20)T

- a. In Latah, Nez Perce, and Clearwater Counties in Idaho; or (3-20-20)T
- b. Within five (5) miles of a susceptible crop or hazard area in any other county in Idaho. (3-20-20)T
- c. Waiver of the restriction is Subsections 550.01.a. and 550.01.b. may be issued on a project-by-project basis by the Director. (3-20-20)T

**02. Low Volatile Ester Restrictions.** No aircraft pilot shall apply low volatile ester formulations of 2,4-D; MCPA and MCPB: (3-20-20)T

- a. In Latah, Nez Perce, and Clearwater Counties in Idaho, unless ambient air temperatures are not above or expected to exceed eighty-five (85) degrees Fahrenheit within twenty-four (24) hours of the expected application time, or (3-20-20)T
- b. Within one (1) mile of a hazard area in any other county in Idaho. (3-20-20)T
- c. Waiver of the restriction in Subsection 550.02.a. may be issued on a project-by-project basis by the Director. (3-20-20)T

**03. Airflow and Temperature Inversion Indicators.** A continuous smoke column or other device satisfactory to the Director shall be employed to indicate to the pilot of any aircraft the direction and velocity of the airflow, and indicate a temperature inversion by layering of smoke, at the time and place of application when applying any formulation of 2,4-D; MCPA; MCPB and Dicamba. (3-20-20)T

**04. Other Spraying Equipment.** If any aerial applicator wishes to use spraying equipment other than the equipment specified, such equipment must be approved by the Director prior to use. (3-20-20)T

**551. -- 799. (RESERVED)**

**800. PESTICIDE USE ON SEED CROP FIELDS.**

**01. Nonfood and Nonfeed Site Conditions.** For purposes of pesticide registration, all alfalfa seed, carrot seed, chicory seed, clover seed, collard seed, coriander/cilantro seed, dill seed, endive seed, garden beet seed,

kale seed, kohlrabi seed, leek seed, lettuce seed, mustard seed, onion seed, parsnip seed, pollinator rows of hybrid canola seed, radish seed, rutabaga seed, sugar beet seed, Swiss chard seed, and turnip seed crop fields are considered nonfood and nonfeed sites for pesticide use and the following conditions shall be met: (3-20-20)T

**a.** No portion of the seed alfalfa, carrot seed, chicory seed, clover seed, collard seed, coriander/cilantro seed, dill seed, endive seed, garden beet seed, kale seed, kohlrabi seed, leek seed, lettuce seed, mustard seed, onion seed, parsnip seed, pollinator rows of hybrid canola seed, radish seed, rutabaga seed, sugar beet seed, Swiss chard seed, or turnip seed plant, including but not limited to seed screenings, green chop, hay, chaff, combine tailings, pellets, meal, whole seed and cracked seed, may be grazed, used, or distributed for food or feed purposes. (3-20-20)T

**b.** The seed conditioner shall keep records of individual growers' alfalfa seed, carrot seed, chicory seed, clover seed, collard seed, coriander/cilantro seed, dill seed, endive seed, garden beet seed, kale seed, kohlrabi seed, leek seed, lettuce seed, mustard seed, onion seed, parsnip seed, pollinator rows of hybrid canola seed, radish seed, rutabaga seed, sugar beet seed, Swiss chard seed, and turnip seed dirt weight and clean weight for three (3) years and shall furnish the records to the Director forthwith upon request. (3-20-20)T

**c.** All seed screenings shall be disposed of at a sanitary landfill, incinerator, or other equivalent disposal site or by a procedure approved by the Director. (3-20-20)T

**d.** The seed conditioner shall keep seed screening disposal records for three (3) years from the date of disposal and shall furnish the records to the Director forthwith, upon request. Disposal records shall consist of documentation from the disposal site and shall show the total weight of disposed screenings and the date of disposal. (3-20-20)T

**e.** All alfalfa seed, carrot seed, chicory seed, clover seed, collard seed, coriander/cilantro seed, dill seed, endive seed, garden beet seed, kale seed, kohlrabi seed, leek seed, lettuce seed, mustard seed, onion seed, parsnip seed, pollinator rows of hybrid canola seed, radish seed, rutabaga seed, sugar beet seed, Swiss chard seed, or turnip seed grown or conditioned in this state shall bear a tag or container label which forbids the use of the seed for human consumption or animal feed. (3-20-20)T

**f.** No alfalfa seed, carrot seed, chicory seed, clover seed, collard seed, coriander/cilantro seed, dill seed, endive seed, garden beet seed, kale seed, kohlrabi seed, leek seed, lettuce seed, mustard seed, onion seed, parsnip seed, pollinator rows of hybrid canola seed, radish seed, rutabaga seed, sugar beet seed, Swiss chard seed, or turnip seed grown or conditioned in this state shall be distributed for human consumption or animal feed. (3-20-20)T

**g.** All portions of the seed alfalfa, seed carrot, seed chicory, seed clover, seed collard, seed coriander/cilantro, seed dill, seed endive, seed of garden beet, seed onion, seed parsnip, pollinator rows of hybrid canola seed, seed radish, seed rutabaga, seed of sugar beets, seed of Swiss chard, or seed turnip plant, including but not limited to seed screenings, pellets, meal, whole seed and cracked seed may be composted. All composted material may be applied to agricultural crop land as approved by the Director. (3-20-20)T

**02. Exemption.** Alfalfa seed, kale seed and radish seed crops grown for human consumption shall be exempt from the requirements of Subsection 800.01 provided: (3-20-20)T

**a.** All pesticides used are labeled for use on alfalfa seed, kale seed, and radish seed crops and have established residue tolerances which allow food or feed use; and (3-20-20)T

**b.** All producers maintain for three (3) years complete records of all pesticides applied as specified in Pesticide Use and Application Rules Subsection 150.02. These records shall be ready to be inspected, duplicated, or submitted when requested by the Director. (3-20-20)T

**801. -- 849. (RESERVED)**

**850. UNUSABLE PESTICIDES COLLECTION AND DISPOSAL.**

The Director or designated agent may, if deemed necessary for the protection of the environment, take possession and dispose of canceled, suspended, or otherwise unusable pesticides. (3-20-20)T

**851. -- 960. (RESERVED)**

**961. GENERAL CHEMIGATION REQUIREMENTS.**

This Section prescribes equipment listing requirements, posting requirements for certain types of pesticides, use of pesticide label directions, a prohibition from chemigation over waters of the state. (3-20-20)T

**01. Chemigation Equipment Standards.** Equipment manufacturers shall provide to the Department of Agriculture verification that the equipment meets the standards established in these rules. If the equipment meets the standards, it shall be placed on the Department's list of approved chemigation equipment. (3-20-20)T

**02. Posting Requirements.** Labels of toxicity category I pesticide products (those with the label signal word "DANGER." allow chemigation on their label and contain posting requirements specific to chemigation) shall be posted in accordance with their label. (3-20-20)T

**03. Pesticides Labeled for Chemigation.** The chemigator shall use only pesticides labeled for chemigation when chemigating. (3-20-20)T

**04. Chemigating Over Waters of the State.** Chemigating over waters of the state shall be prohibited, except for variances allowed in Section 971. (3-20-20)T

**962. IRRIGATION SYSTEMS.**

This Section prescribes the equipment required for each type of irrigation system when chemigation is to be used. (3-20-20)T

**01. Sprinkler or Drip Irrigation.** If chemicals are being chemigated through the sprinkler or drip irrigation system, the chemigator shall verify that the system complies with either Subsection 962.01.a. or 962.01.g. and shall include all of the additionally specified equipment for each: (3-20-20)T

**a. Irrigation Line Check Valve Requirement.** The system shall contain a functional Irrigation Line Check Valve, (Section 966); and (3-20-20)T

**b. Low Pressure Drain Requirement.** The system shall contain an Automatic Low Pressure Drain, (Section 970); and (3-20-20)T

**c. Inspection Port Requirement.** The system shall contain an Inspection Port, (Section 969); and (3-20-20)T

**d. Vacuum Relief Valve Requirement.** The system shall contain a Vacuum Relief Valve or a combination Air and Vacuum Relief Valve, (Section 968); and (3-20-20)T

**e. Chemical Injection System Requirement.** The system shall contain a Chemical Injection System, (Section 965); and (3-20-20)T

**f. Chemical Injection Line Shut Down (System Interlock) Requirement.** The system shall contain a Chemical Injection Line Shut Down (System Interlock), (Section 963); or (3-20-20)T

**g. Gooseneck Pipe Loop, Downhill and Over-A-Hill Requirement.** For surface water impoundments the system may use a Gooseneck Pipe Loop, Downhill and Over-A-Hill system rather than the requirements of Subsections 962.01.a. through 962.01.f., (Section 967); and (3-20-20)T

**h. Chemical Injection System Requirement.** The system shall contain a Chemical Injection System, (Section 965); and (3-20-20)T

**i. Chemical Injection Line Shut Down (System Interlock) Requirement.** The system shall contain a Chemical Injection Line Shut Down (System Interlock), (Section 963). (3-20-20)T

**02. Flood, Basin, Furrow, or Border Irrigation.** If a chemical, including anhydrous ammonia, will be

applied by flood, basin, furrow, or border chemigation through a gravity flow system, the chemigator shall verify that the system complies with the following requirements: systems using a gravity flow dispensing system shall meter the chemical into the water at the head of the field and downstream of a hydraulic discontinuity such as a drop structure or weir box to decrease potential for water source contamination from backflow if water flow stops. (3-20-20)T

**03. Domestic Water Supply System Cross-Connected for Chemigation.** Any irrigation system used for chemical application cross-connected to a domestic water supply system shall verify that the system complies with either Subsection 962.03.a. or 962.03.d. and shall include all other additionally specified equipment for each; (3-20-20)T

**a.** Reduced Pressure Principle Backflow Prevention Assembly (RP). The irrigation system shall contain a functional reduced pressure backflow preventer assembly (RP); and (3-20-20)T

**i.** The RP assembly shall be located on the irrigation pipeline between the water supply pump and the point of chemical injection, and downstream from any domestic water supply diversion point. (3-20-20)T

**ii.** The purpose of a Reduced Pressure Principle Backflow Prevention Assembly (RP) is to keep contaminated water from flowing back into a domestic water supply system when some abnormality in the system causes pressure to be temporarily higher in the contaminated part of the system than in the domestic water supply system piping. (3-20-20)T

**iii.** The RP assembly shall have been manufactured in full conformance with the American National Standards Institute (ANSI)/American Water Works Association (AWWA) ANSI/WWA C511 Standard for Reduced Pressure Principle Backflow Prevention Assemblies established by the AWWA; and have met completely the laboratory and field performance specifications of the Foundation for Cross-Connection Control and Hydraulic Research of the University of Southern California (USC FCCCHR); or an equivalent, Department-approved testing facility. (3-20-20)T

**b.** Chemical Injection System Requirement. The system shall contain a Chemical Injection System, (Section 965); and (3-20-20)T

**c.** Chemical Injection Line Shut Down (System Interlock) Requirement. The system shall contain a Chemical Injection Line Shut Down (System Interlock), (Section 963); or (3-20-20)T

**d.** Air Gap (AG). The water from the domestic water supply system shall be discharged into a reservoir tank prior to the chemical injection. An air gap shall be at least double the diameter of the supply pipe measured vertically above the overflow rim of the vessel – in no case less than one (1) inch. Chemical injection shall not occur upstream of the air gap; and (3-20-20)T

**e.** Chemical Injection System Requirement. The system shall contain a Chemical Injection System, (Section 965); and (3-20-20)T

**f.** Chemical Injection Line Shut Down (System Interlock) Requirement. The system shall contain a Chemical Injection Line Shut Down (System Interlock), (Section 963). (3-20-20)T

**963. CHEMICAL INJECTION LINE SHUT DOWN (SYSTEM INTERLOCK).**

In every chemigation system, there shall be a functional system interlock designed and installed to shut down the chemical injection unit when chemical distribution is adversely affected. The system interlock shall connect the water supply pump and the chemical injection unit or connect the irrigation line pressure switch and the chemical injection unit if there is no water supply pump and the system is pressurized. The chemical injection line shall contain one (1) of the following options found in Subsections 963.01 through 963.05, to ensure that a chemical injection pump will stop if the irrigation pump stops to prevent the entire chemical mixture from emptying from the supply tank into the irrigation pipeline: (3-20-20)T

**01. Electrical Interlock.** The electrical interlock shall contain one (1) of the options in Subsections 963.01.a. through 963.01.d. and shall include all of the additionally specified equipment for each: (3-20-20)T



- a.** Electric Motor-Driven Irrigation Pump or Power Panel: (3-20-20)T
- i. The electrical controls for the irrigation pump panel or power panel at the pivot or linear shall be interlocked with an electric powered chemical injection pump so that if the water pump shuts off or the pressure switch shuts off power at the panel, the chemical injection pump shall shut off (it is recommended that the interlock also be provided to shut off the irrigation system if the chemical injection pump shuts off); and (3-20-20)T
- ii. Injection Line Check Valve, (Section 964), shall be installed; and (3-20-20)T
- iii. In pressurized irrigation systems, the irrigation line or water pump shall include a functional pressure switch. (3-20-20)T
- b.** Solenoid Operated Valve. A functional automatic quick-closing check valve and a functional normally closed solenoid operated valve connected to the system interlock shall be: (3-20-20)T
- i. Normally closed; and (3-20-20)T
- ii. Located on the intake side of the injection pump; and (3-20-20)T
- iii. Open only when there is adequate pressure in the irrigation line to insure uniform chemical distribution; and (3-20-20)T
- iv. In pressurized irrigation systems, the irrigation line or water pump shall include a functional pressure switch. (3-20-20)T
- c.** A functional automatic quick-closing check valve and a functional normally closed hydraulically operated check valve. The hydraulically operated check valve shall be connected to the main water line such that the valve only opens when the main water line is adequately pressurized. In addition, in pressurized irrigation systems, the irrigation line or water pump shall include a functional pressure switch; or (3-20-20)T
- d.** A functional automatic quick-closing check valve and a functional vacuum relief valve located in the chemical injection line between the positive displacement chemical injection pump and the chemical check valve. This alternative is appropriate only for those chemigation systems using a positive displacement chemical injection pump and is not for use with Venturi injection systems. This valve shall be elevated at least twelve (12) inches above the highest fluid level in the chemical supply tank and shall be the highest point in the injection line. The valve shall open at six (6) inches water vacuum or less and shall be spring-loaded or otherwise constructed such that it does not leak on closing. It shall prevent leakage from the chemical supply tank on system shutdown. The valve shall be constructed of chemically resistant materials. In addition, in pressurized irrigation systems, the irrigation line or water pump shall include a functional pressure switch. (3-20-20)T
- 02. Mechanical Interlock.** The mechanical interlock shall contain one (1) of the options in Subsections 963.02.a. or 963.01.b. and shall include all of the additionally specified equipment for each: (3-20-20)T
- a.** Irrigation pumps driven by an internal combustion engine shall be interlocked between the chemical injection pump and the irrigation pump by operating the chemical injection equipment from the engine electrical system, or an electrical generator driven by the pumping plant power unit: (3-20-20)T
- i. Injection Line Check Valve, (Section 964), shall be installed; and (3-20-20)T
- ii. In pressurized irrigation systems, the irrigation line or water pump shall include a functional pressure switch; or (3-20-20)T
- b.** Irrigation pumps driven by an internal combustion engine shall be interlocked between the chemical injection pump and the irrigation pump by belt from the drive shaft of the irrigation pump or an accessory pulley of the engine: and (3-20-20)T
- i. Injection Line Check Valve, (Section 964), shall be installed; and (3-20-20)T

ii. In pressurized irrigation systems, the irrigation line or water pump shall include a functional pressure switch. (3-20-20)T

**03. Hydraulic Interlock.** Functional, normally closed, hydraulically operated check valve. The control line must be connected to the main water line such that the valve opens only when the main water line is adequately pressurized. This valve must prevent leakage from the chemical supply tank on system shutdown. The valve must be constructed of chemically resistant materials, such as a Venturi System. (3-20-20)T

**04. Human Interlock.** (3-20-20)T

a. A human interlock shall consist of human supervision on-site during the injection of a chemical into the irrigation system for one (1) hour or less to shut down the system in case of failure of the injection pump or irrigation system; and (3-20-20)T

b. Injection Line Check Valve (Section 964) shall be installed; and (3-20-20)T

c. In pressurized irrigation systems, the irrigation line or water pump shall include a functional pressure switch. (3-20-20)T

**05. Other Approved Option.** Any other option approved by the Director. (3-20-20)T

**964. INJECTION LINE CHECK VALVE.**

**01. Injection Line Check Valve.** A functional, spring-loaded injection line check valve with a minimum of ten (10) pounds per square inch (psi) opening (cracking) pressure plus one (1) psi per one (1) foot of elevation between the chemical supply tank and the point of chemical injection and shall be: (3-20-20)T

a. Located between the chemical injection pump and the point of chemical injection into the irrigation line; and (3-20-20)T

b. Made of chemically resistant material; and (3-20-20)T

c. Designed to prevent irrigation water under operating pressure from entering the chemical injection line; and (3-20-20)T

d. Designed to prevent leakage from the chemical supply tank on system shut down; and (3-20-20)T

**02. A Substitute System.** The injection line check valve shall be a substitute for both the solenoid-operated valve and the functional, automatic, quick closing check valve in the chemical injection line. (3-20-20)T

**965. CHEMICAL INJECTION SYSTEM.**

All chemical injection systems, except for flood, basin, furrow, or border chemigation through a gravity flow system, shall use: (3-20-20)T

**01. Metering Pump.** A metering pump such as a positive displacement injection pump effectively designed and constructed of materials that are compatible with chemicals and capable of being fitted with a system interlock; or (3-20-20)T

**02. Venturi System.** Venturi systems including those inserted directly into the main water line, those installed in a bypass system, and those bypass systems boosted with an auxiliary water pump. Booster or auxiliary water pumps shall be connected with the system interlock such that they are automatically shut off when the main line irrigation pump stops, or in cases where there is no main line irrigation pump, when the water pressure decreases to the point where pesticide distribution is adversely affected. Venturies shall be constructed of chemically resistant materials. The line from the chemical supply tank to the Venturi shall contain a functional, automatic, quick closing check valve to prevent the flow of liquid back toward the chemical supply tank. This valve shall be located immediately adjacent to the Venturi chemical inlet. This same supply line shall also contain either a functional

normally closed solenoid-operated valve connected to the system interlock or a functional normally closed hydraulically operated valve which opens only when the main water line is adequately pressurized. In bypass systems as an option to placing both valves in the line from the chemical supply tank, the check valve may be installed in the bypass immediately upstream of the Venturi water inlet and either the normally closed solenoid or hydraulically operated valve may be installed immediately downstream of the Venturi water outlet. (3-20-20)T

**966. IRRIGATION LINE CHECK VALVE.**

- 01. Construction.** Construction shall: (3-20-20)T
  - a.** Consist of at least a single check valve; (3-20-20)T
  - b.** Be of heavy duty construction with all materials resistant to corrosion or protected to resist corrosion; (3-20-20)T
  - c.** Be spring-loaded with a chemically resistant and resilient seal that provides a watertight seal against reverse flow; (3-20-20)T
  - d.** Not consist of metal to metal seal surfaces; (3-20-20)T
  - e.** Be rated at a pressure equal to or greater than the system working pressure; and (3-20-20)T
  - f.** Be positioned and oriented according to manufacturer specifications to ensure proper functioning. (3-20-20)T
- 02. Location.** The Irrigation Line Check Valve shall: (3-20-20)T
  - a.** Be located in the pipeline between the irrigation pump and the point of chemical injection into the irrigation pipeline, and downstream from a vacuum relief valve and automatic low pressure drain. (3-20-20)T
  - b.** When installed, be on a horizontal plane and level. A deviation of not more than ten (10) degrees from horizontal is permitted. (3-20-20)T
- 03. Labeling of the Check Valve or Valve Assembly.** Shall be labeled with the following: (3-20-20)T
  - a.** Manufacturer's name and model; (3-20-20)T
  - b.** Working pressure in pounds per square inch (psi); (3-20-20)T
  - c.** Maximum flow rate in gallons per minute; and (3-20-20)T
  - d.** Direction of flow. (3-20-20)T
- 04. Model Certification.** The manufacturer of the irrigation line check valve shall provide verification to the director that the valve model has been tested and certified by an independent laboratory such as the Center For Irrigation Technology, Fresno, California and Great Plains Meter, Inc. Aurora, Nebraska, or other Department approved facility as meeting the following leakage test criteria: (3-20-20)T
  - a.** Low Pressure Drip Test. A check valve shall withstand for sixteen (16) hours without leakage at the valve seat an internal hydrostatic pressure equivalent to the head of a column of water five (5) feet (1.5m) high retained within the downstream portion of the valve body. No leakage shall occur as evidenced by wetting of paper placed beneath the valve assembly. This test is to be conducted with the valve in both the horizontal and vertical position if intended for such use. (3-20-20)T
  - b.** High Pressure Test. A check valve shall withstand for one (1) minute, without leakage at joints or at the valve seat, an internal hydrostatic pressure of two (2) times the rate of working pressure of the valve. (3-20-20)T

**967. GOOSENECK PIPE LOOP, DOWNHILL AND OVER-A-HILL.**

- 01. Location.** Shall be located in the main water line immediately downstream of the irrigation water pump. (3-20-20)T
- 02. Position.** The bottom side of the pipe at the loop apex shall be at least twenty-four (24) inches above the highest sprinkler or other type of water emitting device on the highest part of the field. (3-20-20)T
- 03. Pipe Loop.** The loop shall contain either a vacuum relief or combination air and vacuum relief valve at the apex of the pipe loop, and if the water pump is portable and the apex is a straight, horizontal section of pipe, the pipe shall be level. (3-20-20)T
- 04. Location of Chemical Injection Port.** The chemical injection port shall be located downstream of the apex of the pipe loop and at least six (6) inches below the bottom side of the pipe at the loop apex. (3-20-20)T
- 05. Use Restriction.** Shall not be allowed when pumping from a groundwater source. (3-20-20)T

**968. VACUUM RELIEF VALVE OR COMBINATION AIR AND VACUUM RELIEF VALVE.**

- 01. Location.** Shall be located on top of the horizontal irrigation pipeline on the upstream side of the check valve. (3-20-20)T
- 02. Orifice Size.** Shall have a total (individually or combined) orifice size of at least three-fourths (3/4) inch diameter for a four (4) inch pipe, a one (1) inch diameter for a five (5) to eight (8) inch pipe, a two (2) inch diameter for a nine (9) to eighteen (18) inch pipe, and a three (3) inch diameter for a nineteen (19) inch and greater pipe. (3-20-20)T

**969. INSPECTION PORT.**

- 01. Inspection Port.** The inspection port can be combined with a mounting of a vacuum relief or combination air and vacuum relief valve and shall: (3-20-20)T
- a.** Be located on the pipeline between the irrigation pump and the irrigation pipeline check valve directly above the low pressure drain; (3-20-20)T
  - b.** Have a minimum diameter opening of four (4) inches from which the check valves and low pressure drain shall be visible; (3-20-20)T
  - c.** Be mounted with quick disconnects, quick coupler, ring lock or flange fittings, dresser couplings or other fittings that allow for easy removal of the inspection port. Any bolts shall be located on the outside of the irrigation water pipe; and (3-20-20)T
  - d.** Be located near the irrigation line check valve to allow for inspections and check for malfunctioning of the irrigation line check valve and low pressure drain. (3-20-20)T

**970. AUTOMATIC LOW PRESSURE DRAIN.**

- 01. Automatic Low Pressure Drain.** Automatic low pressure drain shall: (3-20-20)T
- a.** Be installed upstream of the irrigation line check valve at the lowest point of the horizontal water supply pipeline; (3-20-20)T
  - b.** Not extend into the horizontal pipe beyond the inside surface of the bottom of the pipe; (3-20-20)T
  - c.** Be at least three-fourths (3/4) inch in diameter with a closing pressure of not less than five (5) psi; (3-20-20)T

d. If the drain is within twenty (20) feet of the water source, contain a corrosion resistant tube, pipe, hose, or similar conduit three-fourths (3/4) inch in diameter to discharge a solution at least twenty (20) feet down slope from the irrigation water source and away from any other water sources; and (3-20-20)T

e. Not have any valves located on the outlet side of the drain tube. (3-20-20)T

**971. VARIANCES.**

The Department may grant variances with such conditions and safeguards as it determines are necessary to prevent contamination or pollution of the waters of the state. Issuance of variances shall not relieve the recipient from compliance with all other responsibilities under the Pesticide and Chemigation Act and Rules. Such variances may be granted upon a request from the owner or operator of the property affected and approval by the Director. The application will state fully the grounds of the application and the facts relied upon. Upon the Department's further investigation, if certain antipollution devices otherwise required by these rules or the Pesticide and Chemigation Act, are not necessary or consequences inconsistent with the rules or act, such variances may be granted. (3-20-20)T

**972. -- 999. (RESERVED)**

## 02.04.03 – RULES GOVERNING ANIMAL INDUSTRY

### 000. LEGAL AUTHORITY.

This chapter is adopted under the legal authority of Sections 22-103(20), 25-203, 25-207, 25-207B, 25-212, and 25-804, 25-3704 Idaho Code. (3-20-20)T

### 001. TITLE AND SCOPE.

01. **Title.** The title of this chapter is “Rules Governing Animal Industry.” (3-20-20)T

02. **Scope.** These rules govern procedures for the prevention, control and eradication of diseases among the animals in the state of Idaho and the declaration of an animal health emergency. (3-20-20)T

### 002. -- 010. (RESERVED)

### 011. ABBREVIATIONS.

01. **APHIS.** Animal and Plant Health Inspection Service. (3-20-20)T

02. **CFR.** Code of Federal Regulations. (3-20-20)T

03. **USDA.** United States Department of Agriculture. (3-20-20)T

04. **VS.** Veterinary Services. (3-20-20)T

### 012. -- 103. (RESERVED)

## SUBCHAPTER A – ANIMAL INDUSTRY

### 104. INCORPORATION BY REFERENCE.

The following documents are incorporated by reference and apply only to Subchapter A, Sections 110-460: (3-20-20)T

#### 01. Incorporated Documents. (3-20-20)T

a. The USDA Pseudorabies Eradication State-Federal-Industry Program Standards, November 1, 2003, which can be viewed online at [http://www.aphis.usda.gov/animal\\_health/animal\\_diseases/pseudorabies/downloads/program\\_stds.pdf](http://www.aphis.usda.gov/animal_health/animal_diseases/pseudorabies/downloads/program_stds.pdf). (3-20-20)T

b. National Poultry Improvement Plan and Auxiliary Provisions, February 12, 2008, which can be viewed online at <http://edocket.access.gpo.gov/2009/E9-7240.htm>. (3-20-20)T

c. Title 9, Parts 145, 146, 147, and 161, CFR, January 1, 2008, which can be viewed online at [http://www.access.gpo.gov/nara/cfr/waisidx\\_00/9cfrv1\\_00.html](http://www.access.gpo.gov/nara/cfr/waisidx_00/9cfrv1_00.html). (3-20-20)T

d. The Compendium of Animal Rabies Prevention and Control, 2008, which can be viewed online at <http://www.nasphv.org/Documents/NASPHVRabiesCompendium.pdf>. (3-20-20)T

e. Equine Viral Arteritis Uniform Methods and Rules, April 19, 2004, which can be viewed online at <http://www.aphis.usda.gov/vs/nahss/equine/eva/eva-umr.pdf>. (3-20-20)T

### 110. DEFINITIONS.

In addition to the definitions found in Idaho Code Sections 25-239 and 25-802, the definitions in Section 110 apply in the interpretation and enforcement of Subchapter A only: (3-20-20)T

01. **Accredited Veterinarian.** A veterinarian approved by the Administrator and USDA/APHIS/VS, in accordance with the provisions of Title 9, Part 161, Code of Federal Regulations, to perform functions of State-Federal animal disease control programs. (3-20-20)T

02. **Animal.** Any vertebrate member of the animal kingdom, except man. (3-20-20)T

- 03. Approved Pseudorabies Vaccine.** Any pseudorabies vaccine produced under current USDA license and intended for immunizing swine against pseudorabies. (3-20-20)T
- 04. Cachexia.** Weakness and emaciation caused by a serious disease such as tuberculosis or cancer. (3-20-20)T
- 05. Epithelioma.** Cancer or tumor. (3-20-20)T
- 06. Equidae.** Horses, ponies, mules, asses, and zebras. (3-20-20)T
- 07. Exposed Livestock.** Any livestock that have been in contact with an animal infected with, or affected by, any contagious, infectious or communicable disease, including all livestock in a known infected herd. (3-20-20)T
- 08. Gamebirds.** Domesticated gallinaceous fowl such as pheasants, partridge, quail, grouse, and guineas. (3-20-20)T
- 09. Garbage.** Putrescible animal and vegetable waste containing animal parts resulting from the handling, preparation, processing, cooking or consumption of foods. (3-20-20)T
- 10. Hatching Eggs.** Fertilized eggs. (3-20-20)T
- 11. Herd.** A herd is any group of livestock maintained on common ground for any purpose, or two (2) or more groups of livestock under common ownership or supervision, geographically separated, but which have an interchange or movement of animals without regard to whether the animals are infected with or exposed to contagious, infectious, or communicable animal diseases. (3-20-20)T
- 12. Infected Livestock.** Any livestock determined to be infected with a contagious infectious, of communicable disease by an official test or diagnostic procedure, or diagnosed by a veterinarian as infected. (3-20-20)T
- 13. Interstate Movement.** Movements of livestock and poultry from Idaho into any other state, territory or the District of Columbia or from any other state, territory or the District of Columbia into Idaho. (3-20-20)T
- 14. Intrastate Movement.** Movement of any animal from one location to another location within Idaho. (3-20-20)T
- 15. Known Infected Herd.** Any herd in which any livestock has been determined to be infected with contagious, infectious, or communicable diseases by an official test or diagnostic procedure, or diagnosed by a veterinarian as being infected. (3-20-20)T
- 16. Livestock.** Swine, cattle, sheep, goats, equidae, domestic bison, domestic cervidae, camelids, ratites, and other domestically raised animals. (3-20-20)T
- 17. Necrosis.** Death of tissue. (3-20-20)T
- 18. Negative.** An animal that has been tested with official test procedures and is found to be negative. (3-20-20)T
- 19. Neoplastic Tissue.** New growth or tissue associated with a tumor. (3-20-20)T
- 20. Official Pseudorabies Test.** Any test for the diagnosis of pseudorabies that has been approved by USDA/APHIS and is conducted by a state/federal approved laboratory. (3-20-20)T
- 21. Orbital Region.** The cavity containing the eye and surrounding bones. (3-20-20)T

22. **Positive.** An animal that has been tested and found positive with official disease test procedures and is considered infected with any contagious, infectious, or communicable disease. (3-20-20)T
23. **Poultry.** Domesticated fowl, including chickens, turkeys, waterfowl, and gamebirds. (3-20-20)T
24. **Pseudorabies.** The contagious, infectious, and communicable disease of livestock and other animals also known as Aujeszky's disease, mad itch or infectious paralytic. (3-20-20)T
25. **Quarantine.** A written order, or a verbal order followed by a written order, executed by the Administrator, to confine or hold animals on a premise or any other location, and to prevent movement of animals from a premise or any other location when the Administrator has determined that the animals have been found or are suspected to be exposed to or infected with any contagious, infectious, or communicable disease, or the animals are not in compliance with the provisions of this chapter. (3-20-20)T
26. **Quarantined Area.** The counties, areas, or districts, portions thereof, quarantined by the Division of Animal Industries for specific contagious, infectious, or communicable animal diseases. (3-20-20)T
27. **Quarantined.** Isolation of all animals diseased or exposed thereto, from contact with healthy animals and exclusion of such healthy animals from enclosures or grounds where said diseased or exposed animals are, or have been kept. (3-20-20)T
28. **Ratites.** Large, non-flying birds including, but not limited to ostriches, emus, cassowaries, and rheas. (3-20-20)T
29. **Registered Veterinarians.** Veterinarians registered with, and approved by, the Division of Animal Industries to collect Trichomoniasis samples for official Trichomoniasis culture testing. (3-20-20)T
30. **Restrain.** The confinement of livestock, or other animals, in a chute, or other device, for the purpose of efficiently, effectively, and safely inspecting, treating, vaccinating, or testing, as approved by the Administrator. (3-20-20)T
31. **Stockyards.** A facility where trading in livestock is carried on, where yarding, feeding and watering places are provided by the stockyards or transportation companies, or where livestock associations or similar companies maintain corrals for feeding, shearing, dipping and separating animals. (3-20-20)T
32. **Suppuration.** The formation of pus. (3-20-20)T
33. **Suspect.** An animal that has a response to an official test, but the response is not sufficient to determine the disease status of the animal tested. (3-20-20)T
34. **Swine.** All breeds of domestic porcine and all wild and exotic porcine. (3-20-20)T
35. **Swine Feedlot.** Premises designed and used exclusively for the finish feeding of swine, from which the swine will be moved directly to slaughter. (3-20-20)T
36. **Waterfowl.** Domesticated fowl that normally swim such as ducks and geese. (3-20-20)T
37. **Wildfowl.** Wild gallinaceous fowl, turkeys, and waterfowl. (3-20-20)T
111. **ABBREVIATIONS.**
01. **AGID.** Agar gel immunodiffusion. (3-20-20)T
02. **c-ELISA.** Competitive Enzyme Linked Immunosorbent Assay. (3-20-20)T
03. **EIA.** Equine Infectious Anemia. (3-20-20)T



**04.** NPIP. National Poultry Improvement Plan. (3-20-20)T

**112. -- 113. (RESERVED)**

**114. SAMPLES FOR OFFICIAL REGULATORY TESTS.**

No person shall collect samples, in Idaho, for official regulatory tests except: (3-20-20)T

**01. Accredited Veterinarians.** (3-20-20)T

**02. State or Federal Animal Health Officials.** (3-20-20)T

**03. Persons Approved by the Administrator.** (3-20-20)T

**115. QUARANTINE.**

The Administrator and all state and federal animal health officials are authorized to quarantine any animals affected or infected with, or exposed to any contagious, infectious, or communicable disease where such animals are found, or quarantine to a place designated by the Administrator. (3-20-20)T

**01. Written Notice.** The owner or person in charge of the quarantined animals shall be given written notice of the quarantine. (3-20-20)T

**02. Acknowledgment of Quarantine.** A quarantine is valid whether or not it is acknowledged by the signature of the owner or person in charge of the quarantined animals. (3-20-20)T

**03. Disposition of Quarantined Animals.** No quarantined animals shall be moved, treated, or disposed of without the written approval of the Administrator. (3-20-20)T

**04. Hold Order.** A hold order is a form of quarantine that may be used to restrict the movement of animals while the disease status of the animals is being investigated. (3-20-20)T

**116. -- 119. (RESERVED)**

**120. DISINFECTION OF PREMISES, BUILDINGS AND VEHICLES.**

The Administrator is authorized to order the cleaning and disinfecting of any barns, sheds, stockyards, railroad cars, ferryboats and other vehicles, feed yards, stable, pens, corrals, lanes and premises which have been used in confining, trailing or transporting any animals exposed to, affected by, or infected with any contagious, infectious or communicable diseases. (3-20-20)T

**01. Supervision of Cleaning and Disinfection.** State or federal animal health officials supervise the cleaning and disinfecting of such premises or conveyances. (3-20-20)T

**02. Owner Responsibility.** The owner of such premises or conveyances, is responsible for cleaning and disinfecting when directed to do so by the Administrator. (3-20-20)T

**03. Moving Contaminated Vehicle.** Any conveyance that has contained cattle, swine or other livestock exposed to, or affected by, any contagious, infectious or communicable disease, may not be moved for any purpose unless the Administrator has approved the movement in writing, prior to the movement occurring. (3-20-20)T

**04. Yards and Other Premises.** Yards and other premises which have contained cattle, swine or other livestock exposed to, or affected by, any contagious, infectious or communicable disease shall not be used in connection with the movement of healthy animals until the said yards and premises have been cleaned and disinfected, under state or federal supervision, as directed by the Administrator. (3-20-20)T

**05. Disinfectants.** Only disinfectants approved by USDA or the Administrator may be used. (3-20-20)T

**121. -- 124. (RESERVED)**

**125. TRANSIT INSPECTION.**

When deemed necessary, movements of animals will be stopped in transit for inspection. If the animals are suspected of being infected with or exposed to any contagious, infectious or communicable disease, all persons having control of the transportation or movement of the animals shall cease the movement of the animals upon receipt of an order from state or federal animal health officials. (3-20-20)T

**126. -- 129. (RESERVED)**

**130. SLAUGHTERING OF DISEASED ANIMALS.**

**01. Authorized by Law.** When, in order to prevent the spread of contagious, infectious or communicable disease, it becomes necessary to slaughter any diseased or exposed livestock, the purchase of such livestock by the state is authorized by law, and an appropriation is available therefore, the value of the livestock is ascertained and compensation made therefore in accordance with the rules hereinafter provided. (3-20-20)T

**02. Not Authorized by Law.** When, in order to prevent the spread of or to eradicate any contagious, infectious or communicable disease among any animals of this state, it becomes necessary to slaughter or destroy any diseased or exposed animals, and the purchase of such animals by the state is not authorized, and an appropriation not available therefore, the said animals shall be slaughtered under federal meat inspections rules and regulations, or destroyed and disposed of in accordance with IDAPA 02.04.17, "Rules Governing Dead Animal Movement and Disposal." (3-20-20)T

**131. -- 139. (RESERVED)**

**140. INSPECTION OF ANIMALS.**

When animals are being inspected by a state or federal animal health official, proper facilities for restraining the animals, and assistance shall be provided by the owner in order that a careful inspection may be made, and state and federal animal health officials shall not be interfered with in any manner. (3-20-20)T

**141. -- 144. (RESERVED)**

**145. CERTIFICATES OF VETERINARY INSPECTION.**

A copy of certificates issued by an accredited veterinarian, or a state or federal animal health official covering the movement of livestock shall accompany the livestock to destination, and be provided to the receiver of the livestock by the person who delivers the livestock. (3-20-20)T

**01. Copies.** Legible copies of certificates of veterinary inspection shall be submitted to the Division of Animal Industries. (3-20-20)T

**02. Idaho Certificates.** Accredited veterinarians in Idaho shall submit legible copies of all certificates that they issue to the Division of Animal Industries within five (5) business days of issuance. (3-20-20)T

**146. -- 149. (RESERVED)**

**150. STATE AND FEDERAL SEALS.**

No person may break, or in any way tamper with, a seal or other device applied to premises or conveyances by state or federal animal health officials, except: (3-20-20)T

**01. State or Federal Animal Health Officials; or** (3-20-20)T

**02. Persons Designated by the Administrator.** (3-20-20)T

**151. NOTIFICATION OF BROKEN SEALS.**

Any person who discovers a state or federal seal that has been broken, tampered with, or is missing shall immediately notify the Administrator. (3-20-20)T

**152. LIVESTOCK IDENTIFICATION REMOVAL.**

No person, except persons authorized by the Administrator, may remove or tamper with any state or federal livestock identification, including but not limited to: (3-20-20)T

- 01. Official Vaccination Tags.** (3-20-20)T
- 02. Official Identification Tags.** (3-20-20)T
- 03. Trichomoniasis Tags.** (3-20-20)T
- 04. Identification Tattoos.** (3-20-20)T

**153. -- 199. (RESERVED)**

**200. ARTIFICIAL INSEMINATION.**

**01. License Application.** Any person desiring to practice artificial insemination of domestic animals may file an application for a license on an application form furnished by the Administrator and accompanied by a license fee of twenty-five (\$25) dollars. (3-20-20)T

**02. Training.** Each applicant is required to take a course of training in artificial insemination at the place and time designated by the Administrator. (3-20-20)T

**03. Examination.** Examinations are in writing and focused on the skill of artificial insemination. (3-20-20)T

**04. Passing Examination.** To be granted a license to practice artificial insemination applicants must answer correctly seventy-five percent (75%) of all questions asked. (3-20-20)T

**05. Temporary License.** Temporary license to practice artificial insemination under the direct supervision of a licensed inseminator or veterinarian may be granted by the administrator, until such time as the next insemination course and examination is given. (3-20-20)T

**06. License Expiration.** Licenses expire on the 30th day of June of each year, and all persons holding a license shall renew their license on or before the 1st day of July of each year. (3-20-20)T

**07. License Renewal.** Each license renewal is to be addressed to the Administrator and accompanied by a renewal license fee of five dollars (\$5). (3-20-20)T

**08. Renewal Delinquency.** Licenses not renewed by the 1st day of October following the date of delinquency are canceled. (3-20-20)T

**09. Issuance Denial.** The Administrator may refuse to issue or renew a license pursuant to Section 25-810, Idaho Code. (3-20-20)T

**201. -- 209. (RESERVED)**

**210. CANCER EYE - EPITHELIOMA.**

Any animal offered for sale and found to be affected with epithelioma of the eye or of the orbital region in which the eye has been destroyed or obscured by neoplastic tissue and which shows extensive infection, suppuration and necrosis, usually accompanied with foul odor, or any animal affected with epithelioma of the eye or the orbital region which, regardless of extent, is accompanied with cachexia shall not be sold for slaughter for human consumption. All such animals shall be humanely euthanized, or disposed of for immediate slaughter directly to: (3-20-20)T

- 01. Animal Rendering Plants; or** (3-20-20)T

**02. Fur Farms.** Fur or mink farm or other establishment as approved by the Administrator. (3-20-20)T

**211. EPITHELIOMA -- PUBLIC LIVESTOCK MARKETS.**

Any animal entering a public livestock market that is affected, as described in Section 210 of this rule, shall be held only in the quarantine pen and sold only there from. (3-20-20)T

**212. -- 219. (RESERVED)**

**220. RABIES.**

The Administrator is authorized to develop and implement a plan for rabies control in any portion of this state. (3-20-20)T

**01. Reporting.** It is hereby made the duty of all persons practicing veterinary medicine in this state, or owners or persons in charge of animals, to report to the Administrator, by telephone, facsimile, or electronic mail, all cases of rabies within forty-eight (48) hours. (3-20-20)T

**02. Discharging Authority.** State and federal animal health officials are authorized and empowered to: (3-20-20)T

**a.** Inspect, quarantine, treat, condemn, slaughter and dispose of any animals affected or infected with or exposed to rabies. (3-20-20)T

**b.** Quarantine, clean and disinfect all premises where such animals have been kept. (3-20-20)T

**c.** Call upon sheriffs, constables and other peace officers to assist them in the discharge of their duties. (3-20-20)T

**221. -- 229. (RESERVED)**

**230. BIOLOGICALS.**

Veterinary serums, vaccines, recombinant vaccines, bacterins, biologic remedies, diagnostic agents, immunoassay agents and diagnostic probes used in the treatment or diagnosis of disease of livestock, poultry, domestic animals, fish or fur bearing animals shall not be imported into or sold, distributed, or used within the state of Idaho unless such serum, vaccines, recombinant vaccines, bacterins, biologic remedies, diagnostic agents, immunoassay agents and diagnostic probes have been produced under a license by the United States Department of Agriculture and the manufacturers shall have a permit issued by the Idaho Department of Agriculture, Division of Animal Industries. (3-20-20)T

**231. -- 239. (RESERVED)**

**240. POULTRY AND RATITES.**

Any person producing poultry or ratites for any of the following uses, is required to be in compliance with the NPIP program: (3-20-20)T

**01. Sale of Live Birds or Hatching Eggs.** The sale of live birds or hatching eggs; or (3-20-20)T

**02. Release of Live Birds.** Release of live birds, such as hunting clubs, hunting preserves, or dog trials; or the release of live birds into the wild. (3-20-20)T

**241. RECORD REQUIREMENTS.**

In addition to meeting the record keeping requirements of the NPIP program, all NPIP participants shall forward a copy of their annual flock qualification test results to the Division of Animal Industries within fifteen (15) days of the completion of testing. (3-20-20)T

**242. INSPECTIONS.**

The premises where participants in the NPIP program raise poultry or ratites shall be inspected at least once each calendar year by state or federal animal health officials. (3-20-20)T

**01. Scheduling of Inspections.** State or federal animal health officials will attempt to notify the NPIP participant prior to any inspection and schedule the annual inspections in advance with the NPIP participant. (3-20-20)T

**02. Inspecting Records.** During normal business hours, state or federal animal health officials are authorized to inspect, review, and copy any poultry or ratite records deemed necessary to ensure compliance with these rules. State or federal animal health officials will attempt to notify the owner or operator of the premises where records are kept prior to inspecting records. (3-20-20)T

**243. NPIP CERTIFICATES OF PARTICIPATION.**

The Division of Animal Industries will issue NPIP participation certificates annually to the owners of poultry and ratites that meet the following requirements: (3-20-20)T

**01. Records.** Each NPIP participant must have on file records of their flock qualification testing; and (3-20-20)T

**02. Inspection Forms.** Each NPIP participant shall have on file a copy of the annual inspection form from the previous year documenting compliance with the NPIP program. (3-20-20)T

**244. -- 249. (RESERVED)**

**250. EQUIDAE -- EQUINE INFECTIOUS ANEMIA.**

Official tests for EIA include the AGID test, the C-ELISA test, and other EIA tests approved by USDA or the Administrator. (3-20-20)T

**01. Blood Samples.** Equine blood samples collected for official EIA tests shall be collected by a state or federal animal health official or an accredited veterinarian who is licensed in the state in which the animal being tested is located. (3-20-20)T

**02. Official Samples.** Official EIA test samples shall be accompanied to the testing laboratory by an official EIA test report on which is recorded the name and address of the owner or person in charge of the animal, the breed, sex, age and identification of the animal being tested. Identification includes identifying tattoos, brands, color and distinctive markings. The accredited veterinarian or animal health official collecting the EIA test samples shall record the date the samples were collected and affix his signature to the official EIA test report. (3-20-20)T

**03. Official Tests.** Official EIA tests shall be conducted in a laboratory approved by USDA or the state of Idaho to conduct EIA tests. (3-20-20)T

**251. EIA IS A REPORTABLE DISEASE.**

All laboratories conducting EIA tests on Idaho origin equidae and all veterinarians who diagnose EIA in Idaho equidae shall report positive results of all EIA tests and diagnoses to the Administrator of Animal Industries within twenty-four (24) hours of such test or diagnosis. Negative test results shall be reported within forty-eight (48) hours. (3-20-20)T

**252. EIA INFECTED ANIMALS.**

Any equidae which are positive to an official EIA test are to be declared infected with EIA and designated as an EIA reactor. The Administrator may require or recommend a re-test of EIA reactors in order to confirm infection or identification of the animal. In cases where a confirmatory test is conducted, the final determination of infection will be delayed until the results of the confirmatory test are available. The animal on which a confirmatory test is to be conducted will be placed under an official Hold Order until the results of the confirmatory test are available. (3-20-20)T

**253. DISPOSITION OF EIA REACTORS.**

Equidae found to be infected with EIA shall: (3-20-20)T

**01. Quarantined.** Be quarantined to the premises where the animal was found to be infected, the

owner's premises, or another premises that is approved by the Administrator. (3-20-20)T

**02. Duration of Quarantine.** Remain under quarantine until it is: (3-20-20)T

**a.** Consigned to slaughter at a USDA approved equine slaughter establishment; or (3-20-20)T

**b.** Euthanized and buried or incinerated; or (3-20-20)T

**c.** Donated to a university or other research facility for use in EIA research projects. (3-20-20)T

**254. ISOLATION OF EIA REACTORS.**

The quarantine premises or area for EIA reactors shall provide no less than two-hundred (200) yards separation from all other equidae. The quarantine area and quarantined animals therein may be monitored periodically by state or federal animal health officials to ensure that provisions of the quarantine are being met. (3-20-20)T

**255. IDENTIFICATION OF EIA REACTORS.**

All equidae found to be infected with EIA shall be identified with an "82 A", at least two (2) inches high, hot iron or freeze brand on the left neck or left shoulder of the animal. Identification as an EIA reactor shall be accomplished within fifteen (15) days of notification that the animal is infected with EIA. (3-20-20)T

**256. EXPOSED EQUIDAE.**

EIA exposed equidae may include all equidae that are held within two-hundred (200) yards of the location where an EIA reactor is or was maintained. (3-20-20)T

**01. Hold Order.** Exposed equidae shall be placed under a Hold Order until the animals have been tested negative to EIA at least sixty (60) days after the last reactor animal has been removed from the premises. (3-20-20)T

**02. Movement of Exposed Equids.** Individual exposed equids, which have not had a negative sixty (60) day test, may be allowed to move under Hold Order for specific purposes if they have a negative EIA test prior to movement. Such movement shall not be for longer than fifteen (15) days. (3-20-20)T

**257. EXTENDED VALIDITY EQUINE CERTIFICATES.**

Provided there is a written agreement between the Administrator and the chief livestock sanitary official of the state of destination, Idaho origin equidae may be moved from Idaho for shows, rides or other equine events and return to Idaho on an extended validity equine certificate under a state system of equine certification acceptable to the Administrator and the state of destination. The Administrator may authorize the movement of equidae into or out of Idaho on extended validity equine certificates. (3-20-20)T

**258. -- 299. (RESERVED)**

**300. FOREIGN ANIMAL AND REPORTABLE DISEASES.**

It is the duty of all persons in Idaho to report to the Administrator immediately, by telephone, facsimile, or electronic mail, any lesions or symptoms resembling any of the foreign animal and reportable diseases listed in Subchapter A, that they may find existing among the animals in Idaho. The Administrator may add a foreign animal and reportable disease by issuing an administrative order explaining in writing the reasons for requiring the disease to be reported. (3-20-20)T

**301. FOREIGN ANIMAL AND REPORTABLE DISEASES: MULTIPLE SPECIES.**

**01. Anthrax.** (3-20-20)T

**02. Brucellosis.** (3-20-20)T

**03. Foot and Mouth Disease.** (3-20-20)T

**04. Heartwater.** (3-20-20)T

- 05. Leishmaniasis. (3-20-20)T
- 06. Plague (*Yersinia pestis*). (3-20-20)T
- 07. Pseudorabies. (3-20-20)T
- 08. Q Fever (*Coxiella burnetti*). (3-20-20)T
- 09. Rabies. (3-20-20)T
- 10. Rift Valley Fever. (3-20-20)T
- 11. Scabies. (3-20-20)T
- 12. Screw Worms. (3-20-20)T
- 13. Theileriosis. (3-20-20)T
- 14. Trypanosomiasis. (3-20-20)T
- 15. Tuberculosis. (3-20-20)T
- 16. Tularemia. (3-20-20)T
- 17. Vesicular Stomatitis. (3-20-20)T
- 302. **FOREIGN ANIMAL AND REPORTABLE DISEASES - AVIAN DISEASES.**
- 01. Avian Influenza. (3-20-20)T
- 02. Avian Chlamydiosis (*Psittacosis*). (3-20-20)T
- 03. Exotic Newcastle Disease. (3-20-20)T
- 303. **FOREIGN ANIMAL AND REPORTABLE DISEASES - BOVINE DISEASES.**
- 01. Babesiosis. (3-20-20)T
- 02. Bovine Brucellosis (*B. abortus*). (3-20-20)T
- 03. Bovine Spongiform Encephalopathy. (3-20-20)T
- 04. Bovine Tuberculosis. (3-20-20)T
- 05. Contagious Bovine Pleuropneumonia. (3-20-20)T
- 06. Crimean Congo Hemorrhagic Fever. (3-20-20)T
- 07. Lumpy Skin Disease. (3-20-20)T
- 08. Malignant Catarrhal Fever (Foreign Type). (3-20-20)T
- 09. Rinderpest. (3-20-20)T
- 10. Trichomoniasis. (3-20-20)T

- 304. FOREIGN ANIMAL AND REPORTABLE DISEASES - CERVIDAE DISEASES.**  
Chronic Wasting Disease is a reportable disease. (3-20-20)T
- 305. FOREIGN ANIMAL AND REPORTABLE DISEASES - EQUINE DISEASES.**
- 01. African Horse Sickness.** (3-20-20)T
  - 02. Contagious Equine Metritis.** (3-20-20)T
  - 03. Dourine.** (3-20-20)T
  - 04. Equine Encephalomyelitis (Eastern, Western, Venezuelan).** (3-20-20)T
  - 05. Equine Infectious Anemia.** (3-20-20)T
  - 06. Equine Piroplasmosis (*Babesiosis*).** (3-20-20)T
  - 07. Equine Viral Arteritis.** (3-20-20)T
  - 08. Glanders.** (3-20-20)T
  - 09. Hendra Virus.** (3-20-20)T
  - 10. Japanese Encephalitis.** (3-20-20)T
  - 11. Surra (*Trypanosoma evansi*).** (3-20-20)T
- 306. FOREIGN ANIMAL AND REPORTABLE DISEASES - FISH DISEASES.**
- 01. Asian Tapeworm of Carp.** (3-20-20)T
  - 02. Oncorhynchus Masou Virus Disease.** (3-20-20)T
  - 03. Spring Viremia of Carp.** (3-20-20)T
  - 04. Viral Hemorrhagic Septicemia.** (3-20-20)T
- 307. FOREIGN ANIMAL AND REPORTABLE DISEASES - LAGOMORPH DISEASES.**  
Rabbit Hemorrhagic Disease is a reportable disease. (3-20-20)T
- 308. FOREIGN ANIMAL AND REPORTABLE DISEASES - SHEEP AND GOAT DISEASES.**
- 01. Contagious Caprine Pleuropneumonia.** (3-20-20)T
  - 02. Nairobi Sheep Disease.** (3-20-20)T
  - 03. Ovine Brucellosis (*B. melitensis*).** (3-20-20)T
  - 04. Peste des Petits Ruminants.** (3-20-20)T
  - 05. Scrapie.** (3-20-20)T
  - 06. Sheep and Goat Pox.** (3-20-20)T
- 309. FOREIGN ANIMAL AND REPORTABLE DISEASES - SWINE DISEASES.**
- 01. African Swine Fever.** (3-20-20)T



- 02. Classical Swine Fever (Hog Cholera). (3-20-20)T
- 03. Enterovirus Encephalitis (Teschen Disease). (3-20-20)T
- 04. Nipah Virus Encephalitis. (3-20-20)T
- 05. Porcine Brucellosis (*B. suis*). (3-20-20)T
- 06. Swine Vesicular Disease. (3-20-20)T
- 310. -- 329. (RESERVED)
- 330. NOTIFIABLE DISEASES.  
All veterinarians licensed to practice in Idaho shall report any notifiable diseases listed in Subchapter A to the Administrator. The Administrator may add a notifiable disease by issuing an administrative order explaining in writing the reasons for requiring the disease to be reported. (3-20-20)T
- 331. NOTIFIABLE DISEASES: MIXED SPECIES DISEASES.  
West Nile Virus is a notifiable disease. (3-20-20)T
- 332. NOTIFIABLE DISEASES: AVIAN DISEASES.
  - 01. Avian Mycoplasmosis (*M. gallisepticum* and *M. synoviae*). (3-20-20)T
  - 02. Fowl Typhoid (*Salmonella gallinarum*). (3-20-20)T
  - 03. Pullorum Disease (*Salmonella pullorum*). (3-20-20)T
- 333. NOTIFIABLE DISEASES: BOVINE DISEASES.
  - 01. Hemorrhagic Septicemia (*Pasteurella multocida*). (3-20-20)T
  - 02. Malignant Catarrhal Fever (Sheep Associated). (3-20-20)T
- 334. NOTIFIABLE DISEASES: EQUINE DISEASES.
  - 01. Equine Herpesvirus Myeloencephalopathy. (3-20-20)T
  - 02. Equine Rhinopneumonitis. (3-20-20)T
- 335. NOTIFIABLE DISEASES: FISH DISEASES.
  - 01. Epizootic Hematopoietic Necrosis. (3-20-20)T
  - 02. Infectious Hematopoietic Necrosis. (3-20-20)T
  - 03. Whirling Disease. (3-20-20)T
- 336. NOTIFIABLE DISEASES: LAGOMORPH DISEASES.  
Myxomatosis is a notifiable disease. (3-20-20)T
- 337. NOTIFIABLE DISEASES: SHEEP AND GOAT DISEASES.
  - 01. Bluetongue. (3-20-20)T
  - 02. Caprine Arthritis/Encephalitis (CAE). (3-20-20)T

- 03. Caseous Lymphadenitis. (3-20-20)T
- 04. Contagious Agalactia (*Mycoplasma spp.*). (3-20-20)T
- 05. Enzootic Abortion (*Chlamydia psittici*). (3-20-20)T
- 06. Footrot. (3-20-20)T
- 07. Haemonchus Contortus (drug-resistant). (3-20-20)T
- 08. Johne's Disease. (3-20-20)T
- 09. Maedi-Visna/Ovine Progressive Pneumonia (OPP). (3-20-20)T
- 10. Ovine Epididymitis (*Brucella ovis*). (3-20-20)T
- 11. Toxoplasma Gondii Abortion. (3-20-20)T
- 12. Vibrionic Abortion (*Campylobacter fetus*). (3-20-20)T
- 338. NOTIFIABLE DISEASES: SWINE DISEASES.
  - 01. Porcine Reproductive and Respiratory Syndrome (PRRS). (3-20-20)T
  - 02. Transmissible Gastroenteritis. (3-20-20)T
- 339. -- 359. (RESERVED)
- 360. ACTINOMYCOSIS (LUMP JAW).
  - 01. **Selling Diseased Animal.** It is unlawful for any person to knowingly sell, offer for sale, or in any manner transfer ownership to another person any animal infected or affected with the disease known as actinomycosis or lump jaw if the disease shows well-marked clinical symptoms, or is in the advanced stage, except for immediate slaughter, and then only in accordance with the meat inspection rules and regulations of the USDA. (3-20-20)T
  - 02. **Public Livestock Markets.** Animals showing well marked clinical symptoms or in the advanced stage of actinomycosis or lump jaw passing through public livestock markets shall be placed and sold only from quarantine pens. (3-20-20)T
- 361. -- 399. (RESERVED)
- 400. GARBAGE FEEDING.  
No person shall feed garbage to swine. (3-20-20)T
  - 01. **Household Wastes.** Private household wastes not removed from the premises where produced is not considered garbage. (3-20-20)T
  - 02. **Inspection and Investigation.** The Administrator is authorized to enter upon any private or public property for the purpose of inspecting and investigating conditions relating to the feeding of garbage to swine. (3-20-20)T
- 401. PSEUDORABIES -- PROCEDURES FOR CONTROL AND ERADICATION.
  - 01. **Laboratories.** Blood, serum, tissues, or other samples are to be tested only by state/federal-approved laboratories. (3-20-20)T

**02. Supervision.** State or federal veterinarians will supervise pseudorabies control and eradication efforts. (3-20-20)T

**03. Quarantines.** Any herd in which any livestock has been determined to be infected with pseudorabies by an official pseudorabies test or diagnosed by a veterinarian as having pseudorabies will be placed under official state quarantine for pseudorabies. (3-20-20)T

**a.** All swine on pseudorabies-infected premises shall be sold for slaughter under permit within fifteen (15) days of diagnosis. (3-20-20)T

**b.** Livestock, other than swine, on pseudorabies infected premises shall be confined to the premises for a period of ten (10) days after the swine herd is sold for slaughter. Livestock, other than swine can, under permit, be moved to a separate holding area and be released from quarantine after a period of ten (10) days, if no signs of pseudorabies occur in the animals. (3-20-20)T

**402. PSEUDORABIES VACCINE.**

No person shall import into Idaho, possess, use, keep, buy, sell, offer for sale, barter, exchange, give away, or otherwise dispose of any pseudorabies vaccine without written permission from the Administrator. (3-20-20)T

**403. VACCINATED SWINE.**

No person shall import into Idaho any swine that have been vaccinated for Pseudorabies. (3-20-20)T

**404. -- 419. (RESERVED)**

**420. ERADICATION METHODS.**

USDA Program Standards apply to elimination of pseudorabies from a herd. (3-20-20)T

**421. -- 429. (RESERVED)**

**430. IDENTIFICATION OF INFECTED SWINE.**

All seropositive and infected swine are to be individually identified by placing a reactor ear tag in the left ear of the animal and recording the tag number on all movement documents. Identification shall be accomplished within five (5) days of the date the animals were reported as positive or infected. (3-20-20)T

**431. IDENTIFICATION OF EXPOSED SWINE.**

All exposed swine that are removed from the premises of origin shall be individually identified by placing a swine identification tag in the right ear of the animal. The identification number shall be recorded on movement documents. Individual identification may be waived for swine moving directly to slaughter, on a permit, in a sealed vehicle. (3-20-20)T

**432. -- 449. (RESERVED)**

**450. QUALIFIED PSEUDORABIES-NEGATIVE HERDS.**

The qualifying method and development of a pseudorabies-negative herd shall be accomplished in accordance with the USDA Program Standards for pseudorabies. (3-20-20)T

**451. -- 459. (RESERVED)**

**460. CLEANING AND DISINFECTION.**

All pens, wherein swine are held prior to or after their sale, shall be thoroughly cleaned and disinfected within seventy-two (72) hours following completion of the sale or before the next sale, whichever occurs first. (3-20-20)T

**461. -- 503. (RESERVED)**

**SUBCHAPTER B - ANIMAL HEALTH EMERGENCIES**

**504. INCORPORATION BY REFERENCE.**

The following documents are incorporated by reference and apply only to Subchapter B, Sections 510-591:

9 C.F.R. § 53.2, January 1, 2002, which can be viewed online at [http://edocket.access.gpo.gov/cfr\\_2002/janqtr/pdf/9cfr53.2.pdf](http://edocket.access.gpo.gov/cfr_2002/janqtr/pdf/9cfr53.2.pdf). (3-20-20)T

**510. DEFINITIONS.**

The definitions in Section 510 apply in the interpretation and enforcement of Subchapter: B only: (3-20-20)T

- 01. Animals.** All vertebrates, except humans. (3-20-20)T
- 02. Conveyance.** Any type of vehicle, carrier, kennel, or trailer of any kind used to move or hold animals. (3-20-20)T
- 03. Domestic Cervidae.** Elk, fallow deer, and reindeer owned by a person. (3-20-20)T
- 04. Emergency Disease.** A disease, agent or parasite that could have a devastating impact on people, animals, or the economy as determined by the Director. (3-20-20)T
- 05. Epidemiology.** The study of the distribution and determinants of health-related states or events in specified populations, and the application of this study to control of health problems. (3-20-20)T
- 06. Exposed.** Animals that have had contact with other animals, herds, or materials that have been determined to be infected with or affected by any infectious, contagious, or communicable disease. (3-20-20)T
- 07. Federal Animal Health Official.** An employee of USDA/APHIS/VS who is authorized to perform animal health activities. (3-20-20)T
- 08. Foreign Animal Disease.** A transmissible disease of animals, believed to not exist in the United States and its territories, as determined by USDA that has a potential significant health or economic impact. (3-20-20)T
- 09. Infected Zone.** The geographic portion of a quarantine area, which contains all animals known to be infected with or exposed to an emergency disease as designated by the Administrator. (3-20-20)T
- 10. Livestock.** Cattle, swine, horses, mules, asses, sheep, goats, domestic cervidae, camelids, and ratites. (3-20-20)T
- 11. Operator.** The person who has authority to manage or direct an animal premises or conveyance and the animals thereon. (3-20-20)T
- 12. Premises.** The ground area, buildings, corrals, and equipment utilized to keep, hold or maintain animals. (3-20-20)T
- 13. Quarantine.** A written order, executed by the Administrator, to confine or hold animals on a premises or any other location, where found, and prevent movement of animals from a premises or any other location when the Administrator has determined that the animals are infected with or exposed to a disease, or are not in compliance with the provisions of this chapter. (3-20-20)T
- 14. Quarantine Area.** A geographic designation encompassing one (1) or more premises in one (1) or more counties, and consisting of an infected zone and a surveillance zone as determined by the Administrator. (3-20-20)T
- 15. State Animal Health Official.** The Administrator, or his designee, who is responsible for disease control and eradication programs. (3-20-20)T

**16. Surveillance Zone.** The geographic portion of the quarantine area surrounding the infected zone as designated by the Administrator. (3-20-20)T

**511. -- 520. (RESERVED)**

**521. CIRCUMSTANCES OF AN ANIMAL HEALTH EMERGENCY.**

The discovery of any emergency disease, which could have a devastating impact on the livestock, other animals, or people of this state, may constitute an animal health emergency requiring the implementation of prevention, management, control or eradication measures by state animal health officials. (3-20-20)T

**522. DECLARATION OF AN ANIMAL HEALTH EMERGENCY.**

The Director is authorized to declare an animal health emergency upon: (3-20-20)T

**01. Foreign Disease.** The discovery of any disease, parasite or agent which has been identified by the USDA/APHIS/VS as a “communicable foreign disease not known to exist in the United States”; or (3-20-20)T

**02. Eradicated Diseases.** The discovery of any disease, parasite or agent which is not naturally occurring in or has been eradicated from Idaho, as determined by the Administrator, and which, if introduced into Idaho, would have a devastating impact on the livestock or other animals of the state; or (3-20-20)T

**03. Specific Diseases.** The exposure to or infection of foot and mouth disease, bovine spongiform encephalopathy, chronic wasting disease, other transmissible spongiform encephalopathies, brucellosis, tuberculosis, or any foreign, exotic or emerging disease, as determined by the Administrator. (3-20-20)T

**04. Disease Presence.** The presence of any foreign, eradicated, or specific diseases in any state in the United States, any country contiguous to the United States, or any country from which the state of Idaho receives animals or animal products may constitute an emergency. (3-20-20)T

**523. QUARANTINE AUTHORITY.**

State or federal animal health officials are authorized to quarantine any animal infected with or exposed to an emergency disease, or any premises, county or area of the state to prevent ingress or egress of animals, people, or vehicles in the event of an emergency disease. (3-20-20)T

**524. UTILIZATION OF VACCINATION IN ANIMAL HEALTH EMERGENCIES.**

The Administrator is authorized to order the strategic use of vaccinations, treatments or other remedies to reduce the risk or spread of emergency diseases. (3-20-20)T

**525. -- 529. (RESERVED)**

**530. QUARANTINE PROCEDURES FOR AN ANIMAL HEALTH EMERGENCY.**

State or federal animal health officials are authorized to place under quarantine any infected animals, exposed animals, and those animals exhibiting signs of an emergency disease. The quarantine may also include susceptible animals not yet exposed. (3-20-20)T

**01. Written Notice.** Written notice of quarantine will be given to the owner of the animals, or the owner or operator of the premises or conveyance where the animals are found. (3-20-20)T

**02. Validity of Quarantine.** The quarantine is valid whether or not it is acknowledged by signature of the owner or operator. (3-20-20)T

**03. Quarantine Release.** The quarantine remains in place until a state or federal animal health official releases the quarantine in writing. (3-20-20)T

**531. QUARANTINE AREA.**

The Administrator may establish a quarantine area, which includes an infected zone encompassing the infected and exposed animals and premises, and a surveillance zone, based on the locations of said premises and the characteristics

and epidemiology of the disease. The quarantine area may include one or more premises, all or part of a county, or all or part of the state. (3-20-20)T

**532. QUARANTINE AREA SECURITY.**

The Administrator may limit access of people and vehicles to the quarantine area. (3-20-20)T

**533. QUARANTINE AREA BIO-SECURITY.**

Bio-security of the quarantine area will be instituted and maintained. (3-20-20)T

**01. Personnel.** People entering or leaving the quarantine area will follow disinfection or decontamination guidelines and procedures established by state or federal animal health officials. (3-20-20)T

**02. Vehicles and Equipment.** Vehicles and equipment moving into or out of the quarantine area will be cleaned and disinfected or decontaminated according to guidelines and procedures established by state or federal animal health officials. (3-20-20)T

**534. ANIMAL MOVEMENT IN QUARANTINE AREA.**

Animals shall not be moved into, out of, through, or within the quarantine area except by permit issued by the Administrator. (3-20-20)T

**535. SALE OF DISEASED OR EXPOSED ANIMALS NOT ALLOWED.**

Animals infected with, or susceptible animals exposed to, an emergency disease shall not be set free, sold, or in any way transferred to another person without written authorization from the Administrator. (3-20-20)T

**536. EXPOSURE OF ANOTHER'S ANIMALS NOT ALLOWED.**

Animals infected with or exposed to an emergency disease or any disease not known to exist in Idaho shall not be: (3-20-20)T

**01. Housed.** Housed with, or adjacent to, another person's animals that have not been previously exposed or land used for raising such animals; or (3-20-20)T

**02. Turned Out.** Turned out with, or adjacent to, another person's animals that have not been previously exposed or land used for raising such animals. (3-20-20)T

**537. MOVEMENT OR SALE OF ANIMAL PRODUCTS.**

The Administrator may prohibit the movement or sale of products from animals infected with or exposed to an emergency disease. (3-20-20)T

**538. -- 539. (RESERVED)**

**540. RESTRICTIONS ON ANIMALS FROM AREAS OR STATES AFFECTED BY EMERGENCY DISEASES.**

The Administrator may impose restrictions on animal movement into Idaho from areas or states affected by an emergency disease as provided in IDAPA 02.04.21, "Rules Governing the Importation of Animals." (3-20-20)T

**541. ANIMALS IN TRANSIT AT TIME OF DECLARED EMERGENCY.**

The Administrator will determine the disposition of animals in transit at the time of the declaration of an animal health emergency. (3-20-20)T

**542. -- 549. (RESERVED)**

**550. CONDEMNATION OF INFECTED, EXPOSED, OR SUSCEPTIBLE ANIMALS.**

The Administrator is authorized to condemn, and order the slaughter, destruction, or other disposition of animals, infected with, exposed to, or susceptible to an emergency disease. (3-20-20)T

**551. -- 559. (RESERVED)**

**560. DEPOPULATION OF ANIMALS.**

Animals infected with, exposed to, or susceptible to an emergency disease may be depopulated to control and eradicate the disease. (3-20-20)T

**01. Preventive Slaughter or Destruction.** Animals, located within the quarantine area, that are susceptible to an emergency disease may be depopulated to control or eradicate the emergency disease. (3-20-20)T

**02. Scope of Depopulation.** The Administrator will determine the scope of depopulation. (3-20-20)T

**561. METHOD OF DEPOPULATION.**

The Administrator will determine the method for destruction of animals in quarantine areas. (3-20-20)T

**562. TIME LIMIT FOR DEPOPULATION.**

The Administrator will determine the time limit for depopulation of condemned animals. (3-20-20)T

**563. -- 569. (RESERVED)**

**570. COMPENSATION FOR APPRAISED ANIMALS.**

Owners of condemned animals will be compensated for animals ordered destroyed by the Administrator if the animals are appraised prior to depopulation, and the owner is in compliance with these rules. Compensation may be paid on animals that die or are depopulated before appraisal at the discretion of the Administrator. (3-20-20)T

**571. COMPENSATION FOR ANIMALS DESTROYED.**

State compensation is limited to appraised value less any federal indemnity and salvage value for animals condemned, and slaughtered or otherwise destroyed. (3-20-20)T

**572. APPRAISAL PROCEDURE FOR ANIMALS DEPOPULATED.**

**01. Animal Appraisal.** Animals to be depopulated shall be appraised by a team of three (3) persons including: (3-20-20)T

**a.** A representative of the Division of Animal Industries; (3-20-20)T

**b.** The owner; and (3-20-20)T

**c.** A person with experience marketing the species of animal as determined by the Administrator. (3-20-20)T

**02. Dispute of Appraisal.** When the appraisal price is in dispute, the Director may grant a hearing to any person, under such rules as the Department may prescribe which are in compliance with Title 67, Chapter 52, Idaho Code. (3-20-20)T

**573. TIME LIMIT FOR APPRAISAL.**

The Administrator will determine the time limit for completing the appraisal. (3-20-20)T

**574. -- 579. (RESERVED)**

**580. COMPENSATION FOR LABOR EMPLOYED.**

**01. Disposal of Animals.** The Department may pay actual costs for labor employed for disposal of animals depopulated at the direction of the Administrator. (3-20-20)T

**02. Cleaning and Disinfection.** The Department may pay actual costs for labor employed in the cleaning and disinfection of premises where infected or exposed animals were kept. (3-20-20)T

**581. COMPENSATION FOR PROPERTY DESTROYED.**

The Department will compensate owners for property ordered destroyed by the Administrator. (3-20-20)T

**01. Property Destroyed Otherwise.** The department may compensate owners for property otherwise destroyed as approved by the Administrator. (3-20-20)T

**02. Actual Value.** The Department will pay actual value of property destroyed, as determined by the Administrator, if compensation is paid. (3-20-20)T

**582. -- 589. (RESERVED)**

**590. CLEANING AND DISINFECTION OF PREMISES.**

Any premises or area where animals infected with or exposed to an emergency disease were held or kept shall be cleaned, disinfected, or decontaminated under the supervision and at the direction of state or federal animal health officials within the time limit established by the Administrator. (3-20-20)T

**591. CLEANING AND DISINFECTION OF ANIMAL CONVEYANCE.**

Any conveyance used to hold or transport animals infected with or exposed to an emergency disease shall be cleaned, disinfected, or decontaminated under the supervision and at the direction of state or federal animal health officials within the time limit established by the Administrator. (3-20-20)T

**572. -- 999. (RESERVED)**



## 02.04.05 – RULES GOVERNING GRADE A MILK AND MANUFACTURE GRADE MILK

### 000. LEGAL AUTHORITY.

This chapter is adopted under the legal authority of Sections 37-303, 37-402, 37-405, and 37-516, Idaho Code. (3-20-20)T

### 001. TITLE AND SCOPE.

01. **Title.** The title of this chapter is “Rules Governing Grade A Milk and Manufacture Grade Milk.” (3-20-20)T

02. **Scope.** These rules govern procedures for the design, construction, production, manufacture, distribution, handling, storage, quality, analysis and sale of Grade A Milk and Manufacture Grade Milk and Milk Products. (3-20-20)T

### 002. -- 103. (RESERVED)

## SUBCHAPTER A – GRADE A MILK AND MILK PRODUCTS

### 104. INCORPORATION BY REFERENCE.

The following documents are incorporated by reference in Subchapter A only: (3-20-20)T

01. **Grade “A” Pasteurized Milk Ordinance.** The Grade “A” Pasteurized Milk Ordinance, 2017 revision, published by the U. S. Department of Health and Human Services, Public Health Service, Food and Drug Administration, except the bacterial limit standard and the somatic cell count standard in Section 7 of the document. Available online at <https://www.fda.gov/downloads/Food/GuidanceRegulation/GuidanceDocumentsRegulatoryInformation/Milk/UCM612027.pdf>. (3-20-20)T

02. **Evaluation of Milk Laboratories.** The Evaluation of Milk Laboratories, 2017 revision, published by the U. S. Department of Health and Human Services, Public Health Service, Food and Drug Administration. Available online at <https://www.fda.gov/downloads/Food/GuidanceRegulation/GuidanceDocumentsRegulatoryInformation/Milk/UCM615021.pdf>. (3-20-20)T

03. **Methods of Making Sanitation Ratings of Milk Shippers, and the Certifications/Listings of Single-Service Containers and/or Closures for Milk and/or Milk Products Manufactures.** The Methods of Making Sanitation Ratings of Milk Shippers, and the Certifications/Listings of Single-Service Containers and/or Closures for Milk and/or Milk Products Manufactures, 2017 revision, published by the U. S. Department of Health and Human Services, Public Health Service, Food and Drug Administration. Available online at <https://www.fda.gov/downloads/Food/GuidanceRegulation/GuidanceDocumentsRegulatoryInformation/Milk/UCM600123.pdf>. (3-20-20)T

04. **Interstate Milk Shipments.** The Procedures Governing the Cooperative State-Public Health Service/Food and Drug Administration Program of the National Conference on Interstate Milk Shipments, 2017 revision, published by the U. S. Department of Health and Human Services, Public Health Service, Food and Drug Administration, and the National Conference on Interstate Milk Shipments. Available online at <https://www.fda.gov/downloads/Food/GuidanceRegulation/GuidanceDocumentsRegulatoryInformation/Milk/UCM594813.pdf>. (3-20-20)T

### 105. REGULATORY FRAMEWORK.

All Grade A and Manufacture Grade A Milk and Milk Products shall comply with the provisions set forth in the documents incorporated by reference in this Subchapter A. (3-20-20)T

### 106. -- 119. (RESERVED)

### 120 GRADE A MILK AND MILK PRODUCTS QUALITY STANDARDS.

The following standards are substituted for the bacterial limit standard and the somatic cell count standard for Grade A raw milk and milk products for pasteurized, ultra-pasteurization or aseptic processing in Section 7 of the Grade “A” Pasteurized Milk Ordinance. (3-20-20)T

01. **Bacterial Limit Standard.** The bacterial limit standard is eighty thousand (80,000) per mL. (3-20-20)T

**02. Somatic Cell Count Standard.** The somatic cell count standard is four hundred thousand (400,000) per mL. (3-20-20)T

**03. Out of State Milk.** Milk from other states, if processed in Idaho, shall comply with the Idaho somatic cell count standard. (3-20-20)T

**121. -- 209. (RESERVED)**

## **SUBCHAPTER B – MILK AND CREAM PROCUREMENT AND TESTING**

### **210. DEFINITIONS.**

In addition to the definitions found in Chapters 3 and 5, Title 37, Idaho Code, the following definitions apply to the interpretation and enforcement of Subchapter B only: (3-20-20)T

**01. Abnormal Test.** A test result from a producer sample that is dissimilar from recent producer milk component or quality parameter testing results; an anomaly. (3-20-20)T

**02. Accuracy Check.** A test made at the beginning of each testing session and once per hour thereafter to determine the continued accuracy of the testing device. (3-20-20)T

**03. Approved Testing Methods.** Methods approved by the director for testing milk or cream components and quality parameters when those components and parameters are used as a basis of payment. (3-20-20)T

**04. Calibration.** The settings established on a testing device that will result in an average number of results that are within tolerance. (3-20-20)T

**05. Clearance Test.** A sample set issued to an official laboratory, by the Department, to maintain a probationary testing license or reinstate a suspended testing license. (3-20-20)T

**06. Control Samples.** Milk samples used to determine or set the calibration of the testing device. (3-20-20)T

**07. Component Testing.** An analysis of milk or cream constituents including milkfat, protein, lactose or solids-nonfat, which is used as a basis of payment. (3-20-20)T

**08. Detailed Pricing Description.** The method used by the purchaser of milk or cream as the criteria for determining the price paid. (3-20-20)T

**09. Milk Component or Component.** A unique compound within milk whose relative mass within the milk may be used to determine the payment to producers. Component parts of milk include milkfat, protein, lactose, solids-nonfat, other solids, and total solids. (3-20-20)T

**10. Official Laboratory.** A facility, licensed by the department, that tests milk or cream components or quality parameters for the purpose of determining the value of the product when sold or purchased by producers or processors. (3-20-20)T

**11. Outlier.** A regulatory sample result that appears to deviate markedly from other members of the sample set in which it occurs. (3-20-20)T

**12. Pay Records.** Signed written or printed records, which itemize milk volume, milk component and quality parameters used as payment to a producer or other processor. (3-20-20)T

**13. Performance Error.** The difference between the known percentage content of each milk component in the control sample, as determined by the sample provider, and the percentage content as measured by the testing device. (3-20-20)T

14. **Producer.** A dairy farm permitted by the department to sell milk for human consumption. (3-20-20)T
15. **Processor.** A creamery, milk plant, shipping or cream buying station, milk condensing plant, cheese factory, mix making plant, ice cream factory, reprocessing plant, casein plant, powdered milk plant, or factory of milk products, or other person receiving or purchasing milk or cream in bulk other than a retail vendor of milk on the basis of volume, milk components, or milk quality. (3-20-20)T
16. **Quality Parameter.** The quality of milk or cream as determined by the bacteria/plate count method, somatic cell count, temperature, drug residues or other parameters as approved by the department. (3-20-20)T
17. **Rolling Group of Thirteen (13).** A series of thirteen (13) consecutive sample testing dates where the lab performance error of each biweekly component test is averaged together to represent the long-term accuracy of the lab. To be considered a valid testing date, a lab must evaluate and provide results on no less than nine (9) component samples from each round of testing. (3-20-20)T
18. **Testing Device.** The equipment used to determine the percentage of milk or cream components. (3-20-20)T
19. **Sample Set.** A group of not less than nine (9) milk samples issued by the Department to each official laboratory to evaluate component testing accuracy. (3-20-20)T
20. **Tolerance.** The acceptable performance error from the control values of each sample set as determined by the sample provider. (3-20-20)T
- 211 - 219. **(RESERVED)**
220. **MILK AND CREAM PROCUREMENT AND TESTING REQUIREMENTS.**  
All milk and cream produced, purchased or sold in the state of Idaho at a price based upon or determined by the milkfat, protein, lactose, solids-nonfat, somatic cell counts, or other quality parameters, shall comply with the requirements of Subchapter B. (3-20-20)T
221. **LABORATORY LICENSING REQUIREMENTS.**
01. **License Required.** All laboratories that test milk or cream components and quality parameters for a basis of payment must be licensed by the department as an official laboratory. (3-20-20)T
02. **License Application.** A laboratory must apply for a license on a form prescribed by the department. The laboratory must identify (on the application form) the names of all persons who will test milk or cream components and quality parameters. (3-20-20)T
03. **License Fee.** The license fee is twenty-five dollars (\$25). (3-20-20)T
04. **License Term.** The official laboratory license is valid for three (3) calendar years after issuance by the department, unless otherwise suspended or revoked in accordance with these rules. The license expires on December 31 of the third year. (3-20-20)T
- 222 - 229. **(RESERVED)**
230. **OFFICIAL LABORATORIES - RESPONSIBILITIES AND OPERATING PROCEDURES.**
01. **Competency in Testing.** Official laboratories are responsible for ensuring that employees who operate testing devices are competent to operate the devices, and for conducting testing according to Subchapter B. (3-20-20)T

**02. Facility Requirements.** The areas in official laboratories where component or quality parameter testing is conducted shall be well lighted, kept clean, appropriately ventilated and sufficient in size to provide for accurate testing. Laboratories that are certified under the Grade A program set forth in Subchapter B are deemed to satisfy the facility requirements for an official laboratory. (3-20-20)T

**03. Operating Procedures.** An official laboratory shall establish and follow written standard operating procedures consistent with the recommended procedures for operation and maintenance set forth by the manufacturer of the testing device. (3-20-20)T

**231. THIRD PARTY LABORATORIES.**

Procurers of milk who use official laboratories other than one owned or operated by the procurer are not responsible for that laboratory's failure to comply with Subchapter B. (3-20-20)T

**232. - 239. (RESERVED)**

**240. MILK COMPONENT TESTING DEVICES.**

If an automated testing device is used to perform a milk component test for any milk component, that device must be calibrated and regularly checked to ensure that it accurately tests for that milk component. (3-20-20)T

**01. Calibration and Checks.** Calibration and checks must include the utilization of calibration samples, performance checks and accuracy checks. (3-20-20)T

**02. Calibration Standards.** Calibration may be done either in accordance with the standards set forth by the manufacturer of the testing device, or as set forth in Sections 240, 241 and 243 of Subchapter B. (3-20-20)T

**03. Calibration Record Keeping.** In either case, the official laboratory must be able to demonstrate, through records kept in accordance with Section 290, that calibration and checks have been performed in accordance with Subchapter B, and that the testing device produces test results within the tolerances established in Subchapter B. (3-20-20)T

**241. CALIBRATION OF MILK COMPONENT TESTING DEVICES.**

All testing devices shall be calibrated according to the protocols set by the testing device manufacturer, or as set forth in Subchapter B. (3-20-20)T

**01. Calibration Frequency.** A milk component testing device shall be calibrated whenever the mean difference on a daily performance check under Section 242 herein exceeds plus or minus forty-four thousandths percent (.044%) for milkfat or protein, or eighty-four thousandths percent (.084%) for total solids or solids-nonfat. (3-20-20)T

**02. Calibration Samples.** A set of calibration samples may consist of commercially available samples or samples made by the official laboratory. A set of calibration samples must consist of at least nine (9) individual samples, each of which: (3-20-20)T

**a.** Cannot be more than twenty-one (21) days old; (3-20-20)T

**b.** Must be a fresh milk sample preserved with bronopol (2-bromo-2-nitro-1, 3-propanediol) or another approved preservative. Preservative methods, formulations and concentrations must be approved by the department. (3-20-20)T

**c.** Must have a known percentage content of each relevant milk component, determined by the sample provider. (3-20-20)T

**d.** Must meet the requirements of Section 250 of this rule. (3-20-20)T

**03. Calibration Procedure.** To calibrate a testing device, the official laboratory must use the device to test a set of calibration samples. The testing device shall be adjusted, as necessary, to satisfy each of the following requirements: (3-20-20)T

a. The performance error on each calibration sample shall be as near as practicable to zero (0). (3-20-20)T

b. The mean difference for the entire set of calibration samples shall be as near as practicable to zero (0), and not exceed plus or minus forty-four thousandths percent (.044%) for milkfat or protein, or eighty-four thousandths percent (.084%) for total solids or solids-nonfat. The mean difference is the sum of the performance errors for the individual calibration samples, divided by the number of samples in the set. (3-20-20)T

c. The standard deviation of test results, calculated for the set of calibration samples shall not exceed forty-four thousandths percent (.044%) for milkfat or protein, or eighty-four thousandths percent (.084%) for total solids or solids-nonfat. (3-20-20)T

**242. DAILY PERFORMANCE CHECKS.**

All testing devices must be subjected to a daily performance check before each day's testing, in accordance with the standards set by the testing device manufacturer, or as set forth in this Subchapter B. (3-20-20)T

**01. Daily Performance Check Samples.** (3-20-20)T

a. Source. A set of daily performance check samples must be obtained from a sample provider approved by the department, or may be made by the official laboratory. (3-20-20)T

b. Number. Unless otherwise specified by the manufacturer of the testing device, a minimum of two (2) control milk samples must be analyzed before daily component testing begins. (3-20-20)T

c. Requirements. The control samples must comply with the requirements set forth in Section 241 of Subchapter B and fall within the component ranges typically found in the samples to be tested. (3-20-20)T

**02. Procedure.** To conduct a daily performance check, the official laboratory must test a set of daily performance check samples. Based on the daily performance check, the official laboratory must do the following: (3-20-20)T

a. Determine the performance error of the testing device with respect to each daily performance check sample. The performance error is the difference between the known percentage content of each milk component in that sample, as determined by the sample provider, and the percentage content as measured by the testing device; and (3-20-20)T

b. Calculate the mean difference for the set of daily performance check samples. The mean difference is the sum of the performance errors for the individual samples, divided by the number of samples in the set. (3-20-20)T

**03. Calibration Based On Daily Performance Check.** If the mean difference calculated on a daily performance check exceeds plus or minus forty-four thousandths percent (.044%) for milkfat or protein, or eighty-four thousandths percent (.084%) for total solids or solids-nonfat, the testing device shall not be used until it is recalibrated in accordance with Section 241. (3-20-20)T

**243. ACCURACY CHECKS.**

All testing devices shall be subjected to daily and hourly accuracy checks in accordance with the protocols set by the testing device manufacturer, or as set forth in this Section of Subchapter B. (3-20-20)T

**01. Daily Accuracy Check.** A daily accuracy check must be conducted for each relevant milk component before each day's testing at the same time that the daily performance check is conducted. The official laboratory must perform ten (10) tests on a reference sample. The reference sample may be a homogenized milk sample prepared by the official laboratory, or it may be a daily performance check sample obtained from an approved sample provider. The ten (10) test results must be averaged, and the average result will be used as a comparison value for the hourly accuracy checks required in Subsection 243.02. (3-20-20)T

**02. Hourly Accuracy Check.** An hourly accuracy check must be conducted for each milk component before each hour's testing for that component. (3-20-20)T

**a.** To conduct an hourly accuracy check, the official laboratory must test the same reference sample used for the daily accuracy check. (3-20-20)T

**b.** For each relevant milk component, the hourly accuracy check result must be compared to the average result obtained on the daily reference check under Subsection 243.01. If an hourly accuracy check result differs from the average result on the daily accuracy check by more than thirty-four thousandths percent (.034%) for milkfat or protein, or sixty-four thousandths percent (.064%) for total solids or solids-nonfat, the testing device shall not be used until the condition causing the difference is found and corrected. (3-20-20)T

**c.** Test results obtained before the device is corrected, and subsequent to the last previous conforming accuracy check, must not be used in determining the amount paid to milk producers. (3-20-20)T

**244 - 249. (RESERVED)**

**250. SAMPLE INTEGRITY.**

Milk or cream samples must be handled, stored, and shipped in a manner that maintains the integrity of the samples. Samples must be maintained in a temperature range of thirty-three degrees (33°) to forty-five degrees (45°) Fahrenheit (zero point fifty-five hundredths degrees (0.55°) to seven point twenty-two hundredths degrees (7.22°) Celsius). (3-20-20)T

**251. -- 259. (RESERVED)**

**260. ABNORMAL TESTS.**

Whenever an abnormal test occurs on a producer's sample, that result may not be used as a basis of payment. (3-20-20)T

**01. Alternate Tests.** In the case of an abnormal test, the official laboratory will use an average of the previous three (3) tests from that producer or another department approved method. (3-20-20)T

**02. Accidents and Sampling Errors.** Laboratory accidents or sampling errors on milk or cream to be tested will not be used as official results and the criteria in Subsection 260.01 will be instituted. (3-20-20)T

**03. Documentation.** All abnormal tests must be documented by the person conducting the test. (3-20-20)T

**261. -- 269. (RESERVED)**

**270. DETAILED PRICING DESCRIPTION.**

On each pay record to the seller, purchasers or procurers of milk or cream must provide the seller with all pricing detail needed to determine the net payment for the product sold. At a minimum, the detail must include the following: (3-20-20)T

**01. Pricing Method and Pounds Purchased.** If more than one (1) pricing method is used, the detail must include the pounds purchased at each method. The pricing method may include: (3-20-20)T

**a.** The value of each component per pound; (3-20-20)T

**b.** The total value of total component pounds; (3-20-20)T

**c.** The yield formula type and value of the end product(s); or (3-20-20)T

**d.** Fixed pricing type. (3-20-20)T

**02. Total Weight or Volume.** If weight is used, it must be expressed by pounds. If volume is used, it

must be expressed in U.S. gallons. (3-20-20)T

**03. Component Information.** All relevant component testing averages or pounds of solids for each component. (3-20-20)T

**04. Bonuses and Deductions.** All quality bonuses or deductions and the applicable quality parameters used to calculate the bonuses or deductions. (3-20-20)T

**05. Hauling Charges.** All hauling charges and any applicable surcharges. (3-20-20)T

**06. Other Deductions.** All other payment deductions including check-offs, administrative fees, and laboratory fees. (3-20-20)T

**07. Other Factors.** All other factors affecting net payment. (3-20-20)T

**08. Availability.** Pay records must be made available to the department upon request, and be maintained by the procurer or processor for at least one (1) year. (3-20-20)T

**271. -- 279. (RESERVED)**

**280. REGULATORY COMPLIANCE - INSPECTIONS AND RECORDS REVIEW.**

The department shall have access at any time to official laboratories to review testing procedures, records, or to conduct other inspections or tests to determine compliance with Subchapter B and Title 37, Chapter 5, Idaho Code. Any time a testing device is being operated to test for milk components or other quality parameters, the department may provide samples to an official laboratory, and require the official laboratory to immediately process those samples in order to ensure compliance with Subchapter B of this rule. (3-20-20)T

**281. REGULATORY SAMPLES.**

**01. Sample Set.** (3-20-20)T

**a.** The department will provide sample sets to official laboratories, on a bi-weekly basis or at a frequency determined by the department to be necessary to ensure accurate component testing results. (3-20-20)T

**b.** The samples will be obtained from the company or entity that provides calibration samples to the official laboratory, if available. The department may provide regulatory samples from other sources if necessary. (3-20-20)T

**c.** The official laboratory must immediately process the samples for those components used by the processor or procurer as a basis of payment. (3-20-20)T

**d.** The official laboratory must evaluate the sample set using identical control standards and device settings which are used to routinely evaluate Idaho producer milk components for basis of payment. (3-20-20)T

**e.** If the official laboratory is unable to process the samples due to maintenance or mechanical issues, the department may obtain and deliver an additional set of regulatory samples. (3-20-20)T

**02. Regulatory Sample Results.** The regulatory sample results will be compiled and evaluated by the department in rolling groups of thirteen (13). (3-20-20)T

**03. Outliers.** Sample results that have been identified as outliers will not be used in the calculation of tolerance for regulatory test results. (3-20-20)T

**04. Regulatory Sample Tolerances.** Each group of rolling thirteen (13) average shall be within the following tolerances for those components used as a basis of payment by the processor or procurer: (3-20-20)T

**a.** Plus or minus two hundredths percent (.02%) for milkfat and protein. (3-20-20)T

- b. Plus or minus sixty-five thousandths percent (.065%) for solids, other than milkfat or protein. (3-20-20)T

**282. LICENSE SUSPENSION AND REVOCATION BASED ON REGULATORY SAMPLES.**

**01. Two (2) Out of Four (4) Violation.** Whenever the average performance error of two (2) of the last four (4) rolling groups of thirteen (13) exceed the tolerance for milkfat, protein, or solids as set forth in Subsection 281.04 of this rule, the Department will issue a written notice to the official laboratory. This notice is in effect as long as two (2) of the last four (4) rolling groups of thirteen (13) exceed the allowable tolerance for component testing. (3-20-20)T

**02. License Suspension.** If two (2) out of four (4) of an official laboratory's rolling groups of thirteen (13) average are out of tolerance pursuant to Subsection 281.04 of this rule, the Department will evaluate the following items prior to suspending the testing license. (3-20-20)T

a. Records Review. The Department shall review records kept by the official laboratory pursuant to Section 290 of this rule. (3-20-20)T

b. Clearance Test. The average performance error of the official laboratory must be within plus or minus thirty-one thousandths percent (.031%) protein, thirty-three thousandths percent (.033%) milkfat and sixty-five thousandths percent (.065%) other solids on all scheduled sample sets, until the official laboratory no longer exceeds the performance tolerance on two (2) out of four (4) rolling groups of thirteen (13) average. If an official laboratory does not meet these performance requirements on each component of the clearance test, the testing license will be suspended. (3-20-20)T

- c. Probation. The Department may place an official laboratory on probation for two (2) weeks if: (3-20-20)T

- i. The records demonstrate all calibration and performance checks of all testing devices were performed, as required under these rules, and are operating within the tolerances set forth in Sections 240, 241, and 243 of this rule; and (3-20-20)T

- ii. The average performance error in the clearance test sample set was within plus or minus thirty-one thousandths percent (.031%) protein, thirty-three thousandths percent (.033%) milkfat, and sixty-five thousandths percent (.065%) other solids. Clearance test results from laboratories on probationary status shall be included in the calculation of the rolling group of thirteen (13) average. (3-20-20)T

**03. License Reinstatement.** An official laboratory may seek reinstatement of a suspended license by completing the following: (3-20-20)T

a. Written Request. The official laboratory shall provide the Department a written request for reinstatement of their testing license. The request shall include documentation detailing the procedural corrections that have been made to the testing device(s), as well as a minimum of two (2) weeks of component testing results demonstrating that the testing device(s) have been and will remain in tolerance. (3-20-20)T

b. Clearance Test. The average performance error of the official laboratory must be within plus or minus thirty-one thousandths percent (.031%) protein, thirty-three thousandths percent (.033%) milkfat, and sixty-five thousandths percent (.065%) other solids on a sample set issued by the Department. If the request for reinstatement does not coincide with the normal biweekly sample set issued by the Department, the official laboratory will be solely responsible for the cost of procuring and shipping the additional sample set. Clearance test results used for license reinstatement shall not be included in the calculation of the rolling group of thirteen (13) average. (3-20-20)T

**04. License Revocation for Repeated Out of Tolerance Test Results.** If the regulatory sample results are repeatedly out of tolerance, the department may initiate steps to revoke the official laboratory's license to conduct component testing for three (3) months or more. (3-20-20)T



**283. – 289. (RESERVED)**

**290. RECORD KEEPING.**

Records must be maintained by the official laboratory in accordance with this section, and must be made available for examination by the department, upon the department's request. (3-20-20)T

**01. General Provisions.** (3-20-20)T

**a.** No record may be altered except that errors may be corrected by striking through the original entry and inserting the correct entry immediately adjacent to the original. A corrected entry shall be initialed by the person who made the corrected entry. (3-20-20)T

**b.** Records may be maintained in paper or electronic format. In either case, the records must: (3-20-20)T

**i.** Be effectively secured against loss or tampering. (3-20-20)T

**ii.** Be readily retrievable for inspection by the dairy plant operator and the department. (3-20-20)T

**iii.** If corrected, have the correction identified so that the reader may easily compare the corrected version to the original. (3-20-20)T

**02. Calibration Check Equipment Records.** All calibration check and equipment maintenance records must be documented and provided during an inspection by the department. The documentation must include the following: (3-20-20)T

**a.** Instrument identification. (3-20-20)T

**b.** Name of the laboratory technician or maintenance person who performed the calibration or maintenance. (3-20-20)T

**c.** Time and date of the calibration check or maintenance. (3-20-20)T

**d.** Type of analytical test or maintenance performed. (3-20-20)T

**e.** Results of the analytical test or maintenance. (3-20-20)T

**f.** Details of action taken to correct calibration tolerances or mechanical problems. (3-20-20)T

**03. Records Retention - Time Limit.** The dairy plant operator or the official laboratory must maintain the records required under this section of Subchapter B for at least one (1) year. (3-20-20)T

**291. ENFORCEMENT.**

**01. License Suspension.** The director may suspend official laboratory component testing from any laboratory not meeting the requirements set forth in Subchapter B until the official laboratory has satisfactorily demonstrated compliance with Subchapter B. (3-20-20)T

**02. Effect of License Suspension.** If an official laboratory's license is suspended, the official laboratory cannot conduct component testing for use as a basis of payment and must use a licensed third-party laboratory. Procurers of milk who must use a licensed third-party laboratory must pay any associated component testing fees. (3-20-20)T

**292. -- 303. (RESERVED)**

**SUBCHAPTER C – MANUFACTURE GRADE MILK**

**304. INCORPORATION BY REFERENCE.**

The following documents are incorporated by reference into Subchapter C only. (3-20-20)T

**01. Standard Methods for the Examination of Dairy Products (Standard Methods).** (17th Edition, June 1, 2004) published by the American Public Health Association. (3-20-20)T

**02. Official Methods of Analysis of AOAC International (OMA), 19th Edition, 2012.** (3-20-20)T

**03. United States Sediment Standards for Milk and Milk Products (September 1, 1977) (USDA AMS Dairy Division).** This document is available online at <http://www.ams.usda.gov/AMSV1.0/getfile?dDocName=STELDEV3004474>. (3-20-20)T

**04. United States Standards for Grades of Butter (August 31, 1989) (USDA AMS Dairy Division).** This document is available online at <http://www.ams.usda.gov/AMSV1.0/getfile?dDocName=STELDEV3004470>. (3-20-20)T

**05. Appendix D “Standards for Water Sources” of the Grade “A” Pasteurized Milk Ordinance.** The Grade “A” Pasteurized Milk Ordinance, 2013 revision, published by the U. S. Department of Health and Human Services, Public Health Service, Food and Drug Administration. (3-20-20)T

**305. -- 309. (RESERVED)**

**310. DEFINITIONS.**

In addition to the definitions found in Chapters 3, 4, and 5, Title 37, Idaho Code, the following definitions apply to the interpretation and enforcement of Subchapter C only: (3-20-20)T

**01. 3-A Sanitary Standards.** The standards for dairy equipment formulated by the 3-A Sanitary Standards, Inc. (3-A SSI). 3-A SSI is comprised of equipment fabricators, Dairy Processors, and regulatory sanitarians, which include state milk regulatory officials, USDA Agricultural Marketing Service Dairy Programs, the US. Public Health Service, the Food and Drug Administration, academic representatives, and others. (3-20-20)T

**02. Acceptable Milk.** Milk that qualifies as to appearance and odor and that is classified No. 1 or No. 2 for sediment content. (3-20-20)T

**03. Atmosphere Relatively Free From Mold.** No more than ten (10) mold colonies per cubic foot of air as determined in Standard Methods. (3-20-20)T

**04. Bulk Milk Hauler or Bulk Milk Sampler.** A person licensed by the Department who is qualified and trained for the grading or sampling of raw milk in accordance with the quality standards and procedures of these rules and the Universal Sample. (3-20-20)T

**05. C-I-P or Cleaned-in-Place.** The procedure by which sanitary pipelines or pieces of dairy equipment are mechanically cleaned in place by circulation. (3-20-20)T

**06. Commingled Milk.** Milk that has left the Dairy Farm and has been mixed with other individual Producer milk in a Transportation Tank or at a Dairy Plant. (3-20-20)T

**07. Dairy Farm or Farm.** A place or premise certified by the Department where one (1) or more milking cows, sheep, goats, or water buffalo are kept, and from which all or a portion of the milk produced thereon is delivered, sold, or offered for sale to a Dairy Plant. (3-20-20)T

**08. Dairy Certification.** Certification by an Inspector or Approved Fieldman that a Producer’s herd, milking facility and housing, milking procedure, cooling, milkhouse or milkroom, utensils and equipment and water supply have been found to meet the applicable requirements of Section 360 for the production of milk to be used for manufacturing purposes. (3-20-20)T

**09. Dairy Plant or Dairy Processor.** Any place, premise, or establishment licensed by the Department where milk or dairy products are transported, graded, received or handled for processing or manufacturing and/or prepared for distribution. (3-20-20)T

**10. Dairy Products.** Butter, cheese (natural or processed), dry whole milk, nonfat dry milk, dry buttermilk, dry whey, evaporated milk (whole or skim), condensed whole milk and condensed skim milk (plain or sweetened), and such other products, for human consumption, as may be otherwise designated. (3-20-20)T

**11. Excluded Milk.** All of a Producer's milk excluded from the market by the provisions of Section 341. (3-20-20)T

**12. Farm Tank.** A tank used to cool, store or cool, and store milk prior to transportation to the processing plant. (3-20-20)T

**13. Fieldman.** A person qualified and trained in the sanitary methods of production and handling of milk as set forth herein, and generally employed by a Dairy Plant for the purpose of making Dairy Farm surveys and doing quality control work. (3-20-20)T

**14. Fieldman, Approved.** A Fieldman qualified, trained, and approved by the Department to perform Dairy Farm inspections and raw milk grading or sampling. (3-20-20)T

**15. Inspector.** A qualified, trained person employed by the Department to perform Dairy Farm or Dairy Plant inspections and raw milk grading or sampling. (3-20-20)T

**16. Milk.** The lacteal secretion practically free from colostrum obtained by the complete milking of one (1) or more healthy cows, goats, sheep, or water buffalo for manufacturing purposes. (3-20-20)T

**17. Milk for Manufacturing Purposes.** Milk produced from a Department certified Dairy Farm for processing and manufacturing into products for human consumption but not subject to Grade A or comparable requirements. (3-20-20)T

**18. Probational Milk.** Milk classified No. 3 for sediment content. (3-20-20)T

**19. Producer.** The person or persons who exercise control over the production of the milk delivered to a Dairy Plant. (3-20-20)T

**20. Rejected Milk.** Milk rejected from the market according to the provisions of Section 340. (3-20-20)T

**21. Sanitizing Treatment.** Application of any effective method or sanitizing agent to clean surface for the destruction of pathogens and other organisms as far as is practicable. The sanitizing agents used shall comply with the Standard Methods. (3-20-20)T

**22. Transportation Tank.** A tank used to transport milk or supply milk from a Dairy Farm to a Dairy Plant. (3-20-20)T

**23. Universal Sample.** A single milk sample taken for the purpose of chemical, biochemical, or bacterial analyses typically used for regulatory purposes. (3-20-20)T

**311. -- 319. (RESERVED)**

**320. RAW MANUFACTURE GRADE MILK OR CREAM.**

All raw milk or cream for manufacturing purposes from all sources shall be based on the following quality specifications. (3-20-20)T

**01. Raw Milk.** The appearance and odor of acceptable raw milk is normal, fresh, and sweet and free

from objectionable feed and other off odors that would adversely affect the finished dairy product. (3-20-20)T

**02. Milk or Cream.** Milk or cream is unacceptable which: (3-20-20)T

**a.** Is other than the lacteal secretion obtained by the complete milking of one (1) or more healthy cows, goats, sheep, or water buffalo properly kept and fed; (3-20-20)T

**b.** Contains added water; (3-20-20)T

**c.** Contains colostrum, is ropy, bloody or gives any indication of having come from diseased or injured udders; (3-20-20)T

**d.** Contains filth, is contaminated with flies, earwigs or other insects, dirt, oil, economic poisons, pesticides or other foreign matter which renders it unfit for human consumption; (3-20-20)T

**e.** Tests positive for antibiotics or inhibitors as tested by the accepted methods of the Standard Methods or by tests approved by the Department; (3-20-20)T

**f.** Has more than seventeen one hundredths of one percent (.17%) acid calculated as lactic and does not meet the criteria in Subsection 320.01; (3-20-20)T

**g.** In the case of cream, is rancid, putrid, or actively foaming; (3-20-20)T

**h.** In the case of cream, contains more than eight tenths of one percent (.8%) acid calculated as lactic; (3-20-20)T

**i.** Is more than three (3) days or seventy-two (72) hours old when picked up at the Dairy Farm; (3-20-20)T

**j.** Does not meet the quality standards as set forth in Subchapter C. (3-20-20)T

**321. QUALITY REQUIREMENTS FOR MILK FOR MANUFACTURING PURPOSES.**

**01. Basis.** The quality classification of raw milk for manufacturing purposes from each Producer shall be based on an organoleptic examination for appearance and odor, a drug residue test and quality control tests for sediment content, bacterial estimate and somatic cell count. (3-20-20)T

**a.** At least once each month the Bulk Milk Haulers shall bring in not less than a two (2) ounce sample of mixed milk from a Producer's Farm Tank. The sample shall be taken in accordance with recommended procedures outlined in the Standard Methods. (3-20-20)T

**02. Appearance and Odor.** The appearance of acceptable raw milk shall be normal and free of excessive coarse sediment when examined visually or by an acceptable test procedure. The milk shall not show any abnormal condition (including but not limited to curdles, ropy, bloody or mastitic condition), as indicated by sight or other test procedures. The odor shall be fresh and sweet. The milk shall be free from objectionable feed and other off-odors that would adversely affect the finished dairy product. (3-20-20)T

**03. Sediment Content Classification.** Milk shall be classified for sediment content, regardless of the results of the appearance and odor examination described in Subsection 321.02. The USDA Sediment Standard is as follows. (3-20-20)T

**a.** No. 1 (acceptable) - not to exceed five tenths (.5) milligram or equivalent. (3-20-20)T

**b.** No. 2 (acceptable) - not to exceed one and five tenths (1.5) milligram or equivalent. (3-20-20)T

**c.** No. 3 (probational, not over ten (10) days) - not to exceed two and five tenths (2.5) milligram or equivalent. (3-20-20)T

- d. No. 4 (reject) - over two and five tenths (2.5) milligram or equivalent. (3-20-20)T

**04. Method of Testing.** Methods for determining the sediment content of the milk of individual Producers shall be those described in the Standard Methods. Sediment content shall be based on comparison with applicable charts of the United States Sediment Standards for Milk and Milk Products as incorporated by reference. (3-20-20)T

**05. Frequency of Test.** At least once each month, at irregular intervals, the milk from each Producer shall be tested as follows: (3-20-20)T

- a. Milk in Cans. One (1) or more cans of milk selected at random from each Producer. (3-20-20)T
- b. Milk in Farm Tanks. A sample taken from each Farm Tank. (3-20-20)T

**06. Acceptance or Rejection of Milk.** If the sediment disc is classified as No. 1, No. 2, or No. 3, the Producer's milk may be accepted. If the sediment disc is classified No. 4 the milk shall be rejected: provided, that if the shipment of milk is commingled with other milk in a Transport Tank the next shipment shall not be accepted until its quality has been determined at the Dairy Farm before being picked up; however, if the person making the test is unable to get to the farm before the next shipment it may be accepted but no further shipments shall be accepted unless the milk meets the requirements of No. 3 or better. In the case of milk classified as No. 3 or No. 4, if in cans, all cans shall be tested. Producers in No. 3 or No. 4 (milk cans or bulk) shall be notified immediately, and furnished applicable sediment discs and the next shipment will be tested. (3-20-20)T

**07. Retests.** On test of the next shipment (if in cans, all cans shall be tested) milk classified as No. 1, No. 2, or No. 3, may be accepted, but No. 4 milk shall be rejected. Retests of bulk milk classified as No. 4 shall be made at the Dairy Farm before pickup. The Producers of No. 3 or No. 4 milk shall be notified immediately, furnished applicable sediment discs and the next shipment tested. This procedure of retesting successive shipments and accepting probational (No. 3) milk and rejecting No. 4 milk may be continued for not to exceed ten (10) calendar days. If at the end of this time all of the Producer's milk does not meet the acceptable sediment content classification (No. 1 or No. 2) the milk shall be excluded from market. (3-20-20)T

**322. -- 329. (RESERVED)**

**330. BACTERIAL ESTIMATE CLASSIFICATION.**

A laboratory examination to determine the bacterial estimate shall be made on each Producer's milk at least once each month at irregular intervals. Samples shall be analyzed at a laboratory approved by the Department. (3-20-20)T

**01. Methods of Testing.** Milk shall be tested for bacterial estimate by using one (1) of the following methods or any other method approved by Standard Methods or a test approved by the Department: (3-20-20)T

- a. BactoScan FC. (3-20-20)T
- b. Direct microscopic clump count. (3-20-20)T
- c. Standard plate count. (3-20-20)T
- d. Plate loop count. (3-20-20)T
- e. Petrifilm aerobic count. (3-20-20)T
- f. Spiral plate count. (3-20-20)T

**02. Bacterial Estimate Procedures.** Whenever the bacterial estimate indicates the presence of more than two hundred thousand (200,000) bacteria per milliliter, the following procedures shall be applied: (3-20-20)T

- a. The Producer will be notified with a warning of the excessive bacterial estimate. (3-20-20)T

**b.** Whenever two (2) of the last four (4) consecutive bacterial estimates exceed two hundred thousand (200,000) per milliliter, the Department shall be notified and a written warning notice given to the Producer. The notice is in effect so long as two (2) of the last four (4) consecutive samples exceed two hundred thousand (200,000) per milliliter. (3-20-20)T

**c.** An additional sample will be taken after a lapse of three (3) days but within twenty one (21) days of the notice required in Subsection 330.02.b. If this sample also exceeds two hundred thousand (200,000) per milliliter, subsequent milkings shall be excluded from the market until satisfactory compliance is obtained. Shipment may be resumed and a temporary status assigned to the Producer by the Department when an additional sample of herd milk is tested and found satisfactory. The Producer will be assigned a full reinstatement status when three (3) out of four (4) consecutive bacterial estimate test do not exceed two hundred thousand (200,000) per milliliter. (3-20-20)T

**331. -- 339. (RESERVED)**

**340. REJECTED MILK.**

A plant shall reject specific milk from a Producer if the milk fails to meet the requirements for appearance and odor, if it is classified No. 4 for sediment content, or if it tests positive for drug residue. All reject milk shall be identified with a reject tag and/or colored with harmless food coloring. (3-20-20)T

**341. EXCLUDED MILK.**

A Dairy Plant shall not accept milk from a Producer if: (3-20-20)T

**01. Probational Sediment Content.** The milk has been in a probational (No. 3) sediment content classification for more than ten (10) calendar days. (3-20-20)T

**02. Exceeding Maximum Bacteria.** Three (3) of the last five (5) milk samples have exceeded the maximum bacteria estimate of two hundred thousand (200,000) per milliliter. (3-20-20)T

**03. Insanitary Conditions.** If the milk is produced in unclean conditions such as, but not limited to, unclean milk contact surfaces, unclean conditions in the parlor or milk room, poor milking procedures, or poor animal housing conditions. (3-20-20)T

**04. Maximum Somatic Cell Count.** Three (3) of the last five (5) milk samples have exceeded the maximum somatic cell count level of seven hundred fifty thousand (750,000) per milliliter or one million (1,000,000) per milliliter for goat or sheep milk. (3-20-20)T

**05. Positive Drug Test.** The Producer's milk shipments to either the Grade A or the manufacturing grade milk market currently are not permitted due to a positive drug residue test. (3-20-20)T

**342. -- 349. (RESERVED)**

**350. RECORDS OF TESTS.**

Accurate records of the results of the milk quality and drug residue tests for each Producer shall be kept on file for a period of not less than twelve (12) months. The records shall be available for examination by the Department. (3-20-20)T

**351. SOMATIC CELL COUNT.**

**01. Level of Somatic Cells.** A laboratory examination to determine the level of somatic cells shall be made on each Producer's milk at least four (4) times in each six (6) month period at irregular intervals. Samples shall be analyzed at a laboratory and by a method approved by the Department. (3-20-20)T

**02. Procedures.** Whenever the confirmatory somatic cell count indicates the presence of more than seven hundred fifty thousand (750,000) somatic cells per milliliter, (one million (1,000,000) per milliliter for goat and sheep) the following procedures shall be applied: (3-20-20)T

- a. The producer will be notified with a warning of the excessive somatic cell count. (3-20-20)T
- b. Whenever two (2) of the last four (4) consecutive somatic cell counts exceed seven hundred fifty thousand (750,000) per milliliter, (one million (1,000,000) per milliliter for goat and sheep) the Department shall be notified and a written warning notice given to the Producer. The notice will be in effect so long as two (2) of the last four (4) consecutive samples exceed seven hundred fifty thousand (750,000) per milliliter, (one million (1,000,000) per milliliter for goat and sheep). (3-20-20)T
- c. An additional sample shall be taken after a lapse of three (3) days but within twenty-one (21) days of the notice required in Subsection 351.02.b. If this sample also exceeds seven hundred fifty thousand (750,000) per milliliter, (one million (1,000,000) per milliliter for goat and sheep) subsequent milkings shall be excluded from the market until satisfactory compliance is obtained. Shipment may be resumed and a temporary status assigned to the producer by the Department when an additional sample of herd milk is tested and found satisfactory. The Producer will be assigned a full reinstatement status when three (3) out of four (4) consecutive somatic cell count tests do not exceed seven hundred fifty thousand (750,000) per milliliter, (one million (1,000,000) per milliliter for goat and sheep). (3-20-20)T

**352. DRUG RESIDUE LEVEL.**

**01. Dairy Plant's Sampling and Testing Responsibilities.** All milk shipped for processing or intended to be processed on the Dairy Farm where it was produced will be sampled and tested, prior to processing, for beta lactam drug residue or other drugs as determined by the Department. Collection, handling and testing of samples shall be done according to procedures established by the Department. (3-20-20)T

- a. When so specified by the US. Food and Drug Administration (FDA), all milk shipped for processing, or intended to be processed on the Dairy Farm where it was produced, will be sampled and tested, prior to processing, for other drug residues under a random drug sampling program. A random drug sampling program may be conducted at a frequency determined by the Department. (3-20-20)T
- b. When the Commissioner of the FDA determines that a potential problem exists with an animal drug residue or other contaminant in the milk supply, a sampling and testing program will be conducted, as determined by the FDA. (3-20-20)T
- c. Dairy Plants shall analyze samples for beta lactams and other drug residues by methods evaluated by OMA and accepted by the FDA as effective in determining compliance with established "safe levels" or tolerances. "Safe levels" and tolerances for particular drugs are established and amended by the FDA. (3-20-20)T
- d. Individual Producer sampling. (3-20-20)T
- i. Bulk Milk. A milk sample for beta lactam drug residue testing shall be taken at each farm and will include milk from each Dairy Farm Tank. (3-20-20)T
- ii. Can Milk. A milk sample for beta lactam drug residue testing shall be performed separately at the receiving Dairy Plant for each can milk Producer included in a delivery, and be representative of all milk received from the Producer. (3-20-20)T
- iii. Producer Dairy Plant. For those Producers who also have a licensed Dairy Plant, a milk sample for beta lactam drug residue testing shall be performed on each batch of milk to be processed. (3-20-20)T
- e. Load sampling and testing. (3-20-20)T
- i. Bulk milk. A load sample shall be taken from the Transport Tank after its arrival at the Dairy Plant and prior to further commingling. (3-20-20)T
- ii. Can milk. A load sample representing all of the milk received on a shipment shall be formed at the plant, using a sampling procedure that includes milk from every can on the vehicle. (3-20-20)T

iii. Producer Dairy Plant. A load sample shall be tested at the Dairy Plant using a sampling procedure that includes all milk produced and received. (3-20-20)T

f. Sample and record retention. A load sample that tests positive for drug residue shall be retained according to guidelines established by the Department. The records of all sample test results shall be retained for a period of not less than twelve (12) months. (3-20-20)T

g. Dairy Plant follow-up. (3-20-20)T

i. When a load sample or individual Producer sample tests positive for drug residue, Dairy Plant personnel shall notify the Department immediately, of the positive test result and of the intended disposition of the shipment of milk containing the drug residue. All milk testing positive for drug residue shall be disposed of in a manner that removes it from the human or animal food chain, except when acceptably reconditioned under FDA compliance policy guidelines. (3-20-20)T

ii. Each individual Producer sample represented in the positive-testing load sample shall be individually tested as directed by the Department to determine the Producer of the milk sample testing positive for drug residue. Identification of the Producer responsible for producing the milk testing positive for drug residue, and details of the final disposition of the shipment of milk containing the drug residue, shall be reported immediately to the Department. (3-20-20)T

iii. Milk shipment from the Producer identified as the source of milk testing positive for drug residue shall cease immediately and may resume only after a sample from a subsequent milking does not test positive for drug residue. (3-20-20)T

**02. Department's Monitoring and Surveillance Responsibilities.** The Department will monitor the Dairy Plant's drug residue program by conducting unannounced on-site inspections to observe testing and sampling procedures and to collect samples for comparison drug residue testing. In addition, the Department will review industry records for compliance with these rules. The review will seek to determine that: (3-20-20)T

a. Each Producer is included in a routine, effective drug residue milk monitoring program utilizing AOAC-evaluated and FDA-approved methods to test samples for the presence of drug residue; (3-20-20)T

b. The Department receives prompt notification from industry personnel of each occurrence of a sample testing positive for drug residue, and of the identity of each Producer identified as a source of milk testing positive for drug residue; (3-20-20)T

c. The Department receives prompt notification from industry personnel of the intended and final disposition of milk testing positive for drug residue, and that disposal of the load is conducted in a manner that removes it from the human or animal food chain, except when acceptably reconditioned under FDA compliance policy guidelines; and (3-20-20)T

d. Milk shipment from a Producer identified as a source of milk testing positive for drug residue completely and immediately ceases until a milk sample taken from the dairy herd does not test positive for drug residue. (3-20-20)T

**03. Enforcement.** If a Producer ships milk testing positive for drug residue three (3) times within a twelve (12) month period, the Department may initiate procedures to suspend the Producer's milk shipping privileges. (3-20-20)T

**353. RADIONUCLIDES.**

Composite milk samples from selected areas within in the state of Idaho should be tested for biologically significant radionuclides at a frequency which the FDA determines to be adequate to protect the consumer. (3-20-20)T

**354. PESTICIDES AND HERBICIDES.**

Composite milk samples should be tested for pesticides and herbicides at a frequency the FDA determines is adequate to protect the consumer. The test results from the samples shall not exceed established FDA limits. (3-20-20)T



**355. ADDED WATER.**

Milk samples from each Producer should be tested for added water at a frequency the Department determines is adequate to prevent the addition of water to the milk. (3-20-20)T

**356. -- 359. (RESERVED)**

**360. FARM REQUIREMENTS OF MILK FOR MANUFACTURING.**

**01. Health of Herd. (3-20-20)T**

**a.** General Health. All animals in the herd shall be maintained in a healthy condition, properly fed and kept. (3-20-20)T

**b.** Tuberculin Test. The cows and water buffalo shall be located in a Modified Accredited Area, an Accredited Free State, or an Accredited Free Herd as determined by the US. Department of Agriculture (USDA). The goats shall be located in States meeting the current USDA Uniform Methods and Rules and for Bovine Tuberculosis Eradication or an Accredited Free Goat Herd. If the animals are not located in such areas, they shall be tested annually under the jurisdiction of the aforesaid program. All additions to the herd shall be from an area or from herds meeting those same requirements. (3-20-20)T

**c.** Brucellosis Test. The cows shall be located in States meeting Class B status, or Certified-Free Herds, or shall be involved in a milk ring test program or state of Idaho blood testing program. All additions to the herd shall be from an area or from herds meeting these same requirements. (3-20-20)T

**d.** Abnormal Milk. Milk from animals known to be infected with mastitis or milk containing residues of antibiotics or others drugs, or milk containing pesticides or other chemical residues in excess of the established limits shall not be sold or offered for sale for human consumption. The milk shall be disposed of in a method approved by the Department. (3-20-20)T

**02. Milking and Facility Housing. (3-20-20)T**

**a.** A milking barn or milking parlor of adequate size and arrangement shall be provided to permit normal sanitary milking operations. It shall be well lighted and ventilated, and the floors and gutters in the milking area shall be constructed of concrete or other impervious material. The facility shall be kept clean, the manure removed daily and stored to prevent access of animals to accumulation thereof. No swine or fowl are permitted in any part of the milking area. (3-20-20)T

**b.** If milk is exposed during straining or transferring in the milking areas it shall be protected from falling particles from areas above milk facility. (3-20-20)T

**c.** The yard or loafing area shall be of ample size to prevent overcrowding, drained to prevent forming of standing water pools, insofar as practicable, and kept clean. (3-20-20)T

**03. Milking Procedure. (3-20-20)T**

**a.** The udders and flanks of all milking animals shall be kept clean. The udders and teats shall be washed or wiped immediately before milking with a clean, damp cloth or paper towel moistened with a sanitizing solution and wiped dry, or by any other sanitary method. (3-20-20)T

**b.** The milker's outer clothing shall be clean and hands clean and dry. No person with an infected cut or open sores on their hands or arms shall milk animals, or handle milk or milk containers, utensils or equipment. (3-20-20)T

**c.** Animals that secrete abnormal milk shall be milked last or with separate equipment. This milk shall be excluded from the supply as required in Subsection 360.01.d. (3-20-20)T

**d.** Milk stools, surcingles and antikickers shall be kept clean and properly stored. Dusty operations should not be conducted immediately before or during milking. Strong flavored feeds should only be fed after milking. (3-20-20)T

**04. Cooling.** (3-20-20)T

**a.** Milk in cans shall be cooled immediately after milking to forty-five (45) degrees Fahrenheit or lower unless delivered to the Dairy Plant within two (2) hours after milking. The devices, such as cooler, tank, or refrigerated unit to cool milk can or canned milk, shall be kept clean. (3-20-20)T

**b.** Milk in Dairy Farm Tanks shall be cooled to forty (40) degrees Fahrenheit or lower within two (2) hours after the first milking and maintained at forty-five (45) degrees Fahrenheit or lower until transferred to the Transport Tank. (3-20-20)T

**05. Milkhouse or Milkroom.** (3-20-20)T

**a.** A milkhouse or milkroom conveniently located and properly constructed, lighted, and ventilated shall be provided for handling and cooling milk and for washing, handling, and storing the utensils and equipment. Other products shall not be handled in the milkroom which would be likely to contaminate milk, or otherwise create a public health hazard. (3-20-20)T

**b.** It shall be equipped with wash and rinse vat, utensil rack, milk cooling facilities and have an adequate supply of hot water available for cleaning milking equipment. If a part of the barn or other building, it shall be partitioned, screened, and sealed to prevent the entrance of dust, flies, or other contamination. A milking parlor used strictly as a milking facility in combination with a milkhouse or milkroom, when properly equipped, arranged and maintained, need not be partitioned. Concentrates and feed, if stored in the building, shall be kept in a tightly covered box or bin. The floor of the building shall be of concrete or other impervious material and graded to provide proper drainage. The walls and ceilings shall be constructed of smooth easily cleaned material. All outside doors shall open outward and be self-closing, unless they are provided with tight-fitting screen doors that open outward or unless other effective means are provided to prevent the entrance of flies. (3-20-20)T

**c.** If a Dairy Farm Tank is used, it shall be properly located in the milkhouse or milkroom for access to all areas for cleaning and servicing. It shall not be located over a floor drain or under a ventilator. (3-20-20)T

**d.** A small platform or slab constructed of concrete or other impervious material shall be provided outside the milkhouse, properly centered under a suitable port opening in the wall for milkhouse connections. The opening shall be fitted with a tight, self-closing door. The truck approach to the milkhouse or milkroom shall be properly graded and surfaced to prevent mud or pooling of water at point of loading. (3-20-20)T

**e.** The milkhouse or milkroom shall be kept clean and free of trash. Animals and fowl are not allowed access to the milkhouse or milkroom at any time. (3-20-20)T

**06. Farm Chemicals and Animal Drugs.** (3-20-20)T

**a.** Animal biologics and other drugs intended for treatment of animals, and insecticides approved for use in dairy operations, shall be properly labeled and used in accordance with label instructions, and stored in a manner which will prevent accidental contact with milk and milk contact surfaces. (3-20-20)T

**b.** Only drugs that are approved by the FDA or biologics approved by the USDA for use in dairy animals that are properly labeled according to FDA or USDA regulations shall be administered to such animals. (3-20-20)T

**c.** When drug storage is located in the milkroom, milkhouse, or milking area, the drugs shall be segregated in such a way so that drugs labeled for use in lactating dairy animals are separated from drugs labeled for use in non-lactating dairy animals. (3-20-20)T

**d.** Herbicides, fertilizers, pesticides, and insecticides that are not approved for use in dairy operations

shall not be stored in the milkhouse, milkroom, or milking area. (3-20-20)T

**07. Utensils and Equipment.** (3-20-20)T

**a.** Utensils, milk cans, milking machines (including pipeline systems), and other equipment used in the handling of milk shall be maintained in good condition, shall be free from rust, open seams, milkstone, or any unsanitary condition, and shall be washed, rinsed, and drained after each milking, stored in suitable facilities, and sanitized immediately before use with at least fifty (50) parts per million chlorine solution or its equivalent. New or replacement can lids shall be umbrella type. All new utensils and equipment shall comply with applicable 3-A Sanitary Standards. (3-20-20)T

**b.** Dairy Farm Tanks shall meet 3-A Sanitary Standards for construction at the time of installation and shall be installed in accordance with regulations of the Department. (3-20-20)T

**c.** Single service articles shall be properly stored and not reused. (3-20-20)T

**08. Water Supply.** The Dairy Farm water supply shall meet the requirements in Appendix D of the Pasteurized Milk Ordinance as incorporated herein by reference. A source that does not conform with the construction requirements of Appendix D, but is tested annually by an approved laboratory and found to be safe and of sanitary quality, shall be satisfactory: provided any new sources of water supply or any farm water supply requiring repairs or reconstruction or any source from which tested samples have been found unsatisfactory shall meet the construction requirements of the Department. (3-20-20)T

**09. Sewage Disposal.** House, milkhouse or milkroom and toilet wastes shall be disposed of in a manner that will not pollute the soil surface, contaminate any water supply, or be exposed to insects. (3-20-20)T

**10. Qualifications for Dairy Farm Certification.** Dairy Farm certification requires satisfactory compliance with the requirements in Section 370. (3-20-20)T

**361. -- 369. (RESERVED)**

**370. DAIRY FARM CERTIFICATION.**

No milk for manufacturing purposes produced on an uncertified Dairy Farm shall be bought or sold for human consumption. (3-20-20)T

**01. Initial Inspection.** Certified Dairy Farms shall be inspected at least annually after initial certification to determine eligibility for recertification. The inspection criteria for recertification is the same as that for initial certification. (3-20-20)T

**02. Inspection.** Each Dairy Farm shall be inspected by an Inspector or Approved Fieldman. When evidence indicates that it is advisable to do so, the Department may require an examination of the herd by a licensed veterinarian. If the Dairy Farm meets the applicable requirements for Dairy Farm certification described in Section 360, as indicated by the Farm Certification Report Form, the Dairy Farm shall be certified as described in Subsection 370.03. If the Dairy Farm does not meet the requirements for certification, the Dairy Farm shall be reinspected within thirty (30) days after the initial inspection. If the Dairy Farm then meets the requirements for certification, the Dairy Farm shall be certified. If the Dairy Farm does not meet the requirements for certification, the Dairy Farm shall not be certified, and the Producer's authorization to sell milk for human consumption from that Dairy Farm will be withheld by the Department until such time as the Dairy Farm qualifies for certification. Repeat violations on any item may cause a Dairy Farm to lose certification. Provided that, if the Inspector determines during any of these inspections that corrections on the Dairy Farm will require some capital investment, a reasonable extension of the prescribed time limits may be granted by the Department. (3-20-20)T

**03. Certification.** An Inspector or Approved Fieldman will certify Dairy Farms that meet the requirements of Section 360, as applicable, based upon the inspection criteria described in Subsection 370.02. The scoring criteria approved by the Department will be utilized in determining compliance with the provisions of Section 360. Dairy Farm certification shall authorize the sale from that Dairy Farm of milk for manufacturing purposes that meets the quality standards. (3-20-20)T

**04. Probationary Period.** If at any time an Inspector or Approved Fieldman determines that a certified Dairy Farm does not meet the requirements for certification, the Department may allow a reasonable probationary period for the Producer to bring the Dairy Farm within the requirements for certification. If at the end of this time the Dairy Farm does not meet the requirements for certification, the Department may revoke the Dairy Farm certification. (3-20-20)T

**05. Reinstatement.** If, after a period of withholding, probation, or revocation of Dairy Farm certification, a Producer makes the necessary corrections at the Dairy Farm, the Producer may apply for reinspection. When conditions have been corrected, the Dairy Farm will be reinspected by an inspector or Approved Fieldman. When the Inspector or Approved Fieldman determines that requirements for certification have been met, the Dairy Farm will be certified. (3-20-20)T

**371. -- 379. (RESERVED)**

**380. STANDARDS FOR BULK MILK HAULERS.**

**01. Permits.** All Bulk Milk Haulers must possess a permit issued by the Department. The permit will cost twenty-five dollars (\$25) and will be issued to the applicant after a training session on proper procedures and successfully passing an examination administered by the Department. (3-20-20)T

**a.** No permit will be issued unless a score of seventy percent (70%) or better is made on the examination. (3-20-20)T

**b.** A training and refresher course conducted by the Department will be given in each area of the state of Idaho once each year. (3-20-20)T

**c.** Every holder of a permit must attend a training and refresher course every third year. (3-20-20)T

**d.** Each new Bulk Milk Hauler shall apply to the Department for a permit. The bulk milk hauling company shall provide basic instructions on bulk milk protocols, including milk sample collection, pick-up procedures, and safety measures. A permit will be issued upon satisfactory completion of a special training and licensing session held by the Department. (3-20-20)T

**e.** A substitute Bulk Milk Hauler in case of emergency can haul milk for three (3) days without a permit provided the Department has been notified and the substitute Bulk Milk Hauler is provided instruction on approved milk pickup and delivery requirements by the bulk milk hauling company. At the end of three (3) days the substitute Bulk Milk Hauler must apply for a permit. (3-20-20)T

**02. Adulteration.** If the truck is left unattended, Bulk Milk Haulers shall affix a seal or lock on all Transportation Tank ports, covers, and doors to protect the milk from possible adulteration. (3-20-20)T

**03. Authorization.** No Bulk Milk Hauler shall grade, measure or sample his own milk without written authorization from the Dairy Plant receiving the milk. (3-20-20)T

**04. Permit Revocation.** The permit may be revoked if: (3-20-20)T

**a.** The Bulk Milk Hauler fails to grade milk in a Dairy Farm Tank to its odor and appearance and fails to reject all milk that is abnormal in odor or flavor or that contains visible garget or other extraneous matter. (3-20-20)T

**b.** The Bulk Milk Hauler does not accurately take and record the temperature of milk or if he fails to reject the milk in excess of forty-five (45) degrees Fahrenheit. (3-20-20)T

**c.** The Bulk Milk Hauler fails to wash his hands before he proceeds to measure and sample the milk. (3-20-20)T

**d.** The Bulk Milk Hauler fails to follow acceptable procedures in measuring the amount of milk in the Farm Tank or if he does not, immediately after taking the reading convert the reading to pounds or gallons using the chart of the Farm Tank manufacturer and record it on duplicate forms, with one (1) copy to be posted in the milk house and one (1) transmitted to the Dairy Plant. (3-20-20)T

**e.** The Bulk Milk Hauler fails to agitate the milk for at least five (5) minutes in Farm Tanks less than one thousand (1,000) gallons and ten minutes in Farm Tanks over one thousand (1,000) gallons before taking a sample or if he withdraws any part of the milk from the Farm Tank before the sample is taken. (3-20-20)T

**f.** The Bulk Milk Hauler does not take a sample for component testing and/or milk quality analysis in an approved manner or sufficient size in an approved container properly labeled, and that the sample has been cooled and maintained between thirty-two (32) degrees Fahrenheit to forty (40) degrees Fahrenheit. (3-20-20)T

**g.** The Bulk Milk Hauler rinses the bulk Farm Tank before disconnecting and capping the hose. (3-20-20)T

**h.** The Bulk Milk Hauler siphons milk from milk cans, water troughs or other containers other than the Farm Tank. Milk poured into the bulk Farm Tank from other than regular milking machine pails will not be allowed. (3-20-20)T

**381. -- 389. (RESERVED)**

**390. STANDARDS OF IDENTITY, LABELING, AND QUALITY STANDARDS FOR ICE CREAM AND FROZEN DAIRY PRODUCTS AND DESSERTS.**

**01. Definitions.** The standards of identity for ice cream and frozen custards, frozen yogurt, frozen yogurt dessert mix, frozen yogurt dairy products, frozen dairy dessert, ice milk, sherbet and water ices are as defined by the Food and Drug Administration, United States Department of Health Education and Welfare, in Title 21, Part 135, of the Code of Federal Regulations. (3-20-20)T

**02. Labeling.** Each of the products required to be labeled by Section 37-1202, Idaho Code shall also bear on each container an identifiable code identifying the lot and/or date in which the product was manufactured. (3-20-20)T

**03. Quality Standards.** The following quality standards must be met: (3-20-20)T

**a.** Coliform Standard. Compliance with the coliform standard is deemed to have been met if the coliform count does not exceed ten (10) colonies per gram in two (2) of the last four (4) consecutive samples. No enforcement action will be taken if the last sample is within the standard. (3-20-20)T

**b.** Bacteria Standard. Compliance with the bacteria standard is deemed to have been met if the bacteria count per gram does not exceed twenty thousand (20,000) bacteria per gram in two (2) of the last four (4) consecutive samples. Whenever the dairy product is cultured, the bacteria test, using the standard plate count or equivalent method would not be applicable. (3-20-20)T

**c.** Frequency of Tests. During any consecutive six (6) months, at least four (4) samples of ice cream and frozen dairy products and deserts will be collected and tested. If the test or tests exceed the coliform or bacteria limit three (3) out of five (5) consecutive tests, the dairy product cannot be sold for human consumption. For the dairy product to be eligible for human consumption, a subsequent sample must meet the quality standards. (3-20-20)T

**04. Licensed Manufacturers.** All frozen dessert mixes except nondairy frozen dessert shall be secured from a licensed manufacturer and manufactured into a semifrozen state without adulteration. Freezing device salvage shall not be reused as a mix. (3-20-20)T

**05. Violations.** The Director will issue and enforce a written stop sale order to the owner or custodian of any quantity of frozen desserts or frozen novelties which are in violation of Title 37 Chapters 3, 5, and 12, Idaho Code, or Subchapter C of these rules. Disposition of products not in compliance will be at the discretion of the

Director. (3-20-20)T

**391. STANDARDS FOR BUTTER.**

**01. Grading.** Butter grading will be performed in accordance with the United States Standards for grades of butter as incorporated by reference. (3-20-20)T

**02. Quality Standards.** The following quality standards must be met: (3-20-20)T

**a. Coliform Standard.** Compliance with the coliform standard is deemed to have been met if the coliform count does not exceed ten (10) colonies per gram in two (2) of the last four (4) consecutive samples. (3-20-20)T

**b. Bacteria Standard.** Compliance with the bacteria standard is deemed to have been met if the bacteria count per gram does not exceed twenty thousand (20,000) bacteria per gram in two (2) of the last four (4) consecutive samples. Whenever the butter is cultured, the bacteria test using the standard plate count or equivalent method would not be applicable. (3-20-20)T

**c. Frequency of Tests.** During any consecutive six (6) months, at least four (4) samples of butter will be collected and tested. If the test or tests exceed the coliform or bacteria limit three (3) out of five (5) consecutive tests, the butter cannot be sold for human consumption. For the butter to be eligible for human consumption, a subsequent sample must meet the quality standards. (3-20-20)T

**392. STANDARDS FOR WHEY BUTTER.**

**01. Basis for Determining the Acceptability of Whey Butter.** The acceptability of whey butter is determined on the basis of classifying first the flavor characteristics and then the characteristics in body, color and salt. Flavor is the basic quality factor in grading whey butter and is determined organoleptically by taste and smell. The flavor characteristic is identified and together with its relative intensity, is rated according to the applicable classification. When more than one flavor characteristic is discernible in a sample of whey butter, the flavor classification of the sample is established on the basis of the flavor that carries the lowest rating. Body, color and salt characteristics are then noted and any defects are disrated in accordance with the established classification. Acceptability for the sample is then established in accordance with the flavor classification, subject to disratings for body, color and salt. When the disratings for body, color and salt exceed the permitted amount or if the flavor is not acceptable, the whey butter will not be allowed to be sold or distributed within the state of Idaho unless the packages are labeled as provided. (3-20-20)T

**02. Specifications for Acceptability of Whey Butter.** Whey butter shall be free of foreign materials and visible mold. It shall possess a fine and highly pleasing whey butter flavor. May possess any of the following flavors to a slight degree: flat, malty, musty, neutralized, scorched, utensil, stale, and woody. May possess the following flavors to a definite degree: cooked, aged, bitter, coarse-acid, smothered, storage and old cream. May possess feed flavor to a pronounced degree. The permitted total disratings in body, color and salt characteristics are limited to one and one-half (1 1/2). (3-20-20)T

**03. Whey Butter Label Requirements.** It is hereby declared to be unlawful to sell or offer for sale any whey butter within the state of Idaho unless the wrappers and containers in which said butter is packaged are conspicuously labeled as herein provided: (3-20-20)T

**a.** The name of the product is whey butter or whey cream butter or “Butter made from whey cream.” (3-20-20)T

**b.** The name of the product is placed on the principal display panel(s) and shall be of uniform type and prominence. (3-20-20)T

**c.** The manufacturer identification number is conspicuously placed on each wrapper and container of whey butter. (3-20-20)T

**d.** Labels of whey butter sold or distributed within Idaho shall be approved by the Department. (3-20-20)T

**04. Quality Standards.** The following quality standards must be met: (3-20-20)T

**a.** Coliform Standard. Compliance with the coliform standard is deemed to have been met if the coliform count does not exceed ten (10) colonies per gram in two (2) of the last four (4) consecutive samples. (3-20-20)T

**b.** Bacteria Standard. Compliance with the bacteria standard shall be deemed to have been met if the bacteria count per gram does not exceed twenty thousand (20,000) bacteria per gram in two (2) of the last four (4) consecutive samples. Whenever the whey butter is cultured, the bacteria test using the standard plate count or equivalent method would not be applicable. (3-20-20)T

**c.** Frequency of Tests. During any consecutive six (6) months, at least four (4) samples of whey butter will be collected and tested. If the test or tests exceed the coliform or bacteria limit three (3) out of five (5) consecutive tests, the Butter cannot be sold for human consumption. For the whey butter to be eligible for human consumption, a subsequent sample must meet the quality standards. (3-20-20)T

**05. Enforcement.** Whey butter which fails to meet flavor or body, color and salt requirements as defined in Section 392.01 may be sold or distributed within the state of Idaho, provided the word, “undergrade” is placed on the principal display panel(s) immediately preceding or following the product name and is of uniform type size and prominence. (3-20-20)T

**06. Table I -- Classification of Flavor Characteristics.**

Identified Flavors	Acceptable	Unacceptable
Flat	S	D
Malty	S	D
Musty	S	D
Neutralized	S	D
Scorched	S	D
Utensil	S	D
Cooked	D	P
Aged	D	P
Bitter	D	P
Smothered	D	P
Storage	D	P
Old Cream	D	P
Feed	P	-
Acid	D	P
Weed	S	D

(3-20-20)T

**07. Table II -- Characteristics and Disratings in Body, Color, and Salt.**

Characteristics	Body Disratings		
	S	D	P
Crumbly	1/2	1	
Gummy	1/2	1	
Leaky		1/2	1
Mealy or grainy		1/2	1
Short		1/2	1
Weak	1/2	1	
Sticky	1/2	1	
Ragged boring	1	2	

S -- Slight; D -- Definite; P -- Pronounced (3-20-20)T

- 08. Explanation of Terms with Respect to Flavor, Intensity, and Characteristics:** (3-20-20)T
- a.** Slight: Detected only upon critical examination. (3-20-20)T
  - b.** Definite: Detectable but not intense. (3-20-20)T
  - c.** Pronounced: Readily detectable and intense. (3-20-20)T
  - d.** Aged: Characterized by lack of freshness. (3-20-20)T
  - e.** Bitter: Astringent, similar to taste of quinine and produces a puckery sensation. (3-20-20)T
  - f.** Coarse-acid: Lacks a delicate flavor or aroma and is associated with an acid condition but there is no indication of sourness. (3-20-20)T
  - g.** Cooked (fine): Smooth, nutty-like character resembling a custard flavor. (3-20-20)T
  - h.** Feed: Aromatic flavor characteristic of feeds eaten by cows. (3-20-20)T
  - i.** Flat: Lacks natural butter flavor. (3-20-20)T
  - j.** Malty: A distinctive, harsh flavor suggestive of malt. (3-20-20)T
  - k.** Musty: Suggestive of the aroma of a damp vegetable cellar. (3-20-20)T
  - l.** Neutralizer: Suggestive of a bicarbonate of soda flavor or the flavor of similar compounds. (3-20-20)T
  - m.** Old Cream: Aged cream characterized by lack of freshness and imparts a rough aftertaste on the tongue. (3-20-20)T
  - n.** Scorched: A more intensified flavor than cooked (coarse) and imparts a harsh aftertaste. (3-20-20)T
  - o.** Sour: Characterized by an acid flavor and aroma. (3-20-20)T
  - p.** Smothered: Suggestive of improperly cooled cream. (3-20-20)T



- q.** Storage: Characterized by a lack of freshness and more intensified than “aged” flavor. (3-20-20)T
- r.** Utensil: A flavor suggestive of unclean cans, utensils and equipment. (3-20-20)T
- s.** Weed: Aromatic flavor characteristic of the weeds eaten by cows. (3-20-20)T
- 09. With Respect to Body:** (3-20-20)T
- a.** Crumbly: The particles lack cohesion. The intensity is described as “slight” when the trier plug tends to break and the butter lacks plasticity; and “definite” when the butter breaks roughly or crumbles. (3-20-20)T
- b.** Gummy: Gummy-bodied-butter does not melt readily and is inclined to stick to the roof of the mouth. The intensity is described as “slight” when the butter tends to become chewy and “definite” when it imparts a gum-like impression in the mouth. (3-20-20)T
- c.** Leaky: Present when on visual examination there are beads of moisture on the surface of the trier plug and on the back of the trier or when slight pressure is applied to the butter on the trier plug. The intensity is described as “slight” when the droplets or beads of moisture are barely visible and about the size of a pinhead; “definite” when the moisture drops are somewhat larger or the droplets are more numerous and tend to run together; and “pronounced” when the leaky condition is so evident that drops of water drip from the trier plug. (3-20-20)T
- d.** Mealy or grainy: Condition that imparts a granular consistency when the butter is melted on the tongue. The intensity is described as “slight” when the mealiness or graininess is barely detectable on the tongue and “definite” when the mealiness or graininess is readily detectable. (3-20-20)T
- e.** Ragged boring: In contrast to solid boring, ragged boring is when a sticky-crumbly condition is presented to such a degree that a full trier of butter cannot be drawn. The intensity is described as “slight” when there is a considerable adherence “definite” when it is practically impossible to draw a full plug of the butter. (3-20-20)T
- f.** Short: The texture is short-grained, lacks plasticity and tends toward brittleness. The intensity is described as “slight” when the butter lacks pliability and tends to be brittle; and “definite” when sharp and distinct breaks form as pressure is applied against the plug. (3-20-20)T
- g.** Sticky: The butter adheres to the trier as a smear and possesses excessive adhesion. The intensity is described as “slight” when the smear is present only on a portion of the back of the trier and “definite” when the trier becomes smeary throughout its length. (3-20-20)T
- h.** Weak: Body lacks firmness and tends to be spongy. The intensity is described as “slight” when the plug of butter, under slight pressure, tends to depress and is not firm and compact; and “definite” when the plug of butter, under slight pressure, tends to depress easily and definitely lacks firmness and compactness. (3-20-20)T
- 10. With Respect to Color:** (3-20-20)T
- a.** Mottled: Appears as a dappled condition with spots of lighter and deeper shades of yellow. The intensity is described as “slight” when the small spots of different shades of yellow, irregular in shape, are barely discernible on the plug of butter and “definite” when the mottles are readily discernible on the plug of butter. (3-20-20)T
- b.** Specks: Usually appear in butter as small white or yellow spots, however, the latter may be of variable size. The intensity is described as “slight” when the spots are few in number and “definite” when they are noticeable in large numbers. (3-20-20)T
- c.** Streaked: Appears as light colored portions surrounded by more highly colored portions. The intensity is described as “slight” when only a few are present and “definite” when they are more numerous on the trier plug. (3-20-20)T

**d.** Wavy: Uneven in the color in the butter that appears as waves of different shades of yellow. The intensity is described as “slight” when the waves are barely discernible and “definite” when they are readily noticeable on the trier plug. (3-20-20)T

**11. With Respect to Salt:** (3-20-20)T

**a.** Sharp: Characterized by taste sensations suggestive of salt. The intensity is described as “slight” when the salt taste predominates in flavor; and “definite” when the salt taste distinctly predominates in flavor. (3-20-20)T

**b.** Gritty: Condition detected by the gritty feel of the grains of undissolved salt, imparting a sand-like feeling on the tongue. The intensity is described as “slight” when only a few grains of undissolved salt are detected and “definite” when the condition is more readily noticeable. (3-20-20)T

**393. -- 394. (RESERVED)**

**395. NEW DAIRY PRODUCTS.**

**01. General.** Upon request of any interested person, the Director may establish a temporary definition and standard for a new dairy product provided, all the following conditions exist: (3-20-20)T

**a.** Research in the uses of milk and the products or by products of milk has developed a new dairy product for which no definition or standard is prescribed. (3-20-20)T

**b.** The new dairy product cannot be produced or marketed because no definition in standard is prescribed for it. (3-20-20)T

**c.** The public interest would be served by the dairy product. (3-20-20)T

**d.** The quality, wholesomeness and manufacturing requirements of the dairy product are at least equal to established standards for similar dairy products. (3-20-20)T

**e.** The dairy product is labeled in accordance to guidelines for a food product and approved by the Department. (3-20-20)T

**02. Permits.** The Director may issue a special permit to the manufacturer/distributor for the production and sale of a new dairy product(s). The fee for this permit will be twenty five dollars (\$25) per dairy product. Such manufacturer/distributor is subject to the provisions of Title 37 Idaho Code and regulations adopted pursuant thereto applicable to Dairy Plants and milk products. (3-20-20)T

**03. Expiration.** After two (2) years from the date a temporary permit has been issued for a new dairy product(s), the Department will promulgate rules to establish definitions and standards for the new, nonstandardized dairy product(s). (3-20-20)T

**396. -- 403. (RESERVED)**

#### **SUBCHAPTER D – LICENSED DAIRY PLANTS**

**404. INCORPORATION BY REFERENCE.**

The following document is incorporated by reference in this subchapter D only: (3-20-20)T

**01.** “Subpart E -- Requirements for Licensed Dairy Plants,” of the ‘Milk for Manufacturing Purposes and Its Production and Processing, Recommended Requirements’ published by USDA, AMS, Dairy Programs and made effective July 21, 2011. Copies of this document may be obtained from the Idaho State Department of Agriculture or accessed online at <http://www.ams.usda.gov/AMSV1.0/getfile?dDocName=STELDEV3004791>. (3-20-20)T

**405. -- 999. (RESERVED)**

## 02.04.19 – RULES GOVERNING DOMESTIC CERVIDAE

### 000. LEGAL AUTHORITY.

This chapter is adopted under the legal authority of Sections 25-203, 25-305, 25-601, and 25-3704, Idaho Code. (3-20-20)T

### 001. TITLE AND SCOPE.

01. **Title.** The title of this chapter is “Rules Governing Domestic Cervidae.” (3-20-20)T

02. **Scope.** These rules govern procedures for the detection, prevention, control and eradication of diseases among domestic cervidae, and facilities, record keeping, and reporting requirements of domestic cervidae ranches. (3-20-20)T

### 002. – 003. (RESERVED)

### 004. INCORPORATION BY REFERENCE.

The following documents are incorporated by reference. (3-20-20)T

01. **Bovine Tuberculosis Eradication, Uniform Methods and Rules, Effective January 1, 2005.** This document can be viewed online at [https://www.aphis.usda.gov/animal\\_health/animal\\_diseases/tuberculosis/downloads/tb-umr.pdf](https://www.aphis.usda.gov/animal_health/animal_diseases/tuberculosis/downloads/tb-umr.pdf). (3-20-20)T

02. **Code of Federal Regulations, Title 9, Part 161, January 1, 2016.** This document can be viewed online at <http://www.ecfr.gov/cgi-bin/text-idx?SID=aded48cc1dcc4e565ec54ad6aefd2f27&mc=true&node=pt9.1.161&rgn=div5>. (3-20-20)T

03. **Code of Federal Regulations, Title 9, Part 55, January 1, 2016.** This document can be viewed online at <http://www.ecfr.gov/cgi-bin/text-idx?SID=aded48cc1dcc4e565ec54ad6aefd2f27&mc=true&node=pt9.1.55&rgn=div5>. (3-20-20)T

04. **Code of Federal Regulations, Title 9, Subchapter A, Part 1 and 2, January 1, 2016.** This document can be viewed online at <http://www.ecfr.gov/cgi-bin/text-idx?SID=aded48cc1dcc4e565ec54ad6aefd2f27&mc=true&tpl=/ecfrbrowse/Title09/9C1subchapA.tpl>. (3-20-20)T

### 005. -- 009. (RESERVED)

### 010. DEFINITIONS.

01. **Accredited Veterinarian.** A veterinarian approved by the Administrator and USDA/APHIS/VS, in accordance with Title 9, Part 161, CFR, January 1, 2004, to perform functions required by cooperative state-federal animal disease control and eradication programs. (3-20-20)T

02. **Approved Laboratory.** NVSL, an AAVLD accredited laboratory that is qualified to perform CWD diagnostic procedures, or a laboratory designated by the Administrator to perform CWD diagnostic procedures. (3-20-20)T

03. **Approved Slaughter Establishment.** A USDA inspected slaughter establishment at which ante-mortem and post-mortem inspection is conducted by USDA inspectors. (3-20-20)T

04. **Area Veterinarian in Charge.** The USDA/APHIS/VS veterinary official who is assigned to supervise and perform official animal health activities in Idaho. (3-20-20)T

05. **Breed Associations and Registries.** Organizations maintaining permanent records of ancestry or pedigrees of animals, individual animal identification records and records of ownership. (3-20-20)T

06. **Certificate.** An official document issued by a state or federal animal health official or an accredited veterinarian at the point of origin of a shipment of cervidae that contains information documenting the age, sex, species, individual identification of the animals, the number of animals, the purpose of the movement, the points of origin and destination, the consignor, the consignee, the status of the animals relative to official diseases, test results and any other information required by the state animal health official for importation or translocation. (3-20-20)T

- 07. Cervid Herd.** One (1) or more domestic cervidae or groups of domestic cervidae maintained on common ground or under common ownership or supervision that may be geographically separated but can have interchange or movement. (3-20-20)T
- 08. Cervidae.** Deer, elk, moose, caribou, reindeer, and related species and hybrids including all members of the cervidae family and hybrids. (3-20-20)T
- 09. Chronic Wasting Disease.** A transmissible spongiform encephalopathy of cervids that is a nonfebrile, transmissible, insidious, and degenerative disease affecting the central nervous system of cervidae. (3-20-20)T
- 10. Commingling.** Within the last five (5) years, the animals have had direct contact with each other, had less than thirty (30) feet of physical separation, or shared management equipment, pasture, or surface water sources, except for periods of less than forty-eight (48) hours at sales or auctions when a state or federal animal health official has determined such contact presents minimal risk of CWD transmission. (3-20-20)T
- 11. Custom Exempt Slaughter Establishment.** A slaughter establishment that is subject to facility inspection by USDA, but that does not have ante-mortem and post-mortem inspection of animals by USDA inspectors. (3-20-20)T
- 12. CWD-Adjacent Herd.** A herd of domestic cervidae occupying premises that border a premises occupied by a CWD positive herd, including herds separated by roads or streams. (3-20-20)T
- 13. CWD-Exposed Animal.** A cervid animal that is not exhibiting any signs of CWD, but has had contact within the last five (5) years with cervids from a CWD-positive herd or the animal is a member of a CWD-exposed herd. (3-20-20)T
- 14. CWD-Exposed Herd.** A herd of cervidae in which no animals are exhibiting signs of CWD, but:
- a.** An epidemiological investigation indicates that contact with CWD positive animals or contact with animals from a CWD positive herd has occurred in the previous five (5) years; or (3-20-20)T
  - b.** A herd of cervidae occupying premises that were previously occupied by a CWD positive herd within the past five (5) years as determined by the designated epidemiologist; or (3-20-20)T
  - c.** Two (2) herds that are maintained on a single premises even if they are managed separately, have no commingling, and have separate herd records. (3-20-20)T
- 15. CWD-Positive Cervid.** A domestic cervid on which a diagnosis of CWD has been confirmed through positive test results on any official cervid CWD test by an approved laboratory. (3-20-20)T
- 16. CWD-Positive Herd.** A domestic cervidae herd in which any animal(s) has been diagnosed with CWD, based on positive laboratory results, from an approved laboratory. (3-20-20)T
- 17. CWD-Suspect Cervid.** A domestic cervid for which laboratory evidence or clinical signs suggests a diagnosis of CWD. (3-20-20)T
- 18. CWD-Suspect Herd.** A domestic cervidae herd in which any animal(s) has been determined to be a CWD-suspect. (3-20-20)T
- 19. Death Certificate.** A form, approved by the administrator, provided by the Division for the reporting of cervidae deaths and for reporting sample submission for CWD testing. (3-20-20)T
- 20. Designated Epidemiologist.** A state or federal veterinarian who has demonstrated the knowledge and ability to perform the functions required under these rules and who has been selected by the Administrator to fulfill the epidemiology duties relative to the state domestic cervidae disease control program. (3-20-20)T

21. **Disposal.** Final disposition of dead cervidae. (3-20-20)T
22. **Domestic Cervidae.** Fallow deer (*Dama dama*), elk (*Cervus elaphus*) or reindeer (*Rangifer tarandus*) owned by a person. (3-20-20)T
23. **Domestic Cervidae Ranch.** A premises where domestic cervidae are held or kept, including multiple premises under common ownership. (3-20-20)T
24. **Electronic Identification.** A form of unique, permanent individual animal identification such as radio frequency identification tag, radio frequency identification implant, or other forms approved by the Administrator. (3-20-20)T
25. **Escape.** Any domestic cervidae located outside the perimeter fence of a domestic cervidae ranch and not under the immediate control of the owner or operator of the domestic cervidae ranch. (3-20-20)T
26. **Federal Animal Health Official.** An employee of USDA/APHIS/VS who is authorized to perform animal health activities. (3-20-20)T
27. **Harvest.** Any healthy domestic cervid that is intentionally and lethally removed from a domestic cervidae facility, by an owner, designated employee or customer of the facility, strictly for the purposes of either shooting or meat production. (3-20-20)T
28. **Herd of Origin.** A cervid herd, on any domestic cervidae ranch or other premise, where the animals were born, or where they were kept for at least one (1) year prior to date of shipment. (3-20-20)T
29. **Herd Status.** Classification of a cervidae herd with regard to CWD. (3-20-20)T
30. **Intrastate Movement Certificate.** A form approved by the Administrator, and available from the Division, to document the movement of domestic cervidae between premises within Idaho. (3-20-20)T
31. **Individual CWD Herd Plan.** A written herd management agreement and testing plan developed by the herd owner and approved by the Administrator to identify and eradicate CWD from a positive, source, suspect, exposed, or adjacent herd. (3-20-20)T
32. **Limited Contact.** Incidental contact between animals of different herds in separate pens off of the herd's premises at fairs, shows, exhibitions and sales. (3-20-20)T
33. **National CWD Herd Certification Program.** A federal-state-industry cooperative program administered by APHIS and implemented by participating states that establishes CWD surveillance and testing standards that owners must achieve before interstate transport of cervids will be permitted. (3-20-20)T
34. **Official CWD Test.** A test approved by the Administrator and conducted at an approved laboratory to diagnose CWD. (3-20-20)T
35. **Official Identification.** Identification, approved by the Administrator, that individually, uniquely, and permanently identifies each cervid. (3-20-20)T
36. **Operator.** A person who has authority to manage or direct a domestic cervidae ranch. (3-20-20)T
37. **Premises.** The ground, area, buildings, and equipment utilized to raise, propagate, control, or harvest domestic cervidae. (3-20-20)T
38. **Quarantine.** An order issued on authority of the Administrator, by a state or federal animal health official or accredited veterinarian, prohibiting movement of cervids from any location without a written restricted movement permit. (3-20-20)T

- 39. Quarantine Facility.** A confined area where selected domestic cervidae can be secured and isolated from all other cervidae and livestock. (3-20-20)T
- 40. Ranch Management Plan.** A written plan for a domestic cervidae ranch that sets forth best management practices that mitigates the introduction or dissemination of disease among domestic cervidae. (3-20-20)T
- 41. Reidentification.** The identification of a domestic cervid which had been officially identified, as provided by this chapter, but which has lost the official identification device, or the tattoo or official identification device has become illegible. (3-20-20)T
- 42. Restrain.** The immobilization of domestic cervidae in a chute, other device, or by other means for the purpose of efficiently, effectively, and safely inspecting, treating, vaccinating, or testing. (3-20-20)T
- 43. Restricted Movement Permit.** An official document that is issued by the Administrator, AVIC, or an accredited veterinarian for movement of animals from positive, suspect, or exposed herds. (3-20-20)T
- 44. Source Herd.** A herd from which at least one (1) cervid has originated within the previous five (5) years and that cervid has been diagnosed CWD positive. (3-20-20)T
- 45. State Animal Health Official.** The Administrator, or Administrator's designee. (3-20-20)T
- 46. Status Date.** The date on which the Administrator approves in writing a herd status change with regard to CWD. (3-20-20)T
- 47. Trace Back Herd.** An exposed herd in which at least one (1) CWD positive animal resided within any of the previous sixty (60) months prior to diagnosis with CWD. (3-20-20)T
- 48. Trace Forward Herd.** A herd that has received exposed animals from a positive herd within sixty (60) months prior to the diagnosis of CWD in the positive herd or from the identified point of entry of CWD into the positive herd. (3-20-20)T
- 49. Traceback.** The process of identifying the movements and the herd of origin of CWD positive, or exposed animals, including herds that were sold for slaughter. (3-20-20)T
- 50. Wild Cervidae.** Any cervid animal not owned by a person. (3-20-20)T
- 51. Wild Ungulate.** Any four (4) legged, hooved herbivore, including cervids and other ruminants, not owned by a person. (3-20-20)T
- 52. Wild Ungulate Cooperative Herd Plan.** A plan, developed cooperatively by the owner of the domestic cervidae ranch, the ISDA, and the Idaho Department of Fish and Game to determine the disposition of any wild ungulates that are found to be located on a domestic cervidae ranch. (3-20-20)T

**011. ABBREVIATIONS.**

- 01. AAVLD.** American Association of Veterinary Laboratory Diagnosticians. (3-20-20)T
- 02. APHIS.** Animal and Plant Health Inspection Service. (3-20-20)T
- 03. AVIC.** Area Veterinarian in Charge. (3-20-20)T
- 04. AZA.** Association of Zoos and Aquariums. (3-20-20)T
- 05. CFR.** Code of Federal Regulations. (3-20-20)T
- 06. CWD.** Chronic Wasting Disease. (3-20-20)T

- 07. CWDP. Chronic Wasting Disease Program. (3-20-20)T
- 08. ISDA. Idaho State Department of Agriculture. (3-20-20)T
- 09. NAEBA. North American Elk Breeders Association. (3-20-20)T
- 10. NVSL. National Veterinary Services Laboratory. (3-20-20)T
- 11. TB. Tuberculosis. (3-20-20)T
- 12. UM&R. Uniform Methods and Rules. (3-20-20)T
- 13. USDA. United States Department of Agriculture. (3-20-20)T
- 14. VS. Veterinary Services. (3-20-20)T

**012. APPLICABILITY.**

These rules apply to all domestic cervidae located in, imported into, exported from, or transported through the state of Idaho. (3-20-20)T

**013. AZA ACCREDITED FACILITIES AND USDA LICENSED FACILITIES.**

AZA accredited facilities and facilities licensed by USDA under 9CFR Subchapter A Parts 1 and 2 as licensees, dealers, exhibitors, research facilities and zoos are exempt from the provisions of this chapter provided that:

(3-20-20)T

**01. Movement Between AZA and USDA Facilities.** AZA accredited and USDA licensed facilities may not sell, give, or in any way transfer cervidae to persons or domestic cervidae ranches within Idaho, except other to AZA accredited or USDA licensed facilities. (3-20-20)T

**02. Transfer of Cervidae.** Any AZA accredited or USDA licensed facility that in any way transfers cervidae, or title to cervidae, to any person in Idaho, except to other AZA accredited or USDA licensed facilities, must comply with all of the provisions of this chapter. (3-20-20)T

**014. IMPORTATION OF DOMESTIC CERVIDAE.**

All domestic cervidae imported into the state of Idaho must comply with the requirements of the APHIS National CWD Herd Certification Program and IDAPA 02.04.21 "Rules Governing the Importation of Animals," which apply to domestic cervidae. (3-20-20)T

**015. -- 019. (RESERVED)**

**020. LOCATION OF DOMESTIC CERVIDAE.**

Any person who owns or has control of domestic cervidae in Idaho that are not located on a domestic cervidae ranch that is in compliance with the applicable provisions of this chapter, or on an AZA accredited or USDA licensed facility in compliance with this chapter, is in violation of these rules. (3-20-20)T

**01. Department Action.** In addition to any other administrative or civil action, the department may seize, require removal from the state, require removal to a domestic cervidae ranch that is in compliance with the provisions of this chapter, or require disposal of any domestic cervidae that are not located on a domestic cervidae ranch, an AZA accredited facility, or a USDA licensed facility which is in compliance with the provisions of this chapter. (3-20-20)T

**02. Reindeer.** Reindeer may not be owned, possessed, propagated or held in Idaho north of the Salmon River in order to protect the wild caribou herd in northern Idaho. (3-20-20)T

**03. Exceptions.** The Administrator may grant exceptions from the provisions of Section 020 on a case specific basis. (3-20-20)T

**04. Natural Disasters.** Damage caused to domestic cervidae ranch facilities by natural disasters does not constitute a violation of this chapter, provided that the owner or operator begins any necessary repairs immediately upon discovering the damage, acts expeditiously, as determined by the Administrator, to complete any necessary repairs and reports the extent and cause of any damage to the Division within twenty-four (24) hours of the discovery of the damage. (3-20-20)T

**021. OFFICIAL IDENTIFICATION.**

All domestic cervidae must be individually, permanently, and uniquely identified, with two (2) types of official identification approved by the Administrator. (3-20-20)T

**01. Reporting of Identification.** The unique individual identification number, type of identification, and the name, address, and telephone number of the owner of each animal identified must be reported to the Administrator, in writing, by the owner or operator. (3-20-20)T

**02. Identification Assigned.** Official identification, once assigned to an individual animal, may not be changed or transferred to another animal. Animals that lose identification devices must be re-identified in accordance with Section 031. (3-20-20)T

**03. Progeny.** All progeny of domestic cervidae must be officially identified by December thirty-first of the year of birth, upon sale or transfer of ownership, or upon leaving the domestic cervidae ranch, whichever is earlier. (3-20-20)T

**04. Visible Identification.** At least one (1) of the official types of identification used must be visible from one hundred and fifty (150) feet. (3-20-20)T

**022. TYPES OF OFFICIAL IDENTIFICATION.**

All domestic cervidae must be individually identified by two (2) of the following types of official identification, at least one (1) of the types of official identification must be a bangle or lamb tag that is visible from one hundred fifty (150) feet. (3-20-20)T

**01. Official USDA Ear Tag.** (3-20-20)T

**02. Tattoo.** Legible skin tattoo using an alphanumeric tattoo sequence that has been recorded with the Division of Animal Industries and applied to either the ear or escutcheon. (3-20-20)T

**03. Electronic Identification.** A form of electronic identification, approved by the Administrator. (3-20-20)T

**04. Official NAEBA Eartag.** (3-20-20)T

**05. Official ISDA Cervidae Program Ear Tag.** A tamper resistant, unique number sequenced, individual identification tag approved by the Administrator. (3-20-20)T

**06. Official HASCO Brass Lamb Tag.** A brass lamb tag engraved with farm name and individual animal identification number. (3-20-20)T

**07. Freeze Brands.** Legible, freeze brands that uniquely identify the individual domestic cervid. (3-20-20)T

**08. Ranch Specific Unique Bangle or Lamb Tags.** The Administrator may grant written approval for the use of bangle or lamb tags that are: ranch specific; tamper resistant; uniquely numbered; and correlated with another type of official identification on the annual inventory report. (3-20-20)T

**09. Other Identification.** Other forms of unique individual identification approved by the Administrator. (3-20-20)T



**023. NATIONAL CWD HERD CERTIFICATION PROGRAM OFFICIAL IDENTIFICATION.**

All domestic cervidae enrolled in the National CWD Herd Certification Program are required to be identified with two (2) forms of identification for each animal. One (1) form of identification must be a nationally unique official animal identification that uses an APHIS-approved numbering system that is linked to the CWD National Database or equivalent ISDA database. The second form of identification must be unique to the individual animal within the herd and also be linked to the CWD National Database or equivalent ISDA database. (3-20-20)T

**01. APHIS-Approved Identification Devices. (3-20-20)T**

**a.** Electronic Identification; (3-20-20)T

**b.** Official USDA Tamper-Resistant Ear Tag; (3-20-20)T

**c.** Legible Ear or Flank Tattoo; and (3-20-20)T

**d.** Other forms of Identification as approved by APHIS Administrator. (3-20-20)T

**024. -- 029. (RESERVED)**

**030. OFFICIAL VISIBLE IDENTIFICATION.**

**01. Ear Tags.** All domestic cervidae must be identified with a bangle or lamb tag that is visible from one hundred fifty (150) feet. (3-20-20)T

**02. Size.** The large portion of the bangle or lamb tag must be at least two (2) square inches. (3-20-20)T

**03. Color.** No visible identification may have a primary color of brown, black, pink, tan, or silver. (3-20-20)T

**04. Camouflage Patterns.** No visible identification may utilize camouflage patterns. (3-20-20)T

**031. REIDENTIFICATION OF DOMESTIC CERVIDAE.**

No domestic cervidae that were marked with official identification may be re-tattooed for the purpose of reestablishing their identification nor re-ear-tagged with an official identification ear tag at any time subsequent to the original identification, except that re-tattooing or re-ear-tagging for the purpose of reestablishing the official identification is allowed only under the following conditions: (3-20-20)T

**01. Supervision.** Reidentification is accomplished under the supervision of an accredited veterinarian, or state or federal animal health officials. (3-20-20)T

**02. Permanent Identification.** Animals that are presented for reidentification have some permanent identification that identifies the animals as those originally officially identified such as an individual animal registration tattoo, or other approved permanent identification, provided that such identification was submitted on the annual inventory report or other official record. (3-20-20)T

**03. Inventory Evaluation.** In absence of permanent identification, the Administrator may conduct an investigation or inventory evaluation to determine identity of the animal that is being presented for reidentification. (3-20-20)T

**04. Reproduction of Original Tattoo.** Re-tattooing must reproduce the original tattoo that was placed in the animal's ear at the time of official identification. (3-20-20)T

**05. Records.** The accredited veterinarian or state or federal animal health official who supervises the reidentification must correlate the new identification with previous identification and record the ear tag or other identification numbers, the tattoo symbols and the owner's name and address and submit the reidentification record to the Division within ten (10) days of the date of reidentification. (3-20-20)T

**032. -- 039. (RESERVED)**

**040. INSPECTIONS.**

To prevent the introduction and dissemination, or to control and eradicate diseases, state and federal animal health officials are authorized to inspect cervidae records, premises, facilities, and domestic cervidae to ensure compliance with the provisions of this chapter and other state or federal laws or rules applicable to domestic cervidae. State and federal animal health officials must comply with the operation's biosecurity protocol so long as the protocol does not inhibit reasonable access to: (3-20-20)T

**01. Entry.** Enter and inspect, at reasonable times, the premises of domestic cervidae ranches and inspect domestic cervidae. (3-20-20)T

**02. Access to Records.** Review or copy, at reasonable times, any records that must be kept in accordance with these rules. (3-20-20)T

**041. -- 049. (RESERVED)**

**050. GENETICS.**

Domestic cervidae that have red deer genetic influence may not be imported into Idaho. Additionally, any domestic cervidae located in Idaho that are identified as having red deer genetic influence will be destroyed, removed from the state, or neutered. (3-20-20)T

**051. -- 059. (RESERVED)**

**060. WILD CERVIDAE.**

Wild cervidae may not be confined, kept or held on a domestic cervidae ranch. (3-20-20)T

**01. Duty of Ranch Owner.** It is the duty of owners of all domestic cervidae ranches to take precautions, and to conduct periodic inspections, to ensure that wild cervidae are not located within the perimeter fence of any domestic cervidae ranch. (3-20-20)T

**02. Notification of Administrator.** All owners or operators of domestic cervidae ranches must notify the Administrator within twenty-four (24) hours of gaining knowledge of the presence of wild cervidae inside the perimeter fence of the domestic cervidae ranch. (3-20-20)T

**03. Failure to Notify the Administrator.** The failure of any owner or operator of a domestic cervidae ranch to notify the Administrator of the presence of wild cervidae within the perimeter fence of a domestic cervidae ranch is a violation of this chapter. (3-20-20)T

**04. Idaho Department of Fish and Game.** Upon receiving notification that wild cervidae are on a domestic cervidae ranch, the Administrator will notify the Idaho Department of Fish and Game. (3-20-20)T

**05. Wild Ungulate Cooperative Herd Plan.** The Idaho Department of Fish and Game will cooperate with ISDA and the owners or operators of domestic cervidae ranches where any wild cervidae or wild ungulates are present within the external perimeter fence of the domestic cervidae ranch to develop and implement a site specific written herd plan to address the disposition of the wild cervidae or wild ungulates. (3-20-20)T

**061. -- 069. (RESERVED)**

**070. SUPERVISION OF DOMESTIC CERVIDAE PROGRAM.**

A department veterinary medical officer will provide routine supervision of the domestic cervidae program. (3-20-20)T

**071. -- 079. (RESERVED)**

**080. DISPOSAL OF DOMESTIC CERVIDAE.**

All domestic cervidae carcasses and parts of carcasses not utilized for human consumption, except parts of carcasses

utilized for taxidermy purposes, must be disposed of in compliance with IDAPA 02.04.17, "Rules Governing Dead Animal Movement And Disposal." (3-20-20)T

**081. -- 089. (RESERVED)**

**090. FEES.**

**01. Annual Assessment Fee.** A fee, not to exceed ten dollars (\$10) per head per year on elk or three dollars (\$3) per head per year on fallow deer and reindeer, is hereby assessed on all domestic cervidae in the state to cover the cost of administering the program covered in these rules. The fee includes all domestic cervidae present at the ranch as of December 31 and all domestic cervidae that die during the same calendar year. This fee is due January first of each year. The annual assessment fee may be reduced if program revenue accumulates to a balance of at least one hundred thousand dollars (\$100,000) in excess of the projected annual cost of operating the program, as determined by the Department on July 1 of each year. (3-20-20)T

**02. Import, Export, and Movement Fees.** The fees imposed in Section 25-3708(2) through (4), Idaho Code, are due no later than December 31 of each year, but the Department requests all movement fees be submitted within five (5) business days of the movement of the domestic cervids. (3-20-20)T

**091. -- 099. (RESERVED)**

**100. DOMESTIC CERVIDAE RANCHES.**

In order to prevent the introduction or dissemination of diseases, and to control or eradicate diseases, all domestic cervidae ranches must comply with the disease control, facility, and record keeping requirements and all other provisions of this chapter. (3-20-20)T

**01. Each Premises.** Each separate premises where domestic cervidae are kept or held must comply with all of the provisions of this chapter. (3-20-20)T

**02. Vehicle Access.** Domestic cervidae ranches must have motorized vehicle access to the restraining system on each premises, during the portion of the year that cervidae are held or kept on the premises, adequate to facilitate disease prevention and control as determined by the Administrator. (3-20-20)T

**03. Premises Registration.** Each premises where domestic cervidae are kept or held must be registered with the Division and assigned a unique, individual number approved by the Administrator. (3-20-20)T

**101. DOMESTIC CERVIDAE RANCH FACILITY REQUIREMENTS.**

All domestic cervidae ranches are required to have facilities that include, but are not limited to, perimeter fence, restraining system, gathering system, water system, and if required, a quarantine facility. (3-20-20)T

**01. Maintenance.** All facilities must be maintained, at all times that domestic cervidae are present, to prevent the escape of domestic cervidae or ingress of wild cervidae. (3-20-20)T

**02. Inspections.** To ensure compliance with this chapter, state or federal animal health officials will inspect all premises where domestic cervidae are, or will be, possessed, controlled, harvested, propagated, held, or kept. (3-20-20)T

**a.** Each domestic cervidae ranch will be inspected no less than once every five (5) years. Domestic cervidae ranches may be inspected more frequently if requested by the owner or if specified in a ranch management plan. The Administrator may require additional facility inspections as necessary to aid in the prevention, control, or eradication of disease or to ensure compliance with the provisions of this chapter or other state or federal rules applicable to domestic cervidae. (3-20-20)T

**b.** All facilities relating to the handling or raising of domestic cervidae will be inspected. (3-20-20)T

**102. PERIMETER FENCE REQUIREMENTS.**

A perimeter fence, completely enclosing the domestic cervidae ranch to be constructed of high-tensile, non-slip

woven wire or other fencing material approved by the Administrator. (3-20-20)T

**01. Elk and Fallow Deer.** For elk and fallow deer, the fence must be a minimum of eight (8) feet in height for its entire length at all times. (3-20-20)T

**02. Reindeer.** For reindeer, the fence must be at least six (6) feet in height for its entire length at all times. (3-20-20)T

**03. Wire.** The top two (2) feet of each fence may be smooth, barbed or woven wire (at least twelve and one-half (12-1/2) gauge) with horizontal strands spaced not more than six (6) inches apart. (3-20-20)T

**a.** Wire must be placed on the animal side of the fence to prevent pushing the wire away from the posts. (3-20-20)T

**b.** Wire must be attached to all posts at the top, bottom, and not more than eighteen (18) inches apart between the top and bottom of the wire. (3-20-20)T

**04. Posts.** Wooden posts used in the perimeter fence must be at least butt-end treated with a commercially available preservative and have a minimum of four (4) inch top for line posts and a minimum of five (5) inch top for corner posts. Metal pipe posts must be a minimum of two and one-eighth (2-1/8) inches outside diameter with a three-sixteenths (3/16) inch wall thickness for line posts and two and seven-eighths (2-7/8) inches outside diameter with a seven thirty-seconds (7/32) inch wall thickness for corner posts. Posts must be spaced no more than twenty-four (24) feet apart, with stays, supports or braces as needed, and be placed in the ground a minimum of three (3) feet. (3-20-20)T

**05. Gates.** Each domestic cervidae ranch must have gates that prohibit the escape of domestic cervidae or the ingress of wild cervidae. (3-20-20)T

**06. Fence Maintenance.** Fences must be maintained, at all times that domestic cervidae are present, to prevent domestic cervidae from escaping or native wild cervidae from entering the enclosure. (3-20-20)T

**07. Exceptions.** The Administrator may grant exceptions to the specifications in Section 102 on a case specific basis. (3-20-20)T

### **103. GATHERING AND RESTRAINING SYSTEM.**

Each domestic cervidae ranch must have a system for humanely and effectively gathering and restraining domestic cervidae for the purpose of inspecting, identifying, treating, or testing of animals by state or federal animal health officials. (3-20-20)T

**01. Gathering System.** Each domestic cervidae ranch must have a system that facilitates the gathering of domestic cervidae so as to be able to move the domestic cervidae through the restraining system, at any time of the year that domestic cervidae are present. (3-20-20)T

**02. Restraining System.** A system approved by the Administrator, to immobilize domestic cervidae for the purpose of efficient, effective, and safe handling for inspecting, treating, vaccinating, or testing. (3-20-20)T

**03. Exceptions.** The Administrator may grant exceptions to the provisions of this section on a case specific basis. (3-20-20)T

### **104. WATER SYSTEM.**

Each domestic cervidae ranch must have a water system adequate to supply the need of the cervidae herd. (3-20-20)T

### **105. QUARANTINE FACILITY.**

If animals are to be imported onto the domestic cervidae ranch, a quarantine facility, approved by the Administrator, must be provided for holding animals until any disease retesting is accomplished or other requirements are met. (3-20-20)T

**106. -- 199. (RESERVED)**

**200. RECORDS AND REPORTING.**

**01. Reports.** Owners of domestic cervidae ranches must submit complete and accurate reports to the Administrator. Failure to submit complete and accurate reports within the designated time frames is a violation of this chapter. (3-20-20)T

**02. Records.** All owners of domestic cervidae ranches, during normal business hours, must present to state or federal animal health officials, for inspection, review, or copying, any cervidae records deemed necessary to ensure compliance with the provisions of this chapter. (3-20-20)T

**03. Notification.** State or federal animal health officials will attempt to notify the owners or operators of domestic cervidae ranches, and premises where records are kept prior to any inspections. (3-20-20)T

**04. Emergencies.** In the event of an emergency, as determined by the Administrator, the notification requirements of Section 200 may be waived. (3-20-20)T

**201. ANNUAL INVENTORY REPORT.**

**01. Inventory Report.** All owners of domestic cervidae ranches must submit annually, to the Administrator, a complete and accurate inventory of all animals held no later than December 31<sup>st</sup> of each year containing the following minimum information: (3-20-20)T

- a. Name and address of the domestic cervidae ranch. (3-20-20)T
- b. Name and address of the owner of the domestic cervidae ranch. (3-20-20)T
- c. Date the inventory was completed. (3-20-20)T

**02. Individual Domestic Cervidae.** For each individual domestic cervidae that was located on the domestic cervidae ranch during the year for which the report is being made, the following information must be provided: (3-20-20)T

- a. All types of official and unofficial identification; (3-20-20)T
- b. Species; (3-20-20)T
- c. Sex; and (3-20-20)T
- d. Age or year born. (3-20-20)T

**202. INVENTORY VERIFICATION.**

State or federal animal health officials will verify all domestic cervidae ranch inventories of animals held and individual animal identification annually. (3-20-20)T

**01. Visible Identification.** Individual animal identification verification may be accomplished by visually noting the unique official visible identification number or visually noting an unofficial visible identification number if the number is correlated with two (2) forms of official identification on the inventory submitted by the cervidae producer. The Administrator may, on a case by case basis, grant written permission for ranch specific unique bangle tags to be used for official identification. (3-20-20)T

**02. Duty to Gather and Restrain.** It is the duty of the owner of each domestic cervidae ranch to gather and restrain any domestic cervidae that state or federal animal health officials determine are not readily identifiable for inventory verification purposes. The Administrator determines the suitability of the restraint system. (3-20-20)T

**203. CHANGE OF ADDRESS.**

Owners of domestic cervidae ranches must notify the Division in writing within thirty (30) days of any change in the address of the owners of domestic cervidae, the owner of the domestic cervidae ranch, or the domestic cervidae ranch. (3-20-20)T

**204. ESCAPE OF DOMESTIC CERVIDAE.**

It is the duty of each owner or operator of a domestic cervidae ranch to take all reasonable actions to prevent the escape of domestic cervidae from a domestic cervidae ranch. (3-20-20)T

**01. Notification of Escape.** When any domestic cervidae escape from a domestic cervidae ranch, the owner or operator of the domestic cervidae ranch must notify the Administrator by phone, facsimile, or other means approved by the administrator within twenty-four (24) hours of the discovery of the escape. (3-20-20)T

**02. Duty to Retrieve Escaped Cervidae.** It is the duty of each owner or operator of a domestic cervidae ranch to retrieve or otherwise bring under control all domestic cervidae that escape from a domestic cervidae ranch. (3-20-20)T

**03. Fish and Game.** The Administrator will notify the Idaho Department of Fish and Game of each escape. (3-20-20)T

**04. Sheriff and State Brand Inspector.** When domestic cervidae escape from a domestic cervidae ranch and the owner or operator is unable to retrieve the animals within twenty-four (24) hours, the Administrator may notify the county sheriff or the state brand inspector of the escape pursuant to Title 25, Chapter 23, Idaho Code. (3-20-20)T

**05. Capture.** In the event that the owner or operator of a domestic cervidae ranch is unable to retrieve escaped domestic cervidae in a timely manner, as determined by the Administrator, the Administrator may effectuate the capture of the escaped domestic cervidae to ensure the health of Idaho's livestock and wild cervidae populations. (3-20-20)T

**06. Failure to Notify.** Failure of any owner or operator of a domestic cervidae ranch to notify the Administrator within twenty-four (24) hours of the discovery of an escape of domestic cervidae is a violation of this chapter. (3-20-20)T

**07. Taking of Escaped Domestic Cervidae.** A licensed hunter may legally take domestic cervidae that have escaped from a domestic cervidae ranch only under the following conditions: (3-20-20)T

**a.** The domestic cervidae has escaped and has not been in the control of the owner or operator of the domestic cervidae ranch for more than seven (7) days; and (3-20-20)T

**b.** The hunter is licensed and in compliance with all the provisions of the Idaho Department of Fish and Game rules and code. (3-20-20)T

**205. NOTICE OF DEATH OF DOMESTIC CERVIDAE.**

Notice of death of domestic cervidae twelve (12) months or older and all domestic cervidae officially identified and inventoried that died on a ranch or at an approved slaughter or custom exempt slaughter establishment must be submitted by the owner or operator to the division on a report approved by the Administrator: (3-20-20)T

**01. Submission of Death Certificates.** A complete and accurate copy of all CWD sample submission forms/death certificates must be submitted to the division by regular mail, facsimile, electronic mail, or by other means as approved by the Administrator within ten (10) business days of when the owner or operator knew or reasonably should have known of the death. The CWD sample submission form/death certificate must contain the following minimum information: (3-20-20)T

**a.** Name and address of the domestic cervidae ranch; and (3-20-20)T

**b.** Name and address of the owner of the domestic cervidae ranch. (3-20-20)T

**02. Individual Domestic Cervidae.** For each individual domestic cervidae death, the following minimum information must be provided: (3-20-20)T

- a. All individual identification numbers; (3-20-20)T
- b. Sex; (3-20-20)T
- c. Age or year born; (3-20-20)T
- d. Date and time of death; (3-20-20)T
- e. Cause of death; (3-20-20)T
- f. Specify animals submitted for CWD testing; and (3-20-20)T
- g. Dated signature. (3-20-20)T

**206. (RESERVED)**

**207. NOTIFICATION OF EXPOSURE TO DISEASE.**

Any owner, operator, veterinarian practicing in Idaho, laboratory conducting cervidae testing, or any other person who has reason to believe that domestic cervidae are exposed to or infected with a dangerous or reportable disease or parasite must notify the Division immediately. (3-20-20)T

**208. INTRASTATE MOVEMENT CERTIFICATE.**

All owners of domestic cervidae ranches who move cervidae, from one premises to another, including movement from one (1) premises to another premises owned, operated, leased, or controlled by the owner, within the state of Idaho must submit, to the Administrator, a complete and accurate intrastate movement certificate signed by the owner, within ten (10) business days of the movement. The Administrator will provide blank intrastate movement certificates to the owners of domestic cervidae ranches upon request. (3-20-20)T

**209. RANCH MANAGEMENT PLAN.**

**01. Voluntary Ranch Management Plan.** A domestic cervidae ranch may apply, on a form prescribed by the Administrator, to enter into a voluntary ranch management plan. The ranch management plan will be developed cooperatively by the owner or authorized agent and the Administrator. For the ranch management plan, the Administrator will conduct a risk assessment considering the factors in Subsection 209.03. A voluntary ranch management plan may, notwithstanding other rule requirements to the contrary, establish inventory verification requirements and CWD sampling requirements specific for a domestic cervidae ranch. Failure to adhere to an approved voluntary ranch management plan is a violation of these rules. (3-20-20)T

**02. Mandatory Ranch Management Plan.** Domestic cervidae ranches are required to develop and implement an approved ranch management plan if the ranch is found in violation of Sections 060, 204 or 500 of these rules. The ranch management plan must be completed and implemented within six (6) months of the disposition of the violation. For the ranch management plan, the Administrator will conduct a risk assessment considering the factors in Subsection 209.03. Failure to comply with the mandatory ranch management plan is a violation of these rules. (3-20-20)T

**03. Risk Assessment for Ranch Management Plans.** The Administrator will conduct a risk assessment for each ranch management plan. A ranch management plan will not include a double fencing requirement but may require that double gates be installed. The Administrator will consider the following factors when conducting a risk assessment at a domestic cervidae ranch: (3-20-20)T

a. Risk of egress. The risk of egress may be evaluated based on, but not limited to, history of domestic cervidae escape during the previous five (5) years, recovery rate of escaped domestic cervidae, length of time domestic cervidae were outside of the perimeter fence, annual average precipitation, topography, altitude and tree density. (3-20-20)T

**b.** Risk of ingress. The risk of ingress may be evaluated on, but not limited to, history of ingress during the previous five (5) years, annual average precipitation, topography, altitude, tree density and proximity to wildlife migration corridors. (3-20-20)T

**c.** Compliance with CWD sample submission. The Administrator may, based on a risk assessment of the facility, adjust the number of tissue sample submissions required under this rule. The adjustment will be based on, but not limited to, the following: (3-20-20)T

**i.** Whether the domestic cervidae on the ranch have commingled with any domestic cervids of unknown CWD status. (3-20-20)T

**ii.** Whether the domestic cervidae ranch has been in compliance with all requirements of Title 25, Chapter 35, Idaho Code, and these rules. (3-20-20)T

**iii.** Whether the domestic cervidae ranch has had documented cases of ingress of wild cervids or egress of domestic cervidae within the eighteen (18) months prior to the risk assessment. (3-20-20)T

**210. -- 249. (RESERVED)**

**250. INTRASTATE MOVEMENT OF DOMESTIC CERVIDAE.**

All live domestic cervidae moving from one premises to another premises within the state of Idaho must be officially identified, except calves during the year of birth accompanying their dam, and accompanied by: (3-20-20)T

**01. TB Test.** An official negative test for tuberculosis of all cervidae over twelve (12) months of age, conducted within the last ninety (90) days, or written permission from the Administrator, except: (3-20-20)T

**a.** Animals originating from an accredited, qualified or monitored herd, as described in "Bovine Tuberculosis Eradication, Uniform Methods and Rules," effective January 1, 2005, if they are accompanied by a certificate signed by an accredited veterinarian or the Administrator stating such domestic cervidae have originated directly from such herd; or (3-20-20)T

**b.** Those domestic cervidae consigned directly to an approved slaughter establishment or domestic cervidae approved feedlot; or (3-20-20)T

**c.** Those domestic cervidae moving from one premises to another premises owned, operated, leased, or controlled by the same person. (3-20-20)T

**02. Intrastate Movement Certificate.** All intrastate movements of live domestic cervidae, including movement from one premises to another premises owned, operated, leased, or controlled by the same person, must be accompanied by a complete and accurate intrastate movement certificate, which has been signed by the owner or operator of the domestic cervidae ranch where the movement originates and includes a statement of the CWD and TB status of the cervidae. (3-20-20)T

**03. Movement of Cervidae Between Accredited AZA or USDA Licensed Facilities.** Movement of cervidae between accredited AZA and USDA licensed facilities is exempt from the requirements of this chapter. All other movement from AZA accredited or USDA licensed facilities must comply fully with all of the provisions of this chapter. (3-20-20)T

**251. -- 299. (RESERVED)**

**300. DISEASE CONTROL.**

The Administrator may require domestic cervidae in the state to be tested for brucellosis (*Brucella abortus* or *Brucella suis*), tuberculosis (*Mycobacterium bovis*), meningeal worm (*Parelaphostrongylus tenuis*), muscle worm (*Elaphostrongylus cervus*), CWD or for other diseases or parasites determined to pose a risk to other domestic cervidae, livestock, or wildlife. (3-20-20)T



**301. DUTY TO RESTRAIN.**

It is the duty of the owner of each domestic cervidae ranch to gather and restrain domestic cervidae for testing when directed to do so in writing by the Administrator. The Administrator determines the suitability of the restraint system. (3-20-20)T

**302. TESTING METHODS.**

The Administrator determines appropriate testing procedures and methods. (3-20-20)T

**303. TESTING, TREATMENT, QUARANTINE, OR DISPOSAL REQUIRED.**

The Administrator determines when testing, treatment, quarantine, or disposal of domestic cervidae is required at any domestic cervidae ranch pursuant to Title 25, Chapters 2, 3, 4, 6, and 37, Idaho Code. If the Administrator determines that testing, treatment, quarantine, disposal of domestic cervidae, or cleaning or disinfection of premises is required, a written order will be issued to the owner describing the procedure to be followed and the time period for carrying out such actions. (3-20-20)T

**304. QUARANTINES.**

All domestic cervidae animals or herds that are determined to be exposed to, or infected with, any disease that constitutes an emergency, as provided in Title 25, Chapter 2, Idaho Code, will be quarantined. (3-20-20)T

**01. Infected Herds.** Infected herds or animals must remain under quarantine until such time that the herd has been completely depopulated and the premises has been cleaned and disinfected as provided by the Administrator, or the provisions for release of a quarantine established in these rules have been met. (3-20-20)T

**02. Exposed Herds.** The quarantine for exposed herds or animals may take the form of a hold-order which remains in effect until the exposed animals have been tested and the provisions for release of a quarantine as established in these rules have been met. (3-20-20)T

**03. Validity of Quarantine.** The quarantine is valid whether or not acknowledged by signature of the owner. (3-20-20)T

**305. DECLARATION OF ANIMAL HEALTH EMERGENCY.**

The Director is authorized to declare an animal health emergency. (3-20-20)T

**01. Condemnation of Animals.** In the event that the Director determines that an emergency exists, animals that are found to be infected, or affected with, or exposed to an animal health emergency disease may be condemned and destroyed. (3-20-20)T

**02. Indemnity.** Any indemnity is paid in accordance with Sections 25-212 and 25-213, Idaho Code. (3-20-20)T

**03. Notification to Administrator.** Every owner of cervidae, every breeder or dealer in cervidae, every veterinarian, and anyone bringing cervidae into this state who observes the appearance of, or signs of any disease or diseases, or who has knowledge of exposure of the cervidae to diseases that constitute an emergency must give immediate notice to the Administrator by telephone, facsimile, or other means as approved by the Administrator. (3-20-20)T

**04. Failure to Notify.** Any owner of cervidae who fails to report as herein provided forfeits all claims for indemnity for animals condemned and slaughtered or destroyed on account of the animal health emergency. (3-20-20)T

**306. -- 399. (RESERVED)**

**400. BRUCELLOSIS.**

Owners of domestic cervidae ranches must comply with the provisions of IDAPA 02.04.20, "Rules Governing Brucellosis," that apply to domestic cervidae. (3-20-20)T

**401. -- 449. (RESERVED)**

**450. TUBERCULOSIS.**

**01. Change of Ownership.** All domestic cervidae that are sold, or are in any way transferred from one person to another person in Idaho are required to be tested negative for TB within ninety (90) days prior to the change of ownership or transfer, except: (3-20-20)T

**a.** Animals originating from an accredited, qualified or monitored herd, as described in "Bovine Tuberculosis Eradication, Uniform Methods and Rules," effective January 1, 2005, if they are accompanied by a certificate signed by an accredited veterinarian or the Administrator stating such domestic cervidae have originated directly from such herd; or (3-20-20)T

**b.** Those domestic cervidae consigned directly to an approved slaughter establishment or domestic cervidae approved feedlot. (3-20-20)T

**c.** The Administrator, following an evaluation, may grant exceptions to the provisions of this Section on a case-by-case basis. (3-20-20)T

**02. Rules and UM&R.** Owners of domestic cervidae ranches must comply with the provisions of IDAPA 02.04.03, "Rules Governing Animal Industry," that apply to domestic cervidae, and the Bovine Tuberculosis Eradication, UM&R, Effective January 1, 2005. (3-20-20)T

**451. -- 499. (RESERVED)**

**500. SURVEILLANCE FOR CWD.**

**01. Slaughter Surveillance.** Brain tissue from no less than ten percent (10%) of all domestic cervidae sixteen (16) months of age or older that are slaughtered at approved slaughter establishments or custom exempt slaughter establishments must be submitted annually by the owner of the slaughtered cervidae to official laboratories to be tested or examined for CWD as provided for in these rules. If ten (10) or less cervids on a domestic cervidae ranch are slaughtered in a calendar year, at least one (1) testable brain sample must be submitted to meet the annual CWD surveillance requirement. Tissues samples submitted to an official laboratory that are untestable or are given an indeterminate test result do not count towards the tissue submission requirement. (3-20-20)T

**02. Domestic Cervidae Ranch Surveillance.** Brain tissue from no less than ten percent (10%) of all domestic cervidae sixteen (16) months of age or older that are harvested on domestic cervidae ranches must be submitted for CWD testing annually. If ten (10) or less cervids on a domestic cervidae ranch are harvested in a calendar year, at least one (1) testable brain sample must be submitted to meet the annual CWD surveillance requirement. In addition to the tissue samples from the harvested domestic cervidae, brain tissue from one hundred percent (100%) of all domestic cervidae sixteen (16) months of age or older that die for any reason other than being harvested must also be submitted for CWD testing annually. Reindeer and fallow deer are exempt from CWD testing unless the reindeer and fallow deer are part of a CWD positive, exposed, trace, source, or suspect herd or part of an elk herd. The owner or operator of the domestic cervidae ranch must submit all tissue samples to an official laboratory to be tested for CWD, as provided for in these rules. Tissues samples submitted to an official laboratory that are untestable or are given an indeterminate test result do not count towards the tissue submission requirement. In the event a domestic cervidae ranch cannot submit a testable brain sample, the domestic cervidae ranch must submit a CWD Sample Submission Waiver Request within ten (10) business days of determining that a testable brain sample cannot be submitted. (3-20-20)T

**501. COLLECTION OF SAMPLES FOR CWD TESTING.**

Only accredited veterinarians, state and federal animal health officials, and other persons, approved by the Administrator, may collect brain or other tissue samples for CWD testing. Samples must be collected immediately upon discovery of the death of a domestic cervid. (3-20-20)T

**01. Brain Samples.** Only persons trained by state or federal animal health officials, and approved by the Administrator, may remove the obex portion of the brainstem for submission as the sample for CWD testing. (3-20-20)T

**02. Submission of Head.** Only persons trained by state or federal animal health officials, and approved by the Administrator, may submit a head with the official identification attached to the head as the sample for CWD testing. (3-20-20)T

**03. Handling of Samples.** All CWD samples must be handled in a manner that prevents degradation of the sample. (3-20-20)T

**04. Sample Submission Time.** Fresh samples for CWD testing must be submitted, to an approved laboratory, within seventy-two (72) hours of the date of collection. Formalin preserved samples must be submitted, to an approved laboratory, within ten (10) business days of the date of collection. (3-20-20)T

**05. Non-Testable or Samples That Do not Contain Appropriate Tissues.** The Administrator may conduct an investigation to determine if a domestic cervidae ranch is complying with the provisions of Section 500 if: (3-20-20)T

**a.** The owner or operator of a domestic cervidae ranch submits samples for CWD testing which are non-testable; or (3-20-20)T

**b.** The owner or operator of a domestic cervidae ranch submits samples for CWD testing that do not contain the obex portion of the brainstem or other appropriate tissues, if available, for CWD testing. (3-20-20)T

**c.** The owner or operator of a domestic cervidae ranch submits samples for CWD testing which cannot be identified to the animal of origin. (3-20-20)T

**06. Failure to Meet Annual CWD Tissue Submission Requirement.** An owner or operator of a domestic cervidae ranch who fails to submit samples for CWD testing or who fails to meet the annual tissue submission requirements of this chapter, or both, is in violation of these rules, except the Administrator may approve, in writing, a variance from sample submission requirements on a case specific basis. (3-20-20)T

**502. OFFICIAL CWD TESTS.**

**01. Official Tests.** Official tests for CWD, approved by the Administrator, include: (3-20-20)T

**a.** Histopathology; (3-20-20)T

**b.** Immunohistochemistry; (3-20-20)T

**c.** Western Blot; (3-20-20)T

**d.** Negative Stain Electron Microscopy; (3-20-20)T

**e.** Bioassay; and (3-20-20)T

**02. Other Scientifically Validated Test.** The Administrator may approve other scientifically validated laboratory or diagnostic tests to confirm a diagnosis of CWD. (3-20-20)T

**503. CWD STATUS.**

CWD status is based on the number of years that a herd of domestic cervidae has been determined to be in compliance with the provisions of this chapter, during which there is no evidence of CWD in the herd. (3-20-20)T

**01. Status Review.** The Administrator will review the CWD status of each domestic cervidae herd located in Idaho on at least an annual basis. (3-20-20)T

**02. Status Date.** The status date is the date that the Administrator approves a change in the CWD status of a domestic cervidae herd in Idaho. (3-20-20)T

**03. Cervidae of Lesser Status.** If a herd of domestic cervidae has contact with cervidae of a lesser status, the status of the herd with the higher status will be lowered to the status of the cervidae with the lesser status. (3-20-20)T

**04. Change of Ownership.** A herd's status may remain with the herd when a change of ownership, management or premises occurs, if there is no contact with cervidae of lesser status, and no previous history of CWD on the premises. (3-20-20)T

**05. Contact with CWD Positive Animals.** Any herd of domestic cervidae that has contact with CWD positive or exposed animals may have its status reduced or removed. (3-20-20)T

**504. INVESTIGATION OF CWD.**

An epidemiological investigation will be conducted on all CWD positive, suspect, and exposed animals and herds, herds of origin, source herds, all adjacent herds, and all trace herds as determined by the Administrator. (3-20-20)T

**01. Quarantine.** All positive, suspect, and exposed herds or animals, herds of origin, adjacent herds, and herds having contact with positive or exposed animals must be quarantined; and (3-20-20)T

**02. Identification.** CWD suspect and exposed animals must be identified and remain on the premises where they are found until they have met the provisions for release of quarantine established in this chapter, are destroyed and disposed of as directed by the Administrator, or are moved at the Administrator's direction on a restricted movement permit. (3-20-20)T

**505. DURATION OF CWD QUARANTINE.**

Quarantines imposed because of CWD in accordance with this chapter remain in effect until one (1) of the following criteria are met: (3-20-20)T

**01. CWD Positive Herds.** The quarantine may be released after the herd is completely depopulated as provided in Subsection 505.07, or after five (5) years of compliance with an individual herd CWD plan and all provisions of these rules, during which there was no evidence of CWD. (3-20-20)T

**02. CWD Suspect Herds.** The quarantine may be released after the herd is completely depopulated as provided in Subsection 505.07, or after a minimum of five (5) years of compliance with an individual CWD herd plan and all provisions of these rules and during which there was no evidence of CWD, or an epidemiologic investigation determines that there is no evidence CWD exists in the herd as determined by the Administrator. (3-20-20)T

**03. Source Herds and Herds of Origin.** The quarantine may be released after a minimum of five (5) years of compliance with an individual CWD herd plan and all provisions of these rules and during which there was no evidence of CWD, or an epidemiologic investigation determines that there is no evidence CWD exists in the herd and that the herd is not the source of infection as determined by the Administrator. (3-20-20)T

**04. Exposed Herds.** The quarantine may be released after the herd is completely depopulated as provided in Subsection 505.07, or after a minimum of five (5) years of compliance with an individual CWD herd plan and all provisions of these rules and during which there was no evidence of CWD, or an epidemiologic investigation determines that there is no evidence CWD exists in the herd as determined by the Administrator. (3-20-20)T

**05. Adjacent Herds.** The quarantine may be released when directed by the Administrator based upon an epidemiological investigation and in consultation with the designated epidemiologist. (3-20-20)T

**06. Fencing Requirements.** Any owner of a domestic cervidae ranch who chooses to remain under quarantine for five (5) years must construct a second perimeter fence that meets the requirements for perimeter fence, as provided in Section 102, such that no domestic cervidae on the domestic cervidae ranch can get within ten (10) feet of the original exterior perimeter fence or as approved by the Administrator. (3-20-20)T

**07. Complete Depopulation.** The quarantine may be released after: (3-20-20)T

a. Complete depopulation of all cervidae on the premises as directed by the Administrator; and

(3-20-20)T

**b.** The premises have been free of all livestock as specified in an individual CWD herd plan approved by the Administrator; and (3-20-20)T

**c.** The soil and facilities have been cleaned, treated, decontaminated, or disinfected as directed by the Administrator. (3-20-20)T

**08. Disposal of Positive or Exposed Cervidae.** All CWD positive or exposed domestic cervidae must be disposed of as directed by the Administrator. (3-20-20)T

**506. CLEANING, TREATING, DECONTAMINATING, OR DISINFECTING.**

Premises must be cleaned, treated, decontaminated, or disinfected under state or federal supervision as directed by the Administrator within fifteen (15) days after CWD positive or suspect animals have been removed. (3-20-20)T

**01. Exemptions.** The Administrator may authorize, in writing, an exemption from cleaning, treating, decontaminating, or disinfection requirements on a case-by-case basis. (3-20-20)T

**02. Extension of Time.** The Administrator may authorize, in writing, an extension of time for cleaning and disinfection under extenuating circumstances. (3-20-20)T

**03. Requests for Extensions or Exemptions.** The owner of the contaminated facility must submit requests for extensions or exemptions to the Administrator in writing. (3-20-20)T

**507. -- 999. (RESERVED)**

## 02.04.26 – RULES GOVERNING THE PUBLIC EXCHANGE OF LIVESTOCK

### 000. LEGAL AUTHORITY.

This chapter is adopted under the legal authority of Sections 25-203, 25-305, 25-401, 25-601, 25-1723(b), and 25-3520, Idaho Code. (3-20-20)T

### 001. TITLE AND SCOPE.

01. **Title.** The title of this chapter is “Rules Governing the Public Exchange of Livestock.” (3-20-20)T

02. **Scope.** These rules govern the record keeping of livestock dealers and facilities, record keeping, identification, quarantine and movement of livestock through buying stations, trader lots and livestock markets. (3-20-20)T

### 002. -- 109. (RESERVED)

## SUBCHAPTER A – LIVESTOCK DEALERS, BUYING STATIONS, AND LIVESTOCK TRADER LOTS

### 110. DEFINITIONS.

The definitions apply in the interpretation and enforcement of Subchapter A only. (3-20-20)T

01. **Accredited Veterinarian.** A veterinarian approved by the Administrator and the USDA/APHIS/VS, in accordance with provisions of Title 9, Part 161, Code of Federal Regulations, to perform functions of State-Federal animal disease control programs. (3-20-20)T

02. **Approved Slaughter Establishment.** A USDA inspected slaughter establishment where ante-mortem and post-mortem inspection is conducted by USDA inspectors. (3-20-20)T

03. **Cattle.** All domestic bovidae including domestic bison. (3-20-20)T

04. **Domestic Bison.** All animals in the genus *Bison* owned by a person. (3-20-20)T

05. **Domestic Cervidae.** Elk, fallow deer, and reindeer owned by a person. (3-20-20)T

06. **Epithelioma of the Eye.** A carcinoma of the eye of cattle commonly known as cancer eye. (3-20-20)T

07. **Federal Animal Health Official.** An employee of USDA/APHIS/VS who is authorized to perform animal health activities. (3-20-20)T

08. **Interstate Movement.** Movement of livestock from Idaho into any other state, territory or the District of Columbia, or from any other state, territory or the District of Columbia into Idaho. (3-20-20)T

09. **Livestock.** Cattle, domestic bison, swine, horses, mules, asses, domestic cervidae, sheep, goats, camelids, and raites. (3-20-20)T

10. **Lump Jaw.** Condition also known as actinomycosis in cattle. (3-20-20)T

11. **Official Ear Tag.** APHIS approved identification ear tags conforming to the alphanumeric national uniform ear tagging system including official brucellosis vaccination ear tags, or NAIS compliant ear tags, that provide unique identification for each animal. (3-20-20)T

12. **Official Identification.** Official USDA approved ear tag, USDA Backtag, breed registration tattoo, or identification method approved by the Administrator. (3-20-20)T

13. **Official Brucellosis Vaccination Ear Tag.** An APHIS approved identification ear tag conforming to the alphanumeric national uniform ear tagging system that provides unique identification for each animal. (3-20-20)T

14. **Operator.** The person who has authority to manage or direct a buying station or livestock trader lot. (3-20-20)T

15. **Owner.** The person who owns or has financial control of a buying station, livestock trader lot or cattle. (3-20-20)T
16. **Parturient.** Visibly prepared to give birth or within two (2) weeks before giving birth. (3-20-20)T
17. **Postparturient.** Having already given birth. (3-20-20)T
18. **Premises.** The ground, area, buildings, corrals, and equipment utilized to keep, hold, or maintain animals. (3-20-20)T
19. **Previous Location.** The premises where cattle were confined immediately prior to delivery to a buying station, livestock trader lot, or purchase by a livestock dealer. (3-20-20)T
20. **Restraint.** The confinement of cattle in a chute, or other device, for the purpose of efficiently, effectively, and safely inspecting, treating, vaccinating, or testing. (3-20-20)T
21. **State Animal Health Official.** The Administrator, or his designee, responsible for disease control and eradication activities. (3-20-20)T
22. **Test Eligible.** Unless otherwise specifically provided in these rules, all sexually intact cattle and domestic bison eighteen (18) months of age and over, and all parturient, and postparturient cattle and domestic bison regardless of age. (3-20-20)T
23. **USDA Backtag.** A backtag issued by APHIS that conforms to the eight-character alphanumeric National Backtagging System that provides unique identification for each animal. (3-20-20)T

**111. ABBREVIATIONS.**

01. **APHIS.** Animal and Plant Health Inspection Service. (3-20-20)T
02. **AVIC.** Area Veterinarian In Charge. (3-20-20)T
03. **CAFO.** Concentrated Animal Feeding Operation. (3-20-20)T
04. **CFR.** Code of Federal Regulations. (3-20-20)T
05. **NAIS.** National Animal Identification System. (3-20-20)T
06. **USDA.** United States Department of Agriculture. (3-20-20)T
07. **VS.** Veterinary Services. (3-20-20)T

**112. -- 119. (RESERVED)**

**120. APPLICABILITY.**

Subchapter A applies to livestock dealers, buying stations, and livestock trader lots operating in Idaho. (3-20-20)T

**121. -- 129. (RESERVED)**

**130. INSPECTIONS.**

To prevent the introduction and dissemination, or to control and eradicate diseases, state and federal animal health officials are authorized to inspect livestock records, premises, facilities, and livestock to ensure compliance with the provisions of this chapter and other state or federal laws or rules applicable to livestock dealers, buying stations and livestock trader lots. (3-20-20)T

01. **Entering Premises.** In order to conduct activities authorized by this chapter, state or federal animal

health officials are authorized to enter buying stations or livestock trader lots. State or federal officials will attempt to notify the owner or operator of the premises prior to conducting an inspection. (3-20-20)T

**02. Inspecting Records.** To ensure compliance with the provisions of this chapter, state or federal animal health officials are authorized to access, inspect, review, and copy any records deemed necessary during normal business hours. State or federal animal health officials will attempt to notify the owner or operator of the premises prior to inspecting records. (3-20-20)T

**03. Emergencies.** In the event of an emergency, as determined by the Administrator, the notification requirements of this section are not required. (3-20-20)T

**131. -- 139. (RESERVED)**

**140. LIVESTOCK TREATMENT.**

Each livestock dealer, buying station and livestock trader lot shall humanely treat all livestock. All non-ambulatory livestock shall be: (3-20-20)T

**01. Returned.** Returned to premises of origin; or (3-20-20)T

**02. Fed and Watered.** Provided adequate feed and clean water; or (3-20-20)T

**03. Euthanized.** Humanely euthanized. (3-20-20)T

**141. -- 149. (RESERVED)**

**150. DEAD ANIMAL DISPOSAL.**

The movement and disposal of all dead animals shall be pursuant to the provisions of IDAPA 02.04.17, "Rules Governing Dead Animal Movement and Disposal." (3-20-20)T

**151. -- 159. (RESERVED)**

**160. ENVIRONMENTAL REQUIREMENTS.**

All buying stations and livestock trader lots shall meet the provisions of IDAPA 02.04.15, "Rules Governing Beef Cattle Animal Feeding Operations." (3-20-20)T

**161. -- 199. (RESERVED)**

**200. LIVESTOCK DEALERS.**

Livestock dealers that do not operate buying stations or livestock trader lots shall keep complete and accurate records such that cattle purchased may be traced to the previous location, previous owner and the subsequent owner. (3-20-20)T

**201. -- 209. (RESERVED)**

**220. CONTENT OF RECORDS.**

Livestock dealer records shall include, but are not limited to: (3-20-20)T

**01. Name, Telephone Number, and Address.** The name, telephone number, and address of the owner of the cattle prior to purchase by the livestock dealer. (3-20-20)T

**02. Identification.** All cattle shall be identified to their previous location with a form of identification approved by the Administrator. (3-20-20)T

**03. Previous Location.** The location where cattle were held prior to purchase by the livestock dealer shall be either the NAIS premises identification number or the physical address. (3-20-20)T

**04. The Date of Purchase.** The date individual cattle were purchased. (3-20-20)T



- 05. Date of Sale.** Date individual cattle were sold or changed ownership. (3-20-20)T
- 06. Name, Telephone Number, and Address of the Purchaser of Cattle.** The name, telephone number, and address of the person that purchased cattle from the livestock dealer. (3-20-20)T
- 07. Death Loss.** An accurate account of all death loss, including identification, and disposition of the dead cattle. (3-20-20)T
- 221. -- 229. (RESERVED)**
- 230. RECORDS RETENTION.**  
Livestock dealers shall retain all records relating to cattle for a period of not less than two (2) years. Records must be made available to the administrator upon request. (3-20-20)T
- 231. -- 239. (RESERVED)**
- 240. APPROVED FORMS OF IDENTIFICATION.**  
The following are approved forms of identification. (3-20-20)T
- 01. USDA Approved Backtag.** (3-20-20)T
- 02. Official USDA Ear Tag.** (3-20-20)T
- 03. Registration Tattoo.** Breed registration tattoo and corresponding registration papers. (3-20-20)T
- 04. Brand Inspection.** Statement of ownership such as a brand inspection certificate. (3-20-20)T
- 05. Administrator Approval.** The Administrator may approve other forms of individual identification on a case-by-case basis. (3-20-20)T
- 06. Removal of Animal Identification.** No approved or official animal identification shall be removed, tampered with or otherwise altered. (3-20-20)T
- 241. -- 299. (RESERVED)**
- 300. APPROVED BUYING STATIONS.**  
No livestock dealer shall operate a buying station prior to receiving approval from the Administrator. All cattle entering the buying station shall be shipped to an approved slaughter establishment within seven (7) days of arrival at the buying station. (3-20-20)T
- 301. APPLICATION FOR DESIGNATION AS AN IDAHO APPROVED BUYING STATION.**  
Application for designation as an Idaho approved buying station shall be made on application forms available from the Administrator. (3-20-20)T
- 302. ADMINISTRATOR APPROVAL.**  
State or federal animal health officials will inspect all buying stations prior to approval by the Administrator. The Administrator may take any past enforcement or violation history of the owner or operator of the buying station into consideration when making the final approval determination. (3-20-20)T
- 303. APPROVED BUYING STATION NUMBER.**  
The license number issued to the livestock dealer by the State Brand Board will be used to identify the approved buying station. (3-20-20)T
- 304. EXPIRATION OF APPROVED STATUS.**  
Approved buying station status will remain in effect unless the status is revoked by the Administrator or there is a change in ownership or operator. If there is a change in ownership or operator, it is the responsibility of the new

buying station owner or operator to apply for reinstatement of approved status. (3-20-20)T

**305. REVOCATION OF APPROVED BUYING STATION STATUS.**

In addition to any other Department administrative or civil action, the Administrator may withdraw or deny the approval of any buying station, by notifying the owner in writing, when one (1) or more of the following conditions exist: (3-20-20)T

**01. Recordkeeping Requirements.** There is evidence that the owner or operator of the buying station violated the recordkeeping requirements of this rule, or animal health regulations. (3-20-20)T

**02. Inability to Trace Animals.** There is a repeated history of an inability to trace the affected, exposed or reactor cattle handled by the buying station to the previous location and owner. (3-20-20)T

**03. Violations.** A buying station violates any of the provisions of Subchapter A. (3-20-20)T

**04. Owner Request.** Owners may have the approved status revoked by emptying the buying station and requesting in writing that the status be revoked. (3-20-20)T

**05. Regulation Changes.** Idaho approved buying station status may be revoked as required by changes in state or federal rules or regulations. (3-20-20)T

**306. DISPOSITION OF CATTLE.**

When approved buying station status is revoked, cattle still in the buying station shall be removed directly to an approved slaughter establishment within seven (7) days. (3-20-20)T

**307. -- 314. (RESERVED)**

**315. IDENTIFICATION.**

All cattle shall be individually identified with an official USDA backtag immediately upon arrival at a buying station. Animal identification is to be maintained to slaughter and shall not be removed, tampered with or otherwise altered. (3-20-20)T

**316. -- 319. (RESERVED)**

**320. BUYING STATION RECORDS.**

Each buying station shall keep sufficient records of all livestock that enter, leave, or die on the premises to enable state or federal animal health officials to trace such animals satisfactorily to their previous location. (3-20-20)T

**321. CONTENT OF RECORDS -- BUYING STATIONS.**

Buying station records shall include, but are not limited to: (3-20-20)T

**01. Name, Telephone Number, and Address.** The name, telephone number, and address of: (3-20-20)T

**a.** The owner of the livestock entering the buying station; and (3-20-20)T

**b.** The person delivering the livestock to the buying station. (3-20-20)T

**02. Individual Identification.** Individual USDA Backtag number for each animal entering the buying station. (3-20-20)T

**03. Previous Location.** The location where cattle were held prior to purchase by the buying station shall be either the NAIS premises identification number or the physical address. (3-20-20)T

**04. The Date of Entry.** The date individual cattle enter a buying station. (3-20-20)T

**05. Date of Shipment to Slaughter.** (3-20-20)T

**06. Approved Slaughter Establishment Destination.** Name and address of the approved slaughter establishment. (3-20-20)T

**07. Death Loss.** An accurate account of all death loss, including individual identification number and disposition of the dead cattle. (3-20-20)T

**08. Dead Animals.** An accurate description, including any forms of identification, of any dead animals that are left at the buying station by other persons. (3-20-20)T

**322. BUYING STATION RECORDS RETENTION.**

All records relating to cattle that have been in the buying station facility shall be retained for a period of not less than two (2) years. Records must be made available to the administrator upon request. (3-20-20)T

**323. -- 329. (RESERVED)**

**330. CATTLE SUBJECT TO QUARANTINE -- BUYING STATIONS.**

No cattle that have reacted to the brucellosis or tuberculosis test, or cattle affected with, or suspected of being affected with a foreign animal disease, shall be allowed to enter, occupy, or be sold from a buying station. (3-20-20)T

**331. -- 339. (RESERVED)**

**340. PREMISES REQUIREMENTS.**

An approved buying station shall meet the following requirements: (3-20-20)T

**01. Restraint System.** A restraint system, approved by the Administrator, for humanely, efficiently and effectively restraining livestock for the purpose of inspecting, identifying or testing of animals by state or federal animal health officials. (3-20-20)T

**02. Feed and Water.** Provide access to a clean source of water sufficient for the number of animals present, and an adequate quality and quantity of feed for all cattle that are on the premises for over twelve (12) hours. (3-20-20)T

**03. Pens.** Comply with IDAPA 02.04.15, "Rules Governing Beef Cattle Animal Feeding Operations," and pens that contain cattle on the premises for over twelve (12) hours provide adequate pen space for the cattle to rest and ruminate, and provide adequate drainage. (3-20-20)T

**04. Fences.** Construct fences sufficient to prevent the escape of livestock from the premises, as determined by the Administrator. (3-20-20)T

**05. Condition.** Maintain premises in good repair. (3-20-20)T

**341. -- 349. (RESERVED)**

**350. SANITATION.**

All buying stations shall be maintained in a sanitary condition. The buying station shall provide the necessary equipment to clean and disinfect the premises, and the owner or operator of the buying station shall clean and disinfect the premises at the direction of the Administrator. (3-20-20)T

**351. -- 359. (RESERVED)**

**360. SIGNAGE.**

Each buying station shall comply with the following signage requirements: (3-20-20)T

**01. Wording.** Signs state "ALL CATTLE ENTERING THIS FACILITY SHALL GO DIRECTLY TO SLAUGHTER." (3-20-20)T

**02. Color.** Lettering in red and not less than four (4) inches in height on a white background. (3-20-20)T

**03. Location.** Signs placed prominently at each entrance, exit and cattle loading or unloading facility. (3-20-20)T

**361. -- 369. (RESERVED)**

**370. LOCATION OF BUYING STATIONS.**

All buying stations shall be located separate and apart from any other cattle handling facilities, as determined by the Administrator, that handle any cattle not destined to slaughter within seven (7) days. (3-20-20)T

**371. -- 499. (RESERVED)**

**500. APPROVED LIVESTOCK TRADER LOTS.**

All livestock dealers licensed by the Idaho State Brand Board shall receive approval from the Administrator as an Idaho approved feedlot or approved livestock trader lot if the following conditions exist: (3-20-20)T

**01. Cattle Are Received.** Cattle of unknown disease status are received from the farm or ranch of origin. (3-20-20)T

**02. Sold to Individuals.** Brucellosis test eligible cattle are sold and transported to destinations other than an approved slaughter establishment, a specifically approved livestock market, an Idaho approved feedlot, or out of the state of Idaho. (3-20-20)T

**501. APPLICATION FOR APPROVED LIVESTOCK TRADER LOT STATUS.**

Application for approved livestock trader lot status is made on application forms available from the Administrator. (3-20-20)T

**502. ADMINISTRATOR APPROVAL.**

The Administrator may approve livestock trader lot applications after state or federal animal health officials have inspected the trader lot facility and: (3-20-20)T

**01. Adequate Facilities.** The livestock dealer has demonstrated that cattle can be secured and restrained in the facility. (3-20-20)T

**02. Adequate Records.** The livestock dealer's records are adequate to show the origin and disposition of the cattle that enter the facility. (3-20-20)T

**03. Past History.** The Administrator may take any past enforcement or violation history of the owner or operator of the livestock trader lot into consideration when making the final approval determination. (3-20-20)T

**503. APPROVED LIVESTOCK TRADER LOT NUMBER.**

The license number issued by the State Brand Board to livestock dealers shall be used to identify the livestock trader lot. (3-20-20)T

**504. EXPIRATION OF APPROVED STATUS.**

Approved livestock trader lot status remains in effect unless there is a material change in operation, as determined by the Administrator, or the status is revoked by the Administrator. If there is a material change in operation, as determined by the Administrator, it is the responsibility of the livestock dealer to apply for reinstatement of approved status. (3-20-20)T

**505. -- 519. (RESERVED)**

**520. IDENTIFICATION.**

All cattle shall be identified, to their previous location, with a form of identification approved by the Administrator immediately upon arrival at a livestock trader lot. Animal identification is to be maintained and not be removed,

tampered with, or otherwise altered at the livestock trader lot. (3-20-20)T

**521. APPROVED FORMS OF IDENTIFICATION.**

The following are approved forms of individual identification. (3-20-20)T

**01. USDA Approved Backtag.** All brucellosis test eligible cattle shipped to approved slaughter establishments must be individually identified with an approved USDA Backtag. (3-20-20)T

**02. Official USDA Ear Tag.** (3-20-20)T

**03. Registration Tattoo.** A breed registration tattoo accompanied by registration papers. (3-20-20)T

**04. Brand Inspection.** Statement of ownership such as a brand inspection certificate. (3-20-20)T

**05. Administrator Approval.** The Administrator may approve other forms of identification on a case-by-case basis. (3-20-20)T

**06. Removal of Individual Animal Identification.** No approved animal identification shall be removed, tampered with or otherwise altered. (3-20-20)T

**522. CONTENT OF RECORDS FOR APPROVED LIVESTOCK TRADER LOTS.**

All approved livestock trader lots shall keep accurate and complete records of all cattle that enter, leave or die on the premises. These records shall readily show: (3-20-20)T

**01. Name, Telephone Number, and Address.** The name, telephone number, and address of: (3-20-20)T

**a.** The owner of the cattle prior to acquisition by the livestock dealer; and (3-20-20)T

**b.** The person delivering the cattle to the livestock trader lot. (3-20-20)T

**02. Identification.** Identification, approved by the Administrator, for the cattle entering the livestock trader lot. (3-20-20)T

**03. Previous Location.** The location where cattle were held prior to entering the livestock trader lot shall be either the NAIS premises identification number or the physical address of the premises. (3-20-20)T

**04. The Date of Entry.** The date the cattle enter a livestock trader lot. (3-20-20)T

**05. Date of Shipment Out of the Livestock Trader Lot.** (3-20-20)T

**06. Name, Telephone Number, and Address of Shipment Destination.** (3-20-20)T

**07. Death Loss.** An accurate account of all death loss, including identification and disposition of the dead cattle. (3-20-20)T

**08. Dead Animals.** An accurate description of any dead animals, including any forms of identification, that are left at the livestock trader lot by other persons. (3-20-20)T

**09. Requirements.** That all applicable state and federal permit, test, examination, identification and vaccination requirements have been met. (3-20-20)T

**523. TRADER LOT RECORDS RETENTION.**

Livestock trader lots shall retain their records for a period of not less than two (2) years following removal of the cattle from the premises. Records must be made available to the administrator upon request. (3-20-20)T

**524 -- 529. (RESERVED)**

**530. CATTLE SUBJECT TO QUARANTINE -- TRADER LOTS.**

No cattle that have reacted to the brucellosis or tuberculosis test, or animals affected with, or suspected of being affected with a foreign animal or reportable disease shall be allowed to enter, occupy, or be sold from a livestock trader lot. (3-20-20)T

**531. -- 539. (RESERVED)**

**540. REMOVAL REQUIREMENTS.**

All brucellosis test eligible cattle that are removed from an approved livestock trader lot shall be accompanied by a certificate of veterinary inspection issued by an accredited veterinarian prior to removal, except: (3-20-20)T

**01. Livestock Markets.** Cattle shipped directly to a specifically approved livestock market. (3-20-20)T

**02. Slaughter.** Cattle shipped directly to an approved slaughter establishment must be individually identified with an approved USDA Backtag. (3-20-20)T

**03. Approved Feedlots.** Cattle shipped directly to an Idaho approved feedlot. (3-20-20)T

**541. LIVESTOCK DEALER'S DUTY.**

It is the duty of a livestock dealer to ensure that all livestock removed from a livestock trader lot are in compliance with the animal health requirements of the state of Idaho and the point of destination. (3-20-20)T

**542. -- 549. (RESERVED)**

**550. LIVESTOCK TRADER LOT PREMISES.**

Approved livestock trader lots shall meet the following requirements: (3-20-20)T

**01. Restraint System.** A restraint system, approved by the Administrator, for humanely, efficiently and effectively restraining cattle for the purpose of inspecting, identifying, treating or testing of animals by state or federal animal health officials. (3-20-20)T

**02. Feed and Water.** Provide access to a clean source of water sufficient for the number of cattle present, and an adequate quality and quantity of feed for all cattle on the premises for over twelve (12) hours. (3-20-20)T

**03. Pens.** Comply with IDAPA 02.04.15, "Rules Governing Beef Cattle Animal Feeding Operations," and pens that contain cattle on the premises for over twelve (12) hours provide adequate pen space for the cattle to rest and ruminant and be adequately drained. (3-20-20)T

**04. Fences.** Construct fences sufficient to prevent the escape of cattle from the premises, as determined by the Administrator. (3-20-20)T

**05. Condition.** Maintain premises in good repair. (3-20-20)T

**551. -- 559. (RESERVED)**

**560. SANITATION.**

All livestock trader lots shall be maintained in a sanitary manner. The livestock dealer shall provide the necessary equipment to clean and disinfect the premises, and the livestock dealer shall clean and disinfect the premises at the direction of the Administrator. (3-20-20)T

**561. -- 569. (RESERVED)**

**570. REVOCATION OF APPROVED STATUS.**

In addition to any other Department administrative or civil action, the Administrator may withdraw or deny the

approval of any livestock trader lot by notifying the dealer in writing when one or more of the following conditions exist: (3-20-20)T

**01. Recordkeeping Requirements.** There is evidence that the livestock dealer violated the recordkeeping requirements of this rule or animal health regulations. (3-20-20)T

**02. Inability to Trace Animals.** There is a repeated history of inability to trace to the affected, exposed, or reactor cattle that enter the livestock trader lot to the previous location and owner. (3-20-20)T

**03. Violations.** A livestock dealer violates any of the provisions of Subchapter A. (3-20-20)T

**04. Dealer Request.** The livestock dealer may have the approved status revoked by emptying the livestock trader lot and requesting in writing that the status be revoked. (3-20-20)T

**05. Regulation Changes.** Approved trader lot status may be revoked as required by changes in state or federal rules or regulations. (3-20-20)T

**571. -- 603. (RESERVED)**

### **SUBCHAPTER B – LIVESTOCK MARKETING**

**604. INCORPORATION BY REFERENCE.**  
The following document is incorporated by reference into Subchapter B, sections 604-770 only: (3-20-20)T

**01. Incorporated Documents.** The following documents are incorporated by reference: Code of Federal Regulations, Title 9, Parts 71, 75, 77, 78, 85, and 161, CFR, January 1, 2003, which can be viewed online at <https://www.govinfo.gov/content/pkg/CFR-2003-title9-vol1/pdf/CFR-2003-title9-vol1-chapI.pdf>. (3-20-20)T

**605. -- 609. (RESERVED)**

**610. DEFINITIONS.**  
In addition to the definitions found in Idaho Code sections 25-239 and 25-1721, the following definitions apply in the interpretation and enforcement of Subchapter B only: (3-20-20)T

**01. Accredited Veterinarian.** A veterinarian approved by the Administrator and the USDA/APHIS/VS, in accordance with the provisions of Title 9, Part 161, Code of Federal Regulations, to perform functions of State-Federal animal disease control programs. (3-20-20)T

**02. Approved Slaughter Establishment.** A USDA inspected slaughter establishment where ante-mortem and post-mortem inspections are conducted by USDA inspectors. (3-20-20)T

**03. Brucellosis.** An infectious disease of animals and humans caused by bacteria of the genus *Brucella*. (3-20-20)T

**04. Cattle.** All domestic bovidae, including domestic bison. (3-20-20)T

**05. Domestic Bison.** All animals in the genus *Bison* owned by a person. (3-20-20)T

**06. Domestic Cervidae.** Elk, fallow deer, and reindeer owned by a person. (3-20-20)T

**07. Epithelioma of the Eye.** Carcinoma of the eye of cattle commonly known as cancer eye. (3-20-20)T

**08. Federal Animal Health Official.** An employee of USDA/APHIS/VS who is authorized to perform animal health activities. (3-20-20)T

**09. Herd.** Any group of livestock maintained on common ground, or two (2) or more groups of livestock under common ownership or supervision that are geographically separated from other groups but can have an interchange or movement without regard to health status. (3-20-20)T

**10. Interstate Movement.** Movements of livestock from Idaho into any other state, territory or the District of Columbia or from any other state, territory or the District of Columbia into Idaho. (3-20-20)T

**11. Livestock.** Cattle, domestic bison, swine, horses, mules, asses, domestic cervidae, sheep, goats, camelids, and raites. (3-20-20)T

**12. Lump Jaw.** A condition known as actinomycosis or actinobacillosis in cattle. (3-20-20)T

**13. Official Ear Tag.** An APHIS approved identification ear tag conforming to an alphanumeric national uniform ear tagging system, that provides unique identification for each animal. (3-20-20)T

**14. Official Individual Identification.** Official USDA approved ear tag, USDA back tag, registration tattoo, or identification approved by the Administrator. (3-20-20)T

**15. Official Vaccination Ear Tag.** An APHIS approved identification ear tag conforming to the alphanumeric national uniform ear tagging system that provides unique identification for each animal. (3-20-20)T

**16. Operator.** The person who has authority to manage or direct a public livestock market. (3-20-20)T

**17. Owner.** The person who owns or has financial control of a public livestock market. (3-20-20)T

**18. Restraint.** The confinement of livestock in a chute, or other device, for the purpose of efficiently, effectively, and safely inspecting, treating, vaccinating, or testing. (3-20-20)T

**19. State Animal Health Official.** The Administrator, or his designee, responsible for disease control and eradication activities. (3-20-20)T

**20. Tuberculosis.** An infectious disease of humans and animals caused by *Mycobacterium bovis*. (3-20-20)T

**21. USDA Back Tag.** A back tag issued by APHIS that conforms to the eight (8) character alphanumeric National Back Tagging System and that provides unique identification for each animal. (3-20-20)T

**611. -- 629. (RESERVED)**

**630. INSPECTIONS.**

To prevent the introduction and dissemination, or to control and eradicate diseases, state and federal animal health officials are authorized to inspect livestock records, premises, facilities, and livestock to ensure compliance with the provisions of Subchapter B and other state or federal laws or rules applicable to public livestock markets. (3-20-20)T

**01. Entering Premises.** In order to conduct activities authorized by Subchapter B, state or federal animal health officials are authorized to enter public livestock market premises during normal business hours. (3-20-20)T

**02. Inspecting Records.** To ensure compliance with the provisions of Subchapter B, state or federal animal health officials are authorized, during normal business hours, to have access to, inspect, review, and copy any livestock records deemed necessary. (3-20-20)T

**631. -- 639. (RESERVED)**

**640. LIVESTOCK TREATMENT.**

Each public livestock market shall humanely treat all livestock. All non-ambulatory livestock shall be: (3-20-20)T



- 01. Returned.** Returned to the owner; or (3-20-20)T
- 02. Feed and Water.** Provided adequate feed and clean water; or (3-20-20)T
- 03. Euthanized.** Humanely euthanized, and disposed of in accordance with IDAPA 02.04.17 “Rules Governing Dead Animal Movement and Disposal.” (3-20-20)T
- 641. -- 649. (RESERVED)**
- 650. DEAD ANIMAL DISPOSAL.**  
The movement and disposal of all dead animals shall be pursuant to the provisions of IDAPA 02.04.17 “Rules Governing Dead Animal Movement and Disposal.” (3-20-20)T
- 651. -- 659. (RESERVED)**
- 660. ENVIRONMENTAL REQUIREMENTS.**  
All public livestock markets shall meet the provisions of IDAPA 02.04.15 “Rules Governing Beef Cattle Animal Feeding Operations.” (3-20-20)T
- 661. -- 699. (RESERVED)**
- 700. PUBLIC LIVESTOCK MARKET CHARTER.**  
No person shall conduct or operate a public livestock market without first securing a charter from the Department. Charters expire on April 30 of each year. It is the responsibility of the public livestock market operator to apply each year for charter renewal on a form prescribed by the Department. The charter renewal form must be accompanied by an annual market charter fee of one hundred dollars (\$100) and be received by the Department on or before May 1 of each year. (3-20-20)T
- 701. PUBLIC LIVESTOCK MARKET MINIMUM SALE REQUIREMENT.**  
Each chartered public livestock market shall conduct a minimum of one (1) sale during each calendar year. (3-20-20)T
- 702. -- 709. (RESERVED)**
- 710. MARKET RELEASE.**  
Prior to any livestock being released from a public livestock market, the following conditions shall be fulfilled: (3-20-20)T
- 01. Veterinary Inspection.** A visual inspection, of each animal, made by an accredited veterinarian authorized to provide veterinary services to the market. (3-20-20)T
- 02. Affected Animals.** Immediate isolation of animals affected by any infectious or contagious disease in quarantine pens subject to the market’s bio-security protocol or any animals determined to be affected by any infectious or contagious disease. (3-20-20)T
- 03. Removal of Animals.** Animals may not be removed from the livestock market until all animals determined to be affected with a contagious or infectious disease have been examined by an accredited veterinarian authorized to provide veterinary services to the market. (3-20-20)T
- 04. Saleyard Release Form.** Complete an accurate and legible “saleyard release” form, certificate of veterinary inspection, or other market release mechanism, approved by the Administrator certifying that the animals meet the health requirements for movement to the point of destination. (3-20-20)T
- 711. -- 714. (RESERVED)**
- 715. BIO-SECURITY PLAN.**  
All public livestock markets shall submit a bio-security plan to the Administrator for approval. All approved bio-

security plans shall be implemented by the public livestock market. Each bio-security plan includes, but is not limited to, the following elements: (3-20-20)T

**01. Identification.** Procedures for identifying animals that are affected by any contagious or infectious disease. (3-20-20)T

**02. Diagnosis.** Procedures for examination and diagnosis, by an accredited veterinarian, of any animals affected by any contagious or infectious disease. (3-20-20)T

**03. Disposition.** Procedures for the disposition of any livestock diagnosed as affected by any contagious or infectious disease. (3-20-20)T

**04. Records.** Keep complete and accurate records on site at the livestock market, showing that the market's bio-security plan is being implemented. (3-20-20)T

**716. -- 719. (RESERVED)**

**720. IDENTIFICATION.**  
All livestock entering a public livestock market shall be individually identified to the herd of origin. (3-20-20)T

**721. APPROVED FORMS OF IDENTIFICATION.**  
The following are approved methods of identification. (3-20-20)T

**01. Back Tag.** USDA approved back tag; or (3-20-20)T

**02. Ear Tag.** Official USDA ear tag; or (3-20-20)T

**03. Registration Tattoo;** or (3-20-20)T

**04. Brand Inspection.** Statement of ownership such as a brand inspection certificate. (3-20-20)T

**05. Administrator Approval.** The Administrator may approve other forms of identification on a case by case basis. (3-20-20)T

**06. Removal of Identification.** No animal identification may be intentionally removed, tampered with, or otherwise altered, except as approved by the Administrator. (3-20-20)T

**722. -- 729. (RESERVED)**

**730. QUARANTINE PENS.**  
A quarantine pen or pens shall be provided at all public livestock markets and such pens used only to hold animals that have reacted to the brucellosis or tuberculosis test or animals affected with, or suspected of being affected with a contagious or infectious disease, epithelioma of the eye, or lump jaw. The pens shall comply with the following requirements: (3-20-20)T

**01. Hard Surface.** Hard surfaced with concrete or similar impervious material in good repair; and (3-20-20)T

**02. Feed and Water.** Adequate feed and clean water facilities that are completely separate from all other livestock; and (3-20-20)T

**03. Signage.** Identified with the word "QUARANTINE" in red letters, not less than four (4) inches high, on a white background on the pen gate; and (3-20-20)T

**04. Cleaning and Disinfection.** Cleaned and disinfected no later than the day following date of sale; and (3-20-20)T

**05. Fence Construction.** Solid fences, constructed by boards or other material approved by the Administrator, and be a minimum of five and one-half (5 ½) feet high; and (3-20-20)T

**06. Drainage.** Drainage shall not be onto adjoining pens, restraint facilities or alleys. (3-20-20)T

**731. -- 749. (RESERVED)**

**750. RESTRAINT FACILITIES.**

Each public livestock market shall have a restraint system, approved by the Administrator, for humanely, efficiently, and effectively restraining livestock for the purpose of inspecting, identifying, treating, or testing of animals by state or federal animal health officials. (3-20-20)T

**751. -- 759. (RESERVED)**

**760. SANITARY CONDITIONS.**

All pens, alleys, troughs, restraint facilities, and runways shall be kept in a sanitary condition. Operators of public livestock markets shall clean and disinfect livestock market facilities, under the supervision of a state or federal animal health official, upon request by the Administrator. (3-20-20)T

**761. -- 769. (RESERVED)**

**770. RECORDS.**

Each public livestock market shall keep sufficient records of animals presented for sale to enable state or federal animal health officials to trace such animals satisfactorily to their herd of origin, and such records shall be maintained for a minimum of five (5) years. (3-20-20)T

**771. -- 999. (RESERVED)**

## 02.04.32 – RULES GOVERNING POULTRY OPERATIONS

### 000. LEGAL AUTHORITY.

This chapter is adopted under the legal authority of Section 25-4012, Idaho Code. (3-20-20)T

### 001. TITLE AND SCOPE.

01. **Title.** The title of this chapter is IDAPA 02.04.32, “Rules Governing Poultry Operations.” (3-20-20)T

02. **Scope.** These rules govern the design, function and management practices of waste systems on poultry concentrated animal feeding operations. These rules also establish the procedures and requirements for issuance of a permit to construct, operate, or expand poultry concentrated animal feeding operations. (3-20-20)T

### 002. WRITTEN INTERPRETATIONS.

There are no written interpretations of these rules. (3-20-20)T

### 003. ADMINISTRATIVE APPEAL.

Hearing and appeal rights are set forth in Title 67, Chapter 52, Idaho Code. There is no provision for administrative appeal before the department of Agriculture under these rules. (3-20-20)T

### 004. INCORPORATION BY REFERENCE.

The following documents are incorporated by reference and copies of these documents may be obtained from the Idaho State Department of Agriculture central office. (3-20-20)T

01. **The 2004 Code of Federal Regulations (CFR) Title 40 Part 122 Section 122.23 (b).** This document can be viewed online at [http://www.access.gpo.gov/nara/cfr/waisidx\\_04/40cfrv20\\_04.html](http://www.access.gpo.gov/nara/cfr/waisidx_04/40cfrv20_04.html). (3-20-20)T

02. **Natural Resources Conservation Service Agricultural Waste Management Field Handbook Appendix 10D (Appendix 10D) (March 2008 Edition) (USDA, NRCS).** This document can be viewed online at [https://agri.idaho.gov/main/wp-content/uploads/2017/10/2008\\_Appendix\\_10D.pdf](https://agri.idaho.gov/main/wp-content/uploads/2017/10/2008_Appendix_10D.pdf). (3-20-20)T

03. **Nutrient Management Standard (NMS).** The June 2007 publication by the United States Department of Agriculture (USDA) Idaho Natural Resources Conservation Service (NRCS) Idaho Conservation Practice Standard, Nutrient Management Code 590. This document can be viewed online at [https://agri.idaho.gov/main/wp-content/uploads/2017/10/june\\_2007\\_NRCS\\_590.pdf](https://agri.idaho.gov/main/wp-content/uploads/2017/10/june_2007_NRCS_590.pdf). (3-20-20)T

04. **Natural Resources Conservation Service (NRCS) Idaho Conservation Practice Standard Waste Storage Facility Code 313 December 2004.** This document can be viewed online at [https://agri.idaho.gov/main/wp-content/uploads/2017/10/nrcs\\_313\\_Dec\\_2004.pdf](https://agri.idaho.gov/main/wp-content/uploads/2017/10/nrcs_313_Dec_2004.pdf). (3-20-20)T

05. **American Society of Agricultural and Biological Engineers Specification ASAE EP393.3 Manure Storages February 2004.** This document can be viewed online at [https://agri.idaho.gov/main/wp-content/uploads/2017/10/asae\\_EP393.3\\_Feb\\_04.pdf](https://agri.idaho.gov/main/wp-content/uploads/2017/10/asae_EP393.3_Feb_04.pdf). (3-20-20)T

### 005. ADDRESS, OFFICE HOURS, TELEPHONE, FAX NUMBERS, WEB ADDRESS.

The Idaho State Department of Agriculture central office is located at 2270 Old Penitentiary Road, Boise, ID 83712-8298. The office is open from 8 a.m. to 5 p.m., except Saturday, Sunday and legal holidays. The mailing address is PO Box 7249, Boise, Idaho 83707. The phone number is (208) 332-8500 and the fax number is (208) 334-2170. The Department web address is <https://agri.idaho.gov/>. (3-20-20)T

### 006. IDAHO PUBLIC RECORDS ACT.

These rules are public records and are available for inspection and copying at the Idaho State Department of Agriculture central office. (3-20-20)T

### 007. -- 009. (RESERVED)

### 010. DEFINITIONS.

In addition to the definitions set forth in Section 25-4002, Idaho Code, the following definitions apply in the interpretation and the enforcement of this chapter. (3-20-20)T

01. **Discharge.** Release of process wastewater or manure from a poultry animal feeding operation,

including its land application area, to waters of the state or beyond the poultry facility's property boundaries or beyond the property boundary of any facility. Contract manure haulers, producers and other persons who haul manure beyond the operator's property boundaries are responsible for releases of manure between the property boundaries of the operator and the property boundaries at the point of application. A discharge does not include aerosolized matter, or manure that has been reasonably incorporated on the land application area. (3-20-20)T

**02. Idaho Pollutant Discharge Elimination System (IPDES).** Idaho's program for issuing, modifying, revoking and reissuing, terminating, monitoring and enforcing permits, and imposing and enforcing pretreatment requirements, under these rules and the Clean Water Act sections 307, 402, 318, and 405. (3-20-20)T

**03. Runoff.** Any precipitation that comes into contact with manure, compost, bedding, or feed on a poultry feeding operation and flows off the production area or flows off land application areas where the manure, compost, bedding, or feed has not been reasonably incorporated into the soil. (3-20-20)T

**011. ABBREVIATIONS.**

- 01. AFO.** Animal Feeding Operation. (3-20-20)T
- 02. ASABE.** American Society of Agricultural and Biological Engineers. (3-20-20)T
- 03. CAFO.** Concentrated Animal Feeding Operation. (3-20-20)T
- 04. DEQ.** Department of Environmental Quality. (3-20-20)T
- 05. FEMA.** Federal Emergency Management Agency. (3-20-20)T
- 06. IPDES.** Idaho Pollutant Discharge Elimination System. (3-20-20)T
- 07. NMP.** Nutrient Management Plan. (3-20-20)T
- 08. NMS.** Nutrient Management Standard. (3-20-20)T
- 09. NRCS.** United States Department of Agriculture, Natural Resources Conservation Service. (3-20-20)T
- 10. USGS.** United States Geological Survey. (3-20-20)T

**012. -- 109. (RESERVED)**

**110. PERMIT APPLICATION.**

**01. Permit Application.** Every person required by Section 25-4003, Idaho Code, to obtain a permit must submit a permit application to the department. The permit application will be used to determine if the construction and operation of the poultry CAFO will be in conformance with these rules. (3-20-20)T

**02. Contents of Application.** Each application must include, in the format set forth by the director in sufficient detail to allow the director to make necessary application review decisions concerning design and environmental protection by providing the following: (3-20-20)T

- a.** Name, mailing address and phone number of the facility owner. (3-20-20)T
- b.** Name, mailing address and phone number of the facility operator. (3-20-20)T
- c.** Name and mailing address of the facility. (3-20-20)T
- d.** Legal description of the facility location. (3-20-20)T

- e. The one-time animal capacity, by head, of the facility. (3-20-20)T
  - f. The type of animals to be confined at the facility. (3-20-20)T
  - g. The facility's biosecurity and sanitary standards. (3-20-20)T
- 03. Construction Plans.** Plans and specifications for the facility's animal waste management system that include the following information: (3-20-20)T
- a. Vicinity map(s) prepared on one (1) or more seven and one-half minute (7.5') USGS topographic quadrangle maps or a high quality reproduction(s) that includes the following: (3-20-20)T
    - i. Layout of the facility, including buildings and animal waste management system; (3-20-20)T
    - ii. The one hundred (100) year FEMA flood zones or other appropriate flood data for the facility site and land application sites owned or leased by the applicant; and (3-20-20)T
    - iii. Private and community domestic water wells, irrigation wells, monitoring wells, and injection wells, irrigation conveyance and drainage structures, wetlands, streams, springs, and reservoirs that are within a one (1) mile radius of the facility. (3-20-20)T
  - b. A site plan showing: (3-20-20)T
    - i. Building locations; (3-20-20)T
    - ii. Waste facilities; (3-20-20)T
    - iii. All waste conveyance systems; and (3-20-20)T
    - iv. All irrigation systems used for land application, including details of approved water supply protection devices. (3-20-20)T
  - c. Building plans showing: (3-20-20)T
    - i. All wastewater collection systems in housed units; (3-20-20)T
    - ii. All freshwater supply systems, including details of approved water supply protection devices; (3-20-20)T
    - iii. Detailed drawings of wastewater collection and conveyance systems and containment construction. (3-20-20)T
  - d. If a CAFO Site Advisory Team suitability determination was not conducted for the facility, the following additional information must be provided: (3-20-20)T
    - i. Idaho DEQ delineated source water assessment areas within a one (1) mile radius of the facility and land application area; (3-20-20)T
    - ii. Idaho DEQ delineated nitrate priority areas that intersect the facility or land application area; (3-20-20)T
    - iii. Soil characteristics from NRCS; and (3-20-20)T
    - iv. Well logs associated with wells listed in Subsection 110.04.a.iii. (3-20-20)T
  - e. All construction plans will specify how the facility will meet the engineering standards outlined in the Natural Resources Conservation Service Agricultural Waste Management Field Handbook Appendix 10D

(Appendix 10D) (March 2008 Edition) (USDA, NRCS), Natural Resources Conservation Service (NRCS) Idaho Conservation Practice Standard Waste Storage Facility Code 313 December 2004, or American Society of Agricultural and Biological Engineers Specification ASAE EP393.3 Manure Storages February 2004. (3-20-20)T

**04. Nutrient Management Plan.** NMPs must be prepared in conformance with the Nutrient Management Standard or other equally protective standard for managing the amount, source, placement, form and timing of the land application of nutrients or soil amendments. (3-20-20)T

**111. -- 129. (RESERVED)**

**130. PERMIT CONDITIONS.**

The following conditions will apply to all permittees: (3-20-20)T

**01. Compliance Required.** The permittee must comply with all conditions of the permit. The permit must not relieve the permittee of the responsibility of complying with all applicable local, state, and federal laws. (3-20-20)T

**02. Construction, Operation, and Maintenance of the Facility.** The permittee must ensure that construction, operation, and maintenance of the facility proceed according to the construction plans and specifications and the approved nutrient management plans, and comply with the following: (3-20-20)T

**a.** Within thirty (30) days of construction completion, submit as-built construction plans. (3-20-20)T

**b.** Apply best management practices as approved by the director. (3-20-20)T

**c.** The facility or operations associated with the facility must not adversely affect waters of the state or create nuisance conditions including odor. (3-20-20)T

**d.** The removal of animal waste from an impoundment or storage structure must be performed in a manner not to damage the integrity of the liner. (3-20-20)T

**e.** Dead animals must be handled in accordance with IDAPA 02.04.17, "Rules Governing Dead Animal Movement and Disposal." (3-20-20)T

**f.** Nutrient management plans must be amended in accordance with IDAPA 02.04.30.000 et seq. "Rules Governing Environmental and Nutrient Management." (3-20-20)T

**g.** Soil tests must be conducted annually on all land application sites owned or leased by the permittee to determine compliance with the NMP and NMS. The director may require more frequent soil tests if he deems it necessary. (3-20-20)T

**03. Information to be Provided.** The permittee must furnish to the director, within a reasonable time, any information which the director may reasonably require to determine whether causes exists to modify or revoke the permit, or to determine compliance with the permit or applicable rules. (3-20-20)T

**04. Entry and Access.** The permittee must allow the director entry and access in accordance with Section 25-4008, Idaho Code. (3-20-20)T

**05. Reporting.** Permittees must report discharges or noncompliance issues within the following time frames: (3-20-20)T

**a.** Within twenty-four (24) hours of the time the permittee knows or should have known of a discharge or unauthorized discharge, the permittee must verbally report the discharge. (3-20-20)T

**b.** Within five (5) working days from the time a permittee knows or reasonably should have known of any event which has resulted or which may result in noncompliance with these rules, the permittee must file a written report with the director containing: (3-20-20)T

- i. A description of the event and its cause or if the cause is not known, steps taken to investigate and determine the cause; (3-20-20)T
- ii. The period of the event including, to the extent possible, times and dates; (3-20-20)T
- iii. Measures taken to mitigate or eliminate the event; and (3-20-20)T
- iv. Steps taken to prevent recurrence of the event. (3-20-20)T
- c. Immediately, whenever the permittee knows or learns or should reasonably know of material relevant acts not submitted or incorrect information submitted in a permit application or any report or notice to the director. (3-20-20)T

**06. Construction Commencement.** If a permittee fails to begin construction or expansion of a facility within five (5) years of the effective date of the permit, the director may void the permit and require a new permit application. (3-20-20)T

**07. Permit Renewal.** If a permittee intends to continue operation of the permitted facility after expiration of an existing permit, the permittee must apply for a new permit at least one hundred eighty (180) days prior to the expiration of the permit. (3-20-20)T

**08. Specific Permit Conditions.** The director may establish specific permit conditions on a case by case basis. Specific conditions will be established in consideration of facility's specific characteristics and will be designed to protect the state's water resources. (3-20-20)T

**131. -- 139. (RESERVED)**

**140. FEES AND ASSESSMENTS.**

**01. Annual Fees or Assessments.** The director may establish annual fees or assessments for each permittee of no more than three cents (\$0.03) per square foot of containment area. (3-20-20)T

**02. Payment of Annual Fees or Assessments.** Annual fees or assessments are due annually by January 20th of the next calendar year. (3-20-20)T

**141. -- 149. (RESERVED)**

**150. PERMIT MODIFICATION.**

**01. Minor Modifications.** Minor permit modifications are those which do not have a potential effect on the state's water resources. Such modifications will be made by the director, and are generally limited to: (3-20-20)T

- a. The correction of typographical or clerical errors; (3-20-20)T
- b. Transfer of ownership or operational control in accordance with Section 160; or (3-20-20)T
- c. Certain minor changes in monitoring or operational conditions. (3-20-20)T

**02. Major Modifications.** All permit modifications not considered minor will be deemed major. The procedure for making major modifications is the same as that used for a new permit under these rules. (3-20-20)T

**151. -- 159. (RESERVED)**

**160. TRANSFER OF PERMITS.**



**01. Transfer Application.** A new owner or operator of a facility must submit a transfer application to the director that includes at least the following: (3-20-20)T

- a. The relevant information required by Subsection 110.03; and (3-20-20)T
- b. Any change of conditions at the facility resulting from the ownership or operation transfer. (3-20-20)T

**02. Transfer Application Review.** The director will review the transfer application and either approve or deny the application within sixty (60) days of its receipt. (3-20-20)T

a. An approved transfer will be considered a minor modification pursuant to Subsection 150.01 as long as there are no major changes of conditions at the facility. Major changes of conditions at the facility are subject to Subsection 150.02. (3-20-20)T

b. If the director denies the transfer application, he will set forth the specific reasons for the denial, the steps necessary to meet the requirements for a permit transfer, and the opportunity to request a hearing. (3-20-20)T

**161. -- 199. (RESERVED)**

**200. WASTE STORAGE AND CONTAINMENT FACILITIES.**

**01. Wastewater Storage and Containment Facilities.** All poultry AFOs where process wastewater leaves the confinement area and has the potential to impact water of the state or be in violation of state water quality standards or ground water quality standards must have wastewater storage and containment facilities designed, constructed, operated, and maintained sufficient to contain: (3-20-20)T

- a. All process wastewater generated on the facility during the non-land application season; (3-20-20)T
- b. The runoff from a twenty-five (25) year, twenty-four (24) hour rainfall event; and (3-20-20)T
- c. Either three (3) inches of runoff from the accumulation of winter precipitation or the amount of runoff from the accumulation of precipitation from a one-in-five (1 in 5) year winter. (3-20-20)T

**02. All Substances Entering Wastewater Storage and Containment Facilities.** All substances entering wastewater storage and containment facilities must be composed of manure and process wastewater from the operation of the poultry AFO. The disposal of any other materials into a wastewater storage and containment facility, including, but not limited to, human waste, is prohibited. (3-20-20)T

**03. Waste Storage.** Storage areas for poultry waste including compost and solid manure storage areas must be located on approved soils and appropriately protected to prevent run on and run off. (3-20-20)T

**04. Waste and Wastewater System Maintenance.** Waste and wastewater storage and containment systems must be maintained in a condition that allows the producer to regularly inspect the integrity of the systems. (3-20-20)T

**05. Additional Ground Water Protection Requirements.** The permittee must construct and maintain all waste containment structures within the parameters of this rule, including the Natural Resources Conservation Service Agricultural Waste Management Field Handbook Appendix 10D (Appendix 10D) (March 2008 Edition) (USDA, NRCS), Natural Resources Conservation Service (NRCS) Idaho Conservation Practice Standard Waste Storage Facility Code 313 December 2004, or American Society of Agricultural and Biological Engineers Specification ASAE EP393.3 Manure Storages February 2004 (see Section 004, Incorporation by Reference). After inspection, if the Department has information that the waste containment structure(s) has been compromised severely enough to no longer meet the requirements of this rule, the Department may require an evaluation to be conducted by a licensed professional engineer. The engineer will make recommendations on steps needed to bring the facility into compliance with this rule. The permittee is responsible for engineering and reconstruction costs. If the permittee has

a repeat waste containment compromise, as determined by the department, the Director may require ground water monitoring by the permittee. (3-20-20)T

**201. -- 249. (RESERVED)**

**250. NUTRIENT MANAGEMENT.**

Each poultry CAFO must submit an NMP for land owned or controlled by the operator to the director for approval. The NMP must conform to the NMS and address odors generated in excess of odors normally associated with raising poultry in Idaho. (3-20-20)T

**01. Designated Poultry CAFOs.** Any poultry AFO which is designated as a CAFO by the department in accordance with Section 400 must submit an NMP within forty-five (45) days of designation. (3-20-20)T

**02. NMP Approval.** The director will respond to or approve an NMP in writing within forty-five (45) days of submission. (3-20-20)T

**03. NMP Updates or Amendments.** Nutrient management plans must be updated as needed to accurately reflect the facility and its nutrient management system. (3-20-20)T

**251. NUTRIENT MANAGEMENT PLAN RETENTION.**

All NMPs which have been approved by the department and returned to the CAFO must be maintained on site at the CAFO and available to the department upon request. The department will retain a copy of the NMP. (3-20-20)T

**252. NUTRIENT MANAGEMENT RECORDS.**

**01. Required Nutrient Management Records.** The CAFO operator must keep complete and accurate records of: (3-20-20)T

**a.** Land application records, consisting of, at a minimum: (3-20-20)T

**i.** The dates, methods and approximate amounts of any manure or process wastewater applied on land owned or controlled by the operator. (3-20-20)T

**ii.** Weather conditions and soil moisture at the time of application. (3-20-20)T

**iii.** The lapsed time to manure incorporation, rainfall or irrigation event. (3-20-20)T

**iv.** Documentation of the actual rate at which nutrients were applied. When the actual rate used differs from the recommended and planned rates, nutrient management records must indicate the rationale for the difference. (3-20-20)T

**b.** The name and address of any third party receiving manure or process wastewater from the facility, including the dates of the transfer and the amount of manure or process wastewater transferred. (3-20-20)T

**c.** Nutrient Application. The quantities, analyses and sources of nutrients applied. (3-20-20)T

**d.** Soil Analysis. Complete soil analysis to create nutrient budget. (3-20-20)T

**e.** Crops. Crops planted, planting and harvest dates, yields and crop residues removed. (3-20-20)T

**f.** Record Review. Dates of annual review, person performing the review, and recommendations determined from the review. (3-20-20)T

**02. Records Retention.** All nutrient management records must be maintained for a period of five (5) years and provided to the department upon request. (3-20-20)T

**253. NMP VIOLATIONS.**

The failure to implement an approved NMP, failure to retain and maintain an NMP at the CAFO, or failure to retain nutrient management records is a violation of these rules. (3-20-20)T

**254. -- 259. (RESERVED)**

**260. GROUND WATER QUALITY MONITORING.**

At least annually, the department will sample and test the facility's production well water for nitrogen. (3-20-20)T

**261. -- 299. (RESERVED)**

**300. PROHIBITED DISCHARGES.**

Discharges or unauthorized discharges of manure or process wastewater from poultry CAFO or land application sites owned or controlled by a poultry CAFO are prohibited. (3-20-20)T

**301. -- 309. (RESERVED)**

**310. NOTIFICATION OF DISCHARGE.**

Within twenty-four (24) hours of learning of a discharge or unauthorized discharge, the operator of a poultry CAFO must verbally notify the department of the discharge or unauthorized discharge. (3-20-20)T

**311. -- 499. (RESERVED)**

**500. INSPECTIONS.**

Pursuant to Title 25, Chapter 40, Idaho Code, the director or his designee is authorized to inspect any poultry AFO, and to have access to and copy any facility records deemed necessary to ensure compliance with Title 25, Chapter 40, Idaho Code, and these rules. (3-20-20)T

**01. Frequency.** All poultry CAFOs will be inspected at least annually, or at intervals sufficient to determine that waste has been managed to prevent an unauthorized discharge or contamination of waters of the state. (3-20-20)T

**02. Inspection Methods.** Inspections may include, but are not limited to, evaluating effectiveness of best management practices, collecting samples, taking photographs, video recording or collecting other information as necessary. (3-20-20)T

**501. -- 549. (RESERVED)**

**550. VIOLATIONS.**

**01. Failure to Comply.** Failure by a permittee to comply with the provisions of these rules or with any permit condition is a violation of these rules. (3-20-20)T

**02. Falsification of Statements and Records.** It is a violation of these rules for any person to knowingly make a false statement, representation, or certification in any application, report, document, or record developed, maintained, or submitted pursuant to these rules or the conditions of a permit. (3-20-20)T

**03. Discharge.** Any discharge or unauthorized discharge from a facility is a violation of these rules. (3-20-20)T

**551. -- 999. (RESERVED)**

## 02.06.01 – RULES GOVERNING THE PRODUCTION AND DISTRIBUTION OF SEED

### 000. LEGAL AUTHORITY.

This chapter is adopted under the legal authority of Sections 22-108(2), 22-418(4), 22-418(11), 22-2004 and 22-2006, Idaho Code. (3-20-20)T

### 001. TITLE AND SCOPE.

01. **Title.** The title of this chapter is “Rules Governing the Production and Distribution of Seed.” (3-20-20)T

02. **Scope.** These rules govern procedures for sale or distribution of seed in Idaho, including rapeseed and bluegrass. These rules will also establish seed service testing fees for purity, germination, tetrazolium and special tests. (3-20-20)T

### 002. -- 109. (RESERVED)

## SUBCHAPTER A – PURE SEED

### 110. DEFINITIONS.

In addition to the definitions set forth in Section 22-414, Idaho Code, the definition in Section 110 apply to the interpretation and enforcement of Subchapter A only: (3-20-20)T

01. **Condition.** “Condition” means drying, cleaning, scarifying and other operations that could change the purity or germination of the seed and require the seed lot to be retested to determine the label information. (3-20-20)T

### 111. (RESERVED)

### 112. METHODS OF SAMPLING – GENERAL PROCEDURE.

01. **Sample.** In order to secure a representative sample, equal portions are taken from evenly distributed parts of the quantity of seed or screenings to be sampled with access to all parts of that quantity. When more than one (1) trierful of seed is drawn from a bag, different paths will be followed. When more than one (1) handful is taken from a bag, the handfuls will be taken from well-separated points. (3-20-20)T

02. **Free Flowing Seed.** For free-flowing seed in bags or bulk, a probe or trier is used. For small free-flowing seed in bags a probe or trier long enough to sample all portions of the bag is used. (3-20-20)T

03. **Non-Free Flowing Seed.** Non-free-flowing seed, such as certain grass seed, uncleaned seed or screenings difficult to sample with a probe or trier, is sampled by thrusting the hand into the bulk and withdrawing representative portions. The hand is inserted in an open position and the fingers are held closely together while the hand is being inserted and the portion withdrawn. (3-20-20)T

04. **Composite Samples.** Composite samples will be obtained to determine the quality of a lot of seed (i.e., percentages of pure seed, other crop seed, weed seed, inert matter and germination). Individual bag samples may be obtained to determine if the lot of seed is uniform. (3-20-20)T

a. To determine if there is an obvious lack of uniformity of seed from which a composite sample is being obtained, each portion will be examined and the portions then combined to form a composite sample or samples. (3-20-20)T

b. If the lot is found not to be uniform when obtaining a composite sample to determine its quality then additional individual bag samples are taken for the purpose of testing for uniformity. (3-20-20)T

c. Such individual bag samples may also be taken for the purpose of testing for uniformity even though a composite sample has not previously been obtained. The identity of each individual bag sample must be maintained. (3-20-20)T

05. **Bulk.** Bulk seed or screenings are sampled by inserting a long probe or thrusting the hand into the bulk, as circumstances require, in at least seven (7) uniformly distributed parts of the quantity being sampled. At least

as many trierfuls or handfuls are taken as the minimum that would be required for the same quantity of seed or screenings in bags of a size customarily used for such seed or screenings. (3-20-20)T

**06. Bags.** (3-20-20)T

**a.** For lots of six (6) bags or less, each bag will be sampled with a total of at least five (5) trierfuls taken. (3-20-20)T

**b.** For lots of more than six (6) bags, five (5) bags plus at least ten percent (10%) of the number of bags in the lots will be sampled. (Round off numbers with decimals to the nearest whole number, raising five tenths (.5) to the next whole number.) Regardless of the lot size it is not necessary that more than thirty (30) bags be sampled. (3-20-20)T

**c.** Samples are drawn from unopened bags except under circumstances where the identity of the seed has been preserved. (3-20-20)T

**07. Packets.** In sampling seed in packets, entire unopened packets are taken. (3-20-20)T

**08. Size of Sample.** (3-20-20)T

**a.** For composite sample to test for quality, the following are minimum weights for samples of seed to be submitted for analysis, test or examination (3-20-20)T

**i.** Two (2) ounces (approximately fifty five (55) grams) of grass seed not otherwise mentioned, white or alsike clover, or seeds not larger than these. (3-20-20)T

**ii.** Five (5) ounces (approximately one hundred fifty (150) grams) of red or crimson clover, alfalfa, lespedezas, ryegrasses, bromegrasses, millet, flax, rape, or seeds of similar size. (3-20-20)T

**iii.** One (1) pound of Sudangrass, sorghum, proso, hemp seed, or seeds of similar size. (3-20-20)T

**iv.** Two (2) pounds (approximately one thousand (1,000) grams) of cereals, vetches, or seeds of similar or larger size. (3-20-20)T

**b.** For individual bag samples to test for uniformity. (3-20-20)T

**i.** The size of any individual bag sample to determine uniformity in a lot of seed is not less than the quantities set out in the "Rules and Regulations, under the Federal Seed Act" (53 Statute 1275) (Subsection 201.46). (3-20-20)T

**ii.** If the sample drawn is larger than desired, it is thoroughly mixed before it is divided to the desired size. (3-20-20)T

**09. Forwarding and Receipt of Official Samples.** Before being forwarded for analysis test or examination, the containers of official samples shall be properly sealed and identified with the containers of official samples initialed and dated and the sample weighed by the person who breaks the seals. (3-20-20)T

**113. -- 119. (RESERVED)**

**120. GERMINATION STANDARDS FOR VEGETABLE SEEDS.**  
Includes hard seed.

	<b>Percent</b>
Artichoke	60
Asparagus	70

	<b>Percent</b>
Eggplant	60
Endive	70

	Percent
Asparagusbean	75
Bean, garden	70
Bean, lima	70
Bean, runner	75
Beet	65
Broadbean	75
Broccoli	75
Brussels sprouts	70
Burdock, great	60
Cabbage	75
Cabbage, tronchuda	75
Cantaloupe (See muskmelon)	
Cardoon	60
Carrot	55
Cauliflower	75
Celeriac	55
Celery	55
Chard, Swiss	65
Chicory	65
Chinese Cabbage	75
Chives	50
Citron	65
Collards	80
Corn, sweet	75
Cornsalad	70
Cowpea	75
Cress, garden	75
Cress, upland	60
Cress, water	40
Cucumber	80
Dandelion	60

	Percent
Kale	75
Kale, Chinese	75
Kohlrabi	75
Leek	60
Lettuce	80
Muskmelon	75
Mustard, India	75
Mustard, spinach	75
Okra	50
Onion	70
Onion, Welsh	70
Pak-choi	75
Parsley	60
Parsnip	60
Pea	80
Pepper	55
Pumpkin	75
Radish	75
Rhubarb	60
Rutabaga	75
Salsify	75
Sorrel	65
Soybean	75
Spinach	60
Spinach, New Zealand	40
Squash	75
Tomato	75
Tomato, husk	50
Turnip	80
Watermelon	70

(3-20-20)T

121. -- 129. (RESERVED)

**130. GERMINATION STANDARDS FOR FLOWER SEEDS.**

The kinds of flower seeds listed below are those for which standard testing procedures have been prescribed by the Association of Official Seed Analysts (AOSA) and that are required by the labeling provisions of Section 22-415, Idaho Code. The percentage listed opposite each kind is the germination standard for that kind. For the kinds marked with an asterisk, the percentage is arrived at by totaling the percent germination and percent hard seed. (3-20-20)T

**01. Table 1.**

Kind	Percent
Achillea (The Pearl) - <i>Achillea ptarmica</i>	50
African Daisy - <i>Dimorphotheca aurantiaca</i>	55
African Violet - <i>Saintpaulia</i> spp.	30
Ageratum - <i>Ageratum mexicanum</i>	60
Agrostemma (rose champion) - <i>Agrostemma coronaria</i>	65
Alyssum - <i>Alyssum campactum</i> , <i>A. maritimum</i> , <i>A. procumbens</i> , <i>A. saxatile</i>	60
Amaranthus - <i>Amaranthus</i> spp.	65
Anagalis (pimpernel) - <i>Anagalis arvensis</i> , <i>Anagalis coerulea</i> , <i>Anagalis grandiflora</i>	60
Anemone - <i>Anemone coronaria</i> , <i>A. pulsatilla</i>	55
Angel's Trumpet - <i>Datura arborea</i>	60
Arabis - <i>Arabis alpina</i>	60
Arctotis (African lilac daisy) - <i>Arctotis grandis</i>	45
Armeria - <i>Armeria formosa</i>	55
Asparagus, fern - <i>Asparagus plumosus</i>	50
Asparagus, sprenger - <i>Asparagus sprengeri</i>	55
Aster, China - <i>Callistephus chinensis</i> ; except Pompon, Powderpuff, and Princess types	55
Aster, China - <i>Callistephus chinensis</i> ; Pompon, Powderpuff, and Princess types	50
Aubretia - <i>Aubretia deltoides</i>	45
Baby Smilax - <i>Asparagus asparagoides</i>	25
Balsam - <i>Impatiens balsamina</i>	70
Begonia - <i>Begonia fibrous rooted</i>	60
Begonia - <i>Begonia tuberous rooted</i>	50
Bells of Ireland - <i>Molucella laevis</i>	60
Brachycome (swan river daisy) - <i>Brachycome iberidifolia</i>	60
Browallia - <i>Browallia elata</i> and <i>B. speciosa</i>	65
Buphthalmum (sunwheel) - <i>Buphthalmum salicifolium</i>	60

Kind	Percent
Calceolaria - Calceolaria spp.	60
Calendula - Calendula officinalis	65
California Poppy - Eschscholtzia californica	60
Calliopsis - Coreopsis bicolor, C. drummondii, C. elegans	65
Campanula:	
Canterbury Bells - Campanula medium	60
Cup and Saucer Bellflower - Campanula medium calycanthemum	60
Carpathian Bellflower - Campanula carpatica	50
Peach Bellflower - Campanula persicifolia	50
Candytuft, Annual - Iberis amara, I. umbellata	65
Candytuft, Perennial - Iberis gibraltarica, I. sempervirens	55
*Castor Bean - Ricinus communis	60
Cathedral Bells - Cobaea scandens	65
Celosia - Celosia argentea	65
Centaurea:	
Basket Flower - Centaurea americana,	
Cornflower - C. cyanus,	
Dusty Miller - C. candidissima,	60
Royal Centaurea - C. imperialis,	
Sweet Sultan - C. moschata,	
Velvet Centaurea - C. gymnocarpa	
Cerastium (snow-in-summer) - Cerastium biebersteini and C. tomentosum	65
Chinese Forget-me-not - Cynoglossum amabile	55
Chrysanthemum, Annual - Chrysanthemum carinatum, C. coronarium, C. segetum	40
Cineraria - Senecio cruentus	60
Clarkia - Clarkia elegans	65
Cleome - Cleome gigantea	65
Coleus - Coleus blumei	65
Columbine - Aquilegia spp.	50
Coral Bells - Heuchera sanguinea	55
Coreopsis, Perennial - Coreopsis lanceolata	40
Corn, ornamental - Zea mays	75
Cosmos:	
Sensation, Mammoth and Crested types - Cosmos bipinnatus;	65
Klondyke type - C. sulphureus	
Crossandra - (Crossandra infundibuliformis)	50
Dahlia - Dahlia spp.	55



Kind	Percent
Daylily - <i>Hemerocallis</i> spp.	45
Delphinium, Perennial: Belladonna and <i>Bellamosum</i> types; Cardinal Larkspur - <i>Delphinium cardinale</i> ; Chinensis types; Pacific Giant, Gold Medal and other hybrids of <i>D. elatum</i>	55
Dianthus: Carnation - <i>Dianthus caryophyllus</i> China Pinks - <i>Dianthus chinensis</i> , <i>heddewigi</i> , <i>heddensis</i> Grass Pinks - <i>Dianthus plumarius</i> Maiden Pinks - <i>Dianthus deltoides</i> Sweet William - <i>Dianthus barbatus</i> Sweet Wivelsfield - <i>Dianthus allwoodi</i>	60 70 60 60 70 60
Didiscus - (blue lace flower) - <i>Didiscus coerulea</i>	65
Doronicum (leopard's bane) - <i>Doronicum caucasicum</i>	60
Dracaena - <i>Dracaena indivisa</i>	55
Dragon Tree - <i>Dracaena draco</i>	40
English Daisy - <i>Bellis perennis</i>	55
Flax - Golden flax ( <i>Linum flavum</i> ); Flowering flax <i>L. grandiflorum</i> ; Perennial flax, <i>L. perenne</i>	60
Flowering Maple - <i>Abutilon</i> spp.	35
Foxglove - <i>Digitalis</i> spp.	60
Gaillardia, Annual - <i>Gaillardia pulchella</i> ; <i>G. picta</i> ; Perennial - <i>G. grandiflora</i>	45
Gerbera (transvaal daisy) - <i>Gerbera jamesoni</i>	60
Geum - <i>Geum</i> spp.	55
Gilia - <i>Gilia</i> spp.	65
Gloriosa daisy (rudbeckia) - <i>Echinacea purpurea</i> and <i>Rudbeckia hirta</i>	60
Gloxinia - ( <i>Sinningia speciosa</i> )	40
Godetia - <i>Godetia amoena</i> , <i>G. grandiflora</i>	65
Gourds: Yellow Flowered - <i>Cucurbita pepo</i> ; White Flowered - <i>Lagenaria sisceraria</i> ; Dishcloth - <i>Luffa cylindrica</i>	70
Gypsophila: Annual Baby's Breath - <i>Gypsophila elegans</i> ; Perennial Baby's Breath - <i>G. paniculata</i> , <i>G. pacifica</i> , <i>G. repens</i>	70
Helenium - <i>Helenium autumnale</i>	40

Kind	Percent
Helichrysum - Helichrysum monstrosum	60
Heliopsis - Heliopsis scabra	55
Heliotrope - Heliotropium spp.	35
Helipterum (Acroclinium) - Helipterum roseum	60
Hesperis (sweet rocket) - Hesperis matronalis	65
*Hollyhock - Althea rosea	65
Hunnemania (Mexican tulip poppy) - Hunnemania fumariaefolia	60
*Hyacinth bean - Dolichos lablab	70
Impatiens - Impatiens holstii, I. sultani	55
*Ipomea - Cypress Vine - Ipomea quamoclit; Moonflower - I. noctiflora; Morning Glories, Cardinal Climber, Hearts and Honey Vine - Ipomea spp.	75
Jerusalem cross (maltese cross) - Lychnis chalcedonica	70
Job's Tears - Coix lacrymajobi	70
Kochia - Kochia childsi	55
Larkspur, Annual - Delphinium ajacis	60
Lantana - Lantana camara, L. hybrida	35
Lilium (regal lily) - Lilium regale	50
Linaria - Linaria spp.	65
Lobelia, Annual - Lobelia erinus	65
Lunaria, Annual - Lunaria annua	65
*Lupine - Lupinus spp.	65
Marigold - Tagetes spp.	65
Marvel of Peru - Mirabilis jalapa	60
Matricaria (feverfew) - Matricaria spp.	60
Mignonette - Reseda odorata	55
Myosotis - Myosotis alpestris, M. oblongata, M. palustris	50
Nasturtium - Tropaeolum spp.	60
Nemesia - Nemesia spp.	65
Nemophila - Nemophila insignis	70
Nemophila, spotted - Nemophila maculata	60
Nicotiana - Nicotiana affinis, N. sanderae, N. sylvestris	65
Nierembergia - Nierembergia spp.	55
Nigella - Nigella damascena	55

Kind	Percent
Pansy - <i>Viola tricolor</i>	60
Penstemon - <i>Penstemon barbatus</i> , <i>P. grandiflorus</i> , <i>P. laevigatus</i> , <i>P. pubescens</i>	60
Petunia - <i>Petunia</i> spp.	45
Phacelia - <i>Phacelia campanularia</i> , <i>P. minor</i> , <i>P. tanacetifolia</i>	65
Phlox, Annual - <i>Phlox drummondii</i> all types and varieties	55
Physalis - <i>Physalis</i> spp.	60
Platycodon (balloon flower) - <i>Platycodon grandiflorum</i>	60
Plumbago, cape - <i>Plumbago capensis</i>	50
Ponytail - <i>Beaucarnea recurvata</i>	40
Poppy: Shirley Poppy - <i>Papaver rhoeas</i> ; Iceland Poppy - <i>P. nudicaule</i> ; Oriental Poppy - <i>P. orientale</i> ; Tulip Poppy - <i>P. glaucum</i>	60
Portulace - <i>Portulaca grandiflora</i>	55
Primula (Primrose) - <i>Primula</i> spp.	50
Pyrethrum (painted daisy) - <i>Pyrethrum coccineum</i>	60
Salpiglossis - <i>Salpiglossis gloxinaeflora</i> , <i>S. sinuata</i>	60
Salvia: Scarlet Sage - <i>Salvia splendens</i> ; Mealycup Sage (blue bedder) - <i>Salvia farinacea</i>	50
Saponaria - <i>Saponaria ocymoides</i> , <i>S. vaccaria</i>	60
Scabiosa, Annual - <i>Scabiosa atropurpurea</i>	50
Scabiosa, Perennial - <i>Scabiosa caucasica</i>	40
Schizanthus - <i>Schizanthus</i> spp.	60
*Sensitive plant (mimosa) - <i>Mimosa pudica</i>	65
Shasta Daisy - <i>Chrysanthemum maximum</i> , <i>C. leucanthemum</i>	65
Silk Oak - <i>Grevillea robusta</i>	25
Snapdragon - <i>Antirrhinum</i> spp.	55
Solanum - <i>Solanum</i> spp.	60
Statice - <i>Statice sinuata</i> , <i>S. suworonii</i> (flower heads)	50
Stocks: Common - <i>Mathiola incana</i> ; Evening Scented - <i>Mathiola bicornis</i>	65
Sunflower - <i>Helianthus</i> spp.	70
Sunrose - <i>Helianthemum</i> spp.	30

Kind	Percent
*Sweet Pea, Annual and Perennial other than dwarf bush - Lathyrus odoratus, L. latifolius	75
*Sweet Pea, dwarf bush - Lathyrus odoratus	65
Tahoka daisy - Machaeanthera tanacetifolia	60
Thunbergia - Thunbergia alata	60
Torch Flower - Tithonia speciosa	70
Torenia (wishbone flower) - Torenia fournieri	70
Tritoma Kniphofia spp.	65
Verbena, Annual - Verbena hybrida	35
Vinca - Vinca rosea	60
Viola - Viola cornuta	55
Virginian stocks - Malcolmia maritima	65
Wallflower - Cheiranthus allioni	65
Yucca (Adam's needle) - Yucca filamentosa	50
Zinnia (except Linearis and Creeping) - Zinnia angustifolia, Z. elegans, Z. grandiflora, Z. gracillima, Z. haegeana, Z. multiflora, Z. pumila	65
Zinnia, Linearis and Creeping - Zinnia linearis, Sanvitalia procumbens	50
All other kinds	50

(3-20-20)T

**02. Below Standard.** A mixture of kinds of flower seeds will be considered to be below standard if the germination of any kind or combination of kinds constituting twenty-five percent (25%) or more of the mixture by number is below standard for the kind or kinds involved. (3-20-20)T

**131. -- 139. (RESERVED)**

**140. GERMINATION STANDARDS FOR SEED IN HERMETICALLY SEALED CONTAINERS.**

The period of validity of germination tests is extended to the following period for seed packaged in hermetically sealed containers under conditions and label requirements set forth in Subchapter A. (3-20-20)T

**01. Germination Tests.** The germination test for agricultural and vegetable seed shall have been completed within the following period, exclusive of the calendar month in which the test was completed, immediately prior to shipment, delivery, transportation or sales: (3-20-20)T

**a.** In the case of agricultural or vegetable seeds shipped, delivered, transported or sold to a dealer for resale, eighteen (18) months; (3-20-20)T

**b.** In the case of agricultural or vegetable seeds for sale or sold at retail, thirty-six (36) months. (3-20-20)T

**02. Conditions of Packaging.** The following standards, requirements, conditions must be met before seed is considered to be hermetically sealed under the provisions of Subchapter A: (3-20-20)T

**a.** The seed was packaged within nine months after harvest. (3-20-20)T

**b.** The container used does not allow water vapor penetration through any wall, including the seals, greater than five hundredths (0.05) gram of water per twenty-four (24) hours per one hundred (100) square inches of surface at one hundred degrees F. (100F) with a relative humidity on one side of ninety percent (90%) and on the other of zero percent (0%). Water vapor penetration or WVP is measured by the standards of the U.S. Bureau of Standards as-gm. H<sub>2</sub>O/24 hr./100 sq. in./100 F/ 90% RHV. 0% RH. (3-20-20)T

**03. Moisture.** The seed in the container does not exceed the percentage of moisture, on a wet weight basis, as listed below: (3-20-20)T

**a. Table 1.**

<b>Agricultural Seeds</b>	<b>Percent</b>
Beet, field	7.5
Beet, sugar	7.5
Bluegrass, Kentucky	6.0
Clover, crimson	8.0
Fescue, red	8.0
Ryegrass, annual	8.0
Ryegrass, perennial	8.0
All other agricultural seeds	6.0
Mixtures of above	8.0

(3-20-20)T

**b. Table 2.**

<b>Vegetable Seeds</b>	<b>Percent</b>
Bean, garden	7.0
Bean, lima	7.0
Beet	7.5
Broccoli	5.0
Brussels sprouts	5.0
Cabbage	5.0
Carrot	7.0
Cauliflower	5.0
Celeriac	7.0
Celery	7.0
Chard, Swiss	7.5
Chinese cabbage	5.0
Chives	6.5
Collards	5.0

Vegetable Seeds	Percent
Corn, sweet	8.0
Cucumber	6.0
Eggplant	6.0
Kale	5.0
Kohlrabi	5.0
Leek	6.5
Lettuce	5.5
Muskmelon	6.0
Mustard, India	5.0
Onion	6.5
Onion, Welsh	6.5
Parsley	6.5
Parsnip	6.0
Pea	7.0
Pepper	4.5
Pumpkin	6.0
Radish	5.0
Rutabaga	5.0
Spinach	8.0
Squash	6.0
Tomato	5.5
Turnip	5.0
Watermelon	6.5
All other vegetable seeds	6.0

(3-20-20)T

**04. Labeling.** The container is conspicuously labeled in not less than eight (8) point type to indicate that the container is hermetically sealed, that the seed has been preconditioned as to moisture content, and the calendar month and year in which the germination test was completed. (3-20-20)T

**05. Germination.** The percentage of germination of seed at the time of packaging was equal to or above the standards specified elsewhere in Subchapter A of these rules. (3-20-20)T

141. -- 149. (RESERVED)

150. NOXIOUS WEEDS.

01. Prohibited Noxious Weed Seeds -- Table 1.

<b>Common Name</b>	<b>Scientific Name</b>
1. Beancaper, Syrian	1. <i>Zygophyllum fabago</i> L.
2. Bindweed, Field	2. <i>Convolvulus arvensis</i> L.
3. Buffalobur	3. <i>Solanum rostratum</i> Dun.
4. Bursage, Skeleton leaf	4. <i>Ambrosia tomentosa</i> Nutt.
5. Camelthorn	5. <i>Alhagi camelorum</i> Fisch.
6. Carrot, Wild	6. <i>Daucus carota</i> L.
7. Cress, Hoary	7. <i>Cardaria draba</i> (L.) Desv.
8. Crupina, Common	8. <i>Crupina vulgaris</i> Cass.
9. Fieldcress, Austrian	9. <i>Rorippa austriaca</i> (Crantz) Bess.
10. Goatgrass	10. <i>Aegilops cylindrica</i> Host
11. Groundcherry, Smooth	11. <i>Physalis subglabrata</i> Mackenz. & Bush
12. Henbane, Black	12. <i>Hyoscyamus niger</i> L.
13. Johnsongrass	13. <i>Sorghum halepense</i> L.
14. Knapweed, Diffuse	14. <i>Centaurea diffusa</i> Lam.
15. Knapweed, Russian	15. <i>Centaurea repens</i> L.
16. Knapweed, Spotted	16. <i>Centaurea maculosa</i> Lam.
17. Lythrum, Purple	17. <i>Lythrum salicaria</i> L.
18. Nightshade, Silverleaf	18. <i>Solanum elaeagnifolium</i> Cav.
19. Pepperweed, Perennial	19. <i>Lepidium latifolium</i> L.
20. Poison-Hemlock	20. <i>Conium maculatum</i> L.
21. Puncturevine	21. <i>Tribulus terrestris</i> L.
22. Quackgrass	22. <i>Elytrigia repens</i> ; <i>Agropyron repens</i> (L.) Beauv.
23. Ragwort, Tansy	23. <i>Senecio jacobaea</i> L.
24. Skeletonweed, Rush	24. <i>Chondrilla juncea</i> L.
25. Sowthistle, Perennial	25. <i>Sonchus arvensis</i> L.
26. Spurge, Leafy	26. <i>Euphorbia esula</i> L.
27. St. Johnswort, Common	27. <i>Hypericum perforatum</i> L.
28. Starthistle, Yellow	28. <i>Centaurea solstitialis</i> L.
29. Swainsonpea	29. <i>Sphaerophys salsula</i> (Pall.) DC; <i>Swainsona salsula</i> (Pallas) Taubert
30. Thistle, Canada	30. <i>Cirsium arvense</i> (L.) Scop.
31. Thistle, Musk	31. <i>Carduus nutans</i> L.
32. Thistle, Scotch	32. <i>Onopordum acanthium</i> L.

Common Name	Scientific Name
33. Toadflax, Dalmatian	33. <i>Linaria genistifolia</i> spp. <i>dalmatica</i> (L.) Maire & Petitmengin
34. Toadflax, Yellow	34. <i>Linaria vulgaris</i> Mill.
35. Woad, Dyers	35. <i>Isatis tinctoria</i> L.

(3-20-20)T

**02. Restricted Noxious Weed Seeds -- Table 2.**

Common Name	Scientific Name
1. Dodder	1. <i>Cuscuta</i> spp.
2. Halogeton	2. <i>Halogeton glomeratus</i> (Stephen ex Bieb.) C.A. Mey
3. Lettuce, Blue	3. <i>Lactuca pulchella</i> (Pursch) DC.
4. Oats, Wild	4. <i>Avena fatua</i> L.
5. Plantain, Buckhorn	5. <i>Plantago lanceolata</i> L.
6. Ragweed, Western and Perennial	6. <i>Ambrosia psilostachya</i> DC., (T. & G.) Farw.
7. Rye, Medusahead	7. <i>Taeniatherum caput-medusae</i> (L.) Nevski; <i>Elymus caput-medusae</i> (L.)
8. Sumpweed, Poverty	8. <i>Iva axillaris</i> Pursh

(3-20-20)T

**03. Restricted Noxious Weed Tolerances.**

(3-20-20)T

**a.** Seven (7) seeds in fifty (50) grams of *Agrotis* species, *Poa* species, Rhodes grass, Bermudagrass, timothy, celery, and other agricultural or vegetable seeds of similar size and weight, within this group. (3-20-20)T

**b.** Seven (7) seeds in each fifty (50) grams of Dallisgrass, ryegrass, fescue species, foxtail millets, alfalfa, red clover, sweetclover, lespedeza, bromegrass, Brassica species, carrot, onion, and other agricultural or vegetable seeds of similar size and weight or mixtures within this group, or mixtures of this group with those in group A. (3-20-20)T

**c.** Seven (7) seeds in fifty (50) grams of alsike clover, white clover, and other agricultural or vegetable seeds of similar size and weight or mixtures within this group, with those in group A or group B. (3-20-20)T

**d.** Eight (8) seeds in one hundred fifty (150) grams of Proso millet, Sudangrass, and seeds of similar size and weight, or mixtures of seed within this group. (3-20-20)T

**e.** Forty-five (45) seeds in each pound for all wheatgrass species. (3-20-20)T

**f.** Four (4) seeds in each five hundred (500) grams of wheat, oats, rye, barley, buckwheat, sorghums, vetches, field peas, and other seeds of a size and weight similar to or greater than those within this group, or any mixtures within this group. (3-20-20)T

**g.** Containing more than one percent (1%) by weight of weed seeds including restricted noxious weed seeds referred to in Section 22-414(18)(b), Idaho Code, provided, that three percent (3%) of cheat, chess, or downy brome will be allowed in grass seed in which these weeds are found. (3-20-20)T



**151. -- 159. (RESERVED)**

**160. LABEL REQUIREMENTS OF SEEDS FOR SPROUTING.**

The following information shall be indicated on all labels of seeds sold for sprouting in health food stores or other outlets: (3-20-20)T

- 01. Name.** Commonly accepted name of kind. (3-20-20)T
- 02. Lot.** Lot number. (3-20-20)T
- 03. Percentage.** Percentage by weight of the pure seed, crop seeds, inert matter, and weed seeds if required. (3-20-20)T
- 04. Germination Percentage.** Percentage of germination. (3-20-20)T
- 05. Date.** The calendar month and year the test was completed to determine such percentage. (3-20-20)T

**161. -- 169. (RESERVED)**

**170. VIABILITY BY TZ%.**

A TZ (tetrazolium) test may be used in lieu of germination for the following species with the label reading "viability by TZ%": Bitterbrush; Saltbush; Sagebrush; Indian Ricegrass; and Winterfat. (3-20-20)T

**171. -- 179. (RESERVED)**

**180. METHODS OF TESTING.**

All methods used in testing and analyzing seed subject to Subchapter A and the tolerances used in the enforcement of Subchapter A shall conform as nearly as practicable to the current "Rules for Testing Seed adopted by the Association of Official Seed Analysts" (AOSA) file at the Idaho Department of Agriculture, State Seed Lab located at 2240 Kellogg Lane, Boise, Idaho 83712. (3-20-20)T

**181. -- 189. (RESERVED)**

**190. SERVICE TESTING FEES -- PURITY, GERMINATION AND TETRAZOLIUM FEES.**

<b>Purity, Germination, and Tetrazolium Fees</b>			
<b>Kind of Seeds</b>	<b>Purity* \$/Unit</b>	<b>Germination \$/Unit</b>	<b>Tetrazolium** \$/Unit</b>
<b>AGRICULTURAL GRASS SEED</b>			
Bluegrasses	\$45	\$25	\$40
Bromegrasses	\$38	\$24	\$40
Fescues	\$35	\$22	\$40
Orchardgrass	\$38	\$25	\$40
Ryegrasses	\$38	\$23***	\$40
Timothy	\$28	\$23	\$40
For all others the hourly rate will apply			

<b>Purity, Germination, and Tetrazolium Fees</b>			
<b>Kind of Seeds</b>	<b>Purity* \$/Unit</b>	<b>Germination \$/Unit</b>	<b>Tetrazolium** \$/Unit</b>
<b>FIELD SEED</b>			
Alfalfa, clovers and trefoils	\$20	\$17	\$40
Cereals (Barley, Oats, Rice, Rye, Triticale and Wheat	\$25	\$17	\$40
Beans	\$18	\$16	\$40
Corn (all types)	\$20	\$17	\$40
Peas, and Lentils	\$18	\$17.50	\$40
<b>For all others the hourly rate will apply</b>			
<b>VEGETABLES, FLOWERS AND HERB SEED</b>			
Brassica (Canola, Cauliflower, Broccoli, Radish, etc.)	\$40	\$17	\$50
Beets and Swiss chard	\$29	\$32	\$40
Carrots, celery, dill and parsley	\$27	\$20	\$40
Curcubits (Squash, melons, etc.)	\$25	\$20	\$40
Flowers (Bachelors button, poppy, etc.)	\$40	\$25	\$50
Lettuce, tomato, and pepper	\$25	\$20	\$40
Onion and Chives	\$25	\$20	\$40
<b>For all others the hourly rate will apply</b>			
<b>TREE AND SHRUB SEED</b>			
Bitterbrush	\$40	\$30	\$50
Saltbush	\$60	\$30	\$50
Chokecherry and Woods' rose	\$25	\$60	\$60
Serviceberry, cliff-rose and mahogany	\$30	\$30	\$40
Trees (Firs, pines, spruces, etc.)	\$25	\$30	\$40
<b>For all others the hourly rate will apply</b>			
<b>RANGE AND NATIVE SEED</b>			
Bluestems and grammas	Hourly Rate	\$30	\$50
Globemallow and penstemons	\$40	\$30	\$50
Kochia and forage Kochia	\$30	\$30	\$40
Rushes and Sedges	Hourly Rate	\$30	\$50
Sagebrush and Rabbitbrush	Hourly Rate	\$30	\$40

<b>Purity, Germination, and Tetrazolium Fees</b>			
<b>Kind of Seeds</b>	<b>Purity* \$/Unit</b>	<b>Germination \$/Unit</b>	<b>Tetrazolium** \$/Unit</b>
Wheatgrasses, wildryes, and squirreltail	\$40	\$25	\$40
Winterfat	Hourly Rate	\$30	Hourly Rate
For all others the hourly rate will apply			

\* Samples with high levels of impurities (i.e. other crops, weeds, multiple florets, inert materials) requiring more than one (1) hour analyst time for purity testing will be charged the standard hourly rate of forty dollars (\$40) for each additional hour.

\*\* For all samples submitted for a TZ or Germination test requiring more than one (1) hour for cleaning and/or preparing will be charged at the standard hourly rate of forty dollars (\$40) for each additional hour.

\*\*\* With germination fluorescence testing thirty dollars (\$30). (3-20-20)T

**191. SERVICE TESTING FEES -- SPECIAL TESTS.**

<b>Special Testing Fees</b>	
<b>Test Procedures:</b>	<b>Fees \$/Unit</b>
All States Noxious	\$25
Canada:	
Purity	\$13 - Added to purity fee
Germination	\$2.50 - Added to germination fee
Certified Grains	\$13 - Added to purity fee
Cold Test	\$23.50
Crop & Weed Check	\$24.50
Dormancy Percentage	\$10 - Minimum or Dormant % found x germination fee
E.C. Norms	\$20
Ergot Check	\$13.50
Noxious Weed Germination (Compost/Mulch, etc.)	\$18
Noxious Weed Purity (Hay, Straw, etc.)	\$40
Identification	\$5 - Minimum or hourly if necessary
Inventory Germinations (For Carryover Seed Only, when requested)	20% discount of listed germination fee; Available only for the months of March through July.
ISTA:	
Purity	\$13 - Added to purity fee
Germination	\$2.50 - Added to germination fee

<b>Special Testing Fees</b>	
<b>Test Procedures:</b>	<b>Fees \$/Unit</b>
Mixtures:	
Purity	\$12.50 - Added per kind exceeding 5%
Germination	\$12.50 - Added per kind exceeding 5%
Tetrazolium	\$18 - Added per kind exceeding 5%
Moisture Test	\$14
Round-Up-Ready Trait Test (Alfalfa, Canola, Corn)	\$40
Sand Germination	\$25
Seed Count	\$13.50
Soil Exam	\$13.50
Sod Quality:	
Bentgrass	\$66
Bermudagrass	\$64
Bluegrass	\$64
Soil Germination	\$23.50
Species Exam	\$24.50
Undesirable Grass Species	\$25.50

(3-20-20)T

**192. SERVICE TESTING FEES -- MISCELLANEOUS FEES.**

<b>Miscellaneous Fees</b>	
<b>Type of Service:</b>	<b>Fees \$/Unit</b>
Administrative Charge per Test for Internet Access and Data Processing.	Not to exceed \$2 per test
Hourly Charge	\$40
Reports:	
Merge Records	\$4
Rush Service	\$25

(3-20-20)T

**193. -- (RESERVED)**

**194. SEED DEALER'S LICENSE FEES.**

Seed dealers shall obtain a seed dealer's license for each location in Idaho before they can sell, offer for sale, expose for sale or deliver agricultural seeds in packages of eight (8) ounces or more or bulk under contract within the state of Idaho. Seed dealers pay only for the service or services they render according to the following fee schedule:

(3-20-20)T

- 01. In-State Seed Dealer's License Fees:** (3-20-20)T
- a.** License to condition or clean agricultural seeds in Idaho - one-hundred dollars (\$100). (3-20-20)T
  - b.** License to label container or bulk agricultural seeds for sale in Idaho - fifty dollars (\$50). (3-20-20)T
  - c.** License to sell, offer for sale, expose for sale, or deliver agricultural seeds in packages of eight (8) ounces or more or in bulk under a contract in Idaho: (3-20-20)T
    - i.** For annual gross sales of five hundred dollars (\$500) or more, but less than one thousand dollars (\$1,000) - fifty dollars (\$50). (3-20-20)T
    - ii.** For annual gross sales of one thousand dollars (\$1,000) or more - one hundred dollars (\$100). (3-20-20)T
- 02. Out-of-State Seed Dealer's License Fee.** Three hundred fifty dollars (\$350). (3-20-20)T
- 03. Exemptions.** (3-20-20)T
- a.** Any person selling seed who has total annual gross seed sales not exceeding five hundred dollars (\$500) is exempt from Section 194. (3-20-20)T
  - b.** An in-state dealer or out-of-state dealer who sells, offers for sale, exposes for sale or delivers seed only in packages of less than eight (8) ounces is exempt from Section 194. (3-20-20)T
- 195. -- 209. (RESERVED)**

### SUBCHAPTER B – RAPESEED

- 210. DEFINITIONS.**  
The definitions in Section 210 apply to the interpretation and enforcement of Subchapter B only. (3-20-20)T
- 01. Producer.** Any person who is the owner, tenant, or operator of land who has an interest in and is entitled to receive all or any part of the proceeds from the sale of any commodity produced on that land. (3-20-20)T
  - 02. Rapeseed.** Those species of *Brassica napus*, *Brassica rapa* (formerly *Brassica campestris*), and *Brassica juncea*. (3-20-20)T
  - 03. Types.** Those species and varieties of rapeseed classified as follows: (3-20-20)T
    - a. Edible:** (3-20-20)T
      - i.** Low Erucic Acid Rapeseed -- Low Glucosinolates (LEAR-LG), commonly called “canola,” is the seed of the species *Brassica napus*, *Brassica juncea*, or *Brassica rapa*, the oil components of which seed contain less than two percent (2.0%) erucic acid and the seed meal will contain less than thirty (30) micromoles of any one (1) or any mixture of 3-butenyl glucosinolate, 4-pentenyl glucosinolate, 2-hydroxy - 3-butenyl glucosinolate, and 2-hydroxy - 4 pentenyl glucosinolate per gram ( $\mu\text{m/g}$ ) of air dry, oil free solid as determined by any approved method. (3-20-20)T
      - ii.** Low Erucic Acid Rapeseed -- High Glucosinolates (LEAR-HG) Rapeseed varieties shall contain less than two percent (2.0%) erucic acid in the oil of the rapeseed and more than thirty (30) micromoles per one (1) gram ( $\mu\text{m/g}$ ) glucosinolates in the rapeseed meal. (3-20-20)T
    - b. Industrial:** (3-20-20)T

i. High Erucic Acid Rapeseed -- Low Glucosinolates (HEAR-LG) Rapeseed are rapeseed varieties used for production of industrial oil that shall contain erucic acid levels above forty percent (40%) in the oil of the rapeseed and less than thirty (30) micromoles per one (1) gram ( $\mu\text{m/g}$ ) glucosinolates in the meal of the rapeseed. (3-20-20)T

ii. High Erucic Acid Rapeseed -- High Glucosinolates (HEAR-HG) Rapeseed are rapeseed varieties used for production of industrial oil that shall contain erucic acid levels above forty percent (40%) in the oil of the rapeseed and more than thirty (30) micromoles per one (1) gram ( $\mu\text{m/g}$ ) glucosinolates in the meal of the rapeseed. (3-20-20)T

**04. Volunteer Rapeseed.** A plant that arises from accidental or unintentional scattering of seed. (3-20-20)T

**05. Condiment Mustard.** Varieties of *Brassica juncea* produced for seed to be used for spice or condiment. (3-20-20)T

**06. Green Manure Rapeseed.** Varieties of rapeseed used as a cover crop to be plowed down prior to flowering and maturity. (3-20-20)T

**211. (RESERVED)**

**212. PRODUCTION DISTRICTS.**

**01. District I.** All land in Idaho not listed under District II in Subsection 212.02 of Subchapter B. (3-20-20)T

**02. District II.** All land within the boundaries of Ada, Canyon, Gem, Owyhee (north of Murphy) and Payette counties. (3-20-20)T

**213. -- 219. (RESERVED)**

**220. RESTRICTIONS.**

**01. District I.** Except as otherwise provided in Subchapter B, industrial and edible types of rapeseed may be planted in District I. (3-20-20)T

**02. District II.** Except as otherwise provided in Subchapter B, no rapeseed of either variety may be planted in District II. (3-20-20)T

**03. Restrictions:** (3-20-20)T

**a.** Industrial types of rapeseed planted in District I must adhere to the following conditions: (3-20-20)T

i. It is the responsibility of the person planting industrial types of rapeseed in District I to consult with and obtain the written approval from all farmers bordering the fields to be planted with industrial types of rapeseed. (3-20-20)T

ii. Industrial types of rapeseed planted in District I must be at least one (1) mile from a field planted to edible types of rapeseed. (3-20-20)T

**221. -- 229. (RESERVED)**

**230. REQUIREMENTS FOR ALL BRASSICA SEEDS TO BE PLANTED IN IDAHO.**

**01. Requirements.** All *Brassica* seeds to be planted in Idaho shall meet the following requirements. (3-20-20)T

**a.** *Brassica* seeds shall be treated with an EPA and State registered fungicide for the control of blackleg (*Leptosphaeria maculans*). (3-20-20)T

**b.** *Brassica* seed lots produced outside Idaho shall be accompanied by a phytosanitary certificate stating that the seed is free (zero tolerance) from blackleg based on a laboratory test of a minimum of two point nine (2.9) grams or one thousand (1,000) seeds. (3-20-20)T

**02. Exemptions.** The following are not subject to the provisions of Subsections 230.01.a. and 230.01.b. (3-20-20)T

**a.** *Brassica* seeds sold in lots of two (2) pounds or less. (3-20-20)T

**b.** *Brassica* seeds produced in Idaho. (3-20-20)T

**231. -- 239. (RESERVED)**

**240. RAPESEED GROWING OUTSIDE CULTIVATED FIELDS ENFORCEMENT AND PENALTIES.** Volunteer rapeseed plants within designated production districts shall be destroyed prior to flowering. The Director has the authority to require destruction of any rapeseed prior to flowering that has not met the provisions of Subchapter B. In the event that the person responsible for planting the rapeseed does not comply with the destruction order, the Director is authorized to have the rapeseed destroyed by a third party and the cost of destruction charged to the party responsible for planting the rapeseed. (3-20-20)T

**241. -- 249. (RESERVED)**

**250. TRANSPORTATION OF BRASSICA SEEDS INTO AND THROUGHOUT IDAHO.** Any transport of *Brassica* seeds shall be accomplished in suitably packaged, covered or sealed containers or vehicles in order to avoid the accidental spread of seed in non-production and prohibited areas. (3-20-20)T

**251. -- 309. (RESERVED)**

### SUBCHAPTER C – BLUEGRASS

**310. DEFINITIONS.** In addition to the definitions found in Section 22-2005, Idaho Code, the definitions found in Section 310 apply to the interpretation and enforcement of Subchapter C only. (3-20-20)T

**01. Annual Bluegrass.** *Poa annua* and all related species off-types or sub-species of *Poa annua*, hereinafter referred to as annual bluegrass. (3-20-20)T

**02. Annual Bluegrass Analysis Certificate.** A test report from an official laboratory showing freedom from annual bluegrass. (3-20-20)T

**03. Grass Species.** All bluegrass (*Poa*) species, fescue (*Festuca*) species, ryegrass (*Lolium*) species and all bentgrass (*Acrostic*) species. (3-20-20)T

**04. Official Seed Laboratory.** A seed testing laboratory approved by the Director. (3-20-20)T

**05. Annual Bluegrass Quarantine Release Tag.** A numbered tag printed and issued by the Idaho Department of Agriculture to be attached to each bag showing said seed has met quarantine requirements and giving the following information: "This lot of seed was tested and found to be apparently free of annual bluegrass and is eligible for planting in Idaho." (3-20-20)T

**06. Rough Bluegrass Quarantine Release Tag.** A numbered tag printed and issued by the Idaho State Department of Agriculture to be attached to each bag showing said seed has met quarantine requirements and giving

the following information: “This lot of seed was tested and found to be apparently free of rough bluegrass and is eligible for planting in Idaho.” (3-20-20)T

**07. Regulated Pest.** The seeds of *Poa annua* (Annual bluegrass) and all related off-types or sub-species of *Poa annua* hereinafter referred to as Annual bluegrass that are objectionable in grass seed stock, are considered weeds for the purposes of this chapter. (3-20-20)T

**08. Representative Sample.** A sample of seed drawn in accordance to Subchapter A of this rule. (3-20-20)T

**09. Rough Bluegrass.** *Poa trivialis* and all related off-types or sub-species of *Poa trivialis*, hereinafter referred to as rough bluegrass. (3-20-20)T

**10. Rough Bluegrass Analysis Certificate.** A test report from an official laboratory showing freedom from rough bluegrass. (3-20-20)T

**11. Seed Stock.** Those seeds of grass species that are to be planted for seed increase or with intent of seed increase. (3-20-20)T

**311. -- 319. (RESERVED)**

**320. ANNUAL BLUEGRASS REGULATED AREA.**  
The regulated area is the entire state of Idaho. (3-20-20)T

**321. ROUGH BLUEGRASS REGULATED AREA.**  
The regulated areas are the Idaho counties of Benewah, Bingham, Blaine, Bonner, Camas, Clark, Clearwater, Elmore, Idaho, Jerome, Kootenai, Latah, Lewis, Madison, Nez Perce, Power, Shoshone and Twin Falls. (3-20-20)T

**322. ROUGH BLUEGRASS QUARANTINE – RESTRICTIONS.**  
No rough bluegrass shall be planted for seed production in the regulated areas. (3-20-20)T

**323. -- 329. (RESERVED)**

**330. REGULATED ARTICLES.**  
Those articles that are regulated are seed stocks as defined in Subsection 310.11. (3-20-20)T

**331. -- 339. (RESERVED)**

**340. RULES GOVERNING PLANTING OF REGULATED ARTICLES (ANNUAL BLUEGRASS).**

**01. Requirements.** Prior to any person planting any grass species seed stock in Idaho, that person shall comply with the following requirements: (3-20-20)T

**a.** Submit for an official laboratory analysis a representative sample showing freedom from annual bluegrass based on a five (5) gram sample for bentgrass or redtop, a twenty-five (25) gram sample for bluegrass, or a fifty (50) gram sample for other grasses; or (3-20-20)T

**b.** Have a representative sample submitted for testing. (3-20-20)T

**02. Tags.** Upon receipt by the Director of an official seed laboratory analysis showing freedom from annual bluegrass, sequentially numbered tags will be issued for each bag found free of annual bluegrass from those lots according to Subsection 310.06. (3-20-20)T

**03. Analysis Certificate.** In lieu of tags, a seed analysis certificate from an official seed laboratory showing each lot being planted to be free from annual bluegrass must be kept on file for a minimum of one (1) year after all of the inventory of that lot’s harvested seed has been sold. (3-20-20)T



**341. QUALIFICATIONS OF REGULATED ARTICLES FOR QUARANTINE RELEASE (ROUGH BLUEGRASS).**

**01. Planting Seed Stock of Regulated Articles.** Any person planting seed stock of regulated articles shall comply with the following requirements: (3-20-20)T

**a.** Submit to the Director an official laboratory analysis of a representative sample showing freedom from rough bluegrass based on a five (5) gram sample for bentgrass or redtop, a twenty-five (25) gram sample for bluegrass, or a fifty (50) gram sample for other grasses; or (3-20-20)T

**b.** Submit to the Director a representative sample for laboratory analysis. (3-20-20)T

**02. Quarantine Release Tag.** Upon receipt of an official seed laboratory analysis, the Director may upon request issue sequentially numbered tags for each bag of regulated article found free of rough bluegrass. (3-20-20)T

**03. Analysis Certificate.** In lieu of tags, a seed analysis certificate from an official seed laboratory showing each lot being planted to be free from rough bluegrass must be kept on file for a minimum of one (1) year after all of the inventory of that lots harvested seed has been sold. (3-20-20)T

**342. -- 349. (RESERVED)**

**350. INFESTED SEED STOCK (ANNUAL BLUEGRASS).**

Each lot of seed found to contain annual bluegrass shall be placed under a "Hold Order" pursuant to Section 22-103(20), Idaho Code, to be released only for shipment out of Idaho or for planting in nurseries of two (2) acres or less under supervision of the Director. The nursery shall be seeded in rows spaced twenty-four (24) inches apart and it is the duty of the person receiving such seed to rogue this increase area or chemically treat to eradicate the annual bluegrass. Seed increases shall be inspected by the department or the Idaho Crop Improvement Association at least three (3) times during the seedling year. Any areas not passing inspection shall not be harvested but is destroyed upon the order of the Director at the owner's expense. (3-20-20)T

**351. ROUGH BLUEGRASS QUARANTINE - INSPECTIONS.**

The Director will cause inspections to be made in accordance with the provisions of Section 22-2007, Idaho Code. (3-20-20)T

**01. Infested Seed Stock.** Lots of turf seed stock contaminated with rough bluegrass seeds may be planted in an approved nursery of two (2) acres or less under the supervision of the Director. The nursery shall be seeded in rows spaced twenty-four (24) inches apart and it is the duty of the person receiving such seed stock to rogue the planting or chemically treat to eradicate the rough bluegrass. The approved nursery will be inspected by the Department or the Idaho Crop Improvement Association at least three (3) times during the seedling year. Any approved nursery not passing inspection shall not be harvested but will be destroyed upon the order of the Director at the owner's expense. (3-20-20)T

**352. -- 359. (RESERVED)**

**360. APPLICATION FOR NURSERY INSPECTION.**

A person shall make application for nursery inspection to the Idaho Department of Agriculture or the Idaho Crop Improvement Association at least fourteen (14) days prior to planting. (3-20-20)T

**361. -- 369. (RESERVED)**

**370. EXEMPTIONS (ANNUAL BLUEGRASS).**

**01. Forage.** These rules do not apply to seed sown for forage. (3-20-20)T

**02. Experiments.** These rules do not apply to: (3-20-20)T

- a. Experiments or trial grounds of the United States Department of Agriculture; or (3-20-20)T
- b. Experiments or trial grounds of the Idaho State Experiment Station; or (3-20-20)T
- c. Trial grounds of any person, firm, or corporation provided said trial ground plantings are approved by the Director and under supervision of technically-trained personnel familiar with annual bluegrass control. (3-20-20)T

**371. EXEMPTIONS (ROUGH BLUEGRASS).**

**01. Experiments or Trial Grounds.** This quarantine shall not apply to: experiments or trial grounds of the United States Department of Agriculture, experiments or trial grounds of the University of Idaho Agriculture Experiment Station, or trial grounds of any person, provided said trial ground plantings are approved by the Director and under supervision of technically-trained personnel familiar with rough bluegrass. (3-20-20)T

**02. Rough Bluegrass.** Rough bluegrass may be planted in the regulated areas for turf but shall not be allowed to mature to the seed producing stage. (3-20-20)T

**372. -- 379. (RESERVED)**

**380. FEES AND CHARGES.**

**01. Sampling.** Fees for official sampling drawn by the Director are twelve dollars (\$12) per sample. (3-20-20)T

**02. Seed Analysis.** Fees for seed analysis are that fee provided in the fee schedule of the official Seed Testing Laboratory. (3-20-20)T

**03. Inspection.** Inspection fees for nursery plantings are fifty dollars (\$50) per acre or portion thereof for each inspection. Any field of less than one acre is a minimum fee of fifty dollars (\$50). (3-20-20)T

**04. Quarantine Release Tags.** Quarantine release tags will be twenty-five cents (\$0.25) per tag and charged to person(s) when issued. (3-20-20)T

**381. -- 999. (RESERVED)**

## 02.06.02 – RULES GOVERNING REGISTRATIONS AND LICENSES

### 000. LEGAL AUTHORITY.

This chapter is adopted under the legal authority of Sections 22-604, 22-2204, 22-2303(5), 22-2503, 22-2511, and 25-2710, Idaho Code. (3-20-20)T

### 001. TITLE AND SCOPE.

01. **Title.** The title of this chapter is IDAPA 02.06.02, “Rules Governing Registrations and Licenses.” (3-20-20)T

02. **Scope.** These rules specify general commercial feed, fertilizer, and soil and plant amendment product registration and label requirements, and provide inspection authorities. These rules establish a fee schedule for special nursery and florist services and set forth conditions under which a shipping permit will be issued. These rules are also to prevent the introduction or further dissemination of certain bee diseases by providing authority to enter, inspect, and control bee pests and levy penalties. (3-20-20)T

### 002. -- 103. (RESERVED)

## SUBCHAPTER A – COMMERCIAL FEED

### 104. INCORPORATION BY REFERENCE.

The following documents are incorporated by reference into this Subchapter A: (3-20-20)T

01. **The Association of American Feed Control Officials (AAFCO) Official Publication.** The Terms, Ingredient Definitions and Policies as published in the “2020 Official Publication” of AAFCO where those terms and ingredient definitions, and policy statements do not conflict with terms and ingredient definitions, and policy statements adopted under Title 25, Chapter 27, Idaho Code, and any rule promulgated thereunder. A copy may be purchased online from the AAFCO website at: [www.aaeco.org](http://www.aaeco.org). (3-20-20)T

02. **The Merck Index.** The “2013 Merck Index,” 15th Edition, as published by Merck Research Laboratories Division of Merck & Co., Incorporated. The Merck Index is a copyrighted publication and not available in an electronic format. A copy may be purchased online from Merck & Co., Inc at: <http://www.rsc.org/merckindex>. (3-20-20)T

### 105. -- 109. (RESERVED)

### 110. DEFINITIONS AND TERMS.

In addition to the definitions found in Section 25-2703, Idaho Code, the following definitions apply in the interpretation and enforcement of Subchapter A only: (3-20-20)T

01. **All Life Stages.** Gestation/lactation, growth, and adult maintenance life stages. (3-20-20)T

02. **Family.** A group of products, which are nutritionally adequate for any or all life stages based on their nutritional similarity to a lead product, that has been successfully test-fed according to an AAFCO feeding protocol(s). (3-20-20)T

03. **Hay.** The aerial portion of grass or herbage especially cut, cured and baled or stacked for animal feeding, without further processing. (3-20-20)T

04. **Immediate Container.** The unit, can, box, tin, bag, or other receptacle or covering in which a pet food or specialty pet food is displayed for sale to retail purchasers, but does not include containers used as shipping containers. (3-20-20)T

05. **Ingredient Statement.** A collective and contiguous listing on the label of the ingredients of which the pet food or specialty pet food is composed. (3-20-20)T

06. **Principal Display Panel.** The part of a label that is most likely to be displayed, presented, shown, or examined under normal and customary conditions of display for retail sale and may include the front, back, or side panels of the package. (3-20-20)T

**07. Viable Noxious Weed Seed.** Any seed or propagule of a noxious weed, as identified or listed by Title 22, Chapter 24, Idaho Code, or any rules promulgated thereunder, that has not been ground fine enough or otherwise treated to destroy the ability to germinate. (3-20-20)T

**111. -- 114. (RESERVED)**

**115. REGISTRATION AND FEES.**

**01. Product Registration Fee.** Whenever a commercial feed is registered for distribution in the state of Idaho, a fee of forty dollars (\$40) per product will be collected. (3-20-20)T

**a.** The Department will utilize these funds for the operation of all program activities, including but not limited to, registration, label review, inspection and sampling, and laboratory analysis. (3-20-20)T

**b.** The fee will be set by the Department such that all costs associated with the commercial feed program will be covered by the registration fee without the need for additional state general or dedicated funding. (3-20-20)T

**02. Product Registration Fee Exemption.** Sellers who are not regularly engaged in the business of manufacturing or selling commercial feed and whose total amount of gross annual sales does not exceed five hundred dollars (\$500) are exempt from payment of the registration fee. However, the Department retains the right to inspect any feed in the possession of those persons exempted by Subsection 115.02 at any time. (3-20-20)T

**a.** This exemption pertains to the registration fee only, and does not exempt a person or business from other sections of Subchapter A and/or the Idaho Commercial Feed Law. (3-20-20)T

**b.** The Department reserves the right to review the records of sellers who are claiming or who have claimed that they are exempt from the payment of the registration fee, in order to ensure that they qualify for the exemption. (3-20-20)T

**c.** The Department further reserves the right to conduct any and all inspections allowed under Section 25-2709, Idaho Code, in order to ensure compliance with Subchapter A and/or the Idaho Commercial Feed Law. (3-20-20)T

**116. -- 119. (RESERVED)**

**120. LABEL FORMAT.**

**01. Label Format.** Commercial feeds shall be labeled with the information prescribed in Subchapter A on the principal display panel of the product and in the following general format. (3-20-20)T

**a.** Net Weight. (3-20-20)T

**b.** Product name and brand name if any. (3-20-20)T

**c.** If a drug is used, the required directions for use and precautionary statements or reference to their location if the detailed feeding directions and precautionary statements appear elsewhere on the label. (3-20-20)T

**d.** The guaranteed analysis of the feed as required under the provisions of Section 25-2705(1)(c) of the Commercial Feed Law includes the following items, unless exempted, and in the order listed: (3-20-20)T

**i.** Minimum percentage of crude protein. (3-20-20)T

**ii.** Maximum or minimum percentage of equivalent protein from non-protein nitrogen. (3-20-20)T

**iii.** Minimum percentage of crude fat. (3-20-20)T

- iv. Maximum percentage of crude fiber. (3-20-20)T
- v. Minerals, to include, in the following order: minimum and maximum percentages of calcium (Ca), minimum percentage of phosphorus (P), minimum and maximum percentages of salt (NaCl), and other minerals. (3-20-20)T
- vi. Vitamins. (3-20-20)T
- vii. Total sugars as invert on dried molasses products or products being sold primarily for their sugar content. (3-20-20)T
- viii. Exemptions. Guarantees for minerals are not required when there are no specific label claims and when the commercial feed contains less than six and one-half percent (6 1/2%) of Calcium, Phosphorus, Sodium, or Chloride. Guarantees for vitamins are not required when the commercial feed is neither formulated for nor represented in any manner as a vitamin supplement. Guarantees for crude protein, crude fat, and crude fiber are not required when the commercial feed is intended for purposes other than to furnish these substances or they are of minor significance relating to the primary purpose of the product, such as drug premixes, mineral or vitamin supplements, and molasses. (3-20-20)T
- e. Feed ingredients, collective terms for the grouping of feed ingredients, or appropriate statements as provided under the provisions of Section 25-2705(1)(d) of the Commercial Feed Law shall be listed in decreasing order of predominance by weight: (3-20-20)T
- i. The name of each ingredient as defined in the Official Publication of the Association of American Feed Control Officials, common or usual name, or one approved by the Director. (3-20-20)T
- ii. Collective terms for the grouping of feed ingredients as defined in the Official Definitions of Feed Ingredients published in the Official Publication of the Association of American Feed Control Officials in lieu of the individual ingredients; provided that when a collective term for a group of ingredients is used on the label, individual ingredients within that group shall not be listed on the label. The manufacturer shall provide the feed control official, upon request, with a list of individual ingredients within a defined group, that are or have been used at manufacturing facilities distributing in or into the state. (3-20-20)T
- iii. The registrant may affix the statement, "ingredients as registered with the State" in lieu of the ingredient list on the label. The list of ingredients must be on file with the Director. This list shall be made available to the feed purchaser upon request. (3-20-20)T
- f. Name and principal mailing address of the manufacturer or person responsible for distributing the feed. The principal mailing address shall include the street address, city, state, and zip code; however, the street address may be omitted if it is shown in the current city directory or telephone directory. (3-20-20)T
- g. The information required in Section 25-2705 of the Commercial Feed Law must appear in its entirety on the principal display panel of the container. (3-20-20)T
- h. Labeling shall include all statements and promotion on company websites or other internet based customer interfaces. (3-20-20)T
- 02. Customer Formula Invoice and Tag Requirements.** (3-20-20)T
- a. Bulk shipments of customer-formula feed shall be accompanied by an invoice, delivery slip or other shipping documents identifying the shipment as customer-formula feed and the name and address of the customer to whose order it is made. (3-20-20)T
- b. Bagged customer-formula feed will be labeled with a tag identifying each bag as such. The total bags in each customer's shipment will be segregated from other bagged feed and identified with the name and address of the customer to whose order it is made. (3-20-20)T

c. Nutritional guarantees and guarantees of other analytes, and a list of ingredients, in descending order of predominance by weight, of a customer-formula feed may be used in lieu of specific weights or volumes of each ingredient, as required in Section 25-2705(2)(d), Idaho Code, when so ordered by the customer. (3-20-20)T

**121. -- 124. (RESERVED)**

**125. BRAND AND PRODUCT NAMES.**

**01. Intended Use.** The brand or product name must be appropriate for the intended use of the feed and must not be misleading. If the name indicates the feed is made for a specific use, the character of the feed must conform therewith. A mixture labeled "Dairy Feed," for example, must be suitable for that purpose. (3-20-20)T

**126. -- 129. (RESERVED)**

**130. EXPRESSION OF GUARANTEES.**

**01. Percentage by Weight.** The guarantees for crude protein, equivalent protein from non-protein nitrogen, crude fat, crude fiber and mineral guarantees (when required) will be in terms of percentage by weight. (3-20-20)T

**02. Commercial Feeds.** Commercial feeds containing six and one-half percent (6 1/2%) or more Calcium, Phosphorus, Sodium or Chloride shall include in the guaranteed analysis the minimum and maximum percentages of calcium (Ca), the minimum percentage of phosphorus (P), and if salt is added, the minimum and maximum percentage of salt (NaCl). Minerals, except salt (NaCl) shall be guaranteed in terms of percentage of the element. When calcium and/or salt guarantees are given in the guaranteed analysis such shall be stated and conform to the following: (3-20-20)T

a. When the minimum is five percent (5%) or less, the maximum will not exceed the minimum by more than one (1) percentage point. (3-20-20)T

b. When the minimum is above five percent (5%), the maximum will not exceed the minimum by more than twenty percent (20%) and in no case shall the maximum exceed the minimum by more than five (5) percentage points. (3-20-20)T

**03. Vitamin Content.** Guarantees for minimum vitamin content of commercial feeds and feed supplements, when made, shall be stated on the label in milligrams per pound of feed except that: (3-20-20)T

a. Vitamin A, other than precursors of vitamin A, shall be stated in International or USP units per pound. (3-20-20)T

b. Vitamin D, in products offered for poultry feeding, shall be stated in International Chick Units per pound. (3-20-20)T

c. Vitamin D for other uses shall be stated in International or USP units per pound. (3-20-20)T

d. Vitamin E shall be stated in International USP units per pound. (3-20-20)T

e. Guarantees for vitamin content on the label of a commercial feed shall state the guarantee as true vitamins, not compounds, with the exception of the compounds, Pyridoxine Hydrochloride, Choline Chloride, Thiamine, and d-Pantothenic Acid. (3-20-20)T

f. Oils and premixes containing vitamin A or vitamin D or both may be labeled to show vitamin content in terms of units per gram. (3-20-20)T

**131. -- 134. (RESERVED)**

**135. NON-PROTEIN NITROGEN.**

**01. Urea.** Urea and other non-protein nitrogen products defined in the Official Publication of the Association of American Feed Control Officials or by the Director are acceptable ingredients only in commercial feeds for ruminant animals as a source of equivalent crude protein. If the commercial feed contains more than eight and seventy-five hundredths percent (8.75%) of equivalent crude protein from all forms of non-protein nitrogen, added as such, or the equivalent crude protein from all forms of non-protein nitrogen, added as such, exceeds one-third (1/3) of the total crude protein, the label shall bear adequate directions for the safe use of feeds and a precautionary statement: "CAUTION: USE AS DIRECTED." The directions for use and the caution statement shall be in type of such size so placed on the label that they will be read and understood by ordinary persons under customary conditions of purchase and use. (3-20-20)T

**02. Non-Protein Nitrogen Defined.** Non-protein nitrogen defined in the Official Publication of the Association of American Feed Control Officials, when so indicated, are acceptable ingredients in commercial feeds distributed to non-ruminant animals as a source of nutrients other than equivalent crude protein. The maximum equivalent crude protein from non-protein nitrogen sources when used in non-ruminant rations shall not exceed one and twenty-five hundredths percent (1.25%) of the total daily ration. (3-20-20)T

**03. Labels for Medicated Feeds.** On labels such as those for medicated feeds that bear adequate feeding directions and/or warning statements, the presence of added non-protein nitrogen shall not require a duplication of the feeding directions or the precautionary statements as long as those statements include sufficient information to ensure the safe and effective use of this product due to the presence of non-protein nitrogen. (3-20-20)T

**136. -- 139. (RESERVED)**

**140. DRUG AND FEED ADDITIVES.**

**01. Satisfactory Evidence.** Satisfactory evidence of safety and efficacy of a commercial feed may be: (3-20-20)T

**a.** When the commercial feed contains such additives, the use of which conforms to the requirements of the applicable regulation in the Code of Federal Regulations, Title 21, or which are "prior sanctioned" or "generally recognized as safe" for such use; or (3-20-20)T

**b.** When the commercial feed is itself a drug and is generally recognized as safe and effective for the labeled use or is marketed subject to an application approved by the Food and Drug Administration under Title 21 U.S.C. 360(b). (3-20-20)T

**141. -- 144. (RESERVED)**

**145. ADULTERANTS.**

**01. Substances.** For the purpose of Section 25-2707, Idaho Code, of the Commercial Feed Law, the terms "poisonous or deleterious substances" include, but are not limited to, the following: (3-20-20)T

**a.** Fluorine and any mineral or mineral mixture that is to be used directly for the feeding of domestic animals and in which the fluorine exceeds two tenths percent (0.2%) for breeding and dairy cattle; three tenths percent (0.3%) for slaughter cattle; three tenths percent (0.3%) for sheep; thirty-five hundredths percent (0.35%) for lambs; forty-five hundredths percent (0.45%) for swine; and six tenths percent (0.6%) for poultry. (3-20-20)T

**b.** Fluorine bearing ingredients when used in such amounts that they raise the fluorine content of the total ration (exclusive of roughage) above the following amounts: four thousandths percent (0.004%) for breeding and dairy cattle; nine thousandths percent (0.009%) for slaughter cattle; six thousandths percent (0.006%) for sheep; one hundredths percent (0.01%) for lambs; fifteen thousandths percent (0.015%) for swine and three hundredths percent (0.03%) for poultry. (3-20-20)T

**c.** Fluorine bearing ingredients incorporated in any feed that is fed directly to cattle, sheep or goats

consuming roughage (with or without) limited amounts of grain, that results in a daily fluorine intake in excess of fifty (50) milligrams of fluorine per one hundred (100) pounds of body weight. (3-20-20)T

**d.** Soybean meal, flakes or pellets or other vegetable meals, flakes or pellets that have been extracted with trichlorethylene or other chlorinated solvents. (3-20-20)T

**e.** Sulfur dioxide, Sulfurous acid, and salts of Sulfurous acid when used in or on feeds of feed ingredients that are considered or reported to be a significant source of vitamin B1 (Thiamine). (3-20-20)T

**02. Screenings or By-Products.** All screenings or by-products of grains and seeds containing weed seeds, when used in commercial feed or sold as such to the ultimate consumer, shall be ground fine enough or otherwise treated to destroy the viability of such weed seeds. (3-20-20)T

**03. Viable Noxious Weed Seed.** Viable noxious weed seed as defined in Subsection 110.07. (3-20-20)T

**146. -- 149. (RESERVED)**

**150. ADOPTIONS AND PROMULGATION.**

All rules heretofore adopted and promulgated August 16, 1971 pertaining to the Idaho Commercial Feed Law, Title 25, Chapter 27, Idaho Code, are hereby repealed, and are replaced by Subchapter A. (3-20-20)T

**151. -- 159. (RESERVED)**

**160. COTTONSEED.**

**01. Certification.** Prior to entry into the state of Idaho all shipments of cottonseed or cottonseed seed products destined for animal feed shall be certified as having been sampled and analyzed and no greater amount than twenty (20) ppb of aflatoxin shall be contained within the product or products, except that cottonseed meal intended for use as an animal feed or feed ingredient for beef cattle, swine and poultry, may be certified to contain more than twenty (20) ppb but less than three hundred (300) ppb of aflatoxin. (3-20-20)T

**02. Storage Location and Destination.** Whole cottonseed, cottonseed meal or cottonseed seed products entering the state certified to contain no greater than twenty (20) ppb aflatoxin, or cottonseed meal certified to contain more than twenty (20) ppb but less than three hundred (300) ppb aflatoxin shall be accompanied by the certification document aboard carrier, be identified with a storage location at destination, and the certification document shall be maintained on file at the shipment destination for no less than one (1) year. In the case of bulk rail car shipments, the certification document shall accompany the invoice or bill-of-lading and be identified with a storage location at destination. The certification document shall be maintained on file at the shipment destination for no less than one (1) year. (3-20-20)T

**03. Registration.** Idaho firms wishing to import into the state and/or handle cottonseed meal containing more than twenty (20) ppb but less than three hundred (300) ppb aflatoxin for distribution or sale shall register annually with the Department their intent to do so. Feedlots and other end user operations importing the cottonseed meal as defined above in this paragraph for their own use are exempted from registration requirement. The importing firm shall also register the cottonseed meal (if not already registered by another firm) with the Department and pay any applicable registration fees (Sections 25-2704, Idaho Code). As a condition of registration, firms importing and/or handling cottonseed meal certified to contain more than twenty (20) ppb but less than three hundred (300) ppb aflatoxin, shall enter into a compliance agreement with the Department agreeing to: (3-20-20)T

**a.** Store and label cottonseed meal certified to contain more than twenty (20) ppb but less than three hundred (300) ppb aflatoxin separately from cottonseed meal certified to contain less than twenty (20) ppb aflatoxin; (3-20-20)T

**b.** Inform the purchaser in writing of the certified aflatoxin level in the meal purchased; and (3-20-20)T



- c. Submit to periodic record and facility inspections, and product testing by the Department. (3-20-20)T

**04. Certification Performance.** Required certification will be performed by any state government or Federal government engaged in this type of certification. In the event that a state government or Federal government laboratory is not available, an independent or company laboratory may upon request be approved by the Department. Requests and approval shall be made in advance of the shipment entering the state. (3-20-20)T

**161. -- 169. (RESERVED)**

**170. COTTONSEED -- EXEMPTIONS.**

Cottonseed hulls are exempted from laboratory certification requirements as stated in Subsections 160.01 through 160.04, provided that, cottonseed hulls shall not contain greater than twenty (20) ppb aflatoxin as required by the U. S. Food and Drug Administration. Any invoice or bill of lading accompanying or sent in regard to a shipment of cottonseed hulls shall state the level of aflatoxin in parts per billion contained in the shipment. (3-20-20)T

**171. -- 179. (RESERVED)**

**180. DETAINED COMMERCIAL FEEDS.**

**01. Stop Sale, Use, or Removal.** Any commercial feed or identified lot of commercial feed that is the subject of a "stop sale, use, or removal" order under Section 25-2711(1), Idaho Code, may be released from such an order by the following means: (3-20-20)T

- a. A commercial feed detained for nutritional violation(s) may be: (3-20-20)T
- i. Remanufactured, using ingredients listed on the approved label, to meet label guarantees. The remixed feed shall be resampled and analyzed to ensure compliance prior to its return to sale. (3-20-20)T
  - ii. Relabeled to reflect actual values, upon approval of a new label and registration, provided that these values are appropriate for their intended use. (3-20-20)T
  - iii. Returned to the manufacturer if the seller and manufacturer are not the same. (3-20-20)T
  - iv. Diverted to an alternate use such as inclusion into another feed, or feeding to the manufacturer's own livestock, provided that it is appropriate for the diverted use and that it does not conflict with labeling or other State or Federal requirements for the diverted use. (3-20-20)T
  - v. Destroyed. (3-20-20)T
- b. A commercial feed detained for a drug or antibiotic violation may be: (3-20-20)T
- i. Remanufactured to meet label guarantees. The remixed feed shall be resampled and analyzed prior to its return to sale. (3-20-20)T
  - ii. Returned to the manufacturer if the seller and manufacturer are not the same. (3-20-20)T
  - iii. Diverted to an alternate use, provided that it is appropriate for the diverted use labeling or other State or Federal requirements for the diverted use. (3-20-20)T
  - iv. Destroyed. (3-20-20)T
- c. A commercial feed deemed to be adulterated under Section 25-2707(1), Idaho Code, or that cannot safely be remanufactured, relabeled, or diverted to an alternate use may be: (3-20-20)T
- i. Returned to the manufacturer if the seller and manufacturer are not the same. (3-20-20)T

ii. Destroyed. (3-20-20)T

**02. Appropriate Compliance Procedure.** The Department will indicate which of the above listed compliance procedures are appropriate for the particular “withdrawal from sale” order. The seller shall indicate which procedure is to be followed and, upon approval from the Department, shall carry out the procedure within thirty (30) days. Other procedures may be considered upon application by the state inspector or seller to the Department, Bureau of Feeds and Plant Services, Idaho Department of Agriculture, Boise, Idaho. (3-20-20)T

**03. Violation of Stop Sale, Use, or Removal Order.** Any violation of the terms or conditions of a Stop Sale, Use, or Removal Order is considered a prohibited act. (3-20-20)T

**181. -- 211. (RESERVED)**

### **SUBCHAPTER B – NURSERIES AND FLORISTS**

**212. SPECIAL SERVICE.**

When nurseries or florists require additional inspections and special services, a special service fee will be charged. Refer to IDAPA 02.06.04, “Rules Governing Plant Exports,” Section 195, “Fees and Charges,” for a complete schedule of services and fees. (3-20-20)T

**213. -- 219. (RESERVED)**

**220. SHIPPING PERMIT NUMBER.**

Upon request, a licensed nurseryman who holds a valid certificate of inspection from the Idaho Department of Agriculture for his nursery will be issued a shipping permit number. Application for a number must be made annually, and the use of the number is subject to the following conditions: (3-20-20)T

**01. Accompaniment.** The shipping permit number shall accompany all shipments and deliveries of nursery stock. (3-20-20)T

**02. Changes.** Once issued, the shipping permit number will not change unless request is made for a new number. (3-20-20)T

**03. Application Deadline.** Application for a number or renewal of a number must be made by January 1 of each year. Failure to do so will result in suspension of the shipping permit number. (3-20-20)T

**04. Fees.** A number will be issued or renewed only after the proper nursery license fees have been paid for the current license year. A shipping permit number will be held in abeyance until the proper license fees are paid. (3-20-20)T

**05. Reissue Application.** If the business entity of a licensee is changed, or if the membership of a partnership is changed, irrespective of whether or not the business name is changed, application for reissuance of the shipping permit number must be made to the Idaho Department of Agriculture. (3-20-20)T

**06. Permit Number.** The shipping permit number, if printed on containers or cartons, will read as follows:

(SEAL)

IDAHO DEPARTMENT OF AGRICULTURE  
DIVISION OF PLANT INDUSTRIES  
BOISE, IDAHO 83701

SHIPPING  
PERMIT NO.

The nursery doing business under the above permit number has been regularly inspected and, to the best of our knowledge, is free from dangerous insect pests and diseases.

(3-20-20)T

**07. No Other Statements.** No other statements, other than the business name and address, may appear on the side of the container on which the shipping permit number and accompanying statement are printed. The printing of the shipping permit number is the responsibility of the licensee and all costs incurred in printing are his responsibility. (3-20-20)T

**221. -- 309. (RESERVED)**

### **SUBCHAPTER C – BEE INSPECTION**

**310. DEFINITIONS.**

The Department adopts the definitions set forth in Section 22-2502, Idaho Code for the interpretation and enforcement of Subchapter C only. (3-20-20)T

**311. -- 314. (RESERVED)**

**315. REGULATED BEE DISEASES.**

Specifically, American foulbrood, European foulbrood, sac brood and bee paralysis, Varroa mite, tracheal mite, or any other disease or abnormal condition of egg, larval, pupal, or adult stages of honey bees, hereinafter is referred to as bee diseases. (3-20-20)T

**316. -- 329. (RESERVED)**

**330. REGULATED PRODUCTS AND RELATED EQUIPMENT.**

Subchapter C concerns any stage of the common honey bee, *Apis mellifera* L., all equipment used in handling and manipulation of bees, wax, and hives, and includes any containers for honey and wax that may be used in any apiary or in transporting bees and their products and apiary supplies that are located within the state of Idaho. (3-20-20)T

**331. -- 339. (RESERVED)**

**340. REGISTRATION AND COLLECTION OF FEES.**

On or before July 1 of each year any person engaging in the activities of apicultural shall file with the Idaho Department of Agriculture a "Registration" form provided by the Idaho Department of Agriculture specifying the name, residence, place of apiaries, number of hives or colonies of bees owned or controlled, and such other information as may be required, accompanied by the applicable registration fee. (3-20-20)T

**341. -- 349. (RESERVED)**

**350. INSPECTION PROCEDURES.**

**01. Request for Inspection.** All beekeepers requiring an apiary inspection shall complete the "Request for Inspection" form provided by the Department of Agriculture that includes name, address, telephone number of the applicant, number of colonies to be inspected and the state(s) to which entry is desired. The applicant agrees to pay the costs of the inspection according to the fee schedule in Section 370. The request for inspection must be returned to the Department of Agriculture no later than August 15 of each year. Late requests will be accepted through August 31, after which no requests for inspection will be accepted. No inspections will be conducted after November 15 of each year. Apiaries found free of disease will be entitled to receive a health certificate valid for one (1) year from date of issuance permitting access to those states that require and recognize Idaho certification. (3-20-20)T

**02. Disease Inspection.** The apiary inspector will inspect for all diseases and pests cited in Section

315, specifically for American foulbrood and Varroa mite or other bee diseases as specified by the importing state regulatory agency. (3-20-20)T

**03. Posting of Registration.** All apiaries located within the state of Idaho shall be conspicuously posted with the name, address and telephone number and state registration number of the owner. (3-20-20)T

**04. Necessary Precautions.** The apiary inspector will take all necessary precautions to properly disinfect all tools and any other thing that may have come into contact with diseased bees or equipment to prevent spread of the disease. (3-20-20)T

**351. -- 359. (RESERVED)**

**360. DUTY OF OWNER OF BEES.**

**01. Compliance With Rules.** Upon receipt of disease notification, the owner shall control the disease through the use of registered and approved agents in accordance with label directions or eradicate the disease by burning, then burying under not less than eighteen (18) inches of soil, the contaminated bees and equipment. (3-20-20)T

**02. Quarantined Apiary.** Bees shall not be removed from an infested or quarantined apiary without permission, in writing, from the Director or the Director's agents. (3-20-20)T

**361. -- 369. (RESERVED)**

**370. FEES AND CHARGES.**

**01. Inspection, Sampling and Other Field Work:** (3-20-20)T

**a.** Inspection time: fifteen dollars (\$15) per hour. (3-20-20)T

**b.** Travel costs: mileage, meals and lodging will be charged according to established state rates. (3-20-20)T

**02. Laboratory Examination.** Twenty-five dollars (\$25) per worker hour. (3-20-20)T

**371. -- 403. (RESERVED)**

**SUBCHAPTER D – FERTILIZER**

**404. INCORPORATION BY REFERENCE.**  
The following documents are incorporated by reference into Subchapter D: (3-20-20)T

**01. The Association of American Plant Food Control Officials (AAPFCO) Official Publication.** The Terms, Ingredient Definitions, and Policies, as published in the "2020 Official Publication" of AAPFCO where those terms and ingredient definitions, and policy statements do not conflict with terms and ingredient definitions, and policy statements adopted under Title 22, Chapter 6, Idaho Code, and any rule promulgated thereunder. A copy may be purchased online from the AAPFCO website at: [www.aapfco.org](http://www.aapfco.org). (3-20-20)T

**02. The Merck Index.** The "2013 Merck Index," 15th Edition as published by Merck Research Laboratories Division of Merck & Co., Incorporated. The Merck Index is a copyrighted publication and not available in an electronic format. A copy may be purchased online from Merck & Co., Inc. (now hosted by the Royal Society of Chemistry) at: <http://www.rsc.org/merckindex>. (3-20-20)T

**03. The Association of Official Agricultural Chemists (AOAC) International.** The "2019 Official Methods of Analysis (OMA) of the AOAC," 21st Edition, a copyrighted publication, is maintained and published by the AOAC International. The AOAC OMA is available in electronic format at: [www.EOMA.AOAC.org](http://www.EOMA.AOAC.org). A copy may

be purchased online from AOAC International. (3-20-20)T

**405. -- 409. (RESERVED)**

**410. DEFINITIONS.**

In addition to the definitions found in Section 22-603, Idaho Code, the definitions in Subsection 410 apply in the interpretation and enforcement of Subchapter D only. (3-20-20)T

**01. Guarantee.** An affirmation or promise made by the seller to the buyer that relates to the goods and becomes part of the basis of the bargain and creates an express warranty that the fertilizer shall conform to the affirmation or promise. (3-20-20)T

**02. Ultimate Dealer.** The person who distributes fertilizer product to the end-user. (3-20-20)T

**411. -- 419. (RESERVED)**

**420. SAMPLING AND ANALYSIS.**

The methods of sampling and analysis are those of the Association of Official Analytical Chemists (AOAC) or other methods as approved by the department. (3-20-20)T

**421. -- 429. (RESERVED)**

**430. RULES REGARDING THE REGISTRATION OF FERTILIZERS CONTAINING PLANT NUTRIENTS IN ADDITION TO NITROGEN, PHOSPHATE, AND POTASH.**

**01. Other Plant Nutrients.** A fertilizer may contain plant nutrients in addition to nitrogen, phosphate and potash. When these other nutrients are mentioned on the label in any form or manner, the fertilizer shall be registered. In addition, each nutrient amount shall be guaranteed, with the guarantee reported on the label on an elemental basis. Sources of the nutrients subjected to the guaranteed analysis, and proof of availability shall be provided to the department upon request. Any additional nutrients, contained in a fertilizer submitted for registration, must be present in the following minimum concentrations:

Element	Percent
Calcium (Ca)	1.0000
Magnesium (Mg)	0.5000
Sulfur (S)	1.0000
Boron (B)	0.0200
Chlorine (Cl)	0.1000
Cobalt (Co)	0.0005
Copper (Cu)	0.0500
Iron (Fe)	0.1000
Manganese (Mn)	0.0500
Molybdenum (Mo)	0.0005
Nickel (Ni)	0.0010
Sodium (Na)	0.1000
Zinc (Zn)	0.0500

(3-20-20)T

**02. Labeling.** The label shall constitute a guarantee regarding the nutrient content of the fertilizer. No nutrients, other than those listed in Subsection 430.01, will be accepted by the department as guaranteed. Proposed labels and directions for the use of the fertilizer shall be furnished with the application for registration upon request. Any of the above listed elements that are guaranteed shall appear in the order listed immediately following guarantees for the primary nutrients of nitrogen, phosphate and potash. (3-20-20)T

**03. Exemptions.** Guarantees for water soluble nutrients labeled for ready-to-use foliar fertilizers, ready-to-use specialty liquid fertilizers, hydroponic or continuous liquid feed programs, and potting soils, are exempted from the minimum element percentages listed in Subsection 430.01. (3-20-20)T

**431. -- 439. (RESERVED)**

**440. WARNING OR CAUTION STATEMENTS.**

A warning or cautionary statement is required on any fertilizer product: (3-20-20)T

**01. Containing Boron.** If the fertilizer product contains one tenth of a percent (.10%) or more boron in a water soluble form, the statement shall include: (3-20-20)T

- a. The word "Warning" or "Caution" conspicuously displayed; (3-20-20)T
- b. The crops for which the fertilizer is recommended; and (3-20-20)T
- c. That the use of the fertilizer on any crop(s) other than those recommended may result in serious injury to the crop(s). (3-20-20)T

**02. Containing Molybdenum.** If the fertilizer product contains one thousandths of a percent (.001%) or more molybdenum, the statement shall include: (3-20-20)T

- a. The word "Warning" or "Caution" conspicuously displayed; and (3-20-20)T
- b. That the application of fertilizers containing molybdenum may result in forage crops containing levels of molybdenum that are toxic to ruminant animals. (3-20-20)T

**03. Other Fertilizer Products.** The department may require a registrant to include a warning or caution statement for any other fertilizer product that contains a micro-nutrient in water soluble form for which there is evidence that application of the micro-nutrient may be harmful to certain crops or where there are unusual environmental conditions. (3-20-20)T

**04. Examples.** The following are examples of warning or caution statements: (3-20-20)T

- a. Directions: Apply this fertilizer at a maximum rate of (number of pounds) per acre for (name of crop). (3-20-20)T
- b. CAUTION: Do not use on other crops. The (name of micro-nutrient) may cause injury to them. (3-20-20)T
- c. CAUTION: Apply this fertilizer at a maximum rate of (number of pounds) per acre for (name of crop). Do not use on other crops; the (name of micro-nutrient) may cause serious injury to them. (3-20-20)T
- d. WARNING: This fertilizer carries added (name(s) of micro-nutrient(s)) and is intended for use only on (name of crop). Its use on any other crops or under conditions other than those recommended may result in serious injury to the crops. (3-20-20)T
- e. CAUTION: This fertilizer is to be used only on soil that responds to (name of micro-nutrient). Crops high in (name of micro-nutrient) are toxic to grazing animals (ruminants). (3-20-20)T
- f. Caution: (Name of micro-nutrient) is recommended for all crops where (name of micro-nutrient)

may be deficient; however excessive application to susceptible crops may cause damage. (3-20-20)T

**441. -- 449. (RESERVED)**

**450. FERTILIZER LABELS.**

The following information, in the format presented, is the minimum required for all fertilizer labels. For packaged products, this information shall either appear on the package, or be printed on a tag and attached to the package. This information shall be in a readable and conspicuous form. For bulk products, this same information in written or printed form shall accompany delivery and be supplied to the purchaser at time of delivery. (3-20-20)T

**01. Net Weight or Net Volume, If Liquid.** Weight per gallon shall be included on the label of liquid fertilizers if net volume is stated. (3-20-20)T

**02. Brand.** (3-20-20)T

**03. Grade.** Grade (provided that the grade shall not be required when no primary nutrients are claimed). (3-20-20)T

**04. Guaranteed Analysis.** A fertilizer label must contain the results of the guaranteed analysis. Zero (0) guarantees should not be made and shall not appear in any statement except in nutrient guarantee itemizations. The sliding scale method of expressing a guaranteed analysis on fertilizer labels (for example, "Available Phosphate fifteen to eighteen percent (15-18%)") is prohibited. If chemical forms of nitrogen are claimed or required, said form shall be set forth on the label. Nutrients other than nitrogen, phosphate and potash shall be set forth, on an elemental basis, as required by Subsection 430.01. The results of the guaranteed analysis required by Subchapter D of this rule shall be in the following form:

Total Nitrogen	(N). _____%
_____%	Ammoniacal Nitrogen
_____%	Nitrate Nitrogen
_____%	Water Insoluble Nitrogen
_____%	Urea Nitrogen
_____%	(Other recognized and determinable forms of N)
Available Phosphate (P <sub>2</sub> O <sub>5</sub> )	_____%
Soluble Potash (K <sub>2</sub> O)	_____%
(Other nutrients, elemental basis)	_____%

(3-20-20)T

**05. Sources.** Sources of nutrients shall be listed below the completed guaranteed analysis statement. (3-20-20)T

**06. Name and Address.** Name and address of manufacturer, guarantor or registrant. (3-20-20)T

**07. Specialty Fertilizers.** For specialty fertilizers distributed to the end user, the label shall set forth adequate directions for use. Such directions may include, but are not limited to: (3-20-20)T

**a.** The recommended application rate or rates in units of weight or volume per unit of area coverage (where application rates are given in volume, the manufacturer shall provide the bulk density for the product on the

label); (3-20-20)T

**b.** Proper seasonal times and minimum intervals to apply the product when plants can rapidly utilize nutrients and loss to the environment can be minimized; and (3-20-20)T

**c.** The statement “Apply Only As Directed” or a statement of similar designation. (3-20-20)T

**08. Packaging.** Refer to Idaho Department of Agriculture rules, IDAPA 02.02.14, “Rules for Weights and Measures,” for the specific requirements relating to product identity, declaration of quantity and prescribed units. (3-20-20)T

**451. -- 454. (RESERVED)**

**455. PRODUCT REGISTRATION.**

**01. Registration.** All fertilizer companies, including companies engaged in custom-formula mixing of dry or liquid fertilizers, shall comply with the product registration requirements of the Idaho Fertilizer Act of 2000, Section 22-605, Idaho Code, subject to the provisions of this Subchapter D. (3-20-20)T

**02. Alteration From Original State.** When a fertilizer is mixed, added to, or in any way changed from its original grade or its content of secondary or minor nutrients, it is a different product, and must be registered as provided under Section 22-605, Idaho Code. (3-20-20)T

**03. Registering -- Altered Fertilizers.** When a registered grade is altered by any commercial fertilizer manufacturer or ultimate dealer, such manufacturer or ultimate dealer, shall register the altered grade as provided under Section 22-605, Idaho Code. (3-20-20)T

**04. Brand Name.** The addition of another prominent name or graphic design to the brand displayed on the label, other than descriptive words associated with the grade, constitutes a different brand and thus, must be registered as provided under Section 22-605, Idaho Code. For example, changing “Rose Bud 5-10-5” to “Kilmer’s Rose Bud 5-10-5” would constitute a change in brand. (3-20-20)T

**05. Sale of Fertilizer.** When a commercial fertilizer is removed from the package or vehicle in which it was placed by the original registrant and then offered for sale by a person other than the original registrant, it is a different product and shall be registered in accordance with Section 22-605, Idaho Code, except that it is not subject to an additional inspection fee as provided under Section 22-608, Idaho Code, provided that said fee was paid on the product by the original or prior registrant. (3-20-20)T

**456. -- 459. (RESERVED)**

**460. SLOWLY RELEASED PLANT NUTRIENTS.**

**01. Slow Release.** No fertilizer label shall bear a statement that connotes or implies that certain plant nutrients contained in a fertilizer are released slowly over a period of time, unless the slow release components are identified and guaranteed at a level of at least fifteen percent (15%) of the total guarantee for that nutrient(s). (3-20-20)T

**02. Slow Release Properties.** Types of products with slow release properties currently recognized by the department for the purposes of a guarantee include: (3-20-20)T

**a.** Water insoluble, such as natural organics, ureaform materials, urea-formaldehyde products, isobutylidene diurea, oxamide, etc.; (3-20-20)T

**b.** Coated slow release, such as sulfur coated urea and other encapsulated soluble fertilizers; (3-20-20)T

**c.** Occluded slow release, where fertilizers or fertilizer materials are mixed with waxes, resins, or



other inert materials and formed into particles; and (3-20-20)T

**d.** Products containing water soluble nitrogen such as ureaform materials, urea-formaldehyde products, methylenediurea (MDU), dimethylenetriura (DMTU), dicyanodiamide (DCD), etc. (3-20-20)T

**03. Additional Products May Be Added to List of Slow Release Nutrients.** The department may add additional products to the list of recognized slow release nutrients upon an appropriate showing by a registrant. The terms, “water insoluble,” “coated slow release,” “slow release,” “controlled release,” “slowly available water soluble,” and “occluded slow release,” are accepted as descriptive of these products, provided the manufacturer can show a testing program substantiating the claim. Testing shall be under guidance of Experiment Station personnel or a recognized researcher acceptable to the department. A laboratory procedure, acceptable to the department for evaluating the release characteristics of the product(s), must also be provided by the manufacturer. (3-20-20)T

**04. Methods.** Unless otherwise specified by the department, AOAC International Method 970.04 (15th Edition) is to be used to confirm the coated slow release and occluded slow release nutrients and others whose slow release characteristics depend on particle size. AOAC International Method 945.01 (15th Edition) shall be used to determine the water insoluble nitrogen of organic materials. (3-20-20)T

**461. -- 469. (RESERVED)**

**470. INVESTIGATIONAL ALLOWANCES.**

**01. Use of Investigational Allowances.** Investigational Allowances will be used in determining whether a fertilizer is deficient. Fertilizers that are deemed deficient are subject to penalty. Penalties for deficient fertilizers are found in Section 22-611, Idaho Code. (3-20-20)T

**02. Deeming a Fertilizer Deficient.** A fertilizer will be deemed deficient if the analysis of any nutrient is below the guarantee by an amount exceeding the values in the following schedules, or if the overall index value of the fertilizer is below ninety-seven percent (97%). Note: For these investigational allowances to be applicable, the recommended AOAC International procedures for obtaining samples, preparation and analysis must be used. These are described in Official Methods of Analysis of the Association of Official Analytical Chemists, 13th Edition, 1980, and in succeeding issues of the Journal of the Association of Official Analytical Chemists. In evaluating replicate data, Table 19, page 935, Journal of the Association of Official Analytical Chemists, Volume 49, No. 5, October, 1966, should be followed. (3-20-20)T

**03. Investigational Allowances for Nitrogen, Phosphate and Potash.** For guaranteed percentages not listed in the following table, calculate the appropriate investigational allowance by interpolation.

Guaranteed Percent	Nitrogen Percent	Available Phosphate Percent	Potash Percent
04 or less	0.49	0.67	0.41
05	0.51	0.67	0.43
06	0.52	0.67	0.47
07	0.54	0.68	0.53
08	0.55	0.68	0.60
09	0.57	0.68	0.65
10	0.58	0.69	0.70
12	0.61	0.69	0.79
14	0.63	0.70	0.87

<b>Guaranteed Percent</b>	<b>Nitrogen Percent</b>	<b>Available Phosphate Percent</b>	<b>Potash Percent</b>
16	0.67	0.70	0.94
18	0.70	0.71	1.01
20	0.73	0.72	1.08
22	0.75	0.72	1.15
24	0.78	0.73	1.21
26	0.81	0.73	1.27
28	0.83	0.74	1.33
30	0.86	0.75	1.39
32 or more (*)	0.88	0.76	1.44

(\*For DAP and MAP, the Investigational Allowance for Available Phosphate is zero point seventy (0.70); for TSP, the Investigational Allowance shall be: one point fifty-two (1.52)). For dry custom mix fertilizers, an additional five percent (5%) of the guaranteed percentage shall be granted in addition to the allowances made in Subsection 470.03. (3-20-20)T

**04. Investigational Allowance for Other Nutrients.** Secondary and minor elements shall be deemed deficient if any element is below the guarantee by an amount exceeding the values in the following schedule:

<b>Element</b>	<b>Investigational Allowance</b>
Calcium	) 0.2 unit + 5% of guarantee
Magnesium	) 0.2 unit + 5% of guarantee
Sulfur	) 0.2 unit + 5% of guarantee
Boron	) 0.003 unit + 15% of guarantee
Cobalt	) 0.0001 unit + 30% of guarantee
Chlorine	) 0.005 unit + 10% of guarantee
Copper	) 0.005 unit + 10% of guarantee
Iron	) 0.005 unit + 10% of guarantee
Manganese	) 0.005 unit + 10% of guarantee
Molybdenum	) 0.0001 unit + 30% of guarantee
Sodium	) 0.005 unit + 10% of guarantee
Zinc	) 0.005 unit + 10% of guarantee

The maximum allowance when calculated as specified shall be one (1) unit (one percent (1%)). For dry custom mix fertilizers, an additional five percent (5%) of the guarantee shall be granted in addition to the allowances made above in this section. (3-20-20)T

**05. Overall Index Value.** The overall index value is calculated by comparing the commercial dollar value guaranteed with the commercial dollar value found (Commercial Dollar Value found / Commercial dollar value guaranteed) x 100). Unit dollar values of the nutrients used are those referred to in Section 22-612, Idaho Code. The Department will conduct periodic surveys of the industry to determine unit dollar values. (3-20-20)T

**06. Examples.** The following are examples of calculations for a custom mixed fertilizer of a 12-16-14 grade. For the purpose of these examples, the nutrient unit dollar values for all of the examples are assumed to be twenty-three cents (\$.23) per pound of nitrogen, twenty-seven cents (\$.27) per pound of available phosphate (P<sub>2</sub>O<sub>5</sub>), and eighteen cents (\$.18) per pound of potash (K<sub>2</sub>O).

Example 1. A ten thousand (10,000) pound batch of customer formula fertilizer guaranteed at 12.0-16.0-14.0 is analyzed and found at 10.6-16.4-14.3

Nutrient	Guaranteed	x price/lb	Found	x price/lb
N	12.0	\$2.76 (\$.23 x 12.0)	10.6	\$2.438 (\$.23 x 10.6)
P <sub>2</sub> O <sub>5</sub>	16.0	\$4.32 (\$.27 x 16.0)	16.4	\$4.428 (\$.27 x 16.4)
K <sub>2</sub> O	14.0	\$2.52 (\$.18 x 14.0)	14.3	\$2.574 (\$.18 x 14.3)
Total		\$9.60		\$9.44

Overall Index Value = (\$9.44/\$9.60) x 100 = 98.3%

However, the nitrogen value is in violation. The investigational allowance for a nitrogen guarantee of 12.0% is 0.61% (see the chart in section 02.06.12.050.03 above) plus an additional 5% of the guarantee for customer formula mixes. Therefore the nitrogen value must be at least 10.79%: (12.0 - [.61 + 12.0(.05)] = 10.79%) in order to be within permissible values.

To find the amount (Lbs.) of N deficiency multiply the percent guaranteed by the weight of the lot minus the percentage found multiplied by the weight of the lot.

$$(.12) (12\%) \text{ guaranteed} \times 10,000 \text{ lbs} - (.106) (10.6\%) \text{ found} \times 10,000 \text{ lbs} = 140 \text{ pounds}$$

The penalty will be calculated as three times the value of a deficiency of 140 pounds of nitrogen in the 10,000 pound batch.  $3 \times [140 (\$.23)] = \$96.60$

Example 2. A ten thousand (10,000) pound batch of customer formula fertilizer guaranteed at 12.0-16.0-14.0 is analyzed at 11.1-15.3-13.1.

Nutrient	Guaranteed	x price/lb	Found	x price/lb
N	12.0	\$2.76 (\$.23 x 12.0)	11.1	\$2.553 (\$.23 x 11.1)
P <sub>2</sub> O <sub>5</sub>	16.0	\$4.32 (\$.27 x 16.0)	15.3	\$4.131 (\$.27 x 15.3)
K <sub>2</sub> O	14.0	\$2.52 (\$.18 x 14.0)	13.1	\$2.358 (\$.18 x 13.1)
Total		\$9.60		\$9.042

Overall Index Value = (\$9.042/\$9.60) x 100 = 94.2%

Although each of the individual nutrients is within the investigational allowance, the cumulative deficiency is reflected in the Overall Index Value.

The investigational allowance table shows for a nitrogen guarantee of 12%, the allowance is 0.61%. An additional allowance of 5% of the guarantee is 0.60%. The minimum nitrogen value is then 12.0 - [.61 + (.05 x 12)] = 10.79.

The minimum acceptable values for P<sub>2</sub>O<sub>5</sub> and K<sub>2</sub>O will be 14.50 and 12.43, respectively.

The penalty will be calculated as follows:

Nutrient	Guaranteed lbs	-	Found lbs	=	Deficient lbs	x	price/lb
N	1200 (.12 x 10,000)	-	1110 (.111 x 10,000)	=	90	x	\$20.70 (\$.23 x 90 lbs)
P <sub>2</sub> O <sub>5</sub>	1600 (.16 x 10,000)	-	1530 (.153 x 10,000)	=	70	x	\$18.90 (\$.27 x 70 lbs)
K <sub>2</sub> O	1400 (.14 x 10,000)	-	1310 (.131 x 10,000)	=	90	x	\$16.20 (\$.18 x 90 lbs)
Total							\$55.80

3 (\$55.80) = \$167.40

If the examples were specialty fertilizers rather than customer formula mixes, the penalties will be assessed in accordance with Section 22-611, Idaho Code. (3-20-20)T

**471. -- 479. (RESERVED)**

**480. ITEMIZATION OF PLANT FOOD ELEMENTS WITHIN THE GUARANTEED ANALYSIS.**

When a product label sets forth the different components of plant nutrients, the percentage for each component shall be shown before that component's name.

<b>EXAMPLES:</b>	
<b>Total Nitrogen (N)</b>	_____ %
_____ %	Ammoniacal Nitrogen
_____ %	Nitrate Nitrogen
<b>Magnesium (Mg)</b>	_____ %
_____ %	Water Soluble Magnesium (Mg)
<b>Sulfur (S)</b>	_____ %
_____ %	Free Sulfur (S)
_____ %	Combined Sulfur (S)
<b>Iron (Fe)</b>	_____ %

EXAMPLES:	
_____ %	Chelated Iron (Fe)
_____ %	Manganese (Mn)
_____ %	Water Soluble Manganese (Mn)

(3-20-20)T

481. -- 489. (RESERVED)

**490. ORGANIC NITROGEN.**

If an amount of nitrogen is designated as organic then the water insoluble nitrogen or the slow release nitrogen guarantee must not be less than sixty percent (60%) of the nitrogen so designated. Coated urea shall not be included in meeting the sixty percent (60%) requirement. (3-20-20)T

491. -- 503. (RESERVED)

**SUBCHAPTER E – SOIL AND PLANT AMENDMENTS**

**504. INCORPORATION BY REFERENCE.**

The following documents are incorporated by reference into Subchapter E: (3-20-20)T

**01. The Association of American Plant Food Control Officials (AAPFCO) Official Publication.**

The Terms, Ingredient Definitions, and Policies, as published in the “2020 Official Publication” of AAPFCO where those terms and ingredient definitions, and policy statements do not conflict with terms and ingredient definitions, and policy statements adopted under Title 22, Chapter 6, Idaho Code, and any rule promulgated thereunder. A copy may be purchased online from the AAPFCO website at: [www.aapfco.org](http://www.aapfco.org). (3-20-20)T

**02. The Merck Index. The “2013 Merck Index,” 15th Edition as published by Merck Research Laboratories Division of Merck & Co., Incorporated.** The Merck Index is a copyrighted publication and not available in an electronic format. A copy may be purchased online from Merck & Co., Inc. (now hosted by the Royal Society of Chemistry) at <http://www.rsc.org/merckindex>. (3-20-20)T

**03. The Association of Official Agricultural Chemists (AOAC) International.** The “2019 Official Methods of Analysis (OMA) of the AOAC,” 21st Edition, a copyrighted publication, is maintained and published by the AOAC International. The AOAC OMA is available in electronic format at: [www.EOMA.AOAC.org](http://www.EOMA.AOAC.org). A copy may be purchased online from AOAC International. (3-20-20)T

505. -- 509. (RESERVED)

**510. DEFINITIONS.**

In addition to the definitions found in Section 22-2203, Idaho Code, the following definitions apply in the interpretation and enforcement of this Subchapter E only: (3-20-20)T

**01. Animal Manure.** The excreta of animals together with whatever bedding material is present. (3-20-20)T

**02. Dried Animal Manure.** Animal manure resulting from confined animal feeding operations manipulated only to reduce the moisture content. (3-20-20)T

**511. ABBREVIATIONS.**

- 01. AAPFCO.** Association of American Plant Food Control Officials. (3-20-20)T
- 02. AOAC.** Association of Official Analytical Chemists, International. (3-20-20)T
- 03. ISDA.** Idaho State Department of Agriculture. (3-20-20)T

**512. -- 519. (RESERVED)**

**520. SOIL AMENDMENT AND PLANT AMENDMENT REGISTRATION.**

Each separately identifiable soil amendment or plant amendment product shall be registered pursuant to Section 22-2205, Idaho Code. (3-20-20)T

**01. Product Registration.** All soil amendment and plant amendment companies, including companies engaged in custom-formula mixing of dry or liquid soil amendments or plant amendments, will comply with the product registration requirements of the Idaho Soil and Plant Amendment Act, Section 22-2205, Idaho Code, subject to the provisions of this chapter. (3-20-20)T

**02. Exemptions from Registration.** (3-20-20)T

**a.** Dried animal manure without nutrient claims and not commercially packaged or labeled. (3-20-20)T

**b.** Horticultural growing media containing live plant material. (3-20-20)T

**03.** Alteration from Original State. When a soil amendment or plant amendment that has been registered is mixed, added to, or in any way changed from its original content, it is a different product, and must be registered as provided under Section 22-2205, Idaho Code. (3-20-20)T

**04. Sale of Soil Amendment or Plant Amendment.** When a commercial soil amendment or plant amendment is removed from the package or container in which it was placed by the original registrant and then offered for sale by a person other than the original registrant, it is a different product and shall be registered in accordance with Section 22-2205, Idaho Code, except that it is not subject to an additional inspection fee as provided under Section 22-2208, Idaho Code, provided that said fee was paid on the product by the original or prior registrant. (3-20-20)T

**521. -- 529. (RESERVED)**

**530. SOIL AMENDMENT AND PLANT AMENDMENT LABELS.**

**01. Content or Guaranteed Analysis Exemptions.** (3-20-20)T

**a.** The labeling requirements of the Idaho Soil and Plant Amendments Act, Section 22-2207(1)(c), Idaho Code, requiring that soil and plant amending ingredients and other ingredients shall be stated in terms of percentage is required except the following single ingredient soil amendments, when clearly and conspicuously identified as such on the label, are exempt from the content or guaranteed analysis: (3-20-20)T

i. Mulch; (3-20-20)T

ii. Peat; (3-20-20)T

iii. Perlite; (3-20-20)T

iv. Vermiculite; and (3-20-20)T

v. Vermicompost. (3-20-20)T

**b.** In lieu of a content or guaranteed analysis as required in Section 22-2207(1)(c), Idaho Code, the label of the following soil amendments when clearly and conspicuously identified as such on the label may include an ingredient statement: (3-20-20)T

- i. Compost; (3-20-20)T
- ii. Garden Soil; (3-20-20)T
- iii. Landscape Soil; (3-20-20)T
- iv. Mulch; (3-20-20)T
- v. Planting Mix; and (3-20-20)T
- vi. Potting Mix. (3-20-20)T

**c.** In lieu of a content or guaranteed analysis as required in Section 22-2207(1)(c), Idaho Code, a product that claims the presence of a microbe(s), other than naturally occurring microbes, shall guarantee the microbe(s) as follows: (3-20-20)T

- i. Minimum number of each claimed viable organism at the genus and species level in colony forming units (CFU), spores or propagules per gram or milliliter (cm3); (3-20-20)T
- ii. Expiration date; and (3-20-20)T
- iii. Storage & handling instructions. (3-20-20)T

**02. Nutrient Claims and the Use of the Term “Fertilizer.”** (3-20-20)T

**a.** The term “fertilizer” and like terms shall not be used in labeling or literature to describe a soil amendment or plant amendment. (3-20-20)T

**b.** Nutrient claims do not change the primary intended use of a soil or plant amendment product. Any nutrient claim shall be provided on the labeling and literature as an estimated range and stated as a percentage. Nutrient claims and estimates must be supported by lab analysis or documentation acceptable by the ISDA. (3-20-20)T

**c.** Labeling or literature that makes nutrient claims or estimates is required to contain the following statement: “This product is recognized for its soil amendment characteristics. It is recognized that it has nutrient value. Any nutrient claims, verbal or written, are estimates and not guaranteed.” (3-20-20)T

**d.** At the discretion of the registrant, labeling or literature that does not make nutrient claims or estimates may contain the following statement: “This product is recognized for its soil amendment characteristics. It is recognized that it has nutrient value. Any nutrient claims, verbal or written, are estimates and not guaranteed.” (3-20-20)T

**e.** A guaranteed analysis of plant nutrients will be permitted on potting soils, landscape and garden soils, and related amendment products containing only levels of fertilizer sufficient to initiate growth. (3-20-20)T

**03. Microbiological Product.** If the soil amendment or plant amendment is a microbiological product intended as an inoculum, the product label shall include an expiration date and state the number and kind of viable organisms per milliliter or, if the product is other than liquid, state the number and kind of viable organisms per gram. However, if the soil amendment or plant amendment is derived from a microbiological process or culture but is not intended as an inoculum, then the product label shall state that the product is not a viable culture. (3-20-20)T

**04. Ninety-Five Percent Rule.** When a soil amendment or plant amendment is labeled as a specific

material, such as peat moss or leaf mold, the product shall consist of not less than ninety-five percent (95%) of that specific material. (3-20-20)T

**05. Other Ingredients.** When the name of an ingredient(s) appears on the label of a soil amendment or plant amendment and is not one of the ingredients required to be listed, the percentage of that ingredient(s) shall appear prominently in print of the same size and color. (3-20-20)T

**06. Warning or Caution Statements.** The ISDA may require a registrant to include a warning or caution statement to ensure safety to handlers, crops, and the environment. (3-20-20)T

**07. Precautionary Statements.** ISDA may require precautionary statements when needed for safe and effective use of the soil amendment or plant amendment. (3-20-20)T

**531. -- 539. (RESERVED)**

**540. SAMPLING AND ANALYSIS.**

The methods of sampling and analysis shall be those of AAPFCO, AOAC, or other methods as approved by the ISDA. (3-20-20)T

**541. -- 999. (RESERVED)**



## 02.06.04 – RULES GOVERNING PLANT EXPORTS

### 000. LEGAL AUTHORITY.

This chapter is adopted under the legal authority of Sections 22-107, 22-112, and 22-2303(5), Idaho Code.

(3-20-20)T

### 001. TITLE AND SCOPE.

01. **Title.** The title of this chapter is “Rules Governing Plant Exports.”

(3-20-20)T

02. **Scope.** These rules govern the production of pest-free plants and plant products, and provide procedures for compliance with phytosanitary regulations of other states and foreign countries, in order to protect Idaho agriculture from the introduction of foreign pests on imported plant materials. These rules also govern procedures for voluntary certification of virus-free nursery stock for export.

(3-20-20)T

### 002. – 109. (RESERVED)

## SUBCHAPTER A – PHYTOSANITARY AND POST-ENTRY SEED CERTIFICATION

### 110. DEFINITIONS.

The definitions found in Section 110 apply to the interpretation and enforcement of Subchapter A only:

(3-20-20)T

01. **Applicant.** Any person applying for an inspection or certification under Subchapter A.

(3-20-20)T

02. **Federal Phytosanitary Certificate.** This certificate is issued by the Department pursuant to a “Memorandum of Understanding” with the United States Department of Agriculture, Animal and Plant Health Inspection Service, Plant Protection and Quarantine, in accordance with the Code of Federal Regulations, Title 7, Part 353, Sections 353.1 - 353.7 as amended. This type certificate may only be issued for domestic plants and plant products being exported into a foreign country.

(3-20-20)T

03. **Federal Phytosanitary Certificate for Reexport.** This certificate is issued by the Department pursuant to a “Memorandum of Understanding” as referenced in Subsection 110.02 above. This type certificate may only be issued for plants and plant products of foreign origin to certify that, based on the original foreign phytosanitary certificate and/or an additional inspection, the plants and plant products entered the United States in conformance with the phytosanitary regulations of the importing country and have not been subjected to the risk of infestation or infection during storage in the United States. Shipments transiting the United States under a Customs bond are not eligible for reexport certification.

(3-20-20)T

04. **Post-Entry Quarantine Certification.** This program is carried out pursuant to a “Memorandum of Understanding” between the Department and the United States Department of Agriculture, Animal and Plant Health Inspection Service, Plant Protection and Quarantine, in accordance with the Code of Federal Regulations, Title 7, Part 319.37-7 as amended. The purpose of this program is to prevent the accidental introduction of plant pests in living plants that are imported into the United States and Idaho under permit.

(3-20-20)T

05. **Rush Service.** This service is to accommodate phytosanitary certification applications that must be issued earlier than the routine three (3) to four (4) day turn-around. This service will be carried out only after a mutual agreement between the applicant and the Department.

(3-20-20)T

06. **State Phytosanitary Certificate.** This certificate may be issued for shipments of Idaho produced plants and plant products to foreign or domestic locations. This certificate is issued to confirm a field or commodity inspection for foreign destinations. This certificate must be issued to the same standard as a federal certificate as outlined in Subsection 110.02. Idaho Crop Improvement Association field inspections may serve as the basis for the issuance of a state phytosanitary certificate for domestic markets only. This certificate will also bear any notation or comment the Director may make as to any findings concerning the inspection or import requirements of the products being certified.

(3-20-20)T

### 111. -- 119. (RESERVED)

### 120. DESIGNATED INSPECTION AREAS.

The land mass of the state has been divided into fourteen (14) “inspection areas” to facilitate the inspection of all seed-producing localities and to confine the loci of disease infestations when they arise. These areas will be

numbered serially and the boundaries of each remain fixed as described below. The cultural conditions, i.e., weather, elevation, soil type and general farming practices, are relatively uniform within each area; therefore, the disease content of the seed produced within each respective area may be expected to be uniform. (3-20-20)T

- 01. Area 1. Kootenai County. (3-20-20)T
- 02. Area 2. Benewah County. (3-20-20)T
- 03. Area 3. That portion of Latah County above two thousand (2,000) feet elevation and that portion of Nez Perce County north of the Clearwater River and above two thousand (2,000) feet elevation. (3-20-20)T
- 04. Area 4. That portion of Latah County below two thousand (2,000) feet elevation and all of the Clearwater River and below two thousand (2,000) feet elevation (3-20-20)T
- 05. Area 5. Lewis County. (3-20-20)T
- 06. Area 6. Canyon, Ada, Owyhee, Payette, Washington and Gem Counties. (3-20-20)T
- 07. Area 7. Gooding, Jerome, Lincoln and Elmore Counties. (3-20-20)T
- 08. Area 8. Twin Falls County. (3-20-20)T
- 09. Area 9. Cassia County. (3-20-20)T
- 10. Area 10. That portion of Minidoka County lying south of the main line of the Union Pacific Railroad. (3-20-20)T
- 11. Area 11. That portion of Minidoka County lying north of the main line of the Union Pacific Railroad. (3-20-20)T
- 12. Area 12. Bingham, Bonneville, Power and Bannock Counties. (3-20-20)T
- 13. Area 13. Jefferson, Madison, Fremont, Teton, Clark and Butte Counties. (3-20-20)T
- 14. Area 14. All other agricultural areas of the state not specifically designated above. (3-20-20)T

**121. -- 129. (RESERVED)**

**130. CROP/COMMODITY, DISEASE AND PEST(S) INSPECTIONS.**

01. **Minimum Field Inspection(s).** Unless otherwise requested by the applicant, minimum field inspections for diseases will be as follows: (3-20-20)T

a. Corn: Stewart's wilt, - *Erwinia stewartii* ((E.F.Sm.)Dye), head smut - *Sphacelotheca reiliana*, common smut - *Ustilago zeae* (U. maydis), and maize dwarf mosaic virus. (3-20-20)T

b. Peas: Bacterial blight, *Pseudomonas* species. (3-20-20)T

c. Beans: Halo Blight, caused by *Pseudomonas syringae* pv. *phaseolicola* (Burkholder 1926) Young, Dye & Wilkie 1978, (synonym *P. phaseolicola* (Burkholder 1926) Dawson 1943); common blight caused by *Xanthomonas campestris* pv. *phaseoli* (Smith 1897) Dye 1978, (synonyms *X. phaseoli* (Smith 1897) Dawson 1939, *X. phaseoli* var. *fuscans* (Burkholder 1930) Starr and Burkholder 1942); brown spot, caused by *Pseudomonas syringae* pv. *syringae*, van Hall 1902, (synonym *P. syringae*, van Hall 1902) only strains virulent to *Phaseolus* sp.; bacterial wilt, caused by *Corynebacterium flaccumfaciens* (Hedges 1922) Dawson 1942; or any variations or new strains of these bacteria, which are recognized as virulent to and seedborne in *Phaseolus* spp., and are a potential threat to seed production, all of which are hereafter referred to as bacterial diseases of beans. Anthracnose, *Colletotrichum lindemuthianum* (Sacc. and Magn.) Scrib. (3-20-20)T

- d. Alfalfa: Verticillium Wilt - *Verticillium albo-atrum*, stem and bulb nematode - *Ditylenchus dipsaci*. (3-20-20)T
- e. Lettuce: Lettuce mosaic virus. (3-20-20)T
- f. Radish: Bacterial spot - *Xanthomonas campestris pv. vesicatoria*, Anthracnose -- *Colletotrichum higginsianum*, blackleg - *Leptosphaera maculans*. (3-20-20)T
- g. Onion: Stem and bulb nematode -- *Ditylenchus dipsaci*, Onion white rot -- *Sclerotium cepivorum*, onion smut -- *Urocystis cepulae*, neck rot -- *Botrytis alli*, purple blotch -- *Alternari porri*. (3-20-20)T
- h. Carrot: Bacterial blight *Xanthomonas campestris pv. carotae*, soft rot - *Erwinia carotovera*. (3-20-20)T

**02. Special Inspection Requests.** Requests for inspection of plants and plant products for plant diseases or pests not specifically listed in Subchapter A will be performed subject to the availability of Department inspectors and the biology of the pest and plant or plant products for which the request is being made. Procedures for conducting the special field or commodity inspections, the time the inspection is to be made, and any charges or fees will be made at the discretion of the Department and may be in addition to those listed in Section 195. (3-20-20)T

**131. -- 139. (RESERVED)**

**140. APPLICATION FOR INSPECTION - PROCEDURES.**

**01. Application for Field Inspection.** Application(s) must include but will not be limited to the following: company name, grower name, crop, variety, lot number (if available), pest(s)/disease(s) inspections being requested, field location, number of acres and type of irrigation. Application(s) must be filed with the Idaho Department of Agriculture, Division of Plant Industries, P.O. Box 7249, Boise, ID 83707 or Idaho Department of Agriculture, Division of Plant Industries, P.O. Box 401, 434 Shoshone St. West, Twin Falls, Idaho 83303-0401, on forms provided by the Department. (3-20-20)T

**02. Application for Area Inspection (Peas and Corn Only).** Application shall be made in writing on company letterhead listing crop, grower name, variety, lot number, acres, and area grown in as outlined in Subsections 120.01 through 120.14. A minimum of two hundred (200) acres per company per designated inspection area must be submitted to be eligible for an area inspection. Applicants submitting under two hundred (200) acres within a designated inspection area must do so pursuant to Subsection 140.01 above. (3-20-20)T

**03. Deadlines.** Applications for individual and/or area field inspections are to be submitted no later than: April 30 for Alfalfa, May 1 for peas and mint, May 15 for lettuce, radish, onion, or other vegetable crops, and July 1 for beans and corn. Applications submitted after these dates will be performed only at the discretion of the Director. (3-20-20)T

**04. Special Field Inspection Requests.** Requests for field inspections of plants and plant products for diseases or pests not listed in Subsections 130.01.a. through 130.01.h. above shall be written in on the application as provided in Subsection 140.01 above and be subject to the conditions as outlined in Subsection 130.02. (3-20-20)T

**141. -- 149. (RESERVED)**

**150. INSPECTION AUTHORITY.**

The Director will authorize the crop inspections and will delegate competent agents or agencies to conduct the work. Phytosanitary certificates will be issued only by the Director. (3-20-20)T

**151. -- 159. (RESERVED)**

**160. INSPECTION PROCEDURES.**

**01. Mechanics of Inspection.** The mechanics of inspection for a particular crop(s) will be left to the discretion of the Department, but will take into account sound sampling procedures, the biology of the pest, and the crop being inspected. A crop will be inspected a minimum of, but not limited to, one (1) time during the growing season, depending on the biology of the pest or disease being inspected. (3-20-20)T

**02. Reports of Inspection Summaries and Requests for Inventory.** Written reports of the field and area inspections will be filed and retained in the office of the Director, for a minimum of five (5) years after the inspection of the fields is completed. At the end of each inspection season, each applicant will be sent a summary of the inspections performed with a request for any corrections or adjustments to be made as far as lot numbers, varietal names, or other information is concerned. A request will also be made at that time for the clean weights of the product harvested from each lot inspected. No phytosanitary certificate will be issued for any inspected lot for which there is incomplete documentation. (3-20-20)T

**03. Notification of the Detection of Disease(s) or Pest(s).** The Department will notify the applicant in writing upon the confirmation of the presence of a disease or pest. Notification will be limited to those disease(s) or pest(s) outlined in Subsections 130.01.a. through 130.01.h. above or as specifically requested on the applicant's application for inspection for phytosanitary certification pursuant to Subsection 140.04. (3-20-20)T

**161. -- 169. (RESERVED)**

**170. PROCEDURE FOR OBTAINING PHYTOSANITARY CERTIFICATES.**

**01. Requests for Phytosanitary Certificates.** Application shall be made in writing to the Department on the appropriate application form(s) provided by the Department for the certificate(s) being requested. Only fully completed applications will be accepted. Applications can be submitted to either the State of Idaho, Department of Agriculture, Plant Industries Division, P.O. Box 7249, Boise, ID 83707, or State of Idaho, Department of Agriculture, P.O. Box 401, Twin Falls, Idaho 83301. (3-20-20)T

**02. Application Information.** Applications for phytosanitary certificates must include, but will not be limited to the following information: variety, crop (including scientific name), lot number (in the case of blends, all lots used in the blend must be included), number of pounds in each lot, name of grower, area and year in which crop was grown, state number, consignor and consignee, and chemical treatment applied. (3-20-20)T

**03. "Rush" Service.** As defined in Subsection 110.05 must be requested before or upon submission of an application for phytosanitary certification. The request may be made by telephone. "Rush" service will be subject to the fees as outlined in Subsection 195.02.d. (3-20-20)T

**171. -- 179. (RESERVED)**

**180. SIZE OF SAMPLES.**

Size of samples for visual inspection for phytosanitary seed inspection certificates shall be: When shipment is: under two hundred (200) pounds - one half (1/2) pound sample (minimum); two hundred (200) pounds up to one thousand (1,000) pounds - two (2) pound samples; over one thousand (1,000) pounds - five (5) pound samples (maximum); or as may be required by the importing state or country. (3-20-20)T

**181. -- 189. (RESERVED)**

**190. POST-ENTRY QUARANTINE CERTIFICATION.**

Applications shall be made on forms provided by the Department and accompanied by the fee as stated in Subsection 195.05. The applicant must allow inspection by the Department as a condition of application approval, and additional inspections as required by the Department or the United States Department of Agriculture. The United States Department of Agriculture has final approval authority. The minimum period of the quarantine is two (2) years, with a minimum of one (1) inspection being performed during each of the two (2) years. (3-20-20)T

**191. -- 194. (RESERVED)**

**195. FEES AND CHARGES.**

- 01. Phytosanitary Certificates.** (3-20-20)T
- a.** Federal Phytosanitary Inspection Certificates or like documents: sixty dollars (\$60) per certificate. (3-20-20)T
- b.** State Phytosanitary Inspection Certificates or like documents: twenty-five dollars (\$25) per certificate. (3-20-20)T
- 02. Phytosanitary Certification and Like Inspections and Official Treatment Observations.** (3-20-20)T
- a.** Officially Drawn Samples: (i.e., purity and germ samples, referee samples, lab analysis) - twenty dollars (\$20) per sample. (3-20-20)T
- b.** Submitted Samples: twenty dollars (\$20) per item submitted. (3-20-20)T
- c.** Treatment Observations: for official verification of seed and plant treatment, seed lot fumigation, cold storage treatments, and treatment of agricultural products brought into the state in violation of a state quarantine, fees are thirty dollars (\$30) per hour (including travel time), and any per diem incurred. Per diem will be at established state rates. (3-20-20)T
- d.** Rush service fees will be one hundred dollars (\$100) per certification, which will be in addition to the normal phytosanitary certification charges outlined in this Section 195. (3-20-20)T
- e.** Request for phytosanitary or treatment observation services after normal working hours, on weekends, or holidays are subject to overtime and state per diem charges in addition to the normal charges outlined in this section. (3-20-20)T
- 03. Area Inspections.** Area Inspection: fourteen cents (\$.14) per hundred-weight. (3-20-20)T
- 04. Field or Lot Inspections.** (3-20-20)T
- a.** Application for Field Inspection: five dollars (\$5) per application. (3-20-20)T
- b.** Acreage Inspection Fee: three dollars and fifty cents (\$3.50) per acre per inspection. A minimum of fifty dollars (\$50) per inspection will be charged when the total acreage submitted by any one (1) applicant is fifteen (15) acres or less. (3-20-20)T
- 05. Post-Entry Quarantine Inspections.** The inspection fee is two hundred dollars (\$200) for the required two (2) year quarantine and an additional one hundred dollars (\$100) per year for each year beyond the initial two (2) years, if required. For rejected applications, twenty-five dollars (\$25) of the two hundred dollar (\$200) inspection fee is non-refundable, and will be retained to cover administrative costs. (3-20-20)T
- 06. Plant Pathological Laboratory Services.** Fees available upon request. (3-20-20)T
- 07. Special Project Fee.** (3-20-20)T
- a.** Special projects not covered by the existing fee schedule may be billed at twenty-five dollars (\$25) per hour with a minimum twenty-five dollar (\$25) fee. Special projects include, but are not limited to, the following: (3-20-20)T
- i.** Research; (3-20-20)T
- ii.** Lot history verification; (3-20-20)T
- iii.** Data entry; (3-20-20)T

- iv. Sales and purchases; (3-20-20)T
  - v. Transfer of lots into ISDA database; (3-20-20)T
  - vi. ISDA training of private company personnel; (3-20-20)T
  - vii. Special plant pest detection surveys; or (3-20-20)T
  - viii. Any other circumstance approved by the Director. (3-20-20)T
- b.** This fee does not include any laboratory analysis fees that might be required as part of a special plant pest detection survey. (3-20-20)T
- 196. -- 209. (RESERVED)**

**SUBCHAPTER B – VIRUS-FREE NURSERY STOCK CERTIFICATION**

**210. DEFINITIONS.**

In addition to the definitions found in Section 22-2302, Idaho Code, the definitions in Section 210 apply in the interpretation and enforcement of Subchapter B only: (3-20-20)T

**01. Certification.** Verification that proper field sampling procedures were followed and that the indexing results as outlined in this rule are those determined by an approved laboratory designated to test for virus diseases under Subchapter B. (3-20-20)T

**02. Idaho Certified Nursery Seed.** Seed produced from registered seed trees or commercial seed having been tested and found to have a transmissible virus content that does not exceed five percent (5%). (3-20-20)T

**03. Idaho Certified Nursery Stock.** Nursery-grown, true seedlings, clonal rootstocks originating from certified virus-free trees, and nursery-grown trees or seedlings propagated by using top-stock from certified virus-free trees and rootstock originating from certified virus-free trees except as herein provided for certain rootstocks. (3-20-20)T

**04. Index.** To determine virus infection by means of inoculation from the plant to be tested to an indicator plant or by any other acceptable method as designated by the Director. (3-20-20)T

**05. Indicator Plant.** Any herbaceous or woody plant used to index or determine virus infection. (3-20-20)T

**06. Interstock.** Scionwood used for compatibility purposes to graft between a particular top-stock and rootstock. (3-20-20)T

**07. Nursery Stock.** For purposes of this rule includes the plants and plant parts of the genera *Prunus*, *Malus*, *Pyrus*, *Chaenomeles* and *Cydonia*. (3-20-20)T

**08. Off-Type.** Not true-to-name (phenotype) as registered under Subchapter B. (3-20-20)T

**09. Registered Tree.** A tree or clonal planting that has been inspected and tested in accordance with the provisions of this program and assigned a registration number by the Department. (3-20-20)T

**10. Rootstock.** That part of a plant including the roots on which another variety of plant material may be grafted. (3-20-20)T

**11. Scion-Block.** A planting of certified virus-free trees that serves as a source of scionwood for the

propagation of “Idaho certified nursery stock.” (3-20-20)T

**12. Scion (Scionwood).** A detached shoot or other portion of a plant consisting of one or more buds used in propagation by grafting. (3-20-20)T

**13. Seed Block.** A planting of certified virus-free trees that serves as a source of seed for producing rootstock used in the propagation of “Idaho certified nursery stock.” (3-20-20)T

**14. Stool Bed.** A clonal planting of self-rooted, certified virus-free trees for the specific purpose of producing vegetatively propagated rootstock used in the propagation of “Idaho certified nursery stock.” (3-20-20)T

**15. Top-Stock.** Usually scionwood used for grafting onto interstock or rootstock, may include seed. (3-20-20)T

**16. True Seedling.** A tree that has been grown from seed. (3-20-20)T

**17. Virus-Infected.** The presence of a harmful virus(es) in a plant or plant part. (3-20-20)T

**18. Virus-Like.** A disorder of genetic or non-transmissible origin and also includes mycoplasma-like organisms and rickettsia-like organisms. (3-20-20)T

**211. – 219. (RESERVED)**

**220. REQUIREMENTS.**

**01. Participation.** Participation is open only to those nurseries registered under Title 22, Chapter 23, Idaho Code, and is voluntary. (3-20-20)T

**02. Application.** Application forms for the establishment of new blocks will be provided by the Idaho Department of Agriculture. The applicant nurseryman shall furnish to the Department all information pertinent to the operation of this program, including a diagram of each block and give consent to the Department to take plant parts (buds, leaves, roots, etc.) from any tree for testing purposes. (3-20-20)T

**03. Registration.** Trees may be registered as rootstock, top-stock, or seedstock sources for the propagation of certified nursery stock when inspected, tested, and found to be true-to-name and discernibly free from known harmful virus and virus-like diseases by procedures outlined in this program. (3-20-20)T

**04. Responsibility.** The applicant nurseryman is responsible, subject to the approval of the Director, for the selection of the location and the proper maintenance of registered plantings grown under the provisions of Subchapter B. The applicant nurseryman is responsible for maintaining the identity of all nursery stock entered into this program in a manner approved by the Department. Any planting entered into this program shall be kept in a healthy growing condition and free of plant pests. (3-20-20)T

**05. Filing Date.** Application for inspection and testing of new or existing blocks of registered scion, seed, and stool-bed trees and for inspection of nursery stock for certification shall be filed by June 1 of each year with the Idaho Department of Agriculture. (3-20-20)T

**06. Nematode Sampling.** The ground being submitted for planting with virus-free stock as outlined in Subchapter B shall be officially sampled, using established procedures acceptable to the Director, tested, and found free of virus transmitting nematodes prior to planting of any stock. Subsequent sampling for the presence of nematodes after planting may be carried out at the discretion of the Director, to ensure that a nematode-free status is maintained. (3-20-20)T

**07. Grafting.** There shall be no budding, grafting, or top-working of registered trees in any scion-block, seed-block, or stool-block. (3-20-20)T

**08. Inspection.** Maintenance of virus-free integrity of all plants entered into this program will be by

inspection and spot-testing at a minimum of every three (3) years or as stated elsewhere in this rule. (3-20-20)T

**09. Diseased Plants.** Immediately following notice from the Director or his agent, any plant found to be infected by a virus or virus-like disease or if off-type, the plant(s) shall be removed and destroyed. Any ground found to be infested with virus transmitting nematodes must be fumigated with a fumigant registered and approved by the Idaho Department of Agriculture prior to planting, at the grower's expense. (3-20-20)T

**221. -- 229. (RESERVED)**

**230. SCION-BLOCKS.**

**01. Location.** A scion-block shall be located not less than one hundred (100) feet away from any non-registered cultivated plant of the Rosaceae family. The ground in a scion-block and for a distance of twenty (20) feet surrounding it shall be kept either clean-cultivated or in an approved, properly controlled ground cover. Registered scion-block trees shall be planted and maintained in a manner and at sufficient distance so that branches of different varieties do not overlap. Care shall be taken in the use of pollenizing insects and pollen application to prevent the transmission and spread of virus diseases through the use of infected pollen or its application. Registered scion-block trees may not be used for propagation purposes until trueness-to-name or variety has been established. Each tree will bear a permanent registration number. The ground in the scion-block will be sampled, using established procedures acceptable to the Director, and be tested and found free of virus transmitting nematodes prior to planting of any stock. (3-20-20)T

**02. Acceptability.** The rootstock and top-stock sources of the scion-block trees shall have originated from foundation trees established under this program or from virus-tested trees originating through the USDA-ARS Inter-Regional Project No. 2 (IR-2) or other approved programs. If the tree is scion-rooted, its source shall have met the requirements stated in Subchapter B. Only registered trees are permitted in the scion-block. (3-20-20)T

**231. -- 234. (RESERVED)**

**235. SEED-BLOCKS.**

**01. Location.** A Prunus seed-block shall be located not less than three hundred (300) feet from any non-registered flowering plant of the Prunus species. The ground in a seed-block and for a distance of twenty (20) feet surrounding it shall be kept clean-cultivated or in an approved, controlled ground cover. Care shall be taken in the use of pollenizing insects and pollen application to prevent the transmission and spread of virus diseases through the use of infected pollen or its application. Each tree will bear a permanent registration number. (3-20-20)T

**02. Acceptability.** The rootstock and top-stock sources of the seed-tree shall have originated from foundation trees established under this program or from virus-tested trees originating through the USDA-ARS Inter-Regional Project No. 2 (IR-2) or other approved program. If the tree is scion-rooted, its source shall have met the requirements stated in Subchapter B. Only registered trees are permitted in the seed-block. (3-20-20)T

**236. -- 239. (RESERVED)**

**240. STOOL-BEDS.**

**01. Location.** A stool-bed shall be located not less than fifty (50) feet from any non-registered cultivated plant of the Rosaceae family. The following exception will apply: Non-registered stool-beds may be located not less than ten (10) feet from registered stool-bed plantings. The ground in a stool-bed and for a distance of ten (10) feet surrounding it shall be kept clean-cultivated. (3-20-20)T

**02. Acceptability.** Existing stool-beds that index clean on the commonly used virus indicators will qualify as Registered Stool-Beds. New stool-beds (those planted after the effective date of Subchapter B) shall have originated from foundation stock established under this program or from virus-tested plants originating through the USDA-ARS Inter-Regional No. 2 (IR-2) or other approved program. If the tree is scion-rooted, its source shall have met the requirements stated in Subchapter B. Only registered trees are permitted in the stool-beds. (3-20-20)T



**241. -- 244. (RESERVED)**

**245. NURSERY STOCK.**

**01. Rootstocks.** All nursery stock being grown for certification, shall be on rootstock from registered trees except for stone fruit trees grown on peach seedlings and pome fruit trees grown on apple and pear seedlings. These seedling rootstocks, when grown from commercial seed, will be acceptable if seed transmissible virus content does not exceed five percent (5%). Clonal rootstock used in the production of Idaho Certified Nursery Stock must originate from Registered Stool-Beds. (3-20-20)T

**02. Location.** The isolation distances between certified and non-certified nursery stock shall be: (3-20-20)T

**a.** Not less than fifty (50) feet from non-certified plants of the Rosaceae family; (3-20-20)T

**b.** Not less than twenty (20) feet from other non-certified nursery stock; (3-20-20)T

**c.** Program participants shall maintain a twenty (20) foot clean-cultivated area around all certified nursery stock beds. Nursery stock shall be designated as to rootstock, top-stock, and inter-stock sources. There shall be no re-budding or re-grafting of nursery raw stock unless such stock is re-worked with scions from the original registered scion-tree. (3-20-20)T

**03. Identity Maintenance.** The maintenance of certified stock identity shall be a tagging program identifying trees produced from: (3-20-20)T

**a.** Registered rootstock produced from registered seed or stool-beds; (3-20-20)T

**b.** Registered scion source trees. The tracking system involves a numbering diagram system of each participant's nursery stock beds in the program. (3-20-20)T

**04. Seed.** Certified seed shall have been produced on Registered Seed Trees or commercial seed having been tested and found to have a transmissible virus content that does not exceed five percent (5%). (3-20-20)T

**05. Tagging.** An Idaho Certified Nursery Stock Tag designates trees produced from registered scion-source trees and that have been propagated on rootstocks produced from registered seed-source or stool-bed trees, or that are self-rooted. All nursery stock meeting the requirements of this program when sold shall have the variety, inter-stock, and rootstock designated where applicable as follows: variety/inter-stock/rootstock. (3-20-20)T

**06. Acceptability.** All nursery stock meeting the requirements of this program are known as Idaho Certified Nursery Stock. (3-20-20)T

**246. -- 249. (RESERVED)**

**250. BLOCK EXPANSION.**

Expansion within a scion or stool-bed will be allowed with no restriction regarding the number of generations, provided accepted tissue culture methods are employed. Only two (2) propagative steps will be allowed between "mother plants" and foundation trees for scion, seed, and stool-bed blocks. (3-20-20)T

**251. -- 259. (RESERVED)**

**260. INSPECTION PROCEDURES.**

**01. Time of Inspection.** Inspections will be made at the discretion of the Department and at times when specific disease symptoms are most likely to be expressed. (3-20-20)T

**02. Inspection of Nursery Stock for Certification.** At least one (1) visual inspection will be made of nursery rootstock in a planting being grown for certification during the first growing season. At the request of the

Department, any undesirable rootstock will be rogued before propagation. At least two (2) visual inspections will be made of nursery stock during the growing season following bud or graft placement. (3-20-20)T

**03. Refusal of Certification.** The Department will refuse certification if plants have been propagated from registered trees determined to be affected by a virus or virus-like disease or if other requirements of this program have not been met. (3-20-20)T

**261. -- 264. (RESERVED)**

**265. TESTING PROCEDURES.**

Testing standards prescribed in this program will conform to USDA-ARS Inter-Regional Project No. 2 (IR-2) standards or to any other acceptable and approved procedures developed and used for determining the presence of virus diseases in nursery stock. All testing results shall be made available directly to the Department by the approved agency or laboratory. (3-20-20)T

**266. -- 269. (RESERVED)**

**270. TAGGING, IDENTITY, AND RECORDS.**

**01. Official Certification Tags.** The Department will authorize the use of official certification tags for identification of nursery stock or seed that meet the requirements of this program. These tags will be supplied at cost to all program cooperators by the Department. (3-20-20)T

**02. Identity.** Any person selling Idaho Certified Nursery Stock is responsible for the identity of the stock bearing each tag and for such nursery stock meeting the requirements of this program. (3-20-20)T

**03. Records.** Any person selling Idaho Certified Nursery Stock shall keep record on a form prescribed by the Director that includes but is not limited to the source of the stock, quantity, and disposition. (3-20-20)T

**271. -- 279. (RESERVED)**

**280. FEES.**

**01. Application Fees.** A fee of fifty dollars (\$50) per application submitted plus ten cents (\$.10) per tree being certified shall be submitted with each application. (3-20-20)T

**02. Laboratory Fees.** Laboratory fees are established by a Department approved testing facility and will be paid directly to the facility. (3-20-20)T

**03. Service Fees.** Fees for plant or soil sampling and inspection services provided by the Idaho Department of Agriculture are in accordance with the following schedule. (3-20-20)T

**a.** A fee of twenty-five dollars (\$25) per hour for inspection and travel time with a minimum charge of fifty dollars (\$50). (3-20-20)T

**b.** Per diem costs will be charged according to established state rates. (3-20-20)T

**c.** The fees charged for tags will be at cost plus an administrative fee of ten percent (10%) for each order. (3-20-20)T

**281. -- 309. (RESERVED)**

**SUBCHAPTER C – GINSENG EXPORT**

**310. DEFINITIONS.**

In addition to the definitions found in Section 22-2005, Idaho Code, the definitions in Subchapter C apply in the

interpretation and enforcement of Subchapter C, only. (3-20-20)T

**01. Cultivated Ginseng.** Any part of a ginseng plant that is growing or grown in managed beds under artificial or natural shade and cultivated according to recognized ginseng horticultural practices. Cultivated ginseng includes woodsgrown ginseng. (3-20-20)T

**02. Dealer.** Anyone who buys ginseng for resale, or grows and sells it for export. This definition does not apply to persons who buy ginseng solely for the purpose of final retail sale to consumers in the United States. (3-20-20)T

**03. Dealer Registration.** An annual registration issued by the department authorizing a dealer to buy, collect, or otherwise acquire ginseng for resale or export. (3-20-20)T

**04. Dry Weight.** The weight in pounds and ounces of harvested or collected ginseng root that is dried and is no longer viable. (3-20-20)T

**05. Export.** Outside the boundaries of the United States. (3-20-20)T

**06. Ginseng.** Any and all parts of the plant known as American ginseng (*Panax quinquefolius*) including, but not limited to: plants; whole roots; essentially intact roots; root chunks; slices; seeds; and tissue. (3-20-20)T

**07. Green Ginseng.** A ginseng root from which the moisture has not been removed by drying. (3-20-20)T

**08. Green Weight.** The weight in pounds and ounces of freshly harvested or collected ginseng root that is not dried and is still viable. (3-20-20)T

**09. Grower.** A person who grows “cultivated,” “wild simulated,” and or “woodsgrown” ginseng, and sells it to a dealer. (3-20-20)T

**10. Grower Registration.** An annual registration issued by the department that enables a grower to sell cultivated ginseng that the grower has produced. (3-20-20)T

**11. Out-of-State Ginseng.** Ginseng that is grown or originated outside the state of Idaho. (3-20-20)T

**12. Wild Ginseng.** Ginseng growing naturally within its native range. (3-20-20)T

**13. Wild Simulated Ginseng.** Wild ginseng seeds or roots planted in natural habitat, within the natural range, in suitable ginseng habitat that is not further cultivated. (3-20-20)T

**14. Woodsgrown Ginseng.** Ginseng grown in managed beds under natural shade. (3-20-20)T

**311. -- 319. (RESERVED)**

**320. REGULATED PRODUCTS.**  
American ginseng (*Panax quinquefolius*). (3-20-20)T

**321. -- 329. (RESERVED)**

**330. COLLECTION OF WILD GINSENG.**  
No grower’s or dealer’s registration will be issued for the collection, sale or distribution of wild ginseng. (3-20-20)T

**331. DEALERS AND GROWERS ANNUAL REGISTRATION WITH THE DEPARTMENT.**  
No person may act as a dealer or grower without first registering with the department. Any person who acts as a dealer and a grower shall register as both. The department will assign a registration number to each person registered. Registration with the applicable fee will be made annually no later than January 15 of each year on a form provided

by the department and the registration will expire on December 31. (3-20-20)T

**332. --339. (RESERVED)**

**340. GROWER RECORDS.**

A grower selling cultivated ginseng shall do all of the following when selling to a dealer: (3-20-20)T

**01. Record of Sale.** Provide to the dealer a record of sale containing all of the following information: grower's name and address; grower's registration number; ginseng certificate number; ginseng dry weight; year harvested; county of harvest; and date of transaction. (3-20-20)T

**02. Certificate of Origin.** Certify that the ginseng was grown in the state of Idaho. The certificate of origin form is prescribed by the department. (3-20-20)T

**03. Records.** Maintain records of all ginseng production and sales. Records must be maintained for a period of three (3) years. (3-20-20)T

**341. -- 349. (RESERVED)**

**350. DEALER RECORDS.**

Dealers shall keep true and accurate records of transactions, including both sales and purchase records, in a format prescribed by the department. Records must be maintained for a period of three (3) years. (3-20-20)T

**01. Purchase Records.** Purchase records include dealer's name, address and registration number; grower/seller name and registration number; ginseng weight in pounds and ounces; designation of green or dry ginseng; designation of wild or cultivated ginseng; harvest year of ginseng; county in which the ginseng was harvested; and date of transaction. (3-20-20)T

**02. Sales Records.** Sales records shall include the following information: dealer's name, address and registration number; buyer's name, address and registration number; ginseng weight in pounds and ounces; designation of green or dry ginseng; designation of wild or cultivated ginseng; harvest year; county in which the ginseng was harvested; and date of transaction. (3-20-20)T

**351. -- 359. (RESERVED)**

**360. OUT-OF-STATE GINSENG.**

**01. Certificate of Origin.** No dealer may purchase, receive or import out-of-state ginseng unless it is accompanied by a valid certificate of origin issued by the state or country of origin. The certificate must include the state or country of origin, the source (wild or cultivated), year of harvest, and dry weight of the out-of-state ginseng. (3-20-20)T

**02. Recordkeeping.** The dealer shall retain for a period of three (3) years a copy of each written certificate of origin received. (3-20-20)T

**03. Uncertified Ginseng.** If a dealer receives ginseng not accompanied by a valid certificate of origin, the uncertified ginseng must be returned within thirty (30) days to the state or country of origin. Failure to do so renders the ginseng illegal for commerce. (3-20-20)T

**361. SELLING OR SHIPPING OF GINSENG -- CERTIFICATES.**

**01. Export.** Except as described in Subsection 361.06, no person may sell or ship ginseng out-of-state or export Idaho grown ginseng unless it is accompanied by a valid, prenumbered certificate of origin on a form issued by the department. The department will, upon request and receipt of the required fee(s), provide each registered grower or dealer with forms for certificates of origin. The department will identify each certificate of origin form with a serial number, and the registration number of the grower or dealer. Registered growers or dealers may certify their own cultivated ginseng by filling out and signing a certificate of origin form. The certificate of origin contains the

- following information: (3-20-20)T
- a. State of origin; (3-20-20)T
  - b. Serial number of certificate; (3-20-20)T
  - c. Dealer's and/or grower's state registration number; (3-20-20)T
  - d. Year of harvest of ginseng being certified; (3-20-20)T
  - e. Designation as cultivated roots or plants; (3-20-20)T
  - f. Designation as dried or fresh (green) roots, or live plants; (3-20-20)T
  - g. Weight of roots or plants (or number of plants) separately expressed both numerically and in writing; (3-20-20)T
  - h. Date of certification; and (3-20-20)T
  - i. Signature of grower or dealer making certification. (3-20-20)T
- 02. Idaho Certificate of Origin.** All of the following conditions must be met in order for an Idaho certificate of origin to be valid: (3-20-20)T
- a. The grower or dealer whose registration number was entered on it by the department shall sign the certificate; and (3-20-20)T
  - b. The ginseng is cultivated ginseng grown in Idaho. (3-20-20)T
- 03. Forms.** Forms for certificates of origin are issued by the department in triplicate. The original is designated for the dealer's use in commerce; the first copy is for the dealer's records; and the grower or dealer shall send the second copy, within two (2) weeks of issuance, to the Division of Plant Industries, Idaho State Department of Agriculture, P.O. Box 7249, Boise, ID 83707. (3-20-20)T
- 04. Out-of-State Issued Certificates.** No person may export ginseng grown in Idaho using an out-of-state issued certificate. (3-20-20)T
- 05. Wild Ginseng Certificates.** Certificates of origin will not be issued for wild ginseng. (3-20-20)T
- 06. Final Retail Sales.** Subsection 361.01 does not apply to a person who sells or ships cultivated ginseng out-of-state to a person who is buying or receiving it solely for the purpose of final retail sale to consumers in the United States, if the person selling or shipping keeps a record for a period of three (3) years that includes: name and address of the buyer or receiver; weight of the ginseng in pounds and ounces; date of the sale or shipment; county of harvest of the ginseng; and year of harvest of the ginseng. (3-20-20)T
- 362. -- 369. (RESERVED)**
- 370. MAINTAINING SEPARATE LOTS OF GINSENG.**  
Dealers shall maintain separation between lots of out-of-state ginseng and that harvested in Idaho until a certificate of origin has been issued for the ginseng harvested in Idaho. (3-20-20)T
- 371. DEALER OR GROWER HOLDING GINSENG AFTER DECEMBER 31 OF THE YEAR.**  
Any grower or dealer holding ginseng on or after December 31 shall report all carryover stocks on a form provided by the department. The form shall list the name and address of the grower or dealer; location of the lot; lot identification; county of harvest; dry or green weight in pounds and ounces; and year of harvest. (3-20-20)T
- 372. -- 379. (RESERVED)**

**380. INSPECTION AND DISCLOSURE OF RECORDS.**

**01. Inspection.** All records required to be kept under Subchapter C shall be made available to the department upon request for inspection and copying. (3-20-20)T

**02. Disclosure.** The department will not disclose information obtained regarding purchases, sales, or production of an individual ginseng dealer, except for providing reports to the United States Fish and Wildlife Service. (3-20-20)T

**381. -- 389. (RESERVED)**

**390. EXPORT PROCEDURES.**

Valid federal Convention on International Trade in Endangered Species of Wild Fauna and Flora (CITES) documents are necessary to export ginseng. (3-20-20)T

**391. FEES - HOURLY, OVERTIME.**

Fees will be charged to cover the department's cost of implementing Subchapter C. (3-20-20)T

**01. Certification and Overtime Rate.** Ginseng certification services will be provided at an hourly and overtime rate as provided in Section 392 of Subchapter C. The overtime rate will apply for service provided subsequent to a regularly scheduled eight (8) hour week day shift or on Saturdays, Sundays, and state legal holidays. No service will be performed on Thanksgiving Day, Christmas Day or New Year's Day, beginning at 5 p.m., on the previous day. (3-20-20)T

**02. Minimum Charges.** Charges will be for a minimum of one (1) hour. Additional time will be charged in one-half (1/2) hour increments. (3-20-20)T

**392. SCHEDULE OF FEES AND CHARGES.**

The following schedule for ginseng certification services apply: (3-20-20)T

**01. Registration.** Registration (grower or dealer or grower and dealer), twenty-five dollars (\$25). (3-20-20)T

**02. Certificate of Origin Form.** Certificate of origin form, each, ten dollars (\$10). (3-20-20)T

**03. Hourly Rate.** Hourly rate for certification services, twenty-eight dollars (\$28). (3-20-20)T

**04. Overtime Rate.** Overtime rate for certification services, thirty-three dollars (\$33). (3-20-20)T

**393. -- 999. (RESERVED)**

## 02.06.05 – RULES GOVERNING PLANT DISEASE AND QUARANTINES

### 000. LEGAL AUTHORITY.

This chapter is adopted under legal authority of Sections 22-2004, and 22-2006, Idaho Code. (3-20-20)T

### 001. TITLE AND SCOPE.

**01. Title.** The title of this chapter is IDAPA 02.06.05, “Rules Governing Plant Disease and Quarantines.” (3-20-20)T

**02. Scope.** This rule establishes regulated pests, regulated products, regulated articles, control areas, quarantine areas and special permits for certain crops to prevent the spread of plant disease and pests. This rule will provide regional consistency for plant pest quarantines. (3-20-20)T

### 002. -- 009. (RESERVED)

### 010. DEFINITIONS.

The definitions set forth in Section 22-2005, Idaho Code, apply in the interpretation and enforcement of this rule. (3-20-20)T

## SUBCHAPTER A – DISEASES OF HOPS

### 011. -- 111. (RESERVED)

### 112. REGULATED PESTS.

**01. Verticillium Wilt.** Plant Material infected with the disease caused by the fungus *Verticillium nonalfalfae* (formerly known as *Verticillium albo-atrum Reinke* and *Berth*) and any species or strains of the genus *Verticillium* pathogenic to hops. (3-20-20)T

**02. Powdery Mildew.** Plant Material infected with the disease caused by the fungus *Podosphaera macularis* (Wallr. Fr.), synonyms *Sphaerotheca macularis* (Wallr. Fr.) Lind and *Sphaerotheca humuli* (Burril) Lind. (3-20-20)T

**03. Hop Stunt Viroid.** Plant Material infected with the disease caused by the viroid *Hostuviroid hop stunt viroid* and all strains and genetic variants associated with the genus. (3-20-20)T

**04. Ilarvirus Species.** Plant Material infected with the disease caused by virus species within the Genus Ilarvis, including but not limited to Apple Mosaic Virus and Prunus Necrotic Ringspot Virus. (3-20-20)T

### 113. -- 119. (RESERVED)

### 120. REGULATED ARTICLES.

**01. Plant Material.** Plants and all plant parts of hops, except kiln dried cones. (3-20-20)T

**02. Machinery.** Machinery, vehicles, tools, equipment, trellis poles, wire, anchor irons, and any other appurtenances used in the culture and/or production of hops. (3-20-20)T

### 121. -- 129. (RESERVED)

### 130. QUARANTINE AREA.

All areas outside of the territorial borders of Idaho, Oregon, and Washington. (3-20-20)T

### 131. -- 139. (RESERVED)

### 140. RESTRICTIONS ON IMPORT.

No person may import restricted articles from the quarantined area into Idaho unless the person importing the regulated articles first obtains a special permit from the department as set forth in Section 160. (3-20-20)T

### 141. –149. (RESERVED)

**150. MOVEMENT OF USED FARMING EQUIPMENT.**

**01. Clean and Free.** Used farm equipment including, but not limited to, tillage equipment, vehicles, and hop yard appurtenances moving into Idaho from the quarantine area, must be clean and free of soil and plant material including, but not limited to, hop debris. (3-20-20)T

**02. Requirements.** Freedom from plant material and soil may be accomplished by washing, steam cleaning, and/or use of a disinfectant appropriately labeled for the purpose. (3-20-20)T

**151. -- 159. (RESERVED)**

**160. SPECIAL PERMITS.**

Any person(s) or agencies wishing to import covered commodities from the area under quarantine must apply in writing for a special permit as authorized by the director of the department. (3-20-20)T

**01. Application.** Application for special permits must list the prospective buyer and seller; the number, and origin of stock; location of proposed planting site; and any other relevant information. (3-20-20)T

**02. Conditions.** Special permits, when granted, may include such conditions as may be necessary to prevent disease establishment. All permitted material must be found free from regulated pests by the Clean Plant Center at Washington State University, Prosser, Washington, or an equivalent lab approved by the department. (3-20-20)T

**161. -- 169. (RESERVED)**

**170. PEST DETECTION.**

**01. Inspection.** If evidence of a regulated pest is detected by visual inspection, the Department, in cooperation with the University of Idaho, Department of Plant, Soil and Entomological Sciences, will perform laboratory procedures sufficient to determine the causal organism. (3-20-20)T

**02. Consequences.** Positive identification of the presence of Verticillium wilt, hop stunt viroid, ilar viruses, or powdery mildew virulently pathogenic to hops will result in loss of eligibility for sale or transfer for those rootstocks within the infected field. The director may also order that the infested area be removed from hop production and the soil be disinfested. (3-20-20)T

**171. -- 179. (RESERVED)**

**180. AUTHORITY TO ENTER AND INSPECT.**

The Director of the Idaho State Department of Agriculture or his designated agent is authorized to enter and inspect any and all hop plantings within the state of Idaho. (3-20-20)T

**181. -- 189. (RESERVED)**

**190. FEES AND CHARGES.**

**01. Special Permits.** For special permits for importation of hops from areas under quarantine, the fee will be sixty dollars (\$60) per permit. (3-20-20)T

**02. General Fees and Charges.** The fees and charges for inspection, certificates, and permits are as set forth in IDAPA 02.06.04, "Idaho Department of Agriculture, Rules Governing Plant Exports," Section 195. (3-20-20)T

**191. -- 211. (RESERVED)**



**SUBCHAPTER B – WHITE ROT DISEASE OF ONION**

**212. REGULATED PEST.**

Onion white rot (*Sclerotium cepivorum*).

(3-20-20)T

**213. -- 219. (RESERVED)**

**220. DESIGNATED COUNTIES.**

Ada, Bingham, Blaine, Boise, Bonneville, Canyon, Cassia, Elmore, Gem, Gooding, Jefferson, Jerome, Lincoln, Madison, Minidoka, Owyhee, Payette, Power, Twin Falls, and Washington Counties, state of Idaho.

(3-20-20)T

**221. -- 229. (RESERVED)**

**230. REGULATED PRODUCTS.**

Bulbs, sets, or seedlings of onion, garlic, leek, chive, shallot or other Allium species, including all ornamental Allium species, for planting purposes, and all machinery, tools, and equipment used in the production of Allium species.

(3-20-20)T

**231. -- 249. (RESERVED)**

**250. RULES GOVERNING SHIPMENTS.**

**01. Shipment for Planting Purposes.** No person may import into the designated counties bulbs, sets or seedlings of onion, garlic, leek, chives, shallots or other Allium species, including ornamentals, for planting purposes except as provided in Subsections 250.02 through 250.04.

(3-20-20)T

**02. Designated Counties.** Allium production within the designated counties shall be limited to production from seed, or from vegetative propagative material produced from seed within the designated counties. Bulbs, sets or seedlings of Allium species produced within the designated counties then exported from the designated counties for processing or other purposes cannot be returned to the designated counties for planting purposes.

(3-20-20)T

**03. Vegetative Propagative Material.** Vegetative propagative material, produced under aseptic conditions, may be brought into the designated counties if an exemption is granted by the Director, or the Director's designated agent.

(3-20-20)T

**04. Allium Exemption.** Bulbs, sets, or seedlings of Allium species, for planting purposes, produced in Malheur County, Oregon, and regulated by similar rules are exempt from the restrictions of Subsection 250.01.

(3-20-20)T

**05. Machinery, Tools and Equipment.** Except as provided in Subsections 250.06 and 250.07, no person shall, in any manner, import or move into the designated counties any machinery, tools, or equipment that have been previously used in any manner on fields outside the designated counties where the host plants named in Section 230 have ever been cultivated.

(3-20-20)T

**06. Cleaning Machinery, Tools and Equipment.** Machinery, tools, or equipment may be imported or moved into the designated counties if they are first steam cleaned and disinfested to the satisfaction of, and with the prior approval of, the Director. The cleaning shall include the complete removal of all soil by the use of steam under pressure. Disinfestation is accomplished as specified by the Director. For the purpose of Subchapter B, machinery, tools and equipment includes, but is not limited to, farm trucks, harvesters, and tillage equipment.

(3-20-20)T

**07. Exemptions.** Machinery, tools or equipment utilized in Malheur County, Oregon, are exempt from the prohibition in Subsections 250.05 and 250.06.

(3-20-20)T

**08. Authority of Director.** The Director may stop the movement into or within any designated county of any machinery, tools, or equipment that have not been cleaned and disinfested as provided for in Subsection 250.06 until such machinery, tools and equipment are so cleaned and disinfested.

(3-20-20)T

**251. -- 259. (RESERVED)**

**260. DISPOSITION OF VIOLATIONS.**

Any plant material, plant products or machinery, tools or equipment, imported into any designated county in violation of Subchapter B shall immediately be sent out of the county and all counties specified in Section 220 or destroyed at the option and expense of the owner or owners, his or their agents and under the direction of the Director. (3-20-20)T

**261. -- 269. (RESERVED)**

**270. INSPECTION AND CONTROL PROCEDURES.**

**01. Inspection.** The Director may inspect any regulated product or regulated product planting areas within the designated counties during any time of the year to determine if the disease organism is present therein. If the Director finds that any of the regulated products enumerated in Section 230, whether or not being transported, or any fields are infested with the disease organism, the Director will, by written control order, delivered or mailed to the grower and/or land owner, direct the control of the infestation, and may, prior to issuance of the order, seize any infected regulated products that are separated from the land on which grown. (3-20-20)T

**02. Movement.** Movement of such regulated products within the designated counties or removal of such from the designated counties may be carried out only with the Director's prior approval and under the Director's supervision. (3-20-20)T

**03. Controls.** Control methods used are only those approved by the Director and may include, but are not limited to, the following directives: (3-20-20)T

- a.** Any infected regulated products will be destroyed. (3-20-20)T
- b.** A directive that a specific part or all of any infested area will be taken out of Allium species production. (3-20-20)T
- c.** Any infested area will be fenced, properly diked to prevent runoff or irrigation or rainwater, and planted to an approved crop that will prevent soil erosion and will not require annual tillage. (3-20-20)T
- d.** The pasturing of animals on any infested area is prohibited. (3-20-20)T
- e.** Equipment, tools and machinery used on an infested area will be cleaned and disinfested prior to removal from said area. (3-20-20)T

**271. -- 279. (RESERVED)**

**280. SPECIAL EXEMPTIONS.**

The Director may, with the consent of the owner, allow use of an infested growing area as an experimental plot in cooperation with the University of Idaho for onion white rot research. (3-20-20)T

**281. -- 309. (RESERVED)**

**SUBCHAPTER C – APPLE AND CHERRY PESTS**

**310. DEFINITIONS.**

The definitions found in section 310 apply to the interpretation and enforcement of Subchapter C only: (3-20-20)T

**01. Commercial Fruit.** Fruit harvested from a commercial orchard and destined to a commercial processing plant, packing plant, or for retail or wholesale sales. (3-20-20)T

**02. Commercial Orchard.** An orchard in which fruit is grown for commercial purposes under accepted industry, university agricultural extension service, and regulatory guidelines. (3-20-20)T

**03. Graded Culls.** Apples that have failed to meet industry quality standards for fresh markets, yet meet industry quality standards for processing purposes. (3-20-20)T

**04. Infested Area.** An area where a regulated pest is known to be present and is capable of reproducing and maintaining a viable population. (3-20-20)T

**05. Threatened with Infestation.** The entire commercial orchard is threatened with infestation when an outside boundary is within one-half (1/2) mile of an established regulated pest even if a portion of the commercial orchard is beyond one-half (1/2) mile of an established regulated pest. (3-20-20)T

**311. – 319. (RESERVED)**

**320. REGULATED PESTS.**

**01. Apple Maggot** (*Rhagoletis pomonella*). (3-20-20)T

**02. Cherry Fruit Fly** (*Rhagoletis cingulata* complex, including *R. indifferens* and *R. fausta*). (3-20-20)T

**321. REGULATED ARTICLES.**

**01. Apple Maggot.** All fresh fruit of apple (including crabapple), cherry (except cherries that are commercial fruit), hawthorn (haw), pear (except pears that are commercial fruit from California, Idaho, Oregon, Utah, and Washington), plum, prune, quince, and rose hips are regulated under quarantine for apple maggot. (3-20-20)T

**02. Cherry Fruit Fly.** All domestic and wild cherries and cherry trees. (3-20-20)T

**322. --329. (RESERVED)**

**330. REGULATED AREAS - APPLE MAGGOT.**

**01. Non-Infested Areas -- Within Idaho.** The entire counties of Canyon, Owyhee and Payette; portions of the counties of Gem and Washington lying south of the quarantine areas as outlined in Subsections 330.02.a. and 330.02.b. (3-20-20)T

**02. Infested Areas -- Within Idaho.** The following areas are declared by the director to be under quarantine for Apple maggot: the counties of Franklin, Oneida, Caribou, Ada, Boise and Gooding; and portions of Gem and Washington counties as outlined in Subsections 330.02.a. and 330.02.b. (3-20-20)T

**a. Gem County Quarantine Area.** Those portions of Gem county lying northerly of a line described as follows: Commencing at the Northwest corner of Section 3, T.7N, R.2W; thence East along section lines to the Northwest corner of Section 6, T.7N, R.1W; thence South along section lines to the Southwest corner of Section 7; thence East along section lines to the Northeast corner of Section 15, T.7N, R.1W; thence South along section lines to the middle of the main channel of the Payette River; thence easterly along said river to the East line of the county. (3-20-20)T

**b. Washington County Quarantine Area.** Those portions of Washington county lying northerly of a line described as follows. Commencing at the Snake River at the Southern boundary of T.12N, R.7W; thence East along section lines to the Southwest corner of Section 35, T.12N, R.5W; thence North along section lines to the Northwest corner of Section 23, T.12N, R.5W; thence East along section lines to the Northwest corner of Section 21, T.12N, R.4W; thence South along section lines to the Southwest corner of Section 33, T.12N, R.4W; thence East along section lines to the Southwest corner of Section 31, T.12N, R.1E; thence East along section lines to the East line of the county. (3-20-20)T

**03. Infested Areas -- Outside of Idaho.** All states or foreign countries or portion thereof where Apple

maggot is known to occur. (3-20-20)T

**331. -- 339. (RESERVED)**

**340. RESTRICTIONS - APPLE MAGGOT.**

**01. Certification Required.** Regulated articles described in this quarantine that are produced in or shipped from infested areas are prohibited movement into or within the state of Idaho unless a certificate accompanies the shipment evidencing compliance with Subsections 340.03, 340.04, 340.05, or 340.07. No certificate is required for regulated articles meeting the requirements of Subsections 340.02 or 340.06. (3-20-20)T

**02. Reshipments in Original Containers.** Regulated articles in original unopened containers, each bearing labels or other identifying marks evidencing origin outside an infested area, may be reshipped to the regulated area from any point within the area under quarantine. (3-20-20)T

**03. Repacked Regulated Articles.** Regulated articles may be repacked and shipped by common carrier from any point within an infested regulated area provided that each lot or shipment is accompanied by a certificate stating that the regulated articles have been grown outside an infested regulated area and have had their identity continuously maintained while in an infested regulated area. The certificate shall contain the following information: (3-20-20)T

- a.** The county in which the regulated articles were grown. (3-20-20)T
- b.** The point of repacking and reshipment. (3-20-20)T
- c.** The amount and kind of regulated articles comprising the lot or shipment. (3-20-20)T
- d.** The names and addresses of the shipper and consignee. (3-20-20)T

**04. Apples Exposed to Controlled Atmosphere Storage.** Apples exposed for a continuous period of ninety (90) days, during which period the temperature within the storage room has been maintained at thirty-eight (38) degrees Fahrenheit or less, may be admitted into the regulated area, provided that the storage room or building is approved by the Director as a controlled atmosphere facility, and each lot or shipment of such apples to the regulated area is accompanied by a certificate, as provided in Subsection 340.01. (3-20-20)T

**05. Shipments From Cold Storage.** Regulated articles described in Subsection 321.01 that are held in cold storage for a continuous period of forty (40) days or more, during which period the temperature within the storage room is maintained at thirty-two (32) degrees Fahrenheit or less, may be admitted into the regulated area, provided that each lot or shipment is accompanied by a certificate as stated in Subsection 340.01 evidencing compliance with the minimum temperature requirements. (3-20-20)T

**06. Solid Frozen Fruits Exempt.** No restrictions are placed on the movement of fruits that upon arrival are frozen solid and that are under refrigeration to assure their solid frozen state. (3-20-20)T

**07. Regulatory and Control Measures.** Regulatory and control measures may be prescribed by the Director within designated areas to prevent or minimize the possible movement of Apple maggot from commercial orchards. When it has been determined that commercial fruit of apple (including crabapple), hawthorn (both native and ornamental), plum, prune, peach and apricot trees (except graded culls – see Subsection 340.07.b.iii.) may be infested with or threatened with infestation by Apple maggot, the fruit will be sampled by an investigator, following accepted industry procedures for sampling and inspection for presence of Apple maggot. (3-20-20)T

**a.** If found to be free from Apple maggot, a certificate as provided for in Subsection 340.01 will be issued. (3-20-20)T

**b.** If found to be infested with Apple maggot, one (1) or more of the following procedures will be prescribed before fresh fruit of apple (including crabapple) and hawthorn (both native and ornamental) are moved from designated or regulated areas. (3-20-20)T

- i. Fresh fruit to be exposed to controlled atmosphere storage as provided in Subsection 340.04. (3-20-20)T
- ii. Fresh fruit to be exposed to cold storage as provided in Subsection 340.05. (3-20-20)T
- iii. Graded culls are subject to Subsections 340.07.b.i. or 340.07.b.ii. (3-20-20)T

**08. Infested or Damaged Regulated Articles.** All regulated articles as described in Section 321.01 known, or found to be infested with, or damaged by Apple maggot shall not be sold, held for sale, or offered for sale, except as provided for in Subsections 340.04 and 340.05. (3-20-20)T

**341. -- 349. (RESERVED)**

**350. REGULATED AREAS - CHERRY FRUIT FLY.**

**01. Canyon County, Idaho.** The following is hereby designated an area of mandatory control for Cherry fruit fly: Commencing at the corner common to Sections 22, 23, 26 and 27 of Township 4 North, Range 5 West, Boise, Meridian; thence South to the Snake River to the point formed by section line between Sections 11 and 14 in Township 2 North, Range 4 West, Boise, Meridian; then East along said section line projected to where said line meets Lake Lowell; thence northwesterly across Lake Lowell to a point on the section line between Sections 26 and 27 of Township 3 West, Range 3 North, Boise, Meridian where said line meets Lake Lowell; then North along said section line to a point which is the corner common to Sections 10, 11, 14 and 15 of Township 3 North, Range 3 West, Boise, Meridian; thence West to a point, the west corner common to Sections 7, 12, 13 and 18, Township 3 North, Range 3 West Boise, Meridian; thence North to a point the east corner common to Sections 1 and 12, Township 3 North, Range 4 West, Boise, Meridian; thence West to a point the corner common to Sections 2, 3, 10 and 11, Township 3 North, Range 4 West, Boise, Meridian; thence North to a point which is the section corner common to Sections 26, 27, 34 and 35 of Township 4 North, Range 4 West, Boise, Meridian; thence West to a point which is the section corner common to Sections 27, 28, 33 and 34 of Township 4 North, Range 4 West, Boise, Meridian; thence North to a point which is the section corner common to Sections 21, 22, 27 and 28, Township 4 North, Range 4 West, Boise, Meridian; thence West to the point of beginning. (3-20-20)T

**02. Gem County, Idaho.** The following is hereby designated an area of mandatory control for Cherry fruit fly: Commencing at the corner common to Sections 4 and 5 of T. 6 N., R. 3 W. B. M. and Sections 32 and 33 of T. 7 N., R. 3 W., B. M., which corner is on the West line of Gem County, Idaho; thence South along said county line to a point which is the Southwest corner of Section 33 of T. 6 N., R. 3 W., B. M.; thence East along the South line of said Section 33 to its Southeast corner; thence North along the East line of said Section 33; and continuing North along the extension of said line to a point which is the corner common to Sections 15, 16, 22 and 23 of T. 6 N., R. 3 W., B. M.; thence East along the section line between Sections 15 and 22 of T. 6 N., R. 3 W., B. M. to a point on the division line between Ranges 2 and 3 W., T. 6 N., B. M.; thence South along the division line between the said Ranges 2 and 3 W., T. 6 N., B. M., to the East corner common to Sections 24 and 25, T. 6 N., R. 3 W., B. M.; thence East to a point which is the East corner common to Sections 19 and 30 of T. 6 N., R. 2 W., B. M.; thence South to a point which is the East corner common to Sections 30 and 31, T. 6 N., R. 2 W., B. M.; thence East along the section line between said Sections 30 and 31, extended to a point which is the East corner common to Sections 29 and 32, T. 6 N., R. 1 W., B. M.; thence North to a point which is the East corner common to Sections 20 and 29, T. 6 N., R. 1 W., B. M.; thence East to a point which is the East corner common to Sections 21 and 28, T. 6 N., R. 1 W., B. M.; thence North to a point which is the East corner common to Sections 16 and 21, T. 6 N., R. 1 W., B. M.; thence East to a point which is the East corner common to Sections 15 and 22, T. 6 N., R. 1 W., B. M.; thence North to a point which is the East corner common to Sections 8 and 10, T. 6 N., R. 1 W., B. M.; thence East to a point which is the East corner common to Sections 2 and 11, T. 6 N., R. 1 W., B. M.; thence North to a point which would be the East corner common to Sections 23 and 26, T. 7 N., R. 1 W., B. M.; thence West to a point which is the Northwest corner of Section 25, T. 7 N., R. 2 W., B. M.; thence South to a point which is the Northwest corner of Section 1, T. 6 N., R. 2 W., B. M.; thence West to the point of beginning. (3-20-20)T

**351. -- 359. (RESERVED)**

**360. RESTRICTIONS - CHERRY FRUIT FLY.**

**01. Treatments Required.** Each person, or person's agent, located in Cherry fruit fly regulated areas as stated in Section 350 shall treat, or cause to be treated at his own expense, each of the regulated articles as listed in Subsection 321.02 on their property in order to minimize the population of the Cherry fruit fly. (3-20-20)T

**02. Chemical Treatments.** Chemical treatments shall be carried out utilizing proper timing, methods and pesticides as recommended by the University of Idaho Cooperative Extension Service, approved for use on the commodity by the Environmental Protection Agency, and registered with the Idaho State Department of Agriculture. The regulated articles will be treated so as to effect the best control of the Cherry fruit fly, as per the pesticide label and University recommendations. (3-20-20)T

**03. Emergence.** The date of the emergence of the first Cherry fruit fly in the county will be made public in the Cherry fruit fly regulated areas by the Department. The date of first emergence is determined by historical evidence, a population model utilizing degree-day accumulations or by actual trapping of adult individuals. (3-20-20)T

**04. Additional Spraying Responsibilities.** The duty to treat cherry trees includes a similar duty to treat all parts of any type of tree within twenty (20) feet of any portion of a cherry tree, using methods specified in Subsection 360.02. (3-20-20)T

**05. Failure to Treat.** In the event that the person or person's agent fails or refuses to effect the treatment specified in Subsection 360.02, the Director will carry out the treatment at the expense of the person in charge or possession of the tree(s), as provided under Section 22-2010, Idaho Code. (3-20-20)T

**361. – 369. (RESERVED)**

**370. SPECIAL PERMITS.**

The Director may issue special permits admitting regulated articles covered in this quarantine not otherwise eligible for entry from the area under quarantine, subject to conditions and provisions, that the Director may prescribe to prevent introduction, escape or spread of the quarantine pests. (3-20-20)T

**371. -- 411. (RESERVED)**

**SUBCHAPTER D – EUROPEAN CORN BORER**

**412. REGULATED PEST.**

European corn borer (*Ostrinia nubilalis*). (3-20-20)T

**413. -- 419. (RESERVED)**

**420. AREA AND ARTICLES UNDER QUARANTINE.**

**01. Infested Area.** (3-20-20)T

**a.** Alabama, Arkansas, Colorado, Connecticut, Delaware, Georgia, Illinois, Indiana, Iowa, Kansas, Kentucky, Maine, Maryland, Massachusetts, Michigan, Minnesota, Mississippi, Missouri, Montana, Nebraska, New Hampshire, New Jersey, New York, North Carolina, North Dakota, Ohio, Oklahoma, Pennsylvania, Rhode Island, South Carolina, South Dakota, Tennessee, Vermont, Virginia, West Virginia, Wisconsin, Wyoming, and the District of Columbia. (3-20-20)T

**b.** In Florida, the counties of Calhoun, Escambia, Gadsden, Hamilton, Holmes, Jackson, Jefferson, Madison, Okaloosa, and Santa Rosa. (3-20-20)T

**c.** In Louisiana, the parishes of Bossier, Caddo, Concordia, East Carroll, Franklin, Madison, Morehouse, Natchitoches, Ouachita, Red River, Richland, Tensas, and West Carroll. (3-20-20)T

**d.** In Texas, the counties of Bowie, Carson, Castro, Dallam, Deaf Smith, Gray, Hansford, Hartley,

Hemphill, Hutchinson, Lipscomb, Moore, Ochiltree, Oldham, Potter, Randall, Roberts, and Sherman. (3-20-20)T

**02. Noninfested Area.** All parishes, counties, states, districts, and territories of the United States not named in the infested area are known as the non-infested area. (3-20-20)T

**03. Articles and Commodities Covered.** (3-20-20)T

**a.** Corn, broomcorn, sorghum, and sudan grass plants and all parts thereof (including shelled grain and stalks, ears, cobs, and all other parts, fragments, or debris of said plants); (3-20-20)T

**b.** Beans in the pod and pepper fruits; (3-20-20)T

**c.** Plants of aster, chrysanthemum, geranium, hollyhock, dahlia, and gladiolus. (3-20-20)T

**421. -- 429. (RESERVED)**

**430. RESTRICTIONS AND EXEMPTIONS.**

**01. Restrictions.** (3-20-20)T

**a.** Articles and commodities covered are prohibited entry into Idaho from the infested area unless accompanied by a certificate, issued by an authorized representative of the origin state Department of Agriculture, as provided below in Subsections 430.01.a.i. and 430.01.a.ii. (3-20-20)T

**i.** Shelled grain certificate of treatment stating that the grain has passed through a one-half (1/2) inch or smaller size mesh screen. (3-20-20)T

**ii.** Shelled grain not screened as in Subsection 430.01.a.i. or other articles and commodities certificate of processing and inspection specifying that all of the commodities and articles in the lot or shipment were processed and inspected in conformity with a method and in a manner prescribed by the Director, or the Director's agent. Such methods are obtainable on request from the Department. (3-20-20)T

**iii.** Articles and commodities covered originating in the parishes of Louisiana and the counties of Florida and Texas that are not infested with European corn borer may enter Idaho if accompanied by a certificate of origin issued by an authorized representative of the origin state Department of Agriculture specifying that no portion of the articles or commodities in the lot or shipment was grown in an area where the European corn borer is known to occur. Origin certification is not required for entry into Idaho of articles and commodities covered that originated in states, districts, and territories in the noninfested area. (3-20-20)T

**b.** All certificates must be dated and set forth the kind and quantity of articles or commodities constituting the lot or shipment covered thereby, the initials and number of the railway car or license number of the truck, and the names and addresses of the shipper and consignee. (3-20-20)T

**02. Exemptions.** Certification requirements are waived on the following articles and commodities covered, with the stipulation that such articles and commodities are subject to inspection by the Director and must be free of plant portions or fragments capable of harboring European corn borer. (3-20-20)T

**a.** Shelled popcorn, seed for planting or clean sacked grain for human consumption. (3-20-20)T

**b.** Beans in the pod or pepper fruits in lots or shipments of ten (10) pounds or less. (3-20-20)T

**c.** Seedling plants or divisions without stems of the previous year's growth of aster, chrysanthemum or hollyhock. (3-20-20)T

**d.** Dahlia tubers without stems. (3-20-20)T

**e.** Gladiolus corms without stems. (3-20-20)T

- f. Very pungent types of pepper fruits. (3-20-20)T
- g. Articles and commodities covered when they have been processed or manufactured in a manner that in the judgement of the Director eliminates all danger of carrying European corn borer. (3-20-20)T
- h. The Director may, upon application, issue a permit to a recognized research agency to import specified quantities of the quarantined articles listed in Subsection 420.03 for experimental purposes. (3-20-20)T

**431. -- 439. (RESERVED)**

**440. VIOLATIONS.**

**01. Incoming Shipments. (3-20-20)T**

a. Any or all shipments of lots of the quarantined articles enumerated in Subsection 420.03 arriving in Idaho in violation of this quarantine shall immediately be sent out of the state, destroyed, or treated by a method and in a manner prescribed by the Director at the option and expense of the owner or owners, or responsible agents. (3-20-20)T

b. If any lot or shipment certified by the state of origin as prescribed in Subsection 430.01 is found to contain materials capable of harboring an infestation, the Director may review the program of the state of origin to determine if it meets the requirements of Subchapter D. (3-20-20)T

**441. -- 511. (RESERVED)**

**SUBCHAPTER E – PEACH TREE DISEASES**

**512. REGULATED PESTS.**  
The viral diseases known as Peach Yellows, Peach Rosette, and Little Peach. (3-20-20)T

**513. -- 519. (RESERVED)**

**520. AREA UNDER QUARANTINE.**  
The entire states of Alabama, Arkansas, (except counties of Benton, Clark, Columbia, Garland and White), Connecticut, Delaware, Florida, Georgia, Illinois, Indiana, Kentucky, Maryland (except counties of Worcester and Somerset), Massachusetts, Michigan, Mississippi, New Jersey, New York, North Carolina, Ohio, Oklahoma, Pennsylvania, Rhode Island, South Carolina, Tennessee, Virginia, West Virginia, and the District of Columbia. (3-20-20)T

**521. -- 524. (RESERVED)**

**525. REGULATED ARTICLES.**  
All trees, cuttings, grafts, scions, or buds of all species and varieties including the flowering forms of peach, nectarine, apricot, almond, plum, and prune, and any trees budded or grafted on peach stock or peach roots, coming from a regulated area. (3-20-20)T

**526. -- 529. (RESERVED)**

**530. RESTRICTIONS GOVERNING SHIPMENTS.**  
The regulated articles will not be admitted into Idaho from the regulated areas unless the state of origin certifies that they were produced in a county free from infection with the regulated pests, as determined by adequate annual surveys satisfactory to the Director, and from disease-free bud sources, rootstocks, and environs. (3-20-20)T

**531. -- 539. (RESERVED)**

**540. OFFICIAL CERTIFICATE REQUIREMENTS.**



The certificates required by Section 530 of these rules, will state the names and addresses of the shipper and consignee, the number and kind of regulated articles in the shipments, and the area where grown. A copy of the certificate accompanies the shipment, and one (1) copy is forwarded at the time of shipment to the Division of Plant Industry, Idaho State Department of Agriculture, Boise, Idaho. (3-20-20)T

**541. -- 549. (RESERVED)**

**550. EXEMPTIONS.**

This quarantine does not apply to experiments of the United States Department of Agriculture in the state of Idaho nor to experiments of the College of Agriculture, Department of Pathology of the University of Idaho. (3-20-20)T

**551. -- 559. (RESERVED)**

**560. PENALTY.**

Any or all shipments or lots of the regulated articles enumerated in Section 525, of these rules, arriving in Idaho in violation of this chapter shall immediately be sent out of the state or destroyed at the option and expense of the owner or owners, or responsible agents and under the direction of the Director. (3-20-20)T

**561. -- 569. (RESERVED)**

**570. COMMON CARRIER AGENTS MUST HOLD SHIPMENTS.**

Any and all lots of shipments of commodities covered by this quarantine must be held and not delivered to consignee or agent until inspected and passed by the Director. (3-20-20)T

**571. -- 609. (RESERVED)**

**SUBCHAPTER F – DISPOSAL OF CULL ONIONS AND POTATOES**

**610. DEFINITIONS.**

The definitions found in section 610 apply to the interpretation and enforcement of Subchapter F only. (3-20-20)T

**01. Cull Onions.** Refers to those onions that are not marketable or useable for consumption or are generally considered waste, and includes the residue left in the field from the production of onion seed as well as commercial onions. (3-20-20)T

**02. Cull Potatoes.** Refers to those potatoes that are not marketable or useable for consumption or as seed potatoes and includes the residue left in the field from commercial or seed potato production, or as a result of spoilage while in storage. (3-20-20)T

**611. -- 619. (RESERVED)**

**620. REGULATED AREA.**

**01. Onions.** Ada, Canyon, Gem, Payette, Owyhee, and Washington Counties, state of Idaho. (3-20-20)T

**02. Potatoes.** The entire state of Idaho. (3-20-20)T

**621. -- 629. (RESERVED)**

**630. REGULATED PRODUCTS.**

**01. Cull Onions.** All cull onions produced as a result of market conditions, the grading process, or as a result of breakdown in storage or sorted out in the field during harvest and bulbs and waste left over from seed production. (3-20-20)T

**02. Cull Potatoes.** All cull potatoes produced as a result of market conditions, the grading process, or

as a result of breakdown in storage, or sorted out in the field during harvest and tubers and waste left over from potato seed production. (3-20-20)T

**631. -- 639. (RESERVED)**

**640. DISPOSITION OF CULL ONIONS.**

All cull onions existing in the control area shall be disposed of by a method approved of in Section 641 of this rule, to prevent sprouting. Disposal of all existing cull onions and debris must be completed prior to March 15th, of each year; provided; however, that in the case of onions sorted on or after March 15th of each year, the cull onions resulting therefrom shall be disposed of within one (1) week after such sorting regardless of the disposal method. The Department only enforces the cull onion disposal portions of this rule from March 15th through July 1st of each year. (3-20-20)T

**641. DISPOSAL METHODS.**

To control the spread of the onion maggot and related onion diseases, all disposal methods listed in Section 641 must be carried out to the extent that control of the regulated pest(s) is achieved in order to be in compliance with Subchapter F. (3-20-20)T

**01. Disposal by Covering in Dumps or Pits. (3-20-20)T**

**a.** Cull onions disposed of by being dumped in pits shall be managed and covered as recommended by the University of Idaho Agricultural Extension Service. (3-20-20)T

**b.** Covering shall be accomplished by March 15th of each year or as provided in Section 640 of this rule. (3-20-20)T

**02. Disposal by Feeding After March 15th of Each Year. (3-20-20)T**

**a.** Sheep or goats shall be fed no more than fifty-three (53) pounds of cull onions per individual animal per day. Cull onions shall be fed from either bunks or by spreading throughout the pasture or feedlot. Cull onions may not be fed from piles. (3-20-20)T

**b.** Cattle may be fed a ration containing no more than twenty-five percent (25%) cull onions on a dry matter basis. (3-20-20)T

**c.** Onion debris shall be completely removed from feeding areas and buried under twelve (12) inches or more of onion-free soil by March 15th of each year. (3-20-20)T

**d.** In the case of residues of onion debris two (2) inches or less in depth, or onions tramped into the soil so that they cannot be removed, such areas shall be disked and plowed as deep as possible, and such that all onions and debris are buried under eight (8) inches or more of onion-free soil by March 15th of each year. (3-20-20)T

**e.** Feeding areas and areas where onions are buried shall be treated in the manner set out in Section 641. (3-20-20)T

**f.** Cattle and sheep being finished for market or dairy cattle shall not be fed forage or grains grown on feeding areas treated in the manner set forth in Section 641. (3-20-20)T

**03. Disposal by Composting.** Cull onions being composted shall be covered by twelve (12) inches or more of onion-free soil or composting material until the onions have turned to compost. (3-20-20)T

**04. Disposal of Residue in Onion Producing Fields. (3-20-20)T**

**a.** Commercial onion fields where sort-out bulbs are left at harvest shall be disked and plowed as deep as possible, and such that all onions and debris are buried under eight (8) inches or more of onion-free soil by March 15th of each year. (3-20-20)T

**b.** Following final seed harvest, seed bulbs shall be disked and plowed as deep as possible, and such that all onions and debris are buried under eight (8) inches or more of onion-free soil by March 15th of each year. (3-20-20)T

**05. Disposal by Chopping or Shredding.** Cull onions that have been chopped or shredded to the point that they are incapable of sprouting, shall be disked and plowed as deep as possible, and such that all onions and debris are buried under eight (8) inches or more of onion-free soil by March 15th of each year. (3-20-20)T

**06. Disposal by Spreading.** Cull Onions may be disposed of by being spread on agricultural fields destined to be planted to a crop other than onions provided the onions are disked and plowed as deep as possible, and such that all onions and debris are buried under eight (8) inches or more of onion-free soil. (3-20-20)T

**642. INCLEMENT WEATHER.**

If inclement weather prevents disposal by the methods in Subsections 641.01 through 641.06, culls shall be treated with an EPA-labeled insecticide at prescribed intervals as recommended by the University of Idaho Agricultural Extension Service until proper disposal as prescribed in Subsections 641.01 through 641.06 can be carried out. (3-20-20)T

**643. (RESERVED)**

**644. NOTIFICATION REQUIRED.**

Any person or entity delivering cull onions for disposal in the area regulated for cull onion disposal shall provide written notification to the recipient of those cull onions advising the recipient of this rule and the recipient's obligations for the disposal of the cull onions under this rule. If the recipient is not the property owner, written notification shall also be made to the owner of the property where the onions are to be disposed of. Failure to make such notification in writing is a violation of Subchapter F. (3-20-20)T

**645. -- 649. (RESERVED)**

**650. DISPOSITION OF CULL POTATOES.**

All cull potatoes existing west of the Raft River shall be rendered non-viable by April 15th of each year and all cull potatoes generated after April 15th shall be rendered non-viable on a daily basis until September 20th. All cull potatoes existing east of the Raft River shall be rendered non-viable by May 15th of each year and all cull potatoes generated after May 15th shall be rendered non-viable on a daily basis until September 20th. (3-20-20)T

**651. CULL POTATO DISPOSAL METHODS.**

Cull potatoes shall be disposed of in a manner as to render them non-viable. Disposal methods are those as recommended by the University of Idaho Agricultural Extension Service. (3-20-20)T

**652. -- 659. (RESERVED)**

**660. AUTHORITY TO ENTER AND INSPECT.**

The Director or Director's agents are authorized to enter and inspect all onion and potato cull dumps and disposal sites in the state of Idaho for the purpose of insuring compliance with Subchapter F. (3-20-20)T

**661. -- 709. (RESERVED)**

**SUBCHAPTER G – MINT ROOTSTOCK AND CLONE PRODUCTION**

**710. DEFINITIONS.**

The definitions found in section 710 apply in the interpretation and enforcement of Subchapter G only: (3-20-20)T

**01. Certified Defined Generation.** The origin of mint rootstock is in the restricted area and its history may be directly traced, not to exceed five (5) generations, to its source as healthy clones. (3-20-20)T

**02. Healthy Clones (HC).** Those plants, which are cloned, having been cleansed, tested and maintained in an approved greenhouse and under the supervision of the state of origin's agricultural regulatory

authority. The origin of all clones shall be listed on all clone transfer permits. (3-20-20)T

**03. Nuclear Planting Stock (NPS).** Those rootstocks originating from healthy clones. (3-20-20)T

**04. Certified Defined Generation 1 (CDG-1).** Those rootstocks one (1) generation removed from nuclear planting stock, and fulfilling the requirements as herein provided. (3-20-20)T

**05. Certified Defined Generation 2 (CDG-2).** Those rootstocks one (1) generation removed from CDG-1 planting stock and fulfilling the requirements as herein provided. (3-20-20)T

**06. Certified Defined Generation 3 (CDG-3).** Those rootstocks one (1) generation removed from CDG-2 planting stock and fulfilling the requirements as herein provided. (3-20-20)T

**07. Certified Defined Generation 4 (CDG-4).** Those rootstocks one (1) generation removed from CDG-3 planting stock and fulfilling the requirements as herein provided. (3-20-20)T

**08. In-State Defined Generation.** The roots have been grown in the commercial production area and their history may be directly traced, not to exceed five (5) generations, to their source as healthy clones. (3-20-20)T

**09. In-State Defined Generation 1 (SDG-1).** Those rootstocks one (1) generation removed from nuclear planting stock, and fulfilling the requirements as herein provided. (3-20-20)T

**10. In-State Defined Generation 2 (SDG-2).** Those rootstocks one (1) generation removed from SDG-1 or CDG-1 planting stock and fulfilling the requirements as herein provided. (3-20-20)T

**11. In-State Defined Generation 3 (SDG-3).** Those rootstocks one (1) generation removed from SDG-2 or CDG-2 planting stock and fulfilling the requirements as herein provided. (3-20-20)T

**12. In-State Defined Generation 4 (SDG-4).** Those rootstocks one (1) generation removed from SDG-3 or CDG-3 planting stock and fulfilling the requirements as herein provided. (3-20-20)T

**13. Field.** A parcel of land submitted to the department for inspection of the mint being grown thereon, and physically separated by a minimum of five (5) feet of bare ground, or irrigation ditch, or road, or other physically discernible barrier separating it from an adjacent parcel of land planted with mint. (3-20-20)T

**711. (RESERVED)**

**712. REGULATED PESTS.**

**01. Diseases.** Verticillium wilt (*Verticillium dahliae* Kleb) a persistent soil-borne fungal disease of mint and any virulently pathogenic, persistent disease known to be detrimental to the production of mint rootstock in the restricted area and the commercial production area. (3-20-20)T

**02. Insects.** (3-20-20)T

**a.** Restricted area as defined in Subsection 720.02: Mint stem borer (*Pseudobaris nigrina*), insect pests of mint rootstocks and any persistent insect pest known to be detrimental to the production of mint rootstocks and without effective control options. (3-20-20)T

**b.** Commercial production area as defined in Subsection 720.01: Mint stem borer (*Pseudobaris nigrina*), insect pest of mint rootstocks and any persistent insect pest known to be detrimental to the production of mint rootstocks and without effective control options. (3-20-20)T

**03. Noxious Weeds.** (3-20-20)T

**a.** In both the commercial production area and restricted area as defined in Subsections 720.01 and 720.02: those weeds declared noxious by authority of Title 22, Chapter 24, Idaho Code (Noxious Weed Law) and

Rules. (3-20-20)T

**b.** Growers will be notified by the Department of existing noxious weed problems. If noxious weeds have not been effectively controlled as determined by the Department, prior to the second inspection, the field will be rejected for certification by the Department. (3-20-20)T

**713. -- 714. (RESERVED)**

**715. REGULATED PRODUCTS.**

**01. Mentha.** Rootstocks of all species of the genus *Mentha*. (3-20-20)T

**02. Mentha Production Equipment.** Machinery, tools, and equipment used in the production of *Mentha* species. (3-20-20)T

**716. -- 719. (RESERVED)**

**720. CONTROL AREAS.**

To facilitate inspection and control, the land mass of the state of Idaho is divided into two (2) areas, currently defined as: (3-20-20)T

**01. Commercial Production Area. Ada, Canyon, Elmore, Gem, Gooding, Payette, Owyhee, and Washington Counties.** (3-20-20)T

**02. Restricted Area.** That land mass of the state of Idaho not included in the commercial production area. (3-20-20)T

**a.** Certified defined generation mint shall not be grown when the specific location is within five (5) miles of uncertified mint unless there are adequate physical and cultural barriers. (3-20-20)T

**721. -- 729. (RESERVED)**

**730. REQUIREMENTS FOR MINT ROOTSTOCK TO BE PLANTED IN IDAHO.**

**01. Restricted Area as Defined in Subsection 720.02.** (3-20-20)T

**a.** Healthy clones shall be accompanied by a phytosanitary certificate issued by a regulatory agency of the state of origin with zero (0) tolerance for regulated disease(s), insect(s) and noxious weed(s); or (3-20-20)T

**b.** Certified rootstock from the restricted area shall be accompanied by a certified defined generation transfer permit with the parent rootstock number and with zero (0) tolerance for stem borer, or insect(s) without effective control options (i.e. stem borer), regulated disease(s) and noxious weed(s). (3-20-20)T

**02. Commercial Production Area.** As defined in Subsection 720.01, has no restrictions except for those wishing to participate in the inspection program who will adhere to the following rules: (3-20-20)T

**a.** Healthy clones shall be accompanied by a phytosanitary certificate, issued by a regulatory agent of the state of origin with zero (0) tolerance for regulated disease(s), insect(s) and noxious weeds; or (3-20-20)T

**b.** Certified rootstock from the restricted area shall be accompanied by a certified defined generation transfer permit with the parent rootstock number, level of mint root borer infestation and zero (0) tolerance for stem borer, or, insect(s) without effective control options (i.e., stem borer) regulated disease(s) and weed(s); or (3-20-20)T

**c.** In-state defined generation rootstock from the commercial production area shall be accompanied by a transfer permit with the parent rootstock number, level of mint root borer infestation and zero (0) tolerance for stem borer, regulated disease(s) and weed(s). (3-20-20)T

731. -- 739. (RESERVED)

**740. INSPECTION PROCEDURES.**

**01. Inspection Requests.** All requests for inspection shall be made prior to May 1 of each year on forms provided by the Department. (3-20-20)T

**a.** Incomplete applications for inspection will not be accepted. (3-20-20)T

**b.** No application for field inspection will be accepted after June 1 of each year except in the case of healthy clones. (3-20-20)T

**02. First Field Inspection.** Mint fields submitted for inspection will be inspected during active growth prior to oil harvest, but not earlier than the third week of July and not later than the first week of August, by the Idaho Department of Agriculture inspector. The inspection protocol is as follows: (3-20-20)T

**a.** Inspectors will walk the entire field at ten (10) row intervals. (3-20-20)T

**b.** The inspector will wear rubber boots that are sanitized between each field. A ten percent (10%) solution of sodium hypochlorite will be used to sanitize boots. (3-20-20)T

**c.** The site of any sample taken for a Verticillium wilt determination will be marked. (3-20-20)T

**d.** Fields found with Verticillium wilt during the first inspection will result in the entire field being disapproved and permanently ineligible for certification purposes by the Department. (3-20-20)T

**03. Second Field Inspection.** Mint fields submitted for inspection will be sampled after oil harvest or removal of foliage in early to mid September for the presence of the mint root borer. The sampling protocol is as follows: (3-20-20)T

**a.** Three (3) samples per five (5) acres will be collected. (3-20-20)T

**b.** Sampling sites will include areas of plant stress. (3-20-20)T

**c.** In each sampling site one (1) square foot samples of mint roots and two (2) to three (3) inches of soil will be selected. (3-20-20)T

**d.** The mint roots and the soil in each sample will be examined for evidence of regulated pests. (3-20-20)T

**e.** The site of any sample taken will be appropriately marked. (3-20-20)T

**f.** Fields found with Verticillium wilt during the second inspection will result in the entire field being disapproved by the Department and permanently ineligible for certification purposes, by the Department. (3-20-20)T

**g.** Fields with stem borer or other insects without control options (i.e., stem borer), will be disapproved by the Department for certification but, if proven clean at a later date, could again be considered for certification. (3-20-20)T

**04. Notification of Infestation.** The Idaho Department of Agriculture will notify the grower immediately upon the completion of any test results for regulated pest(s). (3-20-20)T

**05. Issuance of Certified Defined Generation and In-State Defined Generation Transfer Permits.** (3-20-20)T

**a.** Restricted area as defined in Subsection 740.02: a certified defined generation transfer permit with the parent rootstock number will be issued for rootstock that meets the following requirements: (3-20-20)T

- i. Roots shall be grown in restricted areas. (3-20-20)T
- ii. Field submitted and inspected per Subsections 740.01 through 740.04. (3-20-20)T
- iii. Zero (0) tolerance for regulated disease(s), insect(s) without effective control options (i.e., stem borer), and noxious weed(s). (3-20-20)T
- iv. Levels of mint root borer infestation will be listed in the transfer permit. (3-20-20)T
- b.** Commercial production area as defined in Subsection 720.01: an in-state defined generation transfer permit with the parent rootstock number and level of mint root borer infestation issued for rootstock that meets the following requirements: (3-20-20)T
  - i. Field submitted and inspected per Subsections 740.01 through 740.04. (3-20-20)T
  - ii. Zero (0) tolerance for regulated disease(s), insect(s) without effective control options (i.e., stem borer), and noxious weed(s). (3-20-20)T
  - iii. Levels of mint root borer infestation will be listed in the transfer permit. (3-20-20)T
- 06. Exemptions -- Issuance of In-State Transfer Numbers.** (3-20-20)T
  - a.** Restricted area as defined in Subsection 720.02: rootstock found to be infested with noxious weed(s), shall not be eligible for a certified defined generation transfer permit for the current year. The Department of Agriculture will issue an in-state transfer number to allow the grower to plant rootstock within their farm for the purpose of controlling the infestation. The field must be submitted for inspection per Subsections 740.01 through 740.04. If the rootstock is found to be free of the noxious weed(s), the rootstock will be eligible for a certified defined generation transfer permit with parent rootstock number. The eligible rootstock will be assigned a certified defined generation transfer permit with parent rootstock number corresponding to the next generation had it not been denied certification the previous year. Rootstock denied certification two consecutive years shall not be eligible for future certification. (3-20-20)T
  - b.** Commercial production area as defined in Subsection 720.01: rootstock found to be infested with a noxious weed(s) or insect(s) shall not be eligible for an in-state defined generation transfer permit for the current year. The Department of Agriculture will issue an in-state transfer number to allow the grower to plant the rootstock within their farm for the purpose of controlling the infestation. The field must be submitted for inspection per Subsections 740.01 through 740.04. If the rootstock is found to be free from the noxious weed(s) the rootstock will be eligible for an in-state defined generation transfer permit with parent rootstock number. The eligible rootstock will be assigned an in-state defined generation transfer permit corresponding to the next generation had it not been denied certification the previous year. Rootstock denied certification two consecutive years is not eligible for future certification. (3-20-20)T
- 07. Laboratory Tests.** In the event visual examination reveals evidence of a regulated pest, laboratory tests, if necessary to determine the causal organism, will be conducted by the Idaho Department of Agriculture laboratory on official samples in addition to the field inspection. In the case of a disagreement between the state Department of Agriculture and the interested party concerning the identity of the regulated pest in question, the state Department of Agriculture will submit an official sample to any lab of the University of Idaho, for a final determination. (3-20-20)T
- 08. Transfer Permits and Resale.** (3-20-20)T
  - a.** It is the responsibility of each grower producing certified or in-state defined generation mint rootstock originating within the state to obtain transfer permits from the Department prior to moving planting stocks for resale. (3-20-20)T
  - b.** Each time a transfer permit is issued, the Idaho Department of Agriculture will send a copy and/or

notification to the office of the Idaho Mint Commission. (3-20-20)T

**741. MOVEMENT OF FARM EQUIPMENT.**

Farm equipment, including but not limited to tillage equipment, planters and digging equipment moving from the infested area into the restricted area shall be clean and free of soil to the satisfaction of the Director or the Director's designated agent. (3-20-20)T

**742. -- 744. (RESERVED)**

**745. GREENHOUSES.**

Greenhouses shall be screened and tightly constructed to preclude the entry of any regulated insect or noxious weed as defined in Subsections 712.02 and 712.03 above. Planting media shall be sterilized prior to planting, and not re-used for planting of any mint destined to be entered in the mint certification process as outlined in this rule. Greenhouses shall be disinfected annually with a ten percent (10%) sodium hypochlorite solution and licensed as such under Chapter 23, Title 22, Idaho Code. (3-20-20)T

**746. -- 749. (RESERVED)**

**750. POSTING OF FIELDS.**

**01. Posting.** All mint fields within the restricted area shall be posted to prevent entry of unauthorized personnel. (3-20-20)T

**02. Approval by Department.** Signs and method of placement shall be of a type and manner approved by the Department with the advice of the Idaho Mint Commission. (3-20-20)T

**751. -- 759. (RESERVED)**

**760. AUTHORITY TO ENTER, INSPECT, AND CONTROL REQUIREMENTS.**

**01. Agent Authorization.** The Idaho Director of Agriculture or the Director's designated agents are authorized to enter and inspect any and all mint plantings in the restricted area and any and all mint plantings that have been submitted for inspection. (3-20-20)T

**02. Submission for Inspection.** Additionally, all mint planted in the restricted area shall be submitted to the Idaho Department of Agriculture for annual inspection. (3-20-20)T

**761. -- 769. (RESERVED)**

**770. PENALTY.**

Restricted area as defined in Subsection 720.02: any field of mint rootstock determined to be infected with a regulated pest including those without control options may be destroyed to eliminate the regulated pest by or at the expense of the grower or landlord. Except if the county, or any portion thereof, as determined by the Department, in which a field of mint rootstock determined to be infected with the regulated disease(s) or infested with insects without control options is to be made part of the commercial production area, then destruction of the field shall not be required. The method of destruction includes but is not limited to uprooting to expose and desiccate the rootstocks. All destruction must be completed by November 1st of each year. (3-20-20)T

**771. -- 779. (RESERVED)**

**780. EXEMPTIONS.**

**01. Government Agencies.** Subchapter G does not apply to any governmental agency growing mint in experimental plots approved by the Director of the Idaho Department of Agriculture and under the supervision of qualified plant scientists. (3-20-20)T

**02. Private, Non-Commercial Home Use.** These rules do not apply to species of the genus *Mentha*



intended for private, non-commercial home use. However, species of the genus *Mentha* intended for private, non-commercial home use entering Idaho shall be accompanied by a phytosanitary certificate issued by the state of origin's department of agriculture certifying them free of pests and diseases listed under Section 712. (3-20-20)T

**781. -- 789. (RESERVED)**

**790. FEES AND CHARGES.**

Under provisions of Section 22-2006, Idaho Code, the fees and charges for inspections, certificates, and permits under Subchapter G are as follows: (3-20-20)T

**01. Transfer Permits.** For in-state sale or movement of certified or in-state defined generation rootstock: ten dollars (\$10) per permit. (3-20-20)T

**02. Field Inspections.** (3-20-20)T

**a.** Application for field inspection: five dollars (\$5) per field. (3-20-20)T

**b.** Field inspection, collection of samples and examination of samples will be assessed at a rate of fifteen dollars (\$15) per acre per inspection. (3-20-20)T

**c.** Travel costs and lodging will be charged according to established state rates and policy. (3-20-20)T

**d.** Every effort will be made to schedule field inspections to insure the most efficient use of travel time. Charges for travel time will be charged on a prorated basis when more than one (1) farm is inspected during a trip. (3-20-20)T

**791. -- 819. (RESERVED)**

**SUBCHAPTER H – GRAPE PLANTING STOCK**

**820. REGULATED AREAS.**

All areas outside of the territorial borders of the state of Idaho. (3-20-20)T

**821. -- 829. (RESERVED)**

**830. REGULATED COMMODITIES.**

Planting stock of grape (*Vitis* species) including live plants, hardwood cuttings, softwood cuttings, rootstocks, and any other parts of the grape plant, except fruit, capable of propagation (except fruit). (3-20-20)T

**831. REGULATED PESTS.**

Regulated pests include, but are not limited to: (3-20-20)T

**01. Grapevine Fanleaf Virus.** (3-20-20)T

**02. Grapevine Leaf Roll - Associated Viruses.** (3-20-20)T

**03. Red Blotch Virus.** (3-20-20)T

**04. Grapevine Corky Bark Disease.** Which include, but may not be limited to: (3-20-20)T

**a.** Grapevine virus A. (3-20-20)T

**b.** Grapevine virus B. (3-20-20)T

**05. Grape Phylloxera.** (*Daktulosphaira vitifoliae*); (3-20-20)T

**06. Pierce's Disease.** As caused by the bacterium *Xylella fastidiosa*; (3-20-20)T

07. **Vine Mealybug.** (*Planococcus ficus*) (3-20-20)T
08. **Glassy-Winged Sharpshooter.** (*Homalodisca vitripennis*). (3-20-20)T
09. **European Grapevine Moth.** (*Lobesia botrana*) (3-20-20)T
10. **Xiphinema Index.** (3-20-20)T

832. -- 834. **(RESERVED)**

**835. RULES GOVERNING SHIPMENTS.**

**01. Admittance into Idaho.** Each shipment of a regulated article from a regulated area must be accompanied by a certificate issued by the state or country of origin's plant protection organization, stating that the grape planting stock to be imported has been certified in accordance with the regulations of an official grapevine certification program of the state or country of origin's plant protection organization, that includes annual inspections at all certification levels and testing at the foundation level for regulated pests and: (3-20-20)T

**a.** The grapevines, rootstock and/or softwood cuttings were grown in and shipped from an area known to be free from regulated pests; or (3-20-20)T

**b.** For small shipments (five hundred (500) or less) of un-rooted softwood cuttings, were individually inspected by an authorized inspector and were found to be free from regulated pests; or (3-20-20)T

**c.** The grapevines, rootstock or softwood cuttings were grown under a sterile soil-less media and treated with a soil or systemic insecticide and a hot water dip treatment, as outlined in Section 840 of this rule, proven to be effective against vine mealybug and any other pests that may be present on the roots; or (3-20-20)T

**d.** The grapevines, rootstock, and/or softwood cuttings were subject to one (1) of the two (2) treatments outlined in Section 840 of this rule, or such additional methods as may be determined to be effective and are approved by the director and were stored in a manner after treatment that would prevent re-infestation. (3-20-20)T

**02. Marking Contents.** All shipments of grape planting stock must be plainly marked with the contents on the outside of the package or container. (3-20-20)T

**03. Shipment Notification.** Persons shipping or transporting grape planting stock into this state from areas under regulation shall notify the department by electronic mail, regular mail or fax prior to shipment including the nature of the grape planting stock (such as live plants, hardwood cuttings, softwood cuttings, rootstocks, or other similar categories), the quantity in each shipment, the expected date of arrival, the name of the intended receiver and the destination. An official certificate issued by the plant protection organization of the state of origin certifying that the grapevines meet the requirements of this chapter must accompany the grape planting stock into the state. All treatments and inspections must have been witnessed or performed by an official of the state of origin's plant protection organization. (3-20-20)T

836. -- 839. **(RESERVED)**

**840. ACCEPTABLE TREATMENTS.**

**01. Hot Water Treatment.** Dormant, rooted grapevines or rootstock shall be washed to remove all soil or other propagative media by immersing in a hot water bath for a period of not less than three (3) minutes, nor more than five (5) minutes, at a temperature of not less than one hundred twenty-five degrees Fahrenheit (125° F.) or fifty-two degrees Celsius (52° C.), nor more than one hundred thirty degrees Fahrenheit (130° F.) or fifty-five degrees Celsius (55° C.) at any time during immersion; or (3-20-20)T

**02. Fumigation.** Grapevines, rootstock or softwood cuttings may be treated with a fumigant approved

for the regulated pests. (3-20-20)T

**03. Other Methods.** Upon written application to the Director, variations to the above mentioned acceptable treatments or additional treatment methods may be considered. (3-20-20)T

**841. -- 844. (RESERVED)**

**845. DISPOSITION OF COMMODITIES IN VIOLATION OF RULES.**

Any commodity set forth in Section 835 of Subchapter H or any grape plants or parts thereof, not meeting the requirements of Subchapter H shall immediately be sent out of the state of Idaho or destroyed at the option and expense of the owner or owners, or responsible agents and under the direction of the Director. (3-20-20)T

**846. -- 849. (RESERVED)**

**850. AUTHORITY TO ENTER, INSPECT, AND CONTROL.**

**01. Entry and Inspection.** The Director is authorized to enter and inspect any or all grape plantings in the state of Idaho. (3-20-20)T

**02. Control and Destruction of Infected Plants.** Whenever the Director finds that there is imminent peril that virus diseases or plant pests will spread from infected grape plantings to and contaminate other uninfected grape plantings because of refusal, failure, or neglect to control the already infected grape plantings, the Director may at once give notice in writing to control or destroy in part or total the infected grape plantings under the provisions of Title 22, Chapter 20, Idaho Code, and may thereafter, if necessary, proceed to destroy such infected grape plantings under the terms and provisions of Title 22, Chapter 20, Idaho Code. (3-20-20)T

**851. -- 854. (RESERVED)**

**SUBCHAPTER I – JAPANESE BEETLE**

**855. REGULATED PEST.**

Japanese beetle (*Popillia japonica*). (3-20-20)T

**856. -- 859. (RESERVED)**

**860. AREAS UNDER QUARANTINE.**

**01. States.** The entire states of Alabama, Connecticut, Delaware, Georgia, Illinois, Indiana, Kentucky, Maine, Maryland, Massachusetts, Michigan, Minnesota, Missouri, New Hampshire, New Jersey, New York, North Carolina, Ohio, Pennsylvania, Rhode Island, South Carolina, Tennessee, Vermont, Virginia, West Virginia, and the District of Columbia. (3-20-20)T

**02. Canada.** In Canada: (3-20-20)T

**a.** In the Province of Ontario: Lincoln, Welland and Wentworth. (3-20-20)T

**b.** In the Province of Quebec: Missiquoi and St. Jean. (3-20-20)T

**03. Other Areas.** Any areas not mentioned above and subsequently found to be infested. (3-20-20)T

**861. -- 869. (RESERVED)**

**870. ARTICLES AND COMMODITIES UNDER QUARANTINE.**

**01. Possible Hosts and Carriers.** The following are hereby declared to be hosts and possible carriers of the Japanese beetle: (3-20-20)T

- a. Soil, humus, compost, and manure (except when commercially packaged); (3-20-20)T
- b. All plants with roots (except bareroot plants free from soil); (3-20-20)T
- c. Grass sod; (3-20-20)T
- d. Plant crowns or roots for propagation (except when free from soil); (3-20-20)T
- e. Bulbs, corms, tubers, and rhizomes of ornamental plants (except when free from soil); (3-20-20)T
- f. Any other plant, plant part, article, or means of conveyance when it is determined by the Director or authorized agent to present a hazard of spreading live Japanese beetle due to infestation or exposure to infestation by Japanese beetle. (3-20-20)T

**02. Soil.** For the purposes of this quarantine, soil is defined as all growing media in which the plants are actually rooted. Packing material other than soil, added to bareroot plants after harvesting would not normally pose a pest risk. Packing material would be covered under (Subsection 930.01.f.), at the inspector's discretion. (3-20-20)T

**03. Free from Soil.** For the purposes of this quarantine, free from soil is defined as soil in amounts that could not contain concealed Japanese beetle larvae or pupae. (3-20-20)T

**871. -- 879. (RESERVED)**

**880. RESTRICTIONS.**

All articles and commodities under quarantine are prohibited entry into Idaho from an area under quarantine with the following exceptions: (3-20-20)T

**01. Certificate of Treatment.** All of the articles and commodities covered are approved for entry into Idaho when accompanied by a certificate issued by an authorized state agricultural official at origin stating that the article or shipment was treated for Japanese beetle or grown in accordance with methods and procedures approved and prescribed by the Director. A Certificate of Treatment shall include the date of treatment. Shipment of the articles or commodities shall not take place sooner than ten (10) days after the date of treatment, but no later than thirty (30) days after treatment. (3-20-20)T

**02. Certificate of Origin.** Commercial plant shipments with soil may be shipped from an area under quarantine into Idaho provided such shipments are accompanied by a certificate issued by an authorized state agricultural official at origin. Such certificates shall be issued only if the shipment confirms fully with either Subsections 880.02.a., 880.02.b., or 880.02.c. of Subchapter I: (3-20-20)T

a. The greenhouse in which the plants were produced was tightly constructed so that adult Japanese beetles would not gain entry, the plants and greenhouses were inspected and found to be free from all stages of Japanese beetle, and the plants and soil were protected from subsequent infestation while being stored, packed and shipped; or (3-20-20)T

b. The plants were not produced in the regulated area, were transported into the regulated area in a closed conveyance or closed containers and at all times thereafter were protected from becoming infested with Japanese beetle; or (3-20-20)T

c. States or portions of states listed in the area under quarantine may have counties that are not infested with Japanese beetle. Shipments of articles and commodities covered will be accepted from these noninfested counties if annual surveys are made in such counties and the results of such surveys are negative for Japanese beetle. A list of counties so approved will be maintained by the Director. Agricultural officials of other states may recommend a noninfested county be placed on the approved county list by writing for such approval and stating how the surveys were made giving the following information: (3-20-20)T

- i. Area surveyed. (3-20-20)T

- ii. How survey was carried out. (3-20-20)T
- iii. Personnel involved. (3-20-20)T
- iv. If county was previously infested, give date of last infestation. (3-20-20)T
- v. The recommendation for approval of such counties will be evaluated by the Department of Feeds and Plant Services, Division of Plant Industries, Idaho Department of Agriculture. (3-20-20)T

**03. Denial of Approval.** If heavy infestations occur in neighboring counties, approval may be denied. To be maintained on the approved list, each county will be reapproved every twelve (12) months. Shipments of articles and commodities under quarantine from noninfested counties will only be allowed entry into Idaho if the noninfested county has been placed on the approved list prior to the arrival of the shipment to Idaho. (3-20-20)T

**04. Privately Owned House Plants.** Up to twenty-five (25) privately owned house plants grown indoors may be inspected and approved for entry by the Director or Director's authorized agent if found free from Japanese beetle. (3-20-20)T

**881. -- 889. (RESERVED)**

**890. PENALTY.**

Any or all shipments or lots of quarantined articles or commodities listed in Section 870 above arriving in Idaho in violation of this quarantine shall immediately be sent out of the state, destroyed, or treated by a method and in a manner as directed by the Director. Treatment shall be performed at the expense of the owner, or owners, or their duly authorized agent. (3-20-20)T

**891. -- 919. (RESERVED)**

**SUBCHAPTER J – ANTHRACNOSE DISEASE OF LENTIL**

**920. REGULATED DISEASE.**

The anthracnose disease of lentil, caused by the fungi identified as *Colletotrichum truncatum* (Schwein) Andrus & W.D. Moore and *Colletotrichum destructivum*. (3-20-20)T

**921. -- 929. (RESERVED)**

**930. REGULATED PRODUCTS.**

The seeds and vegetative parts of lentil, *Vicia sp.*, faba beans, peas, Tangier pea, vetch, and other host of the regulated disease. (3-20-20)T

**931. -- 934. (RESERVED)**

**935. AREA UNDER QUARANTINE.**

The Canadian provinces of Manitoba and Saskatchewan and all states and territories of the United States and foreign countries known to have confirmed the presence of the anthracnose of lentil. (3-20-20)T

**936. -- 939. (RESERVED)**

**940. SHIPMENTS.**

No person shall import any regulated products into Idaho for planting purposes from any area under quarantine. (3-20-20)T

**941. -- 949. (RESERVED)**

**950. INSPECTION AND CONTROL PROCEDURES.**

**01. Inspection.** The Department may inspect any regulated product or planting of regulated products

during any time of the year to determine if the regulated disease is present therein. If the Department finds that any regulated product or planting of the same is infected or otherwise in violation of Subchapter J, it shall direct the control and/or the eradication of the infection. (3-20-20)T

**02. Control.** The control and/or the eradication methods shall be only those approved by the Director, at the expense of the owner, and may include but are not limited to: (3-20-20)T

**a.** Any infected regulated product will be destroyed. (3-20-20)T

**b.** The infected crop will be sprayed with fungicide(s) registered with the United States Environmental Protection Agency and the state of Idaho. (3-20-20)T

**c.** Any infested field will not be planted to any regulated products cited in Section 930. (3-20-20)T

**d.** Volunteer regulated products cited in Section 930 growing in any infested field shall be destroyed by a method(s) approved by the Director. (3-20-20)T

**951. -- 959. (RESERVED)**

#### **SUBCHAPTER K – PLUM CURCULIO**

**960. REGULATED PEST.**  
Plum curculio (*Conotrachelus nenuphar* (Coleoptera: Curculionidae)). (3-20-20)T

**961. -- 969. (RESERVED)**

**970. AREA UNDER QUARANTINE.**  
In the eastern United States and Canada, all states and provinces east of and including Manitoba, North Dakota, South Dakota, Nebraska, Kansas, Oklahoma and Texas. In Utah, Box Elder County. (3-20-20)T

**971. -- 979. (RESERVED)**

**980. ARTICLES AND COMMODITIES COVERED.**

**01. Fresh Fruit of All Plants Listed Below:** (3-20-20)T

**a.** Apple (*Malus spp.*); (3-20-20)T

**b.** Apricot (*Prunus armeniaca*); (3-20-20)T

**c.** Cherry, black (*P. serotina*); (3-20-20)T

**d.** Cherry, choke (*P. virginiana*); (3-20-20)T

**e.** Cherry, pin (*P. pensylvanica*); (3-20-20)T

**f.** Cherry, sand (*P. pumila*); (3-20-20)T

**g.** Cherry, sour (*P. cerasus*); (3-20-20)T

**h.** Cherry, sweet (*P. avium*); (3-20-20)T

**i.** Crabapple (*Malus spp.*); (3-20-20)T

**j.** Hawthorn or haw (*Crataegus spp.*); (3-20-20)T

**k.** Nectarine (*Prunus persica nectarina*); (3-20-20)T

- l.** Peach (*P. persica*); (3-20-20)T
  - m.** Pear (*Pyrus communis*); (3-20-20)T
  - n.** Plum, American (wild) (*Prunus alleghaniensis*); (3-20-20)T
  - o.** Plum, beach (*P. maritima*); (3-20-20)T
  - p.** Plum, European (*P. domestica*); (3-20-20)T
  - q.** Plum, Japanese (*P. salicina*); (3-20-20)T
  - r.** Prune (*P. spp.*); (3-20-20)T
  - s.** Quince (*Cydonia oblonga*). (3-20-20)T
- 02. Soil.** Soil or other growing medium within the drip zone of plants producing or that have produced fruit as listed in Subsection 980.01. (3-20-20)T

**981. -- 989. (RESERVED)**

**990. RESTRICTIONS.**

**01. Certification Required.** Articles and commodities covered that are produced in or shipped from the area under quarantine are prohibited entry into the state of Idaho unless each lot or shipment is accompanied by a certificate issued by and bearing the original or facsimile signature of the authorized agricultural official of the state from which the article or commodity is shipped evidencing compliance with Subsections 990.03, 990.04, 990.06 or 990.07 of Subchapter K. No certificate is required for commodities meeting the requirements of Subsections 990.02 or 990.05 of Subchapter K. (3-20-20)T

**02. Reshipments in Original Containers from Area Under Quarantine of Commodities Grown Outside Thereof.** Commodities in original unopened containers, each bearing labels or other identifying marks evidencing origin outside the area under quarantine, may be reshipped to this state from any point within the area under quarantine. (3-20-20)T

**03. Repacked Commodities Admissible from Area Under Quarantine If Certified Grown Outside Thereof.** Provided each lot or shipment is certified by an authorized agricultural official to have been grown outside the area under quarantine and that continued identity has been maintained while within the area under quarantine, the commodities may be repacked and shipped by common carrier from any point within the area under quarantine to this state. The certificate shall set forth the state in which commodities were grown, point of repacking and reshipment, amount and kind of commodities comprising the lot or shipment, and the names and addresses of the shipper and consignee. (3-20-20)T

**04. Apples Exposed to Controlled Atmosphere (CA) Storage Admissible Under Certificate.** Apples that are exposed to controlled atmosphere (CA) storage for a continuous period of ninety (90) days, during which period the temperature within the storage room is maintained at thirty-eight degrees Fahrenheit (38° F), three point three degrees Celsius (3.3° C) or less, may be admitted into Idaho provided said storage room or building is approved by the proper authorities in the state of origin as a controlled atmosphere facility and further provided each lot or shipment of such apples to Idaho is accompanied by a certificate, as stated in Subsection 990.01, evidencing compliance with the minimum requirements of this section. (3-20-20)T

**05. Solid Frozen Fruits Exempt.** No restrictions are placed by this rule on the entry into this state of fruits that upon arrival are frozen solid and that are under refrigeration to assure their solid frozen state. (3-20-20)T

**06. Shipments from Cold Storage at Thirty-Two Degrees Fahrenheit (32° F), Zero Degrees Celsius (0° C).** Commodities covered that are held in cold storage for a continuous period of forty (40) days or more,

during which period the temperature within the storage room is maintained at thirty-two degrees Fahrenheit (32° F) zero degrees Celsius (0° C) or less, may be admitted into Idaho provided each lot or shipment is accompanied by a certificate, as stated in Subsection 990.01, evidencing compliance with the minimum requirements of Subsection 990.06. (3-20-20)T

**07. Soil or Growing Media When Certified.** Soil or growing media specified in Subsection 980.02 is admissible when certified as treated at origin in a manner approved by the Director. (3-20-20)T

**991. -- 999. (RESERVED)**



## 02.06.06 – RULES GOVERNING THE PLANTING OF BEANS

### 000. LEGAL AUTHORITY.

This chapter is adopted under the legal authority of Sections 22-1907, 22-2004, and 22-2006, Idaho Code.

(3-20-20)T

### 001. TITLE AND SCOPE.

01. **Title.** The title of this chapter is IDAPA 02.06.06, “Rules Governing the Planting of Beans.”

(3-20-20)T

02. **Scope.** These rules govern the planting of beans in Idaho.

(3-20-20)T

### 002. -- 009. (RESERVED)

### 010. DEFINITIONS.

The Department adopts the definitions set forth in Section 22-2005, Idaho Code. In addition, as used in this chapter:

(3-20-20)T

01. **Department Approved Tag (Yellow Tag) (Phaseolus).** A tag issued by the Department to seed lots produced west of the Continental Divide in the contiguous United States. The seed lot must be accompanied by a phytosanitary certificate issued by the regulatory agency of the state of origin, listing the diseases the crop was inspected for, that must include the regulated pests as defined in Section 012 of these rules and be based on growing season and windrow or pre-harvest inspections. Seed lots must pass laboratory testing done by the Department on samples drawn in Idaho by the Department and found free from regulated pest(s) as listed in Section 012 of this rule.

(3-20-20)T

02. **Department Approved Tag (Yellow Tag) (Non-Phaseolus).** A tag issued by the Department to seed lots produced outside of Idaho and imported into Idaho for planting. The seed lot must be certified by the seed certification agency of the state of origin and be accompanied by a phytosanitary certificate or official field inspection report issued by the regulatory agency of the state of origin. Seed lots must pass laboratory testing performed by the Department, or Department approved laboratories, on samples drawn in Idaho by the Department and found free from regulated pest(s) and soil as listed in Sections 012 and 013 of this rule.

(3-20-20)T

03. **Department In-State Planting Tag (Green Tag).** A tag issued by the Department to seed lots in compliance with growing season and windrow inspections in Idaho.

(3-20-20)T

04. **Detailed Varietal Planting Plan.** A plan that shows the variety name, seed lot number, In-state planting tag number (State Number) if applicable, pounds planted, acres planted, origin of seed, and the results of laboratory testing.

(3-20-20)T

05. **Edible Harvest.** Seed planted in Idaho intended for edible purposes (fresh green pod or dried edible seed).

(3-20-20)T

06. **Experimental Plots.** Subdivisions of trial grounds used for the introduction of seed otherwise ineligible for planting in Idaho.

(3-20-20)T

07. **Farmstead.** All land farmed in common with the land upon which the trial ground is located.

(3-20-20)T

08. **Home Garden.** Personal use home gardens wherein Phaseolus or Non-Phaseolus species are planted for consumption and will not be utilized for replanting outside the same home garden where they were produced or offered for sale or sold for further propagation in Idaho.

(3-20-20)T

09. **ICIA Tag.** A tag issued by ICIA provided that the lot was field and windrow inspected by ICIA in accordance with these rules.

(3-20-20)T

10. **In-State Planting Tag Number (State Number).** A number assigned by the Department to each lot which has successfully passed the Department’s field and windrow inspection requirements in which no regulated pests were found.

(3-20-20)T

11. **Introduction Plots.** Subdivisions of trial grounds used for the introduction or increase of bean

seed. (3-20-20)T

**12. Oregon Department of Agriculture Inspection Tag.** A tag issued to seed lots produced in Malheur County, Oregon which were inspected in the growing season and in the windrow by the Oregon Department of Agriculture for the regulated pests as defined in Section 012 and Subsections 013.01 and 013.02 of these rules (3-20-20)T

**13. Pre-Harvest Inspection.** Inspection done prior to harvest, where harvest methods or crop condition do not allow for windrow inspection. (3-20-20)T

**14. Rill Irrigation.** A method of applying non-pressurized irrigation water to crops in a free flow manner by using a series of drip, ditches, canals, siphon tubes, and gated pipe utilizing gravity as means of conveyance within the field. (3-20-20)T

**15. Seed Borne.** Pest(s) that can be found on the seed or within the seed coat but do not necessarily result in the transfer of the pest to the resulting plant. (3-20-20)T

**16. Seed Lot.** A definite quantity of seed identified by a lot number, every portion or bag of which is uniform, within permitted tolerances, for factors that appear in the labeling. (3-20-20)T

**17. Seed Transmitted.** Pest(s) that can be transferred from the seed into the resulting plant. (3-20-20)T

**18. Sprinkler Irrigation.** An overhead water delivery system used to disperse irrigation water to crops in a designated pattern utilizing a pump, a network series of pipes and delivering water under a controlled pressure in a predetermined quantity. (3-20-20)T

**19. Trial Grounds.** Parcels of land located on one (1) farmstead set aside for the purpose of research testing or introduction of bean seed. (3-20-20)T

**20. True Identity of Seed Lot.** True identity of seed lot is recorded using information provided by the applicant on the application for field inspection or on the detailed varietal planting plan and harvest records. The true identity of the seed lot is maintained by the Department after the applicant has finalized the harvest information and provided such to the Department. (3-20-20)T

**21. Windrow Inspection.** An inspection procedure performed on a seed crop prior to harvest but after the crop has been cut and allowed for curing or drying out. (3-20-20)T

**011. ABBREVIATIONS.**

**01. ICIA.** Idaho Crop Improvement Association. (3-20-20)T

**02. ISDA.** Idaho State Department of Agriculture. (3-20-20)T

**012. REGULATED PESTS (PHASEOLUS AND NON-PHASEOLUS).**

**01. Anthracnose.** Caused by (*Colletotrichum lindemuthianum*), (*Glomerella lindemuthiana*). (3-20-20)T

**02. Bacterial Wilt.** Caused by (*Curtobacterium flaccumfaciens pv. flaccumfaciens*), (*Corynebacterium flaccumfaciens*). (3-20-20)T

**03. Brown Spot.** Caused by (*Pseudomonas syringae pv. syringae*), (*P. syringae*). (3-20-20)T

**04. Common Blight.** Caused by (*Xanthomonas axonopodis pv. phaseoli*), (*X. phaseoli*), (*X. phaseoli var. fuscans*). (3-20-20)T

**05. Halo Blight.** Caused by (*Pseudomonas savastanoi* pv. *phaseolicola*), (*P. phaseolicola*). (3-20-20)T

**013. REGULATED PESTS (NON-PHASEOLUS ONLY).**

**01. Soybean Cyst Nematode.** (*Heterodera glycines*). (3-20-20)T

**02. Asian Soybean Rust.** Caused by (*Phakopsora pachyrhizi*). (3-20-20)T

**03. Soil.** There is a zero (0) tolerance, as defined by the soil tolerance standards of the Association of Official Seed Analysts (AOSA), for soil in any lot of a regulated article imported into Idaho and destined for planting in Idaho. This prohibition does not apply to seed of Idaho or Malheur County, Oregon origin. (3-20-20)T

**014. -- 049. (RESERVED)**

**050. REGULATED ARTICLES.**

All seed and growing plants of (*Phaseolus*) species, from any source, being grown or planted for the production of seed or planted for edible harvest within the state of Idaho. All seed of soybean (*Glycine max*), mung bean (*Vigna radiata*), and azuki bean (*Vigna angularis*) and any other plant species capable of spreading a regulated pest as a contaminant or in a seed borne or seed transmitted manner, from any source and being planted within the state of Idaho, unless otherwise exempted in this rule. (3-20-20)T

**051. EDIBLE HARVEST EXEMPTION.**

Seeds planted for edible harvest must bear an approved tag as defined in Section 200.08 or 201.06 of this rule. Seeds planted for edible harvest are not required to undergo inspection requirements defined in Section 150 and 151, and are not covered by the irrigation restrictions defined in Section 200.09. (3-20-20)T

**052. HOME GARDEN EXEMPTION.**

Seeds planted for home garden use and consumption that will not be sold for replanting outside the original home garden space are allowed to utilize small package, non-tagged seed and are exempt from inspection requirements defined in Section 150 and 151 of this rule and from irrigation restrictions defined in Section 200.09. All seed intended for production of seed for replanting outside the home garden where they were produced are defined as Regulated Articles in Section 050. (3-20-20)T

**053. -- 149. (RESERVED)**

**150. INSPECTION (PHASEOLUS).**

All seeds harvested from bean fields in Idaho intended for replanting in Idaho shall be submitted to the Department or ICIA for growing season and windrow inspections. (3-20-20)T

**01. Application for Inspection.** (3-20-20)T

**a. Deadline for Submission.** Received by the Department on or before July 1 of each year. (3-20-20)T

**b. Application Forms.** Forms will be provided by the Department or may be company generated. Company generated application forms must be approved by the Department prior to submission. (3-20-20)T

**c. Additional or Substitute Acreage.** Applications for additional or substitute acreage may be submitted until September 1 and will be accepted on a case by case basis and the cost of inspection to be determined by the Director. (3-20-20)T

**02. Active Growth Inspection.** Unless the Director, in his sole discretion, deems additional inspections are necessary, the bean seed for replanting will be inspected as follows: (3-20-20)T

**a. Fields under rill irrigation -- at least once.** (3-20-20)T

**b. Fields under sprinkler irrigation -- at least twice.** (3-20-20)T

- 03. Windrow or Pre-Harvest Inspection.** (3-20-20)T
- a.** Number of inspections -- at least once. (3-20-20)T
- b.** The Director may authorize qualified personnel to perform windrow inspections under the supervision of the Department. (3-20-20)T
- c.** The Director may upon written request of the seed company agent perform standing crop pre-harvest inspection. (3-20-20)T

**151. INSPECTION (NON-PHASEOLUS)**

All imported or Idaho origin seeds intended for planting or replanting in Idaho shall be submitted to the Department for growing season and pre-harvest/windrow inspections. (3-20-20)T

- 01. Application for Inspection.** (3-20-20)T
- a.** Deadline for Submission. Received by the Department on or before July 1 of each year. (3-20-20)T
- b.** Application Forms. Forms will be provided by the Department or may be company generated. Company generated application forms must be approved by the Department prior to submission. (3-20-20)T
- c.** Additional or Substitute Acreage. Applications for additional or substitute acreage may be submitted until September 1 and will be accepted on a case by case basis and the cost of inspection to be determined by the Director. (3-20-20)T

**02. Inspections.** Unless the Director, at his sole discretion, deems additional inspections are necessary, the bean seed for planting will be inspected as follows: (3-20-20)T

- a.** Fields under rill or sprinkler irrigation -- at least once; (3-20-20)T
- b.** Pre-Harvest or Windrow Inspection -- at least once. (3-20-20)T

**152. -- 199. (RESERVED)**

**200. REQUIREMENTS FOR PLANTING BEAN SEED IN IDAHO (PHASEOLUS).**

In order to be eligible for planting bean seed in Idaho: (3-20-20)T

**01. Idaho Grown Seed.** Seeds planted must be from a lot that has an in-state planting tag number (state number) assigned by the Department based on growing season and windrow inspections and be tagged by the Department with a Department In-State Planting Tag (Green tag) or be tagged by the ICIA in accordance with these rules. (3-20-20)T

**02. Malheur County, Oregon Grown Seed.** Bean seed produced in Malheur County, Oregon must be from a lot inspected in the growing season and in the windrow for the regulated pests as defined in Section 012 of these rules and tagged by the Oregon Department of Agriculture. The ICIA may inspect and issue tags for bean seed grown in Malheur County, Oregon provided that each field is inspected according to these rules and the Malheur County Bean Disease Control Area order. (3-20-20)T

**03. Imported Seed Grown West of the Continental Divide in the Contiguous United States.** Imported bean seed grown west of the Continental Divide in the contiguous United States must: (3-20-20)T

- a.** Be accompanied by a phytosanitary certificate issued by the regulatory agency of the state of origin, listing the diseases for which the crop was inspected, that must include the regulated pests as defined in Section 012 of these rules, and stating that the crop was field and windrow or pre-harvest inspected; (3-20-20)T
- b.** Seed lot shall successfully pass laboratory tests conducted by the Department from samples officially drawn in the state of Idaho by the Department; (3-20-20)T

- c. Bear a Department approved tag (yellow); (3-20-20)T
- d. Not be planted under sprinkler irrigation; and (3-20-20)T
- e. Each field planted in Idaho must be submitted for field and windrow or pre-harvest inspections. (3-20-20)T

**04. Imported Seed Grown East of the Continental Divide in the Contiguous United States or of Foreign Origin.** Imported bean seed grown east of the Continental Divide in the Contiguous United States or of foreign origin to be planted in Idaho shall be planted only on an approved trial ground as outlined in Section 250. (3-20-20)T

**05. Idaho Grown Seeds Shipped East of the Continental Divide in the Contiguous United States or to a Foreign Country and Returned.** Bean seeds shipped east of the Continental Divide in the contiguous United States or to a foreign country may be returned to Idaho but, upon return, be planted on an approved trial ground as outlined in Section 250. (3-20-20)T

**06. Idaho Grown Seeds Shipped West of the Continental Divide in the Contiguous United States, Except Malheur County, Oregon, or to a Foreign Country and Returned.** Bean seeds shipped outside Idaho or Malheur County, Oregon, west of the Continental Divide in the contiguous United States, or to a foreign country, which were tagged prior to leaving the state and at the Director's discretion were segregated in such a way to ensure freedom from regulated pests, may be returned to Idaho for planting under the following conditions: (3-20-20)T

- a. Seed tags and packaging are intact with the segregation of the seed deemed satisfactory by the Director, (3-20-20)T
- b. Bean seed not tagged prior to leaving the state, returned to Idaho without seed tags and packaging intact, or not segregated to the satisfaction of the Director, may be returned to Idaho but, upon return, will fall under Section 200.03 or 201.03 of these rules or may be planted on an approved trial ground as outlined in Section 250. (3-20-20)T

**07. Contaminated Seeds.** The seeds from any bean field found or known to be contaminated with a regulated pest, as defined in Section 012 of these rules, cannot be planted in Idaho. (3-20-20)T

**08. True Identity of Seed Lots.** Failure to maintain the true identity of any seed lot intended for seed purposes will automatically disqualify that lot for future planting in Idaho. (3-20-20)T

**09. Tags.** Bean seeds planted in Idaho shall be from an approved lot bearing an approved tag on each bag or container, stating the kind, variety, and lot number. The following is a list of approved planting tags in Idaho: (3-20-20)T

- a. Department in-state planting tag (green tag); (3-20-20)T
- b. Department approved tag (yellow tag); (3-20-20)T
- c. ICIA tag, provided the lot was field and windrow inspected by ICIA in accordance to these rules; or (3-20-20)T
- d. Oregon Department of Agriculture inspection tag. (3-20-20)T

**10. Irrigation.** (3-20-20)T

- a. Pintos, Reds, Pinks, Great Northerns, Small Whites, Navy Beans, Blacks, Kidneys, Yellows, Cranberries, and Lima beans: (3-20-20)T
  - i. First generation of seed grown in Idaho must be grown and inspected under rill irrigation.

(3-20-20)T

ii. Thereafter, the seed may be grown and inspected for two (2) consecutive generations in Idaho under sprinkler irrigation. (3-20-20)T

iii. Seed grown under sprinkler irrigation for two (2) consecutive generations shall then be grown and inspected for one (1) generation in Idaho under rill irrigation. (3-20-20)T

**b.** All other beans: (3-20-20)T

i. First generation of seed grown in Idaho must be grown and inspected under rill irrigation. (3-20-20)T

ii. Thereafter, the seed may be grown and inspected for one (1) generation in Idaho under sprinkler irrigation. (3-20-20)T

iii. Any time seed has been grown and inspected for one (1) generation in Idaho under sprinkler irrigation and prior to planting the seed under sprinkler irrigation or rill irrigation in Idaho, the seed must be sampled and laboratory tested by the Department in Idaho and found negative for the regulated pests. (3-20-20)T

iv. Following a second consecutive planting of the seed under sprinkler irrigation in Idaho, the seed must be sampled and laboratory tested by the Department in Idaho and found negative for the regulated pests. (3-20-20)T

v. After meeting the requirements of Subsections 200.09.b.i. through 200.09.b.iv., the seed must be grown and inspected for one (1) generation in Idaho under rill irrigation. (3-20-20)T

**201. REQUIREMENTS FOR PLANTING BEAN SEED IN IDAHO (NON-PHASEOLUS).**  
In order to be eligible for planting seed in Idaho: (3-20-20)T

**01. Idaho Origin Seed to Be Replanted.** Seeds planted must be from a lot that was produced in accordance with these rules and has an in-state planting tag number (state number) assigned by the Department based on growing season and pre-harvest or windrow inspections and be tagged by the Department with a Department In-State Planting Tag (Green tag). (3-20-20)T

**02. Malheur County, Oregon Grown Seed.** Seed produced in Malheur County, Oregon must be from a lot inspected in the growing season and pre-harvest or windrow for the regulated pests as defined in Section 012, 013.01, and 013.02 of these rules and tagged by the Oregon Department of Agriculture. (3-20-20)T

**03. Imported Seed From Other Than Malheur County, Oregon.** Imported seed must: (3-20-20)T

**a.** Be certified by the seed certification agency of the state of origin and be accompanied by a state phytosanitary certificate issued by the regulatory agency of the state of origin, listing the diseases for which the crop was inspected, that must include the regulated pests and soil as defined in Sections 012 and 013 of these rules, as identified from official field inspection, official samples and official laboratory testing; or (3-20-20)T

**b.** Each seed lot shall successfully pass laboratory tests on untreated seed for regulated pests and soil conducted by the Department (in the case of nematodes and soil by a Department approved lab) from samples officially drawn in the state of Idaho by the Department; and (3-20-20)T

**c.** Bear a Department Approved Tag (Yellow Tag) at the time of planting; and (3-20-20)T

**d.** Be submitted for a growing season inspection in compliance with Section 151 of this rule; and (3-20-20)T

**e.** If intended for seed production, not be planted under sprinkler irrigation for the first growing season. (3-20-20)T

**04. Contaminated Seeds.** The seeds from any field found or known to be contaminated with a regulated pest or soil, as defined in Section 012 and 013 of these rules, cannot be planted in Idaho. (3-20-20)T

**05. True Identity of Seed Lots.** Failure to maintain the true identity of any seed lot intended for seed purposes will automatically disqualify that lot for future planting in Idaho. (3-20-20)T

**06. Tags.** Seeds planted in Idaho shall be from an approved lot bearing an approved tag on each bag or container, stating the kind, variety, and lot number. The following is a list of approved planting tags in Idaho: (3-20-20)T

a. Department in-state planting tag (green tag); (3-20-20)T

b. Department approved tag (yellow tag); (3-20-20)T

c. Oregon Department of Agriculture inspection tag. (3-20-20)T

**202. -- 249. (RESERVED)**

**250. TRIAL GROUNDS.**

**01. General Trial Ground Requirements.** (3-20-20)T

a. A written request for trial ground must be submitted to the Director for approval prior to May 20 of the year the bean seed will be planted and must contain: (3-20-20)T

i. Name of person in charge. (3-20-20)T

ii. Geographic location and size of trial ground. (3-20-20)T

iii. Detailed varietal planting plan. If the original planting plan is changed, the person in charge of the trial ground must notify the Director. (3-20-20)T

b. Must be jointly supervised by the Department and personnel approved by the Director. (3-20-20)T

c. The land must be owned or leased by the applicant. If leased, a copy of the lease must accompany the application. (3-20-20)T

d. More than one (1) trial ground may be approved provided that a separate application is submitted and each trial ground meets the requirements of Section 250. (3-20-20)T

**02. Trial Ground Subdivisions.** (3-20-20)T

a. Experimental Plots. A maximum of one (1) pound of bean seed per variety may be planted in an experimental plot without laboratory testing. (3-20-20)T

b. Introduction Plots. Introduction plots are limited to a maximum of two (2) acres per variety per company or designated agent for any given year and each seed lot to be planted in an introduction plot must successfully pass laboratory tests conducted by the Department from samples officially drawn in the state of Idaho by the Department. (3-20-20)T

**03. Trial Ground Restrictions and Inspection Procedures.** (3-20-20)T

a. Any machinery used in production of bean seed on trial grounds must be disinfected, to the satisfaction of the Director, prior to movement to other bean fields. (3-20-20)T

b. Approved trial grounds shall not be planted under sprinkler irrigation. (3-20-20)T

c. During each growing season there will be a minimum of four (4) active growth inspections and one (1) windrow or pre-harvest inspection. (3-20-20)T

**04. Detection of Regulated Pest.** If a regulated pest is found by field inspection, windrow or pre-harvest inspection or subsequent laboratory seed testing, the infested seed must be destroyed. None of the remaining bean seed produced on that farmstead may be released for general planting in Idaho. The remaining seeds must be sampled and laboratory tested by the Department. If the laboratory test is negative for the regulated pests, then the seeds must be planted on an approved trial ground for one (1) additional year and are limited to a maximum of two (2) acres. (3-20-20)T

**251. -- 299. (RESERVED)**

**300. SPECIAL SITUATIONS.**

The Director may grant specific exemptions for research purposes for the planting of beans that do not meet the requirements of Sections 200, 201, or 250. Seed not meeting the requirements of Sections 200, 201, or 250 must be planted only in counties where commercial beans or bean seed is not produced, as determined by the Director. (3-20-20)T

**301. -- 349. (RESERVED)**

**350. DETECTION, IDENTIFICATION, AND REPORTING OF REGULATED PESTS.**

**01. Reporting.** Any person may report to the Department the detection of any of the regulated pests. (3-20-20)T

**02. Observation.** Detection of regulated pests will be based on the observance of symptoms in the field. (3-20-20)T

**03. Disagreement.** In case of disagreement concerning the identity of the regulated pest or the virulence of the pathogen to Phaseolus or non-Phaseolus, the Department will submit cultures of the suspected pathogen to a plant pathologist appointed by the Dean of the College of Agriculture, University of Idaho. The results and findings obtained by the approved pathologist are final. (3-20-20)T

**04. Release of Information.** When the presence of a regulated pest is confirmed, information regarding the location and acres involved will be released upon request. (3-20-20)T

**351. -- 399. (RESERVED)**

**400. DISPOSITION OF DISEASED SEED AND INFECTED FIELDS.**

**01. Quarantine.** Any field in which there is a disagreement concerning the identity of the regulated pest or the virulence of the pathogen to its host will be placed under quarantine. Entry to the quarantined area will be restricted to the grower or his agents, Department officials, University of Idaho plant pathologists, and persons authorized in writing by the Director. Persons granted entry to the quarantined area will be required to take all necessary sanitary precautions prescribed by the Director. (3-20-20)T

**02. Destruction.** Upon the confirmation of a regulated pest, any bean fields within the boundaries of the state will be destroyed in part or in total, as required by the Director, to eliminate the pest at the expense of the grower and his landlord. The Director will notify the grower or his landlord of the method and extent of the destruction and safeguards against pest spread in order for the parties to comply. (3-20-20)T

**03. Threshing and Segregating.** When the symptoms of a regulated pest are first detected during windrow inspection and laboratory confirmation is necessary, the Director may allow the beans to be threshed and segregated until laboratory results are obtained. (3-20-20)T

**401. -- 449. (RESERVED)**



**450. EXEMPTIONS FROM DESTRUCTION (PHASEOLUS).**

**01. Brown Spot.** Fields contaminated with brown spot, (*Pseudomonas syringae* pv. *syringae*), are exempt from destruction. The Department will review this exemption as necessary. (3-20-20)T

**02. Beans for Processing or Fresh Consumption.** Snap beans or lima beans for processing or fresh consumption are exempt from destruction if the diseased portion of the field is destroyed or harvested within five (5) days after first detection or verification as per Section 350 and Subsection 400.01 and the crop residue is promptly and completely destroyed after harvest, as required by the Director. (3-20-20)T

**451. EXEMPTIONS FROM DESTRUCTION (NON-PHASEOLUS).**

Those non-Phaseolus crops for forage production are exempt from destruction if the diseased portion of the field is destroyed or harvested within five (5) days after first detection or verification as per Section 350 and Subsection 400.01, as required by the Director. (3-20-20)T

**452. -- 549. (RESERVED)**

**550. FEES AND CHARGES.**

The fees and charges for tags and inspections under these rules are: (3-20-20)T

**01. Tags.** Green tags or Yellow tags for In-State Planting Purposes -- Eighteen cents (\$0.18) per hundred-weight. (3-20-20)T

**02. Applications.** (3-20-20)T

**a.** Application for Field Inspection -- Five dollars (\$5) each. (3-20-20)T

**b.** Late Application for Field Inspection -- Ten dollars (\$10) each. (3-20-20)T

**03. Field Inspections.** (3-20-20)T

**a.** Inspection Fees. (3-20-20)T

**i.** Active Growth Fees -- Three dollars and fifty cents (\$3.50) per acre, per inspection, fifty dollar (\$50) minimum. (3-20-20)T

**ii.** Windrow or Pre-harvest Fees -- Three dollars and fifty cents (\$3.50) per acre, fifty dollars (\$50) minimum. (3-20-20)T

**iii.** Department Approved Trial Grounds - origin east of the Continental Divide -- Ten dollars (\$10) per acre, per inspection, fifty dollars (\$50) minimum. (3-20-20)T

**iv.** Department Approved Trial Grounds - origin West of the Continental Divide -- Three dollars and fifty cents (\$3.50) per acre, per inspection, fifty dollars (\$50) minimum. (3-20-20)T

**v.** Requests for pre-harvest or windrow inspections after office hours, on weekends or holidays will be charged at cost plus mileage. (3-20-20)T

**04. Laboratory Seed Sampling.** Official Sample -- twenty dollars (\$20) per sample. Sample size requirements for imported seed:

<b>Lot size</b>	<b>Sample Size</b>
<10 pounds	Negotiable
10 - 14 pounds	0.5 pounds

15 - 25 pounds	1.0 pounds
26 - 50 pounds	1.5 pounds
51 - 200 pounds	2.0 pounds
201 - 1,000 pounds	3.0 pounds
>1,000 pounds	5.0 pounds for every 10,000 pounds or portion thereof

(3-20-20)T

**05. Plant Pathological Laboratory Services.** Fees will be charged at current laboratory rates and are available upon request. (3-20-20)T

**06. Confirmation Fees.** The party disputing the Department's determination of the presence of a regulated pest per Subsection 350.03 will be responsible for the payment of fees charged by the University of Idaho. (3-20-20)T

**07. Soil Analysis.** Testing for the presence of soil will be performed by the Idaho State Seed Laboratory or other seed laboratory approved by the Department. The cost of soil analysis will be at the normal rates as is charged by those approved laboratories. (3-20-20)T

**08. Nematode Analysis.** Nematodes testing will be performed by the University of Idaho Nematology Laboratory or other laboratory approved by the Department. The cost of analysis for nematodes will be at the normal rates for testing as is charged by those approved laboratories. (3-20-20)T

**09. Special Project Fee.** Special projects not covered by existing fee schedule may be billed at twenty-five dollars (\$25) per hour with a minimum twenty-five dollar (\$25) fee. Special projects, include but are not limited to, research, lot history verification, data entry, sales and purchases, transfer of lots into ISDA database, ISDA training of private company personnel or any other circumstance approved by the Director. (3-20-20)T

**551. -- 999. (RESERVED)**

## 02.06.09 – RULES GOVERNING INVASIVE SPECIES AND NOXIOUS WEEDS

### 000. LEGAL AUTHORITY.

This chapter is adopted under the legal authority of Sections, 22-1907, 22-2004, 22-2006, 22-2403, and 22-2412, Idaho Code. (3-20-20)T

### 001. TITLE AND SCOPE.

**01. Title.** The title of this chapter is IDAPA 02.06.09, “Rules Governing Invasive Species and Noxious Weeds.” (3-20-20)T

**02. Scope.** This rule governs the designation of invasive species, inspection, permitting, decontamination, recordkeeping and enforcement and apply to the possession, importation, shipping, transportation, eradication, and control of invasive species. This rule identifies those noxious weeds that have been officially designated by the Director as Noxious Weeds in the state of Idaho, designates articles capable of disseminating noxious weeds, requires treatment of articles to prevent dissemination of noxious weeds and provides authority to designate cooperative weed management areas for management of noxious weeds. Also this rule governs the inspection, certification, and marking of noxious weed free forage and straw to allow for the transportation and use of forage and straw in Idaho and states where regulations and restrictions are placed on such commodities. (3-20-20)T

### 002. -- 109. (RESERVED)

## SUBCHAPTER A – INVASIVE SPECIES

### 110. DEFINITIONS.

In addition to the definitions found in Section 22-1904 and 22-2005, Idaho Code, the following definitions apply in the interpretation and enforcement of Subchapter A only: (3-20-20)T

**01. Acts.** Title 22, Chapter 19, Idaho Code, the “Idaho Invasive Species Act of 2008” and Title 22, Chapter 20, the “Idaho Plant Pest Act of 2002.” (3-20-20)T

**02. Aquatic Invertebrate Invasive Species.** Those species listed in Section 140. (3-20-20)T

**03. Control.** The abatement, suppression, or containment of an invasive species or pest population. (3-20-20)T

**04. Conveyance.** A terrestrial or aquatic vehicle or a vehicle part that may carry or contain an invasive species or plant pest. A conveyance includes a motor vehicle, a vessel, a motorboat, a sailboat, a personal watercraft, a container, a trailer, or any other means or method of transportation. “Conveyance” also includes a live well or a bilge area. (3-20-20)T

**05. Dreissenia Infested Waterbody.** Body of water designated by the United States Geological Survey, <http://nas.er.usgs.gov/taxgroup/mollusks/zebramussel/>, or the Director as having a population of any life stage of Dreissenia mussels. (3-20-20)T

**06. Early Detection/Rapid Response.** Finding invasive species during the initial stages of colonization and then responding within ten (10) days. (3-20-20)T

**07. Energy Crop Invasive Species.** An Energy Crop Invasive Species is a non-native plant grown to harvest for use in making biofuels, such as bioethanol, or combusted for its energy content to generate electricity or heat. Energy Crop Invasive Species are non-native plants that are cultivated for the purpose of producing (non-food) energy. (3-20-20)T

**08. Equipment.** An article, tool, implement, or device capable of carrying or containing: (3-20-20)T

**a.** Water; or (3-20-20)T

**b.** An invasive species. (3-20-20)T

**09. Facility.** Any place, site or location or part thereof where a species listed as invasive pursuant to Subchapter A are found, handled, housed, held, planted, or otherwise maintained for purposes governed by a

possession, production, or transport permit issued pursuant to Subchapter A and includes, but is not limited to all fields, plats, buildings, lots, structures, and other appurtenances and improvements on the land. (3-20-20)T

**10. Possession.** The act of cultivating, importing, exporting, shipping or transporting a listed invasive species in Idaho. Possession does not include the act of having, releasing or transporting a listed invasive species through circumstances beyond individual control, including but not limited to infestations in a water supply system, infestations resulting from natural spread of the species or some other acts of nature. (3-20-20)T

**11. Trap Crop Invasive Species.** A Trap Crop Invasive Species is a non-native plant species planted for purposes of controlling or eradicating a Plant Pest, as defined in the Idaho Plant Pest Act of 2002. (3-20-20)T

**12. Water Body.** Natural or impounded surface water, including a stream, river, spring, lake, reservoir, pond, wetland, tank and fountain. (3-20-20)T

**13. Water Supply System.** A system used to treat, store, convey, or distribute water for irrigation, industrial, waste water treatment, residential, or culinary use. A Water Supply System includes a pump, canal, ditch, regulating impoundment, in-canal forebay, pipeline, or associated wetland and water quality improvement project, but does not include a Water Body as defined in Subsection 110.12. (3-20-20)T

**111. ABBREVIATIONS.**

**01. AIIS.** Aquatic Invertebrate Invasive Species. (3-20-20)T

**02. EDRR.** Early Detection/Rapid Response. (3-20-20)T

**03. HACCP.** Hazard Analysis and Critical Control Points. (3-20-20)T

**112. – 119. (RESERVED)**

**120. PROHIBITION ON POSSESSION, IMPORTATION, SHIPPING OR TRANSPORTATION OF INVASIVE SPECIES.**

No person may possess, cultivate, import, ship, or transport any invasive species, including but not limited to an Energy Crop Invasive Species or Trap Crop Invasive Species, into or through the state of Idaho following the effective date of Subchapter A, unless the person possessing, importing, shipping or transporting has obtained a permit under Section 122, or unless otherwise exempt by Subchapter A, as set forth in Section 123. Prohibited acts include but are not limited to: (3-20-20)T

**01. Possession or Transportation.** Possessing, cultivating, importing, exporting, shipping, or transporting an invasive species into or through the state of Idaho. (3-20-20)T

**02. Releasing.** Releasing, placing, planting, or causing to be released, an invasive species in a water body, facility, water supply system, field, garden, planted area, ecosystem, or otherwise into the environment within the state of Idaho. (3-20-20)T

**03. Transporting From an Infested Environment.** Transporting a conveyance or equipment into or through the state of Idaho that has been in an infested environment without obtaining a Department-approved decontamination of the conveyance or equipment. (3-20-20)T

**04. Transporting an Infested Article.** Transporting, importing or shipping any plant, animal, mode of transportation, conveyance, or article that is infested with an invasive species into or through the state of Idaho without obtaining a Department-approved decontamination of the object. (3-20-20)T

**121. INTRODUCTION OF NEW SPECIES TO THE STATE.**

Following the effective date of Subchapter A, no person may introduce or import a species not previously present in Idaho without first receiving a determination from the Department that the species is not an invasive species. (3-20-20)T

**122. POSSESSION PERMITS.**

Possession of invasive species is authorized only if the person possessing the species obtains a possession permit. (3-20-20)T

**01. Application for Possession Permits.** Persons seeking a possession permit must make application on a form prescribed by the Director. A separate application must be submitted for each facility where invasive species will be possessed. The application must include: (3-20-20)T

- a. The applicant's name, address (residence and mailing), and Employer or Tax Identification Number. (3-20-20)T
- b. Description of the proposed facility, including:
  - i. A map identifying the location of the proposed facility; (3-20-20)T
  - ii. The legal description of the real property for the proposed facility; (3-20-20)T
  - iii. The approximate total area of the proposed facility; (3-20-20)T
  - iv. A detailed diagram of proposed facility, (3-20-20)T
  - v. A detailed confinement or HACCP Plan if applicable. (3-20-20)T
- c. Name and address of the owner(s) and/or operator(s) of the proposed facility, if different than the applicant. If the proposed facility will be leased, a written and notarized authorization by the property owner must be included. (3-20-20)T
- d. A copy of local zoning authority approval, if approval is required by the local zoning authority. (3-20-20)T
- e. Description of the invasive species to be possessed at the facility, including, to the extent possible, the genus, species, sex, life state, age, identification, and purpose for possessing each species. (3-20-20)T
- f. The date upon which the proposed facility will be available for inspection by the Department, which must be not less than seven (7) days prior to the time the invasive species are possessed at the proposed facility. (3-20-20)T

**02. Application Process.** The Director will consider all information in the application and issue a written decision granting or denying the application. In reviewing the application, the Director will consider factors including but not limited to: (3-20-20)T

- a. Proximity of the facility to agricultural operations, and environmentally sensitive lands and waters. (3-20-20)T
- b. Potential for access to the facility by unauthorized persons. (3-20-20)T
- c. Potential for vandalism, adverse weather, or other events that compromise the security of the facility. (3-20-20)T
- d. Potential for the invasive species to escape or be released from the facility. (3-20-20)T
- e. Whether, based on the applicant's certification and any other evidence received by the Director in connection with the application or proposed facility, all federal, state, county and city laws applicable to the facility have been met. (3-20-20)T
- f. Whether the applicant has adequate knowledge, experience and training to ensure that the invasive species will not harm agriculture, the natural resources and environment of the state of Idaho. Such experience may

be documented by a log book, employment records, education records or other means by which experience may be authenticated. (3-20-20)T

**g.** Whether the facility is or will be adequately designed, constructed, and managed to protect agriculture, the natural resources and environment of the state of Idaho from escape of the invasive species. (3-20-20)T

**h.** Prior to issuing a possession permit, the Director or his designee may perform an inspection of the facility to determine if its design, construction and proposed operation is consistent with the applicable provisions of Idaho law. (3-20-20)T

**03. Grant or Denial of the Permit.** Following review of the application and any other relevant information, the Director will either issue the possession permit or deny the application and notify the applicant. If the Director issues the permit, he may include any necessary conditions to prevent release or escape of the invasive species, and to prevent harm to Idaho's agriculture, natural resources, and the environment. (3-20-20)T

**04. Duration of Possession Permit.** A possession permit is valid until the permitted person no longer possesses the invasive species, or until the invasive species leaves the state. (3-20-20)T

**05. Permit Revocation.** Permits issued pursuant to Subchapter A may be revoked at any time if the Director or Director's designee finds that the permit holder has violated any of the provisions of this Subchapter A, the Invasive Species Act, the Plant Pest Act, or any of the conditions included in the permit. (3-20-20)T

**06. Disposition of Non-Permitted Invasive Species.** The Director may order non-permitted or illegally imported invasive species to be removed from the state or destroyed. (3-20-20)T

**07. Annual Report.** All permit holders shall submit a report no later than January 1 of each calendar year, on forms provided by the Department. (3-20-20)T

**123. EXEMPT SPECIES.**

The following species were present in portions of the state of Idaho prior to adoption of Subchapter A of these Rules. However, they are not present throughout the state, and in accordance with the policy of the state of Idaho, as expressed in Idaho Code, Section 22-1902, the spread of these species should be prevented to the greatest extent possible. Therefore, the species listed below are exempt from the permit requirements of Sections 121 and 122 above. However, those seeking to transport the species listed in Section 123.01 outside the known established distribution area must obtain a transport permit in accordance with Section 123.03. (3-20-20)T

**01. Exempt Species List:** (3-20-20)T

**a.** New Zealand Mud Snail, *Potamopyrgus antipodarum*; (3-20-20)T

**b.** Bullfrog, *Lithobates catesbeianus*; (3-20-20)T

**c.** Asian Clam, *Corbicula fluminea*. (3-20-20)T

**02. Location of Known Established Populations.** Known established distributions of the New Zealand Mud Snail, Bullfrog, and Asian Clam are identified and mapped online at <http://nas.er.usgs.gov/queries>. (3-20-20)T

**03. Transport Permits.** Any person seeking to transport one of the species listed in Subsection 123.01, above, outside of the known established distribution boundaries delineated in Subsection 123.02, above, must obtain a transport permit that will be valid for five (5) years. For the purposes of Subchapter A, transport of these exempt species is assumed when biological organisms and associated water from aquaculture facilities and hatcheries is moved from known infested areas in the state. (3-20-20)T

**04. Application for Transport Permits.** Persons seeking a transport permit must make application on a form prescribed by the Director. A separate application must be submitted for each facility from which invasive

species will be transported. The application must include: (3-20-20)T

- a. The applicant's name, address (residence and mailing), and Employer or Tax Identification Number. (3-20-20)T
- b. Description of the facility of origin, including:
  - i. A map identifying the location of the facility; (3-20-20)T
  - ii. The legal description of the real property for the facility; (3-20-20)T
  - iii. The approximate total area of the facility; (3-20-20)T
  - iv. A detailed diagram of facility, (3-20-20)T
  - v. A detailed HACCP Plan if applicable. (3-20-20)T
- c. Name and address of the owner(s) and/or operator(s) of the facility, if different than the applicant. If the proposed facility will be leased, a written and notarized authorization by the property owner must be included. (3-20-20)T
- d. Description of the invasive species to be transported from the facility, including the genus, species, sex, life state, age, and purpose for transporting the species. (3-20-20)T
- e. Description of self-contained areas needing draining or discharges of water during or after the transport of invasive species. (3-20-20)T
- f. Description of procedures to drain self contained areas after transport is complete, including:
  - i. Into a municipal water treatment facility; or (3-20-20)T
  - ii. Into an on-site waste treatment facility incorporating sand filtration and chlorination; or (3-20-20)T
  - iii. As approved by the Department. (3-20-20)T

**124. ENERGY CROP POSSESSION/PRODUCTION PERMITS.**

Possession and/or production of Energy Crop Invasive Species is authorized only if the person possessing the species obtains an Energy Crop Invasive Species Possession/Production Permit ("Energy Crop Invasive Species Permit"). (3-20-20)T

**01. Application for Energy Crop Invasive Species Permits.** Persons seeking an Energy Crop Invasive Species Permit must make application on a form prescribed by the Director. A separate application must be submitted for each facility or field where the Energy Crop Invasive Species will be possessed and/or produced. The application must include: (3-20-20)T

- a. The applicant's name, address (residence and mailing), and Employer or Tax Identification Number. (3-20-20)T
- b. Description of the proposed facility, including:
  - i. A map identifying the location of the proposed facility or field; (3-20-20)T
  - ii. The legal description of the real property for the proposed facility or field; (3-20-20)T
  - iii. The approximate total area of the proposed facility or field; (3-20-20)T

- iv. A detailed diagram of proposed facility or field; (3-20-20)T
- v. A detailed confinement plan if applicable; and (3-20-20)T
- vi. A detailed plan outlining survey and reconnaissance for escaped Energy Crop Invasive Species and a detailed plan for their control or elimination. (3-20-20)T
- c. Name and address of the owner(s) and/or operator(s) of the proposed facility or field, if different than the applicant. If the proposed facility or field will be leased, a written and notarized authorization by the property owner must be included. (3-20-20)T
- d. A copy of local zoning authority approval, if approval is required by the local zoning authority. (3-20-20)T
- e. Description of the Energy Crop Invasive Species to be possessed at the facility or field, including, to the extent possible, the genus, species, sex, life state, age, identification, and purpose for possessing each species. (3-20-20)T
- f. The date upon which the proposed facility or field will be available for inspection by the Department, which must be not less than seven (7) days prior to the time the Energy Crop Invasive Species are possessed at the proposed facility. (3-20-20)T

**02. Application Process.** The Director will consider all information in the application and issue a written decision granting or denying the application. In reviewing the application, the Director will consider factors including but not limited to: (3-20-20)T

- a. Proximity of the facility to other agricultural operations, and environmentally sensitive lands and waters. (3-20-20)T
- b. Potential for access to the facility or field by unauthorized persons. (3-20-20)T
- c. Potential for vandalism, adverse weather, or other events that compromise the security of the facility or field. (3-20-20)T
- d. Potential for the Energy Crop Invasive Species to escape or be released from the facility or field. (3-20-20)T
- e. Whether, based on the applicant's certification and any other evidence received by the Director in connection with the application or proposed facility, all federal, state, county and city laws applicable to the facility or field have been met. (3-20-20)T
- f. Whether the applicant has adequate knowledge, experience and training to ensure that the Energy Crop Invasive Species will not harm agriculture, the natural resources and environment of the state of Idaho. Such experience may be documented by a log book, employment records, education records or other means by which experience may be authenticated. (3-20-20)T
- g. Whether the facility or field is or will be adequately designed, constructed, and managed to protect agriculture, the natural resources and environment of the state of Idaho from release or escape of the Energy Crop Invasive Species. (3-20-20)T
- h. Prior to issuing an Energy Crop Invasive Species Permit, the Director or his designee may perform an inspection of the facility or field to determine if its design, construction and proposed operation is consistent with the applicable provisions of Idaho law. (3-20-20)T

**03. Grant or Denial of the Permit.** Following review of the application and any other relevant information, the Director will either issue the permit or deny the application and notify the applicant. If the Director issues the permit, he may include any necessary conditions to prevent release or escape of the Energy Crop Invasive



Species, and to prevent harm to Idaho's agriculture, natural resources, and the environment. (3-20-20)T

**04. Duration of Possession Permit.** An Energy Crop Invasive Species Permit is valid for one (1) year. (3-20-20)T

**05. Permit Revocation.** Permits issued pursuant to this section may be revoked at any time if the Director or his designee finds that the permit holder has violated any of the provisions of Subchapter A, the Invasive Species Act, the Plant Pest Act, or any of the conditions included in the permit. (3-20-20)T

**06. Disposition of Non-Permitted Invasive Species.** The Director may order non-permitted or illegally imported Energy Crop Invasive Species to be removed from the state or destroyed. (3-20-20)T

**07. Annual Report.** All permit holders shall submit a report no later than January 1 of each calendar year, on forms provided by the Department. (3-20-20)T

**125. TRAP CROP INVASIVE SPECIES PERMITS.**

Production/research of Trap Crop Invasive Species is authorized only if the person possessing the species obtains a Trap Crop Production/Research Permit ("Trap Crop Invasive Species Permit"). (3-20-20)T

**01. Application for Trap Crop Invasive Species Permits.** Persons seeking a Trap Crop Invasive Species Permit must make application on a form prescribed by the Director. A separate application must be submitted for each facility where Trap Crop Invasive Species will be researched or produced. The application must include: (3-20-20)T

**a.** The applicant's name, address (residence and mailing), and Employer or Tax Identification Number. (3-20-20)T

**b.** Description of the proposed facility, including: (3-20-20)T

**i.** A map identifying the location of the proposed facility; (3-20-20)T

**ii.** The legal description of the real property for the proposed facility; (3-20-20)T

**iii.** The approximate total area of the proposed facility; (3-20-20)T

**iv.** A detailed diagram of proposed facility; (3-20-20)T

**v.** A detailed confinement plan if applicable; and (3-20-20)T

**vi.** A detailed plan outlining survey and reconnaissance for escaped plants and a detailed plan for their control or elimination. (3-20-20)T

**c.** Name and address of the owner(s) and/or operator(s) of the proposed facility, if different than the applicant. If the proposed facility will be leased, a written and notarized authorization by the property owner must be included. (3-20-20)T

**d.** A copy of local zoning authority approval, if approval is required by the local zoning authority. (3-20-20)T

**e.** Description of the Trap Crop Invasive Species to be possessed at the facility, including, to the extent possible, the genus, species, sex, life state, age, identification, and purpose for possessing each species. (3-20-20)T

**f.** The date upon which the proposed facility will be available for inspection by the Department, which must be not less than seven (7) days prior to the time the Trap Crop Invasive Species is possessed at the proposed facility. (3-20-20)T

**02. Application Process.** The Director will consider all information in the application and issue a written decision granting or denying the application. In reviewing the application, the Director will consider factors including but not limited to: (3-20-20)T

- a.** Proximity of the facility to agricultural operations, and environmentally sensitive lands and waters. (3-20-20)T
- b.** Potential for access to the facility by unauthorized persons. (3-20-20)T
- c.** Potential for vandalism, adverse weather, or other events that compromise the security of the facility. (3-20-20)T
- d.** Potential for the Trap Crop Invasive Species to escape or be released from the facility. (3-20-20)T
- e.** Whether, based on the applicant's certification and any other evidence received by the Director in connection with the application or proposed facility, all federal, state, county and city laws applicable to the facility have been met. (3-20-20)T
- f.** Whether the applicant has adequate knowledge, experience and training to ensure that the Trap Crop Invasive Species will not harm agriculture, the natural resources and environment of the state of Idaho. Such experience may be documented by a log book, employment records, education records or other means by which experience may be authenticated. (3-20-20)T
- g.** Whether the facility is or will be adequately designed, constructed, and managed to protect agriculture, the natural resources and environment of the state of Idaho from escape of the Trap Crop Invasive Species. (3-20-20)T
- h.** Prior to issuing a Trap Crop Invasive Species Permit, the Director or his designee may perform an inspection of the facility to determine if its design, construction and proposed operation is consistent with the applicable provisions of Idaho law. (3-20-20)T

**03. Grant or Denial of the Trap Crop Invasive Species Permit.** Following review of the application and any other relevant information, the Director will either issue the Trap Crop Invasive Species Permit or deny the application and notify the applicant. If the Director issues the Trap Crop Invasive Species Permit, he may include any necessary conditions to prevent release or escape of the Trap Crop Invasive Species, and to prevent harm to Idaho's agriculture, natural resources, and the environment. (3-20-20)T

**04. Duration of Trap Crop Invasive Species Permit.** A Trap Crop Invasive Species Permit is valid for one (1) year. (3-20-20)T

**05. Permit Revocation.** Permits issued pursuant to this section may be revoked at any time if the Director or his designee finds that the permit holder has violated any of the provisions of this Subchapter A, the Invasive Species Act, the Plant Pest Act, or any of the conditions included in the permit. (3-20-20)T

**06. Disposition of Non-Permitted Invasive Species.** The Director may order non-permitted or illegally imported Trap Crop Invasive Species to be removed from the state or destroyed. (3-20-20)T

**07. Annual Report.** All permit holders shall submit a report no later than January 1 of each calendar year, on forms provided by the Department. (3-20-20)T

**126. -- 129. (RESERVED)**

**130. EARLY DETECTION AND RAPID RESPONSE AQUATIC INVERTEBRATE INVASIVE SPECIES.**

**01. Statewide EDRR AIIS List.** If any of the species listed in the following table are found to occur in Idaho, they shall be reported to the Department immediately. Positive identification will be made by the Department

or other qualified authority as approved by the Director. Subsections 130.02 through 130.05 are applicable to EDRR AIIS only and not to other invasive species listed in Sections 140 through 148.

Early Detection Rapid Response Aquatic Invertebrate Invasive Species (EDRR AIIS) List	
Common Name	Scientific Name
Quagga Mussel	<i>Dreissenia bugensis</i>
Zebra Mussel	<i>Dreissenia polymorpha</i>

(3-20-20)T

**02. Transporting EDRR AIIS Over Public Roads.** No person may transport Equipment or any Conveyance containing EDRR AIIS over public roads within the state of Idaho without first being decontaminated. (3-20-20)T

**03. Contaminated Conveyances in Idaho Waters.** No person may place any EDRR AIIS contaminated Equipment or Conveyance into any Water Body or Water Supply System in the state of Idaho. (3-20-20)T

**04. Firefighting Equipment.** Precautions should be taken to prevent the introduction and spread of EDRR AIIS through firefighting activities. All firefighting agencies moving equipment into the state of Idaho shall follow protocols similar to the United States Forest Service decontamination protocols set forth in "Preventing Spread of Aquatic Invasive Organisms Common to the Intermountain Region." Those protocols can be viewed online at [http://www.fs.usda.gov/detail/r4/landmanagement/resourcemanagement/?cid=fsbdev3\\_016113](http://www.fs.usda.gov/detail/r4/landmanagement/resourcemanagement/?cid=fsbdev3_016113). (3-20-20)T

**05. Construction and Road Building and Maintenance Equipment.** Construction and equipment used for road building and maintenance must be free of EDRR AIIS. If equipment that is being transported into the state of Idaho has been in an infested water body or water supply system within the preceding thirty (30) days, the equipment must be inspected in accordance with Section 132. The Department may require decontamination. (3-20-20)T

### 131. REPORTING REQUIREMENTS.

**01. Discovery.** Any person who discovers an EDRR AIIS within the state or who has reason to believe that an invasive species may exist at a specific location shall immediately report the discovery to the Department. (3-20-20)T

**02. Contents.** The report shall, to the best of the reporter's ability, contain the following information: location of the invasive species; date of discovery; and identification of any conveyance, equipment, water body, or host in or upon which the invasive species may be found. (3-20-20)T

**03. Methods of Reporting.** The report shall be made in person or in writing (which may include electronic mail) as follows: (3-20-20)T

- a. At any Department office or headquarters; (3-20-20)T
- b. To the Department's toll free hotline at 1-877-336-8676; or (3-20-20)T
- c. Via the Department's website at [www.agri.idaho.gov](http://www.agri.idaho.gov). (3-20-20)T

**04. Hold Harmless.** Reporting parties will be held harmless from violations pursuant to this Subchapter A regarding possession of EDRR AIS. (3-20-20)T

### 132. INSPECTIONS.

**01. Qualified Inspectors.** Inspections to detect the presence of EDRR AIIS may be conducted by any authorized agent, private inspector or peace officer qualified and trained in accordance with the Department's requirements. (3-20-20)T

**02. Conveyances That Have Been in Infested Waters.** All persons transporting a conveyance must receive documentation of an inspection prior to launching in any water of the state if the vessel has been in infested water within the last thirty (30) days. (3-20-20)T

**03. All Other Conveyances.** All conveyances are subject to inspection. All compartments, equipment and containers that may hold water, including, but not limited to live wells and ballast and bilge areas will be drained as part of all inspections. (3-20-20)T

**04. Inspection Methods.** Inspectors will determine if EDRR AIIS are present by interviewing the person transporting the conveyance and using visual and/or tactile inspection methods, or such other methods as may be appropriate and using forms supplied by the Department. (3-20-20)T

**05. Inspection Results.** Any authorized agent or private inspector or private decontaminator who, through the course of an inspection, determines that AIIS are present shall advise the operator that the conveyance is suspected of possessing EDRR AIIS and that it must be decontaminated according to Departmental procedures. (3-20-20)T

**06. Decontamination.** Any conveyance found or reasonably believed to contain EDRR AIIS shall be decontaminated in accordance with Section 134. (3-20-20)T

**133. HOLD ORDERS.**

**01. Hold Order.** If any person refuses to permit inspection or decontamination of his or her conveyance, that conveyance is subject to a hold order until the inspection and/or decontamination is complete. (3-20-20)T

**02. Notification to Owner.** If the person in charge of the conveyance is not the registered owner, the registered owner shall be notified by mail, return receipt requested, within five (5) days of the Hold Order. Such notification must also include Department contact information. If the registered owner is present when the Hold Order is issued, then the same information shall be provided to the registered owner at the time the order is issued. (3-20-20)T

**03. Release of Hold Order.** Decontamination and proof of decontamination, in accordance with Section 134, is necessary in order for the Hold Order to be released. The Hold Order must be released in writing, and may be released only by the Director or his designee. (3-20-20)T

**134. EDRR AIIS DECONTAMINATION.**

**01. Decontamination Protocol.** All decontamination must be accomplished by Department-approved service providers, using Department protocol. All decontamination methods must be in accordance with all applicable laws, disposal methods, recommended safety precautions, and safety equipment and procedures. (3-20-20)T

**02. Reinspection.** After decontamination, the Department or its authorized agent must re-inspect the conveyance to ensure complete decontamination prior to releasing the conveyance and any associated Hold Order. (3-20-20)T

**03. Proof of Decontamination.** Proof of decontamination will consist of a completed post-decontamination inspection form and application of a tamper-proof seal to the conveyance. (3-20-20)T

**135. -- 139. (RESERVED)**

140. INVASIVE SPECIES - AQUATIC INVERTEBRATES.

INVASIVE SPECIES - AQUATIC INVERTEBRATES		
	Common Name	Scientific Name
01.	Zebra Mussel	<i>Dreissenia polymorpha</i>
02.	Quagga Mussel	<i>Dreissenia bugensis</i>
03.	New Zealand Mud Snail	<i>Potamopyrgus antipodarum</i>
04.	Red Claw Crayfish	<i>Cherax quadricarinatus</i>
05.	Yabby Crayfish	<i>Cherax albidus/C. destructor</i>
06.	Marone Crayfish	<i>Cherax tenuimanus</i>
07.	Marbled Crayfish	<i>(Procambarus marmoratus)</i>
08.	Rusty Crayfish	<i>Orconectes rusticus</i>
09.	Asian Clam	<i>Corbicula fluminea</i>
10.	Spiny Waterflea	<i>Bythotrephes cederstroemi</i>
11.	Fishhook Waterflea	<i>Cercopagis pengoi</i>
12.	Marmoratus	<i>Procambarus sp.</i>

(3-20-20)T

141. INVASIVE SPECIES - FISH.

INVASIVE SPECIES - FISH		
	Common Name	Scientific Name
01.	Green Sturgeon	<i>Acipenser medirostris</i>
02.	Walking Catfish	<i>Clariidae</i>
03.	Bowfin	<i>Ania Calva</i>
04.	Gar	<i>Lepiostidae</i>
05.	Piranhas	<i>Serrasalmus spp., Rosseveltella spp., Pygocentrus spp.</i>
06.	Rudd	<i>Scardinius erythrophthalmus</i>
07.	Ide	<i>Leuciscus idus</i>
08.	Diploid Grass Carp	<i>Ctenopharyngodon idella</i>
09.	Bighead Carp	<i>Hypophthalmichthys nobilis</i>
10.	Silver Carp	<i>Hypophthalmichthys molitrix</i>
11.	Black Carp	<i>Mylopharyngodon piceus</i>
12.	Snakeheads	<i>Channa spp., Parachanna spp.</i>

INVASIVE SPECIES - FISH		
	Common Name	Scientific Name
13.	Round Goby	<i>Neogobius melanostomas</i>
14.	Ruffe	<i>Gymnocephalus cernuus</i>

(3-20-20)T

142. INVASIVE SPECIES - AMPHIBIANS

Table 1:

Invasive Species - Amphibians		
	Common Name	Scientific Name
01.	Rough-skinned Newt	<i>Taricha granulose</i>
02.	Bullfrog	<i>Lithobates catesbeianus</i>

(3-20-20)T

143. INVASIVE SPECIES - REPTILES.

Invasive Species - Reptiles		
	Common Name	Scientific Name
01.	Red-eared Slider	<i>Trachemys scripta elegans</i>
02.	Mediterranean Gecko	<i>Hemidactylus turcicus</i>
03.	Common Wall Lizard	<i>Podarcis muralis</i>
04.	Italian Wall Lizard	<i>Podarcis sicula</i>
05.	Brahminy Blindsnake	<i>Ramphotyphlops braminus</i>
06.	Snapping Turtle	<i>Chelydra serpentina</i>

(3-20-20)T

144. INVASIVE SPECIES - BIRDS.

Invasive Species - Birds		
	Common Name	Scientific Name
01.	Monk Parakeet	<i>Myiopsitta monachus</i>

(3-20-20)T

145. INVASIVE SPECIES - MAMMALS.

Invasive Species - Mammals		
	Common Name	Scientific Name
01.	Nutria	<i>Myocastor coypus</i>

(3-20-20)T

146. INVASIVE SPECIES - INSECTS.

Invasive Species - Insects		
	Common Name	Scientific Name
01.	Asian Longhorned Beetle	<i>Anoplophora glabripennis</i>
02.	Citrus Longhorned Beetle	<i>Anoplophora chinensis</i>
03.	Emerald Ash Borer	<i>Agrilus planipennis</i>
04.	Marmorated Stink Bug	<i>Halyomorpha halys</i>
05.	European Woodwasp	<i>Sirex noctilio</i>
06.	European Gypsy Moth	<i>Lymantria dispar</i>
07.	Asian Gypsy Moth	<i>Lymantria dispar</i>
08.	Soybean Aphid	<i>Aphis glycines</i>
09.	Potato Tuber Moth	<i>Tecia solanivora</i>
10.	Japanese Beetle	<i>Popillia japonica</i>
11.	Mexican Bean Beetle	<i>Epilachna varivestis</i>
12.	Kaphra Beetle	<i>Trogoderma granarium</i>
13.	Red Imported Fire Ant	<i>Solenopsis invicta</i>
14.	Glassy-winged Sharpshooter	<i>Homalodisca vitripennis</i>
15.	Grape Phylloxera	<i>Daktulosphaira vitifoliae</i>
16.	Vine Mealybug	<i>Planococcus ficus</i>
17.	Summer Fruit Tortrix	<i>Adoxophyes orana</i>
18.	Silver Y Moth	<i>Autographa gamma</i>
19.	False Codling Moth	<i>Cryptophlebia leucotreta</i>
20.	Light Brown Apple Moth	<i>Epiphyas postvittana</i>
21.	Apple Tortrix	<i>Archips fuscocupreanus</i>
22.	Pine Shoot Beetle	<i>Tomicus piniperda</i>
23.	Cherry Bark Tortrix	<i>Enarmonia formosana</i>
24.	Apple Ermine Moth	<i>Yponomeuta malinellus</i>
25.	Cherry Ermine Moth	<i>Enarmonia formosana</i>
26.	European Grape Vine Moth	<i>Lobesia botrana</i>

Invasive Species - Insects		
	Common Name	Scientific Name
27.	European Grape Berry Moth	<i>Eupoecilia ambiguella</i>
28.	Plum Fruit Moth	<i>Cydia funebrana</i>
29.	Plum Curculio	<i>Conotrachelus nenuphar</i>
30.	Leek Moth	<i>Acrolepiopsis assectella</i>
31.	Bee Mite	<i>Tropilaelaps clareae</i>
32.	Small Hive Beetle	<i>Aethina tumida</i>
33.	Africanized Honey Bee	<i>Apis mellifera</i>
34.	Black Currant Gall Mite	<i>Cecidophyopsis ribis</i>
35.	Exotic Bark Beetles	(Scolytidae): a. <i>Scolytus mali</i> . b. <i>Xylosandrus crassiusculus</i> . c. <i>Xylosandrus germanus</i> . d. <i>Xyleborus californicus</i> .
36.	Sunni Bug	<i>Eurygaster integriceps</i>
37.	German Yellowjacket	<i>Vespa germanica</i>
38.	European Paper Wasp	<i>Polistes dominulus</i>
39.	European Elm Bark Beetle	<i>Scolytus multistriatus</i>
40.	Banded Elm Bark Beetle	<i>Scolytus schevyrewi</i>
41.	Wheat Blossom Midge,	<i>Sitodiplosis mosellana</i>
42.	Potato Tuberworm	<i>Phthorimeaea operculella</i>
43.	Pink Hibiscus Mealybug	<i>Maconellicoccus hirsutus</i>
44.	Bean Plataspid (Kudzu Bug)	<i>Megacopta cribraria</i>

(3-20-20)T

147. INVASIVE SPECIES - PLANT PATHOGENS AND PARASITIC NEMATODES.

Invasive Species - Plant Pathogens And Parasitic Nematodes		
	Common Name	Scientific Name
01.	Phytophthora blight (nursery stock)	<i>Phytophthora ramorum</i> , <i>Phytophthora kernoviae</i>
02.	Karnal Bunt	<i>Tilletia indica</i>
03.	Bean Common Mosaic Necrosis Virus (strain NL-3 and NL-5)	
04.	Potato Wart	<i>Synchytrium endobioticum</i>
05.	Golden Nematode	<i>Globodera rostochiensis</i>
06.	Soybean Cyst Nematode	<i>Heterodera glycines</i>



Invasive Species - Plant Pathogens And Parasitic Nematodes	
Common Name	Scientific Name
07. Bacterial Wilt of Alfalfa	<i>Clavibacter michiganensis</i> spp. <i>insidiosus</i>
08. Wheat Seed Gall Nematode	<i>Anguina tritici</i>
09. Pine Wilt Nematode	<i>Bursaphelenchus xylophilus</i>
10. Brown Rot of Potatoes	<i>Ralstonia solanacearum</i> , race 3, biovar 2 (alternate hosts include tomato, pepper, eggplant, and some greenhouse plants including geranium)
11. Java Downy Mildew of Corn	<i>Peronosclerospora maydis</i>
12. Philippine Downy Mildew of Corn	<i>Peronosclerospora philipeninsis</i>
13. Asian Soybean Rust	<i>Phakopsora pachyrhizi</i>
14. Plum Pox Potyvirus	
15. Cherry Leaf Roll Virus	
16. Stewart's Wilt of Corn	<i>Pantoea stewartii</i>
17. Brown Stripe Downy Mildew of Corn	<i>Sclerophthora rayssiae</i> var. <i>zeae</i> .
18. Potato Spindle Tuber Viroid	
19. Pierce's Disease of Grapes	<i>Xylella fastidiosa</i>
20. Black Currant Reversion Disease	
21. Powdery Mildew of Hops	<i>Sphaerotheca macularis</i> (s. <i>humuli</i> )
22. Wheat Smut	<i>Tilletia tritici</i>
23. Wheat Scab	<i>Fusarium graminearum</i>
24. Potato Ring Rot	<i>Clavibacter michiganensis</i> subsp. <i>sepidonicus</i>
25. Potato Late Blight	<i>Phytophthora infestans</i>
26. Onion White Rot	<i>Sclerotium cepivorum</i>
27. White Pine Blister Rust	<i>Cronartium ribicola</i>
28. Potato Mop Top Virus, PMTV	
29. Black Stem Rust	<i>Puccinia graminis</i> f.sp. <i>tritici</i> Race UG99
30. Apple proliferation phytoplasma	<i>Candidatus Phytoplasma mali</i>

(3-20-20)T

148. INVASIVE SPECIES - INVASIVE MOLLUSKS (TERRESTRIAL SNAILS AND SLUGS).

Invasive Species - Invasive Mollusks (Terrestrial Snails And Slugs)		
	Common Name	Scientific Name
01.	Green or Burrowing Snail	<i>Cantareus apertus</i>
02.	Pulmonate Snail	<i>Helix pomatia</i>
03.	White Garden Snail	<i>Theba pisana</i>
04.	Giant African Snail	<i>Achatha fulica</i>
05.	Lactea Snail	<i>Otala lacteal</i>
06.	Maritime Garden Snail	<i>Cerneuella virgata</i>
07.	Brown Garden Snail	<i>Cryptomphalus aspersa</i>
08.	Wrinkled Snail	<i>Candidula intersecta</i>
09.	Chinese Mysterysnail	<i>Bellamya chinensis</i>
10.	Japanese Mysterysnail	<i>Bellamya japonica</i>
11.	Applesnail	<i>Pomacea spp.</i>
12.	Marisa	<i>Marisa cornuarietis</i>
13.	Red-lipped Melania	<i>Melanoides tuberculata</i>
14.	Quilted Melania	<i>Tarebia granifera</i>
15.	Decollate Snail	<i>Rumina decollate</i>
16.	Faucet Snail	<i>Bithynia tentaculata</i>

(3-20-20)T

149. INVASIVE SPECIES - INVASIVE PLANTS: ENERGY CROPS.

Invasive Species - Invasive Plants: Energy Crops		
	Common Name	Scientific Name
01.	Giant Reed	<i>Arundo donax (and hybrids)</i>
02.	Switch Grass	<i>Panicum virgatum (and hybrids)</i>
03.	Kudzu	<i>Pueraria montana (and hybrids)</i>
04.	Chinese Silver Grass	<i>Miscanthus giganteus (and hybrids)</i>
05.	Purging Nut	<i>Jatropha curcus (and hybrids)</i>
06.	Cold Tolerant Eucalyptis (and hybrids)	

(3-20-20)T

150. INVASIVE SPECIES - INVASIVE PLANTS: TRAP CROPS.

Invasive Species - Invasive Plants: Trap Crops	
Common Name	Scientific Name
01. Litchi Tomato	<i>Solanum sisymbriifolium</i> (and hybrids) (Otherwise known as Sticky Nightshade or Fire and Ice)
02. Black Nightshade	<i>Solanum nigrus</i> (and hybrids)

(3-20-20)T

151. -- 209. (RESERVED)

### SUBCHAPTER B – NOXIOUS WEEDS

#### 210. DEFINITIONS.

In addition to the definitions found in Section 22-2402, Idaho Code, the definitions found in Section 210 apply in the interpretation and enforcement of Subchapter B only: (3-20-20)T

**01. Early Detection and Rapid Response (EDRR).** Finding invasive plant species during the initial stages of colonization and then responding within the same season to initiate eradication of the invasive plant species. (3-20-20)T

**02. Implements of Husbandry.** Every vehicle, including self-propelled units, designed or adapted and used exclusively in agricultural, horticultural, dairy and livestock growing and feeding operations when being incidentally operated as an implement of husbandry. Such implements include, but are not limited to, combines, discs, dry and liquid fertilizer spreaders, cargo tanks, harrows, hay balers, harvesting and stacking equipment, pesticide applicator equipment, plows, swathers, mint tubs and mint wagons, and farm wagons. A farm tractor when attached to or drawing any implement of husbandry shall be construed to be an implement of husbandry. Implements of husbandry do not include semi trailers, nor do they include motor vehicles or trailers, unless their design limits their use to agricultural, horticultural, dairy or livestock growing and feeding operations. (3-20-20)T

**03. Subtaxa(on).** A supplementary piece of identifying information in a plant’s or animal’s scientific name. (3-20-20)T

#### 211. ABBREVIATIONS.

**01. CWMA.** Cooperative Weed Management Area. (3-20-20)T

**02. EDRR.** Early Detection/Rapid Response. (3-20-20)T

**03. ISDA.** Idaho State Department of Agriculture. (3-20-20)T

212. -- 219. (RESERVED)

#### 220. NOXIOUS WEEDS - DESIGNATIONS.

The weeds listed on the Statewide Prohibited Genera, EDRR, Containment, and Control lists are hereby officially designated and published as noxious. (3-20-20)T

**01. Statewide Prohibited Genera Noxious Weed List.** (3-20-20)T

**a.** All plants and plant parts in the genera of: *Cytisus*, *Genista*, *Spartium*, and *Chamaecytisus* additionally including “all” subtaxa of these plant genera are prohibited in Idaho. (3-20-20)T

**b.** Weeds listed in the Prohibited Genera list may exist in varying populations throughout the state. The concentration of these weeds is at a level where control and/or eradication may be possible. A written plan for

weeds on the Statewide Prohibited Genera Noxious Weed List shall be developed by the control authority that specifies active control methods to reduce known populations in not more than five (5) years. The plan shall be available to the Department upon request. (3-20-20)T

**02. Statewide EDRR Noxious Weed List.** If any of the listed plants (Subsection 220.02) are found to occur in Idaho, they shall be reported to the Department within ten (10) days following positive identification by the University of Idaho or other qualified authority as approved by the Director. These weeds shall be eradicated during the same growing season as identified.

	<b>Common Name</b>	<b>Scientific Name</b>
1.	Brazilian Elodea	<i>Egeria densa</i>
2.	Common/European Frogbit	<i>Hydrcharis morsus-ranae</i>
3.	Fanwort	<i>Cobomba caroliniana</i>
4.	Feathered Mosquito Fern	<i>Azolla pinnata</i>
5.	Giant Hogweed	<i>Heracleum mantegazzianum</i>
6.	Giant Salvinia	<i>Salvinia molesta</i>
7.	Hydrilla	<i>Hydrilla verticillata</i>
8.	Iberian Starthistle	<i>Centaurea iberica</i>
9.	Policeman's Helmet	<i>Impatiens glandulifera</i>
10.	Purple Starthistle	<i>Centaurea calcitrapa</i>
11.	Squarrose Knapweed	<i>Centaurea triumfetti</i>
12.	Syrian Beancaper	<i>Zygophyllum fabago</i>
13.	Tall Hawkweed	<i>Hieracium piloselloides</i>
14.	Variable-Leaf-Milfoil	<i>Myriophyllum heterophyllum</i>
15.	Water Chestnut	<i>Trapa natans</i>
16.	Water Hyacinth	<i>Eichhornia crassipes</i>
17.	Yellow Devil Hawkweed	<i>Hieracium glomeratum</i>
18.	Yellow Floating Heart	<i>Nymphoides pelata</i>

(3-20-20)T

**03. Statewide Control Noxious Weed List.** Weeds listed in the control list are known to exist in varying populations throughout the state. The concentration of these weeds is at a level where control or eradication, or both, may be possible. A written plan for weeds on the Statewide Control Noxious Weed List shall be developed by the control authority that specifies active control methods to reduce known populations in not more than five (5) years. The plan shall be available to the Department upon request.

	<b>Common Name</b>	<b>Scientific Name</b>
1.	Black Henbane	<i>Hyoscyamus niger</i>
2.	Bohemian Knotweed	<i>Polygonum X bohemicum</i>
3.	Buffalobur	<i>Solanum rostratum</i>

	Common Name	Scientific Name
4.	Common Crupina	<i>Crupina vulgaris</i>
5.	Common Reed (Phragmites)	<i>Phragmites australis</i>
6.	Dyer's Woad	<i>Isatis tinctoria</i>
7.	Eurasian Watermilfoil	<i>Myriophyllum spicatum</i>
8.	Giant Knotweed	<i>Polygonum sachalinense</i>
9.	Japanese Knotweed	<i>Polygonum cuspidatum</i>
10.	Johnsongrass	<i>Sorghum halepense</i>
11.	Matgrass	<i>Nardus stricta</i>
12.	Meadow Knapweed	<i>Centaurea debeauxii</i>
13.	Mediterranean Sage	<i>Salvia aethiopsis</i>
14.	Musk Thistle	<i>Carduus nutans</i>
15.	Orange Hawkweed	<i>Hieracium aurantiacum</i>
16.	Parrotfeather Milfoil	<i>Myriophyllum aquaticum</i>
17.	Perennial Sowthistle	<i>Sonchus arvensis</i>
18.	Russian Knapweed	<i>Acroptilon repens</i>
19.	Scotch Broom	<i>Cytisus scoparius</i>
20.	Small Bugloss	<i>Anchusa arvensis</i>
21.	Vipers Bugloss	<i>Echium vulgare</i>
22.	Yellow Hawkweed	<i>Hieracium caespitosum</i>

(3-20-20)T

**04. Statewide Containment Noxious Weed List.** Weeds listed in the containment noxious weeds list are known to exist in various populations throughout the state. Weed control efforts may be directed at reducing or eliminating new or expanding weed populations while known and established weed populations, as determined by the weed control authority, may be managed by any approved weed control methodology, as determined by the weed control authority.

	Common Name	Scientific Name
1.	Canada Thistle	<i>Cirsium arvense</i>
2.	Curlyleaf Pondweed	<i>Potamogeton crispus</i>
3.	Dalmatian Toadflax	<i>Linaria dalmatica ssp. dalmatica</i>
4.	Diffuse Knapweed	<i>Centaurea diffusa</i>
5.	Field Bindweed	<i>Convolvulus arvensis</i>
6.	Flowering Rush	<i>Butomus umbellatus</i>
7.	Hoary Alyssum	<i>Berteroa incana</i>
8.	Houndstongue	<i>Cynoglossum officinale</i>
9.	Jointed Goatgrass	<i>Aegilops cylindrica</i>

	Common Name	Scientific Name
10.	Leafy Spurge	<i>Euphorbia esula</i>
11.	Milium	<i>Milium vernale</i>
12.	Oxeye Daisy	<i>Leucanthemum vulgare</i>
13.	Perennial Pepperweed	<i>Lepidium latifolium</i>
14.	Plumeless Thistle	<i>Carduus acanthoides</i>
15.	Poison Hemlock	<i>Conium maculatum</i>
16.	Puncturevine	<i>Tribulus terrestris</i>
17.	Purple Loosestrife	<i>Lythrum salicaria</i>
18.	Rush Skeletonweed	<i>Chondrilla juncea</i>
19.	Saltcedar	<i>Tamarix sp.</i>
20.	Scotch Thistle	<i>Onopordum acanthium</i>
21.	Spotted Knapweed	<i>Centaurea stoebe</i>
22.	Tansy Ragwort	<i>Senecio jacobaea</i>
23.	White Bryony	<i>Bryonia alba</i>
24.	Whitetop (Hoary Cress)	<i>Cardaria draba</i>
25.	Yellow Flag Iris	<i>Iris pseudocorus</i>
26.	Yellow Starthistle	<i>Centaurea solstitialis</i>
27.	Yellow Toadflax	<i>Linaria vulgaris</i>

(3-20-20)T

**05. Designation of Articles Capable of Disseminating Noxious Weeds.** The following articles are designated by the Director as capable of disseminating noxious weeds: (3-20-20)T

- a.** Construction equipment, road building and maintenance equipment, and implements of husbandry. (3-20-20)T
- b.** Motorized vehicles such as, all-terrain vehicles, motorcycles, and other off-road vehicles and non-motorized vehicles such as bicycles and trailers. (3-20-20)T
- c.** Grain and seed. (3-20-20)T
- d.** Hay, straw and other material of similar nature. (3-20-20)T
- e.** Nursery stock including plant material propagated for the support of aquarium, pet, or horticultural activities. (3-20-20)T
- f.** Feed and seed screenings. (3-20-20)T
- g.** Fence posts, fencing and railroad ties. (3-20-20)T
- h.** Sod. (3-20-20)T
- i.** Manure, fertilizers and material of similar nature. (3-20-20)T

- j. Soil, sand, mulch, and gravel. (3-20-20)T
- k. Boats, personal watercraft, watercraft trailers, and items of a similar nature. (3-20-20)T

**221. -- 229. (RESERVED)**

**230. TREATMENT OF ARTICLES.**

**01. Duty.** It is the duty of every person, before removing any article from any place that is infested with noxious weeds or before moving the article onto any public roadway, to enclose, clean, or treat the article in a manner that will prevent the spread of noxious weeds (3-20-20)T

**02. Treatment.** No article containing noxious weed propagules shall be sold or furnished to any person within this state, until it has been treated in a manner sufficient to eliminate all noxious weed propagating capability except when sold or furnished to a person for the purpose of destroying the viability of the noxious weed propagules. (3-20-20)T

**231. – 303. (RESERVED)**

**SUBCHAPTER C – NOXIOUS WEED FREE FORAGE AND STRAW CERTIFICATION**

**304. INCORPORATION BY REFERENCE.**

The following document is incorporated by reference and applies to Subchapter C, only: (3-20-20)T

**01. The NAISMA Weed Free Forage Minimum Certification Standards**, as published at [https://www.naisma.org/images/NAISMA\\_WFF\\_Minimum\\_Standards\\_10\\_17\\_2018\\_Approved\\_Changes.pdf](https://www.naisma.org/images/NAISMA_WFF_Minimum_Standards_10_17_2018_Approved_Changes.pdf). (3-20-20)T

**305. – 309. (RESERVED)**

**310. DEFINITIONS.**

In addition to the definitions found in Section 22-2402, Idaho Code, the definitions found in section 310 apply to the interpretation and enforcement of Subchapter C only: (3-20-20)T

**01. Agent.** Any instrumentality or entity authorized by the Director of the Department, and acting in an official capacity and under the supervision of the Department, to administer the provisions of Subchapter C. The principal purpose of the agent is to establish, conduct, and maintain a uniform and reasonable system of inspection and certification of forage and straw crops to determine if such crops are noxious weed free. (3-20-20)T

**02. Approved Inspector.** An individual who has been accredited by the Department or by the Department's agent in the noxious weed free forage and straw certification program. (3-20-20)T

**03. Bale.** A mechanically compressed package of forage or straw bound by string or wire, or other binding material. (3-20-20)T

**04. Bale Tag.** A tag or label that is attached to the string or wire, or other binding material of a bale of certified forage or straw, and identifies the bale as being certified noxious weed free. (3-20-20)T

**05. Certificate of Inspection.** A record of inspection issued by an approved inspector that states the results of a field or commodity inspection. The certificate shall document that the inspected field or commodity is Idaho State Noxious Weed Free, NAISMA Noxious Weed Free, or that the field or commodity contains noxious weeds. (3-20-20)T

**06. Certification.** The process whereby an approved inspector conducts field or commodity inspections to determine that the field or commodity is noxious weed free. (3-20-20)T

**07. Certification Markings.** Bale tags, purple and yellow colored twine, compressed forage/straw bale binding material, and forage cubes/pellets container tags/labels. (3-20-20)T

- 08. Certified Compressed Forage/Straw Bale Binding Material.** An ISDA approved binding material that is attached to a compressed forage/straw bale of certified noxious weed free forage/straw and identifies the bale as being certified to the NAISMA Standards. (3-20-20)T
- 09. Compressed Forage/Straw Bale.** A bale that has been twice compressed, once in the field by a forage/straw baler and then recompressed a second time and bound by string, wire or other binding material. (3-20-20)T
- 10. Field.** The land on which a forage or straw crop is grown and is not divided by streams, public roads, other crops, or other barriers. (3-20-20)T
- 11. Forage.** Alfalfa, grain, and grass hay, and/or combinations of alfalfa, grain, or grass hay; the term “forage” includes forage cubes, compressed forage bales, and pellets. (3-20-20)T
- 12. Forage Cubes.** Forage that is harvested from a field certified to NAISMA Standards and is mechanically compacted into wafers or cubes. (3-20-20)T
- 13. Forage Cube/Pellet Tag.** A tag, label, or statement that is attached or printed on a container of certified noxious weed free forage cubes or pellets, and identifies the container as being certified to the NAISMA Standards. (3-20-20)T
- 14. Idaho State Noxious Weed Free.** Forage and straw inspected for weeds designated by the Director as noxious as defined in Section 22-2402(17), Idaho Code, and determined to be free of such weeds. (3-20-20)T
- 15. Idaho State Noxious Weed Free Standards.** Forage and straw that meets the requirements Idaho State Noxious Weed Free. (3-20-20)T
- 16. NAISMA Noxious Weed Free.** Forage and straw inspected for, and determined to be free of, weeds designated as noxious by the Director as defined in Section 22-2402(17), Idaho Code, and noxious weeds listed on the NAISMA Designated Weed List. (3-20-20)T
- 17. NAISMA Weed Free Forage Certification Program.** The North American Invasive Species Management Association standard for forage certification. (3-20-20)T
- 18. NAISMA Twine.** Special purple and yellow colored twine approved by NAISMA that is used to mark bales as certified to the NAISMA Standards. (3-20-20)T
- 19. NAISMA Standards.** Requirements of the NAISMA Weed Free Forage Certification Program. (3-20-20)T
- 20. Noxious Weed Free.** No noxious weeds with viable seed, injurious portions, or propagating parts were found during inspection procedures. (3-20-20)T
- 21. Pellets.** Forage that is harvested from a field certified to NAISMA Standards and is manufactured into an agglomerated feed, formed by compacting and forcing through die openings by a mechanical process. (3-20-20)T
- 23. Straw.** The dried stalks or stems remaining after grain is harvested. (3-20-20)T
- 24. Transit Certificate.** A document completed by an approved inspector to certify products proposed for movement as certified noxious weed free into states that require noxious weed free forage and straw certification. The transit certificate must be in the possession of the transporter. (3-20-20)T
- 311. ABBREVIATIONS.**
- 01. ISDA.** The Idaho State Department of Agriculture. (3-20-20)T



**02.** NAISMA. North American Invasive Species Management Association. (3-20-20)T

**03.** NWFF&S. Noxious Weed Free Forage and Straw. (3-20-20)T

**312. -- 319. (RESERVED)**

**320. VOLUNTARY NOXIOUS WEED FREE FORAGE AND STRAW CERTIFICATION PROGRAM.**

**01. Purpose.** The noxious weed free forage and straw certification program is a voluntary program, the purpose of which is to provide a means for the inspection, certification, and marking of forage and straw as noxious weed free. The program will be managed by the Department and may be implemented through an agent of the Department. The program will allow for the preparation of a transit certificate for the purpose of interstate transport or shipping of forage and straw into and through states that place regulations and restrictions on such commodities. The program is intended to reduce the exportation, importation, growth, and spread of noxious weeds. (3-20-20)T

**02. Certifying Authority.** The Department or its agent is the certifying authority. The certifying authority will appoint, as needed, approved inspectors throughout the state, who may issue certificates of inspection. (3-20-20)T

**03. Certification Training.** The Department will determine minimum training and accreditation standards for approved inspectors. Training will be provided annually by the Department or its agent. Attendance at annual training will certify accreditation for the inspector for that calendar year. Approved inspectors will be issued a certificate of training for the calendar year. Annual training includes: (3-20-20)T

**a.** Field inspection techniques and procedures; (3-20-20)T

**b.** ISDA Noxious Weed Lists and NAISMA Weed Free Forage Prohibited Weed List plant identification; (3-20-20)T

**c.** ISDA and NAISMA certification standards and guidelines; (3-20-20)T

**d.** Knowledge of weed management, including: (3-20-20)T

**i.** Burning; (3-20-20)T

**ii.** Mowing, cutting or roguing; (3-20-20)T

**iii.** Mechanical methods; and (3-20-20)T

**iv.** Herbicides. (3-20-20)T

**e.** Inspection forms. (3-20-20)T

**04. Certification Program.** (3-20-20)T

**a.** The Department or its agent will: (3-20-20)T

**i.** Coordinate forage and straw inspections within the state; (3-20-20)T

**ii.** Select, train, and supervise persons who serve as approved inspectors; (3-20-20)T

**iii.** Issue certificates of inspection, transit certificates, NAISMA Twine, forage cubes/pellets tags/labels, certified compressed forage/straw bale binding material, and bale tags to qualifying participants; (3-20-20)T

**iv.** Maintain a record of inspections performed and certificates and tags issued; (3-20-20)T

**b.** Under the direction of the Department or its agent an approved inspector may perform inspections and issue certificates of inspection, transit certificates, NAISMA Twine, forage cubes/pellets tags/labels, and bale tags within the state at cost. (3-20-20)T

**05. Application for Certification.** (3-20-20)T

**a.** Application for certification inspection shall be made on forms available from the Department or its agent and submitted to the Department or its agent. (3-20-20)T

**b.** An applicant's signature on the application for certification is verification of the accuracy of the information submitted, and signifies the applicant's intent to comply with the post-certification and distribution requirements. (3-20-20)T

**06. Field Inspection Procedures.** (3-20-20)T

**a.** Forage or straw shall be inspected within a maximum of ten (10) days prior to cutting/harvesting in the field of origin for each field and cutting to be certified. Fields must be inspected again if circumstances prevent harvest of the forage/straw for a period greater than ten (10) days from the first inspection. (3-20-20)T

**b.** Each field inspected shall be identified by the name of the owner and a field name or number. The certification inspection may be performed on an entire field or a portion of a field, if the portion is plainly marked and identified prior to inspection. (3-20-20)T

**c.** Field inspections must take place prior to any operation that will limit the approved inspector's ability to properly inspect and certify the field. Fields that have been cut or harvested prior to inspection are ineligible for certification. (3-20-20)T

**d.** There shall be a minimum of two (2) entry points per field. (3-20-20)T

**e.** There shall be minimum of one (1) entry point per each ten (10) acres (four (4) hectares). (3-20-20)T

**f.** Each point of entry shall be at least one hundred fifty (150) feet (forty-five (45) meters) into the field, and each additional one hundred fifty (150) feet (forty-five (45) meters) traveled constitutes an entry point. Travel shall be uninterrupted, proceeding through the field being inspected. (3-20-20)T

**g.** The entire field border will be physically inspected. (3-20-20)T

**h.** The field inspection will include all ditches, fence rows, roads, easements, rights-of-way, or buffer zones surrounding the field. (3-20-20)T

**i.** Forage/straw that contains any noxious weeds as identified in Section 22-2402(17) or noxious weeds listed on the NAISMA Weed Free Forage Prohibited Weed List, may be certified if the following requirements are met: (3-20-20)T

**i.** Forage/straw that contains any noxious weeds may still be certified if the field upon which the forage/straw was produced is treated to prevent noxious weed seed or other propagule viability according to agricultural practices acceptable to, and to the satisfaction of, the approved inspector. (3-20-20)T

**ii.** Noxious weed(s) were treated not later than rosette to bud stage, or boot stage for grass species classified as noxious weeds, prior to cutting or harvesting; and (3-20-20)T

**iii.** Treatment method can include, but is not limited to burning, mowing, cutting or roguing, mechanical methods, or chemicals. (3-20-20)T

**j.** An inspection certificate shall document that the above requirements have been met. (3-20-20)T

**k.** Baling equipment must be cleaned of any noxious weeds prior to harvesting certified forage. If the baling equipment is not cleaned, the first three (3) small square bales or the first large round or square bale produced shall be considered non-certified. (3-20-20)T

**l.** Interstate shipment of baled forage and straw shall be accompanied by an original transit certificate issued by the approved inspector in the county of origin. The storage area shall also be inspected and be free of noxious weeds. (3-20-20)T

**m.** An approved inspector may not inspect fields of which said inspector has ownership or financial interest. (3-20-20)T

**07. Certification Standards.** After completing an inspection, the approved inspector will complete a certificate of inspection. (3-20-20)T

**a.** If the field or commodity inspected is certified as NAISMA Noxious Weed Free, the approved inspector will issue a certificate of inspection for that harvest or cutting. If the field or commodity contains NAISMA Noxious Weeds, but does not contain Idaho State noxious weeds, it may be certified as Idaho State noxious weed free, and such certification will be noted on the certificate of inspection. (3-20-20)T

**b.** If the field or commodity inspected is certified as noxious weed free, as defined in Subchapter C, the approved inspector may also issue, upon request, any of the following documents: (3-20-20)T

i. Transit certificates. (3-20-20)T

ii. Bale tags. The date on the bale tag must accurately reflect the year in which the bale was produced. (3-20-20)T

iii. NAISMA Twine only if the field or commodity is certified as NAISMA Noxious Weed Free. (3-20-20)T

iv. Forage cube/pellet tag/labels only if the field or commodity is certified as NAISMA Noxious Weed Free. (3-20-20)T

v. Certified compressed forage /straw bale binding material only if the field or commodity is certified as NAISMA Noxious Weed Free. (3-20-20)T

**c.** Certificates of inspection, transit certificates and bale tags shall be on forms prescribed by the Department or its agent. (3-20-20)T

**d.** NAISMA Twine and bale tags must be purchased from the Department or its agent. (3-20-20)T

**08. Copy of Inspections and a List of Approved Inspectors.** Upon request, the agent shall provide the Department with a copy of certificates of inspections issued and a current list of approved inspectors. (3-20-20)T

**09. Reciprocity.** Forage or straw certified under a reciprocal agreement between the Department and another state, and certified as NAISMA Noxious Weed Free according to the other state's approved certification standards, may be shipped into the state of Idaho and will be considered to meet the requirements of the Idaho program. (3-20-20)T

**10. Exports.** Certification under Subchapter C does not qualify a commodity for export from the United States. Applications for certification for export should be made directly to the Division of Plant Industries within the Department. (3-20-20)T

**11. Voluntary Posting.** After certification, a producer may post signs, or other forms of notification, on the certified commodity indicating that the commodity is certified as noxious weed free. (3-20-20)T

**12. Post-Certification and Distribution Requirements.** After a producer's commodity has been

inspected and certified, the producer shall: (3-20-20)T

- a. Take reasonable and prudent steps to protect the certified commodity from contamination; (3-20-20)T
- b. Keep the certified commodity separated from all uncertified commodity; (3-20-20)T
- c. Attach bale tags, certified compressed forage/straw bale binding material, or NAISMA Twine to each bale of certified forage or straw intended for sale as noxious weed free forage or straw prior to the bales leaving the producers stack yard or storage area; and (3-20-20)T
- d. Attach cube/pellet tag/label to each container of certified forage cubes/pellets intended for sale as noxious weed free forage prior to the containers leaving the producer's facility. (3-20-20)T
- e. Provide the shipper, trucker, or transporter with the appropriate number of transit certificates. (3-20-20)T

**13. Cancellation for Failure to Comply.** Any person who provides false information on an application for inspection or who fails to comply with the post-certification and distribution requirements may, upon order of the Director, be suspended for a period of up to two (2) years from participating in the forage and straw certification program. (3-20-20)T

**14. Enforcement and Cancellation.** Harvested lots of forage or straw from certified fields may be checked at any time by an approved inspector. Manufactured lots of forage cubes, pellets, and compressed forage/straw bales may be checked at any time by an approved inspector. Evidence that forage, straw, forage cubes/pellets, or compressed forage/straw bales are not from a certified field or that any lot has not been protected from contamination shall be cause for cancellation of certification. (3-20-20)T

**15. Misuse of Transit Certificate and Certification Markings.** Using a transit certificate or certification marking for forage/straw from a field that has not been certified constitutes a violation of Subchapter C. (3-20-20)T

**16. Certification Fees.** A minimum of thirty dollars (\$30) per inspection will be charged for up to ten (10) acres, and three dollars (\$3) per acre thereafter, for fields up to ninety-nine (99) acres. Fields that are one-hundred (100) acres or larger in size, the fee is three dollars (\$3) per acre for the first one-hundred (100) acres and two dollars (\$2) per acre thereafter. The agent is authorized to assess a general fee of thirty dollars (\$30) per year to recover overhead costs. (3-20-20)T

**321. – 329. (RESERVED)**

**330. NAISMA WEED FREE FORAGE PROHIBITED WEED LIST.**  
This list is incorporated by reference in Section 304.01 and is available in electronic format at: <https://www.naisma.org>. (3-20-20)T

**331. -- 339. (RESERVED)**

**340. APPLICATION FORM REQUIREMENTS.**  
A person wishing to participate in the noxious weed free forage and straw program shall make an application in writing on a form prescribed by ISDA for NWFF&S certification annually. There are no fees for application. The application shall be made with the ISDA agent in the county in which the person resides or in the county in which the person owns or leases land on which forage/straw will be produced. (3-20-20)T

**341. -- 349. (RESERVED)**

**350. CERTIFICATION MARKING.**  
Each certified bale or container shall be marked by one (1) of the following: (3-20-20)T

- 01. NAISMA Twine.** Only one (1) strand is required per bale. (3-20-20)T
- 02. Bale Tag.** The following information shall be shown on baled forage and straw: (3-20-20)T
- a.** The words - “NAISMA Weed Free Forage Certification Program” or “Idaho State Noxious Weed Free Forage & Straw Certification Program”; (3-20-20)T
  - b.** Bale tag serial number; (3-20-20)T
  - c.** County of origin identification; (3-20-20)T
  - d.** ISDA emblem; (3-20-20)T
  - e.** ISDA telephone number; and (3-20-20)T
  - f.** A statement that the product is “Certified to the NAISMA Standards” or “Certified to the Idaho State Noxious Weed Free Standards.” (3-20-20)T
  - g.** Year the bale tag was issued. (3-20-20)T
- 03. Forage Cube/Pellet Tag/Label.** Certification tags/labels shall be attached to or a statement with the following information printed on each container of noxious weed free product: (3-20-20)T
- a.** The words - “NAISMA Weed Free Forage Certification Program”; (3-20-20)T
  - b.** ISDA forage manufacturer identification number; (3-20-20)T
  - c.** ISDA emblem; (3-20-20)T
  - d.** ISDA telephone number; and (3-20-20)T
  - e.** A statement that the product is “Certified to the NAISMA Standards. (3-20-20)T
- 04. Certified Compressed Forage/Straw Bale Binding Material.** The following information shall be printed in purple ink on yellow binding material. Two (2) consecutive vertical purple lines approximately one-eighth of an inch (1/8”) wide, spaced approximately one and one-quarter inches (1 1/4”) apart, placed before and after written text that includes the acronym “ISDA NWFSS” and can include the manufacturer’s name. (3-20-20)T

**351. -- 359. (RESERVED)**

**360. PROCEDURES FOR CERTIFICATION OF FORAGE CUBES/PELLETS/COMPRESSED FORAGE/STRAW BALES.**

- 01. Application.** A person desiring to certify forage cubes/pellets/compressed forage/straw bales as noxious weed free must make an annual application on the ISDA's forage cube/pellet/compressed forage/straw bale certification application form. (3-20-20)T
- 02. Validity.** The application will be valid from the date of Department approval through December 31 of that calendar year. (3-20-20)T
- 03. Equipment.** Equipment will be cleaned of any noxious weed propagules prior to processing forage/straw for certification. (3-20-20)T
- 04. Purging.** After cleaning equipment, a minimum of five hundred (500) pounds of certified forage/straw must be purged through the entire system prior to processing certified forage cubes/pellets/compressed forage/straw bales. The five hundred (500) pounds of forage/straw used to eliminate any noxious weed seeds shall not be certified. (3-20-20)T

**05. Documentation.** A person who manufactures products referenced in Section 360 shall retain the following records for two (2) years: (3-20-20)T

**a.** All NWFF&S inspection certificates relating to the certified forage/straw delivered to their manufacturing facility each calendar year. (3-20-20)T

**b.** Quantity of certified forage cubes/pellets/compressed forage/straw bales processed each calendar year; and (3-20-20)T

**c.** Quantity of non-certified forage cubes/pellets/compressed forage/straw bales processed each calendar year. (3-20-20)T

**361. -- 999. (RESERVED)**

## 02.06.10 – RULES GOVERNING THE GROWING OF POTATOES

### 000. LEGAL AUTHORITY.

This chapter is adopted under the legal authority of Sections, 22-505, 22-1907, 22-2004, 22-2006, and 22-2013, Idaho Code. (3-20-20)T

### 001. TITLE AND SCOPE.

01. **Title.** The title of this chapter is IDAPA 02.06.10, “Rules Governing the Growing of Potatoes.” (3-20-20)T

02. **Scope.** These rules govern the procedures for all potato management within Seed Potato Crop Management Areas and establish the procedures of identifying, handling and testing uncertified seed potatoes to be planted in Idaho. These rules also seek to prevent the spread of Pale Cyst Nematode and the introduction and/or spread of *Cms* and subsequently bacterial ring rot throughout Idaho and the United States. (3-20-20)T

### 002. -- 103. (RESERVED)

## SUBCHAPTER A – PALE CYST NEMOTODE

### 104. INCORPORATION BY REFERENCE.

The following are incorporated by reference into Subchapter A only: (3-20-20)T

01. **7 CFR Part 301 SubPart - Pale Cyst Nematode.** Sections 301.86 through 301.86-9 as published under Docket No. APHIS-2006-0143 in the Federal Register Volume 72, No. 176, Wednesday, September 12, 2007, and as amended under Docket No. APHIS-2006-0143 published in the Federal Register Vol. 74, No. 81, Wednesday, April 29, 2009, and except as amended below in Subchapter A of this rule. (3-20-20)T

02. **USDA APHIS PPQ Treatment Manual Schedule T406-d, Revision 10, September 2006.** (3-20-20)T

03. **7 CFR Part 305 - Phytosanitary Treatments, as revised September 12, 2007.** (3-20-20)T

### 105. -- 109. (RESERVED)

### 110. DEFINITIONS AND TERMS.

In addition to the definitions found in Section 22-2005, Idaho Code, the following definitions found in Section 110 apply in the interpretation and enforcement of Subchapter A only: (3-20-20)T

01. **Inspector.** Any employee of ISDA, APHIS, the U.S. Department of Agriculture, or other person authorized by the USDA APHIS Administrator or ISDA Director to perform the duties required under Subchapter A. (3-20-20)T

02. **Interstate.** From any state into or through any other state. (3-20-20)T

03. **Intrastate.** Movement within the boundaries of the state of Idaho. (3-20-20)T

### 111. ABBREVIATIONS.

01. **APHIS.** Animal and Plant Health Inspection Service. (3-20-20)T

02. **ISDA.** Idaho State Department of Agriculture. (3-20-20)T

03. **PCN.** Pale Cyst Nematode. (3-20-20)T

04. **PPQ.** Plant Protection and Quarantine. (3-20-20)T

05. **USDA.** United States Department of Agriculture. (3-20-20)T

### 112. -- 119. (RESERVED)

**120. INTRASTATE MOVEMENT.**

No regulated articles may move within the state of Idaho without complying with the federal regulations, as incorporated by reference in Subsection 104.01 in Subchapter A. (3-20-20)T

**121. QUARANTINED AREAS.**

Those areas of the State quarantined or regulated for PCN under 7 CFR Part 301 Sections 301.86-3 as published on the USDA APHIS PPQ internet website at [http://www.aphis.usda.gov/plant\\_health/plant\\_pest\\_info/potato/pcn.shtml](http://www.aphis.usda.gov/plant_health/plant_pest_info/potato/pcn.shtml). (3-20-20)T

**122. RESTRICTIONS.**

**01. Movement From a Non-Quarantined Area.** Movement of regulated articles from a non-quarantined area is subject to inspection by an inspector. Permits and certifications are not required. (3-20-20)T

**02. Movement From a Quarantined Area.** Movement of regulated articles from a quarantined area is subject to the provision of Section 123 of Subchapter A. (3-20-20)T

**03. Other Restrictions.** No potatoes, tomatoes, eggplants, or any other known host crops may be planted in the infested fields. Soil must not be moved from the infested fields. Any equipment leaving the infested fields must be sanitized and certified using USDA APHIS approved protocols. (3-20-20)T

**04. Seed Potatoes.** Seed potatoes may not be grown in a quarantined area. (3-20-20)T

**05. Exemptions.** Host plant material may be planted in infested fields under the authorization and supervision of the USDA and Idaho State Department of Agriculture eradication program. (3-20-20)T

**123. CONDITIONS FOR INTRASTATE OR INTERSTATE MOVEMENT OF REGULATED ARTICLES.**

Regulated articles may only be moved intrastate or interstate from a quarantined area by a person under a compliance agreement if accompanied by a certificate or limited permit issued by an inspector in accordance with 7 CFR Part 301 Sections 301.86-4 and 5, as incorporated by reference in Section 104 in Subchapter A of this rule. (3-20-20)T

**124. -- 129. (RESERVED)**

**130. INSPECTION, SAMPLING, AND TESTING.**

In order to accomplish the purposes of Subchapter A, an inspector may enter upon and inspect any public or private premises, lands, means of conveyance, or article of any person within this State, for the purpose of inspecting, surveying, sampling, testing, treating, controlling, or destroying any soil, plant, or plant material thought to or found to contain or be infested with Pale Cyst Nematode. (3-20-20)T

**131. – 209. (RESERVED)**

**SUBCHAPTER B – SEED POTATO CROP MANAGEMENT AREA**

**210. DEFINITIONS.**

In addition to the definitions found in Idaho Code Sections 22-501 and 22-2005, Idaho Code, the definitions found in section 210 apply to the interpretation and enforcement of Subchapter B. (3-20-20)T

**01. Cull Potatoes.** Potatoes not usable for planting or consumption. (3-20-20)T

**02. Grower.** Any person who plants and cultivates more than fifteen one-hundredths (.15) acres of potatoes within a Seed Potato Crop Management Area. (3-20-20)T

**03. Volunteer Potatoes.** Volunteer potatoes are defined as any residue left in a field from previous years of production that has sprouted and is growing. (3-20-20)T

**211. ABBREVIATIONS.**



**01. ICIA.** Idaho Crop Improvement Association. (3-20-20)T

**212. -- 219. (RESERVED)**

**220. SEED POTATO CROP MANAGEMENT AREAS.**

**01. Fremont Seed Potato Crop Management Area.** That portion of Fremont county described as follows: Beginning at a point that is the southwest corner of Section 16, Township 7 North, Range 43 East, Boise, Meridian, Fremont County, Idaho; Thence north approximately 1 mile to the northwest corner of Section 16, Township 7 North, Range 43 East; Thence west approximately 2 miles to the southwest corner of Section 7, Township 7 North, Range 43 East; Thence north approximately 1 mile to the northwest corner of Section 7, Township 7 North, Range 43 East; Thence west approximately 3 miles to the southwest corner of Section 3, Township 7 North, Range 42 East; Thence north approximately 2 miles to the northwest corner of Section 34, Township 8 North, Range 42 East; Thence west approximately 2 miles to the southwest corner of Section 29, Township 8 North, Range 42 East; Thence north approximately 1-3/8 miles to the center line of Fall River; Thence northwest along Fall River approximately 1-1/8 miles to where Fall River intersects the west line of Section 8, Township 8 North, Range 41 East; Thence north approximately 1-7/8 miles to the northwest corner of Section 7, Township 18 North, Range 41 East; Thence west approximately 2 miles to the southwest corner of Section 2, Township 8 North, Range 41 East; Thence north approximately 1 mile to the northwest corner of Section 2, Township 8 North, Range 41 East; Thence west approximately 1/4 of 1 mile; Thence north along an existing road approximately 4 miles; Thence northeasterly along said road approximately 1-1/10 miles to the northwest corner of Section 11, Township 9 North, Range 41 East; Thence north approximately 1 mile to the northwest corner of Section 2, Township 9 North, Range 41 East; Thence east approximately 14 miles to the northeast corner of Section 1, Township 9 North, Range 43 East; Thence south approximately 2 miles to the southeast corner of Section 12, Township 9 North, Range 43 East; Thence east approximately 4 miles to the northeast corner of Section 15, Township 9 North, Range 44 East, which is the west boundary line of the Targhee National Forest; Thence south along said forest boundary approximately 3 miles to the southeast corner of Section 27, Township 9 North, Range 44 East; Thence east continuing along said forest boundary approximately 2 miles to the northeast corner of Section 36, Township 9 North, Range 44 East; Thence south along said forest boundary approximately 1 mile to the east 1/4 corner of Section 1, Township 8 North, Range 44 East; Thence east continuing along said forest boundary approximately 2 miles to the east 1/4 corner of Section 5, Township 8 North, Range 45 East; Thence south continuing along said forest boundary approximately 5 miles to the east 1/4 corner of Section 32, Township 8 North, Range 45 East; Thence east continuing along said forest boundary approximately 1-1/2 miles to the center of Section 34, Township 8 North, Range 45 East; Thence south continuing along said forest boundary approximately 1-1/8 miles to the center line of Bitch Creek; Thence southwesterly along the center line of Bitch Creek approximately 10-1/2 miles to the confluence of Bitch Creek with the Teton River; Thence westerly 8 miles along the center line of the Teton River to the west line of Section 21, Township 7 North, Range 43 East; Thence north approximately 1/10 of a mile to the southwest corner of Section 16, Township 7 North, Range 43 East and the point of beginning. (3-20-20)T

**02. Teton And Portions Of Madison County Seed Potato Crop Management Area.** (3-20-20)T

**a.** All of Teton County, Idaho; (3-20-20)T

**b.** That portion of Madison County, Idaho, located in Township 6 North and Township 7 North lying East of Canyon Creek; and (3-20-20)T

**c.** That portion of Madison County, Idaho located in Township 6 North, Range 42 East, which includes portions of Sections 11 and 13 located south of Highway 33 and all of Sections 14, 15, 23, and 24. (3-20-20)T

**03. Lost River Seed Potato Crop Management Area.** Those portions of Butte and Custer Counties within Township 3 North to Township 7 North and Range 23 East to Range 27 East. (3-20-20)T

**04. Caribou and Franklin County Seed Potato Crop Management Area.** All of Caribou County, Idaho and all of Franklin County, Idaho. (3-20-20)T

- 05. Almo Valley Bridge Seed Potato Crop Management Area.** (3-20-20)T
- a.** That portion of Cassia County, Idaho located in Township 16 South, Range 24 East, which includes all of Sections 1, 2, 3, 4, 9, 10, 11, 12, 13, 14, 15, 16, 21, 22, 23, 24, 25, 26, 27, 28, 33, 34, 35, and 36; (3-20-20)T
- b.** That portion of Cassia County, Idaho located in Township 15 South, Range 24 East, which includes all of Sections 1, 2, 3, 4, 9, 10, 11, 12, 13, 14, 15, 16, 21, 22, 23, 24, 25, 26, 27, 28, 33, 34, 35, and 36; (3-20-20)T
- c.** That portion of Cassia County, Idaho located in Township 14 South, Range 24 East, which includes all of Section 36; (3-20-20)T
- d.** That portion of Cassia County, Idaho located in Township 14 South, Range 25 East, which includes all of Sections 19, 20, 29, 30, 31, and 32; (3-20-20)T
- e.** That portion of Cassia County, Idaho located in Township 15 South, Range 25 East, which includes all of Sections 5, 6, 7, 8, 18, 19, 20, 29, 30, 31, 32 and the Northeast  $\frac{1}{4}$  of Section 33; (3-20-20)T
- f.** That portion of Cassia County, Idaho located in Township 16 South, Range 25 East, which includes all of Sections 7, 8, 9, 10, 11, 12, 13, 14, 15, 16, 17, 19, 20, 29, 30, 31, 32, 33, 34, 35, and 36; (3-20-20)T
- g.** That portion of Cassia County, Idaho located in Township 16 South, Range 26 East; and (3-20-20)T
- h.** That portion of Cassia County, Idaho located in Township 16 South, Range 27 East, which includes all of Sections 2, 3, 4, 5, 6, 7, 8, 9, 10, 11, 14, 15, 16, 17, 18, 19, 20, 21, 22, 23, 26, 27, 28, 29, and 30. (3-20-20)T
- 06. Ririe Reservoir Seed Potato Crop Management Area.** (3-20-20)T
- a.** That portion of Bonneville County, Idaho located in Township 3 North, Range 40 East, which includes all of Sections 19, 20, 21, 22, 25, 26, 27, 28, 29, 30, 31, 33, 34, 35, and 36; (3-20-20)T
- b.** That portion of Bonneville County, Idaho located in Township 3 North, Range 41 East, which includes all of Sections 8, 15, 16, 17, 18, 20, 21, 22, 26, 27, 28, 29, 30, 31, 32, 33, 34, 35, and 36; (3-20-20)T
- c.** That portion of Bonneville County, Idaho located in Township 2 North, Range 42 East, which includes all of Sections 3, 4, 5, 6, 7, 8, 9, 10, 15, 16, 17, 18, 19, 20, 21, 22, 27, 28, 29, 30, 31, 32, 33, and 34; and (3-20-20)T
- d.** That portion of Bonneville County, Idaho located in Township 3 North, Range 42 East, which includes all of Sections 31, 32, and 33. (3-20-20)T
- 07. Picabo Seed Potato Crop Management Area.** That portion of Blaine County, Idaho beginning with Township 1S, in Range 18, all of sections 23 and 24, leading into Township 1N, in Range 19 all of sections: 19, 20, 21, 22, 23, 26, 27, 28, 29, 30, 31, 32, 33, and 34. Leading into Township 1S, in Range 19, the W  $\frac{1}{2}$  of section 1, and all of sections: 2, 3, 4, 5, 6, 7, 8, 9, 10, 11, 12, 13, 14, 15, 16, 17, 18, 19, 20, 21, 22, 23, 24, 25, 26, 27, 28, and 29. Leading into Township 1S, Range 20, all of sections: 7, 8, 11, 12, 13, 16, 17, 18, 19, 20, 21, 22, 26, 27, 28, 29, 30, 35, and 36, including the N  $\frac{1}{2}$  of Sections 33 and 34. Leading into Township 2S, Range 20, all of sections 1, 2, and 12. Leading into Township 1S, Range 21, all of sections: 3, 4, 5, 6, 7, 8, 9, 10, 16, 17, 18, 19, 20, W  $\frac{1}{2}$  of section 28, and all of sections 29, 30, 31, 32, and the NW  $\frac{1}{4}$  of section 33, from Hwy 20 North, plus section 21 from Dry Creek Road North. Leading into Township 2S, Range 21, all of the W  $\frac{1}{2}$  of section 3, and all of the following sections: 4, 5, 6, 7, 8, E  $\frac{1}{2}$  of section 9, all of sections 17, 18, 19, 20, 21, 28, 29, 30, and 31, W  $\frac{1}{2}$  and the SE  $\frac{1}{4}$  of the NE  $\frac{1}{4}$  of section 10. Leading into Township 1N, Range 21, all of sections: 30, 31, and 32. All U.S. Department of the Interior, Bureau of Land Management property and property owned by the state of Idaho existing within the above mentioned areas will not be considered part of the management area. (3-20-20)T
- 08. Little Camas Ranch Seed Potato Crop Management Area.** (3-20-20)T

**a.** That portion of Elmore County, Idaho located in Township 1 North, Range 9 East, Boise Meridian, which includes the S  $\frac{1}{2}$  N  $\frac{1}{2}$  SE  $\frac{1}{4}$ , S  $\frac{1}{2}$  SE  $\frac{1}{4}$ , SW  $\frac{1}{4}$  of Section 27, the SE  $\frac{1}{4}$  SE  $\frac{1}{4}$ , SW  $\frac{1}{4}$  SW  $\frac{1}{4}$  of Section 28, the S  $\frac{1}{2}$  S  $\frac{1}{2}$ , N  $\frac{1}{2}$  SE  $\frac{1}{4}$ , SE  $\frac{1}{4}$  NE  $\frac{1}{4}$ , W  $\frac{1}{2}$  NE  $\frac{1}{4}$ , NE  $\frac{1}{4}$  NE  $\frac{1}{4}$  NW  $\frac{1}{4}$ , S  $\frac{1}{2}$  NE  $\frac{1}{4}$  NW  $\frac{1}{4}$ , SE  $\frac{1}{4}$  NW  $\frac{1}{4}$ , N  $\frac{1}{2}$  SW  $\frac{1}{4}$ , NE  $\frac{1}{4}$  NE  $\frac{1}{4}$  of Section 32, the E  $\frac{1}{2}$ , E  $\frac{1}{2}$  W  $\frac{1}{2}$ , SW  $\frac{1}{4}$  SW  $\frac{1}{4}$ , NW  $\frac{1}{4}$  SW  $\frac{1}{4}$ , SW  $\frac{1}{4}$  NW  $\frac{1}{4}$ , NW  $\frac{1}{4}$  NW  $\frac{1}{4}$  of Section 33, and all of Section 34; and (3-20-20)T

**b.** That portion of Elmore County, Idaho located in Township 1 South, Range 9 East, Boise Meridian, which includes all of Section 4, all less the SW  $\frac{1}{4}$  NW  $\frac{1}{4}$  and less the W  $\frac{1}{2}$  SW  $\frac{1}{4}$  of Section 5, the N  $\frac{1}{2}$  NE  $\frac{1}{4}$  of Section 8, and the NW  $\frac{1}{4}$  NE  $\frac{1}{4}$ , N  $\frac{1}{2}$  NW  $\frac{1}{4}$  of Section 9; and (3-20-20)T

**c.** That portion of Elmore County, Idaho located in Township 1 South, Range 9 East, Boise Meridian, which includes Lots 1, 2, 3, and 4, and the S  $\frac{1}{2}$  N  $\frac{1}{2}$ , N  $\frac{1}{2}$  SE  $\frac{1}{4}$ , SW  $\frac{1}{4}$  of Section 3 less Tax Lot 1 described as follows: That portion of Elmore County, Idaho located in Township 1 South Range 9 East, Boise Meridian, described above as Tax Lot 1: Save and Except that portion of S  $\frac{1}{2}$  SW  $\frac{1}{4}$ , Section 3, Township 1 South, Range 9 East, Boise Meridian, Elmore County, Idaho more particularly described as follows: Commencing at the Southwest corner of Section 3, Township 1 South, Range 9 East, Boise Meridian, and running thence South 89o51' East along the South Section line of said Section 3, a distance of 437 feet to a steel pin in the center of a graveled road, the Real Point of Beginning. Thence continuing from the Real Point of Beginning North 0o04' West a distance of 1,000 feet to a steel pin; thence South 89o51' East a distance of 1,742.4 feet to a steel pin; thence South 0o04' East a distance of 1,000 feet to a steel pin on the South Section line of said Section 3; thence North 89o51' West along the South Section line of said Section 3 a distance of 1,742.4 feet, more or less to the Real Point of Beginning more particularly described as Tax Lot 1. (3-20-20)T

**09. Hog Hollow Seed Potato Crop Management Area. (3-20-20)T**

**a.** Beginning at a point that is the northeast corner of Section 19, Township 7 North, Range 43 East, Boise Meridian; Thence south along the eastern border of Section 19, Township 7 North, Range 43 East approximately  $\frac{3}{4}$  mile to the centerline of the Teton River as it enters said Section 19 at the eastern border of said Section 19; Thence southwesterly along the centerline of the Teton River as it runs through the southeast corner of Section 19, Township 7 North, Range 43 East; Continuing along the centerline of the Teton River as it runs southwesterly into the N $\frac{1}{2}$  NE $\frac{1}{4}$  of Section 30, Township 7 North, Range 43 East and then northwesterly out of the N $\frac{1}{2}$  NE $\frac{1}{4}$  of said Section 30; Continuing along the centerline of the Teton River as it runs northwesterly from the southern borderline of Section 19, Township 7 North, Range 43 East and then as the river curves southwesterly to the western border of said Section 19; Continuing along the centerline of the Teton River as it runs generally north-northwesterly through Section 24, Township 7 North, Range 42 East to the western border of said Section 24; Continuing along the centerline of the Teton River as it runs generally northwesterly through Section 23, Township 7 North, Range 42 East and to the northern border of said Section 23; Continuing along the centerline of the Teton River as it runs northwesterly through the SW $\frac{1}{4}$  SW $\frac{1}{4}$  of Section 14, Township 7 North, Range 42 East to the western border of said Section 14; Continuing along the centerline of the Teton River as it runs generally westerly through Section 15, Township 7 North, Range 42 East to the western border of said Section 15; Continuing along the centerline of the Teton River as it runs southwesterly through the SE $\frac{1}{4}$  SE $\frac{1}{4}$  of Section 16, Township 7 North, Range 42 East to the southern border of said Section 16; Thence west approximately  $\frac{3}{4}$  mile along the southern border of Section 16, Township 7 North, Range 42 East to the southwest corner of said Section 16; Thence north 1 mile along the western border of Section 16, Township 7 North, Range 42 East to the northwest corner of said Section 16; Thence north approximately  $\frac{1}{4}$  mile along the western border of Section 9, Township 7 North, Range 42 East to the northwest corner of the SW $\frac{1}{4}$  SW $\frac{1}{4}$  of said Section 9; Thence west 1 mile along the northern border of the S $\frac{1}{2}$  S $\frac{1}{2}$  of Section 8, Township 7 North, Range 42 East to the western border of said Section 8; Thence west 1 mile along the northern border of the S $\frac{1}{2}$  S $\frac{1}{2}$  of Section 7, Township 7 North, Range 42 East to the western border of said Section 7; Thence south  $\frac{1}{4}$  mile to the southeast corner of Section 12, Township 7 North, Range 41 East; Thence west approximately  $\frac{3}{4}$  mile along the southern border of Section 12, Township 7 North, Range 41 East to the southwest corner of the SE $\frac{1}{4}$  SW $\frac{1}{4}$  of said Section 12; Thence north approximately  $\frac{3}{4}$  mile to the northwest corner of the SE $\frac{1}{4}$  NW $\frac{1}{4}$  of Section 12, Township 7 North, Range 41 East; Thence east  $\frac{1}{4}$  mile along the northern border of the S $\frac{1}{2}$  NW $\frac{1}{4}$  of Section 12, Township 7 North, Range 41 East to the southwest corner of the N $\frac{1}{2}$  NE $\frac{1}{4}$  of said Section 12; Thence north  $\frac{1}{4}$  mile along the western border of the NE $\frac{1}{4}$  of Section 12, Township 7 North, Range 41 East to the northern border of said Section 12; Thence east along the northern border of Section 12, Township 7 North, Range 41 East to the northeast corner of said Section 12; Excluding from the described portion of Section 12, Township 7 North, Range 41 East, Boise Meridian the following parcel; Commencing at the northeast

corner of Section 12, Township 7 North, Range 41 East thence North 89°02'34" West, along the north line of said Section, 40.03 feet to a point on the westerly line of a county road; said point being the true point of beginning; thence continuing North 89°02'34" West, along the Section line, 612.05 feet; thence South 253.12 feet; thence East 611.96 feet, to a point on the westerly line of said county road: thence North 242.89 feet to the true point of beginning, containing 3.48 acres more or less; Thence east along the northern border of Section 7, Township 7 North, Range 42 East, Boise Meridian to the northeast corner of said Section 7; Thence east along the northern border of Section 8, Township 7 North, Range 42 East to the northeast corner of said Section 8; Thence east along the northern border of Section 9, Township 7 North, Range 42 East to the northeast corner of said Section 9; Thence east along the northern border of Section 10, Township 7 North, Range 42 East to the northeast corner of said Section 10; Thence east 1/4 mile along the northern border of Section 11, Township 7 North, Range 42 East to the northeast corner of the NW1/4 NW1/4 of said Section 11; Thence south approximately 3/4 mile to a county road known as the Old Hog Hollow Road, located approximately along the northern border of the S1/2 S1/2 of Section 11, Township 7 North, Range 42 East; Thence east along the county road known as the Old Hog Hollow Road as it travels easterly approximately along the northern border of the S1/2 S1/2 of Section 11, Township 7 North, Range 42 East approximately to the northeast corner of the SW1/4 SE1/4 of said Section 11; Thence southeast along the county road known as the Old Hog Hollow Road as it travels southeasterly through the SE1/4 SE1/4 of Section 11, Township 7 North, Range 42 East to the to the eastern border of said Section 11; Thence generally easterly along the county road known as the Old Hog Hollow Road as it travels generally easterly through the S1/2 S1/2 of Section 12, Township 7 North, Range 42 East to the eastern border of said Section 12; Thence south approximately 1/4 mile along the eastern border of Section 12, Township 7 North, Range 42 East to the southeast corner of said Section 12; Thence south 1 mile along the eastern border of Section 13, Township 7 North, Range 42 East to the southeast corner of said Section 13; Thence east 1 mile along the northern border of Section 19, Township 7 North, Range 43 East to the northeast corner of said Section 19 the point of beginning. (3-20-20)T

**b.** Including also the following non-contiguous parcel: Beginning at a point that is the northeast corner of Section 5, Township 7 North, Range 42 East, Boise Meridian and continuing south along the eastern border of said Section 5 to the southeast corner of the NE1/4 of said Section 5; Thence west 1 mile along the northern border of the S1/2 of Section 5, Township 7 North, Range 42 East to the western border of said Section 5; Thence north 1/2 mile along the western border of Section 5, Township 7 North, Range 42 East to the northwest corner of said Section 5; Thence north 1/4 mile along the western border of Section 32, Township 8 North, Range 42 East to the northwest corner of the SW1/4 SW1/4 of said Section 32; Thence east 1 mile along the northern border of the S1/2 S1/2 of Section 32, Township 8 North, Range 42 East to the eastern border of said Section 32; Thence south 1/4 mile along the eastern border of Section 32, Township 8 North, Range 42 East to the northeast corner of Section 5, Township 7 North, Range 42 East the point of beginning. (3-20-20)T

**221. -- 229. (RESERVED)**

**230. REGULATED ARTICLES.**

- 01. Irish Potato.** All plants and plant parts of the Irish potato, *Solanum tuberosum*. (3-20-20)T
- 02. Green Peach Aphid Hosts.** All plants that are hosts to the green peach aphid, *Myzus persicae*, including but not limited to peach and apricot trees and bedding plants. (3-20-20)T
- 03. Any Host.** Any host that may spread or assist in the spread of any of the diseases or pests of concern. (3-20-20)T
- 04. Equipment.** All ground working, earth moving, or potato handling equipment shall be cleaned of soil and plant debris and disinfected before entering the Seed Potato Crop Management Areas in order to prevent the introduction of disease(s) or pest(s) of concern. (3-20-20)T

**231. -- 239. (RESERVED)**

**240. DISEASES AND PESTS OF CONCERN.**

- 01. Introduction of Pests.** Introduction into the Seed Potato Crop Management Areas of any of the pests or diseases listed in this Section by a contaminated vehicle or any other means constitutes a violation of

- Subchapter B of this rule. (3-20-20)T
- 02. **Leaf Roll.** *Net necrosis* or leaf roll, caused by potato leaf roll virus. (3-20-20)T
  - 03. **Ring Rot.** Ring rot, *Corynebacterium sepedonicum*. (3-20-20)T
  - 04. **Columbia Root Knot Nematode.** Columbia root knot nematode, *Meloidogyne chitwoodii*. (3-20-20)T
  - 05. **Green Peach Aphid.** Green peach aphid, *Myzus persicae*, a vector of the leaf roll virus. (3-20-20)T
  - 06. **Northern Root Knot Nematode.** Northern root knot nematode, *Meloidogyne hapla*. (3-20-20)T
  - 07. **Corky Ring Spot.** Corky ring spot, a disease caused by tobacco rattle virus. (3-20-20)T
  - 08. **Powdery Scab.** Powdery scab, *Spongospora subterranea* (Wallr.) Lagerh. f. sp. *subterranea*. (3-20-20)T
  - 09. **Stubby Root Nematode.** Stubby root nematode, *Paratrichodorus pachydermus*, *Paratrichodorus christiei*, *Trichodorus primitivus*. (3-20-20)T
  - 10. **Potato Late Blight.** Potato late blight, a disease caused by *Phytophthora infestans*. (3-20-20)T
241. -- 249. (RESERVED)
250. **PLANTING OF POTATOES.**
- 01. **Seed Potato Crop Management Area.** No person shall plant any potatoes in any of the Seed Potato Crop Management Areas except those that have met standards for recertification of the ICIA or equivalent agency of another state or political jurisdiction in accordance with Section 22-503, Idaho Code. (3-20-20)T
  - 02. **Certification.** All plantings of potatoes shall be entered for certification with ICIA who notifies ISDA of any lots of potatoes rejected. Exceptions: (3-20-20)T
    - a. All plantings of potatoes in Lost River Seed Potato Crop Management Area; and (3-20-20)T
    - b. All plantings of potatoes in home gardens that are fifteen one-hundredths (.15) acre or less. (3-20-20)T
  - 03. **Home Gardens.** Potatoes planted in home gardens within a Seed Potato Crop Management Area are subject to inspection by the ISDA for the pests and diseases listed in Section 240. ISDA ensures that proper control measures are taken. (3-20-20)T
  - 04. **Control.** The grower shall spray with a pesticide or take other control measures approved by ISDA when potato late blight is found within a twenty-five (25) mile radius of a Seed Potato Crop Management Area boundary except the Lost River Seed Potato Crop Management Area. A grower in the Lost River Seed Potato Crop Management Area shall spray with a pesticide or take other control measures approved by ISDA when potato late blight is found within the boundaries of the Lost River Seed Potato Crop Management Area. (3-20-20)T
251. -- 259. (RESERVED)
260. **PEACH, APRICOT TREES, OR ANY HOST.**  
Peach, apricot trees, or any host of green peach aphid growing in Seed Potato Crop Management Areas shall be controlled with an ISDA approved pesticide. (3-20-20)T
261. **BEDDING PLANTS.**

**01. Aphid Inspection.** All bedding plants are subject to inspection by the Director for aphids. If aphids are found, the plants shall be treated by a method approved by the Director. Such methods may include destruction of infested plants. (3-20-20)T

**02. Treatment for Infestation.** Bedding plants in transit to Seed Potato Crop Management Areas are subject to inspection for aphids and if found infested, treated in a manner approved by the Director before delivery into Seed Potato Crop Management Areas. (3-20-20)T

**03. Treatment of Property.** The Director may order treatment of property on which there are bedding plants or cut floral arrangements where he determines such treatment is necessary to control aphids. (3-20-20)T

**04. Treatment of Cemeteries.** All cemeteries within Seed Potato Crop Management Areas shall be sprayed or controlled for insects immediately after the Memorial Day holiday. Such spraying or control will be done in compliance with all State and Federal laws, rules and regulations. (3-20-20)T

**262. -- 269. (RESERVED)**

**270. STORAGE OF POTATOES.**

**01. Potatoes Produced Within Seed Potato Crop Management Areas.** All potatoes grown within Seed Potato Crop Management Areas may be stored within Seed Potato Crop Management Areas. All potatoes found to be infested with any disease or pests of concern as defined in Section 240 shall be removed from Seed Potato Crop Management Areas no later than April 15 of the year following harvest. (3-20-20)T

**02. Potatoes Produced Outside Seed Potato Crop Management Areas.** Before any lot of potatoes can be brought into Seed Potato Crop Management Areas, the lot shall be inspected, certified, and tagged by ICIA, the Federal/State Inspection Service or a recognized equivalent agency of another state or territory in accordance with Section 22-503, Idaho Code except the Lost River Seed Potato Crop Management Area. Before any lot of potatoes can be brought into the Lost River Seed Potato Crop Management Area the lot shall pass ICIA summer inspection or inspected, certified, and tagged by the Federal/State Inspection Service or a recognized equivalent agency of another state or territory in accordance with Section 22-503, Idaho Code. (3-20-20)T

**271. SEED DISPOSITION NOTIFICATION.**

The Federal/State Inspection Service will notify the ISDA of all seed lots rejected for certification. This notification will include the variety, grower, storage location and the certification number of each rejected lot. (3-20-20)T

**272. -- 279. (RESERVED)**

**280. CULL AND VOLUNTEER POTATOES.**

**01. Plant Growth.** All plant growth on cull potato piles shall be controlled by a state approved chemical or mechanical measure including, but not limited to, burial with a minimum of eighteen (18) inches of soil, field spreading no more than two (2) potato layers and composting. (3-20-20)T

**02. Destroying Volunteer Potatoes.** It is the responsibility of each grower within Seed Potato Crop Management Areas to destroy all cull piles and volunteer potatoes growing on summer fallow, set-aside and non-cultivated areas of the grower's property. In the event that the grower fails to destroy such plants, the Director may order them destroyed at the expense of the grower. (3-20-20)T

**281. -- 289. (RESERVED)**

**290. TRANSPORTATION OF POTATOES.**

**01. Responsibilities.** It is the responsibility of the growers of rejected lots to keep contaminated trucks and equipment, infested vegetable matter and foliage from contaminating public roadways, neighboring fields and cellars. (3-20-20)T

**02. In Transit.** Potatoes in transit through Seed Potato Crop Management Areas shall be in covered vehicles and not be unloaded in Seed Potato Crop Management Areas. (3-20-20)T

**291. – 294. (RESERVED)**

**295. POTATOES FOR CONSUMPTION.**

Potatoes for human and animal consumption, grown outside Seed Potato Crop Management Areas as defined in Section 220, shall be treated with a sprout inhibitor before being offered for sale within Seed Potato Crop Management Areas as defined in Section 220 of Subchapter B. (3-20-20)T

**296. -- 303. (RESERVED)**

**SUBCHAPTER C – BACTERIAL RING ROT**

**304. INCORPORATION BY REFERENCE.**

The following documents are incorporated by reference into Subchapter C only: (3-20-20)T

**01. IDAPA 08.05.01.000 et seq., “Rules Governing Seed and Plant Certification” and Materials Incorporated Therein By Reference.** A copy may be accessed online at: <http://adminrules.idaho.gov/rules/current/08/index.html>. (3-20-20)T

**305. -- 309. (RESERVED)**

**310. DEFINITIONS.**

In addition to the definitions in Sections 22-1904 and 22-2005, Idaho Code, the definitions in section 310 apply in the interpretation and the enforcement of this Subchapter C only: (3-20-20)T

**01. Bacterial Ring Rot.** Caused by a bacterium, *Clavibacter michiganensis subsp. sepedonicus (Cms)*. (3-20-20)T

**02. Contact Lot.** A seed lot produced on a farming operation using common production and handling equipment or storage facilities, or both. (3-20-20)T

**03. Idaho Crop Improvement Association, Inc.** A grower association of certified seed producers and conditioners. In 1959, the Regents of the University of Idaho appointed the Idaho Crop Improvement Association, Inc. as its duly authorized agent to administer and conduct seed certification in Idaho. (3-20-20)T

**04. Seed Lot.** A field or a group of fields producing seed potatoes or the potatoes (tubers) harvested from a seed potato field, identified with a certification number and a North American Plant Health Certificate, enabling identity preservation and tracking. (3-20-20)T

**05. Seed Potato Certification Process.** The process, timing and requirements for the certification of seed potatoes in Idaho, as set forth in IDAPA 08.05.01, “Rules Governing Seed and Plant Certification” and the materials incorporated therein by reference. (3-20-20)T

**06. Seed Stock.** Seed potatoes intended for use as a planting source for certification that are “Identity Preserved” with a certification number and a North American Plant Health Certificate. (3-20-20)T

**07. Sister Lot.** Seed lots originating from the same lot of seed stock. (3-20-20)T

**311. ABBREVIATIONS.**

**01. BRR.** Bacterial Ring Rot. (3-20-20)T

**02. Cms.** *Clavibacter michiganensis subsp. sepedonicus*. (3-20-20)T

03. ISDA. Idaho State Department of Agriculture. (3-20-20)T
04. ICIA. Idaho Crop Improvement Association. (3-20-20)T
312. – 319. (RESERVED)
320. **REGULATED PEST - BACTERIAL RING ROT.**  
Caused by a bacterium, *Clavibacter michiganensis* subsp. *sepedonicus* (*Cms*). (3-20-20)T
321. -- 329. (RESERVED)
330. **REPORTING OF BRR.**
01. **Mandatory Reporting.** It is mandatory for any person including, but not limited to, a grower, processor, shipper, laboratory staff member, field inspector, or shipping point inspector, to immediately report the presence of BRR to the Department when: (3-20-20)T
- a. The BRR is discovered or observed in seed potato plants or tubers prior to final seed potato certification by ICIA; and (3-20-20)T
- b. The presence of BRR is confirmed via laboratory testing; and (3-20-20)T
- c. The positive tubers or plant parts are still in the possession of the original seed grower. (3-20-20)T
02. **Contents.** All reports shall, to the best of the reporter’s ability, contain the following information: (3-20-20)T
- a. The field, facility or other location at which *Cms* was found; (3-20-20)T
- b. The date of discovery; (3-20-20)T
- c. The location at which the suspect potatoes were grown; (3-20-20)T
- d. The variety and generation of the suspect potatoes; (3-20-20)T
- e. The laboratory submission report and test results; (3-20-20)T
- f. The certification tags and origin of the seed potatoes used to produce the suspect crop; (3-20-20)T
- g. North American Plant Health Certificate. (3-20-20)T
03. **Methods of Reporting.** The report shall be made by phone, in person or in writing (which may include electronic mail sent to [BRR@agri.idaho.gov](mailto:BRR@agri.idaho.gov)). (3-20-20)T
331. **HOLD HARMLESS.**  
Reporting parties and those parties participating in and cooperating with the Department’s trace back investigation of any alleged *Cms* contaminated potatoes will be held harmless from any civil penalties the Department has authority to issue. (3-20-20)T
332. **TRACE BACK INVESTIGATION, SAMPLING, AND TESTING.**
01. **Trace Back and Investigation.** The department, upon receiving a mandatory report of *Cms* infected potatoes, investigates the origin and destination of such potatoes. Trace back and investigation activities may include, but not be limited to: (3-20-20)T
- a. A review of all inspection, certification, shipping and production records held by any person for the potatoes in question; (3-20-20)T



b. Inspection and sampling at the reporting operation as well as points for origin, storage and destination related to that operation; and (3-20-20)T

c. Laboratory testing records of any samples. (3-20-20)T

**02. Mutual Cooperation.** The Department and the Idaho Crop Improvement Association will mutually cooperate with each other in trace back investigations where appropriate. (3-20-20)T

**03. Testing Positive for Cms.** If certified seed potatoes in a lot test positive for Cms after they have left the control of the grower of that lot, ISDA's trace back investigation may include Cms testing any remaining seed from that lot that is still at the seed potato grower's facility. The testing level will be at a rate, depending on lot size, up to a maximum of four hundred (400) randomly selected tubers. (3-20-20)T

**04. Trace Back Investigations.** The public disclosure of information obtained during an investigation conducted under Subchapter C of this rule is subject to disclosure to the public only insofar as it is allowed by Title 74, Chapter 1, Idaho Code. (3-20-20)T

**333. RESTRICTION ON THE USE OF INFECTED POTATOES.**  
Those potatoes found to be infected with *Cms* may not be utilized for planting as seed. (3-20-20)T

**334. -- 349. (RESERVED)**

**350. TESTING FOR BRR.**

**01. Compliance With Certification Standards. Seed potato** tubers for planting for commercial production or for seed certification in Idaho or being imported into Idaho as seed potatoes for commercial production or certification as seed for planting must comply with the Rules Governing Seed and Plant Certification as they relate to *Cms*, as incorporated in Section 304 of Subsection C of this rule. (3-20-20)T

**02. Seed Potatoes to Be Exported Tested.** Seed potato tubers being exported from Idaho to a foreign country as seed potatoes for planting must meet all ICIA requirements for certification and export tag placement, as well as all phytosanitary certification requirements of the importing country. All costs for sampling, transport and testing are borne by the exporter. (3-20-20)T

**351. -- 359. (RESERVED)**

**360. HOLD ORDERS.**

The Director may authorize Hold Orders restricting the movement of infested or suspect potatoes until investigation, trace back, and sample analysis are complete. Hold Orders may require verification that said potatoes will not be utilized for any purposes not authorized in writing by the Department. When potatoes from a certified seed potato lot are sampled and test positive for BRR after the seed potatoes have left the seed potato grower's facility, the department will not issue a hold order on any seed potatoes from that lot that remain on the seed potato grower's facility unless and until potatoes from the affected lot are sampled at the seed potato grower's facility and test positive for BRR. (3-20-20)T

**361. -- 369. (RESERVED)**

**370. FEES.**

Fees for samples for laboratory testing for *Cms* are those normally charged by the approved laboratory doing the testing. (3-20-20)T

**371. -- 409. (RESERVED)**

#### **SUBCHAPTER D – PLANTING SEED POTATOES**

**410. DEFINITIONS.**

In addition to the definitions found in Section 22-501, Idaho Code, the definitions found in section 410 apply in the interpretation and the enforcement of this subchapter D of this rule: (3-20-20)T

**01. Disease.** Any fungus, bacteria, virus, or other organism injurious to plant life or plant products, including the spore or any other propagative state thereof. (3-20-20)T

**02. Pest.** Any form of animal life that is or may be detrimental or injurious to plant life or plant products, including the egg, larva, pupa, or any other immature stage thereof. (3-20-20)T

**411. -- 449. (RESERVED)**

**450. REQUIREMENTS FOR UNCERTIFIED SEED POTATOES ARE:**

**01. No More Than One Generation.** No more than one (1) generation from certified parent seed potatoes. (3-20-20)T

**02. Grown by the Farmer.** Grown by the farmer and separated and graded at the storage of the farmer planting the uncertified seed potatoes. (3-20-20)T

**03. Planting.** Planted only on the farm of the farmer who produced the uncertified seed potatoes. (3-20-20)T

**04. Disease Content.** In compliance with ICIA rules of certification for seed potatoes by having a disease content that does not exceed the standard for the last generation of certified seed potatoes. (3-20-20)T

**05. Laboratory Testing.** Laboratory tested for bacterial ring rot prior to planting. (3-20-20)T

**06. Laboratory Tested and/or Grown Out.** Laboratory tested and/or grown-out for potato leaf roll virus and potato virus Y prior to planting. (3-20-20)T

**07. Testing by Designated Agencies.** Laboratory and/or grow-out tested by agencies designated by the department. (3-20-20)T

**08. Sampling.** Sampled in accordance with procedures established by the department. (3-20-20)T

**451. -- 459. (RESERVED)**

**460. ENFORCEMENT.**

**01. Reporting – Uncertified Seed Potatoes.** All growers planning to plant uncertified seed potatoes shall complete an uncertified seed potatoes report form approved by the department and submit it to the department prior to planting. (3-20-20)T

**02. Records - Certified Seed Potatoes.** All potato growers are required to keep seed potato certification records for a minimum of four years after planting. The records may be official tags or other official documentation issued by the certifying agency and representing each lot planted. These records must include the potato variety name, certification number and certifying agency. These records are to be made available to a Department representative upon request. (3-20-20)T

**461. – 999. (RESERVED)**

## 02.06.33 – ORGANIC FOOD PRODUCTS RULES

### 000. LEGAL AUTHORITY.

This chapter is adopted under the legal authority of Section 22-1103, Idaho Code. (3-20-20)T

### 001. TITLE AND SCOPE.

01. **Title.** The title of this chapter is IDAPA 02.06.33, “Organic Food Products Rules.” (3-20-20)T

02. **Scope.** These rules govern definitions, requirements for production, handling, and labeling of organic plant and animal products. These rules further govern the general requirements for certification of producers and handlers of plant and animal products, as well as program fee structures. (3-20-20)T

### 002. -- 003. (RESERVED)

### 004. INCORPORATION BY REFERENCE.

The Code of Federal Regulations, Title 7, Part 205, National Organic Program Regulations (July 7, 2010), except sections 205.620 through 205.622, is incorporated by reference and can be viewed online at <http://www.ecfr.gov/cgi-bin/text-idx?c=ecfr&SID=b885492294d6e01d334ae6076da2c3c2&rgn=div5&view=text&node=7:3.1.1.9.32&idno=7>. Copies of this document may be obtained from the Idaho State Department of Agriculture (ISDA), 2270 Old Penitentiary Road, Boise, Idaho 83712. (3-20-20)T

### 005. -- 009. (RESERVED)

### 010. DEFINITIONS.

In addition to the definitions found in Section 22-1102, Idaho Code, the following definitions apply to the interpretation and enforcement of these rules: (3-20-20)T

01. **Agent.** Any entity accredited by the Secretary of the United States Department of Agriculture as a certifying agent for the purpose of certifying a production or handling operation. (3-20-20)T

02. **Certification.** A document issued by the Department to a producer/handler who is in compliance with this rule who has more than five thousand dollars (\$5,000) annual gross organic sales. (3-20-20)T

03. **Educational Activity.** Seminar, conference, farm tour, class, or research. (3-20-20)T

04. **Food Products.** Includes all agricultural, horticultural, viticultural and vegetable products of the soil, apiary and apiary products, poultry and poultry products, livestock and livestock products, milk and dairy products and aquaculture products. (3-20-20)T

05. **Materials.** Any substance or mixture of substances that is intended to be used in agricultural production, processing, or handling. (3-20-20)T

### 011. -- 199. (RESERVED)

### 200. IDAHO ORGANIC CERTIFICATION SEAL.

01. **Description of Seal.** Certified operations that become certified for the first time prior to July 1, 2013 may continue to use the seal depicted in Figure 1. Certified operations that become certified for the first time July 1, 2013 and later may only use the seal in Figure 2.

FIGURE 1



FIGURE 2



(3-20-20)T

**02. Utilization of Seal.** The Idaho organic certification seal as approved by the director and as shown in Figure 1 and Figure 2, may be imprinted or affixed on labels, packages or products, or used in advertising in any manner and signifies that the standards and rules developed in accordance with the provisions of this rule and all other conditions of the provisions of this chapter have been met. (3-20-20)T

**a.** Any container manufacturer may apply for authorization to imprint facsimiles of the ISDA organic certification seal on containers of organic products. (3-20-20)T

**b.** Authorization granted to imprint facsimile seals is subject to review by the director on an annual basis, or more frequently if necessary. (3-20-20)T

**201. REGISTRATION OF APPROVED MATERIALS.**

The director may establish a list of registered branded materials for use in organic production, processing, or handling. (3-20-20)T

**01. Registration.** Registration is voluntary. (3-20-20)T

**a.** All applicants applying for registration of materials must submit the application to the Department on forms prescribed by the Department. (3-20-20)T

**b.** An applicant for materials registration must demonstrate that the material meets the requirements and standards of the National Organic Program. Specifically, the material may not be a material prohibited for use in the production, processing, or handling of organic products by 7 C.F.R. Section 205.105, and may not be otherwise prohibited for use in organic production, processing, or handling by the National Organic Program. (3-20-20)T

**02. Effect of Registration.** The fact that a material is registered is not a guarantee that the registered material will be acceptable for use by certified organic producers, processors, or handlers or other organic certifying agencies other than ISDA. (3-20-20)T

**03. Department Not Liable.** The Department is not liable for any losses or damages that occur as a

result of any person's use of any registered branded material. The Department is not liable for any losses or damages that result from delays that occur in the registration process due to lack of resources or expertise. (3-20-20)T

**04. Registration Fees.** The Director may charge the following fees, which are nonrefundable and are not to exceed the stated amounts. (3-20-20)T

**a.** Operations that hold a current approval from a reputable third party accredited material evaluation program such as the Environmental Protection Agency, an NOP Accredited Certifying Agent, or ISO Guide 65 for the material(s) which it is seeking to register in Idaho must pay two hundred dollars (\$200) for an initial registration application fee, and two hundred dollars (\$200) each year thereafter for renewal of the registration. (3-20-20)T

**b.** All operations must pay initial and annual inspection fees to keep their product registered. (3-20-20)T

**05. Initial and Annual Inspection Fees.** (3-20-20)T

**a.** The hourly rate for inspections is fifty dollars (\$50), including travel time. (3-20-20)T

**b.** Travel time from an inspector's normal duty station to the inspection site and return to normal duty station will be compensable time charged to the applicant. (3-20-20)T

**c.** There will be a minimum charge of fifty dollars (\$50) plus mileage for any inspection. (3-20-20)T

**d.** A mileage rate as approved by the Board of Examiners will be included in the inspection fees. (3-20-20)T

**e.** A per diem, lodging, and travel as allowed by state and ISDA rules, and any other out of pocket costs incurred by ISDA in conducting annual or initial certification inspections will be charged to the operation. (3-20-20)T

**f.** Upon approval by ISDA, private inspectors may be utilized. The applicant or operator will bear the total cost of the private inspection. (3-20-20)T

**06. Seal for Registered Branded Materials.** When a material is registered and added to the list of registered branded materials, the Director will approve the use of the seal in Figure 3 on the packaging and in the promotions for the sale of the registered material subject to the National Organic Program and Idaho state rules:

**FIGURE 3**



(3-20-20)T

**07. Revocation of Registration.** If at any time the registered material is determined to be not suitable for organic use, the Director may revoke the registration of the branded material, remove the material from the list of registered branded materials, and revoke authorization to use the seal shown in Subsection 201.06. (3-20-20)T

202. -- 299. (RESERVED)

**300. CERTIFICATION REQUIREMENTS AND FEES.**

**01. Certification Requirements.** All applicants applying for certification with the Department, must submit the application to the Department on forms prescribed or approved by the Department. (3-20-20)T

**a.** All organic food producers/handlers in Idaho with annual gross organic sales of more than five thousand dollars (\$5,000) must be certified with the Department, unless certified by agents other than the Department accredited under the National Organic Program. (3-20-20)T

**b.** Producers/handlers with annual gross organic sales of five thousand dollars (\$5,000) or less may select certification. (3-20-20)T

**c.** All organic food producers and organic handlers certifying with the Department are subject to an annual on-site inspection. (3-20-20)T

**d.** Livestock producer and handler applications will be accepted throughout the year. (3-20-20)T

**02. Certification Fees.** (3-20-20)T

**a.** Organic producers/handlers with annual gross organic sales of more than five thousand dollars (\$5,000) up to fifteen thousand dollars (\$15,000) or producers with annual gross income of five thousand dollars (\$5,000) or less requesting certification - One hundred twenty-five dollars (\$125). (3-20-20)T

**b.** Organic producer/handler with annual gross organic sales of more than fifteen thousand dollars (\$15,000) – Two hundred dollars (\$200). (3-20-20)T

**c.** A person who produces and handles their own organic food products pays only one (1) annual certification fee based on gross annual organic sales. (3-20-20)T

**03. Certification Inspection Fees.** (3-20-20)T

**a.** The hourly rate is thirty-five dollars (\$35) including travel time. (3-20-20)T

**b.** Travel time from an inspector's normal duty station to the inspection site and return to normal duty station will be compensable time charged to the applicant. (3-20-20)T

**c.** There will be a minimum charge of thirty-five dollars (\$35) plus mileage for any inspection. (3-20-20)T

**d.** A mileage rate as approved by the Board of Examiners will be included in the inspection fees. (3-20-20)T

**e.** Inspections conducted on weekends, holidays, or after normal office hours will be charged at an hourly rate of forty-seven dollars and fifty cents (\$47.50) including travel time with a minimum charge of one (1) hour plus mileage. (3-20-20)T

**f.** Upon approval by the Department, private inspectors may be utilized. The applicant bears the total cost of the private inspection. (3-20-20)T

**301. GRADUATED GROSS SALES FEE SCHEDULE.**

**01. Graduated Gross Sales Fee Table.** In addition to the fees prescribed above, all producers and handlers certified by the Department must remit with their certification application an amount based on their annual gross organic sales during the last calendar year, or in the case of a first-time applicant, a projected gross dollar amount for the upcoming calendar year, with a minimum fee of ten dollars (\$10). The graduated gross organic sales

fee structure is as follows:

0 - 2,000	\$10
2,001 - 5,000	\$25
5,001 - 10,000	\$50
10,001 - 15,000	\$75
15,001 - 20,000	\$100
20,001 - 25,000	\$125
25,001 - 30,000	\$150
30,001 - 35,000	\$175
35,001 - 50,000	\$250
50,001 - 75,000	\$375
75,001 - 100,000	\$500
100,001 - 150,000	\$750
150,001 - 200,000	\$1,000
200,001 - 280,000	\$1,400
280,001 - 375,000	\$1,875
375,001 - 500,000	\$2,500
500,001 and up	0.5% of gross organic sales up to \$5,000

(3-20-20)T

**02. Non-Refundable.** Certification application fees are non-refundable.

(3-20-20)T

**302. -- 999. (RESERVED)**

## IDAPA 02.07 – IDAHO HOP GROWERS' COMMISSION

DOCKET NO. 02-0701-2000F (FEE RULE)

### NOTICE OF OMNIBUS RULEMAKING – ADOPTION OF TEMPORARY RULE

**EFFECTIVE DATE:** The effective date of the temporary rule being adopted through this omnibus rulemaking is the adjournment date of the second regular session of the 65th Idaho State Legislature - March 20, 2020.

**AUTHORITY:** In compliance with Sections 67-5226, Idaho Code, notice is hereby given this agency has adopted a temporary rule. The action is authorized pursuant to Title 22, Chapter 31, Idaho Code.

**DESCRIPTIVE SUMMARY:** The following is the required finding and concise statement of its supporting reasons for adopting a temporary rule:

This temporary rulemaking adopts the following chapter under IDAPA 02:

**IDAPA 02.07**

- 02.07.01, *Rules of the Idaho Hop Growers Commission*

**TEMPORARY RULE JUSTIFICATION:** Pursuant to Sections 67-5226(1) and 67-5226(2), Idaho Code, the Governor has found that temporary adoption of these rules is appropriate for the following reasons:

These temporary rules are necessary to protect the public health, safety, and welfare of the citizens of Idaho and confer a benefit on its citizens. These temporary rules implement the duly enacted laws of the state of Idaho, provide citizens with the detailed rules and standards for complying with those laws, and assist in the orderly execution and enforcement of those laws. The expiration of these rules without due consideration and processes would undermine the public health, safety, and welfare of the citizens of Idaho and deprive them of the benefit intended by these rules.

**FEE SUMMARY:** Pursuant to Section 67-5226(2), the Governor has found that the fee(s) or charge(s) being imposed or increased is justified and necessary to avoid immediate danger and the fee(s) is described herein:

The fees or charges, authorized in Section 22-3107, Idaho Code, are part of the agency's 2021 budget that relies upon the existence of these fees or charges to meet the state's obligations and provide necessary state services. Failing to reauthorize these temporary rules would create immediate danger to the state budget, immediate danger to necessary state functions and services, and immediate danger of a violation of Idaho's constitutional requirement that it balance its budget.

The following is a specific description of the fees or charges:

This rulemaking does not impose a fee or charge, or increase a fee or charge, beyond what was previously approved and codified in the prior rules. The fee rule specifies the collections and remittance of the assessment contained in Section 22-3107, Idaho Code.

**ASSISTANCE ON TECHNICAL QUESTIONS:** For assistance on technical questions concerning the temporary rule, contact Candi Fitch, 208-722-5111.

DATED this February 21, 2020

Candi Fitch  
Executive Director  
Idaho Hop Growers Commission  
P.O. Box 909, Parma, ID 83660  
(208) 722-5111



## 02.07.01 – RULES OF THE IDAHO HOP GROWERS' COMMISSION

### 000. LEGAL AUTHORITY.

This chapter is adopted under the legal authority of Section 22-3105(12), Idaho Code.

(3-20-20)T

### 001. TITLE AND SCOPE.

**01. Title.** The title of this chapter is IDAPA 02.07.01, “Rules of the Idaho Hop Growers’ Commission.”

(3-20-20)T

**02. Scope.** These rules govern markings required on hop bales, substituting hops grown out of state as Idaho hops, payment of hop assessments, computation and establishing assessment rate, collection and remittance of assessment to the Idaho Hop Growers’ Commission, and dealer assessment returns, and grower assessment returns.

(3-20-20)T

### 002. -- 009. (RESERVED)

### 010. DEFINITIONS.

The Idaho Hop Growers’ Commission adopts the definitions set forth in Section 22-3103, Idaho Code.

(3-20-20)T

### 011. -- 099. (RESERVED)

### 100. MARKINGS REQUIRED.

Each bale of hops grown within the state of Idaho are to be labeled on the head of the bale by an authorized representative of the Idaho Department of Agriculture at the time of Federal/State inspection. The grower of the hops are to have stenciled on each bale, their grower number and lot number or letter, prior to the Idaho Department of Agriculture representative stenciling the Federal/State inspection seal.

(3-20-20)T

### 101. REMOVAL OR DEFACING OF STENCILS.

It is unlawful for any grower, shipper, dealer, or any person other than the final consumer to remove, stencil over, substitute, mutilate, or in any other way deface the distinctive stencils the Idaho Hop Growers’ Commission has ordered affixed. However, in cases wherein definite proof of necessity is presented by a shipper and/or dealer to the Idaho Hop Growers’ Commission, the Commission may, in its discretion, permit the shipment of hops without the distinctive stencils affixed thereto. (“Proof of necessity” will be a certificate under oath that the shipment of hops in question is intended for export from the continental limits of the United States and that such shipment cannot be made without removal of all identifying marks. In addition to the above oath, the dealer and/or shipper is to furnish all such other information as may have a bearing on the Commission’s decision to allow or disallow removal of the stencil.)

(3-20-20)T

### 102. MISREPRESENTATION.

It is unlawful to substitute or in any manner represent any other hops as Idaho hops in any channel of trade and at any and all times.

(3-20-20)T

### 103. TIME OF PAYMENT OF HOP ASSESSMENT LEVY.

The hop assessment levy as imposed by Chapter 31, Title 22, Idaho Code, is to be paid not later than the last day of the month next succeeding the month in which such hops were first handled in the primary channels of trade.

(3-20-20)T

### 104. COMPUTATION OF ASSESSMENT.

The initial hop assessment levy is computed and paid on the basis of twenty cents (\$0.20) per net two hundred (200) pound bale of hops handled in the primary channels of trade. In addition to such initial assessment there may be levied an assessment not exceeding four dollars and eighty cents (\$4.80) per net two hundred (200) pound bale on each bale of hops handled in the primary channels of trade. The amount of such additional assessment is determined annually by the Commission. Licensed hop dealers of the state of Idaho will be notified of the determined assessment amount by registered mail prior to the harvest period.

(3-20-20)T

### 105. COLLECTION OF HOP ASSESSMENT LEVY.

All assessments levied and imposed under and pursuant to the provisions of Chapter 31, Title 22, Idaho Code, are deducted from the grower’s account by the person or dealer by whom the hops are first handled in the primary channels of trade. All such assessments will be made payable to the Idaho Hop Growers’ Commission, P.O. Box 909, Parma, Idaho 83660 together with a properly prepared assessment return as prescribed by Section 106.

(3-20-20)T

**106. ASSESSMENT RETURN.**

**01. Dealer Assessment Return.** Every dealer or other person buying hops in primary channels of trade is to file an assessment return on forms available from the Commission each time assessments become due under and pursuant to the provisions of Chapter 31, Title 22, Idaho Code. Assessment returns and assessment payments will be mailed together to the Idaho Hop Growers' Commission, P.O. Box 909, Parma, Idaho 83660. (3-20-20)T

**02. Grower Assessment Return.** Every grower of hops in the state of Idaho, upon the delivery of hops to a dealer or brewer, is to file a Commission assessment return form not later than the last day of the month next succeeding the month in which such hops were first handled in the primary channels of trade. Assessment returns are to state the number of bales of hops handled during the period prescribed and mailed by the grower to the Idaho Hop Growers' Commission, P.O. Box 909, Parma, Idaho 83660. (3-20-20)T

**107. -- 999. (RESERVED)**

## IDAPA 02.08 – IDAHO SHEEP AND GOAT HEALTH BOARD

DOCKET NO. 02-0801-2000F (FEE RULE)

### NOTICE OF OMNIBUS RULEMAKING – ADOPTION OF TEMPORARY RULE

**EFFECTIVE DATE:** The effective date of the temporary rule being adopted through this omnibus rulemaking is the adjournment date of the second regular session of the 65th Idaho State Legislature - March 20, 2020.

**AUTHORITY:** In compliance with Sections 67-5226, Idaho Code, notice is hereby given this agency has adopted a temporary rule. The action is authorized pursuant to Sections 25-129(1) and 25-147, Idaho Code.

**DESCRIPTIVE SUMMARY:** The following is the required finding and concise statement of its supporting reasons for adopting a temporary rule:

This temporary rulemaking adopts the following chapter under IDAPA 02:

**IDAPA 02.08**

- 02.08.01, *Sheep and Goat Rules of the Idaho Sheep and Goat Health Board*

**TEMPORARY RULE JUSTIFICATION:** Pursuant to Sections 67-5226(1) and 67-5226(2), Idaho Code, the Governor has found that temporary adoption of the rule is appropriate for the following reasons:

These temporary rules are necessary to protect the public health, safety, and welfare of the citizens of Idaho and confer a benefit on its citizens. These temporary rules implement the duly enacted laws of the state of Idaho, provide citizens with the detailed rules and standards for complying with those laws, and assist in the orderly execution and enforcement of those laws. The expiration of these rules without due consideration and processes would undermine the public health, safety, and welfare of the citizens of Idaho and deprive them of the benefit intended by these rules.

**FEE SUMMARY:** Pursuant to Section 67-5226(2), the Governor has found that the fee(s) or charge(s) being imposed or increased is justified and necessary to avoid immediate danger and the fee(s) is described herein:

The fees or charges, authorized in Sections 700, 701, and 900 these rules, are part of the agency's 2021 budget that relies upon the existence of these fees or charges to meet the state's obligations and provide necessary state services. Failing to reauthorize these temporary rules would create immediate danger to the state budget, immediate danger to necessary state functions and services, and immediate danger of a violation of Idaho's constitutional requirement that it balance its budget.

The following is a specific description of the fees or charges:

- Section 700 – Sheep Assessments
- Section 701 – Goat Assessments
- Section 900 – Violations

**ASSISTANCE ON TECHNICAL QUESTIONS:** For assistance on technical questions concerning the temporary rule, contact Naomi LeGere-Gordon at 208-344-2271 or [naomi.gordon@isda.idaho.gov](mailto:naomi.gordon@isda.idaho.gov).

DATED this 9th Day of April in the year 2020.

Naomi LeGere-Gordon  
Idaho Sheep and Goat Health Board  
2118 West Airport Way  
Boise ID 83705  
208-344-2271

## 02.08.01 – SHEEP AND GOAT RULES OF THE IDAHO SHEEP AND GOAT HEALTH BOARD

### 000. LEGAL AUTHORITY.

This chapter is adopted under the legal authority of Sections 25-129(1) and 25-147, Idaho Code. (3-20-20)T

### 001. TITLE AND SCOPE.

**01. Title.** The title of this chapter is the “Sheep and Goat Rules of the Idaho Sheep and Goat Health Board.” (3-20-20)T

**02. Scope.** These rules govern procedures for the prevention, control and eradication of diseases among sheep and goats, the interstate and intrastate movement of sheep and goats and the assessment of fees on sheep and goats to provide resources to carry out these functions. (3-20-20)T

### 002. – 003. (RESERVED)

### 004. INCORPORATION BY REFERENCE.

Copies of the following documents may be obtained from the Idaho State Department of Agriculture Division of Animal Industries. IDAPA 02.08.01 incorporates by reference: (3-20-20)T

**01.** The Code of Federal Regulations Title 9, Parts 54.1, 54.2, 54.8, 54.9, 54.10, 54.11, 54.20, 54.21, 54.22 and 79, January 1, 2015. (3-20-20)T

**02.** The Voluntary Scrapie Flock Certification Program Standards, USDA, June 2013. (3-20-20)T

**03.** The Code of Federal Regulations, Title 9, Part 161, January 1, 2009. (3-20-20)T

### 005. -- 009. (RESERVED)

### 010. DEFINITIONS.

**01. Accredited Veterinarian.** A veterinarian approved by the Administrator and USDA/APHIS/Vs in accordance with provisions of Title 9, Part 161, Code of Federal Regulations to perform functions of State-Federal animal disease control programs. (3-20-20)T

**02. Animals.** All vertebrates, except humans. (3-20-20)T

**03. Authorized Federal Inspector.** An employee of USDA authorized by the Board to perform the functions of the Idaho Sheep and Goat Health Board. (3-20-20)T

**04. Authorized State Inspector.** An employee of the state of Idaho authorized by the Board to perform the functions of the Idaho Sheep and Goat Health Board. (3-20-20)T

**05. Board.** The Idaho Sheep and Goat Health Board or its designee. (3-20-20)T

**06. Breeding Stock.** Intact male or female sheep or goats of any age. (3-20-20)T

**07. Brucellosis.** An infectious disease of animals and humans caused by bacteria of the genus *Brucella*. (3-20-20)T

**08. *Brucella Ovis* Test Positive.** An animal that tests in the positive range on an approved *Brucella Ovis* ELISA test. (3-20-20)T

**09. *Brucella Ovis* Test Suspect.** An animal that tests in the suspect range on an approved *Brucella Ovis* ELISA test. (3-20-20)T

**10. *Brucella Ovis* Test Negative.** An animal that tests in the negative range on an approved *Brucella Ovis* ELISA test. (3-20-20)T

**11. Certificate.** An official certificate of veterinary inspection or other approved certificate issued by an accredited veterinarian, state or federal animal health official, or other approved official at the point of origin of the shipment of animal(s) being imported. (3-20-20)T

- 12. Commercial Low-Risk Goats.** Intact or castrated goats, raised for fiber or meat, that are not registered or exhibited, that are not scrapie positive, suspect, high risk, or exposed animals and that have not been exposed to sheep or are not from a state that has scrapie in goats. (3-20-20)T
- 13. Contemporary Lambing Group.** The time from the first birth to sixty (60) days post birthing of the entire group in a given lambing season. (3-20-20)T
- 14. Exposed.** Animals that have had direct contact with other animals, herds, or materials that have been determined to be infected with or affected by any infectious, contagious, or communicable disease. (3-20-20)T
- 15. Federal Animal Health Official.** An employee of USDA/APHIS/VS who has been authorized to perform animal health activities. (3-20-20)T
- 16. Flock.** Flock or flocks are interchangeable with the terms herd or herds and denote a group of one (1) or more animals that are fed, housed and birthed together on the same premises, or animals maintained in separate geographic areas that have interchange at or around the time of birth. Changes in ownership of a flock do not change the identity of the flock or the regulatory requirements applicable to the flock. (3-20-20)T
- 17. Flock Plan.** A written flock management agreement signed by the owner, his accredited veterinarian if there is one, a representative of the Division of Animal Industries, and an APHIS representative in which each signatory agrees to undertake action specified in the Flock Plan to eradicate or control scrapie as defined in 9 CFR Part 54.8 a-f. Goats exposed to scrapie will be subjected to the same rules as sheep. (3-20-20)T
- 18. Goats Requiring Premises/Flock Identification Number.** Sexually intact goats or goats that have resided on the same premises as sheep or any other goats not defined in Subsection 010.13. (3-20-20)T
- 19. Idaho Premises/Flock Identification Number.** A unique identification number or alphanumeric designation approved by APHIS, and assigned by the Board to each premises/flock of breeding sheep or goats, as defined in Subsection 010.21, in the state of Idaho. (3-20-20)T
- 20. Low Risk Commercial Sheep.** Commercial whiteface, white-faced cross, or commercial hair sheep from a flock with no known risk factors for scrapie, including any exposure to female black-faced sheep, that are identified with a permanent brand or ear notch pattern registered with an official brand registry and that are not scrapie-positive, suspect, high-risk, or exposed animals and are not animals from an infected, source, or exposed flock. (3-20-20)T
- 21. Negative.** Animals are classified as negative when they have been subjected to official tests for a disease, and the tests performed have failed to disclose evidence of the disease. (3-20-20)T
- 22. Official Individual Identification.** The unique identification of individual animals with an alpha numeric number applied as a tag, a legible tattoo, electronic device, or any other device approved by APHIS. The Idaho Premises/Flock Identification number can serve as the official individual identification number if it contains a unique individual animal number in addition to the Idaho premises/flock identification number. (3-20-20)T
- 23. Post Exposure Monitoring and Management Plan.** A monitoring plan which includes a written agreement signed by the owner of the flock and a representative of the Division of Animal Industries and an APHIS representative in which each participant agrees to undertake actions specified in the agreement to monitor for the occurrence of scrapie in the flock for at least five (5) years after an approved Flock Plan has been completed. The PEMMP requires at least once a year flock inspections and prompt reporting of any animal over fourteen (14) months of age which dies in the flock so that some of these animals can be selected and submitted for scrapie testing. The Plan also includes the requirements outlined in 9 CFR Part 54.8. Owners may request to join the Scrapie Flock Certification Program after two (2) years of participation in the PEMMP. (3-20-20)T
- 24. Premises.** The ground, area, buildings and equipment utilized to raise, propagate or control sheep and goats. (3-20-20)T

**25. Quarantine.** A written order, executed by the Board or the Administrator of Animal Industries, to confine or hold animals on a premises or any other location, where found, and prevent movement of animals from a premises or any other location. (3-20-20)T

**26. Scrapie.** A transmissible spongiform encephalopathy that is a nonfebrile, transmissible, insidious, degenerative disease affecting the central nervous system of sheep and goats. (3-20-20)T

**27. Scrapie Exposed Animal.** Any animal which has been in the same flock at the same time within the previous seventy-two (72) months as a scrapie positive female animal excluding limited contacts. Limited contacts are contacts between animals that occur off the premises of the flock and do not occur during or within sixty (60) days after parturition for any of the animals involved. (3-20-20)T

**28. Scrapie Flock Certification Program.** A cooperative Federal-State-Industry voluntary program for reducing the incidence and controlling the spread of scrapie through flock certification. (3-20-20)T

**29. Scrapie High Risk Animal.** An animal determined by epidemiologic investigation to face a high risk of developing clinical scrapie because the animal was: (3-20-20)T

**a.** Progeny of a scrapie-positive dam; (3-20-20)T

**b.** Born in the same contemporary lambing group as a scrapie-positive animal, or (3-20-20)T

**c.** During any subsequent lambing season if born before the flock completes the requirements of a flock plan; or (3-20-20)T

**d.** Born in the same contemporary lambing group as progeny of a scrapie-positive dam or any QQ, at codon 171, sheep present in the lambing facility/area where a scrapie-positive animal was born during the contemporary birth of a scrapie-positive animal. (3-20-20)T

**e.** Animals that fit the criteria for high risk animals which are determined by genetic testing to be QR or RR at the 171 codon, or are determined by other recognized testing procedures to pose no risk, may be exempted as high risk animals by the Board, upon the recommendation of the State Scrapie Certification Board, based upon evidence from the latest research information available. (3-20-20)T

**30. Scrapie Infected Flock.** Any flock in which a scrapie-positive animal has been born, birthed or aborted. A flock will no longer be considered infected after an approved Flock Plan has been completed. (3-20-20)T

**31. Scrapie-Positive Animal.** An animal for which a diagnosis of scrapie has been made by the National Veterinary Services Laboratories, or another laboratory authorized by state or federal officials to conduct scrapie tests approved for scrapie diagnosis by APHIS or the Administrator. (3-20-20)T

**32. Scrapie Source Flock.** A flock in which an animal was born and subsequently diagnosed as scrapie-positive at less than seventy-two (72) months of age. The flock will no longer be considered a source flock after the requirements of an approved Flock Plan have been completed. A trace to a flock must meet the following criteria to designate the flock as a source flock: The scrapie-positive animal must: (3-20-20)T

**a.** Be identified with a Premises/Flock Identification Number, or on an official ear tag, electronic device, ear tattoo, or flank tattoo which is correlated to the Premises/Flock Identification number on flock records; or (3-20-20)T

**b.** Be identified with a genetic heredity test or nose print; or (3-20-20)T

**c.** Possess the original registry ear tag or individual identification ear tag along with the movement, production, or registry records indicating birth in the source flock; or (3-20-20)T

**d.** Be traced to the flock by a veterinary epidemiologist through a thorough epidemiological investigation of records and all other available evidence. (3-20-20)T

**33. State Animal Health Official.** The Administrator, or his designee, responsible for disease control and eradication programs. (3-20-20)T

**34. State Scrapie Certification Board.** The State Scrapie Certification Board will consist of APHIS-AVIC, the State animal health official, animal producers and accredited veterinarians. Animal producers and accredited veterinarians will be appointed by the AVIC and the State animal health official. (3-20-20)T

**35. Terminal Feedlot.** As defined in Title 9 CFR, Parts 54 and 79. (3-20-20)T

**36. Trace.** All actions required to identify the flock of origin or destination of an animal. (3-20-20)T

**011. ABBREVIATIONS.**

**01. APHIS.** Animal Plant Health Inspection Service. (3-20-20)T

**02. AVIC.** Area Veterinarian in Charge. (3-20-20)T

**03. CFR.** Code of Federal Regulations. (3-20-20)T

**04. PEMMP.** Post Exposure Monitoring and Management Plan. (3-20-20)T

**05. USDA.** United States Department of Agriculture. (3-20-20)T

**06. VS.** Veterinary Services. (3-20-20)T

**012. APPLICABILITY.**

These rules apply to all domestic sheep and goats located in, imported into, exported from, or transported through the state of Idaho. (3-20-20)T

**013. ADDITIONAL IMPORT REQUIREMENTS.**

The Board may impose additional or more restrictive import requirements than the requirements in this chapter by issuing a written order stating the additional requirements and the reasons for the requirements. (3-20-20)T

**014. -- 099. (RESERVED)**

**100. SHEEP AND GOAT STATE ENTRANCE REQUIREMENTS.**

**01. Entrance Requirements.** All breeding sheep and goat stock entering the state of Idaho except as provided in Sections 103, 105, and 107 of these rules will be accompanied by a permit issued by the Board together with a certificate of veterinary inspection certifying that such sheep or goats are free from scrapie, scabies, foot rot, brucella or symptoms of any communicable disease and are not known to have been exposed to scrapie for at least seventy-two (72) months prior to the date of inspection, scabies for a period of at least six (6) months immediately prior to date of inspection and are not known to have been exposed to any communicable disease for at least thirty (30) days immediately prior to date of inspection. All breeding sheep and goats with the exception of low-risk commercial goats imported into the state of Idaho must be individually identified with an official premises/flock identification number, or legible tattoo or other form of individual identification approved by the Board. The premises/flock identification number must be listed on the certificate of veterinary inspection. The original or true copy of the permit and certificate of veterinary inspection required by this rule will be attached to the waybill covering such shipments. No sheep will be shipped, trailed, or in any manner moved into the state of Idaho for any purpose if they originate in a state or area where sheep scabies is known to exist until the Board has been notified by the APHIS that such state or area where sheep scabies is known to exist has been classified by the APHIS as a sheep scabies eradication area. (3-20-20)T

**02. Brucella Ovis.** Intact male sheep six (6) months of age or older must test negative for *Brucella Ovis* within thirty (30) days prior to entry. Rams entering for exhibition only and returning to the state of origin are exempt from testing. Rams imported from a state certified *Brucella Ovis* free flock are also exempt. (3-20-20)T

**101. PERMITS.**

**01. Request for Permits.** Request for the permits required under Section 100 are to be in writing, by telephone or facsimile and set forth the name and address of the owner of the animals offered for movement into the state of Idaho, the number and class of sheep and goats to be brought in, the destination, the name and address of the consignee, and the approximate date and place of entry. A copy of the permit, or permit number written on the face of the waybill or certificate of veterinary inspection accompanying movement, will be shown to a representative of the Board or any law enforcement officer of the state, county, or municipality of the state of Idaho upon request.

(3-20-20)T

**02. Certificates of Veterinary Inspection to Be Furnished.** Copies of the certificates of veterinary inspection from the point of origin must accompany the shipment and include a copy of the permit or the permit number written on the face of the certificate of veterinary inspection and will be shown to a representative of the Board or any law enforcement officer of the state, county, or municipality of the state of Idaho upon request, and a copy forwarded to the Idaho Department of Agriculture, Division of Animal Industries, c/o Idaho Sheep and Goat Health Board, P.O. Box 7249, Boise, Idaho 83707, immediately after issuance for sheep and goats entering the state of Idaho.

(3-20-20)T

**03. Inspection Fees.** An inspection fee of one hundred dollars (\$100) per incidence, plus mileage, will be paid on all sheep and goats exported from or imported into Idaho in violation of these rules. Such incidences require an inspection of animals, certificates of veterinary inspection and permit.

(3-20-20)T

**04. Examination and Treatment Fees.** The Board may assess a fee on sheep and goat producers who receive services from the Board or its representatives, such as examination and treatment of animals for diseases or parasites. The fees assessed are not to exceed the actual costs for the services rendered.

(3-20-20)T

**102. SCABIES.**

All sheep and goats, including rams and bucks, entering Idaho and which have originated in an area or areas in which scabies is known to exist within the past six (6) months must be treated with a product approved by the APHIS under the supervision of an authorized state or federal inspector or accredited veterinarian. At the time of shipment, such sheep or goats must be accompanied by a permit from the Board and a certificate of veterinary inspection from the state of origin and also a treatment certificate showing that such sheep or goats have been treated at point of origin as herein required. Any and all shipments of sheep and goats entering Idaho, and which have originated in states where scabies is known to exist, are subject to a thirty (30) to sixty (60) day quarantine and inspection at the time of arrival at destination, and a second inspection at the time of quarantine release, or as often as it may be deemed necessary by the Board.

(3-20-20)T

**103. ANIMALS IN TRANSIT.**

Sheep and goats in course of transit through the state of Idaho, in trucks, or other vehicles from a point outside the state of Idaho to another state or country, are not to be unloaded in Idaho except in pens designated by APHIS for purpose of feed, water and rest for a period of time not to exceed ten (10) days, need not comply with Section 100, provided waybills or other documents accompanying the sheep or goats show origin and destination of such sheep and goats. Failure to have such waybills or other documents with the sheep or goats constitutes a violation of these rules. The Board, however, may prohibit the transportation of any sheep or goats through the state it feels represents a threat to the general health and welfare of the Idaho sheep industry.

(3-20-20)T

**104. DAIRY GOATS.**

All dairy type goats, including bucks, entering the state of Idaho must be accompanied by a permit issued by the Board, together with a certificate of veterinary inspection issued at point of origin by an authorized veterinarian. All dairy type goats, including bucks, aged six (6) months or older must have been tested negative for *Brucella Melitensis* within thirty (30) days of the date of entry into the state of Idaho accompanied by the negative test chart signed by the person in charge of the laboratory where the test was made and approved by the state animal health official of the state of origin and attached to the certificate of veterinary inspection. Goats entering Idaho on a short-term temporary basis for show or other temporary purposes may be exempted from having a negative test for *Brucella Melitensis* completed, with permission from the Board.

(3-20-20)T



**105. IMPORTATION OF SCRAPIE EXPOSED, SUSPECT AND HIGH RISK ANIMALS.**

Sheep and goats that are scrapie suspect, exposed, or high risk animals or from scrapie infected, source, or exposed flocks, as defined Title 9, Parts 54.1 and 79.1, Code of Federal Regulations, are not allowed entry into Idaho except as follows: (3-20-20)T

**01. Valid Permit.** Scrapie suspect, exposed or high-risk animals and animals from infected, source or exposed flocks may be imported directly to scrapie research facilities, or to approved slaughter establishments for immediate slaughter, or other destinations approved by the Administrator, if accompanied by a permit issued by the Board or its representative; and (3-20-20)T

**02. Officially Identified.** The animals are individually identified by official identification tattoos, tags, or devices on a VS 1-27 or other approved movement document. (3-20-20)T

**106. IDAHO ORIGIN SHEEP INTERSTATE GRAZING PERMIT.**

Idaho origin, low-risk commercial sheep breeding stock with no history of scrapie exposure returning to Idaho from seasonal grazing in other states may return to Idaho without a certificate of veterinary inspection if they are accompanied by an Idaho Origin Sheep Interstate Grazing Permit and a waybill. The Idaho Origin Sheep Interstate Grazing Permit is to be obtained from the Board. (3-20-20)T

**107. INTERSTATE SHIPMENTS.**

**01. Waybill Requirement.** All sheep and goats leaving the state of Idaho by any common carrier, by private conveyance, or any kind of transportation must be accompanied by a waybill, stating the owner's name and indicating destination of sheep or goats, or be accompanied by a certificate of veterinary inspection issued by an inspector appointed by the Board or a representative of the APHIS or accredited veterinarian; said certificates of veterinary inspection to be dated not more than thirty (30) days prior to date of movement, and comply with the rules for the state of destination. (3-20-20)T

**02. Waybill Violation.** Failure to have such waybills or other documents accompanying the sheep or goats constitutes a violation of these rules and is punishable as provided in Section 900. (3-20-20)T

**03. Carriers.** No common or contract carrier or owner or caretaker will unload any breeding sheep, breeding goats, or dairy goats within the state of Idaho from other states or country, other than as provided in Sections 103, 105, 106, and 107, of these rules, unless such shipments be accompanied by an Idaho Origin Sheep Interstate Grazing Permit issued by the Board or other permit issued by the Board, and the official certificate as provided herein. The original or true copy of each certificate with permit must be attached to the waybill covering such shipments or be in possession of the owner or caretaker of shipment. (3-20-20)T

**04. Who May Inspect?** Authorized state or federal inspectors and accredited veterinarians may inspect sheep and goats. (3-20-20)T

**108. -- 199. (RESERVED)**

**200. SCRAPIE PROGRAM STANDARDS, SCRAPIE FLOCK CERTIFICATION, SCRAPIE CONTROL AND ERADICATION.**

The Board adopts the provisions of the Voluntary Scrapie Flock Certification Program Standards, which were effective June 2013, and 9 CFR, Parts 54.1, 54.2, 54.8, 54.9, 54.10, 54.11, 54.20, 54.21, 54.22 and 79, January 1, 2015, as the minimum standards for the scrapie certification program in Idaho. (3-20-20)T

**201. IDENTIFICATION OF BREEDING SHEEP.**

**01. Assignment of APHIS Approved Idaho Premises/Flock Identification Numbers.** The Board or its designee will assign APHIS-approved Idaho premises/flock identification numbers with unique individual animal identification numbers to Idaho sheep and goat flocks/herds. (3-20-20)T

**02. Responsibility for Identification.** Owners and possessors of breeding sheep and goats bear the cost and responsibility of obtaining the identification devices and placing the device in or on the animal. (3-20-20)T

**03. Time of Identification.** All owners or possessors of breeding sheep and goats in Idaho will identify all breeding stock in the flock of any age with a premises/flock identification number before transfer of ownership or possession, show, sale, or other movement unless the animals are under eighteen (18) months of age and are in slaughter channels. (3-20-20)T

**04. Importation Identification.** Breeding sheep or goats imported into the state must be identified with a premises/flock identification number before entry into the state. (3-20-20)T

**05. Loss of Identification.** Breeding sheep or goats sold within the state retain the original premises/flock identification number. In the event an animal loses a premises/flock identification device, the owner of the animal will re-identify the animal with his or her flock identification number and maintain records to document the original and new flock identification numbers. (3-20-20)T

**06. Acceptable Identification.** Acceptable devices for application of the premises/flock identification number to breeding sheep and goats include: APHIS-approved ear tags bearing the premises/flock identification number, legible tattoos bearing the premises/flock identification number, approved Scrapie Flock Certification Program identification devices, except electronic identification, and other identification devices approved by APHIS except electronic identification. (3-20-20)T

**07. Identification Exemption.** Animals exempt from the requirement for identification with a premises/flock identification number include: (3-20-20)T

- a. Neutered animals under eighteen (18) months of age. (3-20-20)T
- b. Sexually intact market lambs under eighteen (18) months of age shipped directly to an approved slaughter establishment or shipped directly to a feedlot for finish feeding for slaughter only. (3-20-20)T
- c. Animals which have not been removed from their premises of origin and/or transferred ownership with the exception of white-face low-risk range sheep as defined in the 9 CFR Part 79 which are moved for grazing or other management purposes and do not change ownership. (3-20-20)T
- d. Castrated or low-risk commercial goats. (3-20-20)T
- e. Registered sheep and goats accompanied by registration papers or a certificate of veterinary inspection with legible unique registration tattoos. (3-20-20)T
- f. Goats registered with a National Goat Registry that allows for electronic implant identification, as recorded on a registration certificate, may be identified with an electronic implant. (3-20-20)T

**202. QUARANTINE.**

Infected and source flocks or flocks that have received high-risk animals will be placed and held under quarantine until the infected or high-risk animals have been slaughtered or depopulated, an approved Flock Plan has been completed and the flock is participating in a Post Exposure Monitoring Program. Flocks that do not participate in a Post Exposure Monitoring Program remain under quarantine until the entire flock has been depopulated. Flocks which are removed from the Post Exposure Monitoring Program before the agreed time will be re-quarantined. (3-20-20)T

**203. RESTRICTION OF HIGH-RISK ANIMALS.**

High-risk animals will be placed under a quarantine when the flock or animals are determined to be exposed. An epidemiological investigation will be conducted on the flock or animals to determine the risk of infection with scrapie. The flock or animals will be maintained under quarantine until the flock is in compliance with the Scrapie Uniform Methods and Rules in effect or until the scrapie epidemiologist has determined that the flock or animals do not pose a substantial risk to other flocks. (3-20-20)T

**204. MOVEMENT OF RESTRICTED ANIMALS.**

Animals from infected and source flocks and high-risk animals may be moved from quarantined premises only under

the following conditions: (3-20-20)T

**01. Individually Identified on Approved Document.** The animals are individually identified on a VS 1-27 form or other approved document, by official ear tags, tattoos or devices; or (3-20-20)T

**02. Indelibly Marked.** The animals are indelibly marked with an “S” at least one (1) inch high on the left jaw; and (3-20-20)T

**03. Consigned Directly to Approved Destination.** The animals are consigned directly to an approved slaughter facility for immediate slaughter or to a terminal feedlot for finish feeding for slaughter only; or (3-20-20)T

**a.** The animals are consigned directly to an approved livestock market for sale directly to an approved slaughter facility for immediate slaughter or to a feedlot for finish feeding for slaughter only. The animals must be individually identified on a VS 1-27 form or other approved document for movement from the approved livestock market to final destination; or (3-20-20)T

**b.** The Board or its representative may, by written permission, allow the animals to be moved, under quarantine, to other pre-approved locations. The animals may be moved in sealed vehicles or be accompanied in transit by representatives of the Board in lieu of individual identification. Animals so moved will be retained under quarantine at the new location. (3-20-20)T

**205. -- 399. (RESERVED)**

**400. CONDEMNATION AND DESTRUCTION OF DISEASED ANIMALS OR FLOCKS.**

**01. Animals or Flocks Infected.** Animals or flocks determined by representatives of the Board or APHIS to be infected with scrapie or other contagious, infectious, or communicable diseases which have been identified by the Board to be diseases of concern to human health or the livestock industry of the state may be condemned by order of the Board. (3-20-20)T

**02. Animals or Flocks Condemned.** Animals or flocks condemned by order of the Board will be destroyed or otherwise disposed of as directed by order of the Board and under the conditions set by the Board. (3-20-20)T

**401. -- 499. (RESERVED)**

**500. INDEMNIFICATION.**

**01. Owners, Individuals, Partnerships, Corporations or Other Legal Entities.** Owners, individuals, partnerships, corporations or other legal entities whose animals or flocks have been destroyed or otherwise disposed of by order of the Board may be eligible for indemnification in the form of cash payment from the Sheep and Goat Disease Indemnity Fund for all or part of the value of the animals destroyed or otherwise disposed of and for the actual cost for burial or disposal of animal carcasses. (3-20-20)T

**02. Indemnity Payments Paid.** Indemnity payments are paid only to an owner of sheep or goats that were born in the state of Idaho or were imported into the state in compliance with existing Idaho statutes and rules promulgated thereunder. (3-20-20)T

**03. Amount of Indemnity to Be Paid for Each Animal.** The amount of indemnity to be paid for each animal is determined by the Board and does not exceed the difference between the appraised price, less federal indemnity, and the salvage value of the animal. In the event federal indemnity is not available the amount of indemnity will not exceed the difference between the appraised price and salvage value. (3-20-20)T

**04. Appraisals.** Appraisals are to be performed by a team comprised of an Animal Health representative, the owner, and a person with experience in sheep or goat marketing. (3-20-20)T

**05. Maximum Amount of Indemnity.** The maximum amount of indemnity for each animal will not

- exceed: (3-20-20)T
- a. Ewes or does one (1) year of age or older - two hundred dollars (\$200) per head. (3-20-20)T
  - b. Rams or bucks one (1) year of age or older - four hundred dollars (\$400) per head. (3-20-20)T
  - c. Lambs or kids under one (1) year of age - current market price per pound with a maximum of one hundred dollars (\$100) per head. (3-20-20)T

**06. Indemnity Payment upon Approval of Appraisal.** Upon approval of the appraisal by the Board, one-half (1/2) of the indemnity payment will be paid at that time. The other one-half (1/2) of the indemnity payment, or the prorated portion thereof, will be paid at the end of the fiscal year. Indemnity payments are paid in their entirety in a single fiscal year and do not exceed the amount in the fund. (3-20-20)T

**501. -- 599. (RESERVED)**

**600. CLEANING AND DISINFECTION.**

Barns, sheds, stockyards, trucks, aircraft, ferryboats and other vehicles, feed yards, stables, pens, corrals, lanes and premises that have been used in confining, trailing, or transporting any sheep or goats affected or infected with any contagious, infectious or communicable diseases, will be cleaned and disinfected under state or federal supervision as directed by the Board, or an authorized representative of the Board, and the owner of such premises, conveyances, or carrier are responsible for such cleaning and disinfecting. (3-20-20)T

**601. -- 699. (RESERVED)**

**700. SHEEP ASSESSMENTS.**

The following rules apply to all sheep. (3-20-20)T

**01. Payment of Assessment.** The owner of sheep on July 1st of the assessment year is responsible for the payment of the assessment levied by the Boards as provided for in Section 25-130 and 25-131, Idaho Code. The rate of assessment is eight cents (\$.08) per pound on all wool, in the grease basis, except tags, crutchings, and dead wool. (3-20-20)T

**02. Assessment as Resident Sheep.** The assessment is levied and assessed to the producer at the time of the first sale of wool and is deducted by the first purchaser from the price paid to the producer at the time of such sale. (3-20-20)T

**03. Migratory Sheep.** In the event that a sheep, which produces wool subject to this assessment, is located outside the state of Idaho during a part of the assessment year, the amount of the assessment is reduced on a prorated basis. A grower will be required to request a prorated adjustment in writing to the Board. (3-20-20)T

**04. Costs of Collection.** All costs of collection of delinquent assessments are borne as an additional charge against the delinquent assessee first purchaser. (3-20-20)T

**701. GOAT ASSESSMENTS.**

The following rules apply to all goats. (3-20-20)T

**01. Payment of Assessment.** The owner of goat(s) is responsible for the payment of the assessment levied by the Board as provided for in Sections 25-130 and 25-131, Idaho Code. The rate of assessment is eighty cents (\$.80) per head. (3-20-20)T

**02. Assessment as Resident Goats.** The assessment is levied and assessed to the producer at the time of the sale of said goat(s). (3-20-20)T

**a. Auction Yards:** Auction yards will deduct the assessment from the price paid to the producer at the time of sale. All goat assessments will be sent to the Idaho Sheep and Goat Health Board (ISGHB) from the auction yards after each sale, but no later than thirty (30) days after the sale. Assessments will be accompanied by a board

approved form that includes a list of the producers (sellers) name, address, and number of head sold. (3-20-20)T

**b.** Private Sales: The producer will handle assessment on private sales. The producer will send at minimum an annual assessment to the ISGHB on all private sales no later than the end of December of the current year. (3-20-20)T

**03. Costs of Collection.** All costs of collection of delinquent assessments are borne as an additional charge against the delinquent assessee. (3-20-20)T

**702. -- 899. (RESERVED)**

**900. VIOLATIONS.**

Any person, company, corporation or association, or any agent, servant or employee of such, who violates or disregard any of these sheep and goat rules or any other sanitary or quarantine rule, order of the Board or inspector thereof, is deemed guilty of a misdemeanor and upon conviction be fined not less than one hundred dollars (\$100) nor more than five thousand dollars (\$5,000) for each offense. (3-20-20)T

**901. -- 999. (RESERVED)**

## IDAPA 07 – DIVISION OF BUILDING SAFETY

### DOCKET NO. 07-0000-2000F (FEE RULE)

#### NOTICE OF OMNIBUS RULEMAKING – ADOPTION OF TEMPORARY RULE

**EFFECTIVE DATE:** The effective date of the temporary rules being adopted through this omnibus rulemaking is the adjournment date of the second regular session of the 65th Idaho State Legislature - March 20, 2020.

**AUTHORITY:** In compliance with Sections 67-5226, Idaho Code, notice is hereby given this agency has adopted a temporary rule. The action is authorized pursuant to the following sections of Idaho Code:

I.C. § 39-4107	I.C. § 39-4112	I.C. § 39-4113	I.C. § 39-4303
I.C. § 39-4302	I.C. § 39-8605	I.C. § 39-8616	I.C. § 44-2103
I.C. § 44-2104	I.C. § 44-2107	I.C. § 54-1005	I.C. § 54-1006
I.C. § 54-2605	I.C. § 54-2606	I.C. § 54-2607	I.C. § 54-1907
I.C. § 54-4510	I.C. § 54-5005	I.C. § 54-5017	I.C. § 54-5022
I.C. § 55-2203	I.C. § 55-2211	I.C. § 67-2601A	

**DESCRIPTIVE SUMMARY:** The following is the required finding and concise statement of its supporting reasons for adopting the temporary rules:

This temporary rulemaking adopts the following chapters under IDAPA 07:

#### **IDAPA 07**

- 07.01.01, *Rules of the Idaho Electrical Board;*
- 07.02.02, *Rules Governing Plumbing;*
- 07.03.01, *Rules of Building Safety (Building Code Rules);*
- 07.03.03, *Rules for Modular Buildings;*
- 07.03.11, *Rules Governing Manufactured/Mobile Home Industry Licensing;*
- 07.03.12, *Rules Governing Manufactured or Mobile Home Installations;*
- 07.04.02, *Safety Rules for Elevators, Escalators, and Moving Walks;*
- 07.05.01, *Rules of the Public Works Contractors License Board;*
- 07.07.01, *Rules Governing Installation of Heating, Ventilation, and Air Conditioning Systems; and*
- 07.10.01, *Rules Governing the Damage Prevention Board*

**TEMPORARY RULE JUSTIFICATION:** Pursuant to Sections 67-5226(1) and 67-5226(2), Idaho Code, the Governor has found that temporary adoption of the rules is appropriate for the following reasons:

These temporary rules are necessary to protect the public health, safety, and welfare of the citizens of Idaho and confer a benefit on its citizens. These temporary rules implement the duly enacted laws of the state of Idaho, provide citizens with the detailed rules and standards for complying with those laws, and assist in the orderly execution and enforcement of those laws. The expiration of these rules without due consideration and processes would undermine the public health, safety and welfare of the citizens of Idaho and deprive them of the benefit intended by these rules.

**FEE SUMMARY:** Pursuant to Section 67-5226(2), the Governor has found that the fee(s) or charge(s) being imposed or increased is justified and necessary to avoid immediate danger and the fee(s) is described herein.

The fees or charges are authorized in the following sections of Idaho Code:

I.C. § 39-4112	I.C. § 39-4113	I.C. § 39-4303	I.C. § 39-8605
I.C. § 39-8616	I.C. § 44-2103	I.C. § 54-1005	I.C. § 54-1014

I.C. § 54-2614	I.C. § 54-2616	I.C. § 54-1904	I.C. § 54-4510
I.C. § 54-5012	I.C. § 54-5017	I.C. § 55-2203	I.C. § 67-2601A

The fees or charges are part of the agency's 2021 budget that relies upon the existence of these fees or charges to meet the state's obligations and provide necessary state services. Failing to reauthorize these temporary rules would create immediate danger to the state budget, immediate danger to necessary state functions and services, and immediate danger of a violation of Idaho's constitutional requirement that it balance its budget.

The following is a specific description of the fees or charges:

The preceding sections of Idaho Code and the attached rules provide a specific description of the fee or charge imposed by this rulemaking. This rulemaking does not impose a fee or charge, or increase a fee or charge, beyond what was previously approved and codified in the prior rules. All fees contained in rules covered by this notice relate to licensing and related administrative fees, fees to perform inspections on various types of construction installations, or the assessment of civil penalties for non-compliance with applicable statutes. All Division programs that are covered by this notice operate from statutorily created dedicated funds that provide for the licensing of persons within the respective professions, as well as the inspection of such installations and/or administration of such programs by the Division. All of these operations require the collection of certain fees to ensure compliance with applicable standards and to protect the health and safety of the public.

**ASSISTANCE ON TECHNICAL QUESTIONS:** For assistance on technical questions concerning the temporary rule, contact Patrick Grace, Regional Manager at 208-332-7120.

DATED this 20th day of February, 2020.

Chris Jensen  
Administrator  
Division of Building Safety  
1090 E. Watertower St., Ste 150  
Meridian, ID 83642  
208-332-7100

## IDAPA 07 – DIVISION OF BUILDING SAFETY

### 07.01.01 – RULES OF THE IDAHO ELECTRICAL BOARD

#### 000. LEGAL AUTHORITY.

These rules are promulgated by the Idaho Electrical Board and the Division of Building Safety under Title 54, Chapter 10, Idaho Code. (3-20-20)T

#### 001. TITLE AND SCOPE.

These rules are titled IDAPA 07.01.01, “Rules of the Idaho Electrical Board.” These rules include criteria for the use of electrical permits for electrical installations, inspections, the criteria and fees for licenses, continuing education, adoption of the National Electrical Code, and civil penalties. (3-20-20)T

#### 002. INCORPORATION BY REFERENCE.

The National Electrical Code, 2017 Edition, is incorporated by reference into these rules as further specified in Section 250. (3-20-20)T

#### 003. DEFINITIONS.

**01. Associated Buildings.** All buildings, structures, and fixtures used for domestic purposes and in connection with the primary or secondary residence, such as garages, sheds, barns, or shops. (3-20-20)T

**02. Board.** Idaho Electrical Board. (3-20-20)T

**03. Division.** Idaho Division of Building Safety. (3-20-20)T

**04. Person.** Includes an individual, company, firm, partnership, corporation, association or other organization. (3-20-20)T

**05. Recognized License.** A license from another jurisdiction that is recognized by the Board as requiring qualifications at least equal to the qualifications for a license contained in Title 54, Chapter 10, Idaho Code, and these rules. (3-20-20)T

**06. Registration Card.** The registration certificate referred to in Title 54, Chapter 10, Idaho Code. (3-20-20)T

#### 004. – 010. (RESERVED)

### SUBCHAPTER A – ELECTRICAL PERMITS AND INSPECTIONS (Rules 011 through 049)

#### 011. ELECTRICAL PERMITS.

Electrical permits as authorized by Section 54-1005, Idaho Code are available for purchase online or at the Division by those legally authorized to make electrical installations. Each permit shall bear a serial number registered in the name of the permit holder to whom they are issued and are transferable only as provided in these rules. Electrical permits shall be used only for the electrical installations identified in the permit application and for which said permit holder shall assume full responsibility. (3-20-20)T

**01. Completion of Electrical Installation.** For each electrical installation made by a permit holder and coming under the provisions of Section 54-1001, Idaho Code, said permit holder or his authorized representative shall request an inspection from the Division. (3-20-20)T

**02. Purchase of Electrical Permit.** All electrical permits shall be purchased before work is commenced. Where the total cost of installation is unknown, the minimum permit fee as listed in the fee schedule of these rules applies. In all cases, payment of the total permit fee shall be made prior to completion of the installation and a final inspection. (3-20-20)T

**a.** The Division may refuse to extend credit to any person with outstanding fines, violations or unpaid permit fees recorded with the Division. Permit holders will not be allowed to purchase further electrical permits unless and until all outstanding fees due have been paid in full. (3-20-20)T



b. No electrical inspections will be provided prior to the purchase of an electrical permit. (3-20-20)T

**03. Power Supply Company.** Pursuant to Section 54-1005, Idaho Code, a power supply company may connect and energize an electrical installation made by an electrical contractor without delay and before the installation has passed inspection if the contractor submits to the power supply company a copy of an electrical permit purchased by the contractor and the power supply company deems the connection and energization necessary to preserve life or property. The contractor shall request that the Division conduct an inspection on the next business day. (3-20-20)T

**012. ELECTRICAL PERMITTING AND INSPECTION REQUIREMENTS FOR PERSONS EXEMPT FROM LICENSING.**

Persons exempt from licensing pursuant to Section 54-1016, Idaho Code, shall secure all electrical permits required by Section 54-1005, Idaho Code, before making any electrical installation. No electrical wiring or equipment may be concealed in any manner from access or sight until the work has been inspected and approved for cover by the electrical inspector. A final inspection shall be made upon the completion of all electrical work. The procedure for obtaining electrical permits follows: (3-20-20)T

**01. Electrical Permit.** Any exempt person shall obtain an electrical permit from the Division with the proper permit fee as provided for in rule. (3-20-20)T

**02. Notice to Power Supplier.** The Division shall provide notice to the power supplier to connect installations requiring energization once an installation has passed inspection. (3-20-20)T

**013. ELECTRICAL PERMIT AND INSPECTION REQUIREMENTS FOR FACILITY ACCOUNTS.**

An electrical facility employer account licensee, as defined by Section 54-1003A, Idaho Code, who uses licensed or registered employees to make electrical installations coming under the provisions of Section 54-1001, Idaho Code, on the licensee's own premises, shall obtain a facility account license and purchase electrical permits from the Division with the proper permit fee as provided in these rules. Employees performing electrical installations under a facility account shall be licensed electrical journeymen or master electricians or registered electrical apprentices under the constant on-the-job supervision of a licensed journeyman or master electrician as provided in Title 54, Chapter 10, Idaho Code. One (1) properly licensed journeyman or master electrician shall be designated the supervising electrician for the facility account with the Division. Individuals employed as maintenance electricians may only perform maintenance electrical installations in accordance with Section 54-1016, Idaho Code. (3-20-20)T

**014. TEMPORARY INSTALLATIONS CONNECTED PRIOR TO INSPECTION.**

Only a licensed electrical contractor may have a power supply company connect and energize a temporary service for construction prior to an inspection being performed. Any contractor energizing a temporary service prior to inspection shall assume full responsibility for the installation of the temporary service. A power supply company may only connect and energize a temporary service upon receipt of a copy of an electrical permit purchased from the Division. (3-20-20)T

**015. -- 049. (RESERVED)**

**SUBCHAPTER B – FEES FOR ELECTRICAL PERMITS AND INSPECTIONS**  
**(Rules 050 through 099)**

**050. FEES FOR ELECTRICAL PERMITS AND INSPECTIONS.**

Electrical permit fees are to cover the cost of electrical inspections as provided by Section 54-1005, Idaho Code; any person making an electrical installation coming under the provisions of Section 54-1001, Idaho Code, shall pay to the Division a permit fee as provided in the following schedule. The type of electrical permit a person may purchase is limited to the scope of work for which the person is licensed. (3-20-20)T

**01. Temporary Construction Service (Temporary Power) Permit.** To be installed for construction purposes only, for a period not to exceed one (1) year: (3-20-20)T

a. Two hundred (200) amp or less, one (1) location: sixty-five dollars (\$65). (3-20-20)T

**b.** All others to be calculated using Subsection 050.06, Other Installation (Including Industrial and Commercial) Permit, of these rules. (3-20-20)T

**02. New Residential.** Includes associated buildings with wiring being constructed on each property.

<b>New – One-Family Dwellings</b>		
Up to 1,500 square feet of living space	-	\$130
1,501 to 2,500 square feet of living space	-	\$195
2,501 to 3,500 square feet of living space	-	\$260
3,501 to 4,500 square feet of living space	-	\$325
Over 4,500 square feet of living space	-	\$325 plus \$65 for each additional 1,000 square feet or portion thereof
<b>New – Two- and Multi-Family Dwellings</b>		
Two-family dwellings	-	\$260
Multi-family dwellings		\$130 per building plus \$65 per unit

(3-20-20)T

**a.** Existing dwelling unit permit: sixty-five dollars (\$65) plus ten dollars (\$10) for each additional branch circuit up to the maximum of the corresponding square footage of the dwelling unit. (3-20-20)T

**b.** Residential Dwelling unit spa, hot tub, hydro massage tub, and swimming pool permit: sixty-five dollars (\$65) for each trip to inspect. (For all other installations of spas, hot tubs, hydro massage tubs, and swimming pools, use Subsection 050.06, Other Installation (including Industrial and Commercial) Permit, of these rules.) (3-20-20)T

**03. Residential Electric Space Heating and Air Conditioning.** When not part of a new residential construction permit, or heat/ventilating/air conditioning permit with no additional wiring: sixty-five dollars (\$65). (3-20-20)T

**04. Domestic Water Pump Permit.** See Subsection 050.06 - Pump (Water, Domestic Water, Irrigation, Sewage) -- Each Motor Permit, of these rules. (3-20-20)T

**05. Mobile/Manufactured Home Permit.** Sixty-five dollars (\$65) basic fee plus ten dollars (\$10) for each additional circuit. Mobile home and RV parks for distribution wiring including pedestal, service conductors and lot supply to individual units come under Subsection 050.06, Other Installation (Including Industrial and Commercial) Permit, of these rules. (3-20-20)T

**06. Other Installation (Including Industrial and Commercial) Permit.** The permit fees listed in this section apply to any and all electrical installations not specifically mentioned elsewhere in this schedule. The electrical cost shall be the cost to the owner of all labor charges and all other costs that are incurred in order to complete the installation of any and all electrical wiring and equipment installed as part of the electrical system, factory assembled industrial machinery to be operated by electrical energy shall not be included in calculating these fees. (3-20-20)T

**a.** Wiring cost not exceeding ten thousand dollars (\$10,000): sixty dollars (\$60) plus two percent (2%) of total wiring cost. (3-20-20)T

**b.** Wiring cost over ten thousand dollars (\$10,000) but not exceeding one hundred thousand dollars (\$100,000): two hundred sixty dollars (\$260) plus one percent (1%) of wiring cost in excess of ten thousand dollars (\$10,000). (3-20-20)T

**c.** Wiring cost over one hundred thousand dollars (\$100,000): one thousand one hundred sixty dollars (\$1,160) plus one-half of one percent (.5%) of the portion of wiring costs exceeding one hundred thousand dollars (\$100,000). (3-20-20)T

**d.** All fees calculated under this schedule must be calculated on the total wiring cost of the job, and this figure must be shown on the permit. The permit fees listed in this Subsection apply to any and all electrical installations not specifically mentioned elsewhere in this schedule. The wiring cost shall be the cost to the owner of all labor charges and all wiring materials and equipment installed as part of the wiring system. When labor is performed by the owner, such labor cost shall be based upon the market value of said labor and used or reused materials shall be based at fifty percent (50%) of the column 3 pricing as published by Trade Service Publication or National Price Service Pricing or the actual cost, whichever is greater. For all owner-supplied, factory assembled electrical infrastructural equipment to be installed, the inspection will be based on one-half of one percent (.5%) of total cost of the equipment OR an hourly rate of one hundred thirty dollars (\$130) for the first hour of each inspection and sixty-five dollars (\$65) for each subsequent hour. Factory assembled machinery to be operated by electrical energy shall not be included when calculating these fees. (3-20-20)T

**e.** Small work not exceeding two hundred dollars (\$200) in cost and not involving a change in service connections: ten dollars (\$10). (3-20-20)T

**07. Pump (Water, Domestic Water, Irrigation, Sewage) -- Each Motor Permit.**

To 25 HP	-	\$65
26 to 200 HP	-	\$95
Over 200 HP	-	\$130
For phase inverters and roto phase equipment, use Subsection 050.06, in addition to the pump motor fee.		

(3-20-20)T

**08. Electrically-Driven Irrigation Machine Permit.** Center Pivot: sixty-five dollars (\$65) plus ten dollars (\$10) per tower or drive motor. Other types: sixty-five dollars (\$65) plus ten dollars (\$10) per motor. (Note: No additional fee required for underground feeder). (3-20-20)T

**09. Electric Sign and Outline Lighting Permit.** Electric signs: sixty-five dollars (\$65) per sign; Outline lighting: sixty-five dollars (\$65) per each occupancy. (3-20-20)T

**10. Requested Inspection Permit.** A base fee of sixty-five dollars (\$65) plus an additional sixty-five dollars (\$65) for each hour, or portion thereof, in excess of one (1) hour including travel time. Out-of-state travel expenses shall be paid by the requesting party. (3-20-20)T

**11. Additional Fees and Reinspection Fees.** A base fee of sixty-five dollars (\$65) plus an additional sixty-five dollars (\$65) for each additional hour, or portion thereof, in excess of one (1) hour including travel time, shall also be paid before approval of the installation if the following services are necessary: (3-20-20)T

**a.** Trips to inspect when the permit holder had given notice to the inspector that the work is ready for inspection when it was not. (3-20-20)T

**b.** Trips to inspect when the permit holder has not clearly or correctly given the location of the installation either by directions, maps, coordinates, or correct address and posting a copy of the permit at the service or other conspicuous location on the property or the inspector cannot gain access to make the inspection. (3-20-20)T

**c.** Trips to inspect corrections required by the inspector as a result of the submitter improperly responding to a corrective notice. (3-20-20)T

**d.** Each trip necessary to remove a red tag from the jobsite. (3-20-20)T

**e.** Trips to conduct a reinspection because corrections have not been made in the prescribed time, unless an extension has been requested and granted. (3-20-20)T

**12. No Permit.** Failure to purchase an electrical permit before work is commenced, may result in the imposition of a double permit fee. (3-20-20)T

**13. Plan Check Fee.** Sixty-five dollars (\$65) minimum for one (1) hour or less. Over one (1) hour: sixty-five dollars (\$65) plus sixty-five dollars (\$65) for each hour, or portion thereof, in excess of one (1) hour. (3-20-20)T

**14. Fees for Temporary Amusement/Industry Electrical Inspections.** Each time a ride, concession, or generator is set up: sixty-five dollars (\$65) base fee plus ten dollars (\$10) for each ride, concession, or generator. (3-20-20)T

**15. Expiration of Permits.** Every permit issued by the Division shall expire by limitation and become null and void if the work authorized by such permit is not commenced within ninety (90) days from the date of issuance of such permit or if the work authorized by such permit is suspended or abandoned at any time after work is commenced for a period of one hundred eighty (180) days. A permit may be renewed for an additional year upon receipt of Division approval and sixty-five dollars (\$65) renewal fee. (3-20-20)T

**16. Transferring a Permit.** An electrical permit may be transferred to another eligible party if such party provides to the Division written authorization signed and notarized by the original permit holder consenting to the transfer itself and assignment of all the responsibilities and conditions incorporated into the original permit issuance. A permit may be transferred to the owner of the property on which the electrical work is to be performed and for which the permit was issued, or such owner's designated legal agent, in cases where such owner has terminated his legal relationship with the electrical contractor who originally obtained the permit. An administrative fee in the amount of forty-five dollars (\$45) for the transfer of the permit shall be assessed by the Division. (3-20-20)T

**17. Refunds of Permits.** The administrator of the Division may authorize a refund for any permit fee paid on the following bases: (3-20-20)T

**a.** The administrator may authorize a refund of the entire permit fee paid when no work has been performed related to the installations or electrical work covered by a permit issued by the Division. A lesser amount up to fifty percent (50%) of the permit fee amount may be refunded if work has commenced and the project is less than fifty percent (50%) complete as determined by the Division; and (3-20-20)T

**b.** The administrator cannot authorize a refund of any permit fee paid except upon written application for such filed by the original permit holder or the property owner's representative not less than one hundred eighty (180) days after the date the permit was issued. (3-20-20)T

**051. -- 099. (RESERVED)**

**SUBCHAPTER C – ELECTRICAL LICENSING AND REGISTRATION**  
**(Rules 100 through 149)**

**100. LICENSURE HISTORY.**

An applicant for any electrical registration or license who has previously obtained a Recognized License as a journeyman or master electrician shall upon application to the Division disclose such license and provide sufficient proof thereof. An applicant for any electrical registration, license, or certificate of competency who has previously obtained a Recognized License as a journeyman or master electrician shall not be issued an electrical apprentice registration. (3-20-20)T

**101. LICENSE AND REGISTRATION APPLICATION.**

Application forms will be available at the Division's offices and electronically on the Division's website. (3-20-20)T

**01. Application Form.** Each applicant shall properly complete and submit to the Division the

applicable form, giving all pertinent information and obtaining notarization of all signatures. (3-20-20)T

**02. Application Fee.** Each applicant shall pay to the Division the applicable fee provided in Section 54-1014, Idaho Code, with the application form. For registrations, the application fee set forth in Section 54-1014, Idaho Code, may satisfy the initial registration fee or any portion thereof. (3-20-20)T

**03. Examination and Licensure Approval.** The Division must approve each application before examination and licensure. (3-20-20)T

**04. Examination.** An applicant who does not take the applicable examination within ninety (90) days of the date of approval must reapply. (3-20-20)T

**05. License.** Upon application approval and successful completion of the applicable examination, each license applicant must purchase a license. A license applicant who does not purchase a license within ninety (90) days of successful completion of the applicable examination must reapply, obtain application approval again, and re-examine. (3-20-20)T

**06. License or Registration Period.** The license or registration period set forth in Section 54-1008, Idaho Code, for each license or registration shall begin upon satisfaction of the applicable fee provided in Section 54-1013, Idaho Code. Each license or registration period shall expire at midnight on the last day of the final month of the license or registration period. Notwithstanding the foregoing, the license or registration period for each expired license or registration revived in accordance with Section 54-1013, Idaho Code, shall begin on the day the license or registration previously expired. (3-20-20)T

## **102. APPRENTICE ELECTRICIAN REGISTRATION.**

**01. Registration Requirements.** To become an apprentice electrician, a person shall comply with Section 54-1010(3), Idaho Code. Each apprentice electrician shall carry a current Registration Card while performing electrical work and present the Registration Card upon request by the Division for examination. (3-20-20)T

**02. Renewal Requirements.** To renew an apprentice registration, an apprentice electrician shall submit to the Division sufficient evidence demonstrating the apprentice electrician has successfully completed one (1) of the following during the prior registration period: (3-20-20)T

**a.** One (1) year of a Board-approved sequence of instruction and one (1) year, defined as a minimum of two thousand (2,000) hours of work experience, under the constant, on-the-job supervision and training of a journeyman electrician. Verification of work experience shall consist of a notarized letter from each employer with which the apprentice electrician obtained the experience. (3-20-20)T

**b.** Continuation training, defined as eight (8) hours of NFPA 70E training and sixteen (16) hours of code-update training, code-related training, or industry-related training. (3-20-20)T

## **103. JOURNEYMAN ELECTRICIAN EXAMINATION AND LICENSE.**

**01. Examination Requirements.** To take the journeyman examination, an applicant shall submit to the Division sufficient evidence demonstrating the applicant has successfully completed one (1) of the following: (3-20-20)T

**a.** Four (4) years of a sequence of instruction approved by the Board and the Idaho Division of Career-Technical Education and three (3) years, defined as a minimum of six thousand (6,000) hours, of work experience under the constant on-the-job supervision and training of a journeyman electrician. (3-20-20)T

**b.** Eight (8) years, defined as a minimum of sixteen thousand (16,000) hours, of work experience in accordance with the requirements of the jurisdiction in which the applicant obtained the experience. Verification of work experience shall consist of a notarized letter from each employer with which the applicant obtained the experience. (3-20-20)T

**02. License Requirements.** (3-20-20)T

**a.** To obtain a provisional journeyman license, an applicant shall submit to the Division evidence demonstrating the applicant has successfully completed eight (8) years, defined as a minimum of sixteen thousand (16,000) hours, of work experience in accordance with the requirements of the jurisdiction in which the applicant obtained the experience. Verification of work experience shall consist of a notarized letter from each employer with which the applicant obtained the experience. (3-20-20)T

**b.** To obtain a journeyman license, an applicant shall submit to the Division sufficient evidence demonstrating the applicant has successfully completed the journeyman examination; and (3-20-20)T

**i.** Four (4) years, defined as a minimum of eight thousand (8,000) hours, of work experience under the constant on-the-job supervision and training of a journeyman electrician; or (3-20-20)T

**ii.** Eight (8) years, defined as a minimum of sixteen thousand (16,000) hours, of work experience in accordance with the requirements of the jurisdiction in which the applicant obtained the experience. (3-20-20)T

**c.** To obtain a journeyman license, an applicant with a Recognized License shall comply with Section 54-1007(5), Idaho Code, and submit to the Division sufficient evidence demonstrating: (3-20-20)T

**i.** The applicant's Recognized License is current, active, and in good standing; and (3-20-20)T

**ii.** The applicant obtained the Recognized License by testing from the issuing jurisdiction. (3-20-20)T

**03. Unacceptable Work Experience.** The Division will not accept work experience in appliance repair, motor winding, or communications to meet the requirements to take the journeyman examination or obtain a provisional journeyman or journeyman license. (3-20-20)T

**104. MASTER ELECTRICIAN.**

An applicant for a master electrician license must have at least four (4) years' experience as a licensed journeyman electrician as provided in Section 54-1007, Idaho Code. Any person having these qualifications may make application at any time by remitting to the Division the application fee. Upon approval, the applicant will be notified and may apply to take the next examination. Upon notification of passing the examination, the applicant must remit the required fee for the issuance of a master license. A person holding a current master license shall not be required to hold a journeyman license. (3-20-20)T

**105. ELECTRICAL CONTRACTOR.**

**01. Qualifications for Electrical Contractor.** (3-20-20)T

**a.** On and after July 1, 2008, except as hereinafter provided, any person, partnership, company, firm, association, or corporation shall be eligible to apply for an electrical contractor license upon the following requirements: (3-20-20)T

**i.** Applicant shall have at least one (1) full-time employee who holds a valid master electrician license issued by the Division. Licensed electrical contractors who are current and active prior to July 1, 2008, shall not be required to have a master electrician as the supervising electrician until a new supervising electrician is designated. A master electrician license will be required for a new supervising electrician designated after July 1, 2008. (3-20-20)T

**ii.** The master electrician shall be designated the supervising electrician and shall be available during working hours to carry out the duties of supervising, as set forth herein, and who will be responsible for supervision of electrical installations made by said company, firm, association, or corporation as provided by Section 54-1010, Idaho Code. (3-20-20)T

**iii.** An individual electrical contractor may act as his own supervising master electrician upon the condition that he holds a valid master electrician license. (3-20-20)T

iv. Applicant must pass a contractor examination administered by the Division or its designee. Any applicant which purports to be a non-individual (such as, corporation, partnership, company, firm, or association), must designate in writing an individual to represent it for examination purposes. Any such designee shall be a full-time supervisory employee and may not represent any other applicant for an electrical contractor's license. (3-20-20)T

v. Applicant shall provide proof of liability insurance to the Division in the amount of three hundred thousand dollars (\$300,000) from an insurance company licensed to do business in the state of Idaho. The liability insurance shall be in effect for the duration of the applicant's contractor licensing period. (3-20-20)T

vi. Applicant shall provide to the Division proof of Idaho's worker's compensation insurance unless specifically exempt from Idaho law. The Division will provide written confirmation of exemption status. (3-20-20)T

b. Any person designated under Paragraph 105.01.a. of these rules, and the contractor he represents, shall each notify the Division in writing if the supervising master's or the designee's working relationship with the contractor has been terminated within ten (10) days of the date of termination. If the supervising master's or the designee's relationship with the contractor is terminated, the contractor's license is void within ninety (90) days unless another supervising master is qualified by the Division, or unless another duly qualified designee passes the electrical contractor's examination on behalf of the contractor, as applicable. (3-20-20)T

**02. Required Signatures on Application.** An application for an electrical contractor license shall be signed by the applicant or by the official representative of the partnership, company, firm, association, or corporation making the application countersigned by the supervising master electrician. (3-20-20)T

**03. Electrical Contracting Work Defined.** An electrical contractor license issued by the Division must be obtained prior to acting or attempting to act as an electrical contractor in Idaho. (3-20-20)T

a. Electrical contracting work includes electrical maintenance or repair work, in addition to new electrical installations, unless such work is expressly exempted by Section 54-1016, Idaho Code. (3-20-20)T

b. Any person or entity performing or offering to perform electrical contracting services, including, but not limited to, advertising or submitting a bid shall be considered as acting or attempting to act as an electrical contractor and shall be required to be licensed. Advertising includes, but is not limited to: newspaper, telephone directory, community flier ads or notices, telephone, television, radio, internet, business card, or door-to-door solicitations. (3-20-20)T

c. Any person or entity, not otherwise exempt, who performs or offers to perform electrical contracting work, is acting as an electrical contractor, whether or not any compensation is received. (3-20-20)T

d. Registered general contractors who submit a bid on a multi-trade construction project that includes a licensed electrical contractor's pricing shall not be considered to be acting or attempting to act as an electrical contractor. (3-20-20)T

**04. Previous Revocation.** Any applicant for an electrical contractor license who has previously had his electrical contractor license revoked for cause, as provided by Section 54-1009, Idaho Code, shall be considered as unfit and unqualified to receive a new electrical contractor license so long as such cause for revocation is continuing and of such nature that correction can be made by the applicant. (3-20-20)T

**05. Reviving an Expired License.** Any applicant for an electrical contractor license who has allowed his license to expire and seeks to revive it under the provisions of Section 54-1013, Idaho Code, may be denied a license as unfit and unqualified if, while operating under the license prior to expiration, he violates any of the laws or rules applicable to electrical contractors. (3-20-20)T

**06. Qualification and Duties for Supervising Journeyman or Master.** (3-20-20)T

a. A master electrician shall not be considered as qualified to countersign an electrical contractor license application as the supervising master, nor shall said application be approved if he does countersign said

application as the supervising master, if said master has had his Idaho electrical contractor license revoked for cause under Section 54-1009, Idaho Code. (3-20-20)T

**b.** A supervising master shall not countersign for more than one (1) contractor. (3-20-20)T

**c.** A journeyman who is a full-time employee of a company, corporation, firm or association with a facility account may sign as supervising journeyman for that facility account in addition to signing as supervising journeyman for his own contractor's license so long as the journeyman is listed as the owner and complies with the provisions of Paragraphs 105.01.a. and 01.b. of these rules. (3-20-20)T

**d.** Duties include: assuring that all electrical work substantially complies with the National Electrical Code and other electrical installation laws and rules of the state, and that proper electrical safety procedures are followed; assuring that all electrical labels, permits, and licenses required to perform electrical work are used; assuring compliance with correction notices issued by the Division. (3-20-20)T

**07. Failure to Correct Defects in Electrical Installations.** If a master countersigns an electrical contractor license application pursuant to Subsection 105.02 of these rules and thereafter willfully fails to correct defects in electrical installations he made or supervised, and such defects are within his power to correct and are not the fault of the contractor, then the Division shall have the power to suspend or revoke said master's license pursuant to Section 54-1009, Idaho Code. (3-20-20)T

**08. Overcharging of Fees.** It shall be grounds for suspension or revocation of an electrical contractor license if he charges and collects from the property owner an electrical permit or inspection fee which is higher than the fee actually in effect at the time of such charging and collection, pursuant to the current Electrical Laws and Rules of the Division, and the fee remitted by the contractor to the Division is less than the fee actually charged and collected by him. (3-20-20)T

**09. Direct Supervision and Training.** It shall be the responsibility of the employing electrical contractor to ensure that each apprentice electrician and provisional journeyman electrician perform electrical work only under the constant on-the-job supervision and training of a journeyman electrician. (3-20-20)T

**a.** Journeyman-to-Apprentice Ratio. One (1) journeyman shall not supervise more than four (4) apprentices performing electrical work on one and two-family dwelling units. One (1) journeyman shall not supervise and train more than two (2) apprentices performing electrical work on all other types of electrical installations. (3-20-20)T

**b.** Any electrical contractor violating the journeyman-to-apprentice ratio established in Paragraph 105.09.a of these rules is presumed to be in violation of the direct supervision requirement of Section 54-1010(1), Idaho Code, and the constant on-the-job supervision requirement of Section 54-1003A(3), Idaho Code. The journeyman-to-apprentice ratio established herein these rules may be adjusted on a case-by-case basis by a showing by an electrical contractor of special circumstances that are peculiar to the work done by that electrical contractor and that allow for effective supervision and training by each journeyman electrician. An electrical contractor must obtain permission from the Division to adjust the journeyman-to-apprentice ratio. Failure to comply with this requirement will be grounds for suspension or revocation of the electrical contractor's license. (3-20-20)T

**106. -- 149. (RESERVED)**

**SUBCHAPTER D – LIMITED ELECTRICAL LICENSING AND REGISTRATION**  
**(Rules 150 through 199)**

**150. QUALIFIED JOURNEYMAN ELECTRICIANS.**

Qualified journeyman electricians, as defined in Section 54-1003A(2), Idaho Code, shall be permitted to make all installations as subsequently described herein without securing an additional license for said installation. (3-20-20)T

**151. MINIMUM EXPERIENCE REQUIREMENTS.**

Experience gained by an individual while engaged in the practice of one (1) or more of the limited categories named below shall not be considered towards the satisfaction of the minimum experience requirements for licensing as a



journeyman electrician.

(3-20-20)T

**152. LIMITED EXPERIENCE REQUIREMENT.**

**01. Limited Electrical Installer.** An applicant for a limited electrical installer license must have at least two (2) years of experience, or more as specified for the individual category, with the type of installation for which the license is being applied for, in compliance with the requirements of the state in which the experience was received, or as a limited electrical installer trainee making electrical installations in accordance with the requirements as stated herein. (3-20-20)T

**02. Limited Electrical Installer Trainee.** A limited electrical installer trainee shall be required to work not less than two (2) years, defined as a minimum of four thousand (4,000) hours of work experience, under the constant on-the-job supervision of a limited electrical installer of the same limited category to qualify for testing as a limited electrical installer. A person wishing to become a limited electrical installer trainee shall register with the Division for a period of three (3) years and pay the applicable fee prior to going to work. Said person shall carry a current registration certificate on his person at all times and present it upon request to personnel. Time shall not be credited while the trainee is inactive or not registered. (3-20-20)T

**153. ELECTRICAL INSTALLATIONS REQUIRING A LIMITED ELECTRICAL INSTALLER LICENSE.**

The following categories of electrical installations shall be considered limited electrical installations, the practice of which shall require a journeyman electrician, master electrician, or limited electrical installer license: (3-20-20)T

**01. Elevator, Dumbwaiter, Escalator, or Moving-Walk Electrical.** Any person qualifying for and having in his possession a current elevator electrical license may install, maintain, repair, and replace equipment, controls, and wiring beyond the disconnect switch in the machine room of the elevator and pertaining directly to the operation and control thereof when located in the elevator shaft and machine room. He shall be employed by a licensed elevator electrical contractor or electrical contractor, and his installations shall be limited to this category. The holder of such limited license may only countersign a limited electrical contractor's license application as a supervising limited electrical installer for work within this category. (3-20-20)T

**02. Sign Electrical.** Any person qualifying for and having in his possession a current sign electrical license may install, maintain, repair, and replace equipment, controls, and wiring on the secondary side of sign disconnecting means; providing the disconnecting means is located on the sign or within sight therefrom. He shall be employed by a licensed sign electrical contractor or electrical contractor, and his installations shall be limited to this category. The holder of such limited license may only countersign a limited electrical contractor's license application as supervising limited electrical installer for work within this category. (3-20-20)T

**03. Manufacturing or Assembling Equipment. (3-20-20)T**

**a.** A licensed limited electrical manufacturing or assembling equipment installer must be employed by a licensed limited electrical manufacturing or assembling equipment contractor or electrical contractor, and his installation shall be limited to this category. The holder of such limited license may only countersign a limited electrical contractor's license application as a supervising limited electrical installer for work within this category. (3-20-20)T

**b.** Any person licensed pursuant to Paragraph 153.03.a. of these rules may install, maintain, repair, and replace equipment, controls, and accessory wiring, integral to the specific equipment, on the load side of the equipment disconnecting means. Electrical service and feeder are to be installed by others. The licensee may also install circuitry in modules or fabricated enclosures for the purpose of connecting the necessary components which individually bear a label from a nationally recognized testing laboratory when such equipment is designed and manufactured for a specific job installation. All wiring completed shall meet all requirements of Title 54, Chapter 10, Idaho Code, all rules promulgated pursuant thereto, and the most current edition of the National Electrical Code. (3-20-20)T

**c.** Subsection 153.03 of these rules does not apply to a limited electrical manufacturing or assembling equipment installer installing electrical wiring, equipment, and apparatus in modular buildings as that term is defined

in Section 39-4105, Idaho Code. Only journeyman electricians and electrical apprentices, employed by an electrical contractor, may perform such installations. (3-20-20)T

**04. Limited Energy Electrical.** (3-20-20)T

**a.** Limited energy systems are defined as fire and security alarm systems, class 2 and class 3 signaling circuits, key card operators, nurse call systems, motor and electrical apparatus controls and other limited energy applications covered by the NEC. (3-20-20)T

**b.** Limited energy systems do not include, and no license of any type is required for, the installation of landscape sprinkler controls or communication circuits, wires and apparatus that include telephone systems, telegraph facilities, outside wiring for fire and security alarm systems which are used for communication purposes, and central station systems of a similar nature, PBX systems, audio-visual and sound systems, public address and intercom systems, data communication systems, radio and television systems, antenna systems and other similar systems. (3-20-20)T

**c.** Unless exempted by Section 54-1016, Idaho Code, any person who installs, maintains, replaces or repairs electrical wiring and equipment for limited energy systems in facilities other than one (1) or two (2) family dwellings shall be required to have a valid limited energy limited electrical license and must be employed by a licensed limited energy limited electrical contractor or electrical contractor. The holder of such limited license may only countersign a limited electrical contractor's application as a supervising limited electrical installer for work within this category. (3-20-20)T

**05. Irrigation Sprinkler Electrical.** Any person qualifying for and having in his possession, an irrigation system electrical license may install, maintain, repair and replace equipment, controls and wiring beyond the disconnect switch supplying power to the electric irrigation machine. The irrigation machine is considered to include the hardware, motors and controls of the irrigation machine and underground conductors connecting the control centers on the irrigation machine to the load side of the disconnecting device. Disconnect device to be installed by others. All such installations performed by individuals under this Subsection shall be done in accordance with the applicable provisions of the National Electrical Code. He shall be employed by a licensed limited electrical contractor whose license is contingent upon the granting of a limited electrical license to an employee, and his installations shall be limited to this category. The holder of such limited license may not countersign a limited electrical contractor's license application as supervising limited electrical installer except for work within this category. (3-20-20)T

**06. Well Driller and Water Pump Installer.** All installations performed by individuals under this Subsection shall be done in accordance with the applicable provisions of the approved National Electrical Code. A license holder in this category shall be employed by a licensed well driller and water pump installer limited electrical contractor or electrical contractor, and his installations shall be limited to this category. The holder of such limited license may only countersign a limited electrical contractor's license application as supervising limited electrical installer for work within this category. Any person currently licensed in this category may perform the following types of installations: (3-20-20)T

**a.** Single or three (3) phase water pumps: install, maintain, repair and replace all electrical equipment, wires, and accessories from the pump motor up to the load side, including fuses, of the disconnecting device. Disconnecting device to be installed by others. (3-20-20)T

**b.** Domestic water pumps, one hundred twenty/two hundred forty (120/240) volt, single phase, sixty (60) amps or less: Install, maintain, repair and replace all electrical equipment, wires, and accessories from the pump motor up to and including the disconnecting device. (3-20-20)T

**c.** Temporarily connect into a power source to test the installations, provided that all test wiring is removed before the installer leaves the site. (3-20-20)T

**d.** Individual residential wastewater pumping units. Install, maintain, repair and replace all electrical equipment, wires, and accessories from the pump motor up to and including the disconnecting device for systems that serve one-family, two-family, or three-family residential installations. (3-20-20)T

**07. Refrigeration, Heating, and Air-Conditioning Electrical Installer.** All installation, maintenance, and repair performed by individuals under this Subsection shall be done in accordance with applicable provisions of the National Electrical Code. A license holder in this category shall be employed by a licensed limited electrical contractor whose license shall be covered by this category or electrical contractor, and his installations shall be limited to this category. The holder of such limited license may only countersign a limited electrical contractor's license application as a supervising limited electrical installer for work in this category. Any person currently licensed in this category may perform the following types of installations, which installations shall be limited to factory-assembled, packaged units: (3-20-20)T

**a.** Heating Units (single phase): install, repair, and maintain all electrical equipment, wires, and accessories from the unit up to the load side, including fuses, of the disconnecting device. Disconnecting device to be installed by others. (3-20-20)T

**b.** Refrigeration, Air-Conditioning Equipment and Heat Pumps (single phase): install, repair, and maintain all electrical equipment, wires, and accessories from the unit up to the load side, including fuses, of the disconnecting device. Disconnecting device to be installed by others. (3-20-20)T

**c.** Refrigeration, Air-Conditioning and Heating Systems (three (3) phase): install, maintain, and repair all electrical equipment and accessories up to the load side, including fuses, of the disconnecting device. Disconnecting device to be installed by others. (3-20-20)T

**08. Outside Wireman.** All installation, maintenance, and repair not exempt under the provisions of Section 54-1016, Idaho Code, performed by individuals under this Subsection shall be done in accordance with the applicable provisions of the National Electrical Code. A license holder in this category shall be employed by a licensed limited electrical contractor whose license shall be covered by this category or electrical contractor, and his installations shall be limited to this category. The holder of such limited electrical license may only countersign a limited electrical contractor's license application as a supervising limited electrical installer for work in this category. Applicants for this license category shall provide documentation of having completed an electrical lineman apprenticeship program or similar program approved by the U.S. Department of Labor, Office of Apprenticeship. Any person currently licensed in this category may perform the following types of installations: (3-20-20)T

**a.** Overhead distribution and transmission lines in excess of six hundred (600) volts. (3-20-20)T

**b.** Underground distribution and transmission lines in excess of six hundred (600) volts. (3-20-20)T

**c.** Substation and switchyard construction in excess of six hundred (600) volts. (3-20-20)T

**09. Solar Photovoltaic.** All installation, maintenance, and repair not exempt under the provisions of Section 54-1016, Idaho Code, performed by individuals under this Subsection shall be done in accordance with the applicable provisions of the National Electrical Code. A license holder in this category shall be employed by a licensed limited electrical contractor whose license shall be covered by this category or electrical contractor, and his installations shall be limited to this category. The holder of such limited electrical license may only countersign a limited electrical contractor's application as a supervising limited electrical installer for work in this category. Applicants for this license category shall provide proof of photovoltaic installer certification by the North American Board of Certified Energy Practitioners (NABCEP) or equivalent. Any person licensed in this category may perform the following types of installations: (3-20-20)T

**a.** Solar Photovoltaic DC Systems: Install, maintain, repair, and replace all electrical equipment, wires, and accessories up to and including the inverter. (3-20-20)T

**b.** Solar Photovoltaic micro-inverter/AC Systems: Install, maintain, repair, and replace all electrical equipment, wires, and accessories up to and including the AC combiner box. (3-20-20)T

**154. APPLICATIONS FOR LIMITED ELECTRICAL INSTALLER LICENSE.**

An application for a limited electrical installer license may be obtained from the Division. The forms shall be returned with the application fee, as provided by Section 54-1014, Idaho Code, with proof of the required two (2)

years of experience in the field of limited electrical category and notarized signature. Upon receiving a passing grade, the applicant may remit the license fee for issuance of the license. (3-20-20)T

**155. LICENSURE PERIOD AND FEES.**

All original limited electrical licenses and registrations shall be issued by the Division immediately upon receipt of the licensure fee and other necessary documentation from the applicant which date will be designated as the original license anniversary date and signify the commencement of the licensing period. All specialty license and registration renewals shall be effective in the year renewed as of the original license anniversary date. All license and registration periods end at midnight on the last day of the final month of the licensing or registration period. Limited electrical licenses and registrations not renewed by this date are expired. Any expired license revived within the twelve-month period following the expiration date will continue to have the original license anniversary date for the purposes of subsequent renewal. The license fee and renewal fee for each type of limited electrical license is provided for by Section 54-1014, Idaho Code, for other journeyman licenses. (3-20-20)T

**156. LIMITED ELECTRICAL CONTRACTOR LICENSE.**

**01. Qualifications for Limited Electrical Contractor.** Except as herein provided, any person, partnership, company, firm, association, or corporation shall be eligible to apply for a limited electrical contractor license upon the condition that such applicant will be responsible for supervision of electrical installations made by said company, firm, association, or corporation as provided by Section 54-1010, Idaho Code. The supervising limited electrical installer shall be available during working hours to carry out the duties of supervising limited electrical installer, as set forth herein. In addition, the applicant shall meet or have at least one (1) full-time employee who meets one (1) of the following criteria: (3-20-20)T

**a.** Holds a valid limited electrical installer license issued by the Division, in the same category as the limited electrical contractor, and has held a valid limited electrical installer license for a period of not less than two (2) years, during which time he was employed as a limited electrical installer for a minimum of four thousand (4,000) hours; (3-20-20)T

**b.** Holds a valid limited electrical installer license issued by the Division, in the same category as the limited electrical contractor, and has at least four (4) years of experience in the limited electrical category with a minimum of two (2) years practical experience in planning, laying out, and supervising electrical installations in the category. (3-20-20)T

**02. Modification to Qualifications.** Applicants for limited electrical contractor licenses, or individuals countersigning such applications, shall be subject to the same requirements, restrictions, and fees applicable to other electrical contractors and countersigning master, as set forth in the current electrical statutes and rules with the exception that an electrical contractor requires a master electrician to countersign as a supervising master whereas a supervising limited electrical installer for a limited electrical contractor must meet the requirements of Subsection 156.01 of these rules. (3-20-20)T

**157. -- 199. (RESERVED)**

**SUBCHAPTER E – EXAMINATIONS**  
**(Rules 200 through 249)**

**200. EXAMINATIONS.**

**01. Frequency of Conducting of Examinations.** Board-approved examinations for all classifications under the Electrical Laws and Rules will be offered a minimum of four (4) times each year at the Division's three (3) office locations. The applicant will be notified in writing of the date, time, and location at which the examination will be given, following approval of the application. (3-20-20)T

**02. Professional Testing Services.** In lieu of the administration by the Board of the examination for licenses pursuant to this rule, the Board may contract with a professional testing service to administer the examination and require license applicants to pay to the testing service the fee that they have set for the examination, take such examination at the time set by such service, and provide the Division acceptable verification of the test

score. If the examination is conducted in this fashion, the Board may charge and retain the application fee provided for by Section 54-1014, Idaho Code, to cover the cost of reviewing the applicant's application. (3-20-20)T

**03. Required Scores.** The following scores are considered minimum for passing and are required to be achieved by the applicant prior to issuance of the appropriate license or certification.

Required Scores		
Journeyman Electrician	-	70%
Limited Electrical Installer	-	70%
Electrical Contractor	-	75%
Limited Electrical Contractor	-	70%
Electrical Inspector	-	75%
Master Electrician	-	75%

(3-20-20)T

**04. Failed Examinations.**

(3-20-20)T

**a.** An applicant receiving less than a passing score on a first or second examination attempt may be reexamined. (3-20-20)T

**b.** Before being reexamined after failing an examination the third time, an applicant must: (3-20-20)T

**i.** Wait until the expiration of one (1) year from the date of the failed third examination; or (3-20-20)T

**ii.** Provide proof, satisfactory to the Board, of completion of a minimum of twenty-four (24) hours of Board-approved, related electrical training or continuing education since the date of the failed third examination. (3-20-20)T

**c.** Before being reexamined after any further failures, an applicant for reexamination must: (3-20-20)T

**i.** Wait until the expiration of an additional one (1) year from the date of the failed examination; or (3-20-20)T

**ii.** Provide proof, satisfactory to the Electrical Board, of completion of thirty-two (32) hours of Board-approved, related electrical training or continuing education since the date of the failed examination. (3-20-20)T

**201. -- 249. (RESERVED)**

**SUBCHAPTER F – USE OF THE NATIONAL ELECTRICAL CODE**  
**(Rules 200 through 299)**

**250. ADOPTION AND INCORPORATION BY REFERENCE OF THE NATIONAL ELECTRICAL CODE.**

**01. Documents.** Under the provisions of Section 54-1001, Idaho Code, the National Electrical Code, 2017 Edition, (herein NEC) is hereby adopted and incorporated by reference for the state of Idaho and are in full force and effect on and after July 1, 2017, with the following amendments: (3-20-20)T

**a.** Article 110.3(A) and 110.3(B) shall not apply to submersible well pumps installed in swimming and marine areas; provided however, such articles shall apply to all other equipment required in the installation of a

- submersible well pump in such areas except for the actual submersible well pump itself. (3-20-20)T
- b.** Article 210.8(A)(7) Sinks. Delete article 210.8(A)(7) and replace with the following: Sinks - located in areas other than kitchens where receptacles are installed within one and eight tenths (1.8) meters (six (6) feet) of the outside edge of the sink. (3-20-20)T
- c.** Article 210.8(A)(10). Delete article 210.8(A)(10). (3-20-20)T
- d.** Article 210.8(D). Delete article 210.8(D). (3-20-20)T
- e.** Article 210.52(E)(3). Delete article 210.52(E)(3) and replace with the following: Balconies, Decks, and Porches. Balconies, decks, and porches having an overall area of twenty (20) square feet or more that are accessible from inside the dwelling unit shall have at least one (1) receptacle outlet installed within the perimeter of the balcony, deck, or porch. The receptacle shall not be located more than two (2.0) meters (six and one half (6½) feet) above the balcony, deck, or porch surface. (3-20-20)T
- f.** Add a new Article 225.30(F) – One (1)- or Two (2)-Family Dwelling Unit(s). For a one (1)- or two (2)-family dwelling unit(s) with multiple feeders with conductors one aught (1/0) or larger, it shall be permissible to install not more than six (6) disconnects grouped at one (1) location where the feeders enter the building, provided that the feeder conductors originate at the same switchboard, panelboard, or overcurrent protective device location. (3-20-20)T
- g.** Where the height of a crawl space does not exceed one and four tenths (1.4) meters or four and one half (4.5) feet it shall be permissible to secure NM cables, that run at angles with joist, to the bottom edge of joist. NM cables that run within two and one tenth (2.1) meters or seven (7) feet of crawl space access shall comply with Article 320.23. (3-20-20)T
- h.** Article 334.10(3). Delete Article 334.10(3) and replace with the following: Other structures permitted to be of Types III, IV, and V construction. Cables shall be concealed within walls, floors, or ceilings that provide a thermal barrier of material that has at least a fifteen (15)-minute finish rating as identified in listings of fire-rated assemblies. For the purpose of this section, cables located in attics and underfloor areas that are not designed to be occupied shall be considered concealed. (3-20-20)T
- i.** Article 675.8(B). Compliance with Article 675.8(B) will include the additional requirement that a disconnecting means always be provided at the point of service from the utility no matter where the disconnecting means for the machine is located. (3-20-20)T
- j.** Article 682.10 shall not apply to submersible well pumps installed in swimming and marine areas; provided however, such articles shall apply to all other equipment required in the installation of a submersible well pump in such areas except for the actual submersible well pump itself. (3-20-20)T
- k.** Article 682.11. Add the following exception to Article 682.11: This article shall not apply to service equipment that is located on or at the dwelling unit and which is not susceptible to flooding. (3-20-20)T
- l.** Article 682.13. Add the following exceptions to Article 682.13: (3-20-20)T
- i.** Exception No 1. Wiring methods such as HDPE schedule eighty (80) electrical conduit or its equivalent or greater, and clearly marked at a minimum “Caution Electrical” to indicate that it contains electrical conductors shall be approved. It shall be buried whenever practical, and in accordance with the requirements of the authority having jurisdiction. The use of gray HDPE water pipe rated at two hundred (200) PSI (e.g. SIDR-7 or DR-9) is suitable for use as a chase only when the following conditions are met: (3-20-20)T
- (1) When internal conductors are jacketed submersible pump cable. (3-20-20)T
- (2) When used in continuous lengths, directly buried, or secured on a shoreline above and below the water line. (3-20-20)T

(3) When submersible pump wiring terminations in the body of water according to 682.13 Exception No. 2 are met. (3-20-20)T

ii. Exception No. 2. Any listed and approved splices required to be made at the submersible well pump itself, outside of a recognized submersed pump sleeve or housing, when wires are too large to be housed inside such sleeve, shall be covered with a non-metallic, impact resistant material, no less than one quarter (.25) inches thick, such as heavy duty heat shrink or other equivalent method approved by the authority having jurisdiction. (Eg. install a heat shrink over the sleeve or housing that the submersible well pump is installed in, and then recover (apply heat) the heat shrink over both the HDPE and the water line). At least six (6) inches shall be over the sleeve and at least twelve (12) inches over the HDPE and water line. (3-20-20)T

iii. Exception No. 3. Pipe, conduit, PVC well casing, or other electrically unlisted tubing may be used as a chase, but not as a raceway, to protect conductors or cables from physical damage. Conductors or cables within a chase shall be rated for the location. (3-20-20)T

**m.** Article 682.14. Add the following additional exception to Article 682.14: For installations of submersible well pumps installed in public swimming and marine areas, submersible well pumps shall be considered directly connected and shall be anchored in place. Ballast is an acceptable form of anchoring. (3-20-20)T

**n.** Article 682.14(A). Add the following exception to Article 682.14(A): For installations of submersible well pumps installed in public swimming and marine areas, motor controller circuits such as remotely located stop pushbutton/s, disconnect/s, relay/s or switches shall be permitted as a required disconnecting means. Such circuits shall be identified at a minimum as “Emergency Pump Stop”, or “Emergency Stop” with other obvious indications on the visible side of the enclosure, that it controls a submersible pump in the body of water. (3-20-20)T

**o.** Article 682.15. Add the following exceptions to Article 682.15: (3-20-20)T

i. Exception No. 1. Submersible pumps, and their motor leads, located in bodies of water, and that are rated sixty (60) amperes maximum, two hundred fifty (250) volts maximum of any phase, shall have GFCI or Ground Fault Equipment Protection designed to trip at a maximum of thirty (30) milliamps or less, protected by means selected by a licensed installer, meeting listing or labeling requirements, and inspected by the AHJ prior to submersion in bodies of water. (3-20-20)T

ii. Exception No. 2. Installations or repair and replacement of submersible pumps located in bodies of water, that are rated over sixty (60) amperes, and rated at any voltage, shall be evaluated by a qualified designer or experienced licensed contractor, or involve engineering or be engineered, for each specific application, with the goal of public safety. Whenever possible, GFCI or Ground Fault Equipment Protection designed to trip at a maximum of thirty (30) milliamps or less, meeting listing or labeling requirements, shall be installed, and inspected by the AHJ prior to submersion in bodies of water. (3-20-20)T

**p.** Article 550.32(B). Compliance with Article 550.32(B) shall limit installation of a service on a manufactured home to those homes manufactured after January 1, 1992. (3-20-20)T

**q.** Poles used as lighting standards that are forty (40) feet or less in nominal height and that support no more than four (4) luminaires operating at a nominal voltage of three hundred (300) volts or less, shall not be considered to constitute a structure as that term is defined by the National Electrical Code (NEC). The disconnecting means shall not be mounted to the pole. The disconnecting means may be permitted elsewhere in accordance with NEC, Article 225.32, exception 3. SEC special purpose fuseable connectors (model SEC 1791-DF or model SEC 1791-SF) or equivalent shall be installed in a listed handhole (underground) enclosure. The enclosure shall be appropriately grounded and bonded per the requirements of the NEC applicable to Article 230-Services. Overcurrent protection shall be provided by a (fast-acting – minimum - 100K RMS Amps 600 VAC) rated fuse. Wiring within the pole for the luminaires shall be protected by supplementary overcurrent device (time-delay – minimum - 10K RMS Amps 600 VAC) in break-a-away fuse holder accessible from the hand hole. Any poles supporting or incorporating utilization equipment or exceeding the prescribed number of luminaires, or in excess of forty (40) feet, shall be considered structures, and an appropriate service disconnecting means shall be required per the NEC. All luminaire-supporting poles shall be appropriately grounded and bonded per the NEC. (3-20-20)T

**r.** Compliance with Article 210.12 Arc-Fault Circuit-Interrupter Protection. Article 210.12 shall apply in full. Exception: In dwelling units Arc-Fault Circuit-Interrupter Protection shall only apply to all branch circuits and outlets supplying bedrooms. All other locations in dwelling units are exempt from the requirements of Article 210.12. (3-20-20)T

**02. Availability.** A copy of the National Electrical Code is available at the offices of the Division. (3-20-20)T

**251. --299. (RESERVED)**

**SUBCHAPTER G – CONTINUING EDUCATION REQUIREMENTS**  
**(Rules 300 through 349)**

**300. CONTINUING EDUCATION REQUIREMENTS.**

Journeyman and master electricians must complete at least twenty-four (24) hours of continuing education instruction in every three (3) year period between renewals of such licenses. The twenty-four (24) hours of instruction shall consist of eight (8) hours of code update covering changes included in the latest edition of the National Electrical Code. The remaining sixteen (16) hours may consist of any combination of code-update training, code-related training, or industry-related training. Proof of completion of these continuing education requirements must be submitted to the Division prior to or with the application for license renewal by any such licensee in order to renew a journeyman or master electrician license for the code change year. (3-20-20)T

**301. COURSE APPROVAL REQUIREMENTS.**

Continuing education courses for electricians must cover technical aspects of the electrical trade. Courses will be approved as either code update, code related or industry related based on the criteria as defined in this section. (3-20-20)T

**01. General Course Requirements.** (3-20-20)T

**a.** Courses must be at least four (4) hours in length. (3-20-20)T

**b.** Courses must be taught by an instructor approved by the Division. (3-20-20)T

**c.** The presentation should be delivered orally with the assistance of power point or other means of visual media. Pre-taped video or audio shall be held to a minimum. (3-20-20)T

**d.** A course evaluation card shall be provided to all participants to evaluate course and presentation. The completed evaluation cards must be submitted to the Division. (3-20-20)T

**e.** All programs are subject to audit by representatives of the Division or Board for content and quality without notice and at no charge. Course and instructor approval are subject to revocation if the minimum requirements of course content or instructor qualifications are not met. (3-20-20)T

**02. Code-Update Programs.** Code-update programs must cover changes to the National Electrical Code utilizing pre-approved materials such as the NFPA-IAEI Analysis of Changes. (3-20-20)T

**03. Code-Related Programs.** Code-related programs must cover portions of NFPA 70 other than changes to the National Electrical Code. (3-20-20)T

**04. Industry-Related Programs.** Industry-related programs shall be technical in nature and directly related to the electrical industry. Electrical theory, application of the National Electrical Code, grounding, photovoltaic systems, programmable controllers, and residential wiring methods are examples of industry-related programs. (3-20-20)T

**05. Program Approval Procedures.** (3-20-20)T

**a.** Program approvals are effective for one (1) code cycle. Subsequent applications for the same



program may incorporate by reference all or part of the original application. An application for course approval must be on a form obtained from the Division and include all requirements specified on the form. (3-20-20)T

**b.** Certificates of Completion. Certificates of completion must contain the following: the date of the program the title of the program; the location of the program the name of the sponsor; the number of hours of credit completed; the name of the attendee; the license number of the attendee; the name of the instructor; and the Idaho course approval number. (3-20-20)T

**c.** Evaluation Cards. Evaluation cards or forms must be pre-addressed to the Division and must include the following: the date; title; and location of the program; the instructors name; and an evaluation of the course and of the instructor's presentation skills. (3-20-20)T

**06. Appeals.** Appeals for courses that have been denied approval shall be submitted in writing to the Board within thirty (30) days for review. (3-20-20)T

**07. Instructor Approval Procedures.** (3-20-20)T

**a.** Instructor approvals shall be effective for one (1) code cycle. (3-20-20)T

**b.** An application for instructor approval may be obtained from the Division. Documentation of the instructor qualifications must be included with the instructor application. The minimum qualification for an instructor shall be established by providing proof of one (1) of the following: (3-20-20)T

**i.** Current and active master or journeyman electrician license; (3-20-20)T

**ii.** An appropriate degree related to the electrical field; or (3-20-20)T

**iii.** Other recognized experience or certification in the subject matter to be presented. (3-20-20)T

**c.** Any person denied instructor approval may appeal to the Board within thirty (30) days. (3-20-20)T

**08. Revocation of Approval.** (3-20-20)T

**a.** The Board may revoke, suspend, or cancel the approval of any continuing education program or instructor if the Board determines that the program or instruction does not meet the intent of furthering the education of electricians. Grounds for revocation of approval include, but are not limited to: (3-20-20)T

**i.** Failure of the instructor to substantially follow the approved course materials; (3-20-20)T

**ii.** Failure to deliver instruction for the full amount of time approved for the course; or (3-20-20)T

**iii.** Substantial dissatisfaction with the instructor's presentation or the content of the course or materials by the class attendees or representatives of the Division or Board. (3-20-20)T

**09. Board and Negotiated Rulemaking Meetings.** Licensees may receive up to eight (8) hours of industry-related continuing education credits by attending eight (8) hours of board meetings or electrical-board negotiated rulemaking meetings. (3-20-20)T

**10. Schedule of Approved Classes.** The Division shall publish a list of approved classes at a minimum of once a year. This list shall be forwarded to all states that are members of the continuing education reciprocal agreement and shall be made available to any licensee through the Division. (3-20-20)T

**302. -- 349. (RESERVED)**

**SUBCHAPTER H – ELECTRICAL INSPECTION APPEALS**  
**(Rules 350 through 399)**

**350. APPEALS.**

In order to determine the suitability of materials and methods of wiring and to provide for interpretations of the provisions of the National Electrical Code NFPA 70, the creation of an electrical appeals board is hereby authorized by the administrator of the Division, to be composed of three (3) members of the Board, or an electrical supervisor and two (2) members of the Board, as determined and selected by the administrator upon receipt of a written notice of appeal as set forth below. (3-20-20)T

**01. Notice of Appeal.** A person, firm, or corporation making an electrical installation subject to the provisions of Title 54, Chapter 10, Idaho Code, may appeal, to the administrator, a decision by the Electrical Program Manager or other electrical inspector, that a particular electrical installation is not in conformance with Idaho Code, these rules, or the National Electrical Code as adopted by Idaho law. An appeal must be lodged by filing a written notice of appeal with the administrator within ten (10) days of the date of issuance of a notice of correction issued pursuant to Section 54-1004, Idaho Code. The notice of appeal shall state in particular the reasons why the appellant contends that the notice of defects is incorrect. (3-20-20)T

**02. Filing Date.** If mailed, the notice of appeal shall be considered filed as of the date of postmark. (3-20-20)T

**03. Appeals Board.** The members of the Board and other persons appointed by the administrator to act as the appeals board, are authorized to hold hearings at the Division in Meridian, Idaho, to determine the merits of an appeal filed pursuant to this rule. (3-20-20)T

**04. Function of Appeals Board.** The members of the Board, acting as an appeals board, shall not have the authority to grant variances from the National Electrical Code; its sole function as an appeals board shall be to determine whether the materials or method of wiring utilized by the appellant meets the requirements of the National Electrical Code. (3-20-20)T

**05. Appeals Hearing Fee.** An appeals hearing fee of one hundred dollars (\$100) shall be charged to an appellant for each appeal brought before the appeals board and accompany the notice of appeal. When the appeal is found in favor of the appellant, the appeals hearing fee shall be returned to the appellant. (3-20-20)T

**06. Conditions Disqualifying Board Member.** No Board member shall sit on an appeals board in which he or his employer, employee, business partner or any person related to him, is the appellant in the matter. or where he has a pecuniary interest in the outcome of the matter to be decided by the appeals board. (3-20-20)T

**07. Rules of Evidence.** The rules of evidence for the hearing are governed by the Idaho Administrative Procedures Act, Title 67, Chapter 52, Idaho Code. (3-20-20)T

**08. Limitations of Appeal.** The filing of an appeal does not stay or discontinue a red tag, disconnect order, or notification to the power company not to connect or energize, in situations where the defect is of a nature so as to be an imminent threat to life or property. (3-20-20)T

**09. Preliminary Order.** Within five (5) days of the conclusion of the administrative hearing, the appeals board shall issue a preliminary order. The preliminary order will become a final order without further notice unless reviewed by the administrator, or review is requested by any party to the inspection appeal, pursuant to the provisions of Section 67-5245, Idaho Code. When a preliminary order is reviewed by the administrator, the administrator will issue a final order pursuant to the requirements of Sections 67-5245 and 67-5246, Idaho Code. (3-20-20)T

**10. Motions for Reconsideration.** Motions for reconsideration of the appeal board's preliminary order or of the administrator's final order are not allowed. (3-20-20)T

**351. -- 399. (RESERVED)**

**SUBCHAPTER I – CERTIFICATION AND APPROVAL OF ELECTRICAL PRODUCTS**

**AND MATERIALS**  
**(Rules 400 through 449)**

**400. CERTIFICATION AND APPROVAL OF ELECTRICAL PRODUCTS AND MATERIALS.**

In the state of Idaho, all materials, devices, fittings, equipment, apparatus, luminaires, and appliances installed or to be used in installations that are supplied with electric energy shall be approved as provided in one (1) of the following methods: (3-20-20)T

**01. Testing Laboratory.** Be tested, examined, and certified (Listed) by a Nationally Recognized Testing Laboratory (NRTL). (3-20-20)T

**02. Field Evaluation.** Non-listed electrical equipment may be approved for use through a field evaluation process performed in accordance with recognized practices and procedures such as those contained in the 2012 edition of NFPA 791 - Recommended Practice and Procedures for Unlabeled Electrical Equipment Evaluation published by the National Fire Protection Association (NFPA). Such evaluations shall be conducted by: (3-20-20)T

**a.** The authority having jurisdiction; (3-20-20)T

**b.** A field evaluation body approved by the authority having jurisdiction. The field evaluation body shall meet minimum recognized standards for competency, such as NFPA 790 - Standard for Competency of Third-Party Field Evaluation Bodies, 2012 edition, published by the National Fire Protection Association (NFPA); or (3-20-20)T

**c.** In the case of industrial machinery only, as defined by NFPA 79 - Electrical Standard for Industrial Machinery, 2012 edition, a field evaluation may be performed by a professional engineer currently licensed to practice electrical engineering by the state of Idaho and who is not involved in the design of the equipment being evaluated or the facility in which the equipment is to be installed. (3-20-20)T

**03. Availability of NFPA Standards.** The most recent edition of NFPA 790 - Standard for Competency of Third-Party Field Evaluation Bodies, and NFPA 791 - Recommended Practice and Procedures for Unlabeled Electrical Equipment Evaluation published by the National Fire Protection Association (NFPA) are available at the Division. (3-20-20)T

**401. -- 449. (RESERVED)**

**SUBCHAPTER J – CIVIL PENALTIES**  
**(Rules 450 through 499)**

**450. CIVIL PENALTIES.**

Except for the acts described in Subsections 450.01 and 450.10 of this rule, the acts described in this section shall subject the violator to a civil penalty of not more than two hundred dollars (\$200) for the first offense and not more than one thousand dollars (\$1,000) for each offense that occurs thereafter within one (1) year of an earlier violation. (3-20-20)T

**01. Electrical Contractor.** Except as provided by Section 54-1016, Idaho Code, any person who acts, or purports to act as an electrical contractor, as defined by Section 54-1003A, Idaho Code, without a valid Idaho state electrical contractor's license shall be subject to a civil penalty of not more than five hundred dollars (\$500) for the first offense and a civil penalty of not more than one thousand dollars (\$1,000) for each offense thereafter. (3-20-20)T

**02. Employees.** Any person, who knowingly employs a person who does not hold a valid Idaho state electrical license or registration as required by Section 54-1010, Idaho Code, to perform electrical installations. (3-20-20)T

**03. License or Registration.** Except as provided by Section 54-1016, Idaho Code, any person performing electrical work as a journeyman electrician as defined by Section 54-1003A(2), Idaho Code, limited

electrical installer as defined by Section 54-1003A(6), Idaho Code, apprentice electrician as defined by Section 54-1003A(3), Idaho Code, or a limited electrical installer trainee as defined by Section 54-1003A(8), Idaho Code, without a valid license or registration. (3-20-20)T

**04. Journeyman to Apprentice Ratio.** Any electrical contractor or facility account employing electricians in violation of the journeyman to apprentice ratio established by the Board. (3-20-20)T

**05. Supervision.** Any contractor failing to provide constant on-the-job supervision to apprentice electricians or trainees by a qualified journeyman electrician or limited electrical installer. (3-20-20)T

**06. Performance Outside Scope of License.** Any limited electrical contractor or limited electrical installer performing electrical installations, alterations or maintenance outside the scope of the contractor's or installer's limited electrical license. (3-20-20)T

**07. Fees and Permits.** Any person failing to pay applicable fees or properly post an electrical permit. (3-20-20)T

**08. Corrections.** Any person who fails to make corrections in the time allotted in the notice on any electrical installation as set forth in Section 54-1004, Idaho Code. (3-20-20)T

**09. Failure to Disclose.** Any applicant for an electrical registration, license, or certificate of competency who upon request fails to disclose any required information including, but not limited to, their complete licensure history or the fact that they have been previously granted a recognized license. (3-20-20)T

**10. Gross Violation.** In the case of continued, repeated or gross violation of Title 54, Chapter 10, Idaho Code, or these rules, a license revocation shall be initiated for licensees under this chapter and non-licensees shall be subject to prosecution by the appropriate jurisdiction under Idaho law. (3-20-20)T

**451. -- 999. (RESERVED)**

## 07.02.02 – RULES GOVERNING PLUMBING

### 000. LEGAL AUTHORITY.

In accordance with Sections 54-2605(1) and 54-2606(3), Idaho Code, the Idaho Plumbing Board is authorized to make, promulgate, and publish such rules as may be necessary for carrying out the provisions of this act in order to effectuate the purposes thereof and for the orderly and efficient administration thereof, and except as may be limited or prohibited by law and the provisions of this act, such rules so made and promulgated have the force of statute.

(3-20-20)T

### 001. TITLE AND SCOPE.

01. **Title.** IDAPA 07.02.02, “Rules Governing Plumbing.”

(3-20-20)T

02. **Scope.** These rules prescribe criteria for plumbing permits, fee schedules for plumbing permits, inspections of plumbing installations, the issuance of licenses for plumbing installation, adoption and amendment of the Idaho State Plumbing Code, and civil penalties.

(3-20-20)T

### 002. ADMINISTRATIVE APPEALS.

Within ten (10) days of receiving notice of a civil penalty, the notified party shall comply with the penalty or file a written request for an administrative appeal before the Board and pay a bond in the amount of the penalty. Title 67, Chapter 52, Idaho Code, and IDAPA 04.11.01, “Idaho Rules of Administrative Procedure of the Attorney General,” shall govern administrative appeals and judicial review thereof.

(3-20-20)T

### 003. INCORPORATION BY REFERENCE.

The Idaho State Plumbing Code, 2017 Edition, is incorporated by reference into these rules as further specified in Rule 301.

(3-20-20)T

### 004. -- 006. (RESERVED)

### 007. DEFINITIONS.

01. **Administrator.** The Division of Building Safety Administrator.

(3-20-20)T

02. **Board.** The Idaho State Plumbing Board, created under the provisions of Section 54-2605, Idaho Code.

(3-20-20)T

03. **Division.** The Division of Building Safety of the state of Idaho.

(3-20-20)T

04. **Fixture.** Any water using or waste producing unit attached to the plumbing system, and includes sewers, water treatment equipment, solar systems, sprinkler systems, hot tubs and spas.

(3-20-20)T

### 008. -- 100. (RESERVED)

## SUBCHAPTER A – PLUMBING PERMITS, FEE SCHEDULE, AND SAFETY INSPECTIONS (Rule 101 through 103)

### 101. PERMITS.

01. **Serial Number.** Each permit must bear a serial number.

(3-20-20)T

02. **Plumbing Contractors.** Permits will be furnished by the Division to licensed plumbing contractors upon request. Permit serial numbers must be registered in the name of the plumbing contractor and are transferable only as provided herein these rules.

(3-20-20)T

03. **Home Owners.** Home owners making plumbing installations on their own premises under the provisions of Section 54-2602, Idaho Code, must secure a plumbing permit by making application to the Division as provided by Section 54-2620, Idaho Code.

(3-20-20)T

04. **Commercial, Industrial and Others.** The application form must be properly completed, and returned to the Division together with a verified copy of bid acceptance and the proper permit fee as hereinafter provided. Persons, companies, firms, associations, or corporations making plumbing installations, other than on their

own property, must be licensed as a contractor by the state of Idaho as provided by Section 54-2610, Idaho Code. (3-20-20)T

**05. Expiration of Permit.** Every permit expires and becomes null and void if the work authorized by such permit is not commenced within one hundred twenty (120) days from the date of permit issuance, or if work authorized by such permit is suspended or abandoned at any time after work is commenced for a period of one hundred twenty (120) days. Before such work can be recommenced, a new permit must first be obtained, and the fee is one-half (1/2) the amount of a new permit for such work; provided, no changes have been made, or will be made in the original plans and specifications for such work; and provided further, that such suspension or abandonment has not exceeded one (1) year. All plumbing fixtures must be listed on the application for permit. (3-20-20)T

**06. Transferring a Permit.** A plumbing permit may be transferred to another eligible party if such party provides to the Division written authorization signed and notarized by the original permit holder consenting to the transfer itself, as well as assignment of all responsibilities and conditions incorporated into the original permit issuance. A permit may be transferred to the owner of the property on which the plumbing work is to be performed and for which the permit was issued, or such owner’s designated legal agent in cases where the property owner has terminated their legal relationship with the plumbing contractor who originally obtained the permit. An administrative fee in the amount of forty-five dollars (\$45) for the transfer of a permit will be assessed by the Division. (3-20-20)T

**07. Refunds of Permits.** (3-20-20)T

**a.** The Administrator may authorize a refund of the entire permit fee paid when no work has been performed related to the installation of plumbing work covered by a permit issued by the Division. A lesser amount up to fifty percent (50%) of the permit fee amount may be refunded if work has commenced and the project is less than fifty percent (50%) complete as determined by the Division; and (3-20-20)T

**b.** The Administrator will not authorize a refund of any permit fee paid except upon written application for such filed by the original permit holder or the property owner’s representative not less than one hundred eighty (180) days after the date the permit was issued. (3-20-20)T

**102. PERMIT FEE SCHEDULE.**

**01. New Residential.** Includes all buildings with plumbing systems being constructed on each property. The following fees shall apply to new residential construction:

<b>One-Family Dwelling</b>	
<b>Square Feet</b>	<b>Fee</b>
Up to 1,500	- \$130
1,501 to 2,500	- \$195
2,501 to 3,500	- \$260
3,501 to 4,500	- \$325
Over 4,500	- \$325 plus \$65 for each additional 1,000 square feet or portion thereof

<b>Two- or Multi-Family Dwelling</b>	
<b>Dwelling</b>	<b>Fee</b>
Two-family dwelling	- \$260

<b>Two- or Multi-Family Dwelling</b>	
<b>Dwelling</b>	<b>Fee</b>
Multi-family dwelling -	130 per Building plus \$65 per Unit

(3-20-20)T

**02. Miscellaneous.** The following fees shall apply for the types of permits listed:

<b>Type</b>	<b>Fee</b>
Existing residential	\$65 per inspection plus \$10 for each additional fixture
Requested inspection	\$65 per hour or portion thereof plus costs of out-of-state travel
Technical service	\$65 per hour or portion thereof
Plan check	
Mobile home, manufactured home, or recreational vehicle park	Calculated under Subsection 102.03 of these rules
Sewer or water service line - nonresidential (new construction, installations, and replacements)	
Reclaimed water system	
Lawn sprinkler system - nonresidential	
Lawn sprinkler system - residential	\$65 per inspection
Sewer or water service line - residential (new construction, installations, and replacements)	
Mobile or manufactured home	
Modular building	
Multipurpose residential fire sprinkler	\$65 or \$4 per fire sprinkler head, whichever is greater
Gray water system	\$130 per inspection

(3-20-20)T

**03. Other Installations Including Industrial and Commercial.** The fees listed in this Subsection shall apply to plumbing installations in this schedule that refer to this Subsection and installations not specifically mentioned elsewhere in this schedule. The plumbing system cost shall be the cost to the owner of labor charges and other costs incurred to complete the installation of plumbing equipment and materials installed as part of the plumbing system. All fees calculated under this Subsection must be based on the total plumbing system cost, which must be listed on the permit.

<b>Plumbing System Cost</b>	<b>Fee</b>
Up to \$10,000 -	\$60 plus 2% of plumbing system cost
\$10,000 to \$100,000 -	\$260 plus 1% of plumbing system cost exceeding \$10,000

Plumbing System Cost	Fee
Over \$100,000	- \$1,160 plus .5% of plumbing system cost exceeding \$100,000

(3-20-20)T

**04. Additional Fees.** A fee of sixty-five dollars (\$65) per hour or portion thereof shall apply to trips to inspect when the permit holder has given notice to the Division of Building Safety that the work is ready for inspection and it is not; (3-20-20)T

- a. If the permit holder has not accurately identified the work location; (3-20-20)T
- b. If the inspector cannot gain access to make the inspection; (3-20-20)T
- c. Corrections required by the inspector as a result of the permit holder improperly responding to a corrective notice. (3-20-20)T
- d. When corrections have not been made in the prescribed time, unless an extension has been requested and granted. (3-20-20)T

**05. No Permit.** Failure to purchase a permit before commencing work may result in the assessment of a double fee. (3-20-20)T

**103. REQUIRED INSPECTIONS.**

**01. Ground Work Inspection Tags.** For ground work to be covered, with acceptance by the inspector. A tag will be attached in a prominent location, preferably to a vertical riser. (3-20-20)T

**02. Rough-In Inspection Tags.** For rough-in, prior to covering or concealing, with acceptance by the inspector. A tag will be placed in a prominent location. (3-20-20)T

**03. Final Inspection Tags.** For final, attached when the plumbing as specified on the permit is complete and conforms to the requirements of the code. (3-20-20)T

**04. Inspection Tags for Unacceptable Plumbing.** Correction Notice - when attached to the plumbing system means that the plumbing is not acceptable and that corrections are required. A reinspection and reinspection fee for such installations shall be required in accordance with this chapter. (3-20-20)T

**104. -- 199. (RESERVED)**

**SUBCHAPTER B – PLUMBING SAFETY LICENSING**  
**(Rule 201 through 210)**

**201. LICENSURE HISTORY.**

An applicant for any plumbing registration or certificate of competency who has been previously licensed as a journeyman or master plumber in any recognized jurisdiction is required upon application to the Division of Building Safety to disclose such licensure history and provide sufficient proof thereof. An applicant for any plumbing registration or certificate of competency who has been previously licensed as a journeyman or master plumber in any recognized jurisdiction will not be issued a plumbing apprentice registration. (3-20-20)T

**202. APPRENTICE REGISTRATION.**

A person wishing to become a plumbing apprentice must register with the Division prior to going to work. All apprentices must pay the registration fee as prescribed by Section 54-2614, Idaho Code. The minimum age for any apprentice must be sixteen (16) years. No examination is required for such registration. In order to maintain registration, the apprentice must renew his registration in accordance with Sections 54-2614 and 54-2614A, Idaho Code. (3-20-20)T



**01. Work Requirements.** A plumbing apprentice must work at the trade under the constant on-the-job supervision of a journeyman and in the employ of a contractor for a total of four (4) years, defined as a minimum of eight thousand (8,000) hours work experience in order to be eligible for a journeyman certificate of competency. (3-20-20)T

**02. Schooling Requirements.** A plumbing apprentice must complete a Board-approved related course of instruction for four (4) years in order to be eligible for a journeyman certificate of competency. Unless prior approval has been granted by the Division the apprentice must complete the required course work sequentially: year one (1) must be completed prior to beginning year two (2); year two (2) must be completed prior to beginning year three (3); and year three (3) must be completed prior to beginning year four (4). A minimum of one hundred forty-four (144) hours of classroom or other Idaho Plumbing Board-approved instruction time per school year is required. A grade average of seventy percent (70%) must be attained in these courses. Upon completion of apprenticeship schooling, the apprentice must obtain a certificate of completion, or a letter signed by the chairman of his apprenticeship committee, and attach the certificate or letter to his application for a journeyman license. (3-20-20)T

**03. Journeyman Examination.** (3-20-20)T

**a.** Any plumbing apprentice who desires to take the written portion of the journeyman examination must complete an Idaho Plumbing Board approved related course of instruction for four (4) years as described in Subsection 202.02 of these rules prior to the date of the exam and provide a certificate of completion with the application for examination. There is no minimum work requirement in order to be eligible to take the written portion of the plumbing journeyman examination. (3-20-20)T

**b.** Successful completion of the journeyman written examination does not eliminate the requirement to complete four (4) years of work experience, defined as eight thousand (8,000) hours, under the constant on-the-job supervision of a journeyman plumber or the practical portion of the examination in order to be issued a journeyman certificate of competency. Successful completion of the written plumbing journeyman examination notwithstanding, no journeyman certificate of competency will be issued until an apprentice successfully completes the practical portion for the examination and furnishes to the Division proof of satisfaction of the work requirements contained in Subsection 011.01 of these rules. Satisfaction of the work requirements contained in Subsection 202.01 of these rules is required before any individual is eligible to take the practical portion of the journeyman examination. (3-20-20)T

## **203. JOURNEYMAN.**

**01. Qualifications for Journeyman Plumber.** An applicant for a journeyman plumber's certificate of competency must have at least four (4) years' experience as an apprentice making plumbing installations under the constant on-the-job supervision of a qualified journeyman plumber, as provided by Section 54-2611, Idaho Code. Pipe fitting will not be accepted as qualifications for a journeyman plumber's certificate of competency. In order to obtain a journeyman certificate of competency, an individual must submit an application for examination and license. The application must be accompanied by proof the applicant has completed an approved course of instruction for four (4) years as provided in Subsection 202.02 of these rules. The journeyman examination may be taken by an individual who has successfully completed a Board-approved course of instruction for four (4) years as described in Subsection 202.03 of these rules. The examination fee is as prescribed by Section 54-2614, Idaho Code, and must accompany the application. (3-20-20)T

**02. Examination.** The journeyman examination grade is based on answers to written questions and practical work performed on plumbing installations as determined by the Division after successful completion of the written examination. Time allowed for the written examination is four (4) hours. A passing grade is required on the written examination. The practical portion of the exam may be performed on a job in-progress or in a laboratory setting and must consist of work performed in either a residential or commercial application. The practical portion of the exam must pass with no violations. (3-20-20)T

**03. Out-of-State Journeyman Applications.** (3-20-20)T

**a.** Exhibition of a license issued by another recognized jurisdiction may be accepted as proof of meeting the experience and schooling requirements listed in Subsections 203.01 and 203.02 of these rules. An

application for a journeyman certificate of competency from an individual previously licensed as a journeyman in another jurisdiction recognized by the Idaho Plumbing Board must include satisfactory proof of licensure in such jurisdiction. The applicant must pay all applicable application and examination fees to the Division, and successfully complete the journeyman examination administered by the Division. (3-20-20)T

**b.** An application for a journeyman certificate of competency from an individual who has never been previously licensed as a journeyman in a jurisdiction recognized by the Board must include evidence that demonstrates that the applicant has four (4) years of plumbing work experience of a nature at least equivalent to that which a plumbing apprentice must perform in Idaho, as well as four (4) years of schooling equivalent to that which a plumbing apprentice must complete in Idaho. Alternatively, such an applicant may submit proof verifying eight (8) years, defined as a minimum of sixteen thousand (16,000) hours of plumbing work experience of a nature at least equivalent to that which a plumbing apprentice must perform in Idaho. Upon submission of sufficient proof of having completed such experience and schooling requirements, such applicant must also pay all applicable application and examination fees to the Division, and successfully complete the journeyman examination administered by the Division. (3-20-20)T

## **204. PLUMBING CONTRACTOR.**

**01. Qualifications for Plumbing Contractor.** A plumbing contractor must be certified as competent by the Idaho Plumbing Board and the administrator of the Division before he offers his service to the public. To obtain the certificate, he must first submit an acceptable application. The applicant must possess an active journeyman plumbing certificate of competency issued by the Division, a provable minimum of two and one-half (2 1/2) years' experience as a licensed journeyman plumber in the state of Idaho, as well as provide payment to the Division for all applicable application and examination fees, and successfully complete the contractor examination administered by the Division. The compliance bond required by Section 54-2606, Idaho Code, is required to be on file with the Division upon successful completion of the examination. The examination fee is as prescribed by Section 54-2614, Idaho Code. (3-20-20)T

### **02. Out-of-State Contractor Applications.** (3-20-20)T

**a.** An applicant for a contractor certificate of competency who has previously been licensed as a journeyman in another jurisdiction recognized by the Idaho Plumbing Board must first obtain an Idaho journeyman certificate of competency in accordance with Section 203 of these rules. Such applicants may provide proof of two and one half (2 1/2) years of experience as a plumbing journeyman by providing satisfactory evidence to the Division of such work history in another recognized jurisdiction. Such applicants must also pay all applicable application and examination fees to the Division, and successfully complete the contractor examination administered by the Division. The compliance bond required by Section 54-2606, Idaho Code, is required to be on file with the Division upon successful completion of the examination. (3-20-20)T

**b.** An applicant for a contractor certificate of competency who has never been previously licensed as a journeyman in a jurisdiction recognized by the Idaho Plumbing Board must first obtain an Idaho journeyman certificate of competency in accordance with Section 203 of these rules. Such applicants must also provide proof of four (4) years of experience performing plumbing work of a nature equivalent to what a journeyman in Idaho must demonstrate to qualify for a contractor certificate of competency. Proof of such work experience may be provided by the submission of three (3) sworn affidavits from individuals attesting to the fact that the applicant has had at least four (4) years' experience performing such work. Alternatively, such an applicant must provide proof of two and one half (2 1/2) years of experience as a journeyman plumber in the state of Idaho. Such applicants must also pay all applicable application and examination fees to the Division, and successfully complete the contractor examination administered by the Division. The compliance bond required by Section 54-2606, Idaho Code, is required to be on file with the Division upon successful completion of the examination. Applications that are incomplete in any detail will be returned as unacceptable, or denied. (3-20-20)T

**03. Restrictive Use of Contractor Certificate.** Any individual holding a contractor certificate and designated by a firm to represent that firm for licensing purposes represents one (1) firm only, and must immediately notify the Division in writing when his working arrangement with that firm has been terminated for purposes of becoming self-employed or affiliation with another firm, or for any other reason. A license holder cannot represent any other person or firm, self-employed or otherwise, than originally stated on his application for license. When a

change is made, he is required to so inform the Division. Otherwise, he is guilty of transferring his license in violation of Section 54-2610, Idaho Code, and is subject to license suspension, revocation, or refusal to renew under Section 54-2608, Idaho Code, or to prosecution under the provisions of Section 54-2628, Idaho Code. (3-20-20)T

**04. Previous Revocation.** Any applicant for a plumbing contractor's license who has previously had his plumbing contractor's license revoked for cause, as provided by Section 54-2608, Idaho Code, is considered as unfit and unqualified to receive a new plumbing contractor's license so long as such cause for revocation is continuing, and of such a nature that correction can be made by the applicant. (3-20-20)T

**05. Reviving an Expired License.** Any applicant for a plumbing contractor's license who has allowed his license to expire and seeks to revive it under the provisions of Section 54-2617, Idaho Code, may be denied a license as unfit and unqualified if, while operating under the license prior to expiration, he violated any of the laws, rules or regulations applicable to plumbing contractors, and such violation is continuing, and of such a nature that corrections can be made by the applicant. (3-20-20)T

**06. Effective Dates.** The effective dates of the compliance bond referred to in Subsection 204.01 of these rules coincide with the effective dates of the contractor's license. Proof of renewal of the compliance bond must be on file with the Division before the contractor can renew or revive his license. (3-20-20)T

**07. Plumbing Contractor's Responsibility.** It is the responsibility of the plumbing contractor to ensure that all his employees working at the plumbing trade are licensed as provided by Idaho Code and these rules. (3-20-20)T

**08. Advertising.** Any person or entity advertising to engage in the business, trade, practice, or work of a plumbing contractor as defined in Section 54-2611, Idaho Code, who does not possess a current and valid plumbing contractor certificate of competency issued by the Division of Building Safety, is in violation of the licensing provisions of Title 54, Chapter 26, Idaho Code. Such conduct is punishable as a misdemeanor as prescribed by Section 54-2628, Idaho Code, and subject to civil penalties in accordance with these rules. (3-20-20)T

**a.** For the purposes of this Section, advertising includes, but is not limited to: newspaper, telephone directory, community flier ads or notices; telephone, television, radio, internet, or door-to-door solicitations. (3-20-20)T

**b.** Any advertising, as defined in Subsection 204.08 of these rules, conducted by those persons or entities with a valid certificate of competency must include the contractor certificate of competency number. (3-20-20)T

## **205. APPLICATIONS.**

All applications for licenses must be properly completed giving all pertinent information, and signatures must be notarized. Applications for plumbing contractor's license must be accompanied by a license fee in the amount prescribed by Section 54-2616, Idaho Code. An application for a journeyman license must be accompanied by a license fee in the amount prescribed by Section 54-2616, Idaho Code, and an examination fee as provided by Section 54-2614, Idaho Code. An application for a license must be submitted to the administrator of the Division and must be approved by an authorized representative of the Division before any examination is given and before any license is issued. The provisions of this section do not apply to renewal of licenses. (3-20-20)T

## **206. EXAMINATIONS.**

**01. Examinations for Journeyman Plumber.** Written examinations for any journeyman plumber's license are formulated and approved by the Idaho Plumbing Board. Examination questions are based on the practical application of the Uniform Plumbing Code. No certificate of competency will be issued unless the applicant receives a final grade of seventy-five percent (75%) or higher on the written examination and passes the practical portion with no violations, as well as completes the work requirements described in Paragraph 202.03.a. of these rules. An applicant receiving a grade of less than seventy-five percent (75%) may apply for reexamination upon payment of the examination fee. An applicant has six (6) months to achieve a passing score. If an applicant does not achieve a passing score in six (6) months, the applicant must enroll in year four (4) in a, Idaho Plumbing Board-approved related training course, complete year four (4), be registered with the Division as an apprentice, and maintain

registration as per Section 202 of these rules before the applicant will be eligible to apply for examination. A completion certificate for year four (4) and the proper application fee must accompany a new application for a journeyman examination. (3-20-20)T

**02. Frequency of Conducting of Examinations.** Examinations for all classifications under the Plumbing Laws and rules will be given a minimum of four (4) times each year in the Division's three office three (3) locations. (3-20-20)T

**03. Professional Testing Services.** In lieu of the administration by the Idaho Plumbing Board of the examination for licenses pursuant to this rule, the Idaho Plumbing Board may contract with a professional testing service to administer the examination, and require license applicants to pay to the testing service the fee that they have set for the examination and to take such examination at the time set by such service. If the examination is conducted in this fashion, the Idaho Plumbing Board may charge and retain the application fee provided for by Section 54-2616, Idaho Code, to cover the cost of reviewing the applicant's application. (3-20-20)T

**207. CERTIFICATES OF COMPETENCY -- ISSUANCE, RENEWAL, EXPIRATION, REVIVAL -- FEES.**

**01. Issuance.** Certificates of competency will be issued in such a manner as to create a renewal date that coincides with the birthdate of the individual to whom the certificate is issued and allows for renewals every three (3) years. (3-20-20)T

**a.** Certificates of competency will be issued for a period of no less than one (1) year and no more than three (3) years. For example: a qualified applicant who applies for a certificate of competency in August of year one (1) but whose birthday will not occur until March of year two (2) will be issued a certificate of competency renewable on the anniversary of the applicant's birthdate. (3-20-20)T

**b.** The fee for issuance of certificates of competency will be prorated based on the number of months for which it is issued. (3-20-20)T

**02. Renewal.** Certificates of competency will be renewed in such a manner as will achieve a staggered system of certificate renewal using the birthdate of the individual to whom the certificate is issued as the expiration date. (3-20-20)T

**a.** Certificates of competency will be renewed for a period of no less than one (1) year and no more than three (3) years. (3-20-20)T

**b.** The fee for renewal of certificates of competency will be prorated based on the number of months for which it is issued. (3-20-20)T

**c.** Continuing Education. The Idaho Plumbing Board will establish criteria for approval of instruction and instructors and courses and instructors will be approved by the Division of Building Safety. Proof of completion of the following continuing education requirements must be submitted to the Division prior to, or with the application for, licensure renewal by any licensee in order to renew a journeyman or contractors plumbing license. (3-20-20)T

**i.** Journeymen must complete eight (8) hours of continuing education for every three-year license cycle, or complete an exam administered by the Division. Of the required eight (8) hours, four (4) hours must be plumbing code update related and the other four (4) hours may be industry related training. (3-20-20)T

**ii.** Contractors must complete sixteen (16) hours of continuing education for every three-year license cycle. Hours accrued obtaining journeyman education may be applied toward this requirement whenever applicable. (3-20-20)T

**03. Expiration - Revival.** (3-20-20)T

**a.** A certificate that has expired may be revived in accordance with Section 54-2617, Idaho Code by submitting a completed application and meeting all other certification requirements. (3-20-20)T

b. Revived certificates will be issued in such a manner as to create a renewal date that coincides with the birthdate of the applicant to achieve a staggered system of renewal. (3-20-20)T

**208. SPECIALTY PLUMBING LICENSES.**

The purpose of this section is to set out the special types of plumbing installations for which a specialty license is required; to set out the minimum experience requirements for such licenses; and to describe the procedure for securing such licenses. (3-20-20)T

**01. Qualified Journeyman Plumbers.** Qualified journeyman plumbers as defined in Section 54-2611(b), Idaho Code, are permitted to make installations as subsequently described herein without securing an additional license for said installation. (3-20-20)T

**02. Minimum Experience Requirements.** (3-20-20)T

a. Experience gained by an individual while engaged in the practice of mobile home hook-ups is not considered towards the satisfaction of the minimum experience requirements for licensing as a journeyman plumber. (3-20-20)T

b. All installers must be licensed and be in the employ of a licensed plumbing contractor or specialty contractor limited to this category. (3-20-20)T

**03. Mobile Home Set-Up or Installers.** (3-20-20)T

a. Any person qualifying for and having in his possession a current license in this category may make the proper connections of sewer and water to existing facilities on site. All material and workmanship must comply with the requirements of the Uniform Plumbing Code. (3-20-20)T

b. All installers must be licensed and be in the employ of a licensed plumbing contractor or specialty contractor limited to this category. This specialty license does not permit any extension, alteration, or addition to the plumbing system within the mobile home or the installation of any underground plumbing outside the mobile home. (3-20-20)T

**04. Applications for Specialty Licenses.** Applications for the above specialty licenses may be obtained from the Division of Building Safety. The forms must be returned with the examination fee provided by Section 54-2614, Idaho Code, with proof of the required two (2) years' experience in the field of this specialty. (3-20-20)T

**05. Examinations for Specialty Licenses.** Written examinations for specialty plumbing licenses are formulated from the practical application of the sections of the Uniform Plumbing Code as adopted by the Idaho Plumbing Board under Section 54-2601, Idaho Code. (3-20-20)T

**06. Fees.** Fees for certificates are required in accordance with Section 54-2616, Idaho Code. (3-20-20)T

**209. APPLIANCE PLUMBING SPECIALTY LICENSE.**

The purpose of this section is to set out the special types of plumbing installations for which an appliance plumbing specialty license is required; to set out the minimum experience requirements for such licenses; and to describe the procedure for securing such licenses. (3-20-20)T

**01. Qualified Journeyman Plumbers.** Qualified journeyman plumbers as defined in Section 54-2611(b), Idaho Code, are permitted to make installations as subsequently described herein without securing an additional license for said installation. (3-20-20)T

**02. Qualified Apprentice Plumbers.** Qualified apprentice plumbers as defined in Section 54-2611(c), Idaho Code, are permitted to make installations as subsequently described herein without securing an additional license for said installation. (3-20-20)T

**03. Minimum Experience Requirements.** (3-20-20)T

**a.** Experience gained by an individual while engaged in the practice of appliance plumbing specialty is not considered towards the satisfaction of the minimum experience requirements for licensing as a journeyman plumber. (3-20-20)T

**b.** All qualified appliance plumbing specialty journeymen must be licensed and be in the employ of a licensed plumbing contractor or specialty contractor limited to this category. (3-20-20)T

**c.** Appliance plumbing specialty contractors must have a two thousand dollar (\$2,000) surety bond, thirty (30) months minimum journeyman experience, and successful completion of appliance plumbing specialty contractor's test. (3-20-20)T

**d.** Appliance plumbing specialty journeymen must have eighteen (18) months apprentice on-the-job experience, satisfactory completion of seventy-two (72) hours of Idaho Plumbing Board-approved, related training classes and successful completion of the appliance plumbing specialty journeyman's test. (3-20-20)T

**e.** Appliance plumbing specialty apprentices must be employed by a licensed contractor, under the supervision of a journeyman, be enrolled in or have completed Idaho Plumbing Board-approved related training classes and maintain state registration. (3-20-20)T

**04. Special Grandfathering Provision.** (3-20-20)T

**a.** Contractor: In lieu of the thirty (30) months minimum journeyman experience requirement, an individual may use five (5) years' experience of owning and operating a business where this specialty applies and satisfactory completion of seventy-two (72) hours of Idaho Plumbing Board-approved related training classes. For this purpose, a business is defined as an activity in which tax returns were required to be and have been filed for at least five (5) years. (3-20-20)T

**b.** Journeyman: In lieu of the eighteen (18) months apprentice on-the-job experience requirement, an individual may use five (5) years' experience working for a business where this specialty applies. For this purpose, working for a business is defined as being issued a W-2 earning form from a related business or businesses for at least five (5) years. (3-20-20)T

**05. Applications for Specialty Licenses.** Applications for the above specialty licenses may be obtained from the Division of Building Safety. The forms must be returned with the examination fee provided by Section 54-2614, Idaho Code, with proof of the required experience in the field of this specialty. (3-20-20)T

**06. Examinations for Specialty Licenses.** Written examinations for specialty plumbing licenses are formulated from the practical application of the sections of the Uniform Plumbing Code as adopted by the Idaho Plumbing Board under Section 54-2601, Idaho Code. (3-20-20)T

**07. Fees.** Fees for certificates are required in accordance with Section 54-2616, Idaho Code. (3-20-20)T

**08. Scope of Work Permitted.** Permitted to disconnect, cap, remove, and reinstall within sixty (60) inches of original location: water heating appliance, water treating or filtering devices; air or space temperature modifying equipment which involves potable water; humidifier; temperature and pressure relief valves; condensate drains and indirect drains in one-family and two-family residences only. Does not include installation, testing, or certifying of backflow prevention devices. Does NOT include any modification to the drain, waste or vent systems. Must comply with all Idaho plumbing laws and rules and the requirements of the Uniform Plumbing Code. (3-20-20)T

**210. WATER PUMP PLUMBING SPECIALTY LICENSE.**

The purpose of this section is to set out the special types of plumbing installations for which a water pump plumbing specialty license is required; to set out the minimum experience requirements for such licenses; and to describe the

procedure for securing such licenses. (3-20-20)T

**01. Qualified Journeyman Plumbers.** Qualified journeyman plumbers as defined in Section 54-2611(b), Idaho Code, are permitted to make installations as subsequently described herein without securing an additional license for said installation. (3-20-20)T

**02. Qualified Apprentice Plumbers.** Qualified apprentice plumbers as defined in Section 54-2611(c), Idaho Code, are permitted to make installations as subsequently described herein without securing an additional license for said installation. (3-20-20)T

**03. Minimum Experience Requirements.** (3-20-20)T

**a.** Experience gained by an individual while engaged in the practice of water pump plumbing specialty is not considered towards the satisfaction of the minimum experience requirements for licensing as a journeyman plumber. (3-20-20)T

**b.** All qualified water pump plumbing specialty journeymen must be licensed and be in the employ of a licensed plumbing contractor or specialty contractor limited to this category. (3-20-20)T

**c.** Water pump plumbing specialty contractors must have a two thousand dollars (\$2,000) surety bond, thirty (30) months minimum journeyman experience, and successful completion of water pump plumbing specialty contractor's test. (3-20-20)T

**d.** Water pump specialty journeymen must have eighteen (18) months apprentice on-the-job experience, satisfactory completion of twelve (12) hours of Idaho Plumbing Board-approved, related training classes and successful completion of the water pump plumbing specialty journeyman's test. (3-20-20)T

**e.** Water pump plumbing specialty apprentices must be employed by a licensed contractor, under the supervision of a journeyman, be enrolled in or have completed Idaho Plumbing Board-approved related training classes and maintain state registration. (3-20-20)T

**04. Special Grandfathering Provision.** (3-20-20)T

**a.** Contractor: In lieu of the thirty (30) month minimum journeyman experience requirement, an individual may use three (3) years' experience of owning and operating a business where this specialty applies and satisfactory completion of twenty-four (24) hours of Idaho Plumbing Board-approved related training classes. For this purpose, a business is defined as an activity in which tax returns were required to be and have been filed for at least three (3) years. (3-20-20)T

**b.** Journeyman: In lieu of the eighteen (18) months apprentice on-the-job experience requirement, an individual may use three (3) years' experience working for a business where this specialty applies. For this purpose, working for a business is defined as being issued a W-2 earning form from a related business or businesses for at least three (3) years. (3-20-20)T

**05. Applications for Specialty Licenses.** Applications for the above specialty licenses may be obtained from the Division of Building Safety. The forms must be returned with the examination fee provided by Section 54-2614, Idaho Code, with proof of the required experience in the field of this specialty. (3-20-20)T

**06. Examinations for Specialty Licenses.** Written examinations for specialty plumbing licenses are formulated from the practical application of the sections of the Uniform Plumbing Code as adopted by the Idaho Plumbing Board under Section 54-2601, Idaho Code. (3-20-20)T

**07. Fees.** Fees for certificates are required in accordance with Section 54-2616, Idaho Code. (3-20-20)T

**08. Scope of Work Permitted.** Permitted to install and connect water service piping from pump to storage expansion pressure tank in one (1) and two (2) family residences only. Does not include installation, testing or

certifying of backflow prevention devices. Must comply with all Idaho plumbing laws and rules and the requirements of the Uniform Plumbing Code. (3-20-20)T

**211. -- 300. (RESERVED)**

**SUBCHAPTER C – IDAHO STATE PLUMBING CODE**  
**(Rule 301)**

**301. ADOPTION AND INCORPORATION BY REFERENCE OF THE IDAHO STATE PLUMBING CODE.**

The Idaho State Plumbing Code published in 2017, including Appendices “A, B, C, D, E, G, I, J, K and L,” (herein ISPC) is adopted and incorporated by reference with amendments as prescribed by the Idaho Plumbing Board and contained in this Section. The Idaho State Plumbing Code is modeled after the 2015 Uniform Plumbing Code (UPC). (3-20-20)T

**01. Section 105.3 Testing of Systems.** (3-20-20)T

**a.** Delete and replace the following: Plumbing systems must be tested and approved in accordance with this code or the Authority Having Jurisdiction. Tests may be conducted in the presence of the Authority Having Jurisdiction or the Authority Having Jurisdiction’s duly appointed representative. (3-20-20)T

**b.** No test or inspection is required where a plumbing system, or part thereof, is set up for exhibition purposes and has no connection with a water or drainage system. In cases where it would be impractical to provide the required water or air tests, or the presences of the Authority Having Jurisdiction, or for minor installations and repairs, the Authority Having Jurisdiction, in accordance with procedures established thereby, is permitted to make such inspection as deemed advisable in accordance with the intent of this code. Joints and connections in the plumbing system must be gastight and watertight for the pressures required by the test. (3-20-20)T

**02. Section 218 Definitions.** Delete definition of “Plumbing System.” Incorporate definition of “Plumbing System” as set forth in Section 54-2604, Idaho Code. (3-20-20)T

**03. Section 314.4 Excavations.** Add: Where unsuitable or soft material is encountered, excavate to a depth not less than two (2) pipe diameters below the pipe and replace with select backfill. Such backfill must be sand, fine gravel, or stone and must provide lateral support for the pipe. Where rock is encountered, the trench must be excavated to a minimum depth of six (6) inches (152 mm) below the bottom of the pipe. Sand must be added to provide uniform bedding and support for the pipe. The pipe may not rest on any rock at any point, including joints. (3-20-20)T

**04. Section 401.2 Qualities of Fixtures.** Replace with the following: Plumbing fixtures must be constructed of dense, durable, non-absorbent materials and must have smooth, impervious surfaces, free from unnecessary concealed fouling surfaces. (3-20-20)T

**05. Section 403.3 Exposed Pipes and Surfaces.** Delete. (3-20-20)T

**06. Section 407.4 Transient Public Lavatories.** Self-closing or self-closing metering faucets may be installed on lavatories intended to serve the transient public, such as those in, but not limited to, service stations, train stations, airports, restaurants, convention halls, and rest stops. Installed metered faucets must deliver a maximum of zero point two six (0.26) gallons (one point zero (1.0) liter) of water per use. (3-20-20)T

**07. Section 408.5 Finished Curb or Threshold.** Delete the last sentences of the first paragraph and replace with the following: The finished floor of the receptor must slope uniformly from the sides toward the drain not less than one-eighth (1/8) inch per foot (20.8 mm/m), nor more than one-half (1/2) inch per foot (41.8 mm/m). (3-20-20)T

**08. Section 408.7.5 Tests for Shower Receptors.** Delete. (3-20-20)T

**09. Section 409.4 Limitation of Hot Water in Bathtubs and Whirlpool Bathtubs.** Delete.



(3-20-20)T

**10. Table 501.1(1) First Hour Rating.** Delete Table 501.1(1) and replace with the following:

<b>TABLE 501.1(1) FIRST HOUR RATING1</b>											
Number of Bathrooms	1 to 1.5			2 to 2.5				3 to 3.5			
Number of Bedrooms	1	2	3	2	3	4	5	3	4	5	6
First Hour Rating,2 Gallons	38	49	49	49	62	62	74	62	74	74	74

For SI units: one (1) gallon = 3.785 L

Notes:

1 The first hour rating is found on the “Energy Guide” label.

2 Solar water heaters must be sized to meet the appropriate first hour rating as shown in the table. (3-20-20)T

**11. Section 503.1 Inspection of Chimneys or Vents.** Add the following to the end of section 503.1: Water heating appliances using Category 3 or 4 exhaust venting must be tested in its entirety with five (5) pounds of air for fifteen (15) minutes. Plastic vents must be constructed using manufacturer’s instructions. (3-20-20)T

**12. Section 507.2 Seismic Provisions.** Delete. (3-20-20)T

**13. Section 507.13 Installation in Garages.** Replace 507.13 with the following: Any plumbing appliance or appurtenance in residential garages and in adjacent spaces that open to the garage and are not part of the living space of a dwelling unit must be installed so that burners, burner-ignition devices or other sources of ignition are located not less than eighteen (18) inches (450 mm) above the floor unless listed as flammable vapor ignition resistant. (3-20-20)T

**14. Table 603.2 Backflow Prevention Devices, Assemblies and Methods.** (3-20-20)T

**a.** Delete from the table the entire row related to freeze resistant sanitary yard hydrant devices. (3-20-20)T

**b.** Delete the backflow preventer for Carbonated Beverage Dispensers text from the first column of the table and replace with the following: Backflow preventer for Carbonated Beverage Dispensers (Reduced Pressure Principle Backflow Prevention Assembly). (3-20-20)T

**15. Section 603.5.7 Outlets with Hose Attachments.** Delete and replace with the following: Potable water outlets with hose attachments, other than water heater drains, boiler drains, freeze resistant yard hydrants and clothes washer connections, must be protected by a nonremovable hose bibb-type backflow preventer, a nonremovable hose bibb-type vacuum breaker, or by an atmospheric vacuum breaker installed not less than six (6) inches (one hundred fifty-two (152) mm) above the highest point of usage located on the discharge side of the last valve. In climates where freezing temperatures occur, a listed self-draining frost-proof hose bibb with an integral backflow preventer or vacuum breaker must be used. (3-20-20)T

**16. Section 603.5.12 Beverage Dispensers.** Delete and replace with the following: Potable water supply to, carbonated beverage dispensers must be protected by an air gap or a Reduced Pressure Principle Backflow Prevention Assembly in accordance with ASSE 1013. For carbonated beverage dispensers, piping material installed downstream of the backflow preventer must not be affected by carbon dioxide gas. Potable water supply to beverage dispensers and coffee machines must be protected by an air gap or a vented backflow preventer in accordance with ASSE 1022. (3-20-20)T

**17. Section 603.5.17 Potable Water Outlets and Valves.** Delete. (3-20-20)T

**18. Section 603.5.21 Chemical Dispensers.** Add the following new section 603.5.21: The water supply to chemical dispensers must be protected against backflow. The chemical dispenser must comply with ASSE 1055 or the water supply must be protected by one of the following methods: (3-20-20)T

- a. Air gap; (3-20-20)T
  - b. Atmospheric vacuum breaker (AVB); (3-20-20)T
  - c. Pressure vacuum breaker backflow prevention assembly (PVB); (3-20-20)T
  - d. Spill-resistant pressure vacuum breaker (SVB); or (3-20-20)T
  - e. Reduced-pressure principle backflow prevention assembly (RP). (3-20-20)T
- 19. Section 604.10.1 Tracer Wire.** Add the following exception: Where the electrical wiring for the pump is installed in the same trench as the water line, from the point of origin to the structure, a tracer wire is not required. (3-20-20)T
- 20. Section 605.6.2 Mechanical Joints.** Add to the end of the section the following: Listed PE (polyethylene), one hundred sixty (160) psi minimum, water service and yard piping may be installed within a building (above ground and below ground) with one (1) joint, provided that only listed and approved metallic transition fittings must be used. Polyethylene (PE) plastic pipe or tubing and fitting joining methods must be installed in accordance with the manufacturer's installation instructions. (3-20-20)T
- 21. Section 609.1 Installation.** Delete the following sentence: Building supply yard piping must be not less than twelve (12) inches (305 mm) below the average local frost depth; and replace it with the following: The cover must be not less than forty-two (42) inches (1068mm) below grade. (3-20-20)T
- 22. Section 609.4 Testing.** Deleting the phrase "Except for plastic piping," at the beginning of the third sentence and add the following sentence at the end of the section: Plastic piping is to be tested in accordance with manufacturer's installation standards. (3-20-20)T
- 23. Section 609.10 Water Hammer.** Does not apply to residential construction. (3-20-20)T
- 24. Section 609.11 Pipe Insulation.** Delete. (3-20-20)T
- 25. Table 610.3 and Appendix Table A 103.1.** Change fixture unit loading value for both public and private for bathtub or combination bath/shower, and clothes washers to two (2) fixture units. (3-20-20)T
- 26. Section 610.2 Pressure Loss.** Add the following: All new one (1) and two (2) family residences built slab on grade or that will have a finished basement at the time of final inspection must have a pre-plumbed water softener loop. The kitchen sink must have one (1) hot soft line and one (1) cold soft line and one (1) cold hard line. Exterior cold hose bibbs intended for irrigation purposes must be piped with hard water. (3-20-20)T
- 27. Table 611.4 Sizing of Residential Softeners.** Amend Footnote 3 to read: Over four (4) bathroom groups, softeners must be sized according to the manufacturer's standards. (3-20-20)T
- 28. Section 612.0 Residential Sprinkler System.** Add the following to the end of the first sentence in section 612.1: and the requirements of the Authority Having Jurisdiction (AHJ). (3-20-20)T
- 29. Table 702.1 Drainage Fixture Unit Valves (DFU).** Change fixture unit loading value for clothes washers, domestic for private to two (2) fixture units. (3-20-20)T
- 30. Section 703.1 Minimum Size.** Add the following at the end of section 703.1: No portion of the drainage or vent system installed underground, underground under concrete or below a basement or cellar must be less than two (2) inches in diameter. (3-20-20)T
- 31. Section 704.2 Single Vertical Drainage Pipe.** Two inch (2") and smaller double sanitary tees may be used for back to back or side by side fixture trap arms without increasing the barrel size. (3-20-20)T

32. **Section 704.3 Commercial Sinks.** Delete. (3-20-20)T
33. **Table 703.2 Maximum Unit Loading and Maximum Length of Drainage and Vent Piping.** Change fixture unit loading value for one and a half (1 1/2) inch horizontal drainage to two (2) fixture units. (3-20-20)T
34. **Section 705.5.2 Solvent Cement Joints.** Add to the end of the section the following: PVC DWV may be joined by the use of one-step solvent cement listed or labeled per U.P.C. Section 301.1.1. (3-20-20)T
35. **Section 707.4 Locations.** Add the following: A clean out must be installed for double sanitary tees two (2) inches (50 mm) or less in diameter that receive the discharge from fixture connections. Exception in Section 707.4 does not apply. A full-sized accessible cleanout must be installed in the vertical immediately above the floor or at the base of each waste or soil stack. A full-size cleanout extending to or above finished grade line must be installed at the junction of the building drain and the building sewer. Cleanouts must be installed at fifty (50) foot intervals in horizontal drain lines two (2) inches or smaller. (3-20-20)T
36. **Section 710.3(4) Sewage Ejectors and Pumps.** Add: Exception (4): One (1) pump is permitted for “public use” occupancies provided that such tank receives the discharge of not more than one (1) water closet and ten (10) fixture units (See Section 710.9 Alarms). (3-20-20)T
37. **Section 710.5 Size Building Drains and Sewers.** Add the following exception: In single family dwellings, one (1) fixture unit may be allowed for each gallon per minute of flow from a pump or a sump ejector. (3-20-20)T
38. **Section 712.1 Media.** In the first sentence, delete the phrase “except that plastic pipe must not be tested with air.” (3-20-20)T
39. **Section 717.0 Size of Building Sewers.** Add the following to the end of section 717.1: Exception: The building drain and building sewer is not less than four (4) inches extending from its connection with the city or private sewer system and must run full size to inside the foundation or building lines. (3-20-20)T
40. **Section 723.0 General.** Delete the following sentence: “Plastic DWV piping systems must not be tested by the air test method.” (3-20-20)T
41. **Section 801.3.3 Food Handling Fixtures.** Add: Food preparation sinks, pot sinks, scullery sinks, dishwashing sinks, silverware sinks, commercial dishwashing machines, silverware-washing machines, steam kettles, potato peelers, ice cream dipper wells, and other similar equipment and fixtures must be indirectly connected to the drainage system by means of an air gap. The piping from the equipment to the receptor must not be smaller than the drain on the unit, but it must not be smaller than one (1) inch (twenty-five and four tenths (25.4) mm). (3-20-20)T
42. **Section 805.41 General.** Add to the end of the first paragraph the following: Provisions must be made for the discharge of the water softener to terminate in an approved location. The drain line for a water softener must be three-fourths (3/4) inch minimum. A washer box with a dual outlet is an approved location as long as it is on the same floor or one (1) floor below the softener unit and the water softener drain line is a minimum three-fourths (3/4) inch. (3-20-20)T
43. **Section 807.3 Domestic Dishwashing Machines.** A domestic dishwashing machine may be installed without the use of an airgap if the drain hose is looped to the bottom side of the counter top and secured properly. (3-20-20)T
44. **Section 906.1 Roof Termination.** Delete the existing provision and replace with the following: (3-20-20)T
- a. Roof venting. When conventional roof venting is utilized, each vent pipe or stack must extend through its flashing and terminate vertically not less than six (6) inches (one hundred fifty-two (152) mm) above the roof nor less than one (1) foot (three hundred five (305) mm) from any vertical surface. (3-20-20)T

**b.** Sidewall venting. When sidewall venting is utilized, the vent must extend flush with the eaves/gable end, turn down using a ninety (90) degree ell, and terminate as close to the roof peak as possible. The vent end must be properly screened. Sidewall venting is acceptable on new or remodel construction on cabins, log homes, and residential or commercial buildings. (3-20-20)T

**c.** Sidewall venting must meet the intent of Section 906.2 of the ISPC. (3-20-20)T

**45. Section 908.1 Vertical Wet Venting.** Add to the end of the section the following: A horizontal wet vent may be created provided it is created in a vertical position and all other requirements of Section 908 of the ISPC are met. (3-20-20)T

**46. Section 909.0 Special Venting for Island Fixtures.** Add: Parameters for the limited use of Air Admittance Valves (A.A.V.). (3-20-20)T

**a.** An A.A.V. may be used only in residential buildings. (3-20-20)T

**b.** In remodels, an A.A.V. may be used with island fixtures or remotely located sinks such as in bar, kitchen, or laundry tray locations. An A.A.V. may not be used in bathroom groups. (3-20-20)T

**c.** In new construction, an A.A.V. may be used on island fixture sinks. (3-20-20)T

**d.** Each A.A.V. may be used to vent only one (1) floor. (3-20-20)T

**e.** Each A.A.V. must be readily accessible. (3-20-20)T

**f.** The cross-sectional area of venting must remain the same and must meet the largest required building drain. (3-20-20)T

**g.** An A.A.V. may only be installed in accordance with the manufacturer's installation standards as per ASSE 1051. (3-20-20)T

**h.** An A.A.V. may not be used in an attic, crawl space, outside installation, or in connection with chemical or acid waste systems. (3-20-20)T

**47. Section 1002.3 Change of Direction.** Trap arms may not exceed one hundred eighty (180) degrees of horizontal turn without the use of a cleanout. (3-20-20)T

**48. Section 1007.0 Trap Seal Protection.** Delete section 1007.1 and replace with the following: Floor drains or similar traps directly connected to the drainage system and subject to infrequent use must be protected with a trap seal primer or other approved trap seal protection device, except where not deemed necessary for safety or sanitation by the Authority Having Jurisdiction. Trap seal primers must be accessible for maintenance. (3-20-20)T

**49. Section 1016.1 Discharge.** Add the following to the end of section 1016.1: Floor drains installed in residential garages must be permitted to use the interceptor as the fixture trap. (3-20-20)T

**50. Section 1502.1 General.** Add to this section the following paragraph: Plumbing for a gray water system from any fixture up to, but not to include the exterior irrigation system tank must be inspected by the Authority Having Jurisdiction. The Idaho Department of Environmental Quality (IDEQ) has jurisdiction to inspect and approve the installation of the exterior irrigation system tank and all piping therefrom to the point of disposal in accordance with IDAPA 58.01.03, "Individual/Subsurface Sewage Disposal Rules." Gray water system location and design criteria requirements related to irrigation and leaching is determined in accordance with the requirements as established by the IDEQ. (3-20-20)T

**302. -- 400. (RESERVED)**

**SUBCHAPTER D – CIVIL PENALTIES**  
**(Rule 401)**

**401. CIVIL PENALTIES.**

Except for the acts described in Subsections 401.01 and 401.07 of this rule, the acts described in this section shall subject the violator to a civil penalty of not more than two hundred dollars (\$200) for the first offense and not more than one thousand dollars (\$1,000) for each offense that occurs thereafter. (3-20-20)T

**01. Plumbing Contractor.** Except as provided by Section 54-2602, Idaho Code, any person who acts, or purports to act as a plumbing contractor, as defined by Section 54-2611(a), Idaho Code, without a valid Idaho certificate of competency authorizing him to do so shall be subject to a civil penalty of not more than five hundred dollars (\$500) for the first offense and not more than one thousand dollars (\$1,000) for each offense that occurs thereafter. (3-20-20)T

**02. Certification or Registration.** Except as provided by Section 54-2602, Idaho Code, performing plumbing as defined in Section 54-2603, Idaho Code, without an appropriate certificate of competency or registration. (3-20-20)T

**03. Failure to Disclose.** Failure to disclose upon request any required information on an application for a plumbing registration or certificate of competency, including complete licensure history or previous licensure as a journeyman or master plumber in another jurisdiction. (3-20-20)T

**04. Performance Outside Scope of Specialty Certificate.** Performance of any plumbing installation, alteration, or maintenance by a plumbing specialty contractor or specialty journeyman outside the scope of the specialty certificate of competency. (3-20-20)T

**05. Fees, Permits, and Inspections.** Failure to obtain a required permit, pay applicable fees, properly post a plumbing permit, or request an inspection of all pipes, fittings, valves, vents, fixtures, appliances, appurtenances, and water treatment installations or repairs. (3-20-20)T

**06. Corrections.** Failure to make corrections in the time allotted in the notice on any plumbing installation as set forth in Section 54-2625, Idaho Code. (3-20-20)T

**07. Gross Violation.** In the case of continued, repeated or gross violation of Title 54, Chapter 26, Idaho Code, or this chapter, disciplinary action shall be initiated against certificate holders under this chapter or the matter shall be referred for prosecution. (3-20-20)T

**402. -- 999. (RESERVED)**

## 07.03.01 – RULES OF BUILDING SAFETY (BUILDING CODE RULES)

### 000. LEGAL AUTHORITY.

The Idaho Building Code Board of the Division of Building Safety is authorized under Section 39-4107, Idaho Code, to promulgate rules concerning the enforcement and administration of the Idaho Building Code Act. (3-20-20)T

### 001. TITLE AND SCOPE.

01. **Title.** These rules are titled IDAPA 07.03.01, “Rules of Building Safety (Building Code Rules).” (3-20-20)T

02. **Scope.** These rules prescribe the criteria for enforcement and administration of the Idaho Building Code Act by the Idaho Building Code Board and the Division of Building Safety. (3-20-20)T

### 002. -- 003. (RESERVED)

### 004. ADOPTION AND INCORPORATION BY REFERENCE.

Under the provisions of Section 39-4109, Idaho Code, the codes enumerated in this Section are hereby adopted and incorporated by reference into IDAPA 07.03.01, “Rules of Building Safety,” Division of Building Safety. Pursuant to Section 39-4109, Idaho Code, the effective date of any edition of the codes adopted in this Section, or any amendments identified thereto, shall be January 1 of the succeeding year following legislative approval of the rulemaking establishing the edition or amendment. Copies of these documents may be reviewed at the office of the Division of Building Safety. The referenced codes may be obtained from International Code Council, 5360 Workman Mill Road, Whittier, California 90601-2298 or the International Code Council at <http://www.iccsafe.org>. (3-20-20)T

01. **International Building Code.** 2018 Edition with the following amendments: (3-20-20)T

a. Delete Section 305.2.3 and replace with the following: 305.2.3 Twelve (12) or fewer children in a dwelling unit. A facility such as the above within a dwelling unit and having twelve (12) or fewer children receiving such day care shall be classified as a Group R-3 occupancy or shall comply with the International Residential Code. (3-20-20)T

b. Delete Section 308.2.4 and replace with the following: 308.2.4 Five (5) or fewer persons receiving custodial care. A facility with five (5) or fewer persons receiving custodial care shall be classified as a Group R-3 occupancy or shall comply with the International Residential Code. (3-20-20)T

c. Delete Section 308.3.2 and replace with the following: 308.3.2 Five (5) or fewer persons receiving medical care. A facility with five (5) or fewer persons receiving medical care shall be classified as a Group R-3 occupancy. (3-20-20)T

d. Delete Section 308.5.4 and replace with the following: 308.5.4 Persons receiving care in a dwelling unit. A facility such as the above within a dwelling unit and having twelve (12) or fewer children receiving day care or having five (5) or fewer persons receiving custodial care shall be classified as a Group R-3 occupancy or shall comply with the International Residential Code. (3-20-20)T

e. Delete Section 310.4 and replace with the following: 310.4 Residential Group R-3. Residential Group R-3 occupancies where the occupants are primarily permanent in nature and not classified as Group R-1, R-2, R-4, E or I, including: 1. Buildings that do not contain more than two (2) dwelling units. 2. Care facilities that provide accommodations for five (5) or fewer persons receiving personal care, custodial care or medical care. 3. Congregate living facilities (nontransient) with sixteen (16) or fewer occupants, including boarding houses (nontransient), convents, dormitories, fraternities and sororities, and monasteries. 4. Congregate living facilities (transient) with ten (10) or fewer occupants, including boarding houses (transient). 5. Dwelling units providing day care for twelve (12) or fewer children. 6. Lodging houses (transient) with five (5) or fewer guest rooms and ten (10) or fewer occupants. (3-20-20)T

f. Delete Section 310.4.1 and replace with the following: 310.4.1 Care facilities within a dwelling. Care facilities for twelve (12) or fewer children receiving day care or for five (5) or fewer persons receiving personal care or custodial care that are within a one- or two-family dwelling are permitted to comply with the International Residential Code. (3-20-20)T

g. Delete footnote <sup>e</sup> under Table 2902.1 Minimum Number of Required Plumbing Fixtures and replace with the following: <sup>e</sup> For business occupancies, excluding restaurants, and mercantile occupancies with an

occupant load of thirty (30) or fewer, service sinks shall not be required. (3-20-20)T

**h.** Delete footnote <sup>f</sup> from Table 2902.1 Minimum Number of Required Plumbing Fixtures, add footnote <sup>f</sup> in the header row of the column in Table 2902.1 labeled “Drinking Fountains,” and delete footnote <sup>f</sup> under Table 2902.1 and replace with the following: <sup>f</sup> Drinking fountains are not required for an occupant load of thirty (30) or fewer. (3-20-20)T

**i.** Delete Section 3113.1 and replace with the following: 3113.1 General. The provisions of this Section shall apply to relocatable buildings. Relocatable buildings manufactured after the effective date of this code shall comply with the applicable provisions of this code; title 39, chapter 43, Idaho Code; and IDAPA 07.03.03. Exception: This Section shall not apply to manufactured housing used as dwellings. (3-20-20)T

**02. International Residential Code.** 2018 Edition with the following amendments: (3-20-20)T

**a.** Delete the exception under Section R101.2 Scope, and replace with the following: Exception: The following shall also be permitted to be constructed in accordance with this code: 1. Owner-occupied lodging houses with five (5) or fewer guestrooms and ten (10) or fewer total occupants. 2. A care facility with five (5) or fewer persons receiving custodial care within a dwelling unit or single-family dwelling. 3. A care facility for five (5) or fewer persons receiving personal care that are within a dwelling unit or single-family dwelling. 4. A care facility with twelve (12) or fewer children receiving day care within a dwelling unit or single-family dwelling. (3-20-20)T

**b.** Delete Section R104.10.1 Flood hazard areas. (3-20-20)T

**c.** Delete item number 7 under the “Building” subheading of Section R105.2 Work exempt from permit, and replace with the following: 7. Prefabricated swimming pools that are not greater than four (4) feet (one thousand, two hundred nineteen (1219) mm) deep. (3-20-20)T

**d.** Add the following as item number 11 under the “Building” subheading of Section R105.2 Work exempt from permit: 11. Flag poles. (3-20-20)T

**e.** Delete Section R109.1.3 and replace with the following: R109.1.3 Floodplain inspections. For construction in areas prone to flooding as established by Table R301.2(1), upon placement of the lowest floor, including basement, the building official is authorized to require submission of documentation of the elevation of the lowest floor, including basement, required in Section R322. (3-20-20)T

**f.** Delete Section R301.2.1.2 Protection of Openings. (3-20-20)T

**g.** Delete Table R302.1(1) and replace with the following:

**TABLE R302.1(1) - EXTERIOR WALLS**

EXTERIOR WALL ELEMENT		MINIMUM FIRE-RESISTANCE RATING	MINIMUM FIRE SEPARATION DISTANCE
Walls	Fire-resistance rated	1 hour-tested in accordance with ASTM E 119, UL263, or Section 703.3 of the International Building Code with exposure from both sides	< 3 feet
	Not fire-resistance rated	0 hours	≥ 3 feet

EXTERIOR WALL ELEMENT		MINIMUM FIRE-RESISTANCE RATING	MINIMUM FIRE SEPARATION DISTANCE
Projections	Fire-resistance rated	1 hour on the underside, or heavy timber, or fire retardant-treated wood <sup>a,b</sup>	≥ 2 feet to < 3 feet
	Not fire-resistance rated	0 hours	≥ 3 feet
Openings in Walls	Not allowed	N/A	< 3 feet
	25% maximum of wall area	0 hours	≥ 3 feet to < 5 feet
	Unlimited	0 hours	5 feet
Penetrations	All	Comply with Section R302.4	< 3 feet
		None required	≥ 3 feet

For SI: 1 foot = 304.8 mm.

N/A = Not Applicable

<sup>a</sup> The fire-resistance rating shall be permitted to be reduced to zero (0) hours on the underside of the eave overhang if fireblocking is provided from the wall top plate to the underside of the roof sheathing.

<sup>b</sup> The fire-resistance rating shall be permitted to be reduced to zero (0) hours on the underside of the rake overhang where gable vent openings are not installed. (3-20-20)T

**h.** Delete Section R302.13 Fire protection of floors. (3-20-20)T

**i.** Delete Section R303.4 and replace with the following: R303.4 Mechanical Ventilation. Dwelling units shall be provided with whole-house mechanical ventilation in accordance with Section M1505.4. (3-20-20)T

**j.** Delete the exception under Section R313.1 Townhouse automatic fire sprinkler systems, and replace with the following: Exception: Automatic residential fire sprinkler systems shall not be required in townhouses where either two (2) one (1)-hour fire-resistance-rated walls or a common two (2)-hour fire-resistance rated wall, as specified in item number 2 of Section R302.2.2 is installed between dwelling units or when additions or alterations are made to existing townhouses that do not have an automatic residential fire sprinkler system installed. (3-20-20)T

**k.** Delete Section R313.2 One- and two-family dwellings automatic fire sprinkler systems. (3-20-20)T

**l.** Delete the exceptions under Section R314.2.2 Alterations, repairs and additions, and replace with the following: Exceptions: 1. Work involving the exterior surfaces of dwellings, such as, but not limited to, replacement of roofing or siding, or the addition or replacement of windows or doors, or the addition of a porch or deck or electrical permits, are exempt from the requirements of this section. 2. Installation, alteration or repairs of plumbing or mechanical systems are exempt from the requirements of this section. (3-20-20)T

**m.** Delete the exceptions under Section R315.2.2 Alterations, repairs and additions, and replace with the following: Exceptions: 1. Work involving the exterior surfaces of dwellings, such as, but not limited to, replacement of roofing or siding, or the addition or replacement of windows or doors, or the addition of a porch or deck or electrical permits, are exempt from the requirements of this section. 2. Installation, alteration or repairs of noncombustion plumbing or mechanical systems are exempt from the requirements of this section. (3-20-20)T

**n.** Delete Section R322.1.10 As-built elevation documentation. (3-20-20)T

**o.** Delete Section R322.2.1 and replace with the following: R322.2.1 Elevation requirements. 1. Buildings and structures in flood hazard areas, including flood hazard areas designated as Coastal A Zones, shall have the lowest floors elevated to or above the base flood elevation. 2. In areas of shallow flooding (AO Zones), buildings and structures shall have the lowest floors (including basement) elevated to a height above the highest adjacent grade



of not less than the depth number specified in feet (mm) on the FIRM, or not less than two (2) feet (610 mm) if a depth number is not specified. 3. Basement floors that are below grade on all sides shall be elevated to or above base flood elevation. Exception: Enclosed areas below the design flood elevation, including basements with floors that are not below grade on all sides, shall meet the requirements of Section R322.2.2. (3-20-20)T

**p.** Delete subparagraph 2.1 of Section R322.2.2 Enclosed area below design flood elevation, and replace with the following: 2.1. The total net area of all openings shall be at least one (1) square inch (645 mm<sup>2</sup>) for each square foot (0.093 m<sup>2</sup>) of enclosed area, or the opening shall be designed and the construction documents shall include a statement that the design and installation of the openings will provide for equalization of hydrostatic flood forces on exterior walls by allowing the automatic entry and exit of floodwaters. (3-20-20)T

**q.** Delete Tables R403 Minimum Depth (D) and Width (W) of Crushed Stone Footings (inches), R403.1(1) Minimum Width and Thickness for Concrete Footings for Light-Frame Construction (inches), R403.1(2) Minimum Width and Thickness for Concrete Footings for Light-Frame Construction and Brick Veneer (inches), and R403.1(3) Minimum Width and Thickness for Concrete Footings with Cast-In-Place or Fully Grouted Masonry Wall Construction (inches). (3-20-20)T

**r.** Add the following as Table R403.1:

**TABLE R403.1**  
**MINIMUM WIDTH OF CONCRETE, PRECAST, OR MASONRY FOOTINGS (inches)<sup>a</sup>**

	LOAD-BEARING VALUE OF SOIL (psf)			
	1,500	2,000	3,000	≥ 4,000
<b>Conventional light-frame construction</b>				
1-Story	12	12	12	12
2-Story	15	12	12	12
3-Story	23	17	12	12
<b>4-inch brick veneer over light frame or 8-inch hollow concrete masonry</b>				
1-Story	12	12	12	12
2-Story	21	16	12	12
3-Story	32	24	16	12
<b>8-inch solid or fully grouted masonry</b>				
1-Story	16	12	12	12
2-Story	29	21	14	12
3-Story	42	32	21	16

For SI: 1 inch = 25.4 mm, 1 pound per square foot = 0.0479 kPa.

<sup>a</sup>Where minimum footing width is twelve (12) inches, use of a single wythe of solid or fully grouted twelve (12)-inch nominal concrete masonry units is permitted. (3-20-20)T

**s.** Delete Section R403.1.1 and replace with the following: R403.1.1 Minimum size. Minimum sizes for concrete and masonry footings shall be as set forth in Table R403.1 and Figure R403.1(1). The footing width (W) shall be based on the load bearing value of the soil in accordance with Table R401.4.1. Spread footings shall be at least six (6) inches in thickness (T). Footing projections (P) shall be at least two (2) inches and shall not exceed the thickness of the footing. The size of footings supporting piers and columns shall be based on the tributary load and allowable soil pressure in accordance with Table R401.4.1. Footings for wood foundations shall be in accordance

with the details set forth in Section R403.2 and Figures R403.1(2) and R403.1(3). (3-20-20)T

**t.** Delete Section R602.10 and replace with the following: R602.10 Wall bracing. Buildings shall be braced in accordance with this Section or, when applicable Section R602.12, or the most current edition of APA System Report SR-102 as an alternate method. Where a building, or portion thereof, does not comply with one (1) or more of the bracing requirements in this Section, those portions shall be designed and constructed in accordance with Section R301.1. (3-20-20)T

**03. International Existing Building Code.** 2018 Edition. (3-20-20)T

**04. International Energy Conservation Code.** 2018 Edition with the following amendments: (3-20-20)T

**a.** Add the following as Section C101.5.2: C101.5.2 Industrial, electronic, and manufacturing equipment. Buildings or portions thereof that are heated or cooled exclusively to maintain the required operating temperature of industrial, electronic, or manufacturing equipment shall be exempt from the provisions of this code. Such buildings or portions thereof shall be separated from connected conditioned space by building thermal envelope assemblies complying with this code. (3-20-20)T

**b.** Add the following as an exception under Section C402.5 Air leakage—thermal envelope (Mandatory): Exception: For buildings having over fifty thousand (50,000) square feet of conditioned floor area, air leakage testing shall be permitted to be conducted on less than the whole building, provided the following portions of the building are tested and their measured air leakage is area-weighted by the surface areas of the building envelope: 1. The entire floor area of all stories that have any spaces directly under a roof. 2. The entire floor area of all stories that have a building entrance or loading dock. 3. Representative above-grade wall sections of the building totaling at least twenty-five percent (25%) of the above-grade wall area enclosing the remaining conditioned space. Floor area tested under subparagraphs 1. or 2. of this exception shall not be included in the twenty-five percent (25%) of above-grade wall sections tested under this subparagraph. (3-20-20)T

**c.** Add the following as exception number 7 under Section C403.5 Economizers (Prescriptive): 7. Unusual outdoor air contaminate conditions – Systems where special outside air filtration and treatment for the reduction and treatment of unusual outdoor contaminants, makes an air economizer infeasible. (3-20-20)T

**d.** Delete Table C404.5.1 and replace with the following:

<b>TABLE C404.5.1</b>			
<b>PIPING VOLUME AND MAXIMUM PIPING LENGTHS</b>			
<b>NOMINAL PIPE SIZE (inches)</b>	<b>VOLUME (liquid ounces per foot length)</b>	<b>MAXIMUM PIPING LENGTH (feet)</b>	
		<b>Public lavatory faucets</b>	<b>Other fixtures and appliances</b>
1/4	0.33	31	50
5/16	0.5	N/A - non-standard size	50
3/8	0.75	17	50
1/2	1.5	10	43

TABLE C404.5.1 PIPING VOLUME AND MAXIMUM PIPING LENGTHS			
NOMINAL PIPE SIZE (inches)	VOLUME (liquid ounces per foot length)	MAXIMUM PIPING LENGTH (feet)	
		Public lavatory faucets	Other fixtures and appliances
5/8	2	7	32
3/4	3	5	21
7/8	4	N/A - non-standard size	16
1	5	3	13
1 1/4	8	2	8
1 1/2	11	1	6
2 or larger	18	1	4

For SI: 1 inch = 25.4 mm; 1 foot = 304.8 mm; 1 liquid ounce = 0.030 L; 1 gallon = 128 ounces. (3-20-20)T

e. Delete the rows in Table R402.1.2 for climate zones “5 and Marine 4” and “6” and replace with the following:

TABLE R402.1.2 INSULATION AND FENESTRATION REQUIREMENTS BY COMPONENT <sup>a</sup>										
Climate Zone	Fenestration U-Factor <sup>b</sup>	Skylight U-factor <sup>b</sup>	Glazed Fenestration SHGC <sup>b, c</sup>	Ceiling R-Value	Wood Frame Wall R-Value	Mass Wall R-Value <sup>i</sup>	Floor R-Value	Basement <sup>c</sup> Wall R-Value	Slab <sup>d</sup> R-Value & Depth	Crawlspace <sup>c</sup> Wall R-Value
5	0.32	0.55	NR	38	20 or 13+5 <sup>h</sup>	13/17	30 <sup>g</sup>	15/19	10, 2 ft	15/19
6	0.30	0.55	NR	49	22 or 13+5 <sup>h</sup>	15/20	30 <sup>g</sup>	15/19	10, 4 ft	15/19

(3-20-20)T

f. Add the following as footnote <sup>k</sup> to the title of Table R402.1.2 - Insulation and Fenestration Requirements by Component: <sup>k</sup> For residential log home building thermal envelope construction requirements see Section R402.6. (3-20-20)T

**g.** Delete the rows in Table R402.1.4 for climate zones “5 and Marine 4” and “6” and replace with the following:

<b>TABLE R402.1.4</b>								
<b>EQUIVALENT U-FACTORS <sup>a</sup></b>								
<b>Climate Zone</b>	<b>Fenestration U-factor</b>	<b>Skylight U-factor</b>	<b>Ceiling U-factor</b>	<b>Frame Wall U-factor</b>	<b>Mass Wall U-factor<sup>b</sup></b>	<b>Floor U-factor</b>	<b>Basement Wall U-factor</b>	<b>Crawlspace Wall U-factor</b>
5	0.32	0.55	0.030	0.060	0.082	0.033	0.050	0.055
6	0.30	0.55	0.026	0.057	0.060	0.033	0.050	0.055

(3-20-20)T

**h.** Delete Section R402.4.1 and replace with the following: R402.4.1 Building thermal envelope. 1. Until June 30, 2021, the building thermal envelope shall comply with Sections R402.4.1.1 (Installation) and either Section R402.4.1.2 (Testing) or Section R402.4.1.3 (Visual inspection). 2. Effective July 1, 2021, the building thermal envelope of a minimum of twenty percent (20%) of all new single-family homes constructed by each builder shall comply with Section R402.4.1.1 (Installation) and Section R402.4.1.2 (Testing). The authority having jurisdiction may: 2.1. Determine how to enforce this requirement, starting with the fifth house and continuing with each subsequent fifth house. 2.2. Waive this requirement if significant testing indicates the five (5) air changes per hour (ACH) requirement is consistently being met or exceeded (resulting in a lower ACH). 2.3. Grant exceptions to this requirement in rural areas where testing equipment is not available or cost effective. 3. Effective July 1, 2021, the building thermal envelope of eighty percent (80%) of all new single-family homes constructed by each builder shall comply with Section R402.4.1.1 (Installation) and either Section R402.4.1.2 (Testing) or Section R402.4.1.3 (Visual inspection). 4. The sealing methods between dissimilar materials shall allow for differential expansion and contraction. (3-20-20)T

**i.** Delete Section R402.4.1.1 and replace with the following: R402.4.1.1 Installation. The components of the building thermal envelope as listed in Table R402.4.1.1 shall be installed in accordance with the manufacturer’s instructions and the criteria listed in Table R402.4.1.1, as applicable to the method of construction. (3-20-20)T

**j.** Delete Section R402.4.1.2 and replace with the following: R402.4.1.2 Testing. Testing building envelope tightness and insulation installation shall be considered acceptable when tested air leakage is less than five (5) air changes per hour (ACH) when tested with a blower door at a pressure of 33.5 psf (50 Pa). Testing shall occur after rough in and after installation of penetrations of the building envelope, including penetrations for utilities, plumbing, electrical, ventilation and combustion appliances. Testing shall be conducted in accordance with RESNET/ICC 380, ASTM E 779 or ASTM E 1827 and reported at a pressure of 0.2-inch w.g. (50 Pascals). During testing: 1. Exterior windows and doors, fireplace and stove doors shall be closed, but not sealed. 2. Dampers shall be closed, but not sealed, including exhaust, intake, makeup air, backdraft and flue dampers. 3. Interior doors shall be open. 4. Exterior openings for continuous ventilation systems and heat recovery ventilators shall be closed and sealed. 5. Heating and cooling system(s) shall be turned off. 6. HVAC ducts shall not be sealed. 7. Supply and return registers shall not be sealed. (3-20-20)T

**k.** Add the following as Section R402.4.1.3: R402.4.1.3 Visual inspection. Building envelope tightness and insulation installation shall be considered acceptable when the items listed in Table R402.4.1.1, applicable to the method of construction, are field verified. Where required by code official an approved party independent from the installer of the insulation shall inspect the air barrier and insulation. (3-20-20)T

**l.** Add the following as Section R402.6: R402.6 Residential log home thermal envelope. Residential log home construction shall comply with Section R401 (General), Section R402.4 (Air leakage), Section R402.5 (Maximum fenestration U-factor and SHGC), Section R403.1 (Controls), the mandatory sections of Sections R403.3 through R403.9, Section R404 (Electrical Power and Lighting Systems), and either 1., 2., or 3. as follows: 1. Sections R402.2 through R402.3, Section R403.3.1 (Insulation), Section R404.1 (Lightning equipment), and Table R402.6

(Log Home Prescriptive Thermal Envelope Requirements by Component). 2. Section R405 (Simulated Performance Alternative). 3. REScheck (U.S. Department of Energy Building Codes Program). (3-20-20)T

**m.** Add the following as Table R402.6:

<b>TABLE R402.6</b>									
<b>LOG HOME PRESCRIPTIVE THERMAL ENVELOPE REQUIREMENTS BY COMPONENT</b>									
For SI: 1 foot = 304.8 mm.									
Climate Zone	Fenestration U-factor <sup>a</sup>	Skylight U-factor	Glazed Fenestration SHGC	Ceiling R-value	Min. Average Log Size In Inches	Floor R-value	Basement Wall R-value <sup>d</sup>	Slab R-value & Depth <sup>b</sup>	Crawl Space Wall R-value <sup>d</sup>
5, 6 - High efficiency equipment path <sup>c</sup>	0.32	0.60	NR	49	5	30	15/19	10, 4 ft.	10/13
5	0.32	0.60	NR	49	8	30	10/13	10, 2 ft.	10/13
6	0.30	0.60	NR	49	8	30	15/19	10, 4 ft.	10/13

<sup>a</sup>The fenestration U-factor column excludes skylights. The SHGC column applies to all glazed fenestration.

<sup>b</sup>R-5 shall be added to the required slab edge R-values for heated slabs.

<sup>c</sup>90% AFUE natural gas or propane, 84% AFUE oil, or 15 SEER heat pump heating equipment (zonal electric resistance heating equipment such as electric base board electric resistance heating equipment as the sole source for heating is considered compliant with the high efficiency equipment path).

<sup>d</sup>“15/19” means R-15 continuous insulated sheathing on the interior or exterior of the home or R-19 cavity insulation at the interior of the basement wall. “15/19” shall be permitted to be met with R-13 cavity insulation on the interior of the basement wall plus R-5 continuous insulated sheathing on the interior or exterior of the home. “10/13” means R-10 continuous insulated sheathing on the interior or exterior of the home or R-13 cavity insulation at the interior of the basement wall.

(3-20-20)T

**n.** Delete Section R403.5.3 and replace with the following: R403.5.3 Hot water pipe insulation (Prescriptive). Insulation for hot water piping with a thermal resistance, R-value, of not less than R-3 shall be applied to the following: 1. Piping serving more than one (1) dwelling unit. 2. Piping located outside the conditioned space. 3. Piping located under a floor slab. 4. Buried piping. 5. Supply and return piping in recirculation systems other than demand recirculation systems. (3-20-20)T

**o.** Delete Section R404.1 and replace with the following: R404.1 Lighting equipment (Mandatory). A minimum of seventy-five percent (75%) of the lamps in permanently installed lighting fixtures shall be high-efficacy lamps or a minimum of seventy-five percent (75%) of the permanently installed lighting fixtures shall contain only high efficacy lamps. (3-20-20)T

**p.** Delete Section R406.3 and replace with the following: R406.3 Energy Rating Index. The Energy Rating Index (ERI) shall be determined in accordance with RESNET/ICC 301. Energy used to recharge or refuel a vehicle used for transportation on roads that are not on the building site shall not be included in the ERI reference design or the rated design. (3-20-20)T

- q. Delete Table R406.4 and replace with the following:

**Table R406.4 - Maximum Energy Rating Index**

Climate Zone	Energy Rating Index <sup>a</sup>
5	68
6	68

<sup>a</sup> Where on-site renewable energy is included for compliance using the ERI analysis of Section R406.4, the building shall meet the mandatory requirements of Section R406.2, and the building thermal envelope shall be greater than or equal to the levels of efficiency and SHGC in Table R402.1.2 or Table R402.1.4 of the 2015 International Energy Conservation Code. (3-20-20)T

**05. References to Other Codes.** Where any provisions of the codes that are adopted in this Section make reference to other construction and safety-related model codes or standards which have not been adopted by the involved authority having jurisdiction, to the extent possible, such reference should be construed as pertaining to the equivalent code or standard that has been duly adopted by such jurisdiction. (3-20-20)T

**005. -- 025. (RESERVED)**

**026. DEFINITIONS.**

The terms defined in this section have the following meaning for all parts of this chapter, unless the context clearly indicates another meaning: (3-20-20)T

**01. Act.** The Idaho Building Code Act, Title 39, Chapter 41, Idaho Code. (3-20-20)T

**02. Administrator.** The administrator of the Division of Building Safety for the state of Idaho. (3-20-20)T

**03. Alterations or Conversions of Modular Buildings and Commercial Coaches.** Any change from the approved plans or installation instructions which would affect the structural, mechanical, electrical or plumbing systems of modular buildings or commercial coaches bearing a Division insignia of approval and includes the replacement, addition, modification or removal of any structural member, plumbing, heat-producing or electrical equipment, or installation which may affect such systems prior to first occupancy. Any such alteration or conversion shall first be approved by testing and inspection in the same manner as original systems or component parts. The following do not constitute alteration or conversion: (3-20-20)T

**a.** Repairs with approved replacement parts; (3-20-20)T

**b.** Conversion of listed fuel-burning appliances in accordance with the terms of their listing; (3-20-20)T

**c.** Replacement of equipment and appliances in kind; (3-20-20)T

**d.** Adjustment and maintenance of equipment. (3-20-20)T

**04. Alterations to Manufactured Homes.** The replacement, addition, and modification, or removal of any equipment or installation after sale by a manufacturer to a dealer but prior to sale by a dealer to a purchaser which may affect the construction, fire safety, occupancy, plumbing, heat-producing or electrical system. It includes any modification made in a manufactured home which may affect the compliance of the home with the standards, but it does not include the repair or replacement of a component or appliance “plug-in” to an electrical receptacle where the replaced item is of the same configuration and rating as the one being replaced. It also does not include the addition of an appliance requiring “plug-in” to an electrical receptacle, which appliance was not provided with the manufactured home by the manufacturer, if the rating of the appliance does not exceed the rating of the receptacle to which it is connected. (3-20-20)T

- Code. **05. Board.** The Idaho Building Code Board created under the provisions of Title 39, Chapter 41, Idaho Code. (3-20-20)T
- 06. Commercial Coach.** In order to further clarify the definition of “commercial coach” as cited in Section 39-4105(5), Idaho Code, the phrase “made so as to be readily movable as a unit on its own running gear” means that the running gear shall be a permanent part of the unit and not intended to be removed or replaced, and such modular structure is used for commercial purposes. (3-20-20)T
- 07. Division.** The Division of Building Safety of the state of Idaho. (3-20-20)T
- 08. Equipment.** All equipment, materials, appliances, devices, fixtures, fittings or accessories installed in the manufacture and assembly of modular buildings. (3-20-20)T
- 09. Field Technical Service.** Interpretation and clarification of the technical data relating to the application of these rules, but not including inspection. (3-20-20)T
- 10. First Purchaser.** The first purchaser of a commercial coach for other than resale. (3-20-20)T
- 11. Insignia.** A label, tab or tag issued by the Division to indicate compliance with the codes, standards, rules and regulations established for manufactured building systems, subsystems, or building elements, modular buildings, and commercial coaches. (3-20-20)T
- 12. Labeled.** Equipment or other building components bearing a label or other approved marking authorized or issued for use by a recognized testing/listing or evaluation agency. (3-20-20)T
- 13. Listed.** Equipment or other building components included within a current list published by a recognized testing/listing agency that maintains periodic inspection on current production of listed equipment or other building components and whose listing states either that the equipment or component complies with recognized standards or has been tested and determined to be suitable for the use intended. (3-20-20)T
- 14. Listing Agency.** A person, firm, association, partnership or corporation which is in the business of listing or labeling and which maintains a periodic inspection program on current production of listed materials, and which makes available, not less frequently than annually, a published report of such listing in which specific information is included that the product has been tested to nationally approved standards and found safe for use in a specified manner. (3-20-20)T
- 15. Minor Alteration.** The following definition is used for the purpose of administering annual permits. (3-20-20)T
- a.** Minor alterations shall include, but are not limited to, the following: partition walls constructed within a defined room; relocation of or existing openings or installation of new doors and windows in non-load bearing walls and not in construction meant to compartmentalize fire; window replacement in unaltered existing openings; roof repairs involving installation of less than one hundred (100) square feet of new roof covering; and new suspended ceilings that are not part of a required fire resistive assembly. (3-20-20)T
- b.** Minor alterations shall not include: work that alters the fire resistive characteristics of the building or fire suppression systems; work that creates new openings in construction meant to compartmentalize fire such as fire walls, fire barriers, fire partitions, smoke barriers, smoke partitions, horizontal assemblies, shaft enclosures, stair enclosures; work that increases the floor area or height of the building; work that changes the structural load path of the building for gravity or horizontal loads; work that reduces the thermal resistant capacity of the building envelop; changes in the occupancy classification of the building or space; increases in the floor loads. (3-20-20)T
- 16. Model.** As referred to in Section 39-4113(3), Idaho Code, for modular buildings and commercial coaches shall mean a specific outside dimension and floor plan with specific structural, plumbing, electrical, and mechanical systems as designated by the manufacturer to be the standard for imitation reproduction. (3-20-20)T

17. **Testing/Listing Agency.** A person, firm, association, partnership or corporation that is: (3-20-20)T
- a. In the business of testing equipment or other building components; and (3-20-20)T
  - b. Recognized by the Division as being qualified and equipped to conduct experimental testing in accordance with recognized standards; and (3-20-20)T
  - c. Not under the jurisdiction or control of any single manufacturer or supplier for an affected industry; and (3-20-20)T
  - d. Making available, not less frequently than annually, a published report in which specific information is included stating that the equipment and systems have been tested and found safe for use in a specified manner. (3-20-20)T

18. **Transit Damage.** Application to manufactured home means that damage encountered en route from the place of manufacture to the dealer or first owner involving structural integrity or any repair that does not result in return to the same construction or assembly as specified in the manufacturer's design approval without additional reinforcement or change. (3-20-20)T

19. **State Buildings.** All buildings to be constructed, altered, or repaired by or for any state of Idaho agency or entity, without regard to purpose, occupancy, or the source of funding for such construction, alteration, or repair. (3-20-20)T

20. **Running Gear.** Springs, spring hangers, axles, bearings, wheels, brakes, rims and tires and their related hardware. (3-20-20)T

21. **Substantially Prefabricated or Assembled.** The module or major portion of modular buildings or commercial coaches assembled in such manner that all portions may not be inspected without disassembly or destruction of the part. (3-20-20)T

22. **Systems Plan.** A design plan concept that allows the interchanging of various approved construction systems to include structural, electrical, plumbing, and mechanical aspects of the system. (3-20-20)T

23. **Technical Service.** Conducting research, evaluation, consultation, model and systems plan reviews, interpretation and clarification by the Division of technical data relating to the application of these rules, and also includes special field inspections that are not covered in other portions of these rules. (3-20-20)T

**027. PERMITS.**

01. **Building Permits.** Building permits shall be obtained from the Division prior to the construction of structures governed by the act or rules promulgated by the Board. (3-20-20)T

02. **Annual Permit.** In lieu of an individual permit for each minor alteration to an already approved building, the Division may issue an annual permit upon application therefor to any state agency or state governmental organization regularly employing one (1) or more qualified trade persons in the building, structure or on the premises or campus owned or operated by the applicant for the permit. The agency to whom an annual permit is issued shall keep a detailed record of alterations made under such annual permit. The Division shall be allowed access to such records at all times or such records shall be filed with the Division as designated. The permit holder shall request inspections and make the work accessible for inspection as required by the adopted codes and this rule. (3-20-20)T

**028. PLAN REVIEW.**

01. **Jurisdiction.** The Division shall have exclusive jurisdiction and authority to conduct plan reviews of the construction, additions, repairs, and occupancy of all state buildings of any agency of government at the state level for any purposes or occupancy regardless of the source of funding for such construction, addition, repair, or occupancy. (3-20-20)T



**02. Plans Specifications.** Construction documents shall be dimensioned and drawn upon suitable material. Plans may be submitted electronically or in digital format as approved by the Division. Drawing format shall be equivalent to the paper format. Construction documents shall be of sufficient clarity to indicate the location, nature, and extent of the work proposed and show in detail that the installations will conform to the provisions of the building code and applicable laws, rules, and policies of the Division. (3-20-20)T

**03. Plans Not Required.** Plans are not required for group U occupancies of Type V conventional light-frame wood construction. (3-20-20)T

**04. Addenda and Change Orders.** (3-20-20)T

**a.** Documents enforcing changes or modifications. Addenda, contract change orders, changes-in-work requests, and other similar written documents enforcing changes or modifications to plans or specifications, already approved by the Division, which addenda, change orders, or change-in-work requests deal with structural or fire resistance changes, or such other changes affecting code conformance, shall be submitted to the Division for approval. The use of the terms “addenda,” “change orders,” and “changes-in-work requests” are not be limited exclusively to such phraseology, but may include such other language used in the professions which essentially have the same meaning. (3-20-20)T

**b.** Application provisions. The provisions of this Section apply to that work which will be accomplished. (3-20-20)T

**029. FEES.**  
 The following fees apply to the functions cited: (3-20-20)T

**01. Document Fees.** (3-20-20)T

**a.** Reasonable and suitable fees necessary for copies of any record, plan approval, permit, map, sketch, drawing or other instrument. (3-20-20)T

**b.** Charges for copies of separate published documents will be actual cost to the Division plus postage. (3-20-20)T

**02. Technical Service Fee.** One hundred dollars (\$100) per hour. (3-20-20)T

**03. Modular Building and Commercial Coaches Fees.** Other than as herein specified in this Section, the fee schedule for modular buildings and commercial coaches are as provided herein in Table 1-A, and such fees are based on the Freight On Board (FOB) cost to the dealer at the point of manufacture. (3-20-20)T

**04. Insignia Tag Fee.** In instances where building permit fees are not charged for modular buildings, a one hundred dollar (\$100) fee will be charged for an insignia. (3-20-20)T

**05. Building Permit Fees.** The building permit fee for each permit are established in the following table. The determination of value or valuation will be made by the administrator and includes the total value of all construction work for which a permit is issued.

<b>TABLE 1-A - BUILDING PERMIT FEES</b>	
<b>Total Valuation</b>	<b>Fee</b>
\$1 to \$500	= \$23.50
\$501 to \$2,000	= \$23.50 for the first \$500 plus \$3.05 for each additional \$100, or fraction thereof, to and including \$2,000
\$2,001 to \$25,000	= \$69.25 for the first \$2,000 plus \$14 for each additional \$1,000, or fraction thereof, to and including \$25,000

<b>TABLE 1-A - BUILDING PERMIT FEES</b>	
<b>Total Valuation</b>	<b>Fee</b>
\$25,001 to \$50,000	= \$391.75 for the first \$25,000 plus \$10.10 for each additional \$1,000, or fraction thereof, to and including \$50,000
\$50,001 to \$100,000	= \$643.75 for the first \$50,000 plus \$7 for each additional \$1,000, or fraction thereof, to and including \$100,000
\$100,001 to \$500,000	= \$993.75 for the first \$100,000 plus \$5.60 for each additional \$1,000, or fraction thereof, to and including \$500,000
\$500,001 to \$1,000,000	= \$3,233.75 for the first \$500,000 plus \$4.75 for each additional \$1,000, or fraction thereof, to and including \$1,000,000
\$1,000,001 to \$5,000,000	= \$5,608.75 for the first \$1,000,000 plus \$3.65 for each additional \$1,000, or fraction thereof, to and including \$5,000,000
\$5,000,001 to \$10,000,000	= \$20,208.75 for the first \$5,000,000 plus \$2.75 for each additional \$1,000, or fraction thereof, to and including \$10,000,000
\$10,000,001 and up	= \$33,958.75 for the first \$10,000,000 plus \$2 for each additional \$1,000, or fraction thereof

(3-20-20)T

**06. Fees for Annual Permits.** A fee for inspections performed on annual permits shall be charged at the rate of one hundred dollars (\$100) per hour. The Division shall bill the applicant for annual permits and failure of the applicant to pay the fee within sixty (60) days may result in cancellation of the annual permit. (3-20-20)T

**07. Plan Review Fees.** Plan review fees shall be charged at an hourly rate of one hundred dollars (\$100) per hour up to a maximum of sixty-five percent (65%) of the calculated building permit fee with a minimum required fee of forty percent (40%) of the calculated building permit fee. All requests for plan review services shall at such time be accompanied by a payment in the amount of at least forty percent (40%) of the calculated building permit fee. Upon completion of the plan review, any additional fees, above the minimum required, are due to the Division by the requesting party. (3-20-20)T

**08. Refund of Plan Review Fees.** Plan review fees are non-refundable. (3-20-20)T

**09. Refund of Permit Fees.** The Administrator may authorize a refund of any permit fee paid which was erroneously paid or collected. The Administrator may authorize a refund of not more than eighty percent (80%) of the permit fee paid when no work has been done under a permit issued in accordance with these rules. The Administrator may not authorize a refund of any permit fee paid except upon written application filed by the original applicant not later than one hundred eighty (180) days after the date of permit issuance. (3-20-20)T

**030. RIGHT OF ENTRY.**

Whenever necessary to make an inspection to enforce any of the provisions of Title 39, Chapters 40 and 41, Idaho Code, or whenever the administrator or his authorized representative has reasonable cause to believe that there exists in any building or upon any premises, any condition which makes such building or premises unsafe, the administrator or his authorized representative shall enter such building or premises at all reasonable times to inspect the same or to perform any duty imposed upon the Division by Title 39, Chapters 40 and 41, Idaho Code; provided that if such building or premises is occupied, he shall first present proper credentials and demand entry; and if such building or premises be unoccupied, he shall first make a reasonable effort to locate the owner or other persons having charge or control of the building or premises and demand entry. If such entry is refused, the administrator shall have recourse to every remedy provided by law to secure entry. (3-20-20)T

**031. WORK PROCEEDING WITHOUT PERMIT OR APPROVAL.**

Where any work for which a permit or approval, to include plan or system approval, is required by these rules, or by

the codes enumerated in Title 39, Chapter 41, Idaho Code, is started or proceeded prior to obtaining said approval or permit, and after notice to such person doing or causing such work to be done, and such person continues or causes to continue such work, the fees specified in these rules shall be doubled, but the payment of such double fee shall not relieve any persons from fully complying with the requirements of Title 39, Chapters 40 or 41, or both, Idaho Code, or these rules in the execution of the work nor from any other penalties prescribed by law. (3-20-20)T

**032. STOP WORK ORDERS.**

Whenever any work is being done contrary to any provisions of the codes enumerated in Title 39, Chapters 40 or 41, or both, Idaho Code, or contrary to these rules, the administrator or his authorized representative may order the work stopped by notice in writing to any persons engaged in such work, and any such persons shall forthwith stop such work until authorized by the administrator or his representative to proceed with the work. Stop work orders shall be accompanied by a notice of violation that states the specific violation and code reference. (3-20-20)T

**033. PROHIBITED SALE OR OCCUPANCY NOTICE.**

Whenever any mobile/manufactured home, commercial coach or other modular building is in violation of any of the provisions of Title 39, Chapter 40 or 41, or both, Idaho Code, or these rules, the administrator may prohibit the sale or occupancy of such building. Prohibited sale or occupancy notices shall be removed only on authority of the administrator or his authorized representative. (3-20-20)T

**034. REMOVAL OF ORDERS AND NOTICES; SALE, RENT, LEASE OR OCCUPANCY OF A UNIT BEARING SUCH ORDER OR NOTICE.**

Removal of stop work orders, prohibited sale or occupancy notices, or the sale, rent, lease or occupancy of a building or structure, bearing such order or notice by any person not authorized by the administrator or his authorized representative, constitutes a violation under the provisions of Section 39-4126, Idaho Code, and falls under the provisions of Section 18-317, Idaho Code. (3-20-20)T

**035. MODULAR BUILDINGS.**

**01. Alternates and Equivalents. (3-20-20)T**

**a.** Alternatives Acceptable. The provisions of these rules are not intended to prevent the use of alternate designs, materials, appliances, systems, devices, arrangements, or methods of construction not specifically prescribed by Title 39, Chapter 41, Idaho Code, or of these rules; provided, any such alternate has first been recognized by the Division. (3-20-20)T

**b.** Satisfactory Alternatives. The Division shall recognize any such alternate if it finds that the proposed design is satisfactory and that the material, appliance, device, arrangement, method, system or method of construction is at least the equivalent in performance in quality, strength, effectiveness, fire resistance, durability and adequate for the protection of the health, safety and general welfare of the people of the state of Idaho. (3-20-20)T

**c.** Unsatisfactory Alternatives. Recognition by the Division shall not be given if there is substantial evidence that any design, material, appliance, device, arrangement, system or method of construction does not conform to the provisions or requirements of prescribed standards or these rules; provided, however, the Division may, in order to substantiate claims for alternates, upon written request cause tests or proof of compliance to be made at the expense of the manufacturer, his agent, or the seller. (3-20-20)T

**d.** Test Methods. Test methods shall be as specified in the standards of the codes listed in Title 39, Chapter 41, Idaho Code, or by other nationally recognized standards recognized by the Division. If there are no appropriate test methods specified in the standards listed above, the Division shall determine the test procedure. (3-20-20)T

**02. Permits.** Prior to construction of modular buildings, appropriate building permits shall first be obtained from the Division. (3-20-20)T

**03. Plans. (3-20-20)T**

**a.** Specifications for Submittal. Plans shall be submitted in accordance with Subsection 028.03 of

these rules. (3-20-20)T

**b.** Nonconformance. Should the plan submittal not conform to the requirements of these rules, the applicant shall be notified in writing within fifteen (15) work days of the date they are received by the Division. Should the applicant fail to submit a completely corrected plan submittal in accordance with the information supplied by the Division within ninety (90) days of such notice, the plan submittal will be deemed abandoned and all fees submitted shall be forfeited to the Division. Subsequent submission thereafter shall be processed as a new plan submittal. (3-20-20)T

**c.** Distribution of Approved Copies. An approved copy of the plan submittal shall be returned to the manufacturer. An approved copy shall be retained at each place of manufacture, and a copy shall be retained by the Division. (3-20-20)T

**d.** Proprietary Information. All material submitted by the manufacturer in the form of design plans, engineering data, test results, and other design information relating to their application will be considered proprietary information and will not be released for public scrutiny except when so ordered by a court of competent jurisdiction. (3-20-20)T

**e.** Changes to Approved Modular Building Plans. Where the manufacturer proposes to change his submitted designs or the Division rule is amended to necessitate such a change, the manufacturer shall submit changed plans for examination and approval. (3-20-20)T

**04. Inspections.** (3-20-20)T

**a.** Inspections at Manufacturing Plants. The Division shall conduct inspections at the manufacturing plant to determine compliance with the provisions of these rules and with Title 39, Chapter 41, Idaho Code. (3-20-20)T

**b.** Field Inspection for Alterations and Conversions. Any alteration or conversion of Division approved modular buildings after leaving the manufacturing facility shall be field inspected in accordance with this section by the local unit of government having jurisdiction. (3-20-20)T

**c.** In-Plant Inspection in Sister States. Where there is evidence that the in-plant inspectional controls in out-of-state plants in states having reciprocal agreements with the state of Idaho are not being maintained for units to be sold or placed in Idaho, the Division reserves the right to make out-of-state inspections, and fees for such inspection as set forth in these rules shall be paid by the manufacturer. (3-20-20)T

**05. Insignia.** (3-20-20)T

**a.** Insignia Location. Single units shall have the insignia permanently attached below the electrical service entrance. Multiple section units shall have the insignia permanently attached on all perimeter sections to the outside wall next to the major access opening. For interior units and second story units the insignia shall be permanently attached on the interior wall next to the major access opening. (3-20-20)T

**b.** Application for Insignia. The manufacturer shall make application for an insignia for each unit to be manufactured as required by Subsection 035.03 of this rule. The permit/insignia application shall be submitted to the Division in accordance with this section and include the appropriate fees. Applications shall include the serial number of each unit for which an insignia is requested. (3-20-20)T

**c.** Alteration or Conversion. Factory alterations or conversions of an approved modular building prior to first occupancy shall NOT take place until a permit under the provisions of this section has been obtained. The jurisdiction for non-factory produced additions, repairs or alterations to modular buildings and commercial coaches built in conformance with and as prescribed in the Idaho Building Code Act, Section 39-4109, Idaho Code, once such unit has left the manufacturing facility or a dealer's lot, and bears an appropriate insignia of compliance, rests with the local unit of government having the jurisdiction for the administration and enforcement of locally adopted codes prescribed within the Idaho Building Code Act. (3-20-20)T

**d.** Denial of Insignia. Should inspection reveal that a manufacturer is not manufacturing units according to the codes specified in Title 39, Chapter 41, Idaho Code, and these rules, and such manufacturer after having been served with a notice setting forth in what respect the provisions of the codes or rules have been violated continues to manufacture units in violation of the codes or rules, applications for new insignia shall be denied and insignia issued for units in noncompliance such manufacturer may resubmit an application for insignia. (3-20-20)T

**e.** Removal of Insignia. In the event any unit bearing an insignia is found to be in violation of the codes enumerated in Title 39, Chapter 41, Idaho Code, or these rules, the Division may remove the insignia and shall furnish the owner or his agent with a written statement of violations. The owner or his agent shall request an inspection after making corrections to bring the unit into compliance before the Division will issue a replacement insignia. (3-20-20)T

**f.** Serial Number. Each commercial coach rented, leased or sold, or offered for rent, lease or sale in Idaho shall bear a legible identifying serial number in accordance with the provisions of this section and include the state of manufacture. Each section of a multiple modular building shall have the same identifying serial number followed by a numerical sequence identifier and letter suffix. (3-20-20)T

**g.** Stamp of Serial Number and State of Manufacture. The unit serial number and the state of manufacture shall be stamped into the foremost cross member of all commercial coaches. Letters and numbers shall be three-eighths (3/8) inch minimum height. Numbers shall not be stamped into a hitch assembly or draw bar. The insignia shall be made of etched brass, stainless steel, anodized or alclad aluminum, or other approved material, not less than two hundredths (0.02) inches thick, and three (3) inches by one and three-fourths (1 3/4) inches minimum size, with lettering not less than one-eighth (1/8) inch high. (3-20-20)T

**h.** Multiple Commercial Coaches. Each section of multiple commercial coaches shall have the same identifying serial number followed by a numerical sequence identifier and letter suffix. (3-20-20)T

**i.** Data on Insignia. The date of manufacture, showing month, week and year will be shown on the insignia. Such data will be provided by the manufacturer on the application for insignia. (3-20-20)T

**036. MANUFACTURED HOMES.**

**01. Construction and Safety Standards.** Effective June 15, 1976, the latest published edition of the Federal Manufactured Home Construction and Safety Standards and Manufactured Home Procedural and Enforcement Regulations shall be in effect for all manufactured homes manufactured within the state of Idaho, and for all new manufactured homes for sale within the state of Idaho. All new manufactured homes offered for sale within Idaho after the effective date of this section shall bear the Housing and Urban Development (H.U.D.) label as authorized in the Federal Manufactured Home procedural and enforcement regulations. Mobile homes manufactured between March 8, 1971 and June 15, 1976 offered for rent, lease, or sale within Idaho shall bear an Idaho insignia of approval. (3-20-20)T

**02. Inspections.** (3-20-20)T

**a.** Special Inspection. Whenever there is a transit damage or any alteration made to a certified manufactured home, or both, a special inspection shall be required of any person offering for rent, lease, or sale said manufactured home. The purpose of the inspection is to insure that the repairs or alteration, or both, do not result in the failure of the manufactured home to comply with the standards. (3-20-20)T

**b.** Installation Inspection. Installation inspections shall be conducted by local jurisdictions in accordance with Title 44, Chapter 22, Idaho Code and the state adopted Idaho Manufactured Home Installation Standard as incorporated by reference in IDAPA 07.03.12, "Rules Governing Manufactured Home Installations," Section 004. (3-20-20)T

**03. Fees.** (3-20-20)T

**a.** Payment of Fees. Fees shall be paid to and collected by the Division. (3-20-20)T

**b.** In-Plant Inspections. The charge for routine in-plant inspections shall be equal to the latest fees approved by the Department of Housing and Urban Development-Office of Manufactured Home Standards: Forty-five dollars (\$45) per floor. (3-20-20)T

**c.** Other Inspections. For all inspections other than routine whether they be in-plant or in the field (for models produced after June 15, 1976): Seventy dollars (\$70) per hour minimum for inspection and travel time, prorated to the nearest quarter hour, per diem and lodging where applicable, plus the current state rate for mileage, as approved by the State Board of Examiners and listed in the Idaho State Travel Policies and Procedures, Appendix “A,” based on the round-trip distance from point of inspection and the inspector’s office location. (3-20-20)T

**037. (RESERVED)**

**038. INTEGRATED DESIGN AND FUNDAMENTAL COMMISSIONING OF PUBLIC SCHOOL FACILITIES.**

**01. Definitions.** The following definitions are intended to supplement, and should be read in conjunction with the definitions contained in Section 33-356, Idaho Code. (3-20-20)T

**a.** Fundamental Commissioning. A quality-focused process for enhancing the delivery of a project. It makes use of a qualified third party employed directly by the building owner. (3-20-20)T

**b.** Integrated Design. Integrated design refers to a collaborative design effort in which each of the individual architectural or engineering professionals focuses on the whole building approach, with an emphasis on optimizing the building’s performance, environmental sustainability, and cost-savings, to include climate, use, loads and systems resulting in a more comfortable and productive environment, and a building that is more energy-efficient than would be realized using current best practices. (3-20-20)T

**02. Technical and Educational Information.** Technical and educational information related to integrated design and fundamental commissioning in the form of the American Institute of Architects Integrated Project Delivery Guide; Portland Energy Conservation, Inc. (PECI) Commissioning Guides; ASHRAE Guideline 0-2005-The Commissioning Process; and the Northwest Energy Efficiency Alliance Integrated Design Special Focus on Energy Performance Guide is available at the Division office locations including 1090 E. Watertower St., Meridian, Idaho 83642, and 1250 Ironwood Dr., Ste. 220, Coeur d’Alene, Idaho 83814. A building commissioned under the prescriptive approaches defined by any of the above-named national organizations is deemed to have completed the Fundamental Commissioning process. (3-20-20)T

**03. Commissioning Agents.** The Division has compiled and made available for public examination a list of all known third party building commissioning agents in Idaho and its contiguous states. The Division has ensured that all such commissioning agents appearing on this list have been certified by the Building Commissioning Association (BCA) or other similar certifying entity. (3-20-20)T

**04. Annual Optimization Review.** (3-20-20)T

**a.** A public school building that qualifies for the school building replacement value calculation pursuant to Section 33-356(5)(a), Idaho Code, shall undergo an annual optimization review each year following the first year of operations that the involved school district seeks to qualify such building for the building replacement value calculation. (3-20-20)T

**b.** The systems within a building required to undergo annual optimization review, as well as any relevant measuring criteria for such systems, shall be formulated by the third party commissioning agent that performs the initial fundamental commissioning. The school district shall be provided with a written report from the commissioning agent identifying the systems which will be subject to the annual optimization review along with any other requirements. (3-20-20)T

**c.** The report required above in Paragraph 038.04.b. of these rules shall include, but is not limited to, at least the following: (3-20-20)T

- i. Verification that the heating, ventilation, and air conditioning (HVAC) controls, dampers, valves, sensors and other equipment used to control the system are functioning as they were at the commissioning of the building. (3-20-20)T
- ii. Verification that the lighting controls are functioning as they were at the commissioning of the building. (3-20-20)T
- iii. The requirement that any changes made to any of the controls contained on the agent’s list after the initial commissioning be re-set back to the commissioned settings unless it can be demonstrated that the new settings result in greater energy efficiency. (3-20-20)T
- d. The annual optimization review shall be performed by persons qualified to make the required determinations and adjustments. (3-20-20)T
- e. The school district shall submit to the Division written verification indicating that the systems identified by the commissioning agent, including those identified in this Section are functioning as they were at the initial commissioning. Such written verification shall also identify the persons performing the optimization and their qualifications. (3-20-20)T

**05. Commissioning Anniversary Date.** The date upon which the commissioning agent provides the school district with the required written report described in Paragraph 038.04.b. of these rules shall be the commissioning anniversary date for purposes of this Section. If a school district seeks to qualify a building for the building replacement value calculation, the annual optimization review shall be performed within thirty (30) days of the annual commissioning anniversary date following the first year the building is in operation. The written verification required by Paragraph 038.03.e. of these rules is due to the Division not later than sixty (60) days after the annual commissioning anniversary date. (3-20-20)T

**06. Fundamental Building Commissioning Requirements.** (3-20-20)T

- a. School districts seeking to qualify a building for the building replacement value calculation shall engage a building commissioning agent. (3-20-20)T
- b. The commissioning agent must document the owner’s requirements for each commissioned system in the facility. All HVAC and controls systems, duct work and piping, renewable and alternative technologies, lighting controls and day lighting, waste heat recovery, and any other advanced technologies incorporated in the building must be commissioned. Building envelope systems must also be verified. The owner’s requirements for these systems may include efficiency targets and other performance criteria such as temperature and lighting levels that will define the performance criteria for the functional performance testing that occurs prior to acceptance. (3-20-20)T
- c. The commissioning agent shall include commissioning requirements in the project construction documents. This includes the scope of commissioning for the project, the systems to be commissioned, and the various requirements related to schedule, submittal reviews, testing, training, O & M manuals, and warranty reviews. (3-20-20)T
- d. The commissioning agent shall develop and utilize a commissioning plan. This plan must include an overview of the commissioning process for the project, a list of commissioned systems, primary commissioning participants and their roles, a communication and management plan, an outline of the scope of commissioning tasks, a list of work products, a schedule, and a description of any commissioning testing activities. (3-20-20)T
- e. The commissioning agent must submit a report to the owner once the commissioning plan has been executed. (3-20-20)T

**039. -- 999. (RESERVED)**

## 07.03.03 – RULES FOR MODULAR BUILDINGS

### 000. LEGAL AUTHORITY.

The Factory Built Structures Advisory Board of the Division of Building Safety is authorized under Section 39-4302, Idaho Code, to promulgate rules concerning the enforcement and administration of Title 39, Chapter 43, Idaho Code, for Modular Buildings. (3-20-20)T

### 001. TITLE AND SCOPE.

**01. Title.** These rules are titled IDAPA 07.03.03, “Rules for Modular Buildings.” (3-20-20)T

**02. Scope.** These rules prescribe the criteria for enforcement and administration of the Idaho Modular Buildings Act by the Factory Built Structures Advisory Board and the Division of Building Safety. (3-20-20)T

### 002. -- 009. (RESERVED)

### 010. DEFINITIONS.

The terms defined in this section have the following meaning, unless the context clearly indicates another meaning. (3-20-20)T

**01. Administrator.** The Administrator of the Division of Building Safety for the state of Idaho. (3-20-20)T

**02. Alterations or Conversions of Modular Buildings.** Any change from the approved plans or installation instructions that would affect the structural, mechanical, electrical or plumbing systems of Modular Buildings bearing a Division Insignia of approval, including the replacement, addition, modification, or removal of any structural member; plumbing, heat-producing or electrical equipment, or installation that may effect such systems prior to first occupancy. Any such alteration or conversion must first be approved by testing and inspection in the same manner as original systems or component parts. The following do not constitute alteration or conversion: (3-20-20)T

**a.** Repairs with approved replacement parts; (3-20-20)T

**b.** Conversion of listed fuel-burning appliances in accordance with the terms of their listing; (3-20-20)T

**c.** Replacement of equipment and appliances in kind; (3-20-20)T

**d.** Adjustment and maintenance of equipment. (3-20-20)T

**03. Commercial Coach.** A Modular Building with permanent running gear and a hitch assembly that is designed and constructed for nonresidential occupancy classifications only. Permanent running gear includes springs, spring hangers, axles, bearings, wheels, brakes, rims and tires and their related hardware. (3-20-20)T

**04. Insignia.** A label or tag issued by the Division to indicate compliance with the codes, standards, rules, and regulations established for manufactured building systems, subsystems, or building elements, Modular Buildings, and Commercial Coaches. (3-20-20)T

**05. Technical Service.** Conducting research, evaluation, consultation, interpretation, and clarification by the Division of technical data relating to the application of these rules, and also include special field inspections that are not covered in other portions of these rules. (3-20-20)T

### 011. -- 026. (RESERVED)

### 027. PERMITS.

Building permits must be obtained from the Division prior to the construction of structures governed by Title 39, Chapter 43, Idaho Code, or Board rules. (3-20-20)T

### 028. PLAN REVIEW.

**01. Jurisdiction.** The Division has exclusive jurisdiction and authority to conduct plan reviews of the in-plant construction of Modular Buildings. (3-20-20)T



**02. Plans Not Required.** Plans are not required for group U occupancies of Type V conventional light-frame wood construction. (3-20-20)T

**03. Non-conformance.** Should the plan submittal not conform to the requirements of these rules, the applicant will be notified in writing within fifteen (15) work days of the date they are received by the Division. Should the applicant fail to submit a completely corrected plan submittal in accordance with the information supplied by the Division within ninety (90) days of such notice, the plan submittal will be deemed abandoned. Subsequent submission thereafter will be processed as a new plan submittal. (3-20-20)T

**04. Distribution of Approved Copies.** An approved copy of the plan submittal will be returned to and retained by the manufacturer and a copy will be retained by the Division. When necessary, an additional copy may be distributed for use by third party or contract inspectors. (3-20-20)T

**05. Proprietary Information.** All material submitted by the manufacturer in the form of design plans, engineering data, test results, and other design information relating to their application will be considered proprietary information and will not be released for public scrutiny except when so ordered by a court of competent jurisdiction. (3-20-20)T

**06. Revisions to Approved Modular Building Plans.** Where the manufacturer proposes to revise his submitted designs, or Division adopted rules or codes are amended to necessitate such a change, the manufacturer must submit revised plans for examination and approval. (3-20-20)T

**07. Application Provisions.** The provisions of this section applies only to plans for work that will be accomplished at the place of manufacture. (3-20-20)T

**029. FEES.** Fees are paid to the Division, and the following fee schedule is applicable for the functions cited: (3-20-20)T

**01. Modular Building Permit Fees.** Other than as herein specified in this section, the permit fee schedule for Modular Buildings is as provided herein in Table 1-A plus ninety dollars (\$90) and two and one-half percent (2.5%) of the plumbing, electrical, and HVAC installation costs. The determination of value or valuation is based on the total value of all construction work for which a permit is issued.

TABLE 1-A – MODULAR BUILDING PERMIT FEES		
TOTAL VALUATION		FEE
\$1 to \$500	=	\$23.50
\$501 to \$2,000	=	\$23.50 for the first \$500 plus \$3.05 for each additional \$100, or fraction thereof, to and including \$2,000
\$2,001 to \$25,000	=	\$69.25 for the first \$2,000 plus \$14 for each additional \$1,000, or fraction thereof, to and including \$25,000
\$25,001 to \$50,000	=	\$391.75 for the first \$25,000 plus \$10.10 for each additional \$1,000, or fraction thereof, to and including \$50,000
\$50,001 to \$100,000	=	\$643.75 for the first \$50,000 plus \$7 for each additional \$1,000, or fraction thereof, to and including \$100,000
\$100,001 to \$500,000	=	\$993.75 for the first \$100,000 plus \$5.60 for each additional \$1,000, or fraction thereof, to and including \$500,000
\$500,001 to \$1,000,000	=	\$3,233.75 for the first \$500,000 plus \$4.75 for each additional \$1,000, or fraction thereof, to and including \$1,000,000

<b>TABLE 1-A – MODULAR BUILDING PERMIT FEES</b>	
\$1,000,001 and up	\$5,608.75 for the first \$1,000,000 plus \$3.65 for each additional \$1,000, or fraction thereof

(3-20-20)T

**02. Other Inspections and Fees.** (3-20-20)T

**a.** Inspections outside of normal business hours: sixty-five dollars (\$65) per hour (minimum charge - one (1) hour). (3-20-20)T

**b.** Re-inspection fees: sixty-five dollars (\$65) per hour. (3-20-20)T

**c.** Inspections for which no fee is specifically indicated: sixty-five dollars (\$65) per hour (minimum charge - one half (1/2) hour). (3-20-20)T

**d.** Additional plan review required by changes, additions, or revisions to plans: sixty-five dollars (\$65) per hour (minimum charge - one-half (1/2) hour). (3-20-20)T

**e.** For use of outside consultants for plan checking and inspections or both: actual costs. (3-20-20)T

**03. Insignia Tag Fee.** In instances where building permit fees are not charged for Modular Buildings, a one hundred dollar (\$100) fee will be charged for an Insignia. (3-20-20)T

**04. Investigation Fee.** Whenever any work for which a permit is required by these rules has been commenced without first obtaining said permit, a special investigation must be made before a permit may be issued for such work. An investigation fee, in addition to the permit fee, must be collected whether or not a permit is then or subsequently issued. The investigation fee is equal to the amount of the permit fee required by these rules. The minimum investigation fee is the same as the minimum fee set forth in Table 1-A. The payment of such investigation fee does not exempt any person from compliance with all other provisions of these rules nor from any penalty prescribed by law. (3-20-20)T

**05. Plan Review.** Where the Modular Building plans have not been previously approved, the Modular Building fee includes an additional amount equal to sixty-five percent (65%) of the permit fee calculated in accordance with Table 1-A. (3-20-20)T

**06. Refund of Permit Fees.** The Administrator may authorize refunding of any permit fee paid that was erroneously paid or collected. The Administrator may authorize refunding of not more than eighty percent (80%) of the permit fee paid when no work has been done under a permit issued in accordance with these rules. The Administrator will not authorize refunding of any permit fee paid except on written application filed by the original applicant not later than one hundred eighty (180) days after the date of fee payment. (3-20-20)T

**07. Refund of Plan Review Fees.** There is no refund of plan review fees. (3-20-20)T

**030. RIGHT OF ENTRY.**

Whenever necessary to make an inspection to enforce any of the provisions of Title 39, Chapter 43, Idaho Code, or whenever the Administrator or his authorized representative has reasonable cause to believe that there exists in any building or upon any premises, any condition that makes such building or premises unsafe, the Administrator or his authorized representative may enter such building or premises at all reasonable times to inspect the same or to perform any duty imposed upon the Division by Title 39, Chapter 43, Idaho Code; provided that if such building or premises is occupied, he must first present proper credentials and demand entry; and if such building or premises be unoccupied, he must first make a reasonable effort to locate the owner or other persons having charge or control of the building or premises and demand entry. If such entry is refused, the Administrator has recourse to every remedy provided by law to secure entry. (3-20-20)T

**031. REMOVAL OF ORDERS AND NOTICES PROHIBITED.**

Removal of stop work or prohibited occupancy orders or notices from a building or structure, bearing such order or notice by any person or persons not authorized by the Administrator or his authorized representative, constitute a violation under the provisions of Section 39-4126, Idaho Code, and falls under the provisions of Section 18-317, Idaho Code. (3-20-20)T

**032. MODULAR BUILDINGS.**

**01. Enforcement and Administration.** The Administrator administers and enforces all the provisions of these rules. Any officer, agent, or employee of the Division is authorized to enter any premises during any normal or operational hours where Modular Buildings are manufactured for the purpose of examining any records pertaining to quality control and inspection and may inspect any such units, equipment, or installations to insure compliance with the provisions of these rules and codes enumerated in Title 39, Chapters 41 and 43, Idaho Code. When it becomes necessary, he may require that a portion or portions of such Modular Building units be removed in order that an inspection may be made to determine compliance. Every manufacturer of Modular Buildings must obtain prior approval and an Insignia for each Modular Building unit to be installed in the state of Idaho. (3-20-20)T

**02. Inspections.** (3-20-20)T

**a. Inspections at Manufacturing Plants.** The Division conducts inspections at the manufacturing plant to determine compliance with the provisions of these rules and with codes adopted by Title 39, Chapter 41, Idaho Code, and Title 54, Chapters 10, 26, and 50, Idaho Code. (3-20-20)T

**b. In-Plant Inspections.** Due to the repetitive nature of the manufacturing process, the required inspections outlined in the International Building Code or Idaho Residential Code may not be required if, in the opinion of the Division, compliance can be obtained by periodic inspections. The Division conducts periodic unannounced inspections at any manufacturing site to review any or all aspects of a manufacturer's production and inspectional control procedures. Each unit, however, must be inspected at least once during the course of production for compliance with the adopted standards. No unit manufactured to be installed in the state of Idaho will be shipped from the point of manufacture without inspection and attached Insignia. (3-20-20)T

**c. Field Inspections.** All existing Modular Buildings to be installed in the state of Idaho not bearing the Division's Insignia may not be used or occupied until required Idaho Insignia has been issued by the Division and properly affixed in accordance with these rules. Applicants for Insignia must obtain permits, plan approvals, and inspections as required by these rules. (3-20-20)T

**d. Qualifications of Inspectors.** All inspectors performing inspections of modular buildings must be properly certified for the type of inspection being conducted. The Factory Built Structures Board recognizes certifications granted through the National Certification Program Construction Code Inspector program (NCPCCI), the National Inspection Testing Certification program (NITC), the International Association of Electrical Inspectors (IAEI), and the International Code Council (ICC). Certifications must be current and of the proper classification for the structure or subsystem being inspected. (3-20-20)T

**03. Installation Inspection.** In order to complete the installation of the Modular Building, approval and inspection of said installation by the enforcement agency having jurisdiction over the site location is required. (3-20-20)T

**04. Field Technical Service.** Any person may request field Technical Service and requests for such service must be submitted to the Division in writing. (3-20-20)T

**05. Local Enforcement Agencies.** (3-20-20)T

**a. Rights of Local Enforcement Agency.** A local enforcement agency has the right to require a complete set of plans and specifications approved by the Division for each Modular Building to be installed within its jurisdiction, to require that all permits be obtained before delivery of any unit to a Building Site. After leaving the manufacturing facility, future alterations or conversions of Division approved Modular Buildings must be field inspected by the local unit of government having jurisdiction. (3-20-20)T

**b.** Limitations of Rights of Local Enforcement Agency. A local enforcement agency does not have the right to: open for inspection any Modular Building or component bearing an Insignia to determine compliance with any codes or ordinances; require by ordinance or otherwise that Modular Buildings meet any requirements not equally applicable to on-site construction; or to charge permit or plan review fees for any portion of the structure prefabricated or assembled at a place other than the Building Site. (3-20-20)T

**06. Insignia.** (3-20-20)T

**a.** Required Insignia. Each Modular Building section must bear a Division Insignia on the front, left-hand side of the building prior to leaving the manufacturing facility. Assigned Insignia are not transferable and are void when not affixed as assigned. All such voided Insignia must be returned to, or may be confiscated by, the Division. Insignia remain the property of the Division and may be confiscated in the event of violation of conditions of approval. Assigned Insignia affixed in the field must be under the direction of the Division's authorized agent. (3-20-20)T

**b.** Serial Number. Each Modular Building must bear a legible identifying serial number and include the state of manufacture. Each section of a multiple Modular Building must have the same identifying serial number followed by a numerical sequence identifier or a letter suffix, or both. Characters for serial numbers must be three-eighths (3/8) inch minimum height. Numbers may not be stamped into a hitch assembly or draw bar. The date of manufacture, showing month and year will be shown on the Insignia. Such data will be provided by the manufacturer on the application for Insignia. (3-20-20)T

**07. Reciprocal Agreements.** The provisions for Insignia of compliance as specified in a written and signed reciprocal agreement between the Division and any other state takes precedence over the provisions of these rules. Where there is evidence that the in-plant inspection controls in out-of-state plants within states having reciprocal agreements with the state of Idaho are not being maintained for units to be placed in Idaho, the Division reserves the right to make out-of-state inspections, and fees for such inspection as set forth in these rules must be paid by the manufacturer. (3-20-20)T

**033. CIVIL PENALTIES.**

The following acts subject the violator to penalties of not more than two hundred dollars (\$200) for the first offense and not more than one thousand dollars (\$1,000) for each offense thereafter based on the following schedule. (3-20-20)T

**01. Installation.** Any person who transports a modular building to or installs a modular building on a building site in this state without first receiving approval and securing to the structure insignia evidencing such approval from the Division. (3-20-20)T

**02. Modification.** Any person who in any way modifies or alters a modular building prior to its initial occupancy which has previously been approved by the Division without first having received approval to do so from the Division. (3-20-20)T

**03. Removal of Orders.** Any person who removes a stop work or prohibited occupancy order or notice from a building or structure bearing such order or notice. (3-20-20)T

**04. Lawful Orders.** Any person who fails, neglects, or refuses to obey any lawful order issued by the Administrator or his representative, or who refuses to perform any duty lawfully enjoined upon him by the Administrator or his representative. (3-20-20)T

**034. -- 999. (RESERVED)**

## 07.03.11 – RULES GOVERNING MANUFACTURED/MOBILE HOME INDUSTRY LICENSING

### 000. LEGAL AUTHORITY.

The administrator of the Idaho Division of Building Safety and the Factory Built Structures Advisory Board are authorized to promulgate rules necessary to implement the provisions of Title 44, Chapters 21 and 22, Idaho Code. (3-20-20)T

### 001. TITLE AND SCOPE.

**01. Title.** These rules are titled IDAPA 07.03.11, “Rules Governing Manufactured/Mobile Home Industry Licensing.” (3-20-20)T

**02. Scope.** These rules apply to persons engaged in the business of manufacturing, selling, or installing manufactured or mobile homes for purposes of human habitation in Idaho. (3-20-20)T

### 002. -- 009. (RESERVED)

### 010. DEFINITIONS.

For the purposes of these rules, the following terms will be used, as defined below: (3-20-20)T

**01. Administrator.** The administrator of the Division of Building Safety of the state of Idaho. (3-20-20)T

**02. Board.** The Factory Built Structures Advisory Board. (3-20-20)T

**03. Bond.** The performance bond required by Section 44-2103, Idaho Code. (3-20-20)T

**04. Branch Office.** An enclosed structure accessible and open to the public, at which the business of the manufactured/mobile home retailer is conducted simultaneously with and physically separated from his principal place of business. There must be displayed on the exterior a sign permanently affixed to the land or building with letters clearly visible to the major avenue of traffic. The sign must provide the business name of the retailer. (3-20-20)T

**05. Business.** Occupation, profession, or trade. (3-20-20)T

**06. Deceptive Practice.** Intentionally publishing or circulating any advertising concerning mobile or manufactured homes which: (3-20-20)T

**a.** Is misleading or inaccurate in any material respect; (3-20-20)T

**b.** Misrepresents any of the products or services sold or provided by a manufacturer, manufactured/mobile home retailer, or installation company. (3-20-20)T

**07. Division.** The Division of Building Safety. (3-20-20)T

**08. Installer.** A person who owns a business which installs manufactured/mobile homes at the sites where they are to be occupied by the consumer. The term does not include the purchaser of a manufactured/mobile home or a manufactured/mobile home retailer who does not install manufactured/mobile homes. A retailer who does install manufactured/mobile homes is an installer. The term also does not include concrete contractors or their employees. (3-20-20)T

**09. Installation.** The term includes “setup” and is the complete operation of fixing in place a manufactured/mobile home for occupancy. (3-20-20)T

**10. Manufactured Home.** A structure, constructed after June 15, 1976, in accordance with the HUD manufactured home construction and safety standards, and is transportable in one (1) or more sections, which, in the traveling mode, is eight (8) body feet or more in width or is forty (40) body feet or more in length, or when erected on site, is three hundred twenty (320) or more square feet, and which is built on a permanent chassis and designed to be used as a dwelling with or without a permanent foundation when connected to the required utilities, and includes the plumbing, heating, air conditioning, and electrical systems contained therein, except that such term must include any structure which meets all the requirements of this subsection except the size requirements and with respect to which the manufacturer voluntarily files a certification required by the secretary of Housing and Urban Development and

complies with the standards established under 42 U.S.C. Section 5401, et seq. (3-20-20)T

**11. Manufactured Home Retailer.** Except as otherwise provided in these rules: (3-20-20)T

**a.** Any person engaged in the business of selling or exchanging new and used units; or (3-20-20)T

**b.** Any person or who buys, sells, lists, or exchanges three (3) or more new and used units in any one (1) calendar year. (3-20-20)T

**12. Manufacturer.** Any person engaged in the business of manufacturing manufactured homes that are offered for sale, lease, or exchange in the state of Idaho. (3-20-20)T

**13. Mobile Home.** A factory-assembled structure or structures generally constructed prior to June 15, 1976, the date of enactment of the Federal Manufactured Housing and Safety Standards Act (HUD Code), and equipped with the necessary service connections and made so as to be readily movable as a unit or units on their own running gear and designed to be used as a dwelling unit or units with or without a permanent foundation. (3-20-20)T

**14. Person.** A natural person, corporation, partnership, trust, society, club, association, or other organization. (3-20-20)T

**15. Principal Place of Business.** The primary physical location at which the business of a manufactured home retailer is lawfully conducted. Each of the following requirements must be met to qualify as the principal place of business: (3-20-20)T

**a.** The business of the manufactured or mobile home retailer is lawfully conducted here; (3-20-20)T

**b.** The office or offices of the retailer is or are located here; (3-20-20)T

**c.** The public may contact the retailer here; (3-20-20)T

**d.** The offices are accessible and open to the public; and (3-20-20)T

**e.** The greatest portion of the retailer's business is conducted here. The books and other records of a retailer must be kept and maintained at the retailer's principal place of business and be open to inspection during normal business hours by any authorized agent of the Division. Moreover, there must be displayed on the exterior a sign permanently affixed to the land or building with letters providing the business name of the retailer clearly visible to the major avenue of traffic. (3-20-20)T

**16. Used Manufactured Home or Mobile Home.** A manufactured home or mobile home, respectively, which has been: (3-20-20)T

**a.** Sold, rented, or leased and occupied prior to or after the sale, rental, or lease; or (3-20-20)T

**b.** Registered with or been the subject of a certificate of title issued by the Idaho Department of Transportation or the appropriate authority of any state, the District of Columbia, or foreign state or country. (3-20-20)T

**011. (RESERVED)**

**012. LICENSE REQUIRED.**

It is unlawful to engage in business as a manufacturer, manufactured/mobile home retailer, or installer without being duly licensed by the Division pursuant to Title 44, Chapter 21, Idaho Code, and these rules. No issued licenses are transferable. (3-20-20)T

**01. Minimum Age Requirement.** No license will be issued to a person under eighteen (18) years of age at the time of license application. (3-20-20)T

**02. Designated License Holder.** Any applicant for a license under these rules who is not a natural person must designate a natural person to be license holder and represent the corporation, partnership, trust, society, club, association, or other organization for all licensing purposes under these rules including, but not limited to, testing and education. (3-20-20)T

**a.** The authorization to act as designated license holder must be in writing, signed by the applicant and the person designated, and filed with the Division along with the application. (3-20-20)T

**b.** Any person designated under Subsection 012.02 of these rules represents one (1) applicant only, and must immediately notify the Division in writing if his working relationship with the applicant has been terminated. The license will be issued in the name of the designated license holder with the name of the organization he represents also noted on the license. The license holder is considered by the Division to be the licensee, even if the license holder is the designated representative of an organization. (3-20-20)T

**c.** The applicant and the person designated under Subsection 012.02 of these rules agree by acceptance of the designation that the designated person acts as agent of the applicant for all purposes under Title 44, Chapters 21 and 22, Idaho Code, and all rules promulgated thereunder. (3-20-20)T

**03. Proof of License.** Proof of the existence of any license issued pursuant to these rules is carried upon the person of the responsible managing employee or supervisor of any installation at all times during the performance of the installation work. Such proof must be furnished upon demand of any person. Moreover, any license issued to a manufactured/mobile home retailer must be posted in a conspicuous place on the business premises of the employer for whom the holder of the license is licensed. The license of a manufacturing facility or branch office must also be posted in a conspicuous place at the location licensed. (3-20-20)T

**04. Real Estate Brokers.** Licensed real estate brokers or real estate salesmen representing licensed real estate brokers are not required to obtain a license under these rules in order to sell or lease a used unit that is currently carried on the tax rolls as personal property and that otherwise falls within the exemption contained in Section 44-2102(2), Idaho Code. (3-20-20)T

**05. License for Manufacturers.** In order to engage in business in the state of Idaho or to be entitled to any other license or permit required by these rules each manufacturer must be licensed by the Division. (3-20-20)T

**06. License for Branch Office of Manufactured/Mobile Home Retailer.** (3-20-20)T

**a.** The Division requires as a condition of licensing and bonding any information it deems necessary for each location where a manufactured/mobile home retailer maintains a branch office. The mere listing of manufactured/mobile homes for sale does not constitute a branch office, but the use of a mobile home park or a state sales office by a licensee for the sale or offering for sale of manufactured/mobile homes does constitute the maintenance of a branch office. A branch office manager may not manage more than one (1) branch office. (3-20-20)T

**b.** To open a branch office, a retailer must: obtain a license from the Division to operate the branch office; and provide for direct supervision of the branch office, either by himself or by employing a branch office manager. (3-20-20)T

**c.** If the branch office is closed, the retailer must immediately deliver the license to the Division. (3-20-20)T

**07. License to Engage in Business as Manufactured/Mobile Home Retailer, Manufacturer, or Installer; Application; Bond; Issuance, Expiration, and Renewal.** (3-20-20)T

**a.** Applicants for a manufacturer's, retailers, or installer's license must furnish: (3-20-20)T

**i.** Any proof the Division may deem necessary that the applicant is a manufacturer, retailer, or installer; (3-20-20)T

- ii. Any proof the Division may require that the applicant has a principal place of business; (3-20-20)T
- iii. Any proof the Division may require of the applicant's good character and reputation and of his fitness to engage in the activities for which the license is sought; (3-20-20)T
- iv. In the case of a retailer in new manufactured homes, an instrument in the form prescribed by the Division executed by or on behalf of the manufacturer certifying that the applicant is an authorized franchise dealer for the make concerned; (3-20-20)T
- v. The fee and proof of bond fixed by rule; and (3-20-20)T
- vi. Proof of passing the examination required by these rules, as applicable. (3-20-20)T
- b.** Within thirty (30) days after receipt of a completed application, the Division will issue or deny the license. (3-20-20)T
- c.** Each license is valid for a period of one (1) year from the date of issuance and may be renewed for like consecutive period upon application to and approval by the Division. (3-20-20)T
- d.** If any installer's working relationship with his employer is terminated, the employer must immediately deliver the license of the terminated installer to the Division. (3-20-20)T

**013. THE DIVISION'S MAILING ADDRESS.**

Any correspondence or notices required by these rules or Title 44, Chapters 21 or 22, Idaho Code, may be addressed to the Division of Building Safety, 1090 E. Watertower Street, Suite 150 Meridian, Idaho 83642. (3-20-20)T

**014. PROOF OF EDUCATION REQUIRED.**

**01. Satisfactory Proof for Initial Application Submission.** An application for a license as a manufactured/mobile home installer must include proof satisfactory to the Division that the applicant has completed the following number of hours of initial education in order to be approved: (3-20-20)T

- a.** Installers and retailers who are installers: eight (8) hours. (3-20-20)T
- b.** The course of initial education must be approved by the Division and must include information relating to the provisions of these rules, Title 44, Chapters 21 and 22, Idaho Code, and the Manufactured Housing Construction Safety Standards Act of 1974. (3-20-20)T

**02. Satisfactory Proof for License Renewal.** The Division will not renew any installer license, or retailer license of any retailer who is also an installer, issued pursuant to Title 44, Chapters 21 or 22, Idaho Code, or these rules until the licensee has submitted proof satisfactory to the Division that he has, during the three (3) years immediately preceding the renewal of the license, completed at least eight (8) hours of continuing education. (3-20-20)T

**03. Continuing Education Course.** The course of continuing education must be approved by the Division and include information relating to the following: (3-20-20)T

- a.** Manufactured housing or mobile home parks; (3-20-20)T
- b.** The construction, including components and accessories, rebuilding, servicing, installation, or sale of manufactured/mobile homes; (3-20-20)T
- c.** Legislative issues concerning manufactured/mobile home housing and manufactured/mobile home parks, including pending and recently enacted state or federal legislation; and (3-20-20)T
- d.** These rules, Title 44, Chapters 21 or 22, Idaho Code, and the Manufactured Housing Safety Standards Act of 1974. (3-20-20)T



**015. EXAMINATION OF APPLICANT FOR LICENSE.**

**01. Required Examinations.** The Division requires a written examination of each applicant for an initial license as a manufactured/mobile home retailer or installer. To avoid the requirement of an examination and be considered a renewal, any licensee must renew his license within six (6) months of its expiration date. (3-20-20)T

**02. Approval of Examination and Grade.** Examinations for all classifications under these rules must be approved by the Division and the Board. No license will be issued unless the applicant receives a final grade of seventy percent (70%) or higher. (3-20-20)T

**016. DISCIPLINARY ACTION AGAINST LICENSEES.**

The Division may deny, suspend, refuse to renew, or revoke any license issued under Title 44, Chapter 21, Idaho Code, or these rules or reissue the license subject to reasonable conditions upon any of the following grounds: (3-20-20)T

**01. Violation of Rules and Statutes.** For any willful or repeated violation of these rules, IDAPA 07.03.12, "Rules Governing Manufactured or Mobile Home Installations," or Title 44, Chapters 21 or 22, Idaho Code. (3-20-20)T

**02. Failure to Have Principal Place of Business.** With regards only to a manufactured/mobile home retailer, failure of the applicant or licensee to have a principal place of business. (3-20-20)T

**03. False Information.** Material misstatement in the application or otherwise furnishing false information to the Division. (3-20-20)T

**04. Disclosing Contents of Examination.** Obtaining or disclosing the contents of an examination given by the Division. (3-20-20)T

**05. Deceptive Practice.** The intentional publication, circulation, or display of any advertising which constitutes a deceptive practice as that term is defined in Subsection 010.06 of these rules. (3-20-20)T

**06. Failure to Provide Business Name.** Failure to include in any advertising the name of the licensed retailer or installer, or the name under which he is doing business. (3-20-20)T

**07. Encouraging Falsification.** Intentionally inducing an applicant or licensee to falsify an application. (3-20-20)T

**08. Poor Workmanship.** Performing workmanship which is grossly incompetent or repeatedly below the standards adopted by Title 44, Chapters 21 and 22, these rules, IDAPA 07.03.12, "Rules Governing Manufactured or Mobile Home Installations," the Federal Manufactured Housing and Safety Standards Act of 1974, or the latest Idaho adopted editions of the International Building Code, the National Electrical Code, the Idaho State Plumbing Code, and the International Mechanical Code, then in effect. (3-20-20)T

**09. Installation Supervisor Required.** Failure to have an employee personally supervise any installation of a manufactured/mobile home. (3-20-20)T

**10. Failure of Organizations to License its Employees.** Failure of an organization to have its employees maintain any license as required by these rules. (3-20-20)T

**11. Failure to Honor Warranties.** Failure to honor any warranty or other guarantee given by a licensee for construction, workmanship, or material as a condition of securing a contract, or of selling, leasing, reconstructing, improving, repairing, or installing any manufactured/mobile home, or accessory structure. (3-20-20)T

**12. Revocation or Denial of License.** Revocation or denial of a license issued pursuant to these rules or an equivalent license by any other state or U.S. territory. (3-20-20)T

**13. Failure to Maintain Any Required License.** Failure of the licensee to maintain any other license required by any city or county of this state. (3-20-20)T

**14. Failure to Respond to Notice.** Failure to respond to a notice served by the Division as provided by law within the time specified in the notice. (3-20-20)T

**15. Failure to Permit Access to Documentary Materials.** Failure or refusing to permit access by the Division to relevant documentary materials after being requested to do so by the Division. (3-20-20)T

**16. Conviction of Misdemeanor.** Conviction of a misdemeanor for violation of any of the provisions of Title 44, Chapters 21 or 22, Idaho Code. (3-20-20)T

**17. Conviction of Felony.** Conviction or withheld judgment for a felony in this state, any U.S. territory, or country. (3-20-20)T

**18. Dealing with Stolen Manufactured or Mobile Homes.** To knowingly purchase, sell, or otherwise acquire or dispose of a stolen manufactured or mobile home. (3-20-20)T

**19. Violation of Permit or Inspection Requirements.** To knowingly violate any permit or inspection requirements of any city or county of this state. (3-20-20)T

**017. PROCEDURES FOR LICENSING SUSPENSION, REVOCATION OR NONRENEWAL.**  
Any proceeding to suspend, revoke, or not renew any license will be conducted as a contested case in accordance with the provisions of Title 67, Chapter 52, Idaho Code, and the "Idaho Rules of Administrative Procedure of the Attorney General," IDAPA 04.11.01.000, et seq. (3-20-20)T

**018. APPLICATION FOR NEW LICENSE.**  
Any person whose license has been revoked may not apply for a new license until the expiration of one (1) year from the date of such revocation. (3-20-20)T

**019. FEES.**

**01. Fees for Issuance and Renewal of License.** The following fees for the issuance and renewal of a license will be charged, and no application for licensing pursuant to these rules will be accepted by the Division unless it is accompanied by the appropriate fee: (3-20-20)T

**a.** Manufactured/mobile home retailer license: four hundred forty dollars (\$440). Retailers who are also installers will not have to pay an installer's license fee in order to hold both licenses. (3-20-20)T

**b.** Manufacturer license: four hundred forty dollars (\$440); (3-20-20)T

**c.** Manufactured/mobile home installer license: two hundred twenty dollars (\$220); (3-20-20)T

**02. Performance Bonding Requirements.** No application for licensing pursuant to these rules will be accepted unless it is accompanied by evidence of the following performance bond: (3-20-20)T

**a.** Manufacturer: twenty thousand dollar (\$20,000) bond; (3-20-20)T

**b.** Manufactured/mobile home retailer: twenty thousand dollar (\$20,000) bond; (3-20-20)T

**c.** Manufactured/mobile home installer: five thousand dollar (\$5,000) bond. Retailers who are also installers will not be required to post an installer's bond in order to hold both licenses. (3-20-20)T

**03. Money or Securities Deposit in Lieu of Performance Bond.** A money or securities deposit will be accepted by the Division in lieu of the performance bonding requirement as set forth at Title 44, Chapter 21, Idaho Code, and Subsection 019.02 of these rules, under the following circumstances: (3-20-20)T

- a. Any such money or securities deposit is in a principal sum equal to the face amount of the performance bond required for the applicable licensing category; (3-20-20)T
- b. Any such money deposit is deposited in a time certificate of deposit that provides on its face that the principal amount of such certificate of deposit is payable to the Division upon presentment and surrender of the instrument; (3-20-20)T
- c. Any such time certificate of deposit has a maturity date of one (1) year from the effective date of licensure and has an automatic renewal provision for subsequent years; (3-20-20)T
- d. Any such time certificate of deposit must be provided to the Division at the time of application for licensure and be retained by the Division during the effective period of licensure unless otherwise expended by the Division to insure completion of the licensee's performance; (3-20-20)T
- e. Any such time certificate of deposit will be returned to an unsuccessful applicant for licensure; (3-20-20)T
- f. The principal amount of any such time certificate of deposit, to the extent not otherwise expended to insure completion of the licensee's performance, will be returned to the depositor by the Division on or before ninety (90) days subsequent to the occurrence of any of the following events: voluntary surrender or return of a license; expiration of a license; lapse of a license; or revocation or suspension of a license; and (3-20-20)T
- g. Any interest income earned by reason of the principal amount of the time certificate of deposit is the property of the licensee. (3-20-20)T

**020. LICENSING COMPLAINTS.**

Persons who wish to submit complaints to the Division for its consideration regarding the fitness to hold a license of anyone currently licensed or applying for a license under these rules must do so in writing and be signed, dated, provide the name of the licensee or applicant, specific details giving rise to the complaint, and contain the complainant's valid address and telephone number. (3-20-20)T

**021. CIVIL PENALTIES.**

The following acts subject the violator to penalties based on the following schedule: (3-20-20)T

**01. Industry Licensing.** Except as provided for by Section 44-2106, Idaho Code, any person who engages in the business of a manufacturer, retailer, resale broker, salesman, or installer, as defined in Section 44-2101A, Idaho Code, without being duly licensed by the Division is subject to a civil penalty of not more than five hundred dollars (\$500) for the first offense and a civil penalty of not more than one thousand dollars (\$1,000) for each offense thereafter. (3-20-20)T

**02. Deceptive Practice.** In accordance with Section 44-2106(2), Idaho Code, any retailer or installer, who intentionally publishes or circulates any advertising that is misleading or inaccurate in any material respect or that misrepresents any of the products or service sold or provided by a manufacturer, retailer or installer is subject to a civil penalty of not more than five hundred dollars (\$500) for the first offense and a civil penalty of not more than one thousand dollars (\$1,000) for each offense thereafter. (3-20-20)T

**03. Dealing with Stolen Manufactured or Mobile Homes.** In accordance with Section 44-2106(2), Idaho Code, any person who knowingly purchases, sells, or otherwise acquires or disposes of a stolen manufactured or mobile home is subject to a civil penalty of not more than one thousand dollars (\$1,000). (3-20-20)T

**04. Failure to Maintain a Principal Place of Business.** In accordance with Section 44-2106(2), Idaho Code, any person who is a retailer duly licensed by the Division and who fails to maintain a principal place of business within Idaho, is subject to a civil penalty of not more than five hundred dollars (\$500) for the first offense and a civil penalty of not more than one thousand dollars (\$1,000) for each offense thereafter. (3-20-20)T

**05. Violation of Rules and Statutes.** Any person who knowingly violates any of the provisions of these rules, IDAPA 07.03.12, "Rules Governing Manufactured or Mobile Home Installations," or the provisions of

Title 44, Chapters 21 or 22, Idaho Code, is subject to a civil penalty of five hundred dollars (\$500) for the first offense and one thousand dollars (\$1,000) for each offense thereafter. (3-20-20)T

**06. Gross Violation.** In case of continued, repeated, or gross violations of these rules or IDAPA 07.03.12, "Rules Governing Manufactured or Mobile Home Installations," a license revocation may be initiated for licensed individuals under Title 44, Chapter 21, Idaho Code. Non-licensed individuals are subject to prosecution by the appropriate jurisdiction under Idaho law. (3-20-20)T

**022. MANUFACTURED HOME BUYER'S INFORMATION AND DISCLOSURE FORM.**

The Manufactured Home Buyer's Information and Disclosure Form must be presented by manufactured home retailers to each purchaser of a new manufactured home, and must be executed by the retailer and purchaser at the time the initial purchase order is signed for the sale of a new manufactured home. The form is available at the Division office. (3-20-20)T

**023. -- 999. (RESERVED)**

## 07.03.12 – RULES GOVERNING MANUFACTURED OR MOBILE HOME INSTALLATIONS

### 000. LEGAL AUTHORITY.

In accordance with Section 44-2201, Idaho Code, the administrator of the Idaho Division of Building Safety is authorized to promulgate rules necessary to implement the provisions of Title 44, Chapters 21 and 22, Idaho Code. (3-20-20)T

### 001. TITLE AND SCOPE.

**01. Title.** These rules are IDAPA 07.03.12, “Rules Governing Manufactured or Mobile Home Installations.” (3-20-20)T

**02. Scope.** These rules apply to the installation of manufactured or mobile homes used for purposes of human habitation in Idaho. (3-20-20)T

### 002. -- 003. (RESERVED)

### 004. ADOPTION AND INCORPORATION BY REFERENCE.

The Idaho Manufactured Home Installation Standard (January 1, 2018 edition), as adopted by the administrator, is hereby adopted and incorporated by reference into these rules. A current copy is available for review or copying at the office of the Division of Building Safety offices. (3-20-20)T

### 005. APPLICATION -- COMPLIANCE.

**01. Application -- State Preemption.** The standards referred to in this chapter are a comprehensive statement of all applicable standards which apply to the installation, alteration or repair of manufactured or mobile homes in Idaho. Cities and counties may not adopt or enforce more or less stringent standards, except as permitted by Section 67-6509(a), Idaho Code, as it pertains to the siting of manufactured homes in residential areas. (3-20-20)T

**02. Compliance -- Disciplinary Action Against Licensees.** Failure to comply with these standards constitutes grounds for discipline as provided in Title 44, Chapters 21 and 22, Idaho Code, and IDAPA 07.03.11, “Rules Governing Manufactured/Mobile Home Licensing,” and these rules. (3-20-20)T

### 006. -- 011. (RESERVED)

### 012. USE OF MANUFACTURERS’ INSTALLATION INSTRUCTIONS.

All new HUD manufactured homes must be installed in accordance with the manufacturer’s Design Approval Primary Inspection Agency (DAPIA) approved installation instructions. All used mobile and manufactured homes must be installed in accordance with the Idaho Manufactured Home Installation Standard. In any instance in which there is a conflict between the DAPIA installation instructions and the Idaho Manufactured Home Installation Standards, the DAPIA installation instructions supersede and serve as the controlling authority. All manufactured or mobile homes must be installed in accordance with all other applicable state laws pertaining to utility connection requirements. (3-20-20)T

### 013. INSTALLATION PERMITS AND INSPECTIONS REQUIRED.

The owner or the installer of a manufactured or mobile home must obtain an installation permit in accordance with the requirements of Section 44-2202, Idaho Code. Installation permits must be obtained from the Division for installations in areas where there is no approved local program, or from a city or county that has by ordinance adopted building codes pursuant to Section 39-4116, Idaho Code, and whose installation program has been approved by the Division. Installation permits will only be issued to the owner of the manufactured home or to a licensed installer. The installer must have a current and valid license in effect at the time of the application for the installation permit. All installations must be inspected and approved by the authority having jurisdiction before the manufactured home is occupied. (3-20-20)T

### 014. INSTALLATION PERMIT FEES.

A city or county whose installation inspection program has been approved by the Division establishes their own fee schedule for installation permits within their jurisdiction. Permits obtained from the Division must be accompanied by a fee in accordance with the following schedule: (3-20-20)T

**01. Single Section Unit.** The permit fee is one hundred fifty dollars (\$150). (3-20-20)T

**02. Double Section Unit.** The permit fee is two hundred dollars (\$200). (3-20-20)T

**03. More Than Two Sections.** The permit fee for a home consisting of more than two (2) sections is two hundred fifty dollars (\$250). (3-20-20)T

**04. Electrical and Plumbing Permits.** Electrical and plumbing permits are administered separately from installation permits, and fees for such are separate from the fees identified in Section 014. Such fees are paid to the Division or other jurisdiction in accordance with the rules promulgated by the governing boards or local ordinance. (3-20-20)T

**015. INSTALLATION TAGS REQUIRED.**

The owner or installer of a new manufactured home must purchase an installation tag for fifty dollars (\$50) from the Division prior to commencing the installation of a manufactured home in Idaho. Such tag is required regardless of which jurisdiction has authority to perform the installation inspection. (3-20-20)T

**016. APPROVAL OF LOCAL MANUFACTURED HOME INSTALLATION INSPECTION PROGRAMS.**

**01. Division Approval.** A city or county that has by ordinance adopted a building code pursuant to Section 39-4116, Idaho Code, is eligible to participate in the inspection of manufactured and mobile homes. Such local installation inspection program must be approved by the Division to provide inspection services if the following minimum criteria is met: (3-20-20)T

**a.** Inspections are conducted by the city or county employing inspectors holding a valid certification as residential building inspector from the International Code Council; (3-20-20)T

**b.** Inspectors have attended annual training sessions provided or approved by the Division and received a certificate evidencing successful completion thereof; and (3-20-20)T

**c.** Approval of a city or county's inspection program has not been withdrawn by the Administrator of the Division. (3-20-20)T

**02. Voluntary Withdrawal.** A city or county may voluntarily withdraw from participation in the program to inspect manufactured homes upon providing to the Administrator of the Division ninety (90) days written notice of its intention to do so. (3-20-20)T

**017. WITHDRAWAL OF APPROVAL OF PROGRAMS.**

**01. Division Withdrawal.** Approval of city or county manufactured home installation program may be withdrawn by the Division if it determines that the city or county's program has failed, upon notification of the program deficiencies, to adequately remedy such deficiencies within a period of time specified by the Administrator. (3-20-20)T

**02. Re-Approval.** Re-approval of a program may be made by the Division when it determines that the reasons for the withdrawal have been remedied. (3-20-20)T

**018. MINIMUM TRAINING REQUIREMENTS FOR INSPECTORS.**

**01. Annual Training or Instruction.** All installation inspectors employed by the Division or a city or county must complete eight (8) hours of training or instruction approved by the Division every three (3) years dedicated to the installation and inspection of manufactured and mobile homes. (3-20-20)T

**02. Revocation of Approval.** Training or instruction approval is subject to revocation by the Division if in its discretion it determines that for any reason the training or instruction fails to meet the intent of furthering the education of manufactured home installation inspectors including, but not limited to, inadequacies in course content or methods of delivery. (3-20-20)T

**019. QUALITY ASSURANCE.**

**01. Inspected Installations.** Any inspected installation is subject to quality assurance reviews by Division of Building Safety at its discretion. Findings made by the Division pursuant to such reviews will be forwarded to the inspection authority having jurisdiction. (3-20-20)T

**02. Inspectors and Programs.** All inspectors and approved programs, including the Division, are subject to review. (3-20-20)T

**03. Reviews by Division Personnel.** Quality assurance reviews must be performed by Division supervisory personnel who are experienced in and knowledgeable about the installation requirements for manufactured homes. (3-20-20)T

**04. Division Personnel Training and Certification.** Supervisory personnel as identified in Section 019 of these rules, must meet minimum training and certification requirements for inspectors of manufactured home installations. (3-20-20)T

**020. MINIMUM SCOPE OF INSTALLATION INSPECTION.**

**01. Scope.** At a minimum, the inspection of the installation of a manufactured home by an installer includes the following: (3-20-20)T

**a.** Completion of an inspection record document as required by Section 44-2202(5), Idaho Code. The inspection record document must verify that the installer has visually inspected the installation and certify that the exterior and interior close-up processes, including the marriage line and other covered-up components, have been completed; (3-20-20)T

**b.** Delivery of a copy of the completed inspection record document to the homeowner and the authority having jurisdiction; (3-20-20)T

**c.** Verification that all installed ductwork, plumbing, electrical and fuel supply systems are operating properly; and (3-20-20)T

**d.** If applicable, verification that skirting has been installed correctly. (3-20-20)T

**02. Inspection Minimum Requirements.** At a minimum, the inspection of the installation of a manufactured home must include the following by an inspector: (3-20-20)T

**a.** Verification that site location is suitable for home design and construction, and inspection of site-specific conditions, including preparation and grading for drainage; (3-20-20)T

**b.** Inspection of the foundation construction; (3-20-20)T

**c.** Verification that installed anchorage meets minimum requirements; and (3-20-20)T

**d.** Verification of receipt of a completed inspection record document from the installer. (3-20-20)T

**021. SUPERVISION BY RESPONSIBLE MANAGING EMPLOYEE.**

A licensed installer or employee thereof must personally supervise any installation of a manufactured or mobile home at its place of occupancy. (3-20-20)T

**022. -- 999. (RESERVED)**

## 07.04.02 – SAFETY RULES FOR ELEVATORS, ESCALATORS, AND MOVING WALKS

### 000. LEGAL AUTHORITY.

This chapter is adopted by the administrator of the Division of Building Safety in accordance with Section 39-8605, Idaho Code. (3-20-20)T

### 001. TITLE AND SCOPE.

**01. Title.** These rules are titled IDAPA 07.04.02, “Safety Rules for Elevators, Escalators, and Moving Walks.” (3-20-20)T

**02. Scope.** These rules govern the design, construction, installation, operation, inspection, testing, maintenance, alteration, or repair of elevators, escalators, moving walks, platform lifts, material lifts, and dumbwaiters. (3-20-20)T

### 002. ADOPTION AND INCORPORATION BY REFERENCE.

**01. Documents.** The following codes, amendments, and updates are hereby adopted and incorporated by reference into these rules for all conveyances subject to this chapter. (3-20-20)T

**a.** ANSI/ASME A17.1 2016, Safety Code for Elevators and Escalators with the following exceptions: (3-20-20)T

**i.** Compliance with section 2.8.3.3.2 requires that the means for disconnecting the main power, as required by this section, to be within sight of controller for all conveyances with an elevator machine room or control room. (3-20-20)T

**ii.** Compliance with section 8.11.2.1.5(c) Car and Counterweight Buffer testing must be conducted at slow speed in accordance with Item 5.9.2.1(a) in ANSI/ASME A17.2 2014. (3-20-20)T

**iii.** Compliance with Section 2.2.2.5, which requires a sump pump or drain in the elevator pit, is optional. If a sump pump or drain is installed, it must meet the requirements of this section. A sump with a cover must be provided in each elevator pit. (3-20-20)T

**b.** ANSI/ASME A17.3 2015 Safety Code for Existing Elevators and Escalators. (3-20-20)T

**c.** ANSI/ASME A17.4 1999 Guide for Emergency Personnel. (3-20-20)T

**d.** ANSI/ASME A17.5 2014 Elevator and Escalator Electrical Equipment. (3-20-20)T

**e.** ANSI/ASME A17.6 2010 Standard for Elevator Suspension, and Governor Systems. (3-20-20)T

**f.** ANSI/ASME A17.7 2012 Performance-based Safety Code for Elevators and Escalators. (3-20-20)T

**g.** ANSI/ASME A17.8 2016 Standard for Wind Tower Turbine Elevators. (3-20-20)T

**h.** ICC/ANSI A117.1 2009 Accessible and Usable Buildings and Facilities. (3-20-20)T

**i.** ANSI/ASME A18.1 2014 Safety Standards for Platform Lifts and Chairlifts. (3-20-20)T

**j.** ASME QE-1 2013 Standard for the Qualification of Elevator Inspectors. (3-20-20)T

**02. Copies.** Copies of the codes, amendments, and updates listed in Subsection 004.01 of these rules are available for review at the Division of Building Safety offices. (3-20-20)T

### 003. -- 009. (RESERVED)

### 010. DEFINITIONS.

**01. Administrator.** The administrator of the Division of Building Safety. (3-20-20)T



- 02. Division.** The Idaho Division of Building Safety. (3-20-20)T
- 011. INSPECTION REQUIREMENTS.**  
For an inspection may to take place: (3-20-20)T
- 01. Access.** All machine rooms and spaces must be free of dirt and debris and have any obstacles to access removed. (3-20-20)T
- 02. Technician on Site.** An elevator technician and fire alarm technician must be present on site to restore elevator and fire alarm systems. (3-20-20)T
- 03. Installation.** The elevator installation must be complete and safe for inspection. Equipment, components, or systems installed on the conveyance must function in accordance with design and code requirements. If equipment, components, or systems are installed that are not required by the currently adopted code, they must function properly or be removed. (3-20-20)T
- 04. Inspection Fees.** Inspection fees for elevators are assessed and collected according to the schedule listed in Section 39-8616, Idaho Code, except that reinspection fees for all types of conveyances is one hundred dollars (\$100) for the first hour of inspection, or portion thereof, and one hundred dollars (\$100) for each hour of inspection thereafter. (3-20-20)T
- 012. APPROVAL OF NEW OR ALTERNATIVE TECHNOLOGY.**
- 01. Administrator Approval Required.** If, due to construction or technological impediments, an elevator or conveyance cannot comply with applicable code requirements, approval of new or alternative construction or technology may be requested from the administrator. Approval must be obtained before commencement of construction. (3-20-20)T
- 02. Submission Deadline.** Details of the proposed construction or technology, including design, material specifications and calculations, and such other information as may be requested, must be submitted to the administrator at least thirty (30) days in advance of the anticipated construction start date. (3-20-20)T
- a.** The manufacturer of the new product or system must provide the administrator with an Accredited Elevator/Escalator Certification Organization (AECO) approval and certification in accordance with ANSI/ASME A17.7 Performance-based Safety Code for Elevators and Escalators or engineering and test data demonstrating that the proposed technology is safe for the intended purpose. (3-20-20)T
- b.** The owner of the new product or system must provide the administrator with a document in which the owner acknowledges that the proposed technology is not governed by the applicable safety code and assures the administrator that, at such time as the code is revised to include the product or system, the owner will modify the product or system to bring it into compliance. The owner must assure the administrator that if the product or system cannot be modified or altered to bring it into compliance with the applicable code it will be removed and replaced with code-compliant equipment. (3-20-20)T
- c.** The manufacturer of the new product or system must provide training to Division personnel on the proposed technology and any related products or systems at no cost to the Division. (3-20-20)T
- 03. Engineer Approval.** The information provided in compliance with the foregoing requirements must be approved by an Accredited Elevator/Escalator Certification Organization (AECO) or a registered professional engineer experienced in elevator or conveyance design prior to submission to the administrator. (3-20-20)T
- 013. -- 999. (RESERVED)**

## 07.05.01 – RULES OF THE PUBLIC WORKS CONTRACTORS LICENSE BOARD

### 000. LEGAL AUTHORITY.

This chapter is adopted pursuant to Section 54-1907, Idaho Code, as amended. (3-20-20)T

### 001. TITLE.

These rules are titled IDAPA 07.05.01, “Rules of the Public Works Contractors License Board.” (3-20-20)T

### 002. -- 009. (RESERVED)

### 010. DEFINITIONS.

As used in these rules. (3-20-20)T

**01. Administrator.** The administrator of the Division of Building Safety. (3-20-20)T

**02. Applicant.** Any person who has filed an application with the administrator. (3-20-20)T

**03. Board.** The Public Works Contractors License Board. (3-20-20)T

**04. Compiled.** A type of financial statement in which the information presented is based solely upon representations by an organization’s management. (3-20-20)T

**05. Estimated Cost.** For the purposes of the application of Section 54-1903(i), Idaho Code, the term “estimated cost” refers to the total aggregate amount of the value of all the separate or individual jobs, parts, components, or undertakings involved in the construction of a single project when combined and considered as a whole, regardless of the types of trades, sub-contracts, work, or other individual aspects involved, and without regard to the number of trades or crafts that are involved. (3-20-20)T

**06. Financial Statement.** A balance sheet and income statement prepared in accordance with generally accepted accounting principles. (3-20-20)T

**07. Incidental Work.** Work, the nature of which does not require any additional trade licenses and which may be carried out in conjunction with an activity for which the licensee is licensed, but is not intended to produce an amount of income over ten percent (10%) of the total bid amount. (3-20-20)T

**08. Independent Audit Report.** A report prepared by an independent certified public accountant presenting such auditor’s opinion on the fairness of the organization’s financial statements and prepared in accordance with generally accepted auditing standards. (3-20-20)T

**09. Licensee.** Includes any individual proprietor, partnership, limited liability partnership, limited liability company, corporation, joint venture, or other business organization holding a current, unrevoked public works contractor license. (3-20-20)T

**10. Qualified Individual.** The person qualifying by examination as to the experience and knowledge required by Section 54-1910(a), Idaho Code. (3-20-20)T

**11. Reviewed.** Refers to a financial statement that is accompanied by the opinion of a certified public accountant stating that, based upon representations by the organization’s management, the reviewer has a reasonable basis for expressing limited assurance that there are no material modifications that should be made to the financial statements in order for the statements to be in accordance with generally accepted accounting principles. (3-20-20)T

### 011. -- 101. (RESERVED)

### 102. COMMUNICATION.

All communications are deemed officially received only when delivered to the office of the administrator. (3-20-20)T

### 103. PETITIONS.

An applicant or licensee seeking an order or decision of the administrator or the Board on any matter, or disciplinary proceeding, must file a written petition. (3-20-20)T

### 104. FORM AND CONTENT OF PETITION.

**01. Form.** The petition, including the heading, the name of the petitioner or person making the request, and the purpose of the petition must contain the following: (3-20-20)T

- a.** The petitioner's name, address, and license number. (3-20-20)T
- b.** The petitioner's request in brief, precise and specific terms, including references to any pertinent statutes or rules, and a detailed explanation of the purpose for the request. (3-20-20)T
- c.** Statements of fact to support the request. Briefs and supporting documents may accompany petitions. (3-20-20)T

**02. Service.** The petition must be dated and signed by the petitioner, and filed as set forth in Section 102 of these rules. (3-20-20)T

**105. LICENSE RENEWAL -- FILING DEADLINES; PETITIONS FOR EXTENSION OF TIME TO FILE; LAPSED LICENSES.**

**01. Filing Deadline.** Applications for renewal of a license must be filed by the last working day of the month in which the license expires. (3-20-20)T

**02. Extension of Time.** A petition for an extension of time in which to renew must be filed by the last working day of the month in which the license expires. The petition must be accompanied by a fee in the amount of the prorated portion of the annual license fee for the class of license applied for, with a minimum fee of at least fifty dollars (\$50). The fee for this service is required in addition to the licensing and renewal fees provided for in Section 201 of these rules and paid to the Division at the time of application for licensure. Petitions not accompanied by the required fees or filed after the license has expired will not be honored. (3-20-20)T

**a.** The petition must specify the number of days for which the extension is being requested; however under no circumstances may an extension exceed sixty (60) days. (3-20-20)T

**03. Approval of Petition.** Approval of a petition for an extension of time authorizes operation as a contractor until the administrator completes action on the renewal application, provided the application for renewal is filed with the Administrator within the extended time specified. (3-20-20)T

**04. Failure to File.** If the licensee fails to file a timely application for renewal or petition for extension, the license lapses and expires on the last day of the license period. Licenses not renewed in a timely manner are considered delinquent for a period of one (1) year from the last day of the license period and may be renewed at any time during that year. Licenses delinquent for more than a period of one (1) year must be reinstated and the applicant for reinstatement must apply as if for a new license. (3-20-20)T

**05. Expedited Licensure.** Upon an applicant's request and payment of a fee of one hundred dollars (\$100), the Division will expedite its review and determination of a license application. The fee for this service is required in addition to the licensing and renewal fees provided for in Section 201 of these rules and must be paid to the Division at the time of application for licensure. (3-20-20)T

**106. SPECIAL PROVISIONS COVERED IN A PETITION TO CHANGE OR ADD TYPES OF CONSTRUCTION.**

A petition to change or add types of construction must be supported by evidence, satisfactory to the administrator, of work history, job performance, experience, equipment, financial responsibility, and a minimum of three (3) letters of reference. The evidence of work history, job performance, experience, and financial responsibility must comply with the requirements of Subsections 110.01 and 110.02 of these rules. All of the evidence must specifically pertain to work that is similar in scope and value to that for which the change or addition is being requested. (3-20-20)T

**107. -- 108. (RESERVED)**

**109. NOTICE.**

In any contested case or other matter of Board business, written notification, mailed to the licensee or the applicant at

the most current address on record with the Board, constitutes sufficient notification for all purposes within Title 54, Chapter 19, Idaho Code, and these rules. (3-20-20)T

**110. APPLICATION FOR LICENSURE -- DOCUMENTATION; APPRAISALS; REFERENCES; BONDING; AND FINANCIAL STATEMENTS.**

**01. Application Documentation.** To obtain a license, the applicant must submit to the administrator, on such forms and in a format as the administrator prescribes, including electronically, accompanied by the required fee for the class of license applied for, a complete written application for such license. All of the information submitted by the applicant must specifically pertain to work that is similar in scope and value to that for which licensure is being requested or that is being requested in a petition to change or add types of construction. The information contained in such application forms must include: (3-20-20)T

**a.** A complete statement of the general nature of applicant's contracting business, including a concise description of the applicant's experience and qualifications as a contractor and a list of clients for whom work has been performed; (3-20-20)T

**b.** A description of the value and character of contract work completed and for whom performed during the three (3) year period prior to filing the application; (3-20-20)T

**c.** A general description of applicant's machinery and equipment; and (3-20-20)T

**d.** An annual financial statement, as herein defined, that covers a period of time ending no more than twelve (12) months prior to the date of submission of the application, indicating compliance with such financial requirements as the Board may prescribe by rule. The applicant's financial statement may be supplemented with: (3-20-20)T

**i.** Bonding. As authorized by Section 54-1910(e), Idaho Code, a letter from applicant's bonding company, not an insurance agent, stating the amount of the applicant's bonding capability per project and in the aggregate, including supporting documentation; (3-20-20)T

**ii.** Guaranty. Documentation, satisfactory to the administrator, of the existence of a written guaranty agreement between the applicant and a third-party in which the third-party guarantor agrees to assume financial responsibility for payment of any obligations of the applicant for any particular project as may be determined by a court of competent jurisdiction. The guaranty agreement, along with financial statements meeting the requirements of Paragraph 110.01.e. of this rule, must be submitted with the license application. (3-20-20)T

**e.** For Class A, AA, AAA, and Unlimited license applications, financial statements must be accompanied by an independent auditor's report or be reviewed. For Class B and CC license applications, financial statements must be accompanied by an independent audit report or be reviewed or compiled by a certified public accountant. For Class C and Class D license applications, financial statements must be accompanied by an independent audit report or be reviewed, compiled, or on the form provided by the administrator, and include such additional information as may be required by the administrator to determine the applicant's fitness for a license. (3-20-20)T

**f.** The name, social security number, and business address of an individual applicant or, if the applicant is a partnership, its tax identification number, business address, and the names and addresses of all general partners; and if the applicant is a corporation, association, limited liability company, limited liability partnership, or other organization, its tax identification number, business address, and the names and addresses of the president, vice president, secretary, treasurer, and chief construction managing officers, or responsible managing employee. (3-20-20)T

**g.** Applicants requesting a licensing class higher than that for which the applicant is currently licensed must provide documentation, satisfactory to the administrator, of having performed projects, similar in scope and character to those for which license is requested. The monetary value of those jobs must fall within a range not less than thirty percent (30%) below that for which the applicant is currently licensed. (3-20-20)T

**02. Application for Change in Licensing Class.** Requests for a licensing class higher than that for which the applicant is currently licensed must be accompanied by the information in Subsection 110.01 of these rules, and the applicable fee. Licenses granted under Subsection 110.02 of these rules are valid for a period of twelve (12) months from the date of issuance. (3-20-20)T

**03. Extension of Time to File Financial Statement.** The administrator may grant an extension of time to file the annual financial statement if the licensee provides an interim compiled balance sheet and income statement for the applicant’s fiscal year-to-date, duly certified as true by the applicant, and if a partnership, limited liability company, or limited liability partnership by a member thereof, and if a corporation, by its executive or financial officer. Such renewal application must be filed prior to the first day of such renewal licensing period. In the event an extension is granted, the renewal license is valid for a period of twelve (12) months from the date of the issuance of the renewal license. (3-20-20)T

**04. Appraisals.** The administrator may require submission of an independent appraisal of any real or chattel property reported by an applicant or licensee. Such appraisals must be conducted by a disinterested person or firm established and qualified to perform such services. (3-20-20)T

**05. References.** The administrator may require an applicant for an original or renewal license to furnish such personal, business, character, financial, or other written references as deemed necessary and advisable in determining the applicant’s qualifications. (3-20-20)T

**111. FINANCIAL REQUIREMENTS.**

The financial requirements for obtaining and maintaining a heavy, highway, building, and specialty construction license under this act must be as described in this section for each respective class. An applicant requesting a license for each class identified in this section must have a minimum net worth and possess an amount of working capital as provided in Table 111.01:

<b>TABLE 111.01 – FINANCIAL REQUIREMENTS</b>		
<b>LICENSE CLASS</b>	<b>NET WORTH</b>	<b>WORKING CAPITAL</b>
Unlimited	\$1,000,000	\$600,000
AAA	\$600,000	\$200,000
AA	\$450,000	\$150,000
A	\$300,000	\$100,000
B	\$150,000	\$50,000
CC	\$75,000	\$25,000
C	\$25,000	\$7,500
D	\$10,000	\$3,000

(3-20-20)T

**112. EXAMINATION.**

The Board approves all subject areas and topics to be included in the public works contractor license examination.

(3-20-20)T

**01. Frequency of Conducting of Examinations.**

(3-20-20)T

**a.** Examinations for all classes of licenses under the Public Contractors laws and rules will be given a minimum of four (4) times each year in the Division’s three (3) office locations. (3-20-20)T

**b.** The applicant will be notified in writing of the date, time, and location at which the examinations will be given, following approval of the application. (3-20-20)T

**02. Professional Testing Services.** In lieu of the administration by the administrator of the examination for licenses, the administrator may contract with a professional testing service to administer the examination, and require all license applicants, with the exception of Class D applicants, to pay to the testing service the fee that they have set for the examination, to take such examination at the time set by such service, and provide the Division acceptable verification of the test score. In such instances, the Division may charge and retain the application fee provided for by Section 54-1911, Idaho Code, to cover the cost of reviewing the applicant's application. (3-20-20)T

**a.** Class D applicants will utilize the existing in-house, open-book examination. (3-20-20)T

**b.** Class D licensees pursuing an upgrade must reapply and pass the examination administered by the professional testing service. (3-20-20)T

**03. Required Score.** The applicant must receive a final grade of seventy percent (70%) or higher prior to issuance of the appropriate license. (3-20-20)T

**04. Failed Examinations.** (3-20-20)T

**a.** An applicant receiving less than a passing score on a first or second examination may be reexamined without reapplication. (3-20-20)T

**b.** Before being reexamined after failing an examination the third time, an applicant must resubmit the application and fee. (3-20-20)T

**c.** Before being reexamined after any further failures, an applicant for reexamination must wait until the expiration of sixty (60) days from the date of the failed examination and resubmit the application and fee for each subsequent examination. (3-20-20)T

**113. INDIVIDUAL QUALIFIED BY EXAMINATION.**

**01. Written Notice.** Written notice, required by Section 54-1910(a), Idaho Code, that the Qualified Individual of a public works contractor has ceased to be connected with the contractor must be provided to the Administrator on forms prescribed by the Administrator indicating the date the Qualified Individual ceased to be connected with the contractor. (3-20-20)T

**02. Reasonable Length of Time.** If a public works contractor notifies the Administrator that the contractor's Qualified Individual has ceased to be connected with the contractor, the contractor's license will remain in force for ninety (90) days from the date of the notice. (3-20-20)T

**114. -- 198. (RESERVED)**

**199. LIMITATIONS.**

**01. One License.** A licensee will be permitted to hold only one (1) class of license at any given time. (3-20-20)T

**02. Previous License Null and Void.** When a licensee of one class has been issued a license of another class, the previous license is null and void. (3-20-20)T

**03. Total Bid Cost.** The total of any single bid on a given public works project, or the aggregate total of any split bids, or the aggregate total of any base bid and any alternate bid items, or the aggregate total of any separate bid by a licensee of any class, except Class Unlimited, may not exceed the estimated cost or bid limit of the class of license held by the licensee. The aggregate total of bids must include all bids of the subcontractors. Subcontractor bids are not considered a separate bid for the purposes of computing the bid on a given public works project. (3-20-20)T

**04. Two or More Licensees.** Two (2) or more licensees of the same class or of different classes are not permitted to combine the estimated cost or bid limit of their licenses to submit a bid in excess of the license held by either licensee. (3-20-20)T

**05. Type 4 License Holder.** The holder of a license for Type 4, Specialty Construction, are entitled to bid a public works project as a prime contractor or as a subcontractor, if more than fifty percent (50%) of the work to be performed by him on such project is covered by a category or categories listed on the license held by the licensee. (3-20-20)T

**200. TYPE 4-SPECIALTY CONSTRUCTION CATEGORIES.**

A license for Type 4-Specialty Construction must list one (1) or more specialty construction categories to which the license is restricted. Categories and their definitions are: (3-20-20)T

**01. 01107 Engineering.** A specialty contractor whose primary business includes providing engineering and design services such as civil, electrical, mechanical, and structural. (3-20-20)T

**02. 01541 Scaffolding and Shoring.** A specialty contractor whose primary business is the installation of any temporary elevated platform and its supporting structure used for supporting workmen or materials or both, and props or posts of timber or other material in compression used for the temporary support of excavations, formwork or unsafe structures; the process of erecting shoring. (3-20-20)T

**03. 01542 Craning and Erection.** A specialty contractor whose primary business includes the art, ability and skill to safely control the workings of a crane in such a manner that building materials, supplies, equipment and structural work can be raised and set in a final position. (3-20-20)T

**04. 01550 Construction Zone Traffic Control.** A specialty contractor whose primary business is the installation or removal of temporary lane closures, flagging or traffic diversions, utilizing pilot cars, portable devices such as cones, delineators, barricades, sign stands, flashing beacons, flashing arrow trailers, and changeable message signs on roadways, public streets and highways or public conveyances. (3-20-20)T

**05. 01570 Temporary Erosion and Sediment Controls.** A specialty contractor whose primary business includes the ability and expertise to install silt fencing or other similar devices to prevent erosion and contain silt. (3-20-20)T

**06. 02110 Excavation, Removal and Handling of Hazardous Material.** A specialty contractor whose primary business includes the excavation and removal of toxic and hazardous site materials. Contractors must be properly licensed and certified if required. (3-20-20)T

**07. 02115 Removal of Underground Storage Tanks.** A specialty contractor whose primary business includes, but is not limited to, the excavation, removal, cleanup, and disposal of underground storage tanks that have contained petrochemical type fuels. This work should include the sampling and testing of surrounding materials and filing of closure documents. (3-20-20)T

**08. 02195 Environmental Remediation, Restoration and Soil Stabilization.** A specialty contractor whose primary business is the remediation and restoration of contaminated environmental sites. (3-20-20)T

**09. 02210 Drilling.** A specialty contractor whose primary business includes practical elementary knowledge of geology and hydrology; the art, ability, knowledge, science and expertise to bore, drill, excavate, case, pack or cement by use of standard practices, including the use of diamond bits, cable tools, percussion, air percussion, rotary, air rotary, reverse circulation rotary methods or jetting. (3-20-20)T

**10. 02220 Demolition.** A specialty contractor whose primary business includes the ability and expertise to demolish all types of buildings or structures and to remove all of such buildings or structures from the premises, and maintain the premises surrounding demolition site safely for passing public. (3-20-20)T

**11. 02230 Site Clearing.** A specialty contractor whose primary business includes the ability and expertise to remove and dispose of all trees, brush, shrubs, logs, windfalls, stumps, roots, debris and other obstacles in

preparation for excavation of a construction site or other uses. (3-20-20)T

**12. 02231 Logging.** A specialty contractor whose primary business and expertise includes the clearing, cutting, removal and transportation of logs and trees and the construction of temporary roads and structures for such operations along with any reclamation work associated with such operations. (3-20-20)T

**13. 02232 Tree Removal and Trimming.** A specialty contractor whose primary business includes pruning, removal, or guying of trees, limbs, stumps, and bushes including grinding and removal of such items. (3-20-20)T

**14. 02240 Dewatering and Subsurface Drainage.** A specialty contractor whose primary business is to control the level and flow of subsurface water. (3-20-20)T

**15. 02260 Earth Retention Systems, Mechanical Stabilized Earth Walls and Retaining Walls.** A specialty contractor whose primary business includes the building of earth retention systems, mechanical stabilized earth walls and retaining walls. (3-20-20)T

**16. 02265 Slurry Walls.** A specialty contractor whose primary business is the construction of below ground structural diaphragm walls or containment walls through the combined use of trench excavation, mud slurry and tremie concrete. (3-20-20)T

**17. 02270 Rockfall Mitigation and High Scaling.** A specialty contractor whose primary business is rockfall mitigation and high scaling. (3-20-20)T

**18. 02310 Excavation and Grading.** A specialty contractor whose primary business includes such work as digging, moving and placing material forming the surface of the earth in such manner that a cut, fill, excavation and any similar excavating operation can be done with the use of hand and power tools and machines that are used to dig, move and place that material forming the earth's surface. (3-20-20)T

**19. 02312 Dust Control, Dust Abatement and Dust Oiling.** A specialty contractor whose primary business is dust control, dust abatement and dust oiling. (3-20-20)T

**20. 02317 Rock Trenching.** A specialty contractor whose primary business is rock trenching. (3-20-20)T

**21. 02318 Hauling.** A specialty contractor whose primary business includes the ability and expertise to obtain or move specified materials by transportation in a vehicle. (3-20-20)T

**22. 02319 Blasting.** A specialty contractor whose primary business includes the use of conventional and high explosives for pre-splitting, surface, underground and underwater blasting, drill, trench, or excavate for use of explosives; priming and loading drilled, trenched or excavated areas by pipe tamping, pneumatic loading, injector loading, mud capping, slurry loading, combination of pneumatic and injector loading or hand loading; use of volt, ohms and milliampere meter (VOM) in testing blasting machine output voltage, power line voltage, measuring electric blasting cap or blasting circuit resistance, testing for current leakage, testing for AC-DC stray current and voltage, leading wires for open or short circuits, rack bar blasting machine for running short or galvanometer output voltage; use of blasting caps, electric blasting caps, delay electric blasting caps, primacord and all other detonating devices. (3-20-20)T

**23. 02325 Dredging.** A specialty contractor whose primary business includes the excavation or removal of earth, rock, silt, or sediment from bodies of water including but not limited to streams, lakes, rivers or bays by means of specialized equipment. (3-20-20)T

**24. 02404 Horizontal and Directional Earth Boring, Trenching and Tunneling.** A specialty contractor whose primary business and expertise includes boring, trenching or tunneling. (3-20-20)T

**25. 02450 Drilled Piers, Pile Driving, Caisson Drilling, Geopier and Helical Piers.** A specialty contractor whose primary business includes drilling piers, pile driving, caisson drilling, Geopier and helical piers. (3-20-20)T



**26. 02500 Utilities.** A specialty contractor whose primary business includes the construction and installation of pipe lines for the transmission of sewage, gas and water, including minor facilities incidental thereto; installation of electrical poles, towers, arms, transformers, fixtures, conduits, conductors, switch gear, grounding devices, panels, appliances and apparatus installed outside of buildings; including excavating, trenching, grading, back fill, asphalt patching as well as all necessary work and installation of appurtenances in connection therewith. (3-20-20)T

**27. 02520 Well Drilling.** A specialty contractor whose primary business includes the practical elementary knowledge of geology, hydrology, the occurrence of water in the ground, water levels in wells, the prevention of surface and sub-surface contamination and pollution of the ground water supply; and the art, ability, experience, knowledge, science, and expertise to bore, drill, excavate, case, screen, cement, clean and repair water wells; or to do any or any combination of any or all such boring, drilling, excavating, casing, cementing, cleaning and repairing with hand or power tools or rigs, including the installation and repair of pumps. (3-20-20)T

**28. 02580 Installation of Communication Towers.** A specialty contractor whose primary business and expertise is the installation of communication towers. (3-20-20)T

**29. 02660 Membrane Liners for Ponds and Reservoirs.** A specialty contractor whose primary business includes the installation of liners for the purpose of containment of liquids. (3-20-20)T

**30. 02720 Crushing.** A specialty contractor whose primary business includes the ability and expertise to reduce rocks and aggregates to a smaller and uniform size and gradation to meet an agreed specification. (3-20-20)T

**31. 02740 Asphalt Paving.** A specialty contractor whose primary business includes the installation of aggregate base course, cement treated base, bitumen treated base, asphalt concrete and the application of asphalt surfacing and surface repairs of streets, intersections, driveways, parking lots, tennis courts, running tracks, play areas; including the application or installation of primer coat, asphalt binder course, tack coating, seal coating and chips, slurry seal and chips, flush or flog coats, asphalt curbs, concrete bumper curbs, redwood headers, asphalt surface binder emulsion, asbestos and sand and acrylic color systems. (Synthetic and athletic surfacing are category 02790 Athletic and Recreational Surfaces.) Also includes crack sealing, asphalt maintenance repair and soil pulverization. (3-20-20)T

**32. 02761 Traffic Marking and Striping.** A specialty contractor whose primary business includes the art, ability and expertise to apply markings to streets, roadways, or parking surfaces pre-designed for the use of parking or passage of vehicles by the application of directional lines, buttons, markers, and signs made of but not limited to plastic, paint, epoxies and rubber, in such manner as to provide for the channeling and controlling of the traffic flow. Also includes temporary striping. (3-20-20)T

**33. 02785 Asphalt Maintenance and Repair, Seal Coating, Crack Sealing and Chip Sealing.** A specialty contractor whose primary business is asphalt maintenance and repair, seal coating, crack sealing and chip sealing. (3-20-20)T

**34. 02790 Athletic and Recreational Surfaces.** A specialty contractor whose primary business is the installation of specialty surfaces including but not limited to non-wood athletic floors, tennis courts, running tracks and artificial turf. This would include any subsurface preparation such as leveling, excavation, fill and compaction or grading. The application of surfacing, mixing, spreading or placing of emulsions, binders, sand and acrylic color systems is also included along with the installation of modular, plastic athletic floors such as "Sport Court" type floors. This category does not include any type of structure required for the installation of these surfaces. (3-20-20)T

**35. 02810 Sprinkler and Irrigation Systems.** A specialty contractor whose primary business includes the installation of types and kinds of water distribution systems for complete artificial water or irrigation of gardens, lawns, shrubs, vines, bushes, trees and other vegetation, including the trenching, excavating and backfilling in connection therewith. (Low voltage only.) (3-20-20)T

**36. 02820 Fencing.** A specialty contractor whose primary business includes the installation and repair

of any type of fencing. (3-20-20)T

**37. 02840 Guardrails and Safety Barriers.** A specialty contractor whose primary business includes the installation of guardrails and safety barriers (including cattle guards). (3-20-20)T

**38. 02850 Bridges and Structures.** A specialty contractor whose primary business includes the installation, alteration and repair of bridges and related structures, including culverts. (3-20-20)T

**39. 02855 Bridge Crossings and Box Culverts.** A specialty contractor whose primary business is the installation or construction, or both, of any bridge or crossing structure shorter than twenty (20) feet measured on the centerline of the roadway or trail. (3-20-20)T

**40. 02880 Installation of School Playground Equipment.** A specialty contractor whose primary business is the installation of school playground equipment. (3-20-20)T

**41. 02890 Traffic Signs and Signals.** A specialty contractor whose primary business includes the art, ability, knowledge, experience, science and expertise to fabricate, install and erect signs, including electrical signs and including the wiring of such signs. A licensed electrician must perform all the electrical work. (3-20-20)T

**42. 02900 Landscaping, Seeding and Mulching.** A specialty contractor whose primary business includes the preparation of plots of land for architectural, horticulture and provisions of decorative treatment and arrangement of gardens, lawns, shrubs, vines, bushes, trees and other decorative vegetation; construction of conservatories, hot and green houses, drainage and sprinkler systems, and ornamental pools, tanks, fountains, walls, fences and walks, arrange, fabricate and place garden furniture, statuary and monuments in connection therewith. (3-20-20)T

**43. 02910 Slope Stabilization, Hydroseeding, Hydromulching, Native Plant Revegetation for Erosion Control.** A specialty contractor whose primary business is slope stabilization, including necessary tillage and plant bed preparation using hydroseeding, hydromulching and native plant revegetation for erosion control. (3-20-20)T

**44. 02935 Landscape Maintenance.** A specialty contractor whose primary business and expertise includes the maintenance of existing lawns, gardens, and sprinkler systems. This would include mowing, weeding, fertilization, pest control and minor repair or relocation of sprinkler systems. (3-20-20)T

**45. 02937 Pest Control, Sterilization and Herbicide Applications.** A specialty contractor whose primary business includes the mixing, transportation and application of fertilizers, pesticides, herbicides, and sterilization chemicals for the control of insects, pests and weeds. (3-20-20)T

**46. 02955 Pipeline Cleaning, Sealing, Lining and Bursting.** A specialty contractor whose primary business and expertise includes cleaning, sealing, lining and bursting pipelines. (3-20-20)T

**47. 02965 Cold Milling, Rumble Strip Milling, Asphalt Reclaiming and Pavement Surface Grinding.** A specialty contractor whose primary business includes cold milling, rumble strip milling, asphalt reclaiming and pavement surface grinding. (3-20-20)T

**48. 02990 Structural Moving.** A specialty contractor whose primary business includes but is not limited to raising, lowering, cribbing, underpinning and moving of buildings or structures. This does not include the alterations, additions, repairs or rehabilitation of the retained portion of the structure. (3-20-20)T

**49. 03200 Concrete Reinforcing Rebar Installation.** A specialty contractor whose primary business includes the ability and expertise to fabricate, place and tie steel mesh or steel reinforcing bars or rods of any profile, perimeter or cross-section that are or may be used to reinforce concrete. (3-20-20)T

**50. 03300 Concrete.** A specialty contractor whose primary business includes the ability and expertise to process, proportion, batch and mix aggregates consisting of sand, gravel, crushed rock or other inert materials having clean uncoated grains of strong and durable minerals, cement and water or to do any part or any combination

of any thereof, in such a manner that acceptable mass, pavement, flat and other cement and concrete work can be poured, placed, finished and installed, including the placing, forming and setting of screeds for pavement or flat work. Also includes concrete sidewalks, driveways, curbs and gutters. (3-20-20)T

**51. 03370 Specially Placed Concrete, Concrete Pumping and Shotcreting.** A specialty contractor whose primary business includes the ability and equipment necessary to deliver and install concrete, and similar materials to their final destination in buildings and structures. (3-20-20)T

**52. 03380 Post-Tensioned Concrete Structures or Structural Members.** A specialty contractor whose primary business is the post-tensioning of structural elements using sleeved tendons of high-strength prestressing steel. (3-20-20)T

**53. 03500 Gypercrete.** A specialty contractor whose primary business includes the ability and expertise to mix and apply gypsum concrete. (3-20-20)T

**54. 03600 Concrete Grouting.** A specialty contractor whose primary business includes the ability and the equipment necessary to place concrete grouts. Concrete grouts are thin, fluid, shrink resistant, mortar-like materials used for filling joints and cavities and setting and anchoring items in masonry and concrete. (3-20-20)T

**55. 03650 Pressure Grouting and Slab Jacking.** A specialty contractor whose primary business includes pressure foundation grouting and jacking and the injection of concrete or mortar into foundations for stabilization. (3-20-20)T

**56. 03900 Concrete Demolition, Concrete Sawing and Cutting, Core Drilling, Joint Sealing and Hydrocutting.** A specialty contractor whose primary business includes concrete cutting, drilling, sawing, cracking, breaking, chipping or removal of concrete. This category also includes the caulking or sealing of joints or cracks caused by such operations. (3-20-20)T

**57. 04000 Masonry.** A specialty contractor whose primary business includes the installation with or without the use of mortar or adhesives of brick, concrete block, adobe units, gypsum partition tile, pumice block or other lightweight and facsimile units and products common to the masonry industry. (3-20-20)T

**58. 04900 Chemical Cleaning and Masonry Restoration.** A specialty contractor whose primary business includes the cleaning or restoration of masonry through the use of chemicals, pressure washing, sand blasting or other methods. (3-20-20)T

**59. 05090 Welding.** A specialty contractor whose primary business causes metal to become permanently attached, joined and fabricated by the use of gases or electrical energy, developing sufficient heat to create molten metal, fusing the elements together. (3-20-20)T

**60. 05100 Steel Fabrication, Erection and Installation.** A specialty contractor whose primary business includes the ability and expertise to fabricate, place and tie steel reinforcing bars, erect structural steel shapes and plates, of any profile, perimeter or cross-section, that are or may be used to reinforce concrete or as structural members for buildings and structures, including riveting, welding and rigging only in connection therewith, in such a manner that steel reinforcing and structural work can be fabricated and erected. (3-20-20)T

**61. 05700 Ornamental Metals.** A specialty contractor whose primary business includes the art, ability, experience, knowledge, science and expertise to assemble, case, cut, shape, stamp, forage, fabricate and install sheet, rolled and cast, brass, bronze, copper, cast iron, wrought iron, monel metal, stainless steel, and any other metal or any combination thereof, as have been or are now used in the building and construction industry for the architectural treatment and ornamental decoration of buildings and structures, in such a manner that, under an agreed specification, acceptable ornamental metal work can be executed, fabricated and installed; but does not include the work of a sheet metal contractor. (3-20-20)T

**62. 05830 Bridge Expansion Joints and Repair.** A specialty contractor whose primary business and expertise is the repair of bridge expansion joints. (3-20-20)T

- 63. 06100 Carpentry, Framing and Remodeling.** A specialty contractor whose primary business includes the placing and erection of floor systems, walls, sheeting, siding, trusses, roof decking of either wood or light gauge metal framing. This contractor also installs finish items such as running trim, sashes, doors, casing, cabinets, cases and other pre-manufactured finished items. (3-20-20)T
- 64. 06130 Log and Heavy Timber Construction.** A specialty contractor whose primary business includes the ability and expertise to build and erect log or heavy timber structures. (3-20-20)T
- 65. 06139 Docks - Log and Wood Structures.** A specialty contractor whose primary business includes the ability and expertise to construct log and wood structured docks. (3-20-20)T
- 66. 06200 Finish Carpentry and Millwork.** A specialty contractor whose primary business includes the art, ability, experience, knowledge, science and expertise to cut, surface, join, stick, glue and frame wood and wood products, in such a manner that, under an agreed specification, acceptable cabinet, case, sash, door, trim, nonbearing partition, and such other mill products as are by custom and usage accepted in the building and construction industry as millwork and fixtures, can be executed; including the placing, erecting, fabricating and finishing in buildings, structures and elsewhere of such millwork and fixtures or to do any part or any combination of any thereof. (3-20-20)T
- 67. 07100 Waterproofing and Dampproofing.** A specialty contractor whose primary business includes the ability and expertise to apply waterproofing membranes, coatings of rubber, latex, asphaltum, pitch, tar or other materials or any combination of these materials, to surfaces to prevent, hold, keep and stop water, air or steam from penetrating and passing such materials, thereby keeping moisture from gaining access to material or space beyond such waterproofing. (3-20-20)T
- 68. 07200 Thermal Insulation.** A specialty contractor whose primary business includes the installation of any insulating media in buildings and structures for the purpose of temperature control. (3-20-20)T
- 69. 07240 Stucco and Exterior Insulation Finish Systems (EIFS).** A specialty contractor whose primary business includes the ability and expertise to install Stucco and EIFS. (3-20-20)T
- 70. 07400 Roofing and Siding.** A specialty contractor whose primary business includes the ability and expertise to examine surfaces and to bring such surfaces to a condition where asphaltum, pitch, tar, felt, flax, shakes, shingles, roof tile, slate and any other material or materials or any combination thereof, that use and custom has established as usable for, or which material or materials are now used as, such waterproof, weatherproof or watertight seal for such membranes, roof and surfaces; but does not include a contractor whose sole contracting business is the installation of devices or stripping for the internal control of external weather conditions. (3-20-20)T
- 71. 07450 Siding and Decking.** A specialty contractor whose primary business includes the application or installation of exterior siding, decking or gutters including wood, wood products, vinyl, aluminum and metal to new or existing buildings and includes wooden decks and related handrails. (This category does not include the construction or installation of covers or enclosures of any kind.) (3-20-20)T
- 72. 07700 Sheet Metal Flashings, Roof Specialties and Accessories.** A specialty contractor whose primary business includes the art, ability, experience, knowledge, science and expertise to select, cut, shape, fabricate and install sheet metal such as cornices, flashings, gutters, leaders, rainwater down spouts, pans, etc., or to do any part or any combination thereof, in such a manner that sheet metal work can be executed, fabricated and installed. (3-20-20)T
- 73. 07800 Sprayed on Fireproofing.** A specialty contractor whose primary business includes the mixing, transportation, and installation of fire proofing materials for buildings and structures. (3-20-20)T
- 74. 07920 Caulking and Joint Sealants.** A specialty contractor whose primary business includes the ability and expertise for installation of elastomeric and rigid joint sealants, caulking compounds, and related accessories. (3-20-20)T
- 75. 08100 Doors, Gates, Specialty Doors and Activating Devices.** A specialty contractor whose

primary business is the installation, modification or repair of residential, commercial or industrial doors and door hardware. This includes but is not necessarily limited to wood, metal clad or hollow metal, glass, automatic, revolving, folding and sliding doors, power activated gates, or movable sun shades/shutters. Card activated equipment and other access control devices and any low voltage electronic or manually operated door hardware devices are also a part of this category. (3-20-20)T

**76. 08500 Windows, Glass and Glazing.** A specialty contractor whose primary business includes the art, ability, experience, knowledge and expertise to select, cut, assemble and install all makes and kinds of glass and glass work, and execute the glazing of frames, panels, sash and doors, in such a manner that under an agreed specification, acceptable glass work and glazing can be executed, fabricated and installed, and may include the fabrication or installation in any building or structure of frames, glazed-in panels, sash or doors, upon or within which such frames, glazed-in panels, sash or doors, such glass work or glazing has been or can be executed or installed. (3-20-20)T

**77. 09110 Steel Stud Framing.** A specialty contractor whose primary business includes the ability and expertise to build or assemble steel stud framing systems. (3-20-20)T

**78. 09200 Lath and Plaster.** A specialty contractor whose primary business includes the ability and expertise to prepare mixtures of sand, gypsum, plaster, quick-lime or hydrated lime and water or sand and cement and water or a combination of such other materials as create a permanent surface coating; including coloring for same and to apply such mixtures by use of a plaster's trowel, brush or spray gun to any surface which offers a mechanical key for the support of such mixture or to which such mixture will adhere by suction; and to apply wood or metal lath or any other materials which provide a key or suction base for the support of plaster coatings; including the light gauge metal shapes for the support of metal or other fire proof lath. Includes metal stud framing. (3-20-20)T

**79. 09250 Drywall.** A specialty contractor whose primary business includes the ability and expertise to install unfinished and prefinished gypsum board on wood and metal framing and on solid substates; gypsum and cementitious backing board for other finishes; accessories and trim; and joint taping and finishing. (3-20-20)T

**80. 09300 Tile and Terrazzo.** A specialty contractor whose primary business includes the ability and expertise to examine surfaces and bring such surfaces to a condition where acceptable work can be executed and fabricated thereon by the setting of chips or marble, stone, tile or other material in a pattern with the use of cement, and to grind or polish the same. (3-20-20)T

**81. 09500 Acoustical Treatment.** A specialty contractor whose primary business includes the installation, application, alteration and repair of all types of acoustical systems, to include acoustical ceilings, wall panels, sound control blocks and curtains, hangers, clips, inserts, nails, staples, related hardware and adhesive, lightweight framing systems and related accessories (electrical excluded), installation and repair of gypsum wall board, painting, accessories, taping and texturing. (3-20-20)T

**82. 09600 Flooring.** A specialty contractor whose primary business includes the ability and expertise to examine surfaces, specify and execute the preliminary and preparatory work necessary for the installation of flooring, wherever installed, including wood floors and flooring (including the selection, cutting, laying, finishing, repairing, scraping, sanding, filling, staining, shellacking and waxing) and all flooring of any nature either developed as or established through custom and usage as flooring. (3-20-20)T

**83. 09680 Floor Covering and Carpeting.** A specialty contractor whose primary business includes the installation, replacement and repair of floor covering materials, including laminates and including preparation of surface to be covered, using tools and accessories and industry accepted procedures of the craft. (3-20-20)T

**84. 09900 Painting and Decorating.** A specialty contractor whose primary business includes the ability and expertise to examine surfaces and execute the preliminary and preparatory work necessary to bring such surfaces to a condition where acceptable work can be executed thereon with the use of paints, varnishes, shellacs, stains, waxes, paper, oilcloth, fabrics, plastics and any other vehicles, mediums and materials that may be mixed, used and applied to the surface of buildings, and the appurtenances thereto, of every description in their natural condition or constructed of any material or materials whatsoever that can be painted or hung as are by custom and usage accepted in the building and construction industry as painting and decorating. (3-20-20)T

- 85. 09950 Sand Blasting.** A specialty contractor whose primary business includes the ability and expertise to sand blast surfaces through the use of equipment designed to clean, grind, cut or decorate surfaces with a blast of sand or other abrasive applied to such surfaces with steam or compressed air. (3-20-20)T
- 86. 09960 Specialty Coatings.** A specialty contractor whose primary business includes the surface preparation and installation of specialty coatings. (3-20-20)T
- 87. 10150 Institutional Equipment.** A specialty contractor whose primary business includes the installation, maintenance and repair of booths, shelves, laboratory equipment, food service equipment, toilet partitions, and such other equipment and materials as are by custom and usage accepted in the construction industry as institutional equipment. (3-20-20)T
- 88. 10270 Raised Access Flooring.** A specialty contractor whose primary business includes the installation of wood or metal-framed elevated computer-flooring systems. This does not include the structural floor on which the computer floor is supported or mezzanines. (3-20-20)T
- 89. 10445 Non-Electrical Signs.** A specialty contractor whose primary business includes the installation of all types of non-electrical signs, including but not limited to traffic delineators, mile post markers, post or pole supported signs, signs attached to structures, painted wall signs, and modifications to existing signs. (3-20-20)T
- 90. 11001 Specialty Machinery and Equipment Installation and Servicing.** A specialty contractor whose primary business is the installation, removal, modification or repair of pumps, water and waste water equipment, conveyors, cranes, dock levelers, various hoisting and material handling equipment, trash compactors and weighing scales installation and servicing. This does not include the construction of buildings or roof structures for this equipment. (3-20-20)T
- 91. 11140 Petroleum and Vehicle Service Equipment, Installation and Repair.** A specialty contractor whose primary business includes the installation and repair of underground fuel storage tanks used for dispensing gasoline, diesel, oil or kerosene fuels. This includes installation of all incidental tank-related piping, leak line detectors, vapor recovery lines, vapor probes, low voltage electrical work, associated calibration, testing and adjustment of leak detection and vapor recovery equipment, and in-station diagnostics. This contractor may also install auto hoisting equipment, grease racks, compressors, air hoses and other equipment related to service stations. (3-20-20)T
- 92. 11200 Water/Wastewater and Chemical Treatment.** A specialty contractor whose primary business is the supply, installation and operational startup of equipment and chemicals for chemical treatment of water, wastewater or other liquid systems. (3-20-20)T
- 93. 11485 Climbing Wall Structures and Products.** A specialty contractor whose primary business includes the ability and expertise to design, fabricate and install climbing wall structures and equipment. This does not include concrete foundations or buildings in which the climbing walls may be supported or housed. (3-20-20)T
- 94. 12011 Prefabricated Equipment and Furnishings.** A specialty contractor whose primary business includes the installation of prefabricated products or equipment including but not limited to the following: theater stage equipment, school classroom equipment, bleachers or seats, store fixtures, display cases, toilet or shower room partitions or accessories, closet systems, dust collecting systems, appliances, bus stop shelters, telephone booths, sound or clean rooms, refrigerated boxes, office furniture, all types of pre-finished, pre-wired components, detention equipment and other such equipment and materials as are by custom and usage accepted in the construction industry as prefabricated equipment. (3-20-20)T
- 95. 12490 Window, Wall Coverings, Drapes and Blinds.** A specialty contractor whose primary business includes the installation of decorative, architectural or functional window glass treatments or covering products or treatments for temperature control or as a screening device. (3-20-20)T
- 96. 13110 Cathodic Protection.** A specialty contractor whose primary business is the prevention of

corrosion by using special cathodes and anodes to circumvent corrosive damage by electric current. (3-20-20)T

**97. 13121 Pre-Manufactured Components and Modular Structures.** A specialty contractor whose primary business includes the moving, setup, alteration or repair of pre-manufactured components, houses or similar modular structures. (3-20-20)T

**98. 13125 Pre-Engineered Building Kits.** A specialty contractor whose primary business includes the assembly of pre-engineered building kits or structures obtained from a single source. This category is limited to assembly only of pre-engineered metal buildings, pole buildings, sunrooms, geodesic structures, aluminum domes, air supported structures, manufactured built greenhouses or similar structures. This does not include any other categories such as concrete foundations, carpentry, plumbing, heating or cooling, or electrical work. (3-20-20)T

**99. 13150 Swimming Pools and Spas.** A specialty contractor whose primary business includes the ability to construct swimming pools, spas or hot tubs including excavation and backfill of material, installation of concrete, Gunite, tile, pavers or other special materials used in pool construction. This category also includes the installation of heating and filtration equipment, using those trades or skills necessary for installing the equipment, which may require other licenses including electrical and plumbing. (3-20-20)T

**100. 13165 Aquatic Recreational Equipment.** A specialty contractor whose primary business includes the ability and expertise to design, fabricate and erect water slides and water park equipment and structures. This does not include any other categories such as concrete foundations, carpentry, plumbing, heating, cooling or electrical work. (3-20-20)T

**101. 13201 Circular Prestressed Concrete Storage Tanks (Liquid and Bulk).** A specialty contractor whose primary business is the construction of circular prestressed concrete structures post-tensioned with circumferential tendons or wrapped circular prestressing. (3-20-20)T

**102. 13280 Hazardous Material Remediation.** A specialty contractor whose primary business includes the ability and expertise to safely encapsulate, remove, handle or dispose of hazardous materials within buildings, including but not limited to asbestos, lead and chemicals. Contractors must be properly licensed and certified. (3-20-20)T

**103. 13290 Radon Mitigation.** A specialty contractor whose primary business and expertise includes the detection and mitigation of Radon gas. (3-20-20)T

**104. 13800 Instrumentation and Controls.** A specialty contractor whose primary business includes the installation, alteration or repair of instrumentation and control systems used to integrate equipment, sensors, monitors' controls and mechanical operators for industrial processes, building equipment, mechanical devices and related equipment. (3-20-20)T

**105. 13850 Alarm Systems.** A specialty contractor whose primary business includes the installation, alteration and repair of communication and alarm systems, including the mechanical apparatus, devices, piping and equipment appurtenant thereto (except electrical). (3-20-20)T

**106. 13930 Fire Suppression Systems (Wet and Dry-Pipe Sprinklers).** A specialty contractor whose primary business includes the ability and expertise to lay out, fabricate and install approved types of Wet-Pipe and Dry-Pipe fire suppression systems, charged with water, including all mechanical apparatus, devices, piping and equipment appurtenant thereto. Licensure with State Fire Marshal is required. (3-20-20)T

**107. 13970 Fire Extinguisher and Fire Suppression Systems.** A specialty contractor whose primary business is the installation of pre-engineered or pre-manufactured fixed chemical extinguishing systems primarily used for protecting kitchen-cooking equipment and electrical devices. Contractor also furnishes, installs and maintains portable fire extinguishers. (3-20-20)T

**108. 14200 Elevators, Lifts and Hoists.** A specialty contractor whose primary business includes the ability to safely and efficiently install, service and repair all elevators, lifts, hoists, including the fabrication, erection and installation of sheave beams, sheave motors, cable and wire rope, guides, cabs, counterweights, doors, sidewalk

elevators, automatic and manual controls, signal systems and other devices, apparatus and equipment appurtenant to the installation. (3-20-20)T

**109. 15100 Pipe Fitter and Process Piping.** A specialty contractor whose primary business is the installation of piping for fluids and gases or materials. This category does not include domestic water, sewage, fire protection and utilities as they are covered under other categories. (3-20-20)T

**110. 15400 Plumbing.** A specialty contractor whose primary business includes the ability to create and maintain sanitary conditions in buildings, by providing a permanent means for a supply of safe, pure and wholesome water, ample in volume and of suitable temperatures for drinking, cooking, bathing, washing, cleaning, and to cleanse all waste receptacles and like means for the reception, speedy and complete removal from the premises of all fluid and semi-fluid organic wastes and other impurities incidental to life and the occupation of such premises, including a safe and adequate supply of gases for lighting, heating, and industrial purposes. (Licensure with Division of Building Safety is required). (3-20-20)T

**111. 15510 Boiler and Steam Fitting.** A specialty contractor who installs, services and repairs boilers and associated steam distribution systems. This category is limited to work not requiring a heating, ventilating, and air conditioning (HVAC) license issued by the Division of Building Safety. (3-20-20)T

**112. 15550 Chimney Repair.** A specialty contractor whose primary business includes the cleaning or repair of multi-type chimneys, flues or emission control devices used to conduct smoke and gases of combustion from above a fire to the outside area. (3-20-20)T

**113. 15600 Refrigeration.** A specialty contractor whose primary business includes the art, ability, experience, knowledge, science and expertise to construct, erect, install, maintain, service and repair devices, machinery and units for the control of air temperatures below fifty (50) degrees Fahrenheit in refrigerators, refrigerator rooms, and insulated refrigerated spaces and the construction, erection, fabrication and installation of such refrigerators, refrigerator rooms, and insulated refrigerator spaces, temperature insulation, air conditioning units, ducts, blowers, registers, humidity and thermostatic controls of any part or any combination thereof, in such a manner that, under an agreed specification acceptable refrigeration plants and units can be executed, fabricated, installed, maintained, serviced and repaired, but does not include those contractors who install gas fuel or electric power services for such refrigerator plants or other units. (3-20-20)T

**114. 15700 Heating, Ventilation, and Air Conditioning (HVAC).** A specialty contractor whose primary business includes the installation, alteration and repair of heating, ventilating, and air conditioning (HVAC) systems. Licensure by the Division of Building Safety as an HVAC contractor is required. (3-20-20)T

**115. 15950 Testing and Balancing of Systems.** A specialty contractor whose primary business includes the installation of devices and performs any work related to providing for a specified flow of air or water in all types of heating, cooling or piping systems. (3-20-20)T

**116. 16000 Electrical.** A contractor engaging in, conducting, or carrying on the business of installing wires or equipment to carry electric current or installing electrical apparatus to be operated by such current. A contractor licensed in this category may perform all work covered in categories defined in Subsection 200.118 of these rules. A contractor in this category must be an electrical contractor, licensed pursuant to Section 54-1007(1), Idaho Code. (3-20-20)T

**117. 16700 Communication.** A specialty contractor whose primary business includes the installation, alteration or repair of communication systems (voice, data, television, microwave, and other communication systems). (3-20-20)T

**118. 16800 Limited Electrical Contractor.** A contractor engaging in, conducting, or carrying on the business of installing, altering, or repairing special classes of electrical wiring, apparatus, or equipment. A contractor in this category must be an electrical specialty contractor, licensed pursuant to Section 54-1007(1), Idaho Code, and may perform only that work included within the specialty license. Electrical specialty categories include, but are not limited to: (3-20-20)T



- a. Elevator, Dumbwaiter, Escalator or Moving-walk Electrical; (3-20-20)T
- b. Sign Electrical; (3-20-20)T
- c. Manufacturing or Assembling Equipment; (3-20-20)T
- d. Limited Energy Electrical License (low voltage); (3-20-20)T
- e. Irrigation Sprinkler Electrical; (3-20-20)T
- f. Well Driller and Water Pump Installer Electrical; and (3-20-20)T
- g. Refrigeration, Heating and Air Conditioning Electrical Installer. (3-20-20)T

**119. 18100 Golf Course Construction.** A specialty contractor whose primary business includes the construction, modification, and maintenance of golf courses. This includes clearing, excavation, grading, landscaping, sprinkler systems and associated work. This does not include the construction of buildings or structures such as clubhouses, maintenance or storage sheds. (3-20-20)T

**120. 18200 Underwater Installation and Diving.** A specialty contractor whose primary business is marine construction under and above water. (3-20-20)T

**121. 18300 Develop Gas and Oil Wells.** A specialty contractor whose primary business includes the ability and expertise to perform oil well drilling and other oil field related specialty work. This does not include water well drilling. (3-20-20)T

**122. 18400 Nonstructural Restoration After Fire or Flood.** A specialty contractor whose primary business includes cleaning and nonstructural restoration after fire, flood or natural disasters. (3-20-20)T

**123. 18600 Building Cleaning and Maintenance.** A specialty contractor whose primary business includes the cleaning and maintenance of a structure designed for the shelter, enclosure and support of persons, chattels, personal and moveable property of any kind. (3-20-20)T

**124. 18700 Snow Removal.** A specialty contractor whose primary business includes the plowing, removal or disposal of snow from roads, streets, parking lots and other areas of the public rights-of-way. (3-20-20)T

**125. 18800 Roadway Cleaning, Sweeping and Mowing.** A specialty contractor whose primary business includes the clearing of trash and debris by manual or automated means from public thoroughfares. This category also includes cutting or mowing of grasses, plants, or weeds from public rights-of-way. (3-20-20)T

**201. FEES.**

**01. Public Works Contractor Licensing Fees.** In accordance with Section 54-1904, Idaho Code, fees for each class of public works contractor licenses are as provided below.

<b>TABLE 201.01 – INITIAL AND RENEWAL LICENSING FEES</b>		
<b>License Class</b>	<b>Initial Fee</b>	<b>Renewal Fee</b>
Unlimited	\$550	\$440
AAA	\$450	\$360
AA	\$350	\$280
A	\$250	\$160
B	\$150	\$120

<b>TABLE 201.01 – INITIAL AND RENEWAL LICENSING FEES</b>		
<b>License Class</b>	<b>Initial Fee</b>	<b>Renewal Fee</b>
CC	\$125	\$100
C	\$100	\$80
D	\$50	\$40

(3-20-20)T

**02. Construction Manager Licensing Fees.** Fees for construction manager licenses are, in accordance with Section 54-4510, Idaho Code, as follows: (3-20-20)T

<b>TABLE 201.02 – CONSTRUCTION MANAGER LICENSING FEES</b>	
<b>License Activity</b>	<b>Fee</b>
Initial Licensing	\$200
License Renewal	\$200
Inactive License	\$50
License Reinstatement	\$200
Exam Administration	Fee established by testing agency
Certificate of Authority	\$100

**03. Payment of Fees.** Fees are payable to “Division of Building Safety -- Public Works Contractors.” (3-20-20)T

**04. Application Filed With Fees.** An application filed without the listed fees is deemed incomplete and returned to the applicant. (3-20-20)T

**202. COMPLAINTS.**

Complaints alleging a violation of Title 54, Chapter 19, Idaho Code, or these rules must be in writing and filed with the administrator. All complaints must be verified and submitted on forms provided by the Board. (3-20-20)T

**203. -- 299. (RESERVED)**

**300. BUSINESS ORGANIZATION -- CHANGES IN ORGANIZATION OR STRUCTURE -- MEMBERS OF JOINT VENTURES - CHANGES FOR REASONS OTHER THAN DEATH.**

A licensed public works contractor or construction manager who undergoes a change in business organization or structure (such as a change from an individual proprietor to a partnership, corporation, limited liability partnership, limited liability company, joint venture, or other combination thereof), or where there is a change in ownership, must file an application for a new license on behalf of such successor organization or new owners within sixty (60) days after such change occurs. The administrator may authorize the continuous operation of the licensee as a contractor during the interim period until the application of the successor organization is reviewed; provided written notice of such change is filed within thirty (30) days after such change occurs. Each participant in a joint venture must be licensed at the time of bidding. Where there is a change in the surviving members of a licensed partnership, limited liability company, or limited liability partnership, due to a reason other than the death of one (1) of the partners, the remaining or succeeding member or members are required to file an application for an original license. (3-20-20)T

**301. -- 399. (RESERVED)**

**400. CERTIFICATES -- DISPLAY AND POSSESSION.**

Licensee must sign and display the license certificate issued to him in his main office or chief place of business and must furnish satisfactory evidence of the possession of a current license upon the administrator's demand.

(3-20-20)T

**401. LICENSE NUMBER ON BIDS.**

Licensee must place his license number on any and all bids submitted or contracts entered into, for any public works projects in the state of Idaho.

(3-20-20)T

**402. CHANGES IN LICENSE CERTIFICATE.**

When any change in the license certificate has been approved by the Board, a new license certificate will be issued.

(3-20-20)T

**403. -- 501. (RESERVED)**

**502. TECHNICALITIES OF FORM.**

The administrator may, during any hearing or proceeding waive any technicalities of form not deemed necessary in the circumstances.

(3-20-20)T

**503. HEARINGS.**

The general procedure for hearings before the administrator and the Board is as prescribed in these rules and Title 67, Chapter 52, Idaho Code.

(3-20-20)T

**01. Notes.** Any interested persons may request, in writing, five (5) days before any scheduled hearing in a contested case that the oral proceedings thereof be taken in the form of stenographic notes to be transcribed at his own expense.

(3-20-20)T

**02. Procedure.** The Board reserves the right to amend, modify or repeal all or any part of the above procedure or to dispense with any part thereof, at any hearing before the Board, as it may deem necessary in the circumstances.

(3-20-20)T

**504. -- 599. (RESERVED)**

**600. CONSTRUCTION MANAGER EXAMINATIONS.**

If the applicant fails an examination, the applicant may take the examination a second time. A grade of at least seventy-five percent (75%) is required to pass each section of the examination. If the applicant fails to score a passing grade, the applicant must pass all failed sections within one (1) year of the initial test date. If the applicant fails to achieve a passing grade in each individual section on the second examination, the applicant must wait one (1) full year before taking the examination again. The applicant must then take and pass all sections of the examination (receiving no credit for sections successfully completed during the previous year).

(3-20-20)T

**601. -- 999. (RESERVED)**

**07.07.01 – RULES GOVERNING INSTALLATION OF HEATING, VENTILATION,  
AND AIR CONDITIONING SYSTEMS**

**000. LEGAL AUTHORITY.**

This chapter is adopted in accordance with Sections 54-5001 and 54-5005(2), Idaho Code. (3-20-20)T

**001. TITLE AND SCOPE.**

**01. Title.** These rules are titled IDAPA 07.07.01, “Rules Governing Installation of Heating, Ventilation, and Air Conditioning Systems” (HVAC Rules). (3-20-20)T

**02. Scope.** These rules establish the minimum standards for heating, ventilation, and air conditioning (HVAC) installation practice, certification, registration, and educational programs. (3-20-20)T

**002. (RESERVED)**

**003. ADMINISTRATIVE APPEALS.**

Title 67, Chapter 52, Idaho Code, and IDAPA 04.11.01, “Idaho Rules of Administrative Procedure of the Attorney General,” govern administrative appeals and judicial review thereof. (3-20-20)T

**004. ADOPTION AND INCORPORATION BY REFERENCE OF THE INTERNATIONAL MECHANICAL CODE, 2018 EDITION; THE INTERNATIONAL FUEL GAS CODE, 2018 EDITION; AND PART V (MECHANICAL) AND PART VI (FUEL GAS) OF THE INTERNATIONAL RESIDENTIAL CODE FOR ONE (1)- AND TWO (2)-FAMILY DWELLINGS, 2018 EDITION.**

The 2018 editions of the International Residential Code for One (1)- and Two (2)-Family Dwellings, International Mechanical Code, and International Fuel Gas Code are available at the Division’s offices located at 1090 E. Watertower St., Suite, 150 Meridian, Idaho 83642; 1250 Ironwood Dr., Ste. 220, Coeur d’Alene, Idaho 83814; and 2055 Garrett Way, Building 1, Suite 4, Pocatello, Idaho 83201. (3-20-20)T

**01. International Mechanical Code.** The 2018 Edition, including appendix “A,” (herein IMC) is adopted and incorporated by reference with the following amendments: (3-20-20)T

**a.** Where differences occur between the IMC and Title 54, Chapter 50, Idaho Code and IDAPA 07, Title 07, the provisions in Idaho Code and IDAPA rules apply. (3-20-20)T

**b.** All references to the International Plumbing Code (IPC) are construed as referring to the Idaho State Plumbing Code (ISPC) as adopted and amended by the Idaho State Plumbing Board. (3-20-20)T

**c.** All references to the International Code Council Electrical Code (ICC EC) are construed as referring to the National Electrical Code (NEC) as adopted and amended by the Idaho State Electrical Board. (3-20-20)T

**d.** Section 109. Delete. (3-20-20)T

**e.** Section 202 Definitions. Delete the definitions provided in the code for the terms identified herein this paragraph and replace with the following: (3-20-20)T

**i.** Light-Duty Cooking Appliance. Light-duty cooking appliances include gas and electric ovens (including standard, bake, roasting, revolving, retherm, convection, combination convection/steamer, countertop conveyORIZED baking/finishing, deck, pastry, and electric and gas conveyor pizza ovens), electric and gas steam jacketed kettles, electric and gas pasta cookers, electric and gas compartment steamers (both pressure and atmospheric) and electric and gas cheesemelters. (3-20-20)T

**ii.** Medium-Duty Cooking Appliance. Medium-duty cooking appliances include electric discrete element ranges (with or without oven), electric and gas hot-top ranges, electric and gas griddles, electric and gas double sided griddles, electric and gas fryers (including open deep fat fryers, donut fryers, kettle fryers and pressure fryers), electric and gas tilting skillets (braising pans) and electric and gas rotisseries. (3-20-20)T

**f.** Section 401.1 Scope. Add the following: Exception: The principles specified in ASHREA 62-2010 may be used as an alternative to this chapter to demonstrate compliance with required ventilation air for occupants. (3-20-20)T

**g.** Section 504.8.1 Material and size. Add the following exception: Dryer duct may be constructed of 0.013 (30 gauge) or equivalent if prefabricated 0.016 (28 gauge) ducts and fittings are not available. (3-20-20)T

**h.** Table 603.4 Duct Construction Minimum Sheet Metal Thickness for Single Dwelling Units. Add the following exception to the Table: Round duct, enclosed rectangular ducts and fittings less than fourteen (14) inches may be constructed of 0.013 (30 gauge) or equivalent if prefabricated 0.016 (28 gauge) ducts and fittings are not available. (3-20-20)T

**02. International Fuel Gas Code.** The 2018 Edition, including appendixes “A, B, C, and D,” (herein IFGC) is adopted and incorporated by reference with the following amendments: (3-20-20)T

**a.** Where differences occur between the IFGC and Title 54, Chapter 50, Idaho Code and IDAPA 07, Title 07, the provisions in Idaho Code and IDAPA rules apply. (3-20-20)T

**b.** All references to the International Plumbing Code (IPC) are construed as referring to the Idaho State Plumbing Code (ISPC) as adopted and amended by the Idaho State Plumbing Board. (3-20-20)T

**c.** All references to the International Code Council Electrical Code (ICC EC) are construed as referring to the National Electrical Code (NEC) as adopted and amended by the Idaho State Electrical Board. (3-20-20)T

**d.** Section 109. Delete. (3-20-20)T

**e.** Section 406.4. Change the last sentence to: Mechanical gauges used to measure test pressure must have a range such that the highest end of the scale is not greater than two (2) times the test pressure nor lower than one and one-half (1.5) times the test pressure. (3-20-20)T

**f.** Section 406.4.1. Test Pressure. Not less than twenty (20) psig (140kPa gauge) test pressure is required for systems with a maximum working pressure up to ten (10) inches water column. For systems with a maximum working pressure between ten (10) inches water column and ten (10) psig (70kPa gauge); not less than sixty (60) psig (420kPa gauge) test pressure is required. For systems over ten (10) psig (70kPa gauge) working pressure, minimum test pressure may be no less than six (6) times working pressure. (3-20-20)T

**g.** Section 406.4.2. The test duration may not be less than twenty (20) minutes. (3-20-20)T

**h.** Add a new section 503.4.1.2 as follows: Testing. All plastic pipe within a dwelling used for venting flue gases must be tested at five (5) psi for fifteen (15) minutes. (3-20-20)T

**i.** Section 505.1.1. Addition. An interlock between the cooking appliance and the exhaust hood system is not be required for appliances that are of the manually operated type and are factory equipped with standing pilot burner ignition systems. (3-20-20)T

**03. Part V (Mechanical) and Part VI (Fuel Gas) of the International Residential Code for One (1)- and Two (2)-Family Dwellings.** The 2018 Edition, including appendixes “A, B, C, and D,” (herein IRC) is adopted and incorporated by reference with the following amendments: (3-20-20)T

**a.** Where differences occur between the IRC and Title 54, Chapter 50, Idaho Code, and IDAPA 07, Title 07, Chapter 01, the provisions in Idaho Code and IDAPA rules apply. (3-20-20)T

**b.** All references to the International Plumbing Code (IPC) are construed as referring to the Idaho State Plumbing Code (ISPC) as adopted and amended by the Idaho State Plumbing Board. (3-20-20)T

**c.** All references to the International Code Council Electrical Code (ICC EC) are construed as referring to the National Electrical Code (NEC) as adopted and amended by the Idaho State Electrical Board. (3-20-20)T

**d.** Add the following as section M1201.3 and section G2402.4 (201.4): Alternative materials, design

and methods of construction equipment. The provisions of this part of the code are not intended to prevent the installation of any material or to prohibit any design or method of construction not specifically prescribed by this code, provided that any such alternative has been approved. An alternative material, design or method of construction must be approved where the authority having jurisdiction finds that the proposed design is satisfactory and complies with the intent of the provisions of this code, and that the material, method or work offered is, for the purpose intended, at least the equivalent of that prescribed in this code. Compliance with the specific performance-based provisions of this part of the code in lieu of specific requirements of this code will also be permitted as an alternate.

(3-20-20)T

**e.** Add the following as section M1201.3.1 and section G2402.4.1 (201.4.1): Tests. Whenever there is insufficient evidence of compliance with the provisions of this part of the code, or evidence that a material or method does not conform to the requirements of this part of the code, or in order to substantiate claims for alternative materials or methods, the authority having jurisdiction has the authority to require tests as evidence of compliance to be made at no expense to the jurisdiction. Test methods are as specified in this code or by other recognized test standards. In the absence of recognized and accepted test methods, the authority having jurisdiction approves the testing procedures. Tests must be performed by an approved agency. Reports of such tests must be retained by the authority having jurisdiction for the period required for retention of public records.

(3-20-20)T

**f.** Add the following as section M1203.1: Carbon monoxide alarms. For new construction, an approved carbon monoxide alarm must be installed outside of each separate sleeping area in the immediate vicinity of the bedrooms in dwelling units within which fuel-fired appliances are installed and in dwelling units that have attached garages.

(3-20-20)T

**g.** Add the following as section M1203.2: Where required in existing dwellings. Where work requiring a permit occurs in existing dwellings that have attached garages or in existing dwellings within which fuel-fired appliances exist, carbon monoxide alarms must be provided in accordance with Subsection 004.03.f. of these rules.

(3-20-20)T

**h.** Add the following as section M1203.3: Alarm requirements. Single station carbon monoxide alarms must be listed as complying with UL 2034 and must be installed in accordance with this code and the manufacturer's installation instructions.

(3-20-20)T

**i.** Section M1502.4.1 Material and size. Add the following exception: Dryer duct may be constructed of 0.013 (30 gauge) or equivalent if prefabricated 0.016 (28 gauge) ducts and fittings are not available.

(3-20-20)T

**j.** Delete Section M1502.4.2 Duct Installation and replace with the following: Exhaust ducts must be supported at four (4) foot (1,219 mm) intervals and secured in place. The insert end of the duct must extend into the adjoining duct or fitting in the direction of airflow. Ducts must not be joined with screws or similar fasteners that protrude into the inside of the duct.

(3-20-20)T

**k.** Table M1601.1.1 (2) Gauges of Metal Ducts and Plenums Used for Heating or Cooling. Add the following exception: Round duct, enclosed rectangular ducts and fittings less than fourteen (14) inches may be constructed of 0.013 (30 gauge) or equivalent if prefabricated 0.016 (28 gauge) ducts and fittings are not available.

(3-20-20)T

**l.** Section G2417.4 (406.4). Change the last sentence to: Mechanical gauges used to measure test pressure must have a range such that the highest end of the scale is not greater than two (2) times the test pressure nor lower than one and one-half (1.5) times the test pressure.

(3-20-20)T

**m.** Section G2417.4.1 (406.4.1). Test Pressure. Not less than twenty (20) psig (one hundred forty (140) kPa gauge) test pressure is required for systems with a maximum working pressure up to ten (10) inches water column. For systems with a maximum working pressure between ten (10) inches water column and ten (10) psig (seventy (70) kPa gauge), not less than sixty (60) psig (four hundred twenty (420) kPa gauge) test pressure is required. For systems over ten (10) psig (seventy (70) kPa gauge) working pressure, minimum test pressure may be no less than six (6) times working pressure.

(3-20-20)T

**n.** Section G2417.4.2 (406.4.2). The test duration may not be less than twenty (20) minutes.

(3-20-20)T

**o.** Add a new section G2427.4.1.2 as follows: Testing. All plastic pipe within a dwelling used for venting flue gases must be tested at five (5) psi for fifteen (15) minutes. (3-20-20)T

**005. OFFICE – OFFICE HOURS – MAILING ADDRESS AND STREET ADDRESS.**

The principal place of business of the Division's HVAC Program is located at 1090 E. Watertower Street, Suite 150, Meridian, Idaho. The office is open from 8 a.m. to 5 p.m., except Saturday, Sunday, and legal holidays. The mailing address is: Division of Building Safety, HVAC Program, 1090 E. Watertower Street, Suite 150, Meridian, Idaho 83642. The office telephone number is (208) 334-6180 and the facsimile number is (208) 855-0768. (3-20-20)T

**006. FILING OF DOCUMENTS.**

All written communications and documents that are intended to be part of an official record for decision in a rulemaking or contested case, must be filed with the administrator of the Division. Communications and documents must be filed by mail, hand-delivery, or by facsimile transmission. One (1) original must be filed with the administrator, and one (1) copy must be submitted to the opposing parties. Whenever documents are filed by facsimile transmission, originals must be deposited in the mail the same day or hand-delivered the following business day to the administrator and opposing parties. (3-20-20)T

**007. PUBLIC RECORDS ACT COMPLIANCE.**

These rules were promulgated in accordance with the Administrative Procedure Act, Title 67, Chapter 52, Idaho Code. These rules and all records of the Board are subject to the provisions of the Idaho Public Records Act, Title 74, Chapter 1, Idaho Code. (3-20-20)T

**008. -- 009. (RESERVED)**

**010. CHANGES IN NAME AND ADDRESS -- ADDRESS FOR NOTIFICATION PURPOSES.**

**01. Change of Name.** Whenever a change of name occurs for a certified contractor, journeyman, specialty journeyman, specialty contractor, registered apprentice, or specialty apprentice, the Board must be notified immediately, in writing, of the change. Documentation confirming the change of name must be provided to the Board on request. (3-20-20)T

**02. Change of Address.** Whenever a change of mailing address occurs for a certificated contractor, journeyman, specialty journeyman, specialty contractor, registered apprentice, or specialty apprentice, the Board must be notified immediately, in writing, of the change. (3-20-20)T

**03. Address for Notification Purposes.** The most recent mailing address on record with the Board will be utilized for purposes of all written communication with certified contractors, journeymen, specialty journeymen, specialty contractors, registered apprentices, and specialty apprentices, including, but not limited to, notification of renewal and notices related to inspections. (3-20-20)T

**011. MEETINGS.**

Board meetings are subject to the provisions of the Idaho Open Meeting Law, Title 67, Chapter 23, Idaho Code. (3-20-20)T

**012. DEFINITIONS.**

**01. Additional Definitions.** Terms defined in Section 54-5003, Idaho Code, will have the same meaning when utilized in these rules. (3-20-20)T

**02. Administrator.** The administrator of the Idaho Division of Building Safety. (3-20-20)T

**03. Board.** The Idaho Heating, Ventilation, and Air Conditioning (HVAC) Board. (3-20-20)T

**04. Division.** The Idaho Division of Building Safety. (3-20-20)T

**05. Recognized Jurisdiction.** A jurisdiction with an HVAC program that is recognized by the Board as being substantially equivalent to Idaho's HVAC program. (3-20-20)T

**013. CERTIFICATES OF COMPETENCY -- ISSUANCE, RENEWAL, EXPIRATION -- REVIVAL.**

**01. Issuance.** Certificates of competency will be issued in such a manner as to create a renewal date that coincides with the birth month of the individual to whom the certificate is issued and allows for renewals every three (3) years. Certificates of competency are issued for a period of no less than one (1) year and no more than (3) three years. The fee for issuance of certificates of competency will be prorated based on the number of months for which the certificate is issued. (3-20-20)T

**02. Renewal.** Certificates of competency will be renewed using the birth month of the individual to whom the certificate is issued as the expiration date. Certificates of competency are renewed for a period of no less than one (1) year and no more than three (3) years. The fee for renewal of certificates of competency will be prorated based on the number of months for which the certificate is issued. (3-20-20)T

**03. Expiration-Revival.** (3-20-20)T

**a.** Certificates that are not timely renewed will expire on the last day of the month in which the renewal is due. (3-20-20)T

**b.** Revived certificates will be issued in such a manner as to create a renewal date that coincides with the birth month of the applicant so as to create a staggered system of renewal. (3-20-20)T

**014. -- 019. (RESERVED)**

**020. HVAC CONTRACTOR AND HVAC JOURNEYMAN APPLICATIONS FOR EXAMINATION AND CERTIFICATES OF COMPETENCY, AND REGISTRATION OF APPRENTICES.**

**01. Application Forms.** All applications for certificates and all applications for registration must be submitted on forms provided by the administrator and be properly completed, giving all pertinent information with notarized signatures. (3-20-20)T

**02. Application, Renewal, and Registration Fees.** Fees for applications for examination, certificates of competency, renewal of certificates, and fees for apprentice registration are as set forth in Section 54-5012, Idaho Code. (3-20-20)T

**03. Application Submission.** All applications must be submitted to the board and be approved by an administrator before any examination may be taken and before any certificate of competency is issued. (3-20-20)T

**021. HVAC CONTRACTOR CERTIFICATE OF COMPETENCY - REQUIREMENTS.**

**01. Bond.** Applicants must provide a compliance bond in the amount of two thousand dollars (\$2,000). Any such bond is required to be effective for the duration of the contractor licensing period. (3-20-20)T

**02. Qualification.** Applicants must provide proof, satisfactory to the Board, of having legally acted as an HVAC journeyman for a period of not less than twenty-four (24) months. (3-20-20)T

**03. Examination.** Applicants for certification as HVAC contractors must successfully complete the examination designated by the Board. (3-20-20)T

**04. Out-of-State Contractor Applications.** (3-20-20)T

**a.** An out-of-state applicant for a contractor certificate of competency shall first obtain an Idaho journeyman certificate of competency in accordance with Section 023 of these rules. The applicant shall pay all applicable application and examination fees to the Division and successfully complete the contractor examination administered by the Division. The applicant shall file the compliance bond required by Section 54-5007, Idaho Code,



with the Division upon successful completion of the examination. Applications that are incomplete in any detail will be returned as unacceptable or denied. (3-20-20)T

**b.** An applicant for a contractor certificate of competency who has previously been licensed as an HVAC journeyman in a Recognized Jurisdiction shall provide to the Division satisfactory proof of two (2) years of work experience as an HVAC journeyman in such jurisdiction. (3-20-20)T

**c.** An applicant for a contractor certificate of competency who has never been previously licensed as a journeyman in a Recognized Jurisdiction shall provide proof of four (4) years of experience performing HVAC work of a nature equivalent to that which an HVAC journeyman in Idaho must demonstrate to qualify for a contractor certificate of competency. Proof of such work experience may be provided by the submission of three (3) sworn affidavits from individuals attesting that the applicant has had at least four (4) years' experience performing such work. (3-20-20)T

**022. HVAC SPECIALTY CONTRACTOR CERTIFICATE OF COMPETENCY - REQUIREMENTS.**

Applicants for certification as HVAC specialty contractors must: (3-20-20)T

**01. Bond.** Provide a compliance bond in the amount of two thousand dollars (\$2,000). Any such bond is required to be effective for the duration of the contractor licensing period. (3-20-20)T

**02. Qualification.** Provide proof, satisfactory to the board, of having legally acted as an HVAC specialty journeyman for a period of not less than twenty four (24) months. (3-20-20)T

**03. Examination.** Successfully complete the examination designated by the board. (3-20-20)T

**023. HVAC JOURNEYMAN CERTIFICATES OF COMPETENCY AND EXAMINATION REQUIREMENTS.**

**01. Certificate of Competency Requirements.** To obtain a journeyman certificate of competency, an applicant shall submit to the Division sufficient evidence demonstrating the applicant has successfully completed the journeyman examination and four (4) years, defined as a minimum of eight thousand (8,000) hours of work experience as a registered apprentice making installations on the job under the supervision of a qualified journeyman. Notwithstanding the requirement that an apprentice demonstrate four (4) years of on-the-job work experience under the supervision of a qualified journeyman, any apprentice who successfully completes a Board-approved, full-time, one (1)-academic-year training course may receive credit for up to one (1) year of on-the-job work experience. (3-20-20)T

**02. Examination Requirement.** To take the journeyman examination, an applicant must submit to the Division sufficient evidence demonstrating the applicant has successfully completed a Board-approved training course. (3-20-20)T

**03. Out of State Journeyman Applications.** (3-20-20)T

**a.** An out-of-state applicant for a journeyman certificate of competency shall pay all applicable application and examination fees to the Division, and successfully complete the journeyman examination administered by the Division. (3-20-20)T

**b.** Exhibition of a license issued by another Recognized Jurisdiction may be accepted as proof of meeting the experience and schooling requirements listed in Subsections 023.01 and 023.02 of these rules. An applicant for a journeyman certificate of competency who has previously been licensed as a journeyman in a Recognized Jurisdiction must provide satisfactory proof of licensure in such jurisdiction. (3-20-20)T

**c.** An applicant for a journeyman certificate of competency who has never been previously licensed as a journeyman in a Recognized Jurisdiction must provide one (1) of the following: (3-20-20)T

**i.** Proof of four (4) years, defined as eight thousand (8,000) hours, of HVAC work experience of a nature equivalent to that which an HVAC apprentice must perform in Idaho and four (4) years of training equivalent

to that which an HVAC apprentice must complete in Idaho. (3-20-20)T

ii. Proof of eight (8) years, defined as a minimum of sixteen thousand (16,000) hours, of HVAC work experience of a nature at least equivalent to that which an HVAC apprentice must perform in Idaho. (3-20-20)T

**024. HVAC HEARTH SPECIALTY JOURNEYMAN CERTIFICATES OF COMPETENCY LIMITATIONS: REQUIREMENTS.**

Certification as a hearth specialty journeyman entitles the holder to install hearth appliances and the associated gas lines. Hearth Specialty Journeymen are required to meet the experience requirement and either the education or examination requirement to receive a certificate of competency. (3-20-20)T

**01. Experience.** Demonstrate, to the satisfaction of the board, a minimum of one (1) year experience working in the trade, in compliance with the requirements of the state in which the applicant received his supervision, or as a registered HVAC apprentice or registered HVAC specialty apprentice making HVAC installations on the job under the supervision of a qualified HVAC journeyman or qualified HVAC specialty journeyman. (3-20-20)T

**02. Education.** Successfully complete a board approved training course(s), such as the National Fireplace Institute program and a minimum of sixty (60) hours of education in fuel gas code and piping installation methods. (3-20-20)T

**03. Examination.** Successfully complete an examination designated by the board. (3-20-20)T

**025. HVAC APPRENTICE REQUIREMENTS FOR REGISTRATION.**

**01. Registration.** To become an apprentice, a person shall comply with Section 54-5012, Idaho Code, and be a minimum of eighteen (18) years of age or sixteen (16) years of age if registered by the Bureau of Apprenticeship and Training of the United States Department of Labor. To renew a registration, an apprentice shall show proof of enrollment in a Board-approved training course or completion of eight (8) hours of Board-approved continuing education for each year of the prior registration period. (3-20-20)T

**02. Supervision.** Each apprentice must work under the supervision of a certified journeyman. (3-20-20)T

**026. HVAC SPECIALTY APPRENTICE REQUIREMENTS FOR REGISTRATION.**  
Requirements for HVAC Specialty Apprentice. (3-20-20)T

**01. Age.** Minimum of eighteen (18) years of age unless registered in a Bureau of Apprenticeship Training (BAT) certified HVAC training program. (3-20-20)T

**02. Training.** Maintain enrollment in or successfully complete a training program approved by the board. (3-20-20)T

**03. Supervision.** Work under the supervision of a certificated HVAC journeyman or certificated HVAC specialty journeyman. (3-20-20)T

**027. HVAC WASTE OIL HEATING SPECIALTY JOURNEYMAN CERTIFICATES OF COMPETENCY LIMITATIONS: REQUIREMENTS.**

Certification as a waste oil heating specialty journeyman entitles the holder to install non-duct connected waste oil heaters. Waste oil heating specialty journeymen are limited to the maintenance, installation, and repair of the equipment, controls, and piping directly associated with the waste oil heater, tank, and burner only. Any plumbing, electrical, ducting, venting, or associated equipment beyond the waste oil heater, tank, and burner must be installed by others. Applicants for the waste oil heating specialty journeyman certificate of competency must: (3-20-20)T

**01. Experience.** Demonstrate to the satisfaction of the board, a minimum of one (1) year experience making waste oil heating installations under the supervision of a qualified HVAC journeyman or HVAC Waste Oil Heating specialty journeyman. (3-20-20)T

**02. Examination.** Successfully complete a waste oil burner manufacturers certification or examination as approved by the board. (3-20-20)T

**028. HVAC FUEL GAS PIPING SPECIALTY JOURNEYMAN CERTIFICATES OF COMPETENCY LIMITATIONS: REQUIREMENTS.**

Certification as fuel gas piping specialty journeyman entitles the holder to install fuel gas piping only and does not make the final termination. Appliances and the associated gas piping, chimney, and vents must be installed by others. Fuel gas specialty journeymen are required to meet the experience requirement and either the education or examination requirement to receive a certificate of competency. (3-20-20)T

**01. Experience.** Demonstrate, to the satisfaction of the board, a minimum of one (1) year experience working in the trade, in compliance with the requirements of the state in which the applicant received his supervision, or as a registered HVAC apprentice or registered HVAC specialty apprentice making HVAC installations on the job under the supervision of a qualified HVAC journeyman or qualified HVAC specialty journeyman. (3-20-20)T

**02. Education.** Successfully complete a board approved training course(s), of a minimum of sixty (60) hours of education in fuel gas code and piping installation methods. (3-20-20)T

**03. Examination.** Successfully complete an examination designated by the board. (3-20-20)T

**029. -- 049. (RESERVED)**

**050. HVAC PERMITS.**

**01. Serial Number.** Each permit must bear a serial number. (3-20-20)T

**02. HVAC Contractors and HVAC Specialty Contractors.** The Division will furnish permits to certified HVAC contractors and HVAC specialty contractors upon request. The serial numbers of such permits must be registered in the name of the HVAC contractor or HVAC specialty contractor to whom they are issued. (3-20-20)T

**03. Home Owners.** Home owners or a contract purchaser of residential property, making HVAC installations on their own residences, coming under the provisions of Section 54-5002, Idaho Code, must secure an HVAC permit by making application to the Division as provided in Section 54-5016, Idaho Code. (3-20-20)T

**04. HVAC Contractors and HVAC Specialty Contractors.** HVAC contractors and HVAC specialty contractors must secure an HVAC permit by making application to the Division as provided in Section 54-5016, Idaho Code. (3-20-20)T

**05. Transferring a Permit.** A HVAC permit may be transferred to another eligible party if such party provides to the Division written authorization signed and notarized by the original permit holder consenting to the transfer itself as well as assignment of all the responsibilities and conditions incorporated into the original permit issuance. A permit may be transferred to the owner of the property on which the HVAC work is to be performed and for which the permit was issued for such owners' designated legal agent, in cases where the property owner has terminated their legal relationship with the HVAC contractor who originally obtained the permit. An administrative fee in the amount of forty-five dollars (\$45) for the transfer of a permit will be assessed by the Division. (3-20-20)T

**06. Refunds of Permits.** The Administrator may authorize a refund for any permit fee paid on the following bases: The Administrator may authorize a refund of the entire permit fee paid when no work has been performed related to the installations or HVAC work covered by a permit issued by the Division. A lesser amount up to fifty percent (50%) of the permit fee amount may be refunded if work has commenced and the project is less than fifty percent (50%) complete as determined by the Division. The Administrator will not authorize a refund of any permit fee paid except upon written application for such filed by the original permit holder or the property owner's representative not less than one hundred eighty (180) days after the date the permit was issued. (3-20-20)T

**051. HVAC PERMIT FEE SCHEDULE.**

Permit fees are to cover the cost of inspections as provided by Section 54-5017, Idaho Code. Any person, partnership,

company, firm, association, or corporation making an installation must pay to the Division a permit fee as provided in the following schedule: (3-20-20)T

**01. Residential.** Includes all buildings with HVAC systems being installed on each property. The following permit fees apply to all residential installations:

Type	Fee
Base permit	\$100
Furnace, furnace-air conditioner combination, heat pump, air conditioner, evaporative cooler, unit heater, space heater, decorative gas-fired appliance, incinerator, boiler, pool heater, mini-split system, free-standing solid-fuel stove, factory-built gas fireplace, or similar fixture or appliance, including ducts, vents, and flues attached thereto	Plus \$30 per first fixture or appliance Plus \$15 per additional fixture or appliance
Exhaust duct or ventilation duct, including dryer vents, range hood vents, cook stove vents, bath fan vents, and similar exhaust ducts or ventilation ducts	Plus \$15 per first duct Plus \$5 per additional duct
Fuel gas piping system	Plus \$5 per appliance outlet
Hydronic systems	Plus \$5 per zone

(3-20-20)T

**02. Miscellaneous.** The following permit fees apply for the types of permits listed:

Type	Fee
Requested inspection	\$65 per hour or portion thereof plus costs of out-of-state travel
Mobile or manufactured home	\$65 per inspection
Modular building	
Plan check or technical service	\$65 per hour or portion thereof

(3-20-20)T

**03. Other Installations Including Industrial and Commercial.** The permit fees listed in this Subsection apply to installations not specifically mentioned elsewhere in this schedule. The HVAC system cost is the cost to the owner of labor charges and other costs incurred to complete the installation of equipment and materials installed as part of the HVAC system. All permit fees calculated under this Subsection are based on the total HVAC system cost, which must be listed on the permit.

HVAC System Cost	Fee
Up to \$10,000	\$60 plus 2% of HVAC system cost
\$10,000 to \$100,000	\$260 plus 1% of HVAC system cost exceeding \$10,000
Over \$100,000	\$1,160 plus 5% of HVAC system cost exceeding \$100,000

(3-20-20)T

**04. Additional Fees.** A fee of sixty-five dollars (\$65) per hour or portion thereof applies to trips to inspect: (3-20-20)T

- is not;
- a. When the permit holder has given notice to the Division that the work is ready for inspection and it (3-20-20)T
  - b. If the permit holder has not accurately identified the work location; (3-20-20)T
  - c. If the inspector cannot gain access to make the inspection; (3-20-20)T
  - d. Corrections required by the inspector as a result of the permit holder improperly responding to a corrective notice; or (3-20-20)T
  - e. When corrections have not been made in the prescribed time, unless an extension has been requested and granted. (3-20-20)T
- 05. No Permit.** Failure to purchase a permit before commencing work may result in the assessment of a double fee. (3-20-20)T

**052. -- 059. (RESERVED)**

**060. REQUIRED INSPECTIONS.**

- 01. Request for Division Inspection.** (3-20-20)T
- a. Inspection. Each permit holder must notify the Division at least one (1) day prior to the desired inspection, Sundays and holidays excluded, that the project is ready for inspection. (3-20-20)T
  - b. Reinspection. If a reinspection is required after the final inspection, due to a failure to meet requirements of Title 54, Chapter 50, Idaho Code, and/or these rules, the permit holder will be charged a fee not to exceed the actual cost of each reinspection. (3-20-20)T
- 02. Inspection Tags.** Inspectors certify to the permit holder that an inspection has been done by securely attaching the inspection tag in a prominent location. (3-20-20)T
- a. Final Inspection Tags. An inspection tag indicating that a final inspection has been performed is attached when the HVAC installation as specified on the permit is complete and conforms to the requirements of the code and rules. (3-20-20)T
  - b. Inspection Tags for Unacceptable HVAC Installations. “Notice of Correction” inspection tags are attached to indicate that the HVAC installation is not acceptable and that corrections are required. (3-20-20)T
  - c. Work-in-Progress Tag. An inspection tag indicating that a work-in-progress inspection has been performed is attached following inspection of ground work, rough-in work, or any portion of the installation that is to be covered or otherwise concealed before completion of the entire HVAC installation as specified on the permit. (3-20-20)T

**061. INSPECTOR QUALIFICATIONS.**

In accordance with Section 54-5021, Idaho Code, all mechanical inspectors in Idaho employed by the state or a local government must hold an inspector certification as a commercial or residential mechanical inspector, as appropriate depending on the type of mechanical work being inspected. Mechanical inspectors must obtain the requisite certification from either the International Association of Plumbing and Mechanical Officials (IAPMO), the International Code Council (ICC), or other professional certifying body as approved by the board. (3-20-20)T

**062. -- 069. (RESERVED)**

**070. CIVIL PENALTIES.**

Except for the acts described in Subsections 070.01 and 07.08 of these rules, the acts described in this section subject the violator to a civil penalty of not more than two hundred dollars (\$200) for the first offense and not more than one thousand dollars (\$1,000) for each offense that occurs thereafter within one (1) year of an earlier violation.

(3-20-20)T

**01. Heating, Ventilation, and Air Conditioning Contractor or Specialty Contractor.** Except as provided by Section 54-5001, Idaho Code, any person who acts, or purports to act, as an HVAC contractor or specialty contractor as defined by Section 54-5003(3) and 54-5003(6), Idaho Code, without a valid Idaho state HVAC contractor or specialty contractor certification is subject to a civil penalty of not more than five hundred dollars (\$500) for the first offense and not more than one thousand dollars (\$1,000) for each offense that occurs thereafter within one (1) year of an earlier violation. (3-20-20)T

**02. Knowingly Employing.** Knowingly employing a person who does not hold a valid Idaho HVAC certification or apprentice registration, as required by Section 54-5008, Idaho Code, to perform HVAC installations. (3-20-20)T

**03. Certification or Registration.** Except as provided by Section 54-5001, Idaho Code, performing HVAC work as an HVAC journeyman as defined by Section 54-5003(4), Idaho Code; specialty journeyman as defined by Section 54-5003(7), Idaho Code; apprentice as defined by Section 54-5003(2), Idaho Code; or specialty apprentice as defined by Section 54-5003(5), Idaho Code, without a valid certification or registration. (3-20-20)T

**04. Supervision.** Working as an HVAC apprentice or specialty apprentice without the required journeyman supervision or employing an apprentice without providing the required journeyman supervision. (3-20-20)T

**05. Performance Outside Scope of Specialty License.** Performance of any HVAC installation, alteration, or maintenance by an HVAC specialty contractor or specialty journeyman outside the scope of the specialty certification. (3-20-20)T

**06. Fees and Permits.** Failing to pay applicable fees or properly post an HVAC permit for, or to request an inspection of, any installation, alteration, improvement, or extension of any piping, venting, ductwork, appliances and appurtenances in connection with any HVAC system or subsystems of such. (3-20-20)T

**07. Corrections.** Failure to make corrections in the time allotted in the notice on any HVAC installation as set forth in Section 54-5019, Idaho Code. (3-20-20)T

**08. Gross Violation.** In the case of continued, repeated, or gross violation of Title 54, Chapter 50, Idaho Code, or these rules, a certification revocation will be initiated for certificated individuals under this chapter and non-certificated individuals is subject to prosecution by the appropriate jurisdiction under Idaho law. (3-20-20)T

**071. -- 999. (RESERVED)**

## 07.10.01 – RULES GOVERNING THE DAMAGE PREVENTION BOARD

### 000. LEGAL AUTHORITY.

The Idaho Damage Prevention Board of the Division of Building Safety is authorized under Section 55-2203, Idaho Code, to promulgate rules for the administration of Title 55, Chapter 22, Idaho Code. (3-20-20)T

### 001. TITLE AND SCOPE.

01. **Title.** These rules are titled IDAPA 07.10.01, “Rules Governing the Damage Prevention Board.” (3-20-20)T

02. **Scope.** These rules are applicable to underground facilities, and facility owners as established in Title 55, Chapter 22, Idaho Code. (3-20-20)T

### 002. ADMINISTRATIVE APPEALS.

01. **Governing Procedural Requirements.** IDAPA 04.11.01, “Idaho Rules of Administrative Procedure of the Attorney General,” Section 100, et seq., applies to contested cases, in addition to the provisions of Title 55, Chapter 22, Idaho Code. (3-20-20)T

02. **Appeal Bond.** Upon notice of the imposition of training or a civil penalty, the notified party may contest the imposition of such before the Damage Prevention Board in accordance with Section 018 of these rules. An appeal bond in the amount of two hundred dollars (\$200) must accompany the request for hearing to contest the matter. In the case of training, the Division of Building Safety will refund the bond if the contesting party appears at the hearing. In the case of a civil penalty, the Division will refund any portion of the bond not used to satisfy the penalty imposed by the Board or the entire bond if the contesting party prevails at the hearing. (3-20-20)T

### 004. -- 006. (RESERVED)

### 007. FUNDING OF BOARD ACTIVITIES.

Each owner of an underground facility must pay a fee of ten cents (\$.10) each time such owner receives notice from a one-number notification service as prescribed by Section 55-2205, Idaho Code. The fee assessed upon the underground facility owner is collected by the one-number notification service, and is payable to the board in accordance with the following schedule: (3-20-20)T

01. **Fee Assessed.** The fee will be assessed on an underground facility owner for each notification issued by the one-number notification service to the underground facility owner, with the one-number notification service required to submit a summary of the number of notices issued in a given month to the board no later than fifteen (15) days following the end of the month in which the notices were issued. (3-20-20)T

02. **Payment Submission.** The one-number notification service must submit payment to the board for all payments received from underground facility owners no later than seventy (70) days following the end of the month in which the notices were issued to the facility owners. In those cases where the payment from the underground facility owner is received after the seventy-day (70) period, the one-number service must include late payments in its next payment to the board. (3-20-20)T

03. **Notices Issued.** The one-number notification service must also submit a detailed list of notices issued, including the facility owner’s contact information, for which payment has not been received within the seventy (70) day period following the end of the month in which the notices were issued. Such list must be updated on a monthly basis to reflect the status of all past-due payments due from underground facility owners that have not been received. (3-20-20)T

### 008. AUDIT OF ONE-NUMBER SERVICE RECORDS.

The Board has the right to review and audit the payment records of any one-number notification service relating to the collection of the fee imposed on underground facility owners. In the event the board wishes to conduct a review and/or audit of a one-number notification service, the board will provide no less than a five (5) business day advance notice of the intended action. The board may delegate any responsibilities contained herein this chapter to the Division of Building Safety. (3-20-20)T

### 009. -- 014. (RESERVED)

### 015. EDUCATIONAL AND TRAINING MATERIALS.

**01. Approval of Training and Educational Programs.** The Board approves acceptable training courses or programs and educational materials on relevant underground facility damage prevention topics pertaining to safe excavation, locating and marking of facilities, determining facility damage, emergency procedures, excavator downtime, pre-marking of intended excavation areas, and appropriate procedures when encountering unmarked facilities. (3-20-20)T

**02. Scope of Training and Educational Programs.** Such training programs and educational materials must relate to various aspects of underground facility damage prevention, and contain practices, information, and standards generally accepted and recognized among stakeholders in Idaho. (3-20-20)T

**03. Accessibility of Training and Educational Programs.** The Division maintains and periodically updates a database of approved educational materials and training programs. (3-20-20)T

**04. Purposes of Training and Educational Programs.** Such programs may be used for general educational use by stakeholders or for remedial training that may be ordered by the board or the administrator pursuant to Section 55-2211, Idaho Code. (3-20-20)T

**016. ADEQUACY OF FACILITY OWNERS LOCATING UNDERGROUND FACILITIES.**

The board reviews all stakeholder complaints of violations related to underground facility line locating, as well as generally accepted practices and procedures related to locating. Stakeholders must take remedial actions to improve line-locating performance and monitor and report performance improvements to the board. (3-20-20)T

**017. IMPROVEMENT OF TECHNOLOGY AND COMMUNICATIONS BY STAKEHOLDERS.**

**01. Adoption of Technology and Communications Materials.** On an annual basis the board reviews and adopts any available technology and communications materials which promote effective underground facility locating. The board will make available any such appropriate technology and communications materials as it may determine to all stakeholders on the Division website. (3-20-20)T

**02. Availability of Technology and Communications Materials.** The board may request that stakeholders provide it with information or data related to procedures, methods, or technologies utilized by such stakeholders to enhance communications among other stakeholders, or that enhances underground facility locating capabilities, or enhances the stakeholder's ability to gather and analyze data related to underground facility damage. The board will review such technologies, methods, or materials adopted by stakeholders to ensure that such use is adequate, as well as to provide stakeholders with best practices. The Division of Building Safety must maintain an approved database of such referenced stakeholder data for public viewing and analysis on its website. (3-20-20)T

**018. DAMAGE PREVENTION COMPLAINTS.**

**01. Complaint Forms.** Persons may submit written complaints to the administrator regarding an alleged violation of Title 55, Chapter 22, Idaho Code, on such forms as required by the Division of Building Safety. Forms are available at the Division of Building Safety offices and electronically on the Division's website. Notice of the complaint may be served concurrently on the alleged violator by the person submitting the complaint. Verifiable proof of such notification of a complaint provided to the alleged violator must also be provided to the administrator. (3-20-20)T

**02. Contents.** Complaints must include the name and address of the complainant and the alleged violator, the date and location of the alleged violation, as well as a complete description of the nature of the violation alleged, including whether it resulted in damage to an underground facility or an excavator downtime event. Complainants may also provide additional documentation in support of a complaint. Complaints must be accompanied by a sworn declaration from the complainant declaring that the information contained therein is true and accurate. The administrator may request additional information or documents in support of the complaint. (3-20-20)T

**03. Complaint Procedures and Timelines.** The following timelines and procedure govern the process of filing and administering complaints related to violations of Title 55, Chapter 22, Idaho Code, and the rules of the Board. (3-20-20)T



**a.** Initial Filing. Complaints must be filed with the administrator not later than thirty (30) days from the date of the alleged violation giving rise to the complaint or from the date the violation should have reasonably been discovered by the complainant, whichever is later. (3-20-20)T

**b.** Response. The administrator must notify the alleged violator of the complaint and request a response and any additional information from the alleged violator as may be necessary. The alleged violator may provide a response to the administrator within thirty (30) days from the date they are notified of the complaint by the administrator. (3-20-20)T

**c.** Recommendation. Within thirty (30) days of receipt of the response, or if no response is received, within fifteen (15) days from the deadline for filing a response, the administrator must notify the complainant and the alleged violator of his recommended course of action. The administrator may extend the period of time in which to determine a recommended course of action, and so notify the parties, if he determines it is necessary to further review or investigate the complaint. (3-20-20)T

**d.** Contest. The alleged violator has the right to contest the imposition of a civil penalty before the damage prevention board. Notice of such contest must be provided by the alleged violator not more than thirty (30) days after receipt of the administrator's recommended course of action. Recommendations of the administrator regarding complaints may be reviewed by the board at its next regularly scheduled meeting. (3-20-20)T

**019. CLAIMS AND REPORTS OF DAMAGE OR EXCAVATOR DOWNTIME.**

**01. Claims.** Claims for the cost of repairs for damaged underground facilities are enforced by the affected underground facility owner in accordance with procedures as may be established by the facility owner, and in accordance with applicable law. Underground facility owners must provide notice to excavator contractors of such procedures, along with sufficient information supporting the basis for the amount of a claim within six (6) months from the date of the event giving rise to the claim or from the date the event should have reasonably been discovered by the underground facility owner, whichever is later. (3-20-20)T

**02. Reports.** Underground facility owners and excavators who observe, suffer or cause damage to an underground facility or observe, suffer or cause excavator downtime related to a failure of one (1) or more stakeholders to comply with applicable damage prevention statutes or regulations must report such information to the board on forms or by such method adopted for such by the board. Forms are available at the Division offices and electronically on the Division's website. (3-20-20)T

**020. CIVIL PENALTIES.**

The Idaho Damage Prevention Board is authorized under Section 55-2203(17), Idaho Code, to establish by administrative rule the fines to be paid for civil penalties issued for violations of Title 55, Chapter 22, Idaho Code. To the extent authorized by Section 55-2211, Idaho Code, the acts described in this section subject the violator to a civil penalty of not more than one thousand dollars (\$1,000) for a second offense and a civil penalty of not more than five thousand dollars (\$5,000) for each offense that occurs thereafter within eighteen (18) months from an earlier violation, and where facility damage has occurred. (3-20-20)T

**01. Violations of Title 55, Chapter 22, Idaho Code.** The following acts subject a person to civil penalties: (3-20-20)T

**a.** Pre-marking Excavation Site. Any person who fails to adequately pre-mark onsite the path of proposed excavation as reasonably required under the circumstances in accordance with Section 55-2205(1)(b), Idaho Code, is subject to a civil penalty. (3-20-20)T

**b.** Notice of Excavation. Any person who fails to provide notice of the scheduled commencement of excavation to any underground facility owner through a one-number notification service, or directly to a facility owner, as applicable within the prescribed time as required by Section 55-2205(1)(c), Idaho Code, is subject to a civil penalty. (3-20-20)T

**c.** One-Number Notification to Facility Owner. A one-number notification service that fails to provide

notice of a scheduled excavation upon notification from an excavator is subject to a civil penalty. (3-20-20)T

**d.** Failure to Locate or Mark. An underground facility owner, owner’s agent, or locator who fails to locate or mark underground facilities when responsible to do so in accordance with Section 55-2205(2), Idaho Code, or within the prescribed time provided therein, is subject to a civil penalty. (3-20-20)T

**e.** Failure to Wait for Locate or Maintain Markings. An excavator who commences excavation prior to waiting the time prescribed by Section 55-2205(2), Idaho Code, for all known facilities to be located and marked, or an excavator who fails to maintain the markings of underground facilities previously so marked subsequent to the commencement of excavation in accordance with Section 55-2205(2), Idaho Code, is subject to a civil penalty. (3-20-20)T

**f.** Failure to Cease Excavation or Report Unidentified Facilities. An excavator who does not cease excavation in the immediate vicinity upon the discovery of underground facilities therein, whether such facilities be active or abandoned, which were not previously identified or located with reasonable accuracy, or does not notify the owner or operator of the facilities, or a one-number notification service in accordance with Section 55-2205(4), Idaho Code, is subject to a civil penalty. (3-20-20)T

**g.** Failure to Identify Facilities in Contract Documents. Project owners who fail to indicate in bid or contract documents the existence of underground facilities known by the owner to be located within the proposed area of excavation in accordance with Section 55-2207, Idaho Code, is subject to a civil penalty. (3-20-20)T

**h.** Precautions to Avoid Damage. An excavator who does not engage in any of the activities required by Section 55-2207(2), Idaho Code, or use reasonable care to avoid damage to underground facilities is subject to a civil penalty. (3-20-20)T

**i.** Reporting of Damage to Facility. An excavator who fails to report to a facility owner and a one-number notification service any contact or damage to an underground facility caused by such excavator in the course of excavation, or fails to alert an appropriate authority upon an actual breach of a facility which causes the release of gas or hazardous liquids as required by Section 55-2208(1), Idaho Code, is subject to a civil penalty. (3-20-20)T

**j.** Reporting to the Board. An excavator or underground facility owner who observes, suffers or causes damage to an underground facility or excavator downtime related to the failure of one (1) or more stakeholders to comply with the damage prevention regulations and fails to report such information to the board as required by Section 55-2208(5), Idaho Code, is subject to a civil penalty. (3-20-20)T

**k.** Failure to Participate. Any person who fails to participate or cooperate with a one-number notification service as prescribed by Section 55-2206, Idaho Code, is subject to a civil penalty. (3-20-20)T

**02. Second Offense.** For the purpose of this section, a second offense is deemed to be any violation of Title 55, Chapter 22, Idaho Code, for which a civil penalty may be imposed in accordance with this section which occurs within eighteen (18) months of a previous violation of any provision. (3-20-20)T

**03. Multiple Violations.** Each day that a violation of Title 55, Chapter 22, Idaho Code, occurs for which a civil penalty may be imposed as provided herein constitutes a separate offense. (3-20-20)T

**021. -- 999. (RESERVED)**

## IDAPA 08 – STATE BOARD OF EDUCATION

### DOCKET NO. 08-0000-2000F (FEE RULE)

#### NOTICE OF OMNIBUS RULEMAKING – ADOPTION OF TEMPORARY RULE

**EFFECTIVE DATE:** The effective date of the temporary rules being adopted through this omnibus rulemaking is the adjournment date of the second regular session of the 65th Idaho State Legislature - March 20, 2020.

**AUTHORITY:** In compliance with Sections 67-5226, Idaho Code, notice is hereby given this agency has adopted temporary rules. The action is authorized pursuant to Sections 33-118, 33-130, 33-1205, 33-2402 and 2403, Idaho Code.

**DESCRIPTIVE SUMMARY:** The following is the required finding and concise statement of its supporting reasons for adopting a temporary rule:

This temporary rulemaking adopts the following chapters under IDAPA 08:

#### **IDAPA 08**

- 08.01.11, *Registration of Postsecondary Educational Institutions and Proprietary Schools:*
  - Subsection 200.07 Registration Fee, Postsecondary Educational Institutions;
  - Subsection 300.06 Registration Fee, Proprietary Schools;
- 08.02.02, *Rules Governing Uniformity:*
  - Subsection 066 Fees, Educator Certification;
  - Subsection 075.03, Fingerprinting and Background Investigation Checks;
- 08.02.03, *Rules Governing Thoroughness:*
  - Subsection 128, Curricular Materials Selection and Online Course Approval.

**TEMPORARY RULE JUSTIFICATION:** Pursuant to Sections 67-5226(1) and 67-5226(2), Idaho Code, the Governor has found that temporary adoption of the rules is appropriate for the following reasons:

These temporary rules are necessary to protect the public health, safety, and welfare of the citizens of Idaho and confer a benefit on its citizens. These temporary rules implement the duly enacted laws of the state of Idaho, provide citizens with the detailed rules and standards for complying with those laws, and assist in the orderly execution and enforcement of those laws. The expiration of these rules without due consideration and processes would undermine the public health, safety, and welfare of the citizens of Idaho and deprive them of the benefit intended by these rules.

**FEE SUMMARY:** Pursuant to Section 67-5226(2), the Governor has found that the fees or charges being imposed or increased are justified and necessary to avoid immediate danger and the fees are described herein:

The fees or charges, authorized in Sections 33-118, 33-130, 33-1205, 33-2402 and 2403, Idaho Code, are part of the agency's 2021 budget that relies upon the existence of these fees or charges to meet the state's obligations and provide necessary state services. Failing to reauthorize these temporary rules would create immediate danger to the state budget, immediate danger to necessary state functions and services, and immediate danger of a violation of Idaho's constitutional requirement that it balance its budget.

The following is a specific description of the fees or charges:

#### **IDAPA 08.01.11** (Collected by the Office of the State Board of Education)

- *Subsection 200.07* - Registration Fee, Postsecondary Educational Institutions:
- *Subsection 300.06* - Registration Fee, Proprietary Schools:
  - Annual registration fee for initial registration or renewal of registration is equal to one-half of one percent (.5%) of the gross Idaho tuition revenue of the institution during the previous tax reporting year (Jan 1 - Dec 31), but not less than one hundred dollars (\$100) and not to exceed five thousand dollars (\$5,000).

#### **IDAPA 08.02.02** (Collected by the State Department of Education)

- *Section 066* - Fees, Educator Certification:
  - Initial Certificate - \$75
  - Renewal Certificate - \$75
  - Alternate Route Authorization - \$100

- Additions or Changes to an Existing Certificate - \$25
- Replace an Existing Certificate - \$10
- *Subsection 075.03* - Fingerprinting and Background Investigation Checks:
  - Fingerprinting Processing Fee, All Applicants (excluding volunteers) - \$28.25
  - Fingerprinting Processing Fee, Volunteers - \$26.25

**IDAPA 08.02.03** (Collected by the State Department of Education)

- *Section 128* - Curricular Materials Selection and Online Course Approval:
  - Curricular Materials Review submission fee \$60 or an amount equal to the retail price of each curricular material.

**ASSISTANCE ON TECHNICAL QUESTIONS:** For assistance on technical questions concerning the temporary rule, contact Tracie Bent, Chief Planning and Policy Officer, at (208)332-1582 or [tracie.bent@osbe.idaho.gov](mailto:tracie.bent@osbe.idaho.gov).

DATED this 13th day of February, 2020.

Tracie Bent  
Chief Planning and Policy Officer  
Office of the State Board of Education  
650 W. State Street  
P.O. Box 83720  
Boise, Idaho 83720-0037  
Phone: (208) 332-1582  
Fax: (208) 334-2632

**08.01.11 – REGISTRATION OF POSTSECONDARY EDUCATIONAL INSTITUTIONS  
AND PROPRIETARY SCHOOLS**

**(BREAK IN CONTINUITY OF SECTIONS)**

**200. REGISTRATION OF POSTSECONDARY EDUCATIONAL INSTITUTIONS.**

**01. Delegation.** Section 33-2403, Idaho Code, provides that a postsecondary educational institution must hold a valid certificate of registration issued by the Board. The Board delegates authority to its Executive Director and the Office of the State Board of Education to administer the registration of postsecondary educational institution, in accordance with Title 33, Chapter 24, Idaho Code, and this rule. (3-20-20)T

**02. Registration Requirement.** (3-20-20)T

**a.** Unless exempted by statute or this rule, as provided herein, a postsecondary educational institution which maintains a presence within the state of Idaho, or that operates or purports to operate from a location within the state of Idaho, shall register and hold a valid certificate of registration issued by the Board. An institution shall not conduct, provide, offer, or sell a course or courses of study, or degree unless registered. (3-20-20)T

**b.** Registration shall be for the period beginning on the date a certificate of registration is issued and continue through June 30 of the next succeeding year. A registered postsecondary educational institution must renew its certificate of registration annually, and renewal of registration is not automatic. (3-20-20)T

**c.** Renewal of registration shall be for the period beginning on July 1 of any year, and continue through June 30 of the next succeeding year. (3-20-20)T

**d.** A new or start-up entity that desires to operate as a postsecondary educational institution in Idaho but which is not yet accredited by an accreditation organization recognized by the Board must register and operate as a proprietary school until accreditation is obtained. A new or start-up entity that is accredited and authorized to operate in another state, and which desires to operate as a postsecondary educational institution in Idaho offering degrees for which specialized program accreditation is required, may be granted approval to operate subject to the successful attainment of such program accreditation within the regular program accreditation cycle required by the accreditor. (3-20-20)T

**e.** There is no inherent or private right to grant degrees in Idaho. That authority belongs only to institutions properly authorized to operate in Idaho under these rules. (3-20-20)T

**03. Idaho Presence.** (3-20-20)T

**a.** An institution shall be deemed to have a presence in Idaho, or to be operating or purporting to be operating from a location within the state of Idaho, if it owns, rents, leases, or uses any office or other type of physical location in Idaho, including a mailing or shipping center, or if it represents in any way, such as on an electronic or Internet website, to have an Idaho street or mailing address, including a post office box in Idaho, for purposes of conducting, providing, offering or selling a course or courses of study or degrees. (3-20-20)T

**b.** Idaho presence shall include medical/osteopathic education clinical instruction occurring in the state of Idaho as part of a course of study leading to a degree pursuant to a formal multi-year arrangement or agreement between such clinic and an institution providing medical/osteopathic education instruction where eleven (11) or more students of the institution are physically present simultaneously at a single field site. (3-20-20)T

**c.** Idaho presence shall not include: (3-20-20)T

**i.** Distance or online education delivered by an institution located outside of the state of Idaho to students in this state when the institution does not otherwise have physical presence in Idaho, as provided in Subsection 200.03.a. of this rule; (3-20-20)T

**ii.** Medical education instruction occurring in the state of Idaho by an institution pursuant to a medical education program funded by the state of Idaho; (3-20-20)T

iii. Internship or cooperative training programs occurring in the state of Idaho where students are employed by or provide services to a business or company in this state and receive course credit from an institution related to such activities; or (3-20-20)T

iv. Activities limited to the recruiting or interviewing of applicants or potential students in the state of Idaho, whether conducted by a compensated employee, agent, or representative of an institution, or by volunteer alumnus of an institution, even if such individual is physically located in this state. (3-20-20)T

**04. Institutions Exempt from Registration.** (3-20-20)T

a. Idaho public postsecondary educational institutions. Section 33-2402(1), Idaho Code, provides that a public institution supported primarily by taxation from either the state of Idaho or a local source in Idaho shall not be required to register. (3-20-20)T

b. Certain Idaho private, nonprofit, postsecondary educational institutions. A private, nonprofit, postsecondary educational institution that is already established and operational as of the date when this rule first went into effect (Brigham Young University - Idaho, College of Idaho, Northwest Nazarene University, New Saint Andrews College, Boise Bible College), and located within the state of Idaho, and that is accredited by an accreditation organization recognized by the Board, as set forth in Section 100 of this rule, shall not be required to register. A private, nonprofit, institution is located within the state of Idaho only if it has been lawfully organized in the state of Idaho and its principal place of business is located within the state of Idaho. An institution exempt under this subsection may voluntarily register by following the procedure for registration provided herein. (3-20-20)T

c. Idaho religious institutions. A religious institution located within the state of Idaho that is owned, controlled, operated, and maintained by a religious organization lawfully operating as a nonprofit religious corporation and that grants only religious degrees shall not be required to register. (3-20-20)T

**05. Institutions That Must Register.** Unless exempt under Subsection 200.04 of this rule, any entity that desires to operate as a postsecondary educational institution in Idaho must register as provided herein. (3-20-20)T

**06. Application.** A postsecondary educational institution that is required to register under this rule must submit to the Board office an application for registration (either an application for initial registration or renewal of registration, as applicable), on the form provided by the Board office. The application must include a list of each course, course of study, and degree the applicant institution intends to conduct, provide, offer, or sell in Idaho during the registration year. (3-20-20)T

**07. Registration Fees.** The Board shall assess an annual registration fee for initial registration or renewal of registration of a postsecondary educational institution. The registration fee must accompany the application for registration, and shall be in the amount of one-half of one percent (.5%) of the gross Idaho tuition revenue of the institution during the previous tax reporting year (Jan 1 - Dec 31), but not less than one hundred dollars (\$100) and not to exceed five thousand dollars (\$5,000). The institution must provide financial documentation to substantiate the amount of revenue reported. Registration fees are nonrefundable. (3-20-20)T

**08. Deadline for Registration.** An initial application for registration may be submitted to the Board at anytime. An institution should expect the Board's review process for an initial registration to take approximately three (3) to five (5) months. An application for renewal of registration must be submitted to the Board on or before the first business day of May that precedes the registration year. The renewal will be processed within thirty (30) days. Institutions that do not adhere to this schedule and whose renewals are not processed by July 1st must cease all active operations until approval of registration is received. (3-20-20)T

**09. Information Required.** (3-20-20)T

a. An application must include all the information requested on the application form, as well as the following information: (3-20-20)T

i. Copy of most recent accreditation letter showing the period of approval; (3-20-20)T

- ii. Current list of chief officers - e.g. president, board chair, chief academic officer, chief fiscal officer; (3-20-20)T
  - iii. Enrollment data for current and past two (2) years; (3-20-20)T
  - iv. Copy of annual audited financial statement, or other financial instrument as established by the executive director; (3-20-20)T
  - v. Any additional information that the Board may request. (3-20-20)T
  - vi. All advertising, pamphlets, and other literature used to solicit students and all contract forms must accurately represent the purpose of the school, its courses or courses of study, and other relevant information to assist students in making an informed decision to enroll. Institutions offering courses or courses of study which require clinical, practicum or internship components must provide students in writing information regarding the number of clinical, practicum or internship positions available and the location of said positions. Institutions with courses or courses of study that have not been fully accredited must disclose to prospective students in these courses or courses of study the accreditation status of the program and anticipated date for full accreditation. (3-20-20)T
- b.** The Board may, in connection with a renewal of registration, request that an institution only submit information that documents changes from the previous year, provided that the institution certifies that all information and/or documentation submitted in a previous registration year remains current. The annual registration fee, described in Subsection 200.07 of this rule, shall remain applicable. (3-20-20)T

**(BREAK IN CONTINUITY OF SECTIONS)**

**300. REGISTRATION OF PROPRIETARY SCHOOLS.**

**01. Delegation.** Section 33-2403, Idaho Code, provides that a proprietary school must hold a valid certificate of registration issued by the Board. The Board delegates authority to its Executive Director and the Office of the State Board of Education to administer the registration of proprietary schools, in accordance with Title 33, Chapter 24, Idaho Code, and this rule. (3-20-20)T

**02. Registration Requirement.** (3-20-20)T

**a.** Unless exempted by statute or this rule, as provided herein, a proprietary school which maintains a presence within the state of Idaho, or which operates or purports to operate from a location within the state of Idaho, shall register annually and hold a valid certificate of registration issued by the Board. A school shall not conduct, provide, offer, or sell a course or courses of study unless registered. A school shall not solicit students for or on behalf of such school, or advertise in this state, unless registered. (3-20-20)T

**b.** Registration shall be for the period beginning July 1 of any year and continue through June 30 of the next succeeding year. For a school that has not previously registered with the Board, registration shall be for the period beginning on the date of issuance of a certificate of registration and continue through June 30 of the next succeeding year. A registered proprietary school must renew its certificate of registration annually and renewal of registration is not automatic. (3-20-20)T

**c.** Renewal of registration shall be for the period beginning on July 1 of any year, and continue through June 30 of the next succeeding year. (3-20-20)T

**03. Idaho Presence.** (3-20-20)T

**a.** A school shall be deemed to have a presence in Idaho, or to be operating or purporting to be operating from a location within the state of Idaho, or if it owns, rents, leases, or uses any office or other type of

physical location in Idaho, including a mailing or shipping center, or if it represents in any way, such as on an electronic or Internet website, to have an Idaho street or mailing address, including a post office box in Idaho, for purposes of conducting, providing, offering or selling a course or courses of study or degrees. (3-20-20)T

**b.** Idaho presence shall not include: (3-20-20)T

i. Distance or online education delivered by an institution located outside of the state of Idaho to students in this state when the institution does not otherwise have physical presence in Idaho, as provided in Subsection 300.03.a. of this rule; (3-20-20)T

ii. Internship or cooperative training programs occurring in the state of Idaho where students are employed by or provide services to a business or company in this state and receive course credit from an institution related to such activities; or (3-20-20)T

iii. Activities limited to the recruiting or interviewing of applicants or potential students in the state of Idaho, whether conducted by a compensated employee, agent, or representative of an institution, or by volunteer alumnus of an institution, even if such individual is physically located in this state. (3-20-20)T

**04. Exemptions from Registration.** The following individuals or entities are specifically exempt from the registration requirements of this rule: (3-20-20)T

**a.** An individual or entity that offers instruction or training solely avocational or recreational in nature, as determined by the Board. (3-20-20)T

**b.** An individual or entity that offers courses recognized by the Board which comply in whole or in part with the compulsory education law. (3-20-20)T

**c.** An individual or entity that offers a course or courses of study sponsored by an employer for the training and preparation of its own employees, and for which no tuition fee is charged to the student. (3-20-20)T

**d.** An individual or entity which is otherwise regulated, licensed, or registered with another state agency pursuant to Title 54, Idaho Code. (3-20-20)T

**e.** An individual or entity that offers intensive review courses designed to prepare students for certified public accountancy tests, public accountancy tests, law school aptitude tests, bar examinations or medical college admissions tests, or similar instruction for test preparation. (3-20-20)T

**f.** An individual or entity offering only workshops or seminars lasting no longer than three (3) calendar days and offered no more than four (4) times per year. (3-20-20)T

**g.** A parochial or denominational institution providing instruction or training relating solely to religion and for which degrees are not granted. (3-20-20)T

**h.** An individual or entity that offers postsecondary credit through a consortium of public and private colleges and universities under the auspices of the Western Governors University. (3-20-20)T

**i.** An individual or entity that offers flight instruction and that accepts payment for services for such training on a per-flight basis after the training occurs, or that accepts advance payment or a deposit for such training in a de minimus amount equal to or less than fifteen (15) percent of the total course or program cost. (3-20-20)T

**05. Application.** A proprietary school that is required to register under this rule must submit to the Board office an application for registration (either an application for initial registration, or renewal of registration, as applicable), on a form provided by the Board office. The application must include a list of each course or courses of study the applicant school intends to conduct, provide, offer or sell in Idaho during the registration year. (3-20-20)T

**06. Registration Fees.** The Board shall assess an annual registration fee for initial registration or renewal of registration. The registration fee must accompany the application for registration, and shall be one-half of



one percent (.5%) of the gross Idaho tuition revenue of the school during the previous tax reporting year (Jan 1 - Dec 31), but not less than one hundred dollars (\$100) and not to exceed five thousand dollars (\$5,000). The school shall provide documentation to substantiate the amount of revenue reported. Registration fees are nonrefundable.

(3-20-20)T

**07. Deadline for Registration.** An initial application for registration may be submitted to the Board at anytime. A school should expect the Board review process for an initial registration to take approximately three (3) to five (5) months. An application for renewal of registration must be submitted to the Board on or before the first business day of May that precedes the registration year. The renewal will be processed within thirty (30) days. Institutions that do not adhere to this schedule and whose renewals are not processed by July 1st must cease all active operations until approval of registration is received.

(3-20-20)T

**08. Information Required.** Such application must include all the information requested on the application form. In addition, a school must attest by signature of the primary official on the application form that it is in compliance with Standards I through V set forth in Section 301 of this rule and must provide verification of compliance with Standards I through V set forth in Section 301 of this rule upon request. The Board may, in connection with a renewal of registration, request that a school only submit information that documents changes from the previous year, provided that the school certifies that all information and/or documentation submitted in a previous registration year remains current. The annual registration fee, described in Subsection 300.06 of this rule, shall remain applicable.

(3-20-20)T

**08.02.02 – RULES GOVERNING UNIFORMITY**

***(BREAK IN CONTINUITY OF SECTIONS)***

**066. FEES.**

The state Department of Education shall maintain a record of all certificates issued, showing names, dates of issue and renewal, and if revoked, the date thereof and the reason therefor. A nonrefundable fee shall accompany each application for a prekindergarten through grade twelve (12) certificate, alternate certificate, change in certificate or replacement as follows: (3-20-20)T

- 01. Initial Certificate.** All types, issued for five (5) years -- seventy-five dollars (\$75). (3-20-20)T
- 02. Renewal Certificate.** All types, issued for five (5) years -- seventy-five dollars (\$75). (3-20-20)T
- 03. Alternate Route Authorization.** All types, issued for one (1) year -- one hundred dollars (\$100). (3-20-20)T
- 04. Additions or Changes During the Life of an Existing Certificate.** Twenty-five dollars (\$25). (3-20-20)T
- 05. To Replace an Existing Certificate.** Ten dollars (\$10). (3-20-20)T

***(BREAK IN CONTINUITY OF SECTIONS)***

**075. FINGERPRINTING AND BACKGROUND INVESTIGATION CHECKS (SECTIONS 33-130 AND 33-512, IDAHO CODE).**

All individuals who are required by the provisions of Section 33-130, Idaho Code, must undergo a background investigation check. (3-20-20)T

- 01. Definitions.** (3-20-20)T
  - a.** Applicant. An individual completing a background investigation check as identified in Subsection 075.02 of these rules. (3-20-20)T
  - b.** Background Investigation Check. The submission of a completed applicant fingerprint card or scan by an authorized entity submitted under an enacted state statute/local ordinance or federal law, approved by the Attorney General of the United States allowing a search of the state and federal criminal history indices for non-criminal justice purposes including employment suitability, licensing determinations, immigration and naturalization matters, and national security clearances. (3-20-20)T
  - c.** Background Investigation Check Result. The response to a state and federal background investigation check initiated by a fingerprint submission from an authorized entity for non-criminal justice purposes. Results are returned to the submitting authorized entity by the state criminal history repository (Idaho State Police Bureau of Criminal Investigation). (3-20-20)T
  - d.** Break-in-Service. A voluntary or involuntary termination in employment, including retirement. (3-20-20)T
  - e.** Candidate. An individual attending a postsecondary program. (3-20-20)T
  - f.** Contractor. An agency, company/business, or individual that has signed a contract or agreement to provide services to an LEA and private or parochial school. (3-20-20)T
  - g.** Employee. A person who is hired for a wage, salary, fee, or payment to perform work for an employer. (3-20-20)T

**h.** Fingerprint Card or Scan. The process for obtaining impressions of an individual's fingerprint images, both ten (10) individual finger impressions rolled from nail to nail and slap or flat impressions taken simultaneously without rolling. Fingerprints may be recorded utilizing either an inked standard fingerprint card or using a livescan device. Standard fingerprint cards may also be scanned for submission to the state repository for background investigation check purposes. (3-20-20)T

**i.** Rejected Fingerprint Cards or Scans. A fingerprint card or scan that has been returned by the Idaho State Police Bureau of Criminal Identification or Federal Bureau of Investigation for poor quality prints. (3-20-20)T

**j.** Unsupervised Contact. Direct contact or interaction with students not under the direct supervision of an LEA employee in a K-12 setting. This includes contact or interaction with students in scheduled school activities that occur outside of the school or outside of normal school hours. (3-20-20)T

**02. Individuals Required to Complete a Background Investigation Check.** (3-20-20)T

**a.** All applicants for certificates; (3-20-20)T

**b.** Certificated and noncertificated employees; (3-20-20)T

**c.** Substitute teachers; (3-20-20)T

**d.** Contractors who have unsupervised contact with students in a public K-12 setting, including contractors who are providing student services; (3-20-20)T

**e.** Student teachers or any postsecondary candidates who have unsupervised contact with students in a public K-12 setting; (3-20-20)T

**f.** Volunteers who have unsupervised contact with students in a public K-12 setting; (3-20-20)T

**g.** Any individuals who have unsupervised contact with students in a public K-12 setting. (3-20-20)T

**03. Fee.** The SDE shall charge a fee for undergoing a background investigation check pursuant to Section 33-130, Idaho Code. (3-20-20)T

**04. Rejected Fingerprint Cards or Scans.** (3-20-20)T

**a.** When a fingerprint card has been rejected a new completed fingerprint card is required. (3-20-20)T

**b.** The rejected fingerprint card will be sent back to the originating LEA, private or parochial school, contractor, postsecondary program, or individual. (3-20-20)T

**c.** A new fingerprint card must be completed by a law enforcement agency to ensure legible fingerprints. Both the rejected fingerprint card and the new fingerprint card must be returned to the SDE within thirty (30) calendar days. (3-20-20)T

**d.** If the new fingerprint card and rejected fingerprint card are returned after thirty (30) calendar days, a fee, pursuant to Subsection 075.03 of these rules, is required to be paid. (3-20-20)T

**05. Secured Background Investigation Check Website.** The SDE will maintain a background investigation check website listing the background investigation check results for review by the LEA, private or parochial school, contractor or postsecondary program. Each LEA, private or parochial school, contractor and postsecondary program will have access to the background investigation check secure site listing their employees, statewide substitute teacher list, and student teacher list. (3-20-20)T

**06. Background Investigation Checks for Certification.** (3-20-20)T

**a.** The SDE will make the final determination if an applicant is eligible for Idaho certification.

(3-20-20)T

**b.** If the SDE makes a determination that the applicant is not eligible for Idaho certification, the SDE may deny the applicant Idaho certification. Upon receiving the written denial, the applicant may request a hearing pursuant to Section 33-1209, Idaho Code. (3-20-20)T

**07. Substitute Teachers.** Substitute teachers as defined in Section 33-512(15), Idaho Code, must undergo a background investigation check. The SDE shall maintain a statewide substitute teacher list. To remain on the list a substitute teacher shall undergo a background investigation check every five (5) years in accordance with Section 33-512, Idaho Code. (3-20-20)T

**08. Break In Service.** (3-20-20)T

**a.** When an employee returns to any LEA, private or parochial school, or contractor after a break in service, a new background investigation check must be completed pursuant to Section 33-130, Idaho Code. (3-20-20)T

**b.** When an employee changes employment between LEAs a new background investigation check must be completed pursuant to Section 33-130, Idaho Code. (3-20-20)T

**09. Postsecondary.** (3-20-20)T

**a.** The postsecondary program will submit a completed fingerprint card or scan for all candidates who are applying for unsupervised contact with students in a public K-12 setting including student teaching, internships, or other types of candidate training. (3-20-20)T

**b.** The SDE will make a preliminary determination based on the CHC result if the candidate is eligible for certification in Idaho. This decision will be forwarded to the postsecondary program concerning the eligibility of their candidate. (3-20-20)T

## 08.02.03 – RULES GOVERNING THOROUGHNESS

### *(BREAK IN CONTINUITY OF SECTIONS)*

#### **128. CURRICULAR MATERIALS SELECTION AND ONLINE COURSE APPROVAL (SECTIONS 33-118; 33-118A, IDAHO CODE).**

The State Board of Education will appoint a committee to select curriculum materials. Committee appointments will be for a period of five (5) years. Committee appointments shall consist of not less than ten (10) total members from the following stakeholder groups: certified Idaho classroom teachers, Idaho public school administrators, Idaho higher education officials, parents, trustees, local board of education members, members of the Division of Career Technical Education, and State Department of Education personnel. The Executive Secretary will be an employee of the State Department of Education and will be a voting member of the committee. The State Department of Education shall charge publishers submission fees of sixty dollars (\$60) or equal to the retail price of each, whichever is greater, to defray the costs incurred in the curricular material review and adoption process. (3-20-20)T

**01. Subject Areas.** Curricular materials are adopted by the State Board of Education for a period of six (6) years in the following subject areas: reading, English, spelling, speech, journalism, languages other than English, art, drama, social studies, music, mathematics, business education, career education and counseling, vocational/technical education, science, health, physical education, handwriting, literature, driver education, limited English proficiency. (3-20-20)T

**02. Multiple Adoptions. Multiple adoptions are Made in Each Subject Area.** (3-20-20)T

**03. Bids.** Each publisher must deliver, according to the committee schedule, a sealed bid on all curricular materials presented for adoption. (3-20-20)T

**04. Depository.** The State Board will appoint a depository for the state-adopted curricular materials. Resource materials are a local option. (3-20-20)T

**05. Local Policies.** School districts will follow their own policies for adoption in subject areas offered by a school district for which materials are not covered by the state curriculum materials committee. (3-20-20)T

**06. Online Course Review and Approval Process.** The State Department of Education shall administer the review and approval of online course providers and courses. Reviewers shall be certified Idaho classroom teachers. Online course providers are approved for a period of four (4) years. The State Department of Education shall charge online course providers submission fees based on the number of courses offered, not to exceed the actual costs incurred in the online course and course provider review and approval process. (3-20-20)T

# IDAPA 10 – BOARD OF PROFESSIONAL ENGINEERS AND PROFESSIONAL LAND SURVEYORS

**DOCKET NO. 10-0101-2000F (FEE RULE)**

## **NOTICE OF OMNIBUS RULEMAKING – ADOPTION OF TEMPORARY RULE**

**EFFECTIVE DATE:** The effective date of the temporary rule being adopted through this omnibus rulemaking is the adjournment date of the second regular session of the 65th Idaho State Legislature - March 20, 2020.

**AUTHORITY:** In compliance with Sections 67-5226, Idaho Code, notice is hereby given this agency has adopted a temporary rule. The action is authorized pursuant to Sections 54-1208 and 55-1606, Idaho Code.

**DESCRIPTIVE SUMMARY:** The following is the required finding and concise statement of its supporting reasons for adopting a temporary rule:

This temporary rulemaking adopts the following chapter under IDAPA 10:

### **IDAPA 10**

- 10.01.01, *Rules of the Idaho Board of Licensure of Professional Engineers and Professional Land Surveyors*

**TEMPORARY RULE JUSTIFICATION:** Pursuant to Sections 67-5226(1) and 67-5226(2), Idaho Code, the Governor has found that temporary adoption of the rule is appropriate for the following reasons:

These temporary rules are necessary to protect the public health, safety, and welfare of the citizens of Idaho and confer a benefit on its citizens. These temporary rules implement the duly enacted laws of the state of Idaho, provide citizens with the detailed rules and standards for complying with those laws, and assist in the orderly execution and enforcement of those laws. The expiration of these rules without due consideration and processes would undermine the public health, safety, and welfare of the citizens of Idaho and deprive them of the benefit intended by these rules.

**FEE SUMMARY:** Pursuant to Section 67-5226(2), the Governor has found that the fee(s) or charge(s) being imposed or increased is justified and necessary to avoid immediate danger and the fee(s) is described herein:

The fees or charges, authorized in Section 54-1213, 54-1216, 54-1219, 54-1220, and 54-1221, Idaho Code, are part of the agency's 2021 budget that relies upon the existence of these fees or charges to meet the state's obligations and provide necessary state services. Failing to reauthorize these temporary rules would create immediate danger to the state budget, immediate danger to necessary state functions and services, and immediate danger of a violation of Idaho's constitutional requirement that it balance its budget.

The following is a specific description of the fees or charges:

- Licensure as a Professional Engineer or Professional Land Surveyor by examination;
- Licensure as a Professional Engineer or Professional Land Surveyor by comity;
- Certification for a business entity applying for a certificate of authorization to practice or offer to practice engineering or land surveying;
- Renewals for professional engineers, professional land surveyors, engineer interns, land surveyor interns, and business entities;
- Late or denied renewals;
- Reissuance of certificates;
- Reinstatement of a retired, expired, and discontinued license or certificate;
- Faculty restricted licensure and renewal as a professional engineer;
- Most administrative penalties for violating the statutes or rules of the Board accrue to the general fund of the State of Idaho, and not the dedicated fund of the Board.

**ASSISTANCE ON TECHNICAL QUESTIONS:** For assistance on technical questions concerning the temporary rule, contact Keith Simila, (208) 373-7210.

DATED this 7th day of February, 2020.

Keith Simila  
Executive Director  
Idaho Board of Professional Engineers and  
Professional Land Surveyors  
1510 E. Watertower St, Ste 110,  
Meridian, ID 83642  
Phone (208) 373-7210  
fax (208)373-7213

# IDAPA 10 – IDAHO BOARD OF LICENSURE OF PROFESSIONAL ENGINEERS AND PROFESSIONAL LAND SURVEYORS

## 10.01.01 – RULES OF THE IDAHO BOARD OF LICENSURE OF PROFESSIONAL ENGINEERS AND PROFESSIONAL LAND SURVEYORS

### 000. LEGAL AUTHORITY.

These rules are promulgated as authorized by Sections 54-1208(1) and 55-1606, Idaho Code. (3-20-20)T

### 001. TITLE AND SCOPE.

**01. Title.** These rules are titled IDAPA 10.01.01, “Rules of the Idaho Board of Licensure of Professional Engineers and Professional Land Surveyors.” (3-20-20)T

**02. Scope.** These rules include procedures of the Board, rules of professional responsibility, rules of continuing professional development, and rules for properly completing corner perpetuation and filing forms. (3-20-20)T

### 002. -- 009. (RESERVED)

### 010. DEFINITIONS.

The following terms are used as defined below: (3-20-20)T

**01. Active Participation.** Serving as an officer or committee chair at either the national, state or local (section or chapter) level. (3-20-20)T

**02. Activity.** Any qualifying action with a clear purpose and objective which will maintain, improve, or expand the skills and knowledge relevant to the licensee's field of practice or practices. Routine job assignments are not considered qualified activities. (3-20-20)T

**03. Board.** The Board of Licensure of Professional Engineers and Professional Land Surveyors. (3-20-20)T

**04. Certificate Holder.** Any person holding a current certificate as an Engineer Intern or a Land Surveyor Intern or a business entity (which is also herein referred to as a “person”) holding a current certificate of authorization, which has been duly issued by the Board. (3-20-20)T

**05. College Semester or Quarter Credit Hour.** Credit for college courses. (3-20-20)T

**06. Continuing Education Unit (CEU).** Unit of credit customarily used for continuing education courses. One (1) continuing education unit equals ten (10) hours of class in an approved continuing education course. (3-20-20)T

**07. Deceit.** To intentionally misrepresent a material matter, or intentionally omit to disclose a known material matter. (3-20-20)T

**08. Documented Self-Study.** Documented study of professional/technical journals, published papers, articles, books, software or other areas of training which increase knowledge of the technology above and beyond routine job assignments. (3-20-20)T

**09. Incompetence.** Failure to meet the standard of care. (3-20-20)T

**10. Licensee.** Any person holding a current license as a Professional Engineer, a Professional Land Surveyor, or a combination thereof, which has been duly issued by the Board. (3-20-20)T

**11. Misconduct.** A violation or attempt to violate these rules of professional responsibility or to knowingly assist or induce another to do so, or do so through the acts of another; a finding of guilt of commitment of a felony or a plea of guilty to a felony; commit fraud or deceit; failure to respond within twenty (20) days of an inquiry from the Board or its representative, unless such time is extended by the Board for justifiable cause; state or imply an ability to influence improperly a government agency or official. (3-20-20)T



**12. Professional Development Hour (PDH).** A contact hour (minimum of fifty (50) minutes) of instruction or presentation. The common denominator for other units of credit. (3-20-20)T

**SUBCHAPTER A – RULES OF PROCEDURE**  
**(Rules 011 through 099)**

**011. FEES.**

**01. Applications and Renewals.** All fees are set by the Board in the following categories and may in no event be more than the amount specified in Sections 54-1213, 54-1214, 54-1216, 54-1219 and 54-1223, Idaho Code. Fees are not refundable. (3-20-20)T

- a.** Licensure as a professional engineer or professional land surveyor by examination. (3-20-20)T
- b.** Reinstatement of a retired or expired license. (3-20-20)T
- c.** Certification for a business entity applying for a certificate of authorization to practice or offer to practice engineering or land surveying. (3-20-20)T
- d.** Renewals for professional engineers, professional land surveyors, engineer interns, land surveyor interns, and business entities. (3-20-20)T
- e.** Licensure for professional engineers or professional land surveyors by comity. (3-20-20)T

**02. Late or Denied Renewals.** Failure on the part of any licensee or business entity to renew their license or certificate of authorization prior to their expiration will not deprive such persons or business entity of the right of renewal, but the fees to be paid for renewal after their expiration will be increased as prescribed in Section 54-1216, Idaho Code, unless otherwise waived by the Board. (3-20-20)T

**012. REISSUANCE OF CERTIFICATES.**

A new certificate of licensure or authorization, to replace any certificate lost, destroyed or mutilated, may be issued upon written request and payment of fee of ten dollars (\$10). (3-20-20)T

**013. (RESERVED)**

**014. SEALS.**

**01. Official Seal of Board.** The official seal of this Board consists of the seal of the state of Idaho, surrounded with the words “Board of Professional Engineers and Professional Land Surveyors” and “State of Idaho.” (3-20-20)T

**02. Standard Seals for Engineers and Land Surveyors.** The Board adopts standard seals for use by licensed professional engineers and professional land surveyors as prescribed by Section 54-1215, Idaho Code. Seals prepared and approved prior to July 1, 2008 are valid for continued use. (3-20-20)T

**03. Seal for Professional Engineer/Land Surveyor.** Engineers obtaining licensure as land surveyors under the changes to Section 54-1217, Idaho Code, by the 1978 Legislature use the seal showing licensure as a Professional Engineer and Land Surveyor as adopted by the Board. Seals prepared and approved prior to July 1, 2008 are valid for continued use. (3-20-20)T

**015. CERTIFICATES.**

Certificates of licensure or authorization issued by the Board must be displayed in the place of business. (3-20-20)T

**016. APPLICATION FOR LICENSURE OR CERTIFICATION.**

**01. Forms.** Application forms for licensure as a professional engineer, or professional land surveyor,

certification as an engineer intern, land surveyor intern or certificates of authorization to practice or offer to practice engineering or land surveying by a business entity may be obtained online from the Board. (3-20-20)T

**02. Completion of Application.** Applications must be made on such forms as may be prescribed by the Board. All forms, references, transcripts and other written materials must be in English. An application that is not fully completed by the applicant need not be considered or acted upon by the Board. The application by a business entity for a certificate of authorization to practice or offer to practice engineering or land surveying must set forth its address, and name and address of the individual, or individuals, duly licensed to practice engineering or land surveying in this state, who will be in responsible charge of engineering or land surveying services offered or rendered by the business entity in this state. (3-20-20)T

**03. Submittal of Applications and Examination Cutoff Date.** Submittal of applications for licensure or intern certification must occur after passing the required national examinations. Examinations may be given in various formats and different registration dates apply depending on the examination format. (3-20-20)T

**a.** For national examinations administered in a computer-based or paper format once or twice per year the registration requirements, including the deadline and testing windows, are established by the National Council of Examiners for Engineering and Surveying (NCEES). (3-20-20)T

**b.** For national examinations administered continuously in a computer-based format, there is no deadline for registering with NCEES. The registration requirements, including the testing windows, are established by NCEES. (3-20-20)T

**c.** In order for the Board to be able to verify experience, only experience up to the date of submittal of the application for licensure will be considered as valid. (3-20-20)T

**d.** Applications for certification as engineering or surveying interns are submitted after passing the Fundamentals of Engineering or the Fundamentals of Surveying examination and providing evidence of graduation with educational credentials required by Subsection 017.03 of this chapter. (3-20-20)T

**04. Residency Requirement.** Except for military personnel stationed in the state of Idaho on military orders, and except for persons employed full-time in the state of Idaho, only residents of the state of Idaho and students enrolled at an Idaho university or college may qualify for initial licensure. The Board will accept as proof of Idaho residency a valid Idaho issued driver's license, a utility bill issued within the last sixty (60) days with an Idaho address in the name of the applicant, a statement from a financial institution issued within the last sixty (60) days to the applicant at an Idaho address, proof of current voter registration in Idaho, or current Idaho vehicle registration in the name of the applicant. The Board will accept as proof of full-time employment in the state of Idaho verification from the Idaho employer stating employment status. The Board will accept a valid student identification card as proof of enrollment at an Idaho university or college. (3-20-20)T

**05. Confidentiality of References.** All information received from references named by the applicant is held in confidence by the Board except as provided by Section 74-113, Idaho Code. Neither members of the Board nor relatives of the applicant by blood or marriage may be named or accepted as references. (3-20-20)T

**06. Minimum Standards -- References.** An applicant may not be licensed until satisfactory replies have been received from a minimum of five (5) of his references for professional engineers or land surveyors. It is the responsibility of each applicant to furnish references with the forms prescribed by the Board. (3-20-20)T

**07. Minimum Boundary Survey Experience.** The Board requires a minimum of two (2) years boundary survey experience as a condition of professional land surveyor licensure. (3-20-20)T

**017. EXAMINATIONS AND EDUCATION.**

**01. Special or Oral Examination.** Examinations for licensure as a professional engineer or professional land surveyor, or certification as an engineer intern or land surveyor intern will be held on dates and at times and places to be determined by the Board. Special oral or written examinations may be given by the Board as necessary. (3-20-20)T

**02. Use of NCEES Examinations.** National examinations prepared and graded by the National Council of Examiners for Engineering and Surveying (NCEES) may be used by the Board. Applicants registering for a national professional examination must have first passed the fundamentals examination unless exempted per Subsection 017.10 of this chapter. (3-20-20)T

**03. Eligibility for Licensure, Educational Requirements.** The application for licensure as a professional engineer or professional land surveyor together with a passing score on the written ethics questionnaire or Idaho specific land surveying examination, is considered in the determination of the applicant's eligibility. Each applicant must meet the minimum requirements as set forth in Section 54-1212, Idaho Code, before being licensed. Prescriptive education requirements are as follows: (3-20-20)T

**a.** In regard to educational requirements, the Board will consider as unconditionally approved only those engineering programs that are accredited by the Engineering Accreditation Commission (EAC) of ABET, Inc., or the bachelor of science programs accredited by the Canadian Engineering Accrediting Board, or those bachelor of science engineering programs that are accredited by official organizations recognized by the U.K. Engineering Council. Non-EAC/ABET accredited engineering programs, related science programs, and engineering technology programs will be considered by the Board on their specific merits, but are not considered equal to engineering programs accredited by EAC/ABET. The Board may continue consideration of an application for valid reasons for a period of one (1) year, without forfeiture of the application fee. (3-20-20)T

**b.** An applicant who has completed a four (4) year bachelor degree program in engineering not accredited by EAC/ABET or a four (4) year bachelor degree program in engineering technology, or in a related science degree program other than engineering must have completed the following before the Board will consider them to possess knowledge and skill approximating that attained through graduation from an approved four (4) year engineering curriculum as required by Section 54-1212(3)(b), Idaho Code, for certification as an Engineer Intern or as required by Section 54-1212(1)(b), Idaho Code, for licensure as a professional engineer: (3-20-20)T

**i.** Thirty-two (32) college semester credit hours of higher mathematics and basic sciences. The credits in mathematics must be beyond algebra and trigonometry and emphasize mathematical concepts and principles rather than computation. Courses in differential and integral calculus are required. Additional courses may include differential equations, linear algebra, numerical analysis, probability and statistics and advanced calculus. The credits in basic sciences must include at least two (2) courses. These courses must be in general chemistry, general calculus-based physics, or general biological sciences; the two (2) courses may not be in the same area. Additional basic sciences courses may include earth sciences (geology, ecology), advanced biology, advanced chemistry, and advanced physics. Computer skills and/or programming courses may not be used to satisfy mathematics or basic science requirements. Basic engineering science courses or sequence of courses in this area are acceptable for credit but may not be counted twice. (3-20-20)T

**ii.** Twelve (12) college credit hours in a general education component that complements the technical content of the curriculum. Examples of traditional courses in this area are philosophy, religion, history, literature, fine arts, sociology, psychology, political science, anthropology, economics (micro and macro), professional ethics, social responsibility. Examples of other general education courses deemed acceptable include management (such as organizational behavior), accounting, written and oral communications, business, and law. No more than six (6) credit hours may come from courses in management, accounting, business, or law. Courses in engineering economics, engineering management, systems engineering/ analysis, production, and industrial engineering/management will not be counted. Language courses in the applicant's native language are not acceptable for credit; no more than six (6) credit hours of foreign language courses are acceptable for credit. Native language courses in literature and civilization may be considered in this area. Courses which instill cultural values are acceptable, while routine exercises of personal craft are not. (3-20-20)T

**iii.** Forty-eight (48) college credit hours of engineering science and/or engineering design courses. Courses in engineering science must be taught within the college / faculty of engineering having their roots in mathematics and basic sciences but carry knowledge further toward creative application of engineering principles. Examples of approved engineering science courses are mechanics, thermodynamics, heat transfer, electrical and electronic circuits, materials science, transport phenomena, and computer science (other than computer programming skills). Courses in engineering design stress the establishment of objectives and criteria, synthesis, analysis,

construction, testing, and evaluation. Graduate level engineering courses may be included to fulfill curricular requirements in this area. Engineering technology courses cannot be considered to meet engineering topic requirements. (3-20-20)T

iv. The Board may require detailed course descriptions for seminar, directed study, special problem and similar courses to ensure that the above requirements are met. (3-20-20)T

c. In regard to educational requirements, the Board will consider as unconditionally approved only those surveying programs that are accredited either by the Engineering Accreditation Commission (EAC), the Applied and Natural Science Accreditation Commission (ANSAC) or the Engineering Technology Accreditation Commission (ETAC) of ABET, Inc. An applicant who has completed a four (4) year bachelor degree program in a related program must have completed a minimum of the following college level academic courses, or their equivalents as determined by the Board, before the Board will consider them to possess knowledge and skill approximating that attained through graduation from an approved four (4) year surveying curriculum as required by Section 54-1212(4)(b), Idaho Code, for certification as a Land Surveyor Intern or as required by Section 54-1212(2)(b), Idaho Code, for licensure as a professional land surveyor: (3-20-20)T

i. Eighteen (18) college semester credit hours of mathematics and basic sciences. A minimum of twelve (12) credits in mathematics must be beyond basic mathematics, but the credits include college algebra or higher mathematics. These courses must emphasize mathematical concepts and principles rather than computation. Mathematics courses may include college algebra, trigonometry, analytic geometry, differential and integral calculus, linear algebra, numerical analysis, probability and statistics, and advanced calculus. A minimum of six (6) credits must be in basic sciences. These courses must cover one or more of the following topics: general chemistry, advanced chemistry, life sciences (biology), earth sciences (geology, ecology), general physics, and advanced physics. Computer skills and/or programming courses may not be used to satisfy mathematics or basic science requirements; (3-20-20)T

ii. Twelve (12) college semester credit hours in a general education component that complements the technical content of the curriculum. Examples of traditional courses in this area are religion, history, literature, fine arts, sociology, psychology, political science, anthropology, economics, professional ethics, and social responsibility. No more than six (6) credit hours of languages other than English or other than the applicant's native language are acceptable for credit. English and foreign language courses in literature and civilization may be considered in this area. Courses that instill cultural values are acceptable, while routine exercises of personal craft are not; (3-20-20)T

iii. Thirty (30) college semester credit hours of surveying science and surveying practice. Courses must be taught by qualified surveying faculty. Examples of surveying courses are basic surveying, route surveying, geodesy, geographic information systems, land development design and planning, global positioning systems, photogrammetry, mapping, survey adjustment and coordinates systems, cartography, legal descriptions, and remote sensing. Required courses will include a minimum of basic surveying, route surveying, geodesy, surveying law, public land survey system and global positioning systems. Graduate-level surveying courses can be included to fulfill curricular requirements in this area. (3-20-20)T

d. The Board may require an independent evaluation of the engineering education of an applicant who has a non-EAC/ABET accredited engineering degree or a non-engineering degree. Such evaluation must be done through an organization approved by the Board and be done at the expense of the applicant to ensure that the applicant has completed the coursework requirements of Subsection 017.03.b. The Board may table action on the application pending receipt of the evaluation, and, in the event the applicant does not provide the evaluation within one (1) year, the Board may terminate the application, in which case the application fee is forfeited. (3-20-20)T

**04. Two Examinations for Engineering Licensure.** The complete examining procedure for licensure as a professional engineer normally consists of two (2) separate written examinations. The first is the Fundamentals of Engineering examination for engineer intern certification, and the second is the Principles and Practice of Engineering for professional engineer licensure. The examination will be a duration as determined by the Board. Normally, applicants are eligible to take the Fundamentals of Engineering examination during the last or second-to-last semester of or after graduation from an accredited bachelor of science engineering program. A certificate as an Engineer Intern will be issued only to those student applicants who earn a passing grade on the examination and who receive a degree. Having passed the Fundamentals of Engineering examination, applicants will be required to take the

Principles and Practice of Engineering examination at a later date when qualified by the Board. (3-20-20)T

**05. Fundamentals of Engineering.** The Fundamentals of Engineering examination will cover such subjects as are ordinarily given in engineering college curricula and which are common to all fields of practice. The examination may also cover subject matters that are specific to the engineering discipline of the applicants' education. (3-20-20)T

**06. Principles and Practice of Engineering -- Disciplines.** The Principles and Practice of Engineering examination will cover the practice of engineering to test the applicant's fitness to assume responsibility for engineering works affecting the public health, safety and welfare. Separate examinations will be given to test the applicant's fitness in any discipline for which there is an examination which, in the opinion of the Board, meets the requirements of duration and difficulty necessary to adequately test the applicant's fitness to practice in that particular discipline. The Board may use examinations prepared by the National Council of Examiners for Engineering and Surveying (NCEES) or it may prepare or commission the preparation of, or utilize other state examinations in disciplines other than those for which examinations may be available from NCEES. (3-20-20)T

**07. Three Examinations for Land Surveying Licensure.** The complete examining procedure for licensure as a professional land surveyor consists of three (3) separate written examinations. The first is the Fundamentals of Surveying examination for land surveyor intern certification, and the second is the Principles and Practice of Surveying, and the third is the Idaho specific professional land surveying examination. All examinations are required for professional land surveyor licensure. The examination will be a duration as determined by the Board. Having passed the Fundamentals of Surveying examination, applicants will be required to take the Principles and Practice of Surveying examination at a later date when qualified by the Board. The examination covers the theory and principles of surveying, the practice of land surveying and the requirements of legal enactments. The Principles and Practice of Surveying examination may consist of separate modules, each of which must be passed. Having passed the Principles and Practice of Surveying examination, applicants will be required to pass the Idaho specific professional land surveying examination, which tests for knowledge of the laws and rules of Idaho, and the legal and technical aspects of land surveying in Idaho. (3-20-20)T

**08. Oral or Unassembled Examinations.** An oral examination or unassembled written examination, in addition to the prescribed written examination, may be required for professional engineer and professional land surveyor applicants. (3-20-20)T

**09. Grading.** Unless otherwise provided in 54-1219, or 54-1223 Idaho Code, each land surveyor intern, engineer intern, professional land surveyor and professional engineer applicant must attain a passing score on the entire examination or modules as determined by the Board, before being awarded certification or licensure. Passing scores on national examinations are established by the National Council of Examiners for Engineering and Surveying. A passing score on the Idaho specific ethics questionnaire is eighty (80), a passing score on the law and rules module of the Idaho specific land surveying examination is ninety (90), and a passing score on the public land surveying module of the Idaho specific land surveying examination is seventy-five (75). (3-20-20)T

**10. Exemption – Examination on the Fundamentals of Engineering.** The Board may exempt an exceptional individual who has twelve (12) or more years of appropriate engineering experience from the requirement for satisfactory completion of an examination on the fundamentals of engineering as specified in 54-1223(2), Idaho Code. The Board will exempt an individual who has an earned bachelor's degree and an earned doctoral degree from an approved engineering program from the requirement for satisfactory completion of an examination on the fundamentals of engineering as specified in 54-1223(3), Idaho Code. (3-20-20)T

**11. Review of Examination by Examinee.** Due to security concerns about the examinations, examinees are not allowed to review their examinations. Examinees who fail an examination will be provided a diagnostic analysis of their performance on the examination if such an analysis is available to the Board. (3-20-20)T

**018. REEXAMINATIONS.**

The reexamination policy for each failed national examination will be established by NCEES. Reexamination for failed Idaho specific examinations will be allowed until a passing score is attained, but the Board may, in addition, require oral or other examinations. (3-20-20)T

**019. LICENSEES OR CERTIFICATE HOLDERS OF OTHER STATES, BOARDS, AND COUNTRIES.**

**01. Interstate Licensure Evaluation.** Each application for an Idaho professional engineer license or professional land surveyor license submitted by an applicant who is licensed as a professional engineer, or licensed as a professional land surveyor, respectively, in one (1) or more states, possessions or territories or the District of Columbia, will be considered by the Board on its merits, and the application evaluated for substantial compliance with respect to the requirements of the Idaho law related to experience, examination, and education. A minimum of four (4) years of progressive experience after graduation with a bachelor of science degree is required for licensure. Individuals who have passed the National Council of Examiners for Engineering and Surveying (NCEES) examinations for professional engineering or professional land surveying will be considered to have satisfied the examination requirement for issuance of a license as a professional engineer or professional land surveyor provided that land surveyor applicants also pass the Idaho specific professional land surveying examination. Prescriptive education requirements are as follows: (3-20-20)T

**a.** Graduates from programs accredited by the Engineering Accreditation Commission of the ABET, Inc., (EAC/ABET), or graduates of university bachelor of science engineering programs accredited by the Canadian Engineering Accrediting Board, or those university bachelor of science engineering programs that are accredited by official organizations recognized by the U.K. Engineering Council, or graduates of engineering programs with coursework evaluated by the Board as being substantially equivalent to EAC/ABET degrees, will be considered to have satisfied the educational requirement for issuance of a license as a professional engineer. (3-20-20)T

**b.** The Board may require an independent evaluation of the engineering education of an applicant who has a non-EAC/ABET accredited four (4) year bachelor degree. Such evaluation must be done through an organization approved by the Board and is done at the expense of the applicant to ensure that they have completed the coursework requirements of Subsection 019.01.c. Such evaluation is not required if the applicant has been licensed in another jurisdiction of the United States for a minimum of ten (10) years and has not had any disciplinary action against them and there is none pending, and possesses the education, experience and examination credentials that were specified in the applicable registration chapter in effect in this state at the time such certification was issued. The Board may table action on the application pending receipt of the evaluation, and, in the event the applicant does not provide the evaluation within one (1) year, the Board may terminate the application, in which case the application fee will be forfeited. (3-20-20)T

**c.** An applicant who was originally licensed in another jurisdiction after June 30, 1996, and who has completed a four (4) year bachelor degree program in engineering technology, or in a related science degree program other than engineering must have completed the following before the Board will consider them to possess knowledge and skill approximating that attained through graduation from an approved four (4) year engineering curriculum as required by Section 54-1212(1)(b), Idaho Code: (3-20-20)T

**i.** Thirty-two (32) college semester credit hours of higher mathematics and basic sciences. The credits in mathematics must be beyond algebra and trigonometry and must emphasize mathematical concepts and principles rather than computation. Courses in differential and integral calculus are required. Additional courses may include differential equations, linear algebra, numerical analysis, probability and statistics and advanced calculus. The credits in basic sciences must include at least two (2) courses. These courses must be in general chemistry, general calculus-based physics, or general biological sciences; the two (2) courses may not be in the same area. Additional basic sciences courses may include earth sciences (geology, ecology), advanced biology, advanced chemistry, and advanced physics. Computer skills and/or programming courses may not be used to satisfy mathematics or basic science requirements. Basic engineering science courses or sequence of courses in this area are acceptable for credit but may not be counted twice. (3-20-20)T

**ii.** Twelve (12) college credit hours in a general education component that complements the technical content of the curriculum. Examples of traditional courses in this area are philosophy, religion, history, literature, fine arts, sociology, psychology, political science, anthropology, economics (micro and macro), professional ethics, social responsibility. Examples of other general education courses deemed acceptable include management (such as organizational behavior), accounting, written and oral communications, business, and law. No more than six (6) credit hours may come from courses in management, accounting, business, or law. Courses in engineering economics, engineering management, systems engineering/ analysis, production, and industrial engineering/management will not be counted. Language courses in the applicant's native language are not acceptable for credit; no more than six (6)

credit hours of foreign language courses are acceptable for credit. Native language courses in literature and civilization may be considered in this area. Courses which instill cultural values are acceptable, while routine exercises of personal craft are not. (3-20-20)T

iii. Forty-eight (48) college credit hours of engineering science and engineering design courses. Courses in engineering science must be taught within the college / faculty of engineering having their roots in mathematics and basic sciences but carry knowledge further toward creative application of engineering principles. Examples of approved engineering science courses are mechanics, thermodynamics, heat transfer, electrical and electronic circuits, materials science, transport phenomena, and computer science (other than computer programming skills). Courses in engineering design stress the establishment of objectives and criteria, synthesis, analysis, construction, testing, and evaluation. Graduate level engineering courses may be included to fulfill curricular requirements in this area. Engineering technology courses cannot be considered to meet engineering topic requirements. (3-20-20)T

d. In regard to educational requirements, the Board will consider as unconditionally approved only those surveying programs that are accredited either by the Engineering Accreditation Commission (EAC), the Applied and Natural Science Accreditation Commission (ANSAC) or the Engineering Technology Accreditation Commission (ETAC) of ABET, Inc. An applicant who has completed a four (4) year bachelor degree program in a related program must have completed a minimum of the following college level academic courses, or their equivalents as determined by the Board, before the Board will consider them to possess knowledge and skill approximating that attained through graduation from an approved four (4) year surveying curriculum as required by Section 54-1212(2)(b), Idaho Code, for licensure as a professional land surveyor: (3-20-20)T

i. Eighteen (18) college semester credit hours of mathematics and basic sciences. A minimum of twelve (12) credits in mathematics must be beyond basic mathematics, but the credits include college algebra or higher mathematics. These courses must emphasize mathematical concepts and principles rather than computation. Mathematics courses may include college algebra, trigonometry, analytic geometry, differential and integral calculus, linear algebra, numerical analysis, probability and statistics, and advanced calculus. A minimum of six (6) credits must be in basic sciences. These courses must cover one or more of the following topics: general chemistry, advanced chemistry, life sciences (biology), earth sciences (geology, ecology), general physics, and advanced physics. Computer skills and/or programming courses may not be used to satisfy mathematics or basic science requirements; (3-20-20)T

ii. Twelve (12) college semester credit hours in a general education component that complements the technical content of the curriculum. Examples of traditional courses in this area are religion, history, literature, fine arts, sociology, psychology, political science, anthropology, economics, professional ethics, and social responsibility. No more than six (6) credit hours of languages other than English or other than the applicant's native language are acceptable for credit. English and foreign language courses in literature and civilization may be considered in this area. Courses that instill cultural values are acceptable, while routine exercises of personal craft are not; (3-20-20)T

iii. Thirty (30) college semester credit hours of surveying science and surveying practice. Courses must be taught by qualified surveying faculty. Examples of surveying courses are basic surveying, route surveying, geodesy, geographic information systems, land development design and planning, global positioning systems, photogrammetry, mapping, survey adjustment and coordinates systems, cartography, legal descriptions, and remote sensing. Required courses will include a minimum of basic surveying, route surveying, geodesy, surveying law, public land survey system and global positioning systems. Graduate-level surveying courses can be included to fulfill curricular requirements in this area. (3-20-20)T

**02. International Engineering Licensure Evaluation - Countries or Jurisdictions with Board Approved Licensure Process.** The Board may determine the professional engineering licensure process in other countries or jurisdictions within other countries is substantially equivalent to that required 54-1219 Idaho Code. As such, the Board may waive prescriptive education and examination requirements if the applicant possesses a professional engineer license credential, attains a minimum of eight (8) years of experience after licensure, provided the applicant has no criminal or outstanding disciplinary action in any country or jurisdiction, and is in good standing with the licensing Board within that country or jurisdiction. A bona fide licensing process in another country must include requirements of experience, education, testing, a code of professional responsibility, regulation of licensees including the ability take disciplinary action and the willingness, availability, and capacity of a foreign Board to

release information to the Idaho Board in English.

(3-20-20)T

**03. International Engineering Licensure Evaluation - Countries or Jurisdictions Without a Board Approved Licensure Process.** Each application for an Idaho professional engineer license submitted by an applicant who is licensed as a professional engineer in one (1) or more foreign countries or jurisdictions within a country, will be considered by the Board on its merits, and the application evaluated for substantial compliance with the requirements of Idaho law with respect to experience, examination, and education. A minimum of four (4) years of progressive experience after graduation is required for licensure. The Board will require two (2) years of experience working in the United States or two (2) years of experience working on projects requiring the knowledge and use of codes and standards similar to those utilized in the United States where the experience is validated by a professional engineer licensed in the United States. The Board may postpone acting on or deny an application for a license by comity if disciplinary or criminal action related to the applicant's practice has been taken or is pending in any country or jurisdiction. Applicants must have passed a professional engineering examination administered by NCEES. Applicants who meet the residency requirements of 54-1212, Idaho Code, are eligible for initial licensure in Idaho when qualified by the Board. Prescriptive education requirements are as follows: (3-20-20)T

**a.** Graduates of engineering university programs accredited by the Canadian Engineering Accrediting Board, or official organizations recognized by the U.K. Engineering Council, or graduates of engineering university programs accredited by EAC/ABET or evaluated by the Board as being substantially equivalent to EAC/ABET programs will be considered to have satisfied the educational requirement for issuance of a license as a professional engineer. (3-20-20)T

**b.** The Board may require an independent credentials evaluation of the engineering education of an applicant educated outside the United States who has a non-EAC/ABET accredited engineering degree. Such evaluation must be done through NCEES or another organization approved by the Board and is done at the expense of the applicant. (3-20-20)T

**c.** The Board may require an independent credentials evaluation of the education for an applicant who has completed a four (4) year bachelor degree program outside the United States in engineering technology, or in a related science degree program other than engineering and must demonstrate completion of the requirements of Subsection 019.01.c. before the Board will consider the applicant to possess the knowledge and skill approximating that attained through graduation from an approved four (4) year engineering curriculum as required by Section 54-1212(1)(b), Idaho Code. Such evaluation must be done through NCEES or another organization approved by the Board and is done at the expense of the applicant. (3-20-20)T

**04. Waiver of Prescriptive Engineering Licensure Evaluation for Unique International Expertise.** The Board may waive the prescriptive licensure evaluation requirements of 019.03 for international applicants who, in the Board's opinion, are qualified by reason of education and experience and offer unique technical expertise, provided the licensee meets the requirements of 54-1219 Idaho Code. (3-20-20)T

**05. Denials or Special Examinations.** An application from a licensee of another state, possession or territory, District of Columbia, or foreign country may be denied by the Board for any just cause and the application fee retained; or the Board may approve the applicant for a special written and/or oral examination. (3-20-20)T

**06. Business Entity Requirements.** No application for a certificate of authorization to practice or offer to practice professional engineering or professional land surveying, or both, in Idaho by a business entity authorized to practice professional engineering or professional land surveying, or both, in one (1) or more states, possessions or territories, District of Columbia, or foreign countries are considered by the Board unless such application includes the name and address of the individual or individuals, duly licensed to practice professional engineering or professional land surveying or both in this state, who will be in responsible charge of the engineering or land surveying services, or both, as applicable, to be rendered by the business entity in Idaho. The said individual or individuals must certify or indicate to the Board their willingness to assume responsible charge. (3-20-20)T

**020. DISCONTINUED, RETIRED, AND EXPIRED LICENSES AND CERTIFICATES.**

**01. Reinstatement – Disciplinary.** Licensees who choose to convert their license to retired status as part of a disciplinary action, or in lieu of discipline, or in lieu of compliance with continuing professional



development requirements, may be reinstated upon written request. The Board will consider the reinstatement request at a hearing or may waive the hearing for minor violations. (3-20-20)T

**02. Reinstatement – Nondisciplinary.** Licensees who chose to convert their license to retired status not as part of a disciplinary action may request reinstatement in writing. Reinstatement may require a hearing by the Board. (3-20-20)T

**03. Continuing Professional Development.** Licensees requesting reinstatement must demonstrate compliance with the continuing professional development requirements described in these rules as a condition of reinstatement. (3-20-20)T

**04. Practice Not Permitted.** Discontinued, retired, or expired status does not permit a licensee or certificate holder to engage in the practice of professional engineering or professional land surveying. (3-20-20)T

**05. Designation.** Licensees who chose retired status may represent themselves with the title of Professional Engineer Retired or Professional Land Surveyor Retired or similar designation. (3-20-20)T

**06. Fee for Reinstatement of Retired License.** The fee for reinstatement of a retired license to active practice is as required for renewals in Section 54-1216, Idaho Code. (3-20-20)T

**07. Fee for Renewal of Expired License.** The fee for renewal of an expired license or certificate to active practice is as required for delayed renewals in Section 54-1216, Idaho Code. (3-20-20)T

**08. Eligibility.** Unless otherwise approved by the Board, only unexpired licensees are eligible to convert to retired status. (3-20-20)T

**09. Discontinued Certificate of Authorization.** Business entities no longer providing engineering or land surveying services in Idaho may request their certificates be discontinued. Reinstatement of a discontinued certificate may be requested by submitting a new application with the Board. (3-20-20)T

**10. Fee for Reinstatement of Discontinued Certificate of Authorization.** The fee for reinstatement of a discontinued certificate will be as required for applications in Section 54-1213, Idaho Code. (3-20-20)T

**021. (RESERVED)**

**022. REQUIREMENTS TO BE CONSIDERED “EXCEPTIONAL” UNDER SECTION 54-1223(2), IDAHO CODE.**

**01. Waiver of the Fundamentals of Engineering Examination.** In order to be considered “exceptional” under Section 54-1223(2), Idaho Code, an applicant for licensure as a professional engineer, either by examination or by comity, who seeks waiver of the fundamentals of engineering examination, must have a record of service and contributions beyond the ordinary in two (2) of the following three (3) areas: (3-20-20)T

- a. Professional or technical; (3-20-20)T
- b. Business or industry; and (3-20-20)T
- c. Community or cultural. (3-20-20)T

**02. Activities That the Board Believes Are Exceptional.** Examples of activities that the Board believes are exceptional are serving as an officer or committee chair, originating projects or initiatives, investing time or energy into the community, authoring significant publications, and receiving significant awards. (3-20-20)T

**03. Activities That the Board Believes Are Ordinary.** Examples of activities that the Board believes are only ordinary are completing routine job assignments, holding membership in professional and technical societies, contributing money to causes, attending community events, and owning a business. (3-20-20)T

**04. Written Request for Exceptional Designation.** An applicant who seeks waiver of the fundamentals of engineering examination must submit a written request for the exceptional designation accompanied by two (2) written references supporting and explaining the applicants contributions that are beyond the ordinary. (3-20-20)T

**023. PROFESSIONAL ENGINEER LICENSURE FOR FACULTY APPLICANTS.**

Written examinations related to applicable laws and rules for engineering licensure based upon criteria established by the Board must be offered to Idaho college or university faculty applicants whose credentials have been approved by the Board and who possess an earned doctorate degree. The credentials the Board considers in this regard should include the applicant's university course work completed, the applicant's thesis and dissertation work, the applicant's peer reviewed publications, and the nature of the applicant's professional experience. A satisfactory application, along with a passing score on the examination exempts the applicant from the written technical examinations, and may qualify the applicant for a restricted license as a professional engineer. The restricted license applies only to college or university related teaching upper division design subjects. All conditions for maintaining licensure, such as compliance with the laws and rules of the Board, fees and continuing professional development are the same as required for all licensees. The restricted license is effective from the date of issuance until such time as the licensee ceases to be a faculty member of an Idaho college or university, unless not renewed, retired, suspended or revoked and is subject to renewal requirements established in 54-1216, Idaho Code. Teaching and teaching work products are exempt from the requirements of sealing and signing engineering work under 54-1215(c), Idaho Code. Restricted licensees are not required to obtain a seal. (3-20-20)T

**024. -- 099. (RESERVED)**

**SUBCHAPTER B – RULES OF PROFESSIONAL RESPONSIBILITY**  
**(Rules 100 through 199)**

**100. RESPONSIBILITY TO THE PUBLIC.**

**01. Primary Obligation.** All Licensees and Certificate Holders must at all times recognize their primary obligation is to protect the safety, health and welfare of the public in the performance of their professional duties. (3-20-20)T

**02. Standard of Care.** Each Licensee and Certificate Holder must exercise such care, skill and diligence as others in that profession ordinarily exercise under like circumstances. (3-20-20)T

**03. Professional Judgment.** If any Licensee's or Certificate Holder's professional judgment is overruled under circumstances where the safety, health and welfare of the public are endangered, the Licensee or Certificate Holder must inform the employer or client of the possible consequences and, where appropriate, notify the Board or such other authority of the situation. (3-20-20)T

**04. Obligation to Communicate Discovery of Discrepancy.** Except as provided in the Idaho Rules of Civil Procedure 26(b)(4)(B), if a Licensee or Certificate Holder, during the course of his work, discovers a material discrepancy, error, or omission in the work of another Licensee or Certificate Holder, which may impact the health, property and welfare of the public, the discoverer must make a reasonable effort to inform the Licensee or Certificate Holder whose work is believed to contain the discrepancy, error or omission. Such communication must reference specific codes, standards or physical laws which are believed to be violated and identification of documents which are believed to contain the discrepancies. The Licensee or Certificate Holder whose work is believed to contain the discrepancy must respond within twenty (20) calendar days to any question about his work raised by another Licensee or Certificate Holder. In the event a response is not received within twenty (20) days, the discoverer must notify the Licensee or Certificate Holder in writing, who has another twenty (20) days to respond. Failure to respond (with supportable evidence) on the part of the Licensee or Certificate Holder whose work is believed to contain the discrepancy is considered a violation of these rules and may subject the Licensee or Certificate Holder to disciplinary action by the Board. The discoverer must notify the Board in the event a response that does not answer the concerns of the discoverer is not obtained within the second twenty (20) days. A Licensee or Certificate Holder is exempt from this requirement if their client is an attorney and they are being treated as an expert witness. In this case, the Idaho Rules of Civil Procedure apply. (3-20-20)T

**05. Obligation to Comply with Rules of Continuing Professional Development.** All Licensees must comply with the continuing professional development requirements contained in these rules. (3-20-20)T

**06. Obligation to Affected Landowners.** Land surveyors have a duty to set monuments at the corners of their client's property boundaries in compliance with 54-1227, Idaho Code. Per Subsection 100.04 above, land surveyors also have a duty to notify other licensees of a material discrepancy prior to setting monuments that represent a material discrepancy with a prior survey. If a monument is to be set at a location that represents a material discrepancy with an existing monument at any corner of record, land surveyors must also notify in writing all affected adjoining land owners and the Board prior to setting the new monument. (3-20-20)T

#### **101. COMPETENCY FOR ASSIGNMENTS.**

**01. Assignments in Field of Competence.** A Licensee must undertake to perform assignments only when qualified by education or experience in the specific technical field involved, however, a Licensee, as the prime professional, may accept an assignment requiring education or experience outside of his own field of competence, but his services are restricted to those phases of the project in which the Licensee is qualified. All other phases of such project must be performed by qualified associates, consultants or employees. For projects encompassing one (1) or more disciplines beyond the Licensee's competence, a Licensee may sign and seal the cover sheet for the total project only when the Licensee has first determined that all elements of the project have been prepared, signed and sealed by others who are competent, licensed and qualified to perform such services. (3-20-20)T

**02. Aiding and Abetting an Unlicensed Person.** A Licensee or Certificate Holder must avoid actions and procedures which, in effect, amount to aiding and abetting an unlicensed person to practice engineering or land surveying. (3-20-20)T

**03. Use of Seal on Documents.** A Licensee must affix his signature and seal only to plans or documents prepared under his responsible charge. (3-20-20)T

#### **102. PUBLIC STATEMENTS.**

**01. Reports, Statements or Testimony.** A Licensee or certificate holder must not commit fraud, violate the standard of care, or engage in deceit or misconduct in professional reports, statements or testimony. Each licensee or certificate holder must include all relevant and pertinent information in such reports, statements or testimony and will express opinions in such reports, statements or testimony in accordance with the standard of care. (3-20-20)T

**02. Opinions Based on Adequate Knowledge.** A Licensee or Certificate Holder, when serving as an expert or technical witness before any court, commission or other tribunal, may express an opinion only when it is founded upon adequate knowledge of the facts in issue, upon a background of technical competence in the subject matter, and upon honest conviction of the accuracy and propriety of his testimony. (3-20-20)T

**03. Statements Regarding Public Policy.** On matters connected with establishing public policy a Licensee or Certificate Holder may issue no statements, criticisms or arguments that are paid for by an interested party, or parties, unless he has prefaced his comment by explicitly identifying himself, by disclosing the identities of the party, or parties, on whose behalf he is speaking, and by revealing the existence of any pecuniary interest he may have in the matters. (3-20-20)T

**04. Actions in Regard to Other Licensees or Certificate Holders.** A Licensee or Certificate Holder may not attempt to injure, maliciously or falsely, directly or indirectly, the professional reputation, prospects, practice or employment of another Licensee or Certificate Holder, nor may he indiscriminately criticize another Licensee's or Certificate Holder's work in public. If he believes that another Licensee or Certificate Holder is guilty of fraud, deceit, negligence, incompetence, misconduct or violation of these rules he should present such information to the Board for action. (3-20-20)T

#### **103. CONFLICT OF INTEREST.**

**01. Conflict of Interest to Be Avoided.** Each Licensee or Certificate Holder must conscientiously

avoid conflict of interest with an employer or client, and, when unavoidable, must forthwith disclose the circumstances in writing to the employer or client. In addition, the Licensee or Certificate Holder must promptly inform the employer or client in writing of any business association, interests, or circumstances which could influence a Licensee's or Certificate Holder's judgment or quality of service, or jeopardize the clients' interests.

(3-20-20)T

**02. Compensations From Multiple Parties on the Same Project.** A Licensee or Certificate Holder may accept compensation, financial or otherwise, from more than one (1) party for services on the same project, or for services pertaining to the same project, provided the circumstances are fully disclosed, in writing, in advance and agreed to by all interested parties.

(3-20-20)T

**03. Solicitation From Material or Equipment Suppliers.** A Licensee or Certificate Holder may not solicit or accept financial or other valuable considerations from material or equipment suppliers for specifying or recommending the products of said suppliers, except with full disclosure as outlined in Subsection 103.02.

(3-20-20)T

**04. Gratuities.** A Licensee or Certificate Holder may not solicit or accept gratuities, gifts, travel, lodging, loans, entertainment or other favors directly or indirectly, from contractors, their agents or other third parties dealing with a client or employer in connection with work for which the Licensee or Certificate Holder is responsible, which can be construed to be an effort to improperly influence the Licensee's or Certificate Holder's professional judgment. Minor expenditures such as advertising trinkets, novelties and meals are excluded. Neither may a Licensee or Certificate Holder make any such improper offer.

(3-20-20)T

**05. Solicitation From Agencies.** A Licensee, a Certificate Holder or a representative thereof may not solicit or accept a contract from a governmental authority on which an existing officer, director, employee, member, partner, or sole proprietor of his organization serves as a member of the elected or appointed policy and governing body of such governmental authority or serves as a member of an entity of such governmental authority having the right to contract or recommend a contract for the services of a Licensee or a Certificate Holder.

(3-20-20)T

**06. Professional Services Decisions of Agencies.** A Licensee, Certificate Holder or representative thereof serving as a member of the governing body of a governmental authority, whether elected or appointed, or an advisor or consultant to a governmental Board, commission or department may at all times be subject to the statutory provisions concerning ethics in government, Section 74-401, Idaho Code, et seq. A violation of the "Ethics in Government Act of 2015" will be considered a violation of these rules.

(3-20-20)T

**07. Unfair Advantage of Position and Work Outside Regular Employment.** When a Licensee or an individual Certificate Holder is employed in a full time position, the person may not use the advantages of the position to compete unfairly with other professionals and may not accept professional employment outside of that person's regular work or interest without the knowledge of and written permission or authorization from that person's employer.

(3-20-20)T

#### **104. SOLICITATION OF WORK.**

**01. Commissions.** A Licensee or Certificate Holder may not pay or offer to pay, either directly or indirectly, any commission, gift or other valuable consideration in an effort to secure work, except to bona fide employees or bona fide established business enterprises retained by a Licensee or Certificate Holder for the purpose of securing business or employment.

(3-20-20)T

**02. Representation of Qualifications.** A Licensee or Certificate Holder may not falsify or permit misrepresentation of his or his associates' academic or professional qualifications, and may not misrepresent or exaggerate the degree of responsibility in or for the subject matter of prior assignments. Brochures or other presentations incident to the solicitation of employment may not misrepresent pertinent facts concerning employers, employees, associates, joint-venturers or his or their past accomplishments with the intent and purpose of enhancing qualifications for the work. The Licensee or Certificate Holder may not indulge in publicity that is misleading.

(3-20-20)T

**03. Assignment on Which Others Are Employed.** A Licensee or Certificate Holder may not

knowingly seek or accept employment for professional services for an assignment that another Licensee or Certificate Holder is employed, or contracted to perform without the currently employed or contracted entity being informed in writing. (3-20-20)T

**04. Contingency Fee Contracts.** A Licensee or Certificate Holder may not accept an agreement, contract, or commission for professional services on a “contingency basis” that may compromise his professional judgment and may not accept an agreement, contract or commission for professional services that includes provisions wherein the payment of fee involved is contingent on a “favorable” conclusion, recommendation or judgment. (3-20-20)T

**05. Selection on the Basis of Qualifications.** A Licensee or Certificate Holder should seek professional employment or professional service work on the basis of qualifications and competence for proper accomplishment of the work assignment. On selections for professional engineering and land surveying services that are required pursuant to Section 67-2320, Idaho Code, a licensee or certificate holder, in response to solicitations described in Section 67-2320, Idaho Code, may not submit information that constitutes a bid for services requested either as a consultant or subconsultant. (3-20-20)T

**105. IMPROPER CONDUCT.**

**01. Fraudulent or Dishonest Enterprises.** A Licensee or Certificate Holder may not knowingly associate with, or permit the use of his name or the firm name in a business venture by any person or firm that it is known to be, or there is reason to believe, is engaging in business or professional practices of a fraudulent or dishonest nature. (3-20-20)T

**02. Confidentiality.** Licensees or Certificate Holders may not reveal confidential facts, data or information obtained in a professional capacity without prior written consent of the client or employer except as authorized or required by law. (3-20-20)T

**03. Actions by Other Jurisdictions.** The surrender, revocation, suspension or denial of a license to practice Professional Engineering or Professional Land Surveying, as an individual or through a business entity, in another jurisdiction, for reasons or causes which the Board finds would constitute a violation of the Idaho laws regulating the practice of Engineering and Land Surveying, or any code or rules promulgated by the Board, is sufficient cause after a hearing for disciplinary action as provided in Title 54 Chapter 12, Idaho Code. (3-20-20)T

**106. -- 199. (RESERVED)**

**SUBCHAPTER C – RULES OF CONTINUING PROFESSIONAL DEVELOPMENT**  
**(Rules 200 through 299)**

**200. REQUIREMENTS.**

Every Licensee is required to obtain thirty (30) PDH units during the renewal period biennium (beginning on the first day of the month following the month in which the Licensee was born). Alternatively, the licensee may choose to obtain thirty (30) PDH units cumulative during the two (2) calendar years which are closest to the renewal period biennium. If a Licensee exceeds the biennial requirement in any renewal period or earns PDH’s during a period in which he is exempt, a maximum of thirty (30) PDH units may be carried forward into the subsequent renewal period. If the exemption is for the “First Renewal Period” (see Rule 204.01), then at any time in the full biennium before this first license renewal the licensee may earn up to 30 PDHs to carry forward into their second renewal period following licensure. If the licensee chooses to use the calendar year basis, PDH’s in excess of thirty (30) cumulative in two (2) years, or PDH’s earned during a period in which he is exempt, can be carried forward to the next two (2) year calendar period, not to exceed thirty (30) PDH’s carried forward to the next two (2) year calendar period. PDH units may be earned in the following activities, however, PDH units must come from two (2) or more activities. (3-20-20)T

- 01. Successful Completion of College Credits.** (3-20-20)T
- 02. Successful Completion of Continuing Education Units.** (3-20-20)T

- 03. Successful Completion of Other Courses.** Correspondence, televised, online, and other short courses/tutorials for which college credits or CEUs are awarded. (3-20-20)T
- 04. Attending Qualifying Seminars.** Attending qualifying seminars, inhouse courses, workshops, or technical or professional presentations made at meetings, conventions, or conferences for which no college credits or CEUs are awarded. (3-20-20)T
- 05. Mentoring, Teaching or Instructing.** Teaching or instructing in Subsections 200.01 through 200.04, above and beyond routine job assignments. (3-20-20)T
- 06. Authoring Published Papers, Articles, or Books.** (3-20-20)T
- 07. Membership in Technical or Professional Organizations.** (3-20-20)T
- 08. Active Participation in Technical or Professional Organizations.** (3-20-20)T
- 09. Patents.** (3-20-20)T
- 10. Presentations to Technical, Professional or Civic Organizations.** (3-20-20)T
- 11. Documented Self Study.** (3-20-20)T

**201. UNITS.**

The conversion of other units of credit to PDH (Professional Development Hour) units is as follows:

1 College semester credit hour	=	45 PDH
1 College quarter credit hour	=	30 PDH
1 Continuing Education Unit	=	10 PDH
1 Hour of attendance in course work, seminars, or technical or professional presentations made at meetings, conventions, or conferences	=	1 PDH
Mentoring or teaching the above, above and beyond normal job assignments, apply multiple of 2 for teaching the first time only	=	8 PDH per year for mentoring
Each published technical or professional paper, article, or book chapter not to exceed a total of 10 PDH's per year, above and beyond normal job assignments	=	5 PDH per paper, article, or book chapter
Each peer review of a published technical or professional paper, article, or book chapter not to exceed a total of 6 PDH's per year, above and beyond normal job assignments	=	3 PDH per paper, article, or book chapter
Membership in technical or professional organizations (Maximum of 2 organizations)	=	1 PDH per year per organization
Active participation in technical or professional organizations (Maximum of 2 organizations)	=	1 PDH per year per organization
Each patent 5 PDH's, not to exceed per year	=	5 PDH
Presentations to technical, professional, or civic organizations, first presentation only	=	2 PDH per hour of presentation
Documented self-study not to exceed 3 PDH per year at the rate of ½ PDH per hour of self-study		

(3-20-20)T

**202. DETERMINATION OF CREDIT.**

With the exception of those seminars and courses of continuing professional development offered by an organization registered with the Registered Continuing Education Providers Program of the American Council of Engineering Companies, which are preapproved, the Board will not pre-approve activities as qualifying for continuing professional development, but has final authority to judge the PDH value for all activities submitted to fulfill continuing professional development requirements. (3-20-20)T

**203. RECORD KEEPING.**

Maintenance of records to support credits claimed is the responsibility of the Licensee. Records required include, but are not limited to: (3-20-20)T

**01. Log.** A log showing the type of activity claimed, sponsoring organization, location, duration, instructor's or speaker's name, and PDH credits earned; and (3-20-20)T

**02. Attendance Verification.** Attendance verification records in the form of completion certificates or other documents supporting evidence of attendance; Time sheets or expense sheets signed by the Licensee documenting the Continuing Professional Development activity claimed (sponsoring organization, location, duration, instructor's or speaker's name), time and/or expense related thereto, and claimed PDH credits earned are acceptable if attendance certificates are not available; or (3-20-20)T

**03. Records.** Records may be maintained by a repository for same. (3-20-20)T

**04. Documented Self-Study.** In order to qualify in this category, the licensee must prepare and retain an abstract of the material studied, the date the activity occurred and the number of PDH's claimed, and a bibliographic reference of the material studied. A photocopy of pertinent parts of the material studied, annotated with the date the activity occurred and the number of PDH's claimed, are deemed to meet this requirement. (3-20-20)T

**05. Record Retention.** All continuing professional development records must be maintained for a period of six (6) years and copies must be provided to the Board upon request for audit purposes. (3-20-20)T

**204. EXEMPTIONS.**

A Licensee may be exempt from the continuing professional development requirements for one (1) of the following reasons: (3-20-20)T

**01. First Renewal Period.** New Licensees by way of examination or comity, reinstated licensees, and delayed renewal licensees less than one year from the biennial renewal date, are exempt from compliance with these rules during the time between issuance or reinstatement or delayed renewal of the license and the due date of their first renewal following the issuance of the license. (3-20-20)T

**02. Active Duty in the Armed Forces.** A Licensee serving on active duty in the armed forces of the United States, or a civilian deployed with the military, and temporarily assigned duty at a location other than their normal home station for a period of time exceeding one hundred twenty (120) consecutive days in a renewal period or the two (2) calendar year period closest to the renewal biennium is exempt from obtaining the professional development hours required during that renewal period or the two (2) calendar year period closest to the renewal biennium. (3-20-20)T

**03. Extenuating Circumstances.** A Licensee experiencing physical disability, serious illness, or other extenuating circumstances accepted by the Board. (3-20-20)T

**04. Retired.** A Licensee who has chosen "Retired" status is exempt from the professional development hours required. In the event such a person elects to return to active practice of professional engineering or professional land surveying, professional development hours must be earned before returning to active practice. Thirty (30) PDH's must be earned for an exempted period less than four (4) years prior to the reinstatement request date. The thirty (30) PDH's earned must be earned within the previous two (2) years of the reinstatement request date. Sixty (60) PDH's must be earned for exempted periods of four (4) years or more prior to the reinstatement request date. The sixty (60) PDH's must be earned within the previous four (4) years of the reinstatement request date. All PDH's earned must comply with the requirements of this chapter. (3-20-20)T

**05. Expired License.** A Licensee who has chosen to allow his license to expire is exempt from the professional development hours required. In the event such a person elects to renew the license, professional development hours must be earned and documented before renewing the license. The requirements for PDH's are the same as shown for retired licensees in Subsection 204.04 for delayed renewals more than three (3) months. (3-20-20)T

**205. COMITY/OUT-OF-JURISDICTION RESIDENTS.**  
The CPD requirements for non-resident licensees are the same as that for resident licensees. (3-20-20)T

**206. USE OF NCEES MODEL CPC STANDARD.**  
Licensees have the option of complying with the requirements of this chapter, or may choose to comply with the National Council of Examiners for Engineering and Surveying (NCEES) Continuing Professional Competency (CPC) renewal standard as identified in the latest version of the NCEES Model Rule 240.30. This standard is found at <http://ncees.org/wp-content/uploads/https://ncees.org/wp-content/uploads/CPC-Guidelines-2017-final.pdf>. (3-20-20)T

**207. -- 299. (RESERVED)**

**SUBCHAPTER D – RULES FOR CORNER PERPETUATION AND FILING**  
**(Rules 300 through 399)**

**300. FORM.**  
The form to be used in filing corner perpetuations in the state of Idaho shall be substantially the same as that form available from the Idaho Board of Licensure of Professional Engineers and Professional Land Surveyors, 1510 E. Watertower St., Ste. 110, Meridian, ID 83642-7993. Clear spaces on the form may be provided as requested and required by County Recorders in order to place recording information in an unobstructed area. The form is not available in quantity from the Board, but one (1) copy will be furnished, upon request, and it may be duplicated or reproduced. (3-20-20)T

**301. COMPLETION OF FORM.**  
Prior to filing of the form, the professional land surveyor performing the work shall complete the form in compliance with the requirements set forth in these rules. Additional information, for example latitude and longitude, with datum used, may be included. (3-20-20)T

**302. CONTENTS ON THE FORM.**  
The contents on the form must contain the following: (3-20-20)T

**01. Record of Original Corner and Subsequent History.** Information provided in this section includes the name of the original surveyor and the date or dates on which the original survey was performed and a description of the original monument set. The information also includes the history of subsequent remonumentation, including the name(s) of the surveyor(s), the agency or company they represented, the date(s) of the survey(s) and a description of all monuments found or set, including all monuments and accessories that are not shown on previously recorded corner records. Information provided in this section also includes the instrument numbers of all previously recorded corner records, or the filing information if the corner record was not recorded, pertaining to the corner in question. (3-20-20)T

**02. Description of Corner Evidence Found.** Information provided in this section includes a description of any evidence found relating to the original corner. If no evidence of the original corner is found, evidence of a subsequent remonumentation shall be indicated on the form. (3-20-20)T

**03. Description and Sketch of Monument and Accessories Found or Established to Perpetuate the Location of this Corner.** Information provided in this section includes a description and a sketch of the monument and accessories found or placed in the current survey as well as the date the work was performed and the true or assumed magnetic declination at the time of the survey if magnetic bearings are used. If magnetic bearings are not used, the professional land surveyor shall indicate the basis of bearing to accessories. (3-20-20)T

**04. Surveyor's Certificate.** Include a print of the surveyor's name, the license number issued by the



Board, and the name of the employer for whom the surveyor is working. (3-20-20)T

**05. Seal, Signature, Date.** Include an imprint of the surveyor's professional land surveyor seal, which is signed and dated by the surveyor. (3-20-20)T

**06. Marks on Monument Found or Set.** Include a sketch or legible image of the marks found or placed on the monument, if applicable. (3-20-20)T

**07. Diagram.** Include clear marks on the section diagram the location of the monument found or being established or reestablished in the survey. (3-20-20)T

**08. Location.** State the county, section, township, range and the monument location being established or reestablished or found in the survey. (3-20-20)T

**303. -- 999. (RESERVED)**

## **IDAPA 11 – IDAHO STATE POLICE**

### **DOCKET NO. 11-0000-2000F (FEE RULE)**

#### **NOTICE OF OMNIBUS RULEMAKING – ADOPTION OF TEMPORARY RULE**

**EFFECTIVE DATE:** The effective date of the temporary rule(s) being adopted through this omnibus rulemaking is upon the adjournment date of the second regular session of the 65th Idaho State Legislature - March 20, 2020.

**AUTHORITY:** In compliance with Sections 67-5226, Idaho Code, notice is hereby given this agency has adopted a temporary rule. The action is authorized pursuant to Sections (Alcohol Beverage Control) 23-616, 23-932, 23-946, 23-1010(7), 23-1011A, 23-1330, 23-1408, (Bureau of Criminal Identification) 67-3001, 67-3003, 67-3004, 67-3007, 67-3010, Idaho Code.

**DESCRIPTIVE SUMMARY:** The following is the required finding and concise statement of its supporting reasons for adopting a temporary rule:

The Idaho State Police Alcohol Beverage Control is tasked with issuing licenses, maintaining priority waiting lists, inspecting new and existing premises, and enforcing violations of Idaho criminal statutes. The Idaho state central repository of criminal history records is an automated database of records based on fingerprint arrest records reported to BCI from Idaho criminal justice agencies. The information in the database is critical to effective decision-making at every phase of the criminal justice process. Additionally, the criminal history system is increasingly used for non-criminal justice background checks, such as employment screening and licensure. BCI also provides fingerprinting services to the public for a fee as prescribed in rule. These rules are necessary for the Idaho State Police to carry out the statutory duties of providing public safety services to law enforcement, prosecuting attorneys, the judicial system, and everyone who travels through or resides in the State of Idaho.

This temporary rule adopts the following chapters under IDAPA 11:

#### **IDAPA 11**

- 11.05.01, *Rules Governing Alcohol Beverage Control*
- 11.10.02, *Rules Governing State Criminal History Records and Crime Information*

**TEMPORARY RULE JUSTIFICATION:** Pursuant to Sections 67-5226(1) and 67-5226(2), Idaho Code, the Governor has found that temporary adoption of the rule is appropriate for the following reasons:

These temporary rules are necessary to protect the public health, safety, and welfare of the citizens of Idaho and confer a benefit on its citizens. These temporary rules implement the duly enacted laws of the state of Idaho, provide citizens with the detailed rules and standards for complying with those laws, and assist in the orderly execution and enforcement of those laws. The expiration of these rules without due consideration and processes would undermine the public health, safety, and welfare of the citizens of Idaho and deprive them of the benefit intended by these rules.

**FEE SUMMARY:** Pursuant to Section 67-5226(2), the Governor has found that the fee(s) or charge(s) being imposed or increased is justified and necessary to avoid immediate danger and the fee(s) is described herein:

The fees or charges, authorized in Sections 23-904, 23-907, and 67-3010, Idaho Code, are part of the agency's 2021 budget that relies upon the existence of these fees or charges to meet the state's obligations and provide necessary state services. Failing to reauthorize these temporary rules would create immediate danger to the state budget, immediate danger to necessary state functions and services, and immediate danger of a violation of Idaho's constitutional requirement that it balance its budget.

The following is a specific description of the fees or charges:

- 11.05.01.013.01 – Priority list fee
- 11.05.01.013.03 – Licensing fee return provision
- 11.10.02.031 – Fingerprint and background check fees

**ASSISTANCE ON TECHNICAL QUESTIONS:** For assistance on technical questions concerning the temporary rule, contact:

- 11.05.01 ABC — Captain Brad Doty, Phone: (208) 884-7062, Fax: (208) 884-7462,  
E-mail [bradley.doty@isp.idaho.gov](mailto:bradley.doty@isp.idaho.gov)
- 11.10.02 BCI — Bureau Chief Leila McNeill, Phone: (208) 884-7136, Fax: (208) 884-7193,  
E-mail [leila.mcneill@isp.idaho.gov](mailto:leila.mcneill@isp.idaho.gov)

DATED this February 21, 2020.

Charlie Spencer  
Police Services Major  
Rules Review Officer  
Idaho State Police  
700 S. Stratford Drive  
Meridian, ID 83642  
[charlie.spencer@isp.idaho.gov](mailto:charlie.spencer@isp.idaho.gov)  
Phone: (208) 884-7203  
Fax: (208) 884-7290

## 11.05.01 – RULES GOVERNING ALCOHOL BEVERAGE CONTROL

### 000. LEGAL AUTHORITY.

The Director of the Idaho State Police has general rulemaking authority to prescribe rules and regulations for alcohol beverage enforcement, pursuant to Sections 23-932, 23-946(b), 23-1330 and 23-1408, Idaho Code. (3-20-20)T

### 001. TITLE AND SCOPE.

**01. Title.** These rules are titled IDAPA 11.05.01, “Rules Governing Alcohol Beverage Control.” (3-20-20)T

**02. Scope.** The rules relate to the governance and operation of Alcohol Beverage Control. Unless a specific reference herein limits application of a rule to a particular kind of alcoholic beverage, these rules apply to and implement Idaho Code Sections for liquor (Title 23, Chapter 9, Idaho Code), beer (Title 23, Chapter 10, Idaho Code), and wine (Title 23, Chapter 13, Idaho Code). (3-20-20)T

### 002. -- 009. (RESERVED)

### 010. DEFINITIONS.

**01. Licensed Premises.** Any premises for which a license has been issued under any of the provisions of Title 23, Chapters 9, 10 or 13, Idaho Code. All areas included on the floor plan submitted to the Director with the licensee’s application for a license constitute the licensed premises. In the event of loss or move of the physical licensed premises, the licensee has ninety (90) days to secure and occupy a new premises in which to display the license. All licenses must be prominently displayed in a suitable premises and remain in actual use by the licensee and available for legitimate sales of alcoholic beverages by the drink. An additional sixty (60) days may be granted by the Director, upon petition by the license holder. (3-20-20)T

**02. New Licenses.** For purposes of Section 23-908(4), Idaho Code, a “new license” is one that has become available as an additional license within a city’s limits under the quota system after July 1, 1980. The requirement of Section 23-908(4), Idaho Code, that a new license be placed into actual use by the licensee and remain in use for at least six (6) consecutive months is satisfied if the licensee makes actual sales of liquor by the drink during at least eight (8) hours per day, no fewer than six (6) days per week. (3-20-20)T

**03. Multipurpose Arena.** (3-20-20)T

**a.** For purposes of Section 23-944(3), Idaho Code, a Multipurpose Arena is a: (3-20-20)T

**i.** Publicly or privately owned or operated arena, coliseum, stadium, or other facility where sporting events, concerts, live entertainment, community events, and other functions are presented for a ticketed price of admission or one whose premises are leased for private events such as receptions; (3-20-20)T

**ii.** Facility that is licensed to sell liquor by the drink at retail for consumption upon the premises; and (3-20-20)T

**iii.** Facility that has been endorsed by the director. (3-20-20)T

**b.** A Multipurpose Arena facility must apply annually for an endorsement on its alcohol beverage license. (3-20-20)T

**c.** To receive a Multipurpose Arena endorsement under this Section will require the facility to have food available including, but not limited to, hamburgers, sandwiches, salads, or other snack food. The director may also restrict the type of events at a Multipurpose Arena facility at which beer, wine, and liquor by the drink may be served. The director will also consider the seating accommodations, eating facilities, and circulation patterns in such a facility, and other amenities available at a Multipurpose Arena facility before the director will endorse the license. (3-20-20)T

**d.** A licensee that applies for a Multipurpose Arena endorsement must submit with the application an operating/security plan to the director and the local law enforcement agency for review and approval. Once approved, the plan remains in effect until the licensee requests a change or the director determines that a change is necessary due to demonstrated problems or conditions not previously considered or adequately addressed in the original plan. The plan must be submitted in a format designated by the director and contain all of the following elements: (3-20-20)T

- i. How the Multipurpose Arena facility will prevent the sale and service of alcohol to persons under twenty-one (21) years of age and those who appear to be intoxicated; (3-20-20)T
  - ii. The ratio of alcohol service staff and security staff to the size of the audiences at events where alcohol is being served; (3-20-20)T
  - iii. Training provided to staff who serve, regulate, or supervise the service of alcohol; (3-20-20)T
  - iv. The facility's policy on the number of alcoholic beverages that will be served to an individual patron during one (1) transaction; (3-20-20)T
  - v. A list of event type/categories to be held in the facility at which alcohol service is planned, along with a request for the level of alcohol service at each event; and (3-20-20)T
  - vi. Diagrams and designation of alcohol service areas for each type of event category with identified restrictions of minors. (3-20-20)T
- e.** Prior to the first of each month, the licensee must provide a schedule of events for the upcoming month to the director and local law enforcement office. This schedule must show the date and time of each event during which alcohol service is planned. The licensee must notify the director and local law enforcement at least twenty-four (24) hours in advance of any events where alcohol service is planned that were not included in the monthly schedule. (3-20-20)T
- f.** To prevent persons who are under twenty-one (21) years of age or who appear intoxicated from gaining access to alcohol, the director may require that an operating plan include additional mandatory requirements if it is determined that the plan does not effectively prevent violations of liquor laws and regulations, particularly those that prevent persons under twenty-one (21) years of age or who are apparently intoxicated from obtaining alcohol. (3-20-20)T
- g.** If premises, licensed as a Multipurpose Arena, subsequently ceases to meet the qualifications of a Multipurpose Arena, the restrictions contained in Section 23-943, Idaho Code, apply and the posting of signs as provided for in Section 23-945, Idaho Code, is required. The licensee shall advise the director, by mail, that his premises no longer constitute a Multipurpose Arena, so that the license may be modified accordingly. (3-20-20)T
- 04. Partition.** A partition, as used in Section 23-944 Idaho Code, is defined as a structure separating the place from the remainder of the premises. Access through the structure to the place will be controlled to prevent minors from entering the place. The structure must be: (3-20-20)T
- a.** Permanently fixed from the premises ceiling to the premises floor. (3-20-20)T
  - b.** Made or constructed of solid material such as glass, wood, metal or a combination of those products. (3-20-20)T
  - c.** Designed to prevent an alcoholic beverage from being passed over, under or through the structure. (3-20-20)T
  - d.** All partitions must be approved by the Director. (3-20-20)T
- 05. Place.** For the purposes of Section 23-943, Idaho Code, "Place" as defined by Section 23-942(b), for a one (1) room restaurant without a barrier or partition, refers to the immediate bar area wherein there is seating alongside a counter or barrier that encloses bar supplies and equipment that are kept, and where alcoholic beverages are mixed, poured, drawn or served for consumption. (3-20-20)T
- 06. Restaurant.** The term Restaurant, as defined by Section 23-942(c), Idaho Code, is further defined as an establishment maintained, advertised and held out to the public as primarily a food eating establishment, where individually priced meals are prepared and regularly served to the public, primarily for on-premises consumption. The establishment must also have a dining room or rooms, kitchen and cooking facilities for the preparation of food,

and the number, and type of employees normally used in the preparing, cooking and serving of meals. Primarily as defined for the purposes of Section 010, also includes that the licensee must show to the director the following:

(3-20-20)T

- a. An established menu identifying the individually priced meals for consumption; (3-20-20)T
- b. Food service and preparation occurs on the premises by establishment employees; (3-20-20)T
- c. Stoves, ovens, refrigeration equipment or such other equipment usually and normally found in restaurants are located on the premises of the establishment; (3-20-20)T
- d. The licensee must demonstrate to the satisfaction of the Director, through appropriate business records, that the establishment is advertised and held out to the public as primarily a food eating establishment, or that at least forty percent (40%) of the establishment's consumable purchases are derived from purchases of food and non-alcoholic beverages. (3-20-20)T

**07. Stock Transfer.** For the purposes of Section 23-908, Idaho Code, the sale or exchange of stock in a closely held corporation holding a license is deemed a transfer of the license. However, the sale or exchange of shares in a family corporation among family members, is not a transfer. (3-20-20)T

**011. GENERAL PROVISIONS.**

**01. Delegation of Authority to License Alcoholic Beverages.** The Director hereby delegates his authority for the licensing of establishments which sell alcoholic beverages, as contained in Title 23, Chapters 9, 10, and 13, Idaho Code, to the, Alcohol Beverage Control Bureau, Idaho State Police. All applications and inquiries concerning alcoholic beverage licenses must be directed to the Alcohol Beverage Control Bureau. The Alcohol Beverage Control Bureau provides forms for all applications and inquiries. Nothing contained herein shall interfere with the Director's supervisory authority for alcoholic beverage licensing. (Section 67-2901(4), Idaho Code). (3-20-20)T

**02. Authority to Stagger the Renewal of Licenses to Sell Alcohol.** For the purposes of Sections 23-908, 23-1010 and 23-1316, Idaho Code, the Director may adjust the renewal month to accommodate population increases. Renewal months vary by county and are available on the Alcohol Beverage Control website. (3-20-20)T

**012. TRANSFER OF ALCOHOLIC BEVERAGE LICENSES.**

**01. Transfer of License Subject to Sanctions.** The Director of the Idaho State Police may deny the transfer of an alcoholic beverage license which is subject to possible disqualification, revocation or suspension under the provisions of Title 23, Chapters 9, 10, and 13, Idaho Code, or these rules, when an action has been filed to such effect before the Idaho State Police pursuant to Sections 23-933, 23-1037 or 23-1331, Idaho Code. (3-20-20)T

**02. Death or Incapacity of Licensee.** In the event of the incapacity, death, receivership, bankruptcy, or assignment for the benefit of creditors of a licensee, his guardian, executor, administrator, receiver, trustee in bankruptcy, or assignee for benefit of creditors may, upon written authorization from the Alcohol Beverage Control Bureau, continue the business of the licensee on the licensed premises for the duration of the license or until the business is terminated. Any person operating the licensed premises under this regulation must submit a signed agreement that he will assume all of the responsibilities of the licensee for operation of the premises in accordance with law. A person operating licensed premises under the regulation must demonstrate to the satisfaction of the Alcohol Beverage Control Bureau that he is qualified to hold an alcoholic beverage license. A guardian, executor, administrator, receiver, trustee in bankruptcy, or assignee for benefit of creditors may renew or transfer a license so held, in the same manner as other licensees, subject to the approval of the Alcohol Beverage Control Bureau. (Sections 23-908(1), 23-1005A, and 23-1317, Idaho Code). (3-20-20)T

**03. Authorization to Transfer and Assignment of Privilege to Renew.** Any person applying to renew a liquor license who was not the licensee at the applicable premises for the preceding year, must submit with the application to renew, a written Authorization to Transfer and Assignment of Privilege to Renew signed by the current licensee. (3-20-20)T

**04. Temporary Permits.** When application for transfer of an alcoholic beverage license has been made, the Alcohol Beverage Control Bureau, in its discretion, may authorize issuance of a temporary permit during the review of the application, during which time the applicant for transfer may conduct business as a temporary permit holder. The permit holder, in accepting the temporary permit, is responsible for complying with all statutes and rules pertinent to the sale of alcoholic beverages. Sanctions against such permit holder, whether civil, administrative, or criminal lies with the permittee, and acceptance of the permit constitutes a waiver of any defenses by permit holder based upon the fact that the permit holder is not, technically, a licensee. The Alcohol Beverage Control Bureau may withdraw a temporary permit it has issued pursuant to this rule at any time without hearing or notice. (3-20-20)T

**05. Product Replacement and Credit.** Any beer or wine products removed from the licensed retailer's premises by a wholesaler/distributor for quality control or public health are not considered to be a violation of Section 23-1033 or 23-1325, Idaho Code, which prohibit aid to the retailer or of Sections 23-1031 or 23-1326, Idaho Code, which prohibit extension of credit to a retailer, if: (3-20-20)T

**a.** The packages or kegs are replaced with identical product and quantity; or (3-20-20)T

**b.** In the instance of replacement of a partial keg of beer or wine, a credit to be redeemed on subsequent alcoholic beverage purchases by the retailer is given for the value of the unused portion; or (3-20-20)T

**c.** In the instance of removal of product for which the identical product or quantity thereof is not immediately available to the wholesaler/distributor at the time of removal of the product, a credit is given. The credit shall be redeemed on subsequent alcoholic beverage purchases by the retailer; or (3-20-20)T

**d.** In the case of a licensed establishment which is in operation no less than two (2) months and no more than nine (9) months of each year, prior to its period of closure, it is apparent that product will become outdated or spoiled before the date of re-opening, a wholesaler/distributor may remove product from the retailer's premises and may give a credit to the retailer. Such credit shall be redeemed on subsequent alcoholic beverage purchases by the same retailer. (3-20-20)T

**e.** Credit is given to a retailer for the amount paid by the retailer at the time of purchase of the product being removed by the wholesaler/distributor. (3-20-20)T

**06. Expiration of Licenses.** When a county or city has, pursuant to Sections 23-927 and/or 23-1012, Idaho Code, passed an ordinance extending the hours of sale of liquor and/or beer to two o'clock a.m. (2:00 a.m.), all liquor and/or beer licenses in that county expire at two a.m. (2 a.m.), on the first of the renewal month of the year following their issuance. (Section 23-908(1), Idaho Code). (3-20-20)T

**07. Maintenance of Keg Receipts.** Licensees shall retain a copy of all completed keg receipts required by Section 23-1018, Idaho Code, for a period of six (6) months. (3-20-20)T

### **013. PRIORITY LISTS.**

**01. Priority Lists for Incorporated City Liquor Licenses.** The Alcohol Beverage Control Bureau maintains a priority list of applicants for those cities in which no incorporated city liquor license is available. A separate list is maintained for each city. A person, partnership, or corporation desiring to be placed on a priority list shall file a completed application for an incorporated city liquor license, accompanied by payment of one-half (1/2) of the annual license fee. Such application need not show any particular building or premises upon which the liquor is to be sold, nor that the applicant is the holder of any license to sell beer. Priority on the list is determined by the earliest application, each succeeding application is placed on the list in the order received. (3-20-20)T

**02. Written Notification.** When an incorporated city liquor license becomes available Alcohol Beverage Control offers it in writing to the applicant whose name appears first on the priority list. If the applicant does not notify the Alcohol Beverage Control Bureau in writing within ten (10) days of receipt of the notice of his intention to accept the license, the license is offered to the next applicant in priority. An applicant accepting the license shall have a period of one hundred eighty (180) days from the date of receipt of Notice of License Availability in which to complete all requirements necessary for the issuance of the license. Provided, however, that upon a

showing of good cause the Director of the Idaho State Police may extend the time period in which to complete the necessary requirements for a period not to exceed ninety (90) days. (3-20-20)T

**03. Refusal to Accept Offer of License or Failure to Complete Application for License.** An applicant refusing a license offered under this rule or an applicant who fails to complete his application may have his name placed at the end of the priority list upon his request. Should the applicant holding first priority refuse or fail to accept the license or to complete the application within the time specified, the applicant shall be dropped from the priority list, the deposit refunded, and the license offered to the applicant appearing next on the list. (3-20-20)T

**04. Limitations on Priority Lists.** An applicant shall hold only one position at a time on each incorporated city priority list. An applicant must be able to demonstrate to the Director the ability to place an awarded license into actual use as required by Section 23-908(4), Idaho Code and these rules. An applicant for a place on an incorporated city liquor license priority list may not execute an inter vivos transfer or assignment of his place on the priority lists. For the purposes of this rule, "inter vivos transfer or assignment" means the substitution of any individual; partnership; corporation, including a wholly owned corporation; organization; association; or any other entity for the original applicant on the waiting list. An attempt to assign inter vivos a place on an incorporated city liquor license priority list shall result in the removal of the name of the applicant from the lists. An applicant, however, may assign his or her place on an alcoholic liquor license priority list by devise or bequest in a valid will. A place on an incorporated city liquor license priority list becomes part of an applicant's estate upon his or her death. (3-20-20)T

**05. Priority Lists Where Licenses Are Available.** The Alcohol Beverage Control Bureau shall not maintain a list for a city in which a liquor license is available, nor for a city that does not permit retail sale of liquor. (3-20-20)T

**014. CONDUCT OF LICENSED PREMISES.**

Upon request of an agent of the Director, a licensee, or anyone acting on his behalf, must produce any records required to be kept pursuant to Title 23, Chapters 9, 10, or 13, Idaho Code, and permit the agent of the Director or peace officer to examine them and permit an inspection of the licensee's premises. Upon request of a peace officer, a licensee, or anyone acting on his behalf, must permit an inspection of the licensee's premises. Any inspection performed pursuant to this rule must occur during the licensee's regular and usual business hours. The failure to produce such records or to permit such inspection on the part of any licensee is a violation of this rule. A violation of this rule, federal or state law or local code or ordinance may subject the licensee to administrative sanctions pursuant to Sections 23-933, 23-1037 and 23-1331, Idaho Code. (3-20-20)T

**015. -- 020. (RESERVED)**

**021. AGE RESTRICTION REQUIREMENTS.**

**01. Over/Under Clubs.** Minors cannot enter, remain or loiter in any licensed establishment that sells alcoholic beverages by the drink, or where drinking alcohol is the predominant activity, or where an environment is created in which drinking alcohol appears to be the predominant activity. This includes an establishment that provides entertainment and whose primary source of revenue comes from the sale of alcoholic beverages for consumption on the premises, or cover charges, or both. (3-20-20)T

**02. Posting of Age Restriction Signs.** Sections 23-945 and 23-1026, Idaho Code, require every alcoholic beverage licensee to post an age restriction sign. Such sign must contain the following words in lettering of at least one (1) inch in height: "Admittance of persons under twenty-one (21) years of age prohibited by law." Such sign must be placed conspicuously over or on the door of each entrance to the licensed premises and be clearly visible from the exterior approached to such premises. (3-20-20)T

**03. Counterfeit or Altered Age Documents.** If alcoholic beverage licensees, their employees, or agents receive age identification documents which have been lost or voluntarily surrendered, they shall deliver the documents to an agent or investigator of the Alcohol Beverage Control Bureau or to other law enforcement officials within fifteen (15) days from the date they were received, found or voluntarily surrenders. When identification documents that appear to be mutilated, altered or fraudulent are presented to a licensee, their employees or agents, they must contact law enforcement and/or refuse service. (3-20-20)T



**022. AGE RESTRICTION REQUIREMENTS FOR LICENSED MOVIE THEATERS - WHEN MINORS PERMITTED.**

**01. Minors Prohibited.** Persons under twenty-one (21) years of age are prohibited from entering or being in any movie theater licensed to sell alcoholic beverages during the time alcohol is available for sale or consumption in the movie theater. Age restriction signs must be posted as outlined in Subsection 021.02 of these rules at all times alcoholic beverages are sold, served or consumed in the movie theater. (3-20-20)T

**02. Minors Permitted.** Any person under twenty-one (21) years of age is permitted in a movie theater licensed to sell alcoholic beverages and no age restriction posting is required at any time when all alcohol is secured, locked up and not available for sale or consumption. (3-20-20)T

**03. Exemption.** Nothing in this rule applies to any movie theater that qualifies under Section 23-944(7), Idaho Code. (3-20-20)T

**023. -- 999. (RESERVED)**

## 11.10.02 – RULES GOVERNING STATE CRIMINAL HISTORY RECORDS AND CRIME INFORMATION

### 000. LEGAL AUTHORITY.

These rules are authorized by Sections 67-3001, 67-3003, 67-3004, 67-3007, and 67-3010, Idaho Code. (3-20-20)T

### 001. TITLE AND SCOPE.

**01. Title.** These rules are titled IDAPA 11.10.02, “Rules Governing State Criminal History Records and Crime Information.” (3-20-20)T

**02. Scope.** The rules relate to the governance and operation of criminal history records and crime information. (3-20-20)T

### 002. -- 009. (RESERVED)

### 010. DEFINITIONS.

Except as otherwise specifically provided, the terms defined or abbreviated in Section 67-3001, Idaho Code, have the same meaning in these rules. Any other terms not defined in Section 67-3001 are given their ordinary and commonly understood meaning. (3-20-20)T

**01. Acquittal.** The legal certification by a jury or judge that a person is not guilty of the crime charged. (3-20-20)T

**02. Criminal Summons.** Includes any summons, information or indictment issued in a criminal proceeding or action. (3-20-20)T

**03. Dismissal.** Termination of a criminal action without further hearing or trial in the interest of justice. (3-20-20)T

**04. Expunge.** To erase or destroy, to declare null and void outside the record, so that it is noted in the original record as expunged, and redacted from all future copies. (3-20-20)T

**05. Serious Misdemeanor.** A crime, that if convicted, could be punishable by imprisonment in a county jail. (3-20-20)T

### 011. -- 020. (RESERVED)

### 021. EXPUNGEMENT PROCEDURE.

A person seeking to expunge their criminal history record must: (3-20-20)T

**01. Application.** Submit the proper completed application to the Bureau of Criminal Identification as provided by the Bureau. (3-20-20)T

**02. Required Information.** Include a copy of one (1) of the following to the Bureau of Criminal Identification: (3-20-20)T

**a.** Criminal citation; or (3-20-20)T

**b.** Criminal Summons, Complaint, and Affidavit of Service by the county sheriff’s office; or (3-20-20)T

**c.** Indictment; or (3-20-20)T

**d.** Information. (3-20-20)T

**03. Certified Copy of Order of Acquittal or Order of Dismissal.** (3-20-20)T

**a.** Include a certified copy of the court’s order of acquittal finding the applicant was not guilty of the crime charged; or (3-20-20)T

**b.** A certified copy of the dismissal order, showing that all charges related to that arrest were dismissed. (3-20-20)T

**022. TRANSMITTAL OF CRIMINAL HISTORY RECORDS.**

The transmittal of criminal history arrest fingerprint(s) may be via electronic submission from a live-scan or card scanner over a secured and approved network or by hard copy through regular mail. (3-20-20)T

**023. PROCEDURE FOR CONTESTING THE ACCURACY AND COMPLETENESS OF A CRIMINAL HISTORY RECORD CONTAINED IN AGENCY FILE.**

**01. Challenge Accuracy of Records.** A person may challenge the accuracy and correctness of their criminal history records contained in the Bureau's database. (3-20-20)T

**a.** The applicant must submit to fingerprinting through either the Bureau of Criminal Identification or other law enforcement agency. A fingerprinting fee may apply. (3-20-20)T

**02. Notification of Fingerprints Not Matched.** If the applicant's fingerprints do not match those contained in the Bureau's database, the applicant will be notified by certified mail. (3-20-20)T

**03. Documentation of Erroneous Information.** If the applicant's fingerprints match, but the applicant has documentation showing the information is in error, the applicant may submit such information to the Bureau of Criminal Identification. (3-20-20)T

**04. Correction of Records.** The Bureau of Criminal Identification will correct its records per the direction of the law enforcement agency where the initial criminal action arose or appropriate court order. (3-20-20)T

**024. -- 030. (RESERVED)**

**031. FEES FOR SERVICES.**

The Bureau shall charge fees as follows: (3-20-20)T

**01. Fingerprint Check.** Not more than twenty-five dollars (\$25) for each fingerprint check requested for other than law enforcement purposes. (3-20-20)T

**02. Name Check.** Not more than twenty dollars (\$20) for each name check requested for other than law enforcement purposes. (3-20-20)T

**03. Rolling Fingerprint.** Not more than ten dollars (\$10) for rolling a set of fingerprints and no more than five dollars (\$5) for each additional copy of such rolled fingerprints. (3-20-20)T

**032. -- 999. (RESERVED)**

**IDAPA 11 – IDAHO STATE POLICE  
STATE BRAND BOARD**

**DOCKET NO. 11-0201-2000F (FEE RULE)**

**NOTICE OF OMNIBUS RULEMAKING – ADOPTION OF TEMPORARY RULE**

**EFFECTIVE DATE:** The effective date of the temporary rules being adopted through this omnibus rulemaking is the adjournment date of the second regular session of the 65th Idaho State Legislature - March 20, 2020.

**AUTHORITY:** In compliance with Sections 67-5226, Idaho Code, notice is hereby given this agency has adopted a temporary rule. The action is authorized pursuant to Sections 25-1102, 25-1110, 25-1121, 25-1122, 25-1160, 25-3302 and 25-3303, Idaho Code.

**DESCRIPTIVE SUMMARY:** The following is the required finding and concise statement of its supporting reasons for adopting a temporary rule:

The Idaho State Brand Board is tasked with serving and protecting the Idaho livestock industry, by creating a deterrent of theft, illegal transportation and slaughter of livestock. The Brand Board finds that without adoption these rules would eliminate the Boards ability to carry out the statutory duties of protecting and regulating the livestock industry. Additionally the Brand Board is solely operated by dedicated funds derived from Brand Recording, Brand Inspection and Dealer Licensing fees which are set in Rule. These rules are necessary to provide funding to provide necessary state service.

This temporary rulemaking adopts the following chapter under IDAPA 11, Title 02:

**IDAPA 11**

- 11.02.01, *Rules of the Idaho State Brand Board*

**TEMPORARY RULE JUSTIFICATION:** Pursuant to Sections 67-5226(1) and 67-5226(2), Idaho Code, the Governor has found that temporary adoption of the rule is appropriate for the following reasons:

These temporary rules are necessary to protect the public health, safety, and welfare of the citizens of Idaho and confer a benefit on its citizens. These temporary rules implement the duly enacted laws of the state of Idaho, provide citizens with the detailed rules and standards for complying with those laws, and assist in the orderly execution and enforcement of those laws. The expiration of these rules without due consideration and processes would undermine the public health, safety, and welfare of the citizens of Idaho and deprive them of the benefit intended by these rules.

**FEE SUMMARY:** Pursuant to Section 67-5226(2), the Governor has found that the fees or charges being imposed or increased is justified and necessary to avoid immediate danger and the fees is described herein:

The fees or charges, authorized in Sections 25-1160, 25-1121, 25-1122 and 25-3303, Idaho Code, are part of the agency’s 2021 budget that relies upon the existence of these fees or charges to meet the state’s obligations and provide necessary state services. Failing to reauthorize these temporary rules would create immediate danger to the state budget, immediate danger to necessary state functions and services, and immediate danger of a violation of Idaho’s constitutional requirement that it balance its budget.

The following is a specific description of the fees or charges by section or subsection:

Section or Subsection	Fee
011.02.a.	Brand Recording Fee
011.02.d.	Brand Renewal Fee
011.04.a.	Brand Renewal Fee

<b>Section or Subsection</b>	<b>Fee</b>
<b>011.05.b.</b>	Brand Transfer Fee
<b>016.01</b>	Sheep Brand Recording Fee
<b>019.04</b>	Brand Inspection Fees
<b>021.05</b>	Annual Brand Inspection Certificate Fee
<b>031</b>	Idaho Livestock Moving to Pasture Out of State Fee
<b>032.03</b>	Livestock Auction Sales Fee
<b>034</b>	Schedule of Fees for the Idaho State Brand Board
<b>100</b>	Idaho Livestock Dealer Licensing – Application Fees

**ASSISTANCE ON TECHNICAL QUESTIONS:** For assistance on technical questions concerning the temporary rule, contact Cody D. Burlile, State Brand Inspector, phone (208) 884-7070, fax (208) 884-7097, email [cody.burlile@isp.idaho.gov](mailto:cody.burlile@isp.idaho.gov).

DATED this February 21, 2020.

Charlie Spencer  
Police Services Major  
Rules Review Officer  
Idaho State Police  
700 S. Stratford Dr.  
Meridian, ID 83642  
[charlie.spencer@isp.idaho.gov](mailto:charlie.spencer@isp.idaho.gov)  
Phone 208-884-7203

**IDAPA 11 – IDAHO STATE POLICE  
STATE BRAND BOARD**

**11.02.01 – RULES OF THE IDAHO STATE BRAND BOARD**

**000. LEGAL AUTHORITY.**

The State Brand Board has authority to make rules to implement and enforce the state brand laws pursuant to Title 25, Chapters 11 and 33, Idaho Code. (3-20-20)T

**001. TITLE AND SCOPE.**

**01. Title.** These rules are titled IDAPA 11.02.01, “Rules of the Idaho State Brand Board.” (3-20-20)T

**02. Scope.** The rules relate to the governance and operation of the Idaho State Brand Board. These rules also provide for the issuance and administration of livestock dealer licenses, the collection of appropriate fees for licensure, the provision of requirements necessary for licensure. (3-20-20)T

**002. -- 004. (RESERVED)**

**005. DEFINITIONS.**

The definitions found in Sections 25-1101 and 25-3301, Idaho Code, also apply to these rules. Additionally, as used in rules 000 through 052, the following terms have the following definitions: (3-20-20)T

**01. Auction Brand Inspection Certificate.** A brand inspection certificate issued to the new owner only from organized auction market sales. In addition to the information required of a brand inspection certificate by Section 25-1101, Idaho Code, the auction brand certificate must contain: (3-20-20)T

- a.** The names and addresses of the buyer and/or new owner; (3-20-20)T
- b.** The destination of the livestock for the new owner; (3-20-20)T
- c.** The auction market name and location and the date of the sale; (3-20-20)T
- d.** The number of livestock inspected in each category of animals as designated on the auction brand inspection certificate. (3-20-20)T
- e.** The signature of either an Idaho brand inspector or a clerk. (3-20-20)T

**02. Auction Brand Inspection.** A brand inspection made at an Idaho Auction market with a record made of such inspection on a tally sheet. (3-20-20)T

**03. Bar Brand.** A horizontal elongation of a line placed either above, between or below the main part of a brand, causing the name of the brand to be read to include the bar. (3-20-20)T

**04. Bill of Sale.** The formal instrument for transfer of title to livestock. A bill of sale must include the date of the sale, a description of the livestock sold, the name of the purchaser, and the signature of the seller. (3-20-20)T

**05. Board.** The Idaho State Brand Board. (3-20-20)T

**06. Brand Card.** A wallet size card issued by the State Brand Inspector in a specific color for each brand renewal period, showing a drawing of the brand, the location of the brand, the name and address of each owner of the recorded brand. (3-20-20)T

**07. Brand Inspection.** The physical examination of livestock by a brand inspector to determine ownership of the livestock. A brand inspection includes examination of proofs of ownership, including the visual examination of brands and marks. (3-20-20)T

**08. Consignee.** Any person who has possession of livestock for feed, care or sale, but who is not deemed to be the owner of the livestock unless a later proper transfer of title to the livestock is completed.

- (3-20-20)T
- 09. Courtesy Brand Inspection.** An inventory of livestock requested by a financial institution or owner or a regulatory agency, shown on a tally sheet. (3-20-20)T
- 10. Dash Brand.** A horizontal elongation of a line placed either ahead of, between or behind the main part of a brand causing the name of the brand to be read to include the dash. (3-20-20)T
- 11. Destination.** The place where the livestock are to be transported. (3-20-20)T
- 12. DOT Brands.** A brand that is a spot or blotch brand that is unreadable. (3-20-20)T
- 13. Field Brand Inspection Certificate.** A brand inspection certificate issued following a field brand inspection. In addition to the information required of a brand inspection certificate by Section 25-1101, Idaho Code, the field brand certificate must contain: (3-20-20)T
- a.** Names and address of the owner, seller, buyer and new owner; (3-20-20)T
  - b.** The location where the brand inspection was made; (3-20-20)T
  - c.** The date of the inspection; (3-20-20)T
  - d.** The destination of the livestock designated by the new owner; (3-20-20)T
  - e.** The number of livestock inspected on the field brand inspection certificate; (3-20-20)T
  - f.** The brand inspection fees paid by the owner/seller; and (3-20-20)T
  - g.** The signature of the owner/seller or his agent and an Idaho brand inspector. (3-20-20)T
- 14. Field Brand Inspection.** A brand inspection made for livestock other than those sold at an auction market. (3-20-20)T
- 15. Hold Order.** A written order issued by an Idaho Brand Inspector, requiring an auction market, slaughter plant or feed lot to retain either livestock or the proceeds from the sale of livestock until a release order is filed by a brand inspector. (3-20-20)T
- 16. Idaho Livestock Owner.** A livestock owner who owns real property in the state of Idaho, and uses such property to feed, pasture or otherwise hold livestock for at least four (4) consecutive months each year. (3-20-20)T
- 17. Lifetime Certificate.** An ownership and transportation certificate. (3-20-20)T
- 18. Livestock.** (3-20-20)T
- a.** Defined in Section 25-1101, Idaho Code, as used in Title 25, Chapter 11, Idaho Code. (3-20-20)T
  - b.** Defined in Section 25-3301, Idaho Code, as used in Title 25, Chapter 33, Idaho Code. (3-20-20)T
- 19. Order Buyer.** A livestock dealer. (3-20-20)T
- 20. Ownership and Transportation Certificate.** A certificate issued pursuant to Section 25-1122, Idaho Code, that permits a horse owner to transport horses in Idaho or nationwide, for any purpose except for sale or trade. (3-20-20)T
- 21. Person.** (3-20-20)T

- a. Defined in Section 25-1101, Idaho Code, as used in Title 25, Chapter 11, Idaho Code. (3-20-20)T
- b. Defined in Section 25-3301(5), Idaho Code, as used in Title 25, Chapter 33, Idaho Code. (3-20-20)T
- 22. **Release Order.** A written order issued by an Idaho Brand inspector that clears a release on a hold order of livestock or the proceeds from a sale of livestock. (3-20-20)T
- 23. **Representative of a Licensee (“Representative”).** Any full time employee, agent, or other person who buys, receives, sells, or assembles livestock for resale on behalf of a licensed livestock dealer. (3-20-20)T
- 24. **Tally Sheet.** A document containing a list of all livestock inspected at an auction market or courtesy brand inspection, which must include a listing of all livestock inspected. The tally sheet must indicate the name of the owner, the brands or brand inspection certificates on the animals, and the number of livestock inspected. The name of the owner must be either the name under which the brand is recorded or the name of the new owner as shown on the brand inspection certificate. (3-20-20)T

**006. -- 010. (RESERVED)**

**011. RECORDING, USE AND PLACEMENT OF BRANDS.**

- 01. **Recording and Use of Brands.** (3-20-20)T
  - a. All brands must be recorded with the State Brand Inspector, as required by Section 25-1144, Idaho Code. (3-20-20)T
  - b. No person may brand livestock with an unrecorded brand. (3-20-20)T
  - c. No person may use any brand registered to any other person. (3-20-20)T
  - d. No person may lease a brand to any other person. (3-20-20)T
- 02. **Recording Procedures.** (3-20-20)T
  - a. Any person desiring to record a brand in the state of Idaho must submit an application and fee with the State Brand Inspector, at the main office as provided by Section 25-1144, Idaho Code. If the State Brand Inspector finds that the proposed brand does not conflict with any presently recorded brand, the State Brand inspector must record the proposed brand. (3-20-20)T
  - b. Upon recording of the brand, the State Brand Inspector issues a certificate of recorded brand and a brand card to each owner of the brand. The brand card will be recognized by all brand inspectors as proof that the brand indicated thereon has been properly registered. (3-20-20)T
  - c. A brand may be recorded in more than one name, subject to space limitations on the brand card. (3-20-20)T
  - d. Section 25-1144, Idaho Code, authorizes the Idaho State Brand Board to prorate the brand recording fee to facilitate entry into the staggered brand renewal schedule. The staggered brand renewal system records a new brand on a five (5) year cycle determined by first initial of the applicant's last name. This is a continually staggered five (5) year renewal cycle and can be reviewed at any time at the Idaho State Brand Board Main Office. (3-20-20)T
- 03. **Brands Acceptable for Recording.** (3-20-20)T
  - a. Dash brands and bar brands must be at least two (2) inches long and slashes at least four (4) inches long. (3-20-20)T



**b.** Recorded brands appearing on the neck, horns, hooves or jaw of livestock, or on any other location not expressly included within the definition of “brand” in Section 25-1101, Idaho Code, may not be recorded and are not relevant for identification. (3-20-20)T

**c.** Markings made on the necks of equine animals made pursuant to the “International Horse Identification System,” otherwise known as the “Angle Numerical System,” U.S. Patent Number 3633584 may not be recorded as brands, but may be recognized for identification purposes. (3-20-20)T

**d.** A vertical arrangement of numbers in groups of two (2) or more made by freeze or hot iron branding for the purpose of individual identification of cattle must be preceded with the oval cipher “o” and must be placed on the shoulder, rib or hip. Such numbers may not be recorded as brands, but may be recognized for identification purposes. Said animals are also to be branded with an Idaho recorded ownership brand. (3-20-20)T

**e.** Lip Tattoos may not be recorded as brands, but may be recognized for identification purposes. (3-20-20)T

**f.** Wattles, earmarks, dewlaps or ear tags may not be recorded as brands, but may be recognized for identification purposes. (3-20-20)T

**g.** No new DOT brands will be recorded. Existing DOT brands will be grandfathered in to the official brand records. (3-20-20)T

**04. Renewal of Brands.** (3-20-20)T

**a.** A brand may be renewed by making application and submitting the renewal fee to the Main Office of the Idaho State Brand Board. (3-20-20)T

**b.** Recorded brands are renewed as provided in Section 25-1145, Idaho Code. (3-20-20)T

**c.** A minimum of two (2) new brand cards will be issued to the recorded owner(s) upon renewal. The State Brand Inspector maintains a record of each renewal of a recorded brand. (3-20-20)T

**05. Transfer of Recorded Brands.** (3-20-20)T

**a.** Brands must be transferred whenever brand is sold or otherwise transferred to a new owner; or whenever persons are added to or deleted from the list of owners of a particular recorded brand. (3-20-20)T

**b.** A transfer fee is charged for all transfers; provided, however, if the change is made on or before July 1 of the renewal year, no fee will be charged whenever one (1) or more new owners are added to or deleted from the recorded brand; or whenever the brand is transferred to a corporation, the stockholders of which are the same persons who were the owners of the brand. (3-20-20)T

**c.** If any owner of a recorded brand is deceased, the personal representative for the estate of the deceased person must file with the State Brand Inspector a certified copy of the court order showing his appointment. The personal representative may thereafter transfer the ownership interests of the deceased person in the brand. Alternatively, where no personal representative has been appointed, the surviving spouse of the owner of a recorded brand may submit a certified copy of a death certificate to effectuate transfer of the brand. (3-20-20)T

**d.** A brand inspection of the livestock must occur prior to the transfer of the recorded brand pursuant to Subsection 019.01.d. (3-20-20)T

**06. Conflicts Between Brands.** The State Brand Inspector may, at any time after recording, cancel any brand that infringes upon any previously recorded brand. Notice of cancellation of the brand will be mailed to the owners of the brand. The owners have thirty-five (35) days from the date indicated on the postmark of the notice to appeal the Brand Inspector’s decision to the Brand Board. (3-20-20)T

**012. -- 014. (RESERVED)**

**015. BRAND ALTERNATIVES.**

**01. Identification.** Identification marks, devices or documents issued by the state brand inspector as an alternative to permanent marks may be used for each animal. Documents acceptable as an alternative to a permanent brand must be approved by the State Brand Inspector and are as follows: (3-20-20)T

**a.** Lifetime Ownership and Transportation certificate for horses, mules and asses. Such certificate must show pictures of two (2) side views, including registration numbers where appropriate. (3-20-20)T

**b.** Purebred registration papers for cattle used for breeding or show purposes. (3-20-20)T

**c.** Any other form of positive identification requested to be used by a livestock owner. (3-20-20)T

**016. BRANDING OF SHEEP.**

Recording and placement of Sheep Brands. Brands for sheep may be recorded in the same manner and for the same fee as other recorded brands. Sheep brands must comply with Section 25-1142, Idaho Code. (3-20-20)T

**017. -- 018. (RESERVED)**

**019. BRAND INSPECTIONS.**

**01. Owners.** Owners of livestock must obtain a brand inspection in any of the following situations: (3-20-20)T

**a.** When ownership of livestock changes in any manner; (3-20-20)T

**b.** When livestock are to be moved out of the state within ninety-six (96) hours, unless the transportation of the livestock is covered by an ownership and transportation certificate or an annual inspection certificate; (3-20-20)T

**c.** When livestock are to be slaughtered within ninety-six (96) hours; (3-20-20)T

**d.** When a recorded brand is sold or transferred to a new owner, except that no brand inspection is required if no livestock carry the brand that is to be transferred; or the transfer involves the addition or deletion of owners to the recorded brand as provided in Subsection 011.05.b.; or when brand owners incorporate as provided in Subsection 011.05.b. (3-20-20)T

**02. General Procedures.** (3-20-20)T

**a.** Brand inspectors will be available upon request to inspect livestock during the normal daylight working hours. At least twenty-four (24) hours notice should be given to the brand inspector when a brand inspection is required. Brand inspections should be performed at the point of origin of the livestock, unless otherwise approved by the State Brand Inspector or District Brand Supervisor. Requested brand inspections may be made in the nighttime by artificial light only with the expressed consent of the State Brand Inspector or the district brand supervisor. (3-20-20)T

**b.** The livestock to be inspected should be gathered and ready for inspection prior to the arrival of the Brand Inspector. Brand inspectors are not responsible for gathering livestock to be inspected. (3-20-20)T

**c.** The brand inspector must notify any owner of stray livestock found during the brand inspection process. If the owner of the stray animals cannot be found, the strays are sold pursuant to the estray statutes, Title 25, Chapter 23, Idaho Code. (3-20-20)T

**d.** Upon change of ownership of livestock, any previous brand inspection certificate must be surrendered to the brand inspector. (3-20-20)T

- 03. Proof of Ownership.** (3-20-20)T
- a.** The livestock owner must maintain proof of ownership of this livestock by branding them and/or by keeping brand inspection certificates. Proof of ownership of livestock may be established by: (3-20-20)T
- i.** The animals being branded with its owner’s recorded brand. (3-20-20)T
- ii.** A brand inspection certificate, issued by Idaho or another state. (3-20-20)T
- iii.** An ownership and transportation certificate, or by an ownership and transportation certificate issued by another state (applies only to horses, mules or asses). (3-20-20)T
- iv.** A bill of sale, providing that the brand inspection takes place within ten (10) days of the purchase and the brand inspector can be reasonably assured that the bill of sale is valid. Bills of sale may be issued in livestock transactions but do not replace a brand inspection certificate. (3-20-20)T
- b.** Fresh brands on livestock bearing older brands, may or may not be accepted at the discretion of the State Brand Inspector or District Brand Supervisor as proof of ownership unless accompanied by a brand inspection certificate or a bill of sale covering the older brands as provided for in Subsection 019.03.a.iv. above. The State Brand Inspector may inquire into the ownership of all livestock bearing two (2) or more brands. (3-20-20)T
- c.** If the inspector finds that the livestock brands are not owned by the person claiming the same, such person is required to produce a bill of sale or other satisfactory evidence of ownership. (3-20-20)T
- 04. Fees.** (3-20-20)T
- a.** Except as provided in Subsection 019.04.b. of this rule, the fees for any brand inspection are as provided in Subsection 034.01. (3-20-20)T
- b.** Livestock owned by an Idaho livestock owner, bearing an Idaho recorded brand, leaving the state of Idaho for grazing purposes only and that will return to the state at a later date, will be inspected at a rate of one-half (1/2) of the regular per head inspection fee. (3-20-20)T
- 020. BABY CALVES – OWNER INSPECTION.**
- 01. General Requirements for Baby Calf Inspection.** Baby calves that are ten (10) days or less old, may be sold within the state of Idaho, by their owner or the owner’s agent, without a state brand inspection established in the provisions of Section 019, under the following conditions: (3-20-20)T
- a.** The baby calf must have been given birth to by a cow that the owner of the baby calf owned at the time of the baby calf’s birth; (3-20-20)T
- b.** The owner of the baby calf, or the owner’s agent, must inspect the baby calf; (3-20-20)T
- c.** The owner of the baby calf, or the owner’s agent, must maintain an accurate baby calf sales report, that establishes proof of ownership and transfer of any baby calves; (3-20-20)T
- d.** The completed baby calf sales report must fully and accurately set forth the names and addresses of the owner and the buyer and be signed by both the owner or the owner’s agent and the buyer and must be made available to a Brand Inspector upon request; (3-20-20)T
- e.** At the time of the owner inspection, the baby calf must have no brand or have the owner’s brand; (3-20-20)T
- f.** Conditions of Baby Calf Inspections by owner contained here do not apply to baby calves sold at public livestock markets, slaughter plants, or circumstances that require a brand inspection for baby calves leaving the state of Idaho. (3-20-20)T

**02. Inspection of Calves Eleven Days or More Old.** Any calf eleven (11) days old or older must be inspected pursuant to Section 019 whenever an inspection is required. (3-20-20)T

**021. ANNUAL BRAND INSPECTION CERTIFICATE.**

**01. Certificates.** Annual brand inspection certificates for livestock may be used to transport livestock or for any purpose other than for the purpose of slaughter, sale or trade. (3-20-20)T

**02. Annual Brand Inspection Form Also Known as “Seasonal.”** Annual brand inspection certificates will expire zero (0) to twelve (12) months from the date of issue as determined by the Brand Inspector and contain the breed, color, sex, markings, brands and location thereof, breed registry number if appropriate, and any other information that distinguishes the animal or animals for which the certificate is issued. (3-20-20)T

**03. Annual Inspection.** Subsection 030.01 which requires that livestock be transported out of the state within ninety-six (96) hours of the brand inspection of the livestock, does not apply to annual inspections.(3-20-20)T

**04. Agreements.** The State Brand Inspector is authorized to enter into reciprocal agreements with brand authorities in adjacent states to allow livestock to move between the two states using the annual brand inspection issued in the home state. (3-20-20)T

**05. Fee.** The fee for an annual brand inspection certificate is provided in Subsection 034.01. (3-20-20)T

**022. LIFETIME OWNERSHIP AND TRANSPORTATION CERTIFICATES.**

**01. Owner.** Any owner of a horse, mule or ass may request a lifetime ownership and transportation certificate by contacting a brand inspector. (3-20-20)T

**02. Detain.** In the event that a brand inspector or other law enforcement officer finds a person who is not the owner of an animal in possession of both the animal and the lifetime ownership and transportation certificate, the brand inspector or other law enforcement officer may detain the animal for a sufficient period of time to determine the validity of the non-owner’s possession of such animal. Any expenses caused by the detention are paid by the person in possession of the animal and certificate, or by the actual owner of the animal. (3-20-20)T

**03. Nationwide.** Lifetime ownership and transportation certificates issued under Section 25-1122, Idaho Code, may be used nationwide for transportation of horses, mules and asses. (3-20-20)T

**04. Validity.** Lifetime ownership and transportation certificates for any horse, mule or ass is valid so long as the animal remains within the ownership of the person to whom the certificate was issued. The lifetime ownership and transportation certificate is not transferable. (3-20-20)T

**023. -- 029. (RESERVED)**

**030. TRANSPORTATION OF LIVESTOCK.**

**01. Out-of-State.** Any person transporting livestock out of the state of Idaho must obtain a brand inspection before the animals leave the state, as provided by Section 25-1121, Idaho Code. The brand inspection must be obtained no more than ninety-six (96) hours prior to the transport of the livestock out of the state. Provided, however, that a brand inspection is not required if the livestock are accompanied by either of the following documents: (3-20-20)T

**a.** The Idaho lifetime ownership and transportation certificate described in Section 022, which may be used by the owner to transport horses, mules or asses nationwide; and (3-20-20)T

**b.** The annual inspection certificate described in Section 021, which may be used to transport livestock out of the state of Idaho. (3-20-20)T

**02. In-State.** Livestock may be transported intrastate as follows: (3-20-20)T

**a.** Persons in possession of their brand cards may transport their livestock marked with the brand shown on the card any place within the state of Idaho without obtaining a brand inspection. (3-20-20)T

**b.** In those instances where the livestock have been purchased, and such livestock does not carry a brand or if the livestock carry the brand of the previous owner, the blue copy of the field brand inspection certificate or auction brand inspection certificate issued to the present owner may be used to transport the livestock within Idaho. (3-20-20)T

**c.** By written ownership transportation permit, pursuant to Section 25-1101, Idaho Code. (3-20-20)T

**031. IDAHO LIVESTOCK MOVING TO PASTURE OUT OF STATE.**

Livestock owned by an Idaho livestock owner, bearing an Idaho recorded brand, leaving the state of Idaho for grazing or pasture purposes only, and to be returned to the state of Idaho at a later date, will be inspected by an Idaho brand inspector at one-half (1/2) of the regular per head inspection fee, provided that if the State Brand Inspector determines an inspection fee is not necessary, he may issue a brand inspection without charge. Livestock leaving the state of Idaho for pasture purposes, which are not to be returned to the state of Idaho by their owner, will be charged the regular inspection fee and additional fees provided in Subsection 034.01. (3-20-20)T

**032. LIVESTOCK AUCTION SALES.**

**01. General.** Livestock auction sales include all public livestock markets chartered by law, dispersal sales of livestock subject to brand inspection, and sales of livestock by an association of breeders subject to brand inspection where livestock are physically sold to the highest bidder. (3-20-20)T

**02. Other Groups.** Sales of livestock at county fairs within the state involving Future Farmers of America (FFA) and 4-H groups are not auction sales for the purpose of charging and collecting the minimum brand inspection fee in Subsection 034.01. (3-20-20)T

**03. Fee.** The minimum brand inspection fee will be charged and collected at all auction sales described in this rule. The fee must be paid by the livestock auction sale, whether or not the inspection fees received from the owners of livestock inspected equals the minimum fee. If the fees paid by the owners of livestock inspected at the sale, as shown as to number of head on the brand inspector's auction tally sheet, exceed the minimum fee, the actual amount of fees collected by the auction operator must be paid, rather than the minimum amount. (3-20-20)T

**033. BRAND INSPECTIONS AT SLAUGHTER PLANTS AND MOBILE SLAUGHTER UNITS.**

**01. Notification.** All livestock slaughtering plants and mobile slaughtering units must notify the local brand inspector in advance of any livestock slaughtering operation. Brand inspection of the animals to be slaughtered must be accomplished not more than ninety-six (96) hours prior to slaughtering, whether for commercial purposes or for the owner's immediate family needs. (3-20-20)T

**02. Records.** Such slaughtering operations must keep accurate records indicating the number of animals slaughtered, the source of the animals, ownership and the brands on such animals. Such records must be available for inspection by the brand inspector during regular business hours. (3-20-20)T

**03. Record of Ownership.** In the event no brand inspector is available for inspection prior to slaughter of livestock, the owner of such livestock and the persons slaughtering the livestock must complete a record of ownership. Such record must be retained by the person who slaughtered the animal(s) until it may be submitted to the brand inspector. (3-20-20)T

**04. Collection.** In situations when a brand inspector cannot be present before the time of slaughter, slaughter plants and mobile slaughter units must collect the brand inspection fees for each animal slaughtered and remit the same to the brand inspector. (3-20-20)T

**05. Inspection.** All slaughter plants and mobile slaughter units must permit a brand inspector to inspect the hides removed from slaughtered livestock. The hides must be kept for ten (10) days. (3-20-20)T

**034. SCHEDULE OF FEES FOR THE IDAHO STATE BRAND BOARD.**

**01. Fees.** Fees authorized by the State Brand Board and to be collected by the State Brand Inspector are as follows:

<b>SCHEDULE OF FEES</b>		
<b>Recording of a Brand</b>	<b>\$50 initial recording fee plus a \$20 per year prorated staggered recording fee every year thereafter</b>	
Transfer of a recorded brand	\$50.00	
Renewal of a recorded brand (every five years)	\$100.00	
Duplicate brand registration certificate	\$1.50	
Lifetime ownership and transportation certificate	\$50.00	
Duplicate lifetime ownership and transportation certificate	\$5.00	
Annual inspection equine or bovine	\$5.00	
	<b>CATTLE</b>	<b>HORSES</b>
Brand inspection (per head)	\$1.19	\$5.00
Idaho livestock to pasture (per head)	\$.60	\$2.50
Minimum auction fee (per day)	\$50.00	\$50.00
Minimum field brand inspection fee	\$20.00	\$20.00
Equine farm service fee		\$45.00
Courtesy brand inspection	\$1.19	\$5.00

<b>Fees To Be Collected By The State Brand Inspector For Other State Agencies:</b>	
Idaho Beef Council (per head)	\$1.50
Idaho Horse Board (per head)	\$3.00
Idaho Department of Agriculture:	
Animal Disease Control (per head)	\$.22
Animal Damage Control (per head)	\$.05
Wolf Control Assessment	\$25/brand renewal \$5/staggered recording fee every year thereafter

(3-20-20)T

**02. Due and Payable.** Pursuant to Section 25-1160, Idaho Code, all brand inspection fees, and all other fees required to be collected by the Brand Inspector are due and payable at the time of inspection, except that

livestock owners may make arrangements with a deputy brand inspector and approved by the state brand inspector to pay for all accumulated brand inspection fees to be paid at least monthly. Failure to comply with the payment arrangement makes all fees immediately due and payable. (3-20-20)T

**03. Minimum Fees.** Feedlots, currently approved by the Idaho Department of Agriculture, and slaughter plants are exempt from the minimum brand inspection fee. Other minimum brand inspection fees may be waived at the discretion of the State Brand Inspector or District Brand Supervisor. (3-20-20)T

**04. Equine Farm Service Fee.** See Section 25-1160(2), Idaho Code. (3-20-20)T

**035. -- 039. (RESERVED)**

**040. CLAIMS FOR FUNDS OR LIVESTOCK SUBJECT TO A HOLD ORDER.**

**01. Claim.** Any person claiming to be the owner of any animal sold under Section 25-1174, Idaho Code, may claim the proceeds of the sale by filing a written and verified claim for such proceeds together with any supporting documents with the State Brand Inspector, 700 S. Stratford, Meridian, Idaho 83642. The claim must contain the following information: (3-20-20)T

**a.** The name and address of the claimant; (3-20-20)T

**b.** A short, plain statement of the matters asserted in the claim, including but not limited to: facts as to ownership, a description of the animal including brands and marks, the location of the animals when they were last in the possession of the claimant, and any other pertinent facts tending to establish the claim; (3-20-20)T

**c.** A claim for the proceeds, or portion of the proceeds, of the sale; (3-20-20)T

**d.** Names and addresses, if known, of any other potential claimants to the funds; and (3-20-20)T

**e.** A request for a hearing, if desired. (3-20-20)T

**02. More Than One Claimant.** Where there is more than one (1) claimant, each claimant must serve a complete copy of his claims upon the other claimants to the funds. (3-20-20)T

**03. Investigation.** The State Brand Inspector will then investigate the matter and will determine whether the claimants can stipulate to the disposition of the funds. If a stipulation is reached, the State Brand Inspector or Deputy Brand Inspector will issue a release order on the livestock or the funds in accordance with the stipulation. (3-20-20)T

**04. Hearing.** In the event that a stipulation is not possible, or where a claimant has requested in writing that a hearing be held, a hearing will be held by the State Brand Inspector, after giving thirty (30) days notice to all claimants. (3-20-20)T

**041. – 099. (RESERVED)**

**SUBCHAPTER B – IDAHO LIVESTOCK DEALER LICENSING**

**100. APPLICATION FEES.**

**01. Annual Fees.** The annual fees cover the period from July 1 to June 30 of the next year. (3-20-20)T

**02. Livestock Dealer.** One hundred dollars (\$100). (3-20-20)T

**03. Representative.** Thirty-five dollars (\$35). (3-20-20)T

**101. FINANCIAL INFORMATION.**

Financial information must be filed with an application and show the gross amount of livestock purchases for the

previous year. (3-20-20)T

**102. LIVESTOCK DEALER BONDS.**

A surety bond must be filed to support the application for a livestock dealer license as follows: (3-20-20)T

**01. Bond.** File a bond from an Idaho surety or Packers and Stockyards U.S.D.A. in the amount required under “Coverage” shown herein. (3-20-20)T

**a. Coverage.** To compute the required amount of bond coverage, divide the total dollar value of livestock purchased in Idaho during the preceding year, by one-half the number of days on which business was conducted. The number of days in any business year, for the purpose of this rule is two hundred sixty (260). Therefore, the divisor is one hundred thirty (130). The amount of bond coverage must be the next multiple of five thousand dollars (\$5,000) above the amount so determined. When the computation exceeds seventy-five thousand dollars (\$75,000) the amount of bond coverage need not exceed seventy-five thousand dollars (\$75,000) plus ten percent (10%) of the excess over seventy-five thousand dollars (\$75,000), raised to the next five thousand dollars (\$5,000) multiple. In no case shall the amount of bond coverage be less than ten thousand dollars (\$10,000). (3-20-20)T

**b. Evidence.** Provide evidence of an Idaho surety or bond filed with the Packers and Stockyards U.S.D.A in the amount required. (Subject to verification). (3-20-20)T

**103. APPLICATION FOR A LICENSE TO REPRESENT A LICENSED LIVESTOCK DEALER.**

A representative may only represent one (1) licensed livestock dealer at any one time. If an individual desires to act on behalf of more than one (1) dealer, he must apply for a regular livestock dealer license. The licensed livestock dealer who sponsors the applicant must sign and approve the application as well as agree to cover this representative under the dealer’s bond. (3-20-20)T

**104. LICENSE CERTIFICATES AND CARDS.**

Upon approval of the application for a livestock dealer’s license, the State Brand Inspector will issue a card to the licensed livestock dealer and representative(s). (3-20-20)T

**105. NOTIFICATION REQUIRED.**

The office of the state brand inspector must be notified within two (2) days of cancellation of a bond affecting the license of the livestock dealer or, termination of a representative that has been previously approved. (3-20-20)T

**106. BRAND INSPECTOR TO REQUIRE DEALER LICENSE NUMBER.**

Each licensed livestock dealer and each representative shall provide a livestock dealer license number at the time a brand inspection is made for cattle, horses, mules or asses. The name of the licensed livestock dealer or representative together with the appropriate certificate or card number will be placed on the brand inspection certificate in the space for the “buyer.” (3-20-20)T

**107. RULES APPLY TO OUT OF STATE BUYERS.**

**01. Application.** A livestock dealer who resides outside the state of Idaho may operate as a livestock dealer or representative within the state of Idaho by filing a proper application for an Idaho livestock dealer’s license by complying with the bond requirements and receive a certificate authorizing such out of state livestock dealer to purchase livestock within the state of Idaho. (3-20-20)T

**02. Applicability.** These rules apply to any livestock dealer purchasing livestock within the state of Idaho, whether or not such livestock as a destination within or outside the state of Idaho. (3-20-20)T

**108. -- 999. (RESERVED)**



**IDAPA 11 – IDAHO STATE POLICE  
RACING COMMISSION**

**DOCKET NO. 11-0400-2000F (FEE RULE)**

**NOTICE OF OMNIBUS RULEMAKING – ADOPTION OF TEMPORARY RULE**

**EFFECTIVE DATE:** The effective date of the temporary rule(s) being adopted through this omnibus rulemaking is upon the adjournment date of the second regular session of the 65th Idaho State Legislature - March 20, 2020.

**AUTHORITY:** In compliance with Sections 67-5226, Idaho Code, notice is hereby given this agency has adopted a temporary rule. The action is authorized pursuant to Sections 54-2506, 54-2507, 54-2508, 54-2509, 54-2512, 54-2513, and 54-2514, Idaho Code.

**DESCRIPTIVE SUMMARY:** The following is the required finding and concise statement of its supporting reasons for adopting a temporary rule:

These rules are necessary to provide regulatory safeguards for the integrity of imminent horse races, the safety of horses and personnel involved in races, the prevention of monetary fraud upon racing industry members and the public, and provide consistent enforcement for the racing industry and the public.

This temporary rule adopts the following chapter(s) under IDAPA 11:

**IDAPA 11**

- 11.04.02, *Rules Governing Simulcasting*
- 11.04.03, *Rules Governing Licensing and Fees*
- 11.04.05, *Rules Governing Advanced Deposit Wagering*
- 11.04.07, *Rules Governing Racing Associations*
- 11.04.11, *Rules Governing Equine Veterinary Practices, Permitted Medications, Banned Substances and Drug Testing of Horses*
- 11.04.15, *Rules Governing Controlled Substance and Alcohol Testing of Licensees, Employees, and Applicants*

**TEMPORARY RULE JUSTIFICATION:** Pursuant to Sections 67-5226(1) and 67-5226(2), Idaho Code, the Governor has found that temporary adoption of the rule is appropriate for the following reasons:

These temporary rules are necessary to protect the public health, safety, and welfare of the citizens of Idaho and confer a benefit on its citizens. These temporary rules implement the duly enacted laws of the state of Idaho, provide citizens with the detailed rules and standards for complying with those laws, and assist in the orderly execution and enforcement of those laws. The expiration of these rules without due consideration and processes would undermine the public health, safety, and welfare of the citizens of Idaho and deprive them of the benefit intended by these rules.

**FEE SUMMARY:** Pursuant to Section 67-5226(2), the Governor has found that the fee(s) or charge(s) being imposed or increased is justified and necessary to avoid immediate danger and the fee(s) is described herein:

The fees or charges, authorized in Sections 54-2506, 54-2508, 54-2512, and 54-2515 Idaho Code, are part of the agency's 2021 budget that relies upon the existence of these fees or charges to meet the state's obligations and provide necessary state services. Failing to reauthorize these temporary rules would create immediate danger to the state budget, immediate danger to necessary state functions and services, and immediate danger of a violation of Idaho's constitutional requirement that it balance its budget.

The following is a specific description of the fees or charges:

<p><b>11.04.02, <i>Rules Governing Simulcasting</i></b></p> <p>11.04.02.015.03 - Daily Simulcast License Fee</p> <p>11.04.02.015.03.a - Daily Simulcast License Fee</p>
---

11.04.02.015.03.b. - Daily Simulcast License Fee
11.04.02.015.03.c. - Daily Simulcast License Fee
<b>11.04.03, Rules Governing Licensing and Fees</b>
11.04.03.050.01 - Applicant License (fingerprint fee)
11.04.03.050.03 - Applicant License (fingerprint fee)
11.04.03.095 - Applicant License Add-on Fees
11.04.03.095.01 - Applicant License Add-on Fees
11.04.03.095.02 - Applicant License Add-on Fees
11.04.03.330.05 - Supplemental Hair Testing Fee
11.04.03.600 - General Licensing Fee Schedule
<b>11.04.05, Rules Governing Advanced Deposit Wagering</b>
11.04.05.010.19 - Source Market Fee Definition
11.04.05.060 - Source Market Fee
<b>11.04.07, Rules Governing Racing Associations</b>
11.04.07.110 - Racing Association License Fees
<b>11.04.11, Rules Governing Equine Veterinary Practices, Permitted Medications, Banned Substances and Drug Testing of Horses</b>
11.04.11.160.03 - Shipping and Testing Fees For Split Samples
<b>11.04.15, Rules Governing Controlled Substance and Alcohol Testing of Licensees, Employees, and Applicants</b>
11.04.15.150.02 - Costs Associated With Retesting of the Sample
11.04.15.300 - Alcohol/Drug Testing Expense

**ASSISTANCE ON TECHNICAL QUESTIONS:** For assistance on technical questions concerning the temporary rule, contact Ardie Noyes at phone 208-884-7080, fax 208-884-7098, or email [ardie.noyes@isp.idaho.gov](mailto:ardie.noyes@isp.idaho.gov).

DATED this February 21, 2020.

Charlie Spencer  
Police Services Major  
Rules Review Officer  
Idaho State Police  
700 S. Stratford Dr.  
Meridian, ID 83642  
[charlie.spencer@isp.idaho.gov](mailto:charlie.spencer@isp.idaho.gov)  
Phone 208-884-7203  
Fax 208-884-7290

**IDAPA 11 – IDAHO STATE POLICE  
RACING COMMISSION**

**11.04.02 – RULES GOVERNING SIMULCASTING**

**000. LEGAL AUTHORITY.**

This chapter is adopted pursuant to the legal authority of Title 54, Chapter 25, Idaho Code. (3-20-20)T

**001. TITLE AND SCOPE.**

**01. Title.** These rules are titled IDAPA 11.04.02, “Rules Governing Simulcasting,” of the Idaho State Racing Commission. (3-20-20)T

**02. Scope.** These rules regulate simulcasting within Idaho and all aspects of simulcasting. (3-20-20)T

**002. -- 009. (RESERVED)**

**010. DEFINITIONS.**

In addition to the definitions in Title 54, Chapter 25, Idaho Code, the following apply: (3-20-20)T

**01. Authorized User.** A person authorized by the Racing Commission to receive, decode, and use for legal purposes the encrypted simulcast signal of pari-mutuel events. (3-20-20)T

**02. Breakage.** The odd cents rounded down to the lowest multiple of ten cents (\$.10) in a positive pool and down to the lowest multiple of five cents (\$.05) in a minus pool. (3-20-20)T

**03. Downlink.** A receiving antenna coupled with an audio-visual signal receiver that is compatible with and capable of receiving simultaneous audio-visual signals or data emanating from a host association. This includes the electronic transfer of received signals from the receiving antenna to TV monitors within the satellite facility. (3-20-20)T

**04. Enclosure, Enclosure-Public.** Includes all enclosed areas of the simulcast wagering facility. (3-20-20)T

**05. Encryption.** The scrambling or other manipulation of the audio-visual signals to mask the original content of the signal and so cause such signals to be indecipherable and unrecognizable to any person receiving such signal. (3-20-20)T

**06. Guest, Guest Association or Simulcast Operator.** A simulcast licensee authorized by the Racing Commission to offer, sell, cash, redeem or exchange pari-mutuel tickets on races being run at a host association. (3-20-20)T

**07. Handle or Gross Handle.** Total amount of money wagered on a race less refunds and cancels. (3-20-20)T

**08. Horse.** Includes filly, mare, colt, horse or gelding in general; when referring to sex, filly becomes a mare when five (5) years old; a horse is an intact male when five (5) years old or older. (3-20-20)T

**09. Host or Host Association.** The racing association conducting a licensed horse racing meeting when it is authorized by the Racing Commission to simulcast its racing program. It may also be considered the sending track which means any track from which simulcast signals originate. (3-20-20)T

**10. Hub.** A facility that acts as an intermediary between pari-mutuel wagering facilities for the transmission of wagering data and that is responsible for generating all reports necessary for the reconciliation of payments. (3-20-20)T

**11. Intrastate Simulcasting Wagering.** Pari-mutuel wagering at an Idaho guest association on Idaho horse racing events run at an Idaho host association. (3-20-20)T

**12. Racing Association.** Any person licensed by the Racing Commission to conduct a race meet and pari-mutuel wagering. (3-20-20)T

**13. Simulcast Facility.** The physical premises, structure and equipment utilized by a guest or host association for conducting pari-mutuel wagering on horse racing events and permitted pari-mutuel events. Such facility must be a part of the license granted to the guest or host association. (3-20-20)T

**14. Simulcast Service Supplier.** (3-20-20)T

**a.** A person engaged in providing service, supplies or equipment necessary to the operation of intrastate, interstate or out-of-state simulcast wagering for use by a host association, guest association, simulcast operator, or authorized user, including pari-mutuel wagering terminals, uplink, downlink, television receivers and related equipment. (3-20-20)T

**b.** It does not include persons authorized by the Federal Communications Commission to provide telephone service or space segment time on satellite transponders. (3-20-20)T

**15. Satellite Transponder, Transponder.** Leased space segment time of an earth-orbit communication satellite. (3-20-20)T

**16. Take or Takeout.** Money deducted from mutuel pools that is shared by the track and local and state governing bodies in the form of a tax. (3-20-20)T

**17. Terminal.** The device connected to the pari-mutuel system used to place wagers. (3-20-20)T

**18. Totalizator.** A computer that, directly or indirectly through one (1) or more other totalizators, receives pari-mutuel wagering information, calculates pay-offs for winning tickets and generates reports with respect to such information, and may refer to the linked computers of the hub and the track. (3-20-20)T

**19. Uplink.** An earth station broadcasting facility, whether mobile or fixed, which is used to transmit audio-visual signals or data on Federal Communication Commission-controlled frequencies, and includes any electronic transfer of the audio-visual signals from within the racing enclosure to the location of the transmitter at the uplink. (3-20-20)T

**011. -- 014. (RESERVED)**

**015. REQUIREMENTS FOR LICENSURE OF A SIMULCAST FACILITY.**

**01. General.** Any racing association or simulcast operator authorized under these rules to conduct pari-mutuel wagering who desires to display the simulcast of pari-mutuel events on which pari-mutuel betting will be permitted, in the manner and subject to the conditions provided for under these rules, may apply to the Racing Commission for a license. (3-20-20)T

**02. Application for License.** The application for a license must be in such form as may be prescribed by the Racing Commission and contain such information or other material or evidence as the Racing Commission may require. (3-20-20)T

**03. Daily Simulcast License Fee.** The fee for such license is based upon the weekly handle. (3-20-20)T

**a.** If the handle is greater than thirty thousand dollars (\$30,000), the fee will be one hundred dollars (\$100) per day of simulcast operation payable by the licensee to the Racing Commission. Seventy-five dollars (\$75) of this fee will be paid to the Idaho State Racing Commission and twenty-five (\$25) will be deposited in the Public School Income Fund. (3-20-20)T

**b.** If the weekly handle is at least fifteen thousand dollars (\$15,000), but less than thirty thousand dollars (\$30,000), the fee will be fifty dollars (\$50) per day of simulcast operation payable by the licensee to the Racing Commission. Twenty-five dollars (\$25) of this fee will be deposited in the Public School Income Fund and twenty-five dollars (\$25) will be paid to the Idaho State Racing Commission. (3-20-20)T

c. If the weekly handle is less than fifteen thousand dollars (\$15,000), the fee will be twenty-five dollars (\$25) which will be deposited in the Public School Income Fund. (3-20-20)T

**04. Review and Approve.** Before the Racing Commission grants such license, it will review and approve a plan of operation submitted with a license application including, but not limited to, the following information: (3-20-20)T

a. A feasibility study denoting the revenue earnings expected from the simulcast facility and the costs expected to operate such a facility. The feasibility study includes: (3-20-20)T

- i. The number of simulcast races to be displayed; (3-20-20)T
- ii. The types of wagering to be offered; (3-20-20)T
- iii. The level of attendance expected and the area from which such attendance will be drawn; (3-20-20)T
- iv. The level of anticipated wagering activity; (3-20-20)T
- v. The source and amount of revenues expected from other than pari-mutuel wagering; (3-20-20)T
- vi. The cost of operating the simulcast facility and the identification of costs to be amortized and the method of amortization of such costs; and (3-20-20)T
- vii. The probable impact of the proposed operation on revenues to local government. (3-20-20)T

b. The security measures to be employed to protect the facility, to control crowds, to safeguard the transmission of wagering data to effectuate common wagering pools. (3-20-20)T

c. The type of data processing, communication and transmission equipment to be utilized. (3-20-20)T

d. The description of the management groups responsible for the operation of the simulcast facility. (3-20-20)T

e. The system of accounts to maintain a separate record of revenues collected by the simulcast facility, the distribution of such revenues and the accounting of costs relative to the simulcast operation. (3-20-20)T

f. The location of the facility and a written confirmation from appropriate local officials that the location of such facility and the number of patrons expected to occupy such facility are in compliance with all applicable local ordinances, along with approval by appropriate county or city officials. (3-20-20)T

**016. CRITERIA FOR APPROVAL OF APPLICATION FOR SIMULCAST OPERATOR.**

The Racing Commission uses the following decisional criteria in the approval or disapproval of an application for simulcast operator. (3-20-20)T

**01. General Benefit to the State.** The operator's general benefit to the state of Idaho. (3-20-20)T

**02. General Benefit to Horse Racing Industry.** The operator's general benefit to the state of Idaho's horse racing industry. (3-20-20)T

**03. Operator's Integrity.** The operator's integrity, including: (3-20-20)T

a. Individual and corporate conduct; (3-20-20)T

b. Criminal history; and (3-20-20)T

- c. Betting and gaming industry conduct. (3-20-20)T
- 04. **Operator's Credibility.** The operator's credibility, including: (3-20-20)T
  - a. Accuracy of a feasibility study; and (3-20-20)T
  - b. Experience and expertise of the operator in the simulcast industry. (3-20-20)T
- 05. **Financial Stability.** The operator's financial stability. (3-20-20)T
- 017. -- 025. **(RESERVED)**
- 026. **HOST ASSOCIATION.**
  - 01. **Contract.** Subject to Racing Commission approval of a simulcast contract, a host association licensed by the Racing Commission may simulcast its horse races to intrastate, interstate and out-of-state authorized users for the purpose of pari-mutuel wagering. (3-20-20)T
  - 02. **Content.** A racing association is responsible for the content of its simulcast and needs to use all reasonable effort to present a simulcast that offers the viewers an exemplary depiction of its racing program, a periodic display of wagering information, and continuity programming between horse racing events. (3-20-20)T
  - 03. **Video.** Unless otherwise permitted by the Racing Commission, every simulcast needs to contain in its video content a digital display of the actual time of day, the name of the host facility from where it emanates, the number of the horse race being displayed, and the minutes to post. (3-20-20)T
  - 04. **Security Controls.** As a condition of contract approval, or when deemed necessary by the Racing Commission, the host association may be required to provide and maintain security controls, including encryption over its uplink and communications systems. (3-20-20)T
- 027. **GUEST ASSOCIATIONS.**
  - 01. **Contract Approval.** Guest racing associations that are licensed by the Racing Commission and subject to contract approval by the Racing Commission may receive simulcast races for the purpose of pari-mutuel wagering from one (1) or more host associations. (3-20-20)T
  - 02. **Plan for Testing.** A plan that is subject to approval by the Racing Commission must be submitted by a guest racing association for testing the transmission, encryption and decoding, and data communication to assure proper system function prior to the commencement of each simulcast program or race from a host association. (3-20-20)T
- 028. **INTERSTATE COMMON POOL WAGERING.**

Subject to contract approval by the Racing Commission, a racing association may participate in common pool wagering by accepting wagers placed in other jurisdictions or by offering wagers on races run in other jurisdictions. Contract approval requirements include, but may not be limited to, the following: (3-20-20)T

  - 01. **Licensing Requirement.** A contract to participate in interstate common pool wagering must include evidence that the authorized user in the other jurisdiction is licensed or otherwise authorized or approved by the pari-mutuel authority or equivalent in that jurisdiction. (3-20-20)T
  - 02. **Pari-Mutuel Systems Requirement.** A contract to participate in interstate common pool wagering must:
    - a. Include evidence that the authorized user in the other jurisdiction utilizes a pari-mutuel wagering system fully compliant with requirements for totalizator systems used by licensed racing associations in Idaho; (3-20-20)T

**b.** Specify the regulatory authority responsible for granting a license to the racing association serving as host for purposes of aggregation of common pool wagering; (3-20-20)T

**c.** Specify the name and location of the racing association that is the host for the common pool, and the individuals and contact information for matters relating to the contract and common pool wagering; and (3-20-20)T

**d.** Specify the name of the totalizator company, location of the totalizator facility utilized to receive wagers and aggregate pools for the purpose of common pool wagering and the individuals and contact information for matters relating to the contract and common pool wagering. (3-20-20)T

**03. Access to Reports and Wagering Information Requirement.** A contract to participate in interstate common pool wagering must include evidence that the authorized user in the other jurisdiction will provide full and prompt access to, and cooperation in providing, all reports and information that may be requested by the Racing Commission. This includes wagering transaction data in either a hard copy report or a standard electronic data format acceptable to the Racing Commission. Such requirement apply to all wagering on races run in Idaho and all wagering pools that accept wagers placed from Idaho. (3-20-20)T

**04. Breakage.** The contract must include provisions specifying the distribution of breakage consistent with the requirement for wagers placed in Idaho. (3-20-20)T

**029. NET POOL PRICING.**

**01. Takeout Rates.** If takeout rates are not the same for all jurisdictions and net pool pricing is utilized, the contract must specify net pool pricing. (3-20-20)T

**a.** Individual wagering transactions are deemed to be made at the point of sale in the state where placed unless otherwise specified by statute or court ruling. (3-20-20)T

**b.** Any surcharges or withholdings in addition to the takeout may only be applied in the jurisdiction otherwise imposing such surcharges or withholdings. (3-20-20)T

**c.** In determining whether to approve an interstate common pool which does not include the host track or which includes races from more than one racing association, the Racing Commission will consider and may approve use of a bet type which is not utilized at the host association, application of a takeout rate not in effect at the live event track, or other factors which are presented to the Racing Commission. (3-20-20)T

**d.** The content and format of the visual display of racing and wagering information at facilities in other jurisdictions where wagering is permitted in the interstate common pool need not be identical to the similar information permitted or required to be displayed under these rules. (3-20-20)T

**02. Guest Participation in Interstate Common Pools.** (3-20-20)T

**a.** The Racing Commission may approve a takeout from the pari-mutuel pools identical to that of other jurisdictions participating in a merged pool. (3-20-20)T

**b.** Rules, either Live or Historic, as established in the host state will apply to the merged pool. (3-20-20)T

**c.** The simulcast operator must designate which one of the following procedures it will use if it becomes impossible to successfully merge the corresponding pools into the interstate common pool, and publish their designated procedure in the printed program: (3-20-20)T

**i.** Compute payouts in accordance with payout prices that would have been in effect if prices for the pool of bets were calculated without regard to wagers placed elsewhere; or (3-20-20)T

**ii.** With permission of the Racing Commission, pay winning tickets at the payout prices at the host

track; or (3-20-20)T

- iii. Declare such accepted bets void and make refunds in accordance with the applicable rules. (3-20-20)T

**030. HOST PARTICIPATING IN INTERSTATE COMMON POOLS.**

**01. Rules of Racing Established.** Rules of racing established for races held in Idaho will also apply to interstate common pools unless the Racing Commission has specifically determined otherwise. (3-20-20)T

**02. When Impossible to Merge Pools.** Any contract for interstate common pools must contain a provision that states that if, for any reason, it becomes impossible to successfully accept placed wagers or to merge corresponding pools into the interstate common pool formed by the pari-mutuel pool host and the Racing Commission's or the pari-mutuel pool host's representative determines that accepting wagers or attempting to effect transfer of pool data from the guest association may endanger the integrity of the pool or the timely processing of payouts, the pari-mutuel pool host will have no liability for guest's wagers or corresponding pools not being accepted into the host pool. (3-20-20)T

**031. -- 034. (RESERVED)**

**035. LICENSES FOR SIMULCAST OPERATORS.**

**01. License.** Every person acting as a simulcast operator within Idaho must procure a license from the Racing Commission and no person will act in the capacity of a simulcast operator without a valid license. Such license may be renewed annually unless the application is denied for any cause that justifies the suspension or revocation of the license for violation of these rules. (3-20-20)T

**02. Responsibilities of Applicant.** Each applicant must: (3-20-20)T

- a. Submit a financial statement as required by the Idaho State Racing Commission; (3-20-20)T
- b. Post with the Racing Commission a surety, in the amount and in such form as the Racing Commission may require, that is sufficient to ensure payment of distributable amounts of pari-mutuel pools pursuant to statute, operational costs, salaries, wages, benefits, and related financial obligations; and (3-20-20)T
- c. Demonstrate experience or adequate knowledge of the conduct of simulcast wagering or pari-mutuel wagering operations. (3-20-20)T

**03. Simulcast License Application.** The simulcast operator intending to conduct wagering on an out-of-state race must file with the Racing Commission a completed simulcast application. The application will be provided and approved by the Racing Commission. At a minimum the application will require the applicant to provide the following information: (3-20-20)T

- a. The number of live races projected in the current year; (3-20-20)T
- b. The number of live races run in the preceding year; (3-20-20)T
- c. Documentation that the required bond has been posted; (3-20-20)T
- d. Documentation that the appropriate public liability insurance has been obtained; (3-20-20)T
- e. Evidence of approval from the appropriate county or city officials; (3-20-20)T
- f. A signed contract from a local horsemen's group. The horsemen's group must be one that meets the definition of a horsemen's group as defined in Section 54-2502, Idaho Code. The contract cannot conflict with any of the provisions of Sections 3001 through 3007 of Title 15 of the United States Code or any other federal laws; (3-20-20)T



**g.** A statement setting forth the date and time it intends to commence accepting wagers on out-of-state race or races; and (3-20-20)T

**h.** Any other written or oral approvals required by the Racing Commission. (3-20-20)T

**04. Restrictions.** (3-20-20)T

**a.** No license will be granted to any person or entity that has failed, refused or neglected to comply with any rule, condition of license, or order of the Racing Commission or its stewards that is reasonably related to its conduct as a simulcast operator. (3-20-20)T

**b.** No license will be granted to any person or entity that has engaged in any activity that is grounds for denial, suspension or revocation of license pursuant to the rules of the Racing Commission or whose general partners, officers, directors, or employees have engaged in any unlawful activity determined to be conduct detrimental to the best interest of horseracing. (3-20-20)T

**c.** Additionally, no license will be granted to a person or entity that has failed, refused or neglected to enter into an agreement with a horsemen's group as defined in Section 54-2502, Idaho Code. (3-20-20)T

**05. No Limitation.** There will be no limitation as to the number of days a licensee may operate except as may otherwise be provided for within these rules or the Idaho Code. (3-20-20)T

**036. SIMULCAST PURSE MONEY COLLECTION AND DISTRIBUTION.**

**01. Designated Purse Monies.** Each simulcast operator licensed by the Racing Commission must remit to the Racing Commission those monies designated by the horsemen's agreement as purse monies. Payment must be made on a timely basis as provided in said agreement which will in no event be greater than thirty (30) days after accrual to the simulcast facility. (3-20-20)T

**02. Dual Signature Insured Account.** Each horsemen's group signatory to a horsemen's agreement authorizing simulcasting must open and maintain a dual signature insured account, hereinafter called a "purse accumulation account." (3-20-20)T

**03. Deposit into Appropriate Account.** Prior to commencement of the live race meet, the Racing Commission will annually deposit into the appropriate purse accumulation account those funds paid to the Racing Commission by the respective simulcast operator(s). The Racing Commission has the authority to approve more frequent payments, if requested by said horseman's group. (3-20-20)T

**04. Sanctions.** In addition to all available sanctions, any person or licensee who receives monies designated as purse monies as described in these rules, and who violates these rules, can be ordered to pay a monetary penalty as set forth in Section 54-2509(4), Idaho Code, and daily interest accrued thereupon at the rate set by the Idaho State Treasurer. (3-20-20)T

**037. -- 039. (RESERVED)**

**040. DUTIES OF SIMULCAST OPERATOR.**

**01. General.** A simulcast operator conducts and operates a pari-mutuel wagering system at one (1) or more guest associations on the results of horse races being held or conducted and simulcast from the enclosures of one (1) or more host associations pursuant to its agreement with such guest and host association and with the approval of the Racing Commission. (3-20-20)T

**02. Provisions.** A simulcast operator must provide: (3-20-20)T

**a.** Adequate transmitting or receiving equipment that does not interfere with the closed circuit TV system of the host association. All equipment must be of acceptable broadcast quality and meet applicable Federal

Communications Commission and Racing Commission rules and orders. Said equipment may include approved microwave transmitters, with appropriate safeguards, as approved by the Racing Commission. (3-20-20)T

**b.** Pari-mutuel terminals, pari-mutuel odds display, modems or switching units enabling pari-mutuel data transmissions, and data communication between the sending and the receiving racing associations. (3-20-20)T

**03. Pari-Mutuel Inspector.** The Racing Commission will appoint at least one (1) state pari-mutuel inspector to monitor all approved simulcast facilities and may require additional pari-mutuel inspectors as is reasonably necessary for the protection of the public interest. The state pari-mutuel inspector, as well as a member or members of the Racing Commission, must: (3-20-20)T

**a.** Be given free access to all of the books, papers and records of the simulcast operator's simulcast operations during normal business hours. (3-20-20)T

**b.** Be empowered to direct the simulcast operator to adopt such rules and to install such methods and systems of operating the mutuel department as may be deemed reasonably necessary so as to ensure compliance with the law and the rules of the Racing Commission. (3-20-20)T

**c.** The state pari-mutuel inspector must report to the Racing Commission any failure of the licensee to comply with the provision hereof or any violation of the law or any of the rules of the Racing Commission which may come to his attention, including in his reports, recommendations with respect to the revocation of the licenses of any employee of the simulcast operator for failure to comply with the rules of the Racing Commission, or for fraud, dishonesty, or incompetency. (3-20-20)T

**04. Video Record.** Upon the request of the Racing Commission the simulcast operator must make its best effort to provide the Racing Commission with a copy of the simulcast race requested. (3-20-20)T

**05. Test Program.** Not less than thirty (30) minutes prior to the commencement of transmission of the racing program for each day or night, the simulcast operator must initiate a test program of its transmitter, encryption and decoding, and data communication to assure proper operation of the system. (3-20-20)T

**06. Locations Listing.** At the request of any representative of the Racing Commission the Racing Association must provide a listing of all locations within this state enabled to receive the simulcast in decoded forms. Failure to do so is grounds for immediate summary suspension of license and immediate cessation of simulcasting activities. (3-20-20)T

**07. Security.** The Racing Association must maintain such security controls over its uplink and communications system as directed by the Racing Commission. (3-20-20)T

**08. Filing.** Every simulcast operator at the request of the Racing Commission must file an annual report of its simulcast operations, and an audited balance sheet and income statement prepared according to Generally Accepted Accounting Principles. (3-20-20)T

**09. Compliance.** The simulcast operator must comply with Section 54-2512, Idaho Code. (3-20-20)T

**041. PROHIBITION OF SIMULCAST SIGNAL.**

Pertaining to the simulcasting of greyhound racing, should substantial, competent evidence of cruelty to or misconduct in the treatment of greyhounds occur at a site under the jurisdiction of another state regulatory agency, the Racing Commission will prohibit the retransmission of any and all simulcast signals until appropriate action has been taken by the other state regulatory agency. (3-20-20)T

**042. -- 044. (RESERVED)**

**045. DISTRIBUTION OF DEPOSITS.**

The Racing Commission will distribute deposits generated by simulcast races in accordance with the provisions of Section 54-2507 and 54-2513, Idaho Code, as applicable. (3-20-20)T

**046. CONFLICT OF LAWS.**

In the event of a conflict between the laws of the host track and the laws or rules of the state of Idaho, the laws or rules of the state of Idaho will apply. (3-20-20)T

**047. TOTALIZATOR OR OTHER APPROVED EQUIPMENT REQUIRED.**

Pari-mutuel wagering on live horse races may only be conducted through the use of a totalizator or other similar mechanical equipment approved by the Commission. (3-20-20)T

**048. -- 999. (RESERVED)**

### 11.04.03 – RULES GOVERNING LICENSING AND FEES

#### 000. LEGAL AUTHORITY.

This chapter is adopted pursuant to the legal authority of Title 54, Chapter 25, of the Idaho Code. (3-20-20)T

#### 001. TITLE AND SCOPE.

**01. Title.** These rules are titled IDAPA 11.04.03, “Rules Governing Licensing and Fees,” of the Idaho State Racing Commission. (3-20-20)T

**02. Scope.** These rules govern licensing procedures and the fees charged for licenses by the Idaho State Racing Commission. (3-20-20)T

#### 002. -- 009. (RESERVED)

#### 010. DEFINITIONS.

In addition to the definitions in Title 54, Chapter 25, Idaho Code, the following apply: (3-20-20)T

**01. Admissions.** A racing association employee who collects admission money for entrance to the racetrack. (3-20-20)T

**02. Authorized Agent.** A person appointed by a written instrument signed and acknowledged before a notary public empowered to transact the business of a stable owner or horse breeder. (3-20-20)T

**03. Apprentice Jockey.** A jockey who has not ridden a certain number of winners within a specified period of time. (3-20-20)T

**04. Announcer.** A person employed by a racing association to announce during the running of the races. (3-20-20)T

**05. Assistant Starter.** The employee of a racing association who, under direct supervision of the starter, helps place the starting gate for a race, leads horses into the gate, helps jockeys and handles horses while in the gate until the start. (3-20-20)T

**06. Chart Person.** An official who compiles the statistical “picture” of a race which shows the position and margin of each horse at designated points of call during the race and other data. (3-20-20)T

**07. Clerk of Scales.** The employee of a racing association responsible for sequestering all jockeys each racing day, weighing all jockeys out and in from races, checking their assigned riding weights versus their actual weights, and reporting all changes. (3-20-20)T

**08. Clocker.** A person who times workouts and races. (3-20-20)T

**09. Concessionaire.** A person that offers goods or services for sale to the public at a racetrack. (3-20-20)T

**10. Concession Employee.** An employee of a concessionaire or a racing association employee offering goods or services for sale to the public. (3-20-20)T

**11. Duplicate.** Replacement license for a license that has been lost or destroyed. (3-20-20)T

**12. Emergency Medical Technician.** An emergency responder trained and certified to provide emergency medical services to the critically ill and injured person. (3-20-20)T

**13. Exercise Person.** A rider who exercises horses at a racetrack. (3-20-20)T

**14. Groom.** A person hired by a trainer who cares for a horse at a racetrack. (3-20-20)T

**15. Horsemen’s Bookkeeper.** A bonded racing association employee who manages the horsemen’s accounts which covers all monies due horseman in regards to purses, stakes, rewards, claims and deposits. (3-20-20)T

**16. Identifier.** The employee of a racing association who checks the lip tattoo, other identification, and

- markings of each horse as it enters the paddock to make sure the correct horses are running in the race. (3-20-20)T
17. **Jockey.** A professional rider licensed to ride in races. (3-20-20)T
18. **Jockey Agent.** A person who helps a jockey obtain mounts in return for a portion of the jockey's earnings. (3-20-20)T
19. **Jocks Room Custodian.** A racing association employee authorized to regulate the conduct of the jockeys, ensure good order is maintained, and monitors the jockeys. (3-20-20)T
20. **Maintenance.** A racing association employee hired to maintain the grounds and facility of the racetrack. (3-20-20)T
21. **Medical Professional.** A doctor, physician's assistant, or emergency medical technician licensed or certified in the state of Idaho. (3-20-20)T
22. **Mutuel Employee.** A racing association employee that accepts the patrons' money and issues the betting ticket. (3-20-20)T
23. **Office Personnel.** A racing association employee who works in the office of the racetrack. (3-20-20)T
24. **Official.** Persons licensed by the state to ensure the rules of racing are enforced. (3-20-20)T
25. **Outrider.** The employee of a racing association who leads the post parade at a racetrack and gets the horses and jockeys to the starting gates on time. (3-20-20)T
26. **Owner.** The person that has legal title to, or has financial control of, a horse utilized for racing in Idaho. However, an interest in the winnings of a horse does not itself constitute ownership. (3-20-20)T
27. **Owner/Trainer.** An owner who conditions and prepares his own horse for racing, with the absolute responsibility to ensure the physical condition and eligibility of the race horse. (3-20-20)T
28. **Paddock Judge.** The employee of a racing association responsible for getting jockeys and horses in order to go to the starting gate; also checks the equipment used by each horse and supervises the saddling of the horses. (3-20-20)T
29. **Photographer.** A person who takes photographs of the winning horses in the winner's circle. (3-20-20)T
30. **Plater.** A blacksmith who shoes horses at a racetrack. (3-20-20)T
31. **Pony Person.** A person on horseback who accompanies a horse and jockey to the starting gate. (3-20-20)T
32. **Racetrack.** The grounds and enclosures of any racing association where horse racing or pari-mutuel betting occurs under the authority and supervision of the Racing Commission. (3-20-20)T
33. **Racing Association.** Any person licensed by the Racing Commission to conduct a race meet and pari-mutuel wagering. (3-20-20)T
34. **Racing Secretary.** The employee of a racing association, who writes the conditions for the races, assigns the weights for handicap races, receives entries, conducts the draw, and is responsible for the operation and organization of the race office. (3-20-20)T
35. **Stable Name.** An assumed business name used by a person for his horse racing operation. (3-20-20)T

**36. Stall Superintendent.** A racing association employee hired to assign applicants such stabling as deemed proper to be occupied by horses in preparation for racing and determines all conflicting claims to stable space. (3-20-20)T

**37. Starter.** The employee of a racing association responsible for dispatching the horses for a race. (3-20-20)T

**38. State Veterinarian.** A veterinarian employed by the Racing Commission to serve as professional adviser and consultant to the Racing Commission on veterinary matters including all regulatory aspects of the application and practice of veterinary medicine at racetracks. (3-20-20)T

**39. Steward.** A horse racing official who presides over a race meeting, has jurisdiction over all racing officials, rules on protests and claims of foul, and imposes fines and suspensions. (3-20-20)T

**40. Tote Employee.** An employee of a company providing the automated pari-mutuel system that dispenses and records betting tickets, calculates and displays odds and payoffs, and provides the mechanism for cashing winning tickets. (3-20-20)T

**41. Track Superintendent.** The employee of a racing association responsible for maintaining acceptable racing and training track conditions during a race meet. (3-20-20)T

**42. Track Security.** A person responsible to provide security at a racetrack. (3-20-20)T

**43. Trainer.** The person who conditions and prepares a race horse for racing, with the absolute responsibility to ensure the physical condition and eligibility of the race horse. (3-20-20)T

**44. Valet.** A person who attends riders and keeps their wardrobe and equipment in order. (3-20-20)T

**45. Veterinarian.** A private veterinary practitioner employed by owners or trainers on an individual case or contract basis. (3-20-20)T

**46. Vet Assistant.** A person who assists a state veterinarian. (3-20-20)T

**47. Video Employee.** An employee hired by a photo/video provider to operate the equipment during the running of horse races for the benefit of the stewards and racetracks. (3-20-20)T

**011. -- 019. (RESERVED)**

**020. APPLICABILITY.**

Pursuant to Section 54-2506, Idaho Code, these rules apply to any person that participates, directly or indirectly, in any race meet. (3-20-20)T

**021. -- 029. (RESERVED)**

**030. REFUSAL TO ISSUE LICENSE.**

The Racing Commission may refuse to issue a license and may revoke any license already issued to any person: (3-20-20)T

**01. Convicted.** Who has been convicted of any felony and whose civil rights have not yet been restored pursuant to Section 18-310(2), Idaho Code. (3-20-20)T

**02. Felony Probation.** Who is on probation, or parole for a conviction or withheld judgment for any felony. (3-20-20)T

**03. Misrepresentation.** Who has made any material misrepresentation or false statement to the Racing Commission or its agents in his application for license or otherwise, or who fails to answer any material question on

any application for a license. (3-20-20)T

**04. Unqualified.** Who is unqualified by age, skill, knowledge or ability to engage in the activities for which a license is required. (3-20-20)T

**05. Ownership.** Who fails to disclose the true ownership or interest in any or all horses as required by any application. (3-20-20)T

**06. Ejection.** Who is subject to exclusion or ejection from the racing enclosure or is within the classes of persons prohibited from participating in pari-mutuel wagering. (3-20-20)T

**07. Conduct.** Who has committed an act or acts demonstrating financial instability, intemperate habits or has a bad reputation for truth, honesty and integrity, or other similar conduct contrary to the best interest of racing. (3-20-20)T

**08. Narcotics.** Who has been convicted of possession, use, or sale of any narcotic, dangerous drug, or marijuana if such conviction was a misdemeanor, within two (2) years prior to the date of making application for any license. (3-20-20)T

**09. Drug Probation.** Who is on probation or parole for a conviction or withheld judgment for misdemeanor possession, use, or sale of any narcotic, dangerous drug, or marijuana. (3-20-20)T

**10. Not Permitted.** Who is not permitted by law or statute to engage in the occupation for which the license is sought. (3-20-20)T

**11. Violated Rules.** Who has violated or who aids or abets or conspires with any person to violate any provision of the Racing Commission rules or of Sections 54-2501 through 54-2516, Idaho Code. (3-20-20)T

**12. Age.** No person under sixteen (16) years of age may be issued a license by the Racing Commission with the exception that a person under sixteen (16) years of age may be licensed as a co-owner with a parent or guardian if the person under sixteen (16) years of age submits an Assumption of Liability form signed by the parent or guardian and notarized by a notary public. This co-ownership is not intended to allow an underage person access to any areas of the track facility. (3-20-20)T

**13. Deny or Revoke.** The Racing Commission may deny a license to, or revoke the license of, any person who has had a license revoked or denied by any recognized racing jurisdiction. (3-20-20)T

**031. -- 039. (RESERVED)**

**040. CRUELTY TO ANIMALS.**

No licensee may violate Title 25, Chapter 35, Idaho Code, "Cruelty to Animal," while on the grounds of a racing association. The stewards will be the sole judges of whether or not a violation of Title 25, Chapter 35, Idaho Code, has occurred on racing association grounds. The penalty for a first offense may include a fine or a suspension or both. A second violation within a calendar year will include a mandatory suspension, the length of which will be at the discretion of the stewards. (3-20-20)T

**041. -- 049. (RESERVED)**

**050. FINGERPRINTS.**

All persons between the ages of eighteen (18) and sixty-nine (69) applying for licensing pursuant to this chapter are required to submit information and fingerprints necessary to obtain criminal history information from the Idaho State Police Bureau of Criminal Identification and the Federal Bureau of Investigation. The Idaho State Racing Commission (ISRC) may receive criminal history information from the Idaho State Police Bureau of Criminal Identification and from the Federal Bureau of Investigation for the purpose of evaluating the fitness of applicants pursuant to Section 54-2508, Idaho Code. Pursuant to state and federal law, further dissemination or other use of the criminal history information is prohibited. (3-20-20)T

**01. License Applicants.** Any person that applies for a license from the Racing Commission who has not been fingerprinted within the past five (5) years must be fingerprinted prior to a license being issued. Pursuant to Section 67-3008, Idaho Code, the ISRC will submit a set of fingerprints obtained from the applicant and the required fees to the Idaho State Police Bureau of Criminal Identification for a criminal records check of state and national databases. (3-20-20)T

**02. Existing Licensees.** Any person that currently holds a valid license from the ISRC must be re-fingerprinted at least every five (5) years in accordance with the procedures outlined in Subsection 050.01 of these rules. (3-20-20)T

**03. Fees.** The cost of taking and processing such fingerprints is the responsibility of the applicant. Fees for taking and processing fingerprints are in accordance with the amount(s) charged by the Idaho State Police Bureau of Criminal Identification pursuant to Section 67-3010, Idaho Code. (3-20-20)T

**051. -- 089. (RESERVED)**

**090. APPLICATIONS.**

All application forms must be filled out completely and legibly. (3-20-20)T

**01. Application Forms.** All applications must be submitted to the Racing Commission on forms obtained from the Racing Commission, and all persons applying for licenses shall submit completed applications meeting all requirements, including obtaining necessary signatures as indicated on the form or otherwise noted in this chapter. License types are listed in the License Fee section of this chapter. (3-20-20)T

**02. Other Forms.** All other forms to be submitted to the Racing Commission by this chapter must be of a type approved by the Racing Commission. (3-20-20)T

**03. Age.** Applicants between sixteen (16) and eighteen (18) years of age are required to submit an Assumption of Liability Form signed by their guardian and notarized by a notary public. (3-20-20)T

**091. -- 094. (RESERVED)**

**095. ADD-ON.**

Any qualified person may add an additional license category to an existing license by paying the add-on fee unless: (3-20-20)T

**01. Higher Fee.** The fee for the category added is higher than the fee for the existing license category. (3-20-20)T

**02. Additional License.** If the fee for the license category that is requested is higher than the fee for the existing license category, the person must pay the Racing Commission the higher fee. (3-20-20)T

**096. DUPLICATE LICENSE.**

The Racing Commission may issue a duplicate license in the event an existing license has been lost or destroyed. (3-20-20)T

**097. -- 099. (RESERVED)**

**100. LICENSES REQUIRING RACING ASSOCIATION SIGNATURES.**

The following application types are also signed by a racing association: (3-20-20)T

**01. Admissions.** (3-20-20)T

**02. Announcer.** (3-20-20)T

**03. Clocker.** (3-20-20)T



- |     |                        |            |
|-----|------------------------|------------|
| 04. | Clerk of Scales.       | (3-20-20)T |
| 05. | Horsemen's Bookkeeper. | (3-20-20)T |
| 06. | Identifier.            | (3-20-20)T |
| 07. | Jocks Room Custodian.  | (3-20-20)T |
| 08. | Maintenance.           | (3-20-20)T |
| 09. | Office Personnel.      | (3-20-20)T |
| 10. | Outrider.              | (3-20-20)T |
| 11. | Paddock Judge.         | (3-20-20)T |
| 12. | Racing Secretary.      | (3-20-20)T |
| 13. | Stall Superintendent.  | (3-20-20)T |
| 14. | Starter.               | (3-20-20)T |
| 15. | Track Superintendent.  | (3-20-20)T |
| 16. | Valet.                 | (3-20-20)T |
- 101. -- 109. (RESERVED)**
- 110. APPRENTICE JOCKEY LICENSE.**  
The application is also signed by a steward and an apprentice jockey certificate signed by a licensed starter, two (2) licensed jockeys, a licensed outrider, and a steward. (3-20-20)T
- 111. -- 129. (RESERVED)**
- 130. ASSISTANT STARTER LICENSE.**  
The application is also signed by a licensed starter. (3-20-20)T
- 131. -- 139. (RESERVED)**
- 140. AUTHORIZED AGENT LICENSE.**  
A notarized authorized agent form is submitted with the application. (3-20-20)T
- 01. Each Owner Represented.** A separate authorized agent form must be filed for each owner represented. (3-20-20)T
- 02. Written Instrument.** A written instrument signed by the owner must accompany the application and clearly set forth the delegated powers of the authorized agent. The owner's signature on the written instrument must be acknowledged before a notary public. (3-20-20)T
- 03. Power of Attorney.** If the written instrument is a power of attorney, it must be filed with the Racing Commission and attached to the regular application form. (3-20-20)T
- 04. Changes.** Any changes must be made in writing and filed with the Racing Commission as described in Subsection 140.02 of these rules. (3-20-20)T
- 05. Termination.** The authorized agent's appointment may be terminated by the owner, in writing, acknowledged before a notary public and filed with the Racing Commission whereupon the license is no longer valid.

(3-20-20)T

**141. -- 144. (RESERVED)**

**145. BAD CHECKS.**

Any licensee who make, draw, order or deliver a check, draft or order for the payment of money to another Idaho licensee, Racing Association, Racing Commission or employee of said Association, Racing Association or Racing Commission, which check, draft or order for the payment of money is invalid on its face or non-negotiable, or there are not sufficient funds on deposit for full payment of such check, draft or order, may be subject to suspension or disciplinary action, or both, by the Racing Commission. (3-20-20)T

**146. -- 159. (RESERVED)**

**160. CONCESSIONAIRE LICENSE.**

The application includes: (3-20-20)T

**01. Names of Owners.** The names and addresses of all of the principal owners. (3-20-20)T

**02. Proof of Financial Stability.** A financial statement of assets and liabilities. (3-20-20)T

**03. Type of Business.** The type of business generally engaged in by the applicant. (3-20-20)T

**161. -- 165. (RESERVED)**

**166. CONCESSION EMPLOYEE LICENSE.**

The application is also signed by a licensed concessionaire. (3-20-20)T

**167. -- 189. (RESERVED)**

**190. EMERGENCY MEDICAL TECHNICIAN LICENSE.**

All persons applying for an emergency medical technician license must submit a completed application signed by a racing association and a copy of Emergency Medical Technician Certification. (3-20-20)T

**191. -- 199. (RESERVED)**

**200. EXERCISE PERSON LICENSE.**

A Steward must also sign the application for a first time licensee. (3-20-20)T

**201. -- 209. (RESERVED)**

**210. GROOM LICENSE.**

The application signed by a licensed trainer. (3-20-20)T

**211. -- 239. (RESERVED)**

**240. JOCKEY LICENSE.**

**01. Application for License.** The application includes a current physical evaluation from a medical professional. (3-20-20)T

**02. First Time Licensed.** The application for a person that has not been previously licensed as a jockey in Idaho is also signed by a steward. (3-20-20)T

**241. -- 249. (RESERVED)**

**250. JOCKEY AGENT LICENSE.**

The application contains a list of licensed jockeys represented. Each jockey agent may represent no more than two (2)

jockeys and one (1) apprentice jockey. (3-20-20)T

**251. -- 279. (RESERVED)**

**280. MUTUEL EMPLOYEE LICENSE.**

The application is also signed by a racing association and the applicant is at least eighteen (18) years of age. (3-20-20)T

**281. -- 299. (RESERVED)**

**300. OFFICIAL LICENSE.**

The application is also signed by a racing association or Racing Commission. (3-20-20)T

**301. -- 329. (RESERVED)**

**330. OWNER LICENSE.**

All persons listed on the registration papers must obtain an owners license. (3-20-20)T

**01. Financial Responsibility.** If the Racing Commission has reason to doubt the financial responsibility of an applicant for an owner's license, the applicant may be required to complete a verified financial statement. (3-20-20)T

**02. Transfer of Horse Prohibited.** The Racing Commission may refuse, deny, suspend or revoke an owner's license for the spouse or member of the immediate family or household of a person ineligible to be licensed as an owner, unless there is a showing on the part of the applicant or licensed owner, and the Racing Commission determines that participation in racing will not permit a person to serve as a substitute for an ineligible person. The transfer of a horse to circumvent the intent of a Racing Commission rule or ruling is prohibited. (3-20-20)T

**03. Multiple Owners.** If the legal owner of any horse is a partnership, corporation, limited liability company, syndicate or other racing association or entity, each shareholder, member or partner must be licensed as an owner. (3-20-20)T

**04. Lease Agreements.** A horse may be raced under lease provided a completed breed registry or other lease form acceptable to the Racing Commission is attached to the certificate of registration and on file with the Racing Commission. The lessee must be licensed as a horse owner. (3-20-20)T

**05. Supplemental License Fee.** When submitting a horse for hair testing as required in IDAPA 11.04.11, "Rules Governing Equine Veterinary Practices, Permitted Medications, Banned Substances and Drug Testing of Horses," the owner(s) must pay a supplemental license fee of two hundred twenty-five dollars (\$225) per hair test. The Racing Commission, its Executive Director, or its Business Operations Manager are authorized to, and will designate the individual(s) responsible for collecting the supplemental fee. The owner or trainer must submit payment to said designated individual prior to testing. (3-20-20)T

**331. -- 359. (RESERVED)**

**360. PLATER LICENSE.**

The application for a first time plater license includes a letter of recommendation from an owner or trainer. (3-20-20)T

**361. -- 369. (RESERVED)**

**370. PONY PERSON LICENSE.**

If the application is for a first time pony person license, the application is also signed by a steward. (3-20-20)T

**371. -- 389. (RESERVED)**

**390. STABLE NAME LICENSE.**

The application includes the identity or identities of the ownership interests involved in the horse racing operation. (3-20-20)T

**01. Changes of Ownership.** Any change in ownership of the horse racing stable must be reported immediately to and approved by the Racing Commission. (3-20-20)T

**02. Trainer.** A trainer who is licensed as an owner or part owner may use a stable name as owner or part owner. However, no trainer may be licensed as a trainer other than in his legal name. (3-20-20)T

**391. STABLE NAME CHANGE.**

**01. Cancellation.** Any person who has been granted a stable name license may at anytime cancel the stable name license if written notice has been submitted to the Racing Commission and the Racing Commission approves the cancellation. (3-20-20)T

**02. Name Change.** A stable name may be changed at anytime by canceling the existing stable name and submitting a new stable name application with the appropriate fee. (3-20-20)T

**392. STABLE NAMES PROHIBITED.**

No stable name may be: (3-20-20)T

**01. Registered.** Registered by any other person with a racing association conducting a recognized meeting, or the Jockey Club (N.Y.) or with another racing authority; (3-20-20)T

**02. Real Name.** The real name of any owner of race horses nor the real or assumed name of any prominent person not owning race horses; (3-20-20)T

**03. Misleading.** Misleading to the public or unbecoming to the sport; (3-20-20)T

**04. Distinguishable.** All stable names must be plainly distinguishable from all other licensed stable names. (3-20-20)T

**05. One Name.** No individual may license more than one (1) stable name. (3-20-20)T

**393. -- 419. (RESERVED)**

**420. STATE VETERINARIAN LICENSE.**

The applicant must have a signed contract on file in the Racing Commission office. (3-20-20)T

**421. -- 429. (RESERVED)**

**430. STEWARD LICENSE.**

All persons applying for a steward license must meet the Stewards Qualifications, as set down in IDAPA 11.04.06, "Rules Governing Racing Officials," Section 050, and must submit a completed license application signed by the Racing Commission. (3-20-20)T

**431. -- 459. (RESERVED)**

**460. TRACK SECURITY LICENSE.**

The application is also signed by their employer. (3-20-20)T

**461. -- 469. (RESERVED)**

**470. TRAINER LICENSE.**

All persons applying for a trainer license for the first time in Idaho must pass the trainer's test and have their application signed by a steward, or have a current valid trainers license from another recognized jurisdiction. (3-20-20)T

**471. -- 489. (RESERVED)**

**490. VETERINARIAN LICENSE.**

The applicant must have a current valid license to practice veterinary medicine from the state of Idaho. (3-20-20)T

**491. -- 499. (RESERVED)**

**500. VET ASSISTANT LICENSE.**

The application is also signed by a state veterinarian. (3-20-20)T

**501. -- 599. (RESERVED)**

**600. LICENSE FEES.**

All persons must submit completed applications when applying for license types listed below and pursuant to this chapter and also pay the Racing Commission the fee associated with the type of license being sought before any license will be issued.

LICENSE	FEE	LICENSE	FEE
Add-ons	- \$10	Official	- \$50
Admission	- \$15	Outrider	- \$25
Announcer	- \$25	Owner	- \$50
Apprentice Jockey	- \$50	Owner/Trainer	- \$65
Assistant Starter	- \$25	Paddock Judge	- \$25
Authorized Agent	- \$50	Photographer	- \$25
Chart Person	- \$25	Plater	- \$50
Clerk of Scales	- \$25	Pony Person	- \$25
Clocker	- \$25	Racing Secretary	- \$35
Concession Employee	- \$15	Stable Registration	- \$50
Concessionaire	- \$50	Stall Superintendent	- \$25
Duplicate	- \$10	Starter	- \$25
EMT	- \$25	State Veterinarian	- \$0
Exercise Person	- \$25	Steward	- \$50
Groom	- \$25	Tote Employee	- \$15
Horsemen's Bookkeeper	- \$35	Track Security	- \$25
Identifier	- \$25	Track Superintendent	- \$25
Jockey	- \$50	Trainer	- \$50
Jockey Agent	- \$50	Valet	- \$10
Jocks Room Custodian	- \$25	Veterinarian	- \$50
Maintenance	\$15	Vet Assistant	- \$15
Mutuel Employee	- \$15	Video Employee	- \$15
Office Personnel	- \$15		-

(3-20-20)T

**601. -- 989. (RESERVED)**

**990. PENALTIES.**

Any person violating any of the provisions of this chapter is subject to the penalties provided for in Title 54, Chapter 25, Idaho Code.

(3-20-20)T

**991. -- 999. (RESERVED)**

## 11.04.05 – RULES GOVERNING ADVANCED DEPOSIT WAGERING

### 000. LEGAL AUTHORITY.

This chapter is adopted pursuant to the legal authority of Title 54, Chapter 25, of the Idaho Code. (3-20-20)T

### 001. TITLE AND SCOPE.

01. **Title.** These rules are titled IDAPA 11.04.05, “Rules Governing Advanced Deposit Wagering.” (3-20-20)T

02. **Scope.** These rules govern advanced deposit wagering in Idaho. (3-20-20)T

### 002. -- 009. (RESERVED)

### 010. DEFINITIONS.

In addition to the definitions in Title 54, Chapter 25, Idaho Code, the following apply: (3-20-20)T

01. **Account.** An account for advanced deposit wagering with a specific identifiable record of credits, debits, deposits, wagers, and withdrawals established by an account holder and managed by the advanced deposit wagering operator. (3-20-20)T

02. **Account Holder.** A natural person who successfully completed an application and for whom the advance deposit wagering operator has opened an account. (3-20-20)T

03. **Advance Deposit Wagering Facility.** An actual location, equipment, and staff of an advance deposit wagering operator involved in the management, servicing and operation of advance deposit wagering. (3-20-20)T

04. **Advance Deposit Wagering Operator.** Those persons or entities licensed by the Idaho State Racing Commission with the authority to accept deposits and wagers, issue a receipt or other confirmation to the account holder evidencing such deposits and wagers, and transfer credits and debits to and from accounts. (3-20-20)T

05. **Confidential Information.** Confidential information includes: (3-20-20)T

a. The amount of money credited to, debited from, withdrawn from, or present in any particular account holder's account; (3-20-20)T

b. The amount of money wagered by a particular account holder on any race or series of races; (3-20-20)T

c. The account number and secure personal identification code of a particular account holder; (3-20-20)T

d. The identities of particular entries on which the account holder is wagering or has wagered; (3-20-20)T

e. Unless otherwise authorized by the account holder, the name, address, and other information in the possession of the advance deposit wagering operator that would identify the account holder to anyone other than the Racing Commission. (3-20-20)T

06. **Credits.** All positive inflow of money to an account. (3-20-20)T

07. **Debits.** All negative outflow of money from an account. (3-20-20)T

08. **Deposit.** A payment of money by cash, check, money order, credit card, debit card, or electronic funds transfer made by an account holder to the account holder's account. (3-20-20)T

09. **Natural Person.** Any person at least eighteen (18) years of age, but does not include any corporation, partnership, limited liability company, trust, or estate. (3-20-20)T

10. **Principal Residence Address.** That place where the natural person submitting an application for an account resides at least fifty percent (50%) of the time during the calendar year. (3-20-20)T

**11. Proper Identification.** A form of identification accepted in the normal course of business to establish that the person making a transaction is the account holder. (3-20-20)T

**12. Secure Personal Identification Code.** An alpha-numeric character code chosen by an account holder as a means by which the advance deposit wagering operator may verify a wager or account transaction as authorized by the account holder. (3-20-20)T

**13. Source Market Fee.** That part of a wager, made outside of the state by an Idaho resident, that is returned to the Racing Commission. (3-20-20)T

**14. Withdrawal.** A payment of money from an account by the advance deposit wagering operator to the account holder when property requested by the account holder. (3-20-20)T

**15. Withdrawal Slip.** A form provided by the advance deposit wagering operator for use by an account holder in withdrawing funds from an account. (3-20-20)T

**011. -- 014. (RESERVED)**

**015. LICENSING FOR ADVANCED DEPOSIT WAGERING.**

No person may conduct advanced deposit wagering activities within Idaho prior to receiving an advance deposit wagering license from the Racing Commission. (3-20-20)T

**016. -- 019 (RESERVED)**

**020. ADVANCED DEPOSIT WAGERING LICENSE.**

Any person may request a license from the Racing Commission to conduct advanced deposit wagering in accordance with Section 54-2512(5), Idaho Code, and these rules. As part of the request, such person must submit a detailed plan of how its proposed advance deposit wagering system would operate. The Racing Commission may require changes in a proposed plan of operations as a condition of granting a request. No subsequent changes in the system's operation may occur unless ordered by the Racing Commission or until approval is obtained from the Racing Commission after it receives a written request. (3-20-20)T

**021. -- 024. (RESERVED)**

**025. ADVANCE DEPOSIT WAGERING LICENSE APPLICATION.**

An applicant for an advance deposit wagering operator license must provide the following information as part of the application: (3-20-20)T

**01. Legal Name.** The legal name of the person seeking the license. (3-20-20)T

**02. Corporation.** If the person seeking a license is a corporation: the names, addresses of all directors and officers, the date of incorporation and the place of incorporation;. (3-20-20)T

**03. Partnership.** If the person seeking a license is a partnership: the names, addresses of all partners. If a partner is a corporation the date of incorporation, the place of incorporation and the names and addresses of all directors and officers. (3-20-20)T

**04. Race Tracks.** The names of the race tracks the advance deposit wagering operator has contracts with that allow the applicant to provide wagering on the product. (3-20-20)T

**05. Financial Information.** Financial information that demonstrates the financial resources to operate. (3-20-20)T

**06. Budget.** A detailed budget showing anticipated revenue, expenditures and cash flows by month during the license period. (3-20-20)T

**07. Number of Days.** The number of days of planned operation during the fiscal year in which they are



seeking to be licensed. (3-20-20)T

**026. DETAILED PLAN OF OPERATION FOR ADVANCED DEPOSIT WAGERING.**

**01. Detailed Plan of Operation.** The detailed plan of operation for an advanced deposit wagering license must include, but is not limited to, the following information: (3-20-20)T

**a.** The manner in which the wagering system will operate; (3-20-20)T

**b.** Programs for responsible wagering; and (3-20-20)T

**c.** Mitigation for the effects of advance deposit wagering on the source market in which the account holder resides. (3-20-20)T

**02. Requirements for Accounts Established and Operated for Persons Whose Principal Residence is Outside of the State of Idaho.** The Racing Commission may require changes in a proposed plan of operations as a condition of granting a license. No subsequent changes in the system's operation may occur unless ordered by the Racing Commission or until approval is obtained from the Racing Commission after it receives a written request. (3-20-20)T

**027. -- 029. (RESERVED)**

**030. INVESTIGATIONS OR INSPECTIONS.**

The Racing Commission may conduct investigations and inspections and request additional information from the advanced deposit wagerer as it deems appropriate. (3-20-20)T

**031. -- 039. (RESERVED)**

**040. CLAIMS OF NON-PAYMENT.**

**01. Claim of Non-Payment.** An account holder, who is claiming that non-payment has occurred, must make a claim of non-payment to the Racing Commission. (3-20-20)T

**02. Investigation of Claim.** The Racing Commission will investigate the claim and provide the advance deposit wagering operator with an opportunity to respond thereto and submit any supporting documents or evidence it needs to defend the claim. (3-20-20)T

**03. Commission Determination.** If the Racing Commission determines that the account holder is entitled to restitution, the advance deposit wagering operator has ten (10) days to pay the amount determined by the Racing Commission. (3-20-20)T

**041. -- 049. (RESERVED)**

**050. PROMOTE AND ADVERTISE.**

An applicant licensed under these rules may enter into such agreements, for what it deems good and sufficient reasons, that are necessary to promote, advertise, and further the sport of racing, or that may be necessary for the effective operation of interstate account wagering, including, without limitation, television production and telecommunications services. Such agreements are reviewed by the Racing Commission and may be denied. (3-20-20)T

**051. -- 059. (RESERVED)**

**060. OUT-OF-STATE PROVIDERS.**

Any advance deposit wagering by an account holder with a provider outside of the State by telephone or other electronic means is illegal, unless that provider is licensed by the Racing Commission and provides a source market fee of not less than ten percent (10%) of the handle forwarded monthly to the Racing Commission. (3-20-20)T

**061. -- 069. (RESERVED)**

**070. RESIDENCE OUTSIDE THE STATE OF IDAHO.**

Requirements for the establishment and operation of accounts for individuals whose principle residence is outside of the state of Idaho must be set forth in the operation plan as stated in these rules. (3-20-20)T

**071. -- 079. (RESERVED)**

**080. ESTABLISHING AN ACCOUNT.**

**01. Establishing an Account.** The application for establishing the account must be authorized in a manner acceptable to the Racing Commission and include the applicant's: (3-20-20)T

- a.** Full legal name; (3-20-20)T
- b.** Principal residence address; (3-20-20)T
- c.** Telephone number of their permanent residence; (3-20-20)T
- d.** Social security number; and (3-20-20)T
- e.** Proper identification or certification demonstrating that the applicant is at least eighteen (18) years of age. (3-20-20)T

**02. Other Information.** As needed, any other information required by the Racing Commission or the advance deposit operator must be included. (3-20-20)T

**081. ACCOUNT INFORMATION.**

Each application for an advance deposit wagering account may be subject to verification. (3-20-20)T

**082. IDENTIFYING AN ACCOUNT NUMBER.**

Each account must have a unique identifying account number. The identifying account number may be changed at any time by the advance deposit wagering operator provided the advance deposit wagering operator informs the account holder in writing prior to the change. (3-20-20)T

**01. Secure Personal Identification Code.** The applicant must supply the advance deposit wagering operator with an alpha-numeric code to be used as a secure personal identification code when the account holder is placing an account wager. The account holder has the right to change this code at any time. (3-20-20)T

**02. Principle Residence.** The principal residence address will be established by reliance on the information submitted on the application form provided and certified by the applicant. (3-20-20)T

**03. Upon Approval Account Holder Receives.** The account holder will receive, at the time the account is approved: (3-20-20)T

- a.** A unique account identification number; (3-20-20)T
- b.** A copy of the advance deposit wagering rules and such other information and material that is pertinent to the operation of the account; and (3-20-20)T
- c.** Such other information as the advance deposit wagering operator or Racing Commission may deem appropriate. (3-20-20)T

**04. Name of Natural Persons.** The advance deposit wagering operator will accept accounts in the name of a natural person only. (3-20-20)T

**05. Nontransferable.** The account is nontransferable between natural persons. (3-20-20)T

**083. -- 089. (RESERVED)**

**090. CLOSE OR REFUSE TO OPEN AN ACCOUNT.**

The advance deposit wagering operator may close or refuse to open an account, for what it deems good and sufficient reason, and will order an account closed if it is determined that information that was used to open an account was false, or that the account has been used in violation of these rules. (3-20-20)T

**091. -- 094. (RESERVED)**

**095. ACCOUNT HOLDER RESPONSIBILITIES.**

**01. Personal Use Only.** Accounts are for the personal use of the account holder. (3-20-20)T

**02. Security.** The account holder is responsible for maintaining the secrecy of the account number and secure personal identification code. (3-20-20)T

**03. Account Losses.** Except where the advance deposit wagering center or its employees or agents act without good faith or fail to exercise ordinary care, the advance deposit wagering center is not be responsible for any loss arising from the use by any other person or persons of an account holder's account. (3-20-20)T

**04. Notification of Account Security Breach.** The account holder must immediately notify the advance deposit wagering center of a breach of the account's security. (3-20-20)T

**096. -- 099. (RESERVED)**

**100. OPERATION OF AN ACCOUNT.**

**01. Operator May Refuse Deposits.** The advance deposit wagering operator may refuse deposits to an account for what it deems good and sufficient reason. (3-20-20)T

**02. Operator May Suspend or Close Account.** The advance deposit wagering operator may suspend or close any account at any time provided that within five (5) business days of closing the account the advance deposit wagering operator returns to the account holder all monies then on deposit by sending it to the principal residence address as listed on the application. (3-20-20)T

**101. -- 104. (RESERVED)**

**105. CREDITS TO AN ACCOUNT.**

After the initial establishment of an account, credits to an account may be made as follows: (3-20-20)T

**01. Deposits.** Deposits to an account by an account holder must be made in the following forms: (3-20-20)T

**a.** Cash given to the staff of an advance deposit wagering operator; (3-20-20)T

**b.** Personal or cashier check, or money order given or sent to an advance deposit wagering operator; (3-20-20)T

**c.** Charges made to an account holder's credit card or debit card upon the direct and personal instruction of the account holder. Such instructions may be given by telephone or any electronic device to the advance deposit wagering facility by the account holder if the use of the card has been approved by the advance deposit wagering operator; or (3-20-20)T

**d.** Transfer by means of an electronic funds transfer from a monetary account controlled by an account holder to his account. The account holder is liable for any charges imposed by the transmitting or receiving entity with such charges to be deducted from the account. (3-20-20)T

**02. Credit for Winnings.** Credit for winnings from wagers placed with funds in an account and credit for account wagers on entries that are scratched will be posted to the account by the advance deposit wagering operator. (3-20-20)T

**03. Accordance with Financial Institution.** Checks, money orders and other negotiable instruments will be posted to the credit of the account holder in accordance with financial institution funds availability schedules. (3-20-20)T

**106. DEBITS TO AN ACCOUNT.**

**01. Debits to an Account.** Debits to an account are made as follows: (3-20-20)T

**a.** Upon receipt by the advance deposit wagering operator of an account wager, the advance deposit wagering center debits the account in the amount of the wager; or (3-20-20)T

**b.** For fees for service or other transaction-related charges by the advance deposit wagering operator. (3-20-20)T

**02. Account Withdrawals.** An advance deposit wagering operator may authorize a withdrawal from an account when one (1) of the following exists: (3-20-20)T

**a.** The account holder of an account appears personally at the advance deposit wagering operators location and provides the following: (3-20-20)T

**i.** Proper identification; (3-20-20)T

**ii.** The correct secure personal identification code; and (3-20-20)T

**iii.** A properly completed and signed withdrawal slip. (3-20-20)T

**b.** The account holder sends to the advance deposit wagering operator a properly completed and signed withdrawal slip by any means, electronic or otherwise. (3-20-20)T

**i.** Upon receipt of a properly completed and signed withdrawal slip, and if there are sufficient funds in the account to cover the withdrawal, the advance deposit wagering operator must, within five (5) business days of its receipt, send a check to the account holder. The check is payable to the holder of the account and in the amount of the requested withdrawal. (3-20-20)T

**ii.** If funds are not sufficient to cover the withdrawal, the account holder will be notified in writing and those funds in the account will be withdrawn and sent to the account holder within the five (5) business day time period. Electronic funds transfers may be used for withdrawals in lieu of a check at the discretion of the account holder and the advance deposit wagering operator subject to the same conditions described for electronic funds transfer credits. (3-20-20)T

**c.** The advance deposit wagering operator may close accounts in which there has been no activity for at least six (6) months, returning funds remaining therein to the account holder at his principal residence address. (3-20-20)T

**d.** In the event an account holder is deceased, funds accrued in the account will be released to the decedent's legal representative upon receipt of a copy of a valid death certificate, tax releases or waivers, probate court authorizations or other documents required by applicable laws. (3-20-20)T

**107. WAGERS IN EXCESS OF ACCOUNT BALANCE.**

The advance deposit wagering operator will not accept wagers from an account holder in an amount in excess of the account balance. (3-20-20)T

**108. ACCOUNTS WILL NOT BEAR ANY INTEREST.**

Monies deposited with the advance deposit wagering operator for advance deposit wagering must not bear any interest to the account holder. (3-20-20)T

**109. PAYMENTS ON WINNING PARI-MUTUEL WAGERS.**

Payments on winning pari-mutuel wagers and credits for account wagers on entries which are scratched must be posted to the credit of the account holder as soon as practicable after the race is declared official. (3-20-20)T

**110. MAILING ADDRESS.**

The principal residence address, provided in writing by the account holder at the time of application, is deemed to be the proper address for the purposes of mailing checks, statements of account, account withdrawals, notices, or other appropriate correspondence. The mailing of checks or other correspondence to the address given by the account holder is at the sole risk of the account holder. (3-20-20)T

**111. -- 119. (RESERVED)**

**120. POWERS OF THE RACING COMMISSION TO REVIEW AND AUDIT RECORDS.**

The Racing Commission or its staff will be given access to all records and financial information of the advance deposit wagering operator for review and audit. The Racing Commission may require that the advance deposit wagering operator annually submit to the Racing Commission audited financial statements of the advance deposit wagering system. (3-20-20)T

**121. -- 124. (RESERVED)**

**125. CONFIDENTIAL INFORMATION.**

No confidential information related to the placing of any wager or to the operation of the advance deposit wagering center may be divulged by any employee or agent of the advance deposit wagering center, except, as required by these rules, to the account holder or the Racing Commission, or as otherwise required by state or federal law or regulation or rules of the Racing Commission. (3-20-20)T

**126. -- 129. (RESERVED)**

**130. APPLICABLE LAWS, RULES, AND REGULATIONS.**

All advance deposit wagering operators must adhere to all applicable state and federal laws, rules, and regulations. (3-20-20)T

**131. -- 999. (RESERVED)**

## 11.04.07 – RULES GOVERNING RACING ASSOCIATIONS

### 000. LEGAL AUTHORITY.

This chapter is adopted pursuant to the legal authority of Title 54, Chapter 25, of the Idaho Code. (3-20-20)T

### 001. TITLE AND SCOPE.

01. **Title.** These rules are titled IDAPA 11.04.07, “Rules Governing Racing Associations.” (3-20-20)T

02. **Scope.** This rule governs conduct and licensing of racing associations. (3-20-20)T

### 002. -- 009. (RESERVED)

### 010. DEFINITIONS.

In addition to the definitions in Title 54, Chapter 25, Idaho Code, the following apply: (3-20-20)T

01. **Bookmaker.** A person who makes a business of accepting the bets of others on the outcome of any sports contest including horse racing. (3-20-20)T

02. **Breed Association.** A group organized under Idaho law to receive breeder awards. (3-20-20)T

03. **Breeder.** Breeder of a horse is determined by the definition of breeder used by the registry of the particular breed of that horse. (3-20-20)T

04. **Chemical.** A substance composed of chemical elements or obtained by chemical processes. (3-20-20)T

05. **Claiming Race.** A race in which any horse entered therein may be claimed in conformity with the rules. (3-20-20)T

06. **Conditions.** Qualifications and requirements set by the Racing Association which determine a horse’s eligibility to be entered in a race. (3-20-20)T

07. **Drug.** Any chemical compound or any noninfectious biological substance not used for its mechanical properties, which may be administered to or used on or for patients, either human or animal, as an aid in diagnosis, treatment or prevention of disease or other abnormal condition, for the relief of pain or suffering, or to control or improve any physiological or pathological condition. (3-20-20)T

08. **Entry.** Means, according to the requirements of the text: (3-20-20)T

a. A horse made eligible to run a race. (3-20-20)T

b. Two (2) or more horses that are entered or run in a race and are coupled because of common ties or ownership. Where two (2) or more horses owned by separate owners but trained by the same Trainer are entered in the same race, the horses may run as separate betting interests. (3-20-20)T

09. **Forfeit.** Money due because of an error fault, neglect of duty, breach of contract or a penalty. (3-20-20)T

10. **Grounds.** Any area owned or leased by any licensed Association, Corporation, or Race Track which is operated for the purpose of conducting pari-mutuel racing. (3-20-20)T

11. **Handbook.** A method of soliciting and recording wagers on the outcome of a sports contest including a horse race. (3-20-20)T

12. **Horse.** Includes filly, mare, colt, horse and gelding in general; when referring to sex, a filly becomes a mare when five (5) years old; a horse is an entire male when five (5) years old or older. (3-20-20)T

13. **Horsemen’s Agreement.** An agreement approved by the Racing Commission between the Racing Association and the authorized horsemen’s group. (3-20-20)T

14. **Idaho Bred.** A foal dropped by a mare in Idaho. (3-20-20)T

15. **Jockey.** A race rider, whether a licensed Jockey, apprentice, or amateur. (3-20-20)T
16. **Meet.** The entire consecutive period for which a license to race has been granted to any one (1) association by the Racing Commission. (3-20-20)T
17. **Month.** A calendar month. (3-20-20)T
18. **Owner.** Includes the owner, part owner and lessee of any horse. An interest only in the earnings of a horse does not constitute ownership. In case of husband and wife, it is presumed that joint ownership exists. (3-20-20)T
19. **Place.** Means first, second or third and in that order is called "Win," "Place," and "Show." (3-20-20)T
20. **Purse Race.** A race for money or any other prize to which the owners of the horses do not contribute. (3-20-20)T
21. **Racing Association.** Any person licensed by the Racing Commission to conduct live or simulcast pari-mutuel wagering. (3-20-20)T
22. **Racing Dates.** The number of racing dates authorized by the Racing Commission in a Racing Association license. (3-20-20)T
23. **Ruled Off.** An action by the racing stewards, under these rules, to suspend a license for a violation of these rules. (3-20-20)T
24. **Starter.** (3-20-20)T
- a. The individual approved to dispatch the horses in a race. (3-20-20)T
- b. The horse is a "starter" for a race when the stall doors of the starting gate open in front of it at the time the starter dispatches the horses. (3-20-20)T
25. **Stewards.** The Stewards of the meet or their duly appointed deputies. (3-20-20)T
26. **Winner.** Winner of a single race of a certain sum or value unless otherwise expressed in the conditions. (3-20-20)T
27. **Year.** A calendar year. (3-20-20)T

**011. -- 019. (RESERVED)**

**020. ENTER, SEARCH AND INSPECT.**

Every Racing Association, the Racing Commission, the Stewards or trained and qualified agents of the Idaho State Police, have the right to enter, search and inspect the buildings, stables, rooms and other places where horses which are eligible to race are kept, or where property and effects of the licensee are kept within the grounds of the Racing Association. Any licensee accepting a license is deemed to have consented to such search and to the seizure of any non-approved or prohibited materials, chemicals, drugs or devices and anything apparently intended to be used in connection therewith. (3-20-20)T

**021. -- 039. (RESERVED)**

**040. RACING COMMISSION.**

**01. Visit and Inspection.** The Racing Commission or designated representatives will visit and inspect the race meets. Each Racing Association conducting a race meet must make available to the Racing Commission a box of four (4) seats for each day of the race meet. The private cars of Racing Commissioners or designated

representatives will have access to the restricted parking area of all tracks. (3-20-20)T

**02. Association Office.** Each Racing Association must furnish and provide an adequate office for the use of the Racing Commission or its designated representatives. (3-20-20)T

**041. -- 049. (RESERVED)**

**050. EMPLOYEES.**

**01. Licenses.** Any Racing Association that employs any person in a capacity that is required to be licensed by the Racing Commission prior to the Racing Commission granting such a license may be subject to suspension or a fine, or both. (3-20-20)T

**02. Suspension or Fine.** The extent of said suspension or fine, or both, is determined by the Board of Stewards. (3-20-20)T

**03. Report to Stewards.** Any licensee who harbors anyone not licensed by the Racing Commission will be immediately reported to the Stewards of the race meet so that they may make investigation thereof and report the fact to the Racing Commission. (3-20-20)T

**051. -- 054. (RESERVED)**

**055. DISTURBING THE PEACE.**

No person will in any manner or at any time disturb the peace or behave in a disorderly manner on the grounds of a Racing Association; nor will any person interfere with the performance of the duties of a racing official or any employee or representative of the Racing Commission. (3-20-20)T

**056. -- 059. (RESERVED)**

**060. RULED OFF.**

**01. Admittance to Grounds.** No person or horse ruled off, or under suspension by any recognized racing authority, will be admitted to or allowed to remain upon the grounds of any Racing Association. (3-20-20)T

**02. Persons Ruled Off a Track Ineligible.** When a person is ruled off a course or suspended, every horse owned in whole or part by him, or under his care, management, training or superintendence, is ineligible to enter or to start in any race until the rescinding of said person's penalty, or by the placement of the horse or horses in the hands of a licensed Trainer approved by the Stewards. (3-20-20)T

**061. -- 069. (RESERVED)**

**070. PROHIBITED PRINTED MATERIAL.**

No unauthorized tip sheet, pamphlet or other printed matter, other than official programs, the Daily Racing Form and general newspapers, are to be sold on the Racing Association grounds. (3-20-20)T

**01. Copies.** Copies of all such materials offered for sale in the parking area or elsewhere on or off the grounds of the Racing Association must be furnished daily to the Presiding State Steward, not later than two (2) hours before first post. (3-20-20)T

**02. Publishers.** All tip sheet publishers and vendors must be licensed by the Racing Commission. (3-20-20)T

**071. -- 074. (RESERVED)**

**075. HANDBOOKS.**

No person may make a handbook or a foreign book, or solicit a bet with a handbook or a foreign book on the grounds of a Racing Association. (3-20-20)T



**076. -- 079. (RESERVED)**

**080. BOOKMAKERS.**

**01. Entry Prohibited.** The following persons will not be allowed entry into or remain upon the premises of any Racing Association: (3-20-20)T

**a.** A person who is a bookmaker or who is known or reputed to be a bookmaker; (3-20-20)T

**b.** A person who is a vagrant within the meaning of the laws of Idaho; (3-20-20)T

**c.** A person who is a fugitive from justice; (3-20-20)T

**d.** A person whose conduct now or heretofore has been improper, obnoxious, unbecoming or detrimental to the best interest of racing. (3-20-20)T

**02. Ejection.** Upon discovery or recognition, all such persons described in Subsection 080.01 of these rules will be ejected by the Racing Association or representatives and agents of the Racing Commission. (3-20-20)T

**03. License Revocation.** Associating with a person or persons such as described in Subsection 080.01 of these rules may be grounds for the revocation of any license. (3-20-20)T

**081. -- 089. (RESERVED)**

**090. IDAHO BRED RACES.**

At least one (1) race each day at each race meet must be limited to Idaho bred horses. If a sufficient class of horses is not available to fill the race, said race may be opened to Idaho bred preferred. (3-20-20)T

**01. Number of Races.** The Racing Secretary must alternate among breeds according to the applicable horsemen's agreement. (3-20-20)T

**02. Certificate of Registration.** The owners' certificate of registration is proof that horses entered in such races were bred in Idaho. (3-20-20)T

**091. BREEDER AWARDS.**

A sum equal to ten percent (10%) of the first place purse money won by an Idaho bred horse must be paid by the Racing Association to the breeder of such horse. All purse moneys derived from pari-mutuel racing and all purse enhancement moneys from the Idaho State Racing Commission are included in the calculation of these breeder payments. All nominating and sustaining fees, and any moneys from outside sponsors are excluded from the calculation of these breeder payments. (3-20-20)T

**092. -- 094. (RESERVED)**

**095. BREED ASSOCIATIONS.**

Pursuant to Section 54-2513, Idaho Code, on or before December 15 of each year, representatives of each breed which received money the preceding year must file a financial report showing disposition of any funds thus received. (3-20-20)T

**01. Failure to File.** Failure to file such report is grounds for the Racing Commission to deny approval of any future disbursement to that breed. (3-20-20)T

**02. Representatives.** "Lawfully constituted representatives of each breed" is the designated representative of the one (1) recognized breed organization for each breed racing in Idaho that has established itself as the traditional breed acknowledged by the Racing Commission. (3-20-20)T

**096. -- 099. (RESERVED)**

**100. RACING ASSOCIATION LICENSE.**

No person may conduct a live race meet unless they possess a valid Racing Association license issued by the Racing Commission. (3-20-20)T

**101. -- 109. (RESERVED)**

**110. RACING ASSOCIATION LICENSE FEES.**

Every Racing Association conducting a race meet in Idaho must pay a fee of twenty-five dollars (\$25) for each day of racing, except as otherwise provided in Title 54, Chapter 25, Idaho Code. (3-20-20)T

**111. -- 119. (RESERVED)**

**120. RACING ASSOCIATION LICENSE APPLICATIONS.**

Applications for Racing Association licenses must be made on forms approved by the Racing Commission. The Racing Commission sets the application date. (3-20-20)T

**121. -- 129. (RESERVED)**

**130. APPLICATIONS FOR SUCCEEDING SEASONS.**

Applications for a license to conduct a race meet during the next succeeding season must be filed with the Racing Commission over the signature of an executive officer of the Racing Association. The Racing Commission sets the application date. (3-20-20)T

**131. -- 139. (RESERVED)**

**140. HORSEMEN'S AGREEMENT.**

Every Racing Association must have in effect a signed Horsemen's Agreement. (3-20-20)T

**141. -- 149. (RESERVED)**

**150. RACING ASSOCIATIONS OPERATION.**

**01. Requirements.** The scope of the Racing Associations operation and plant facilities will determine the Racing Commission's requirements for the following: (3-20-20)T

- a. Proof of financial stability; (3-20-20)T
- b. Names of stockholders; (3-20-20)T
- c. Medical and veterinary facilities; (3-20-20)T
- d. Lodging facilities; and (3-20-20)T
- e. Protective facilities. (3-20-20)T

**02. Additional Information.** The Racing Commission or Idaho State Police may require additional background information of applicants or licensees. (3-20-20)T

**151. -- 159. (RESERVED)**

**160. REPORT OF FUNDS.**

Pursuant to Section 54-2513, Idaho Code, prior to or at the time of making application for licensing Racing Associations which received money the preceding year must file a financial report with the Racing Commission showing disposition of any funds thus received. (3-20-20)T

**161. -- 169. (RESERVED)**

**170. APPROVAL OF RACING ASSOCIATION LICENSES.**

The Racing Commission will consider each application for a Racing Association license individually and decide whether to grant the license or not on a case by case basis. (3-20-20)T

**171. -- 179. (RESERVED)**

**180. LICENSE GRANTED UPON CONDITIONS.**

Every Racing Association license is granted upon the condition that the licensee accept, observe and enforce the Racing Commission rules. (3-20-20)T

**01. Duty.** It is the duty of each and every officer to observe and enforce the Racing Commission rules. (3-20-20)T

**02. Investigations.** The Racing Commission may require background investigations, fingerprints and photographs of Racing Association officers, stockholders or employees. (3-20-20)T

**181. -- 189. (RESERVED)**

**190. REFUSAL TO ISSUE LICENSE.**

The Racing Commission may refuse to issue a Racing Association license when such refusal appears to be for the best interest of racing and of the public. The Racing Commission will, in deciding upon applications for Racing Association licenses, consider the following matters: (3-20-20)T

**01. Properly Develop.** The opportunity for the sport to properly develop. (3-20-20)T

**02. Competition.** The avoidance of competition with established tracks in Idaho. (3-20-20)T

**03. Community Support.** The extent of community support for the promotion and continuance of the tracks. (3-20-20)T

**04. Reputation.** The character and reputation of the persons identified with the Racing Association. (3-20-20)T

**05. Safety.** The general conditions and safety of the Racing Association facilities. (3-20-20)T

**191. -- 199. (RESERVED)**

**200. FINGERPRINTS -- PHOTOGRAPH.**

Every person holding a Racing Association license in Idaho, and every person that holds such a license who is an officer or director of a Racing Association that is in any capacity connected to any extent with the pari-mutuel wagering business in this State, must, on demand, furnish his fingerprints and photograph to the Racing Commission for its files. Fingerprints and photograph are to be taken at such time and place and in such manner as the Racing Commission may from time to time direct and prescribe. (3-20-20)T

**201. -- 209. (RESERVED)**

**210. RACING DATES.**

Application for racing dates must be made on forms approved by the Racing Commission. Application for racing dates does not commit the Racing Commission to the granting of a license to conduct race meets upon the dates requested. (3-20-20)T

**211. -- 219. (RESERVED)**

**220. LICENSE NOT TRANSFERABLE.**

No Racing Association license or any part thereof is transferable or assignable without the consent of the Racing Commission and said license is not valid for any racing days other than those set out therein. (3-20-20)T

221. -- 239. (RESERVED)

**240. PROPOSED OFFICIALS.**

Thirty (30) days prior to the first day of a race meet the Racing Association must submit in writing to the Racing Commission all names and personal data of proposed officials for processing for licensing. No official may act until approved by the Racing Commission. A Racing Commission representative at the track will process substitutions. The required form will be provided by the Racing Commission. (3-20-20)T

**01. Hardship.** To avoid undue hardship the Racing Commission may authorize Racing Associations to allow officials other than Stewards to act in dual capacities. (3-20-20)T

241. -- 249. (RESERVED)

**250. RACING ASSOCIATIONS: GENERAL RULES.**

**01. Laws and Rules.** The laws of Idaho and the rules promulgated by the Racing Commission supersede the conditions of the race or the regulations of a race meet. (3-20-20)T

**02. Racing Hours.** Each Racing Association may conduct horse racing only between the hours of 12:00 noon and 12:00 midnight, unless otherwise specifically authorized by the Racing Commission. (3-20-20)T

**03. Conditions of Races.** Each Racing Association must file with the Racing Commission the conditions of races it proposes to hold together with the stakes, purse or rewards. (3-20-20)T

**04. Open Market.** Owners and stables participating in race meets operating under license of the Racing Commission may purchase feed and supplies on the open market. No Racing Association may grant exclusive concessions which will interfere with this right. (3-20-20)T

**05. Toilets and Other Facilities.** Each Racing Association must on every racing day provide and maintain adequate toilet facilities and facilities for furnishing drinking water for its patrons and persons having business at the track. (3-20-20)T

**06. Tampering.** Each Racing Association must provide protection facilities to prevent tampering with horses or any other corrupt practices at licensed race meets. The Racing Commission may at any time require Racing Associations to expand their protective services. (3-20-20)T

**07. Fire Regulations Posted.** Every Racing Association must post in the stable area of its premises the fire regulations applicable on its grounds and state the location of the nearest fire alarm box and the telephone number of the fire department or other pertinent instructions as to the method for reporting a fire in the area. Such notices must be posted no more than one hundred (100) feet apart or as approved by the local fire authority. No Racing Association or other person may violate the posted fire regulations specified by the Racing Commission. (3-20-20)T

**08. Credentials.** A full record of credentials issued by the Racing Association must be compiled and open to inspection at all times with all additions made to or changes in the list of employees of any Racing Association reported promptly to the Racing Commission in writing. (3-20-20)T

**09. Horse Ambulance.** Racing Associations must furnish, maintain, and have available a horse ambulance, as required by the Racing Commission, for each day that the track is open for racing or exercising during the race meet. (3-20-20)T

**10. Human Emergency Medical Response Vehicle.** Racing Associations must furnish and maintain a human emergency medical response vehicle, as required by the Racing Commission, for each day that the track is open for racing or exercising during the race meet. If the human emergency medical response vehicle is being used to transport an individual, the Racing Association may not conduct a race until the ambulance is replaced. (3-20-20)T

**11. Medical Professionals.** Racing Associations must have a licensed physician, registered nurse,

paramedic or licensed emergency medical technician on duty at the track on each day of racing and also provide adequate first aid and medical facilities to protect patrons and participants at licensed race meets. (3-20-20)T

**12. Comfort and Safety.** Racing Associations must at all times maintain the premises in good condition and properly secured, with special consideration for the comfort and safety of the public, of the horses and of all others present. (3-20-20)T

**13. Violators.** Violators of any rules are subject to ejection from the grounds, fine, suspension, being ruled off or any combination of the preceding. (3-20-20)T

**14. Post Notices.** Racing Associations must promptly post Racing Commission notices in places that can be easily viewed by licensees. (3-20-20)T

**251. -- 259. (RESERVED)**

**260. HORSEMEN'S ACCOUNT.**

Unless otherwise authorized by the Racing Commission and consistent with the Horsemen's agreement pertaining to the Horsemen's account, each Racing Association must keep an account, to be known as the "Horsemen's Account," with sufficient funds at all times in such account to cover all monies due horsemen in regard to purses, stakes, rewards, claims and deposits. (3-20-20)T

**01. Subject to Review or Audit.** The account is at all times be subject to review or audit by the Racing Commission. (3-20-20)T

**02. Bonded.** The horsemen's bookkeeper is in charge of such an account and must be insured against crime or employee dishonesty in a manner approved by the Racing Commission. (3-20-20)T

**261. -- 269. (RESERVED)**

**270. PURSE MONEY.**

Purse money must be made available to the winners promptly following release by the Racing Commission or its representative. (3-20-20)T

**01. Release.** Release will be given when test results of the horse's urine, blood or other specimens have been reported to the Racing Commission. (3-20-20)T

**02. Breeder's Awards.** Breeder's awards will be payable when the purse is cleared. (3-20-20)T

**03. Weekly Remittance.** The one-half (1/2) of one percent (1%) to benefit owners or breeders is to be remitted weekly by the Racing Association to the Racing Commission for distribution quarterly to the representatives of each breed. (3-20-20)T

**271. -- 279. (RESERVED)**

**280. COMMUNICATION.**

**01. Communication System.** Racing Associations must provide and maintain in good working order a communication system between racing officials and locations as determined by the Racing Commission. (3-20-20)T

**02. Public Address System.** Racing Associations must provide and maintain a public address system capable of clearly transmitting announcements to the patrons and to the stable area. (3-20-20)T

**281. -- 289. (RESERVED)**

**290. DOCUMENTS FILED WITH RACING COMMISSION.**

Not less than thirty (30) days before opening a race meet each Racing Association must file with the Racing Commission the following: (3-20-20)T

**01. Bond.** A bond signed by a surety company licensed to do business in this State in such form and in the sum as may be required by the Racing Commission, conditioned that the association will pay to the state of Idaho all money due under the provisions of Title 54, Chapter 25, Idaho Code. (3-20-20)T

**02. Liability Insurance.** Proof of public liability insurance by a company licensed to do business in this State in such form and in the amount as may be required by the Racing Commission for the protection of the public, the exhibitors and visitors. (3-20-20)T

**03. Accident Insurance or Workmen's Compensation Insurance.** Proof of an accident insurance policy or workmen's compensation insurance policy issued by a company licensed to do business in Idaho for the protection of Jockeys and exercise persons for injuries incurred in connection with race meets in such form and amount as may be required by the Racing Commission. (3-20-20)T

**291. -- 299. (RESERVED)**

**300. HORSE RACE TRACKS.**

**01. Track Width.** A minimum of twenty (20) feet of track width must be allowed for the first two (2) horses in a race, with an additional five (5) feet for each added starter. (3-20-20)T

**02. Implements.** Racing Associations must provide adequate equipment and personnel to maintain the track surface in a safe training and racing condition and provide back-up equipment for maintaining the track surface. (3-20-20)T

**03. Limit on Number of Horses.** No more than eight (8) horses may start in any race on a one-half (1/2) mile track. (3-20-20)T

**04. Racing Surface.** The surface of a racetrack, including the cushion, subsurface and base, must be designed, constructed and maintained to provide for the safety of the jockeys and horses. (3-20-20)T

**05. Rails.** Race tracks must have inside and outside rails, including gap rails, designed, constructed and maintained to provide for the safety of jockeys and horses. The design and construction of rails must be approved by the Racing Commission prior to the first race meet at the track. (3-20-20)T

**301. -- 309. (RESERVED)**

**310. JOCKEY ROOM.** Each Racing Association must provide a room reserved for jockeys to prepare for a race. (3-20-20)T

**311. -- 319. (RESERVED)**

**320. OFFICIALS' STANDS.** Racing Associations must provide adequate stands for officials to have a clear view of the racetrack. The location and design of the stands must be approved by the Racing Commission. (3-20-20)T

**321. -- 329. (RESERVED)**

**330. PHOTO FINISH DEVICES.** Racing Associations must provide two (2) electronic photo finish devices with mirror image to photograph the finish of each race and record the time of each horse in at least hundredths of a second. (3-20-20)T

**01. Location.** The location and operation of the photo finish devices must be approved by the Racing Commission before its first use in a race. (3-20-20)T

**02. Posting Photographs.** The Racing Association must promptly post a photograph of each photo finish for win, place or show in an area accessible to the public. (3-20-20)T

**03. Devices Calibrated.** The Racing Association must ensure that the photo finish devices are calibrated before the first day of each race meet and at other times as required by the Racing Commission. (3-20-20)T

**04. Print Provided.** On request by the Racing Commission, the Racing Association must provide, without cost, a print of a photo finish to the Racing Commission. (3-20-20)T

**05. Records.** Photo finish records of each race must be maintained by the Racing Association for not less than six (6) months after the end of the race meet, or such other period as may be requested by the stewards or the Racing Commission. (3-20-20)T

**331. -- 339. (RESERVED)**

**340. VIDEOTAPING SYSTEM.**

Racing Associations must provide a videotaping system approved by the Racing Commission. Cameras must be located to provide clear panoramic and head-on views of each race. (3-20-20)T

**01. Monitors.** Separate monitors that simultaneously display the images received from each camera and are capable of simultaneously displaying a synchronized view of the recordings of each race for review must be provided in the stewards' stand. (3-20-20)T

**02. Location.** The location and construction of video towers must be approved by the Racing Commission. (3-20-20)T

**03. Stewards.** The stewards may, at their discretion, direct the video camera operators to videotape the activities of any horses or persons handling horses prior to, during or following a race. (3-20-20)T

**04. Oval Track.** Races run on an oval track must be recorded by at least three (3) video cameras. (3-20-20)T

**05. Straight Course.** Races run on a straight course must be recorded by at least two (2) video cameras. (3-20-20)T

**06. Videotape Copy.** Racing Associations must, upon request, provide to the Racing Commission, without cost, a copy of a videotape of a race. (3-20-20)T

**07. Videotapes Maintained.** Videotapes recorded prior to, during and following each race must be maintained by the Racing Association for not less than six (6) months after the end of the race meet, or such other period as may be requested by the stewards or the Racing Commission. (3-20-20)T

**08. Objection.** Following any race in which there is an inquiry or objection, the Racing Association must display to the public on designated monitors the videotaped replays of the incident in question which were utilized by the stewards in making their decision. (3-20-20)T

**341. -- 349. (RESERVED)**

**350. STARTING GATE.**

All horse races must utilize a starting gate approved by the Racing Commission, except that with permission of the Stewards a race may be started with or without a gate. When the starting gate is used, it must be placed on the track at the direction of the Starter. (3-20-20)T

**01. Training Hours.** Racing Associations must make at least one (1) starting gate and qualified starting gate personnel available for schooling during designated training hours. (3-20-20)T

**02. Backup Equipment.** If a race is started at a place other than in a chute, the Racing Association must provide and maintain in good operating condition backup equipment for moving the starting gate. The backup

equipment must be immediately available to replace the primary moving equipment in the event of failure. (3-20-20)T

**351. -- 359. (RESERVED)**

**360. DISTANCE MARKERS.**

Racing Associations must provide starting point markers and distance poles in a size and position that is clearly seen from the stewards' stand. (3-20-20)T

**361. -- 369. (RESERVED)**

**370. BARNs.**

Racing Associations must provide barns containing a sufficient number of stalls to accommodate all horses approved to race and all other horses approved to be on the grounds. The Racing Association's stable area configuration and facilities must be approved by the Racing Commission. (3-20-20)T

**01. Good Repair.** Racing Associations must ensure that the barns are kept clean and in good repair, have a water supply available, be well-ventilated, have proper drainage, and be constructed to be comfortable during the race meet. (3-20-20)T

**02. Stall Size.** Racing Associations must ensure that each horse is stabled in an individual box stall with minimum dimensions of ten feet by ten feet (10' x 10'). (3-20-20)T

**371. -- 379. (RESERVED)**

**380. TEST AREA.**

Racing Associations must provide a test area for taking specimens of urine, blood or other bodily substances or tissues for testing, and limit access to the test area to persons authorized by the commission veterinarian. (3-20-20)T

**381. -- 389. (RESERVED)**

**390. ISOLATION AREA.**

Racing Associations must provide an isolation area, approved by the Racing Commission, for the care and treatment of a horse that is ordered isolated by the commission veterinarian. (3-20-20)T

**391. -- 899. (RESERVED)**

**900. SECURITY.**

Racing Associations conducting live race meets must maintain security controls over their grounds. Security controls are subject to the approval of the Racing Commission. (3-20-20)T

**01. Restricted Areas.** Racing Associations must restrict access of licensees or their guests to certain areas of the grounds. Those restricted areas are the Paddock, Jockey Room, Veterinarian's Test Area, the Steward's Stand, the Mutuel Room, racing offices and any other area the Racing Association feels should be limited access. (3-20-20)T

**02. Escort Guests.** Any licensee may escort an unlicensed guest through the enclosure of a Racing Association except restricted areas. The licensee and the guest must sign in and out and identify all such persons. The licensee by signing accepts full responsibility for the safety and actions of the guest while in the enclosure. (3-20-20)T

**03. Passes.** Racing Associations may establish a system or method of issuing credentials or passes to restrict access to its restricted areas or to ensure that all participants at its race meet are licensed as required by these rules. (3-20-20)T

**04. Prevent Access.** Racing Associations must prevent access to and remove or cause to be removed from its restricted areas any person who is unlicensed, or who has not been issued a visitor's pass or other identifying



credential, or whose presence in such restricted area is unauthorized. (3-20-20)T

**05. List of Security Personnel.** On request by the Racing Commission, a Racing Association must provide a list of the security personnel, including the name, qualifications, training, duties duty station and area supervised by each employee. (3-20-20)T

**06. Daily Reports.** Each day, the chief of security for a Racing Association must deliver a written report to the stewards regarding occurrences on Racing Association grounds on the previous day. Not later than twenty-four (24) hours after an incident occurs requiring the attention of security personnel, the chief of security must deliver to the stewards a written report describing the incident. The report must include the name of each individual involved in the incident, the circumstances of the incident and any recommended charges against each individual involved. (3-20-20)T

**901. -- 909. (RESERVED)**

**910. COMPLAINTS.**

Racing Associations must promptly notify the Racing Commission of any complaints regarding: (3-20-20)T

**01. Violations.** Alleged violation of Section 54-2501, Idaho Code, ordinances or statutes, or a rule of the Racing Commission; (3-20-20)T

**02. Accidents or Injuries.** (3-20-20)T

**03. Unsafe Conditions.** Unsafe or unsanitary conditions for patrons, licensees or horses. (3-20-20)T

**911. -- 919. (RESERVED)**

**920. EXCLUSION AND EJECTION.**

Racing Associations must immediately, upon notification by the Racing Commission, take steps to bar admittance to the racing grounds to any person who is subject to an exclusion order of the Racing Commission. (3-20-20)T

**01. Lawful Reason.** Racing Associations may eject or exclude a person for any lawful reason. Racing Associations must immediately notify the stewards and the Racing Commission in writing of any person ejected or excluded by the Racing Association and the reasons for the ejection or exclusion. (3-20-20)T

**02. Readmission.** Any person ejected from the grounds of a Racing Association will be denied readmission to said grounds until permission has been approved by the Racing Commission. (3-20-20)T

**921. -- 999. (RESERVED)**

**11.04.11 – RULES GOVERNING EQUINE VETERINARY PRACTICES, PERMITTED MEDICATIONS, BANNED SUBSTANCES AND DRUG TESTING OF HORSES**

**000. LEGAL AUTHORITY.**

This chapter is adopted pursuant to the legal authority of Title 54, Chapter 25, of the Idaho Code. (3-20-20)T

**001. TITLE AND SCOPE.**

**01. Title.** These rules are cited as IDAPA 11.04.11, “Rules Governing Equine Veterinary Practices, Permitted Medications, Banned Substances and Drug Testing of Horses.” (3-20-20)T

**02. Scope.** These rules governs the practices of veterinarians licensed by the Racing Commission, permitted medication of horses and drug testing of horses by the Idaho State Racing Commission. (3-20-20)T

**002. -- 009. (RESERVED)**

**010. DEFINITIONS AND ABBREVIATIONS.**

In addition to the definitions in Title 54, Chapter 25, Idaho Code, the following apply: (3-20-20)T

**01. Bleeder List.** A list maintained by the commission veterinarian with all horses that have demonstrated external evidence of exercise induced pulmonary hemorrhage from one (1) or both nostrils during or after a race or workout. (3-20-20)T

**02. Calendar Year.** A calendar year beginning January 1 and ending December 31. (3-20-20)T

**03. Colt.** An intact male horse under five (5) years of age. (3-20-20)T

**04. Commission Veterinarian.** A Racing Commission appointed veterinarian having authority to enforce the Racing Commission’s rules relating to veterinary practices. (3-20-20)T

**05. DMSO.** Dimethyl Sulfoxide. (3-20-20)T

**06. Filly.** A female horse that has not reached five (5) years of age. (3-20-20)T

**07. Gelding.** An altered male horse of any age. (3-20-20)T

**08. Horse.** Includes filly, mare, colt, horse or gelding in general; when referring to sex, a horse is an intact male five (5) years old or older. (3-20-20)T

**09. Hypodermics.** Any hypodermic instrument, hypodermic syringe or hypodermic hollow needle used for injection of substances into the body of a horse. (3-20-20)T

**10. Inspection of Horses.** A veterinarian inspection to assess the racing condition of every horse entered in an official race. (3-20-20)T

**11. Mare.** A female horse that has reached the age of five (5) years. (3-20-20)T

**12. Medication Report Form.** A form signed by the treating veterinarian disclosing the identity of the horse, the permitted drug being used with dosage or procedure administered, the time administered and the name of the trainer. (3-20-20)T

**13. Needle and Syringe.** See Hypodermics - Subsection 010.08 of this rule. (3-20-20)T

**14. Owner.** The person that has legal title to, or has financial control of, a horse utilized for racing in Idaho. However, an interest in the winnings of a horse does not itself constitute ownership. (3-20-20)T

**15. Penalties.** For this chapter, a penalty issued against an individual(s) found guilty of medication and drug violations. (3-20-20)T

**16. Primary Laboratory.** A laboratory approved by the Racing Commission to conduct testing and official analysis of post-race samples. (3-20-20)T

**17. Prohibited Substances.** Medication and drugs that should not be administered to a horse.

(3-20-20)T

**18. Racing Association.** Any person licensed by the Racing Commission to conduct live or simulcast pari-mutuel wagering. (3-20-20)T

**19. Racing Condition.** The physical ability to race of a horse determined by the commission veterinarian. (3-20-20)T

**20. Referee Laboratory.** Laboratory approved by the Racing Commission to conduct split sample testing. (3-20-20)T

**21. Sample.** A blood, urine, saliva, hair, or any other acceptable specimen taken from a horse at the direction of the commission veterinarian. (3-20-20)T

**22. Split Sample.** A blood, urine, saliva, hair, or any other acceptable specimen taken from a horse that is greater than the minimum sample requirement. (3-20-20)T

**23. Suspension.** Punishment for violation of the Racing Commission rules. The offender is denied privileges of the racing facilities for a specified period of time. (3-20-20)T

**24. Test Area.** A secured testing area provided by a racing association used for taking samples of blood, urine, saliva, hair, or any other acceptable specimen for testing. (3-20-20)T

**25. Trainer.** The person who conditions and prepares a race horse for racing, with the absolute responsibility to ensure the physical condition and eligibility of the race horse. (3-20-20)T

**26. Veterinarian's List.** A list of all horses which are ineligible to be entered in any race due to a physical condition. (3-20-20)T

**27. Veterinarians' Reports.** The Medication Report Form completed by every veterinarian who treats a racehorse at any location under the jurisdiction of the Racing Commission. (3-20-20)T

**28. Veterinarian.** Practicing Private practitioner employed by owners and trainers on an individual case or contract basis. (3-20-20)T

**011. -- 019. (RESERVED)**

**020. ENTER, SEARCH AND INSPECT.**

Every Racing Association, the Racing Commission, the Stewards or trained and qualified agents of the Idaho State Police, have the right to enter, search and inspect the buildings, stables, rooms and other places where horses which are eligible to race are kept, or where property and effects of the licensee are kept within the grounds of the Racing Association. Any licensee accepting a license is deemed to have consented to such search and to the seizure of any non-approved or prohibited materials, chemicals, drugs or devices and anything apparently intended to be used in connection therewith. (3-20-20)T

**021. AUTHORITY OF THE COMMISSION VETERINARIAN.**

The Commission Veterinarian has the authority to supervise the actions of veterinarians licensed by the Racing Commission while they are practicing at any location under the jurisdiction of the Racing Commission. The commission veterinarian recommends to the Stewards or the Racing Commission disciplinary actions for any veterinarian who violates any Racing Commission rule. (3-20-20)T

**022. REPORT OF DISEASE.**

All practicing veterinarians must promptly notify the commission veterinarian of any reportable disease and any unusual incidence of a communicable illness in any horse in his charge. (3-20-20)T

**023. RESTRICTIONS OF WAGERING.**

A practicing veterinarian may not wager on the outcome of any race if the practicing veterinarian has treated a horse

participating in the race within the past thirty (30) days. (3-20-20)T

**024. -- 029. (RESERVED)**

**030. TREATMENT RESTRICTIONS.**

Except as otherwise provided by these rules, no person other than a veterinarian licensed to practice veterinary medicine in Idaho and licensed by the Racing Commission may administer a prescription or controlled medication, drug, chemical or other substance, including any medication, drug, chemical or other substance by injection, to a horse at any location under the jurisdiction of the Racing Commission. (3-20-20)T

**031. ADMINISTRATION OF NON-INJECTABLE SUBSTANCES.**

These rules do not apply to the administration of the following substances in approved quantitative levels present in post-race samples, if any, or as they may interfere with post-race testing: (3-20-20)T

**01. Nutritional Supplement.** A recognized non-injectable nutritional supplement or other substance approved by the commission veterinarian; (3-20-20)T

**02. Prescription.** A non-injectable substance on the direction or by prescription of a licensed veterinarian; or (3-20-20)T

**03. Non-Prescription.** A non-injectable non-prescription medication or substance. (3-20-20)T

**032. -- 034. (RESERVED)**

**035. HYPODERMIC NEEDLES.**

**01. Possession Prohibited.** No person may possess a hypodermic needle, syringe or injectable of any kind on Racing Association grounds, unless approved by the Racing Commission. (3-20-20)T

**02. Disposable Needles.** At any location under the jurisdiction of the Racing Commission, licensed veterinarians may use only one-time disposable needles, and must dispose of them in a manner approved by the Racing Commission. (3-20-20)T

**03. Medical Condition.** If a person has a medical condition that makes it necessary to have a syringe at any location under the jurisdiction of the Racing Commission, that person must: (3-20-20)T

**a.** Request permission of the Stewards or the Racing Commission in writing; (3-20-20)T

**b.** Furnish a letter from a licensed physician explaining why it is necessary for the person to possess a syringe; and (3-20-20)T

**c.** Comply with any conditions and restrictions set by the Stewards or the Racing Commission. (3-20-20)T

**036. -- 039. (RESERVED)**

**040. BANNED SUBSTANCES.**

**01. Banned Substances.** Any medication, drug, chemical, narcotic, anesthetic, or analgesic that is not specifically permitted by these rules is banned from use in horses that are eligible to race in Idaho and are located on the grounds of a racing association. (3-20-20)T

**02. Administration by Veterinarians.** All practicing veterinarians administering drugs, medications or other substances are responsible for ensuring that the drugs, medications or other substances and the veterinary treatment of horses are administered in accordance with these rules. (3-20-20)T

**041. -- 049. (RESERVED)**

**050. NON-PERMITTED MEDICATION.**

If the Stewards find that any non-permitted medication, drug, chemical, narcotic, anesthetic, or analgesic has been administered to a horse in such a manner that it is present in a pre-race or post-race test sample, such presence constitutes prima facie evidence of a violation of these rules. (3-20-20)T

**051. -- 059. (RESERVED)**

**060. MEDICATIONS.**

**01. Taking Samples.** The Commission Veterinarian, the Racing Commission, or any member of the Board of Stewards may take samples of any medicines or other materials suspected of containing improper medication, drugs or chemicals that would affect the racing condition of a horse in a race. (3-20-20)T

**02. Location.** Any substances found in stables or elsewhere on the grounds of a racing association or in the possession of any person connected with racing are subject to sampling. (3-20-20)T

**03. Testing.** Substances sampled must be delivered to a laboratory designated by the Racing Commission for testing. (3-20-20)T

**061. -- 069. (RESERVED)**

**070. ANTI-ULCER MEDICATIONS.**

The following anti-ulcer medications are permitted to be administered, at the stated dosage, up to twenty-four (24) hours prior to the race in which the horse is entered: (3-20-20)T

**01. Cimetidine (Tagamet®).** Dosage 8-20 mg/kg PO BID-TID. (3-20-20)T

**02. Omeprazole (Gastrogard®).** Dosage 2.2 grams PO SID. (3-20-20)T

**03. Ranitidine (Zantac®).** Dosage 8 mg/kg PO BID. (3-20-20)T

**071. -- 074. (RESERVED)**

**075. ENVIRONMENTAL CONTAMINANTS AND SUBSTANCES OF HUMAN USE.**

The following substances can be environmental contaminants in that they are endogenous to the horse or that they can arise from plants traditionally grazed or harvested as equine feed or are present in equine feed because of contamination during the cultivation, processing, treatment, storage or transportation phases. (3-20-20)T

**01. Caffeine.** Caffeine is recognized as a substance of human use and could be found in the horse due to its close association with humans. The regulatory threshold for caffeine is 100 nanograms of caffeine per milliliter of serum or plasma. (3-20-20)T

**02. Positive Test.** If the preponderance of evidence presented in a hearing shows that a positive test is the result of environmental contamination or inadvertent exposure due to human drug use it should be considered as a mitigating factor in any disciplinary action taken against the affected trainer. (3-20-20)T

**076. -- 099. (RESERVED)**

**100. TESTING FACILITIES.**

The Racing Commission may require the Racing Association to provide such facilities for medication, drug or other tests of a horse as may be required by the Racing Commission. (3-20-20)T

**101. -- 104. (RESERVED)**

**105. LABORATORY MINIMUM STANDARDS.**

Laboratories conducting either primary or split post-race sample analysis must meet at least the following minimum

standards: (3-20-20)T

**01. Lab Accreditation.** A testing laboratory must be accredited by a recognized accrediting body to any standards set forth and required by the Racing Commission. (3-20-20)T

**02. Instrumentation for Screening.** A testing laboratory must have, or have access to, LC/MS instrumentation for screening or confirmation purposes, or both. (3-20-20)T

**03. Standards of Detection.** A testing laboratory must be able to meet minimum standards of detection, which is defined as the specific concentration at which a laboratory is expected to detect the presence of a particular drug or metabolite, or both, or by the adoption of a regulatory threshold. (3-20-20)T

**106. -- 109. (RESERVED)**

**110. TESTING.**

**01. Testing.** The official winning horse and any other horse ordered by the Racing Commission or the Stewards must be taken to the testing area to have a blood, urine, saliva, hair, or any other acceptable specimen taken at the direction of the Commission Veterinarian. (3-20-20)T

**02. Examination.** Examination of the race winner or other designated horses must be made by the Commission Veterinarian or his assistant. (3-20-20)T

**03. Specimens.** All specimens must be collected by the Commission Veterinarian or his assistant. (3-20-20)T

**111. OUT-OF-COMPETITION TESTING.**

**01. Racing Commission Authority to Request Test.** The Racing Commission may request an out-of-competition testing (OCT) sample be collected and screened for any violation of Section 600 of these rules. (3-20-20)T

**02. Conditions for Racing Commission Request.** The Racing Commission may request any owner or trainer currently licensed by the Racing Commission to allow for an OCT sample be collected under any of the following conditions: (3-20-20)T

**a.** The horse is stabled on the grounds of a licensed race meet. (3-20-20)T

**b.** The horse is nominated or eligible for a stake or handicap race. (3-20-20)T

**c.** The registration certificate of the horse is currently on file with the racing association. If the horse selected is not currently stabled on the grounds, the owner or trainer shall present the horse to the test barn at a time designated by the commission. (3-20-20)T

**03. Horse Selection.** Horses will be selected for OCT by a Racing Commission veterinarian, steward, or executive secretary. (3-20-20)T

**04. Sample Collection and Split Samples.** Sample collection and split samples will be done in accordance with Sections 110 through 180 of these rules. (3-20-20)T

**05. Refusal to Submit.** Refusal to submit to an OCT sample request will result in penalties consistent with Sections 501, 990, and 995 of these rules. (3-20-20)T

**06. Qualified Horse.** If a horse that qualifies under Subsection 111.02 of this rule is selected for testing and is not stabled at a race meet licensed by the Racing Commission, the Racing Commission may approve a regulatory veterinarian from another jurisdiction to collect and submit the sample providing the process complies with Sections 110 through 180 of these rules. (3-20-20)T

**07. Penalties.** Penalties for a report of a positive laboratory finding in violation of this Section 111 will be consistent with Sections 501, 990, and 995 of these rules. (3-20-20)T

**112. -- 114. (RESERVED)**

**115. RANDOM OR EXTRA TESTING.**

Random or extra testing may be required by the Stewards or the Racing Commission at any time on any horse on Racing Association grounds. Unless otherwise directed by the Stewards or the Commission Veterinarian, a horse that is selected for testing must be taken directly to the testing area. (3-20-20)T

**116. -- 119. (RESERVED)**

**120. TRAINER PRESENT.**

**01. Present During Testing.** The Trainer, or his authorized representative, must be present in the testing area when a blood, urine, saliva, hair, or any other acceptable specimen is taken from a horse. (3-20-20)T

**02. Tag Signed.** The sample tag must be signed by the Trainer or his representative, as witness to the taking of the specimen. (3-20-20)T

**03. Refusal.** Willful failure to be present at or a refusal to allow the taking of such specimen, or any act or threat to impede or prevent or otherwise interfere therewith, subjects the person or persons doing so to immediate suspension by the Stewards and the matter will be referred to the Racing Commission for such further penalty as may be determined. (3-20-20)T

**121. -- 129. (RESERVED)**

**130. SPECIMENS.**

**01. Delivery to Approved Laboratory.** All specimens taken by or under direction of the Commission Veterinarian, or other authorized representative of the Racing Commission, must be delivered to the laboratory approved by the Racing Commission for official analysis. (3-20-20)T

**02. Number and Date.** Each specimen must be marked by number and date and may also bear such information as may be essential to its proper analysis. (3-20-20)T

**03. Identity.** The identity of the horse from which the specimen was taken or the identity of its Owner, Trainer, Jockey, or stable must not be revealed to the laboratory. (3-20-20)T

**04. Container.** The container of each specimen must be sealed as soon as the specimen is placed therein and must bear the name of the Racing Commission. (3-20-20)T

**131. -- 139. (RESERVED)**

**140. DETERMINATION OF SAMPLE.**

**01. Minimum Sample.** The commission veterinarian will determine a minimum sample requirement for the primary testing laboratory. (3-20-20)T

**02. Less Than The Minimum.** If the specimen obtained from a horse is less than the minimum sample requirement, the entire specimen must be sent to the primary testing laboratory. (3-20-20)T

**03. More Than The Minimum.** If a specimen obtained is greater than the minimum sample requirement, the portion of the sample that is greater than the minimum sample requirement may be secured as the split sample if proper storage capabilities exist. (3-20-20)T

**141. -- 149. (RESERVED)**

**150. STORAGE AND SHIPMENT OF SPLIT SAMPLES.**

Split samples obtained in accordance with Subsection 140.03 of these rules, must be secured and made available for further testing in accordance with the following procedures: (3-20-20)T

**01. Secured.** A split sample must be secured under the same manner as the portion of the specimen acquired for shipment to a primary laboratory until such time as specimens are packed and secured for shipment to the primary laboratory. (3-20-20)T

**02. Transfer of Samples.** Split samples must then be transferred to a freezer or other approved storage container, at a secure location approved by the Racing Commission. (3-20-20)T

**151. -- 159. (RESERVED)**

**160. TESTING SPLIT SAMPLES.**

After having been notified that a written report from a primary laboratory stating that a prohibited substance has been identified in a specimen obtained pursuant to these rules, a trainer or owner of a horse may request that a split sample, corresponding to the portion of the specimen tested by the primary laboratory, be sent to another laboratory approved by the Racing Commission. (3-20-20)T

**01. Submission of Testing Request.** A formal request for split sample testing must be made in writing and delivered to the Stewards not later than three (3) business days after the trainer of the horse receives written notice of the findings of the primary laboratory. The request must include the requesting trainer or owner's top three (3) referee laboratory choices. Any request for split sample testing not received by the specified deadline, and/or without all the required information, is considered invalid. (3-20-20)T

**02. Lab's Willingness to Test.** Upon receipt of the written request for split sample testing, the Racing Commission will confirm the referee laboratory has agreed to accommodate the request and provide official test results to the Racing Commission. The Racing Commission will identify the confirmed referee laboratory to the requesting owner or trainer to arrange for payment of shipping costs and testing services costs. (3-20-20)T

**03. Shipping and Testing Fees.** The requesting owner or trainer is entirely responsible for all costs and fees associated with sample shipment and testing services. Payment for sample shipment must be made to the Commission Veterinarian, or his authorized designee, prior to shipment of the split sample. Once the Racing Commission has received confirmation of payment of necessary fees required for split sample testing, the requested split samples will be shipped to the referee laboratory within ten (10) business days. Shipments are mailed only on Monday, Tuesday or Wednesday to avoid the samples sitting in a warehouse unrefrigerated over a weekend if there is a problem in transit. (3-20-20)T

**04. Unforeseen Circumstances.** (3-20-20)T

**a.** If the Racing Commission is unable to secure the services of a referee laboratory, the Racing Commission has the option to request the primary laboratory to conduct the split sample testing. The owner and trainer affected will be notified by the Racing Commission. (3-20-20)T

**b.** If the Racing Commission is unable to contact the affected trainer or owner by telephone or last known location, the Racing Commission may proceed with split sample testing by the primary laboratory. (3-20-20)T

**c.** If an Act of God, power failure, accident, strike, or other action that is beyond the control of the Racing Commission prevents a split sample from being tested, the test results of the primary laboratory will be accepted as prima facie evidence. (3-20-20)T

**05. Split Sample Test Results.** The referee laboratory sends the results of the split sample test to the Racing Commission and the Racing Commission will forward those results simultaneously to the requesting owner or trainer as quickly as possible. (3-20-20)T



**a.** If the split sample testing confirms the findings of the primary laboratory, it is considered a prima facie violation of the applicable provisions of this chapter. (3-20-20)T

**b.** If the split sample testing does not substantially confirm the findings of the primary laboratory, it does not constitute a prima facie violation of this chapter and no penalty will be imposed by the Racing Commission. (3-20-20)T

**161. -- 179. (RESERVED)**

**180. CHAIN OF CUSTODY.**

The Racing Commission will provide a split sample chain of custody verification form. (3-20-20)T

**181. -- 199. (RESERVED)**

**200. NON-STEROIDAL ANTI-INFLAMMATORY DRUGS.**

**01. Exception.** No horses may be entered into a race utilizing a Non-Steroidal Anti-Inflammatory Drug, except DMSO, unless: (3-20-20)T

**a.** The Trainer and Veterinarian of the horse submit to the Commission Veterinarian the Non-Steroidal Anti-Inflammatory Drug Request Form; and (3-20-20)T

**b.** The Commission Veterinarian has granted written approval for the use. (3-20-20)T

**02. Procedures.** The Commission Veterinarian must establish and publish reasonable procedures pertaining to use of the Non-Steroidal Anti-Inflammatory Drug Request Form. (3-20-20)T

**03. Posted.** A copy of the established procedures must be posted in the office of the Racing Secretary. (3-20-20)T

**201. -- 209. (RESERVED)**

**210. NON-STEROIDAL ANTI-INFLAMMATORY DRUG REQUEST FORM.**

The Non-Steroidal Anti-Inflammatory Drug Request Form submitted to the Commission Veterinarian must include and be processed as follows: (3-20-20)T

**01. Name of Horse.** The name, age, sex and breed of the horse; (3-20-20)T

**02. Name of Trainer and Veterinarian.** The name of the licensed Trainer and veterinarian; (3-20-20)T

**03. Nature of Injury.** The nature of the horse's injury or disease as determined by an examination by a qualified and duly licensed veterinarian; (3-20-20)T

**04. Name of Drug Requested.** The name of the Non-Steroidal Anti-Inflammatory drug requested and the proposed time and method of administration; (3-20-20)T

**05. Signature.** Signature of Trainer and veterinarian attending the horse and the Commission Veterinarian. (3-20-20)T

**06. Filing.** The trainer or veterinarian attending the horse must file the completed request form with the racing secretary. (3-20-20)T

**211. -- 219. (RESERVED)**

**220. APPROVAL OF NON-STEROIDAL ANTI-INFLAMMATORY DRUG REQUEST.**

The Commission Veterinarian will approve the Non-Steroidal Anti-Inflammatory Drug request only if: (3-20-20)T

**01. Professional Judgment.** In the exercise of his professional judgment, a need for the use of the Non-Steroidal Anti-Inflammatory Drug for the particular horse's injury or disease has been satisfactorily demonstrated. (3-20-20)T

**02. Professional Diagnosis.** In arriving at the decision, the Commission Veterinarian may take into account or rely upon the written professional diagnosis made by a qualified and duly licensed veterinarian. (3-20-20)T

**221. -- 229. (RESERVED)**

**230. EXPIRATION OF APPROVAL.**  
Approved medication may be discontinued with permission of the Commission Veterinarian. (3-20-20)T

**231. -- 239. (RESERVED)**

**240. PERMITTED NON-STEROIDAL ANTI-INFLAMMATORY DRUGS.**  
The only Non-Steroidal Anti-Inflammatory Drugs permitted by these rules are: (3-20-20)T

**01. Phenylbutazone (Butazoladin);** (3-20-20)T

**02. Mechlofenamic Acid (Arquel);** (3-20-20)T

**03. Flunixin (Banamine); and** (3-20-20)T

**04. Ketoprofen (Ketofen).** (3-20-20)T

**241. -- 249. (RESERVED)**

**250. DAILY RACING PROGRAM.**  
Horses that are on a Non-Steroidal Anti-Inflammatory Drug must be indicated on the daily racing programs or any other publications and a list of horses on a Non-Steroidal Anti-Inflammatory Drug will be posted at a location designated by the Racing Commission. (3-20-20)T

**251. -- 259. (RESERVED)**

**260. NON-STEROIDAL ANTI-INFLAMMATORY DRUG ADMINISTRATION.**  
No Non-Steroidal Anti-Inflammatory Drug may be administered to the horse later than twenty-four (24) hours prior to the time the horse is scheduled to race. Only one (1) Non-Steroidal Anti-Inflammatory Drug may be in a horse's system on race day. (3-20-20)T

**261. -- 264. (RESERVED)**

**265. BLEEDER TREATMENT.**

**01. Written Approval Needed.** Epistaxis treatment for bleeders is permitted as a race day medication provided that written approval of the Commission Veterinarian is obtained prior to race day treatment on the Medication Request Form. (3-20-20)T

**02. Bleeders.** Bleeders that have been running under Epistaxis treatment must obtain written approval of the Commission Veterinarian prior to entry in any race before running without similar treatment. (3-20-20)T

**03. Premarin.** Premarin is a permissible Epistaxis treatment and may be used up to two (2) hours before post time. (3-20-20)T

**04. Lasix.** Lasix is a permissible Epistaxis treatment. (3-20-20)T

**266. -- 269. (RESERVED)**

**270. IDAHO BLEEDER LIST.**

Any horse which exhibits symptoms of Epistaxis or respiratory tract hemorrhage is eligible for placement on the Idaho Bleeder List and for treatment on race days with approved medication to prevent or limit bleeding during racing. (3-20-20)T

**01. Placed on Idaho Bleeder List.** To be placed on the Idaho Bleeders List a horse must be found to have shed free blood from one (1) or both nostrils or bled internally in the respiratory tract during or immediately following a race or workout. The Commission Veterinarian, following his personal examination of a horse or after consulting with the horses' private veterinarian, may certify a horse as a bleeder. (3-20-20)T

**02. Bleeder.** (3-20-20)T

**a.** Any horse that bleeds a second time in Idaho will not be able to race for a period of thirty (30) days from the date of the second bleeding offense. (3-20-20)T

**b.** Any horse that bleeds a third time in Idaho, and each time thereafter, will be suspended from racing for a period of one (1) year from the date of each bleeding offense. (3-20-20)T

**03. Bleeder from Another Jurisdiction.** A bleeder horse shipped into Idaho from another racing jurisdiction must comply with Racing Commission rules. Any horse on a bleeder list in another racing jurisdiction may be placed on the Idaho Bleeder List provided a current certificate from the jurisdiction where it was confirmed on the bleeder list, or a letter from the horses private veterinarian, who is currently licensed by the racing jurisdiction, is presented to the Commission Veterinarian for his approval. (3-20-20)T

**04. Removal from Bleeder List.** The Commission Veterinarian may remove a horse from the Idaho Bleeder List, provided the proper paperwork is complete and it is the recommendation of the licensed veterinarian treating the horse, or after an examination by the Commission Veterinarian, it is determined that the horse is not a bleeder and is no longer eligible for the Bleeder List. (3-20-20)T

**271. -- 279. (RESERVED)**

**280. URINE SAMPLES.**

**01. Phenylbutazone.** No urine sample taken from a horse authorized to use phenylbutazone may exceed one hundred sixty-five (165) micrograms total of phenylbutazone or its metabolites per milliliter of urine. (3-20-20)T

**02. Lasix.** Any horse whose post-race urine creatinine is less than forty (40) milligrams creatinine per one hundred (100) milliliters urine, and the ratio of urine furosemide to urine creatinine does not exceed fifteen hundredths (.15), with urine furosemide being measured in micrograms per milliliter of urine will be said to be positive for Lasix overage. (3-20-20)T

**281. -- 289. (RESERVED)**

**290. BLOOD SAMPLES.**

No blood sample taken from a horse authorized to use the following substances may exceed these limits: (3-20-20)T

**01. Phenylbutazone.** May not exceed five (5) micrograms of phenylbutazone or oxyphenbutazone per milliliter of plasma; (3-20-20)T

**02. Flunixin (Banamine).** May not exceed twenty (20) nanograms per milliliter of plasma. (3-20-20)T

**03. Mechlofenamic Acid (Arquel).** May not exceed one (1) microgram per milliliter of plasma. (3-20-20)T

**04. Ketoprofen (Ketofen).** May not exceed ten (10) nanograms per milliliter of plasma. (3-20-20)T

**05. Lasix (Furosemide)** May not exceed one hundred (100) nanograms of furosemide per milliliter of plasma. (3-20-20)T

**291. HAIR TESTING.**

No hair sample taken from a horse may contain any prohibited drug or other non-approved medication. (3-20-20)T

**01. Racing Commission Authority.** The Racing Commission is authorized to collect and submit hair samples for testing in quarter horses and mixed breed races. Hair samples will be collected consistent with Section 111 of these rules. (3-20-20)T

**02. Presence of Prohibited Substances.** The presence of any prohibited substances that appears in a pre or post-race sample including, but not limited to, Clenbuterol, Zilpaterol, and Ractopamine in Quarter Horse and mixed breed races will constitute a violation. Any report of prohibited or non-permitted medication in a hair sample will result in the horse being placed on a stewards list for sixty (60) days. A horse must provide a negative hair test prior to removal from list. (3-20-20)T

**03. Positive Finding for Prohibited Substance.** Samples collected for out-of-competition testing in Quarter Horses and mixed breed horses that result in a positive finding for a prohibited substance as listed in Section 600 of these rules will be reported to the Board of Stewards and considered a violation. The presence of Clenbuterol in an out-of-competition test in a Quarter Horse will result in the horse being placed on the official veterinarians list for a minimum of sixty (60) days or until a sample is submitted and is reported as negative for the presence of Clenbuterol. If, at the owner's request, a sample is submitted for screening for removal from the official veterinarians list, the owner is responsible for the cost of the testing. (3-20-20)T

**04. Hair Sample.** If a horse is selected for hair testing and the mane is less than four and one-half inches (4 1/2") in length, the Racing Commission may elect to collect a hair sample using the tail. (3-20-20)T

**292. -- 299. (RESERVED)**

**300. LASIX ADMINISTRATION.**

**01. Time of Treatment.** Horses on the Bleeder List must be treated at least four (4) hours prior to post time with the bleeder medication furosemide (ie. Lasix). (3-20-20)T

**02. Dosage.** Bleeder medication must be administered in the manner and at a dose level approved by the Commission Veterinarian, such dosage not to exceed two hundred fifty (250) mg. (3-20-20)T

**03. Witness.** At his request, the Commission Veterinarian or his designee may witness the administration of Lasix by the trainer's private licensed veterinarian. (3-20-20)T

**04. Reporting.** Administration of Lasix must be reported in writing, on the form designated by the Racing Commission, to the Commission Veterinarian no later than three (3) hours prior to the scheduled post time of the last live race of the program. (3-20-20)T

**301. -- 319. (RESERVED)**

**320. HORSES NOT STABLED ON GROUNDS.**

Any horse on the Idaho Bleeder List that is not stabled on the actual grounds of the Racing Association where it is to race must be brought on to the grounds of the Racing Association where it is scheduled to race at least five (5) hours prior to the post time for the race for which it is entered. (3-20-20)T

**321. -- 399. (RESERVED)**

**400. BICARBONATE TESTING.**

**01. Administration Prohibited.** No bicarbonate-containing substance or alkalizing substance that effectively alters the serum or plasma pH or concentration of bicarbonates or carbon dioxide in a horse may be administered to a horse on race day. (3-20-20)T

**02. Positive Test Level.** Test samples collected from a horse either before or within one (1) hour following a race may not exceed thirty-seven point zero (37.0) millimoles of total carbon dioxide concentration per liter of serum or plasma. A serum total carbon dioxide level exceeding this value constitutes a positive test. (3-20-20)T

**03. Collection of Test Samples.** The Commission Veterinarian, the Board of Stewards, or the Executive Director acting on behalf of the Racing Commission may at their discretion and at any time order the collection of test samples from any horses ordered to the test area to determine the serum or plasma pH or concentration of bicarbonate, carbon dioxide, or electrolytes. A sample consisting of at least thirteen (13) ml in a SST tube must be taken from any horse either just prior to a race or up to one (1) hour after a race to determine the serum total carbon dioxide concentration. If the primary testing laboratory finds that the total carbon dioxide levels in the tubes exceed the standard test values of thirty-seven point zero (37.0) millimoles per liter, this may be grounds for disciplinary action. (3-20-20)T

**04. Split Sample Testing Prohibited.** When taking samples for total carbon dioxide levels, split samples are prohibited. The procedures for split sample testing does not apply to bicarbonate testing procedures. (3-20-20)T

**401. -- 499. (RESERVED)**

**500. PROTECTION OF HORSES.**

The Trainer, groom and any other person having charge, custody or care of a horse is obligated to properly protect the horse and guard it against actual or attempted administration of drugs. If the Stewards find that any person has failed to properly protect and guard a horse, they may impose such penalty and take such other action as they deem proper. (3-20-20)T

**501. ILLEGAL PRACTICES BY TRAINER.**

**01. Disciplinary Sanctions.** A trainer who is found to have committed illegal practices under the statutes or rules, or both, that govern live horse racing in Idaho is subject to disciplinary sanctions, which may be levied by a fine up to two thousand five hundred dollars (\$2,500), license suspension or license revocation. (3-20-20)T

**02. Disqualification for Non-Permitted Substance.** If a horse tests positive for any substance (medication, drug, chemical, narcotic, anesthetic, or analgesic) not specifically permitted by these rules by either a pre- or post-race laboratory test, that horse is deemed ineligible to have raced in the race and will be disqualified retroactively to the start of the affected race. If such disqualification occurs, the horse's owner(s) shall, within five (5) calendar days, return the entire amount of the purse or sweepstakes or trophy that was awarded in the affected race and the same will be redistributed. If the affected race is a qualifying race for a subsequent race and if a horse is disqualified, the eligibility of other horses that ran in the affected race and that have started in the subsequent race before announcement of such disqualification will not in any way be affected. (3-20-20)T

**502. -- 599. (RESERVED)**

**600. NON-APPROVED MEDICATION.**

**01. Administration by Owner or Trainer.** A horse owner or trainer found to have administered any non-approved medication substances is in violation of these rules. (3-20-20)T

**02. Clenbuterol.** A finding of Clenbuterol is prohibited in blood, urine, saliva, hair, or any other acceptable specimen. (3-20-20)T

**601. -- 699. (RESERVED)**

**700. MEDICATION REPORT FORM.**

**01. Submission of Medication Report Form.** All practicing licensed Veterinarians must submit daily to the Commission Veterinarian a Medication Report Form furnished by the Racing Commission. (3-20-20)T

**02. Content of Medication Report Form.** The form must contain the following information: (3-20-20)T

**a.** The name, age, sex and breed of the horse; (3-20-20)T

**b.** The permitted drug used; (3-20-20)T

**c.** The time the permitted drug was administered; and (3-20-20)T

**d.** The route and dosage of the administration. (3-20-20)T

**03. Signed and Dated.** The report must be dated and signed by the licensed Veterinarian so administering the medication. (3-20-20)T

**04. Confidential.** Any such report is confidential and its content may not be disclosed except in a proceeding before the Stewards or the Racing Commission or in the exercise of the Racing Commission's jurisdiction. (3-20-20)T

**701. -- 989. (RESERVED)**

**990. PENALTIES.**

Any person violating any of the provision of these rules is subject to the penalties provided for in Title 54, Chapter 25 Idaho Code and any of the Racing Commission rules. (3-20-20)T

**991. -- 994. (RESERVED)**

**995. VIOLATIONS.**

Any person violating any of the provisions of these rules is subject to the penalties provided for in Title 54, Chapter 25, Idaho Code and any of the Racing Commission rules. (3-20-20)T

**01. First Violation.** The first violation of these rules will result in the issuance of a fine to the horse's Trainer and such other penalty deemed appropriate. (3-20-20)T

**02. Second Violation.** The second violation of this chapter by the same Trainer during the same calendar year will result in a suspension, a fine and such other penalty deemed appropriate. (3-20-20)T

**03. Third Violation.** A third violation of this chapter will be referred to the Racing Commission for appropriate action up to and including revocation of license. (3-20-20)T

**04. Not Detected.** If a Non-Steroidal Anti-inflammatory Drug other than DMSO is not detected in the urine or in any other specimen taken from a horse authorized to use the Non-Steroidal Anti-Inflammatory Drug, a fine up to five hundred dollars (\$500) may be imposed upon the horse's Trainer without loss of purse. (3-20-20)T

**05. Detected.** If a Non-Steroidal Anti-Inflammatory Drug is detected in the urine or in any other specimen taken from a horse not authorized to use the Non-Steroidal Anti-Inflammatory Drug, the violation will result in loss of purse and the horse's Trainer is subject to such penalties deemed appropriate. (3-20-20)T

**996. -- 999. (RESERVED)**

**11.04.15 – RULES GOVERNING CONTROLLED SUBSTANCE AND ALCOHOL TESTING  
OF LICENSEES AND APPLICANTS**

**000. LEGAL AUTHORITY.**

This chapter is adopted pursuant to the legal authority of Title 54, Chapter 25, of the Idaho Code. (3-20-20)T

**001. TITLE AND SCOPE.**

**01. Title.** These rules are cited as IDAPA 11.04.15, “Rules Governing Controlled Substance and Alcohol Testing of Licensees and Applicants,” of the Idaho State Racing Commission. (3-20-20)T

**02. Scope.** These rules govern controlled substance and alcohol testing of licensees and applicants by the Idaho State Racing Commission. (3-20-20)T

**002. -- 009. (RESERVED)**

**010. DEFINITIONS.**

In addition to the definitions in Title 54, Chapter 25, Idaho Code, the following apply: (3-20-20)T

**01. Alcohol.** The intoxicating agent in beer, wine, or liquor, as the terms are defined in Title 23, Idaho Code, and includes ethyl, methyl, and isopropyl alcohols. (3-20-20)T

**02. Applicant.** Any person who has applied to the Racing Commission for a license. (3-20-20)T

**03. Controlled Substance.** A drug, substance, or immediate precursor listed in schedules I through V of Article II of Title 37, Chapter 27, Idaho Code. (3-20-20)T

**04. Licensee.** Any person who has been issued a license by the Racing Commission. (3-20-20)T

**05. Person.** Any individual, association, partnership, firm, joint stock company, joint venture, trust, estate, political subdivision, public or private corporation, or any legal entity, which is recognized by law as the subject of rights and duties. (3-20-20)T

**06. Racing Association.** Any person licensed by the Racing Commission to conduct live horse races and pari-mutuel wagering. (3-20-20)T

**07. Reasonable Suspicion.** Behavior or pattern of behavior indicates that the licensee or applicant is under the influence of a controlled substance or alcohol. The basis of the suspicion may be a specific, contemporaneous event or conduct that has been observed over a period of time. (3-20-20)T

**08. Suspension.** A temporary remedial measure designed to protect the safety and integrity of the horse racing industry and the participants therein. (3-20-20)T

**09. Sample.** A urine sample collected for the purpose of drug testing, or a blood, breath, or saliva sample collected for the purpose of alcohol testing. (3-20-20)T

**011. -- 019. (RESERVED)**

**020. PRIMARY PURPOSE.**

In order to protect the integrity of horse racing in the state of Idaho, to protect the health and welfare of licensees and applicants engaged in horse racing within the state of Idaho, to prevent exploitation of the public, licensees and applicants engaged in horse racing in the state of Idaho, to foster fairness of competition within the racing industry and in order to protect public safety within the state of Idaho, the Racing Commission intends to regulate the use of any controlled substance and alcohol at all race meets licensed by it. (3-20-20)T

**021. -- 049. (RESERVED)**

**050. USE OF CONTROLLED SUBSTANCES.**

No licensee or applicant may have within their body any unauthorized controlled substance while within the enclosure of or on the premises managed by any racing association or the Racing Commission. (3-20-20)T

**051. -- 059. (RESERVED)**

**060. CONSUMPTION OF ALCOHOL.**

No jockey, starter, assistant starter, pony person, outrider, or racing official may have present within his body any amount of alcohol while participating in any horse race held that day. (3-20-20)T

**061. -- 099. (RESERVED)**

**100. TESTING.**

The Board of Stewards, or the Racing Commission acting through the executive director, may require any licensee or applicant to provide blood, urine, or saliva samples for the purpose of drug or alcohol analysis under either of the following circumstances: (3-20-20)T

**01. Random Testing.** As part of a random testing program. (3-20-20)T

**02. Reasonable Suspicion.** When the Board of Stewards finds that there is reasonable suspicion to believe that the proposed testee has used any controlled substance. (3-20-20)T

**101. -- 119. (RESERVED)**

**120. POST-ACCIDENT TESTING.**

At its discretion the Board of Stewards may conduct post-accident controlled substance or alcohol testing of any licensee or applicant who is involved in a racing or job-related accident on the track or on racing association grounds that requires treatment away from the scene of the accident. (3-20-20)T

**121. -- 129. (RESERVED)**

**130. REFUSAL TO TEST.**

**01. Refusal to Supply a Sample.** When any licensee or applicant is requested to submit to a drug test in a manner prescribed in these rules, the person must do so in a prompt manner. Refusal to supply such sample will result in: (3-20-20)T

**a.** The immediate suspension of the licensee or applicant; and (3-20-20)T

**b.** A hearing before the Board of Stewards in accordance with IDAPA 11.04.04, "Rules Governing Disciplinary Hearings and Appeals," Section 050. (3-20-20)T

**02. Suspended from Racing for Refusal to Test.** (3-20-20)T

**a.** If the Board of Stewards finds at the hearing that said refusal to test occurred, the licensee or applicant will be suspended from racing for seven (7) calendar days and be subject to random testing for one (1) year. (3-20-20)T

**b.** In the event of a finding of just cause the licensee or applicant must submit to a test immediately once the conditions which justly prevented testing abate or can be eliminated. (3-20-20)T

**03. Subject to Random Testing.** In the event a licensee or applicant refuses to test when requested after previously refusing to test or previously testing positive for drugs, that licensee or applicant will be suspended from racing for a period of ninety (90) calendar days and subject to random testing for a period of one (1) year. (3-20-20)T

**131. -- 149. (RESERVED)**

**150. TESTING PROCEDURE.**

**01. Accordance with Established Procedures.** Testing must be done in accordance with established medical and law enforcement procedures in the state of Idaho. (3-20-20)T



**02. Retesting.** The sample may be retested at the request of the licensee or applicant at either the laboratory used by the Racing Commission or a separate laboratory selected from a list provided by the Racing Commission. The licensee or applicant is responsible for all costs associated with the retesting of the sample.

(3-20-20)T

**151. -- 199. (RESERVED)**

**200. A POSITIVE TEST.**

On receiving written notice from the approved laboratory that a sample has been found positive for a controlled substance, the Racing Commission will initiate the following procedure:

(3-20-20)T

**01. Notification.** The Racing Commission, through the Executive Director, will notify the presiding Steward and forward the test results to the Board of Stewards.

(3-20-20)T

**02. Hearing Set.** The Board of Stewards will set a hearing in accordance with IDAPA 11.04.04, "Rules Governing Disciplinary Hearings and Appeals," within the next two (2) racing days or seven (7) calendar days, whichever is less, after they receive notice of a positive test from the Executive Director.

(3-20-20)T

**03. Written Notice.**

(3-20-20)T

**a. Notice of Hearing.** Written notice of the hearing must be given to the licensee or applicant as soon as the hearing date is set. The hearing may be held within a shorter or longer period of time if the licensee, employee, or applicant named and the Board of Stewards agree.

(3-20-20)T

**b. Service of Notice.** Service must be to the licensee or applicant personally by leaving the notice at the person's residence with someone of reasonable age and discretion residing therein, or by mail to the person's last known address. If by mail, service is deemed completed on the third day after mailing.

(3-20-20)T

**04. Opportunity for Explanation.** The hearing will be conducted before the Board of Stewards pursuant to IDAPA 11.04.04, "Rules Governing Disciplinary Hearings and Appeals." At the hearing, the licensee or applicant will be provided an opportunity to present evidence and explain the positive test.

(3-20-20)T

**05. Confidentiality.** The Board of Stewards' hearing must be closed and the facts therein will be kept confidential, unless for use with respect to any subsequent contested hearing or order by the Racing Commission or judicial hearing with regard to such facts. Closure of the hearing and confidentiality of the proceedings may be waived by the licensee, employee, or applicant.

(3-20-20)T

**06. Lacking Satisfactory Explanation.** Lacking a satisfactory explanation and documentation or upon the licensee or applicant agreeing with the test results, the Board of Stewards will suspend the licensee or applicant in accordance with Section 220 of these rules.

(3-20-20)T

**201. -- 219. (RESERVED)**

**220. PROCEDURES FOLLOWING A POSITIVE CHEMICAL ANALYSIS.**

**01. First Positive Test.** For a licensee's or applicant's first positive drug test he will not be allowed to participate in racing for seven (7) calendar days and until such time as he has received a substance abuse evaluation and has begun the recommended rehabilitation program. Additionally, the licensee or applicant will be subject to random testing for a period of one (1) year from the date the positive sample was taken.

(3-20-20)T

**02. After Evaluation.** After such evaluation, but not before the tolling of the seven (7) calendar days awarded in Subsection 220.01 of these rules, if said licensee's or applicant's condition proves non-addictive and not detrimental to the best interest of racing, said licensee or applicant will be allowed to participate in racing provided he can produce a negative test result from a laboratory approved by the Racing Commission and agrees to further testing at the discretion of the Stewards or designated Racing Commission representative to ensure his unimpaired.

(3-20-20)T

**03. Second Violation.** For a licensee's or applicant's second violation, he will be suspended for ninety (90) consecutive days and until he provides the Stewards with documentation that he has enrolled and is progressing satisfactorily in a certified drug rehabilitation program approved by the Racing Commission. (3-20-20)T

**04. Third Violation.** For a licensee's or applicant's third violation, he will be suspended and the case referred to the Racing Commission for consideration of revocation of the individual's license. (3-20-20)T

**221. -- 249. (RESERVED)**

**250. CONFIDENTIALITY OF TEST RESULTS.**

All test results are obtained as part of an inquiry into a person's fitness to be granted or to retain a license and are exempt from public disclosure pursuant to Section 9-304C, Idaho Code. A statistical summary will be made available annually. (3-20-20)T

**251. -- 299. (RESERVED)**

**300. TESTING EXPENSE.**

Except for retesting requested by a licensee or applicant, all testing ordered pursuant to these rules, whether blood, urine, or breath, will be at the expense of the Racing Commission. All expense of drug or alcohol evaluation, treatment, reports, and fees will be at the expense of the licensee or applicant undergoing such evaluation or treatment. (3-20-20)T

**301. -- 999. (RESERVED)**

**IDAPA 11 – IDAHO STATE POLICE  
IDAHO PUBLIC SAFETY AND SECURITY INFORMATION SYSTEM  
DOCKET NO. 11-1001-2000F (FEE RULE)  
NOTICE OF OMNIBUS RULEMAKING – ADOPTION OF TEMPORARY RULE**

**EFFECTIVE DATE:** The effective date of the temporary rule(s) being adopted through this omnibus rulemaking is the adjournment date of the second regular session of the 65th Idaho State Legislature - March 20, 2020.

**AUTHORITY:** In compliance with Sections 67-5226, Idaho Code, notice is hereby given this agency has adopted a temporary rule. The action is authorized pursuant to Sections 19-5201 - 5204, Idaho Code.

**DESCRIPTIVE SUMMARY:** The following is the required finding and concise statement of its supporting reasons for adopting the temporary rule:

ILETS is a dedicated data communication network that links local, state, federal and foreign criminal justice agencies to state records and files, and to the National Crime Information Center (NCIC), which includes criminal history data and files on wanted or missing persons, orders of protection, property and other files critical to criminal justice and public protection. Through ILETS, information and identification services are provided that assist law enforcement agencies to detect and apprehend criminals, promoting public and officer safety, and supporting the criminal justice system in the prosecution, adjudication, and correctional supervision of offenders. This IDAPA rule is necessary to support the operation and connection of ILETS to other state and national criminal history data, provide a vital connection that is not available in any other agency, form, or process.

This temporary rulemaking adopts the following chapter under IDAPA 11, Title 10:

**IDAPA 11**

- *11.10.01, Rules Governing Idaho Public Safety and Security Information System*

**TEMPORARY RULE JUSTIFICATION:** Pursuant to Sections 67-5226(1) and 67-5226(2), Idaho Code, the Governor has found that temporary adoption of the rule is appropriate for the following reasons:

These temporary rules are necessary to protect the public health, safety, and welfare of the citizens of Idaho and confer a benefit on its citizens. These temporary rules implement the duly enacted laws of the state of Idaho, provide citizens with the detailed rules and standards for complying with those laws, and assist in the orderly execution and enforcement of those laws. The expiration of these rules without due consideration and processes would undermine the public health, safety, and welfare of the citizens of Idaho and deprive them of the benefit intended by these rules.

**FEE SUMMARY:** Pursuant to Section 67-5226(2), the Governor has found that the fees or charges being imposed or increased are justified and necessary to avoid immediate danger and the fees are described herein:

The fees or charges, authorized in Section 19-5202(4), Idaho Code, are part of the agency's 2021 budget that relies upon the existence of these fees or charges to meet the state's obligations and provide necessary state services. Failing to reauthorize these temporary rules would create immediate danger to the state budget, immediate danger to necessary state functions and services, and immediate danger of a violation of Idaho's constitutional requirement that it balance its budget.

The following is a specific description of the fees or charges:

All law enforcement agencies with a signed user agreement and a direct terminal connection or system access to the ILETS network pay access and usage fees based on that agency's percentage of total annual messages sent and received by the agency through the ILETS message switcher. The total percentage for an agency includes the message traffic generated by any other agency authorized to access ILETS through that agency's direct terminal or system access.

**ASSISTANCE ON TECHNICAL QUESTIONS:** For assistance on technical questions concerning the temporary rule, contact Bureau Chief Leila McNeill, phone 208-884-7136, fax 208-884-7193, email [Leila.mcneill@isp.idaho.gov](mailto:Leila.mcneill@isp.idaho.gov).

DATED this February 21, 2020.

Charlie Spencer  
Police Services Major  
Rules Review Officer  
Idaho State Police  
700 S. Stratford Dr.  
Meridian, ID 83642  
[Charlie.spencer@isp.idaho.gov](mailto:Charlie.spencer@isp.idaho.gov)  
Phone 208-884-7203  
Fax 208-884-7290

**IDAPA 11 – IDAHO STATE POLICE  
IDAHO PUBLIC SAFETY AND SECURITY INFORMATION SYSTEM**

**11.10.01 – RULES GOVERNING IDAHO PUBLIC SAFETY AND SECURITY INFORMATION SYSTEM**

**000. LEGAL AUTHORITY.**

Title 19, Chapter 52, Idaho Code, creates an information system board and authorizes it to make rules necessary to establish and operate the Idaho Public Safety and Security Information System, known as "ILETS." (3-20-20)T

**001. TITLE AND SCOPE.**

**01. Title.** These rules are cited as IDAPA 11.10.01, "Rules Governing Idaho Public Safety and Security Information System." (3-20-20)T

**02. Scope.** These rules relate to the governance and operation of the Idaho Public Safety and Security Information System. (3-20-20)T

**002. INCORPORATION BY REFERENCE.**

**01. Incorporated Documents.** IDAPA 11.10.01 incorporates by reference the full text of the requirements relating to criminal justice information and the system used to transport such information found in the following documents: (3-20-20)T

**a.** "Criminal Justice Information Systems," 28 CFR Part 20 (July 1, 2006); (3-20-20)T

**b.** "Criminal Justice Information Systems--CJIS Security Policy," Federal Bureau of Investigation, Criminal Justice Information Services (CJIS) Division, Version 5.8 (June 2019); (3-20-20)T

**c.** "National Crime Information Center 2000, Operating Manual," Federal Bureau of Investigation, National Crime Information Center (August 2015); (3-20-20)T

**d.** The International and Public Safety Network, NLETS, Users Guide, (October 19, 2012); (3-20-20)T

**e.** The International and Public Safety Network, NLETS, Policies and Procedures, (October 19, 2012). (3-20-20)T

**02. Document Availability.** The above listed documents are available during normal working hours for inspection and copying at the Idaho State Police. (3-20-20)T

**003. -- 009. (RESERVED)**

**010. DEFINITIONS.**

**01. Access Agency.** An agency that electronically accesses ILETS through the services of an interface agency. (3-20-20)T

**02. Administration of Criminal Justice.** (3-20-20)T

**a.** Performance of any of the following activities: detection, apprehension, detention, pretrial release, post-trial release, prosecution, adjudication, correctional supervision, or rehabilitation of accused persons or criminal offenders. (3-20-20)T

**b.** It also includes: criminal identification activities; and collection, storage, and dissemination of criminal history record information. (3-20-20)T

**03. Associated System.** Any automated or manual information system that is accessible through ILETS. (3-20-20)T

**04. Board.** The Board created by Title 19, Chapter 52, Idaho Code to establish priorities and operational policies and procedures relating to ILETS. (3-20-20)T

- 05. Criminal Justice Agency.** (3-20-20)T
- a.** Federal and state courts having jurisdiction to hear criminal matters; and (3-20-20)T
- b.** A government agency or a subunit of a government agency that performs the administration of criminal justice pursuant to a statute or executive order and that allocates a substantial part of its annual budget to the administration of justice. (3-20-20)T
- 06. Department.** The Idaho State Police, or its successor agency. (3-20-20)T
- 07. Executive Officer.** A position on the ILETS Board filled by the director of the Idaho State Police, or its successor agency. (3-20-20)T
- 08. III.** The Interstate Identification Index, which is a cooperative federal-state system for the exchange of automated criminal history records and, to the extent of their participation in the III system, the criminal history repositories of the states. (3-20-20)T
- 09. ILETS.** The Idaho Public Safety and Security Information System as established by the director of Idaho State Police pursuant to Title 19, Chapter 52, Idaho Code, includes all hardware, software, electronic switches, peripheral gear, microwave links, and circuitry that comprise the system. (3-20-20)T
- 10. Interface Agency.** An agency that has management control of a computer system directly connected to ILETS. (3-20-20)T
- 11. Management Control Agreement.** A written agreement between a criminal justice agency and a non-criminal justice agency that provides services (dispatching, record keeping, computer services, etc.) to the criminal justice agency. The agreement gives the criminal justice agency authority to set and enforce policies governing the non-criminal justice agency's access to ILETS. (3-20-20)T
- 12. NCIC 2000.** The Federal Bureau of Investigation National Crime Information Center, is a computerized information system that includes telecommunications lines and message facilities authorized by law, regulation, or policy approved by the United States Attorney General to link local, state, tribal, federal, foreign, and international criminal justice agencies for the purpose of exchanging NCIC related information. (3-20-20)T
- 13. NLETS.** The International Justice and Public Safety Information Sharing Network, is a national computerized message switching system that links national and state criminal justice information systems. (3-20-20)T
- 14. Non-Criminal Justice Agency.** A state agency, federal agency, or unit of local government that is not a criminal justice agency. The term does not refer to private individuals, corporations, or non-governmental agencies or organizations. (3-20-20)T
- 011. (RESERVED)**
- 012. EXECUTIVE OFFICER OF THE BOARD.**
- 01. Authority of Office.** The executive officer represents the Board in the day-to-day administration of ILETS and is responsible for ensuring that all policies and decisions of the Board are promulgated pursuant to the authority of Chapter 52, Title 19, Idaho Code. The executive officer may delegate duties to employees and officers of the department and executes instruments for, and on behalf of, the Board and ILETS. (3-20-20)T
- 02. Additional Responsibilities.** In addition to the responsibilities assigned to the office by statute, the executive officer is responsible for ensuring, subject to adequate legislative appropriations, that the Board receives adequate staff support and that the following staff duties are performed: (3-20-20)T
- a.** Preparation and dissemination of agendas, posting of legal notices of all meetings, and maintenance

of a written record of the proceedings of board meetings; and (3-20-20)T

- b. Management and safekeeping of all documents relating to the Board and ILETS operations. (3-20-20)T

**03. Governing Policies and Rules.** The executive officer and any department employees and officials assigned by the executive officer to support ILETS operations will be governed by policies and rules of the State of Idaho and the department concerning, but not limited to, fiscal, purchasing, and personnel matters. (3-20-20)T

**013. ILETS BOARD: MEETINGS AND QUORUM.**

**01. Schedule of Meetings.** The Board holds regular meetings twice annually and may hold special meetings at other times as the executive officer deems necessary or upon the written request of a majority of the Board. (3-20-20)T

**02. Quorum.** When meeting, four (4) members of the Board constitutes a quorum necessary for transacting business. (3-20-20)T

**03. Representation at Meetings.** A board member may appoint a proxy to attend a meeting and exercise the voting privilege of that member. (3-20-20)T

- a. An Idaho State Police proxy must be at least a major in rank; (3-20-20)T

- b. A police chief proxy must be an Idaho police chief; (3-20-20)T

- c. A sheriff proxy must be an Idaho sheriff; and (3-20-20)T

- d. Proxy designations must be made in writing to the Executive Officer prior to the meeting. (3-20-20)T

**014. ILETS BOARD: POWERS AND DUTIES, CHAIRMAN, AND AD HOC ADVISORY COMMITTEES.**

**01. Powers and Duties.** Pursuant to its authority under Title 19, Chapter 52, Idaho Code, the Board establishes policies relating to management and operation of ILETS. The Board enforces compliance with all laws and regulations governing ILETS operations. (3-20-20)T

**02. Election of Chairman.** At the first regular meeting of a calendar year, the Board elects a chairman from its membership by majority vote. The chairman serves a term of one (1) year and may succeed himself. (3-20-20)T

**03. Presiding Officer.** The chairman presides at all meetings and conduct the meetings pursuant to “Roberts’ Rules of Order, Current Revised Edition.” If the chairman is absent from a meeting, the executive officer presides at that meeting. (3-20-20)T

**04. Advisory Committees.** With the approval of the Board, the chairman may appoint ad hoc advisory committees to assist the Board in the execution of its statutory duties. (3-20-20)T

**015. (RESERVED)**

**016. ILETS NETWORK.**

**01. Establishment.** The executive officer establishes ILETS as a program of the Idaho State Police or its successor agency. (3-20-20)T

**02. Responsibilities.** The program, as established by the executive officer, has the following responsibilities: (3-20-20)T

- a. Develop and operate a computerized criminal justice telecommunications and information system that provides message switching and record inquiry and retrieval capabilities. (3-20-20)T
- b. Publish an ILETS Operations Manual and distribute copies to each user agency. (3-20-20)T
- c. Function as the NCIC control terminal agency and the NLETS control terminal agency for the State of Idaho. (3-20-20)T
- d. Assist and train criminal justice agencies regarding information retrieved from ILETS and associated systems for use in administration of criminal justice. (3-20-20)T
- e. Develop and maintain linkages with the Idaho Transportation Department, Idaho Department of Correction, other agencies and systems to make appropriate information available to Idaho criminal justice agencies that will assist them in the enforcement of state criminal and traffic laws and regulations. (3-20-20)T
- f. Provide staff support to the ILETS Board. (3-20-20)T
- g. Operate a program of record validation, quality control, and audits to ensure that records entered into ILETS and NCIC files by the department and user agencies are kept accurate and complete and that compliance with state and national standards is maintained. (3-20-20)T
- h. Create model management control agreements between criminal justice agencies and non-criminal justice agencies. (3-20-20)T
- i. Provide assistance and information access to non-criminal justice user agencies for statutory licensing, employment and regulatory purposes and for other purposes authorized by law and approved by the Board. (3-20-20)T

**017. AGENCY ACCESS TO ILETS.**

**01. Authorized Agencies.** Consistent with Title 19, Chapter 52, Idaho Code, which mandates the exclusive use of ILETS for law enforcement and traffic safety purposes, access to ILETS shall be restricted to the following governmental agencies: (3-20-20)T

- a. Criminal justice agencies; (3-20-20)T
- b. Non-criminal agencies that provide computer services, dispatching support, or other direct support service to one (1) or more criminal justice agencies, and which have signed an ILETS-approved management control agreement with the criminal justice agency; (3-20-20)T
- c. Non-criminal justice agencies with a statutory requirement to use information capabilities that may be available via ILETS, and use of terminal access will not adversely affect criminal justice agency users, and use of the terminal will be for the administration of criminal justice; and (3-20-20)T
- d. Non-criminal justice agencies that provide information or capabilities needed by criminal justice agencies for a criminal justice purpose, and access or use of a terminal will improve the ability to provide such information or capabilities. (3-20-20)T

**02. Management Control Agreements.** The management control agreement between a criminal justice agency and a non-criminal justice agency grants to the criminal justice agency the authority to set and enforce: (3-20-20)T

- a. Priorities of service; (3-20-20)T
  - b. Standards for the selection, supervision, and termination of personnel authorized to access ILETS; (3-20-20)T
- and



c. Policies governing the operation of computers, circuits, and telecommunications terminals used to process, store, or transmit information to or receive information from ILETS. (3-20-20)T

**03. Board Approval.** The Board reviews all requests for access to ILETS and determines whether an agency meets the criteria for access and whether access is appropriate based on system resources. Approved non-criminal justice agencies may have access to ILETS information on a limited basis (for example, motor vehicle information only) as authorized by the Board. (3-20-20)T

**018. USER ACCESS FEES.**

**01. Payment of Fees Required.** Any agency that has signed a user agreement with ILETS to have direct terminal or system access to the network must pay access and usage fees as provided in Section 018. (3-20-20)T

**02. ILETS Network User Access Fees.** The access fees approved by the Board and to be collected quarterly in advance by the department are as follows: (3-20-20)T

a. An agency at the county or municipal level pays an annual access fee of five thousand dollars (\$5,000). (3-20-20)T

b. An agency at the state, federal, or tribal level pays an annual access fee of eight thousand, seven hundred fifty dollars (\$8,750). (3-20-20)T

**03. Usage Fee.** Any agency that has signed a user agreement with ILETS to have direct terminal or system access to the ILETS network pays quarterly a usage fee based on that agency's percentage of total annual messages sent and received by user agencies through the ILETS message switcher. The total percentage for an agency includes the message traffic generated by any other agency authorized to access ILETS through that agency's direct terminal or system access. (3-20-20)T

a. The usage fee is assessed according to the following schedule:

<b>Percentage of Total ILETS Message Traffic</b>	<b>Annual Usage Fee Effective October 1, 2014</b>
0 - .25 %	\$1,875
.26 - .50 %	\$3,750
.51 - .75 %	\$7,500
.76 - 1.0 %	\$15,000
1.01 - 1.50 %	\$22,500
1.51 – 2.0 %	\$33,750
2.01 – 5.0 %	\$50,625
> 5.01 %	\$75,939

(3-20-20)T

b. The department will conduct audits of ILETS message switcher traffic for even-numbered years to determine an agency's annual usage fee. This fee is effective for two (2) years and begins with the quarterly statement beginning October 1 of odd-numbered years. (3-20-20)T

c. If an agency discontinues direct terminal or system access to ILETS and acquires authorized access through another agency, the usage fee for the agency maintaining direct access will be adjusted to reflect the combined historical usage. (3-20-20)T

**d.** A new agency approved for direct ILETS access that does not have historical usage will be assessed an interim usage fee by the department pending the next audit of ILETS message traffic. The department sets an interim fee based on the agency's similarities to existing agencies with direct terminal or system access. An agency may appeal the interim usage fee set by the department to the ILETS Board. (3-20-20)T

**e.** As operator of ILETS, the department, in lieu of payment of fees, provides direct and in-kind support of network operations. The Board reviews biennially the proportion of that support to the overall operating cost of the system. (3-20-20)T

**04. Billing and Payment.** The department mails billing statements quarterly to all agencies with direct terminal or system access to ILETS. Payment of the fees is due by the first day of the month of each quarter (October 1, January 1, April 1, and July 1), unless it is a Saturday, a Sunday, or a legal holiday, in which event the payment is due on the first successive business day. (3-20-20)T

**05. Sanctions for Delinquency.** Any user agency that becomes delinquent in payment of assessed fees is subject to sanctions under Section 028. (3-20-20)T

**019. ADJUSTED ACCESS FEES DURING PILOT PROJECTS.**

The Board may adjust access fees of user agencies participating in pilot projects being conducted by the department in behalf of ILETS. The fee adjustment is based on any cost savings, actual or anticipated, realized by the ILETS network. (3-20-20)T

**020. USER RESPONSIBILITIES.**

**01. User Agreement.** Any agency with access to ILETS, whether directly or through another agency, is responsible for adhering to all applicable ILETS rules and policies and must have signed an agreement with ILETS or an interface agency to that effect. (3-20-20)T

**02. Record Validation.** Any agency that enters information into ILETS or NCIC files is responsible for the accuracy, timeliness and completeness of that information. ILETS will send a record validation review list, regularly, to each agency. Validation is accomplished by reviewing the original entry and current supporting documents. Recent consultation with any appropriate complainant, victim, prosecutor, court, motor vehicle registry files, or other appropriate source or individual also is required with respect to the wanted person, missing person, and vehicle files. In the event the agency is unsuccessful in its attempts to contact the victim, complainant, etc., the entering authority must make a determination based on the best information and knowledge available whether or not to retain the original entry in the file. Validation procedures must be formalized and copies of these procedures be on file for review during an ILETS or NCIC audit. When the agency has completed the validation process, the records must be modified to verify their validity no later than thirty (30) days after receiving electronic notification. (3-20-20)T

**03. Minimum Training.** Each agency employee who operates a computer to access ILETS must complete ILETS training at a level consistent with the employee's duties. Each employee who operates a computer to access ILETS must be re-certified by the agency every two (2) years. (3-20-20)T

**04. Hit Confirmation.** When another agency receives a positive record response (Hit) from ILETS or NCIC and requests confirmation of the status of the record (warrant, stolen vehicle, etc.), the agency responsible for entry of the record must respond within ten (10) minutes for urgent hit confirmation requests or within one (1) hour for routine hit confirmation requests, with an answer that indicates the status of the record or a time frame when the record status will be confirmed. (3-20-20)T

**05. Terminal Agency Coordinators.** The agency administrator of each agency with computer access to ILETS must designate one (1) or more terminal agency coordinators who will be the primary contact(s) for all matters relating to use of ILETS by the agency. A terminal agency coordinator must have sufficient authority to implement and enforce necessary policy and procedures. (3-20-20)T

**06. Background Checks of Terminal Operators Required.** Policies for access to the FBI-NCIC

system require background screening of all terminal operators with access to the NCIC system. For efficiency and consistency, the NCIC background screening policies are also adopted for all ILETS access. (3-20-20)T

**021. INFORMATION ACCESS AND DISSEMINATION.**

**01. General Policy.** Information is made available to ILETS users from various sources and agencies, including ILETS and other state justice information system files, motor vehicle departments, NCIC, and NLETS. Each user must observe any restrictions placed on the use or dissemination of information by its source. It is ILETS' responsibility to advise user agencies of any restrictions which apply to any information accessed via ILETS. (3-20-20)T

**02. Criminal History Records.** Criminal history information accessed via ILETS from a state or national computerized file is available only to criminal justice agencies for criminal justice purposes. This precludes the dissemination of such information for use in connection with licensing applications, regulatory activities, or local or state employment, other than with a criminal justice agency. (3-20-20)T

**03. Administrative Messages.** An administrative message (AM) is a free text message from one (1) agency to one (1) or more agencies. All administrative messages transmitted via ILETS must be by the authority of an authorized user and relate to criminal justice purposes or matters of interest to the user community. Administrative messages sent within Idaho, either statewide, regionally or to individual terminal identifiers are subject to the following restrictions: (3-20-20)T

**a.** No messages supportive or in opposition to political issues, labor management issues, or announcements of meetings relative to such issues. (3-20-20)T

**b.** No messages supportive or in opposition of legislative bills. (3-20-20)T

**c.** No requests for criminal history record information. (3-20-20)T

**022. -- 023. (RESERVED)**

**024. ILETS SECURITY.**

**01. General Policy.** The data stored in the ILETS, NCIC, and other criminal justice information system files is documented criminal justice information. This information must be protected to ensure its integrity and its correct, legal and efficient storage, dissemination and use. It is incumbent upon an agency accessing ILETS directly, or another system that has access to the ILETS network, to implement the procedures necessary to make the access device secure from any unauthorized use and to ensure ILETS is not subject to a malicious disruption of service. ILETS access agencies must participate in ILETS training and compliance activities to ensure that all agency personnel authorized to access the ILETS network are instructed in the proper use and dissemination of the information and that appropriate agency personnel are aware of security requirements and of the dangers to network integrity. ILETS retains the authority to disconnect an access agency or network connection when serious security threats and vulnerabilities are detected. (3-20-20)T

**02. Definitions.** The following is a list of terms and their meanings as used in the ILETS security rule: (3-20-20)T

**a.** Computer interface capabilities means any communication to ILETS allowing an agency to participate in the system. (3-20-20)T

**b.** Firewall means a collection of components placed between two (2) networks that keep the host network secure by having the following properties: (3-20-20)T

**i.** All traffic from inside the network to outside, and vice-versa, must pass through it; (3-20-20)T

**ii.** Only authorized traffic is allowed to pass; and (3-20-20)T

- iii. The components as a whole are immune to unauthorized penetration and disablement. (3-20-20)T
  - c. ILETS Security Officer (ISO) is the department staff member designated by the executive officer to monitor and enforce agency compliance with site and network security requirements. (3-20-20)T
  - d. Peer networks are computer interfaces between cooperative governmental agencies in Idaho where none of the participating entities exercise administrative or management control over any other participating entity. (3-20-20)T
  - e. Interface agency is an agency that has management control of a computer system directly connected to ILETS. (3-20-20)T
  - f. Untrusted system is a system that does not employ sufficient hardware or software security measures to allow its use for simultaneously processing a range of sensitive or confidential information. (3-20-20)T
- 03. Interface Agency Agreements.** To ensure agencies having computer interface capabilities to ILETS are fully aware of their duties and of the consequences of failure to carry out those duties, a written and binding Interface Agency Addendum must exist between ILETS and all interface agencies. This agreement will clarify that the interface agency is equally responsible for actions by secondary and affiliated systems connected through their site to ILETS. Interface agencies must put in place similar subsidiary security agreements with secondary and affiliated systems to protect its network and ILETS. (3-20-20)T
- 04. ILETS Security Officer.** The ILETS Security Officer is responsible for the following duties: (3-20-20)T
- a. Disseminating to user agencies copies of ILETS security policies and guidelines; (3-20-20)T
  - b. Communicating to user agencies information regarding current perceived security threats and providing recommended measures to address the threats; (3-20-20)T
  - c. Monitoring use of the ILETS network either in response to information about a specific threat, or generally because of a perceived situation; (3-20-20)T
  - d. Directing an interface agency, through its nominated contact, to rectify any omission in its duty of responsibility; (3-20-20)T
  - e. When an agency is unable or unwilling to co-operate, reporting the issue to the executive officer and initiating the procedure for achieving an emergency disconnection; and (3-20-20)T
  - f. Provide support and coordination for investigations into breaches of security. (3-20-20)T
- 05. Agency Security Contacts.** A terminal agency coordinator shall serve as that agency's security contact for ILETS, unless another individual is specifically selected for this purpose and approved by the ILETS Security Officer. ILETS primary sites shall ensure the agency's security contact, or another person or position designated in an incident contingency plan, can be contacted by the ILETS security officer at any time. (3-20-20)T
- 06. Peer Networks.** The security responsibilities of the operators of peer networks connected to ILETS, with respect to their user organizations, are parallel to those of ILETS user organizations in respect to their individual users. The ILETS Security Officer shall ensure that a written agreement exists between ILETS and an interface agency, signed by the agency heads, that embodies these principles. (3-20-20)T
- 07. Physical Security Standards.** Interface agencies will observe standards and procedures to ensure security of the physical premises and computing equipment. The minimum standards and procedures include the following: (3-20-20)T
- a. Access to computer rooms will be limited to staff who require access for the normal performance of their duties. (3-20-20)T

**b.** Electrical power protection devices to suppress surges, reduce static, and provide battery backup in the event of a power failure will be used as necessary. (3-20-20)T

**c.** Computer system backups shall be stored in a secure location with restricted access. (3-20-20)T

**d.** Network infrastructure components will be controlled with access limited to support personnel with a demonstrated need for access. (3-20-20)T

**e.** Physical labeling of infrastructure components will be done to assist in proper identification. Additionally, all components will be inventoried at regular intervals for asset management and physical protection. (3-20-20)T

**f.** An interface agency must create and enforce a password policy in which the agency is responsible for assigning ILETS users a unique password. The password policy must require that a new password be initiated by the user or agency every ninety (90) days. (3-20-20)T

**08. Network Security Standards.** User agencies must exercise appropriate security precautions when connecting ILETS and computer systems linked to ILETS with external untrusted systems. The primary objective of such precautions is to prevent unauthorized access to sensitive information while still allowing authorized users free access. The minimum standards and procedures include the following: (3-20-20)T

**a.** Agencies must routinely audit for and remove unused or unneeded services/accounts, review accounts periodically, and enforce aggressive and effective password strategies. (3-20-20)T

**b.** Agencies must ensure that the software security features of the networks they manage are installed and functioning correctly. (3-20-20)T

**c.** Agencies must monitor network security on a regular basis. Adequate information concerning network traffic and activity must be logged to ensure that breaches in network security can be detected. (3-20-20)T

**d.** Agencies must implement and maintain procedures to provide the ILETS network adequate protection from intrusion by external and unauthorized sources. (3-20-20)T

**e.** No computer connected to the network can have stored, on its disk(s) or in memory, information that would permit access to other parts of the network. For example, scripts used in accessing a remote host may not contain passwords. (3-20-20)T

**f.** No connection to ILETS may be established utilizing dial-up communications. Asynchronous communications connections should be limited and tightly controlled as they pose a serious risk because they can circumvent any security precaution enacted to protect networks from untrusted sources. (3-20-20)T

**g.** Network management protocols must be limited to internal or trusted networks. (3-20-20)T

**h.** Any system having direct or indirect access to the Internet via their computer network must have in place services that allow no access to ILETS from the Internet. Organizations with large distributed Wide Area Networks connecting many remote sites may choose to incorporate many security layers and a variety of strategies. These strategies must incorporate the implementation of a firewall to block network traffic, and restriction of remote user access. (3-20-20)T

**i.** Agencies accessing ILETS directly or through another agency, must insure that all telecommunications infrastructure meets the FBI CJIS Security Policy for encryption standards. (3-20-20)T

**j.** No routing or IP Network Translations are to be performed on individual access devices. All routing and translation must be performed on a router or firewall device. (3-20-20)T

**025. -- 027. (RESERVED)**

**028. USER AGENCY SANCTIONS.**

**01. Review of Violations.** The board reviews violations of ILETS rules and may impose appropriate sanctions on access agencies. (3-20-20)T

**02. Objective of Sanctions.** The objectives of the sanction procedure are as follows: (3-20-20)T

**a.** To ensure the security, integrity, and financial stability of the ILETS. (3-20-20)T

**b.** To create an awareness among access agencies of the importance of following rules, regulations, and procedures in order to minimize the risk to liabilities that may be incurred by misuse of the system and access to its information. (3-20-20)T

**03. Class of Sanctions.** Sanctions are based upon the class of violation, any previous violations, and any exposure to criminal and civil liabilities that the violation might place on the system, its officials, and the offending agency. Violations are classed as either administrative (minor) or security (serious) violations. Security violations are defined as ones which have or could result in access of ILETS data by unauthorized individuals. All other violations are classed as administrative. (3-20-20)T

**04. Form of Sanctions.** When imposing sanctions, the Board considers the severity of the violation, the violation type, either administrative or security, and previous sanctions issued. The Board may require the violating agency to submit a mediation plan showing how the violation will be corrected and future violations prevented. The Board shall consider such a mediation plan, if submitted, when imposing sanctions. The Board may impose as sanctions one (1) or more of the following: (3-20-20)T

**a.** Written warning. (3-20-20)T

**b.** Written notice of violation. (3-20-20)T

**c.** Written notice of probation. (3-20-20)T

**d.** Written notice of temporary suspension. (3-20-20)T

**e.** Written notice of permanent suspension. (3-20-20)T

**05. Effective Date of Sanctions.** Temporary or permanent suspension of service will not begin, unless an emergency exists, until fifteen (15) days after the agency head has received written notice by certified mail or personal service. (3-20-20)T

**06. Reinstatement.** An agency placed on permanent suspension may apply to the Board for reinstatement. (3-20-20)T

**029. -- 999. (RESERVED)**

**IDAPA 11 – IDAHO STATE POLICE  
PEACE OFFICER STANDARDS AND TRAINING COUNCIL**

**DOCKET NO. 11-1101-2000F (FEE RULE)**

**NOTICE OF OMNIBUS RULEMAKING – ADOPTION OF TEMPORARY RULE**

**EFFECTIVE DATE:** The effective date of the temporary rule(s) being adopted through this omnibus rulemaking is the adjournment date of the second regular session of the 65th Idaho State Legislature - March 20, 2020.

**AUTHORITY:** In compliance with Sections 67-5226, Idaho Code, notice is hereby given this agency has adopted a temporary rule. The action is authorized pursuant to Section 19-5107, Idaho Code.

**DESCRIPTIVE SUMMARY:** The following is the required finding and concise statement of its supporting reasons for adopting the temporary rule:

Peace Officer Standards and Training (POST) is tasked with establishing the requirements for basic training and certification, providing academy and in-service training, issuing certifications, and maintaining permanent files and transcripts for all law enforcement officers in the State of Idaho. POST is also responsible for conducting decertification investigations of officers who violate standards of conduct as established by the POST Council's code of ethics. This rule must be adopted to allow POST to carry out the statutory duties of providing training and certification to the law enforcement officers who provide public safety services to the citizens of the State of Idaho.

This temporary rulemaking adopts the following chapter under IDAPA 11, Title 11:

**IDAPA 11**

- 11.11.01, *Rules of the Idaho Peace Officer Standards and Training Council*

**TEMPORARY RULE JUSTIFICATION:** Pursuant to Sections 67-5226(1) and 67-5226(2), Idaho Code, the Governor has found that temporary adoption of the rule is appropriate for the following reasons:

These temporary rules are necessary to protect the public health, safety, and welfare of the citizens of Idaho and confer a benefit on its citizens. These temporary rules implement the duly enacted laws of the state of Idaho, provide citizens with the detailed rules and standards for complying with those laws, and assist in the orderly execution and enforcement of those laws. The expiration of these rules without due consideration and processes would undermine the public health, safety, and welfare of the citizens of Idaho and deprive them of the benefit intended by these rules.

**FEE SUMMARY:** Pursuant to Section 67-5226(2), the Governor has found that the fees or charges being imposed or increased are justified and necessary to avoid immediate danger and the fees are described herein:

The fees or charges, authorized in Section 19-5112 and 19-5118, Idaho Code, are part of the agency's 2021 budget that relies upon the existence of these fees or charges to meet the state's obligations and provide necessary state services. Failing to reauthorize these temporary rules would create immediate danger to the state budget, immediate danger to necessary state functions and services, and immediate danger of a violation of Idaho's constitutional requirement that it balance its budget.

The following is a specific description of the fees or charges:

- Section 134 – Course evaluation fee
- Subsection 135.03 – Course evaluation fee

**ASSISTANCE ON TECHNICAL QUESTIONS:** For assistance on technical questions concerning the temporary rule, contact POST Division Administrator, Brad Johnson, phone 208-884-7251, fax 208-884-7295, email [brad.johnson@POST.idaho.gov](mailto:brad.johnson@POST.idaho.gov).

DATED this February 21, 2020.

Charlie Spencer  
Police Services Major  
Rules Review Officer  
Idaho State Police  
700 S. Stratford Dr.  
Meridian, ID 83642  
[charlie.spencer@isp.idaho.gov](mailto:charlie.spencer@isp.idaho.gov)  
Phone 208-884-7203  
Fax 208-884-7290



**IDAPA 11 – IDAHO STATE POLICE  
PEACE OFFICER STANDARDS AND TRAINING COUNCIL**

**11.11.01 – RULES OF THE IDAHO PEACE OFFICER STANDARDS AND TRAINING COUNCIL**

**000. LEGAL AUTHORITY.**

Pursuant to Section 19-5107, Idaho Code, the Peace Officer Standards and Training Council has authority, in accordance with Title 67, Chapter 52, Idaho Code, to promulgate rules it deems necessary to carry out the provisions of Title 19, Chapter 51, Idaho Code. (3-20-20)T

**001. TITLE AND SCOPE.**

**01. Title.** These rules are titled IDAPA 11.11.01, “Rules of the Idaho Peace Officer Standards and Training Council,” IDAPA 11, Title 11, Chapter 01. (3-20-20)T

**02. Scope.** These rules constitute the minimum standards of training, education, employment, and certification for any discipline certified by the POST Council. (3-20-20)T

**002. APPLICATIONS AND FORMS.**

All persons seeking certification or endorsement by POST under these rules must complete all relevant POST approved forms, which shall be signed by the applicant’s agency head or designee (on file at POST) prior to submission to POST. (3-20-20)T

**003. DOCUMENTATION – COPIES.**

**01. Citizenship, Education, Military and Criminal Records.** All documentation of citizenship, educational records and transcripts, military service, and criminal records required by these rules shall be submitted to POST in the form of a copy of a certified original document. (3-20-20)T

**02. Training and Other Records.** Training records and other records required or allowed to be submitted to POST by these rules shall be submitted in the form of an original or certified copy. Where neither an original or certified copy is available, records shall be legible and not mutilated, altered or damaged. (3-20-20)T

**03. Notice of Employment/Termination.** The names of all officers hired must be submitted to the Council within fifteen (15) days of employment. The termination of an officer’s employment must also be relayed to the Council within fifteen (15) days of such action on an appropriate form designated by the Council. (3-20-20)T

**004. – 009. (RESERVED)**

**010. DEFINITIONS.**

In addition to the definitions under 19-5101, Idaho Code, the following terms apply: (3-20-20)T

**01. Act.** Title 19, Chapter 51, of the Idaho Code. (3-20-20)T

**02. Adult Felony Probation and Parole Officer.** An employee of the Idaho Department of Correction who is responsible for supervision of adult offenders on felony probation or parole. (3-20-20)T

**03. Adult Misdemeanor Probation Officer.** An employee of a county misdemeanor probation department or contractor of a county who is responsible for preparing reports to the court, making recommendations regarding conditions of probation, and the supervision of misdemeanor offenders’ compliance with court orders. (3-20-20)T

**04. Agency.** A law enforcement agency which is a part of or administered by the state of Idaho or any political subdivision thereof and which is responsible for the prevention and detection of crime and the enforcement of penal, traffic or highway laws of this state or any political subdivision; a juvenile detention center; a juvenile probation department; an adult misdemeanor probation department, a Public-Safety Answering Point (PSAP); the Idaho Department of Juvenile Corrections; the Idaho Department of Correction; or a private prison contractor of the State Board of Correction that is responsible for the first-line supervision, security, protection, and risk reduction of offenders housed in the a private correctional facility. (3-20-20)T

**05. Agency Head.** A chief of police of a city, sheriff of a county or chief administrator of a law

- enforcement agency, as defined herein. (3-20-20)T
- 06. Applicant.** A person applying to participate in a POST training program or applying for POST certification. (3-20-20)T
- 07. Basic Training Academy.** A basic course of Council approved instruction in a discipline certified by POST. (3-20-20)T
- 08. Canine Team.** A specific person and a specific dog controlled by that person as its handler, formally assigned to perform law enforcement duties together. (3-20-20)T
- 09. Canine Team Evaluator.** An officer trained and certified by POST to evaluate the competence of canine teams. (3-20-20)T
- 10. Challenge Examination.** A test to aid POST in determining whether an officer has sufficient competence that a waiver of completion of a basic training academy for that officer is warranted. (3-20-20)T
- 11. College Credit.** A unit of work toward an academic or vocational degree awarded by a college or university accredited by one of the accrediting agencies listed in Subsection 11.11.01.053.01.d. or other POST accepted U.S. regional accrediting agency. (3-20-20)T
- 12. Conviction.** Any conviction in any federal, tribal, state, county, or municipal court; a voluntary forfeiture of bail, bond, or collateral deposited to secure a defendant's appearance in court as final disposition; the payment of a fine or civil penalty; a plea of guilty or nolo contendere; or a finding of guilt, notwithstanding the form of judgment or withheld judgment, regardless of whether the sentence is imposed, suspended, deferred, or withheld, or whether the plea or conviction is set aside or withdrawn, or the case or charge is dismissed or reduced, or the record expunged under Section 19-2604, Idaho Code, or any other comparable statute or procedure, where the setting aside of the plea or conviction, or dismissal or reduction of the case or charge, or expungement of the record is based upon lenity or rehabilitation rather than upon a defect in the legality or factual basis of the plea, finding of guilt, or conviction. "Conviction" does not include a misdemeanor conviction upon a bond forfeiture for a violation that is or would at the time have in Idaho been an infraction violation, if the only reason it is classified as a misdemeanor is due to the bond forfeiture. (3-20-20)T
- 13. Correction Officer.** An employee of the Idaho Department of Correction or a private prison contractor of the State Board of Correction who is responsible for the first-line supervision, security, protection, and risk reduction of offenders housed in a correction facility. (3-20-20)T
- 14. Council.** The Idaho Peace Officer Standards and Training Council. (3-20-20)T
- 15. County Detention Officer.** An employee of a county sheriff who works in a county jail and is responsible for the safety, care, protection, and monitoring of county jail inmates. (3-20-20)T
- 16. Crime of Deceit.** Any offense described in Section 18-1301 et seq., Idaho Code, (Bribery), Section 18-1401 et seq. (Burglary), Sections 18-1901 (Fictitious Stock Subscription), 18-1902 (Exhibition of False Papers to Public Officers), 18-1903 (Use of False Name in Prospectus), 18-1904 (Illegal Dividends and Reductions of Capital), 18- 1905 (Falsification of Corporate Books), 18-1906 (Fraudulent Reports by Officers), 18- 2202(1) (Computer Crime), 18-2302 (False Swearing as to Qualifications as Voter), 18- 2304 (Procuring Illegal Votes), 18-2305 (Intimidation, Corruption and Frauds), 18-2306 (Illegal Voting or Interference with Election), 18-2307 (Attempting to Vote When Not Qualified or to Repeat Voting), 18-2309 (Officers Attempting to Change Result), 18- 2310 (Forging or Counterfeiting Returns), 18-2311 (Adding to or Subtracting From Votes), 18-2316 (Tampering with Certificates of Nomination or Ballots), 18-2320 (Bribery of Electors), Section 18-2401 et seq. (Theft), Section 18-2601 et seq. (Falsifying Evidence -- Offering Forged or Fraudulent Documents in Evidence), Section 18-2701 et seq. (Bribery of Executive Officers), Sections 18-3105 (False Statement by Commission Merchant, Broker, Agent, Factor or Consignee to Principal or Consignor), 18-3106 (Drawing Check Without Funds -- Drawing Check With Insufficient Funds -- Prima Facie Evidence of Intent -- Standing of Person Having Acquired Rights -- Probation Conditions), 18- 3123 (Forgery of a Financial Transaction Card), 18-3124 (Fraudulent Use of a Financial Transaction Card), 18-3125 (Criminal Possession of Financial Transaction Card and FTC Forgery Devices), 18-3125A

(Unauthorized Factoring of Credit Card Sales Drafts), 18-3126 (Misappropriation of Personal Identifying Information), 18-3127 (Receiving or Possessing Fraudulently Obtained Goods or Services), 18-3201 (Officer Stealing, Mutilating or Falsifying Public Records), 18-3202 (Private Person Stealing, Mutilating or Falsifying Public Records), 18-3203 (Offering False or Forged Instrument for Record), 18-3204 (False Certificates or Other Instruments from Officers), 18-3206 (Mutilating Written Instruments), Section 18-3601 et seq. (Forgery and Counterfeiting), Sections 18-4616 (Defacing Marks on Logs or Lumber), 18- 4617 (Stealing Rides on Trains), 18-4621 (Stealing Electric Current -- Tampering with Meters), 18-4622 (Stealing Electric Current -- Accessories Liable as Principals), 18-4624 (Taken or Converted Merchandise as Theft), 18-4626 (Willful Concealment of Goods, Wares or Merchandise -- Defense for Detention), 18-4630 (Illegal Use of Documents), 18-4701 (Alteration of Bills), 18-4702 (Alteration of Enrolled Copies), 18-4703 (Offering Bribes to Legislators), 18-4704 (Legislators Receiving Bribes), Section 18-5401 et seq. (Perjury), Section 18-6501 et seq. (Robbery), Sections 18-8201 (Money Laundering and Illegal Investment -- Penalty -- Restitution), 41-293 (Insurance Fraud), 41-294 (Damage to or Destruction of Insured Property), 41-1306 (False Financial Statements), 49-228 (Receiving or Transferring Stolen Vehicles), 49-231 (Farm Implements -- Purchasing or Selling When Identifying Number Altered or Defaced a Felony), 49-232 (Fraudulent Removal or Alteration of Numbers Prohibited), 49-518 (Altering or Forging Certificate -- Stolen Cars -- Destroying or Altering Engine or Decal Number -- Use of Fictitious Name -- Fraud), or any attempt, conspiracy or solicitation to commit any of the foregoing offenses, or any racketeering offense under Section 18-7801 et seq., Idaho Code, in which any of the foregoing offenses constitutes at least one (1) of the predicate acts, or any other crime defined in the Idaho Code involving any form of theft or including fraudulent intent as an element, or an offense equivalent to any of the foregoing in any other jurisdiction. (3-20-20)T

**17. Division Administrator.** The administrator of the Idaho Peace Officers Standards and Training Division of the Idaho State Police. (3-20-20)T

**18. Emergency Communications Officer.** Any emergency call taker or dispatcher employed by a Public Safety Answering Point (PSAP), whose responsibilities include receiving or dispatching 9-1-1 calls. (3-20-20)T

**19. Field Training.** Formal, on the job training for special and defined purposes. (3-20-20)T

**20. Full Time.** An employee who is, for a calendar month, employed on average at least thirty (30) hours of service per week, or one hundred thirty (130) hours of service per month. (3-20-20)T

**21. Hearing Board.** A board of three members designated by the Chair of the Council to hear contested cases and enter recommended orders for the Council's decision. (3-20-20)T

**22. Hearing Officer.** A person designated by the Council to preside over decertification proceedings and to render findings of fact, conclusions of law and a recommended order at the conclusion of those proceedings. (3-20-20)T

**23. In-Service Training.** Training designed to refresh or enhance a certified officer's ability to perform their duties. (3-20-20)T

**24. Juvenile Corrections Direct Care Staff.** An employee of the Idaho Department of Juvenile Corrections whose primary job duties include the safety, care, education, protection, or supervision of juveniles committed to the custody of the department. Direct care staff positions include: Rehabilitation Technician Trainee; Rehabilitation Technician; Rehabilitation Supervisor; Rehabilitation Specialist; Rehabilitation Specialist Associate; Instructor – DJC; Instructor Specialist; Instructor Assistant; Safety and Security Officer; Recreation Coordinator, Corrections; and Safety and Security Supervisor. (3-20-20)T

**25. Juvenile Detention Center.** A facility that is part of or administered by an Idaho county and is responsible for the safety, care, protection, and monitoring of juvenile offenders. (3-20-20)T

**26. Juvenile Detention Officer.** An employee working in a juvenile detention center who is responsible for the safety, care, protection, and monitoring of juvenile offenders. (3-20-20)T

**27. Juvenile Probation Department.** A public or private agency administered by or contracted with

the court, and providing juvenile probation services to a county at the concurrence and expense of the county commissioners. (3-20-20)T

**28. Juvenile Probation Officer.** An employee of a juvenile probation department who is responsible for preparing social history reports to the court, making recommendations regarding conditions of probation, and the supervision of juvenile offenders' compliance with court orders. (3-20-20)T

**29. Law Enforcement Certification Program.** A program operated by a college or university, law enforcement agency, or private entity and satisfying POST basic training academy requirements. (3-20-20)T

**30. Law Enforcement Certification Program Facility.** A facility at which law enforcement certification programs conduct training. (3-20-20)T

**31. Law Enforcement Profession.** As used in these rules in reference to agreements authorized pursuant to Section 19-5112, Idaho Code, the “law enforcement profession” includes the following positions: Peace Officer, County Detention Officer, Emergency Communications Officer, Juvenile Detention Officer, Juvenile Probation Officer, Correction Officer, Juvenile Corrections Direct Care Staff, Adult Felony Probation and Parole Officer, Idaho Department of Juvenile Corrections Direct Care Staff, and Adult Misdemeanor Probation Officer. (3-20-20)T

**32. Marine Deputy.** A person employed by a county sheriff whose primary function is to perform marine-related enforcement duties within established policies and procedures. (3-20-20)T

**33. Misdemeanor Probation Department.** A public or private agency administered by or contracted with the county, and providing misdemeanor probation services to a county at the concurrence and expense of the county commissioners. (3-20-20)T

**34. Part-Time Employee.** An employee, regardless of discipline, who works less than thirty (30) hours per week or one hundred thirty (130) hours per month. (3-20-20)T

**35. Peace Officer.** A full or part-time patrol officer employed by an agency whose duties primarily consist of the prevention and detection of crime and the enforcement of penal, traffic or highway laws of this state or any political subdivision. “Peace officer” also means a patrol or reserve officer employed by a police or law enforcement agency of a federally recognized Indian tribe who has completed a POST basic training academy and has been deputized by a sheriff of a county or a chief of police of a city in Idaho. (3-20-20)T

**36. POST.** The Idaho Peace Officer Standards and Training Program. (3-20-20)T

**37. POST Certified Instructor.** A person certified by POST as qualified to instruct or assess students in a course of instruction which meets POST standards for certification or training. (3-20-20)T

**38. Program Coordinator.** A person designated by a college, university, or agency to be responsible for a law enforcement certification program. (3-20-20)T

**39. Prosecutor.** A city prosecuting attorney, city assistant prosecuting attorney, county prosecuting attorney, county deputy prosecuting attorney, attorney general, deputy attorney general, United States attorney, or assistant United States attorney. (3-20-20)T

**40. Public Safety Answering Point (PSAP).** A city, county, or state emergency call center that receives direct or transferred 9-1-1 calls for police, firefighting, and ambulances. (3-20-20)T

**41. Regional Training Specialist.** A POST employee who is assigned to a specific region of the state, and who assesses training materials and instruction for law enforcement personnel to assure compliance with POST standards. (3-20-20)T

**42. Reserve Peace Officer.** A person appointed by an agency to perform the duties of a peace officer on a limited basis. (3-20-20)T

**43. School.** A school, college, university, academy, or local training program which offers law enforcement training and which is certified by the Council. (3-20-20)T

**44. State.** Unless otherwise indicated, the state of Idaho. (3-20-20)T

**45. Student.** A person participating in any Council-approved basic training program or law enforcement certification training program. (3-20-20)T

**46. Temporary/Seasonal.** Employment of less than one hundred eighty (180) consecutive days. (3-20-20)T

**47. Trainee.** A POST certified officer participating in in-service training. (3-20-20)T

**011. – 029. (RESERVED)**

**030. POST COUNCIL.**

**01. Council Members.** The Council will be made up of such members as designated by statute. (3-20-20)T

**02. Compensation.** Council members will not be compensated for services to POST, but will be allowed actual and necessary expenses incurred in performing their duties. (3-20-20)T

**03. Resignations.** A Council member who ceases to qualify as such or intends to resign from the Council needs to notify the Governor and Chair in writing as soon as practicable. (3-20-20)T

**031. POWERS AND DUTIES OF POST COUNCIL.**

The duties of the Council include, but are not limited to, the following: (3-20-20)T

**01. Certification.** Authorizing POST to issue certification to members of the law enforcement profession as defined in these rules and issue certifications, approvals or endorsements to instructors, schools and programs providing instruction to law enforcement personnel. (3-20-20)T

**02. Records.** Maintaining records on all certified officers, certified or endorsed instructors and approved law enforcement certification programs, and furnish records upon request in accordance with the Idaho Public Records Act. (3-20-20)T

**03. Committees.** Establishing such committees as may be necessary to more fully carry out the duties of the Council. (3-20-20)T

**04. Vice-Chairman.** Electing a Vice-Chairman annually from among the Council's membership. (3-20-20)T

**05. Rules.** Adopting rules and procedures for the internal management of POST and the operation of law enforcement certification programs. (3-20-20)T

**06. Assist, Study, Consult and Cooperate.** Assisting departments and law enforcement certification training programs in complying with POST requirements, studying law enforcement training methods, consulting and cooperating with agencies and educational institutions concerned with law enforcement training. (3-20-20)T

**07. Additional Time to Complete POST Training and Certification.** Granting or delegating to the Division Administrator the authority to grant additional time, upon a showing of good cause and in writing, to complete POST training and certification. Good cause includes, but is not limited to, sickness or physical disability of officer or immediate family member, cancellation of a basic academy, natural disaster, or reapplication to the academy after failing or being unable to complete a previous basic academy. (3-20-20)T

**08. Reimbursement of Instructors.** Reimbursing instructors at POST certified training programs for travel, food and lodging at state per diem rates. (3-20-20)T

**032. POST HEARING BOARD.**

The Council may appoint a Hearing Board to hear matters assigned to the Board by the Council. (3-20-20)T

**01. Members.** The Council Chair will appoint three (3) members of the Council to serve on the Hearing Board. (3-20-20)T

**02. Recommended and Final Orders.** Orders issued by the Hearing Board at the conclusion of proceedings are recommended orders and become final orders after the Council's review. (3-20-20)T

**03. Discovery.** Discovery may be conducted in contested cases before a Hearing Officer and the Council. (3-20-20)T

**033. POST DIVISION ADMINISTRATOR.**

The Idaho State Police will employ a POST Division Administrator in a non-classified position, to serve under the direction of the Council. (3-20-20)T

**01. Selection.** The Director of the Idaho State Police will, subject to approval of the Council, select the Division Administrator from the register established by the Idaho Division of Human Resources after competitive testing. The Council Chair will select one (1) Chief or Sheriff from the Council to serve on the examining board. (3-20-20)T

**02. Responsibilities.** The Division Administrator will: (3-20-20)T

**a.** Supervise POST employees; (3-20-20)T

**b.** Report to the Council on such matters as the Council may direct; and (3-20-20)T

**c.** Perform such other duties as set forth in these rules or as the Council and the Director of the Idaho State Police direct. (3-20-20)T

**03. Administration.** For administrative purposes, the Division Administrator and POST staff are governed by the Policies and Rules of the Idaho State Police, concerning but not limited to fiscal, purchasing, and personnel matters. (3-20-20)T

**034 – 049. (RESERVED)**

**050. BASIC CERTIFICATION OF LAW ENFORCEMENT OFFICERS.**

All applicants for POST certification must meet the following standards and comply with the following requirements to be eligible to attend a basic training academy and for certification and employment in Idaho in any law enforcement discipline. (3-20-20)T

**051. MANDATORY AND VOLUNTARY CERTIFICATION.**

**01. Mandatory Certification.** Except as otherwise provided in these rules, no person shall act as a peace officer, marine deputy, county detention officer, emergency communications officer, juvenile detention officer, juvenile probation officer, correctional officer, adult probation and parole officer, juvenile direct care staff or misdemeanor probation officer in Idaho unless they are certified to do so by POST in accordance with these rules. (3-20-20)T

**02. Voluntary Certification for Correctional Officers and Adult Probation and Parole Officers Employed Prior to July 1, 2005.** Correctional officers and adult probation and parole officers who were employed prior to July 1, 2005 are not required to be POST certified in those disciplines, but may become certified by meeting all requirements for certification set forth in these rules. (3-20-20)T

**03. Voluntary Certification for Emergency Communications Officers Employed Prior to July 1, 2012.** Emergency Communications Officers who were employed prior to July 1, 2012 are not required to be POST certified, but may become certified by meeting all requirements for certification set forth in these rules. (3-20-20)T

**04. Voluntary Certification for Certain Officials.** The director of the Idaho State Police or any elected official, although specifically excluded by law from meeting the requirements set by the Council, may be certified if they so desire, provided they meet the minimum requirements for certification as prescribed in these rules. (3-20-20)T

**052. CITIZENSHIP.**

An applicant shall be a citizen of the United States and submit a certified copy or original of one (1) of the following as verification of citizenship: (3-20-20)T

- 01. Birth Certificate.** A birth certificate issued by a city, county, or state; (3-20-20)T
- 02. Passport.** A current passport issued by the United States Government; (3-20-20)T
- 03. Naturalization Certificate;** (3-20-20)T
- 04. Consular Report of Birth Abroad or Certification of Birth;** or (3-20-20)T
- 05. Certificate of Citizenship.** (3-20-20)T

**053. EDUCATION.**

- 01. Acceptable Education.** An applicant must have: (3-20-20)T
  - a.** Graduated from a school accredited as a high school at the time of graduation by the state in which it is located or by a recognized regional accreditation body; (3-20-20)T
  - b.** Passed a GED or an IBM Assessment Test in subject areas required by POST; (3-20-20)T
  - c.** Have completed a high school equivalency program and obtained a state- issued certificate; (3-20-20)T
  - d.** Completed a minimum of fifteen (15) credits at a college accredited by one of the following: Middle States Association of Schools and Colleges; New England Association of Schools and Colleges; North Central Association of Colleges and Schools (the Higher Learning Commission); Northwest Association of Colleges and Universities; Southern Association of Colleges and Schools; and Western Association of Schools and Colleges; or (3-20-20)T
  - e.** Completed a course of study, either in a formal school setting or through homeschooling if the program is recognized by a state or by a local school district within a state as having met that state's high school graduation requirements. (3-20-20)T
  - f.** If educated outside the United States, an applicant must have passed GED testing or provide an evaluation from a member of the National Association of Credential Evaluation Services (NACES) or Association of International Credential Evaluators, Inc. (AICE), showing the applicant's education meets or exceeds the U.S. requirements for high school graduation. (3-20-20)T

- 02. Documentation of Education.** An applicant must provide a certified copy or original of one of the following: (3-20-20)T
  - a.** High school diploma indicating date of graduation; (3-20-20)T
  - b.** Official high school transcript indicating date of graduation; (3-20-20)T

- c. Official transcript of GED results indicating a passing score; (3-20-20)T
- d. Correspondence from the Idaho Department of Labor, providing a passing score result of testing; (3-20-20)T
- e. Correspondence from a state or local school district indicating that the applicant has met that state's high school graduation requirements; (3-20-20)T
- f. State-issued high school equivalency certificate; (3-20-20)T
- g. Official transcript from a POST accepted U.S. regionally-accredited college indicating completion of a minimum of fifteen (15) credits; (3-20-20)T
- h. Official evaluation of foreign education by a member of the National Association of Credential Evaluation Services (NACES) or Association of International Credential Evaluators, Inc. (AICE) showing the applicant's education meets or exceeds the U.S. requirements for high school graduation. (3-20-20)T

**054. AGE.**

The minimum age requirements for employment in the following disciplines are: (3-20-20)T

**01. Twenty-One (21) Years of Age.** Patrol officers, felony probation and parole officers, misdemeanor probation officers, juvenile detention officers, juvenile probation officers, and juvenile corrections direct care staff. (3-20-20)T

**02. Eighteen (18) Years of Age.** Corrections officers, adult detention officers, emergency communications officers. (3-20-20)T

**055. INELIGIBILITY BASED UPON PAST CONDUCT.**

An applicant is ineligible to attend a basic training academy and for certification under the following circumstances. (3-20-20)T

**01. Criminal Conviction.** An applicant is ineligible if he was convicted of: (3-20-20)T

a. A felony, if the applicant was eighteen (18) years old or older at the time of conviction; (3-20-20)T

b. A misdemeanor Driving Under the Influence offense(s) within two (2) years immediately preceding application, or two or more (2) misdemeanor Driving Under the Influence offenses within five (5) years immediately preceding application; (3-20-20)T

c. A misdemeanor crime involving domestic violence, if the relevant law enforcement discipline requires the applicant to possess a firearm in the course of their duty, or if the conviction occurred within 5 years immediately preceding application; (3-20-20)T

d. A misdemeanor crime of deceit, as defined in these rules, or a misdemeanor sex offense, if the conviction occurred within five (5) years immediately preceding application; (3-20-20)T

e. A misdemeanor drug-related offense, if the conviction occurred within one (1) year immediately preceding application. (3-20-20)T

**02. Driver's License.** An applicant is ineligible if he does not possess a valid driving license from the applicant's state of residence and is unable to qualify for an Idaho driver's license, except for the following disciplines: (3-20-20)T

a. Correction Officers; (3-20-20)T

b. Emergency Communications Officers. (3-20-20)T



**03. Marijuana.** An applicant is ineligible if he used marijuana, cannabis, hashish, hash oil, or THC in synthetic and natural forms, whether charged or not, if such use occurred: (3-20-20)T

**a.** Within one (1) year immediately preceding application; (3-20-20)T

**b.** While employed as a law enforcement officer, in a prosecutorial position, or in a position of public safety, regardless of when the use occurred. (3-20-20)T

**04. Violations of Idaho Controlled Substances Act.** An applicant is ineligible if he, while eighteen (18) years old or older, violated any provision of the Idaho Uniform Controlled Substances Act, Section 37-2701 et seq., Idaho Code, whether charged or not, that constitutes a felony, or of a comparable statute of another state or country, if the violation occurred: (3-20-20)T

**a.** Within three (3) years immediately preceding application; (3-20-20)T

**b.** While employed as a law enforcement officer, in a prosecutorial position, or in a position of public safety, regardless of when the illegal use occurred. (3-20-20)T

**05. Use of Prescription or Other Legally Obtainable Controlled Substance.** An applicant is ineligible if he unlawfully used any prescription drug or a legally obtainable controlled substance within the past three (3) years, unless: (3-20-20)T

**a.** The applicant was under the age of eighteen (18) at the time of using the controlled substance; or (3-20-20)T

**b.** An immediate, pressing, or emergency medical circumstance existed to justify the use of a prescription controlled substance not specifically prescribed to the person. (3-20-20)T

**06. Military Discharge.** An applicant is ineligible if he received a “dismissal,” “bad conduct discharge” (BCD), “dishonorable discharge” (DD), or administrative discharge of other than honorable (OTH) from military service. (3-20-20)T

**07. Decertification or Denial of Certification.** An applicant is ineligible if he has been denied certification or his basic certificate has been revoked by the Council in this state or the responsible licensing agency in any other issuing jurisdiction, unless the denial or revocation has been rescinded by the Council or by the responsible licensing agency of the issuing jurisdiction. (3-20-20)T

**056. DOCUMENTATION OF CRIMINAL, TRAFFIC, AND MILITARY DISCHARGE RECORDS.**  
With a POST application, an applicant shall submit the following to verify criminal, traffic or military records. (3-20-20)T

**01. Criminal or Traffic Matters.** Charging documents, including citations, complaints, information or indictments; judgements of convictions, orders of restitution; orders involving probation, parole, or revocation of probation or parole; orders of dismissal or release; records of payments to the court. (3-20-20)T

**02. Military Discharge.** Copies of a DD214 for active military service, NGB Form 22 for National Guard Service, or Official Military Discharge Documentation for Reserve military service. (3-20-20)T

**057. REQUIREMENTS FOR BASIC CERTIFICATION.**  
In addition to complying with the foregoing standards, each applicant for certification must also comply with the following requirements. (3-20-20)T

**01. Agency Employment.** Each applicant must be an employee of an agency, as defined in these rules, in a position requiring POST certification, or be a member of POST professional staff. (3-20-20)T

**02. Background Investigation.** The employing agency must conduct a comprehensive background

investigation of each applicant to ensure that he meets requirements for POST certification and employment in the law enforcement profession. (3-20-20)T

**a.** The applicant must complete a comprehensive application and personal history statement prior to a background investigation in aid of determining he is eligible for certification. (3-20-20)T

**b.** The applicant must be fingerprinted on a standard FBI Applicant fingerprint card and a search of local, state, and national fingerprint data bases must be made to disclose any criminal record. The employing agency must retain originals of all records check results. (3-20-20)T

**c.** The employing agency must investigate the applicant's traffic records in each state in which he resided. (3-20-20)T

**d.** The background investigation must include information from personal references, schools, the applicant's last three (3) previous employers, and law enforcement agency or PSAP records in jurisdictions where the applicant has lived or worked. (3-20-20)T

**e.** The employing agency must interview each applicant to ascertain his suitability for the law enforcement profession. Interview topics must include use of intoxicants, controlled substances, physical, mental, and emotional history, family problems, moral outlook and habits, and the applicant's financial history. (3-20-20)T

**f.** An experienced investigator must conduct a thorough investigation into the applicant's reputation, integrity, honesty, dependability, qualifications, experience, associations, emotional stability, and respect for the law. (3-20-20)T

**03. Physical Readiness Assessment.** The employing agency shall require an assessment of an applicant's physical readiness to ensure he can perform physically demanding tasks and tests while attending a basic training academy or equivalent program. An applicant who fails a required physical test during an academy may be dismissed, but may attend a future academy and must pass a physical readiness test prior to certification. (3-20-20)T

**04. Mental Readiness Assessment.** Where there is a question as to whether the applicant may be subject to a mental or emotional disorder that calls his suitability for the law enforcement profession into question, the employing agency shall have a psychiatrist or clinical psychologist conduct a thorough evaluation to ensure he is capable of performing law enforcement duties. (3-20-20)T

**05. Application.** Each applicant must fill out a POST Application and submit it to the employing agency, which shall submit it to POST with all required documentation. (3-20-20)T

**a.** Upon review of an application, POST may inspect an agency's background investigation file to ensure it is accurate and complete. If a review indicates that information submitted to POST may be inaccurate, incomplete or falsified, the Division Administrator must inspect the agency's background investigation file. (3-20-20)T

**b.** If the application contains inaccuracies or omissions, the Division Administrator may require the agency to supplement the application, and may approve the application. (3-20-20)T

**c.** If the application contains evident falsifications, the Division Administrator shall reject the application. (3-20-20)T

**06. Aptitude Test.** An applicant shall complete an aptitude test to ensure he is capable of performing law enforcement duties. (3-20-20)T

**07. Code of Ethics/Standards of Conduct.** Each applicant shall attest that he will abide by the following Law Enforcement Code of Ethics, and that he understands violations thereof constitute grounds for decertification:

As a member of the law enforcement profession, my fundamental duty is to serve the community; to

safeguard lives and property; to protect the innocent against deception, the weak against oppression or intimidation, and the peaceful against violence or disorder; and to respect the Constitutional rights of all to liberty, equality and justice.

I will keep my private life unsullied as an example to all and will behave in a manner that does not bring discredit to me or my agency. I will maintain courageous calm in the face of danger, scorn, or ridicule; develop self-restraint; and be constantly mindful of the welfare of others. Honest in thought and deed in both my personal and official life, I will be exemplary in obeying the law and the regulations of my department. Whatever I see or hear of a confidential nature or that is confided to me in my official capacity will be kept ever secret, unless revelation is necessary in the performance of my duty.

I will never act officiously or permit personal feelings, prejudices, political beliefs, aspirations, animosities or friendships to influence my decisions. With no compromise for crime and the relentless prosecution of criminals, I will enforce the law courteously and appropriately without fear or favor, malice or ill will, never employing unnecessary force or violence and never accepting gratuities.

I recognize the badge or position of my office as a symbol of public faith, and I accept it as a public trust to be held so long as I am true to the ethics of law enforcement/public service. I will never engage in acts of corruption or bribery, nor will I condone such acts by other law enforcement or emergency communications officers. I will cooperate with all legally authorized agencies and their representatives in the pursuit of justice.

I know that I alone am responsible for my own standard of professional performance and will take every reasonable opportunity to enhance and improve my level of knowledge and competence. I will constantly strive to achieve these objectives and ideals, dedicating myself before God or have a sincere and unfaltering commitment to my chosen profession...law enforcement.

(3-20-20)T

**08. Time for Completing Basic Training Academy or Alternative Training, Field Training and Probationary Period.** (3-20-20)T

**a.** Except as otherwise provided in these rules, every person attending a basic training academy must complete that academy, a minimum of 40 hours of field training and six consecutive months of probation in that discipline with that hiring agency within twelve months of beginning employment in order to be certified.(3-20-20)T

**b.** Emergency communications officers attending a basic training academy must complete that academy, and six consecutive months of probation in that discipline with that hiring agency within eighteen (18) months of beginning employment in order to be certified. (3-20-20)T

**c.** Any person who does not become certified in the relevant discipline within three (3) years of graduating from a basic training academy or POST certified equivalent program must repeat that entire academy or program in order to become certified. (3-20-20)T

**d.** Every person seeking certification through the POST challenge process must complete that process within one year of beginning employment with an agency. (3-20-20)T

**058. STANDARDS OF CONDUCT FOR BASIC TRAINING ACADEMY STUDENTS.**

**01. Required Behavior.** All students shall conduct themselves in a manner which will bring credit to the law enforcement profession. Student behavior must reflect courtesy, consideration and respect for others. (3-20-20)T

**02. Prohibited Conduct.** Any conduct detrimental to the efficiency or discipline of the academy, whether or not stated in the instructions, is prohibited and can be cause for disciplinary action or expulsion. A student's agency head will be informed of any such infraction. (3-20-20)T

**03. Notice.** POST shall inform students of requirements relating to residency, equipment, supplies, and

conduct at the academy at the time of their acceptance into an academy. (3-20-20)T

**059. CHALLENGING A BASIC TRAINING ACADEMY.**

An applicant for POST certification may challenge the basic training academy in the relevant discipline under the following circumstances, and subject to the following conditions. (3-20-20)T

**01. Requirements for Challenging a Basic Training Academy.** Except as otherwise provided by these rules, an applicant challenging a basic training academy must: (3-20-20)T

- a. Be employed by an agency in Idaho; (3-20-20)T
- b. Have been employed, and if applicable, have been certified or commissioned by another state or the federal government as an officer in the relevant discipline within the last five (5) years, or a student who has satisfactorily completed a basic training academy equivalent to the POST basic training academy in the relevant discipline within the last three (3) years; (3-20-20)T
- c. Submit a POST certification challenge packet, including copies of all relevant service, educational and training records; (3-20-20)T
- d. Disclose all information regarding any decertification investigation or proceeding or the equivalent from any other jurisdiction; (3-20-20)T
- e. Complete a probationary period of at least six (6) consecutive months with the employing agency in the relevant discipline; (3-20-20)T
- f. Comply with any additional provisions required by POST for a challenge in a specific discipline; and (3-20-20)T
- g. Reserve Officers must have been employed, certified, or commissioned by another state or the federal government as an officer in the relevant discipline within the last three (3) years. (3-20-20)T

**02. Patrol and Detention Law Enforcement Certification Program or POST Academy Graduates.** An applicant who is appointed to either a peace officer or a detention officer position from 3 to 5 years after completing both the patrol and detention officer training through a POST approved law enforcement certification program or POST basic training academy, will be eligible for certification in the other discipline without attending an additional basic training academy, provided the officer: (3-20-20)T

- a. Was appointed to a peace officer or detention officer position in Idaho within three (3) years from graduating from a law enforcement certification program or a POST Academy; (3-20-20)T
- b. Possesses a detention or peace officer certification from POST; (3-20-20)T
- c. Submits a POST challenge packet; (3-20-20)T
- d. Discloses information regarding any decertification investigation or proceeding or the equivalent from any other jurisdiction; (3-20-20)T
- e. Completes a probationary period of at least six (6) consecutive months with the employing agency in the relevant discipline; and (3-20-20)T
- f. Complies with any additional provisions required by POST for a challenge in a specific discipline. (3-20-20)T

**060. AGREEMENT TO SERVE – REIMBURSEMENT REQUIREMENT.**

**01. Agreement.** Pursuant to Section 19-5112, Idaho Code, any student attending a POST funded basic training academy must execute an agreement promising to remain within the law enforcement profession in Idaho for

two (2) years immediately following graduation. Violation of the agreement will give rise to a civil action which may be commenced by the Council on behalf of the state for restitution of all costs of education paid by the Council plus costs and reasonable attorney's fees. (3-20-20)T

**02. Fulfillment of Agreement.** The agreement will be fulfilled if, following graduation from a basic training academy, the student remains in the law enforcement profession in Idaho, as follows: (3-20-20)T

**a.** On a full-time basis, for two (2) full calendar years immediately following graduation date; or (3-20-20)T

**b.** On a part-time basis, and the officer provides the Council with documentation of four thousand one hundred sixty (4,160) hours of service immediately following graduation date. (3-20-20)T

**03. Relief from Obligation to Serve.** A student is relieved of his obligations under the agreement if the student is: (3-20-20)T

**a.** Terminated by the employing agency due to budget cutbacks or loss of funding and the agency provides POST with a letter stating the student was terminated due to the agency's lack of funding; (3-20-20)T

**b.** Forced to resign due to his own or an immediate family member's terminal illness or prolonged debilitating condition and the student provides POST with documentation from an attending physician verifying the medical condition; (3-20-20)T

**c.** Ordered into full-time active military service, and the student provides POST with documentation of official military orders; or (3-20-20)T

**d.** The spouse of a person who is a member of the military and is being required to transfer outside Idaho for a prolonged period of time, and the student provides POST with documentation of the spouse's official military orders. (3-20-20)T

**04. Reimbursement.** A student who graduates from a basic training academy whose employment is terminated or resigns prior to fulfillment of the agreement or does not qualify for disqualification must reimburse the state for educational training expenses. (3-20-20)T

**05. Proration.** A student's reimbursement obligation under the agreement will be prorated if he remains in the law enforcement profession in Idaho following graduation from a basic training academy for the following time periods: (3-20-20)T

**a.** On a full-time basis for less than twelve (12) complete months following graduation. The full amount of money set forth in the agreement shall be owed; (3-20-20)T

**b.** On a full-time basis for a minimum of twelve (12) complete months following graduation but less than twenty-four (24) complete months. The amount owed to the Council will be reduced proportionately for each complete month worked from the date of graduation to the date of separation; or (3-20-20)T

**c.** On a part-time basis for a documented minimum of two thousand eighty (2,080) hours service following graduation, but less than four thousand one hundred sixty (4,160) hours. The amount owed to the Council will be reduced proportionately for each one hundred seventy-three (173) hours worked from the date of graduation to the date of separation. (3-20-20)T

**06. Multiple Basic Training Academies.** A student who graduates from more than one (1) basic training academy must fulfill a two-year agreement for each academy attended. (3-20-20)T

**07. Decertification.** A student who is decertified by POST prior to a period of two (2) years after graduating from an academy shall not be relieved of the obligation to reimburse POST pursuant to this section. (3-20-20)T

**061. – 069. (RESERVED)**

**070. HIGHER LEVEL CERTIFICATION.**

In addition to basic certification, the Council may issue higher-level certifications in recognition of additional training and experience to full-time officers already possessing a basic POST certification. (3-20-20)T

**01. Types of Higher-Level Certification.** In addition to basic certification, the Council may issue the following: (3-20-20)T

**a.** Intermediate certification for peace officers, detention officers, juvenile probation officers, juvenile detention officers and emergency communications officers; (3-20-20)T

**b.** Advanced certification for peace officers, detention officers and emergency communications officers; (3-20-20)T

**c.** Supervisor certification for peace officers, detention officers and emergency communications officers; (3-20-20)T

**d.** Master certification for peace officers, detention officers and emergency communications officers; (3-20-20)T

**e.** Management certification for peace officers, detention officers and emergency communications officers; (3-20-20)T

**f.** Executive certification for peace officers. (3-20-20)T

**02. Requirements.** In addition to the requirements otherwise set forth in these rules, the following are required for higher level certification: (3-20-20)T

**a.** An applicant shall possess POST basic certification in the relevant discipline and be a full-time employee of an agency. (3-20-20)T

**b.** An applicant shall attach to his POST application all relevant transcripts, certificates, diplomas, degrees, course outlines, or other documents not listed on the applicant's POST training record, verifying his education and training. (3-20-20)T

**c.** The agency of an applicant for a Supervisor, Management, or Executive certification must submit a job description or other documentation verifying the applicant's duties. (3-20-20)T

**071. LAW ENFORCEMENT EXPERIENCE, MILITARY EXPERIENCE, AND COLLEGE CREDITS FOR PURPOSES OF HIGHER CERTIFICATION.**

For purposes of determining whether a person is eligible for higher level certifications based upon experience and education, the following apply. (3-20-20)T

**01. Law Enforcement Experience.** Law enforcement experience shall include actual time served with a law enforcement agency as a peace officer or county detention officer. POST Council determines the acceptability of time served in one of those positions in a jurisdiction other than Idaho, or one which does not comply with the minimum standards set forth in these rules. (3-20-20)T

**02. Juvenile Justice Experience.** Juvenile justice experience means actual time served as a full-time juvenile corrections, juvenile detention, or juvenile probation officer. (3-20-20)T

**03. Emergency Communications Officer Experience.** Emergency communications officer experience means actual time served as a full-time emergency communications officer with a duly constituted law enforcement or PSAP agency. (3-20-20)T

**04. Military Law Enforcement Service and Education.** An applicant who has served in the military

as a full-time military law enforcement officer may be awarded partial credit toward law enforcement experience and training. The applicant shall have served as a full-time military law enforcement officer for the period of time for which credit is requested. Regular guard duty does not qualify. (3-20-20)T

**a.** Credit will be awarded as follows: (3-20-20)T

**i.** One (1) year of accepted military law enforcement service shall equal three (3) months of law enforcement experience. (3-20-20)T

**ii.** Eight (8) hours of accepted military law enforcement training shall equal four (4) hours of law enforcement training. (3-20-20)T

**b.** No applicant shall be awarded more than two (2) years of law enforcement experience or more than one thousand (1,000) hours of law enforcement training. (3-20-20)T

**c.** Educational credit may be awarded for completion of military law enforcement schools. All certificates, course outlines, diplomas, DD-214's, and certificates of completion showing length of school shall be submitted to POST with the application for higher certification. (3-20-20)T

**05. College Credits.** POST may award credits for college education as follows: (3-20-20)T

**a.** One (1) college or university semester hour or unit shall equal one (1) college credit. (3-20-20)T

**b.** One (1) college or university quarter hour or unit shall equal two-thirds (2/3) of one (1) college credit. (3-20-20)T

**c.** College credits may be converted to POST training hours at the rate of twenty (20) POST training hours for one (1) college credit. (3-20-20)T

**d.** When college credit is awarded or purchased for POST approved training, it may be counted for either POST training hours or college credit, whichever is to the advantage of the applicant. (3-20-20)T

**e.** Applicants shall submit an official college transcript as verification of college credit. (3-20-20)T

**072. INTERMEDIATE AND ADVANCED CERTIFICATION.**

POST Intermediate and Advanced certification recognizes the additional training and experience of patrol, detention, emergency communications officers, juvenile probation officers and juvenile detention officers already possessing a basic POST certification. In addition to the requirements otherwise set forth in these Rules, the following are required for an Intermediate or Advanced Certificate. (3-20-20)T

**01. Intermediate Certification.** An applicant shall hold a current POST basic certification, and have acquired either the combination of college credits and/or POST training hours, combined with the prescribed years of law enforcement experience, or an associate or baccalaureate degree from a college recognized by a regional accreditation agency, combined with the prescribed years of law enforcement experience, as set forth in the following subsections: (3-20-20)T

**a.** Peace officers.

POST Training Hours Including POST Basic Patrol Academy	600 hours	800 hours	1,200 hours	1,600 hours	1,800 hours	POST Basic Patrol Academy	
One College Credit Equals Twenty (20) POST Training Hours	The above may be a combination of College Credits and POST Training Hours					Associate Degree	Baccalaureate Degree

Years of Law Enforcement Experience	8 or more	7	6	5	4	4	2
-------------------------------------	-----------	---	---	---	---	---	---

(3-20-20)T

**b. Detention officers.**

POST Training Hours Including POST Basic Detention Academy	600 hours	800 hours	1,200 hours	1,600 hours	1,800 hours	POST Basic Detention Academy	
One College Credit Equals Twenty (20) POST Training Hours	The above may be a combination of College Credits and POST Training Hours					Associate Degree	Baccalaureate Degree
Years of Law Enforcement Experience	8 or more	7	6	5	4	4	2

(3-20-20)T

**c. Emergency communications officers. The applicant shall:**

(3-20-20)T

i. Have completed a minimum of one hundred twenty (120) hours of POST certified training, which must include basic training. (3-20-20)T

ii. A minimum of three (3) years of emergency communications officer experience. (3-20-20)T

(3-20-20)T

**d. Juvenile detention officers.**

POST Training Hours Including POST Basic Juvenile Detention Academy	200 hours	400 hours	600 hours	800 hours	1,000 hours	POST Basic Juvenile Detention Academy	
One College Credit Equals Twenty (20) POST Training Hours	The above may be a combination of College Credits and POST Training Hours					Associate Degree	Baccalaureate Degree
Years of Juvenile Justice Experience	8 or more	7	6	5	4	4	2

(3-20-20)T

**e. Juvenile probation officers.**

POST Training Hours Including POST Basic Juvenile Probation Academy	200 hours	400 hours	600 hours	800 hours	1,000 hours	POST Basic Juvenile Probation Academy	
---	-----------	-----------	-----------	-----------	-------------	---------------------------------------	--



One College Credit Equals Twenty (20) POST Training Hours	The above may be a combination of College Credits and POST Training Hours					Associate Degree	Baccalaureate Degree
Years of Juvenile Justice Experience	8 or more	7	6	5	4	4	2

(3-20-20)T

**02. Advanced Certification.** An applicant shall hold a current POST basic certification, possess or be eligible to possess an intermediate certificate, and have acquired either the combination of college credits and POST training hours, combined with the prescribed years of law enforcement experience, or an associate, baccalaureate, master's or doctoral degree from a college recognized by a regional accreditation agency, combined with the prescribed years of law enforcement experience, as set forth in the following subsections: (3-20-20)T

**a. Peace officers.**

POST Training Hours Including POST Basic Patrol Academy	500 hours	600 hours	700 hours	800 hours	900 hours	1,200 hours	POST Basic Patrol Academy		
College Credits	15	20	30	40	45	60	Associate Degree	Baccalaureate Degree	Master's Degree or PhD
Years of Law Enforcement Experience	13 or more	12	11	10	9	8	8	6	4

Graduation from the Drug Enforcement Administration School in Washington, D.C., the Northwestern University Traffic Institute School of Police Staff and Command, the FBI National Academy or Southern Police Institute's Administrative Officers Course/Command Officers Development Course shall be accepted in lieu of the fifteen (15) college credits required for the Advanced Certificate with thirteen (13) years or more of experience. (3-20-20)T

**b. Detention officers.**

POST Training Hours Including POST Basic Detention Academy	500 hours	600 hours	700 hours	800 hours	900 hours	1,200 hours	POST Basic Detention Academy		
College Credits	15	20	30	40	45	60	Associate Degree	Baccalaureate Degree	Master's Degree or PhD
Years of Law Enforcement Experience	13 or more	12	11	10	9	8	8	6	4

Graduation from the Drug Enforcement Administration School in Washington, D.C., the Northwestern University

Traffic Institute School of Police Staff and Command, the FBI National Academy or Southern Police Institute's Administrative Officers Course/Command Officers Development Course shall be accepted in lieu of the fifteen (15) college credits required for the Advanced Certificate with thirteen (13) years or more of experience. (3-20-20)T

- c. Emergency communications officers. (3-20-20)T
- i. Have completed a minimum of five hundred (500) hours of POST certified training, which must include POST approved basic training. (3-20-20)T
- ii. Have at least ten (10) years of communications specialist experience. (3-20-20)T

**03. Probationary Period.** An applicant shall have completed a probationary period of at least six (6) consecutive months with the employing agency prior to applying for intermediate or advanced certificates. Agencies may require a longer probationary period prior to application. (3-20-20)T

**073. SUPERVISOR CERTIFICATION.**

POST supervisor certification recognizes the training and experience of patrol, detention and emergency communications officers employed in positions above the operational level who holds the rank of sergeant or equivalent title and who are responsible for the direct supervision of line personnel. In addition to the requirements otherwise set forth in these rules, an applicant for a supervisor certificate must: (3-20-20)T

**01. Position.** Be employed for a minimum of one (1) year by an agency in a first-line supervision position above the operational level which is responsible for the direct supervision of nonsupervisory personnel. (3-20-20)T

**02. Certification.** Possess an intermediate or advanced patrol, detention officer or emergency communications officer certificate. (3-20-20)T

**03. Training.** Have completed one hundred (100) hours of POST certified supervisory-level training, of which fifty (50) hours shall have been completed within three (3) years immediately prior to submitting an application for the supervisor certificate. (3-20-20)T

**074. MASTER CERTIFICATION.**

POST master certification recognizes the training and experience of patrol, detention and emergency communications officers who hold a rank below sergeant or equivalent title and who have focused their career efforts on line functions. In addition to the requirements otherwise set forth in these Rules, an applicant for a master certificate must: (3-20-20)T

**01. Prior Certification.** Possess an advanced certificate. (3-20-20)T

**02. Training.** Have completed one thousand five hundred (1,500) hours of POST certified training. College credits may be converted to POST training hours at the rate of one (1) college credit equals twenty (20) POST training hours. (3-20-20)T

**03. Experience.** Have completed a minimum of fifteen (15) years of full-time law enforcement service in assignments which did not include full-time supervisory, management, or executive positions. (3-20-20)T

**075. MANAGEMENT CERTIFICATION.**

POST management certification recognizes the training and experience of patrol, detention and emergency communications officers in positions between a first-line supervisor and an executive, with responsibility for direct supervision of supervisory personnel and/or command duties. POST management certification is also available to city police chiefs or administrators within state agencies having law enforcement powers whose duties are primarily administrative. In addition to the requirements otherwise set forth in these rules, the following are required for an award of a management certificate. (3-20-20)T

**01. Position.** An applicant must be employed by an agency for a minimum of six (6) months in a management or executive position with primary responsibilities that are administrative or managerial in nature,

including direct supervision of supervisory personnel and/or command duties, and which is typically occupied by a person holding the rank of lieutenant or higher, or equivalent title. (3-20-20)T

**02. Certification.** An applicant must possess POST certification as a peace officer, detention officer, or emergency communications officer; certification from another state that has minimum peace officer standards; or a certificate of completion from a city, county, state, or federal law enforcement academy that meets that state's minimum training standards. (3-20-20)T

**03. Training.** An applicant must have completed one hundred (100) hours of POST certified management-level training, of which fifty (50) hours shall have been completed within three (3) years immediately prior to submitting an application for the Management Certificate. (3-20-20)T

**04. Officers not Certified in Idaho.** In addition to the other requirements of this section, officers who are not POST certified must: (3-20-20)T

**a.** Submit a Patrol Challenge Packet to POST, including copies of POST training records from other states, transcripts, certificates, diplomas, or other documents substantiating the officer's training, education and experience. (3-20-20)T

**b.** Attend a POST approved course of study in Idaho law and pass the POST Idaho law exam. (3-20-20)T

**05. Police Chiefs, Agency Administrators.** City police chiefs or administrators within state agencies having law enforcement powers who have duties which are primarily administrative may satisfy the certification requirement of Section 19-5109(2), Idaho Code, by obtaining this certificate. All other city police chiefs or state agency administrators having law enforcement powers may be awarded this certificate upon meeting the requirements, but shall also complete the requirements necessary to obtain a Basic Certificate. (3-20-20)T

**076. EXECUTIVE CERTIFICATION.**

POST Executive Certification recognizes the training and experience of law enforcement agency heads. In addition to the requirements otherwise set forth in these rules, an applicant for an Executive Certificate must: (3-20-20)T

**01. Position.** Be employed for a minimum of three (3) years as a chief of police, sheriff, director or chief executive of an agency. (3-20-20)T

**02. Prior Certification.** Possess a POST Advanced or Management Certificate, or the equivalent from another state meeting or exceeding Idaho standards. (3-20-20)T

**03. Training.** Have completed one hundred (100) hours of POST certified executive-level training, of which fifty (50) hours shall have been completed within three (3) years immediately prior to application for an Executive Certificate. (3-20-20)T

**077. – 079. (RESERVED)**

**080. CERTIFICATIONS FOR PART-TIME OFFICERS.**

In addition to basic POST certification, as set forth in these rules, the Council may issue certifications to the following employees who work under the supervision of full-time, POST certified Officers. (3-20-20)T

**01. Requirements.** Part-time officers in all disciplines except reserve peace officers, marine deputies and part-time juvenile detention officers will meet the same requirements as full time officers and will be issued a basic certificate. (3-20-20)T

**a.** Part-time juvenile detention officers who attend the basic juvenile detention academy will receive a basic certificate. Part-time juvenile detention officers who attend the part-time juvenile detention training will be issued a part-time juvenile detention certificate. (3-20-20)T

**b.** Part-time misdemeanor probation officers must work sixty (60) hours per year to maintain

certification. (3-20-20)T

c. Reserve peace officers will be issued a reserve peace officer certification. (3-20-20)T

d. Marine deputies will be issued a marine deputy certification. (3-20-20)T

**02. Lapse of Certification.** All part-time POST certifications shall lapse in the same manner as basic certifications, and as set forth in these rules. (3-20-20)T

**03. Decertification.** All-part time officers are subject to decertification in the manner set forth in these rules. (3-20-20)T

**04. Limit and Authority.** The certification and authority of part-time officers is not limited except where indicated in these rules. (3-20-20)T

**081. RESERVE PEACE OFFICER CERTIFICATION.**

The Council may issue reserve peace officer certification for part-time employees of agencies who are assigned limited duties and work under the supervision of full-time, POST certified peace officers. (3-20-20)T

**01. Eligibility.** An applicant for reserve peace officer certification must be a reserve peace officer employed on a part-time basis by an agency and meet minimum standards for employment as provided in these rules. (3-20-20)T

**02. Reserve Officer Training.** An applicant for reserve peace officer certification shall complete the POST approved reserve peace officer academy. (3-20-20)T

**03. Peace or Reserve Officers Certified In Another State, Commissioned by the Federal Government, or Graduates of a Basic Police Academy.** An applicant who has served as a full-time certified peace officer or reserve officer in another state or as a full-time commissioned peace officer of the federal government within the three (3) years immediately preceding application or a student who has completed an equivalent to the basic patrol academy within the three (3) years immediately preceding application is eligible for reserve office certification without attending the reserve officer academy, provided he: (3-20-20)T

a. Submits, with a reserve officer certification packet, records of certifications and training from other states, and transcripts, certificates, diplomas, or other documents that verify the officer's training and experience; (3-20-20)T

b. Discloses all information regarding any decertification investigation or proceeding or the equivalent from any other jurisdiction; (3-20-20)T

c. Comply with any additional provisions required by POST. (3-20-20)T

**04. Absence of Three Years.** An officer who has not served in law enforcement for over three (3) years must complete all requirements set forth in this section to be eligible for reserve peace officer certification. (3-20-20)T

**05. Supervision.** An agency utilizing reserve peace officers shall have a policy regarding the duties and supervision of certified reserve peace officers. (3-20-20)T

**06. Limitation on Certification.** A reserve peace officer's certification is effective only while he is formally assigned to peace officer duties by the employing agency. (3-20-20)T

**07. Retaining Certification.** A certified reserve peace officer must work a minimum of one hundred twenty (120) hours annually in a peace officer capacity to retain certification. A certified reserve peace officer working less than one hundred twenty (120) hours annually must complete all requirements for initial reserve peace officer certification to be recertified. (3-20-20)T

**082. MARINE DEPUTY CERTIFICATION.**

**01. Appointment by Sheriff.** Marine deputies may be appointed by the Sheriff of a county for the purpose of enforcing: (3-20-20)T

- a. The provisions of Title 67, Chapter 70, Idaho Code; (3-20-20)T
- b. The provisions of IDAPA 26, Title 01, Chapter 30, Administrative Rules of the Idaho Department of Parks and Recreation; (3-20-20)T
- c. City and county ordinances pertaining to watercraft and waterways; and (3-20-20)T
- d. Enforcement of Idaho Code as assigned by the Sheriff. (3-20-20)T

**02. Minimum Basic Training.** A person desiring marine deputy certification shall complete the Council approved core curriculum, comprising basic law enforcement and marine specific courses. (3-20-20)T

**03. Peace Officer Eligibility.** A person who, within the three (3) years immediately preceding application, has served as a full-time POST certified peace officer shall be eligible for POST marine deputy certification without completing the core curriculum, provided he completes required marine specific courses and passes the marine deputy certification examination. (3-20-20)T

**04. Certified or Commissioned in Another Jurisdiction; Graduate of Basic Police Academy.** A person who has, within the three (3) years immediately preceding application, served as a full-time certified peace officer in another state, or served as a full-time commissioned peace officer for the federal government, or completed a basic police academy equivalent to the POST basic patrol academy may be eligible for POST marine deputy certification, provided he passes the POST marine deputy certification examination and meets all additional POST requirements for marine deputy certification. (3-20-20)T

**05. Absence of Three Years.** A person who has not served as a marine deputy or as a peace officer for over three (3) years must complete the POST core curriculum to be eligible for marine deputy certification. (3-20-20)T

**083. PART-TIME JUVENILE DETENTION OFFICER CERTIFICATION.**

A part-time juvenile detention officer must be certified by the Council within one (1) year of the date he was first employed as a part-time juvenile detention officer. (3-20-20)T

- 01. Eligibility.** An applicant shall: (3-20-20)T
- a. Meet the definition of part-time juvenile detention officer as defined in these rules. (3-20-20)T
  - b. Meet the minimum standards for certification provided in these rules. (3-20-20)T
  - c. Must have been employed by the agency for a minimum six (6) consecutive months, which may include part-time juvenile detention officer training time, prior to certification. (3-20-20)T

- 02. Requirements for Certification.** An applicant must: (3-20-20)T
- a. Complete POST approved part-time juvenile detention officer training. (3-20-20)T
  - b. Complete POST approved part-time juvenile detention officer field-training of no less than forty (40) hours. (3-20-20)T
  - c. Comply with any additional provisions required by POST. (3-20-20)T

**03. Retaining Certification.** A certified part-time juvenile detention officer must work sixty (60) hours annually in a juvenile detention officer capacity to retain certification. Documentation of hours worked must be

kept on file at the appointing agency. A part-time juvenile detention officer working less than sixty (60) hours annually must complete all requirements for certification set forth in this section to be recertified. (3-20-20)T

**04. Limitations on Certification and Authority.** (3-20-20)T

**a.** A part-time juvenile detention officer's certification is effective only during those periods when he is formally assigned by the employing agency to perform the duties of a certified part-time juvenile detention officer. (3-20-20)T

**b.** All certified part-time juvenile detention officers shall be directly supervised by a POST certified full-time juvenile detention officer, and each agency shall have a policy regarding supervision of part-time juvenile detention officers. (3-20-20)T

**084. – 089. (RESERVED)**

**090. CANINE-RELATED CERTIFICATIONS.**

Canine related certificates ensure the competence of law enforcement canine teams and evaluators. These rules do not limit the use of canine teams employed by other states or federal agencies for law enforcement purposes, or the use of volunteer canine teams in which the handler is not an Idaho peace, detention, correction, or adult probation and parole officer. (3-20-20)T

**091. CANINE TEAM CERTIFICATION.**

**01. Mandatory Certification.** A canine team shall be POST certified to perform law enforcement duties. (3-20-20)T

**02. Eligibility.** A canine handler shall hold a POST law enforcement certification. Contract employees are not eligible for canine team certification. (3-20-20)T

**03. Areas of Certification.** The Council shall certify a canine team which successfully demonstrates the handler's ability to control the dog, under the scrutiny of an evaluator, in addition to proficiency in one (1) or more areas as deemed by the Council. (3-20-20)T

**04. Evaluation.** Evaluators of canine teams shall use POST standards for that particular skill category. Performance shall be rated on a pass/fail basis. The evaluator may discontinue testing if excessive time has been spent without results. The evaluator shall not be the owner or handler of the dog being evaluated, and not have a proprietary interest in the training of the team being evaluated. A Regional Training Specialist shall be notified of all canine certification testing. (3-20-20)T

**05. Failed Evaluation.** If a team fails any portion of an evaluation, the entire evaluation is considered as having been failed. All skills shall be repeated and successfully demonstrated during retesting. The team shall wait at least twenty-four (24) hours before retesting, and be retested by the same evaluator, or his designee, that evaluated the failed test. (3-20-20)T

**06. Expiration of Certification.** POST Canine Certification is valid for fifteen (15) months. A canine team must be evaluated prior to their certification expiration date to maintain certification. Certification shall lapse if the handler and canine dog cease to perform canine team functions together. (3-20-20)T

**092. CANINE EVALUATOR CERTIFICATION.**

**01. Certification.** POST shall certify applicants who meet the requirements set forth in this section and are deemed qualified by their training and experience to evaluate police canine teams. Certificates shall be issued in the areas of Patrol and Detection. (3-20-20)T

**02. Eligibility.** To be eligible for a Canine Evaluator Certificate, each applicant shall: (3-20-20)T

**a.** Possess a current or previous POST professional certification and not have been previously

decertified as a public safety official in any jurisdiction; (3-20-20)T

- b.** Have three (3) years of experience as a certified canine handler; (3-20-20)T
- c.** Have three hundred ninety (390) hours of POST certified or federally- approved canine-related training; (3-20-20)T
- d.** Complete the POST certified Canine Evaluators course; (3-20-20)T
- e.** Evaluate seven (7) dogs while under supervision of a POST certified canine evaluator; and (3-20-20)T
- f.** Submit a Canine Evaluator Application Packet to POST, which includes: (3-20-20)T
  - i.** Transcripts, certificates, diplomas, or other documents verifying the applicant's education and training in the canine field; and (3-20-20)T
  - ii.** A letter of recommendation from an administrator within the applicant's agency. (3-20-20)T

**03. Retaining Certification.** A certified canine evaluator shall evaluate a minimum of four (4) dogs every two (2) years in the discipline in which they are certified to evaluate. Any evaluator not satisfying this requirement shall complete all requirements for initial canine evaluator certification to be recertified. (3-20-20)T

**04. Revocation.** The Council may revoke Canine Evaluator certification if an evaluator is deemed unqualified to continue evaluating police canine teams. Review of canine evaluator certification may be initiated upon the request of an agency head, other reliable source or the Council. (3-20-20)T

**093. – 099. (RESERVED)**

**100. LAPSE OF BASIC CERTIFICATION – REINSTATEMENT.**

**01. Lapse by Time.** POST basic certification in any discipline will lapse if the officer does not serve as an officer in the discipline of certification in Idaho for three (3) consecutive years. The three-year period will be tolled during any time an officer is the subject of a POST decertification investigation and is no longer employed in law enforcement. (3-20-20)T

**02. Exception for Officers Remaining With Agency.** A POST certified officer who changes from one certified discipline to another while remaining with the same agency will retain certification in the original discipline in which he was employed if he satisfies the continuing training requirements set forth in these rules. (3-20-20)T

**03. Reinstatement After Three to Five Years Absence.** An officer who has not served in full-time law enforcement from three (3) to five (5) years must meet the following requirements to be recertified: (3-20-20)T

- a.** Submit a POST Certification Challenge Packet; (3-20-20)T
- b.** Disclose all information regarding any decertification investigation or proceeding or the equivalent from any other jurisdiction. (3-20-20)T
- c.** Comply with any additional provisions required by POST. (3-20-20)T
- d.** Satisfy any applicable probationary period set forth in these rules. (3-20-20)T

**04. Reinstatement After Five Years to Eight Years Absence.** An officer who has not served in full-time law enforcement for over five (5) years but less than eight (8) years must attend a basic training academy to be recertified. (3-20-20)T

- a.** The Council may waive this requirement on a showing of good cause supported by clear and

convincing evidence that during a substantial part of the that time out of full-time law enforcement, the officer engaged in an occupation requiring law enforcement training, skill, and experience equivalent to that required in the officer's discipline of certification. This evidence must be submitted with a POST challenge packet. (3-20-20)T

- b.** Upon receiving a waiver, the officer must: (3-20-20)T

  - i.** Disclose all information regarding any decertification investigation or proceeding or the equivalent from any other jurisdiction. (3-20-20)T
  - ii.** Satisfy any applicable probationary period set forth in these rules. (3-20-20)T
  - iii.** Comply with any additional provisions required by POST. (3-20-20)T

**05. Reinstatement After Eight Years Absence.** An officer who has not served in full-time law enforcement for over eight (8) years must attend a basic training academy to be recertified. (3-20-20)T

**101. – 109. (RESERVED)**

**110. DECERTIFICATION.**

- 01. Mandatory Decertification.** The Council shall decertify any person for: (3-20-20)T

  - a.** A conviction of any felony or offense which would be a felony if committed in Idaho; (3-20-20)T
  - b.** A conviction for a misdemeanor offense involving domestic violence; (3-20-20)T
  - c.** Willfully falsifying or omitting any material information to obtain certification. (3-20-20)T
- 02. Discretionary Decertification.** The Council may decertify any person for: (3-20-20)T

  - a.** A conviction of any misdemeanor; (3-20-20)T
  - b.** A violation of the Council's Code of Ethics; (3-20-20)T
  - c.** Criminal conduct whether charged or not; (3-20-20)T
  - d.** Consuming alcoholic beverages on duty, except as necessary for the lawful performance of duties; (3-20-20)T
  - e.** Harassment or intimidation; (3-20-20)T
  - f.** Lying or falsifying official written or verbal communications; (3-20-20)T
  - g.** Inappropriate sexual conduct while on duty; (3-20-20)T
  - h.** An inappropriate relationship, sexual or otherwise, with a person who the officer knows or should have known is a victim, witness, defendant, or informant in an ongoing investigation or adjudication; (3-20-20)T
  - i.** Unauthorized use or unlawful conversion of the employing agency's property, equipment, or funds; (3-20-20)T
  - j.** Intentional and unauthorized disclosure of confidential information or information that may compromise an official investigation; (3-20-20)T
  - k.** Failure to report being charged with a felony or misdemeanor within five (5) business days; (3-20-20)T



**l.** Failure to respond or to respond truthfully to questions related to an investigation or legal proceeding. (3-20-20)T

**03. Required Notifications by Officers and Agencies.** (3-20-20)T

**a.** An officer charged with a felony or a misdemeanor shall notify his agency head within five (5) business days. (3-20-20)T

**b.** The agency head of an officer charged with a felony or misdemeanor shall notify the Division Administrator within fourteen (14) days of learning of the charge. (3-20-20)T

**c.** A person who is not currently employed by a law enforcement agency but is certified by POST shall notify POST of a misdemeanor or felony charge within fourteen (14) business days. (3-20-20)T

**04. Effect of Decertification.** (3-20-20)T

**a.** A person decertified by the Council is ineligible for POST certification of any kind for ten (10) years following the date of decertification. After the expiration of ten (10) years an agency head may petition the Council to allow a decertified officer to attend a basic academy and become certified. (3-20-20)T

**b.** No decertified person shall exercise any law enforcement authority until recertified. Any officer who is the subject of a decertification investigation is ineligible for any additional POST certification while under investigation. (3-20-20)T

**111. DUE PROCESS PROCEDURES IN DECERTIFICATION PROCEEDINGS.**

**01. Legal Authority.** In accordance with the Idaho Rules of Administrative Procedure of the Attorney General, IDAPA 04.11.01.050, the Council declines to adopt the procedures established in IDAPA 04.11.01 for contested cases. The procedures provided within these rules meet the unique requirements of the law enforcement profession for expeditious resolution of contested cases in order to assure public safety and to secure a just, speedy and economical determination of all matters presented to the Council. These procedures meet or exceed minimum Constitutional requirements for due process while allowing the Council to fulfill its obligations to protect the safety of the public and the integrity of the law enforcement profession. (3-20-20)T

**02. Overview.** The Division Administrator shall investigate all trustworthy allegations of misconduct by a person holding POST certification and determine whether decertification proceedings will be commenced. (3-20-20)T

**03. Decertification Investigations.** A person who is the subject of a decertification investigation shall receive an administrative warning requiring that he respond to questions, to answer such questions truthfully, and to acknowledge his understanding that no statements provided shall be used against him in criminal proceedings, as based on *Garrity v. New Jersey*, 385 U.S. 493 (1967). (3-20-20)T

**112. DECERTIFICATION PROCEEDINGS.**

If the Division Administrator determines that the allegations of misconduct by an officer, if proven, are cause for decertification, the officer shall be provided with notice and an opportunity to respond before a decision regarding decertification is made. (3-20-20)T

**01. Notice of Intent to Decertify.** The Division Administrator shall provide the person who is the subject of the proceeding with a notice of the intent to decertify, which includes: (3-20-20)T

**a.** The basis for the contemplated decertification and an explanation of the evidence supporting the intended action. (3-20-20)T

**b.** That the person shall have the opportunity to respond and present the Division Administrator, in writing or in person, any reasons why the intended action should not be taken. (3-20-20)T

- c. That the officer person has a right to be represented by a person of their own choosing. (3-20-20)T
- d. That the person may waive a response by submitting a written waiver to the Division Administrator. (3-20-20)T
- e. That, if the person waives a response or fails to respond within the designated time, the Division Administrator will enter an order of decertification. (3-20-20)T

**02. Decision – Request for Hearing.** After the person who is the subject of the decertification proceeding has responded or waived a response, or the period to respond has expired, the Division Administrator shall, within twenty-eight (28) days, issue a decision on decertification. (3-20-20)T

- a. The decision shall include findings of fact and conclusions of law and be final unless the person files a request for a hearing on the decision with the Council within fourteen (14) days of the date of the Division Administrator’s decision. (3-20-20)T
- b. A request for hearing shall include a brief statement of the issues on which the person contends a hearing is required. (3-20-20)T

**03. Hearing and Order.** Upon receipt of a request for hearing, the Council shall assign the matter to a hearing officer for hearing. (3-20-20)T

- a. The hearing officer shall have the power to subpoena witnesses, administer oaths, examine evidence and witnesses and request additional information from the parties. (3-20-20)T
- b. The person who is the subject of the proceeding shall have the right to be represented at the hearing by a person of their own choosing and the right to conduct discovery. (3-20-20)T
- c. Prior to submitting testimonial evidence, the person shall receive an administrative warning requiring that he provide testimony truthfully, and to acknowledge his understanding that no statements provided shall be used against him in criminal proceedings, based on Garrity v. New Jersey, 385 U.S. 493 (1967). (3-20-20)T
- d. The hearing shall be recorded at the Council’s expense. The recording will be the official record of the hearing. Any party to the action may, at their expense, request that a transcript of the hearing be prepared or that additional recordings be made. Such a request shall be approved if the additional recording does not distract from or disrupt the hearing. (3-20-20)T
- e. Pursuant to Idaho Code Section 19-5113, the Division Administrator shall have the authority to compel the attendance and testimony of witnesses and production and examination of books, papers, and records. (3-20-20)T
- f. At the conclusion of proceedings, the hearing officer shall issue a decision in writing consisting of findings of fact, conclusions of law and an order that the person be decertified or that POST failed to show grounds for decertification and reinstating the officer. The decision and the record of the proceedings, shall be filed with the Council. (3-20-20)T

**g.** The decision shall be final, unless a petition for review by the full Council is filed with the Council within twenty-eight (28) days of the date of the decision. A petition for review shall include a brief statement of the basis upon which review is requested. (3-20-20)T

**h.** Where the decision directs the reinstatement of the person’s certification, the Division Administrator shall reinstate certification upon the expiration of the time for filing a petition for review. (3-20-20)T

**04. Petition for Review.** (3-20-20)T

- a. Upon receipt of a petition for review, the Council shall issue a briefing schedule allowing the petitioner an opening brief, the respondent a response brief and the petitioner a reply brief. The Council shall review the

record, briefs submitted and may allow oral argument. The petitioner may be represented by a person of their own choosing. (3-20-20)T

**b.** The Council may affirm, reverse, or modify the decision of the hearing officer, or may remand the matter. The Council's decision shall be final and may be appealed to district court by filing a notice of appeal within twenty-eight (28) days of the date of service of the decision. (3-20-20)T

**05. Service.** Service of all notices to be given, orders or other documents under Section 092 shall be by personal service, facsimile, other electronic means, or by U.S. mail, with postage prepaid, addressed to a party's last known address. (3-20-20)T

**113. – 119. (RESERVED)**

**120. POST INSTRUCTOR CERTIFICATION.**

To ensure the competence of instructors of subjects pertinent to law enforcement personnel, the Council will certify instructors who meet the requirements set forth in these rules. (3-20-20)T

**121. POST INSTRUCTOR CERTIFICATION – GENERAL PROVISIONS.**

**01. POST Training Credit.** POST will grant training credit for completion of training conducted by POST or instructed entirely by POST certified instructors provided the training is documented and meets POST training standards. (3-20-20)T

**02. Agency Responsibility.** Agencies, school directors, and POST Academy and Regional Training Specialists shall supervise, monitor, and audit instructors and courses to ensure that instructional excellence is maintained. (3-20-20)T

**122. REQUIREMENTS FOR INSTRUCTORS OF LAW ENFORCEMENT SUBJECTS.**

In addition to the other requirements for instructor certification set forth in these rules, instructors of law enforcement subjects must meet the following requirements. (3-20-20)T

**01. Experience and Certification.** An applicant must have a minimum of three (3) years of law enforcement experience, possess current or previous Idaho POST professional certification, and must not have been previously decertified as a law enforcement official of any jurisdiction. (3-20-20)T

**02. Instructor Development Course.** An applicant must complete the POST Instructor Development Course or approved equivalent. (3-20-20)T

**03. Additional Requirements.** An applicant must comply with any additional provisions required by POST. (3-20-20)T

**123. REQUIREMENTS FOR HIGH LIABILITY INSTRUCTOR ENDORSEMENT.**

POST certified instructors must obtain additional endorsements to instruct any topics deemed as "high liability" by the Council. (3-20-20)T

**01. Completion of a High Liability Instructor School.** An applicant for High Liability Instructor Endorsement must complete all requirements of the POST instructor course specific to the high liability topic area in which the applicant intends to instruct. (3-20-20)T

**02. Application.** After meeting the requirements for POST instructor certification, the applicant must submit a completed POST High Liability Instructor Endorsement Application Packet and must comply with any additional provisions required by POST. (3-20-20)T

**03. Multiple Endorsements.** A current POST endorsed high liability instructor applying for instructor endorsement in an additional high liability topic area must meet the requirements of this section for the additional topic area prior to endorsement in that topic. (3-20-20)T

**04. Instruction Pending Endorsement.** Prior to evaluation by a Regional Training Specialist, high liability instructor endorsement applicants cannot act as an instructor for any course offered for POST training credit in the intended topic area: Following completion of the POST instructor course specific to the intended high liability intended topic area, and upon notice from the Regional Training Specialist, the applicant may begin co-instruction of in the intended topic area, in preparation for evaluation. (3-20-20)T

**05. Continuing Training Requirements.** High liability instructors must complete a minimum of eight (8) hours of continuing instructor training every two (2) years, including use of force law, liability, and further instructor training specific to the endorsed topic area(s). (3-20-20)T

**124. REQUIREMENTS FOR CANINE INSTRUCTOR CERTIFICATION.**

POST canine instructor certificates recognize the competency of instructors of canine subjects pertinent to law enforcement. In addition to the other requirements set forth in these rules of POST Instructors, the following are necessary for award of a POST canine instructor certificate: (3-20-20)T

**01. Canine Instructor School.** The applicant must have completed a POST approved Canine Instructor School. (3-20-20)T

**02. Certification and Service in Specific Discipline.** The applicant must have served a minimum of five (5) years as a handler and have a minimum of five (5) annual certifications in the specific discipline for which certification is sought. (3-20-20)T

**03. Canine Training.** The applicant must have received a minimum of six hundred eighty (680) hours of canine training. (3-20-20)T

**04. Recommendation.** The applicant must be recommended for canine instructor certification by a committee comprised of a POST Training Specialist and two (2) POST certified canine instructors. (3-20-20)T

**05. Application.** After meeting the foregoing requirements, the applicant must submit a completed Certified Instructor Packet to POST. (3-20-20)T

**06. Requirements for Maintaining Certification.** To maintain certification, a POST certified canine instructor must teach a minimum of forty (40) hours every two (2) years in the specific discipline they are certified to teach. (3-20-20)T

**07. Additional Requirements for Patrol Canine Instructor Certification.** In addition to the requirements in this section, applicants for Patrol Canine Instructor Certification must obtain a High Liability Instructor Endorsement. (3-20-20)T

**125. MASTER INSTRUCTOR CERTIFICATION.**

POST master instructor certificates recognize exceptional competence as an instructor of instructors in subjects pertinent to law enforcement personnel. The Council will determine master instructor disciplines. In addition to the requirements otherwise set forth in these Rules, the following are required for award of a master instructor certificate. (3-20-20)T

**01. POST Instructor Certification.** POST will determine the number of master instructor certifications issued based upon POST's need of instructors. An applicant shall be a current POST certified instructor in the subject for which master instructor certification is sought in for a minimum of three (3) years prior to application. The Council may, upon written request, waive this requirement in exceptional cases. An applicant shall: (3-20-20)T

**02. Instruction.** Have instructed a minimum of forty (40) hours of classes in the subject for which he is applying for master instructor certification during each of the previous two (2) years. (3-20-20)T

**03. Additional Training or Education.** Have received additional training or education beyond basic training in the area of their instructor certification. (3-20-20)T

**04. Exceptional Ability.** Have demonstrated exceptional ability to develop and present training. (3-20-20)T

**05. Recommendation.** Be recommended for master instructor certification by a Regional Training Specialist or POST certified master instructor. (3-20-20)T

**06. Maintain Certification.** Teach a minimum of one (1) instructor class during the certification period to maintain certification. (3-20-20)T

**07. Compliance With Other POST Requirements.** Comply with any additional provisions required by POST. (3-20-20)T

#### **126. MAINTAINING POST INSTRUCTOR CERTIFICATIONS AND ENDORSEMENTS.**

**01. Renewal of High Liability Endorsement.** High liability instructor endorsements are valid for two (2) years, except Firearms endorsements which are valid for one (1) year, provided the instructor remains in good standing and complies with all POST requirements for in-service training. To renew the endorsement, the instructor must comply with any additional provisions required by POST. (3-20-20)T

**02. Renewal of Master Instructor Certification.** Master instructor certification is valid for three (3) years. To renew the certification, the instructor must comply with any additional provisions required by POST. If a master instructor's certification through the manufacturer becomes invalid for any reason, his POST certification for that device shall immediately be deemed inactive. (3-20-20)T

**03. Renewal of Canine Instructor Certification.** Canine instructor certification is valid for two (2) years. To renew the certification, the instructor must comply with any additional provisions required by POST. (3-20-20)T

**04. Lapse of POST Instructor Certification.** Except as otherwise set forth in these rules, POST instructor certification is valid indefinitely, provided it is not suspended or revoked, the instructor remains in good standing, and complies with all POST in-service training requirements. (3-20-20)T

**a.** Instructors who fail to instruct for a period of two (2) years will be deemed inactive and may not instruct as a POST instructor until they have reapplied. (3-20-20)T

**b.** Inactive instructors may be required to complete a POST approved instructor orientation course. (3-20-20)T

#### **127. SUSPENSION AND REVOCATION OF INSTRUCTOR CERTIFICATION OR ENDORSEMENT.**

**01. Suspension.** The Division Administrator may suspend instructor certification or endorsement for up to one year if an instructor significantly or repeatedly fails to develop, document, conduct, or report training activities according to POST standards, or fails to abide by the POST Instructor Code of Ethics. A suspension will initiate an immediate review to determine if a revocation of the instructor's certificate is warranted. (3-20-20)T

**02. Revocation.** The Council may revoke instructor certification if an instructor is deemed unqualified to continue instructing. Review of instructor certification may be initiated upon request of an agency head, school director or coordinator, POST Division Administrator, the Council, or other reliable source. (3-20-20)T

#### **128. – 129. (RESERVED)**

#### **130. IN-SERVICE TRAINING REQUIREMENTS.**

The Council may, as a condition of continuing certification, require law enforcement officers to attend in-service training meeting POST standards. (3-20-20)T

#### **131. IN-SERVICE TRAINING REQUIREMENTS FOR RETAINING BASIC CERTIFICATION.**

**01. Peace Officers and County Detention Officers.** To retain POST certification, a peace officer or county detention officer must complete a minimum of forty (40) hours of continuing law enforcement training related to law enforcement every two (2) calendar years beginning January 1 following the date the officer was certified.

(3-20-20)T

**02. Emergency Communications Officers.** To retain POST certification, an emergency communications officer must complete a minimum of forty (40) hours of continuing training related to public safety emergency communications every two (2) calendar years beginning January 1 following the date the officer was certified.

(3-20-20)T

**03. Tolling of Two-Year Period.** The two (2) year continuing training period shall be tolled while an officer is on active military duty, and recommence upon the officer's return to duty with his agency. The agency shall submit a Notice of Separation/Change in Status form upon the officer's departure from and return to the agency.

(3-20-20)T

### **132. DOCUMENTATION OF IN-SERVICE TRAINING.**

**01. Agency Responsibility to Ensure Accuracy of Training Records.** Agency heads are required to ensure POST records of agency personnel training are up to date and complete as of December 31 of each year.

(3-20-20)T

**02. Agency Retention of Training Records.** Each agency shall maintain, and make available to POST, records of each in-service training course provided, including:

(3-20-20)T

**a.** The name of the course provider and name and resume of the course instructor;

(3-20-20)T

**b.** The course learning objectives, the number of instructional hours, the number of in-service training hours awarded and the attendance roster.

(3-20-20)T

**c.** The names of the trainees completing the course and the date of completion.

(3-20-20)T

**03. POST Training Credit.** No officer may receive POST training credit for training which has not been certified or approved by POST.

(3-20-20)T

**04. Notice of Non-Compliance.** POST shall give written notice to officers who are not in compliance with in-service training requirements, and their agency heads. If an officer is not in compliance by December 31 of a two-year training cycle, his certification shall be suspended beginning January 1 of the following calendar year, unless an extension of time, not to exceed six (6) months, is granted by POST. The Division Administrator, may grant an additional extension of time for good cause shown.

(3-20-20)T

**05. College Courses.** An officer fulfilling continuing training requirements by successfully completing a college course must have the college provide the employing agency with a transcript. The agency will make the transcript available to POST upon request.

(3-20-20)T

### **133. POST CREDIT FOR IN-SERVICE TRAINING.**

**01. Credit for POST In-Service Training Provided by a Post Certified Instructor in Idaho.** POST will grant training credit for in-service training according to the following criteria:

(3-20-20)T

**a.** The training was provided by Idaho POST Certified Instructor(s). One (1) or more training instructors for any class must be POST certified. Instructors who are not POST certified will not be given credit for POST instructor hours.

(3-20-20)T

**b.** The training was at least thirty (30) minutes in length.

(3-20-20)T

**02. Credit for POST In-Service Training Provided by an Organization or Vendor who is not POST Certified.** All third-party in-service training must be pre-approved. The Council may maintain a list of

organizations and vendors that will be exempt from this pre-approval process based on their reputation providing quality training, that are well established training organizations within the law enforcement training community, or that are offered through a regionally accredited college or university. Organizations and vendors who do not meet the criteria established through the Council, or its designee must meet the following criteria. (3-20-20)T

**a.** At least thirty (30) days prior to an in-service training session, the host agency will submit the following documents to a Regional Training Specialist: (3-20-20)T

i. A course outline; (3-20-20)T

ii. A description of the subject material and the time period to be devoted to each subject area; (3-20-20)T

iii. A description of the enforcement personnel to be instructed; (3-20-20)T

iv. A résumé on each instructor, unless the instructor is POST certified or approved; and (3-20-20)T

v. A lesson plan and all presentation and handout materials used in the course. (3-20-20)T

**b.** The course must be at least four (4) hours in length. (3-20-20)T

**c.** Any course which has been approved through this process, may be placed on the Council's designated pre-approved list after meeting the following criteria: (3-20-20)T

i. The course has been taught at least once in a calendar year, for at least three (3) consecutive years; or (3-20-20)T

ii. Is approved by the International Association of Directors of Law Enforcement Standards and Training (IADLEST) and placed on the IADLEST national course certification index. (3-20-20)T

**03. Course Attendance Roster.** A lead instructor or facilitator must submit an original or electronic POST course attendance roster no later than thirty (30) days following the completion of the training for POST training credit approval. (3-20-20)T

**04. Training Outside Idaho.** In-service training which is delivered outside of Idaho will be considered POST approved if the trainee provides any of the following: (3-20-20)T

**a.** The training was approved by the state's equivalent of POST, where the training occurred; or (3-20-20)T

**b.** The training course was approved by the International Association of Directors of Law Enforcement Standards and Training (IADLEST); or (3-20-20)T

**c.** The training course meets the criteria set forth above; and (3-20-20)T

**d.** Is submitted within thirty (30) days of the completion of the course; and (3-20-20)T

**e.** The trainee provides POST with the location, hours of the training, and a course syllabus or table of contents. (3-20-20)T

#### **134. COURSE EVALUATION FEE.**

**01. Fee Schedule.** POST may charge an entity applying for school or course approval a course evaluation fee at the time of application as follows: (3-20-20)T

**a.** One (1) to four (4) hour course: \$200. (3-20-20)T

- b. Five (5) to eight (8) hour course: \$400. (3-20-20)T
- c. Nine (9) to sixteen (16) hour course: \$600. (3-20-20)T
- d. Seventeen (17) to twenty-four (24) hour course: \$800. (3-20-20)T
- e. Twenty-five (25) to forty (40) hour course: \$1,000. (3-20-20)T
- f. Over 40 hours: A combination of the above as determined by the Division Administrator. (3-20-20)T
- 02. **Exception.** POST will not charge a course evaluation fee to governmental entities. (3-20-20)T
- 03. **Waiver.** The Division Administrator may waive a course evaluation fee in whole or in part. (3-20-20)T

**135. ALTERNATIVE METHODS OF IN-SERVICE TRAINING.**

The Council may approve alternative methods of delivering training, including but not limited to training by videotape or compact discs, computer programs, internet-based training or written correspondence. (3-20-20)T

**01. Training Medium.** The training medium utilized must be indicated on the application for approval of the training. (3-20-20)T

**02. Specialized Equipment.** The applicant must provide POST with any specialized equipment, software, network access, etc. needed for the evaluation, at no cost at the time of application. (3-20-20)T

**03. Course Evaluation Fee.** A course evaluation fee may be charged pursuant to these rules. (3-20-20)T

**136. – 139. (RESERVED)**

**140. LAW ENFORCEMENT CERTIFICATION PROGRAM APPROVAL.**

POST approval of a law enforcement certification program is established to ensure that instruction offered by such programs is equivalent to or exceeds POST basic academy training. (3-20-20)T

**141. LAW ENFORCEMENT CERTIFICATION PROGRAM – GENERAL PROVISIONS.**

**01. Eligibility.** To be eligible for approval as a law enforcement certification program, program must comply with all Idaho Department of Education standards if applicable, for such programs, and all other requirements of these rules. (3-20-20)T

**02. Permission to Proceed With Approval Process.** A program seeking approval as a law enforcement certification program must receive permission to proceed from POST prior to beginning the approval process, comply with the requirements of these Rules, and contact a Regional Training Specialist to schedule an on-site assessment. (3-20-20)T

**03. Initial Assessment.** POST will conduct an on-site assessment and provide the results to the program coordinator. (3-20-20)T

**a.** If the assessment finds that all requirements for program approval have not been met, the program will be given ninety (90) days to correct the deficiencies and a Regional Training Specialist will conduct a second on-site assessment. (3-20-20)T

**b.** If all requirements for the program approval are met, the Council will approve the program. (3-20-20)T

**04. Assessment Visits.** POST may conduct scheduled and unscheduled visits to entities seeking law



enforcement certification program approval and currently- approved programs, to assess adherence to POST standards. (3-20-20)T

**05. Expiration and Renewal of Certification.** (3-20-20)T

**a.** Initial and subsequent law enforcement certification program approval is valid for two (2) years. (3-20-20)T

**b.** Renewals must be completed prior to the program approval expiration date. (3-20-20)T

**142. ADMINISTRATION OF COLLEGE OR UNIVERSITY PROGRAM.**

A college or university law enforcement certification program shall have an advisory committee comprised of the Division Administrator or his designee and criminal justice executives or their designees from several agencies representative of the region the program serves. (3-20-20)T

**01. Chair and Vice-Chair; Selection; Term.** The advisory committee will elect a chair and vice-chair from among the committee members other than the Division Administrator or designee. The terms of office will be initially staggered. No chair or vice-chair may serve in that capacity for longer than four (4) consecutive years. (3-20-20)T

**02. Duties of Chair and Vice-Chair.** The chair or vice-chair schedule meetings and set agendas for advisory committee, meetings, work with the program coordinator and the program's administration, and perform other duties as necessary. (3-20-20)T

**143. MAINTENANCE OF RECORDS.**

A law enforcement certification program must maintain: (3-20-20)T

**01. Course File.** A file for each POST approved law enforcement training course it conducts, including curriculum, class schedules, attendance and discipline records, counseling records, tests with answer sheets, a course summary, and course evaluations. (3-20-20)T

**02. Student Training File.** A training file for each student including sufficient records to determine whether the student has completed all performance objectives. (3-20-20)T

**03. Instructor File.** A file for each instructor for the program including proof that the instructor is POST certified for each subject the instructor teaches, a copy of the instructor's student evaluations for the past year, and any other pertinent information related to the instructor's performance. (3-20-20)T

**144. MINIMUM ATTENDANCE REQUIREMENTS.**

A law enforcement certification program may have no fewer than six (6) students in a required class. Training required for certification will not be conducted for a class of less than six (6) students. The Council may consider exceptions upon a written request from the program coordinator. (3-20-20)T

**145. POST-GRADUATION SELF-EVALUATION.**

A law enforcement certification program must conduct post-graduation evaluations of its entry-level training from six (6) to twelve (12) months after students leave the program, and must assess the relevance of the training to current law enforcement practices. (3-20-20)T

**146. INSTRUCTION.**

A law enforcement certification program must: (3-20-20)T

**01. Monitoring of Instruction.** Conduct periodic and random monitoring of instruction to ensure that lesson plans are being used, objectives are being addressed, appropriate instructional aids are available and being used properly, the instructor is in control and engaging the students; and classroom conditions such as lighting, noise levels, and temperature are acceptable. (3-20-20)T

**02. Lesson Plans.** Have a lesson plan on file for every training class and must review and update

lesson plans and curricula on a regular basis to ensure compliance with POST requirements. (3-20-20)T

**03. Evaluation of Instructors.** Require students to complete written evaluations of every instructor. (3-20-20)T

**04. Student Complaints.** Investigate any student complaint regarding an instructor or the training process. (3-20-20)T

**147. STANDARDS.**

**01. Law Enforcement Certification Program Student.** Shall: (3-20-20)T

**a.** Meet the minimum standards for POST certification as set forth in these rules, with the exception of age. (3-20-20)T

**b.** Attest that he has read, understands, and will abide by the Law Enforcement Code of Conduct as set forth in these rules. (3-20-20)T

**02. Law Enforcement Certification Program.** Shall: (3-20-20)T

**a.** Have an integrity policy, which provides that dishonesty, including academic dishonesty, plagiarism and untruthfulness are grounds for disciplinary action and expulsion. All students shall review this policy on entering the program. (3-20-20)T

**b.** Have a policy prohibiting students from social contact, on or off campus, with staff members or instructors. Students and program staff or instructors shall maintain a professional relationship at all times. (3-20-20)T

**c.** Address other standards of conduct and behavior that reflect courtesy, consideration, and respect for others. Any conduct detrimental to the conduct, efficiency, or discipline of the program is prohibited. (3-20-20)T

**148. PERIODIC ASSESSMENT BY POST.**

**01. Assessment.** POST will perform periodic on-site assessments of each law enforcement certification program. POST will provide the program coordinator with no less than two (2) weeks notice prior to the assessment, and notify the program coordinator of the results. (3-20-20)T

**02. Failure to Comply With Standards; Reassessment.** If a law enforcement certification program does not meet all requirements for POST approval, the Council may suspend approval and direct corrective action. (3-20-20)T

**a.** The program must remedy all deficiencies within ninety (90) days of the initial assessment unless the Council grants an extension of time. (3-20-20)T

**b.** After ninety (90) days, or the applicable period if an extension of time is granted, POST will conduct a reassessment of the program. If all deficiencies are corrected, the Council will approve the program. (3-20-20)T

**c.** If all standards are not met, POST will notify the program administrator and, if applicable, the chairman of the program's advisory committee of the continuing deficiencies. The Council will review the reassessment report and may grant additional time to correct the deficiencies. (3-20-20)T

**d.** If all deficiencies are not corrected, the Council will revoke approval. (3-20-20)T

**149. – 999. (RESERVED)**

## IDAPA 12 – IDAHO DEPARTMENT OF FINANCE

### DOCKET NO. 12-0000-2000F (FEE RULE)

#### NOTICE OF OMNIBUS RULEMAKING – ADOPTION OF TEMPORARY RULE

**EFFECTIVE DATE:** The effective date of the temporary rules being adopted through this omnibus rulemaking is the adjournment date of the second regular session of the 65th Idaho State Legislature - March 20, 2020.

**AUTHORITY:** In compliance with Sections 67-5226, Idaho Code, notice is hereby given this agency has adopted a temporary rule. The action is authorized pursuant to Section 30-14-605, Idaho Code.

**DESCRIPTIVE SUMMARY:** The following is the required finding and concise statement of its supporting reasons for adopting the temporary rule:

This temporary rulemaking adopts the following chapter under IDAPA 12, Rules of the Idaho Department of Finance:

#### **IDAPA 12**

- IDAPA 12.01.08, *Rules Pursuant to the Uniform Securities Act*

**TEMPORARY RULE JUSTIFICATION:** Pursuant to Sections 67-5226(1) and 67-5226(2), Idaho Code, the Governor has found that temporary adoption of these rules are appropriate for the following reasons:

These temporary rules are necessary to protect the public health, safety, and welfare of the citizens of Idaho and confer a benefit on its citizens. These temporary rules implement the duly enacted laws of the state of Idaho, provide citizens with the detailed rules and standards for complying with those laws, and assist in the orderly execution and enforcement of those laws. The expiration of these rules without due consideration and processes would undermine the public health, safety, and welfare of the citizens of Idaho and deprive them of the benefit intended by these rules.

**FEE SUMMARY:** Pursuant to Section 67-5226(2), the Governor has found that the fees or charges being imposed or increased is justified and necessary to avoid immediate danger and the fees are described herein:

The fees or charges, authorized in Section 30-14-605, Idaho Code, are part of the agency's 2021 budget that relies upon the existence of these fees or charges to meet the state's obligations and provide necessary state services. Failing to reauthorize these temporary rules would create immediate danger to the state budget, immediate danger to necessary state functions and services, and immediate danger of a violation of Idaho's constitutional requirement that it balance its budget.

The following is a specific description of the fees or charges in IDAPA 12.01.08:

1. Rule 004.04: \$50 fee with each request for no-action position or interpretive opinion letter.
2. Rule 040.03: \$300 fee for annual renewal of registration statement.
3. Rules 053.01.b. and 01.c.: \$300 fee for filing of notice of offering and annual renewal of mutual funds by investment companies, and \$100 filing fee for notice of offering and annual renewal of unit investment trusts.
4. Rules 053.02.b. and 02.c.: \$50 fee for Regulation D Rule 506 notice filings, and \$50 additional fee for late filing.

**ASSISTANCE ON TECHNICAL QUESTIONS:** For assistance on technical questions concerning the temporary rule, contact Anthony Polidori, (208) 332-8060.

Dated this 20th day of March, 2020.

Patricia Perkins, Director  
Idaho Department of Finance  
800 Park Blvd., Suite 200

Phone: (208) 332-8030  
Fax: (208) 332-8099  
Boise, ID 83720-0031

## 12.01.08 – RULES PURSUANT TO THE UNIFORM SECURITIES ACT (2004)

### 000. LEGAL AUTHORITY.

This chapter is promulgated pursuant to Section 30-14-605, Idaho Code. (3-20-20)T

### 001. TITLE AND SCOPE.

**01. Title.** The title of this chapter is the “Securities Rules of the Idaho Department of Finance”; and may be cited as IDAPA 12.01.08, “Rules Pursuant to the Uniform Securities Act (2004).” (3-20-20)T

**02. Implementation.** These rules implement statutory intent with respect to the offer and sale of securities and the giving of investment advice in the state of Idaho by licensed individuals and others. (3-20-20)T

### 002. -- 003. (RESERVED)

### 004. SECURITIES EXEMPTIONS, OPINIONS, AND NO-ACTION LETTERS.

**Interpretative Opinions.** The Administrator, in his discretion, may honor requests from interested persons for formal interpretive opinions and no-action positions, including consideration of waivers, relating to an actual specific factual circumstance where appropriate and in the public interest, on the basis of facts stated and submitted in writing, with respect to the provisions of the Act or any rule or statement of policy adopted thereunder, provided such requests satisfy and conform to the following requirements: (3-20-20)T

**01. Written Requests.** Such requests shall be in writing and shall include or be accompanied by all information and material required by any statute, rule or statement of policy under which an exception or exemption may be claimed, including but not limited to, copies of prospectuses or offering circulars if applicable or appropriate. (3-20-20)T

**02. Narrative.** The letter should contain a brief narrative of the fact situation and should set out all of the facts necessary to reach a conclusion in the matter; however, such narratives should be concise and to the point. (3-20-20)T

**03. Hypotheticals Not Considered.** The names of the company or companies, organization or organizations and all other persons involved should be stated and should relate and be limited to a particular factual circumstance. Letters relating to hypothetical situations will not warrant a formal response. (3-20-20)T

**04. Fee.** Each request for a no-action position or interpretive opinion letter shall be accompanied by payment of a fee in the amount of fifty dollars (\$50). (3-20-20)T

### 005. INCORPORATION BY REFERENCE.

**01. Incorporated Documents.** IDAPA 12.01.08, “Rules Pursuant to the Uniform Securities Act (2004),” adopts and incorporates by reference the full text of the following Statements of Policy and guidelines adopted by the North American Securities Administrators Association (NASAA): (3-20-20)T

**a.** “Loans and Other Material Affiliated Transactions,” as adopted with amendments through March 31, 2008; (3-20-20)T

**b.** “Options and Warrants,” as adopted with amendments through March 31, 2008; (3-20-20)T

**c.** “Corporate Securities Definitions,” as adopted with amendments through March 31, 2008; (3-20-20)T

**d.** “Impoundment of Proceeds,” as adopted with amendments through March 31, 2008; (3-20-20)T

**e.** “Preferred Stock,” as adopted with amendments through March 31, 2008; (3-20-20)T

**f.** “Promotional Shares,” as adopted with amendments through March 31, 2008; (3-20-20)T

**g.** “Promoters’ Equity Investment,” as adopted with amendments through March 31, 2008; (3-20-20)T

**h.** “Specificity in Use of Proceeds,” as adopted with amendments through March 31, 2008; (3-20-20)T

- i.** “Underwriting Expenses, Underwriter’s Warrants, Selling Expenses, and Selling Securities Holders,” as adopted with amendments through March 31, 2008; (3-20-20)T
- j.** “Unsound Financial Condition,” as adopted with amendments through March 31, 2008; (3-20-20)T
- k.** “Unequal Voting Rights,” as adopted March 31, 2008; (3-20-20)T
- l.** “Debt Securities,” as adopted April 25, 1993; (3-20-20)T
- m.** “NASAA Guidelines Regarding Viatical Investments,” as adopted October 1, 2002; (3-20-20)T
- n.** “NASAA Statement of Policy Regarding Small Company Offering Registrations (SCOR),” as adopted April 28, 1996. (3-20-20)T

**02. Availability of Referenced Documents.** Copies of the “NASAA Statements of Policy” are available at the following locations: (3-20-20)T

- a.** NASAA, 750 First Street, N.E., Suite 1140, Washington, D.C. 20002. (3-20-20)T
- b.** Department of Finance, 800 Park Blvd., Suite 200, Boise, ID 83712. (3-20-20)T
- c.** NASAA Web site at <http://www.nasaa.org/regulatory-activity/statements-of-policy/>. (3-20-20)T

**006. -- 009. (RESERVED)**

**010. DEFINITIONS.**

- 01. Act.** The Uniform Securities Act (2004) set forth in Chapter 14, Title 30, Idaho Code. (3-20-20)T
- 02. Administrator.** The Director of the Department of Finance. (3-20-20)T
- 03. Agent of Issuer.** The term “agent of issuer” is used interchangeably with the term “issuer agent” through these rules. (3-20-20)T
- 04. CRD.** Central Registration Depository. (3-20-20)T
- 05. Department.** The Idaho Department of Finance. (3-20-20)T
- 06. EFD.** Electronic Filing Depository. (3-20-20)T
- 07. FINRA.** Financial Industry Regulatory Authority. (3-20-20)T
- 08. Form ADV.** The Uniform Application for Investment Adviser Registration. (3-20-20)T
- 09. Form ADV-H.** The Uniform Application for a Temporary or Continuing Hardship Exemption. (3-20-20)T
- 10. Form ADV-W.** The Uniform Request for Withdrawal of Investment Adviser Registration. (3-20-20)T
- 11. Form BD.** The Uniform Application for Broker-Dealer Registration. (3-20-20)T
- 12. Form BDW.** The Uniform Request for Withdrawal from Registration as a Broker-Dealer. (3-20-20)T
- 13. Form BR.** The Uniform Application for Broker-Dealer Branch Registration. (3-20-20)T

14. **Form D.** The federal form entitled “Notice of Sale of Securities Pursuant to Regulation D, Section 4(6) and or Uniform Limited Offering Exemption.” (3-20-20)T
15. **Form NF.** The Uniform Notice Filing Form. (3-20-20)T
16. **Form 1-A.** A federal securities registration form of that number. (3-20-20)T
17. **Form S-18.** A federal securities registration form of that number. (3-20-20)T
18. **Form U-1.** The Uniform Application to Register Securities. (3-20-20)T
19. **Form U-2.** The Uniform Consent to Service of Process. (3-20-20)T
20. **Form U-4.** The Uniform Application for Securities Industry Registration or Transfer. (3-20-20)T
21. **Form U-5.** The Uniform Request for Withdrawal of Securities Industry Registration or Transfer. (3-20-20)T
22. **Form U-7.** The Uniform Small Company Offering Registration Form. (3-20-20)T
23. **IARD.** Investment Adviser Registration Depository. (3-20-20)T
24. **NASAA.** The North American Securities Administrators Association, Inc. (3-20-20)T
25. **NASD.** The National Association of Securities Dealers, Inc. (3-20-20)T
26. **NASDAQ.** The National Association of Securities Dealers Automated Quotations. (3-20-20)T
27. **SEC.** The U.S. Securities and Exchange Commission. (3-20-20)T
28. **Transact Business.** For purposes of the Act, to “transact business” means to buy or to sell or contract to buy or to sell or dispose of a security or interest in a security for value. It also means any offer to buy or offer to sell or dispose of, and every solicitation of clients or of any offer to buy or to sell, a security or interest in a security for value. With respect to investment advisers and investment adviser representatives, “transact business” includes preparation of financial plans involving securities, recommendations to buy or sell securities or interests in a security for value, and solicitation of investment advisory clients. (3-20-20)T
29. **USA.** The Uniform Securities Act (2004). (3-20-20)T
30. **Unsolicited Order or Offer.** (3-20-20)T
- a. As used in these rules, an order or offer to buy is considered “unsolicited” if: (3-20-20)T
- i. The broker-dealer has not made a direct or indirect solicitation or recommendation that the customer purchase the security; and (3-20-20)T
- ii. The broker-dealer has not recommended the purchase of the security to the customer, either directly or in a manner that would bring its recommendation to the customer; and (3-20-20)T
- iii. The broker-dealer has not volunteered information on the issuer to the customer; and (3-20-20)T
- iv. The customer has previously, and independent of any information furnished by the broker-dealer, decided to buy the security. (3-20-20)T
- b. Any offer or order to buy from a customer whose first knowledge of the specific security or issuer was volunteered to him by the broker-dealer is regarded as a solicited order. (3-20-20)T

c. Any claim of exemption pursuant to Section 30-14-202(6), Idaho Code, shall be supported by the broker-dealer's certificate that the transaction in question was, in fact, unsolicited. (3-20-20)T

**011. -- 019. (RESERVED)**

**020. APPLICATION FOR REGISTRATION OF SECURITIES.**

**01. Registration by Coordination.** A registration statement to register securities by coordination shall contain the following: (3-20-20)T

- a. The Form U-1 and accompanying documents (including subscription agreement); (3-20-20)T
- b. A consent to service of process (Form U-2) in compliance with Section 30-14-611, Idaho Code; (3-20-20)T
- c. A copy of the prospectus, including financial statements where: (3-20-20)T
  - i. The prospectus for a securities registration by coordination under Section 30-14-303, Idaho Code, shall be prepared using the forms required under the Securities Act of 1933, and (3-20-20)T
  - ii. All historical financial statements in the registration statement shall be in conformity with generally accepted accounting principles (GAAP) and financial statements filed with a registration statement by coordination that complies with the requirements of the United States Securities and Exchange Commission. (3-20-20)T
- d. All exhibits filed with the United States Securities and Exchange Commission in connection with the registration statement; (3-20-20)T
- e. The filing fee specified in Section 30-14-305(b), Idaho Code; and (3-20-20)T
- f. Any additional information or documents requested by the Department. (3-20-20)T

**02. Registration by Qualification.** A registration statement to register securities by qualification shall contain the following in addition to the requirements of Section 30-14-304, Idaho Code: (3-20-20)T

- a. Financial Statements. Except for SCOR applications, registration statements filed pursuant to Section 30-14-304, Idaho Code, shall contain audited financial statements of the issuer for its last two (2) fiscal years. An issuer with less than one (1) year of operations may file reviewed financial statements until the end of its first fiscal year. Registration statements filed with SCOR applications on the Form U-7 shall contain the financial statements specified in the instructions to the Form U-7. (3-20-20)T
- b. Unaudited Interim Financial Statements. If the audited financial statements or unaudited financial statements required in Subsection 020.02.a. of this rule are not current to within four (4) months of the date of filing of the registration statement, additional unaudited financial statements as of the issuer's last fiscal quarter or any later date designated by the Administrator shall be included. (3-20-20)T

c. Small Company Offering Registration (SCOR). A SCOR registration statement shall contain the following: (3-20-20)T

- i. The Form U-1 and accompanying documents (including subscription agreement); (3-20-20)T
- ii. An executed Form D; (3-20-20)T
- iii. A consent to service of process (Form U-2) in compliance with Section 30-14-611, Idaho Code; (3-20-20)T
- iv. For SCOR offerings, the prospectus to be used shall be the Form U-7, as adopted and revised by

- NASAA in September 1999; (3-20-20)T
- v. The filing fee specified in Section 30-14-305(b), Idaho Code; and (3-20-20)T
  - vi. Any additional information or documents requested by the Department. (3-20-20)T
  - d.** Registration statements by qualification shall contain the following: (3-20-20)T
    - i. The Form U-1 and accompanying documents (including subscription agreement); (3-20-20)T
    - ii. A consent to service of process (Form U-2) in compliance with Section 30-14-611, Idaho Code; (3-20-20)T
    - iii. Financial statements prepared in accordance with Subsection 020.02.a. of this rule; (3-20-20)T
    - iv. A copy of the prospectus containing the information or records specified in Sections 30-14-304(b)(1) through 304(b)(18), Idaho Code; (3-20-20)T
    - v. The prospectus shall be prepared using one of the following forms: Part II of Form 1-A of Regulation A of the Securities Act of 1933; Parts I and II of Form SB-2 of the Securities Act of 1933; Form U-7; or any other applicable form used to prepare a prospectus under the Securities Act of 1933, if approved by the department. (3-20-20)T
- 03. Other Forms.** Any other applicable form used to prepare a prospectus under the Securities Act of 1933, if approved by the Department, containing: (3-20-20)T
- a. The filing fee specified in Section 30-14-305(b), Idaho Code; and (3-20-20)T
  - b. Any additional information or documents requested by the Department. (3-20-20)T
- 021. AMENDMENTS TO REGISTRATION STATEMENT.**
- 01. Amendments Required.** A correcting amendment to an effective registration statement shall be prepared and submitted to the Department any time that the information contained therein becomes inaccurate or incomplete in any material respect. The responsibility for identifying and reporting a material change lies with the registrant. (3-20-20)T
- 02. Contents of Amendment Filing.** Each filing of a correcting amendment to a registration statement shall contain a copy of each item of the registration statement which has been changed, with all changes clearly marked. To be complete, a filing of a correcting amendment to the registration statement shall contain a report of material changes setting forth a summary of each material change and indicating the location of such change in the documents filed. Neither the Administrator nor any member of his staff shall be held to have taken notice of any item of material change not summarized in such a report. (3-20-20)T
- 03. Time of Filing and Undertaking.** Every registration statement shall contain an undertaking by the applicant to file correcting amendments to the registration statement whenever the information in the registration statement becomes inaccurate or incomplete in any material respect by the earlier of: (3-20-20)T
- a. Two (2) business days after filing such amendment with the SEC; or (3-20-20)T
  - b. Fifteen (15) business days following the event giving rise to the amendment. (3-20-20)T
  - c. If not registered with the SEC, registrants shall file an amended registration statement if required within fifteen (15) business days following the event giving rise to the amendment. (3-20-20)T
- 04. Effect of Failure to Amend.** Solicitation of prospective investors through utilization of a prospectus containing information which is inaccurate or incomplete in any material respect is a violation of Section



30-14-501, Idaho Code, and constitutes a basis for the suspension or revocation of the registration under Section 30-14-306(a)(1), Idaho Code. Nothing in Section 021, of these rules, shall be construed to require any open-end investment company registered under the 1940 Act and the Act to disclose fluctuations in its investment portfolio.

(3-20-20)T

**022. FINANCIAL STATEMENTS.**

**01. Application of Regulation S-X.** As to definitions, qualifications of accountants, content of accountant's certificates, requirements for consolidated or combined statements, and actual form and content of financial statements, the Administrator shall apply Regulation S-X of the SEC (17 CFR Part 210) in its most currently amended form as of the date of the filing of the application to all financial statements filed with the Department in connection with the registration of securities.

(3-20-20)T

**02. Financial Statements Incorporated by Reference.** Where financial statements in a prospectus are incorporated by reference from another document, the Administrator may require that such other document be filed with the Department and be delivered to investors with the prospectus.

(3-20-20)T

**03. Application of Antifraud Provisions.** Any financial statement distributed in connection with the offer or sale of securities under the Act shall be subject to the provisions of Section 30-14-501, Idaho Code. Any financial statement filed with the Department shall be subject to the provisions of Section 30-14-505, Idaho Code.

(3-20-20)T

**023. -- 035. (RESERVED)**

**036. NASAA STATEMENTS OF POLICY -- REGISTERED OFFERINGS.**

The Department will apply the applicable statement(s) of policy adopted by NASAA and incorporated herein by reference pursuant to Section 005, of these rules, to an offering seeking registration in Idaho when conducting a review to determine whether an offering is fair, just and equitable. Such an offering must comply with the requirements of such policy or policies, unless waived by the Administrator.

(3-20-20)T

**037. REGISTRATION OF DEBT SECURITIES.**

In addition to the requirements contained in the NASAA Statement of Policy Regarding Debt Securities, as adopted on April 25, 1993, the issuer of debt securities will incorporate the following standards:

(3-20-20)T

**01. Suitability.** In establishing standards of fairness and equity, the Department has established the following investor suitability guidelines for debt offerings registered under the Act:

(3-20-20)T

**a.** No more than ten percent (10%) of any one (1) Idaho investor's net worth (exclusive of home, home furnishings, and automobiles) shall be invested in the securities being registered with the Department; and either

(3-20-20)T

**b.** A gross income of forty-five thousand dollars (\$45,000) and a net worth of forty-five thousand dollars (\$45,000) (exclusive of home, home furnishings and automobiles); or

(3-20-20)T

**c.** A net worth of one hundred fifty thousand dollars (\$150,000) (exclusive of home, home furnishings and automobiles).

(3-20-20)T

**02. Department May Establish Standards.** The suitability standard in Subsection 037.01 of this rule is a guideline. Higher or lower suitability standards may be established or may be required by the Department as a condition of registration.

(3-20-20)T

**03. Standards To Be Disclosed.** The suitability standards must be disclosed in the prospectus.

(3-20-20)T

**038. WITHDRAWAL/ABANDONMENT OF A REGISTRATION STATEMENT.**

**01. Withdrawal.** The withdrawal of an application (prior to effectiveness) may be permitted by the

Administrator upon the written request of the applicant. (3-20-20)T

**02. Abandonment.** The abandonment of an application, where there has been no activity on the application by the applicant for a period of six (6) months or more, may be considered to signify a request for withdrawal. (3-20-20)T

**03. Time Limit.** An application for registration of securities pursuant to Section 30-14-303 or 30-14-304, Idaho Code, shall be deemed abandoned if such registration is not effective in the state of Idaho within one (1) year from the date of receipt by the Department of the initial filing of the application for registration. (3-20-20)T

**04. Abandoned Applications Not Reinstated.** Once deemed abandoned, the original application shall not be reinstated. A new application including the registration statement, appropriate exhibits and filing fees is required. (3-20-20)T

**039. REPORT OF COMPLETION OF OFFERING.**

**01. Completion Statement.** Within thirty (30) days of the completion of a registered offering in Idaho, the registrant shall provide a written statement to the Department that states the following: (3-20-20)T

**a.** The date the offering was completed in Idaho; and (3-20-20)T

**b.** The number and amount of registered securities sold in Idaho, for SCOR offerings and offerings registered by qualification. (3-20-20)T

**02. Signatures.** The written statement must be signed by an officer, director or agent of the issuer or by an authorized signatory of the registrant. (3-20-20)T

**040. ANNUAL REPORT FOR THE RENEWAL OF A REGISTRATION STATEMENT.**

To renew a registration statement for an additional year, the registrant shall file the following with the Department before the anniversary of the effective date of the registration statement in Idaho: (3-20-20)T

**01. Cover Letter.** A cover letter requesting renewal; (3-20-20)T

**02. Consent to Service.** A consent to service of process (Form U-2) in accordance with Section 30-14-611, Idaho Code; and (3-20-20)T

**03. Filing Fee.** A filing fee of three hundred dollars (\$300) for all registered offerings. (3-20-20)T

**041. SUBSCRIPTION AGREEMENT.**

The subscription agreement shall contain, among other things, an acknowledgment by the subscriber that he has received a copy of the prospectus. Each completed subscription agreement shall be kept in the office of the issuer or broker-dealer for a period of five (5) years and be subject to inspection by the Department. (3-20-20)T

**042. DELIVERY OF PROSPECTUS.**

As a condition of registration, an applicant shall comply with the following: (3-20-20)T

**01. Registration by Qualification.** A person offering or selling a security under a registration by qualification, other than through a broker-dealer, shall deliver a copy of the final prospectus to each prospective purchaser before or at the time of the confirmation of a sale made by or for the account of the person. (3-20-20)T

**02. Registration by Coordination.** A person offering or selling a security under a registration by coordination shall deliver a copy of the prospectus as required by the Securities Act of 1933. (3-20-20)T

**043. REGISTRATIONS -- NOTICE OF INTENDED IDAHO BROKER -- DEALER OR AGENT.**

At the time of filing of an application for registration of any security required to be registered in Idaho, written notice shall be provided to the Department of the name of at least one (1) broker-dealer or agent, registered as such in this state, that is intended or qualified to offer or sell such security in Idaho. The Administrator may deny or revoke

effectiveness of any registration pending receipt of the notice or may hold the application without further review until the notice has been received. (3-20-20)T

**044. RECORDS TO BE PRESERVED BY ISSUERS.**

**01. Required Records.** All issuers who effect sales of registered securities, other than through a broker-dealer, shall preserve the following records for at least three (3) years following the expiration of the registration: (3-20-20)T

- a.** Copies of all documents contained in the registration statement; (3-20-20)T
- b.** Copies of all advertisements, including a record of the dates, names and addresses of media carrying those advertisements; (3-20-20)T
- c.** Copies of all communications received and sent by the issuer pertaining to the offer, sale and transfer of the securities, including purchase agreements and confirmations; and (3-20-20)T
- d.** A list of the name, address and telephone number of each investor to whom the securities were sold, and for each such person, information regarding: (3-20-20)T
  - i.** The type of securities sold; (3-20-20)T
  - ii.** The number and amount of securities sold; (3-20-20)T
  - iii.** The type of consideration paid; and (3-20-20)T
  - iv.** The name of the agent that sold the securities. (3-20-20)T

**02. Retention Period.** An issuer will need to retain the records set forth in Subsection 044.01 of this rule for each investor at least three (3) years after the investor's investment has terminated, even if more than three (3) years has lapsed since the expiration of the registration. (3-20-20)T

**03. Form.** Records may be stored in paper form or electronically. (3-20-20)T

**045. EXAMINATION OF APPLICATION.**

The Department shall conduct a special examination of each application for registration under Sections 30-14-303 and 30-14-304, Idaho Code, to determine the adequacy of disclosure and to fulfill the Department's obligations under Section 30-14-306, Idaho Code. This examination shall be based upon material contained in the registration statement and any other documentation which the applicant may be required to submit. Each application for registration shall be accompanied by the filing fee set forth in Section 30-14-305(b), Idaho Code. The examination report shall consist of the Department's written comments regarding the filing. (3-20-20)T

**046. ON-SITE EXAMINATION OF ISSUERS.**

The business and records of issuers offering and/or selling securities in, or out of, Idaho may be subject to periodic on-site examinations by the Administrator, or his designee, at such times as the Administrator determines necessary for the protection of the public. (3-20-20)T

**047. ADVERTISING.**

**01. Definitions.** The following words and terms, when used in Section 047, of these rules, have the following meaning, unless the context clearly indicates otherwise: (3-20-20)T

- a.** "Sales literature" means material published, or designed for use, in a newspaper, magazine or other periodicals, radio, television, telephone solicitation or tape recording, videotaped display, signs, billboards, motion pictures, telephone directories (other than routine listings), other public media and any other written communication distributed or made generally available to customers or the public including, but not limited to, prospectuses, pamphlets, circulars, form letters, seminar texts, research reports, surveys, performance reports or summaries and

reprints or excerpts of other sales literature or advertising to include publications in electronic format. (3-20-20)T

**b.** “Sales literature package” means all submissions of sales literature to the Department under one (1) posting or delivery relating to a specific issue of securities. (3-20-20)T

**02. Filing Requirement.** Pursuant to Section 30-14-504, Idaho Code, this rule requires the filing of all sales literature for review and response by the Administrator before use or distribution in Idaho. A complete filing shall consist of the sales literature package and a representation by the applicant, issuer or broker-dealer, that reads substantially as follows: “I ----- hereby attest and affirm that the enclosed sales literature or advertising package contains no false or misleading statements or misrepresentations of material facts, and that all information set forth therein is in conformity with the Company’s most recently amended registration statement as filed with the Department on or about -----.” (3-20-20)T

**03. Exemption From Filing.** The following types of sales literature are excluded from the filing requirements set forth herein: (3-20-20)T

**a.** Sales literature which does nothing more than identify a broker-dealer or investment adviser, and/or offer a specific security at a stated price; (3-20-20)T

**b.** Internal communications that are not distributed to the public; (3-20-20)T

**c.** Prospectuses, preliminary prospectuses, prospectus supplements and offering circulars which have been filed with the Department as part of a registration statement, including a final printed copy if clearly identified as such; (3-20-20)T

**d.** Sales literature solely related to changes in a name, personnel, location, ownership, offices, business structure, officers or partners, telephone or teletype numbers; (3-20-20)T

**e.** Sales literature filed with and approved by FINRA, the SEC, or other regulatory agency with substantially similar requirements; (3-20-20)T

**f.** Sales literature relating to certain federal covered securities as set forth in Section 30-14-504(b), Idaho Code. (3-20-20)T

**04. Piecemeal Filings.** The Department will not approve any sales literature package until a complete filing is received. Piecemeal filings will not be accepted and will result in the disapproval of any materials submitted therewith. (3-20-20)T

**05. Application of Antifraud Provisions.** Sales literature used in any manner in connection with the offer or sale of securities is subject to the provisions of Section 30-14-501, Idaho Code, whether or not such sales literature is required to be filed pursuant to Section 30-14-504, Idaho Code, or Section 047 of these rules. Further, sales literature filed with the Department is subject to the provisions of Sections 30-14-501 and 30-14-505, Idaho Code. Sales literature should be prepared accordingly and should not contain any ambiguity, exaggeration or other misstatement or omission of material fact, which might confuse or mislead an investor. (3-20-20)T

**06. Prohibited Disclosures.** Unless stating that the Administrator or Department has not approved the merits of the securities offering or the sales literature, no sales literature shall contain a reference to the Administrator or Department unless such reference is specifically requested by the Administrator. (3-20-20)T

**048. DEPARTMENT ACCESS.** Each issuer examined shall provide the personnel of the Department access to business books, documents, and other records. Each issuer shall provide personnel with office space and facilities to conduct an on-site examination, and assistance in the physical inspection of assets and confirmation of liabilities. Failure of any issuer to comply with any provision here of shall constitute a violation of Section 048, of these rules, and shall be a basis for denial, suspension or revocation of the registration or application for registration or other administrative or civil action by the Department. (3-20-20)T

**049. -- 051. (RESERVED)**

**052. ISSUER AGENT REGISTRATION.**

Any individual not exempted pursuant to Sections 30-14-402(b)(3), (4) or (5), Idaho Code, must be registered as an issuer agent or comply with the registration requirement of Section 30-14-402(a), Idaho Code, if the individual is compensated in connection with the agent's participation by the payment of commissions or other remuneration based, directly or indirectly, on transactions in those securities. (3-20-20)T

**053. FEDERAL COVERED SECURITIES (RULE 53).**

**01. Investment Company Notices. (3-20-20)T**

**a.** Notice Requirement. Pursuant to Section 30-14-302, Idaho Code, prior to the offer in this state of a series or portfolio of securities of an investment company that is registered, or that has filed a registration statement, under the Investment Company Act of 1940, that is not otherwise exempt under Sections 30-14-201 through 30-14-203, Idaho Code, the issuer must file a notice with the Administrator relating to such series or portfolio of securities. (3-20-20)T

**b.** Content of Notice. Each required notice shall include the following: (3-20-20)T

- i.** A properly completed Form NF; (3-20-20)T
- ii.** A consent to service of process (Form U-2); (3-20-20)T
- iii.** A filing fee of three hundred dollars (\$300) for mutual funds and one hundred dollars (\$100) for unit investment trusts; and (3-20-20)T

**iv.** Notification of SEC effectiveness. (3-20-20)T

**c.** Renewal of Notice. The effectiveness of a notice required pursuant to Subsection 053.01.a. of this rule may be renewed each year for an additional one (1) year period of effectiveness by filing on or before the expiration of the effectiveness of such notice: (3-20-20)T

- i.** A properly completed Form NF clearly indicating the state file number of the Notice to be renewed; (3-20-20)T
- ii.** A consent to service of process (Form U-2) in accordance with Section 30-14-611, Idaho Code; and (3-20-20)T
- iii.** A renewal fee of three hundred dollars (\$300) for mutual funds and one hundred dollars (\$100) for unit investment trusts. (3-20-20)T

**d.** Amendments. Amendment filings are required for the following: (3-20-20)T

- i.** Issuer name change; (3-20-20)T
- ii.** Address change for contact person; and (3-20-20)T
- iii.** Notification of termination or completion. (3-20-20)T

**e.** Other Documents. Documents other than those required in Subsections 053.01.b., 053.01.c., and 053.01.d. of this rule, unless specifically requested by the Department, should not be filed with the Department. Documents that should be filed with the Department only if specifically requested include, but are not limited to, registration statements, prospectuses, amendments, statements of additional information, quarterly reports, annual reports, and sales literature. (3-20-20)T

**02. Regulation D Rule 506 Notice Filing. (3-20-20)T**

**a.** Notice Requirement. Issuers offering a security in this state in reliance upon Section 30-14-301, Idaho Code, by reason of compliance with Regulation D, Rule 506, adopted by the United States Securities and Exchange Commission, are required to file a notice with the Department or with EFD pursuant to the authority of Section 30-14-302(c), Idaho Code, if a sale of a security in this state occurs as a result of such offering. (3-20-20)T

**b.** Terms of Notice Filing. The issuer shall file with the Department or with EFD no later than fifteen (15) days after the first sale of a security in this state for which a notice is required under Subsection 053.02.a. of this rule: (3-20-20)T

i. One (1) copy of the SEC-filed Form D; and (3-20-20)T

ii. The notice filing fee of fifty dollars (\$50). (3-20-20)T

iii. A cover letter should be included in the notice filing which states the date in which the first sale of securities occurred in Idaho. (3-20-20)T

**c.** Terms of Late Notice Filing. An issuer failing to file with the Administrator as required by Subsection 053.02.b. of this rule may submit its notice filing with an additional fifty dollars (\$50) late filing payment within thirty (30) days after the first sale of a security in this state. Failure to file a notice on or before the thirtieth day after the first sale of a securities in Idaho will result in the inability of the issuer to rely on Section 30-14-302(c), Idaho Code, for qualification of the offering in Idaho. (3-20-20)T

**d.** Issuer Agent Registration. Pursuant to Section 30-14-402(b)(5), Idaho Code, an individual who represents an issuer who effects transactions in a federal covered security under Section 18(b)(4)(F) of the Securities Act of 1933 (15 U.S.C. 77r(b)(4)(F)) is not exempt from the registration requirements of Section 30-14-402(a), Idaho Code, if the individual is compensated in connection with the agent's participation by the payment of commissions or other remuneration based, directly or indirectly, on transactions in those securities. In addition, if such person is registered as a broker-dealer or agent in another state or with FINRA, or affiliated with a broker-dealer registered in another state, with the SEC or FINRA, then such person must also be similarly registered in Idaho. (3-20-20)T

**054. NOT FOR PROFIT DEBT SECURITIES NOTICE FILING.**

**01. Securities Exempt.** With respect to the offer or sale of a note, bond, debenture, or other evidence of indebtedness, such issuers relying upon the exemption from registration provided in Section 30-14-201(7), Idaho Code, shall file a notice with the Administrator at least thirty (30) days prior to the first offering of sale pursuant to such claim. Such exemption shall become effective thirty (30) days after the filing of a complete notice if the Administrator has not disallowed the exemption. (3-20-20)T

**02. Notice Information.** The notice required in Subsection 054.01 of this rule shall specify, in writing, the material terms of the proposed offer or sale to include, although not limited to, the following: (3-20-20)T

**a.** The identity of the issuer; (3-20-20)T

**b.** The amount and type of securities to be sold pursuant to the exemption; (3-20-20)T

**c.** A description of the use of proceeds of the securities; and (3-20-20)T

**d.** The person or persons by whom offers and sales will be made. (3-20-20)T

**03. Notice Requirements.** The following items must be included as a part of the notice in Subsection 054.01 of this rule: (3-20-20)T

**a.** The offering statement, if any; and (3-20-20)T

**b.** A consent to service of process (Form U-2). (3-20-20)T

**04. Sales and Advertising Literature.** All proposed sales and advertising literature to be used in connection with the proposed offer or sale of the securities shall be filed with the Administrator only upon request. (3-20-20)T

**05. NASAA Statements of Policy or Guidelines.** The Statements of Policy or guidelines adopted by NASAA may be applied, as applicable, to the proposed offer or sale of a security for which a notice must be filed pursuant to this rule. Failure to comply with the provisions of an applicable Statement of Policy or guideline promulgated by NASAA may serve as the grounds for disallowance of the exemption from registration provided by Section 30-14-201(7), Idaho Code. (3-20-20)T

**06. Waiver.** The Administrator may waive any term or condition set forth in this rule. (3-20-20)T

**055. MORTGAGE NOTE EXEMPTION.**

**01. Investment Contract or Profit-Sharing Agreement.** The exemption specified in Section 30-14-202(11), Idaho Code, shall not extend to any transaction in a security in the nature of an investment contract or profit-sharing agreement. (3-20-20)T

**02. Definition “Offered and Sold as a Unit.”** As used in Section 30-14-202(11), Idaho Code, “offered and sold as a unit” means an offer and sale of the entire mortgage or other security agreement to a single purchaser at a single sale. (3-20-20)T

**056. MANUAL EXEMPTION.**

For the purpose of the manual exemption (Section 30-14-202(2), Idaho Code), the following securities manuals or portions of the manuals are recognized. (3-20-20)T

- a.** Best’s Insurance Reports- Life-Health. (3-20-20)T
- b.** Mergent’s Industrial Manual. (3-20-20)T
- c.** Mergent’s International Manual. (3-20-20)T
- d.** Walkers Manual of Western Corporations. (3-20-20)T

**057. MINING, OIL OR GAS EXPLORATION EXEMPTION REQUIREMENTS.**

**01. Legal Opinion for Extractive Industries.** If the Department deems it necessary or advisable in the public interest or for the protection of investors, it may require an issuer engaged in mining, gas, or oil exploration or extraction to submit an opinion of counsel on the nature of the title held to the property noting any defects or liens or both, and the principal terms of any lease or option with respect to the property. If continued possession of the property by the issuer depends upon the satisfaction of certain working conditions, describe these conditions and state the extent to which they have been met. The Department may require other issuers to submit a status of title to any real estate which is material to the business of the issuer. (3-20-20)T

**02. Quarterly Reports.** The issuer shall file quarterly reports, on the “Quarterly Report Form for Small Mining Issues.” during the time the securities remain registered. Such reports are due within thirty (30) days following the end of the issuer’s quarter. Failure to comply with this rule could be grounds for suspension or revocation of a permit. (3-20-20)T

**03. Advertising.** The only advertising of exempt mining securities, whether on radio, television, print media, or other medium, shall be restricted to announcing the securities offering and stating the name and address of the issuer, the type of security, the underwriter, and where additional information may be obtained. (3-20-20)T

**04. Offering Circulars.** All offers of the security must be accompanied by a complete, current offering circular previously reviewed by the Administrator adequate to satisfy the antifraud provisions of the Act. (3-20-20)T

**058. STOCK EXCHANGE LISTED SECURITIES.**

Stock exchanges specified by or approved under Section 30-14-201(6), Idaho Code, are as follows: (3-20-20)T

- 01. The New York Stock Exchange;** (3-20-20)T
- 02. The American Stock Exchange;** (3-20-20)T
- 03. The NASDAQ Global Market and Global Select Market;** (3-20-20)T
- 04. The Chicago Stock Exchange;** (3-20-20)T
- 05. The Chicago Board Options Exchange;** (3-20-20)T
- 06. Tier I of the Pacific Stock Exchange; and** (3-20-20)T
- 07. Tier I of the Philadelphia Stock Exchange, Inc.** (3-20-20)T

**059. (RESERVED)**

**060. REGISTRATION OR EXEMPTION OF “BLIND POOL” OFFERINGS PROHIBITED.**

An offering in which it is proposed to issue stock or other equity interest without an allocation of proceeds to sufficiently identifiable properties or objectives shall be considered a “blind pool” offering and one in which the duty to provide full disclosure cannot be met. Because of the inability or failure to make full disclosure, the Department is of the position that the offering would work a fraud upon purchasers and, therefore, the offering may not be registered or qualify for an exemption from registration in Idaho. (3-20-20)T

**061. CROSS-BORDER TRANSACTIONS EXEMPTION.**

By authority delegated to the Administrator in Section 30-14-203, Idaho Code, transactions effected by a Canadian broker-dealer and its agents that meet the requirements for exemption from registration pursuant to Section 084 of these rules, are determined to be classes of transactions for which registration is not necessary or appropriate for the protection of investors and are exempt from Sections 30-14-301 and 30-14-504, Idaho Code. (3-20-20)T

**062. DESIGNATED MATCHING SERVICES.**

**01. In General.** Sections 30-14-301 through 30-14-305, Idaho Code, shall not apply to any offer or sale of a security by an issuer in a transaction that meets the requirements of this rule. A designated matching service shall not be deemed a broker-dealer subject to registration within the meaning of the Act or the rules thereunder. (3-20-20)T

**02. Definitions.** The following words and terms, when used in this rule, shall have the following meanings, unless the context clearly indicates otherwise. (3-20-20)T

**a. Designated Matching Service.** Means a matching service designated by the Administrator under Section 062 of these rules. (3-20-20)T

**b. Designated Matching Service Facility.** Means a computer system operated, or a seminar or meeting conducted, by a designated matching service. (3-20-20)T

**c. Individual Accredited Investor.** Means any natural person whose individual net worth, or joint net worth with that person’s spouse, at the time of his or her purchase, exceeds one million dollars (\$1,000,000) or any natural person who had an individual income in excess of two hundred thousand dollars (\$200,000) in each of the two (2) most recent years or joint income with that person’s spouse in excess of three hundred thousand dollars (\$300,000) in each of those years and has a reasonable expectation of reaching the same income level in the current year. In addition each purchaser must evidence such knowledge and experience in financial and business matters that he is capable of evaluating the merits and risks of the prospective investment. The term “individual accredited investor” also includes any self-directed employee benefit plan with investment decisions made solely by persons that are “individual accredited investors” as defined in Subsection 062.02.c. of this rule, and the individual retirement account of any such individual accredited investor. (3-20-20)T



**d.** Investor Member. Means an investor who has been properly qualified by and uses a designated matching service. Either of the following investors may be properly qualified: any institutional investor as described in Section 30-14-102(11), Idaho Code, or an individual accredited investor as defined in this rule. (3-20-20)T

**e.** Issuer Member. Means an issuer who uses a designated matching service facility. (3-20-20)T

**f.** Summary Business Plan. Means a brief statement specifically describing the issuer, its management, its products or services, and the market for those products or services. Other information, including, specifically, financial projections, must not be included in a summary business plan. (3-20-20)T

**03. Application.** A person may apply to the Administrator to be a designated matching service by filing such forms as required by the Administrator. No designation will be made unless the applicant demonstrates that it: (3-20-20)T

**a.** Owns, operates, sponsors, or conducts a matching service facility limited to providing investor members with the summary business plans and identities of issuer members; (3-20-20)T

**b.** Will not be involved in any manner in the sale, offer for sale, solicitation of a sale or offer to buy, a security other than as set forth in Subsection 062.03.a. of this rule; (3-20-20)T

**c.** Will make a reasonable factual inquiry to determine whether an investor member is properly qualified; (3-20-20)T

**d.** Is a governmental entity, quasi-governmental entity, an institution of higher education or an Idaho nonprofit corporation that is associated with a governmental or quasi-governmental entity or an institution of higher education; (3-20-20)T

**e.** Does not employ any person required to be registered under the Act as a broker-dealer, investment adviser, agent, or investment adviser representative; (3-20-20)T

**f.** Does not have, and does not employ any person who has a business relationship with any investor member or issuer member other than to provide such member access to the matching service facility; (3-20-20)T

**g.** Charges fees only in an amount necessary to cover its reasonable operating costs and that are unrelated to the amount of money being raised by any issuer member or the amount of securities sold by any issuer member; (3-20-20)T

**h.** Agrees to not use any advertisement of its matching service facility that advertises any particular issuer or any particular securities or the quality of any securities or that is false or misleading or otherwise likely to deceive a reader thereof; and (3-20-20)T

**i.** Meets such other conditions as the Administrator considers appropriate for the protection of investors and consistent with the purposes fairly intended by the policy and provisions of the Act, and the rules thereunder. (3-20-20)T

**04. Designation Consistent with Act.** Designation under this rule is not available to any matching service formed in a manner that constitutes part of a scheme to violate or evade the provisions of the Act or rules thereunder. (3-20-20)T

**05. Withdrawal of Designation.** The Administrator, upon ten (10) days notice and hearing before the Administrator or a hearing officer, may withdraw a person's designation as a matching service if the person does not meet the standards for designation provided in this rule. (3-20-20)T

**06. Disqualifications.** (3-20-20)T

**a.** No exemption under this rule shall be available for the securities of any issuer if the issuer:

(3-20-20)T

i. Within the last five (5) years, has filed a registration statement which is the subject of a currently effective registration stop order entered by the United States Securities and Exchange Commission or any state securities administrator; (3-20-20)T

ii. Within the last five (5) years, has been convicted of any criminal offense in connection with the offer, purchase, or sale of any security or any felony involving fraud or deceit or a misdemeanor involving financial fraud; (3-20-20)T

iii. Is the subject of any state or federal administrative enforcement order, entered within the last five (5) years, finding fraud or deceit in connection with the purchase or sale of any security; or (3-20-20)T

iv. Is the subject of any order, judgment or decree of any court of competent jurisdiction, entered within the last five (5) years, temporarily, preliminarily or permanently restraining or enjoining such party from engaging in or continuing to engage in any conduct or practice involving fraud or deceit in connection with the purchase or sale of any security. (3-20-20)T

**b.** For purposes of this rule, the term “issuer” includes: (3-20-20)T

i. Any of the issuer’s predecessors or any affiliated issuer; (3-20-20)T

ii. Any of the issuer’s directors, officers, general partners, or beneficial owners of ten percent (10%) or more of any class of its equity securities (beneficial ownership meaning the power to vote or direct the vote or the power to dispose or direct the disposition of such securities); (3-20-20)T

iii. Any of the issuer’s promoters presently connected with the issuer in any capacity, including: (3-20-20)T

(1) Any person who, acting alone or in conjunction with one (1) or more other persons, directly or indirectly takes initiative in founding and organizing the business or enterprise of an issuer; or (3-20-20)T

(2) Any person who, in connection with the founding and organizing of the business or enterprise of an issuer, directly or indirectly receives in consideration of services or property, or both services and property, ten percent (10%) or more of any class of securities of the issuer or ten percent (10%) or more of the proceeds from the sale of any class of such securities; however, a person who receives such securities or proceeds either solely as underwriting commissions or solely in consideration of property shall not be deemed a promoter within the meaning of Subsection 062.06.b.iii. of this rule, if such person does not otherwise take part in founding and organizing the enterprise. (3-20-20)T

iv. Any underwriter of the issuer. (3-20-20)T

**c.** The exemption under this rule is not available to an issuer that is in the development stage that either has no specific business plan or purpose or had indicated that its business plan is to engage in a merger or acquisition with an unidentified company or companies, or other entity or person. (3-20-20)T

**07. Notice of Transaction.** The issuer shall file with the Administrator a notice of transaction, consent to service of process (Form U-2), and a copy of its summary business plan within fifteen (15) days after the first sale in this state. (3-20-20)T

**063. -- 077. (RESERVED)**

**078. IMPLEMENTATION OF CRD.**

**01. Designation and Use of CRD System.** Pursuant to Section 30-14-406, Idaho Code, the Administrator designates the web-based Central Registration Depository (CRD) operated by FINRA to receive and store filings and collect related fees from broker-dealers, agents and investment adviser representatives on behalf of

the Administrator. Forms U-4, U-5, BD, BR, and BDW shall be used to register or terminate agents, investment adviser representatives or broker-dealers, respectively, in the state of Idaho through the CRD system. The CRD system will be utilized to effect FINRA registration as well as registration, termination, and renewal in the state.

(3-20-20)T

**02. Registrations Not Automatic.** A filing of Form U-4, BD, or BR with the CRD system does not constitute an automatic registration in Idaho. Broker-dealers and investment advisers should not consider agents or investment adviser representatives registered until such approval from the state of Idaho has been received by them through CRD.

(3-20-20)T

**03. Electronic Signature.** When a signature or signatures are required by the particular instructions of any filing to be made through CRD, a duly authorized officer of the applicant or the applicant him or herself, as required, shall affix his or her electronic signature to the filing by typing his or her name in the appropriate fields and submitting the filing to CRD. Submission of a filing in this manner shall constitute irrefutable evidence of legal signature by any individuals whose names are typed on the filing.

(3-20-20)T

**079. IMPLEMENTATION OF IARD.**

**01. Designation.** Pursuant to Section 30-14-406, Idaho Code, the Administrator designates the web-based Investment Adviser Registration Depository (IARD) operated by FINRA to receive and store filings and collect related fees from investment advisers on behalf of the Administrator.

(3-20-20)T

**02. Use of IARD.** Unless otherwise provided, all investment adviser applications, amendments, reports, notices, related filings and fees required to be filed with the Administrator pursuant to the rules promulgated under the Act, shall be filed electronically with and transmitted to IARD. The following additional conditions relate to such electronic filings:

(3-20-20)T

**a. Electronic Signature.** When a signature or signatures are required by the particular instructions of any filing to be made through IARD, a duly authorized officer of the applicant or the applicant him or herself, as required, shall affix his or her electronic signature to the filing by typing his or her name in the appropriate fields and submitting the filing to IARD. Submission of a filing in this manner shall constitute irrefutable evidence of legal signature by any individuals whose names are typed on the filing.

(3-20-20)T

**b. When Filed.** Solely for purposes of a filing made through IARD, a document is considered filed with the Administrator when all fees are received and the filing is accepted by IARD on behalf of the state.

(3-20-20)T

**03. Electronic Filing.** The electronic filing of any particular document and the collection of related processing fees shall not be required until such time as IARD provides for receipt of such filings and fees and thirty (30) days notice is provided by the Administrator. Any documents or fees required to be filed with the Administrator that are not permitted to be filed with or cannot be accepted by IARD shall be filed directly with the Administrator.

(3-20-20)T

**04. Hardship Exemptions.** Subsection 079.04 of this rule provides two (2) "hardship exemptions" from the requirements to make electronic filings as required by the rules.

(3-20-20)T

**a. Temporary Hardship Exemption.**

(3-20-20)T

**i.** Investment advisers registered or required to be registered under the Act who experience unanticipated technical difficulties that prevent submission of an electronic filing to IARD may request a temporary hardship exemption from the requirements to file electronically.

(3-20-20)T

**ii.** To request a temporary hardship exemption, the investment adviser must file Form ADV-H which can be found at 17 CFR 279.3 in paper format with the Administrator where the investment adviser's principal place of business is located, no later than one (1) business day after the filing (that is the subject of the Form ADV-H) was due; and submit the filing that is the subject of the Form ADV-H in electronic format to IARD no later than seven (7) business days after the filing was due.

(3-20-20)T

iii. Effective Date - Upon Filing. The temporary hardship exemption will be deemed effective upon receipt by the Administrator of the complete Form ADV-H. Multiple temporary hardship exemption requests within the same calendar year may be disallowed by the Administrator. (3-20-20)T

b. Continuing Hardship Exemption. (3-20-20)T

i. Criteria for Exemption. A continuing hardship exemption will be granted only if the investment adviser is able to demonstrate that the electronic filing requirements of this rule are prohibitively burdensome. (3-20-20)T

ii. To apply for a continuing hardship exemption, the investment adviser must file Form ADV-H which can be found at 17- CFR 279.3 in paper format with the Administrator at least twenty (20) business days before a filing is due; and, if a filing is due to more than one (1) securities regulator, the Form ADV-H must be filed with the Administrator where the investment adviser's principal place of business is located. The Administrator who receives the application will grant or deny the application within ten (10) business days after the filing of Form ADV-H. (3-20-20)T

iii. Effective Date - Upon Approval. The exemption is effective upon approval by the Administrator. The time period of the exemption may be no longer than one (1) year after the date on which the Form ADV-H is filed. If the Administrator approves the application, the investment adviser must, no later than five (5) business days after the exemption approval date, submit filings to IARD in paper format (along with the appropriate processing fees) for the period of time for which the exemption is granted. (3-20-20)T

**080. BROKER-DEALER REGISTRATION -- APPLICATION/RENEWAL.**

**01. Initial Application -- FINRA Member Firms.** Broker-dealers applying for initial registration pursuant to Section 30-14-406, Idaho Code, and who are contemporaneously applying for FINRA membership or who are a FINRA member, shall file: (3-20-20)T

a. With CRD, a completed Form BD, including Schedules A-D; (3-20-20)T

b. With CRD, a filing fee as specified in Section 30-14-410, Idaho Code; (3-20-20)T

c. With CRD, the Form BR. (3-20-20)T

**02. Initial Application -- Non-FINRA Member Firms.** Broker-dealers applying for initial registration pursuant to Section 30-14-406, Idaho Code, and who are not contemporaneously applying for FINRA membership or are not a FINRA member, shall file with the Department: (3-20-20)T

a. A completed Form BD, including Schedules A-E; (3-20-20)T

b. The filing fee specified in Section 30-14-410, Idaho Code; (3-20-20)T

c. Audited financial statements; (3-20-20)T

d. Documentation of compliance with the minimum capital requirements of Section 087 of these rules; (3-20-20)T

e. Designation and qualification of a principal officer; (3-20-20)T

f. A list of the addresses, telephone numbers and resident agents of all office locations within the state of Idaho, to be provided within sixty (60) days of becoming registered; (3-20-20)T

g. A copy of the written supervisory procedures of the broker-dealer; (3-20-20)T

h. Any additional documentation, supplemental forms and information as the Administrator may

deem necessary. (3-20-20)T

**03. Incomplete Applications.** After a period of six (6) months from date of receipt, an incomplete application will automatically be considered abandoned and withdrawn if the requirements have not been fulfilled. (3-20-20)T

**04. Annual Renewal.** (3-20-20)T

**a.** A FINRA member shall renew its registration by submitting the renewal fee specified in Section 30-14-410, Idaho Code, to the CRD according to their policies and procedures. A non-FINRA member shall renew its registration by submitting to the Department current information required for initial registration, and the renewal fee specified in Section 30-14-410, Idaho Code. (3-20-20)T

**b.** It is required that an application for the renewal of the registration of a broker-dealer must be filed with the Department before the registration expires, which is the thirty-first day of December next following such registration, per the provisions of Section 30-14-406(d), Idaho Code. Any registration that is not renewed within that time limit will be deemed to have lapsed, thus requiring the broker-dealer to reapply for registration with the Department in accordance with the requirements of the Act. (3-20-20)T

**05. Updates and Amendments.** (3-20-20)T

**a.** A broker-dealer must file with CRD, in accordance with the instructions in Form BD, any amendments to the broker-dealer's Form BD. All broker-dealers must assure that current and accurate information is on file with the Department at all times. If information in an application for registration becomes inaccurate or incomplete, additional information must be submitted through updates on the Form BD or by direct notice to the Department. (3-20-20)T

**b.** An amendment will be considered to be filed promptly if the amendment is filed within thirty (30) days of the event that requires the filing of the amendment. (3-20-20)T

**c.** Litigation Notice. Any broker-dealer shall notify the Administrator in writing or through the CRD of any civil, administrative, or criminal complaint, petition, or pleading issued or filed against him and of any bankruptcy proceeding filed by or against him within thirty (30) days of his receipt of the initial pleading. This requirement does not include minor traffic violations or minor civil actions unrelated to the registrant's business as a broker-dealer. (3-20-20)T

**d.** Notice of Address. Every broker-dealer shall provide the Department, with an address sufficiently descriptive to allow service of process pursuant to the Idaho Rules of Civil Procedure. (3-20-20)T

**e.** Change of Name. If a registered broker-dealer desires to change its name, notice of such an intent must be submitted to the CRD or this Department for non-FINRA members, either before or within a reasonable time after the effective date of the change. The name change will not be effective in this state until the notice is received. (3-20-20)T

**06. Completion of Filing.** An application for initial or renewal registration is not considered filed for purposes of Section 30-14-406, Idaho Code, until the required fee and all required submissions have been received by the Administrator. (3-20-20)T

**07. Deferral of Effectiveness.** The Administrator may defer the effective date of any registration until noon on the forty-fifth day after the filing of any amendment completing the application. (3-20-20)T

**081. WITHDRAWAL OF BROKER -- DEALER AND AGENT REGISTRATION.**

**01. Application Withdrawal.** Withdrawal from registration as a broker-dealer or agent becomes effective thirty (30) days after receipt of an application to withdraw or within such shorter period of time as the Administrator may determine, unless a revocation or suspension proceeding is pending when the application is filed or a proceeding to revoke or suspend or to impose conditions upon the withdrawal is instituted within sixty (60) days

after the application is filed. If a proceeding is pending or instituted, withdrawal becomes effective at such time and upon such conditions as the Administrator by order determines. If no proceeding is pending or instituted and withdrawal automatically becomes effective, the Administrator may nevertheless institute a revocation or suspension proceeding under Section 30-14-412, Idaho Code, within one (1) year after withdrawal became effective and enter a revocation or suspension order as of the last date on which registration is effective. (3-20-20)T

**02. Broker-Dealer.** The application for withdrawal of registration as a broker-dealer shall be completed by following the instructions on Form BDW and filing Form BDW with CRD. (3-20-20)T

**03. Agents.** The application for withdrawal of registration as an agent shall be completed by following the instructions on Form U-5 and filed upon Form U-5 with CRD. (3-20-20)T

**082. WITHDRAWAL OF AGENT OF ISSUER REGISTRATION.**

**01. Pending Revocation or Suspension.** Withdrawal from registration as an agent of issuer becomes effective thirty (30) days after receipt of an application to withdraw or within such shorter period of time as the Administrator may determine, unless a revocation or suspension proceeding is pending when the application is filed or a proceeding to revoke or suspend or to impose conditions upon the withdrawal is instituted within sixty (60) days after the application is filed. If a proceeding is pending or instituted, withdrawal becomes effective at such time and upon such conditions as the Administrator by order determines. If no proceeding is pending or instituted and withdrawal automatically becomes effective, the Administrator may nevertheless institute a revocation or suspension proceeding under Section 30-14-412, Idaho Code, within one (1) year after withdrawal became effective and enter a revocation or suspension order as of the last date on which registration is effective. (3-20-20)T

**02. Agent of Issuer.** The application for withdrawal of registration as an agent of issuer shall be completed by following the instructions on Form U-5 and filed upon Form U-5 with the Department. (3-20-20)T

**083. BROKER-DEALER AGENT/ISSUER AGENT REGISTRATION.**

**01. Broker-Dealer Agents.** Agents of broker-dealers applying for initial registration in the state of Idaho pursuant to Section 30-14-406, Idaho Code, shall file the following: (3-20-20)T

- a.** With CRD, a completed Form U-4; (3-20-20)T
- b.** With CRD, the filing fee specified in Section 30-14-410, Idaho Code; (3-20-20)T
- c.** With CRD, proof of successful completion of the applicable examinations specified in Section 103 of these rules; (3-20-20)T
- d.** With the Department, any additional documentation, supplemental forms and information as the Administrator may deem necessary; (3-20-20)T
- e.** With the Department, Subsections 083.01.a. through 083.01.d. of this rule, for any agent of a non-FINRA member. (3-20-20)T

**02. Agents of Issuer.** (3-20-20)T

**a.** Agents of issuers applying for initial registration in the state of Idaho pursuant to Section 30-14-406, Idaho Code, shall file the following with the Department: (3-20-20)T

- i.** A completed Form U-4; (3-20-20)T
- ii.** The fee specified in Section 30-14-410, Idaho Code; (3-20-20)T
- iii.** Proof of successful completion of the applicable examination(s) specified in Section 103 of these rules; (3-20-20)T

iv. Proof of a bond of a surety company duly authorized to transact business in this state, said bond to be in the sum of ten thousand dollars (\$10,000) and conditioned upon faithful compliance with the provisions of the Act by the agent, such that upon failure to so comply by the agent, the surety company is liable to any and all persons who may suffer loss by reason thereof. Provided, however, that the obligation of the surety bond must be maintained at all times in the amount therein provided; and provided further, that a certificate of deposit issued by any bank in the state of Idaho and assigned to the Administrator in an amount equal to the bond which would otherwise be required may be accepted by the administrator in lieu of a bond, if the certificate of deposit is maintained at all times in the amount and manner herein provided during the term for which the registration is effective and for three (3) years thereafter; (3-20-20)T

v. Any additional documentation, supplemental forms and information as the Administrator may deem necessary. (3-20-20)T

b. An individual who represents an issuer that effects transactions in a federal covered security under Section 18(b)(3) (transactions relating to “qualified purchasers” as that term may be defined by the SEC), 18(b)(4)(D) (commonly known as Regulation A, Tier 2), or 18(b)(4)(F) (commonly known as Regulation D, Rule 506) of the Securities Act of 1933 is not exempt from the registration requirements of Section 30-14-402(a), Idaho Code, if the individual is compensated, directly or indirectly, for participation in the specified securities transactions. (3-20-20)T

c. Exceptions for officers. If there are not more than two (2) officers of an issuer, such officers may be registered as agents for a particular original offering of the issuer’s securities without having to pass such written examination or file an agent’s bond as provided by Subsection 083.02.a.iii. and 02.a.iv. of this rule, unless such person has registered under this rule within the prior five (5) years. (3-20-20)T

**03. Incomplete Applications.** After a period of six (6) months from date of receipt, an incomplete application will automatically be considered abandoned and withdrawn if the requirements have not been fulfilled. (3-20-20)T

**04. Annual Renewal.** (3-20-20)T

a. Broker-Dealer Agent. Agents of FINRA members shall renew their registrations by submitting the renewal fee specified in Section 30-14-410, Idaho Code, to the CRD. Agents of non-FINRA members shall renew their registrations by submitting a completed renewal application and a renewal fee as specified in Section 30-14-410, Idaho Code. (3-20-20)T

b. Issuer Agent. Issuer agents shall renew their registrations by submitting a completed renewal application and a renewal fee as specified in Section 30-14-410, Idaho Code. (3-20-20)T

**05. Updates and Amendments.** (3-20-20)T

a. A broker-dealer agent or agent of issuer must file with CRD, or with this Department, in accordance with the instructions in Form U-4, any amendments to the broker-dealer agent’s or issuer agent’s Form U-4. It is the responsibility of each broker-dealer agent or issuer agent to assure that current and accurate information is on file with the Department at all times. If information in an application for registration becomes inaccurate or incomplete, additional information must be submitted through updates on the Form U-4 or by direct notice to the Department. (3-20-20)T

b. An amendment will be considered to be filed promptly if the amendment is filed within thirty (30) days of the event that requires the filing of the amendment. (3-20-20)T

c. Litigation Notice. Any broker-dealer agent or issuer agent shall notify the Administrator in writing or through the CRD of any civil, administrative, or criminal complaint, petition, or pleading issued or filed against him and of any bankruptcy proceeding filed by or against him within thirty (30) days of his receipt of the initial pleading. This requirement shall not include minor traffic violations or minor civil actions unrelated to the registrant’s business as a broker-dealer. (3-20-20)T

**d.** Notice of Address. Every broker-dealer agent and issuer agent shall provide the Department with an address sufficiently descriptive to allow service of process pursuant to the Idaho Rules of Civil Procedure. (3-20-20)T

**e.** Change of Name. If a registered broker-dealer agent or issuer agent changes his or her name, notice of such must be submitted to the CRD or this Department within a reasonable time after the effective date of the change. The name change will not be effective in this state until the notice is received. (3-20-20)T

**06. Completion of Filing.** An application for initial or renewal registration is not considered complete for purposes of Section 30-14-406(c), Idaho Code, until the required fee and all amendments, including submissions requested by the Department, have been received by the Department. (3-20-20)T

**07. Deferral of Effectiveness.** The Administrator may defer the effective date of any registration until noon on the forty-fifth day after the filing of any amendment completing the application. (3-20-20)T

**084. CROSS-BORDER LICENSING EXEMPTION.**

By authority delegated to the Administrator in Section 30-14-401(d), Idaho Code, a Canadian broker-dealer meeting all of the following conditions is determined to be exempt from the registration requirement in Section 30-14-401(a), Idaho Code: (3-20-20)T

**01. Canadian Broker-Dealer.** The broker-dealer is registered in Canada, does not have an office or other physical presence in this state, and is not an office or branch of a broker-dealer domiciled in the United States. (3-20-20)T

**02. Registered Broker-Dealer.** The broker-dealer is registered with or a member of a Canadian self-regulatory organization, stock exchange, or the Bureau des Services Financiers and maintains that registration or membership in good standing. (3-20-20)T

**03. Customers.** The broker-dealer and its agents effect transactions in securities with or for, or induce or attempt to induce the purchase or sale of any security by: (3-20-20)T

**a.** An individual from Canada that temporarily resides or is temporarily present in this state and with whom the broker-dealer had a bona fide broker-dealer-customer relationship before the individual entered the United States; or (3-20-20)T

**b.** An individual present in this state whose transactions relate to a self-directed, tax advantaged Canadian retirement plan of which the individual is the holder or contributor. (3-20-20)T

**04. Disclosure.** The broker-dealer prominently discloses in writing to its clients in this state that the broker-dealer and its agents are not subject to the full regulatory requirement of the Act. (3-20-20)T

**05. Jurisdiction.** Neither the broker-dealer nor its agents disclaim the applicability of Canadian law or jurisdiction to any transaction conducted pursuant to this exemption. (3-20-20)T

**06. Anti-Fraud Provisions.** The broker-dealer and its agents comply with the antifraud provisions of the Act and of federal securities laws. (3-20-20)T

**07. Consent to Service.** Prior to or contemporaneously with the first transaction in Idaho, the broker-dealer must file a consent to service of process (Form U-2) in a manner that effectively appoints the Administrator as agent for service of process. (3-20-20)T

**08. Provide Requested Information.** Any Canadian broker-dealer or agent relying on this exemption shall, upon written request, furnish the Department any information relative to a transaction covered by Section 084, of these rules, that the Administrator deems relevant. (3-20-20)T

**085. RELICENSING (FORMERLY TEMPORARY AGENT TRANSFER (TAT) SYSTEM).**



**01. Relicensing Agents.** Transfer of agents from one broker-dealer to another shall be effected pursuant to, and in accordance with, the NASAA/CRD relicense program which allows for an automatic temporary license. (3-20-20)T

**02. Relicensing Investment Adviser Representatives.** Transfer of investment adviser representatives from one (1) investment adviser to another shall be effected pursuant to, and in accordance with, the NASAA/CRD relicense program which allows for an automatic temporary license. (3-20-20)T

**03. Temporary License Expiration.** An agent or investment adviser representative may not transact business in Idaho after the expiration of a temporary license unless a permanent license has been issued. In all cases, the Administrator retains the right to deny, suspend, or revoke a temporary license for the causes listed in Section 30-14-412, Idaho Code. (3-20-20)T

**086. AGENT TERMINATION.**

Termination notice pursuant to the requirements of Section 30-14-408, Idaho Code, shall be given by filing within thirty (30) calendar days of termination, a completed Form U-5. For agents terminating registration with a FINRA member, such notice shall be filed with the CRD. For agents terminating registration with a non-FINRA member, such notice shall be filed with the Department. (3-20-20)T

**087. NET CAPITAL REQUIREMENTS FOR BROKER-DEALERS.**

Every registered broker-dealer shall have and maintain an adjusted net capital in compliance with 17 CFR 240.15c3-1 under the Securities Exchange Act of 1934, as currently amended. (3-20-20)T

**088. RECORDS REQUIRED FOR BROKER-DEALERS.**

**01. Required Books and Records.** Unless otherwise provided by order of the SEC, each broker-dealer registered or required to be registered under the Act shall make, maintain and preserve books and records in compliance with the SEC rules 17a-3 (17 CFR 240.17a-3), 17a-4 (17 CFR 240.17a-4), 15g-9 (17 CFR 240.15g-9) and 15c2-11 (17 CFR 240.15c2-11), which are adopted and incorporated by reference. (3-20-20)T

**02. Compliance.** To the extent that the SEC promulgates changes to the above referenced rules, broker-dealers in compliance with such rules as amended are not subject to enforcement action by the Department for violation of this rule to the extent that the violation results solely from the broker-dealer's compliance with the amended rule. (3-20-20)T

**089. INVESTMENT ADVISER REGISTRATION -- APPLICATION/RENEWAL.**

**01. Initial Application.** The application for initial registration as an investment adviser, pursuant to Section 30-14-406, Idaho Code, shall be made by completing Form ADV which can be found at 17 CFR 279.1 in accordance with the form instructions and by filing the form with IARD. The application for initial registration shall also include the following: (3-20-20)T

**a.** Proof of compliance by the investment adviser with the examination requirements of Section 103 of these rules; (3-20-20)T

**b.** A bond of a surety company duly authorized to transact business in this state, said bond to be in the sum of twenty-five thousand (\$25,000) and conditioned upon faithful compliance with the provisions of the Act by the investment adviser such that upon failure to so comply by the investment adviser, the surety company shall be liable to any and all persons who may suffer loss by reason thereof. Except that an investment adviser that has its principal place of business in a state other than this state shall be excluded from these bonding requirements provided that such investment adviser is registered as an investment adviser in the state where it maintains its principal place of business and is in compliance with such state's bonding or minimum net worth requirements; (3-20-20)T

**c.** A copy of the investment advisory contract to be executed by Idaho clients; (3-20-20)T

**d.** A balance sheet, prepared substantially in accordance with Generally Accepted Accounting Principles, dated as of the investment adviser's prior fiscal year-end; however, if the investment adviser has not been

in operation for an entire year, a balance sheet dated within ninety (90) days of filing shall be submitted; (3-20-20)T

e. The fee required by Section 30-14-410, Idaho Code; and; (3-20-20)T

f. Any other information the Department may reasonably require. (3-20-20)T

**02. Incomplete Applications.** After a period of six (6) months from the date of receipt by the Department, an incomplete application will automatically be considered abandoned and withdrawn if the requirements have not been fulfilled. (3-20-20)T

**03. Annual Renewal.** The application for annual renewal registration as an investment adviser shall be filed with IARD according to their policies and procedures. The application for annual renewal registration shall include the fee required by Section 30-14-410, Idaho Code. (3-20-20)T

**04. Applications Prior to Expiration.** An application for the renewal of the registration of an investment adviser must be filed with the Department before the registration expires, which is the thirty-first day of December next following such registration, per the provisions of Section 30-14-406(d), Idaho Code, unless an order is in effect under Section 30-14-412, Idaho Code. Any registration that is not renewed within that time limit will be deemed to have lapsed, thus requiring the investment adviser to reapply for registration with the Department in accordance with the requirements of the Act. (3-20-20)T

**05. Updates and Amendments.** (3-20-20)T

a. An investment adviser must file with IARD, in accordance with the instructions in Form ADV, any amendments to the investment adviser's Form ADV. All investment advisers must assure that current and accurate information is on file with the Department at all times. If information in an application for registration becomes inaccurate or incomplete, additional information must be submitted through updates on the Form ADV or by direct notice to the Department. An amendment will be considered to be filed promptly if the amendment is filed within thirty (30) days of the event that requires the filing of the amendment. (3-20-20)T

b. Within ninety (90) days of the end of the investment adviser's fiscal year, an investment adviser must file a copy of the investment adviser's balance sheet as of the prior fiscal year-end. (3-20-20)T

c. **Litigation Notice.** Any investment adviser shall notify the Administrator in writing or through the IARD of any civil, administrative, or criminal complaint, petition, or pleading issued or filed against him and of any bankruptcy proceeding filed by or against him within thirty (30) days of his receipt of the initial pleading. This requirement does not include minor traffic violations or minor civil actions unrelated to the registrant's business as an investment adviser. (3-20-20)T

d. **Notice of Address.** Every investment adviser shall provide the Department, through IARD, with an address sufficiently descriptive to allow service of process pursuant to the Idaho Rules of Civil Procedure. (3-20-20)T

**06. Completion of Filing.** An application for initial or renewal registration is not considered filed for purposes of Section 30-14-406, Idaho Code, until the required fee and all submissions have been received by the Administrator and until the investment adviser is registered in the jurisdiction where it maintains its principal place of business. (3-20-20)T

**07. Deferral of Effectiveness.** The Administrator may defer the effective date of any registration until noon on the forty-fifth day after the filing of any amendment completing the application. (3-20-20)T

**090. INVESTMENT ADVISER REPRESENTATIVE REGISTRATION – APPLICATION/RENEWAL.**

**01. Initial Application.** The application for initial registration as an investment adviser representative pursuant to Section 30-14-406, Idaho Code, shall be made by completing Form U-4 in accordance with the form instructions and by filing Form U-4 with CRD. The application for initial registration also shall include the following: (3-20-20)T

**a.** Proof of compliance by the investment adviser representative with the examination requirements of Section 103 of these rules; and (3-20-20)T

**b.** The fee required by Section 30-14-410, Idaho Code. (3-20-20)T

**02. Incomplete Applications.** After a period of six (6) months from the date of receipt by the Department, an incomplete application will automatically be considered abandoned and withdrawn if the requirements have not been fulfilled. (3-20-20)T

**03. Annual Renewal.** The application for annual renewal registration as an investment adviser representative shall be filed with CRD. The application for annual renewal registration shall include the fee required by Section 30-14-410, Idaho Code. (3-20-20)T

**04. Updates and Amendments.** (3-20-20)T

**a.** The investment adviser representative is under a continuing obligation to update information required by Form U-4 as changes occur. All investment adviser representatives must assure that current and accurate information is on file with the Department, through CRD, at all times. If information in an application for registration becomes inaccurate or incomplete, additional information must be submitted through updates on the Form U-4. (3-20-20)T

**b.** An investment adviser representative and the investment adviser must file promptly with CRD any amendments to the representative's Form U-4. An amendment will be considered to be filed promptly if the amendment is filed within thirty (30) days of the event that requires the filing of the amendment. (3-20-20)T

**c.** Litigation Notice. Any investment adviser representative shall notify the Administrator in writing, through CRD, of any civil, administrative, or criminal complaint, petition, or pleading issued or filed against him and of any bankruptcy proceeding filed by or against him within thirty (30) days of his receipt of the initial pleading. This requirement shall not include minor traffic violations or minor civil actions unrelated to the registrant's business as an investment adviser representative. (3-20-20)T

**d.** Change of Name. If a registered investment adviser representative changes his or her name, notice of such must be submitted to the CRD or this Department either before or within a reasonable time after the effective date of the change. The name change will not be effective in this state until the notice is received. (3-20-20)T

**e.** Notice of Address. Every investment adviser representative shall provide the Department, through CRD, with an address sufficiently descriptive to allow service of process pursuant to the Idaho Rules of Civil Procedure. (3-20-20)T

**05. Completion of Filing.** An application for initial or renewal registration is not considered filed for purposes of Section 30-14-406, Idaho Code, until the required fee and all submissions have been received by the Administrator. (3-20-20)T

**06. Dual Registration Exemption.** A person may transact business in this state as an investment adviser representative if he is registered as an agent pursuant to Section 30-14-402, Idaho Code, and is employed by a broker-dealer registered pursuant to Section 30-14-401, Idaho Code, and (3-20-20)T

**a.** The person's investment advisory activities are limited to recommending the investment advisory services of an investment adviser registered under Section 30-14-403, Idaho Code, or a federal covered adviser that has made a notice filing pursuant to Section 30-14-405, Idaho Code, and all such recommendations are made on behalf of the employing broker-dealer; (3-20-20)T

**b.** The person is not compensated directly for making such recommendations; and (3-20-20)T

**c.** The person provides written notice to the administrator that he is relying on this exemption from the requirement to be registered as an investment adviser representative. (3-20-20)T

**07. Deferral of Effectiveness.** The Administrator may defer the effective date of any registration until noon on the forty-fifth day after the filing of any amendment completing the application. (3-20-20)T

**091. WITHDRAWAL OF INVESTMENT ADVISER AND INVESTMENT ADVISER REPRESENTATIVE REGISTRATION.**

**01. Application Withdrawal.** Withdrawal from registration as an investment adviser or investment adviser representative becomes effective thirty (30) days after receipt of an application to withdraw or within such shorter period of time as the Administrator may determine, unless a revocation or suspension proceeding is pending when the application is filed or a proceeding to revoke or suspend or to impose conditions upon the withdrawal is instituted within sixty (60) days after the application is filed. If a proceeding is pending or instituted, withdrawal becomes effective at such time and upon such conditions as the Administrator by order determines. If no proceeding is pending or instituted and withdrawal automatically becomes effective, the Administrator may nevertheless institute a revocation or suspension proceeding under Section 30-14-412, Idaho Code, within one (1) year after withdrawal became effective and enter a revocation or suspension order as of the last date on which registration is effective. (3-20-20)T

**02. Investment Adviser.** The application for withdrawal of registration as an investment adviser shall be completed by following the instructions on Form ADV-W which can be found at 17 CFR 279.2 and filed upon Form ADV-W with IARD. (3-20-20)T

**03. Investment Adviser Representative.** The application for withdrawal of registration as an investment adviser representative shall be completed by following the instructions on Form U-5 and filed upon Form U-5 with CRD. (3-20-20)T

**092. NOTICE FILING REQUIREMENTS FOR FEDERAL COVERED ADVISERS.**

**01. Notice Filing.** The notice filing for a federal covered adviser pursuant to Section 30-14-405, Idaho Code, shall be filed with IARD on an executed Form ADV which can be found at 17 CFR 279.1. A notice filing of a federal covered adviser shall be deemed filed when the fee required by Section 30-14-410, Idaho Code, and the Form ADV are filed with and accepted by IARD on behalf of the state. (3-20-20)T

**02. When Deemed Filed.** The Administrator will deem filed Part 2 of Form ADV if a federal covered adviser provides, within five (5) days of a request, Part 2 of Form ADV to the Administrator. Because the Administrator deems Part 2 of the Form ADV to be filed, a federal covered adviser is not required to submit Part 2 of Form ADV to the Administrator unless requested. (3-20-20)T

**03. Renewal.** The annual renewal of the notice filing for a federal covered adviser pursuant to Section 30-14-405, Idaho Code, shall be filed with IARD. The renewal of the notice filing for a federal covered adviser shall be deemed filed when the fee required by Section 30-14-410(e), Idaho Code, is filed with and accepted by IARD on behalf of the state. (3-20-20)T

**04. Updates and Amendments.** A federal covered adviser must file with IARD, in accordance with the instructions in the Form ADV, any amendments to the federal covered adviser's Form ADV. (3-20-20)T

**093. RECORDS REQUIRED OF INVESTMENT ADVISERS.**

Pursuant to provisions of the Act, every investment adviser registered or required to be registered under the Act shall make and keep true, accurate and current books and records as listed in 17 CFR 275.204-2 under the Investment Advisers Act of 1940, as currently amended. (3-20-20)T

**094. CLIENT CONTRACTS – INVESTMENT ADVISERS.**

**01. Contract.** As used in this rule, “investment advisory contract” means any contract or agreement whereby a person agrees to act as investment adviser or to manage any investment or trading account for a person other than an investment company, as defined in the Investment Company Act of 1940, as amended. (3-20-20)T

**02. Contents of Client Contract.** No investment adviser shall enter into, extend, or renew any investment advisory contract, or in any way perform any investment advisory contract entered into, extended, or renewed, after the effective date of this rule, unless such contract is in writing and contains the following: (3-20-20)T

**a.** Provides that an investment adviser shall not receive compensation based on a share of capital gains upon or capital appreciation of funds or any portion of the funds of the client, except as exempted in 17 CFR 275.205-3 under the Investment Adviser Act of 1940; (3-20-20)T

**b.** Provides that no assignment of the contract shall be made by the investment adviser without the written consent of the client; (3-20-20)T

**c.** Provides that if the investment adviser is a partnership, the investment adviser shall notify the client of any change in the membership of such partnership within a reasonable time after such change; (3-20-20)T

**d.** Provides the investment adviser's policy regarding termination of the contract, in compliance with 17 CFR 275.204-3(b). (3-20-20)T

**e.** Detailed description of the services to be provided; (3-20-20)T

**f.** Terms of the contract; (3-20-20)T

**g.** Amount of the advisory fee, the formula for computing the fee, and the amount of any prepaid fee to be returned in the event of contract termination or non-performance; (3-20-20)T

**h.** Discloses whether the contract grants discretionary power to the investment adviser; (3-20-20)T

**i.** A contract may not contain any provision that limits or purports to limit the liability of the investment adviser for conduct or omission arising from the advisory relationship that does not conform to the Act, applicable federal statutes, or common law fiduciary standard of care; or the remedies available to the client at law or equity or the jurisdiction where any action shall be filed or heard. (3-20-20)T

**095. INVESTMENT ADVISER BROCHURE RULE.**

An investment adviser registered or required to be registered under the Act shall, in accordance with 17 CFR 275.204-3 under the Investment Advisers Act of 1940, deliver to each advisory client and prospective advisory client with a written disclosure statement that may be either a copy of Part 2 of its Form ADV which complies with 17 CFR 275.204-1(b) of the Investment Advisers Act of 1940, or a written document containing at least the information then so required by Part 2 of Form ADV. (3-20-20)T

**096. REQUIREMENTS FOR CUSTODY.**

If an investment adviser registered or required to be registered under the Act maintains custody of client funds, it shall be done in accordance with the requirements and standards set forth in 17 CFR 275.206(4)-2 of the Investment Advisers Act of 1940. (3-20-20)T

**097. INVESTMENT ADVISER AFFILIATION WITH BROKER-DEALERS/ISSUERS/AGENTS.**

If an investment adviser becomes affiliated with a broker-dealer or issuer, he will be under a continuing obligation to make full disclosure of the affiliation to all parties to the affiliation, and must provide written notice to the Administrator of any material changes concerning any affiliation. Compliance with Part 2 of Uniform Form ADV and delivery of Part 2 of that form, or of a separate brochure or document containing substantially the same information that meets the requirements of the federal brochure rule, will be deemed to be in compliance with this rule. (3-20-20)T

**098. NAMES USED BY BROKER-DEALERS AND INVESTMENT ADVISERS.**

**01. Unregistered Names.** (3-20-20)T

**a.** Broker-dealers, Broker-dealer Agents. Upon written request, the Administrator, in his discretion, may allow use by a broker-dealer of the name of an entity which is not registered with the Department as a broker-

dealer if, in all communications and advertising, a notation is prominently displayed indicating that all securities transactions are made through a named registered broker-dealer. However, any and all payments received must be in the name of the registered broker-dealer. The Administrator may impose any further conditions or restrictions on the use of the nonregistered name that he deems appropriate for the protection of the public. Except as provided in this rule, the use of unregistered names by a broker-dealer is prohibited. (3-20-20)T

**b.** Investment Advisers, Investment Adviser Representatives. All advising, transactions, communications, and advertising regarding securities and the conducting of business as an investment adviser must be accomplished under the name of the investment adviser that is currently registered with the Department. Upon written request, the Administrator, in his discretion, may allow use by an investment adviser or investment adviser representative of the name which is not registered with the Department. (3-20-20)T

**02. Change of Name.** If a registered broker-dealer, investment adviser, investment adviser representative or agent desires a name change, notice of such an intent must be submitted through CRD or to the Department within thirty (30) days after the effective date of the change. The name change will not be effective in this state until the notice is received. Any notice of a name change must include a copy of the rider to be attached to the investment adviser's surety bond, if such bond is required, reflecting the name change. (3-20-20)T

**099. CIRCUMVENTION OF ORDERS PROHIBITED.**

A broker-dealer, investment adviser, agent, or investment adviser representative may not circumvent the imposition of an order denying registration or revoking registration by withdrawing the application through the CRD system after such order has been issued. Such action will not be recognized by the Administrator, and will have no effect on the outcome of the order. (3-20-20)T

**100. WAIVER BY ADMINISTRATOR.**

The Administrator may, either upon request or upon his own motion, waive or modify the application of any particular section to a particular agent, broker-dealer or investment adviser when, in his opinion, just and reasonable cause exists for such action and the waiving or modifying of such rule would not be contrary to the provisions of the Act or to the public interest. (3-20-20)T

**101. NOTIFICATION OF OPENING, CLOSING OR RELOCATION OF BRANCH OFFICES.**

Any broker-dealer or investment adviser, registered as such with the Department, shall notify the Administrator in writing or through CRD, no later than thirty (30) days after the opening, closing or relocation of any branch office. For purposes of this rule, "branch office" is defined by FINRA. (3-20-20)T

**102. CANCELLATION OF REGISTRATION OR APPLICATION -- GROUNDS.**

If the Administrator finds that any registrant or applicant for registration is no longer in existence or has ceased to do business as a broker-dealer, investment adviser, salesman or investment adviser representative, or is subject to an adjudication of mental incompetence or to the control of a committee, conservator or guardian, or cannot be located after reasonable search, the Administrator may by order cancel the registration or application. (3-20-20)T

**103. EXAMINATION REQUIREMENTS.**

**01. Examination Required.** The following examinations are required for the following applicants: (3-20-20)T

**a.** Broker-dealer agent application. General agents of securities broker-dealers are required to take and pass: (3-20-20)T

i. The applicable FINRA examinations; and (3-20-20)T

ii. Either the Series 63 or the Series 66 examination. (3-20-20)T

**b.** Investment adviser representative and investment adviser qualifying officer application. Applicants for registration as investment adviser representatives or as an investment adviser qualifying officer shall take and pass: (3-20-20)T

- i. The Series 65; or (3-20-20)T
- ii. The Series 66, the Series 7, and the Securities Industry Essentials examinations. (3-20-20)T
- c. Specialized agent of a broker-dealer, issuer agent and qualifying officer for non-FINRA broker-dealer application. Specialized agents of broker-dealers, issuer agents and qualifying officers for non-FINRA broker-dealers application are required to take and pass: (3-20-20)T
  - i. The applicable FINRA examinations; and (3-20-20)T
  - ii. Either the Series 63 or the Series 66 examination. (3-20-20)T
- d. Sales of Viaticals. Persons selling viatical investments are required to take and pass the Securities Industry Essentials and Series 7 examinations. (3-20-20)T

**02. Specialized Examination Authority.** Any registration granted pursuant to a specialized examination will be restricted, and the registrant will be authorized to effect securities transactions only in securities of the type specified by the conditions of the license. (3-20-20)T

**03. Investment Adviser Representatives - Waiver.** An applicant for investment adviser representative or investment adviser qualifying officer registration may qualify for a waiver of the examination requirement if the applicant currently holds one (1) of the following designations: (3-20-20)T

- a. Certified Financial Planner (CFP) awarded by the Certified Financial Planner Board of Standards, Inc.; (3-20-20)T
- b. Chartered Financial Consultant (ChFC) awarded by the American College, Bryn Mawr, Pennsylvania; (3-20-20)T
- c. Chartered Financial Analyst (CFA) awarded by the Institute of Chartered Financial Analysts; (3-20-20)T
- d. Personal Financial Specialist (PFS) awarded by the American Institute of Certified Public Accountants; (3-20-20)T
- e. Chartered Investment Counselor (CIC) awarded by the Investment Counsel Association of America, Inc.; or (3-20-20)T
- f. Such other professional designation as the Administrator may by rule or order recognize. (3-20-20)T

**04. Waiver.** The Administrator, in his sole discretion, may waive any examination required by this rule upon a sufficient showing of good cause and upon any conditions he may impose. (3-20-20)T

**104. FRAUDULENT, DISHONEST AND UNETHICAL PRACTICES - BROKER-DEALER, BROKER-DEALER AGENTS, ISSUER AGENTS, INVESTMENT ADVISERS, INVESTMENT ADVISER REPRESENTATIVES.**

**01. Fraudulent, Dishonest and Unethical Practices.** Any broker-dealer, agent, issuer agent, investment adviser or investment adviser representative who engages in one (1) or more of the practices identified in Subsections 104.02 through 104.47 of this rule shall be deemed to have engaged in one (1) or both of the following: (3-20-20)T

- a. An “act, practice, or course of business that operates or would operate as a fraud or deceit” as used in Section 30-14-501 and Section 30-14-502, Idaho Code; (3-20-20)T
- b. A dishonest and unethical practice as used in Section 30-14-412(d)(13), Idaho Code, and such

conduct may constitute grounds for denial, suspension, or revocation of registration or such other action authorized by statute. (3-20-20)T

**c.** This rule is not intended to be all-inclusive, and thus, acts or practices not enumerated herein may also be deemed fraudulent, or dishonest and unethical. (3-20-20)T

**02. Delivery Delays.** Engaging in a pattern of unreasonable and unjustifiable delays in the delivery of securities purchased by any of its customers and/or in the payment upon request of free credit balances reflecting completed transactions of any of its customers. (3-20-20)T

**03. Churning.** Inducing trading in a customer's account which is excessive in size or frequency in view of the financial resources and character of the account. (3-20-20)T

**04. Unsuitable Recommendations.** (3-20-20)T

**a.** Recommending to a customer the purchase, sale, or exchange of any security without reasonable grounds to believe that such transaction or recommendation is suitable for the customer based upon reasonable inquiry concerning the customer's investment objectives, financial situation and needs, and any other relevant information known by the broker-dealer, agent, or issuer agent. (3-20-20)T

**b.** Recommending to a customer, to whom investment advice is provided, the purchase, sale, or exchange of any security without reasonable grounds to believe that the recommendation is suitable for the customer on the basis of information furnished by the customer after reasonable inquiry concerning the customer's investment objectives, financial situation and needs, and any other information known by the investment adviser or investment adviser representative. (3-20-20)T

**05. Unauthorized Transactions.** Executing a transaction on behalf of a customer without authorization to do so. (3-20-20)T

**06. Discretionary Authority.** Exercising any discretionary power in effecting a transaction for a customer's account without first obtaining written discretionary authority from the customer, unless the discretionary power relates solely to the time and/or price for the executing of orders. (3-20-20)T

**07. Margin Accounts.** Executing any transaction in a margin account without securing from the customer a properly executed written margin agreement before or promptly after the initial transaction in the account. (3-20-20)T

**08. Segregation of Client Securities.** Failing to segregate customers' free securities or securities held in safekeeping. (3-20-20)T

**09. Hypothecating Customer Securities.** Hypothecating a customer's securities without having a lien thereon unless the broker-dealer secures from the customer a properly executed written consent before or promptly after the initial transaction, except as permitted by rules of the Securities and Exchange Commission. (3-20-20)T

**10. Unreasonable Price, Commission.** Entering into a transaction with or for a customer at a price not reasonably related to the current market price of the security or receiving an unreasonable commission or profit. (3-20-20)T

**11. Failure to Supervise.** Failure by a broker-dealer or investment adviser to exercise diligent supervision over the securities activities of all its broker-dealer agents, investment adviser representatives and employees as set forth in Section 105 of these rules. (3-20-20)T

**12. Unreasonable Fees.** Charging unreasonable and inequitable fees for services performed, including miscellaneous services such as collection of monies due for principal, dividends or interest, exchange or transfer of securities, appraisals, safekeeping, or custody of securities and other services related to its securities business. (3-20-20)T



**13. Sales at the Market.** Representing that a security is being offered to a customer “at the market” or a price relevant to the market price unless such broker-dealer knows or has reasonable grounds to believe that a market for such security exists other than that made, created, or controlled by such broker-dealer, or by any such person for whom the broker-dealer is acting or with whom the broker-dealer is associated in such distribution, or any person controlled by, controlling, or under common control with such broker-dealer. (3-20-20)T

**14. Manipulative, Deceptive or Fraudulent Practices.** Effecting any transaction in, or inducing the purchase or sale of, any security by means of any manipulative, deceptive, or fraudulent device, practice, plan, program, design, or contrivance, which may include: (3-20-20)T

**a.** Effecting any transaction in a security which involves no change in the beneficial ownerships thereof; (3-20-20)T

**b.** Entering an order or orders for the purchase or sale of any security with the knowledge that an order or orders of substantially the same size, at substantially the same time and substantially the same price, for the sale of any such security, has been or will be entered by or for the same or different parties for the purpose of creating a false or misleading appearance of active trading in the security or a false or misleading appearance with respect to the market for the security. However, nothing in Subsection 104.14, of this rule, prohibits a broker-dealer from entering bona fide agency cross transactions for customers; or (3-20-20)T

**c.** Effecting, alone or with one (1) or more other persons, a series of transactions in any security creating actual or apparent active trading in such security or raising or depressing the price of such security, for the purpose of inducing the purchase or sale of such security by others. (3-20-20)T

**15. Loss Guarantees.** Guaranteeing a customer against loss in any securities account of such customer carried by the broker-dealer or in any securities transaction effected by the broker-dealer or in any securities transaction effected by the broker-dealer with or for such customer. (3-20-20)T

**16. Bona Fide Price Reports.** Publishing or circulating, or causing to be published or circulated, any notice, circular, advertisement, newspaper article, investment service, or communication of any kind which purports to report any transaction as a purchase or sale of any security unless such broker-dealer believes that such transaction was a bona fide purchase or sale of such security; or which purports to quote the bid price or asked price for any security, unless such broker-dealer believes that such quotation represents a bona fide bid for, or offer of, such security. (3-20-20)T

**17. Deceptive or Misleading Advertising.** Using any advertising or sales presentation in such a fashion as to be deceptive or misleading. (3-20-20)T

**18. Disclosure of Control.** Failing to disclose that the broker-dealer or investment adviser is controlled by, controlling, affiliated with, or under common control with the issuer of any security before entering into any contract with or for a customer for the purchase or sale of such security, the existence of such control to such customer, and if such disclosure is not made in writing, it shall be supplemented by the giving or sending of written disclosure at or before the completion of the transaction. (3-20-20)T

**19. Bona Fide Distribution.** Failing to make a bona fide public offering of all of the securities allotted to a broker-dealer for distribution, whether acquired as an underwriter, a selling group member, or from a member participating in the distribution as an underwriter or selling group member by, among other things, transferring securities to a customer, another broker-dealer or a fictitious account with the understanding that those securities will be returned to the broker-dealer or its nominees or parking or withholding securities. (3-20-20)T

**20. Customer Communication.** Failure or refusal to furnish a customer, upon reasonable request, information to which the customer is entitled, or to respond to a formal written request or complaint. (3-20-20)T

**21. Loans from Customers.** Borrowing money or securities from a customer, unless the customer is a broker-dealer, an affiliate, or a financial institution engaged in the business of loaning funds or securities, or immediate family. For purposes of this rule, the term “immediate family” means parents, mother-in-law, father-in-law, husband, wife, brother, sister, brother-in-law, sister-in-law, son-in-law, daughter-in-law, and children. (3-20-20)T

- 22. Loans to Customers.** Loaning money to a customer, other than an immediate family member, unless the broker-dealer or investment adviser is a financial institution engaged in the business of loaning funds or the customer is an affiliate of the broker-dealer or investment adviser. (3-20-20)T
- 23. Unrecorded Transactions.** Effecting securities transactions not recorded on the regular books or records of the broker-dealer which the agent represents, unless the transactions are authorized in writing by the broker-dealer prior to execution of the transaction. (3-20-20)T
- 24. Fictitious Accounts.** Establishing or maintaining an account containing fictitious information in order to execute transactions which would otherwise be prohibited. (3-20-20)T
- 25. Profit/Loss Sharing.** Sharing directly or indirectly in profits or losses in the account of any customer without the written authorization of the customer and the broker-dealer which the agent represents. (3-20-20)T
- 26. Splitting Commissions.** Dividing or otherwise splitting the agent's commissions, profits, or other compensation from the purchase or sale of securities with any person not also registered in Idaho as an agent for the same broker-dealer, or for a broker-dealer under direct or indirect common control. (3-20-20)T
- 27. Unsolicited Transactions.** Marking any order tickets or confirmations as unsolicited when in fact the transaction was solicited. (3-20-20)T
- 28. FINRA and NASD Rules Compliance.** Failing to comply with any applicable provision of the NASD Conduct Rules and any other FINRA Rules or any applicable fair practice or ethical standard promulgated by the Securities and Exchange Commission or by a self-regulatory organization approved by the Securities and Exchange Commission. (3-20-20)T
- 29. Contradicting Prospectus Information.** Contradicting or negating the importance of any information contained in a prospectus or other offering materials with intent to deceive or mislead. (3-20-20)T
- 30. Inside Information.** In connection with the offer, sale, or purchase of a security, falsely leading a customer to believe that the broker-dealer, agent, investment adviser or investment adviser representative is in possession of material, non-public information which would impact the value of the security, or communicating to customers or other persons bona fide information not generally available to the public that may be used in the person's decision to buy, sell, or hold a security. (3-20-20)T
- 31. Contradictory Recommendations.** In connection with the solicitation of a sale or purchase of a security, engaging in a pattern or practice of making contradictory recommendations to different investors of similar investment objective for some to sell and others to purchase the same security, at or about the same time, when not justified by the particular circumstance of each investor. (3-20-20)T
- 32. Prospectus Delivery.** Failure to comply with any prospectus delivery requirement promulgated under federal law. (3-20-20)T
- 33. Penny Stock Sales.** Effect any transaction in, or to induce or attempt to induce the purchase or sale of, any penny stock by any customer except in accordance with the requirements as set forth in the 1934 Securities Exchange Act, Section 15(h) and the rules and regulations prescribed thereunder. (3-20-20)T
- 34. Misrepresentations Concerning Advisory Services.** To misrepresent to any advisory client, or prospective advisory client, the qualifications of the investment adviser, investment adviser representative or any employee of the investment adviser, or to misrepresent the nature of the advisory services being offered or fees to be charged for such service, or to omit to state a material fact necessary to make the statements made regarding qualifications, services, or fees, in light of the circumstances under which they are made, not misleading. (3-20-20)T
- 35. Unreasonable Advisory Fees.** Charging a client an unreasonable advisory fee. (3-20-20)T

**36. Conflicts of Interest.** Failing to disclose to clients in writing before any advice is rendered any material conflict of interest relating to the adviser or any of its employees which could reasonably be expected to impair the rendering of unbiased and objective advice including: (3-20-20)T

**a.** Compensation arrangements connected with advisory services to clients which are in addition to compensation from such clients for such services; and (3-20-20)T

**b.** Charging a client an advisory fee for rendering advice when a commission for executing securities transactions pursuant to such advice will be received by the adviser or its employees. (3-20-20)T

**37. Guaranteeing Specific Results.** Guaranteeing a client that a specific result will be achieved (gain or no loss) with advice which will be rendered. (3-20-20)T

**38. Advertising.** Publishing, circulating, or distributing any advertisement that does not comply with 17 CFR 275.206(4)-1 under the Investment Advisers Act of 1940. (3-20-20)T

**39. Disclosure of Private Information.** Disclosing the identity, affairs, or investments of any client unless required by law to do so, or unless consented to by the client. (3-20-20)T

**40. Advisory Contract Disclosures.** Entering into, extending, or renewing any investment advisory contract unless such contract is in writing and discloses, in substance the services to be provided, the term of the contract, the advisory fee, the formula for computing the fee, the amount of prepaid fee to be returned in the event of contract termination or non-performance, whether the contract grants discretionary power to the adviser and that no assignment of such contract shall be made by the investment adviser without the consent of the other party to the contract. (3-20-20)T

**41. Protection of Non-Public Information.** Failing to establish, maintain, and enforce written policies and procedures reasonably designed to prevent the misuse of material nonpublic information, or that are contrary to the provisions of Section 204A, and rules associated with it, of the Investment Advisers Act of 1940. (3-20-20)T

**42. Advisory Contract to Comply with Federal Law.** To indicate, in an advisory contract, any condition, stipulation, or provisions binding any person to waive compliance with any provision of the Act or of the Investment Advisers Act of 1940, or any other practice contrary to the provisions of Section 215, and rules associated with it, of the Investment Advisers Act of 1940. (3-20-20)T

**43. Waiver of State or Federal Law Prohibited.** Engaging in any act, practice, or course of business which is fraudulent, deceptive, or manipulative in contrary to the provisions and associated rules of Section 206(4) of the Investment Advisers Act of 1940, notwithstanding the fact that such investment adviser is not registered or required to be registered under Section 203 of the Investment Advisers Act of 1940. (3-20-20)T

**44. Fraudulent, Deceptive or Manipulative Acts.** Engaging in any act, practice, or course of business which is fraudulent, deceptive, or manipulative in contrary to the provisions and associated rules of Section 206(4) of the Investment Advisers Act of 1940, notwithstanding the fact that such investment adviser is not registered or required to be registered under Section 203 of the Investment Advisers Act of 1940. (3-20-20)T

**45. Outside Business Activities - Selling Away.** Any agent or investment adviser representative associated with a broker-dealer or investment adviser registered under the Act shall not engage in business activities, for which he receives compensation either directly or indirectly, outside the scope of his regular employment unless he has provided prior written notice to his employer firm. (3-20-20)T

**46. Third Party Conduct.** Engaging in conduct or any act, indirectly or through or by any other person, which would be unlawful for such person to do directly under the provisions of the Act or any rules thereunder, or engaging in other conduct such as nondisclosure, incomplete disclosure, or deceptive practices shall be deemed an unethical business practice. The federal statutory and regulatory provisions referenced herein shall apply to investment advisers and federal covered advisers, to the extent permitted by the National Securities Markets Improvement Act of 1996 (Pub. L. No. 104-290). (3-20-20)T

**47. Misleading Filings.** For purposes of Section 30-14-505, Idaho Code, the term “proceeding” includes, but is not limited to, any investigation, examination or other inquiry initiated by the Department. (3-20-20)T

**105. SUPERVISION OF AGENTS, INVESTMENT ADVISER REPRESENTATIVES AND EMPLOYEES.**

**01. Supervision Required.** Every broker-dealer, investment adviser, and designated supervisor shall exercise diligent supervision over the securities activities of all of his agents, investment adviser representatives and employees. (3-20-20)T

**02. Broker-Dealer Procedures.** Every agent and employee of the broker-dealer shall be subject to the supervision of a supervisor designated by such broker-dealer. The supervisor may be the broker-dealer in the case of a sole proprietor, or a partner, officer, office manager, or any other qualified person. (3-20-20)T

**03. Written Compliance Procedure.** Every broker-dealer shall establish, maintain and enforce written procedures and keep a copy in each business office, that set forth the procedures adopted by the broker-dealer to comply with the following duties imposed by this rule, and state at which business office or offices the broker-dealer keeps and maintains the records required by Section 30-14-411, Idaho Code: (3-20-20)T

**a.** The review and written approval by the designated supervisor of the opening of each new customer account; (3-20-20)T

**b.** The frequent examination of all customer accounts to detect and prevent irregularities or abuses, including a review for churning and switching of securities in customers’ accounts, as well as unsuitable recommendations and sales of unregistered securities; (3-20-20)T

**c.** The prompt review and written approval by the designated supervisor of all securities transactions and all correspondence pertaining to the solicitation or execution of all securities transactions; (3-20-20)T

**d.** The review of back office operations, i.e., all systems and procedures, including the currency and accuracy of books and records, the status and causes of “Fails to Receive” and “Fails to Deliver.” net capital, credit extensions and financial reports; (3-20-20)T

**e.** The review of form, content and filing of all correspondence related in any way to the purchase or sale or solicitation for the purchase or sale of securities; (3-20-20)T

**f.** The review and written approval by the designated supervisor of the delegation by any customer of discretionary authority with respect to his account to a stated agent or associate of the broker-dealer and the prompt written approval of each discretionary order entered on behalf of that account; and (3-20-20)T

**g.** The prompt review and written approval of the handling of all customer complaints. As used in these rules, “complaint” is considered to be any written statement by a customer or by any person acting for a customer which complains about the activities of the broker-dealer, agent or associate in connection with the solicitation or execution of a transaction or the disposition of funds of that customer. (3-20-20)T

**04. Investment Adviser Procedures.** Every investment adviser shall establish, maintain and enforce written procedures and keep a copy in each business office, that set forth procedures reasonably designed to prevent violation of the Idaho Uniform Securities Act and Rules and comply with the following duties as applicable to the business of the investment adviser: (3-20-20)T

**a.** The review and written approval by the designated supervisor of the opening of each new customer account; (3-20-20)T

**b.** The frequent examination of all customer accounts to detect and prevent irregularities or abuses, including a review for unsuitable recommendations and recommendations of unregistered securities; (3-20-20)T

**c.** The prompt review and written approval by the designated supervisor of all securities recommendations and all correspondence pertaining to the solicitation or execution of all securities recommendations; (3-20-20)T

**d.** The review of form, content and filing of all correspondence related in any way to the recommendation of the purchase of any securities; (3-20-20)T

**e.** The prompt review and written approval of the handling of all customer complaints. As used in these rules, a “complaint” is considered to be any written statement by a customer, or by any person acting for a customer, questioning the activities of the investment adviser or representative in connection with recommendations concerning, or disposition of, funds in the account. (3-20-20)T

**106. -- 999. (RESERVED)**

## IDAPA 13 – DEPARTMENT OF FISH AND GAME

### DOCKET NO. 13-0000-2000F (FEE RULE)

#### NOTICE OF OMNIBUS RULEMAKING – ADOPTION OF TEMPORARY RULE

**EFFECTIVE DATE:** The effective date of the temporary rules being adopted through this omnibus rulemaking is the adjournment date of the second regular session of the 65th Idaho State Legislature - March 20, 2020.

**AUTHORITY:** In compliance with Section 67-5226, Idaho Code, notice is hereby given this agency has adopted temporary rules. The action is authorized pursuant to Sections 36-104, 36-303, 36-404, 36-407, 36-409, 36-412, 36-701, 36-703, and 36-708, Idaho Code.

**DESCRIPTIVE SUMMARY:** This temporary rulemaking adopts the following chapters under IDAPA 13, rules of the Department of Fish and Game:

- 13.01.02.200 and 201, *Rules Governing Mandatory Education and Mentored Hunting*
- 13.01.04.601, *Rules Governing Licensing*
- 13.01.08.263, *Rules Governing the Taking of Big Game Animals in the State of Idaho*
- 13.01.10.410, *Rules Governing the Importation, Possession, Release, Sale or Salvage of Wildlife*
- 13.01.19.102, *Rules for Selecting, Operating, Discontinuing, and Suspending Vendors*

**TEMPORARY RULE JUSTIFICATION:** Pursuant to Sections 67-5226(1) and 67-5226(2), Idaho Code, the Governor has found that temporary adoption of these rules is appropriate for the following reasons:

These temporary rules are necessary to protect the public health, safety, and welfare of the citizens of Idaho and confer a benefit on its citizens. These previously approved and codified rules implement the duly enacted laws of the state of Idaho, provide citizens with the detailed rules and standards for complying with those laws, and assist in the orderly execution and enforcement of those laws. The expiration of these rules without due consideration and processes would undermine the public health, safety and welfare of the citizens of Idaho and deprive them of the benefit intended by these rules.

In addition, the Idaho Constitution, Art. 1, Sec. 23, states the “rights to hunt, fish and trap, including by the use of traditional methods, are a valued part of the heritage of the State of Idaho and shall forever be preserved for the people and managed through the laws, rules and proclamations that preserve the future of hunting, fishing and trapping.” Continuity of existing fee rules supports hunter, archery, and trapper education, and implements good governance, public transparency, accountability for license vendors and large commercial wildlife facilities, and responsible management of state monies and assets.

The fee or charge imposed by these rules is necessary to avoid immediate danger. The fees or charges reauthorized in this rulemaking are currently existing and have been previously promulgated by the agency and reviewed and approved by the Legislature. These fees and charges are part of the dedicated fund portion of the state budget, which makes up a material portion of the agency’s budget, or are bond requirements for security of public money or guarantee of performance and reimbursement of state costs. The FY2020 budget has already been set by the Legislature and passed into law. That budget relies upon the existence of these fees and charges to meet the state’s obligations and provide necessary state services. Failing to reauthorize these fee rules would create immediate danger to the state budget, immediate danger to necessary state functions and services, and immediate danger of a violation of Idaho’s constitutional requirement that it balance its budget.

The following are agency specific findings for the fees on a chapter-by-chapter basis.

The fees in IDAPA 13.01.02, Sections 200 and 201 (IDAPA 13.01.02.200.02 and 201.02) implement an eight dollar (\$8) fee for hunter, archery, and trapper education. Section 36-412(c), Idaho Code, specifically directs the Commission to establish education program fees not to exceed eight dollars (\$8). These fees are part of the dedicated fund portion of the State of Idaho’s budget. The Department’s obligation to provide hunter, archery, and trapper education is a crucial safety measure and integral in fulfilling the Department’s constitutional and statutory obligation to provide hunting and trapping opportunities to the public.

The fee rule in IDAPA 13.01.04, Section 601 (IDAPA 13.01.04.601.01) establishes a fifty dollar (\$50) processing fee and sliding scale for refund of nonresident licenses, permits, and tag in special circumstances. These fees are part of the dedicated fund portion of the State of Idaho's budget and are integral the Department's license system.

The fee rule in IDAPA 13.01.08, Section 263 (IDAPA 13.01.08.263.01.d.) provides that overpayment of fees of more than five dollars (\$5) will be refunded and overpayment of five dollars (\$5) or less will not be refunded and will be retained by the Department. This rule is critical for the Department because refunds of these amounts cost more to process than the amount of the actual refund.

The fee rule in IDAPA 13.01.10, Section 410 (IDAPA 13.01.10.410.03) provides bond requirements for large commercial wildlife facilities. These bonding requirements avoid immediate danger because they are integral to guarantee performance of license conditions and to reimburse the Department for any costs incurred for cleanup of abandoned or closed facilities, removal of animals from abandoned or closed facilities, capture or termination of escaped animals, or disease control.

The fee rule in IDAPA 13.01.19, Section 102 (IDAPA 13.01.19.102.04) implements a \$10,000 minimum surety bond requirement for vendors that present a risk level appropriate for surety. License vendors receive and hold public monies from the sale of licenses, and Section 36-303, Idaho Code, recognizes bonding requirements for license vendors. This fee rule needs to be reauthorized to avoid immediate danger because it is critical to ensuring the Department has the ability to recoup public licensing dollars from vendors who do not fully reimburse the Department.

**FEE SUMMARY:** The preceding provides a specific description of the fee or charge reauthorized by this rulemaking. This rulemaking does not impose a fee or charge, or increase a fee or charge, beyond what was previously approved and codified in prior rules. The following is a description of each fee category:

- IDAPA 13.01.02.200.02 and 13.01.02.201.02 implement a statutory mandate to charge for hunter, archery, and trapping education. Section 36-412, Idaho Code, mandates that the Commission implement education programs in hunting, trapping, and archery and provides the "commission shall establish fees for each program not to exceed eight dollars (\$8)." This rule carries out this statutory mandate by implementing an eight dollar (\$8) fee for hunter, archery, and trapper education. These fees have been in effect since March 24, 2017.
- IDAPA 13.01.04.601.01 provides that non-resident general season and controlled hunt deer or elk tag fees may be refunded in certain circumstances. This rule establishes a \$50 processing fee for tag refunds or a sliding scale for tag refunds in these special circumstances. This rule has been in effect since April 6, 2005.
- IDAPA 13.01.08.263.01.d. provides that overpayment of fees of more than five dollars (\$5) will be refunded and overpayment of five dollars (\$5) or less will not be refunded and will be retained by the Department. This fee rule has been in effect since July 1, 1993.
- IDAPA 13.01.10.410.03 provides bond requirements for large commercial wildlife facilities of fifty thousand dollars (\$50,000) or an amount equal to ten percent (10%) of the total facility construction cost plus two thousand dollars (\$2,000) per animal. This bond is meant to guarantee performance of license conditions and to reimburse the Department for any costs incurred for cleanup of abandoned or closed facilities, removal of animals from abandoned or closed facilities, capture or termination of escaped animals, or disease control. This fee rule has been in effect since July 1, 1999.
- IDAPA 13.01.19.102.04 requires a \$10,000 minimum surety bond for vendors that present an undue risk. This bonding requirement ensures license vendors have sufficient coverage to ensure the Department is fully reimbursed for license sales and mitigating undue risk that may otherwise be placed upon the Department in the absence of such bonding. Section 36-303, Idaho Code, authorizes the Department to require a surety bond for license vendors. These vendor bonding rules have been in place since March 20, 1997.

**FISCAL IMPACT:** This rulemaking is not anticipated to have any fiscal impact on the state general fund. It is consistent with the Department's FY2021 budget, which has already been set by the Legislature, and approved by the Governor, anticipating the existence of the rules and fees being reauthorized by this rulemaking.

**ASSISTANCE ON TECHNICAL QUESTIONS:** For assistance on technical questions concerning the temporary rules, contact Paul Kline, (208)334-3771.

Dated this 20th day of March, 2020.

Paul Kline  
Deputy Director  
Idaho Department of Fish and Game  
600 S. Walnut Street  
P.O. Box 25 Boise, ID 83707  
Phone: (208) 334-3771  
Fax: (208) 334-4885  
[rules@idfg.idaho.gov](mailto:rules@idfg.idaho.gov)



## 13.01.02 – RULES GOVERNING MANDATORY EDUCATION AND MENTORED HUNTING

### *(BREAK IN CONTINUITY OF SECTIONS)*

#### **200. HUNTER AND ARCHERY EDUCATION.**

**01. Mandatory Hunter and Archery Education Programs.** A person may obtain certification of completion of hunter/archery education to comply with Section 36-411, Idaho Code, through classroom or on-line study, or other approved methods. The Department manages the Hunter Education Program pursuant to the Idaho Hunter Education Policy and Procedure Manual. “Equivalent certification” for hunter/archery education means completed instruction by an authorized agency or association including firearms/archery safety, wildlife management, wildlife law, hunter ethics, first aid/survival, and practical experience in handling and shooting firearms/archery equipment. (3-20-20)T

**02. Fees.** The Department will charge a fee of eight dollars (\$8) to each student enrolling in the Hunter or Archery Education Program. (3-20-20)T

**03. Parent to Attend Shooting Clinic with Student.** Students under the age of twelve (12) may only attend a Hunter Education Shooting Clinic if accompanied by a parent, legal guardian or other adult designated by the parent or legal guardian. (3-20-20)T

#### **201. TRAPPER EDUCATION.**

**01. Mandatory Trapper Education Program.** No person who first purchased an Idaho trapping license on or after July 1, 2011 may be issued a trapping license unless that person presents a certificate of completion in trapper education issued by the Department or proof of equivalent certification from an authorized agency or association in Idaho or elsewhere. “Equivalent certification” for trapper education means completed instruction including safe trapping methods and rules, non-target species avoidance techniques, wildlife identification, and good conduct and respect for the rights and property of others. Trapping education specific only to wolves in Idaho or elsewhere is not equivalent certification. (3-20-20)T

**02. Fee.** The Department will charge a fee of eight dollars (\$8) to each student enrolling in the Trapper Education Program. (3-20-20)T

**03. Exemption.** Persons who are acting pursuant to Section 36-1107, Idaho Code, are exempt from Subsection 201.01. (3-20-20)T

### *(BREAK IN CONTINUITY OF SECTIONS)*

**13.01.04 – RULES GOVERNING LICENSING**

***(BREAK IN CONTINUITY OF SECTIONS)***

**601. REFUNDS TO NONRESIDENTS.**

The Department will not refund any fee for any nonresident license (as defined in Section 36-202(aa), Idaho Code), except as follows, and provided the refund request is in writing, is accompanied by the original license and tag, and is received or postmarked on or before December 31 of the calendar year in which the license was valid. (3-20-20)T

**01. Refund.** Nonresident general or controlled hunt deer or elk tag fees and hunting license fees may be refunded due to the death of licensee; illness or injury of licensee that totally disabled the licensee for the entire length of any applicable hunting season; or military deployment of licensee due to an armed conflict; as substantiated by death certificate, published obituary, written justification by a licensed medical doctor, copy of military orders, or similar documentation. The hunting license fee will not be refunded if it was used to apply for any controlled hunt or to purchase a turkey, mountain lion, or bear tag. The amount refunded will be the amount of the applicable deer or elk tag and hunting license fees, less all issuance fees and a fifty dollar (\$50) processing fee. (3-20-20)T

**02. Partial Refund.** Nonresident general and controlled hunt deer or elk tag fees may be partially refunded for a reason other than those in the preceding subsection based on the postmark date in the below table. The hunting license fee will not be refunded.

<b>Postmarked</b>	<b>Percent of Tag Fee Refunded</b>
Before April 1	75%
In April through June	50%
In July and August	25%
September through December	0%

(3-20-20)T

**03. Department Error.** The Department will refund fees when it determines that a Department employee made an error in the issuance of the license. (3-20-20)T

***(BREAK IN CONTINUITY OF SECTIONS)***

**13.01.08 – RULES GOVERNING THE TAKING OF BIG GAME ANIMALS**

***(BREAK IN CONTINUITY OF SECTIONS)***

**263. REFUNDS OF CONTROLLED HUNT FEES.**

**01. Refunds. (3-20-20)T**

**a.** Controlled hunt tag fees will be refunded to unsuccessful or ineligible applicants for moose, sheep, mountain goat, and grizzly bear. Unsuccessful applicants may donate all or a portion of refunded tag fees to Citizens Against Poaching by checking the appropriate box on the application. One dollar (\$1) of the non-refundable application fee will go to Citizens Against Poaching unless the applicant instructs otherwise. (3-20-20)T

**b.** Fees for hunting licenses will not be refunded to unsuccessful or ineligible controlled applicants. (3-20-20)T

**c.** Fees for deer or elk tags purchased prior to the drawing will not be refunded to unsuccessful or ineligible applicants. (3-20-20)T

**d.** Overpayment of fees of more than five dollars (\$5) will be refunded. Overpayment of five dollars (\$5) or less will NOT be refunded and will be retained by the Department. (3-20-20)T

**e.** Controlled hunt application fees are nonrefundable. (3-20-20)T

**f.** Fees for resident and nonresident adult controlled hunt tags subsequently designated to a minor child or grandchild are not refundable. (3-20-20)T

**g.** Fees for special controlled hunt application, tag and related hunting license are not refundable. (3-20-20)T

***(BREAK IN CONTINUITY OF SECTIONS)***

**13.01.10 – RULES GOVERNING THE IMPORTATION, POSSESSION,  
RELEASE, SALE, OR SALVAGE OF WILDLIFE**

***(BREAK IN CONTINUITY OF SECTIONS)***

**410. LARGE COMMERCIAL WILDLIFE FACILITIES.**

Commercial wildlife facilities that are of a size large enough or with a large number of animals incompatible with the cage or enclosure requirements of Section 400 may, in the Director's discretion, be addressed with facility-specific license terms. Only facilities housing at least three (3) or more species or encompassing display or exhibit areas larger than one (1) acre will qualify for this consideration. (3-20-20)T

**01. Animal Display and Security.** Any cage or enclosure shall be of such structure or type of construction to prevent escape of the captive wildlife, or damage to native wildlife through habitat degradation, genetic contamination, competition, or disease. In identifying facility-specific license terms, the Department may refer to standards such as those set by the American Zoological Association for cage, open space, shelter, enclosure, and display in a natural-appearing environment and in such a way as to preserve animal dignity. Terms may include, but are not limited to, fence specifications, electric fence specifications, pits or moats, buried fencing, and display features to enhance appreciation for the species and its natural history. (3-20-20)T

**02 Application.** Application for a large commercial wildlife facility license will generally meet the requirements of Subsection 400.04, and will identify the veterinarian of record for the facility. (3-20-20)T

**03. Bond.** The Department will require, as a license condition, any large commercial wildlife facility to provide a bond to the Department in the amount of fifty thousand dollars (\$50,000), or an amount equal to ten percent (10%) of the total facility construction cost plus two thousand dollars (\$2,000) per animal, whichever is greater, executed by a qualified surety duly authorized to do business in the state of Idaho, to guarantee performance of license conditions and to reimburse the Department for any costs incurred for clean up of abandoned or closed facilities, removal of animals from abandoned or closed facilities, capture or termination of escaped animals, or disease control. With prior approval, the applicant may instead submit a cash bond to the Department including, but not limited to, certificates of deposit, registered checks, certified funds, and money orders. (3-20-20)T

**04. Specific Requirements.** The Director has discretion to identify specific license conditions, and violation of any such condition is a violation of these rules. (3-20-20)T

***(BREAK IN CONTINUITY OF SECTIONS)***

## 13.01.19 – RULES FOR SELECTING, OPERATING, DISCONTINUING, AND SUSPENDING VENDORS

### *(BREAK IN CONTINUITY OF SECTIONS)*

#### **102. SELECTION.**

The following factors will be considered for selecting an applicant to become a license vendor: (3-20-20)T

**01. Low Numbered Vendors.** Applicants classified in lower-numbered vendor classifications will be given priority over applicants in higher-numbered classifications from the same general location. (3-20-20)T

**02. Class Six Applicants.** Class six (6) applicants will be approved only when they demonstrate a significant public benefit to have a license vendorship at their location. (3-20-20)T

**03. Unsettled Debts.** Applicants who have unsettled debts listed with a credit bureau will not be approved. Unsettled debts that are in dispute will not be considered against the applicant. (3-20-20)T

**04. Surety Bond.** The Department may require an applicant to provide for each location, a ten thousand dollar (\$10,000) surety bond from a corporate surety authorized to do business in the state of Idaho, which guarantees the payment of all state funds collected as a result of licenses issued by the vendor if it appears from the application or other information that an undue risk might otherwise be placed upon the Department in the absence of such bonding. Applicants who otherwise qualify for a vendorship and have been in business less than three (3) years will be required to furnish the Department a ten thousand dollar (\$10,000) surety bond in the form and length as determined by the Director. Upon request, at the completion of two (2) years of service, the Department may release the vendor from the bonding requirement based on a review of financial risk. (3-20-20)T

**05. Permanence and Accessibility.** Applicants who do not have a permanent place of business open and accessible to all segments of the public will not be approved. (3-20-20)T

**06. Number of Existing Vendors in Area.** The three (3) closest existing vendors, their hours and days of operation, classification, accessibility to the public, and other pertinent information, including their distance to the applicant, will be compared to the applicant. (3-20-20)T

**07. Minimum Sales Volume.** If the applicant is seeking to replace an existing vendor at the prior vendor's location, the prior vendor's sales volume will be used to estimate the applicant's sales volume. (3-20-20)T

**08. Performance Record.** An applicant who was a license vendor or the manager for a vendor within the past five (5) years will not be approved unless the applicant's performance record was satisfactory. (3-20-20)T

**09. Fish and Game Violations.** No owner or store manager (if the applicant is a corporation) may have had a fish and game violation other than an infraction within the past five (5) years. (3-20-20)T

### *(BREAK IN CONTINUITY OF SECTIONS)*

**IDAPA 15 – OFFICE OF THE GOVERNOR  
IDAHO FOREST PRODUCTS COMMISSION**

**DOCKET NO. 15-0300-2000F (FEE RULE)**

**NOTICE OF OMNIBUS RULEMAKING – ADOPTION OF TEMPORARY RULE**

**EFFECTIVE DATE:** The effective date of the temporary rule being adopted through this omnibus rulemaking is the adjournment date of the second regular session of the 65th Idaho State Legislature - March 20, 2020.

**AUTHORITY:** In compliance with Sections 67-5226, Idaho Code, notice is hereby given this agency has adopted a temporary rule. The action is authorized pursuant to Section 38-1508, Idaho Code.

**DESCRIPTIVE SUMMARY:** The following is the required finding and concise statement of its supporting reasons for adopting a temporary rule:

This temporary rulemaking adopts the following chapter under IDAPA 15.03, Rules of the Idaho Forest Products Commission.

**IDAPA 15.03**

- IDAPA 15.03.01, *Rules of Administrative Procedure of the Idaho Forest Products Commission*

**TEMPORARY RULE JUSTIFICATION:** Pursuant to Sections 67-5226(1) and 67-5226(2), Idaho Code, the Governor has found that temporary adoption of the rule is appropriate for the following reasons:

These temporary rules are necessary to protect the public health, safety, and welfare of the citizens of Idaho and confer a benefit on its citizens. These temporary rules implement the duly enacted laws of the state of Idaho, provide citizens with the detailed rules and standards for complying with those laws, and assist in the orderly execution and enforcement of those laws. The expiration of these rules without due consideration and processes would undermine the public health, safety, and welfare of the citizens of Idaho and deprive them of the benefit intended by these rules.

**FEE SUMMARY:** Pursuant to Section 67-5226(2), the Governor has found that the fee(s) or charge(s) being imposed or increased is justified and necessary to avoid immediate danger and the fee(s) is described herein:

The fees or charges, authorized in Section 38-1515, Idaho Code, are part of the agency's 2021 budget that relies upon the existence of these fees or charges to meet the state's obligations and provide necessary state services. Failing to reauthorize these temporary rules would create immediate danger to the state budget, immediate danger to necessary state functions and services, and immediate danger of a violation of Idaho's constitutional requirement that it balance its budget.

The following is a specific description of the fees or charges: This rulemaking does not impose a fee or charge, or increase a fee or charge, beyond what was previously approved and codified in the prior rules. The fee rule specifies the collection and remittance of the assessment contained in Section 38-1515, Idaho Code.

**ASSISTANCE ON TECHNICAL QUESTIONS:** For assistance on technical questions concerning the temporary rule, contact Jennifer Okerlund, Director, Idaho Forest Products Commission (208) 334.3292, [ifpc@idahoforests.org](mailto:ifpc@idahoforests.org).

DATED this February 3, 2020.

Jennifer Okerlund, Director  
Idaho Forest Products Commission  
350 N 9th Street, Suite 102  
Boise, Idaho 83702  
(208) 334-3292  
[ifpc@idahoforests.org](mailto:ifpc@idahoforests.org)

**IDAPA 15 – OFFICE OF THE GOVERNOR  
IDAHO FOREST PRODUCTS COMMISSION**

**15.03.01 – RULES OF ADMINISTRATIVE PROCEDURE OF THE IDAHO  
FOREST PRODUCTS COMMISSION**

**000. LEGAL AUTHORITY.**

This chapter is adopted under the legal authority of Title 38, Chapter 15, Idaho Code. (3-20-20)T

**001. TITLE AND SCOPE.**

The title of this chapter is “Rules of Administrative Procedure of the Idaho Forest Products Commission,” and cited as IDAPA 15.03.01. These rules set forth the practices and procedures for the activities of the Idaho Forest Products Commission. (3-20-20)T

**002. -- 003. (RESERVED)**

**004. DEFINITIONS.**

In addition to the definitions set forth in Section 38-1502, Idaho Code, as used in this chapter: (3-20-20)T

**01. Assessment.** The fee authorized by Section 38-1515, Idaho Code, which is levied against financial supporters for their individual share of the Commission budget for the assessment year. The assessment will be based upon data compiled from the base year. (3-20-20)T

**02. Financial Supporter.** Person who pays an assessment to the Commission. (3-20-20)T

**03. Person.** An individual, partnership, association, corporation or other entity qualified to do business in the state of Idaho. (3-20-20)T

**005. -- 099. (RESERVED)**

**100. NOMINATIONS, VACANCIES AND TERMS.**

**01. Chair and Vice-Chair.** The Commission nominates and elects, by majority vote, a Chair to serve as presiding officer at all Commission meetings. The Commission may also nominate and elect, by majority vote, a Vice-Chair to accept the duties of the Chair in the event that the Chair is unable to attend a meeting of the Commission. The term of the office of Chair and Vice-Chair is one (1) year, commencing July 30 of each year. (3-20-20)T

**02. Nominations.** Nominations for expiring seats on the Commission will be made by the financial supporters of the Commission from the district in which the seat is expiring, or from all districts in the case of an at-large member, no later than June 1 of that year. The Commission will provide nomination applications to all financial supporters and will forward the names of all qualified nominees to the Governor. The Commission may also make recommendations or nominations. In making the appointments, the Governor will take into consideration recommendations made to him by the Commission and by organizations that represent or are engaged in harvesting, transporting or manufacturing forest products. (3-20-20)T

**03. Vacancies.** Vacancies in any unexpired term will be filled by the Governor for the remainder of the unexpired term. The Commission will identify qualified candidates and forward their names to the Governor. The member appointed to fill the vacancy will represent the same region and interests as the person whose seat has become vacant. The at-large member will represent all regions. (3-20-20)T

**04. Terms.** Terms of office for Commission members consist of three (3) year terms beginning on July 1 of the year of appointment. (3-20-20)T

**101. -- 199. (RESERVED)**

**200. ASSESSMENTS AND FEES.**

An assessment for all logs harvested, measured or processed within the state of Idaho and for all employees, including self employed, engaged in the harvest or transport of timber, logs, unfinished lumber, chips, sawdust, shavings or hog fuel in Idaho, and for each acre of forest land owned by a business entity or person that owns more

than ten thousand (10,000) acres of forest land will be set by the Commission no later than January 1 of the assessment year. Notice of the assessment will be mailed no later than the last day of the fourth week of May of the assessment year to the last known address of each financial supporter. Assessment will not be reduced for financial supporters who cease business during an assessment year. (3-20-20)T

**01. Payment Method.** Financial supporters of the Commission may choose to pay their assessment in either one (1) full payment due thirty (30) days after the date the notice of assessment is mailed, or in four (4) equal payments with payment in full made by December 31 of the assessment year. (3-20-20)T

**02. Assessments Levied.** Assessments on logs processed into various manufactured products will be levied against the forest products manufacturer that initiates the manufacturing process. (3-20-20)T

**03. Insufficient Funds Checks.** The Commission will establish a policy and schedule for insufficient funds checks that will be reviewed annually. This policy and schedule will be available to the public under the procedures set forth by the Public Records Act, Title 74, Chapter 1, Idaho Code. (3-20-20)T

**201. -- 299. (RESERVED)**

**300. LATE PAYMENTS AND PENALTIES.**

Whenever payment in full or a quarterly payment is not received within thirty (30) days of the posting date of an assessment invoice, the payment will be considered delinquent. Interest of one percent (1%) per calendar month on the balance due will be levied against all delinquent accounts, commencing thirty-one (31) calendar days after the posting date of the assessment invoice. The Commission may proceed with legal action against delinquent accounts in Fourth Judicial District Court or under the provisions of the Administrative Procedure Act, Title 67, Chapter 52, Idaho Code, and seek attorney fees and costs in such proceedings. (3-20-20)T

**301. -- 999. (RESERVED)**



**IDAPA 15 – OFFICE OF THE GOVERNOR  
IDAHO MILITARY DIVISION**

**DOCKET NO. 15-0600-2000F (FEE RULE)**

**NOTICE OF OMNIBUS RULEMAKING – ADOPTION OF TEMPORARY RULE**

**EFFECTIVE DATE:** The effective date of the temporary rule(s) being adopted through this omnibus rulemaking is the adjournment date of the second regular session of the 65th Idaho State Legislature - March 20, 2020.

**AUTHORITY:** In compliance with Section 67-5226, Idaho Code, notice is hereby given this agency has adopted a temporary rule. The action is authorized pursuant to Section 46-804, Idaho Code.

**DESCRIPTIVE SUMMARY:** The following is the required finding and concise statement of its supporting reasons for adopting a temporary rule:

This temporary rulemaking adopts the following chapter under IDAPA 15.06:

**IDAPA 15.06**

- 15.06.03, *Public Safety Communications Systems Installation and Maintenance Fee Rules*

**TEMPORARY RULE JUSTIFICATION:** Pursuant to Sections 67-5226(1) and 67-5226(2), Idaho Code, the Governor has found that temporary adoption of the rule is appropriate for the following reasons:

These temporary rules are necessary to protect the public health, safety, and welfare of the citizens of Idaho and confer a benefit on its citizens. These temporary rules implement the duly enacted laws of the state of Idaho, provide citizens with the detailed rules and standards for complying with those laws, and assist in the orderly execution and enforcement of those laws. The expiration of these rules without due consideration and processes would undermine the public health, safety, and welfare of the citizens of Idaho and deprive them of the benefit intended by these rules.

**FEE SUMMARY:** Pursuant to Section 67-5226(2), the Governor has found that the fees or charges being imposed or increased is justified and necessary to avoid immediate danger and the fee(s) is described herein:

The fees or charges, authorized in Section 46-804, Idaho Code, are part of the agency's 2021 budget that relies upon the existence of these fees or charges to meet the state's obligations and provide necessary state services. Failing to reauthorize these temporary rules would create immediate danger to the state budget, immediate danger to necessary state functions and services, and immediate danger of a violation of Idaho's constitutional requirement that it balance its budget.

The following is a specific description of the fees or charges:

This rulemaking does not impose a fee or charge, or increase a fee or charge, beyond what was previously approved and codified in the prior rules. The rule allows fees to be negotiated, which was permitted in the previous rule. The various fees are associated with fleet communication services or emergency communication services, to include: Fleet Vehicle Equipment Installation, Time and Materials Rate, Microwave Communication Services, Building Space Rental, Radio Communication Equipment Space Rental, and Radio Communication Services.

**ASSISTANCE ON TECHNICAL QUESTIONS:** For assistance on technical questions concerning the temporary rule, contact Maj Lauren Tschampl at 208-941-6984.

DATED this 20 February 2020

Michael J. Garshak  
The Adjutant General  
Idaho Military Division  
4040 W. Guard, Building 600  
Boise, Idaho 83705  
208-422-5242

**15.06.03 – PUBLIC SAFETY COMMUNICATIONS SYSTEMS INSTALLATION  
AND MAINTENANCE FEE RULES**

**000. LEGAL AUTHORITY.**

This chapter is adopted under the authority of Section 46-804, Idaho Code. (3-20-20)T

**001. TITLE AND SCOPE.**

**01. Title.** This chapter is titled IDAPA 15.06.03, “Public Safety Communications Systems Installation and Maintenance Fee Rules.” (3-20-20)T

**02. Scope.** These rules establish fees for the installation and maintenance of public safety communications systems for local, state, federal, and tribal agencies, emergency, and first responders. (3-20-20)T

**002. -- 009. (RESERVED)**

**010. DEFINITIONS.**

**01. Public Safety Communications.** The ability to transmit voice, video and data sent electronically by means of radio, wireless, data, fiber, leased lines circuits, and digital transmission for emergency and first responders. (3-20-20)T

**02. Public Safety Communications Systems.** Equipment used in providing interoperable means of communications between local, state, federal, and tribal agencies. These systems are designed to give emergency and first responders the ability to respond to normal and emergency situations and carry out normal and emergency operations in the protection of life, property and civil authority. (3-20-20)T

**03. Interoperable Communications.** The ability of emergency response officials to share information via voice and data signals on demand, in real time, when needed, and as authorized, and may include one (1) or more forms of wireless communications and microwave systems. (3-20-20)T

**04. Wireless Communications.** Is the ability to transfer information over distance utilizing electromagnetic waves through space as the medium to send voice, video, data, and information. Wireless communications for interoperability specifically refers to the ability of emergency response officials to share information via voice and data signals on demand, in real time, when needed, and as authorized. (3-20-20)T

**a. Radio Systems.** These wireless systems are typically known as Land Mobile Radio. Land Mobile Radio Systems are the main wireless communications systems deployed by public safety communications for emergency and first responders. (3-20-20)T

**b. Data Systems.** These wireless systems are used to transmit data at rates typically from 1.2 kilobit up to approximately 1 megabit. These systems are used to send data and text messaging utilized by emergency and first responders. (3-20-20)T

**c. Video Systems.** These wireless systems are used to transmit video and closed circuit television (cctv) for use by emergency and first responders. These systems also carry full motion video for broadcast use such as Idaho Public Television. (3-20-20)T

**d. Broadband Systems.** These wireless systems are used to transmit voice, video, and data information in multiple applications. These systems can either be point-to-point links or point to multi-point systems deployed today by emergency and first responders. (3-20-20)T

**05. Microwave Systems.** Equipment or apparatus that utilize electromagnetic wavelengths between 1 meter down to 1 millimeter with the equivalent operating frequency between 0.3 GHz and 300 GHz to transmit and receive information. These transmissions are sent on micro-wave links which is a communications system operating between 0.3 GHz – 300 GHz that use electromagnetic waves to send voice, video and data information over distances ranging from a few feet to several hundred miles. (3-20-20)T

**011. FEES.**

All fees for or associated with fleet communication services or emergency communication services will be determined using the Idaho Military Division standard fee schedule or as negotiated or renewed. (3-20-20)T

**012. -- 999. (RESERVED)**

**IDAPA 15 – OFFICE OF THE GOVERNOR  
IDAHO STATE LIQUOR DIVISION**

**DOCKET NO. 15-1000-2000F (FEE RULE)**

**NOTICE OF OMNIBUS RULEMAKING – ADOPTION OF TEMPORARY RULE**

**EFFECTIVE DATE:** The effective date of the temporary rule(s) being adopted through this omnibus rulemaking is the adjournment date of the second regular session of the 65th Idaho State Legislature - March 20, 2020.

**AUTHORITY:** In compliance with Sections 67-5226, Idaho Code, notice is hereby given this agency has adopted a temporary rule. The action is authorized pursuant to Section 23-206(b), Idaho Code.

**DESCRIPTIVE SUMMARY:** The following is the required finding and concise statement of its supporting reasons for adopting a temporary rule:

This temporary rulemaking adopts the following chapter under IDAPA 15.10:

**IDAPA 15.10**

- 15.10.01, *Rules of the Idaho State Liquor Division*

**TEMPORARY RULE JUSTIFICATION:** Pursuant to Sections 67-5226(1) and 67-5226(2), Idaho Code, the Governor has found that temporary adoption of the rule is appropriate for the following reasons:

These temporary rules are necessary to protect the public health, safety, and welfare of the citizens of Idaho and confer a benefit on its citizens. These temporary rules implement the duly enacted laws of the state of Idaho, provide citizens with the detailed rules and standards for complying with those laws, and assist in the orderly execution and enforcement of those laws. The expiration of these rules without due consideration and processes would undermine the public health, safety, and welfare of the citizens of Idaho and deprive them of the benefit intended by these rules.

**FEE SUMMARY:** Pursuant to Section 67-5226(2), the Governor has found that the fees or charges being imposed or increased is justified and necessary to avoid immediate danger and the fees are described herein:

The fees or charges, authorized in Section 23-206(b), Idaho Code, are part of the agency's 2021 budget that relies upon the existence of these fees or charges to meet the state's obligations and provide necessary state services. Failing to reauthorize these temporary rules would create immediate danger to the state budget, immediate danger to necessary state functions and services, and immediate danger of a violation of Idaho's constitutional requirement that it balance its budget.

The following is a specific description of the fees or charges allowed by IDAPA 15.10.01 Section 022:

1. **Cost Reimbursement.** The Division may seek cost reimbursement, as determined by the Division, from Supplier Representatives for mailing, shipping, or other expenses incurred by the Division to distribute information or displays to liquor stores at the request of a Supplier Representative.
2. **Maximum Fee for Samples.** There will be a maximum fee of twenty-five dollars (\$25) per case charged to Supplier Representatives for Samples.
3. **Maximum Fee for Annual Supplier Representative Permit.** There will be a maximum fee of fifty dollars (\$50) charged to Supplier Representatives each year for an annual permit.

**ASSISTANCE ON TECHNICAL QUESTIONS:** For assistance on technical questions concerning the temporary rule, contact Tony Faraca, Chief Deputy Director, at 208-947-9414.

DATED this February 19, 2020.

Jeffrey Anderson, Director  
Idaho State Liquor Division  
Office Hours - 8:30am to 5:00pm

1349 E. Beechcraft Court  
Boise, ID 83716  
Ph. (208) 947-9400 / Fax (208) 947-9401

**IDAPA 15 – OFFICE OF THE GOVERNOR  
IDAHO STATE LIQUOR DIVISION**

**15.10.01 – RULES OF THE IDAHO STATE LIQUOR DIVISION**

**000. LEGAL AUTHORITY.**

These rules are adopted by the Director of the Idaho State Liquor Division pursuant to Section 23-206(b), Idaho Code. (3-20-20)T

**001. TITLE AND SCOPE.**

This chapter is titled IDAPA 15.10.01, “Rules of the Idaho State Liquor Division,” Office of the Governor. These rules provide guidance regarding operational aspects of the Division and support and enforce applicable terms in the Idaho Liquor Act, Title 23, Idaho Code. (3-20-20)T

**002. DEFINITIONS.**

The following terms, whenever used in these rules, have the meanings ascribed thereto, unless the context in which they are used clearly requires otherwise. (3-20-20)T

**01. Bailment.** A system of storing Supplier-owned inventory in state-operated Warehouses. The Division holds the Liquor in trust until stock is needed at retail. (3-20-20)T

**02. Central Office.** The main business office and Warehouse of the Idaho State Liquor Division. (3-20-20)T

**03. Close Relative.** A person related by blood or marriage within the second degree of kinship. (3-20-20)T

**04. Delisting.** The process of discontinuing any product offered for sale resulting in the product’s removal from the Division’s Product Line. The decision to retain or delist a product rests solely with the Director. (3-20-20)T

**05. Director.** The chief executive officer of the Division. (3-20-20)T

**06. Division.** The Idaho State Liquor Division. (3-20-20)T

**07. Distressed Liquor.** Liquor which is not in its original state of packaging. (3-20-20)T

**08. Distributing Station.** A privately owned business that sells Liquor. It operates under an Agreement with the Division pursuant to Title 23, Chapter 3, Idaho Code. Distributing Stations may also be termed Contract Stores. (3-20-20)T

**09. Distillery Distributing Station.** A privately owned business that holds a permit issued by the Alcohol and Tobacco Tax and Trade Bureau (TTB), a manufacturer’s license pursuant to Section 23-507, Idaho Code, and sells Liquor to retail customers pursuant to a Special Distributor Agreement with the Division in accordance with Title 23, Chapter 3, Idaho Code. Distillery Distributing Stations are “manufacturers of distilled spirits” under Section 23-509A, Idaho Code. Distillery Distributing Stations may also be termed Contract Stores for purposes of retail sales of Liquor within the state of Idaho. (3-20-20)T

**10. Liquor.** Liquor controlled by the Division has the definition ascribed to it by Section 23-105, Idaho Code, excluding certain beers as defined in Section 23-1002, Idaho Code, and certain Wines as defined in Section 23-1303, Idaho Code. (3-20-20)T

**11. Licensee.** Person authorized to sell beer or Wine by the drink or by the bottle, Liquor by the drink, or any combination thereof. (3-20-20)T

**12. Listing (Listed).** Liquor that is carried or approved to be carried in the Division’s Product Line. (3-20-20)T

**13. Political Office.** A public office for which partisan politics is a basis for nomination, election, or appointment. (3-20-20)T

14. **Price Quotation.** Written verification of detailed product information submitted to the Division by Suppliers. (3-20-20)T
15. **Product Line.** Items offered for sale by the Division. (3-20-20)T
16. **Promotional Samples.** Liquor furnished by the liquor industry to local representatives for the purpose of promoting the product that are attached to another Liquor product in the liquor store as a value added promotion. (3-20-20)T
17. **Retail Store.** Any State Store or Distributing Station. (3-20-20)T
18. **Samples.** Liquor furnished by the liquor industry to Supplier Representatives for the purpose of promoting the product. (3-20-20)T
19. **Shortage.** Any amount of cash or Liquor less than the true balance as maintained by the Central Office. Liquor Shortages are based on current retail value. (3-20-20)T
20. **Special Distributor (Distributor).** A private business owner authorized to operate a Distributing Station. A Special Distributor is not a state employee. (3-20-20)T
21. **Special Distributor Agreement (Agreement).** The contract signed by a Special Distributor acknowledging the conditions and terms for operation of a Distributing Station in accordance with Idaho Code and the rules of the Division. (3-20-20)T
22. **Special Order.** Any item not regularly offered as part of the Division's Product Line. (3-20-20)T
23. **State Store.** A Retail Store that sells Liquor. It is operated by state employees under the direct supervision of the Division. (3-20-20)T
24. **Supplier.** Any manufacturer, rectifier, importer, wholesaler or Supplier of Liquor, Wine, or related products offered for sale by the Division. (3-20-20)T
25. **Supplier Representative.** An individual, company, or entity authorized to represent a Supplier in the state of Idaho. A Supplier Representative may be an individual, a group of individuals operating as a brokerage firm or may be a direct employee of the Supplier. (3-20-20)T
26. **Warehouse.** The main Division distribution center and satellite distribution points. (3-20-20)T
27. **Wine.** Alcoholic beverages defined in Section 23-1303, Idaho Code. (3-20-20)T
28. **Wine Gallon.** The liquid measure equivalent to the volume of two hundred thirty-one (231) cubic inches or one hundred twenty-eight (128) ounces. (3-20-20)T

**003. -- 009. (RESERVED)**

**010. RETAIL STORES.**

01. **Site Location.** Based on the criteria set forth in this section and in accordance with Sections 23-301 and 23-302, Idaho Code, the Division will select an appropriate Retail Store site to adequately serve the community. (3-20-20)T
02. **Site Selection Criteria.** The following criteria will be used in selecting a location for a new Retail Store. (3-20-20)T
- a. Public acceptability of location in accordance with Sections 23-301 and 23-302, Idaho Code. (3-20-20)T

- b.** Location and suitability of premises. (3-20-20)T
- c.** Lease amount may not be the sole determining factor in site selection; final selection will be determined at the discretion of the Director. (3-20-20)T
- d.** Compliance with local zoning. (3-20-20)T
- 03. Customer Refunds and Exchanges.** No refunds will be authorized without prior approval of the Director or his authorized agent. (3-20-20)T
- a.** Liquor may be exchanged for other Liquor of the same price upon approval of the store manager and presentation of a valid receipt. (3-20-20)T
- b.** Liquor brought in for exchange or refund must have been purchased in Idaho through the Division. (3-20-20)T
- c.** A re-shelving charge may be assessed on returned items in accordance with Section 23-311, Idaho Code. (3-20-20)T
- 04. Disabled Customers.** Appropriate special services, in accordance with the Americans with Disabilities Act, will be provided to disabled customers. (3-20-20)T
- 05. Prices.** All prices will be in accordance with the published price list set by the Director in accordance with Section 23-207(g), Idaho Code. (3-20-20)T
- 06. Distressed Liquor.** Price adjustments can be made on Distressed Liquor with the approval of the Director or his authorized agent. (3-20-20)T
- 07. Hours and Days of Operation.** Retail Store hours and days of business operation will be set by the Director in accordance with Section 23-307, Idaho Code. (3-20-20)T
- 08. Audits.** Designated personnel will perform periodic inspections of all Retail Stores. Such inspections may be on an unannounced basis and may include physical inventory counts with the assistance of the store manager or authorized agent to assess the suitability of inventory levels and product mix and other evaluation procedures. (3-20-20)T
- 09. Admission to State Store.** Division personnel may refuse entry or take actions as are appropriate to cause the removal of a person from a State Store where such person is disrupting performance of the Division's duties or is inconsistent with the Division's charge to curtail the intemperate use of alcoholic beverages. (3-20-20)T
- 011. DISTRIBUTING STATIONS.**
- 01. Term of Agreement.** Special Distributor Agreements are valid for a specified period as determined at the discretion of the Director. (3-20-20)T
- 02. Transfer of Agreement.** A Special Distributor Agreement is a personal privilege and is not considered property nor is it assignable or transferable. (3-20-20)T
- 03. Agreement Renewal.** If a Distributing Station's operation exceeds Division expectations, agreement renewals may be allowed. (3-20-20)T
- 04. Agreement Evaluations.** Periodic evaluation of the agreement, in accordance with the guidelines set in Subsection 011.06 of these rules, will be considered to insure reasonable, uniform and non-discriminatory criteria and procedures for selection and renewal of special Distributing Stations pursuant to Section 23-302, Idaho Code. These criteria are applicable to the replacement of an existing Distributing Station and to the establishment of a new Distributing Station. (3-20-20)T

**05. Acceptance of Applications.** Applications for Distributing Stations are accepted only in response to public notices. Unsolicited applications may not be held on file pending future openings. (3-20-20)T

**06. Applicant Selection.** The selection of the most qualified applicant for a Distributing Station will be made by the Director in accordance with Section 23-304, Idaho Code. The Director reserves the right to refuse to select any and all applicants. Applicant selection will be based on the following criteria: (3-20-20)T

**a.** Public acceptability in accordance with Section 23-302, Idaho Code. (3-20-20)T

**b.** Location and suitability of premises. (3-20-20)T

**c.** An applicant who has been convicted of, or has plead guilty to, a felony or a crime of moral turpitude (an element of which is dishonesty or fraud) under the laws of any state, U.S. Territory or protectorate, the District of Columbia, or the United States will not be allowed to operate a Distributing Station. (3-20-20)T

**d.** An applicant may not be a Close Relative of, or have a partnership or other close business relationship with any person employed by the Division who has the responsibility for establishing, approving, or influencing policies of the Division. (3-20-20)T

**e.** An applicant may be a spouse, child, employee, blood relative, relative through marriage, or business associate of the retiring or deceased Distributor. (3-20-20)T

**f.** Distributing Stations will not be established in a business that has a license to sell Liquor, Wine or beer by the drink. (3-20-20)T

**g.** Where a new Distributing Station is created by the conversion of a State Store, an employee of that former state store can be chosen by the Division as the Special Distributor. (3-20-20)T

**h.** If an existing Distributing Station is sold, the purchaser may, at the sole and absolute discretion of the Division, continue to operate the Distributing Station under comparable terms and conditions applied to the previous Special Distributor. (3-20-20)T

**07. General Operational Obligations.** Special Distributors will: (3-20-20)T

**a.** Furnish an adequate building or facility with suitable shelving, display counters and storeroom facilities. It must be kept clean and sanitary at all times. (3-20-20)T

**b.** Not permit a person under the age of nineteen (19) to perform any acts for the Division. (3-20-20)T

**c.** Keep the Distributing Station open for business in accordance with Section 23-307, Idaho Code. (3-20-20)T

**d.** Not hold a partisan state elective political office. He cannot be a Close Relative of, or be in a business partnership with a person in a partisan state elective Political Office. (3-20-20)T

**e.** Not present his views as being representative of the views of the Division and not attempt to politically influence customers in any manner. (3-20-20)T

**f.** Make and transmit all reports as required by the Division in the time frame established by the Division. (3-20-20)T

**g.** Be responsible for and account to the Division for all Liquor furnished by the Division. (3-20-20)T

**h.** Only sell Liquor received from the Division. (3-20-20)T

**i.** Only sell the Liquor at prices set by the Division in accordance with Section 23-207(h), Idaho Code. (3-20-20)T

- j. Not deliver Liquor off premise without explicit authorization of the Director. (3-20-20)T
- 08. Days and Hours of Operation.** (3-20-20)T
- a. Standard store hours will be in accordance with Subsection 010.07 of these rules. (3-20-20)T
- b. The Distributor will not exceed the maximum legal selling hours as set by the Director. (3-20-20)T
- 09. Fiduciary Responsibility.** Any and all unremitted monies collected in trust for the Division, and upon their receipt, are assigned to the Division in accordance with Section 23-401, Idaho Code. (3-20-20)T
- 10. Liquor Shortage.** The Distributor must pay the monetary value of any Shortage immediately after receipt of the request for payment from the Division showing its calculation of the Shortage. (3-20-20)T
- a. If the Distributor disputes Liquor or cash Shortages, he may request a hearing before the Director. (3-20-20)T
- b. Any payment made by the Distributor for Liquor shortages may be refunded in whole or in part if the Distributor's position is upheld by the Director. (3-20-20)T
- 11. Compensation.** The compensation paid by the Division to the Special Distributor will be full payment for the furnishing of all facilities, operating costs and expenses incidental to the operation of the Distributing Station, as well as full consideration for all services provided by the Distributor. Such compensation will be uniformly applied statewide in accordance with Section 23-305, Idaho Code. (3-20-20)T
- 12. Supplies.** The Division will furnish books, forms, and equipment for use by the distributor in transacting the business of the Division as required by law or as deemed necessary by the Director. (3-20-20)T
- 13. Voluntary Agreement Termination.** (3-20-20)T
- a. The Distributor Agreement may be voluntarily terminated by the Distributor upon written notice by certified mail or personal delivery to the Division or its specified representative specifying the date of termination. (3-20-20)T
- b. The Distributor will allow reasonable time for the Division to conduct a final inventory audit and to remove all Liquor. (3-20-20)T
- c. The sale of the Distributor's business to any other party, the forfeiture of the business to a lien holder, or the foreclosure upon the business will be considered voluntary Agreement termination. (3-20-20)T
- 14. Automatic Agreement Termination.** Upon the death of the Distributor, the Distributor's estate, assisted by the Division, will be responsible for the operation of the Distributing Station until the termination date, as established by the Director. (3-20-20)T
- 15. Agreement Termination for Cause.** The Division may terminate the Special Distributor Agreement for cause which includes, but is not limited to, any of the following: (3-20-20)T
- a. A Distributor who at any time becomes insolvent or experiences a substantial change in financial condition that, in the judgment of the Director, creates a financial risk to the Division. (3-20-20)T
- b. Significant breach of Distributor's obligations to manage the Distributing Station properly. (3-20-20)T
- c. Intoxication of the Distributor while in discharge of his duties as a representative of the Division. (3-20-20)T



- d. Participation of the Distributor in misappropriation of any assets of the Division. (3-20-20)T
  - e. Distributor having been found guilty of a felony or a misdemeanor involving moral turpitude. (3-20-20)T
  - f. Conduct detrimental to the good order of the Division as defined in IDAPA 15.04.01, "Rules of the Division of Human Resources and Personnel Commission," regarding classified conduct unbecoming state classified employees. Note - this Subsection in no way confers employee status on such Special Distributors, however outlines a specifically referenced standard of conduct. (3-20-20)T
- 16. Agreement Termination Procedure. (3-20-20)T**
- a. The Division will notify the distributor in writing, by certified mail or personal delivery, specifying the reasons for the proposed termination and its effective date. (3-20-20)T
  - b. The Division may notify the Distributor that he is immediately suspended pending final determination of the proposed termination. At the time of notification, the Division reserves the right to conduct a final audit and remove all Division property pending a final determination. (3-20-20)T
  - c. If the Distributor wishes a hearing on the proposed termination to present information relative to the reason given for termination, he will notify the Division in writing within twenty (20) days after receiving the notice of the proposed termination. (3-20-20)T
  - d. Upon termination of this agreement, the Division will: (3-20-20)T
    - i. Remove all property owned by it; and (3-20-20)T
    - ii. Cease compensation to the Distributor as of the date of termination. (3-20-20)T
- 012. DISTILLERY DISTRIBUTING STATIONS.**
- 01. Sample Tasting.** Distillery Distributing Stations may offer sample tastings on the premises of its distillery in accordance with Section 23-509A, Idaho Code. (3-20-20)T
  - 02. Retail Sales.** Distillery Distributing Stations may sell Liquor manufactured on premises of such distillery to customers outside the state of Idaho in accordance with Section 23-507, Idaho Code. Distillery Distributing Stations may sell Liquor manufactured on the premises that is purchased from the Division to customers on the premises of its distillery in accordance with and pursuant to a Special Distributor Agreement with the Division. The Special Distributor Agreement will include governing terms and conditions for retail sale of Liquor manufactured on the premises within the state of Idaho in accordance with Title 23, Chapter 3, Idaho Code, and applicable rules of the Division governing retail sale operations. (3-20-20)T
- 013. -- 019. (RESERVED)**
- 020. STORE CONVERSIONS.**  
The Division reserves the right at any time to convert a State Store to a Distributing Station or to convert a Distributing Station to a State Store. However, this right will not be arbitrarily applied and will not be exercised until relevant facts presented to the Director have been reviewed and there has been reasonable time during which appropriate public notice has been given. (3-20-20)T
- 021. SUPPLIERS.**
- 01. Price Quotations.** All Suppliers must submit a Liquor Price Quotation, on forms prescribed by the Division, for every item they have Listed with the Division. (3-20-20)T
  - 02. Warranties.** Supplier warranties will conform to the requirements of the Tax and Trade Bureau of the U.S. Department of Treasury. (3-20-20)T

**03. Liquor Shipments.** Pursuant to Sections 23-203(a), 23-203(b) and 23-207(d), Idaho Code, all Liquor transported into the state of Idaho is under the direction of the Division. (3-20-20)T

**a.** It is a violation of Sections 23-203(a), 23-203(b) and 23-207(d), Idaho Code, for any Supplier or other party to ship Liquor into the state of Idaho for purposes not authorized by the Director. (3-20-20)T

**b.** The Division reserves the right to select the mode of transportation for all Liquor within the state of Idaho. (3-20-20)T

**04. Title to Liquor, Wines and Related Products.** Title to Product Line items delivered to the Division passes from the Supplier to the Division when the Division accepts the product, unless Product Line items are delivered directly to Bailment status. (3-20-20)T

**a.** The Division reserves the right to conduct quality tests, or to inspect products directly ordered or withdrawn from Bailment. (3-20-20)T

**b.** The Division reserves the right at any time to reject any Product Line item if, upon tests and inspections, it does not conform to requirements. (3-20-20)T

**c.** In the event the Division rejects any delivery, ownership of products refused will remain with the Supplier. It will be the Supplier's responsibility to remove or relocate any refused products. (3-20-20)T

**05. Product Returns.** Liquor, Wine, or related products may be returned to Suppliers by the Division, in full or partial cases, for "ordinary and usual commercial reasons" in accordance with the Tax and Trade Bureau of the U.S. Department of Treasury regulations. (3-20-20)T

**a.** The Supplier will reimburse the Division the full invoice cost plus an additional amount, fixed by the Division, as reimbursement for the Division's expense in shipping to and from its stores and Warehouse. (3-20-20)T

**06. New Listings.** New Listings will be added at the discretion of the Director pursuant to Sections 23-203 and 23-207, Idaho Code. (3-20-20)T

**07. Delisting.** Delistings are at the discretion of the Director pursuant to Sections 23-203 and 23-207, Idaho Code. (3-20-20)T

**08. Resident Supplier Representatives.** All Suppliers doing business with the Division will have resident representation. A resident Supplier Representative cannot have been convicted of any felony. (3-20-20)T

**09. Supplier Representative Permits.** Supplier Representatives will obtain a permit from the Division, that is renewed annually. (3-20-20)T

**a.** Permits will not be issued to any holder of a bartender's permit, retail licensee, a distributor of restaurant or bar supplies, a distributor of beer or Wine, or to a food wholesaler. (3-20-20)T

**b.** Supplier Representatives may represent more than one (1) Supplier without additional permit fees. (3-20-20)T

**10. Facility Visitations.** Supplier Representatives, or anyone acting in that capacity, will obtain prior approval from the Director or his authorized agent to conduct business at any State Store or Distributing Station. (3-20-20)T

**11. Samples.** Samples are limited to ten (10) Wine Gallons per month and the sizes of Samples are that which are permitted by federal regulation or statute. (3-20-20)T

**12. Promotional Samples.** Promotional Samples are limited to fifty (50) ml size bottles unless

specified otherwise by the Director. (3-20-20)T

**13. Contact With Licensees.** No Supplier Representative, or anyone acting in that capacity, will deliver any Liquor, Wine, or beer sold by the Division to a Licensee's place of business, other than Samples that are: (3-20-20)T

**a.** Limited to sizes permitted by federal regulation or statute. (3-20-20)T

**b.** Only those items not carried in that Licensee's Product Line. (3-20-20)T

**14. Liquor Displays.** The Division will regulate all Retail Store Liquor displays. (3-20-20)T

**15. Advertising.** Advertising in all Retail Stores will be in accordance with Section 23-607, Idaho Code. (3-20-20)T

**16. Violations.** Any Supplier Representative, or anyone acting in that capacity, who violates Title 23, Idaho Code, or any rule of the Division, may subject the manufacturer's, wholesaler's or Distributor's products to removal from the Division's Product Line or; the Director, at his discretion, may suspend (temporarily or permanently) their Supplier Representative permit. (3-20-20)T

**022. SCHEDULE OF FEES.**  
The following fees may be charged by the Division. (3-20-20)T

**01. Cost Reimbursement.** The Division may seek cost reimbursement, as determined by the Division, from Supplier Representatives for mailing, shipping, or other expenses incurred by the Division to distribute information or displays to liquor stores at the request of a Supplier Representative. (3-20-20)T

**02. Maximum Fee for Samples.** There will be a maximum fee of twenty-five dollars (\$25) per case charged to Supplier Representatives for Samples. (3-20-20)T

**03. Maximum Fee for Annual Supplier Representative Permit.** There will be a maximum fee of fifty dollars (\$50) charged to Supplier Representatives each year for an annual permit. (3-20-20)T

**023. -- 030. (RESERVED)**

**031. STATE STORES SOLICITATION AND PROMOTIONAL PRESENTATIONS.**  
No school, church, fraternal, civic, political or charitable organization or individual is allowed to solicit for donations or advertise for any purpose within any State Store. (3-20-20)T

**032. WINES.**  
Wines may be sold in any State Store or Distributing Station at the discretion of the Director pursuant to Section 23-1305, Idaho Code. All rules of the Division applicable to Liquor are also applicable to Wines and beer sold by the Division. (3-20-20)T

**033. LIQUOR FUND.**  
Determination of the final annual amount of cash available for distribution in the liquor account under Section 23-404, Idaho Code, is the amount of the Division's annual net income determined in accordance with Generally Accepted Accounting Principles, consistently applied. Notwithstanding the above, cash reserves are allowed under Section 23-403, Idaho Code. Further, the Director with the concurrence of the State Controller may hold back from distribution additional cash reserves needed for prudent operation of the Division. Such final annual amount of available cash will be disbursed no later than ninety (90) days following each fiscal year end. (3-20-20)T

**034. -- 999. (RESERVED)**

# IDAPA 16 – DEPARTMENT OF HEALTH AND WELFARE

## DOCKET NO. 16-0000-2000F (FEE RULE)

### NOTICE OF OMNIBUS RULEMAKING – ADOPTION OF TEMPORARY RULE

**EFFECTIVE DATE:** The effective date of the temporary rules being adopted through this omnibus rulemaking is the adjournment date of the second regular session of the 65th Idaho State Legislature - March 20, 2020.

**AUTHORITY:** In compliance with Sections 67-5226, Idaho Code, notice is hereby given this agency has adopted temporary rules. The action is authorized pursuant to Sections 7-1206, 16-1629, 16-2102, 16-2433, 19-2524, 20-511A, 32-1207, 32-1209, 32-1214G, 32-1217, 39-242, 39-309, 39-1105, 39-1107, 39-1111, 39-1209 through 1211, 39-1210(10), 39-1211(4), 39-1213, 39-3137, 39-3305, 39-3505, 39-3520, 39-5403, 39-5603, 39-5604, 39-7501, 39-9109, 56-202(b), 56-203(2), 56-203A, 56-204A, 56-803, 56-1003, 56-1004, 56-1004A, 56-1005, 56-1005(8), 56-1007, 56-1009, 56-1023, 56-1028, 56-1041, 56-1043, 66-404(7), 15-5-308(4), 15-5-311(5), 15-5-316(5), Title 39, Chapter 3 and 31, Title 66, Chapters 1 and 3, and Title 67, Chapter 52, Idaho Code, and 42 USC Section 9858f.

**DESCRIPTIVE SUMMARY:** The following is the required finding and concise statement of its supporting reasons for adopting the temporary rules:

This temporary rulemaking adopts the following chapters under IDAPA 16:

#### **IDAPA 16**

- IDAPA 16.01.07, *Emergency Medical Services (EMS) – Personnel Licensing Requirements*
- IDAPA 16.02.01, *Idaho Time Sensitive Emergency System Council*
- IDAPA 16.02.08, *Vital Statistics Rules*
- IDAPA 16.02.13, *State of Idaho Drinking Water Laboratory Certification Program*
- IDAPA 16.02.14, *Construction and Operation of Public Swimming Pools*
- IDAPA 16.02.25, *Fees Charged by the State Laboratory*
- IDAPA 16.02.26, *The Idaho Children's Special Health Program*
- IDAPA 16.02.27, *Idaho Radiation Control Rules*
- IDAPA 16.03.03, *Child Support Services*
- IDAPA 16.03.18, *Medicaid Cost-Sharing*
- IDAPA 16.03.19, *Certified Family Homes*
- IDAPA 16.03.22, *Residential Assisted Living Facilities*
- IDAPA 16.04.07, *Fees for State Hospital North and State Hospital South*
- IDAPA 16.05.06, *Criminal History and Background Checks*
- IDAPA 16.06.01, *Child and Family Services*
- IDAPA 16.06.02, *Child Care Licensing*
- IDAPA 16.07.01, *Behavioral Health Sliding Fee Schedules*

**TEMPORARY RULE JUSTIFICATION:** Pursuant to Sections 67-5226(1) and 67-5226(2), Idaho Code, the Governor has found that temporary adoption of the rules is appropriate for the following reasons:

These temporary rules are necessary to protect the public health, safety, and welfare of the citizens of Idaho and confer a benefit on its citizens. These temporary rules implement the duly enacted laws of the state of Idaho, provide citizens with the detailed rules and standards for complying with those laws, and assist in the orderly execution and enforcement of those laws. The expiration of these rules without due consideration and processes would undermine the public health, safety and welfare of the citizens of Idaho and deprive them of the benefit intended by these rules.

**FEE SUMMARY:** Pursuant to Section 67-5226(2), the Governor has found that the fees or charges being imposed or increased are justified and necessary to avoid immediate danger and the fees are described herein:

The fees or charges, authorized in Sections 56-1023, 56-1007, 56-1003, 56-264, 32-1207, 56-203A, 66-327, 66-118, 56-354, 39-1107, 16-2433, 19-2524, 20-511A, 39-3137, 56-253, 56-257, 39-3358, and Title 39, Chapter 2, Idaho Code, are part of the agency's 2020 budget that relies upon the existence of these fees or charges to meet the state's obligations and provide necessary state services. Failing to reauthorize these temporary rules would create immediate danger to the state budget, immediate danger to necessary state functions and services, and immediate danger of a violation of Idaho's constitutional requirement that it balance its budget.

**Licensing, Certification, Permit, or Registration Fees:**

- *IDAPA 16.01.07, Emergency Medical Services (EMS) -- Personnel Licensing Requirements* -- Fees paid by emergency medical personnel, for licensure and renewal of licensure
- *IDAPA 16.02.13, State of Idaho Drinking Water Laboratory Certification Program* -- Fees paid by laboratories for certification to test drinking water
- *IDAPA 16.02.14, Construction and Operation of Public Swimming Pools* -- Establishes reasonable fees for services for all public swimming pools.
- *IDAPA 16.02.27, Idaho Radiation Control Rules* -- Establishes licensing fees for all radiation producing machines in the State.
- *IDAPA 16.03.19, Certified Family Homes* -- Fees paid by Certified Family Homes for application and certification.
- *IDAPA 16.06.02, Child Care Licensing* -- Fees paid by childcare providers for licensing.

**Designation Fees:**

- *IDAPA 16.02.01, Idaho Time Sensitive Emergency System Council* -- Fees paid by hospitals for designation under the Idaho Time Sensitive Emergency System.

**Records Fees:**

- *IDAPA 16.02.08, Vital Statistics Rules* -- Fees paid to the Department for copies of vital records, searches, and other services.

**Fee for Service:**

- *IDAPA 16.02.25, Fees Charged by the State Laboratory* -- Fees paid to the Department for laboratory testing and services.
- *IDAPA 16.02.26, The Idaho Children's Special Health Program* -- Fees paid by Children's Special Health Program clients for program services.
- *IDAPA 16.03.03, Child Support Services* -- Fees paid by clients of the Department's child support program.
- *IDAPA 16.03.22, Residential Assisted Living Facilities* -- Fees paid by providers for building evaluation and survey services.
- *IDAPA 16.04.07, Fees for State Hospital North and State Hospital South* -- Fees for services provided at State Hospitals.
- *IDAPA 16.05.06, Criminal History and Background Checks* -- Fees charged by the Department for criminal history and background checks.
- *IDAPA 16.06.01, Child and Family Services* -- Fees charged by the Department for child protection central registry checks.
- *IDAPA 16.07.01, Behavioral Health Sliding Fee Schedules* -- Sliding fee schedules for behavioral health services.

**Premiums:**

- *IDAPA 16.03.18, Medicaid Cost-Sharing* -- Establishes premium fee schedule for Youth Empowerment Services (YES) program participants.

**ASSISTANCE ON TECHNICAL QUESTIONS:** For assistance on technical questions concerning the temporary rules, contact Administrative Rules Unit, [dhwrules@dhw.idaho.gov](mailto:dhwrules@dhw.idaho.gov), 450 W State St., 10 Floor, Boise, ID, 83720.

DATED this 19th day of February, 2020.

Tamara Prisock  
DHW – Administrative Rules Unit  
450 W. State Street – 10th Floor  
P.O. Box 83720 Boise, ID 83720-0036  
phone: (208) 334-5500  
fax: (208) 334-6558  
e-mail: [dhwrules@dhw.idaho.gov](mailto:dhwrules@dhw.idaho.gov)

## 16.01.07 – EMERGENCY MEDICAL SERVICES (EMS) – PERSONNEL LICENSING REQUIREMENTS

### 000. LEGAL AUTHORITY.

The Idaho Board of Health and Welfare is authorized under Section 56-1023, Idaho Code, to adopt rules and standards concerning the administration of the Idaho Emergency Medical Services Act, Sections 56-1011 through 56-1023, Idaho Code. The Director is authorized under Section 56-1003, Idaho Code, to supervise and administer an emergency medical service program. (3-20-20)T

### 001. TITLE AND SCOPE.

**01. Title.** These rules are titled IDAPA 16.01.07, “Emergency Medical Services (EMS) – Personnel Licensing Requirements.” (3-20-20)T

**02. Scope.** These rules include requirements and standards for certification and licensure of emergency medical personnel, the establishment of fees for licensure, renewals of licensure, and education criteria for needed skills to perform duties of specific types of licensure. Emergency medical personnel licensed under these rules work or provide EMS services for agencies licensed by the state. (3-20-20)T

### 002. -- 008. (RESERVED)

### 009. CRIMINAL HISTORY AND BACKGROUND CHECK REQUIREMENTS.

Licensed EMS personnel must comply with the provisions in IDAPA 16.05.06, “Criminal History and Background Checks,” to include: (3-20-20)T

**01. Initial Licensure.** An individual applying for initial licensure described in Section 110 of these rules. (3-20-20)T

**02. Reinstatement of Licensure.** An individual applying for reinstatement of licensure described in Section 131 of these rules. (3-20-20)T

**03. Certificate of Eligibility.** An individual applying for a certificate of eligibility described in Section 150 of these rules. (3-20-20)T

**04. Additional Criminal Background Check.** The EMS Bureau may require an updated or additional criminal background check at any time, without expense to the candidate, if there is cause to believe new or additional information will be disclosed. (3-20-20)T

### 010. DEFINITIONS.

For the purposes of this chapter, the definitions in IDAPA 16.01.02, “Emergency Medical Services (EMS) -- Rule Definitions” apply. (3-20-20)T

### 011. -- 074. (RESERVED)

### 075. INVESTIGATION OF COMPLAINTS FOR PERSONNEL LICENSING VIOLATIONS.

Investigation of complaints and disciplinary actions for personnel licensing are provided under IDAPA 16.01.12, “Emergency Medical Services (EMS) -- Complaints, Investigations, and Disciplinary Actions.” (3-20-20)T

### 076. ADMINISTRATIVE ACTION IMPOSED FOR LICENSE OR CERTIFICATION.

Any license or certification may be suspended, revoked, denied, or retained with conditions for noncompliance with any standard or rule. Administrative license or certification actions imposed by the EMS Bureau for any action, conduct, or failure to act which is inconsistent with the professionalism, or standards, or both, are provided under Sections 56-1011 through 56-1023, Idaho Code, and IDAPA 16.01.12, “Emergency Medical Services (EMS) -- Complaints, Investigations, and Disciplinary Actions.” (3-20-20)T

### 077. STANDARDS OF PROFESSIONAL CONDUCT FOR EMS PERSONNEL.

**01. Method of Treatment.** EMS personnel must practice medically acceptable methods of treatment and must not endeavor to extend their practice beyond their competence and the authority vested in them by the medical director. EMS personnel must not perform any medical procedure or provide medication that deviated from or exceeds the scope of practice for the corresponding level of licensure established under IDAPA 16.02.02, “Idaho Emergency Medical Services (EMS) Physician Commission.” (3-20-20)T

**02. Knowledge and Proficiency.** EMS personnel must maintain standards of knowledge and

proficiency as required by this chapter of rules and IDAPA 16.02.02, “Idaho Emergency Medical Services (EMS) Physician Commission.” (3-20-20)T

**03. Respect for the Patient.** EMS personnel must provide all services with respect for the dignity of the patient, unrestricted by considerations of social or economic status, personal attributes, or the nature of health problems. (3-20-20)T

**04. Confidentiality.** EMS personnel must hold in strict confidence all privileged information concerning the patient except as disclosure or use of this information is permitted or required by law or Department rule. (3-20-20)T

**05. Conflict of Interest.** EMS personnel must not accept gratuities for preferential consideration of the patient and must guard against conflicts of interest. (3-20-20)T

**06. Professionalism.** EMS personnel must uphold the dignity and honor of the profession and abide by its ethical principles and must be familiar with existing laws governing the practice of emergency medical services and comply with those laws. EMS personnel must never perform duties of the profession while under the influence of alcohol, illegal substances, or legal drugs or medication causing impairment of function. (3-20-20)T

**07. Cooperation and Participation.** EMS personnel must cooperate with other health care professionals and participate in activities to promote community and national efforts to meet the health needs of the public. (3-20-20)T

**08. Ethical Responsibility.** EMS personnel must refuse to participate in unethical procedures, and assume the responsibility to expose incompetence or unethical conduct of others to the appropriate authority in a proper and professional manner. Misrepresentation in an application or documentation for licensure by means of concealment of a material fact is a violation of ethical responsibility. (3-20-20)T

**09. Integrity.** EMS personnel must act with honesty and integrity and assure that reports, applications and documentation for which they are responsible are free of fraudulent and false information. (3-20-20)T

**078. -- 089. (RESERVED)**

**090. ADVANCE DO NOT RESUSCITATE (DNR) DIRECTIVES.**  
Licensed EMS personnel must follow the DNR protocol established by the Department. (3-20-20)T

**091. -- 099. (RESERVED)**

**PERSONNEL LICENSURE REQUIREMENTS**  
**(Sections 100-199)**

**100. PERSONNEL LICENSURE REQUIRED.**  
Any individual who provides emergency medical care must obtain and maintain a current EMS personnel license issued by the EMS Bureau, or recognition by the EMS Bureau described under Section 140 of these rules. The levels of Idaho personnel licensure are: (3-20-20)T

**01. Emergency Medical Responder (EMR).** (3-20-20)T

**02. Emergency Medical Technician (EMT).** (3-20-20)T

**03. Advanced Emergency Medical Technician (AEMT).** (3-20-20)T

**04. Paramedic.** (3-20-20)T

**101. AFFILIATION REQUIRED TO PRACTICE.**  
Licensed EMS personnel must be affiliated with an EMS agency, and only practice under the supervision of the agency medical director as required in IDAPA 16.02.02, “Idaho Emergency Medicaid Services (EMS) Physician

Commission.” (3-20-20)T

**102. (RESERVED)**

**103. RECOGNITION OF EMS PERSONNEL LICENSURE INTERSTATE COMPACT (REPLICA).**

**01. Licensed EMS Personnel from a REPLICA Member State.** An individual who possesses a current, valid, and unrestricted EMS personnel license from a REPLICA member state whose primary affiliation is an Idaho-licensed EMS agency: (3-20-20)T

**a.** Must apply for Idaho EMS licensure within ninety (90) days of affiliation with an Idaho EMS agency. (3-20-20)T

**b.** May affiliate and respond with the Idaho-licensed EMS agency during the initial ninety (90) day period. (3-20-20)T

**c.** Will be issued an Idaho EMS personnel license at the same level of licensure as the REPLICA home state license upon payment of any applicable licensure fee in accordance with Section 111 of these rules. (3-20-20)T

**02. Out-of-State Primary Affiliation.** If EMS personnel licensed in another REPLICA state claim an EMS agency in that state as their primary affiliation, Idaho licensure is not required. (3-20-20)T

**104. (RESERVED)**

**105. APPLICATION AND INSTRUCTIONS FOR EMS PERSONNEL LICENSURE.**

A personnel license or certificate of eligibility application and instructions may be obtained from the EMS Bureau, see online at: <http://www.idahoems.org>. (3-20-20)T

**106. TIME FRAME FOR PERSONNEL LICENSURE AFTER SUCCESSFUL COMPLETION OF EDUCATION COURSE.**

An individual who has successfully completed an EMS education course is eligible to attempt the standardized examination for the appropriate level of licensure. (3-20-20)T

**01. Complete Standardized Examination.** A candidate must successfully complete all components of the standardized examination within twenty-four (24) months of completing an EMS training course in order to be eligible for an Idaho EMS personnel license. (3-20-20)T

**02. Standardized Examination Not Completed.** If all components of the standardized examination are not successfully completed period within twenty-four (24) months of course completion, the candidate must repeat the initial training course and all components of the standardized examination in order to be eligible for an Idaho EMS personnel license. (3-20-20)T

**107. LICENSURE OF MEMBERS OF THE MILITARY, VETERANS, AND SPOUSES.**

A member of the military, a veteran, or a spouse of any such person who possesses a current, valid, and unrestricted EMS personnel license in another state, district, or territory of the United States is eligible for EMS personnel licensure in Idaho as follows: (3-20-20)T

**01. Licensure in REPLICA Member State.** A member of the military, a veteran, or a spouse of such a person who possesses a REPLICA member state EMS personnel license is eligible for licensure in Idaho under Section 103 of these rules. (3-20-20)T

**02. Licensure in Non-REPLICA Member State.** A member of the military, a veteran, or a spouse of such a person who possesses an EMS personnel license from a state that is not a REPLICA member state is eligible for licensure by endorsement in Idaho under Section 108 of these rules. (3-20-20)T



**108. QUALIFICATIONS FOR LICENSURE BY ENDORSEMENT -- MEMBERS OF THE MILITARY, VETERANS, AND SPOUSES.**

Members of the military, veterans, and their spouses may apply to the EMS Bureau for licensure by endorsement provided they meet the following: (3-20-20)T

**01. Military, Veteran, or Spouse.** Are a member of the military, a veteran, or a spouse of any such person. (3-20-20)T

**02. Graduation Required.** Have successfully completed an education program that is substantially equivalent to the approved education course recognized by the EMS Bureau under IDAPA 16.01.05, "Emergency Medical Services -- Education, Instructor, and Examination Requirements." (3-20-20)T

**03. Licensing Examination.** Successfully complete, or have successfully completed, the same standardized examination for the level of licensure on the application required under IDAPA 16.01.05, "Emergency Medical Services (EMS) -- Education, Instructor, and Examination Requirements." (3-20-20)T

**04. License from Another Jurisdiction.** Possess a current, valid, and unrestricted EMS personnel license, at the same or higher level as the Idaho license being requested, from another state, district, or territory of the United States. The license of any individual subject to official investigation or disciplinary proceedings is not considered current, valid, and unrestricted. (3-20-20)T

**05. Criminal History and Background Check.** Successfully complete a criminal history and background check in accordance with the provisions in IDAPA 16.05.06, "Criminal History and Background Checks." Denial without the grant of an exemption under the provisions in IDAPA 16.05.06, "Criminal History and Background Checks," will result in denial or revocation of licensure. (3-20-20)T

**06. Declaration of Previous Applications and Licensures.** Declare each state or jurisdiction in which they have ever applied for, been denied, or held an EMS license or certification. (3-20-20)T

**07. Authorization for Release of Information.** Provide authorization for the EMS authority in other states or jurisdictions to release the candidate's registration, licensure, and certification information to the Idaho EMS Bureau. (3-20-20)T

**08. Provide Current Affiliation with EMS Agency.** Declare all organizations in which they are allowed to practice as licensed personnel. A candidate must have a current affiliation with a licensed EMS agency that functions at, or above, the level of licensure being sought by the candidate. (3-20-20)T

**09. Valid Identification.** Have a valid state driver's license, an Idaho identification card issued by a county driver's license examining station, or an identification card issued by the armed forces of the United States. (3-20-20)T

**10. Submit Required Licensure Fee.** Submit the applicable initial licensure fee provided in Section 111 of these rules. A candidate for EMR or EMT level of licensure has no fee requirement. (3-20-20)T

**109. (RESERVED)**

**110. INITIAL PERSONNEL LICENSURE.**

Upon successful completion of an approved education course recognized by the EMS Bureau under IDAPA 16.01.05, "Emergency Medical Services -- Education, Instructor, and Examination Requirements," an individual may apply to the EMS Bureau for licensure. The candidate must meet the following: (3-20-20)T

**01. Candidate Age Requirements.** An individual applying for licensure must meet the following age requirements: (3-20-20)T

**a.** An EMR and EMT candidate must be either sixteen (16) or seventeen (17) years old with parental or legal guardian consent, or eighteen (18) years old. (3-20-20)T

- b.** An AEMT and Paramedic candidate must be eighteen (18) year old. (3-20-20)T
- 02. Declaration of Previous Applications and Licensures.** A candidate must declare each state or jurisdiction in which they have applied for, been denied, or held an EMS license or certification. (3-20-20)T
- 03. Authorization for Release of Information.** A candidate must provide authorization for the EMS authority in other states or jurisdictions to release the candidate’s registration, licensure, and certification information to the Idaho EMS Bureau. (3-20-20)T
- 04. Provide Current Affiliation with EMS Agency.** A candidate must declare all organizations in which they are allowed to practice as licensed personnel. A candidate must have a current affiliation with a licensed EMS agency that functions at, or above, the level of licensure being sought by the candidate. (3-20-20)T
- 05. Valid Identification.** A candidate must have a valid state driver’s license, an Idaho identification card issued by a county driver’s license examining station, or an identification card issued by the Armed Forces of the United States. (3-20-20)T
- 06. Criminal History and Background Check.** A candidate must successfully complete a criminal history and background check according to the provisions in IDAPA 16.05.06, “Criminal History and Background Checks.” Denial without the grant of an exemption under the provisions in IDAPA 16.05.06, “Criminal History and Background Checks,” will result in denial or revocation of licensure. (3-20-20)T
- 07. Pass Standardized Examination.** A candidate must successfully complete the standardized examination for the level of licensure on the application required under IDAPA 16.01.05, “Emergency Medical Services (EMS) -- Education, Instructor, and Examination Requirements.” (3-20-20)T
- a.** A candidate for EMR licensure must have successfully completed the standardized examination at the EMR level or higher within the preceding thirty-six (36) months. (3-20-20)T
- b.** A candidate for EMT licensure must have successfully completed the standardized examination at the EMT level or higher within the preceding thirty-six (36) months. (3-20-20)T
- c.** A candidate for AEMT licensure must have successfully completed the standardized examination at the AEMT level or higher within the preceding twenty-four (24) months. (3-20-20)T
- d.** A candidate for Paramedic licensure must have successfully completed the standardized examination at the Paramedic level within the preceding twenty-four (24) months. (3-20-20)T
- 08. Standardized Exam Attempts For Initial Licensure.** A candidate for initial licensure is allowed to attempt to successfully pass the standardized exam as follows: (3-20-20)T
- a.** An EMR candidate is allowed three (3) attempts to pass the exam, after which the initial EMR course must be successfully completed again before another three (3) attempts are allowed. (3-20-20)T
- b.** An EMT candidate is allowed three (3) attempts to pass the exam, after which twenty-four (24) hours of remedial education must be successfully completed before another three (3) attempts are allowed. (3-20-20)T
- c.** An AEMT candidate is allowed three (3) attempts to pass the exam, after which thirty-six (36) hours of remedial education must be successfully completed before another three (3) attempts are allowed. (3-20-20)T
- d.** A Paramedic candidate is allowed three (3) attempts to pass the exam, after which forty-eight (48) hours of remedial education must be successfully completed before another three (3) attempts are allowed. (3-20-20)T
- 09. Submit Required Licensure Fee.** A candidate must submit the applicable initial licensure fee

provided in Section 111 of these rules. A candidate for EMR or EMT level of licensure has no fee requirement. (3-20-20)T

**111. APPLICATION FEES FOR PERSONNEL LICENSURE.**

**01. Initial Licensure.** A candidate applying for an initial personnel license must submit the following license fee at time of application: (3-20-20)T

**a.** EMR and EMT have no license fee. (3-20-20)T

**b.** AEMT and Paramedic license fee is thirty-five dollars (\$35). (3-20-20)T

**02. Renewal.** A candidate applying for personnel license renewal must submit the following amount at the time of application: (3-20-20)T

**a.** EMR and EMT have no license renewal fee. (3-20-20)T

**b.** AEMT and Paramedic license renewal fee is twenty-five dollars (\$25). (3-20-20)T

**03. Reinstatement.** A candidate applying for a personnel license reinstatement must pay the following amount at the time of application: (3-20-20)T

**a.** EMR and EMT have no reinstatement fee. (3-20-20)T

**b.** AEMT and Paramedic reinstatement fee is thirty-five dollars (\$35). (3-20-20)T

**112. -- 114. (RESERVED)**

**115. EMS PERSONNEL LICENSE DURATION.**

Duration of a personnel license is determined using the following specified time intervals. (3-20-20)T

**01. Initial License Duration for EMR and EMT Level Licensure.** EMR and EMT personnel licenses expire on March 31 or September 30. Expiration dates for EMR and EMT initial licenses are set for not less than thirty-six (36) months and not more than forty-two (42) months from the date of successful certification examination completion in order to establish an expiration date of March 31 or September 30. (3-20-20)T

**02. Initial License Duration for AEMT and Paramedic Level Licensure.** AEMT and Paramedic personnel licenses expire on March 31 or September 30. Expiration dates for AEMT and Paramedic initial licenses are set for not less than twenty-four (24) months and not more than thirty (30) months from the date of successful certification examination completion in order to establish an expiration date of March 31 or September 30. (3-20-20)T

**03. EMS Personnel License Renewal Duration for EMR and EMT Level Licensure.** An EMR and EMT level personnel license is renewed for three (3) years. (3-20-20)T

**04. EMS Personnel License Renewal Duration for AEMT and Paramedic Level Licensure.** An AEMT and Paramedic level personnel license is renewed for two (2) years. (3-20-20)T

**05. EMS REPLICIA Licensure Duration.** EMS personnel from another REPLICIA state who become licensed in Idaho will have their Idaho EMS license expire March 31 or September 30 following the expiration of their EMS license from the original state. (3-20-20)T

**116. PERSONNEL LICENSE TRANSITION.**

Personnel licensed at the AEMT level can opt to either transition to the AEMT-2011 level, or they may remain at the AEMT-1985 level. (3-20-20)T

**117. (RESERVED)**

**118. REPLICA EXPIRATION.**

EMS personnel from another REPLICA state who become licensed in Idaho will have their Idaho license expire in March or September following the expiration of their license in the original state. (3-20-20)T

**119. (RESERVED)**

**120. PERSONNEL LICENSE RENEWAL.**

Licensed personnel must provide documentation that they meet the following requirements: (3-20-20)T

**01. Documentation of Affiliation with EMS Agency.** A candidate applying for renewal of licensure must be affiliated with a licensed EMS agency which functions at, or above, the level of licensure being renewed. Documentation that the license holder is currently credentialed or undergoing credentialing by an affiliating EMS agency medical director must be submitted as assurance of affiliation for license renewal. (3-20-20)T

**02. Documentation of Continuing Education for Level of Licensure Renewal.** A candidate for renewal of licensure must provide documentation of continuing education consistent with the license holder's level of licensure. All continuing education and skill proficiency requirements must be completed under the provisions in Sections 300 through 325 of these rules. The time frame for continuing education courses must meet the following requirements: (3-20-20)T

**a.** All continuing education and skill proficiency requirements for renewal of an initial Idaho personnel license must be completed as follows: (3-20-20)T

i. For EMR or EMT, within the thirty-six (36) months preceding expiration. (3-20-20)T

ii. For AEMT and Paramedic, within the twenty-four (24) months preceding expiration. (3-20-20)T

**b.** All continuing education and skill proficiency requirements for successive licenses must be completed between the effective and expiration dates of the license being renewed, or according to Section 116 or 125 of these rules. (3-20-20)T

**c.** All continuing education and skill proficiency requirements for renewal of licenses obtained through conversion of a Certificate of Eligibility must be completed as follows: (3-20-20)T

i. For EMR or EMT, within the thirty-six (36) months preceding expiration. (3-20-20)T

ii. For AEMT and Paramedic, within the twenty-four (24) months preceding expiration. (3-20-20)T

**d.** A licensee certified by a national EMS certification body may petition the Department to review the certification standards under which the licensee was certified. The Department may waive specific duplicated continuing educational requirements where appropriate. When an external education requirement is found to be more rigorous than these rules, the Department may elect to renew a license based on that education. (3-20-20)T

**03. Declarations of Convictions or Adjudications.** A candidate for renewal of licensure must provide a declaration of any misdemeanor or felony adjudications. (3-20-20)T

**04. Time Frame for Application of Licensure Renewals.** Documentation of license renewal requirements is due to the EMS Bureau prior to the license expiration date. Failure to submit a complete renewal application by the license expiration date renders the license invalid and the individual must not practice or represent himself as a license holder. (3-20-20)T

**05. Submit Required Licensure Renewal Fees.** A candidate must submit the applicable license renewal fee provided in Section 111 of these rules. A candidate for EMR or EMT level of licensure has no fee requirement. (3-20-20)T

**121. -- 124. (RESERVED)**

**125. SUBMISSION OF EMS PERSONNEL LICENSURE APPLICATION AND DOCUMENTATION.**

Each EMS personnel license holder or candidate is responsible for meeting license renewal requirements and submitting completed license renewal documentation to the EMS Bureau by the current license expiration date.

(3-20-20)T

**01. Early Submission for License Renewal.**

(3-20-20)T

**a.** Licensed EMS personnel may submit renewal application and documentation to the EMS Bureau up to six (6) months prior to the current license expiration date.

(3-20-20)T

**b.** Continuing education (CE) taken after early submission of a renewal application may be counted as CE for the next licensure cycle. Prior to the expiration date of the current license, the licensee must submit written notification to the EMS Bureau of the intention to use those CE hours for the next licensure cycle.

(3-20-20)T

**02. EMS Personnel License Expiration Date Falls on a Non-Work Day.** When a license expiration date falls on a weekend, holiday, or other day the EMS Bureau is closed, the EMS Bureau will accept applications until the close of the next regular business day following the non-work day.

(3-20-20)T

**126. -- 129. (RESERVED)**

**130. LAPSED LICENSE.**

Licensed personnel who fail to submit a complete renewal application prior to the expiration date of their license cannot practice or represent themselves as licensed EMS personnel.

(3-20-20)T

**01. Failure to Submit an Application and Renewal Documentation.** No grace periods or extensions to an expiration date may be granted. After the expiration date the EMS personnel license will no longer be valid.

(3-20-20)T

**02. Application Under Review by the EMS Bureau.** Provided the license renewal candidate submitted the renewal application to the EMS Bureau prior to the application deadline, a personnel license does not lapse while under review by the EMS Bureau.

(3-20-20)T

**03. Failure to Provide Application Information Requested by the EMS Bureau.** After the expiration date of a license, a candidate for license renewal who does not provide the information requested by the EMS Bureau within twenty-one (21) days from the date of notification to the last known address, will be considered to have a lapsed license.

(3-20-20)T

**04. Reinstatement of Lapsed EMS Personnel License.** In order to reinstate at lapsed license, a candidate must submit an application for license reinstatement to the EMS Bureau within twenty-four (24) months of the expiration date of the lapsed license.

(3-20-20)T

**05. Reinstatement of an EMS Personnel License Lapsed for More Than Twenty-Four Months.** An individual whose license has been lapsed for more than twenty-four (24) months must retake and successfully complete an initial education course for the level of licensure for reinstatement. The individual must then meet all requirements in Section 110 of these rules for an initial personnel license.

(3-20-20)T

**131. REINSTATEMENT OF A LAPSED EMS PERSONNEL LICENSE.**

An individual desiring to reinstate a lapsed personnel license must provide documentation that he meets the following requirements:

(3-20-20)T

**01. Declaration of Previous Applications and Licensures.** A reinstatement candidate must declare each state or jurisdiction in which he has applied for, been denied, or held an EMS license or certification.

(3-20-20)T

**02. Authorization for Release of Information.** A reinstatement candidate must provide authorization for the EMS authority in other states or jurisdictions to release the candidate's registration, licensure, and certification

information to the Idaho EMS Bureau. (3-20-20)T

**03. Provide Current Affiliation with EMS Agency.** A reinstatement candidate must declare all organizations in which they are allowed to practice as licensed personnel. The candidate must have a current affiliation with a licensed EMS agency that functions at, or above, the level of licensure being sought by the candidate. (3-20-20)T

**04. Documentation of Continuing Education for Lapsed License Reinstatement.** A candidate for reinstatement of a lapsed license must provide documentation of continuing education consistent with the license holder's lapsed license. Continuing education requirements are provided in Sections 300 through 325 of these rules. The time frame for meeting the continuing education requirements for reinstatement are as follows: (3-20-20)T

**a.** The candidate must meet continuing education requirements under Sections 320 through 325 of these rules for the last valid licensure cycle; and (3-20-20)T

**b.** Additional continuing education hours in any combination of categories and venues, proportionate to the amount of time since the expiration date of the lapsed license, as follows: (3-20-20)T

i. EMR -- Three-quarters (3/4) of one (1) hour of continuing education per month of lapsed time. (3-20-20)T

ii. EMT -- One and one-half (1 ½) hours of continuing education per month of lapsed time. (3-20-20)T

iii. AEMT -- Two and one-quarter (2 ¼) hours of continuing education per month of lapsed time. (3-20-20)T

iv. Paramedic -- Three (3) hours of continuing education per month of lapsed time. (3-20-20)T

**05. Valid Identification for Reinstatement of Lapsed License.** A reinstatement candidate must have a valid state driver's license, an Idaho identification card which is issued by a county driver's license examining station, or identification card issued by the Armed Forces of the United States. (3-20-20)T

**06. Criminal History and Background Check for Reinstatement of Lapsed License.** A reinstatement candidate must successfully complete a criminal background check under the provisions in IDAPA 16.05.06, "Criminal History and Background Checks." Denial without the grant of an exemption under IDAPA 16.05.06 will result in denial of reinstatement of licensure. (3-20-20)T

**07. Competency Certification.** The Medical Director of the reinstatement candidate's affiliating EMS agency must certify that he has actively assessed the reinstatement candidate's competency in both the psychomotor and cognitive domains and found that the reinstatement candidate meets the baseline competency requirements for the level of the lapsed license. (3-20-20)T

**08. Submit Required Licensure Fee for Reinstatement.** A candidate must submit the applicable reinstatement license fee provided in Section 111 of these rules. A candidate for reinstatement of an EMR or EMT level of licensure has no fee requirement. (3-20-20)T

**09. Expiration Date of a Reinstated License.** The expiration date for a lapsed license that is reinstated is determined as provided in Section 115 of these rules. (3-20-20)T

**132. -- 139. (RESERVED)**

#### **140. RECOGNITION OF REGISTRATION, CERTIFICATION, OR LICENSURE FROM OTHER JURISDICTIONS.**

**01. EMS Personnel Licensed or Certified in Other States.** An individual, possessing an EMS personnel license or certification from a state other than Idaho, must have prior recognition or reciprocity granted by

the EMS Bureau prior to providing emergency medical care in Idaho. The following applies: (3-20-20)T

**a.** An individual certified or licensed in a state that has an interstate compact with Idaho that allows reciprocal recognition of EMS personnel may practice as licensed personnel as defined in the interstate compact. (3-20-20)T

**b.** An individual who is currently licensed or certified by another state to provide emergency medical care can apply to the EMS Bureau for limited recognition to practice in Idaho as provided in Subsection 140.02 of this rule. (3-20-20)T

**02. Limited Recognition in Idaho.** An individual, who is currently licensed or certified by another state to provide emergency medical care and applies to practice EMS within the confines of a specific incident, may be granted limited recognition by the EMS Bureau. Limited recognition allows an individual to practice EMS in Idaho only within the confines of the specific incident for which it was issued and only for a specified period of time not to exceed the duration of the incident for which it was issued. (3-20-20)T

**03. Personnel with NREMT Registration or Current EMS Certification.** An individual, possessing a current NREMT registration or a current EMS certification or license from another state at or above the level of licensure they are seeking in Idaho, is eligible for an Idaho EMS personnel licensure if they satisfy the requirements in Section 110 of these rules. (3-20-20)T

**04. Personnel Licensure Candidate Trained in Other States.** A candidate trained outside of Idaho must apply for and obtain an Idaho EMS license as required in Section 110 of these rules prior to providing emergency medical care in Idaho. A declaration that the candidate is fully eligible for EMS licensure in the state in which they were trained, must be obtained from the EMS licensing authority in that state and submitted to the EMS Bureau. (3-20-20)T

**141. -- 144. (RESERVED)**

**145. CHANGES TO AN EXISTING LICENSE.**

**01. Surrender of a Current EMS Personnel License.** An individual who possesses a current EMS personnel license may surrender that license at any time by submitting a letter of intent and their license to the EMS Bureau. (3-20-20)T

**02. Surrender of License to Prevent Investigation or Disciplinary Action.** Surrendering or expiration of a license does not prevent an investigation or disciplinary action against the individual. (3-20-20)T

**03. Relinquish a Current EMS Personnel License for a Lower Level License.** An individual who possesses a current license may relinquish that license and receive a license at a lower level with the same expiration date as the original license. The individual must have current affiliation with a licensed EMS agency which functions at, or higher than, the level of licensure being sought. (3-20-20)T

**04. Relinquishment of a License to a Lower Level License to Prevent Investigation or Disciplinary Action.** Relinquishing a personnel license does not prevent an investigation or disciplinary action against the individual. (3-20-20)T

**05. Reporting Requirements for Changes in Status.** Licensed personnel must notify the EMS Bureau within thirty (30) days of a change in name, mailing address, telephone number or agency affiliation. (3-20-20)T

**06. Personnel License Duration Shortened.** The EMS Bureau will issue a license with a shortened licensure duration upon the request of the license holder. (3-20-20)T

**146. MULTIPLE LICENSES.**

An individual may hold more than one (1) level of personnel licensure in Idaho, but can only renew one (1) personnel license at one (1) level. (3-20-20)T

147. -- 149. (RESERVED)

**150. CERTIFICATE OF ELIGIBILITY REQUIREMENTS.**

**01. Personnel Licensure Requirements are Met.** An individual, who has successfully completed an approved course, and meets all requirements for EMS personnel licensure required in Section 110 of these rules, except for obtaining an agency affiliation provided in Subsection 110.04 of these rules, may apply to the EMS Bureau for a certificate of eligibility. (3-20-20)T

**02. Certificate of Eligibility Duration.** Duration of a certificate of eligibility is determined using the specified time intervals of the personnel licensure level requirements in Section 115 of these rules. (3-20-20)T

**03. Criminal History and Background Check.** An individual applying for a certificate of eligibility must successfully complete a criminal history and background check within the six (6) months prior to the issuance or renewal of a certificate of eligibility, according to the provisions in IDAPA 16.05.06, "Criminal History and Background Checks." Denial without the grant of an exemption under the provisions in IDAPA 16.05.06, "Criminal History and Background Checks," will result in denial of a certificate of eligibility. (3-20-20)T

**04. Renewal of Certificate of Eligibility.** An individual must provide documentation that the following requirements have been met in order to renew a certificate of eligibility: (3-20-20)T

**a.** Continuing education requirements for the level of licensure listed under the license renewal requirements in Section 120 of these rules have been met; and (3-20-20)T

**b.** Successful completion of the standardized examination designated by the EMS Bureau for the certificate of eligibility. (3-20-20)T

**05. Revocation of Certificate of Eligibility.** The EMS Bureau will revoke a certificate of eligibility if the certificate holder is determined to no longer meet eligibility requirements or has obtained a personnel license. (3-20-20)T

**151. AMBULANCE CERTIFICATION.**

**01. Ambulance Certification is Required.** In order for a licensed EMR to serve as the sole patient care provider who is delivering patient care, the EMR must possess a current ambulance certification issued by the EMS Bureau. (3-20-20)T

**02. Ambulance Certification Requirements.** A licensed EMR applying for and meeting the requirements defined in this section of rule will be issued an ambulance certification. The requirements for ambulance certification are: (3-20-20)T

**a.** Have a valid, unrestricted EMR license; (3-20-20)T

**b.** Have successfully completed an ambulance certification training program, examination, and credentialing; (3-20-20)T

**03. Duration of Certification.** Ambulance certifications are valid as long as the license holder is continually licensed. (3-20-20)T

**04. Disciplinary and Corrective Action.** The Department may impose disciplinary and corrective actions on an ambulance certification based on the procedures for administrative license actions described in IDAPA 16.01.12, "Emergency Medical Services (EMS) – Complaints, Investigations, and Disciplinary Actions." (3-20-20)T

152. -- 174. (RESERVED)

**175. EMS BUREAU REVIEW OF APPLICATIONS.**



**01. Review of License Applications.** The EMS Bureau reviews each application for completeness and accuracy. Random applications are selected for audit by the EMS Bureau. Applications will also be audited when information declared on the application appears incomplete, inaccurate, or fraudulent. (3-20-20)T

**02. EMS Bureau Review of Renewal Application.** A personnel license does not expire while under review by the EMS Bureau, provided the license renewal candidate submitted the renewal application to the EMS Bureau prior to the application deadline required under Section 130 of these rules. (3-20-20)T

**176. -- 299. (RESERVED)**

**CONTINUING EDUCATIONAL AND SKILLS PROFICIENCY REQUIREMENTS  
FOR PERSONNEL LICENSURE  
(Sections 300-399)**

**300. CONTINUING EDUCATION AND SKILLS PROFICIENCY.**

**01. Continuing Education Must Meet Objectives of Initial Course Curriculum.** All continuing education and skills proficiency assurance must be consistent with the objectives of the initial course curriculum or be a logical progression of those objectives. (3-20-20)T

**02. Documentation of Continuing Education.** Licensed personnel must maintain documentation of all continuing education as follows: (3-20-20)T

**a.** An EMR and EMT must maintain documentation of continuing education for four (4) years. (3-20-20)T

**b.** An AEMT and Paramedic must maintain documentation of continuing education for three (3) years. (3-20-20)T

**03. Transition to New Scope of Practice.** Education required to transition to a new scope of practice must meet the following: (3-20-20)T

**a.** Within the same level of licensure, all transition education may count on an hour-for-hour basis in the appropriate categories within a single venue. When transition education hours exceed seventy-five percent (75%) of the total continuing education hours required, all continuing education hours can be in a single venue; and (3-20-20)T

**b.** Education must be completed during a single license duration. (3-20-20)T

**301. CONTINUING EDUCATION RECORDS ARE SUBJECT TO AUDIT.**

The EMS Bureau reserves the right to audit continuing education records to verify that renewal requirements have been met. (3-20-20)T

**01. Documentation Record.** All documentation for continuing education hours must include: (3-20-20)T

**a.** Name of attendee; (3-20-20)T

**b.** Date education was completed; and (3-20-20)T

**c.** Education sponsor or instructor. (3-20-20)T

**02. Proof of Completion.** The following are acceptable formats for proof of completion of continuing education: (3-20-20)T

**a.** Signed course roster; (3-20-20)T

- b. Certificate of completion; (3-20-20)T
- c. Electronic verification of completion of on-line course; (3-20-20)T
- d. Verification of attendance from EMS conference; (3-20-20)T
- e. Verification or proof of providing instruction; or (3-20-20)T
- f. Agency training record validated by agency administrator. (3-20-20)T

**302. -- 304. (RESERVED)**

**305. CONTINUING EDUCATION CATEGORIES FOR PERSONNEL LICENSURE RENEWAL.**

- 01. Airway.** (3-20-20)T
- 02. Cardiovascular.** (3-20-20)T
- 03. Trauma.** (3-20-20)T
- 04. Medical.** (3-20-20)T
- 05. Operations.** (3-20-20)T
- 06. Pediatrics.** (3-20-20)T

**306. -- 309. (RESERVED)**

**310. VENUES OF CONTINUING EDUCATION FOR PERSONNEL LICENSURE RENEWAL.**

Continuing education for all personnel must include at least two (2) of the venues described in Subsections 310.01 through 310.12 of this rule for each licensure period. (3-20-20)T

- 01. Structured Classroom Sessions.** (3-20-20)T
- 02. Refresher Programs.** Refresher programs that revisit the original curriculum and have an evaluation component (3-20-20)T
- 03. Nationally Recognized Courses.** (3-20-20)T
- 04. Regional and National Conferences.** (3-20-20)T
- 05. Teaching Continuing Education Topics.** The continuing education topics being taught must fall under the categories in Section 305 of these rules. (3-20-20)T
- 06. Agency Medical Director-Approved Self-Study or Directed Study.** This venue is not allowed to be used for a certificate of eligibility continuing education requirement. (3-20-20)T
- 07. Case Reviews and Grand Rounds.** (3-20-20)T
- 08. Distributed Education.** This venue includes distance and blended education using computer, video, audio, Internet, and CD resources (3-20-20)T
- 09. Journal Article Review with an Evaluation Instrument.** (3-20-20)T
- 10. Author or Co-Author an EMS-Related Article in a Nationally Recognized Publication.** (3-20-20)T

- 11. **Simulation Training.** (3-20-20)T
- 12. **Evaluator at a State or National Psychomotor Exam.** (3-20-20)T

**311. -- 319. (RESERVED)**

**320. LICENSE RENEWAL CONTINUING EDUCATION REQUIREMENTS.**

A license renewal candidate must provide documentation of the following continuing education hours provided in the table below during each licensure period. (3-20-20)T

<b>TABLE 320</b>				
<b>LICENSE RENEWAL CONTINUING EDUCATION (CE) REQUIREMENTS</b>				
<b>CE CATEGORIES</b>	<b>EMR</b>	<b>EMT</b>	<b>AEMT</b>	<b>PARAMEDIC</b>
	<b>24 TOTAL CE Hours</b>	<b>48 TOTAL CE Hours</b>	<b>54 TOTAL CE Hours</b>	<b>72 TOTAL CE Hours</b>
<b>An individual must complete at least 1 hour of continuing education in each category.</b>				
Airway, Respiration, and Ventilation	No more than 7 CE hours in any single category may be counted toward the total number of CE Hours needed for renewal.	No more than 14 CE hours in any single category may be counted toward the total number of CE Hours needed for renewal.	No more than 16 CE hours in any single category may be counted toward the total number of CE Hours needed for renewal.	No more than 22 CE hours in any single category may be counted toward the total number of CE Hours needed for renewal.
Cardiovascular				
Trauma				
Medical				
Operations: Landing Zone & Extrication Awareness				
Pediatrics	2 hours	4 hours	6 hours	8 hours

(3-20-20)T

**321. -- 324. (RESERVED)**

**325. LICENSE RENEWAL SKILLS PROFICIENCY REQUIREMENTS.**

A license renewal candidate must demonstrate proficiency in the skills necessary to provide safe and effective patient care at the licensure level consistent with the scope of practice provided in IDAPA 16.02.02, "Idaho Emergency Medical Services (EMS) Physician Commission." (3-20-20)T

**326. -- 999. (RESERVED)**

## 16.02.01 – IDAHO TIME SENSITIVE EMERGENCY SYSTEM COUNCIL

### 000. LEGAL AUTHORITY.

The Idaho Time Sensitive Emergency System Council (TSE) is authorized under Section 56-1028, Idaho Code, to promulgate rules for the purpose of establishing standards and for the administration of a voluntary time sensitive emergency system of care. Sections 56-1024 through 56-1030, Idaho Code, provide requirements for the TSE Council, its membership, duties, regional TSE committees, standards criteria, and the designation of centers. The Department is authorized to charge and collect fees established by rule under Section 56-1007, Idaho Code, and to establish and collect data for a Time Sensitive Emergency (TSE) Registry under Section 57-2003, Idaho Code.

(3-20-20)T

### 001. TITLE, SCOPE, AND INTENT.

**01. Title.** The title of these rules is IDAPA 16.02.01, “Idaho Time Sensitive Emergency System Council.”

(3-20-20)T

**02. Scope.** These rules provide for the administration and establishment of standards for a voluntary statewide time sensitive emergency system of care that includes procedures and requirements for designation of trauma, stroke, and heart attack centers including data reporting, fees, appeal process and enforcement procedures, determination of regions to provide an effective access to the TSE system within the state, and operational procedures for regional TSE committees.

(3-20-20)T

**03. Intent.** With the maturation of the Time Sensitive Emergency System (TSE), the intent is for the state to have the ability to designate TSE centers without reliance on national accreditation bodies. The TSE Council, upon review of appropriate documentation, may provide reciprocity for facilities in Idaho that also choose to operate under a designation in a neighboring state’s system.

(3-20-20)T

### 002. -- 003. (RESERVED)

### 004. INCORPORATION BY REFERENCE.

The Time Sensitive Emergency System Standards Manual, Edition 2020-1, is incorporated by reference in this chapter of rules. Copies of the manual may be obtained online at <https://tse.idaho.gov/> or from the Bureau of Emergency Medical Services and Preparedness located at 2224 East Old Penitentiary Road, Boise, ID 83712-8249.

(3-20-20)T

### 005. -- 009. (RESERVED)

### 010. DEFINITIONS.

For the purposes of this chapter, the following terms and definitions apply.

(3-20-20)T

**01. American College of Surgeons (ACS).** The American College of Surgeons (ACS) is a national body that sets standards and verifies compliance with published standards.

(3-20-20)T

**02. Department.** The Idaho Department of Health and Welfare.

(3-20-20)T

**03. Director.** The Director of the Idaho Department of Health and Welfare or their designee.

(3-20-20)T

**04. Division.** The Division of Public Health, Idaho Department of Health and Welfare.

(3-20-20)T

**05. EMS Agency.** Any organization licensed by the Department under Sections 56-1011 through 56-1023, Idaho Code, and IDAPA 16.01.03, “Emergency Medical Services (EMS) - Agency Licensing Requirements,” that operates an air medical service, ambulance service, or non-transport service.

(3-20-20)T

**06. EMS Bureau.** The Bureau of Emergency Medical Services (EMS) & Preparedness of the Idaho Department of Health and Welfare.

(3-20-20)T

**07. Facility.** A health care organization that is voluntarily seeking designation from the Idaho Time Sensitive Emergency Council. A facility may be any of the following:

(3-20-20)T

**a. Center.** A facility designated by the Idaho Time Sensitive Emergency Council is known as a center.

(3-20-20)T

- b.** Freestanding emergency department: (3-20-20)T

  - i. Is owned by a hospital with a dedicated emergency department; (3-20-20)T
  - ii. Is located within thirty-five (35) miles of the hospital that owns or controls it; (3-20-20)T
  - iii. Provides emergency services twenty-four (24) hours per day, seven (7) days per week on an outpatient basis; (3-20-20)T
  - iv. Is physically separate from a hospital; and (3-20-20)T
  - v. Meets the staffing and service requirements in IDAPA 16.03.14, "Hospitals." (3-20-20)T
- c.** Hospital. As defined in Section 39-1301, Idaho Code, is a facility primarily engaged in providing, by or under the daily supervision of physicians: (3-20-20)T

  - i. Concentrated medical and nursing care on a twenty-four (24) hour basis to inpatients experiencing acute illness; (3-20-20)T
  - ii. Diagnostic and therapeutic services for medical diagnosis and treatment, psychiatric diagnosis and treatment, and care of injured, disabled, or sick persons; (3-20-20)T
  - iii. Rehabilitation services for injured, disabled, or sick persons; (3-20-20)T
  - iv. Obstetrical care; (3-20-20)T
  - v. Provides for care of two (2) or more individuals for twenty-four (24) or more consecutive hours; and (3-20-20)T
  - vi. Is staffed to provide nursing professional nursing care on a twenty-four (24) hour basis. (3-20-20)T
- d.** Rural Clinic. A health care clinic in a rural area that is located more than thirty-five (35) miles from a hospital via maintained roads and is capable of providing emergency care to patients. (3-20-20)T
- 08. Heart Attack.** STEMI, a common name for ST-elevation myocardial infarction, is a more precise definition for a type of heart attack caused by a prolonged period of blocked blood supply that affects a large area of the heart and has a substantial risk of death or disability calling for a quick response. (3-20-20)T
- 09. Idaho Time Sensitive Emergency (TSE) System Council.** The Idaho Time Sensitive Emergency System Council established in Section 56-1027, Idaho Code. (3-20-20)T
- 10. National Accrediting Body.** An organization whose standards criteria is recognized by the Idaho Time Sensitive Emergency System Council and verifies compliance with those standards. (3-20-20)T
- 11. Regional Time Sensitive Emergency (TSE) Committee.** An Idaho regional TSE committee established under Section 56-1030, Idaho Code. (3-20-20)T
- 12. STEMI.** STEMI is an ST segment elevation myocardial infarction that is a particular type of heart attack, or MI (myocardial infarction), that is caused by a prolonged period of blocked blood supply. It affects a large area of the heart muscle, and so causes changes on the ECG as well as in blood levels of key chemical markers. This is considered a major heart attack and is referred to in medical shorthand as a STEMI. (3-20-20)T
- 13. Stroke.** An interruption of blood flow to the brain causing paralysis, slurred speech, or altered brain function usually caused by a blockage in a blood vessel that carries blood to the brain (ischemic stroke) or by a blood vessel bursting (hemorrhagic stroke). (3-20-20)T
- 14. Time Sensitive Emergency (TSE).** Time sensitive emergencies specifically for this chapter of

rules are trauma, stroke, and heart attack. (3-20-20)T

**15. Trauma.** The result of an act or event that damages, harms, or hurts a human being resulting in intentional or unintentional damage to the body resulting from acute exposure to mechanical, thermal, electrical, or chemical energy, or from the absence of such essentials as heat or oxygen. (3-20-20)T

**16. TSE-Designated Center.** A facility that has voluntarily applied for TSE designation, met and is in compliance with the designation criteria and standards of these rules, and that the TSE Council has designated as one (1) or more of the following: (3-20-20)T

- a. Level I Trauma Center; (3-20-20)T
- b. Level II Trauma Center; (3-20-20)T
- c. Level III Trauma Center; (3-20-20)T
- d. Level IV Trauma Center; (3-20-20)T
- e. Level V Trauma Center; (3-20-20)T
- f. Pediatric Level I Trauma Center; (3-20-20)T
- g. Pediatric Level II Trauma Center; (3-20-20)T
- h. Level I Stroke Center (Comprehensive); (3-20-20)T
- i. Level II Stroke Center (Primary); (3-20-20)T
- j. Level III Stroke Center (Acute Stroke Ready); (3-20-20)T
- k. Level I STEMI Center (Heart Attack Receiving); or (3-20-20)T
- l. Level II STEMI Center (Heart Attack Referring). (3-20-20)T

**17. TSE Registry.** The population-based data system defined under Section 57-2003, Idaho Code. (3-20-20)T

**18. TSE System.** An organized statewide approach to treating trauma, stroke, and heart attack patients that establishes and promotes standards for patient transportation, equipment, and information analysis for effective and coordinated TSE care. (3-20-20)T

**011. -- 074. (RESERVED)**

**075. TSE COUNCIL.**

Under Section 56-1027, Idaho Code, the TSE Council will consist of members appointed by the Governor of Idaho and the chair of each regional TSE committee. (3-20-20)T

**076. TSE COUNCIL -- RESPONSIBILITIES AND DUTIES.**

The TSE Council is responsible for the duties described under Section 56-1028, Idaho Code. (3-20-20)T

**077. -- 079. (RESERVED)**

**080. TSE REGIONS.**

Under Section 56-1028, Idaho Code, the TSE Council is required to establish TSE regions that provide more effective access to the Idaho TSE system through education, but not for the purpose of promoting competition, restricting, or directing patient referrals within the region. The TSE Council has established six (6) regions in Idaho described in the Time Sensitive Emergency System Standards Manual incorporated under Section 004 of these rules. (3-20-20)T

**081. TSE REGIONS -- REALIGNMENT OF REGION.**

The TSE Council may realign a region by initiation of the TSE Council, or at the request of a regional TSE committee, a county or local government entity within the region, a TSE-designated center, or a licensed EMS agency within the region. (3-20-20)T

**01. Requesting Entity.** The requesting entity must forward correspondence to the TSE Council specifying the reason for the realignment request. The correspondence must include: (3-20-20)T

- a. Existing patient routing patterns used by both EMS agencies and health care centers; (3-20-20)T
- b. Distances and transport times involved in patient routing patterns; (3-20-20)T
- c. A list of all entities affected by the request; (3-20-20)T
- d. A list of all other licensed health care facilities and licensed EMS agencies in the county; and (3-20-20)T
- e. Documentation that all affected regional TSE committees are agreeable to the realignment. (3-20-20)T

**02. Copies of Request for Realignment.** The entity requesting the TSE Council for realignment must provide copies of the correspondence to all affected regional TSE committees, county and local governments, licensed health care facilities, and EMS agencies in the requesting entity's county. (3-20-20)T

**03. TSE Decision for Realignment.** The TSE Council will evaluate the request based on the impact to patient care and will notify all parties of the council's decision. (3-20-20)T

**082. REGIONAL TSE COMMITTEES -- ORGANIZATION AND RESPONSIBILITIES.**

The regional TSE committees' organization and responsibilities are described under Section 56-1030, Idaho Code. (3-20-20)T

**083. -- 099. (RESERVED)**

**100. DESIGNATION OF TSE CENTERS -- CRITERIA.**

Under Section 56-1029, Idaho Code, the TSE Council will designate a hospital as a trauma, stroke, or STEMI (heart attack) center when such hospital, upon proper application and verification, is found by the TSE Council to meet an applicable designation level for trauma, stroke, or STEMI (heart attack) designation criteria established in the Time Sensitive Emergency System Standards Manual incorporated under Section 004 of these rules. (3-20-20)T

**101. -- 104. (RESERVED)**

**105. TRAUMA DESIGNATION CENTERS.**

To be an Idaho TSE-designated Level I, II, III, IV, V, or a Pediatric Level I or Level II Trauma Center, a facility must meet or exceed required standards published for state designation in the Time Sensitive Emergency System Standards Manual incorporated under Section 004 of these rules. (3-20-20)T

**106. -- 109. (RESERVED)**

**110. STROKE DESIGNATION CENTERS.**

To be an Idaho TSE-designated Level I, II, or III Stroke Center, a facility must meet or exceed required standards published for state designation in the Time Sensitive Emergency System Standards Manual incorporated by reference under Section 004 of these rules. (3-20-20)T

**111. -- 114. (RESERVED)**

**115. STEMI (HEART ATTACK) DESIGNATION CENTERS.**

To be an Idaho TSE-designated Level I or II STEMI (Heart Attack) Center, a facility must meet or exceed required standards published for state designation in the Time Sensitive Emergency System Standards Manual incorporated under Section 004 of these rules. (3-20-20)T

**116. -- 119. (RESERVED)**

**120. DESIGNATION OF CENTERS -- GENERAL REQUIREMENTS.**

**01. Application.** A facility applying for initial TSE designation must submit an application along with applicable fees for each designation it is requesting. Application process and requirements are provided in the Time Sensitive Emergency System Standards Manual incorporated under Section 004 of these rules. Fee requirements are provided in Section 200 of these rules. (3-20-20)T

**02. Initial Designation.** Initial designation requires completion of appropriate application, submission of appropriate fees, and completion of an appropriate on-site survey based on the Time Sensitive Emergency System Standards Manual incorporated by reference under Section 004 of these rules. (3-20-20)T

**121. -- 189. (RESERVED)**

**190. TSE DESIGNATION -- LENGTH OF DESIGNATION.**

A TSE center will be designated for a period of three (3) years, unless the designation is rescinded by the TSE Council for non-compliance with the designation standards of these rules or adjusted to coincide with applicable external verification timetables. (3-20-20)T

**191. RENEWAL OF TSE DESIGNATION.**

A TSE center must submit its renewal application and applicable fees no later than six (6) months prior to the center's designation expiration date. Designation will not lapse due to a delay in scheduling the on-site survey, if the delay is through no fault of renewing center. (3-20-20)T

**192. -- 194. (RESERVED)**

**195. NOTIFICATION OF LOSS OF CERTIFICATION OR LICENSURE.**

Any TSE-designated center that has a loss of certification or licensure must immediately notify the TSE Council by contacting TSE program staff. (3-20-20)T

**196. -- 199. (RESERVED)**

**200. DESIGNATION AND TSE ON-SITE SURVEY FEES.**

**01. Application With National Verification.** An applicant applying for a TSE designation that is verified by a national accrediting body must submit the appropriate designation fees with its application for initial designation and renewal. The designation fees are for a three (3) year designation and are payable on an annual basis. TSE designation fees are not to exceed those listed in Subsections 200.03 through 200.05 of this rule. (3-20-20)T

**02. Application Without National Verification.** An applicant who requires a TSE on-site survey prior to designation is required to pay the applicable on-site survey fee at the time of application. TSE designation and on-site survey fees are not to exceed those listed in Subsections 200.03 through 200.05 of this rule. (3-20-20)T

**03. Trauma Designation and TSE On-Site Survey Fees.**

<b>TRAUMA DESIGNATIONS 200.03</b>	<b>DESIGNATION FEE 3-year / Annual (Not to exceed)</b>	<b>TSE ON-SITE SURVEY FEE (Not to exceed)</b>
LEVEL I	\$45,000 / \$15,000	\$3,000 / Not applicable with ACS verification



<b>TRAUMA DESIGNATIONS 200.03</b>	<b>DESIGNATION FEE 3-year / Annual (Not to exceed)</b>	<b>TSE ON-SITE SURVEY FEE (Not to exceed)</b>
LEVEL II	\$36,000 / \$12,000	\$3,000 / Not applicable with ACS verification
LEVEL III	\$24,000 / \$8,000	\$3,000 / Not applicable with ACS verification
LEVEL IV	\$12,000 / \$4,000	\$1,500 / Not applicable with ACS verification
LEVEL V	\$3,000 / \$1,000	\$1,500
PEDIATRIC LEVEL I and LEVEL II	\$36,000 / \$12,000	\$3000 / Not applicable with ACS verification

(3-20-20)T

**04. Stroke Designation and TSE On-Site Survey Fees.**

<b>STROKE DESIGNATIONS 200.04</b>	<b>DESIGNATION FEE 3-year / Annual (Not to exceed)</b>	<b>TSE ON-SITE SURVEY FEE (Not to exceed)</b>
LEVEL I	\$21,000 / \$7,000	\$3,000 / Not applicable with national or acceptable state verification
LEVEL II	\$12,000 / \$4,000	\$3,000 / Not applicable with national or acceptable state verification
LEVEL III	\$1,500 / \$500	\$3,000 / Not applicable with national or acceptable state verification

(3-20-20)T

**05. STEMI (Heart Attack) Designation and TSE On-Site Survey Fees.**

<b>STEMI (HEART ATTACK) DESIGNATIONS 200.05</b>	<b>DESIGNATION FEE 3-year / Annual (Not to exceed)</b>	<b>TSE ON-SITE SURVEY FEE (Not to exceed)</b>
LEVEL I	\$21,000 / \$7,000	\$3,000 / Not applicable with national or acceptable state verification
LEVEL II	\$1,500 / \$500	\$3,000 / Not applicable with national or acceptable state verification

(3-20-20)T

**06. Designation Fee Payment.** After completion of the TSE on-site survey, the TSE Council will notify the applicant facility of the designation determination by letter. The applicant facility must then pay either the annual designation fee or the entire three (3) year designation fee. After designation notification and upon the

Department's receipt of the designation fee, designation is effective. The TSE Council will send a certificate of designation and confirmation of the designation period. Annual designation fees for those facilities paying yearly are due to the Department within thirty (30) days of the date of the invoice in order to maintain designation. Failure to meet this deadline will result in suspension or revocation of designation as provided in Section 285 of these rules. (3-20-20)T

**201. -- 249. (RESERVED)**

**250. TSE ON-SITE SURVEY.**

The TSE Council will conduct an on-site survey of each TSE-designated center at least once every three (3) years, unless the center has been verified by a national accrediting body to meet or exceed the standards set in these rules. The TSE Council will schedule the on-site survey with the designated center in a timely manner. (3-20-20)T

**251. TSE ON-SITE SURVEY -- GENERAL REQUIREMENTS.**

The TSE on-site survey will consist of and consider each facility's application and compliance with the standards published for state designation and incorporated under Section 004 of these rules for the specific type of designation being requested. The general requirements in Subsections 251.01 through 251.06 of this rule apply: (3-20-20)T

**01. Survey Team Member Requirements.** Survey team members will meet the following inclusion criteria: (3-20-20)T

**a.** A physician surveyor must: (3-20-20)T

**i.** Be certified by the American Board of Medical Specialties or the American Board of Osteopathic Medicine; (3-20-20)T

**ii.** Be board-certified in the specialty area being represented on the review team; (3-20-20)T

**iii.** Be currently active, or active in the last twelve (12) months, in trauma, stroke, or emergency cardiac care at a center that is at or above the level being reviewed; (3-20-20)T

**iv.** Have no conflict of interest with the facility under review; (3-20-20)T

**v.** Be from another state when performing a survey for Level I or Level II Trauma Center designations; and (3-20-20)T

**vi.** Be from outside the region of the center being verified. (3-20-20)T

**b.** A nurse surveyor or program manager must: (3-20-20)T

**i.** Be currently active, or active in the last twelve (12) months, in trauma, stroke, or emergency cardiac care at a center that is at or above the level being reviewed; and (3-20-20)T

**ii.** Have no conflict of interest with the facility under review; (3-20-20)T

**iii.** Be from another state when performing a survey for Level I or Level II Trauma Center designations; and (3-20-20)T

**iv.** Be from outside the region of the center being verified. (3-20-20)T

**02. Communication Between Surveyors and Facilities.** In order to standardize ethical practice, all communication between surveyors and facilities prior to the survey must be facilitated by TSE program staff. (3-20-20)T

**03. Survey Team Member Notification of Potential Conflict of Interest.** Upon being assigned to an on-site survey team, a potential team member must notify the TSE Council of any potential conflict of interest regarding any financial, professional, or personal bias that may affect the survey of the applicant's facility.

(3-20-20)T

**04. Notification to Applicant of Survey Team Members.** The TSE Council will provide the applicant with the names of the on-site survey team once they have been selected and at least thirty (30) calendar days prior to the scheduled survey. (3-20-20)T

**05. Facility Notification to TSE Council of Potential Conflict of Interest.** If the applicant believes that a potential surveyor has a financial, professional, or personal bias that may affect the survey, the applicant must notify the TSE Council in writing no later than seven (7) calendar days after the applicant receives the TSE Council's notification of the proposed survey team. (3-20-20)T

**06. Notification of Decision for Conflict of Interest.** The TSE Council will consider the conflict of interest notice and make a decision concerning replacement of the survey team member in question. No person who has a substantial conflict of interest in the operation of any facility under review will participate in the on-site survey of the applicant. (3-20-20)T

**252. TSE ON-SITE SURVEY -- SURVEY TEAM COMPOSITION.**

The TSE Council will select an on-site survey team based on the applicant's designation application and specifications provided in these rules and the standards published in the Time Sensitive Emergency System Standards Manual incorporated under Section 004 of these rules. (3-20-20)T

**253. ON-SITE SURVEY -- ADDITIONAL SURVEYS.**

The TSE Council may conduct additional, announced or unannounced, full or partial, on-site reviews of TSE designated centers or applicants when there is reason to believe that the center is not in compliance with the designation criteria standards of these rules. (3-20-20)T

**254. -- 259. (RESERVED)**

**260. DESIGNATION DECISION.**

**01. Summary Report.** The survey team will present a verbal summary of the survey results to the applicant. The survey team will submit in writing to the TSE Council its recommendation on the center's designation at the completion of the site survey. (3-20-20)T

**02. Written Report.** The TSE Council will consider all evidence and notify the applicant in writing of its decision within thirty (30) calendar days of receiving the survey team's recommendation. (3-20-20)T

**03. Final Determination.** The TSE Council's final determination regarding each application will be based upon consideration of: (3-20-20)T

**a.** The application; (3-20-20)T

**b.** The evaluation and recommendations of the on-site survey team; (3-20-20)T

**c.** The best interests of patients; and (3-20-20)T

**d.** Any unique attributes or circumstances that make the facility capable of meeting special community needs. (3-20-20)T

**04. Provisional Designation.** The TSE Council may grant a provisional designation to a facility with deficiencies it deems correctable. A facility receiving a provisional designation must: (3-20-20)T

**a.** Resolve the deficiencies within the time period specified by the TSE Council; (3-20-20)T

**b.** Submit documentation that the deficiency has been resolved; and (3-20-20)T

**c.** If necessary, submit to an additional focused on-site survey and pay the applicable survey fees.

(3-20-20)T

**05. Denial.** If the TSE Council denies an applicant a designation, the provisions of IDAPA 16.05.03, “Contested Case Proceedings and Declaratory Rulings,” will apply. (3-20-20)T

**261. -- 269. (RESERVED)**

**270. WAIVERS.**

**01. Granting a Waiver.** The TSE Council may grant a waiver from one (1) or more designation criteria for a center applying for TSE designation. (3-20-20)T

**02. Waiver Application.** A center requesting a waiver must submit a completed TSE Waiver Application Form. The TSE Council may require the applicant to provide additional information, and the application will not be considered complete until all required information is provided. (3-20-20)T

**03. Post Notice.** A center requesting a waiver must post a notice of the waiver application at all public entrances to the center and in at least one (1) area that is commonly used by the patients. The notice must: (3-20-20)T

- a.** Include a meaningful description of the reason for the waiver; (3-20-20)T
- b.** Be posted on the date the waiver application is submitted; (3-20-20)T
- c.** Remain posted for a minimum of thirty (30) calendar days; and (3-20-20)T
- d.** Describe where and to whom comments may be submitted during the thirty (30) calendar days. (3-20-20)T

**04. Notice Distribution.** When the notice is posted, the center must also distribute copies of the notice to prehospital emergency medical service agencies active in the community served by the center. (3-20-20)T

**05. Waiver Application Submission.** The completed waiver application must be submitted to the TSE Council at least thirty (30) calendar days before a TSE Council meeting in order to be placed on the agenda. Applications submitted less than thirty (30) calendar days in advance of a TSE Council meeting will be placed on the next agenda. (3-20-20)T

**06. Waiver Application Distribution.** The TSE Council will make available the public notice of the TSE Council meeting regarding the waiver application to all TSE-designated centers. (3-20-20)T

**07. Waiver Application Review.** The regional TSE committee must review the request and make recommendations to the TSE Council. The TSE Council must make a decision and notify the facility administrator in writing within thirty (30) calendar days of the TSE Council meeting during which the waiver decision is made. (3-20-20)T

**08. Waiver Conditions.** When a waiver is granted, the TSE Council must: (3-20-20)T

- a.** Specify the terms and conditions of the waiver; (3-20-20)T
- b.** Specify the duration of the waiver; duration will not exceed the designation period for that center or three (3) years, whichever is shorter; and (3-20-20)T
- c.** Require the submission of progress reports from the center that was granted a waiver. (3-20-20)T

**09. Waiver Renewal.** A center that plans to maintain a waiver beyond its expiration must submit a new waiver application to the TSE Council no less than three (3) months prior to the expiration of the waiver. (3-20-20)T

- 10. Waiver Revocation.** The TSE Council may revoke or suspend a waiver when it determines: (3-20-20)T
- a.** That continuation of the waiver jeopardizes the health, safety, or welfare of the patients;(3-20-20)T
  - b.** The applicant has provided false or misleading information in the waiver application; (3-20-20)T
  - c.** The applicant has failed to comply with conditions of the waiver; or (3-20-20)T
  - d.** That a change in federal or state law prohibits continuation of the waiver. (3-20-20)T

**11. Notification and Appeal.** When the TSE Council denies, revokes, or suspends a waiver, the TSE Council must provide the center with a written notification of the action and the basis for the action. The notice will inform the facility of the right to appeal and the procedure to appeal the waiver action under the provisions in IDAPA 16.05.03, "Contested Case Proceedings and Declaratory Rulings." Notification will be made in writing within thirty (30) calendar days of the TSE Council meeting during which the appeal decision is made. (3-20-20)T

**271. -- 279. (RESERVED)**

**280. DENIAL AND MODIFICATION.**

- 01. Denial.** The TSE Council may deny an initial or renewal application for a center's designation when a center: (3-20-20)T
- a.** Does not meet the criteria for designation required in these rules; (3-20-20)T
  - b.** Application or accompanying documents contain false statements of material facts; (3-20-20)T
  - c.** Refuses to allow any part of an on-site survey; (3-20-20)T
  - d.** Fails to comply with or to successfully complete a plan of correction, or (3-20-20)T
  - e.** Is substantially out of compliance with any TSE rules. (3-20-20)T

**02. Modification.** When a center fails to meet the criteria at the level of designation for which it applied or opts to surrender its designation, the TSE Council may recommend a designation at a lesser level described in Section 290 of these rules, or a complete revocation of state designation. This action, unless agreed to by the applicant, will represent a denial of the application. (3-20-20)T

**03. Notification and Appeal.** When the TSE Council denies an application for designation, the TSE Council must provide the center with a written notification of the denial and the basis for the denial. The notice will inform the facility of the right to appeal and the procedure to appeal the denial under the provisions in IDAPA 16.05.03, "Contested Case Proceedings and Declaratory Rulings." (3-20-20)T

**281. -- 284. (RESERVED)**

**285. REVOCATION AND SUSPENSION.**

- 01. Revocation.** The TSE Council may revoke the designation of a center or a waiver when an owner, officer, director, manager, or other employee: (3-20-20)T
- a.** Fails or refuses to comply with the provisions of these rules; (3-20-20)T
  - b.** Fails to make annual designation fee payment for those facilities paying yearly; (3-20-20)T
  - c.** Makes a false statement of material fact about the center's capabilities or other pertinent circumstances in any record or matter under investigation for any purposes connected with these rules; (3-20-20)T

**d.** Prevents, interferes with, or attempts to impede in any way, the work of a representative of the TSE Council in implementing or enforcing these rules; (3-20-20)T

**e.** Falsely advertises, or in any way misrepresents the facility's ability to care for patients based on its designation status; (3-20-20)T

**f.** Is substantially out of compliance with these rules and has not rectified such noncompliance; (3-20-20)T

**g.** Fails to provide reports required by the TSE registry or the Department in a timely and complete fashion; or (3-20-20)T

**h.** Fails to comply with or complete a plan of correction in the time or manner specified. (3-20-20)T

**02. Suspension.** The TSE Council may suspend a center's designation or waiver when it finds, after investigation, that the center has engaged in a deliberate and willful violation of these rules, or that the public's health, safety, or welfare is endangered. (3-20-20)T

**03. Notification and Appeal.** When the TSE Council revokes or suspends a center's designation or waiver, it must provide the center with a written notification of the action and the basis for the action. The notice will inform the center of the right to appeal and the procedure to appeal the action under the provisions in IDAPA 16.05.03, "Contested Case Proceedings and Declaratory Rulings." (3-20-20)T

**286. -- 289. (RESERVED)**

**290. DESIGNATION AT A LESSER LEVEL.**

**01. Inability to Meet Criteria.** The TSE Council may opt to redesignate a center at a lesser level due to the center's inability to meet current designation criteria, without regard to any waiver previously granted. (3-20-20)T

**02. Notification and Appeal.** When the TSE Council decides to redesignate a center, it must provide the center with a written notification of the action and the basis for the action. The notice will inform the center of the right to appeal and the procedure to appeal the action under the provisions in IDAPA 16.05.03, "Contested Case Proceedings and Declaratory Rulings." (3-20-20)T

**291. -- 999. (RESERVED)**

## 16.02.08 – VITAL STATISTICS RULES

### 000. LEGAL AUTHORITY.

The Idaho Board of Health and Welfare is authorized under Section 39-242, Idaho Code, to adopt rules that carry out the provisions of Title 39, Chapter 2, Idaho Code, related to vital statistics. (3-20-20)T

### 001. TITLE.

These rules are titled IDAPA 16.02.08, “Vital Statistics Rules.” (3-20-20)T

### 002. -- 049. (RESERVED)

### 050. TERMS AND DEFINITIONS.

For the purpose of vital statistics administration, the following definitions are applicable to this chapter: (3-20-20)T

**01. Assistant Local Registrar.** An individual, appointed by the State Registrar of Vital Statistics, who carries out the prescribed functions of the local registrar in the same location as the local registrar, either as an assistant to, or in the absence of, the local registrar. (3-20-20)T

**02. Attendant at Birth or Stillbirth.** Any physician, midwife, or other person who assists in the delivery of a live born infant or stillborn fetus. (3-20-20)T

**03. Birth Out of Wedlock.** A birth occurring when the mother was not married at the time of either conception or birth, or between conception and birth. (3-20-20)T

**04. Confidential Registry.** A file of all notices of putative fathers’ claims to paternity for their child(ren) born out of wedlock and intent to support such child(ren), that is established in the office of the State Registrar of Vital Statistics. (3-20-20)T

**05. Current Registration.** The filing of a certificate less than one (1) year after the event occurs. (3-20-20)T

**06. Delayed Registration.** The filing of a certificate one (1) year or more after the event occurs. (3-20-20)T

**07. Department.** The Idaho Department of Health and Welfare. (3-20-20)T

**08. Director.** The Director of the Idaho Department of Health and Welfare or designated individual. (3-20-20)T

**09. Expedited Certified Copy.** A certified copy of a vital record that has been given priority status for processing and issuance or issued by a local deputy state registrar. (3-20-20)T

**10. Local Deputy State Registrar.** The local registration officer designated by the Director to serve in a single health district for limited purposes. (3-20-20)T

**11. Local Registrar.** The local registration officer identified in Section 39-247, Idaho Code, appointed by the State Registrar of Vital Statistics to collect certificates of birth, death, and stillbirth, and to carry out duties incidental to registration within a specified territory. (3-20-20)T

**12. Mortician or Funeral Director.** Any person who makes a business of disposing of dead bodies. The term “mortician or person acting as such” refers to any person having charge of the burial, cremation, or other disposition of a dead body. This includes stillborn fetuses. (3-20-20)T

**13. Nurse Midwife.** A nurse practitioner who is certified by the Idaho Board of Nursing to practice midwifery. (3-20-20)T

**14. Putative Father.** The biological father of a child as identified by himself, the natural mother, an adoption agency, or a court. (3-20-20)T

**15. Registration District.** The district (area of land) specified in the letter of appointment to the local registrar over which the local registrar exercises exclusive local control for the purpose of vital record registration. (3-20-20)T

**16. Relatives of Deceased Qualified Adult Adoptees.** The adoptive parents or grandparents of the adult adoptee. (3-20-20)T

**17. Relatives of Deceased Qualified Birth Parents.** The parents or grandparents of birth parents. (3-20-20)T

**051. -- 099. (RESERVED)**

**100. CERTIFICATES, RECORDS, AND FORMS.**

**01. Form and Content.** The Director will prescribe the form and content of official vital records and certificates. (3-20-20)T

**02. Official Nature of Forms.** Other forms and reports may be prescribed and distributed by the State Registrar for reporting vital statistics. These forms and reports may be used only for official purposes. (3-20-20)T

**03. Requirements for Preparation of Certificates.** All certificates and records relating to vital statistics must be printed legibly in dark, unfading ink. All signatures required must be entered in dark, unfading ink. Unless otherwise directed by the State Registrar, no certificate will be complete and correct and acceptable for registration that: (3-20-20)T

**a.** Does not have the certifier's name typed or printed legibly under the certifier's signature; (3-20-20)T

**b.** Does not supply all items of information called for thereon or satisfactorily account for their omission; (3-20-20)T

**c.** Contains alterations or erasures; (3-20-20)T

**d.** Does not contain signatures as required; (3-20-20)T

**e.** Is marked "copy" or "duplicate"; (3-20-20)T

**f.** Is a photographic or a carbon copy; (3-20-20)T

**g.** Is prepared on an improper form; (3-20-20)T

**h.** Contains improper or inconsistent data; (3-20-20)T

**i.** Contains an indefinite cause of death that denotes only symptoms of disease or conditions resulting from disease; and (3-20-20)T

**j.** Is not prepared in conformity with statutes, regulations, or with instructions issued by the State Registrar. (3-20-20)T

**04. Certificates with Defects.** Certificates with defects as cited in Subsections 100.03.a. through 100.03.j. of this rule may be withheld from certification until the defect is remedied by persons who have the knowledge and authority to do so. (3-20-20)T

**101. -- 149. (RESERVED)**

**150. ADDITIONAL OFFICES.**

**01. Determination.** The State Registrar will determine whether offices other than the Vital Statistics Unit are needed in this state to aid in the efficient administration of the system of vital statistics. Such determination will be based on the identification of the most efficient method to meet the needs of the people of this state with respect to the establishment and operation of the system of vital statistics. If the State Registrar determines that



additional offices are necessary, such offices will be designated with the approval of the Director. The duties and responsibilities may be assigned to currently existing offices or special branch offices of the Vital Statistics Unit may be established in those areas where they are deemed necessary, or a combination of existing offices and branch offices may be used. In all cases where existing offices are utilized, the employees of such offices are subject to the control of the State Registrar when they are performing functions relating to the system of vital statistics. (3-20-20)T

**02. Assignment of Duties.** The State Registrar, with the approval of the Director, will determine the specific responsibilities and duties of each office. The State Registrar will assign to such offices such duties and responsibilities as may be deemed necessary to ensure the efficient operation of the system of vital statistics. These may include any or all of the following: (3-20-20)T

**a.** Receiving and processing birth, death, and stillbirth records. This would include the receipt of these records from the person responsible for filing the records, checking the records for accuracy and completeness, and forwarding them to the Vital Statistics Unit at intervals prescribed by the State Registrar. (3-20-20)T

**b.** Issuing certified copies of birth, death, or stillbirth records. The records from which the certified copies are issued will be maintained by the Vital Statistics Unit. All forms and procedures used to issue the copies will be provided or approved by the State Registrar. If it is deemed appropriate and feasible, any such office may be provided access to all birth, death, or stillbirth records filed in this state. (3-20-20)T

**c.** Acting as the agent of the State Registrar in their designated area and providing assistance to physicians, coroners, hospitals, morticians, and others in matters related to the system of vital statistics. (3-20-20)T

**03. Copies of Original Certificates.** (3-20-20)T

**a.** Copies from the original certificate will not be made or certified by any firm or person other than the State Registrar of Vital Statistics except under Subsection 150.02.b. of this rule. (3-20-20)T

**b.** If the State Registrar finds evidence that a certificate was registered through misrepresentation or fraud, the State Registrar has authority to withhold the issuance of a certified copy of such certificate until a determination of the facts has been made. (3-20-20)T

**151. LOCAL REGISTRATION OFFICERS.**

The State Registrar will contract for the services of local registrars who collect certificates of birth, death, and stillbirth, carry out duties incidental to registration within a specified territory (registration district), and perform other duties as assigned by the State Registrar. (3-20-20)T

**01. Qualifications of Local Registrar.** To be and remain eligible for the office of local registrar a person must meet the following minimum qualifications: (3-20-20)T

**a.** Be sufficiently mature and responsible to carry out the duties of the office; and (3-20-20)T

**b.** Be physically able to perform the duties of the office; and (3-20-20)T

**c.** Be able to read, to comprehend what is read, and to write legibly; and (3-20-20)T

**d.** Work in the registration district and be readily accessible. (3-20-20)T

**02. Removal of Local Registrar.** (3-20-20)T

**a.** If a local registrar does not meet all qualifications as listed in these rules or in the contract, the local registrar may be removed from office upon written notification by the State Registrar. (3-20-20)T

**b.** When any local registrar fails to perform any of the duties imposed by law, rule, or by the instructions of the State Registrar, the local registrar may be summarily removed from office by the State Registrar. (3-20-20)T

**03. Local Deputy State Registrars.** The Director may officially deputize local registrars for the purpose of expediting certified copies of death or stillbirth certificates and other purposes as may be deemed necessary by the Director. (3-20-20)T

**152. -- 199. (RESERVED)**

**200. TRANSMITTAL OF CERTIFICATES AND LOCAL RECORDS -- REPORTS.**

**01. Transmittal of Certificates of Death and Stillbirth.** Certificates of death and stillbirth must be transmitted by the local registrar to the State Registrar of Vital Statistics within one (1) working day from the date they were received by the local registrar, except when certificates are to be used for expedited copies, in which case they must be transmitted to the State Registrar on the sixth working day from the date they were received by the local registrar. (3-20-20)T

**02. Expedited Certified Copies of Certificates of Death or Stillbirth.** No certified copies of certificates of death or stillbirth can be issued by a local deputy state registrar until the registrar is satisfied that the requesting person(s) has "direct and tangible interest" in the certificate as defined in IDAPA 16.05.01, "Use and Disclosure of Department Records," Subsections 011.01 and 011.03 and Section 283. (3-20-20)T

**03. Transmittal of Certificates of Birth.** All certificates of birth must be transmitted by the local registrar to the State Registrar of Vital Statistics within five (5) working days from the date they are received by the local registrar. (3-20-20)T

**201. COMPLETION AND CORRECTION OF CERTIFICATES.**

**01. Correction of Minor Errors on Certificates During the First Year.** Except as otherwise provided in these rules, correction of obvious errors or transposition of letters in words of common knowledge, may be made by the State Registrar or an authorized agent within the first year after the date of the event either upon individual observation or query or upon request of any person with a direct and tangible interest as defined in IDAPA 16.05.01, "Use and Disclosure of Department Records," Subsections 011.01 and 011.03, or any person listed in Subsection 201.07.d. of these rules. The method of correction will be determined by the State Registrar, and is not subject to the requirements of Subsection 201.09 of these rules. When such minor corrections are made by the State Registrar, a notation as to the source of the information, together with the date the change was made and the initials of the authorized agent making the change must be made on the certificate in such a way as not to become a part of any certification issued. The certificate must not be marked as amended. (3-20-20)T

**02. Amendment of Registrant's Given Names or Surname on Birth Certificates Within the First Year.** (3-20-20)T

**a.** Until the registrant's first birthday, given names or surname may be amended upon written notarized request of: (3-20-20)T

i. Both parents; (3-20-20)T

ii. The mother in the case of a child born out of wedlock and the father's name is not shown on the certificate; (3-20-20)T

iii. The father in the case of the death or incapacity of the mother; (3-20-20)T

iv. The mother in the case of the death or incapacity of the father; or (3-20-20)T

v. The legal guardian or agency having legal custody of the registrant. (3-20-20)T

**b.** The certificate must be marked as amended. (3-20-20)T

**03. Amendment of Registrant's Given Name on Birth Certificate After the First Year.** (3-20-20)T

**a.** After one (1) year from the date of birth, the provisions of Subsection 201.07 of these rules must be followed to amend the given name if the name was entered in error at the time of the preparation of the birth certificate. (3-20-20)T

**b.** In all other cases, a legal change of name order from a court of competent jurisdiction must be submitted to change a given name after one (1) year. (3-20-20)T

**04. Addition of Given Names on Birth Certificates.** (3-20-20)T

**a.** Until the registrant's seventh birthday, given names, for a child whose birth was recorded without given names, may be added to the certificate upon written notarized request of: (3-20-20)T

**i.** Both parents; (3-20-20)T

**ii.** The mother in the case of a child born out of wedlock and the father's name is not shown on the certificate; (3-20-20)T

**iii.** The father in the case of the death or incapacity of the mother; (3-20-20)T

**iv.** The mother in the case of the death or incapacity of the father; or (3-20-20)T

**v.** The legal guardian or agency having legal custody of the registrant. (3-20-20)T

**b.** The certificate shall be marked as amended. (3-20-20)T

**c.** After the registrant's seventh birthday, the provisions of Subsection 201.07 of these rules must be followed to add a given name. (3-20-20)T

**05. Acknowledgment of Paternity.** (3-20-20)T

**a.** Subject to the provisions of Subsection 201.05.b. of these rules, a new certificate of birth will be prepared by the State Registrar for a child born out of wedlock in this state upon receipt of an affidavit of paternity signed by both parents and a written request by both parents. The child's surname will be changed on the certificate to that of the father if both parents so request. (3-20-20)T

**b.** If another man is shown as the father of the child on the original certificate, a new certificate may be prepared only when a determination of paternity is made by a court of competent jurisdiction, or following adoption. (3-20-20)T

**c.** The certificate must not be marked as amended. (3-20-20)T

**06. Amendment of Indicator of Gender.** (3-20-20)T

**a.** The State Registrar must issue an amended Idaho certificate of live birth for the change of the indicator of sex upon receipt of the following: (3-20-20)T

**i.** For a registrant eighteen (18) years of age and older, a completed and notarized application on a form approved by the State Registrar that includes the following information: (3-20-20)T

(1) The identity of the applicant; (3-20-20)T

(2) The Idaho certificate of live birth to be amended; (3-20-20)T

(3) A declaration that the registrant's indicator of sex on the Idaho certificate of live birth does not match the registrant's gender identity; and (3-20-20)T

(4) The gender indicator as it should appear on the amended certificate of live birth. (3-20-20)T

ii. For a registrant under the age of eighteen (18), a completed and notarized application on a form approved by the State Registrar that includes the following information: (3-20-20)T

(1) The identity of the applicant; (3-20-20)T

(2) The Idaho certificate of live birth to be amended; (3-20-20)T

(3) A declaration that the registrant's indicator of sex on the Idaho certificate of live birth does not match the registrant's gender identity; (3-20-20)T

(4) The gender indicator as it should appear on the amended certificate of live birth; and (3-20-20)T

(5) The consent of all parents listed on the certificate of live birth or the consent of the registrant's legal guardian. If a parent is deceased, a copy of the death certificate must be submitted with the application. If a parent cannot be located, the applicant must also submit a certified copy of an order from an Idaho court of competent jurisdiction ordering that the consent of only one (1) parent is required. (3-20-20)T

**b.** The amended certificate of live birth issued under this rule must not be marked amended, must not refer to the original certificate of live birth sex, and must show the amended gender as requested. The certificate of live birth being amended, application, and court order if required, must be placed in a sealed file which may only be opened by an order from an Idaho court of competent jurisdiction. (3-20-20)T

**c.** A one-time name change made under an amendment of sex on the certificate of live birth, whether made prior to, at the time of, or subsequent to a change of indicator of gender on a certificate of live birth must not be marked amended and must not refer to the original birth certificate name or indicator of sex. Any additional name changes are governed by Subsections 201.08 and 201.09 of this rule. (3-20-20)T

**07. All Other Amendments.** Unless otherwise provided in these rules or in Section 39-250, Idaho Code, all other amendments to vital records must be supported by: (3-20-20)T

**a.** An affidavit setting forth: (3-20-20)T

i. Information to identify the certificate; (3-20-20)T

ii. The incorrect data as it is listed on the certificate; and (3-20-20)T

iii. The correct data as it should appear. (3-20-20)T

**b.** If one (1) year has elapsed since the date the event occurred, one (1) or more items of documentary evidence which support the alleged facts and which were established at least five (5) years prior to the date of application for amendment or within seven (7) years of the date of the event. (3-20-20)T

**c.** Any item of a medical nature can be amended only upon receipt of an affidavit from the person certifying such item, except that queries originating in the vital statistics office and subsequently completed and signed by the certifier may be used to complete or modify the reported cause of death. The State Registrar may require documentary evidence to substantiate the requested amendment. (3-20-20)T

**d.** Applications to amend a specific vital record will be accepted as follows: (3-20-20)T

i. An application to amend a birth certificate may only be made by one (1) or both of the parents, the legal guardian, the registrant if eighteen (18) years of age or older, or the individual responsible for filing the certificate. (3-20-20)T

ii. An application to amend a death certificate may only be made by the informant, the next of kin, the funeral director or person acting as such who signed the death certificate, or the certifying physician or coroner. (3-20-20)T

iii. An application to amend a stillbirth certificate may only be made by a person listed in Subsections 201.07.d.i. or 201.07.d.ii. of these rules. (3-20-20)T

iv. An application to amend a marriage or divorce certificate may only be made by the custodian of the official record from which the certificate was prepared, either of the parties to the marriage or divorce, or the individual responsible for filing the certificate. (3-20-20)T

e. The State Registrar will evaluate the evidence submitted in support of any amendment, or require additional documentation. The State Registrar's decision and determination will be based upon serving the objectives of the vital statistics statutes and the best interests of the public. In the event the application is rejected or additional information is required, the State Registrar must advise the applicant of the reason for the action and the right to appeal pursuant to Section 39-250(5), Idaho Code. (3-20-20)T

**08. Amendment of the Same Item More Than Once.** Once an item is amended on a vital record, that item can not be amended again except upon receipt of a court order from an Idaho court of competent jurisdiction. (3-20-20)T

**09. Methods of Amending Certificates.** (3-20-20)T

a. Certificates of birth, death, stillbirth, marriage, and divorce may only be amended by the State Registrar as follows: (3-20-20)T

i. Preparing a new certificate showing the correct information when the State Registrar deems that the nature of the amendment so requires. The new certificate may be prepared on the form used for registering current events at the time of amendment. Except as provided elsewhere in these rules, the item number of the entry that was amended must be identified on the new certificate. In every case, except as provided elsewhere in these rules or the Idaho Code, the new certificate must show the date the amendment was made and be given the same state file number as the existing certificate. Signatures appearing on the existing certificate must be typed on the new certificate. (3-20-20)T

ii. Completing the item in any case where the item was left blank on the existing certificate. (3-20-20)T

iii. Drawing a single line through the item to be amended and inserting the correct data immediately above or to the side. The line drawn through the original entry must not obliterate such entry. (3-20-20)T

iv. A certificate of birth amended in accordance with the provisions of Section 39-250(4), Idaho Code, must be amended as prescribed in Subsection 201.09.a.iii. of these rules. The fact that the name was changed in accordance with a court order must be stated on the certificate. (3-20-20)T

b. Unless prohibited by statute or rule, there must be inserted on the face of the certificate the date the amendment was made and the initials of the person making the change; the certificate must be marked as amended. (3-20-20)T

**202. -- 250. (RESERVED)**

**251. FEES FOR COPIES, SEARCHES, AND OTHER SERVICES.**

**01. Certified Copies.** The fee for the issuance of a certified copy of a certificate of death is sixteen dollars (\$16) per copy. This fee incorporates the additional one dollar (\$1) coroner training and education fund fee in accordance with Section 39-252(2), Idaho Code. The fee for the issuance of a certified copy of any other vital record is sixteen dollars (\$16) per copy. (3-20-20)T

**02. Searches.** The fee for a search of the files for a record of any vital event when no record is found, no copy is made, or a special document search is requested, is sixteen dollars (\$16). (3-20-20)T

**03. Verifications.** (3-20-20)T

**a.** Except for Idaho state agencies and public health districts, the fee for manual or written verification of data from a certificate is ten dollars (\$10). (3-20-20)T

**b.** The fees for electronic verification by the Department’s automated systems of data from a certificate of any vital event are based on the national pricing model as follows:

Fees for Electronic Verification	
National Monthly Transaction Volume	Charge per Verification Match Provided to Vital Records Agency
1 - 100,000	\$1.35
100,000 - 500,000	\$1.15
500,000 - 1,200,000	\$1.03
1,200,000+	\$0.87

(3-20-20)T

**04. Statistical, Research, or Public Health Services.** The State Registrar assesses the fee for statistical, research or public health services. The costs are calculated based upon the costs of retrieving the data and the costs of compiling, organizing, and printing the data. Cost may be reduced on a prorated basis to reflect the number of expected requests for the same information or service. (3-20-20)T

**05. Fees for Other Services.** (3-20-20)T

**a.** The fee for filing a report, certificate, or decree of adoption is twenty dollars (\$20). (3-20-20)T

**b.** The fee for establishing a delayed certificate of any vital event is twenty-five dollars (\$25). (3-20-20)T

**c.** For any vital event, the fee for establishing a new certificate due to a court order, a replacement certificate, or an amended certificate is twenty dollars (\$20), except as specified under Subsection 251.05.g.ii. of this rule. (3-20-20)T

**d.** A service fee of three dollars (\$3), in addition to the sixteen dollars (\$16) for a certified copy of a death or stillbirth certificate, must be paid to the local deputy state registrar for securing each expedited certified copy of a vital record. (3-20-20)T

**e.** The fee for a copy of a certificate of any vital event provided upon written request to local, states other than Idaho, or federal government agencies in accordance with Section 39-270(b), Idaho Code, is sixteen dollars (\$16). (3-20-20)T

**f.** Fees for correction of a certificate of any vital event. (3-20-20)T

**i.** The fee for a replacement certified copy of a certificate of any vital event when the incorrect certified copy is returned for exchange within sixty (60) days of a correction of an error is five dollars (\$5) per certified copy. (3-20-20)T

**ii.** There is no charge for a correction of an error or errors on a certificate of any vital event when the required documentation is received within the first year after the date of the event. (3-20-20)T

iii. The fee for correction of an error or errors on a certificate of any vital event, when the required documentation is received one (1) year or more after the date of the event, is twenty dollars (\$20) per submitted correction request. (3-20-20)T

g. Fees for priority processing or special handling. (3-20-20)T

i. A service fee of ten dollars (\$10) per certificate or document will be added for priority processing or special handling of a request for a certified copy or copies of a certificate of any vital event, a request for a disinterment permit, a request to file a registry form, or a request regarding another vital event related form or document, other than those identified in Subsection 251.05.g.ii. of this rule. This fee will be in addition to the current fee or fees for each certified copy, search, or filing requested, or any combination thereof. This fee is forfeited and a new service fee must be paid for priority processing or special handling in the event that the requester takes longer than ninety (90) days to respond to a request for additional information, or documentation, or both. (3-20-20)T

ii. A service fee of twenty-five dollars (\$25) per certificate will be added for priority processing to establish a new or amended certificate of any vital event due to a report, certificate or decree of adoption, delayed certificate filing, a court order, a paternity affidavit or rescission, a subsequent marriage affidavit or a correction of a certificate. This fee is in addition to the current fee or fees for the legal amendment processing or request for a certified copy or copies, or both. This fee is forfeited and a new legal amendment service fee must be paid for priority processing or special handling in the event that the requester takes longer than ninety (90) days to respond to a request for additional information or documentation or both. (3-20-20)T

**06. Waiver of Fee Requirement.** Fees may be waived for Idaho state agency and public health district administrative use requests. Statistical information prepared for public health planning purposes may be published and distributed without charge whenever the Director determines that the publication and distribution is in the public interest. (3-20-20)T

**252. -- 299. (RESERVED)**

**300. REGISTRATION OF BIRTHS.**

**01. Certifier's Signature.** The person certifying the facts of birth according to Section 39-255, Idaho Code, must sign the birth certificate. No stamps or other types of facsimile signatures may be used. The State Registrar may require additional evidence of the birth when the birth did not occur in an institution and was not attended by a person who regularly attends births. (3-20-20)T

**02. Signature of Certifier.** When a birth occurs in an institution, the signature of the certifier on the medical record of birth may satisfy the requirements of Section 39-255(a), Idaho Code. (3-20-20)T

**03. Signature of the Informant.** When a birth occurs in an institution and the institution maintains a working paper (worksheet) signed by either parent (named on the birth certificate) as informant, and the working paper (worksheet) is part of the medical record, the signature of the informant on the working paper (worksheet) may satisfy the requirements of Section 39-255(c), Idaho Code. (3-20-20)T

**301. REGISTRATION OF FOUNDLINGS.**

**01. Form of Certificate.** A special foundling certificate must be filed for any infant of unknown parentage. It must include, as a minimum, the following items: (3-20-20)T

a. The name designated for the infant; (3-20-20)T

b. The estimated date of birth; (3-20-20)T

c. The sex and race of the infant; (3-20-20)T

d. The address where the infant was found; (3-20-20)T

- e. The name and address of the person or agency assuming custody of the infant; (3-20-20)T
  - f. A short description of the circumstances surrounding the finding of the infant, including the date of the finding; and (3-20-20)T
  - g. The signature of the informant and the date the certificate was signed. (3-20-20)T
- 02. Responsibility for Filing.** The person or authorized representative of the agency assuming custody of the infant must sign the certificate and file it within fifteen (15) days of the finding with the State Registrar. (3-20-20)T

**302. -- 399. (RESERVED)**

**400. NEW CERTIFICATES OF BIRTH FOLLOWING MARRIAGE OF NATURAL PARENTS.**

- 01. Requirements.** If the natural parents marry after the birth of a child born in this state, a new certificate of birth will be prepared for the child by the State Registrar upon receipt of an affidavit of paternity signed by the natural parents of said child, together with a certified copy of the parents' marriage record. However, if another man is shown as the father of the child on the original certificate, a new certificate will be prepared only when a determination of paternity is made by a court of competent jurisdiction, or following adoption. (3-20-20)T
- 02. Common-Law Marriage.** If the natural parents establish a marriage by common law after the birth of a child, an affidavit of common-law marriage, provided by the Vital Statistics Unit and signed by the natural parents, may be substituted for the certified copy of the parents' marriage record required in Subsection 400.01 of this rule. (3-20-20)T

**401. ADOPTION OF PERSONS BORN IN IDAHO.**

**01. Examination of Adoptive Child Born in Idaho for Whom No Original Certificate of Birth Can Be Located.** (3-20-20)T

- a. The physician's report of the physical examination of the adoptive child, conducted under Section 39-258, Idaho Code, must indicate the sex, the estimated age, the race, and the existence or absence of obvious congenital malformations or anomalies of the child. (3-20-20)T
- b. The State Registrar may require the adoptive parents to furnish a court order that identifies natural parents, date of birth, place of birth, and those facts found by the physician's physical examination. (3-20-20)T

**02. Corrections on Adoptive Certificates.** (3-20-20)T

- a. Minor corrections may be made within one (1) year after the establishment of the adoptive birth certificate in accordance with Subsection 201.01 of these rules. (3-20-20)T
- b. Change of name amendments may be made by a court order amending the original adoption order or by a new order of a court, according to Subsection 201.09 of these rules. (3-20-20)T
- c. All other amendments (except the registrant's name) will be made according to Subsections 201.07 through 201.09 of these rules. (3-20-20)T
- d. In order to protect the confidential nature of adoptive births, the State Registrar may elect not to mark the record amended when carrying out amendments under Section 401 of this rule, when the indication of amendment would not be in the best interest of the registrant. (3-20-20)T

**402. REGISTRATION SYSTEM FOR ADULT ADOPTEES.**

- 01. Search for "the Other Birth Parent."** The State Registrar will not participate in the search for "the other birth parent." The adoption service units of the Department may participate in such searches when



requested to do so by a birth parent or the adult adoptee. Costs of the search will be provided by the birth parent or adult adoptee seeking the match. Such service costs will be set by the adoption service unit and are based upon the actual cost of the search and cost of notification of the registrant(s). (3-20-20)T

**02. Completion of Match.** When dated evidence of a completed search is presented to the State Registrar and “the other birth parent” has not been found, then and only then will a match be completed as cited in Section 39-259A(e) and (f), Idaho Code. (3-20-20)T

**a.** When one (1) of the birth parents cannot be found according to Section 39-259A(b)(3), Idaho Code, no information about the missing birth parent will be released to either registrant. (3-20-20)T

**b.** When one (1) birth parent is deceased, proof of death must be established by a certified copy of the death certificate or a verification of the fact of death from the Vital Statistics official of the state where death occurred. Such proof is the responsibility of the registered birth parent. (3-20-20)T

**03. Siblings of Adult Adoptee.** When it appears that there is a match between siblings, the State Registrar may confirm the match from the sealed adoption record on file in the Vital Statistics Office and make appropriate notification to the siblings. However, if the birth parent(s) has not also voluntarily registered, no identifying information about the birth parent(s) will be provided to the adult adoptee or the sibling, except where proof of death of the birth parent(s) is found. (3-20-20)T

**04. Notification.** When it appears to the State Registrar that a match has occurred, the State Registrar will notify the registrants by certified mail of the opportunity to withdraw from the register prior to proceeding with full notification of the registrants. Such withdrawal must be made by written notarized request and must be received by the State Registrar within thirty (30) days of the date of registrant’s receipt of notification from the State Registrar. Such withdrawal is exempt from the usual withdrawal fee. (3-20-20)T

**05. Registration Time.** Birth parents or relatives of qualified birth parents may register at any time after an adoption has taken place, whether prior to or after the adoptive person reaches the age of eighteen (18). Adopted persons may register after they have reached their eighteenth birthday. (3-20-20)T

**06. Fees.** An initial filing fee of ten dollars (\$10) is paid by or on behalf of each registrant and must be submitted with the registration form. An update fee of ten dollars (\$10) is charged whenever a registrant requests in writing a revision, update, or withdrawal of a previous registration. (3-20-20)T

**07. Release of Information.** When it appears there is a match between registered adult siblings and no birth parent information has been registered, before release of identifying information to any registered adult sibling, the State Registrar will require proof from the registrant(s) of the identity and the relationship of the registrant to other registrants. At least two (2) documents providing such proof must be viewed and recorded by the State Registrar. Such documents may include sworn statements, court decrees, copies of birth certificates, marriage licenses, school records, and voter registration cards. (3-20-20)T

**403. -- 449. (RESERVED)**

**450. REGISTRATION OF DEATHS AND STILLBIRTHS.**

**01. Acceptance of Incomplete Death Certificate.** If all the information necessary to complete a death certificate is not available within five (5) days after the date the death occurred, the person in charge of interment or removal of the body from the district in which the death occurred must file the certificate as prescribed by the State Registrar with all information that is available, provided that the medical certification of the cause of death has been signed by the person responsible for such certification. If the cause of death is unknown or undetermined, the cause of death must be shown as unknown or undetermined on the certificate. The person responsible for the medical certification of the cause of death must also sign the authorization for final disposition of the body. If the body is to be cremated, the coroner must also give additional authorization. (3-20-20)T

**a.** A supplemental report providing the cause of death information missing from the original certificate must be filed by the person responsible for medical certification of the cause of death with the State

Registrar within fifteen (15) days of the filing of the death certificate on a form provided or approved by the State Registrar. (3-20-20)T

**b.** A supplemental report providing all other information missing from the original certificate must be filed with the State Registrar by the person responsible for filing the certificate within thirty (30) days of the date the death occurred or as otherwise authorized by the State Registrar on a form provided or approved by the State Registrar. (3-20-20)T

**c.** The State Registrar will make the information on the supplemental report(s) a part of the existing death certificate and will file the supplemental report(s) with the death certificate. The State Registrar will also mark the death certificate to show that supplemental information was added. (3-20-20)T

**02. Signatures Required on Death Certificates.** (3-20-20)T

**a.** The mortician, or person acting as such, must sign the death certificate. No stamps or other types of facsimile signatures may be used. (3-20-20)T

**b.** The responsible person must sign the medical certification of the cause of death. Failure to do so will invalidate the record as a legal document. No stamps or other types of facsimile signatures may be used. (3-20-20)T

**03. Signatures Required on Stillbirth Certificates.** (3-20-20)T

**a.** The mortician's signature must meet the following criteria: (3-20-20)T

**i.** The mortician, or person acting as such, must sign the certificate. No stamps or other types of facsimile signatures may be used. (3-20-20)T

**ii.** When a hospital disposes of a stillborn fetus, in accordance with Section 39-268(3), Idaho Code, the hospital authority must complete and sign the certificate as mortician. (3-20-20)T

**b.** The person responsible according to Section 39-260, Idaho Code, for the attendant or medical certification, must sign the certificate. No stamps or other types of facsimile signatures may be used. (3-20-20)T

**451. INDUCED ABORTION REPORTING FORMS -- COMPILATIONS.**

**01. Form of Report.** The contents of the report of induced abortion must comply with Section 39-261, Idaho Code. (3-20-20)T

**02. Nature of Reports.** The completed forms submitted to the Vital Statistics Unit are statistical reports, not certificates. Copies of the reports will not be issued. (3-20-20)T

**03. Patient Identification.** No information will be collected that would identify the woman who had the abortion. (3-20-20)T

**04. Compilations.** No compilations will be released for public use that identify the institution where the induced abortion was performed, the physician who performed the induced abortion procedure, or the person completing the report of induced abortion. (3-20-20)T

**452. -- 500. (RESERVED)**

**501. MARRIAGE LICENSE RECORDING FEES.**  
The county recorders will charge a recording fee of two dollars (\$2) for each marriage certificate. (3-20-20)T

**502. -- 599. (RESERVED)**

**600. DIVORCE CERTIFICATE FILING FEE.**

Effective July 1, 1985, the Clerk of the Court will charge a fee of one dollar (\$1) for each divorce certificate filed in accordance with Section 39-266, Idaho Code. (3-20-20)T

**601. -- 649. (RESERVED)**

**650. LATE OR DELAYED REGISTRATION OF BIRTH.**

**01. Late Registration -- Fifteen Days to One Year. (3-20-20)T**

**a.** Certificates of birth filed after fifteen (15) days, but within one (1) year from the date of birth, will be registered on the standard form of live birth certificate in the manner prescribed in Section 39-255, Idaho Code. Such certificate will not be marked as delayed. (3-20-20)T

**b.** In any case where the certificate is signed by someone other than the attendant or person in charge of the institution where birth occurred, a notarized statement setting forth the reason must be attached to the certificate. The State Registrar may require additional evidence in support of the facts of birth. (3-20-20)T

**02. Form of Delayed Certificate of Birth.** All certificates registered one (1) year or more after the date of birth will be registered on a delayed certificate of birth form prescribed by the Director. (3-20-20)T

**03. Who May Request the Registration of and Sign a Delayed Certificate of Birth. (3-20-20)T**

**a.** Any person born in this state whose birth is not recorded in this state, or the parent, guardian, next of kin of that person, or older person acting for the registrant and having personal knowledge of the facts of birth, may request the registration of a delayed certificate of birth, subject to these rules and instructions issued by the State Registrar. (3-20-20)T

**b.** Each delayed certificate of birth must be signed and sworn to before a notary public by the person whose birth is to be registered if such person is eighteen (18) years of age or older and is competent to sign and swear to the accuracy of the facts stated therein; otherwise, the certificate must be signed and sworn to by one (1) of the following in the indicated order of priority: (3-20-20)T

i. One (1) of the parents of the registrant; or (3-20-20)T

ii. The guardian of the registrant; or (3-20-20)T

iii. The next of kin of the registrant; or (3-20-20)T

iv. Any older person over eighteen (18) years of age having personal knowledge of the facts of birth. (3-20-20)T

**04. Facts to be Established for a Delayed Registration of Birth.** The minimum facts that must be established by documentary evidence are the following: (3-20-20)T

**a.** The original full name of the registrant; (3-20-20)T

**b.** The date of birth and place of birth; (3-20-20)T

**c.** The full maiden name of the mother; and (3-20-20)T

**d.** The full name of the father, unless the registrant was born out of wedlock, in which case the name of the father will not be entered on the delayed certificate except as provided in Sections 39-250, 39-255, or 39-257, Idaho Code, and rules adopted in accordance with these statutes. (3-20-20)T

**05. Delayed Registration Following a Legal Change of Status. (3-20-20)T**

**a.** When evidence is presented reflecting a legal change of status by adoption, legitimation, paternity

determination, acknowledgment of paternity, or a court-ordered change of name, a new delayed certificate may be established to reflect such change. (3-20-20)T

**b.** In such cases changing legal status, when no birth certificate is found, the delayed certificate may be filed reflecting the information established by the legal change. (3-20-20)T

**06. Documentary Evidence -- Requirements.** (3-20-20)T

**a.** To be acceptable for filing, the name of the registrant and the date and place of birth entered on a delayed certificate of birth must be supported by at least: (3-20-20)T

**i.** Two (2) pieces of documentary evidence, only one (1) of which may be an affidavit of personal knowledge, if the record is filed within seven (7) years after the date of birth. (3-20-20)T

**ii.** Three (3) pieces of documentary evidence, only one (1) of which may be an affidavit of personal knowledge, if the record is filed seven (7) years or more after the date of birth. One (1) document must be dated within seven (7) years after the date of birth. (3-20-20)T

**b.** Facts of parentage must be supported by at least one (1) document. This document may be one (1) of the documents above other than an affidavit of personal knowledge. (3-20-20)T

**07. Documentary Evidence -- Acceptability.** (3-20-20)T

**a.** The State Registrar may establish a priority of best evidence. (3-20-20)T

**b.** Documents presented, such as census, hospital, church, and school records, must be from independent sources and must be in the form of the original record or a certified copy of the original or a notarized statement from the custodian of the record or document. (3-20-20)T

**c.** All documents submitted in evidence, other than an affidavit of personal knowledge, must have been established at least ten (10) years prior to the date of application or have been established prior to the applicant's seventh birthday. (3-20-20)T

**d.** An affidavit of personal knowledge, to be acceptable, must be made by a parent of the applicant or an older person other than a parent, who is over eighteen (18) years of age and must be signed before a notary public. In all cases, the affiant must be at least ten (10) years older than the applicant and have personal knowledge of the facts of birth. (3-20-20)T

**08. Abstraction of Documentary Evidence.** (3-20-20)T

**a.** The State Registrar, or a designated representative, will abstract on the delayed certificate of birth a description of each document submitted to support the facts shown on the delayed birth certificate. This description will include: (3-20-20)T

**i.** The title or description of the document; (3-20-20)T

**ii.** The name and address of the affiant, if the document is an affidavit of personal knowledge, or of the custodian, if the document is an original or certified copy of a record or a notarized statement from the custodian; (3-20-20)T

**iii.** The date of the original filing of the document being abstracted; and (3-20-20)T

**iv.** The information regarding the birth facts contained in the document. (3-20-20)T

**b.** All documents submitted in support of the delayed birth registration will be returned to the applicant after review, provided, however, that the State Registrar may make and keep on file abstracts or photocopies of any such documents. (3-20-20)T

**09. Certification by the State Registrar.** The State Registrar, or a designated representative, will by signature certify: (3-20-20)T

- a.** That no prior birth certificate is on file for the person whose birth is to be recorded; (3-20-20)T
- b.** That the State Registrar or a designated representative has reviewed the evidence submitted to establish the facts of birth; and (3-20-20)T
- c.** That the abstract of the evidence appearing on the delayed certificate of birth accurately reflects the nature and content of the documents. (3-20-20)T

**10. Dismissal After One Year.** Applications for delayed certificates that have not been completed within one (1) year from the date of application may be dismissed at the discretion of the State Registrar. Upon dismissal, the State Registrar will so advise the applicant, and all documents submitted in support of such registration will be returned to the applicant. (3-20-20)T

**651. LATE OR DELAYED REGISTRATION OF DEATHS.**

The registration of death after the time prescribed by statute or rule must be made on the standard certificate of death form in the following manner: (3-20-20)T

**01. Minimum Evidence Required.** (3-20-20)T

**a.** If the person responsible for the medical certification of death, according to Section 39-260, Idaho Code, and the attending mortician or person who acted as such are available and they do complete and sign the certificate of death; and (3-20-20)T

**i.** If the certificate is filed within one (1) year after the date of death or finding of the body, the certificate of death may be completed without additional evidence and filed with the State Registrar; or (3-20-20)T

**ii.** If the certificate is filed one (1) year or more after the date of death or finding of the body, the medical certifier and the mortician or person who acted as such must state in accompanying affidavits that the information on the certificate is based on records kept in their files. (3-20-20)T

**b.** If either the medical certifier or the attending mortician, or person acting as such (or both), is unavailable, the certificate may be filed by the next of kin of the deceased and must be accompanied by: (3-20-20)T

**i.** An affidavit of the person filing the certificate, swearing to the accuracy of the information on the certificate; and (3-20-20)T

**ii.** Two (2) documents that identify the name of the deceased and the date and place of death. (3-20-20)T

**02. Additional Evidence.** In all cases, the State Registrar may require additional documentary evidence to prove the facts of death. (3-20-20)T

**03. Summary Statement.** A summary statement of the evidence submitted in support of the delayed registration will be entered on the certificate, and the certificate will be marked as delayed. (3-20-20)T

**652. -- 699. (RESERVED)**

**700. LATE AND DELAYED REGISTRATION OF MARRIAGE.**

**01. Late Registration.** Until one (1) year has elapsed from the date of the ceremony, marriage certificates will be accepted for filing by the State Registrar in accordance with Section 39-262, Idaho Code, and will not be marked as delayed. (3-20-20)T

**02. Delayed Registration.** The registration of a marriage after one (1) year must be made on the regular certificate of marriage form in the following manner: (3-20-20)T

**a.** The certificate must be filed with the county recorder where the marriage license was originally issued. (3-20-20)T

**b.** To be acceptable for registration by the State Registrar, the delayed certificate of marriage must be supported by a notarized statement from two (2) people other than the bride and groom who know that a marriage ceremony was performed and the date and place of the marriage ceremony. One (1) of these statements must be from an actual witness to the marriage ceremony. (3-20-20)T

**c.** When the officiant is not available to sign the delayed certificate of marriage, the delayed certificate of marriage must be signed by an actual witness to the marriage ceremony, other than the bride and groom. (3-20-20)T

**03. Additional Evidence.** In all cases, the State Registrar may require additional documentary evidence to prove the facts of marriage. (3-20-20)T

**04. Summary Statement.** A summary statement of the evidence submitted in support of the delayed registration will be entered on the certificate, and the certificate will be marked as delayed. (3-20-20)T

**701. LATE AND DELAYED REGISTRATION OF DIVORCE.**

**01. Late Registration.** Until one (1) year has elapsed from the date of the divorce decree, divorce certificates will be accepted for filing by the State Registrar in accordance with Section 39-265, Idaho Code, and will not be marked as delayed. (3-20-20)T

**02. Delayed Registration.** The registration of a divorce after one (1) year must be made on the regular certificate of divorce form in the following manner: (3-20-20)T

**a.** The divorce certificate must be filed by the court directly with the State Registrar; and (3-20-20)T

**b.** The certificate must be accompanied by a certified copy of the final decree of divorce. (3-20-20)T

**03. Additional Evidence.** In all cases, the State Registrar may require additional documentary evidence to prove the facts of divorce. (3-20-20)T

**04. Summary Statement.** A summary statement of the evidence submitted in support of the delayed registration will be entered on the certificate, and the certificate will be marked as delayed. (3-20-20)T

**702. -- 799. (RESERVED)**

**800. DELAYED REGISTRATION OF STILLBIRTH.**

The requirements for filing a delayed certificate of stillbirth are the same as those for a delayed certificate of death, except that the section on paternity is governed by Section 39-260, Idaho Code. (3-20-20)T

**801. -- 849. (RESERVED)**

**850. REMOVAL OF DEAD BODY OR FETUS FROM PLACE OF DEATH OR STILLBIRTH.**

Before removing a dead body or fetus from the place of death or stillbirth, the funeral director, or person acting as such, must, in accordance with Section 39-268, Idaho Code: (3-20-20)T

**01. Obtain Assurance That Death Is from Natural Causes.** Obtain assurance from the attending physician, physician assistant, advanced practice registered nurse, or their designated associate, responsible for medical certification of the cause of death or stillbirth: (3-20-20)T

**a.** That the death or stillbirth is from natural causes; and (3-20-20)T

**b.** That the attending physician, physician assistant, advanced practice registered nurse, or their designated associate, will assume responsibility for certification of the cause of death or stillbirth; or (3-20-20)T

**02. Notify the Coroner.** Notify the coroner when: (3-20-20)T

**a.** The case falls within the jurisdiction of the coroner in accordance with Section 39-260, Idaho Code; or (3-20-20)T

**b.** The death or stillbirth is due to natural causes; and (3-20-20)T

**i.** There was no attending physician, physician assistant, or advanced practice registered nurse during the last illness; or (3-20-20)T

**ii.** There was no physician, physician assistant, or advanced practice registered nurse in attendance at the stillbirth; or (3-20-20)T

**iii.** When the attending physician, physician assistant, advanced practice registered nurse, or their designated associate, is not available or is physically incapable of providing assurance that the death or stillbirth is from natural causes or providing permission to remove the dead body or fetus from the place of death or stillbirth. (3-20-20)T

**03. Receive Permission to Remove the Dead Body or Fetus.** Receive permission to remove the dead body or fetus from the place of death or stillbirth from: (3-20-20)T

**a.** The attending physician, physician assistant, advanced practice registered nurse, or their designated associate, if the death is from natural causes and all assurances in Subsection 850.01 of this rule have been met; or (3-20-20)T

**b.** The coroner, if the case falls within the jurisdiction of the coroner, in accordance with Section 39-260, Idaho Code, or if the death or stillbirth is due to natural causes and one (1) of the conditions listed in Subsections 850.02.b.i. through 850.02.b.iii. of this rule has been met. (3-20-20)T

**851. AUTHORIZATION FOR DISINTERMENT AND REINTERMENT.**

**01. Disinterment and Reinterment of a Dead Body or Fetus.** Upon receipt of a notarized application, or an order of a court of record of this state, the State Registrar will issue a permit for the disinterment and reinterment of a dead body or fetus. The permit will be issued only to the mortician who is identified on the application or order as the mortician in charge of the disinterment. The application for the permit must be signed by the applicant and the mortician in charge of the disinterment. The applicant for the permit must be either: (3-20-20)T

**a.** The person or persons who have the highest authority under the provisions of Section 54-1142, Idaho Code; or (3-20-20)T

**b.** A person authorized by Section 39-269, Idaho Code, to request a special disinterment for legal purposes, in which case the application must state facts showing that the ends of justice require disinterment. (3-20-20)T

**02. Mass Disinterment and Reinterment.** Upon receipt of a notarized application, or an order of a court of record of this state, the State Registrar may issue a single permit for the disinterment and reinterment of all remains included in a mass disinterment. The permit will be issued only to the mortician who is identified on the application or order as the mortician in charge of the disinterment. The application or order for the permit must identify the remains of each body to the extent possible and specify the place of disinterment and reinterment. The application for the permit must be signed by the applicant and the mortician in charge of the disinterment. The applicant for the permit must be either: (3-20-20)T

**a.** The person or persons who have the highest authority under the provisions of Section 54-1142,

Idaho Code, for each of the deceased; or

(3-20-20)T

**b.** A person authorized by Section 39-269, Idaho Code, to request a special disinterment for legal purposes, in which case the application must state facts showing that the ends of justice require disinterment.

(3-20-20)T

**03. Nature of Permit.** The authorization issued in accordance with the statutes and rules governing disinterment is permission for disinterment, transportation and reinterment.

(3-20-20)T

**852. -- 999. (RESERVED)**



## 16.02.13 – STATE OF IDAHO DRINKING WATER LABORATORY CERTIFICATION PROGRAM

### 000. LEGAL AUTHORITY.

Under Section 56-1003, Idaho Code, the Idaho Legislature has delegated to the Board of Health and Welfare the authority to set standards for laboratories in the State of Idaho. Under Section 56-1007, Idaho Code, the Department is authorized to charge and collect fees for services rendered by the Department. (3-20-20)T

### 001. TITLE AND SCOPE.

**01. Title.** These rules are titled IDAPA 16.02.13, “State of Idaho Drinking Water Laboratory Certification Program.” (3-20-20)T

**02. Scope.** These rules establish a process for certification and standards of operation for laboratories certified by the State of Idaho to test drinking water. (3-20-20)T

### 002. INCORPORATION BY REFERENCE.

**01. Selected Sections from the Code of Federal Regulations, Title 40, Part 141 -- National Primary Drinking Water Regulations, July 1, 2010 Edition.** 40 CFR 141 and 143 may be accessed in electronic format at <https://ecfr.io/Title-40/cfrv25#0>. The following sections from the Code of Federal Regulations are hereby incorporated by reference: (3-20-20)T

- a. 40 CFR 141.6 (h), effective dates; (3-20-20)T
- b. 40 CFR 141.27, alternate testing program; (3-20-20)T
- c. 40 CFR 141.21(f)(3), total coliform rule; (3-20-20)T
- d. 40 CFR 141.23, inorganic methods; (3-20-20)T
- e. 40 CFR 141.24, organic methods; (3-20-20)T
- f. 40 CFR 141.25, methods for radioactivity; (3-20-20)T
- g. 40 CFR 141.131, disinfection by-products; (3-20-20)T
- h. 40 CFR 141.74(a), surface water treatment rule; (3-20-20)T
- i. 40 CFR 141.89, lead and copper; (3-20-20)T
- j. 40 CFR 141.402(c)(2), ground water; (3-20-20)T
- k. 40 CFR 141.704, long-term surface water treatment rule 2; (3-20-20)T
- l. 40 CFR 141.803, aircraft drinking water rules; (3-20-20)T
- m. 40 CFR 141, Appendix A to Subpart C, expedited method approval; and (3-20-20)T
- n. 40 CFR 143.4, secondary contaminants. (3-20-20)T

**02. Manual for the Certification of Laboratories Analyzing Drinking Water EPA 815-R-05-004, Fifth Edition, January 2005.** The Manual for the Certification of Laboratories Analyzing Drinking Water EPA 815-R-05-004, Fifth Edition, January 2005, including Supplement 1 EPA 815-F-08-006, June 2008, is hereby incorporated by reference. It may be accessed in electronic format at <https://www.epa.gov/dwlabcert/laboratory-certification-manual-drinking-water>. (3-20-20)T

### 003. -- 009. (RESERVED)

### 010. DEFINITIONS.

**01. Analyst.** A person responsible for testing, quality control, and reporting of analytical results. (3-20-20)T

- 02. Board.** The Idaho Board of Health and Welfare. (3-20-20)T
- 03. Certification Authority for the State of Idaho (CA).** The CA has signature authority for all certification decisions as required for primacy in 40 CFR 142.10 (b)(3)(i). The Bureau Chief of the Idaho Bureau of Laboratories is the certification authority for the State of Idaho. (3-20-20)T
- 04. Certification Officer (CO).** The CO is the person responsible for on-site evaluations and providing technical support and guidance to a certified drinking water laboratory (CDWL). (3-20-20)T
- 05. Certified Drinking Water Laboratory (CDWL).** A facility that examines drinking water for the purpose of identifying or measuring microbiological, chemical, radiological, or physical parameters, and is certified by the State of Idaho. (3-20-20)T
- 06. Department.** The Idaho Department of Health and Welfare. (3-20-20)T
- 07. Department of Environmental Quality (DEQ).** The state agency that has primacy and is primarily responsible for administrating and enforcing regulations related to environmental quality. (3-20-20)T
- 08. Director.** The Director of the Idaho Department of Health and Welfare, or their designee. (3-20-20)T
- 09. Discipline.** Areas of certification for the testing of drinking water, i.e., microbiology, radiochemistry, inorganic chemistry, and organic chemistry. (3-20-20)T
- 10. Drinking Water Coordinator (DWC).** The drinking water coordinator is an Environmental Health Specialist at a public health district assigned to monitor public water systems. (3-20-20)T
- 11. Idaho Bureau of Laboratories (IBL).** The IBL is a bureau in the Division of Public Health in the Idaho Department of Health and Welfare. (3-20-20)T
- 12. LIMS.** Laboratory Information Management System. (3-20-20)T
- 13. Laboratory Supervisor.** A person who directs the day-to-day activities of a CDWL. (3-20-20)T
- 14. Maximum Contaminant Level (MCL).** The maximum permissible level of a contaminant in water that is delivered to any user of a public water system. (3-20-20)T
- 15. On-Site Evaluation.** The physical, quality control, and data audit of a laboratory, including all aspects of operation related to the testing of drinking water samples. (3-20-20)T
- 16. Primacy.** The responsibility for ensuring that Safe Drinking Water Act (SDWA) laws are implemented and the authority to enforce a law and related regulations (40 CFR 142.2) applicable to public water systems within the state. (3-20-20)T
- 17. Proficiency Test (or Testing) (PT).** Sample(s) provided to demonstrate that a laboratory can successfully analyze the sample(s) within the acceptance limits specified in the regulations. The qualitative or quantitative composition of the reference material is unknown to the laboratory at the time of the analysis. (3-20-20)T
- 18. Public Water System (PWS).** A system for the provision to the public of water for human consumption through pipes or other constructed conveyances, if such system has at least fifteen (15) service connections, regardless of the number of water sources or configuration of the distribution system, or regularly serves an average of at least twenty-five (25) individuals daily at least sixty (60) days out of the year. (3-20-20)T
- 19. Quality Assurance (QA).** An integrated system of management activities that involves planning, quality control, quality assessment, reporting, and quality improvement to ensure a product or service meets defined standards of quality with a stated level of confidence. (3-20-20)T

- 20. Quality Control (QC).** The overall system of technical activities whose purpose is to measure and control the quality of a product or service so that it meets the needs of the users. QC also includes operational techniques and activities that are used to fulfill the requirement of quality. (3-20-20)T
- 21. Quality Assurance Plan (QA Plan).** A comprehensive plan detailing the aspects of quality assurance required to adequately fulfill the needs of a program. This document is required before a laboratory can be certified or reciprocity is granted. (3-20-20)T
- 22. Reciprocity.** An extension of certification by the CA to an accredited or certified out-of-state laboratory based upon satisfactory review of documentation that demonstrates compliance with these rules. (3-20-20)T
- 23. Regulatory Agency.** The Idaho Department of Environment Quality (DEQ). (3-20-20)T
- 24. Regulatory Authority (RA).** The assigned drinking water Analyst III at a regional DEQ office. (3-20-20)T
- 25. Standard Operating Procedure (SOP).** A written document that describes the method of an operation, analysis, or action whose techniques and procedures are thoroughly prescribed and that is officially approved as the method for performing a routine or repetitive test. (3-20-20)T
- 26. Standard Methods (SM).** SM refers to a standard method of water testing published in the Standard Methods for the Examination of Water and Wastewater, as incorporated by reference under Section 004 of these rules. (3-20-20)T
- 27. Subcontracting.** The procedure whereby a laboratory certified by the State of Idaho may send samples to another laboratory that is certified or has been granted reciprocity by the State of Idaho for analysis. (3-20-20)T
- 011. -- 099. (RESERVED)**

**REQUIREMENTS FOR CERTIFICATION OF DRINKING WATER LABORATORIES**  
**(Sections 100-199)**

**100. APPLICATION FOR CERTIFICATION.**

- 01. Required Information on Application.** An application for first-time certification for microbiology, inorganic chemistry, organic chemistry, or radiochemistry must be submitted to the CA on a form provided by the IBL. The following information must be included: name, location, and contact information of the drinking water laboratory, name of the owner, listing of methods/analytes for which certification is requested, documentation of the education, experience, and training of the laboratory supervisor for each discipline for which certification is being requested. (3-20-20)T
- 02. Time Frame for Renewal of Application for Reciprocity.** Applications for renewal of reciprocity must be received by the IBL at least thirty (30) days before the current certificate expires. (3-20-20)T
- 03. Reapplication for Additional Analytes or to Change Methods.** An in-state laboratory seeking to change methods or to add analytes utilizing the same method for which the laboratory is currently certified must submit a written application requesting the change in certification and include a copy of the SOP with QC requirements specific to the method. (3-20-20)T
- 04. Reapplication for Certification.** A laboratory that has been downgraded to provisional or has been decertified for an analyte or method, or both, must provide written documentation to the CO of the corrective actions within the specified period. A laboratory that has been decertified in entirety must re-apply following the same procedure as a laboratory applying for first-time certification. (3-20-20)T

**05. Reciprocity for Out-State-Laboratories.** Each out-of state laboratory seeking reciprocity with Idaho must submit the same information as an in-state drinking water laboratory applying for first-time certification. (3-20-20)T

**101. CERTIFICATION FEES.**

**01. Annual Base Fee.** All CDWLs must pay an annual base fee of fifty dollars (\$50) per discipline and twenty dollars (\$20) per analyte per method for which certification is requested. Certification is valid for one (1) year from the date of issuance. (3-20-20)T

**02. Non-Refundable Application Fee.** Each new laboratory that is seeking certification or reciprocity must include a non-refundable application fee of two hundred dollars (\$200) per discipline with the application. (3-20-20)T

**102. TYPES OF CERTIFICATION.**

**01. Certified.** A certified laboratory meets the regulatory performance criteria described in these rules. (3-20-20)T

**02. Provisionally Certified.** A provisionally certified laboratory has deficiencies, but demonstrates the ability to consistently produce valid data within the acceptance limits in these rules. (3-20-20)T

**03. Not Certified.** A laboratory with the status of “not certified” can not produce consistently valid data, or is not following method protocol, or both. Such laboratories cannot analyze compliance samples. (3-20-20)T

**04. Interim Certification.** The CA may grant interim certification to a laboratory if the laboratory has appropriate instrumentation, is using approved methods, has adequately trained personnel to perform the analyses, and has satisfactorily analyzed PT samples for the contaminants involved. The CO will review the laboratory’s quality control data before granting this type of certification and will conduct an on-site evaluation as soon as possible. (3-20-20)T

**05. Reciprocity.** Reciprocity may be granted by the CA to out-of-state laboratories if such laboratories are certified or accredited by an approved regulatory agency and meet the regulatory performance criteria described in these rules. (3-20-20)T

**103. SUBCONTRACTING.**

**01. List of Subcontractors.** Laboratories who subcontract work must maintain a list of subcontractors and documentation of the subcontracting laboratories' certification or reciprocity with the State of Idaho. (3-20-20)T

**02. Identification Requirements for Subcontracting Laboratory.** The laboratory performing the subcontracted analysis must be identified by name and EPA identification number on the final report. (3-20-20)T

**03. Availability of the Report from the Subcontracting Laboratory.** The report from the subcontracting laboratory must be available to the client upon request. (3-20-20)T

**04. Availability of all Subcontracting Laboratory Records.** All subcontracting laboratory records must be available to the COs. (3-20-20)T

**104. -- 109. (RESERVED)**

**110. ON-SITE EVALUATION.**

**01. On-Site Audits and Evaluations.** COs will perform audits of the premises and operations of new laboratories or laboratories requesting continuing certification for the purpose of determining if there is enough security to maintain the integrity of the samples and data. The frequency of the on-site evaluation is at the discretion of the CA or a minimum of every three (3) years. In addition, the CO will evaluate the: (3-20-20)T

- a. Physical set up of the laboratory; (3-20-20)T
- b. Quality assurance program; (3-20-20)T
- c. Personnel qualifications; (3-20-20)T
- d. Equipment considerations; and (3-20-20)T
- e. Adequacy of data handling. (3-20-20)T

**02. Written Report of Findings from the On-Site Evaluation.** The CO will generate a written report of findings from the on-site evaluation. The report will detail areas requiring a written response and specify the length of time the laboratory has to respond. The length of time for the laboratory to respond will be proportional to the number and severity of deviations. If the conditions observed during an on-site evaluation are such that an immediate down grade or decertification is warranted the laboratory will be notified by certified mail within thirty (30) days by the CA. (3-20-20)T

**111. -- 119. (RESERVED)**

**120. PERSONNEL QUALIFICATIONS.**

**01. General Supervisor Qualifications. (3-20-20)T**

a. A supervisor must be on-site frequently enough to satisfactorily perform the required duties outlined below. The CO must be notified if the supervisor is unable to be on-site for a period greater than three (3) consecutive weeks. (3-20-20)T

b. Supervisors are responsible for ensuring that all laboratory personnel have demonstrated proficiency for assigned functions and that all data reported by the laboratory meet the required quality assurance criteria and regulatory requirements. (3-20-20)T

c. If a formal complaint is received from the regulatory agency, then the CO will notify the responsible laboratory supervisor and request a report describing the incident, the probable cause, and the corrective action to be taken to ensure the situation is resolved. The incident report must be received by the CA within thirty (30) days of the laboratory being notified of the problem. The CO in conjunction with the CA will evaluate the response and if found to be acceptable, no further action will be required of the laboratory. If the response is incomplete, the CO will provide in writing the additional steps that must be completed for certification status to remain uninterrupted. (3-20-20)T

d. No drinking water supervisor will be responsible for the supervision of more than two (2) certified drinking water laboratories unless specifically approved by the CA. (3-20-20)T

e. If a microbiology supervisor is not available, a consultant having the same qualifications may be utilized. The laboratory must submit the academic qualifications and work experience of the potential consultant to the CA. In addition, the laboratory must define and submit a list of the specific functions the consultant will be performing along with a schedule of routine visits. If the information is found to be acceptable, the CA will notify the laboratory director or owner in writing. A record of all consultant visits and communications must be maintained and be available for review during the on-site evaluation. The record must include a brief description of on-site findings and include any telephone or electronic consultation. Each entry must be dated and signed by the consultant. (3-20-20)T

**02. Supervisor Qualifications by Discipline. (3-20-20)T**

a. The supervisor of a microbiology laboratory must have a bachelor's degree from an accredited college in microbiology, biology, or equivalent. Supervisors who have a degree in a subject other than microbiology must have had at least two (2) college-level microbiology courses in which environmental microbiology was part of

the curriculum. In addition, the supervisor must have a minimum of two (2) weeks training at a federal agency, state agency, or academic institution in the microbiological analysis of drinking water or eighty (80) hours of on-the-job-training in water microbiology at a certified laboratory, or other comparable training acceptable to the CA.

(3-20-20)T

**b.** The supervisor of a chemistry laboratory must have at least a bachelor's degree from an accredited college with a major in chemistry or equivalent and at least one (1) year of experience in the analysis of drinking water. In addition, the supervisor must have a working knowledge of quality assurance principles.

(3-20-20)T

**c.** The supervisor of a radiochemistry laboratory must have at least a bachelor's degree from an accredited college with a major in chemistry, or equivalent, and should have at least one (1) year of experience in the measurement of radioactive analytes in drinking water. In addition, the supervisor must have a working knowledge of QA and QC principles as applied to all radiochemical practices and procedures conducted in the laboratory.

(3-20-20)T

**03. Analyst or Equivalent Job Title.**

(3-20-20)T

**a.** An analyst performing microbiological testing must have a minimum of a high school education or equivalent, at least three (3) months of bench experience in environmental microbiological testing, and thirty (30) days on-the-job training in drinking water microbiology under the direction of an experienced analyst. If an analyst has a bachelor's degree in microbiology, or related field, the three (3) month bench training may be shortened to thirty (30) hours at the discretion of the laboratory supervisor. Before analyzing compliance samples, the analyst must demonstrate competency by successfully completing a PT.

(3-20-20)T

**b.** Analysts in each of the chemical disciplines should have at least a bachelor's degree with a major in chemistry, or equivalent, and at least one (1) year of experience in the analysis of drinking water for the discipline in which they are working. If the analyst is responsible for the operation of analytical instrumentation, they must have completed specialized training offered by the manufacturer or another qualified training facility or have successfully served an apprenticeship under an experienced analyst. The duration of this apprenticeship should be proportional to the sophistication of the instrument. Data produced by analysts and instrument operators while in the process of obtaining the required training or experience are acceptable only when reviewed and validated by a fully qualified analyst or the laboratory supervisor. Documentation of training must be maintained for each analyst and available for evaluation by the CO.

(3-20-20)T

**04. Chemistry Technician.** Technicians in each of the chemical disciplines must have at least a high school diploma or equivalent, have completed a method-training program under an experience analyst, and have six (6) months bench experience in the analysis of drinking water. The method-training record for each analyst should be recorded in a training file and available for evaluation by the CO.

(3-20-20)T

**121. -- 129. (RESERVED)**

**130. REPORTING, NOTIFICATION, AND DISTRIBUTION OF LABORATORY RESULTS.**

**01. Submission of Test Results in Approved Format.** The drinking water supervisor in each of the disciplines of certification is responsible for submission of all test results performed on samples submitted by PWSs, including subcontracted samples, in a format approved by the DEQ Drinking Water Program. Reports must be submitted to the appropriate regulatory authority or drinking water coordinator in a timely manner not to exceed ten (10) business days after the completion of testing or upon receipt of results from subcontract laboratories. (3-20-20)T

**02. Notification of High Contaminant Levels.** The chemistry supervisor or designee must notify the appropriate regulatory agency or drinking water coordinator by phone as soon as feasible of any nitrate and nitrite level exceeding the current MCL including subcontracted samples. Notification must also be made when any other regulated chemical or radiological contaminant exceeds four (4) times the MCL.

(3-20-20)T

**03. Notification of Positive Microbiological Results.** The microbiological supervisor or designee is responsible for an immediate telephone notification to the appropriate regulatory agency in the case of a positive result for a microbiological test. If the RA or DWC is not available, the results must be given to the person designated

by the RA or DWC to take the information. (3-20-20)T

**131. -- 139. (RESERVED)**

**140. LABORATORY QUALITY ASSURANCE.**

**01. The QA Plan.** Each laboratory certified or having reciprocity with the State of Idaho must have and adhere to a QA plan. Laboratories seeking certification will be required to submit such a plan for review as part of the application process. (3-20-20)T

**02. Required Items for the QA Plan.** The EPA Manual for the Certification of Laboratories Analyzing Drinking Water lists the items that must be included: (3-20-20)T

- a.** Laboratory organization and responsibility; (3-20-20)T
- b.** SOPs with dates of last revision; (3-20-20)T
- c.** Laboratory sample receipt and handling procedure; (3-20-20)T
- d.** Instrument calibration procedures; (3-20-20)T
- e.** Analytical procedures; (3-20-20)T
- f.** Data reduction, validation, reporting and verification; (3-20-20)T
- g.** Type of quality control (QC) checks and frequency of use; (3-20-20)T
- h.** List of schedules of internal and external system and data quality audits and inter laboratory comparisons; (3-20-20)T
- i.** Preventive maintenance procedures and schedules; (3-20-20)T
- j.** Corrective action contingencies; and (3-20-20)T
- k.** Record-keeping procedures. (3-20-20)T

**03. Chain-of-Custody Procedures.** Each laboratory must have a procedure in place in the event the submitter requires an evidence chain-of-custody. (3-20-20)T

**04. Maintenance of Records.** Each laboratory must: (3-20-20)T

- a.** Maintain a record keeping system that allows the history of the sample and associated data to be readily understood through documentation. This would include access to LIMS, both present and prior systems, all electronic data including backup, QC documents and all associated calculations, maintenance records including replacement history of instruments, submission forms, submission forms to subcontracting laboratories, final reports from subcontracting laboratories, and final reports generated by the certified laboratory. (3-20-20)T
- b.** Retain all records for a minimum of five (5) years from generation of the last entry in the records. (3-20-20)T
- c.** Notify public water system clients before disposing of records. (3-20-20)T
- d.** Be aware of and adhere to specific record retention as required for specific analytes or disciplines. (3-20-20)T

**05. Proficiency Testing (PT).** Proficiency test samples must be successfully analyzed annually per analyte per method for which the laboratory is certified. All PT samples must be obtained from an approved supplier,

and must be analyzed in the same manner as routine samples by the primary analyst assigned to the specific analysis. If testing is rotated among a number of analysts the supervisor will be responsible for determining who completes the PT. Records must include the name of the analyst who completed the testing. The results of the PT must be sent directly from the supplier to the CO. The methods listed on the laboratory's certificate must be the methods used for PT samples. (3-20-20)T

**141. -- 149. (RESERVED)**

**150. EVALUATION.**

**01. Documentation of Corrective Action.** If a CDWL is found to be noncompliant, it will be notified in writing by the CA of the number and seriousness of the deviations. The noncompliant laboratory will be required to submit documentation of correction to the CA or their designee within the time limit specified by the CA. (3-20-20)T

**02. Adequacy of Corrective Action.** Upon receipt of documentation of corrective action, the CO in conjunction with the CA will review the response to determine the adequacy of the corrective action taken. The laboratory will be eligible for certification if the response is found to be complete. If the response is incomplete or inadequate, the laboratory will be notified in writing of the additional changes required along with a specified time for completion. (3-20-20)T

**03. Unacceptable PT Result.** In the event of an unacceptable PT, the laboratory must submit an incident report to the CO that includes a description of the incident and corrective action taken. A second PT must be completed within sixty (60) days of the laboratory being notified of the failure. If the second PT is successfully analyzed no further action will be taken. If a second PT is not analyzed or if the second PT is also unacceptable, the laboratory will be downgraded in accordance with Section 210 of these rules. (3-20-20)T

**04. Continued Certification of Other Tests.** A CDWL that has an unacceptable PT result per analyte per method may remain certified for performance of all tests for which satisfactory performance has been demonstrated through the annual successful PT testing. (3-20-20)T

**151. -- 199. (RESERVED)**

**REQUIREMENTS FOR DRINKING WATER LABORATORIES TO MAINTAIN,  
DOWNGRADE, OR REVOKE CERTIFICATION  
(Sections 200-299)**

**200. MAINTENANCE OF CERTIFICATION.**

In order to maintain certification, drinking water laboratories must be able to demonstrate they continue to meet all of the following requirements. (3-20-20)T

**01. Successful Completion of PT Samples.** Each year, each laboratory must successfully complete a PT per analyte per method for which the laboratory is seeking to maintain certification. (3-20-20)T

**02. Use of Specified Methods.** Each laboratory must be able to demonstrate it is using the methods specified in the drinking water regulations. (3-20-20)T

**03. Maintain Required Standard of Quality.** The CO must be satisfied the laboratory is maintaining the required standard of quality for certification. This is based on the results of the PT testing, on-site evaluations, and any feedback from regulatory agencies. (3-20-20)T

**04. Notification of Major Changes.** The laboratory must notify the CA in writing within thirty (30) days of major changes that could affect the accuracy and precision of testing. A major change includes the loss of a laboratory supervisor, equipment failure or breakdown, or change in location or ownership. (3-20-20)T

**201. -- 209. (RESERVED)**



**210. CRITERIA AND PROCEDURES FOR DOWNGRADING OR REVOKING CERTIFICATION STATUS.**

**01. Reasons a Laboratory May be Downgraded to Provisionally Certified Status.** A laboratory may be downgraded to provisionally certified status for an analyte or method for any of the following reasons: (3-20-20)T

- a.** Failure to analyze a PT annually within acceptance limits specified in the regulations as demonstrated by a failure of a second PT; (3-20-20)T
- b.** Failure to submit an incident report after failing a PT or to analyze a second PT; (3-20-20)T
- c.** Failure to notify the CA within thirty (30) days of major changes; (3-20-20)T
- d.** Failure to maintain the required standard of quality based upon observations made by the CO during an on-site evaluation; or (3-20-20)T
- e.** Failure to report compliance data to the regulatory agency in a timely manner. (3-20-20)T

**02. Procedure for Downgrading to Provisionally Certified Status.** (3-20-20)T

**a.** The CA will notify the laboratory director or owner by certified mail of the intent to downgrade the laboratory to provisional certification per analyte per method within thirty (30) days of learning of any of the items listed under Subsection 210.01 of this rule. The laboratory will be given thirty (30) days from the date of receipt to develop a written corrective action plan and submit it with all supporting documentation to the CA. This information will be reviewed and evaluated for adequacy. The laboratory will be notified by certified mail if the response is acceptable or if additional corrective action must be taken. The CO will document that the corrective action plan has been implemented during the next on-site evaluation. (3-20-20)T

**b.** If a laboratory fails a second PT, the CA will downgrade the laboratory to provisionally certified status for that analyte or method and notify the laboratory by certified mail. (3-20-20)T

**c.** A provisionally certified laboratory has three (3) months to correct the problem in a manner that is acceptable to the CA. If the downgrading of certification is based on the results of PT testing, the reason for the error must be identified and corrected. A third PT must be successfully analyzed. A provisionally certified laboratory may continue to analyze samples for compliance purposes, but must notify its clients of the downgraded status of certification and provide that information in writing on all reports. (3-20-20)T

**d.** An out-of-state laboratory that has reciprocity with Idaho and is downgraded to provisional status by either the accreditation agency or certification authority of the home state must notify the CA of the change within thirty (30) days of the downgrade. (3-20-20)T

**03. Criteria for Revoking Certification Status.** (3-20-20)T

**a.** A laboratory must be downgraded from certified, provisionally certified, or interim certified status to “not certified” for a particular analyte or method for the following reasons: (3-20-20)T

- i.** Reporting PT data from another laboratory as its own; (3-20-20)T
- ii.** Falsification of data or other deceptive practices; (3-20-20)T
- iii.** Failure to use the analytical methodology specified in the regulations; and (3-20-20)T
- iv.** For provisionally certified laboratories, failure to correct the identified deficiencies that lead to the downgrading of certification status. (3-20-20)T

**b.** Reciprocity of out-of-state laboratories who do not notify the CA of any changes in the status of

certification or accreditation will automatically be revoked. (3-20-20)T

**04. Procedure for Revocation.** (3-20-20)T

**a.** The CA will notify the laboratory in writing of the intent to revoke certification. The laboratory will have thirty (30) days from the time of the notification to provide a written response. (3-20-20)T

**b.** If the laboratory responds with an acceptable written corrective action plan, including documentation of implementation, the revocation will be suspended. (3-20-20)T

**c.** If the response is unacceptable, incomplete, or both, certification will be revoked. If the laboratory does not respond, certification will be revoked. The laboratory will be notified in writing of the revocation. (3-20-20)T

**05. Upgrading or Reinstatement of Certification.** A laboratory seeking an upgrade of certification must request this change in writing and provide documentation that the deficiencies that led to the provisional certification have been corrected. In addition, an on-site evaluation and successful completion of an additional PT may be required. A laboratory seeking certification after a revocation must follow the same procedure as a new laboratory seeking initial certification. (3-20-20)T

**211. -- 999. (RESERVED)**

## 16.02.14 – CONSTRUCTION AND OPERATION OF PUBLIC SWIMMING POOLS

### 000. LEGAL AUTHORITY.

Sections 56-1003 and 56-1007, Idaho Code, grant authority to the Director of the Department of Health and Welfare, to enforce minimum standards of health, safety and sanitation and to establish reasonable fees for services for all public swimming pools within the state of Idaho. (3-20-20)T

### 001. TITLE, SCOPE, AND INTENT.

01. **Title.** These rules are titled IDAPA 16.02.14, “Construction and Operation of Public Swimming Pools.” (3-20-20)T

02. **Scope.** The provisions of these rules apply to all public swimming pools and related facilities. The purpose of these rules is to control and regulate the design, construction, operation, and maintenance of public pools to protect public health and safety. (3-20-20)T

03. **Intent.** To prevent the spread of communicable disease and to assure a clean and safe environment in public swimming pools. (3-20-20)T

### 002. APPLICABILITY.

All public swimming pools, as defined, must be constructed and operated in conformance with these rules. Public swimming pools constructed prior to 1982 that can meet the requirement of Sections 190 through 198 and Sections 230 and 231 of these rules are not be required to meet the structural aspects of these rules. These rules apply to all public swimming pools. (3-20-20)T

### 003. -- 009. (RESERVED)

### 010. DEFINITIONS.

For the purpose of these rules, the following words and phrases are used, as defined below: (3-20-20)T

01. **Bather.** A person who becomes partially or totally immersed in water in a pool. (3-20-20)T
02. **Board.** Idaho Board of Health and Welfare. (3-20-20)T
03. **Break in Grade.** Where the slope of the bottom of pool exceeds a uniform slope greater than one (1) foot in twelve (12) feet horizontally. (3-20-20)T
04. **Department.** Idaho Department of Health and Welfare. (3-20-20)T
05. **Director.** Director of the Idaho Department of Health and Welfare. (3-20-20)T
06. **Director’s Designee.** The seven Public Health Districts. (3-20-20)T
07. **Geothermal Water.** Water derived from and heated exclusively from the natural heat energy from the earth. (3-20-20)T
08. **Geothermal Pool.** A flow-through public pool, which uses water solely derived from and heated exclusively by the natural heat energy from the earth. (3-20-20)T
09. **Flow-Through Pool.** A pool fed by a continuous supply of acceptable water that causes an equal volume of water to overflow to waste. (3-20-20)T
10. **Lifeguard.** A person who holds a current lifeguard training certificate and basic life support cardiopulmonary resuscitation (CPR) certificate from the American Red Cross, YMCA, Ellis & Associates, or any other equivalent certifying agency approved by the Director’s Designee. (3-20-20)T
11. **Lifeguard Chair.** An elevated stand erected for use by a lifeguard while superintending the safety of bathers in a pool. The height and location must afford the user an unobstructed view of all bathers within the pool enclosure. (3-20-20)T
12. **Operator.** An individual eighteen (18) years of age or older, who is familiar with the operation of the pool and is responsible for the health and safety of the public using the pool and for operating the pool in compliance with these rules. The operator must have an approved certification of competency from a Certified Pool

Operator (CPO), National Swimming Pool Foundation Certification; an Aquatic Facility Operator (AFO), National Recreation and Parks Association Certification; a National Swimming Pool Institute (NSPI Tech 1), National Spa and Pool Institute Certification Program, District Health Department Certification, or other certification programs approved by the Director designee. The operator must also have a basic life support cardiopulmonary resuscitation (CPR) certificate and current first aid certification as stated in Subsection 010.10 of these rules. (3-20-20)T

**13. Person.** A person, firm, partnership, association, corporation, company, governmental agency, club or organization of any kind. (3-20-20)T

**14. Pool.** An artificial structure containing water and its related elements used or intended to be used for swimming, diving, or recreation. (3-20-20)T

**15. Private Pool.** Any pool constructed in connection with or appurtenant to single-family dwellings or condominiums used solely by the persons maintaining their residence within such dwellings and the guests of such persons. (3-20-20)T

**16. Public Swimming Pool.** Herein referred to as public pool. A pool, and its related elements, that contains water more than two (2) feet deep, is used or intended to be used for swimming, diving, or recreational bathing, and is for the use of any segment of the public under a general invitation but not an invitation to a specific occasion or occasions. (3-20-20)T

**17. Remodel.** To replace all or part of any structure, circulation system, or related element of a pool facility, or to modify to the extent its design, configuration, or operating characteristics differ from those of the original. The term does not include normal maintenance, repair, or replacement of equipment or similar equipment that has previously been approved. Only that which is being remodeled needs to meet current specifications. (3-20-20)T

**18. Spa.** An artificial structure containing water no more than four (4) feet deep and a recirculation system primarily designed for relaxation or therapeutic use where the user is sitting, reclining, or at rest. (3-20-20)T

**19. Special-Use Pool.** A pool used exclusively for rehabilitating, curing, or treating a disease or disorder. This term also includes geothermal flow-through pools used exclusively for relaxation or therapeutic use where the user is sitting, reclining, or at rest. (3-20-20)T

**20. Wading Pool.** A public pool with water less than two (2) feet deep used mainly by non-swimming children and those supervising the children. (3-20-20)T

**011. -- 019. (RESERVED)**

**020. SUBMISSION OF PLANS AND SPECIFICATIONS.**

**01. Plans.** No person may construct or remodel any public pool until plans, specifications, and a plan review fee have been submitted, and the Director's designee has issued a letter of acceptance. Plans and specifications must be prepared by an architect or engineer licensed to practice in the state of Idaho. The architect or engineering plans, specifications and reports, must contain information sufficient to demonstrate the proposed pool is in compliance with these rules and certify the same. (3-20-20)T

**02. Construction Compliance Certificate.** The operator must submit, prior to public use of new facilities, a construction compliance certificate to the Director's designee. This certificate must: (3-20-20)T

**a.** Be prepared and signed by a professional engineer or architect licensed to practice in the state of Idaho; and (3-20-20)T

**b.** Include a statement that the pool and the related elements have been constructed in accordance with approved plans and specifications. (3-20-20)T

**03. Stability.** Pools must be designed and constructed to withstand all anticipated loadings for both full

and empty conditions. A hydrostatic relief valve or other suitable means must be provided in areas having a high water table. The designing architect or engineer is responsible for certifying the structural stability and safety of the pool. (3-20-20)T

**021. -- 029. (RESERVED)**

**030. PERMITS.**

No public pool may be open to the public unless the operator has applied for and received a permit. Permits expire on December 31 of each year, unless earlier revoked or suspended for violation of these rules. Exempt pools may voluntarily request to obtain a permit and be inspected. Only persons who comply with these rules are entitled to receive and retain a permit. Permits are not transferable. (3-20-20)T

**031. APPLICATION.**

An application for permit must be made on forms obtained from the Director's designee. (3-20-20)T

**032. PERMIT FEE AND PLAN REVIEW FEE.**

All applications must be accompanied by payment of the permit fee of fifty dollars (\$50) annually for each swimming pool. A plan review fee per unit for each swimming pool is one hundred dollars (\$100). (3-20-20)T

**033. WAIVER OF FEES.**

Upon written application to the Director, a waiver of a specific fee may be granted to an applicant who is required by these rules to pay the fee. (3-20-20)T

**01. Determination of Good Cause.** Good cause for a waiver must be shown before it is granted by the Director. Good cause may include hardship or extenuating circumstances, as determined by the Director. (3-20-20)T

**02. Duration of Waiver.** If the fee sought to be waived becomes due periodically, the fee may be waived for a designated period of time. (3-20-20)T

**03. Limitations.** Granting of a waiver will not be considered as precedent or be given any force or effect in any other proceeding. (3-20-20)T

**034. -- 039. (RESERVED)**

**040. INSPECTIONS.**

The Director's designee is authorized to conduct inspections as deemed necessary to insure compliance with all provisions of these rules and will have right of entry at any time the pool is in operation. (3-20-20)T

**041. NOTICE OF VIOLATION.**

If a violation of any provision of these rules is found during an inspection, the inspector will provide a written notice of such violation to the operator, which will establish a time frame for correction. (3-20-20)T

**042. REINSPECTION.**

A reinspection will be made to determine if the violation has been corrected. If upon reinspection the violation has been corrected, the pool will be allowed to remain open. If upon reinspection the violation still remains, the permit may be temporarily suspended and the pool closed until such time the violation has been corrected and approved by the Director, or the Director's designee. (3-20-20)T

**043. -- 049. (RESERVED)**

**050. TEMPORARY SUSPENSION AND REVOCATION OF PERMITS.**

**01. Cause.** The Director or the Director's designee may temporarily suspend, or revoke a permit for failure to comply with these rules or in cases where the permit has been obtained through nondisclosure, misrepresentation, or misstatement of a material fact. (3-20-20)T

**02. Suspension.** If the Director or the Director's designee determines that conditions at a public pool

constitutes a serious danger to the health or safety of the public, a written order stating the particular reason for suspension will be given to the operator; the permit will be immediately suspended and the pool closed until such time the condition is corrected. If the violation to these rules has not been corrected and a reinspection shows the violation still remains, a written order stating the particular reason for suspension will be given to the operator and the permit will be temporarily suspended and the pool closed until such time the condition is corrected. In the event a permit is suspended, the person to whom the permit was issued has the right to appeal under Section 003 of these rules. (3-20-20)T

**03. Revocation.** If an operator fails to comply with the orders of a temporary suspension, the permit will be revoked unless the operator immediately closes the pool. Before a permit is revoked, the person to whom the permit was issued will receive notice in writing indicating items that fail to comply with this chapter. The permit holder will be advised of his right to appeal. (3-20-20)T

**04. Reissue.** The permit may be reissued upon proper application and upon presentation of evidence that the deficiencies or abuses causing revocation have been corrected. (3-20-20)T

**051. -- 059. (RESERVED)**

**060. PENALTY.**  
Any person who willfully violates, disobeys, or disregards the provisions of these rules is guilty of a misdemeanor under the provisions of Section 56-1008, Idaho Code. (3-20-20)T

**061. -- 069. (RESERVED)**

**070. CONSTRUCTION REQUIREMENTS: PLUMBING CODES.**  
All plumbing must conform with and meet the provisions of IDAPA 07.02.06, "Rules Concerning the Idaho State Plumbing Code." (3-20-20)T

**071. CONSTRUCTION REQUIREMENTS: ELECTRICAL CODE.**  
All electrical appliances and wiring must conform with and meet the provisions of IDAPA 07.01.06, "Rules Governing the Use of National Electrical Code." (3-20-20)T

**072. CONSTRUCTION REQUIREMENTS: UNIFORM BUILDING CODE.**  
All buildings must conform with and meet the provisions of IDAPA 07.03.01, "Rules of Building Safety." (3-20-20)T

**073. CONSTRUCTION REQUIREMENTS: MATERIALS.**  
Pools and all related elements must be constructed of materials that are inert, nontoxic to humans, impervious, permanent, and enduring; can withstand the design stresses; and will provide a tight tank with a smooth and easily cleanable surface, or to which an easily cleaned surface finish can be applied. (3-20-20)T

**074. CONSTRUCTION REQUIREMENTS: CORNERS.**  
Corners formed by intersection of walls and floors must be rounded. (3-20-20)T

**075. CONSTRUCTION REQUIREMENTS: FINISH.**  
Pool finish, including bottom and sides, must be of light colored material, nontoxic to humans, with a smooth and easily cleanable surface. (3-20-20)T

**076. -- 079. (RESERVED)**

**080. DESIGN DETAIL: DIMENSIONS.**  
No limits are specified for length and width of pools except any pool in which diving is allowed must be at least sixteen (16) feet wide. (3-20-20)T

**081. DESIGN DETAIL: CIRCULATION.**  
Provisions must be made for complete, continuous circulation of water throughout all parts of the pool. Pools with a recirculation system must have the necessary treatment and filtration equipment as required. Flow-through pools that

can meet the bacterial and clarity requirements of Sections 230 and 231 will not be required to meet Sections 250 through 256 and Sections 260 and 261 of these rules. (3-20-20)T

**082. DESIGN DETAIL: SHAPE.**

The shape of any pool must be such that the circulation of water and the safety of bathers are not impaired. (3-20-20)T

**083. DESIGN DETAIL: WADING POOLS.**

All wading pools must have a maximum depth of two (2) feet, be physically separated from any pool, have a turnover rate of at least once every two (2) hours, have separate equipment for water recirculation and disinfection with no cross connections between a wading pool and any other pool, and be equipped with anti-vortex drains to avoid any possibility of entrapment. (3-20-20)T

**084. DESIGN DETAIL: NO DIVING SIGN.**

If a pool is not designed for diving, a conspicuous sign must be posted and state "NO DIVING," and contain lettering no less than six (6) inches high. Pools allowing diving must be at least eight (8) feet six (6) inches deep and meet manufacturer's installation criteria. (3-20-20)T

**085. DESIGN DETAIL: SAFETY LINE.**

A safety line must provide a visual and physical indicator of the separation between the shallow and deep portions of a pool and be in place when the pool is open to the general public, except during periods of lap swimming, competitive swimming or supervised training. It must be located in the shallow area no closer than one (1) foot nor any further than two (2) feet away from the break in grade line or five (5) foot depth, be securely fastened to wall anchors of corrosion-resistant material and of the type that is recessed or has no projections that would constitute a hazard when the line is removed, and be marked with visible floats. (3-20-20)T

**086. -- 089. (RESERVED)**

**090. SLOPE OF FLOOR: SHALLOW AREA.**

Any portion of the pool floor with a depth less than five (5) feet must be uniform, slope to drain, and must not exceed a slope of more than one (1) foot in twelve (12) feet horizontally. (3-20-20)T

**091. SLOPE OF FLOOR: DEEP AREA.**

The slope of the pool floor at a water depth of five (5) feet or more must be uniform, sloped to drain, and must not exceed a slope of one (1) foot in three (3) feet horizontally. (3-20-20)T

**092. -- 099. (RESERVED)**

**100. SIDE WALLS.**

Walls of a swimming pool must be either: vertical for water depth of at least six (6) feet; or vertical to a depth of three (3) feet below the water surface and then curved to join the bottom with a radius not greater than the difference between the depth at that point and three (3) feet, provided vertical is interpreted to permit slopes not greater than one (1) foot horizontally for each five (5) feet of sidewall depth (eleven (11) degrees from vertical). (3-20-20)T

101. ILLUSTRATION OF POOL SIDE WALL.

Illustration of Pool Side Wall

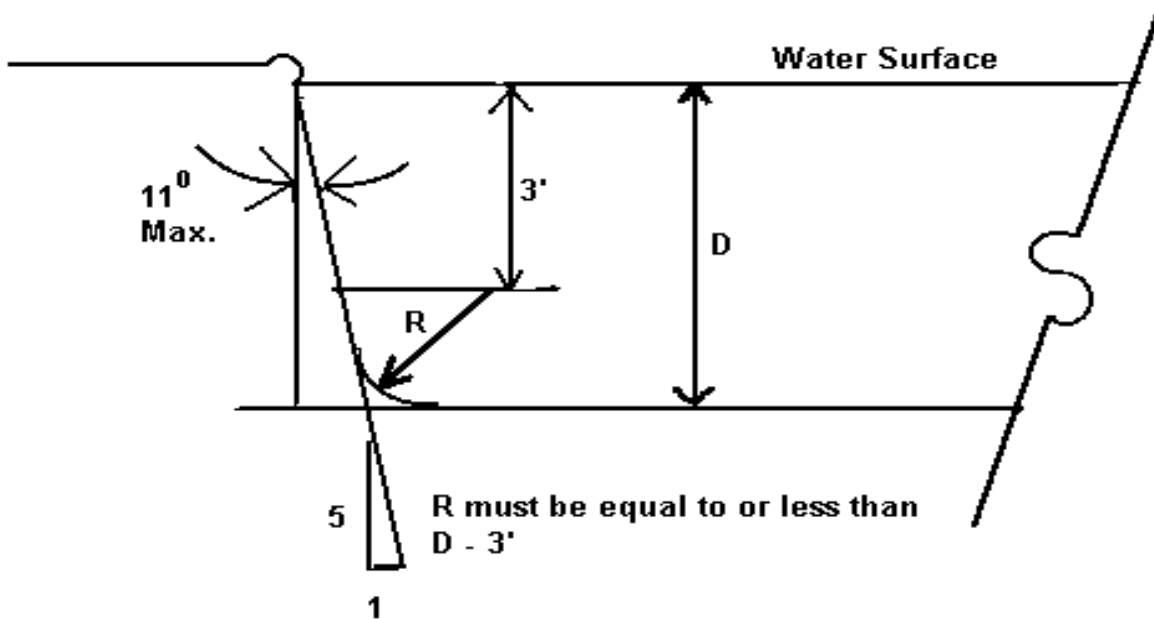

(3-20-20)T

102. -- 109. (RESERVED)

110. WIDTH OF DECKS AND WALKWAYS.

01. **Pool Deck.** A pool must have: (3-20-20)T

a. A continuous deck, a minimum of eight (8) feet wide, that extends completely around the pool if it has one thousand eight hundred (1,800) square feet of surface area, or more; (3-20-20)T

b. A continuous deck a minimum of four (4) feet wide if it has less than one thousand eight hundred (1,800) square feet of surface area; and (3-20-20)T

c. A minimum of three (3) feet at the rear of any diving equipment or slide. (3-20-20)T

02. **Spa.** A spa may be constructed adjacent to a pool provided: (3-20-20)T

a. The spa has one hundred twenty (120) square feet of water surface area or less; (3-20-20)T

b. The spa is separated from the pool by a common wall no more than twelve (12) inches wide; (3-20-20)T

c. The common wall is constructed to prevent its use as a walkway; and (3-20-20)T

d. A continuous deck a minimum of four (4) feet wide extends completely around the pool and the spa. (3-20-20)T

111. SLOPE OF DECKS AND WALKWAYS.

Decks must have a nonslip surface and be sloped to remove any surface drainage from entering the pool water.



Drainage must be conducted from the deck in a manner that will not create hazardous or objectionable conditions and not be returned to the recirculation system. (3-20-20)T

**112. -- 119. (RESERVED)**

**120. LADDERS, RECESSED STEPS, AND STAIRS REQUIREMENTS.**

Recessed steps, stairs, or ladders must be provided at the shallow and deepest end of a pool. If the pool is over thirty (30) feet wide, such steps, ladders, or stairs must be installed on each side. (3-20-20)T

**121. RECESSED STEPS.**

Recessed steps must be readily cleanable and must be arranged to drain into the pool. The steps must have a minimum tread of five (5) inches and a minimum width of fourteen (14) inches. (3-20-20)T

**122. STAIRS.**

Where stairs are provided, they must be equipped with a handrail, have walking surfaces and treads that are of nonslip design with the leading edge in contrasting color, have steps with a minimum tread of twelve (12) inches and a maximum rise of ten (10) inches, and have no abrupt drop-off or submerged projections into the pool, unless guarded by handrails. (3-20-20)T

**123. LADDERS.**

All ladders must be corrosion-resistant, equipped with nonslip treads, designed to provide a handhold, be rigidly installed, and have a clearance of not more than five (5) inches or less than three (3) inches between any ladder and the pool wall. (3-20-20)T

**124. HANDRAILS.**

Where recessed steps or ladders are provided within the pool, handrails must be positioned at the top of both sides that extend over the coping or edge of the deck and be tight and secure. (3-20-20)T

**125. ACCESS TO DIVING BOARDS.**

Platforms and steps for diving boards must be of sufficient structural strength to safely carry the maximum anticipated loads. Steps must be of corrosion-resistant material, easily cleanable, and of nonslip design. Handrails must be provided at all steps and ladders leading to diving boards more than one (1) meter above the water. Platforms and diving boards over one (1) meter high must be protected with guard railings. (3-20-20)T

**126. -- 129. (RESERVED)**

**130. DIVING AREA: HEADROOM.**

All pools must have at least thirteen (13) feet of unobstructed area above each diving board as measured from the front end of the board, and this unobstructed area must extend horizontally at least sixteen (16) feet forward of the plummet, at least eight (8) feet behind the plummet, and at least eight (8) feet to both sides of the plummet. (3-20-20)T

**131. DIVING AREA: WATER DEPTH.**

The dimensions of the diving area on public pools must conform to the following:

Minimum Dimensions					
Height of the diving board above the water level		Depth of water at the plummet	Distance ahead of plummet	Depth of water at the distance L From plummet	Overhang of diving board beyond edge of pool
H		D-1	L	D-2	O-H
Meters	Feet	Feet	Feet	Feet	Feet
0.00 to 0.50	0'0" to 1.7"	8'6"	11'6"	8'6"	3'0"

Minimum Dimensions					
Height of the diving board above the water level		Depth of water at the plummet	Distance ahead of plummet	Depth of water at the distance L From plummet	Overhang of diving board beyond edge of pool
0.51 to 0.75	1'8" to 2'6"	9'3"	11'6"	9'3"	4'0"
0.76 to 1.00	2'7" to 3'3"	10'0"	14'0"	10'0"	5'0"
1.01 to 3.00	3'4" to 10'0"	13'0"	20'0"	13'0"	6'0"
*Diving boards and platforms in excess of three (3) meters or ten (10) feet in height are not allowed in a pool without special provisions, controls, and definite limitation on their use, which has been approved by the Director's designee.					

(3-20-20)T

132. ILLUSTRATION OF DIMENSIONS OF DIVING AREA.

**Illustration of Dimensions of Diving Area**

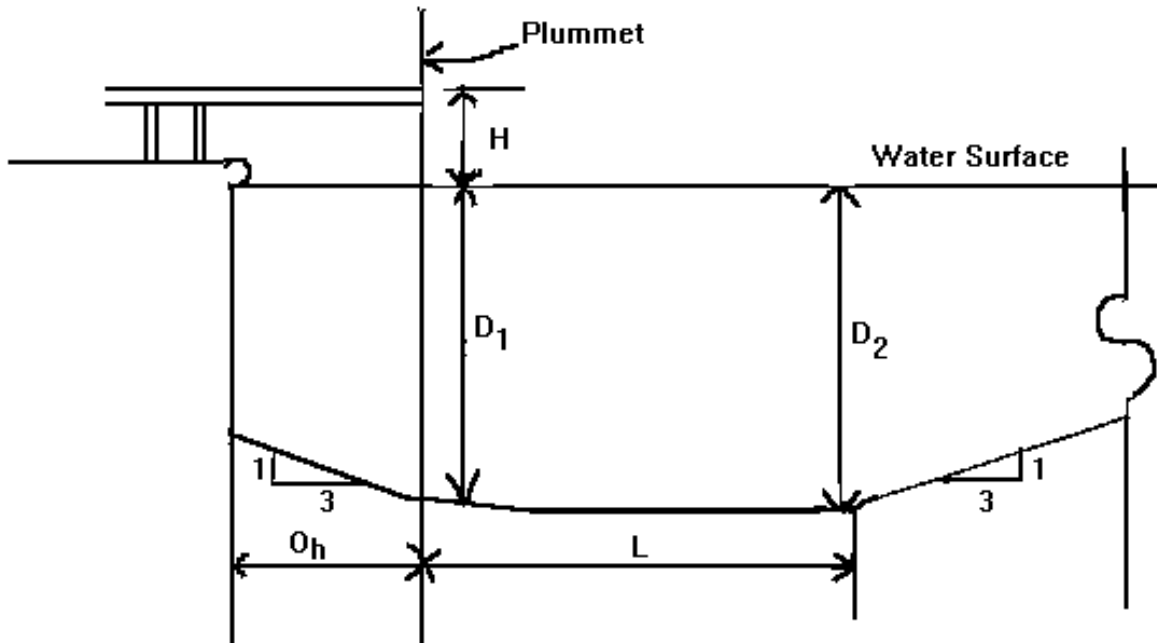

(3-20-20)T

133. SEPARATION OF LOW DIVING BOARDS.

All diving boards installed on pools at heights not greater than three (3) feet three (3) inches or one (1) meter above the water level must be separated from adjacent diving boards of the same or less height by a distance of not less than eight (8) feet, and must be located not less than ten (10) feet from the side wall of the pool. (3-20-20)T

134. SEPARATION OF HIGH DIVING BOARDS.

All diving boards installed on pools at heights greater than three (3) feet three (3) inches or one (1) meter above the water level must be separated from adjacent diving boards of the same or less height by a distance of not less than ten

(10) feet, and must be located not less than twelve (12) feet from the side wall of the pool. (3-20-20)T

**135. ANCHORING OF DIVING BOARDS.**

All installed equipment must be firmly anchored. (3-20-20)T

**136. -- 139. (RESERVED)**

**140. LIGHTING AND ELECTRICAL REQUIREMENTS.**

All electrical appliances and wiring must conform with and meet the provisions of IDAPA 07.01.06, "Rules Governing the Use of National Electrical Code." Defects in the electrical system, including underwater lights, overhead lights, and their respective lenses, must be immediately repaired. (3-20-20)T

**141. PORTABLE ELECTRICAL DEVICES.**

Portable electrical devices such as announcing systems and radios, unless battery operated, are prohibited within the pool enclosure. (3-20-20)T

**142. OVERHEAD WIRING.**

There may not be any overhead electrical wiring within twenty (20) feet horizontal distance of the pool enclosure. (3-20-20)T

**143. UNDERWATER LIGHTING.**

Where underwater lighting is used, the lights must be spaced to provide illumination so all portions of the pool, including the bottom, may be readily seen without glare. (3-20-20)T

**144. -- 149. (RESERVED)**

**150. VENTILATION.**

All indoor pools, bathhouses, dressing rooms, shower rooms, and toilet spaces must be ventilated either by natural or mechanical means to prevent corrosion or the build-up of mold or mildew. (3-20-20)T

**151. -- 159. (RESERVED)**

**160. DRESSING ROOMS, TOILETS, AND SHOWERS.**

Dressing rooms, toilets, and showers must be made available to all users of a pool. Dressing rooms must be finished in light colors and planned so good sanitation can be maintained throughout the buildings at all times. No glass containers are permitted. (3-20-20)T

**161. LOCATION OF DRESSING ROOMS.**

Dressing rooms must be located near toilets and showers, and should be adjacent to the locker or checkroom, and have a layout such that bathers, on leaving the dressing room, should pass the toilet and shower en route to the pool. (3-20-20)T

**162. FLOORS IN DRESSING ROOMS, TOILETS, AND SHOWERS.**

Floors must be constructed of non-absorbent materials with non-slip finishes, slope to properly located drains, and have a sufficient number of drains installed to prevent water from collecting on the floor. (3-20-20)T

**163. CONSTRUCTION OF DRESSING ROOMS.**

The material used for walls, partitions, and furniture must be such that it can be easily cleaned and will not be damaged by frequent hosing, wetting, or disinfection. (3-20-20)T

**164. TOILETS.**

Toilet facilities must be provided for both men and women, be accessible to disabled persons, and be kept clean and properly maintained. (3-20-20)T

**165. SHOWERS.**

The following must be provided: (3-20-20)T

- 01. Showers.** Showers for both men and women that are accessible to disabled persons. (3-20-20)T
- 02. Fixtures.** Fixtures that are kept clean and properly maintained. (3-20-20)T
- 03. Water Temperature.** Hot water for showers that is no less than ninety (90) degrees and no more than one hundred twenty (120) degrees. (3-20-20)T
- 04. Scald Prevention.** Thermostatic tempering, or mixing valves, to prevent scalding of bathers. (3-20-20)T
- 05. Soap.** (3-20-20)T

**166. HAND SINKS.**

A minimum of one (1) hand wash sink with hot and cold running water and soap must be provided in each toilet room. (3-20-20)T

**167. EXCEPTION.**

The requirements of Sections 160 through 166 of these rules do not apply to any pool operated solely for and in conjunction with a hotel, motel, or other place of lodging or other facility containing multiple dwellings. However, dressing rooms, toilets, and showers must be in compliance with Sections 160 through 166 of these rules, if provided in the pool area of hotels, motels, or other facilities containing multiple dwellings. (3-20-20)T

**168. -- 169. (RESERVED)**

**170. WATER SUPPLY.**

The water supply serving a pool must meet the water quality requirements of the Director's designee for potable water except the Director's designee may approve the use of geothermal waters. Drinking water must be approved and, if applicable, meet the provisions of IDAPA 58.01.08, "Idaho Rules For Public Drinking Water Systems." All portions of the water distribution system must be protected against backflow and cross connections. (3-20-20)T

**171. -- 179. (RESERVED)**

**180. SEWER SYSTEM.**

A sewer system must be provided and be adequate to serve the facility, including bathhouse, locker room, and related accommodations. The sanitary sewer serving the pool and auxiliary facilities must discharge to a public sewer system wherever possible. Where no such sewer is available, the connection must be made to a suitable disposal system designed, constructed, and operated in accordance with IDAPA 58.01.03, "Individual/Subsurface Sewage Disposal Rules." (3-20-20)T

**181. -- 189. (RESERVED)**

**190. HEALTH AND SAFETY: POOL CLOSURE.**

The operator must immediately close the pool when a pool is in violation of Sections 191, 192, 198, and 230 of these rules, or when ordered by the Director or the Director's designee, and keep the pool closed until such time as conditions are brought into compliance or the order has been rescinded. (3-20-20)T

**191. HEALTH AND SAFETY: OPERATOR.**

All pools must have an operator. (3-20-20)T

**192. HEALTH AND SAFETY: LIFEGUARD REQUIREMENT.**

- 01. When Lifeguards Are Required.** Lifeguard(s) are required at any public swimming pool when: (3-20-20)T
  - a.** The numbers of bathers within the pool enclosure exceed thirty-five (35); and (3-20-20)T
  - b.** Children under the age of thirteen (13) are allowed to swim without adult supervision. (3-20-20)T

02. **When Lifeguards Are Not Required.** When lifeguard services are not required, a warning sign must: (3-20-20)T
- a. Be placed in plain view for all swimmers; (3-20-20)T
  - b. State, “WARNING NO LIFEGUARD ON DUTY” with clearly legible letters at least four (4) inches in height; and (3-20-20)T
  - c. Also state, “CHILDREN UNDER 13 YEARS OLD SHALL NOT USE THE FACILITY WITHOUT AN ADULT IN ATTENDANCE,” and “DO NOT SWIM ALONE.” (3-20-20)T

**193. HEALTH AND SAFETY: LIFEGUARD CHAIRS.**

If lifeguard chairs are provided, they must be located and constructed to provide a clear, unobstructed view of the pool bottom in the area under surveillance. (3-20-20)T

**194. HEALTH AND SAFETY: LIFESAVING EQUIPMENT.**

- 01. **Rescue Tube.** Each lifeguard on duty must have a rescue tube. (3-20-20)T
- 02. **Shepherd’s Crook, Backboard, and First Aid Kit.** Every pool must have: (3-20-20)T
  - a. At least one (1) shepherd’s crook or life-saving pole, having blunted ends, at least twelve (12) feet in length; (3-20-20)T
  - b. A readily accessible full-length backboard that complies with American Red Cross specifications or equivalent; and (3-20-20)T
  - c. A readily accessible first aid kit and a pocket face mask to assist with CPR. (3-20-20)T
- 03. **Equipment Accessibility and Condition.** Equipment must be readily accessible, be mounted in a conspicuous place, and be kept in good repair and ready condition. (3-20-20)T

**195. HEALTH AND SAFETY: SAFETY AND SANITATION.**

A lifeguard or operator must be in full charge of bathers and have authority and responsibility to enforce all rules of safety and sanitation. Suitable placards embodying sanitation requirements are to be conspicuously posted in the pool enclosure. Safety and sanitation requirements are as follows: (3-20-20)T

- 01. **Shower.** A cleansing shower should be taken before swimming. (3-20-20)T
- 02. **Disease.** Persons having an infectious or communicable disease that may be transmitted through water are excluded from swimming. (3-20-20)T
- 03. **Running and Roughhousing.** No running or rough play are permitted. (3-20-20)T
- 04. **Contamination.** Contamination of water, walkways, or dressing room floors in any way is prohibited. (3-20-20)T
- 05. **Glass.** Glass containers are prohibited in the pool area. (3-20-20)T

**196. HEALTH AND SAFETY: ACCESS.**

When the pool is not open for use, access must be restricted. (3-20-20)T

**197. HEALTH AND SAFETY: EMERGENCY COMMUNICATION.**

A means of contacting emergency medical services must be readily accessible and be provided on the premises. (3-20-20)T

**198. CLARITY.**

Water must have sufficient clarity at all times so the main drain can be clearly visible from the deck. Failure to meet this requirement is grounds for immediate closure of the pool. It is the responsibility of the operator to close the pool when conditions exist that the main drain is not visible from the deck. (3-20-20)T

**199. (RESERVED)**

**200. SUPERVISION.**

Every pool must be operated under the supervision of an operator who assumes responsibility for compliance with all parts of these rules. The operator is responsible for operating the pool in a safe and healthful manner. (3-20-20)T

**201. OPERATIONS MANUAL.**

Each pool must have a readily accessible pool operations manual to ensure proper operation and maintenance. The operations manual should include instructions for such items as maintenance schedules, records and reports, water chemistry, accidents, emergency procedures, care of filters, operation of pumps and other equipment, and proper handling and storage of all chemicals used. (3-20-20)T

**202. RECORD KEEPING.**

The following information must be recorded each day the pool is open, and be kept on the premises and available for review: (3-20-20)T

**01. Disinfectant Levels;** (3-20-20)T

**02. pH Readings;** (3-20-20)T

**03. Clarity Readings;** (3-20-20)T

**04. Amount and Type of Chemicals Used; and** (3-20-20)T

**05. Accidents Requiring Professional Medical Treatment.** Accidents requiring professional medical treatment, including drownings or near drownings. (3-20-20)T

**203. REPORTABLE ACCIDENTS.**

Accidents requiring professional medical treatment, including drownings or near drownings, must be reported within twenty-four (24) hours of occurrence to the Director's designee. (3-20-20)T

**204. -- 209. (RESERVED)**

**210. DEPTH MARKING LOCATIONS.**

**01. Water Depth.** Water depth must be plainly marked at or above the water surface on the vertical wall of the pool and on the horizontal edge of the deck or walk next to the pool. (3-20-20)T

**02. Depth Markers.** Depth markers must be placed at: (3-20-20)T

**a.** Maximum and minimum depths; (3-20-20)T

**b.** The five (5) foot break between the deep and shallow portions; (3-20-20)T

**c.** Intermediate one (1) foot increments of depth, where the water depth is five (5) feet or less; and (3-20-20)T

**d.** Regular intervals around the pool, not more than twenty-five (25) feet apart. (3-20-20)T

**211. DEPTH MARKERS.**

Depth markers must be numerals a minimum of four (4) inches high of a color contrasting with the background, and plainly visible to persons both in and out of the pool. Where depth markers cannot be placed on the vertical walls

above the water level, other means must be used. (3-20-20)T

**212. -- 219. (RESERVED)**

**220. WATER QUALITY STANDARDS.**

Pools must be designed to provide for continuous disinfection of the pool water with a chemical that has an effective disinfectant and imparts an easily measured, active residual. A test kit for measuring the accurate concentration of the disinfectant must be provided at each pool. (3-20-20)T

**221. CHLORINE DISINFECTION.**

When chlorine is used, a minimum free available chlorine residual of not less than one (1) part per million (ppm) with a maximum of five (5) parts per million (ppm) must be maintained whenever a pool is in use. (3-20-20)T

**222. BROMINE DISINFECTION.**

When bromine is used, a minimum residual of not less than one (1) part per million (ppm) with a maximum of five (5) parts per million (ppm) must be maintained whenever a pool is in use. (3-20-20)T

**223. CHLORINATED ISOCYANURATES DISINFECTION.**

If chlorinated isocyanurates are used, the maximum allowable concentration must be one hundred (100) parts per million (ppm). When isocyanurates are used, a test kit for measuring the concentration of the stabilizer must be provided. (3-20-20)T

**224. ORP OR HRR DISINFECTION.**

If a pool uses an oxidation reduction potential (ORP) controller or a high resolution redox (HRR) controller as a method of measuring an effective index of disinfection, the chemical used should be introduced in quantities needed to maintain levels at a minimum of six hundred and fifty (650) millivolts (mV). (3-20-20)T

**225. OTHER DISINFECTION METHODS.**

Other disinfecting methods may be used when it can be demonstrated to the Director's designee that a pool provides a satisfactory residual effect that is easily measured. Other disinfection methods may also be allowed if demonstration and analysis provide assurance that results are effective and not dangerous to public health, create objectionable physiological effects, or impart toxic properties to the water. (3-20-20)T

**226. ACID BASED CHEMISTRY.**

Pool water must be maintained in an alkaline condition as indicated by a pH of not less than seven and two-tenths (7.2) and not over seven and eight-tenths (7.8). The total alkalinity of the water should be within the acceptable range of eighty (80) parts per million (ppm) to two hundred (200) parts per million (ppm). An accurate pH testing kit must be provided at each pool. (3-20-20)T

**227. OTHER CHEMICALS.**

Any chemical must be used in accordance with the manufacturer's recommendations and not cause irritation to the eyes or skin of the bathers, or have other objectionable physiological effects on bathers. (3-20-20)T

**228. CHEMICAL STORAGE.**

All chemicals must be kept from the reach of the general public, be stored in original containers, and be stored in accordance with the instructions of the manufacturer or, in the absence of such instructions, as directed by the Director's designee. (3-20-20)T

**229. CLEANING.**

**01. Pools.** Pools must be maintained and operated in a clean, safe, and sanitary manner at all times. Pool walls and bottom should be vacuumed or brushed as needed to remove visible material. (3-20-20)T

**02. Decks.** Decks must be kept clean, safe, and maintained in good condition. (3-20-20)T

**03. Bathrooms, Showers, and Dressing Rooms.** Bathrooms, showers, and dressing rooms must be kept clean, safe, and sanitary at all times. (3-20-20)T

**230. BACTERIOLOGICAL QUALITY OF POOL WATERS.**

The water in public pools must not contain the presence of fecal coliform bacteria. If fecal coliform bacteria are present in any sample, a confirmation sample must be taken within twenty-four (24) hours. Should any two (2) consecutive water samples taken show the presence of fecal coliform bacteria, the pool must be closed immediately until the bacterial quality of the water is found absent for the presence of fecal coliform bacteria. (3-20-20)T

**231. MONTHLY SAMPLING.**

Pools not required to have a disinfection system, or those pools having a disinfection system but do not meet the requirements of Sections 220 through 225 of these rules, are required to sample the water for the presence of fecal coliform bacteria on a monthly basis. Sampling must be done during hours of peak bather loads. (3-20-20)T

**232. -- 239. (RESERVED)**

**240. DISINFECTANT AND CHEMICAL FEEDERS.**

**01. Feeder.** Pools must be equipped with a disinfectant feeder or feeders that meet the following requirements. Equipment must be: (3-20-20)T

**a.** Capable of being easily disassembled for cleaning or repair and be constructed of corrosion-resistant materials; (3-20-20)T

**b.** Constructed to permit repeated adjustments without loss of output rate accuracy and be constructed to minimize stoppage from debris that may be contained in aid chemicals used; (3-20-20)T

**c.** Designed specifically for the type of disinfectant used; and (3-20-20)T

**d.** Provided with controls for adjusting the flow rate of disinfectant. (3-20-20)T

**02. Backflow Prevention.** When the disinfectant is introduced at the suction side of the pump, a device or method must be provided to prevent air lock of the pump or recirculation system. (3-20-20)T

**03. Chlorine Gas Equipment.** When compressed chlorine gas is used, the following additional features must be provided: (3-20-20)T

**a.** Chlorine rooms must have a ventilating fan with an airtight duct beginning near the floor and terminating at a safe point of discharge to the outdoors, away from any occupied area or any fresh air intake. A louvered air intake must be provided near the ceiling. The ventilating fan must provide one (1) air change per minute and operate from a switch located outside the door. (3-20-20)T

**b.** Chlorinator equipment must be designed to withstand wear without developing leaks. (3-20-20)T

**c.** Chlorine cylinders must be anchored in an upright position to prevent falling over. A valve stem wrench must be maintained on the chlorine cylinder so the supply can be shut off quickly in the case of an emergency. Empty chlorine gas cylinders must be tagged as such. Full and empty gas cylinders must be stored only in the chlorine room and have protective hoods in place when not in use. (3-20-20)T

**d.** A new washer or gasket approved for use on chlorine gas must be used each time a chlorine cylinder is connected to the chlorinator. Spare washers/gaskets must be kept on site. (3-20-20)T

**e.** A self-contained breathing apparatus designed for use in a chlorine atmosphere must be provided, and be located in an area outside the chlorination room easily accessible to pool employees. (3-20-20)T

**f.** An automatic chlorine leak detector or commercial twenty-six (26) degrees Baume Aqua Ammonia must be provided for chlorine gas leak detection. (3-20-20)T

**g.** Installation of chlorinator equipment, and operation thereof, must be carried out by or under the



supervision of personnel trained in the installation and operation of such equipment. (3-20-20)T

**04. Hypochlorite Equipment.** When a hypochlorite solution is fed through hypochlorinator equipment, such equipment must also provide the following additional features: (3-20-20)T

**a.** Positive feed under all conditions of pressure in the circulating system, without artificial constriction of the pump suction line whether this line is under vacuum or pressure head; (3-20-20)T

**b.** Constant feed with varying supply or back pressure; (3-20-20)T

**c.** Prevent backflow from the circulation system to the solution container; and (3-20-20)T

**d.** Prevent siphoning of hypochlorite solution when recirculation pump and hypochlorinator are both turned off. (3-20-20)T

**241. -- 249. (RESERVED)**

**250. RECIRCULATION SYSTEM: FLOW RATE.**

A recirculation system, consisting of pumps, piping, skimmers, filters, water disinfection equipment, and other accessory equipment must be so designed and sized as to completely recirculate the pool volume of water at least once every eight (8) hours. (3-20-20)T

**251. RECIRCULATION SYSTEM: SIZING.**

All equipment and connecting piping must be designed to reduce friction losses, and for the piping to carry the required quantity of water at a velocity not to exceed six (6) feet per second for suction side pipe, and not more than ten (10) feet per second for filter discharge pipe. Piping must be of non-toxic material, resistant to corrosion, and able to withstand normal operating pressures. It is recommended all plastic pipes conform with NSF Standard 14 for potable water applications of the National Sanitation Foundation (NSF) and bear the NSF seal. (3-20-20)T

**252. RECIRCULATION SYSTEM: CLEANING.**

**01. Cleaning System.** A cleaning system must be provided to remove dirt from the bottom of the pool. (3-20-20)T

**02. Integral Vacuum.** When a vacuum is used as an integral part of the recirculation system: (3-20-20)T

**a.** Connections must be located in the walls of the pool, at least eight (8) inches below waterline, and at such point the floor of pool can be cleaned; and (3-20-20)T

**b.** The vacuum system must also be designed to preclude any possible entrapment. (3-20-20)T

**253. RECIRCULATION SYSTEM: FLOW INDICATOR.**

A functioning rate-of-flow indicator must be installed and located so the recirculation rate will be accurately measured, be accurate within five percent (5%) of true flow, and be located in a position that is easy to read. (3-20-20)T

**254. RECIRCULATION SYSTEM: CLEANING.**

A pump and motor unit must be provided for the recirculation of water that has been selected to meet the quantity of water required for filtering, and cleaning the filter, with the total dynamic head developed by the complete system. It is recommended the pump comply with requirements of NSF Standard 50, "Circulation System Components and Related Materials for Swimming Pools, Spas/Hot Tubs," of the National Sanitation Foundation (NSF) and bear the NSF seal. (3-20-20)T

**255. RECIRCULATION SYSTEM: THERMOMETERS.**

Pools equipped with heaters must have a minimum of one (1) fixed thermometer located between the heating outlet and the pool. (3-20-20)T

**256. RECIRCULATION SYSTEM: STRAINER.**

The recirculation system must include a corrosion-resistant strainer, readily accessible for frequent cleaning. (3-20-20)T

**257. -- 259. (RESERVED)**

**260. FILTRATION SYSTEM AND FILTERS.**

**01. Filtration System.** All pools must be equipped with a filtration system for the purpose of clarifying the water so it meets or exceeds the minimum clarity requirement. (3-20-20)T

**02. Filters.** All filters must: (3-20-20)T

**a.** Be designed and sized to achieve the proper turnover rate without exceeding the maximum flow rate; (3-20-20)T

**b.** Be equipped with pressure or vacuum gauges; and (3-20-20)T

**c.** Comply with all applicable requirements of NSF Standard 50, "Circulation System Components and Related Materials for Swimming Pools, Spas/Hot Tubs," or in the absence of applicable requirements, be approved by the Director's designee. (3-20-20)T

**261. DISPOSAL OF WASTE.**

Provisions must be made to dispose of material cleaned from filters and backwash water in a manner that will not create a nuisance. If drainage to a sanitary sewer or storm drain is permitted, an air gap must be provided that will positively preclude against surge or backflow introducing contaminated water into the pool or recirculation system. (3-20-20)T

**262. -- 269. (RESERVED)**

**270. WALL INLETS.**

**01. General Inlet Requirements.** Except as otherwise provided in this rule, inlets must: (3-20-20)T

**a.** Be rounded and smooth and installed not less than eighteen (18) inches below the normal operating level and located to produce a uniform circulation, without the existence of dead spots; and (3-20-20)T

**b.** Not extend from the pool wall or floor so as to create a hazard. (3-20-20)T

**02. Wall Inlet Requirements.** If wall inlets are used, there must: (3-20-20)T

**a.** Be at a minimum of one (1) per each six hundred (600) square feet of pool surface area. (3-20-20)T

**b.** Be a minimum of two (2) inlets. In case of a shallow pool, the Director's designee may grant an exception to this requirement if inlets cannot be installed at the depth otherwise required. (3-20-20)T

**271. FLOOR INLETS.**

Any pool having a width greater than forty (40) feet must have floor inlets or a combination of wall and floor inlets that meet the requirements of Section 260 of these rules and are located so they provide general circulation and do not direct flow to floor drains. (3-20-20)T

**272. -- 279. (RESERVED)**

**280. OVERFLOW SYSTEMS.**

All pools must be designed to provide continuous skimming, have overflow gutters or surface skimmers, and have an overflow system designed and installed so the water level of the pool is maintained at the operating level of the rim or

weir device. (3-20-20)T

**281. OVERFLOW GUTTERS.**

The gutter, drains, and return piping to the surge system must be designed to rapidly remove overflow water caused by recirculation displacement, wave action, or other causes produced from the maximum pool bathing load.

(3-20-20)T

**01. General Requirements.** Overflow gutters must: (3-20-20)T

**a.** Extend around the entire perimeter of the pool except at steps or recessed ladders; (3-20-20)T

**b.** Have the gutter lip be level within three-tenths (.3) inch; (3-20-20)T

**c.** Be capable of continuously removing fifty percent (50%) of the recirculated water and returning it to the recirculation system; and (3-20-20)T

**d.** Be designed to prevent entrance or entrapment of bathers. (3-20-20)T

**02. Overflow Gutters Connected to the Recirculation System.** All overflow gutters connected to the recirculation system must be connected in an approved manner, such as a surge tank. (3-20-20)T

**282. SKIMMERS: REQUIREMENT.**

**01. Minimum Requirements.** There must be provided: (3-20-20)T

**a.** A minimum of one (1) skimmer for each four hundred (400) square feet of water surface area or fraction thereof; and (3-20-20)T

**b.** No fewer than two (2) skimmers in every pool. (3-20-20)T

**02. Standard Requirements.** Any skimmer used in a pool must comply with all applicable requirements of NSF Standard 50 "Circulation System Components and Related Materials for Swimming Pools, Spas/Hot Tubs," of the NSF International or in the absence of applicable requirements, be approved by the Director's designee. (3-20-20)T

**283. SKIMMERS: CAPACITY.**

**01. Total Capacity.** The total capacity of all skimmers used must be a minimum of two-thirds (2/3) of the required filter flow. (3-20-20)T

**02. Piping.** Piping for skimmers used must be designed for a capacity of not less than eighty (80) percent of the required filter flow of the recirculation system, and in no case less than thirty (30) gallons per minute per eight (8) inches of weir. (3-20-20)T

**284. SKIMMERS: EQUALIZERS.**

**01. Equalizer Valve and Line.** All skimmers used must be equipped with an approved equalizer valve and an equalizer line with an inside diameter of not less than two (2) inches, installed not less than twelve (12) inches below the normal operating level of the water. (3-20-20)T

**02. Inlet to the Equalizer Line.** The inlet to the equalizer line or lines must: (3-20-20)T

**a.** Be designed to prevent the creation of a holding force whenever the body or limb of a bather comes into contact with the inlet; and (3-20-20)T

**b.** Be protected by a grill or shroud that will prevent a bather or any limb of a bather from entering the inlet. (3-20-20)T

**285. SKIMMERS: LOCATION.**

All inlets must be spaced at least five (5) feet away from any skimmer. One (1) skimmer must be placed at a point in the pool opposite the direction of the prevailing winds. (3-20-20)T

**286. -- 289. (RESERVED)**

**290. LOCATION OF DRAINS.**

Every pool must have a tandem main drain located in the deepest section of the pool and have the ability to empty the pool through this drain. (3-20-20)T

**291. MULTIPLE DRAINS.**

Multiple drains must be provided. Outlet drains must not be further apart than twenty (20) feet on center. (3-20-20)T

**292. DRAIN GRATING.**

The main drain outlet grating must: (3-20-20)T

**01. Area of Openings.** Have an area of openings four (4) times the area of the discharge pipe or provide sufficient area so the maximum velocity of water passing through the grate will not exceed six (6) feet per second; (3-20-20)T

**02. Maximum Width of Openings.** Have grate openings with a maximum width of not more than one-half (1/2) inch; and (3-20-20)T

**03. Securely Fastened.** Be securely fastened in such a way that they cannot be removed without the use of tools. (3-20-20)T

**293. -- 299. (RESERVED)**

**300. FENCE AND BARRIERS.**

**01. For Pools Under 1,800 Square Feet.** A fence or barrier a minimum of four (4) feet high to exclude unauthorized persons from the pool area must enclose each public pool with less than one thousand eight hundred (1,800) square feet of surface area. (3-20-20)T

**02. For Pools 1,800 Square Feet or Greater.** A fence or barrier a minimum of eight (8) feet high to exclude unauthorized persons from the pool area must enclose each public pool with one thousand eight hundred (1,800) square feet of surface area, or greater. (3-20-20)T

**301. -- 309. (RESERVED)**

**310. GEOTHERMAL POOL EXEMPTIONS.**

**01. Exemptions.** Geothermal pools are hereby exempt from the following rules: (3-20-20)T

**a.** If a geothermal pool can meet the bacterial requirements of Section 230 of these rules and the clarity requirements of Section 198 of these rules, it will not be required to meet any requirements of Sections 220 through 225, and Sections 240, 250, and 260 of these rules. (3-20-20)T

**b.** Section 226 of these rules, "Acid Base Chemistry." (3-20-20)T

**c.** If an existing geothermal pool has a gravel bottom, Sections 075, 271, and Sections 290 through 292 of these rules. (3-20-20)T

**02. Remodeling.** Remodeling of an existing geothermal pool will not change exemptions. (3-20-20)T

**311. -- 319. (RESERVED)**

**320. TECHNICAL WAIVERS OR MODIFICATIONS.**

**01. Director Waiver.** The Director or the Director's designee may waive or modify the requirements of these rules as a condition of the permit to operate a pool, except no technical waiver or modification will be granted from the health and safety portion of these rules. (3-20-20)T

**02. Waiver Requirements.** The person requesting a technical waiver or modification must submit a written request to the Director's designee specifying: (3-20-20)T

**a.** The section number of these rules and the rationale for considering a modification or waiver of the requirements; (3-20-20)T

**b.** An analysis of the potential public health, safety hazards, and issues associated with the proposed action; and (3-20-20)T

**c.** Scientific data or other information, as appropriate, showing safety or public health will not be compromised by the proposed action. (3-20-20)T

**321. -- 999. (RESERVED)**

**16.02.25 – FEES CHARGED BY THE STATE LABORATORY**

**000. LEGAL AUTHORITY.**

Under Section 56-1003, Idaho Code, the Department of Health and Welfare is responsible for the supervision and administration of laboratories and administration of standards of tests for environmental pollution, chemical analyses, and communicable diseases. Authority to set fees and establish charges for laboratory services is vested in the Director, under Section 56-1007, Idaho Code. (3-20-20)T

**001. TITLE, SCOPE, AND POLICY.**

**01. Title.** These rules are titled IDAPA 16.02.25, “Fees Charged by the State Laboratory.” (3-20-20)T

**02. Scope.** The intent of these rules is to standardize all fees levied by the Bureau of Laboratories for the services it provides. The Bureau of Laboratories is also known as the “State Laboratory.” (3-20-20)T

**03. Policy.** The primary purpose of the Bureau of Laboratories of the Idaho Department of Health and Welfare is to provide laboratory services to support the various programs carried out by the Department, district health departments, and other agencies. Since it is not economically feasible for all departments of state governments to develop their own laboratories, the Department laboratories provide services, as appropriate, to other state agencies. (3-20-20)T

**002. -- 009. (RESERVED)**

**010. DEFINITIONS.**

For the purposes of these rules, the following terms are used as defined below: (3-20-20)T

**01. Clinical Laboratory Tests.** Microbiological analysis for diagnosis of infectious diseases affecting human health. (3-20-20)T

**02. Department.** Idaho Department of Health and Welfare. (3-20-20)T

**03. Director.** The Director of the Idaho Department of Health and Welfare or designee. (3-20-20)T

**04. Environmental Laboratory Tests.** Analysis of various samples from air, microbiological, organic, or inorganic sources. (3-20-20)T

**05. State Health Official.** Administrator of the Department’s Division of Public Health. (3-20-20)T

**011. -- 099. (RESERVED)**

**100. FEES FOR CLINICAL LABORATORY TESTS.**

<b>Fees for Clinical Laboratory Tests</b>	
<b>Clinical Test Name</b>	<b>Fee</b>
Agglutination - Not Otherwise Specified	\$9.00
Bacterial Primary Culture - Not Otherwise Specified	\$51.00
Bordetella pertussis, Culture	\$27.00
<i>Bordetella pertussis</i> , PCR	\$42.00
<i>Chlamydia trachomatis</i> and <i>Neisseria gonorrhoeae</i> by Nucleic Acid Amplification	\$16.00
<i>Cryptosporidium</i> / <i>Giardia</i> , IFA	\$69.00
Disk Diffusion Test	\$17.00
Enteric Pathogens, Primary Culture	\$68.00
Enterovirus Isolation	\$95.00
Enzyme-Linked Immunoassay (EIA) - Not Otherwise Specified	15.00

<b>Fees for Clinical Laboratory Tests</b>	
<b>Clinical Test Name</b>	<b>Fee</b>
Fluorescent Antibody (FA) - Not Otherwise Specified	\$53.00
Hantavirus, IGG & IGM Antibody, EIA	\$167.00
Hepatitis B, Core Total Antibody, EIA	\$15.00
Hepatitis B, Surface Antibody, EIA	\$15.00
Hepatitis B, Surface Antigen Confirmation, EIA	\$127.00
Hepatitis B, Surface Antigen, EIA	\$15.00
Hepatitis C, Antibody, EIA	\$20.00
Herpes Simplex Type 1 & Type 2, IGG Antibody, EIA	\$35.00
Herpes Simplex Virus Isolation	\$53.00
HIV-1/2 Plus O, Antibody, EIA	\$15.00
HIV-1, Western Blot	\$311.00
Influenza Virus, RT-PCR	\$69.00
<i>Legionella</i> , Culture, Clinical	\$120.00
Microsphere Immunoassay (MIA) - Not Otherwise Specified	\$64.00
Mumps, IGG Antibody, EIA	\$15.00
Mumps, IGM Antibody, IFA	\$56.00
Mumps, Virus Isolation	\$88.00
Mycobacteria, AFS-Fluorochrome	\$98.00
Mycobacteria, Drug Susceptibility	\$373.00
Mycobacteria, Primary Culture	\$57.00
Mycobacteria, Reference Culture	\$130.00
Mycobacteria, Tuberculosis Quantiferon -TB Gold In Tube	\$85.00
<i>Neisseria gonorrhoeae</i> , Primary Culture	\$37.00
Norovirus, RT-PCR	\$66.00
Parasite Exam, Concentrate & Trichrome Stain	\$94.00
Plaque Reduction Neutralization Test (PRNT) - Not Otherwise Specified	\$260.00
Polymerase Chain Reaction (PCR) - Not Otherwise Specified	\$62.00
Pulsed Field Gel Electrophoresis	\$90.00
Rabies, FA	\$50.00
rDNA Sequence Analysis	\$113.00
Reference Culture, Aerobe	\$49.00
Reference Culture, Anaerobe	\$81.00
Respiratory Virus Isolation	\$94.00

<b>Fees for Clinical Laboratory Tests</b>	
<b>Clinical Test Name</b>	<b>Fee</b>
Rubella, IGG Antibody, EIA	\$15.00
Rubella, IGM Antibody, EIA	\$47.00
Rubeola (Measles), IGG Antibody, EIA	\$15.00
Rubeola (Measles), IGM Antibody, EIA	\$37.00
Serotyping	\$73.00
Shiga Toxin, Immunoassay	\$21.00
<i>Staphylococcus aureus</i> , Methicillin Resistant (MRSA), Identification/Confirmation	\$96.00
<i>Staphylococcus aureus</i> , Methicillin Resistant (MRSA), PCR	\$78.00
Syphilis, Treponema Pallidum Passive Agglutination	\$43.00
Syphilis, Venereal Disease Research Laboratory (VDRL)	\$9.00
Syphilis, Venereal Disease Research Laboratory (VDRL), Quantitative	\$6.00
Vancomycin Resistant <i>Enterococcus</i> (VRE)	\$119.00
Vancomycin-Intermediate/Resistant <i>Staphylococcus aureus</i> (VISA)	\$119.00
Varicella Zoster, IGG Antibody, EIA	\$15.00
Varicella Zoster, IGM Antibody, IFA	\$56.00
Varicella Zoster, Virus Isolation	\$91.00
Viral Culture - Not Otherwise Specified	\$67.00
West Nile Virus, IGG Antibody Screen, EIA	\$73.00
West Nile Virus, IGM Antibody Screen, EIA	\$78.00
West Nile Virus/St. Louis Encephalitis Virus IGM Antibody, Microsphere Immunoassay	\$65.00
West Nile Virus/St. Louis Encephalitis Virus Plaque Reduction Neutralization Test (PRNT)	\$278.00
West Nile Virus/St. Louis Encephalitis Virus/Western Equine Encephalitis, RT-PCR	\$156.00

(3-20-20)T

**101. -- 199. (RESERVED)**

**200. FEES FOR ENVIRONMENTAL LABORATORY TESTS.**

**01. Environmental Laboratory Tests, Air -- Table.**



Fees for Environmental Laboratory Tests -- Air	
Air Test Name	Fee
PM 10 Filter, Air	\$13.00
PM 25 Filter, Air	\$20.00

(3-20-20)T

**02. Environmental Laboratory Tests, Microbiology -- Table.**

Fees for Environmental Laboratory Tests -- Microbiology	
Microbiology Test Name	Fee
<i>Escherichia coli</i> O157:H7	\$100.00
Heterotrophic Plate Count	\$25.00
Identification System, Water, Food or Vegetation	\$50.00
<i>Legionella</i> , Water	\$100.00
Pathogen Screen, Water, Food, or Vegetation	\$23.00
<i>Pseudomonas aeruginosa</i> , Water	\$25.00
Salmonella Confirmation, Water	\$75.00
Total Coliform/E. coli, Presence/Absence	\$18.00
Total Coliform/E. coli, Quantitative	\$20.00
Total Coliform/Fecal Coliform/E. coli (MPN)	\$28.00

(3-20-20)T

**03. Environmental Laboratory Tests, Inorganic -- Table.**

Fees for Environmental Laboratory Tests -- Inorganic	
Inorganic Test Name	Fee
5-Day BOD, Water	\$45.00
Alkalinity (CaCO <sub>3</sub> ), Water	\$14.00
Ammonia as N, Water	\$18.00
Arsenic, Water	\$21.00
Bromate, Water	\$100.00
Bromide, Water	\$32.00
Chemical Oxygen Demand, Water	\$29.00
Chlorate, Water	\$100.00
Chloride, Water	\$19.00
Chlorite, Water	\$150.00

<b>Fees for Environmental Laboratory Tests -- Inorganic</b>	
<b>Inorganic Test Name</b>	<b>Fee</b>
Chlorophyll A and Pheophytin A, Water	\$75.00
Conductivity, Water	\$11.00
Corrosivity, Calculation, Water	\$59.00
Cyanide, Total, Water or Soil	\$33.00
Cyanide, WAD, Water or Soil	\$33.00
Direct Mercury Analysis	\$44.00
Fluoride, Water	\$19.00
Hardness, Water	\$22.00
Lead, Water	\$21.00
Mercury, Water	\$34.00
Metals Digestion, Water, Soil, or Solids	\$19.00
Metals each (Aluminum, Antimony, Barium, Beryllium, Boron, Cadmium, Calcium, Chromium, Cobalt, Copper, Iron, Magnesium, Manganese, Molybdenum, Nickel, Potassium, Selenium, Silicon, Silver, Sodium, Strontium, Thallium, Tin, Vanadium, Zinc)	\$13.00
Metals Speciation	\$150.00
Nitrate + Nitrite as N, Water	\$19.00
Nitrate as N, Water	\$19.00
Nitrite as N, Water	\$19.00
Orthophosphate as P, Water	\$17.00
pH, Water	\$10.00
Settleable Solids, Water	\$16.00
Sulfate, Water	\$19.00
Sulfide as H <sub>2</sub> S, Water	\$19.00
TCLP Extraction	\$165.00
Total Dissolved Solids, Water	\$15.00
Total Kjeldahl Nitrogen, Soil	\$53.00
Total Kjeldahl Nitrogen, Water	\$34.00
Total Phosphorus, Water	\$24.00
Total Solids, Water	\$13.00
Total Suspended Sediment, Water	\$14.00
Total Suspended Solids, Water	\$14.00
Turbidity, Water	\$13.00
Uranium, Water	\$44.00

<b>Fees for Environmental Laboratory Tests -- Inorganic</b>	
<b>Inorganic Test Name</b>	<b>Fee</b>
Volatile Solids, Water	\$24.00

(3-20-20)T

**04. Environmental Laboratory Tests, Organic -- Table.**

<b>Fees for Environmental Laboratory Tests -- Organic</b>	
<b>Organic Test Name</b>	<b>Fee</b>
1,2-dibromo-3-chloropropane/ethylene dibromide (DBCP/EDB/TCP), Water	\$100.00
Benzene, Toluene, Ethylbenzene and Xylenes (BTEX)	\$97.00
Carbamates, Water	\$169.00
Chlorinated Herbicides, Water	\$162.00
Diquat, Water	\$117.00
ELISA, Water (Submitter provides test kit; cost is for the analysis of each sample)	\$12.00
Endothall, Water	\$144.00
Glyphosate, Water	\$142.00
Haloacetic Acids, Water	\$150.00
Oil and Grease, Water	\$44.00
Organochlorine Pesticides, Water	\$135.00
Polychlorinated Biphenyls (PCBs)	\$117.00
Polycyclic aromatic hydrocarbons (PAHs), Soil	\$200.00
Semi-volatile Compounds, Water	\$182.00
Semi-volatile, GC-MS Screen (Qualitative Results)	\$125.00
Total Trihalomethanes (TTHMs)	\$100.00
Trichloroethylene (TCE) Tetrachloroethylene (PCE), Air	\$50.00
Unknown Identification	\$100.00
Volatile Organic Compounds (VOC), Water and Soil	\$187.00

(3-20-20)T

**201. -- 899. (RESERVED)**

**900. WAIVER OF FEES.**

Upon demonstration of good cause, any fee levied under this chapter may be suspended or waived, in full or in part, by the State Health Official.

(3-20-20)T

**901. -- 999. (RESERVED)**

## 16.02.26 – THE IDAHO CHILDREN’S SPECIAL HEALTH PROGRAM

### 000. LEGAL AUTHORITY.

Section 56-1003, Idaho Code, directs the Department of Health and Welfare to establish rules as may be necessary to deal with problems related to personal health. The Children’s Special Health Program (CSHP) provides medical and rehabilitative services to persons age birth to eighteen (18) years who meet the diagnostic eligibility criteria defined in Sections 101 through 108 of these rules. The Omnibus Budget Reconciliation Act (OBRA) of 1989 requires that thirty percent (30%) of the Maternal and Child Health Block Grant to each state be committed to programs for children with special health care needs. (3-20-20)T

### 001. TITLE AND SCOPE.

**01. Title.** These rules apply to the administration of the Idaho Children’s Special Health Program and are titled IDAPA 16.02.26, “The Idaho Children’s Special Health Program.” (3-20-20)T

**02. Scope of Services.** The scope of activities provided by CSHP contractors and private providers such as diagnosis, case management, and treatment. The types of services for which reimbursement is made are related directly to program fiscal resources. Funds available for CSHP are limited in amount. Changes in the scope of services and in rates of reimbursement may be made by administrative decision should budgetary reductions or cost overruns occur. (3-20-20)T

### 002. WRITTEN INTERPRETATION.

This agency has written statements that pertain to the interpretation of the rules of this chapter, or to the documentation of compliance with the rules of this chapter. These documents are available for public inspection and copying at cost in the main office and each regional or district office of this agency. (3-20-20)T

### 003. -- 009. (RESERVED)

### 010. DEFINITIONS.

For the purposes of these rules, the following terms are used: (3-20-20)T

**01. Applicant.** A person under age eighteen (18) seeking services provided by CSHP. (3-20-20)T

**02. Care Coordinator.** A Department employee or contractor responsible for receiving and processing CSHP applications and supporting documentation from current and potential CSHP clients. A care coordinator issues authorization memos for services authorized by CSHP. (3-20-20)T

**03. Children's Special Health Program (CSHP).** The program section within the Idaho Department of Health and Welfare, Division of Health, which is responsible for the administration of services leading to the identification, diagnosis, and aftercare of children with special health care needs. (3-20-20)T

**04. Client.** A person under age eighteen (18) with a chronic physically disabling condition which meets one (1) of the diagnostic categories of CSHP. (3-20-20)T

**05. Department.** The Idaho Department of Health and Welfare. (3-20-20)T

**06. Diagnosis.** The act of identifying a disease from its signs or symptoms. (3-20-20)T

**07. Division.** The Division of Health, a division of the Idaho Department of Health and Welfare, and where CSHP is housed administratively. (3-20-20)T

**08. Medical Food.** A food which is formulated to be consumed or administered enterally (i.e., passing through the stomach and digested in the intestine), under the supervision of a physician and metabolic nutritionist, and which is intended for the specific dietary management of PKU. (3-20-20)T

**09. Patient.** The term “patient” is synonymous with the term “client” as defined in Subsection 101.04 of this rule. (3-20-20)T

### 011. -- 050. (RESERVED)

### 051. DIAGNOSTIC/CONSULTATIVE SERVICES.

Clinical examination of a CSHP client to confirm or determine the extent of their condition and recommend treatment options. Physician specialists under contract to CSHP may continue to serve in consultative roles to clients’ primary

care physicians following clinical examination. (3-20-20)T

**052. TREATMENT SERVICES.**

Following the diagnostic process, individuals may be closed to further service as having "no eligible condition found." Program-eligible clients are accepted for continuing service coordination under CSHP. Care is provided through clinics where treatment schedules are planned and periodic review of cases are conducted, and through private medical providers. An individual client's treatment plan may cover a variety of related services. (3-20-20)T

**053. FOLLOW UP AND CASE MANAGEMENT.**

CSHP will contract with care coordinators to follow-up on CSHP clients receiving treatment through the program to assure that a treatment plan is outlined. These staff will also implement timely scheduling of medical habilitative and rehabilitative services. (3-20-20)T

**054. HOSPITAL IN-PATIENT SERVICES.**

If diagnostic evaluation requires hospitalization, a maximum of three (3) days inpatient care may be authorized. No inpatient hospital services are paid for emergency, acute or chronic medical care. (3-20-20)T

**055. -- 099. (RESERVED)**

**100. DIAGNOSTIC CATEGORIES.**

CSHP will serve clients in eight (8) general diagnostic categories: Cardiac, Cleft Lip and Palate, Craniofacial, Cystic Fibrosis, Neurological, Orthopedic, Phenylketonuria (PKU) and Plastic/Burn. These categories are explained further in Sections 101 through 108 of these rules. (3-20-20)T

**101. CARDIAC.**

**01. Eligible Conditions.** Eligible conditions include congenital heart disease or defects, acquired heart disease and dysrhythmia. (3-20-20)T

**02. Excluded Conditions.** The following conditions are excluded from care under CSHP: patent ductus arteriosus (PDA) in premature neonates, inpatient care for non-diagnostic and non-surgical admissions. Acute care, despite its potential relationship to an underlying covered condition. (3-20-20)T

**03. Spending Limit.** Services provided to eligible patients under the Cardiac Program are subject to a per patient, annual spending limit of twenty five thousand dollars (\$25,000) for each fiscal year, July 1 through June 30. (3-20-20)T

**102. CLEFT LIP AND PALATE.**

**01. Eligible Conditions.** Eligible conditions include cleft lip, cleft palate, cleft palate with cleft lip, cleft nose, Pierre Robin syndrome, choanal atresia, palatal incompetence, severe malocclusions resulting from disease or trauma, severe structural deformities involving the growth and development of the mandible or maxilla. (3-20-20)T

**02. Excluded Conditions.** The following conditions are specifically excluded from care under the CSHP Cleft Lip/Palate Program: isolated hyper/hyponasality, non-cleft-related malocclusions, mild familial malocclusions. (3-20-20)T

**03. Spending Limits.** Services provided to eligible patients under the CSHP Cleft Lip and Palate program are subject to a per patient, annual spending limit of fifteen thousand dollars (\$15,000) for each fiscal year, July 1 through June 30. (3-20-20)T

**103. CRANIOFACIAL.**

**01. Eligible Conditions.** Eligible conditions include congenital anomalies of the skull and face, acrocephalosyndactyly, craniosynostosis, Crouzon's Disease, hyperterlorism (severe), platybasia, hemifacial microsomia, including associated microtia. (3-20-20)T

**02. Excluded Conditions.** The following conditions are excluded from care under the Idaho CSHP Craniofacial Program: isolated microtia, temporal mandibular joint disease (TMJ), simple hemangioma not affecting other organ systems. (3-20-20)T

**03. Spending Limits.** Services provided to eligible patients under the CSHP Craniofacial Program are subject to a per patient, annual spending limit of eighteen thousand dollars (\$18,000) for each fiscal year, July 1 through June 30. (3-20-20)T

#### **104. CYSTIC FIBROSIS.**

**01. Eligible Conditions.** In addition to cystic fibrosis, services are also provided under this program to clients eighteen (18) years of age and under who have Kartagener's Syndrome or immotile cilia. (3-20-20)T

**02. Services Provided.** Services available include Physician's office visits or clinic visits, laboratory, x-ray and other tests ordered by physician, medications and drugs prescribed in connection with treatment of cystic fibrosis, transportation to out-of-state medical centers based on physician referral, and home therapy equipment prescribed by the physician. Genetic counseling clinics are available through the state or contractors, and cystic fibrosis patients and their families are encouraged to make use of this service. (3-20-20)T

**03. Excluded Services.** Inpatient hospital care is not paid for under the CSHP Cystic Fibrosis Program, consistent with CSHP policy of not paying acute care. (3-20-20)T

**04. Spending Limit.** Services provided to eligible patients under the CSHP Cystic Fibrosis Program are subject to a per patient, annual spending limit of eighteen thousand dollars (\$18,000) for each fiscal year, July 1 through June 30. (3-20-20)T

#### **105. NEUROLOGIC.**

**01. Eligible Conditions.** Eligible conditions include cerebral palsy, seizures/epilepsy, metabolic and storage diseases, central nervous system (CNS) degenerative disorders, congenital CNS anomalies, chronic encephalopathy and CNS injury (near drowning, birth asphyxia), neurocutaneous and neuromuscular syndromes, chronic residua of CNS infections, neuromuscular disorders, attention deficit hyperactive disorder (ADHD) (limited to two (2) visits per year after diagnosis), Tourette's Syndrome, rehabilitation services associated with tumors, infections, trauma and cerebral vascular disease (CVD). (3-20-20)T

**02. Excluded Conditions.** The following conditions are excluded from care under the CSHP Neurologic Program: speech problems without associated CSHP eligibility, primary intellectual disabilities, autism, acute head and spinal cord injuries, primary psychiatric and emotional disorders, headache, and night terrors. (3-20-20)T

**03. Spending Limit.** Services for eligible patients under the CSHP Neurologic Program are subject to a per patient, annual spending limit of twelve thousand dollars (\$12,000) for each fiscal year, July 1 through June 30. (3-20-20)T

#### **106. ORTHOPEDIC.**

**01. Eligible Conditions.** Eligible conditions include juvenile rheumatoid arthritis (JRA), developmental dysplasia of the hip, cerebral palsy, neuromuscular dystrophies and atrophies, spinal column defects and deformities causing functional impairment, congenital anomalies of the extremities causing functional impairment, chronic conditions resulting from trauma, limb deficiencies and length discrepancies, chronic infections and inflammations of bones and joints, congenital developmental hip conditions, skeletal dysplasia and other forms of dwarfism, fractures associated with bracing or other long-term care, rehabilitation services associated with tumors and malignancies, metatarsus varus and adductus, polydactyly. (3-20-20)T

**02. Excluded Conditions.** The following conditions are excluded from care: simple fractures and other trauma without handicapping residual, acute infections of bone or joint, simple flat feet (painless), acute care for

amputations, acute care for fractures or other injuries, benign genu valgum (knock knee), benign genu varum (bow legs), tibial torsion/femoral version, growth hormone therapy for short stature. (3-20-20)T

**03. Spending Limits.** Services provided to eligible patients under the CSHP Orthopedic Program are subject to a per patient, annual spending limit of fifteen thousand dollars (\$15,000) for each fiscal year, July 1 through June 30. (3-20-20)T

**107. PHENYLKETONURIA (PKU).**

Under this program eligible patients are provided treatment services which include nutritional assessment, dietary counseling, and provision of medical foods, including formula, in compliance with the patient's treatment plan. PKU patients under eighteen (18) years of age may purchase medical foods from CSHP or CSHP's contractor(s) by pre-paying the appropriate percentage, if any, of CSHP's cost. The percentage of cost is based on the sliding fee scale in Section 157 of these rules. (3-20-20)T

**01. PKU Patients Under Eighteen Years of Age.** PKU patients under eighteen (18) years of age may purchase medical foods from CSHP or CSHP's contractor(s) by pre-paying the appropriate percentage, if any, of CSHP's cost. The percentage of cost is based on the sliding fee scale in Section 157 of these rules. (3-20-20)T

**108. PLASTIC/BURN.**

**01. Eligible Conditions.** Eligible conditions include hemangioma and lymphangioma depending on severity, location and effect on function; cystic hygroma; and hemifacial microsomia, including associated microtia. (3-20-20)T

**02. Excluded Conditions.** The following conditions are excluded from care under the Idaho CSHP Plastic/Burn program: acute burn care, cosmetic surgery, hemangioma, including port wine stain, not affecting physical function. (3-20-20)T

**03. Spending Limit.** Services provided to eligible patients under the CSHP Plastic/Burn Program are subject to a per patient, annual spending limit of fifteen thousand dollars (\$15,000) for each fiscal year, July 1 through June 30. (3-20-20)T

**109. -- 148. (RESERVED)**

**149. PROGRAM ELIGIBILITY.**

Eligibility for participation in CSHP is based on age, diagnosis, legal residence, insurance status, and financial criteria. Eligibility criteria is explained further in Sections 150 through 158 of these rules. (3-20-20)T

**150. INSURANCE STATUS.**

Any person with creditable medical insurance as determined by the Department is not eligible for this program, with the exception of CF and PKU participants. Creditable insurance is determined by using IDAPA 16.03.01, "Eligibility For Health Care Assistance For Families and Children." (3-20-20)T

**151. AGE.**

Applications may be accepted on persons up to age eighteen (18). CSHP will pay for no services after the patient's 18th birthday unless the person is receiving active inpatient treatment at the time of the birthday. In that case CSHP will pay for services until discharge if they fall within the guidelines described in Section 054 of these rules. (3-20-20)T

**152. DIAGNOSIS.**

Eligible persons are those born with or who acquire physical disabilities or special health care needs as defined under the various programs in Sections 101 through 108 and who require long-term multi-disciplinary care to improve their ability to function. (3-20-20)T

**153. RESIDENCE.**

Applicants must be legal residents of the state of Idaho to receive services from CSHP. Legal residents of neighboring states are not eligible for services. Non-citizens who are legal residents of Idaho are eligible to receive services but

undocumented aliens are not.

(3-20-20)T

**154. (RESERVED)**

**155. INCOME.**

Income for a family is defined as "adjusted taxable income" from the family's most recent tax return. Financial eligibility is redetermined annually and may be redetermined more often if family circumstances change during the year.

(3-20-20)T

**156. FAMILY SIZE.**

Family is defined as a "group of related or non-related individuals who are not residents of an institution, but who are living together as one (1) economic unit." Family size is the number of individuals included in that unit.

(3-20-20)T

**157. SLIDING FEE SCALE.**

The sliding fee scale in Table 157 of this rule is used to determine the family's percentage of financial participation for a CSHP client's treatment. Each percentage category includes an annual per-client maximum for which a family would be responsible in any given year. The percentage amount applies to all costs incurred for services provided to the client up to the annual maximum indicated.

<b>TABLE 157 - SLIDING FEE SCALE FOR CSHP SERVICES</b>		
<b>Percent of Federal Poverty Level</b>	<b>Percentage of Cost Sharing Responsibility for Responsible Party</b>	<b>Annual Maximum Responsibility Per Client</b>
0% - 185%	0%	\$0
186% -199%	10%	\$1,800
200% - 224%	20%	\$3,600
225% -249%	30%	\$5,400
250% -274%	50%	\$9,000
275% -299%	75%	\$13,500
300% and above	100%	\$18,000

(3-20-20)T

**158. APPLICATION FOR OTHER RESOURCES.**

CSHP applicants are required to apply for benefits from other programs for which they may be eligible and which would reduce the costs to CSHP. The use of all available other resources is required in order to supplement program dollars to the greatest degree possible. For new applicants and during redetermination there will be a review for possible eligibility for other programs and appropriate referrals will be made. Families who refuse to obtain benefits for which they are eligible or do not complete the application process will be closed to the program.

(3-20-20)T

**159. -- 199. (RESERVED)**

**200. APPLICATIONS.**

An application for services from CSHP must, at a minimum, consist of a completed Application Form. A copy of the family's most recent tax return will also be required in order to determine financial eligibility. CSHP may require additional forms such as a Request for Services, Consent for the Release of Information and an Authorization to Release Information. Applications are processed by CSHP staff and contractors. Applicants are notified as to their acceptance or denial by a CSHP Care Coordinator.

(3-20-20)T

**201. -- 249. (RESERVED)**



**250. PAYMENTS TO PROVIDERS.**

CSHP payments are made on the basis of fee schedules or set allowances; where applicable, Idaho Medicaid rates are used. (3-20-20)T

**251. PRIOR AUTHORIZATION.**

To qualify for payment by CSHP, services other than diagnostic/consultative and follow-up/case management must be preauthorized by the CSHP Care Coordinator or designee. A CSHP Authorization Memo, obtained from the District CSHP Care Coordinator, must be issued for any service authorized under CSHP. (3-20-20)T

**252. MAXIMUM ON HOSPITAL IN-PATIENT PAYMENTS.**

There is a twelve thousand dollar (\$12,000) maximum payment, per hospitalization, for inpatient hospital expenses, exclusive of surgeon, anesthesiologist or other physician costs related to the hospitalization. These costs are applied toward the annual program cap. (3-20-20)T

**253. BILLING THIRD PARTIES FIRST.**

Providers must bill all other sources of direct third party payment before submitting their claims to CSHP for payment. Private insurance must be billed and benefits, or the denial of benefits, ascertained before the CSHP will consider payment. Typically either an Explanation of Benefits (EOB) from the third party payor or a letter stating that the service is not covered will be required before CSHP payment will be made. (3-20-20)T

**254. THIRD PARTY PAYMENTS IN EXCESS OF CSHP LIMITS.**

CSHP will not reimburse providers for services rendered when the amount received by the provider from the third party payor is equal to or exceeds the level of reimbursement allowed by CSHP for those particular services. (3-20-20)T

**255. MEDICAID ELIGIBILITY.**

Any person who may be eligible for Medicaid is required to apply before CSHP services are authorized. CSHP is always last payor to Medicaid. (3-20-20)T

**256. OUT-OF-STATE-CARE.**

CSHP will not pay for care out-of-state that is available in-state. Any exceptions to this rule will be determined by the state office of the CSHP. All out-of-state care must be preauthorized through a CSHP clinic or other regular program mechanism. (3-20-20)T

**257. DURABLE MEDICAL EQUIPMENT.**

The CSHP will always be payor of last resort for all durable medical equipment provided to clients. (3-20-20)T

**258. -- 349. (RESERVED)**

**350. PROGRAM EXCLUSIONS.**

The following is a list of additional conditions, services and items not covered or paid for by CSHP: (3-20-20)T

**01. Excluded Conditions, Services and Items.** (3-20-20)T

- a. Acute care, such as hospitalization for congestive heart failure or complications of cystic fibrosis. (3-20-20)T
- b. Ambulance/air ambulance charges. (3-20-20)T
- c. Behavior problems. (3-20-20)T
- d. Brain tumors. (3-20-20)T
- e. Biofeedback equipment. (3-20-20)T
- f. Routine dental care. (3-20-20)T

	<b>g.</b>	Congenital defects of the gastrointestinal or genitourinary tracts.	(3-20-20)T
	<b>h.</b>	Cancer care.	(3-20-20)T
	<b>i.</b>	Cosmetic surgery.	(3-20-20)T
	<b>j.</b>	Diabetes care.	(3-20-20)T
	<b>k.</b>	Prescription medicine -- except those prescribed for eligible cystic fibrosis patients.	(3-20-20)T
	<b>l.</b>	Educational services.	(3-20-20)T
arthritis.	<b>m.</b>	Eye care except as related to an eligible condition such as cerebral palsy or juvenile rheumatoid arthritis.	(3-20-20)T
	<b>n.</b>	Eyeglasses.	(3-20-20)T
	<b>o.</b>	Fractures.	(3-20-20)T
	<b>p.</b>	Growth Hormone.	(3-20-20)T
	<b>q.</b>	Hearing problems, except as related to cleft lip and palate.	(3-20-20)T
	<b>r.</b>	Hernias.	(3-20-20)T
	<b>s.</b>	Home health/home nursing services.	(3-20-20)T
	<b>t.</b>	Infectious diseases.	(3-20-20)T
	<b>u.</b>	Legal services.	(3-20-20)T
femoral anteversion.	<b>v.</b>	Minor foot and leg deformities: flat feet, bow legs, knock knees, pigeon toes, tibial torsion and mild femoral anteversion.	(3-20-20)T
	<b>w.</b>	Neonatal intensive care in the newborn period.	(3-20-20)T
	<b>x.</b>	Orthoptics - visual training therapy.	(3-20-20)T
	<b>y.</b>	Routine pediatric care.	(3-20-20)T
	<b>z.</b>	Prematurity.	(3-20-20)T
	<b>aa.</b>	Pseudohermaphroditism.	(3-20-20)T
	<b>bb.</b>	Psychological or psychiatric care or counseling.	(3-20-20)T
	<b>cc.</b>	Respiratory or pulmonary problems except as related to cystic fibrosis.	(3-20-20)T
	<b>dd.</b>	Respite care.	(3-20-20)T
	<b>ee.</b>	Shoes (corrective or orthopedic).	(3-20-20)T
	<b>ff.</b>	Sleep Apnea Monitors.	(3-20-20)T
	<b>gg.</b>	Spinal disc lesions.	(3-20-20)T
	<b>hh.</b>	Transplants.	(3-20-20)T

ii. Transportation to in-town clinics or other regular services. (3-20-20)T

**02. Individual Consideration.** Conditions not specifically identified within these rules as included or excluded by CSHP will be considered on a case by case basis that may include review by a medical advisor. (3-20-20)T

**351. -- 999. (RESERVED)**

## 16.02.27 – IDAHO RADIATION CONTROL RULES

### 000. LEGAL AUTHORITY.

The Idaho Legislature, under the following Sections of statute has granted authority to the Board of Health and Welfare and the Director of the Department to adopt rules related to x-ray producing machines in order to protect the health of the people of Idaho. Sections 56-1041 and 56-1043, Idaho Code, grant authority to the Board of Health and Welfare to adopt radiation control rules. Section 56-1041, Idaho Code, establishes the Department as the designated agency to regulate, license, and control radiation associated with x-ray machines. Section 56-1044, Idaho Code, requires that radiation machines for mammography be registered with the Department, as provided in rule. Section 56-1046, Idaho Code, grants authority to the Department to establish record-keeping and reporting requirements for those who possess or use an x-ray machine. Section 56-1003, Idaho Code, grants authority to the Director to supervise and administer laboratories. Section 56-1007, grants authority to the Department to charge and collect fees established by rule. (3-20-20)T

### 001. TITLE AND SCOPE.

**01. Title.** These rules are titled IDAPA 16.02.27, “Idaho Radiation Control Rules.” (3-20-20)T

**02. Scope.** Except as otherwise specifically provided, these rules apply to all persons who possess, use, transfer, own, or acquire any radiation machine. (3-20-20)T

### 002. -- 003. (RESERVED)

### 004. INCORPORATION BY REFERENCE.

The documents referenced in Subsections 004.01 through 004.03 of this rule are used as a means of further clarifying these rules. These documents are incorporated by reference and are available online as provided, or may be reviewed at the Department of Health and Welfare, Idaho Bureau of Laboratories at 2220 Old Penitentiary Road, Boise, Idaho 83712-8299. (3-20-20)T

**01. National Council of Radiation Protection (NCRP) Report No. 147.** National Council of Radiation Protection (NCRP) Report No. 147, entitled: “Structural Shielding Design and Evaluation for Medical Use of X-rays and Gamma Rays of Energies up to Ten (10) MeV,” issued November 19, 2004, by the National Council on Radiation Protection and Measurement. This document may be obtained from: NCRP Publications, 7910 Woodmont, Bethesda, MD 20814, e-mail: [NCRPpubs@NCRPonline.org](mailto:NCRPpubs@NCRPonline.org), phone: 1-301-657-2652, Ext. 14. (3-20-20)T

**02. Mammography Quality Standards Act Regulations, Part 900.** The Mammography Quality Standards Act Regulations, Part 900, located at 21 CFR 900.12 as authorized by 21 U.S.C. 360i, 360nn, 374(e); and 42 U.S.C. 263b. A copy of these regulation may be ordered from the U.S. Food and Drug Administration, 10903 New Hampshire Avenue, Silver Spring, MD 20993, phone: 1-888-INFO-FDA (1-888-463-6332). These regulations are available online at <http://www.fda.gov/Radiation-EmittingProducts/MammographyQualityStandardsActandProgram/Regulations/ucml10906.htm#s9001>. (3-20-20)T

**03. Suggested State Regulations for Control of Radiation, Volume 1.** This publication is being adopted with the exclusions, modifications, and additions listed below in Subsections 004.03.a through 004.03.k of this rule. Suggested State Regulations for Control of Radiation, Volume 1, is published by the Conference of Radiation Control Program Directors, Inc., 1030 Burlington Lane, Suite 4B, Frankfort, Kentucky 40601. It is also available online at <https://www.crcpd.org/page/SSRCRs>. (3-20-20)T

**a.** Part A -- General Provisions (March 2003). Modifications have been made to this Part. See Sections 100 - 199 of these rules. (3-20-20)T

**b.** Part B -- Registration [Licensure] of Radiation Machine Facilities, [Services] - And Associated Healthcare Professionals (February 2009). Exclusions and modifications have been made to this Part. See Sections 200 - 299 of these rules. (3-20-20)T

**c.** Part C -- Licensing of Radioactive Material (March 2010). This Part is excluded from incorporation. (3-20-20)T

**d.** Part D -- Standards for Protection Against Radiation (March 2003). The following Sections of this Part are incorporated: 1101a, 1101b, 1101c, 1201a, 1201b, 1201c, 1201f, 1206, 1207, 1208, 1301, 1501, 1502, 1503, 1601, 1602, 1901, 1902, 1903, 1904c, 2102, 2103a, 2104, 2105, 2106, 2107a, 2110, 2201, 2202, 2203, 2204, 2205, and 2207b. (3-20-20)T

**e.** Part E -- Radiation Safety Requirements for Industrial Radiographic Operations (February 1999). Exclusions have been made to this Part. See Sections 400 - 499 of these rules. (3-20-20)T

**f.** Part F -- Diagnostic X-rays and Imaging Systems in the Healing Arts (May 2009). This Part is incorporated with no exclusions, modifications, or additions. (3-20-20)T

**g.** Part G -- Use of Radionuclides in the Healing Arts (March 2003). This Part is excluded from incorporation. (3-20-20)T

**h.** Part H -- Radiation Safety Requirements for Analytical X-ray Equipment (January 1991). This Part is incorporated with no exclusions, modifications, or additions. (3-20-20)T

**i.** Part I -- Radiation Safety Requirements For Particle Accelerators (January 1991). This Part is excluded from incorporation. (3-20-20)T

**j.** Part J -- Notices, Instructions and Reports to Workers; Inspections (March 2003). This Part is incorporated with no exclusions, modifications, or additions. (3-20-20)T

**k.** Parts M through Z. These Parts are excluded from incorporation. (3-20-20)T

**005. -- 049. (RESERVED)**

**050. LICENSING.**

Sections 050 through 099 of these rules provide for the licensing of radiation machines. (3-20-20)T

**051. MACHINES REQUIRED TO BE LICENSED.**

Radiation producing machines, unless exempt under Section B.4 of the Suggested State Regulations for Control of Radiation incorporated under Section 004 of these rules, must be licensed with the Radiation Control Agency in accordance with the requirements of Sections B.6 through B.9, of the Suggested State Regulations for Control of Radiation, as applicable. (3-20-20)T

**052. FEES.**

**01. Radiation Licensing Fees.** Radiation facility fees apply to each person or facility owning, leasing, storing, or using radiation-producing machines. This fee is assessed on the same cycle as inspections and consists of a base licensing fee and a per tube charge. Fees are due within thirty (30) calendar days of the renewal date. A late charge of fifty (\$50) dollars will be assessed at thirty-one (31) days past the renewal date. If the fees are not paid by day ninety-one (91) past the renewal date, licensure will be terminated.

<b>X-Ray Renewal Cycle and Facility Fees</b>			
<b>Facility Type</b>	<b>Renewal Cycle</b>	<b>Facility Fee</b>	<b>Per Tube Fee</b>
Hospital, Clinic, Medical Practice	2 Years	\$50	\$25
Dental, Chiropractic, Podiatric, Veterinary Practice	4 Years	\$50	\$25
Industrial, research, academic/ educational, or security	10 Years	\$50	\$25

(3-20-20)T

**02. X-Ray Shielding Plan Review and Fee.** Facilities housing X-ray producing devices and regulated under these rules must obtain a review of their shielding plan by a qualified expert. A copy of this review, to include a floor plan and site specific shielding calculations, must be submitted to the Radiation Control Agency within thirty (30) days of receipt. Facilities may request a departmental review of the X-ray shielding calculations and floor plan

by the Radiation Control Agency. A three hundred fifty dollar (\$350) fee will be charged for this service. (3-20-20)T

**03. Radiation Safety Program Fee.** If a facility or group of facilities under one administrative control employs one (1) or more full-time individuals whose positions are entirely devoted to in-house radiation safety, the facility may pay a flat annual facility fee of one thousand dollars (\$1,000) instead of the licensing fees required in Subsection 052.01 of this rule. In addition, annual submittal of documentation of evidence of an ongoing and functioning quality control program must be submitted for review and approval. (3-20-20)T

**053. APPLICATION FOR LICENSE.**

In addition to the requirements detailed in the incorporated reference, Section B, the following is required with application for use of x-ray producing devices. (3-20-20)T

**01. Responsible Authority.** All applications must be signed by the responsible authority (RA) over the x-ray producing device. Required qualifications of the RA can be found in Section B.6c of the SSRCR. (3-20-20)T

**02. Application For License.** Application for license must be on forms furnished by the Radiation Control Agency and must contain: (3-20-20)T

**a.** Name of the owner, organization or person having administrative control and responsibility for use (responsible authority); and (3-20-20)T

**b.** Address and telephone number where the machine is located; and if the radiation producing machine is used as a mobile device, a central headquarters must be used. (3-20-20)T

**c.** A designation of the general category of use, such as dental, medical, industrial, veterinary, and research; and (3-20-20)T

**d.** The manufacturer, model number, and type of machine; and (3-20-20)T

**e.** Name of the radiation machine supplier, installer, and service agent. (3-20-20)T

**f.** Name of an individual to be responsible for radiation protection, when applicable. (3-20-20)T

**03. Qualifications for Authorized Operation, Service, and Repair of X-ray Machines.** The responsible authority must prohibit any person from operating, performing maintenance, or furnishing servicing or services to an x-ray producing machine under their authority that is not properly trained, certified, or licensed to do so. The responsible authority must obtain and retain documentation for a minimum of two (2) years that all operation, service, repair, and maintenance of x-ray producing machine(s) under their authority are done so by a qualified individual or entity. (3-20-20)T

**04. Operator Qualifications.** No individual will be permitted to act as an operator of a particular machine until such individual has received an acceptable amount of training in radiation safety as it applies to that machine and is approved by the Radiation Protection Supervisor or Radiation Safety Officer. Operators will be responsible for: (3-20-20)T

**a.** Keeping radiation exposure to himself and to others as low as is practical; (3-20-20)T

**b.** Being familiar with safety procedures as they apply to each machine; (3-20-20)T

**c.** Wearing of personnel monitoring devices, if applicable; and (3-20-20)T

**d.** Notifying the Radiation Protection Supervisor or Radiation Safety Officer of known or suspected excessive radiation exposures to himself or others. (3-20-20)T

**05. Minimum Safety Requirements.** Unless otherwise specified within these or the incorporated rules, the following are the minimum safety requirements for personnel acting as radiographers or radiographers assistants. (3-20-20)T

**a.** Licensees must not permit any individuals to act as radiographers as defined in these rules until such individuals: (3-20-20)T

i. Have received copies of and instructions in the licensee's operating and emergency procedures; and have demonstrated understanding thereof; and (3-20-20)T

ii. Have been instructed in the subjects outlined in Subsection 053.06 of this rule, and have demonstrated understanding thereof; and (3-20-20)T

iii. Have received copies of and instruction in the correct execution of these rules and have demonstrated understanding thereof; and (3-20-20)T

iv. Have demonstrated competence to use the specific radiation machine(s), related handling tools, and survey instruments that will be employed in their assignment. (3-20-20)T

v. Have demonstrated an understanding of the instructions in this section by successful completion of a written test and a field examination on the subjects covered. (3-20-20)T

**b.** Licensees must not permit any individuals to act as a radiographer's assistant as defined in these rules until such individuals: (3-20-20)T

vi. Have received copies of and instructions in the licensee's operating and emergency procedures; and have demonstrated understanding thereof; and (3-20-20)T

vii. Have demonstrated competence to use under the personal supervision of the radiographer the radiation machine(s) and radiation survey instrument(s) that will be employed in their assignment. (3-20-20)T

viii. Have demonstrated an understanding of the instructions in this section by successfully completing a written or oral test and a field examination on the subjects covered. (3-20-20)T

**c.** Records of the above training, including copies of written tests and dates of oral tests and field examinations, must be maintained for inspection by the Radiation Control Agency for three (3) years following termination of employment. (3-20-20)T

**d.** Each licensee must conduct an internal audit program to ensure that the Radiation Control Agency's conditions and the licensee's operating and emergency procedures are followed by each radiographer and radiographer's assistant. These internal audits must be performed at least quarterly, and each radiographer must be audited at least annually. Records of internal audits must be maintained for inspection by the Agency for two (2) years from the date of the audit. (3-20-20)T

**06. Subjects to Be Covered During the Instruction of Radiographers.** (3-20-20)T

**a.** Fundamentals of Radiation Safety, to include at least: (3-20-20)T

i. Characteristics of gamma and x-radiation; (3-20-20)T

ii. Units of radiation dose (millirem); (3-20-20)T

iii. Bioeffects of excessive exposure of radiation; (3-20-20)T

iv. Levels of radiation from radiation machines; (3-20-20)T

v. Methods of controlling radiation dose, including: (3-20-20)T

(1) Working time; (3-20-20)T

- (2) Working distances; and (3-20-20)T
- (3) Shielding; (3-20-20)T
- vi. Radiation Protection Standards; (3-20-20)T
- b.** Radiation Detection Instrumentation, to include at least: (3-20-20)T
  - i. Use of radiation surveys instruments, including: (3-20-20)T
    - (1) Operation; (3-20-20)T
    - (2) Calibration; and (3-20-20)T
    - (3) Limitations; (3-20-20)T
  - ii. Survey techniques; (3-20-20)T
  - iii. Use of Personnel Monitoring Equipment, including: (3-20-20)T
    - (1) Film badges, TLDs; (3-20-20)T
    - (2) Pocket dosimeters; and (3-20-20)T
    - (3) Pocket chambers; (3-20-20)T
  - c.** Radiographic Equipment, to include operation and control of x-ray equipment; (3-20-20)T
  - d.** The Requirements of Pertinent Federal regulations and State rules; (3-20-20)T
  - e.** The Licensee's Written Operating and Emergency Procedures; and (3-20-20)T
  - f.** Case histories of radiography accidents. (3-20-20)T
- 07. Modification, Revocation, and Termination of Licensees.** In accordance with amendments to the Act, departmental rules or regulations, or orders issued by the Radiation Control Agency, the terms and conditions of all licenses are subject to amendment, revision, or modification, and are subject to suspension or revocation. (3-20-20)T
  - a.** Any license can be revoked, suspended, modified, or denied, in whole or in part. (3-20-20)T
    - i. For any materially false statement: (3-20-20)T
      - (1) In the application; or (3-20-20)T
      - (2) In any statement of fact required under provisions of the Act or under these rules; or (3-20-20)T
    - ii. Because of conditions revealed: (3-20-20)T
      - (1) Within the application; any report, record, or inspection; or (3-20-20)T
      - (2) By any other means that would warrant the Radiation Control Agency to refuse to grant a license on an original application; or (3-20-20)T
    - iii. For violations of or failure to observe any of the terms and conditions: (3-20-20)T
      - (1) Of the Act; or (3-20-20)T



- (2) Of the license; or (3-20-20)T
- (3) Of any rule; or (3-20-20)T
- (4) Of any regulation; or (3-20-20)T
- (5) Of an order of the Radiation Control Agency. (3-20-20)T

**b.** Except in cases of willful violation or in which the public health, interest or safety requires otherwise, no license can be modified, suspended, or revoked unless such issues have been called to the attention of the licensee in writing and the licensee afforded the opportunity to demonstrate or achieve compliance with all lawful requirements. (3-20-20)T

**08. Emergency Action.** If the Radiation Control Program Director finds the public health, safety or welfare requires emergency action, the Director will incorporate findings in support of such action in a written notice of emergency revocation issued to the licensee. Emergency revocation is effective upon receipt by the licensee. Thereafter, if requested by the licensee in writing, the Director will provide the licensee a revocation hearing and prior notice thereof. Such hearings are conducted in accordance with IDAPA 16.05.03, "Contested Case Proceedings and Declaratory Rulings." (3-20-20)T

**054. -- 099. (RESERVED)**

**100. GENERAL PROVISIONS.**

Sections 100 through 199 of these rules will be used for exclusions, modifications, and additions to Part A of the Suggested State Regulations for Control of Radiation, Volume 1, as incorporated in Section 004 of these rules. (3-20-20)T

**101. SCOPE.**

Modification to Part A, Section A.1. Except as otherwise specifically provided, these regulations apply to all persons who receive, possess, use, transfer, own, or acquire any source of radiation; provided that nothing in these regulations applies to any person to the extent such person is subject to regulation by the Nuclear Regulatory Commission. (3-20-20)T

**102. DEFINITIONS.**

Additions to Part A, Section A.2. (3-20-20)T

**01. Act.** "Act" means Section 56-1053, Idaho Code. (3-20-20)T

**02. Agency.** "Agency" means the Idaho Department of Health and Welfare. (3-20-20)T

**103. VIOLATIONS.**

Modification to Part A, Section A.8. Any person who willfully violates any provision of the Act is subject to penalties under Section 56-1053, Idaho Code. (3-20-20)T

**104. IMPOUNDING.**

Modification to Part A, Section A.9. Sources of radiation are subject to impounding under Section 56-1052, Idaho Code. (3-20-20)T

**105. COMMUNICATIONS.**

Modification to Part A, Section A.12. All communications and reports concerning these rules, and applications filed under these rules, must be addressed to the Agency at Radiation Control Section, Idaho Department of Health and Welfare, Bureau of Laboratories, 2220 Old Penitentiary Road, Boise, Idaho 83712-8299. (3-20-20)T

**106. -- 199. (RESERVED)**

**200. LICENSURE OF RADIATION MACHINE FACILITIES, (SERVICES) - AND ASSOCIATED HEALTHCARE PROFESSIONALS.**

Sections 200 through 299 of these rules will be used for exclusions, modifications, and additions to Part B of the Suggested State Regulations for Control of Radiation, Volume 1, as incorporated in Section 004 of these rules. (3-20-20)T

**201. LICENSURE OF RADIATION MACHINE FACILITIES.**

Exclusion to Part B, Section B.6. Subsection B.6.b is excluded from incorporation. (3-20-20)T

**202. RECIPROCAL RECOGNITION OF OUT-OF-STATE RADIATION MACHINES.**

Modifications and additions to Part B, Section B.16. (3-20-20)T

**01. Modification to Part B, Section B.16.a.iv.** States in which this machine is registered or licensed. (3-20-20)T

**02. Addition to Part B, Section B.16 -- New Subsection d.** The owner or person having possession of any radiation producing machine registered or licensed by a federal entity or state other than Idaho, or both, planning to establish regular operations in Idaho, must complete registration of the machine with the Agency within thirty (30) days after taking residence and prior to operation of the machine. Thirty (30) days prior to the expiration date of any out-of-state license for any radiation producing machine, the owner must apply to the Agency for a machine license. (3-20-20)T

**203. -- 399. (RESERVED)**

**400. RADIATION SAFETY REQUIREMENTS FOR INDUSTRIAL RADIOGRAPHIC OPERATIONS.**

Sections 400 through 499 of these rules will be used for exclusions, modifications, and additions to Part E of the Suggested State Regulations for Control of Radiation, Volume 1, as incorporated in Section 004 of these rules. (3-20-20)T

**401. LICENSING AND REGISTRATION REQUIREMENTS FOR INDUSTRIAL RADIOGRAPHY OPERATIONS.**

Exclusions to Part E, Section E.5. Subsections E.5.b.i and E.5.b.ii, are excluded from incorporation. (3-20-20)T

**402. LEAK TESTING AND REPLACEMENT OF SEALED SOURCES.**

Part E, Section E.10 is excluded from incorporation. (3-20-20)T

**403. QUARTERLY INVENTORY.**

Part E, Section E.11 is excluded from incorporation. (3-20-20)T

**404. LABELING, STORAGE, AND TRANSPORTATION.**

Exclusions to Part E, Section E.14. Subsections E.14.a, E.14.b, and E.14.d, are excluded from incorporation. (3-20-20)T

**405. CONDUCTING INDUSTRIAL RADIOGRAPHIC OPERATIONS.**

Exclusion to Part E, Section E.15. Subsection E.15.d is excluded from incorporation. (3-20-20)T

**406. RECORDS OF LEAK TESTING OF SEALED SOURCES AND DEVICES CONTAINING DU.**

Part E, Section E.27 is excluded from incorporation. (3-20-20)T

**407. RECORDS OF QUARTERLY INVENTORY.**

Part E, Section E.28 is excluded from incorporation. (3-20-20)T

**408. UTILIZATION LOGS.**

Part E, Section E.29 is excluded from incorporation. (3-20-20)T

**409. LOCATION OF DOCUMENTS AND RECORDS.**

Exclusions to Part E, Section E.37. Subsections E.37.b.iii, E.37.b.xi, and E.37.b.xii are excluded from incorporation.

(3-20-20)T

**410. NOTIFICATIONS.**

Exclusions to Part E, Section E38. Subsections E.38.a.i, and E.38.a.ii are excluded from incorporation. (3-20-20)T

**411. APPLICATION AND EXAMINATIONS.**

Part E, Section E.39 is excluded from incorporation. (3-20-20)T

**412. CERTIFICATION IDENTIFICATION (ID) CARD.**

Part E, Section E.40 is excluded from incorporation. (3-20-20)T

**413. RECIPROCITY.**

Part E, Section E.41 is excluded from incorporation. (3-20-20)T

**414. SPECIFIC REQUIREMENTS FOR RADIOGRAPHIC PERSONNEL PERFORMING INDUSTRIAL RADIOGRAPHY.**

Part E, Section E.42 is excluded from incorporation. (3-20-20)T

**415. -- 599. (RESERVED)**

**600. NOTICES, INSTRUCTIONS AND REPORTS TO WORKERS; INSPECTIONS.**

Sections 600 through 699 of these rules will be used for exclusions, modifications, and additions to Part J of the Suggested State Regulations for Control of Radiation, Volume 1, as incorporated in Section 004 of these rules.

(3-20-20)T

**601. -- 999. (RESERVED)**

### 16.03.03 – CHILD SUPPORT SERVICES

#### 000. LEGAL AUTHORITY.

The Department of Health and Welfare is authorized to promulgate these rules under Sections 7-1206, 32-1207, 32-1209, 32-1214G, 32-1217, 56-203A, and 56-1004, Idaho Code. (3-20-20)T

#### 001. TITLE, SCOPE, AND GOAL.

01. **Title.** These rules are titled IDAPA 16.03.03, “Child Support Services.” (3-20-20)T

02. **Scope.** These rules provide the requirements for the administration of the Department’s child support program. (3-20-20)T

03. **Goal.** The goal of child support services is to ensure that both parents provide the financial support necessary to provide for their children. This program requires cooperation between families, employers, and the community. (3-20-20)T

#### 002. -- 049. (RESERVED)

#### 050. DISTRIBUTION OF SUPPORT COLLECTED IN TITLE IV-E FOSTER CARE MAINTENANCE CASES.

01. **Payment of Support Obligation.** The amount collected as current support shall first be retained by the State to reimburse itself for the foster care assistance payment for that month. Any amount collected in excess of the current month’s foster care assistance payment, but less than the monthly support obligation, shall be paid to the state agency responsible for the child’s placement and care. Any amount collected in excess of the monthly support obligation shall be retained by the State to reimburse any previous foster care assistance payments. The State is limited to reimbursement for past foster care assistance by the amount of the total support obligation owed. Any excess collected after the State has been reimbursed for past foster care assistance payments shall be paid to the state agency responsible for the child’s placement and care. Collections shall be applied to future payments only after all current support and arrears have been satisfied. (3-20-20)T

02. **Termination of Foster Care Payments.** When a state stops providing foster care assistance under Title IV-E, the assignment of support rights ends except as to unpaid support which accrued prior to or during the assignment. (3-20-20)T

#### 051. – 074. (RESERVED)

#### 075. FEES.

01. **Application Fee.** At the time of application for child support services, a written application must be completed and a fee of twenty-five dollars (\$25) must be paid. The fee must be paid in advance of any services to be provided and is not refundable. (3-20-20)T

02. **Income Tax Offset Fees.** A fee of twenty-five dollars (\$25) will be deducted each time child support is collected as a result of an income tax offset. (3-20-20)T

03. **Internal Revenue Service (IRS) Referral Fees.** A fee of one hundred twenty-two dollars and fifty cents (\$122.50) shall be charged for a referral to the IRS for full collection of the child support obligation. (3-20-20)T

04. **Locate Fees.** Child Support Services may charge an applicant/recipient a fee of ten dollars (\$10) for referral to FPLS for location of a non-custodial parent when no other child support services are being provided. Child Support Services may also charge a fee of four dollars (\$4) for referral to the FPLS for a social security number search. Child Support Services may charge a fee of seventy cents (\$.70) for referral to FPLS for location of a non-custodial parent. (3-20-20)T

05. **Federally Mandated Annual Service Fees.** Child Support Services must charge an annual fee of thirty-five dollars (\$35) for each support enforcement case in which it has collected and disbursed at least five hundred fifty dollars (\$550) of support in the federal fiscal year. The fee will be billed to the parent ordered to pay support, but will not be assessed on any case in which an individual has ever received benefits under the Temporary Assistance for Needy Families program. (3-20-20)T

**076. – 099. (RESERVED)**

**100. LEGAL COSTS.**

An applicant/recipient will be notified at the time of the application that legal costs incurred by Child Support Services will be deducted from any child support collected to reimburse the State. The applicant/recipient will be notified as to the legal costs being incurred. No more than twenty percent (20%) of any collection will be deducted for reimbursement of these costs. Child Support Services will attempt to obtain an order against the non-custodial parent in favor of the applicant/recipient for reimbursement of the legal costs incurred by Child Support Services. (3-20-20)T

**101. -- 199. (RESERVED)**

**200. SECURING AND ENFORCING MEDICAL SUPPORT.**

Medical support enforcement services must be provided in any case for which an assignment of medical support is in effect, including: (3-20-20)T

**01. Petition.** Petitioning the court to include health insurance that is available to either parent at reasonable cost in new or modified court orders for support. Health insurance is considered reasonable in cost if it is available through employment or other group health benefit plan. (3-20-20)T

**02. Enforcement.** Taking any necessary action to ensure that one (1) parent secures and maintains medical insurance required by the support order. (3-20-20)T

**201. ADMINISTRATIVE REVIEW FOR ENFORCEMENT OF MEDICAL SUPPORT.**

**01. Request.** An obligor may request an administrative review within twenty (20) days after a notice of intent to enroll one (1) or more children in a health benefit plan is mailed by the Department. (3-20-20)T

**02. Scope of Administrative Review.** The Department will cancel a notice of intent to enroll or a National Medical Support Notice (NMSN) if: (3-20-20)T

**a.** The parent does not owe medical support. (3-20-20)T

**b.** The parent is no longer obligated to provide medical support. (3-20-20)T

**c.** Medical support, excluding Medicaid, is already being provided by either parent. (3-20-20)T

**202. -- 299. (RESERVED)**

**300. REVIEW AND MODIFICATION OF SUPPORT ORDERS.**

**01. Notice.** Each parent subject to a child support order in effect in the State that is being enforced by Child Support Services must be notified of the right of the parent to request a review of the order by Child Support Services every thirty-six (36) months. Reviews are not to be done more frequently unless there has been a substantial and material change in circumstances. (3-20-20)T

**02. Review.** A support order will be reviewed for possible modification: (3-20-20)T

**a.** If requested by either parent; (3-20-20)T

**b.** If requested by any state, tribal, or foreign child support services agency; or (3-20-20)T

**c.** Automatically, at least every thirty-six (36) months, in any case where the custodial parent or other custodian of the child or children is receiving benefits under Title IV-A of the Social Security Act, either in Idaho or elsewhere. (3-20-20)T

**03. After the Review.** Each parent will be notified of the proposed adjustment or of the determination

that there should be no change in the amount of child support. (3-20-20)T

**04. Adjustment.** A modification of a support order will only be sought if the review conducted under Subsection 300.02 of this rule results in an obligation under the Child Support Guidelines which differs from the existing order by at least fifteen percent (15%), but not less than fifty dollars (\$50) per month. The following criteria will be applied by Child Support Services to determine whether there has been a substantial and material change of circumstances: (3-20-20)T

**a.** Whether there has been an increase or decrease in the income, as the term is defined in the Child Support Guidelines, of either parent or other person legally obligated for the support of a child; (3-20-20)T

**b.** Whether there has been a substantial increase or decrease in the assets of either parent or other person legally obligated for the support of a child; (3-20-20)T

**c.** Whether there has been a substantial change in the needs of the child; (3-20-20)T

**d.** Whether there has been a change in the custody or visitation rights of the non-custodial parent; and (3-20-20)T

**e.** Whether other factors exist indicating a substantial and material change in circumstances since the entry or modification of the support order. (3-20-20)T

### **301. CONSUMER REPORTING AGENCIES.**

**01. Consumer Reporting Agency.** Any person who for monetary fees, dues or on a cooperative basis, regularly engages in whole or in part in the practice of assembling or evaluating consumer credit information or other information on consumers for the purpose of furnishing consumer reports to third parties, and who uses any means or facility of interstate commerce for the purpose of preparing or furnishing consumer reports. (3-20-20)T

**02. Reports.** Reports are made to consumer reporting agencies of any non-custodial parent who owes overdue support exceeding two thousand dollars (\$2,000) and is at least three (3) months in arrears after the court order is finalized. Notice will be provided to the non-custodial parent prior to the report being made available to the agencies and will inform the non-custodial parent of the methods available for contesting the accuracy of the information. (3-20-20)T

### **302. GOOD CAUSE DETERMINATION IN LICENSE SUSPENSION PROCEEDINGS.**

**01. Definitions.** The following definitions apply for this section of rules: (3-20-20)T

**a.** “Obligor” means an individual who is ordered to pay child support under an order issued by a court or authorized administrative authority. (3-20-20)T

**b.** “Obligee” means an individual who is ordered to receive child support under an order issued by a court or authorized administrative authority. (3-20-20)T

**c.** “Motor Vehicle License” means a license required to operate any type of motor vehicle. (3-20-20)T

**d.** “Occupational or Professional License” means a license issued to allow a person to practice or engage in any business, occupation, or profession. (3-20-20)T

**e.** “Recreational License” means a license, certificate, or permit authorizing an individual to engage in any recreational activity including, but not limited to, hunting, fishing, and trapping. (3-20-20)T

**02. Res Judicata.** No issues that have been previously litigated may be considered at the license suspension hearing. (3-20-20)T

**03. Good Cause in Motor Vehicle and Occupational License Suspension Proceedings.** The license suspension will be denied or stayed if the obligor proves one (1) of the following conditions exist: (3-20-20)T

**a.** The obligor has been declared physically disabled by Social Security, workman's compensation, or another competent authority that works with disabled individuals, and that the disability has directly resulted in the current inability to pay the child support obligation; (3-20-20)T

**b.** The obligor is experiencing the effects of an extended illness or accident that has directly resulted in the current inability to pay the child support obligation; (3-20-20)T

**c.** The obligor is a student whose enrollment is a result of a referral from Vocational Rehabilitation, workman's compensation, or other competent authority working with disabled individuals; (3-20-20)T

**d.** The obligor is incarcerated in any county, state, or federal correctional facility, and proves that they have no assets. (3-20-20)T

**e.** The obligor is receiving Temporary Assistance for Families in Idaho (TAFI) or Supplemental Security Income benefits; (3-20-20)T

**f.** The obligor has court-ordered physical custody of all of the children listed in the order or orders for support; (3-20-20)T

**g.** Child support is being collected directly from the obligor's income through an income withholding order issued by the Department to the obligor's employer or other income source. (3-20-20)T

**04. Not Good Cause in Motor Vehicle and Occupational License Suspension Proceedings.** Any factor not defined as good cause in Subsection 302.03 of this rule is not good cause for a denial or stay of a license suspension, including but not limited to the following: (3-20-20)T

**a.** The obligor is unemployed, underemployed, or has difficulty maintaining consistent employment; (3-20-20)T

**b.** The obligor claims to be disabled but has not applied for disability or other benefits, or has been refused benefits; (3-20-20)T

**c.** The obligor asserts that the child support obligation is too high; (3-20-20)T

**d.** The obligor has been denied full visitation with the child or children; or (3-20-20)T

**e.** The obligor alleges the obligee misuses the child support. (3-20-20)T

**05. Good Cause in Recreational License Suspension Proceedings.** The license suspension will only be stayed if the obligor proves one (1) of the following conditions exist: (3-20-20)T

**a.** The obligor is receiving TAFI or Supplemental Security Income benefits; or (3-20-20)T

**b.** The obligor has court-ordered physical custody of all of the children listed in the order or orders for support. (3-20-20)T

**303. -- 999. (RESERVED)**

APPENDIX A - ORDER/NOTICE TO WITHHOLD INCOME FOR CHILD SUPPORT

ORDER/NOTICE TO WITHHOLD INCOME FOR CHILD SUPPORT

State _____	Original Order/Notice
Co./City/Dist. of _____	Amended Order/Notice _____
Date of Order/Notice _____	Terminate Order/Notice _____
Court/Case Number _____	
Employer/Withholder's Federal EIN Number _____ )	RE: * _____
_____ )	Employee/Obligor's Name (Last, First, MI)
_____ )	Employee/Obligor's Social Security Number
Employer/Withholder's Name _____ )	*
Employer/Withholder's Name _____ )	Employee/Obligor's Case Identifier
_____ )	Custodial Parent's Name (Last, First, MI)
_____ )	

Child(ren)'s Name(s):                      DOB                      Child(ren)'s Name(s):                      DOB

**ORDER INFORMATION:** This is an Order/Notice to Withhold Income for Child Support based upon an order for support from \_\_\_\_\_. By law, you are required to deduct these amounts from the above-named employee's/obligor's income until \_\_\_\_\_ even if the Order/Notice is not issued by your State.

If checked, you are required to enroll the child(ren) identified above in any health insurance coverage available through the employee's/obligor's employment. \_\_\_\_\_

\$ _____ per _____ in current support	
\$ _____ per _____ in past-due support	Arrears 12 weeks or greater? _ yes _ no
\$ _____ per _____ in medical support	
\$ _____ per _____ in other (specify)	
\$ _____ per _____ in other (specify)	

for a total of \$ \_\_\_\_\_ per \_\_\_\_\_ to be forwarded to the payee below.

You do not have to vary your pay cycle to be in compliance with the support order. If your pay cycle does not match the ordered support payment cycle, use the following to determine how much to withhold:  
\$ \_\_\_\_\_ per weekly pay period. \$ \_\_\_\_\_ per semimonthly pay period (twice a month).  
\$ \_\_\_\_\_ per biweekly pay period (every two weeks). \$ \_\_\_\_\_ per monthly pay period.

**REMITTANCE INFORMATION:** Follow the laws and procedures of the employee's/obligor's principal place of employment even if such laws and procedures are different from this paragraph:

You must begin withholding no later than the first pay period occurring \_\_\_\_\_ working days after the date of this Order/Notice. Send payment within \_\_\_\_\_ working days of the payday date of withholding. You are entitled to deduct a fee of \_\_\_\_\_ to defray the cost of withholding. The total withheld amount, including your fee, cannot exceed \_\_\_\_\_% the employee/obligor's aggregate disposable weekly earnings. For the purpose of the limitation on withholding, the following information is needed (see #9 below):



When remitting payment provide the paydate/date of withholding and the case identifier \_\_\_\_\_.  
If remitting by EFT/EDI, use this FIPS code: \*; \_\_\_\_\_; Bank routing code: \* \_\_\_\_\_;  
Bank account number: \* \_\_\_\_\_.

Make it payable to: **Payee and case identifier**

Send check to: **Payee's Address**

Authorized by \_\_\_\_\_

Print Name \_\_\_\_\_

**ADDITIONAL INFORMATION TO EMPLOYERS AND OTHER WITHHOLDERS**

\_\_\_ **If checked you are required to provide a copy of this form to your employee.**

1. **Priority:** Withholding under this Order/Notice has priority over any other legal process under State law against the same income. Federal tax levies in effect before receipt of this order have priority. If there are Federal tax levies in effect please contact the requesting agency listed below.

2. **Combining Payments:** You can combine withheld amounts from more than one employee/obligor's income in a single payment to each agency requesting withholding. You must, however, separately identify the portion of the single payment that is attributable to each employee/obligor.

3. **Reporting the Paydate/Date of Withholding:** You must report the paydate/date of withholding when sending the payment. The paydate/date of withholding is the date on which the employee is paid and controls the income, i.e. the date the income check or cash is given to the employee, or the date in which the income is deposited directly in his/her account.

4. **Employee/Obligor with Multiple Support Withholdings:** If you receive more than one Order/Notice against this employee/obligor and you are unable to honor them all in full because together they exceed the withholding limit of the State of the employee's principal place of employment (see #9 below), you must allocate the withholding based on the law of the State of the employee's principal place of employment. If you are unsure of that State's allocation law, you must honor all Orders/Notices' current support withholdings before you withhold for any arrearages, to the greatest extent possible under the withholding limit. You should immediately contact the last agency that sent you an Order/Notice to find the allocation law of the state of the employee's principal place of employment.

5. **Termination Notification:** You must promptly notify the payee when the employee/obligor is no longer working for you. Please provide the information requested and return a copy of this order/notice to the agency identified below.

**EMPLOYEE'S/OBLIGOR'S NAME:** \_\_\_\_\_  
**EMPLOYEE'S CASE IDENTIFIER:** \_\_\_\_\_ **DATE OF SEPARATION:** \_\_\_\_\_  
**LAST KNOWN HOME ADDRESS** \_\_\_\_\_  
**NEW EMPLOYER'S ADDRESS** \_\_\_\_\_

6. **Lump Sum Payments:** You may be required to report and withhold from lump sum payments such as bonuses, commissions, or severance pay. If you have any questions about lump sum payments, contact the person or authority below.

7. **Liability:** If you fail to withhold income as the Order/Notice directs, you are liable for both the accumulated amount you should have withheld from the employee/obligor's income and any other penalties set by State law.

\_\_\_\_\_  
\_\_\_\_\_

8. **Anti-discrimination:** You are subject to a fine determined under State law for discharging an employee/obligor from employment, refusing to employ, or taking disciplinary action against any employee/obligor because of a child support withholding.

\_\_\_\_\_

9. **Withholding Limits:** You may not withhold more than the lesser of: 1) the amounts allowed by the Federal Consumer Credit Protection Act (15 U.S.C. Section 1673(b)); or 2) the amounts allowed by the State of the employee's/obligor's principal place of employment. The Federal limit applies to the aggregate disposable weekly earnings (ADWE). ADWE is the net income left after making mandatory deductions such as: State, Federal, local taxes; Social Security taxes; and Medicare taxes. The Federal CCPA limit is 50% of the ADWE for child support and alimony, which is increased by: 1) 10% if the employee does not support a second family; and/or 2) 5% if arrears are more than 12 weeks old. (see boxes on front)

10. \_\_\_\_\_  
\_\_\_\_\_  
\_\_\_\_\_

**Requesting Agency** \_\_\_\_\_  
\_\_\_\_\_  
\_\_\_\_\_

If you or your employee/obligor have any questions, contact:

by telephone at \_\_\_\_\_ or  
by FAX at \_\_\_\_\_ or  
by Internet \_\_\_\_\_.

## 16.03.18 – MEDICAID COST-SHARING

### 000. LEGAL AUTHORITY.

Under Section 56-202(b), Idaho Code, the Legislature has delegated to the Department of Health and Welfare the responsibility to establish and enforce such rules as may be necessary or proper to administer public assistance programs within the state of Idaho. Under Sections 56-253 and 56-257, Idaho Code, the Department of Health and Welfare is to establish enforceable cost-sharing requirements within the limits of federal Medicaid law and regulations. Furthermore, the Idaho Department of Health and Welfare is the designated agency to administer programs under Title XIX and Title XXI of the Social Security Act. (3-20-20)T

### 001. TITLE AND SCOPE.

**01. Title.** These rules are titled IDAPA 16.03.18, “Medicaid Cost-Sharing.” (3-20-20)T

**02. Scope.** These rules describe the general requirements regarding the administration of the cost-sharing provisions for participation in a medical assistance program providing direct benefits in Idaho. (3-20-20)T

### 002. WRITTEN INTERPRETATIONS.

This agency may have written statements which pertain to the interpretation of the rules of this chapter. These documents are available for public inspection. (3-20-20)T

### 003. -- 009. (RESERVED)

### 010. DEFINITIONS.

**01. Copayment (Copay).** The amount a participant is required to pay to the provider for specified services. (3-20-20)T

**02. Cost-Sharing.** A payment the participant or the financially responsible adult is required to make toward the cost of the participant’s health care. Cost-sharing includes both copays and premiums. (3-20-20)T

**03. Creditable Health Insurance.** Creditable health insurance is coverage that provides benefits for inpatient and outpatient hospital services and physicians' medical and surgical services. Creditable coverage excludes liability, limited scope dental, vision, specified disease or other supplemental-type benefits. (3-20-20)T

**04. Department.** The Idaho Department of Health and Welfare, or a person authorized to act on behalf of the Department. (3-20-20)T

**05. Family Income.** The gross income of all financially responsible adults who reside with the participant, as calculated under IDAPA 16.03.01, “Eligibility for Health Care Assistance for Families and Children.” (3-20-20)T

**06. Family Size.** Family size is the number of people living in the same home as the child. This includes relatives and other optional household members. (3-20-20)T

**07. Federal Poverty Guidelines (FPG).** The federal poverty guidelines issued annually by the U. S. Department of Health and Human Services (HHS). The federal poverty guidelines are available on the U.S. Health and Human Services website at <http://aspe.hhs.gov/poverty>. (3-20-20)T

**08. Financially Responsible Adult.** An individual who is the biological or adoptive parent of a child and is financially responsible for the participant. (3-20-20)T

**09. Medical Assistance.** Payments for part or all of the cost of services funded by Titles XIX or XXI of the federal Social Security Act, as amended. (3-20-20)T

**10. Participant.** A person eligible for and enrolled in the Idaho Medical Assistance Program. (3-20-20)T

**11. Physician Office Visit.** Services performed by a physician, nurse practitioner or physician's assistant at the practitioner's place of business, including Federally Qualified Health Centers (FQHCs) and Rural Health Clinics (RHCs). Indian Health Clinic/638 Clinics providing services to individuals eligible for Indian Health Services are not included. (3-20-20)T

12. **Premium.** A regular and periodic charge or payment for health coverage. (3-20-20)T
13. **Social Security Act.** 42 U.S.C. 101 et seq., authorizing, in part, federal grants to the states for medical assistance to eligible low-income individuals. (3-20-20)T
14. **State.** The state of Idaho. (3-20-20)T
15. **Title XIX.** Title XIX of the Social Security Act, known as Medicaid, is a medical benefits program jointly financed by the federal and state governments and administered by the states. This program pays for medical assistance for certain individuals and families with low income and limited resources. (3-20-20)T
16. **Title XXI.** Title XXI of the Social Security Act, known as the State Children's Health Insurance Program (SCHIP). This is a program that primarily pays for medical assistance for low-income children. (3-20-20)T

**011. -- 024. (RESERVED)**

**025. PARTICIPANTS EXEMPT FROM COST-SHARING.**

Native American and Alaskan Native participants are exempt from the cost-sharing provisions of Sections 200, 205, 215, 320, and 400 of these rules. The participant must declare his race to the Department to receive this exemption. Participants in the Medicaid Workers with Disabilities (MWD) program are exempt from the cost-sharing provisions of Sections 200, 205, 207, and 400 of these rules. (3-20-20)T

**026. -- 049. (RESERVED)**

**050. GENERAL COST-SHARING.**

01. **Cost-Sharing Maximum Amount.** A family will be required to pay out of pocket costs not to exceed five percent (5%) of the family's anticipated gross monthly income unless an exception is made as provided in Subsection 050.02 of this rule. (3-20-20)T

02. **Exception to Cost-Sharing Maximum.** A family will be required to pay cost-sharing amounts as provided in Sections 215 and 400 of these rules. These cost-sharing amounts may exceed the family's five percent (5%) of anticipated gross monthly income. (3-20-20)T

03. **Proof of Cost-Sharing Payment.** If a participant believes that their cost-sharing exceeded the five percent (5%) cost-sharing of the family's anticipated gross monthly income, they must provide proof to the Department of the copy amounts that were paid. (3-20-20)T

04. **Excess Cost-Sharing.** A family that establishes proof of payment for cost-sharing that exceeds the five percent (5%) of the family's anticipated gross monthly income will be reimbursed by the Department for the amount paid that exceeds the five percent (5%), except as provided in Subsection 050.02 of this rule. (3-20-20)T

05. **Cost-Sharing Suspended.** A family that exceeds the five percent (5%) maximum amount for cost-sharing will not be required to pay a cost-sharing portion for any family participant for the remainder of the calendar month in which proof of payment is established. (3-20-20)T

**051. - 199. (RESERVED)**

**200. PREMIUMS FOR PARTICIPATION UNDER THE STATE CHILDREN'S HEALTH INSURANCE PROGRAM (SCHIP).**

01. **Family Income Above 133% of FPG.** Each SCHIP participant with family income above one hundred thirty-three percent (133%) and equal to or less than one hundred fifty percent (150%) of the current FPG must pay a monthly premium of ten dollars (\$10) to the Department. (3-20-20)T

02. **Family Income Above 150% of FPG.** Each SCHIP participant with family income above one hundred fifty percent (150%) and equal to or less than one hundred eighty-five percent (185%) of the current FPG

must pay a monthly premium of fifteen dollars (\$15) to the Department. (3-20-20)T

**201. -- 204. (RESERVED)**

**205. PREMIUMS FOR PARTICIPATION UNDER HOME CARE FOR CERTAIN DISABLED CHILDREN (HCCDC).**

**01. Family Income Above 150% and Equal to or Less Than 185% of FPG.** Each HCCDC participant with a family income above one hundred fifty percent (150%) and equal to or less than one hundred eighty-five percent (185%) of the current FPG must pay a monthly premium of fifteen dollars (\$15) to the Department. The maximum monthly premium a family must pay is limited to thirty dollars (\$30). (3-20-20)T

**02. Family Income Above 185% of FPG.** Each HCCDC family with income above one hundred eighty-five percent (185%) of the current FPG must pay a monthly premium to the Department. The monthly premium is a fixed percent of the family's income as provided in the table below. (3-20-20)T

<b>TABLE 205.02</b>		
<b>SLIDING FEE SCHEDULE FOR MONTHLY PREMIUMS FOR HCCDC PARTICIPATION</b>		
<b>Family Income Above 185% of Current FPG</b>		<b>Premium Based on % of Family Income</b>
<b>ABOVE</b>	<b>LESS THAN OR EQUAL TO</b>	
185%	250%	1.0%
250%	300%	1.5%
300%	400%	2.0%
400%	500%	2.5%
500%	600%	3.0%
600%	700%	3.5%
700%	800%	4.0%
800%	900%	4.5%
900%	No Upper Limit	5.0%

(3-20-20)T

**03. Reduction of Premium for Creditable Health Insurance.** A family who purchases creditable health insurance for the participant may receive a twenty-five percent (25%) reduction of the required monthly premium. (3-20-20)T

**04. Failure to Provide Information.** Failure to provide the Department with information needed to determine family income and household size may subject the participant to a monthly premium equal to the average monthly cost of coverage for participants receiving Medicaid Enhanced Plan Benefits through HCCDC. (3-20-20)T

**05. Failure to Pay Premium.** Failure to pay the premium for an HCCDC participant will not cause the participant to lose coverage or eligibility for services. A participant eligible through HCCDC is exempt from the provisions of Section 250 of these rules. (3-20-20)T

**06. Waiver of Premium.** The premium may be waived if the Department determines that payment of the premium would cause undue hardship on the family. Undue hardship exists when an unexpected expense would cause the family to forgo basic food or shelter in order to make a premium payment. Detailed documentation of the

family's living and insurance expenses demonstrating such hardship must be provided to the Department. (3-20-20)T

**07. Premium Recalculation.** The premium amount is recalculated at each annual eligibility renewal. If a financially responsible adult reports a reduction in family income prior to renewal, the premium will be reduced to the appropriate level upon verification of the reduction to the family's income. When the family income is at a level that does not require premium payments, the premium will no longer be assessed. (3-20-20)T

**206. (RESERVED)**

**207. PREMIUMS FOR PARTICIPATION UNDER THE YOUTH EMPOWERMENT SERVICES (YES) PROGRAM.**

**01. Premium Fee Schedule.** Each YES program participant, as that individual is defined in IDAPA 16.03.10, "Medicaid Enhanced Plan Benefits," Section 636, is subject to assessment of a premium based on family income. The Department will establish a premium fee schedule at rates not to exceed maximums set forth in federal law and regulations governing state Medicaid programs. The fee schedule will be published on the Department's website and provided to families participating in the YES program who are subject to premiums. (3-20-20)T

**02. Enforcement of Premiums.** Payment of premiums will be enforced within the limitations of federal laws and regulations governing state Medicaid programs. (3-20-20)T

**03. Waiver of Premium.** The monthly premium described in Subsection 207.01 of this rule may be waived if the Department determines that the family is unable to participate in the cost of care. (3-20-20)T

**04. Premium Recalculation.** The premium amount is recalculated at each annual eligibility redetermination. If a financially responsible adult reports a reduction in family income prior to eligibility redetermination, the premium will be reduced to the appropriate level upon verification of the reduction in the family's income. When the family income is reduced to a level that does not require premium payments, the premium will no longer be assessed. (3-20-20)T

**208. -- 209. (RESERVED)**

**210. DEPARTMENT RESPONSIBILITIES.**

**01. Assessed Premiums.** A participant will not be assessed premiums during the time initial eligibility is determined. Obligation for premium payments does not begin for at least sixty (60) days after receipt of application, except for workers with disabilities under Section 215 of these rules. (3-20-20)T

**02. Premiums Not Assessed Due to Late Review.** A participant can not be assessed premiums for extra months of eligibility received due solely to the Department's late review of continuing eligibility, except for workers with disabilities under Section 215 of these rules. (3-20-20)T

**03. No Retroactive Premiums Assessed.** A participant can not be assessed premiums for months of retroactive eligibility. (3-20-20)T

**04. Notification of Premiums.** The Department is required to routinely notify a participant of their premium payment obligations including any delinquencies, if applicable. (3-20-20)T

**211. -- 214. (RESERVED)**

**215. PREMIUMS FOR PARTICIPATION IN MEDICAID ENHANCED PLAN.**

**01. Workers with Disabilities.** A participant in the Medicaid for Workers with Disabilities coverage group must share in the cost of Medicaid coverage, if required. Countable income is determined under IDAPA 16.03.05, "Rules Governing Eligibility for Aid to the Aged, Blind, and Disabled (AABD)." A participant's premium for his share of Medicaid costs under this coverage group is determined in Subsections 215.01.a. through 215.01.c. of this rule. (3-20-20)T

**a.** A participant who has countable income at or below one hundred thirty-three percent (133%) of the current federal poverty guideline is not required to pay a premium for Medicaid. (3-20-20)T

**b.** A participant who has countable income above one hundred thirty-three percent (133%) to two hundred fifty percent (250%) of the current federal poverty guideline is required to pay a monthly premium of ten dollars (\$10) to the Department. (3-20-20)T

**c.** A participant who has countable income in excess of two hundred fifty percent (250%) of the current federal poverty guideline is required to pay a monthly premium to the Department. The amount due is the greater of ten dollars (\$10); or seven and one-half percent (7.5%) of the participant's income above two hundred fifty percent (250%) of the current federal poverty guideline. (3-20-20)T

**02. Recomputed Premium Amount.** Premium amounts are recomputed when changes to a participant's countable income result in a different percentage premium calculation as determined in Subsections 215.02 through 215.04 of this rule, and at the annual re-determination. (3-20-20)T

**216. -- 249. (RESERVED)**

**250. DELINQUENT PREMIUM PAYMENTS.**

If the participant is sixty (60) days or more past due on its premium payments, the participant is contacted to determine the reason for the delinquency. If the participant's countable income is less than the amount used for the most recent eligibility determination, the participant is offered a new eligibility determination. If a participant's family income is at a level that does not require premium payments, the premium will no longer be assessed. The change is effective the month after the participant becomes eligible for such benefits. The following Subsections 250.01 through 250.03 of this rule apply to delinquent premium payments. (3-20-20)T

**01. Delinquent Payments.** A participant must not be approved for or renewed for coverage that requires premium payments, if their premium payments are sixty (60) days or more delinquent as of the last working day of their twelve (12) month eligibility period. (3-20-20)T

**02. Reestablishing Eligibility.** A participant can reestablish eligibility by paying the premium debt in full, unless one (1) of the conditions listed in Subsection 250.03 applies. (3-20-20)T

**03. Premium Debt.** Any premium debt assessed, but not paid, will be forgiven if one (1) of the following applies: (3-20-20)T

**a.** The participant reports and the Department determines that the participant's family income is below one hundred and thirty-three percent (133%) FPG. This may occur at any time during the eligibility period; or (3-20-20)T

**b.** A participant in the Medicaid Basic Plan has a medical condition that requires the participant to receive the benefits provided in IDAPA 16.03.10 "Medicaid Enhanced Plan Benefits." (3-20-20)T

**251. -- 299. (RESERVED)**

**300. PARTICIPANTS EXEMPT FROM COPAYMENT.**

**01. Exempt Participants.** Certain participants are exempt from copayments for services described in Section 320.03 through 320.10 of these rules. Exempt participants include: (3-20-20)T

**a.** A child under the age of nineteen (19) with family income less than or equal to one hundred and thirty-three percent (133%) of the current federal poverty guidelines (FPG); (3-20-20)T

**b.** An individual age of nineteen (19) or older with family income less than or equal to one hundred percent (100%) of the current federal poverty guidelines (FPG); (3-20-20)T

- c. A pregnant or post-partum woman when the services provided are related to the pregnancy; (3-20-20)T
- d. An inpatient in a hospital, nursing facility, intermediate care facility for persons with intellectual disabilities (ICF/ID), or other medical institution, who is required to pay all but a nominal amount of their income to the institution for their care; (3-20-20)T
- e. An adult participant who receives services provided under a waiver of Section 1915c of the Social Security Act (SSA); (3-20-20)T
- f. A participant who has other health care coverage that is the primary payor for the services provided; (3-20-20)T
- g. A participant receiving hospice care; (3-20-20)T
- h. A child in foster care receiving aid or assistance under the Social Security Act (SSA), Title IV, Part B; (3-20-20)T
- i. A participant receiving adoption or foster care assistance under the Social Security Act (SSA), Title IV, Part E, regardless of age; and (3-20-20)T
- j. A woman eligible under the breast and cervical cancer eligibility group. (3-20-20)T

**02. Notification of Copayment.** The Department will provide notification to each participant who is not exempt from the copayment requirements in Subsections 320.03 through 320.10 of these rules. (3-20-20)T

**301. -- 309. (RESERVED)**

**310. COPAYMENT FEE AMOUNTS.**

**01. Nominal Amount.** The amount of the copayment must be a nominal amount as provided in 42 CFR 447.54. This nominal amount is set by the U.S. Department of Health and Human Services. (3-20-20)T

**02. Fee Amount.** Beginning on November 1, 2011, the nominal fee amount required to be paid by the participant as a copayment is three dollars and sixty-five cents (\$3.65). This copayment amount will be adjusted annually as determined by the Secretary of Human Services. (3-20-20)T

**03. Annual Increase.** The nominal fee amount will be increased annually by an adjusted percentage rate determined by the Secretary of Health and Human Services as set in the Social Security Act Section 1916. (3-20-20)T

**311. -- 319. (RESERVED)**

**320. MEDICAID OUTPATIENT SERVICES SUBJECT TO COPAYMENTS.**

Medicaid participants are responsible for making copayments for the outpatient services described in Subsections 320.01 through 320.10 of this rule, unless exempted. The amount of the copayment is provided in Section 310 of these rules. (3-20-20)T

**01. Accessing Hospital Emergency Department for Non-Emergency Medical Conditions.** A participant who seeks care at a hospital emergency department for services that do not meet the definition of an emergency medical condition as defined in IDAPA 16.03.09, "Medicaid Basic Plan Benefits," may be required to pay a copayment to the provider. A participant who must access a hospital emergency department in order to receive routine services for their medical condition is exempt from this provision. (3-20-20)T

**02. Accessing Emergency Transportation Services for Non-Emergency Medical Conditions.** A participant who accesses emergency transportation services for a condition that is determined by the Department to be a non-emergency medical condition may be required to pay a copayment to the provider of the service.(3-20-20)T



- 03. Chiropractic Services.** Those services for spinal manipulation performed by a chiropractor. (3-20-20)T
- 04. Occupational Therapy.** (3-20-20)T
- 05. Optometric Services.** Those services performed by an optometrist that fall into the “General Ophthalmological Services” category of Current Procedural Terminology (CPT). (3-20-20)T
- 06. Outpatient Hospital Services.** Any of the services included in Subsections 320.03 through 320.05 and Subsections 320.07 through 320.10 of this rule performed in an outpatient hospital setting. Services performed in a Hospital Emergency Department are excluded, except as provided for in Subsection 320.01 of this rule. (3-20-20)T
- 07. Physical Therapy.** (3-20-20)T
- 08. Podiatry Services.** Services provided by a podiatrist during an office visit. (3-20-20)T
- 09. Physician Office Visit.** Each physician office visit, unless: (3-20-20)T
- a.** The visit is for a preventive wellness exam, immunizations, or family planning: (3-20-20)T
- b.** The visit is for urgent care provided at a clinic billing as an urgent care facility. (3-20-20)T
- 10. Speech Therapy.** (3-20-20)T
- 321. -- 324. (RESERVED)**
- 325. EXCEPTION TO CHARGING A COPAYMENT.**  
In order for a copay to be charged by the provider, the Medicaid payment amount for the services rendered during a visit must be equal to or greater than ten (10) times the amount of the copay described in Section 310 of these rules. The Medicaid payment amount is determined by the Department and published in the Medicaid Fee Schedule. (3-20-20)T
- 326. -- 329. (RESERVED)**
- 330. COLLECTION OF COPAYMENTS.**
- 01. Responsibility for Collection.** The provider of services is responsible for collection of the copayment from the participant. (3-20-20)T
- 02. Denial of Services.** The provider may require payment of an applicable copay prior to rendering services. (3-20-20)T
- 03. Waiver of Copayment.** The provider may choose to waive payment of any copay. The provider must have a written policy describing the criteria for enforcing collection of copayments and when the copay may be waived. (3-20-20)T
- 04. Reduction in Reimbursement.** When a copay is applicable, the provider's reimbursement will be reduced by the amount of the copay regardless of whether or not a copay was charged or collected by the provider. (3-20-20)T
- 331. -- 399. (RESERVED)**
- 400. PARTICIPATION IN THE COST OF HOME AND COMMUNITY-BASED WAIVER SERVICES.**  
Medicaid participants required to participate in the cost of Home and Community-Based Waiver (HCBS) services as described in IDAPA 16.03.10, “Medicaid Enhanced Plan Benefits,” must have their share of cost determined as described in Subsections 400.01 through 400.10 of this rule. (3-20-20)T

**01. Excluded Income.** Income excluded under the provisions of IDAPA 16.03.05, “Rules Governing Eligibility for Aid to the Aged, Blind, and Disabled (AABD),” Sections 723 and 725, is excluded in determining participation. (3-20-20)T

**02. Base Participation.** Base participation is income available for participation after subtracting all allowable deductions, except for the incurred medical expense deduction in Subsection 400.07 of this rule. Base participation is calculated by the participant's Self Reliance Specialist. The incurred medical expense deduction is calculated by the Division of Welfare. (3-20-20)T

**03. Community Spouse.** Except for the elderly or physically disabled participant’s personal needs allowance, base participation for a participant with a community spouse is calculated under IDAPA 16.03.05, “Rules Governing Eligibility for Aid to the Aged, Blind, and Disabled (AABD),” Section 725. A community spouse is the spouse of an HCBS participant who is not an HCBS participant and is not institutionalized. The HCBS personal needs allowance for a participant living in adult residential care equals the federal Supplemental Security Income (SSI) benefit rate for an individual living independently. (3-20-20)T

**04. Home and Community Based Services (HCBS) Spouse.** Except for the elderly or physically disabled participant's personal needs allowance (PNA), base participation for a participant with an HCBS spouse is calculated and specified under IDAPA 16.03.05, “Rules Governing Eligibility for Aid to the Aged, Blind, and Disabled (AABD),” Section 723. An HCBS spouse is the spouse of a participant who also receives HCBS. (3-20-20)T

**05. Personal Needs Allowance.** The participant's personal needs allowance depends on whether the participant has a legal obligation to pay rent or mortgage. The participant's personal needs allowance is deducted from any countable income after income exclusions and before other allowable deductions. To determine the amount of the personal needs allowance, use Table 400.05 of this rule:

<b>TABLE 400.05 - PERSONAL NEEDS ALLOWANCE</b>	
<b>Amount of Personal Needs Allowance (PNA) for Participation</b>	
<b>Not Responsible for Rent or Mortgage</b>	<b>Responsible for Rent or Mortgage</b>
One hundred percent (100%) of the federal SSI benefit for a person with no spouse	One hundred and eighty percent (180%) of the Federal SSI benefit for a person with no spouse

(3-20-20)T

**06. Developmentally Disabled Participants.** These allowances are specified in IDAPA 16.03.05, “Rules Governing Eligibility for Aid to the Aged, Blind, and Disabled (AABD).” The HCBS personal needs allowance for adult participants receiving waiver services under the Developmentally Disabled Waiver is three (3) times the federal SSI benefit amount to an individual in his own home. (3-20-20)T

**07. Incurred Medical Expenses.** Amounts for certain limited medical or remedial services not covered by the Idaho Medicaid Plan and not paid by a third party may be deducted from the base participation amount. The Department must determine whether a participant’s incurred expenses for such limited services meet the criteria for deduction. The participant must report such expenses and provide verification in order for an expense to be considered for deduction. Costs for over-the-counter medications are included in the personal needs allowance and will not be considered a medical expense. Deductions for necessary medical or remedial expenses approved by the Department will be deducted at application, and changed, as necessary, based on changes reported to the Department by the participant. (3-20-20)T

**08. Remainder After Calculation.** Any remainder after the calculation in Subsection 400.05 of this rule is the maximum participation to be deducted from the participant's provider payments to offset the cost of

services. The participation amount will be collected from the participant by the provider. The provider and the participant will be notified by the Department of the amount to be collected. (3-20-20)T

**09. Recalculation of Participation.** The participant's participation amount must be recalculated annually at redetermination or whenever a change in income or deductions becomes known to the Department. (3-20-20)T

**10. Adjustment of Participation Overpayment or Underpayment Amounts.** The participant's participation amount is reduced or increased the month following the month the participant overpaid or underpaid the provider. (3-20-20)T

**401. -- 999. (RESERVED)**

## 16.03.19 – CERTIFIED FAMILY HOMES

### 000. LEGAL AUTHORITY.

The Idaho Board of Health and Welfare is authorized under Sections 56-1005 and 39-3505, Idaho Code, to adopt and enforce rules and standards for Certified Family Homes. The Department is authorized under Sections 56-264 and 56-1007, Idaho Code, to adopt and develop application and certification criteria, and to charge and collect application and certification fees. Under Sections 56-1002, 56-1003, 56-1004, 56-1004A, 56-1005, and 56-1009, Idaho Code, the Department and the Board of Health and Welfare have prescribed powers and duties to provide for the administration and enforcement of Department programs and rules. (3-20-20)T

### 001. TITLE, SCOPE, AND EXCEPTIONS.

- 01. Title.** These rules are titled IDAPA 16.03.19, “Certified Family Homes.” (3-20-20)T
- 02. Scope.** These rules set the minimum standards and administrative requirements for any care provider who is paid to care for an adult living in the care provider’s home, when the adult is elderly or has a developmental disability, mental illness, or physical disability, and needs assistance with activities of daily living. (3-20-20)T
- 03. Exceptions to These Rules.** These rules do not apply to the following: (3-20-20)T
- a.** Any individual who provides only housing, meals, transportation, housekeeping or recreational and social activities. (3-20-20)T
  - b.** Any health facility defined by Title 39, Chapter 13, Idaho Code. (3-20-20)T
  - c.** Any residential care or assisted living facility defined by Title 39, Chapter 33, Idaho Code. (3-20-20)T
  - d.** Any arrangement for care in a relative’s home that is not compensated through a publicly-funded program. (3-20-20)T
  - e.** Any home approved by the Department of Veterans Affairs as a “medical foster home” described in 38 CFR Part 17 and Sections 39-3502 and 39-3512, Idaho Code. Care providers who provide care to both veterans and non-veterans living in a “medical foster home” are not exempt from these rules. (3-20-20)T
- 04. State Certification to Supersede Local Regulation.** These rules will supersede any program of any political subdivision of the state which certifies or sets standards for certified family homes. These rules do not supersede any other local regulations. (3-20-20)T

### 002. INCORPORATION BY REFERENCE.

The Americans with Disabilities Act Accessibility Guidelines, 28 CFR Part 36 - 2010 ADA Standards for Accessible Design, is incorporated by reference. The internet website is [http://www.ada.gov/2010ADASTandards\\_index.htm](http://www.ada.gov/2010ADASTandards_index.htm). (3-20-20)T

### 003. -- 008. (RESERVED)

### 009. CRIMINAL HISTORY AND BACKGROUND CHECK REQUIREMENTS.

- 01. Department Criminal History and Background Check Clearance.** The provider, substitute caregivers, and all adults living in the home are required to complete a Department criminal history and background check and receive a clearance in compliance with IDAPA 16.05.06, “Criminal History and Background Checks.” The resident is exempt from criminal history check requirements. (3-20-20)T
- 02. When Certification Can Be Granted.** Prior to certification being granted: (3-20-20)T
- a.** The provider must have a completed criminal history check, including clearance; and (3-20-20)T
  - b.** Any other adult living in the home must have completed a self-declaration form, be fingerprinted, and not have any designated crimes listed in IDAPA 16.05.06, “Criminal History and Background Checks.” (3-20-20)T
- 03. New Adults in the Home After Certification Is Granted.** A new adult who plans to live in the

home must complete a self-declaration form, be fingerprinted, and not have any designated crimes listed in IDAPA 16.05.06, "Criminal History and Background Checks," before moving into the home. Any adult who is a visitor in the home and leaves within thirty (30) days is not required to have a criminal history check but must not have unsupervised contact with the resident. (3-20-20)T

**04. Minor Child Turns Eighteen.** A minor child turning eighteen (18) and living in the home must complete a self-declaration form, be fingerprinted, and not have disclosed any designated crimes listed in IDAPA 16.05.06, "Criminal History and Background Checks," within thirty (30) days following the month of his eighteenth birthday. (3-20-20)T

**05. Substitute Caregiver.** A substitute caregiver must complete a self-declaration form, be fingerprinted, and not have disclosed any designated crimes listed in IDAPA 16.05.06, "Criminal History and Background Checks," prior to any unsupervised contact with the resident. (3-20-20)T

**06. Additional Criminal Convictions, Pending Investigations, or Charges.** Once criminal history clearances have been received, the provider must report to the Department any additional criminal convictions, pending investigation or charges for himself, any other adult living in the home or a substitute caregiver as described in Section 210 of these rules. (3-20-20)T

**07. Renewal of Clearance.** Any adult who needs to clear a Department criminal history and background check according to these rules must obtain a new clearance from the Department at least every five (5) years. (3-20-20)T

**010. DEFINITIONS AND ABBREVIATIONS -- A THROUGH K.**

For the purposes of these rules, the following definitions apply: (3-20-20)T

**01. Abuse.** A nonaccidental act of sexual, physical, or mental mistreatment or injury of the resident through the action or inaction of another individual. (3-20-20)T

**02. Activities of Daily Living.** The performance of basic self-care activities in meeting an individual's needs to sustain them in a daily living environment, including bathing, washing, dressing, toileting, grooming, eating, communication, mobility, and associated tasks. (3-20-20)T

**03. Adult.** A person who has attained the age of eighteen (18) years. (3-20-20)T

**04. Alternate Caregiver.** A certified family home provider approved by the Department to care for a resident from another certified family home for up to thirty (30) consecutive days when the original provider is temporarily absent or unable to care for the resident. (3-20-20)T

**05. Assessment.** The conclusions reached through evaluation of functional and cognitive ability using uniform criteria that identifies the resident's strengths, weaknesses, risks and needs, and includes functional needs, medical needs and behavioral needs. (3-20-20)T

**06. Certificate.** A permit issued by the Department to operate a certified family home. (3-20-20)T

**07. Certified Family Home.** A home certified by the Department to provide a family-styled living environment and care to one (1) or two (2) adults who are not able to reside in their own home and who require care, help with activities of daily living, help with instrumental activities of daily living, protection and security, supervision, personal assistance or encouragement toward independence. The certified family home is referred to as "the home" in these rules. (3-20-20)T

**08. Certified Family Home Care Provider.** The adult member of the certified family home living in the home who is responsible for providing care to the residents and maintaining the home. The certified family home care provider is referred to as "the provider" in these rules. (3-20-20)T

**09. Certifying Agent.** A person acting under the authority of the Department to participate in the certification, inspection, and regulation of a certified family home. (3-20-20)T

**10. Chemical Restraint.** The use of any medication that results or is intended to result in the modification of behavior for the purposes of discipline or convenience and not required to treat the resident's medical condition or symptoms. (3-20-20)T

**11. Core Issue.** Abuse, neglect, exploitation, inadequate care, inoperable fire detection or extinguishing systems with no fire watch in place pending the correction of the system, and situations in which advocates, representatives, and certifying agents are denied access to records, residents, or the home according to their respective authority. (3-20-20)T

**12. Criminal Offense.** Any crime as defined in Section 18-111, Idaho Code, in 18 U.S.C. Section 4A1.2 (o), and 18 U.S.C. Sections 1001 through 1027. (3-20-20)T

**13. Critical Incident.** Any actual or alleged event or situation that creates a significant risk of substantial or serious harm to the physical or mental health, safety or well being of a resident. (3-20-20)T

**14. Department.** The Idaho Department of Health and Welfare. (3-20-20)T

**15. Director.** The Director of the Idaho Department of Health and Welfare or their designee. (3-20-20)T

**16. Exploitation.** The misuse of a vulnerable adult's funds, property, or resources by another person for profit or advantage. (3-20-20)T

**17. Health Care Professional.** An individual licensed to provide health care within their respective discipline and scope of practice. (3-20-20)T

**18. Immediate Jeopardy.** An immediate or substantial danger to a resident. (3-20-20)T

**19. Inadequate Care.** The provider fails to provide services required to meet the terms of the negotiated plan of service or provide for room, board, activities of daily living, supervision, first aid, assistance and monitoring of medications, emergency intervention, coordination of outside services or a safe living environment, or engages in violations of residents' rights or takes residents who have been admitted in violation of the provisions of Section 39-3507, Idaho Code. (3-20-20)T

**20. Incident.** An actual or alleged minor event or situation that has impacted or has the potential to impact the resident's health or safety, but does not rise to the level of a critical incident. (3-20-20)T

**21. Incidental Supervision.** Supervision provided by an individual approved by the provider to supervise the resident, not to exceed four (4) hours per week. (3-20-20)T

**22. Instrumental Activities of Daily Living.** The performance of secondary level activities that enable a person to live independently in the community, including preparing meals, accessing transportation, shopping, laundry, money management, housework, medication management, using tools and technology, and other associated tasks. (3-20-20)T

**011. DEFINITIONS AND ABBREVIATIONS -- L THROUGH Z.**  
For the purposes of these rules, the following definitions apply: (3-20-20)T

**01. Level of Care.** A categorical assessment of the resident's functional ability in any given activity of daily living, instrumental activity of daily living or self-preservation and the degree of care required in that area to sustain the resident in a daily living environment. (3-20-20)T

**02. Neglect.** The failure to provide food, clothing, shelter or medical care to sustain the life and health of a resident. (3-20-20)T

**03. Negotiated Service Agreement.** The agreement between the resident or their representative, and

the provider based on the resident's assessment, health care professional's orders, admission records, and desires of the resident, that outlines services to be provided and the obligations of the provider and the resident. This agreement is also known as a plan of service. (3-20-20)T

**04. Personal Assistance.** The provision of care to the resident by the provider of one (1) or more of the following services: (3-20-20)T

- a.** Assisting the resident with activities of daily living; (3-20-20)T
- b.** Assisting the resident with instrumental activities of daily living; (3-20-20)T
- c.** Arranging for supportive services; (3-20-20)T
- d.** Being aware of the resident's general whereabouts; and (3-20-20)T
- e.** Monitoring the activities of the resident while on the premises of the home to ensure the resident's health, safety and well-being. (3-20-20)T

**05. Plan of Service.** The generic term used in these rules to refer to the Negotiated Service Agreement, Personal Care Plan, Plan of Care, Individual Support Plan, Support and Spending Plan, or any other comprehensive service plan. (3-20-20)T

**06. PRN (Pro Re Nata).** PRN is an abbreviation meaning "when necessary" used for medication or treatment ordered by a health care professional to an individual allowing the medication or treatment to be given as needed. (3-20-20)T

**07. Relative.** A person related by birth, adoption, or marriage to the third degree, including spouses, parents, children, siblings, grandparents, grandchildren, aunts, uncles, nephews, nieces, great-grandparents, great-grandchildren, great-aunts, great-uncles, and first cousins. (3-20-20)T

**08. Resident.** An adult who lives in a certified family home and who requires personal assistance or supervision. (3-20-20)T

**09. Substitute Caregiver.** An adult designated by the provider to provide care, services and supervision to the resident in the provider's certified family home for up to thirty (30) consecutive days. (3-20-20)T

**10. Supervision.** An administrative activity which provides the following: protection, guidance, knowledge of the resident's whereabouts and monitoring activities. (3-20-20)T

**11. Supportive Services.** The specific services that are provided to the resident in the community and that are required by the plan of service or reasonably requested by the resident. (3-20-20)T

**12. Variance.** A temporary exception not to exceed twelve (12) months issued by the Department to a certified family home allowing noncompliance with a specific standard required under these rules when the provider has shown good cause for such an exception and the variance does not endanger the health and safety of any resident. (3-20-20)T

**13. Vulnerable Adult.** A person eighteen (18) years of age or older who is unable to protect himself from abuse, neglect, or exploitation due to physical or mental impairment that affects the person's judgment or behavior to the extent that they lack sufficient understanding or capacity to make or communicate or implement decisions regarding their person as defined in Section 39-5302(10), Idaho Code. (3-20-20)T

**14. Waiver.** A permanent exception issued by the Department to a certified family home allowing noncompliance with a specific standard required under these rules when the provider has shown good cause for such an exception and the waiver does not endanger the health and safety of any resident. (3-20-20)T

**012. -- 099. (RESERVED)**

**100. CERTIFICATION REQUIREMENTS.**

Certification is required in order to operate a certified family home in the State of Idaho. The Department will issue a certificate to a provider when all certification requirements are met. (3-20-20)T

**01. Certificate Issued in the Name of Provider.** The certificate is issued in the name of the provider applying for certification, and only to the address of the home stated in the application. A new certificate is required if the provider or the location of the certified family home changes. (3-20-20)T

**02. Accessibility to the Home.** The home, physical premises, and all records required under these rules must be accessible at all times to the Department for the purposes of inspection, with or without prior notification. (3-20-20)T

**03. Number of Residents in the Home.** The home cannot be certified for more than two (2) residents. A variance may be granted by the Department as described in Section 140 of these rules. (3-20-20)T

**04. Certification Limitations.** (3-20-20)T

**a.** A home cannot be certified if it also provides room or board to any person who is not a resident or relative of the provider as defined by these rules. A variance may be granted by the Department when the individual receiving room or board is the spouse of the resident and does not require certified family home care or any higher level of care. (3-20-20)T

**b.** A home cannot be certified as a certified family home and a children's foster home at the same time, unless a variance is granted by the Department. (3-20-20)T

**c.** The provider, provider's relatives, and other adults living in the home must not be the legal guardian of the resident unless the provider, provider's relative, or other adult living in the home is a relative of the resident. A variance may be granted by the Department when determined the guardianship is in the best interest of the resident. (3-20-20)T

**d.** The provider may not be absent from the certified family home for more than thirty (30) consecutive days when the home has an admitted resident. Appropriate care and supervision must be provided to the resident in the provider's absence as described in Section 300 of these rules. (3-20-20)T

**e.** The provider's primary residence must be the certified family home. (3-20-20)T

**05. Certification Study Required.** Following receipt of an acceptable application and other required documents, the Department will begin a certification study within thirty (30) days. The certification study, along with the application and other required material, will serve as the basis for issuing or denying a certificate. The study will include the following: (3-20-20)T

**a.** A review of all material submitted; (3-20-20)T

**b.** A home inspection; (3-20-20)T

**c.** An interview with the proposed provider; (3-20-20)T

**d.** An interview with the provider's relatives or other members of the household, when deemed necessary; (3-20-20)T

**e.** A review of the number, age, and sex of children or other adults in the home to evaluate the appropriateness of a placement to meet the needs of the resident; (3-20-20)T

**f.** A medical or psychological examination of the provider or other members of the household, when the Department determines it is necessary, including a statement from a health care professional that the provider has the ability to provide adequate care to the resident and ensure a safe living environment; (3-20-20)T



and g. Proof that the provider or provider's spouse is listed on the deed, mortgage, or lease of the home; (3-20-20)T

h. Other information necessary to verify that the home is in compliance with these rules. (3-20-20)T

**06. Provider Training Requirements.** As a condition of initial certification, the provider must receive training in the following areas: (3-20-20)T

a. Resident rights; (3-20-20)T

b. Certification in first aid and adult Cardio-Pulmonary Resuscitation (CPR) which must be kept current and include hands-on skills training; (3-20-20)T

c. Emergency procedures; (3-20-20)T

d. Fire safety, including use and maintenance of fire extinguishers, smoke alarms, and carbon monoxide alarms; (3-20-20)T

e. Completion of an approved "Assistance with Medications" course available through an Idaho Professional Technical Education Program or other course approved by the Department; and (3-20-20)T

f. Complaint investigation and inspection procedures. (3-20-20)T

**07. Effect of Previous Revocation or Denial of Certificate or License.** The Department is not required to consider the application of any applicant who has had a health care certificate or license denied or revoked until five (5) years have elapsed from the date of denial or revocation according to Section 39-3525, Idaho Code. (3-20-20)T

**101. APPLICATION FOR CERTIFICATION.**

The applicant must apply for certification on forms provided by the Department, pay the application fee, and provide information required by the Department. (3-20-20)T

**01. Completed and Signed Application.** A completed application form signed by the applicant. (3-20-20)T

**02. Statement to Comply.** A written statement that the applicant has thoroughly read and reviewed this chapter and is prepared to comply with all of its provisions. (3-20-20)T

**03. Criminal History and Background Checks.** Satisfactory evidence that the applicant and all adults living in the home are of reputable and responsible character, including criminal history and background checks as provided in Section 009 of these rules. (3-20-20)T

**04. Statement Disclosing Revocation or Disciplinary Actions.** A written statement that discloses any revocation or other disciplinary action taken or in the process of being taken against the applicant as a care provider in Idaho or any other jurisdiction, or a statement from the applicant stating they have never been involved in any such action. (3-20-20)T

**05. Electrical Inspection.** A current statement from a licensed electrician or the local/state electrical inspector that all wiring in the home complies with applicable local code. (3-20-20)T

**06. Environmental Sanitation Inspection.** If the home is not on a municipal water supply or sewage disposal system, a current statement is needed from the local environmental health agency that the water supply and sewage disposal system meet the legal standards. If the local environmental health agency cannot provide this information, the applicant must obtain a statement to that effect. In addition, the applicant must provide a signed statement from a person in the business of servicing these systems that the water supply and sewage disposal system are in good working order. (3-20-20)T

**07. Proof of Insurance.** Proof of homeowner's or renter's insurance on the applicant's home. For continued certification, the provider must ensure that insurance is kept current. (3-20-20)T

**08. List of Individuals Living in the Home.** A list of all individuals living in the home at the time of application and their relationship to the applicant. (3-20-20)T

**09. Payment of Application Fee.** Payment of the application fee required in Section 109 of these rules. (3-20-20)T

**10. Other Information as Requested.** Other information that may be requested by the Department for the proper administration and enforcement of the provisions of these rules. (3-20-20)T

**11. Termination of Application Process.** Failure of the applicant to cooperate with the Department in the application process will result in the termination of the application process. Failure to cooperate means that the information described in Section 101 of these rules is not provided in a timely manner, or not provided in the form requested by the Department, or both. (3-20-20)T

**102. -- 108. (RESERVED)**

**109. APPLICATION AND CERTIFICATION FEES FOR CERTIFIED FAMILY HOMES.**

**01. Application Fee Amount.** An applicant is required to pay to the Department at the time of application a one-time non-refundable application fee of one hundred fifty (\$150) dollars. (3-20-20)T

**02. Payment of Application Fees.** The application fee is required for the following: (3-20-20)T

**a.** Upon application to become a certified family home care provider; (3-20-20)T

**b.** When an application is terminated or the home closes, the applicant must pay the application fee again to reapply for certification; or (3-20-20)T

**c.** When the home will be operated by a new care provider. (3-20-20)T

**03. Certification Fees.** The provider is required to pay to the Department a certification fee of twenty-five (\$25) dollars per month. This amount is billed to the provider quarterly, and is due and payable within thirty (30) days of date of the invoice. (3-20-20)T

**a.** Failure of the provider to pay certification fees when due may cause the Department to take enforcement action described in Section 913 of these rules. (3-20-20)T

**b.** Monthly certification fees paid in advance for the home will be refunded when the provider operates the home for less than fifteen (15) days during any given month for which payment was received by the Department. An advanced payment refund may be paid when the provider voluntarily closes the home as provided in Section 115 of these rules, or involuntarily closes the home due to an enforcement remedy imposed by the Department. (3-20-20)T

**110. ISSUANCE OF CERTIFICATE.**

**01. Certificate.** A certificate is valid for no more than twelve (12) months from the date of approval. The certificate expires at the end of the stated period unless it is continued in effect by the Department as provided in Section 111. of these rules. (3-20-20)T

**a.** The initial certificate requires a scheduled home inspection by a certifying agent. (3-20-20)T

**b.** The certificate is valid only for the location and person named in the application and is not transferable or assignable. (3-20-20)T

- c. The certificate must be available at the home upon request. (3-20-20)T

**02. Temporary Certificate.** A temporary certificate may be issued to allow time for the provider to meet all certification requirements without a lapse in certification when the provider plans to relocate to a residence within the state and plans to continue operation of a certified family home. A temporary certificate is valid for no more than sixty (60) days from the date of approval. (3-20-20)T

a. At least thirty (30) days prior to moving into a new residence, the provider must notify the certifying agent for the region in which the new home will be located. Prior to moving into the new residence, the provider must submit to the certifying agent the following: (3-20-20)T

i. A completed application form as required in Section 101 of these rules. An application fee is not required for only a change of location of the home; (3-20-20)T

ii. An electrical inspection for the new residence as required in Section 101 of these rules; (3-20-20)T

iii. Inspection and approval of any fuel-fired heating system in the new residence as required in Section 600 of these rules; and (3-20-20)T

iv. Other information requested by the Department to ensure the new residence is appropriate for use as a certified family home and safe for occupation. (3-20-20)T

b. The Department will issue a temporary certificate upon review and approval of the information required under Subsection 110.02 of this rule. (3-20-20)T

c. The provider must coordinate with the certifying agent an inspection of the new residence to occur prior to the expiration of the temporary certificate and be prepared to demonstrate compliance with this chapter of rules during the home inspection. (3-20-20)T

d. The Department will issue a certificate as described in Subsection 110.01 of this rule when it determines that the home is in compliance with these rules. (3-20-20)T

**03. Provisional Certificate.** A provisional certificate may be issued to the home as provided in Section 909 of these rules when it is not in substantial compliance with these rules and the deficiencies do not adversely affect the health or safety of the resident and are not likely to continue beyond six (6) months. (3-20-20)T

a. A provisional certificate may be issued for up to six (6) months and is contingent on compliance with the conditions for the provisional certificate and implementation of an approved plan to correct all deficiencies prior to the expiration of the provisional certificate. (3-20-20)T

b. A provisional certificate may be replaced with a certificate when the Department has determined the home is in substantial compliance with these rules prior to the expiration of the provisional certificate. (3-20-20)T

c. A certified family home will not be issued more than one (1) provisional certificate in any twelve (12) month period. (3-20-20)T

**111. RENEWAL OF CERTIFICATE.**

The provider must submit a written request on a form provided by the Department to renew the home's certificate at least thirty (30) days prior to the expiration of the existing certificate. The completed renewal application form and any required documentation must be returned to the regional certifying agent where the home is located. (3-20-20)T

**01. Home Inspection.** A home inspection by a certifying agent is required the year after the initial home certification study and at least every twenty-four (24) months thereafter. The home inspection will consist of the elements of the certification study as required in Section 100 of these rules. (3-20-20)T

**02. Desk Review.** When the Department determines a home inspection is not required to renew the

certificate, the Department may conduct a desk review by written notification to the provider. The provider must submit the renewal application to the certifying agent and copies of the following documentation: (3-20-20)T

- a. Current first aid and adult CPR cards; (3-20-20)T
- b. Furnace, well, and fireplace inspection reports, as applicable; (3-20-20)T
- c. Septic system inspection or pumping report, as applicable, when the previous inspection is older than five (5) years; (3-20-20)T
- d. Annual fire extinguisher inspection reports, or sales receipts for fire extinguishers that comply with Section 600 of these rules that are less than twelve (12) months old; (3-20-20)T
- e. Log of smoke and carbon monoxide alarm tests, fire extinguisher examinations, emergency plan reviews, and fire drill and evacuation summaries; (3-20-20)T
- f. Training logs; (3-20-20)T
- g. List of individuals currently living in the home and individuals who moved in and out of the home during the year; (3-20-20)T
- h. Proof that the provider or provider's spouse is listed on the deed, mortgage, or lease of the home; (3-20-20)T
- i. Proof of homeowner's or renter's insurance; (3-20-20)T
- j. Request for a waiver, variance, or renewal of a variance that meets the requirements in Sections 120 through 140 of these rules as applicable; and (3-20-20)T
- k. Other information as requested by the Department. (3-20-20)T

**03. Validity of Existing Certificate.** The existing certificate, unless suspended or revoked, remains valid until the Department has acted on the renewal application when the application and supporting documentation is filed in a timely manner with the certifying agent. (3-20-20)T

**112. CHANGE OF PROVIDER OR LOCATION.**

**01. Change of Provider.** Certificates are not transferable or assignable from one (1) individual to another. The home must be certified using the same procedure as a new home that has never been certified when a change of care provider occurs. (3-20-20)T

**02. Change of Location.** Certificates are not transferable or assignable from one (1) location to another. When a change of location occurs, the provider's new home must be: (3-20-20)T

- a. Certified using the same procedure as required in Section 100 of these rules for a new home that has never been certified; or (3-20-20)T
- b. Temporarily certified by the procedure described in Section 110 of these rules. (3-20-20)T

**113. DENIAL OF APPLICATION FOR CERTIFICATE.**

The Department may deny the application for issuance of a certificate when conditions exist that endanger the health, safety, or welfare of any resident or when the home or provider is not in compliance with these rules. (3-20-20)T

**01. Additional Causes For Denial.** Additional causes for denial of an application for a certificate include the following: (3-20-20)T

- a. The applicant or provider has willfully misrepresented or omitted information on the application or

other documents pertinent to obtaining a certificate; (3-20-20)T

**b.** The applicant or provider has been convicted of fraud, gross negligence, abuse, assault, battery or exploitation; (3-20-20)T

**c.** The applicant or provider has been convicted of a criminal offense within the past five (5) years, other than a minor traffic violation or similar minor offense; (3-20-20)T

**d.** The applicant or provider has been denied or has had revoked any child care (including foster home) or health facility license, residential care or assisted living facility license, or certified family home certificate; (3-20-20)T

**e.** The applicant or provider has been found to have operated a health facility, residential care or assisted living facility, or certified family home without a license or certificate; (3-20-20)T

**f.** A court has ordered that the applicant or provider must not operate a health facility, residential care or assisted living facility, or certified family home; (3-20-20)T

**g.** The applicant or provider is listed on the statewide Child Abuse Registry, Adult Protection Registry, Sexual Offender Registry, or Medicaid exclusion lists; or (3-20-20)T

**h.** The applicant or provider is directly under the control or influence of any person who is described in Subsection 113.01 of this rule. (3-20-20)T

**02. Notice of Denial.** Immediately upon denial of any application for a certificate, the Department will notify the applicant or provider in writing by certified mail or by personal service of its decision, including the reason(s) for the Department's decision and how to appeal the decision. (3-20-20)T

#### **114. FAMILY HOME OPERATING WITHOUT A CERTIFICATE.**

**01. Operating Without Certificate.** A person found to be operating a family home without first obtaining a certificate may be referred for criminal prosecution. (3-20-20)T

**02. Placement or Transfer of Resident.** Upon discovery of a family home operating without a certificate, the Department may transfer residents to the appropriate placements or refer to the local adult protective services agency when: (3-20-20)T

**a.** There is an immediate threat to any resident's health and safety; or (3-20-20)T

**b.** The individual operating the home does not cooperate with the Department to apply for certification, meet certification standards and obtain a valid certificate. (3-20-20)T

#### **115. VOLUNTARY CLOSURE OF THE HOME.**

When choosing to voluntarily close the home, the provider must provide written notice to the certifying agent in the region where the home is located. The notification must include the following: (3-20-20)T

**01. Date of Notification.** (3-20-20)T

**02. Provider's Certificate.** A copy of the certificate, or information from the certificate that includes: (3-20-20)T

**a.** Provider's name; (3-20-20)T

**b.** Address of the home; and (3-20-20)T

**c.** Certificate number. (3-20-20)T

**03. Closure Date.** The written notice must include the planned closure date. The Department will not refund or prorate prepaid certification fees on retroactive closures. (3-20-20)T

**04. Discharge Plans.** If applicable, discharge plans for current residents must accompany the written notice. (3-20-20)T

**116. REQUIRED ONGOING TRAINING.**

The provider must document a minimum of eight (8) hours per year of ongoing, relevant training in the provision of supervision, services, and care. (3-20-20)T

**01. Initial Provider Training.** The initial provider training required in Section 100 of these rules satisfies the eight (8) hour training requirement for the first year of certification. (3-20-20)T

**02. Type of Training.** (3-20-20)T

**a.** Interactive training means the provider is able to ask questions of a live instructor and receive answers in real time. The instructor must be a professional or a recognized authority in their subject matter. At least half of the required ongoing training hours each year must consist of interactive training. (3-20-20)T

**b.** Independent study means any training not provided by a live instructor. The remaining required training hours may be independent study through books, articles, videos, online courses, and other resources. (3-20-20)T

**03. Content of Training.** (3-20-20)T

**a.** Resident specific. At least half of the required ongoing training hours each year must be devoted to the specific conditions, diagnoses and needs of admitted residents, when residents are admitted. (3-20-20)T

**b.** General topics. The remaining hours may be devoted to other topics related to care giving, health or safety. Up to two (2) hours of first aid or adult CPR training will count toward the annual requirement. (3-20-20)T

**04. Documentation of Training.** The provider must document ongoing training. The documentation must include: (3-20-20)T

**a.** Topic of the training with a brief description; (3-20-20)T

**b.** Source of training, including the name of the instructor or author; (3-20-20)T

**c.** Number of hours; (3-20-20)T

**d.** Type and content of training: (3-20-20)T

**i.** Interactive or independent; and (3-20-20)T

**ii.** Resident specific or general. (3-20-20)T

**117. -- 119. (RESERVED)**

**120. WAIVERS.**

The Department may grant permanent waivers. The decision to grant a waiver for a home or provider is not a precedent or applicable to any other home or provider and has no force of effect in any other proceeding. (3-20-20)T

**01. Written Request.** The provider must submit a written request for a waiver to the regional certifying agent where the home is located prior to any planned noncompliance with any rule under this chapter. The appropriateness of granting a waiver is determined by the Department. The request must include the following: (3-20-20)T

- a. Reference to the section of the rules for which the waiver is requested; (3-20-20)T
- b. Reasons that show good cause for granting the waiver, including any extenuating circumstances and any compensating factors or conditions that may have bearing on the waiver, such as additional floor space or additional staffing; and (3-20-20)T
- c. A signed statement from the provider that assures the resident's health and safety will not be jeopardized if the waiver is granted. The statement must include an agreement to implement any special conditions the Department requires. (3-20-20)T

**02. Special Conditions.** When granting a waiver, the Department may require the provider to meet special conditions while the waiver is in effect to ensure the health and safety of residents. (3-20-20)T

**03. Waiver Not Transferable.** A waiver granted under Section 120 of this rule is not transferable to any other provider, home, or resident. (3-20-20)T

**121. GENERAL VARIANCES.**

The Department may grant temporary variances that may be effective for up to twelve (12) months at a time. The decision to grant a variance for a home or provider is not a precedent or applicable to any other home or provider and has no force of effect in any other proceeding. (3-20-20)T

**01. Written Request.** The provider must submit a written request for a variance to the regional certifying agent where the home is located prior to any planned noncompliance with any rule under this chapter. The appropriateness of granting a variance is determined by the Department. The request must include the following: (3-20-20)T

- a. Reference to the section of the rules for which the variance is requested; (3-20-20)T
- b. Reasons that show good cause for granting the variance, including any extenuating circumstances and any compensating factors or conditions that may have bearing on the variance, such as additional floor space or additional staffing; and (3-20-20)T
- c. A signed statement from the provider that assures resident health and safety will not be jeopardized if the variance is granted, including an agreement to implement any special conditions the Department may require. (3-20-20)T

**02. Special Conditions.** When granting a variance, the Department may require the provider to meet special conditions while the variance is in effect to ensure the health and safety of residents. (3-20-20)T

**03. Variance Renewal.** To renew a variance, the provider must submit a written request to the regional certifying agent where the home is located at least thirty (30) days prior to expiration of the variance. The request for renewal must include the information required in Subsection 121.01 of this rule. The appropriateness of renewing a variance is determined by the Department. (3-20-20)T

**04. Variance Not Transferable.** A variance granted under Section 121 of this rule is not transferable to any other provider, home, or resident. (3-20-20)T

**122. REVOKING A WAIVER OR VARIANCE.**

The Department may revoke a waiver or variance. (3-20-20)T

- 01. Causes for Revocation.** Revocation of a waiver or variance may occur when: (3-20-20)T
  - a. The provider has not met the special conditions associated with granting the exception; (3-20-20)T
  - b. Conditions within the home have changed such that an exception is no longer prudent; or (3-20-20)T

c. The health and safety of residents have otherwise been compromised. (3-20-20)T

**02. Written Notice.** The Department will provide written notice to the provider when a waiver or variance is revoked, including the reason for the revocation. (3-20-20)T

**03. Time Frame to Comply.** The provider must comply with the rule for which the waiver or variance is revoked according to the following time frames: (3-20-20)T

a. Immediately upon notification, when there is a threat to the life or safety of residents; or (3-20-20)T

b. Within thirty (30) days of notification, when there is no threat to the life or safety of residents. (3-20-20)T

**123. -- 129. (RESERVED)**

**130. NURSING FACILITY LEVEL OF CARE VARIANCE.**

A certified family home may care for one (1) resident who requires nursing facility level of care as defined in Section 39-1301(b), Idaho Code, without obtaining a variance. A home seeking to provide care to two (2) residents who require nursing facility level of care must request a variance in writing from the Department as required in Section 121 of these rules. (3-20-20)T

**01. Conditions for a Variance.** The Department may issue a written variance permitting the arrangement when: (3-20-20)T

a. Each of the residents provides a written statement to the Department requesting the arrangement; (3-20-20)T

b. Each of the residents making the request is competent, informed, and has not been coerced; (3-20-20)T

c. The Department finds the arrangement safe and effective. (3-20-20)T

**02. Revoking a Variance.** The Department will revoke the variance when: (3-20-20)T

a. There is a threat to the life or safety of either resident; (3-20-20)T

b. One (1) of the residents leaves the home permanently; (3-20-20)T

c. One (1) of the residents notifies the Department in writing that they do not wish to live in the home with the other resident; or (3-20-20)T

d. The Department finds the arrangement is no longer safe and effective. (3-20-20)T

**03. Variance Not Transferable.** A variance granted under Subsection 130.01 of this rule is not transferable to any other provider, home, or resident. (3-20-20)T

**131. -- 139. (RESERVED)**

**140. VARIANCE TO THE TWO RESIDENT LIMIT.**

**01. Application for Variance.** The provider may apply on forms provided by the Department for a variance to the two (2) resident limit in order to care for three (3) or four (4) residents on a per resident basis prior to any new admissions. The application must be submitted to the certifying agent where the home is located. The appropriateness of granting the variance is determined by the Department. (3-20-20)T

**02. Criteria for Determination.** The Department will determine if safe and appropriate care can be



provided based on residents' needs. The Department will consider, at a minimum, the following factors in making its determination: (3-20-20)T

- a. Each current or prospective resident's physical, mental and behavioral status and history; (3-20-20)T
- b. The household composition including the number of adults, children and other family members requiring care from the provider; (3-20-20)T
- c. The training, education, and experience of the provider to meet each resident's needs; (3-20-20)T
- d. Potential barriers that might limit egress from and ingress to the home; (3-20-20)T
- e. The number and qualifications of care givers in the home; (3-20-20)T
- f. The desires of the prospective and current residents; (3-20-20)T
- g. The individual and collective hours of care needed by the residents; (3-20-20)T
- h. The physical layout of the home and the square footage available to meet the needs of all persons living in the home; and (3-20-20)T
- i. If a variance to the two (2) resident limit would result in two (2) or more residents who require nursing facility level of care living in the home, then the application for the variance must also include the information required in Section 130 of these rules. (3-20-20)T

**03. Other Employment.** A provider who is granted a variance to admit three (3) or four (4) residents must not have other gainful employment outside the home unless: (3-20-20)T

- a. The total direct care time for all residents as reflected by their plans of service and assessments or, if not indicated by these documents for a publicly-funded program, the time that the program bases its payment, does not exceed eight (8) hours per day; (3-20-20)T
- b. The provider is immediately available to meet resident needs as they arise; and (3-20-20)T
- c. Each resident is supervised at all times unless the assessment or plan of service indicates the resident may be left unattended for designated periods of time. (3-20-20)T

**04. Additional Training.** A provider who is granted a variance to admit three (3) or four (4) residents must obtain additional training to meet the needs of the residents as follows: (3-20-20)T

- a. A provider who cares for three (3) residents must obtain twelve (12) hours per year of ongoing relevant training as required in Section 116 of these rules. (3-20-20)T
- b. A provider who cares for four (4) residents must obtain sixteen (16) hours per year of ongoing relevant training as required in Section 116 of these rules. (3-20-20)T

**05. Variance Nontransferable.** A variance to care for more than two (2) residents is not transferable to another provider, home, or resident. (3-20-20)T

**06. Reassessment of Variance.** A variance to care for more than two (2) residents must be reassessed at least annually and when either of the following occurs: (3-20-20)T

- a. Each time a new admission is considered; or (3-20-20)T
- b. When there is a significant change in any of the factors specified in Subsection 140.02 of this rule. (3-20-20)T

**07. Annual Home Inspection.** A certified family home with a variance to care for more than two (2) residents must have a home inspection by a certifying agent at least annually. (3-20-20)T

**08. Shared Sleeping Rooms.** In addition to the requirements in Section 700 of these rules, the provider must not allow more than two (2) residents to share any one (1) sleeping room. (3-20-20)T

**09. Fire Drill Frequency.** A provider who is granted a variance to admit three (3) or four (4) residents must conduct fire drills as described in Section 600 of these rules, except the frequency of the fire drills must be at least monthly. (3-20-20)T

**141. -- 149. (RESERVED)**

**150. INSPECTIONS OF HOMES.**

The Department will inspect each certified family home at least every twenty-four (24) months, calculated from the first month of the most recent certification. Inspections may occur more frequently as the Department deems necessary. The Department may consider the results of previous inspections, history of compliance with rules, and complaints to determine the frequency of inspections. (3-20-20)T

**01. Notice of Inspection.** All inspections, except for the initial certification study, may be made unannounced and without prior notice. (3-20-20)T

**02. Inspection by Department or Certifying Agent.** The Department may use the services of any qualified person or organization, either public or private, to examine and inspect any home requesting certification. The inspector has the authority to have full access to the home and the authority to: (3-20-20)T

**a.** Examine quality of care and service delivery; (3-20-20)T

**b.** Examine home records, resident records, and any records or documents pertaining to any financial transactions between residents and the home, including resident accounts; (3-20-20)T

**c.** Examine the physical premises, including the condition of the home, grounds and equipment, food service, water supply, sanitation, maintenance, and housekeeping practices; (3-20-20)T

**d.** Examine any other areas necessary to determine compliance with these rules and standards; (3-20-20)T

**e.** Interview the provider, any adults living in the home, the resident and the resident's relatives, substitute caregivers, persons who provide incidental supervision, and any other person who is familiar with the home or its operation. Interviews with residents are confidential and conducted privately unless otherwise specified by the resident; and (3-20-20)T

**f.** Inspect the entire home, including the personal living quarters of members of the household, to check for inappropriate storage of combustibles, faulty wiring, or other conditions that may have a direct impact on the operation of the home. The provider, substitute caregiver, or any other adult living in the home may accompany the inspector. (3-20-20)T

**03. Statement of Deficiencies.** When violations of these rules are identified through the course of an investigation or inspection, depending on the severity, the Department may send a statement of deficiencies to the provider within thirty (30) days of the completed inspection or investigation. The statement of deficiencies will include the findings of the investigation or inspection and any rules the home was found to have violated. (3-20-20)T

**04. Plan of Correction.** When a statement of deficiencies is issued, the provider must develop a plan of correction and submit it to the Department for review and approval. (3-20-20)T

**a.** Depending on the severity of the deficiency, the provider may be given up to fourteen (14) calendar days to develop a written plan of correction and to return the plan of correction to the regional certifying agent where

the home is located. (3-20-20)T

- b.** An acceptable plan of correction must include: (3-20-20)T
  - i.** How each deficiency identified in the statement of deficiencies was corrected or how it will be corrected; (3-20-20)T
  - ii.** What steps have been taken to assure that the deficiency does not recur; (3-20-20)T
  - iii.** Acceptable time frames for correction of the deficiency; and (3-20-20)T
  - iv.** Signature of the provider. (3-20-20)T
- c.** Follow-up inspections may be conducted to determine whether corrections to deficiencies are being made according to the Department approved plan of correction. (3-20-20)T
- d.** The Department may provide consulting services to the provider, upon request, to assist in identifying and correcting deficiencies and upgrading the quality of care in the home. (3-20-20)T

**05. List of Deficiencies.** A current list of deficiencies, including plans of correction, are available to the public upon request at the home or by written request to the Department according to Section 006 of these rules. (3-20-20)T

**151. -- 159. (RESERVED)**

**160. COMPLAINT PROCEDURE.**

Any person who believes that any rule in this chapter has been violated by a certified family home may file a complaint with the Department. (3-20-20)T

**01. Investigation.** (3-20-20)T

**a.** The Department will investigate any complaint alleging a violation of these rules. Any complaint involving abuse, neglect, or exploitation of a vulnerable adult will also be referred to adult protective services according to Section 39-5303, Idaho Code. (3-20-20)T

**b.** The Department will investigate or cause to be investigated any reported critical incident affecting health and safety or change in a resident's condition, including the death of a resident, that indicates there was a violation of these rules. (3-20-20)T

**02. Investigation Method.** The nature of the complaint will determine the method used to investigate the complaint. On-site investigations at the home can be unannounced and without prior notice. (3-20-20)T

**03. Written Report.** Following completion of an investigation, the Department will provide a written report to the provider within thirty (30) days. The report will include the findings of the investigation. (3-20-20)T

**04. Statement of Deficiencies.** When violations of these rules are identified through the course of an investigation, depending on the severity, the Department may send the home a statement of deficiencies as described in Section 150 of these rules. When the Department issues a statement of deficiencies, the provider must prepare and submit a plan of correction as described in Section 150 of these rules. (3-20-20)T

**05. Public Disclosure.** Information received by the Department through filed reports, inspections, or as otherwise authorized under the law, must not be disclosed publicly in such a manner as to identify individual residents except in a proceeding involving a question of certification. (3-20-20)T

**161. -- 169. (RESERVED)**

**170. MINIMUM STANDARDS OF CARE.**

The provider must adequately care for each resident as follows: (3-20-20)T

**01. Plan of Service.** Provide the services required to meet the terms of the resident's plan of service as described in Section 250 of these rules, including development and implementation of the plan of service for private-pay residents and implementation of the plan of service for publicly-funded residents. (3-20-20)T

**02. Supervision.** Provide appropriate and adequate supervision for twenty-four (24) hours each day according to the resident's plan of service. (3-20-20)T

**03. Daily Living Activities.** Provide assistance to the resident at the level of care indicated on the resident's plan of service in the areas of activities of daily living and instrumental activities of daily living. (3-20-20)T

**04. Medication Management.** Provide assistance and monitoring of medications as described in Sections 400 through 402 of these rules, as applicable. (3-20-20)T

**05. Emergency Services.** Provide immediate and appropriate interventions on behalf of the resident in response to an emergency, including the following: (3-20-20)T

**a.** Developing plans in advance of an emergency as described in Section 600 of these rules and executing those plans when necessary; (3-20-20)T

**b.** Evacuating the resident from the home; (3-20-20)T

**c.** Providing first aid to the resident when seriously injured; (3-20-20)T

**d.** Administering CPR to the resident unless the resident has an order not to resuscitate; (3-20-20)T

**e.** Arranging for emergency transportation; and (3-20-20)T

**f.** Contacting 9-1-1 for involvement of law enforcement officers or the fire department when necessary for the protection of the resident. (3-20-20)T

**06. Supportive Services.** Coordinate paid services for the resident outside the home, including: (3-20-20)T

**a.** Medical appointments; (3-20-20)T

**b.** Dental appointments; (3-20-20)T

**c.** Other services in the community as identified in the plan of service or reasonably requested by the resident; and (3-20-20)T

**d.** Arrange transportation to the service location and return to the home. (3-20-20)T

**07. Resident Rights.** Protect the resident's rights as listed in Section 200 of these rules. (3-20-20)T

**08. Safe Living Environment.** Provide a physical living environment that complies with Sections 500 through 710 of these rules. (3-20-20)T

**171. -- 173. (RESERVED)**

**174. ACTIVITIES AND COMMUNITY INTEGRATION.**

Section 39-3501, Idaho Code, requires that a certified family home provide a homelike, family-styled living environment with a focus on integrated community living. The provider must offer the following: (3-20-20)T

**01. Activities.** Recreational activities, provisions for trips to social functions, and daily activities.

(3-20-20)T

- 02. Activity Supplies.** Activity supplies in reasonable amounts, that reflect the interests of the resident. (3-20-20)T

**03. Transportation.** Arrangement of transportation to and from community, recreational, and religious activities within twenty-five (25) miles of the home when requested by the resident at least twenty-four (24) hours in advance. (3-20-20)T

**175. ROOM, UTILITIES AND MEALS.**

The home must provide room, utilities and three (3) daily meals to the resident. The charge for room, utilities and three (3) daily meals must be established in the admission agreement. The following are included in the charge for room, utilities and meals: (3-20-20)T

**01. Sleeping Room.** The resident sleeping room must meet the requirements of Section 700 of these rules, must be equipped with a dresser, and when requested by the resident a chair, that are both substantially constructed and in good repair. (3-20-20)T

**02. Bed.** The resident must be provided with their own bed that is at least thirty-six (36) inches wide, substantially constructed, and in good repair. Roll-away type beds, cots, folding beds, or double bunks must not be used. The bed must have box springs kept in good repair, a clean and comfortable mattress, bedspread, sheets and pillow cases, and pillow that are standard for the size of the bed. (3-20-20)T

**03. Monitoring or Communication System.** A monitoring or communication system must be provided when necessary due to the size or design of the home or the needs of the resident. The provider must hold a written agreement with the resident or resident's representative prior to using a monitoring system that may violate the resident's right to privacy. (3-20-20)T

**04. Secure Storage.** On request, each sleeping room must be equipped with a lockable storage cabinet or drawer for personal items for each resident, in addition to the required storage in resident sleeping rooms. (3-20-20)T

**05. Bathroom.** Access to bathing and toilet facilities that meet the requirements of Section 700 of these rules. (3-20-20)T

**06. Common Areas.** Access to a common living area that contains reading lamps, tables, comfortable chairs or sofas, and basic television. The resident must be allowed to eat with the other members of the household if they so choose. (3-20-20)T

**07. Supplies.** Bath and hand towels; wash cloths; a reasonable supply of soap, shampoo, toilet paper, and facial tissue; and first aid supplies. (3-20-20)T

**08. Housekeeping Service.** Housekeeping and maintenance as required in Section 500 of these rules, including laundering of linens and clothing. (3-20-20)T

**09. Water.** Potable water that meets the requirements of Section 500 of these rules. (3-20-20)T

**10. Sewer.** A sewage disposal system that meets the requirements of Section 500 of these rules. (3-20-20)T

**11. Trash.** Disposal of garbage that meets the requirement of Section 500 of these rules. (3-20-20)T

**12. Heating and Cooling.** Sufficient heating and cooling to meet the requirements of Section 700 of these rules. (3-20-20)T

**13. Electricity.** Sufficient electricity to power common household and personal devices. (3-20-20)T

- 14. Telephone.** Access to a telephone that meets the requirements of Section 700 of these rules. (3-20-20)T
- 15. Meals.** The provider must offer breakfast, lunch, and dinner to the resident. (3-20-20)T
- a.** Food must be prepared in safe and sanitary methods that conserve nutritional value, flavor and appearance, when prepared by the provider or other member of the household. (3-20-20)T
- b.** Meals offered by the home must meet the dietary requirements or restrictions of the resident when so ordered by a health care professional. (3-20-20)T
- 176. -- 179. (RESERVED)**
- 180. HOURLY ADULT CARE.**  
Hourly adult care, also referred to as adult day health, is a supervised, structured, paid service that may be provided in the home for up to fourteen (14) hours in any twenty-four (24) hour period to adult participants who are not residents of the home. Hourly adult care encompasses health and social services, recreation, supervision, and assistance with activities of daily living needed to ensure the optimal functioning of the participant. The standards in this section do not apply if the service does not include a payment component to the provider, or the hourly adult care participant is a relative of the provider whose care is not publicly funded. Hourly adult care may be offered in the home when the following requirements are met: (3-20-20)T
- 01. Participants.** No individual will be admitted to the home for hourly adult care who requires ongoing skilled nursing care or for whom the provider cannot adequately provide services and supervision. (3-20-20)T
- 02. Records.** All records of services delivered by the provider must be maintained in the home for at least five (5) years from the date of service. (3-20-20)T
- 03. Enrollment Contract.** The provider maintains an enrollment contract with each hourly adult care participant that contains the following: (3-20-20)T
- a.** Full name of the participant; (3-20-20)T
- b.** The participant's date of birth; (3-20-20)T
- c.** Primary address of the participant; (3-20-20)T
- d.** Names and telephone numbers of the participant's responsible party and other emergency contacts; (3-20-20)T
- e.** Name and telephone number of the participant's primary physician; (3-20-20)T
- f.** List of medications, diets, allergies, services, and treatments prescribed for the participant and other pertinent health information regarding the participant's needs; (3-20-20)T
- g.** Services the provider must provide to the participant while in the home, which may include: activities, meals, supervision, assistance with medications, and assistance with activities of daily living, and the level of care required for each service; (3-20-20)T
- h.** The rate charged by the provider for hourly adult care services if the participant is private pay; (3-20-20)T
- i.** The number of days the provider will give written notice to the participant's primary contact in advance of terminating the enrollment contract; (3-20-20)T
- j.** The date on which hourly adult day services will commence; and (3-20-20)T

**k.** The printed name, signature, and contact information of the individual who completed the enrollment contract and the provider's printed name, signature, and contact information. Upon entering into the contract, a copy of the enrollment information must be provided to each party. (3-20-20)T

**04. Service Logs.** Service logs that identify, on a per day basis when hourly adult care services are provided in the home, the name of each participant who received services, the times of arrival to and departure from the home for each participant, and the names of staff who provided services and their arrival and departure times. (3-20-20)T

**05. Space and Accommodations.** The provider must only accept hourly adult care participants for whom the home can provide reasonable accommodations. The home must provide the following for hourly adult care participants: (3-20-20)T

**a.** Seating on cushioned chairs or sofas positioned at least thirty-two (32) inches apart in common living areas such that all residents and participants in the home may comfortably enjoy the space; (3-20-20)T

**b.** A rest area away from the common living areas to permit privacy and to isolate participants who become ill or require rest and is equipped with furniture for napping, such as a bed, lounge chair, couch, or recliner; (3-20-20)T

**c.** Access to a bathroom that meets the requirements of Section 700 of these rules; and (3-20-20)T

**d.** When caring for participants with physical or sensory impairments, a physical environment that meets the requirements of Section 700 of these rules, as applicable. (3-20-20)T

**06. Resident's Personal Space.** The personal living space of the resident, including their sleeping room and on-suite bathroom, if equipped, must not be used by hourly adult care participants at any time. (3-20-20)T

**07. Staffing.** The provider must only accept hourly adult care participants for whom they can safely provide the level and types of service required. The provider must ensure that all staff providing hourly adult care services have been sufficiently trained in and follow universal infection control precautions and each participant's specific care plan as documented in the enrollment contract. In addition: (3-20-20)T

**a.** Each caregiver providing hourly adult care services must meet the qualifications of a substitute caregiver as described under Section 300 of these rules. (3-20-20)T

**b.** The provider must employ sufficient staff to assure safe and proper care for both residents and hourly adult care participants. Staffing must be based on: (3-20-20)T

**i.** The functional and cognitive status of each hourly adult care participant and resident; (3-20-20)T

**ii.** The size and layout of the home; and (3-20-20)T

**iii.** Staffing ratios must not fall below one (1) caregiver to four (4) residents and hourly adult care participants, combined. (3-20-20)T

**08. Medications.** Assistance with medications to hourly adult care participants must meet the requirements in Sections 400 through 402 of these rules. (3-20-20)T

**a.** The provider is responsible for safeguarding the participant's medications while the participant is receiving services at the home. (3-20-20)T

**b.** The participant's medications must not be stored at the home during hours in which the participant is not receiving hourly adult care services at the home. (3-20-20)T

**09. Fire and Life Safety.** The provider must ensure the home adheres to fire and life safety standards

described in Section 600 of these rules. For fire and life safety purposes, the hourly adult care participant is considered a “resident” when that term is used in Section 600 of these rules. When offering hourly adult care, the provider must: (3-20-20)T

- a. Prohibit smoking or unsupervised smoking in accordance with Section 600 of these rules. (3-20-20)T
- b. Review emergency preparedness plans as required under Section 600 of these rules with the individual who completed the enrollment contract and provide a written copy of the plans to that individual. (3-20-20)T
- c. Conduct fire drills as required in Section 600 of these rules, except that the frequency of the drills must be at least monthly. (3-20-20)T

**181. -- 199. (RESERVED)**

**200. RESIDENT RIGHTS POLICY.**

The provider must possess, annually review, and implement a written policy designed to protect and promote the rights of each resident as provided in this section. The written resident rights policy must include a statement that the resident or any other individual may file a complaint with the Department as described in Section 160 of these rules, when they believe that any resident’s right has been violated. Resident rights policies must include the following: (3-20-20)T

**01. Privacy.** Each resident must be assured the right to privacy with regard to accommodations, medical and other treatment, written and telephone communications, visits and meetings of family and resident groups, including: (3-20-20)T

a. The right to send and receive mail unopened, either by postal service, electronically, or by other means, unless the resident's plan of service specifically calls for the provider to monitor the correspondence in order to protect the resident from abuse or exploitation; (3-20-20)T

b. If the resident is married, privacy for visits by their spouse. If both are residents in the home, they are permitted to share a room unless medically inadvisable, as documented by the resident's health care professional; (3-20-20)T

c. The right to control the use of pictures and videos containing the resident’s image. (3-20-20)T

**02. Humane Care.** Each resident has the right to humane care and a humane environment, including the following: (3-20-20)T

a. The right to a diet which is consistent with any religious or health-related restrictions; (3-20-20)T

b. The right to refuse a restricted diet; (3-20-20)T

c. The right to a safe and sanitary living environment; and (3-20-20)T

d. The right to an environment free of illicit drug use or possession and other criminal activities. (3-20-20)T

**03. Respectful Treatment.** Each resident has the right to be treated with dignity and respect, including: (3-20-20)T

a. The right to be treated in a courteous manner by the provider and other individuals in the home; (3-20-20)T

b. The right to receive a response from the provider to any request of the resident within a reasonable



- time; (3-20-20)T
- c.** Freedom from discrimination on the basis of race, color, national origin, sex, religion, age, disability, or veteran status; (3-20-20)T
  - d.** Freedom from intimidation, manipulation, and coercion; (3-20-20)T
  - e.** The right to wear their own clothing; and (3-20-20)T
  - f.** The right to determine their own dress and hair style. (3-20-20)T
- 04. Basic Needs Allowance.** Each resident whose care is paid for by publicly-funded assistance must retain, for their personal use, the difference between their total monthly income and the Certified Family Home allowance established by IDAPA 16.03.05. "Eligibility for Aid to the Aged, Blind, and Disabled," Section 513. (3-20-20)T
- 05. Resident Funds and Property.** Each resident has the right to manage their personal funds and use their personal property. (3-20-20)T
- a.** The provider must not require the resident to deposit their personal funds into an account controlled by any other person. (3-20-20)T
  - b.** Upon accepting written authorization from the resident, or the resident's representative, allowing the provider, provider's relative, or other member of the provider's household to manage the resident's personal funds, the provider must hold, safeguard, and account for the resident's personal funds as required in Section 275 of these rules. (3-20-20)T
  - c.** The resident has the right to retain and use their own personal property in their own living area in order to maintain their individuality and personal dignity. The storage and use of these items by the resident must not present a fire or life safety hazard. (3-20-20)T
- 06. Access to Resident.** Each provider and individuals living in the home must permit immediate access to any resident by any representative of the Department, by the state ombudsman for the elderly or their designee, by an adult protection investigator or by the resident's personal health care professional. Each home must also permit the following: (3-20-20)T
- a.** Immediate access to a resident by their relatives, subject to the resident's right to deny or withdraw consent at any time; (3-20-20)T
  - b.** Immediate access to a resident by others who are visiting with the consent of the resident, subject to reasonable restrictions and the resident's right to deny or withdraw consent at any time; (3-20-20)T
  - c.** Reasonable access to a resident by any entity or individual that provides health, social, legal, or other services to the resident, subject to the resident's right to deny or withdraw consent at any time; and (3-20-20)T
  - d.** Reasonable access to the resident's records, medications and treatments by the resident's health care professional subject to the resident's permission. (3-20-20)T
- 07. Freedom From Harm.** The resident has the right to be free from: (3-20-20)T
- a.** Physical, mental, or sexual abuse; (3-20-20)T
  - b.** Neglect; (3-20-20)T
  - c.** Exploitation; (3-20-20)T
  - d.** Corporal punishment; (3-20-20)T

- e. Involuntary seclusion; and (3-20-20)T
- f. Any physical or chemical restraints imposed for purposes of discipline or convenience and not required to treat a medical condition. (3-20-20)T
- 08. Health Services.** The resident has the right to control their health-related services, including: (3-20-20)T
  - a. The right to retain the services of their own personal physician and dentist; (3-20-20)T
  - b. The right to select the pharmacy or pharmacist of their choice; (3-20-20)T
  - c. The right to confidentiality and privacy concerning their medical or dental condition and treatment; (3-20-20)T
  - d. The right to participate in the formulation of their plan of service; (3-20-20)T
  - e. The right to decline treatment for any medical condition; and (3-20-20)T
  - f. When the resident is unable to give medical consent, the provider will give the name and contact information of the person holding guardianship or power of attorney for health care to any health care provider upon request. (3-20-20)T
- 09. Grievance.** (3-20-20)T
  - a. The resident has the right to voice or file a grievance with respect to care or service that is or fails to be furnished, without discrimination or reprisal for voicing the grievance and the right to prompt efforts by the provider to resolve grievances the resident may have, including those with respect to the behavior of other residents. (3-20-20)T
  - b. The provider must provide a written response to the resident or resident's representative describing how they resolved or attempted to resolve the grievance, and maintain a copy of this written response in the resident record. (3-20-20)T
- 10. Advance Notice.** The resident must receive written advance notice at least thirty (30) calendar days prior to their non-emergency transfer or discharge unless the transfer or discharge is for a reason described in Section 260, including the following: (3-20-20)T
  - a. The resident is transferred or discharged only for medical reasons; (3-20-20)T
  - b. To protect their welfare or the welfare of other members of the household; (3-20-20)T
  - c. Nonpayment for their stay; (3-20-20)T
  - d. The resident violates any condition mutually established between the resident and the provider at the time of admission; or (3-20-20)T
  - e. The resident engages in unlawful delivery, production, or use of a controlled substance on the premises of the home. (3-20-20)T
- 11. Other Rights.** In addition to the rights outlined in Subsections 200.01 through 200.10 of this rule, the resident has the following rights: (3-20-20)T
  - a. The resident has the right to refuse to perform services for the home except as contracted between the resident and the provider. The provider agrees to pay the resident for such services, and the provider pays the resident a wage consistent with state and federal law; (3-20-20)T

- b.** The resident must have access to their personal records, including those described in Section 270 of these rules, and must have the right to confidentiality of personal, medical, and clinical records; (3-20-20)T
- c.** The resident has the right to practice the religion of their choice or to abstain from religious practice. Residents must also be free from the imposition of the religious practices of others; (3-20-20)T
- d.** The resident has the right to participate in social, religious, and community activities that do not interfere with the rights of other residents in the home; (3-20-20)T
- e.** The resident has the right to examine, upon reasonable request, the results of the most recent inspection of the home conducted by the Department with respect to the home and any plan of correction in effect with respect to the home; (3-20-20)T
- f.** The resident has the right to review a list of other certified family homes that may be available to meet their needs in case of transfer; (3-20-20)T
- g.** The resident has the right to refuse routine care of a personal nature from any person whom the resident is uncomfortable receiving such care; (3-20-20)T
- h.** The resident has the right to be informed, in writing, regarding the formulation of advance directives as described in Title 39, Chapter 45, Idaho Code; and (3-20-20)T
- i.** The resident must have any other right established by law. (3-20-20)T

**201. NOTICE OF RESIDENT RIGHTS.**

- 01. Resident Rights Notice.** The provider must inform the resident or their representative, verbally and in writing, at the time of admission to the home, of their legal rights during the stay at the home acknowledged by date and signatures. These rights are found in Section 200 of these rules. The provider must supply a copy of the resident rights policy to the resident or the resident's representative. (3-20-20)T
- 02. Annual Review of Resident Rights.** The provider must review the resident rights policy with the resident or their representative at least annually including date and signature. (3-20-20)T
- 03. Documentation of Review.** The provider must retain the signed and dated copy of the policy in the resident's record indicating that the resident or resident's representative has had the opportunity to review the policy. (3-20-20)T

**202. ACCESS BY ADVOCATES AND REPRESENTATIVES.**

The provider, substitute caregivers and adult members of the household must permit advocates and representatives of community and legal services programs, whose purposes include rendering assistance without charge to residents, to have access to the home at reasonable times. Advocates and representatives may observe all common areas of the home. Access must be permitted in order for advocates and representatives to provide the following: (3-20-20)T

- 01. Inform Residents of Services.** Visit, talk with and make personal, social and legal services available to all residents. (3-20-20)T
- 02. Inform Residents of Rights.** Inform residents of their rights and entitlements, their corresponding obligations under state, federal, and local laws by distribution of educational materials or discussion in groups and with individuals. (3-20-20)T
- 03. Assist Residents to Secure Rights.** Assist residents in asserting their legal rights regarding claims for public assistance, medical assistance, and social security benefits, as well as in other matters in which residents are aggrieved. This assistance may be provided individually or in a group basis, and may include organizational activity, counseling, and litigation. (3-20-20)T

**04. Advise and Represent.** Engage in other methods of assisting, advising, and representing residents so as to extend to them the full enjoyment of their rights. (3-20-20)T

**05. Communicate Privately.** Communicate privately and without restrictions with any resident who consents to the communication. (3-20-20)T

**203. -- 209. (RESERVED)**

**210. REPORTING REQUIREMENTS.**

The provider must report to the regional certifying agent where the home is located or appropriate agency or individual for the following: (3-20-20)T

**01. Serious Physical Injury or Death.** The provider must report to the appropriate law enforcement agency within four (4) hours when there is reasonable cause to believe that abuse, neglect, or sexual assault has resulted in death or serious physical injury jeopardizing the life, health, or safety of a resident according to Sections 39-5303 and 39-5310, Idaho Code. (3-20-20)T

**02. Abuse, Neglect, or Exploitation.** When the provider has reasonable cause to believe that a vulnerable adult is being or has been abused, neglected, or exploited, they must immediately report this information to the Idaho Commission on Aging or its Area Agencies on Aging, according to Section 39-5303, Idaho Code. (3-20-20)T

**03. Critical Incidents.** The provider must notify the certifying agent when a critical incident affects the health or safety of the resident or leads to a change in the resident's condition, including serious illness, accident, elopement, death, or adult protective services or law enforcement contact and investigation. Reporting requirements are as follows: (3-20-20)T

a. Within twenty-four (24) hours of the resident's death or disappearance; and (3-20-20)T

b. Within three (3) business days following: (3-20-20)T

i. Contact from adult protective services or law enforcement in conjunction with an investigation; (3-20-20)T

ii. A visit to an urgent care clinic or emergency room; or (3-20-20)T

iii. Admission to a hospital. (3-20-20)T

**04. Report of Fire.** A separate report on each fire incident occurring within the home, for which a fire extinguisher was discharged or 9-1-1 was contacted, must be submitted to the certifying agent within three (3) business days of the occurrence. The report must include: (3-20-20)T

a. Date of the incident; (3-20-20)T

b. Origin of the fire; (3-20-20)T

c. Extent of damage; (3-20-20)T

d. How and by whom the fire was extinguished; and (3-20-20)T

e. Injuries or deaths, if any. (3-20-20)T

**05. Additional Criminal Convictions.** The provider must immediately report any additional criminal convictions for himself, any other adult living in the home or a substitute caregiver to the certifying agent. (3-20-20)T

**06. Notice of Investigations.** The provider must immediately report to the certifying agent when they,

any other adult living in the home, or a substitute caregiver is charged with or under investigation by law enforcement, adult protection services, or child protection services for: (3-20-20)T

- a. Abuse, neglect, or exploitation of any vulnerable adult or child; (3-20-20)T
- b. Other criminal conduct; or (3-20-20)T
- c. When an adult protection or child protection complaint is substantiated. (3-20-20)T

**07. Reporting of Funds Managed by the Provider for a Deceased Resident.** For funds managed under Section 275 of these rules, the following is required: (3-20-20)T

- a. On the death of a private-pay resident, the provider must convey the resident's funds, with a final accounting of those funds, to the individual administering the resident's estate within thirty (30) days. (3-20-20)T
- b. On the death of a publicly funded resident, the provider must convey the resident's funds, with a final accounting of those funds, to the Department within thirty (30) days. (3-20-20)T

**08. Discharge of a Resident.** The provider must immediately notify the certifying agent upon the discharge of any resident from the home. (3-20-20)T

**211. -- 224. (RESERVED)**

**225. UNIFORM ASSESSMENT REQUIREMENTS.**

**01. State Responsibility for Publicly Funded Residents.** The Department will assess residents accessing services through a publicly funded program according to uniform criteria developed to assess all participants within that respective program. Assessment criteria may vary from one program to another, but must be uniform within the same program. (3-20-20)T

**02. Provider Responsibility for Private-Pay Residents.** The provider will develop, identify, assess, or direct a uniform needs assessment of each private-pay resident. The uniform needs assessment: (3-20-20)T

- a. Must be completed no later than fourteen (14) calendar days after admission; (3-20-20)T
- b. Must be reviewed when there is a change in condition, or every twelve (12) months, whichever occurs first; (3-20-20)T
- c. Must include: (3-20-20)T
  - i. Identification and background information; (3-20-20)T
  - ii. Medical diagnosis; (3-20-20)T
  - iii. Medical and health needs; (3-20-20)T
  - iv. Prescriptions, including route of administration, and all over-the-counter medications, supplements, treatments, and special diets, if applicable; (3-20-20)T
  - v. Historical and current behavior patterns; (3-20-20)T
  - vi. Cognitive function; (3-20-20)T
  - vii. Psychosocial and physical needs of the resident; (3-20-20)T
  - viii. Functional status; (3-20-20)T

- ix. Assessed level of care; and (3-20-20)T
- x. A statement from the resident's health care professional indicating the resident is appropriate for certified family home care. (3-20-20)T
- d. May be the Department's Uniform Assessment Instrument (UAI) as described in IDAPA 16.03.23, "Uniform Assessments for State-Funded Clients," for a private-pay resident's uniform needs assessment. Upon request by the provider, the Department will provide training in conducting uniform needs assessments. (3-20-20)T

**03. Results of Assessment.** The results of the assessment for both publicly funded and private-pay residents are used to evaluate the ability of the provider to meet the identified resident's needs. The results of the assessment may also be used to determine the need for special training or licenses or certificates that may be required to care for certain residents. (3-20-20)T

**226. -- 249. (RESERVED)**

**250. PLAN OF SERVICE.**

The resident must have a plan of service. The plan must identify the resident, describe the services to be provided, and describe how the services will be delivered. (3-20-20)T

**01. Core Elements.** A resident's plan of service must be based on the orders of the resident's health care professionals, and: (3-20-20)T

- a. Assessment; (3-20-20)T
- b. Service needs for activities of daily living; (3-20-20)T
- c. Need for limited nursing services; (3-20-20)T
- d. Need for medication assistance; (3-20-20)T
- e. Frequency of needed services; (3-20-20)T
- f. Level of care; (3-20-20)T
- g. Habilitation and training needs; (3-20-20)T
- h. Behavioral management needs, including identification of situations that trigger inappropriate behavior; (3-20-20)T
- i. Dated history and physical from the resident's health care professional reflecting the resident's current health status and conducted no earlier than twelve (12) months prior to admission; (3-20-20)T
- j. Admission records; (3-20-20)T
- k. Community supportive services; (3-20-20)T
- l. Resident's desires; (3-20-20)T
- m. Resident's need for supervision, including the degree; (3-20-20)T
- n. Transfer and discharge requirement; and (3-20-20)T
- o. Other identified needs. (3-20-20)T

**02. Signature and Approval.** The provider and the resident or the resident's representative must sign and date the plan of service upon its completion, within fourteen (14) days after the resident's admission. (3-20-20)T

**03. Developing the Plan.** The provider will consult the resident and other individuals identified by the resident in developing the plan of service. Professional staff must be involved in developing the plan if required by another program. (3-20-20)T

**04. Resident Choice.** A resident must be given the choice and control of how and what services the provider or external vendors will provide to the extent the resident can make choices. (3-20-20)T

**05. Copy of the Plan.** Signed copies of the plan of service must be placed in the resident's file, given to the resident, and given to their representative, if applicable, no later than fourteen (14) days after admission. For a resident receiving services through a publicly-funded program, the copy of the plan must indicate that it has been approved by the Department. (3-20-20)T

**06. Changes to the Plan.** A record must be made of any changes to the plan or when the provider is unable to provide services outlined in the plan of service. When changes to the plan are made, the resident or resident's representative and the provider must sign and date the changes. (3-20-20)T

**07. Periodic Review.** The next scheduled date of review must be documented in the plan of service. The plan of service should be reviewed as necessary but must be reviewed at least every twelve (12) months. (3-20-20)T

**251. – 259. (RESERVED)**

**260. ADMISSIONS.**

According to Section 39-3507, Idaho Code, the provider must only admit or retain residents in the home for whom they have the training, appropriate skills, and time to provide adequate care. The provider must be able to provide the levels of service or types of service required for each resident admitted to the home. (3-20-20)T

**01. Prior Approval Required.** The provider must obtain approval from the Department for each admission prior to the prospective resident moving into the home. The following must be provided to the regional certifying agent where the home is located to aid the Department in making its determination: (3-20-20)T

- a.** Name, gender and date of birth of the prospective resident; (3-20-20)T
- b.** The contemplated date of admittance of the prospective resident into the home; (3-20-20)T
- c.** The prospective resident's history and physical from their health care professional, conducted within the previous twelve (12) month period reflecting their current health status; (3-20-20)T
- d.** A list of the resident's current medications and treatments from their health care professional; (3-20-20)T
- e.** Contact information for the resident's health care professionals; (3-20-20)T
- f.** Contact information for the prospective resident's representative, if applicable; (3-20-20)T
- g.** The resident's plan of service from another health care setting, or any such plan of service conducted for the resident within the previous six (6) months, if one exists, when the resident transfers to the home from another health care setting; and (3-20-20)T
- h.** Other information requested by the Department relevant to the appropriateness of the admission and the provider's ability to provide adequate care. (3-20-20)T

**02. Notification.** Within five (5) business days of receipt of the documents listed in Subsection 260.01 of this rule, the Department will notify the provider verbally or in writing whether the proposed admission is approved or denied. When verbal notification is given, the Department will provide follow-up written communication to the provider stating the approval or denial within ten (10) business days. (3-20-20)T

**03. Emergency Admission.** The provider may not accept an emergency admission without prior approval from the Department except under the following conditions: (3-20-20)T

**a.** The provider may make a conditional admission when they reasonably believe they have the ability to provide adequate care to the resident when the request for an emergency placement occurs after normal business hours and the provider is unable to contact the Department for prior approval. The provider must notify the resident or their representative that the admission is conditional upon Department approval. (3-20-20)T

**b.** The provider must notify the regional certifying agent where the home is located the next business day after making a conditional admission. (3-20-20)T

**c.** The provider must follow the regular admission process described in Subsection 260.01 of this rule within two (2) business days of making a conditional admission. The Department may deny the placement and require the resident to transfer when there is reasonable cause to believe the provider lacks the ability to provide adequate care. (3-20-20)T

**04. Admission Agreement.** At the time of admission to a certified family home, the provider and the resident or resident's representative, if applicable, must enter into an admission agreement. The agreement must be in writing and must be signed and dated by both parties. The agreement must, in itself or by reference to the resident's plan of service, include at least the following: (3-20-20)T

**a.** Whether or not the resident will assume responsibility for their own medication; (3-20-20)T

**b.** The provider must have a plan in place for steps the provider will take if the resident is not able to carry out their own self-preservation. (3-20-20)T

**c.** Whether or not the provider will accept responsibility for the resident's funds; (3-20-20)T

**d.** How a partial month's refund will be managed; (3-20-20)T

**e.** Responsibility for valuables belonging to the resident and provision for the return of a resident's valuables should the resident leave the home; (3-20-20)T

**f.** Amount of liability coverage provided by the homeowner's or renter's insurance policy and whether the insurance policy covers the resident's personal belongings; (3-20-20)T

**g.** Written notice of at least thirty (30) calendar days as agreed to in the admission agreement prior to discharge on the part of either party or transfer, when the transfer is not for medical reasons or for the resident's welfare or the welfare of others, or when the discharge is not for a situation described in Subsection 260.05.b. of this rule; (3-20-20)T

**h.** Conditions under which an emergency temporary placement will be made as described under Subsection 260.06 of this rule; (3-20-20)T

**i.** Signed permission to provide pertinent information from the resident's record to a hospital, nursing home, residential and assisted living facility, or other certified family home; (3-20-20)T

**j.** Responsibility to obtain consent for medical procedures including the name, address, and telephone number of the guardian or power of attorney for health care for any resident who is unable to make their own medical decisions; (3-20-20)T

**k.** Resident responsibilities as appropriate; (3-20-20)T

**l.** Amount the provider will charge the resident for room, utilities and three (3) daily meals on a monthly basis, and if the resident is private-pay or has a share of cost, a separately listed amount the provider will charge for care on a monthly basis; (3-20-20)T



**m.** Written notice of at least fifteen (15) calendar days as agreed to in the admission agreement prior to the provider changing the charges to the resident as described in Subsection 260.04.l. of this rule; (3-20-20)T

**n.** Protections that address eviction processes and appeals comparable to those provided under Idaho landlord tenant law. The admission agreement must either: (3-20-20)T

**i.** Adopt the eviction and appeal processes as described in Title 6, Chapter 3, Idaho Code; or (3-20-20)T

**ii.** Adopt the eviction and appeal processes as described in the version of the admission agreement provided by the Department; and (3-20-20)T

**o.** Additional conditions as agreed upon by both parties but consistent with the requirements of these rules. (3-20-20)T

**05. Termination of Admission Agreement.** The admission agreement must only be terminated under the following conditions: (3-20-20)T

**a.** The provider or the resident, or the resident's representative, if applicable, provides the other party at least thirty (30) calendar days' written notice as agreed to in the admission agreement; or (3-20-20)T

**b.** A three (3) day written notice may be given by the provider to the resident or the resident's representative, if applicable, when any of the following occur, subject to the appeal process required under Subsection 260.04.n. of this rule: (3-20-20)T

**i.** Nonpayment of the resident's bill identified in Subsection 260.04.l. of this rule; (3-20-20)T

**ii.** The resident violates written conditions as mutually established between the resident and the provider at the time of admission; or (3-20-20)T

**iii.** The resident engages in the unlawful delivery, production, or use of a controlled substance on the premises of the home. (3-20-20)T

**06. Emergency Temporary Placement.** The admission agreement will remain in force and effect, excluding the provider's responsibility for care and the charge to the resident for such care as identified in Subsection 260.04.l. of this rule, while the resident is temporarily transferred from the home to another care setting on an emergency basis unless either party terminates the agreement as described in Subsection 260.05 of this rule. An emergency temporary placement must only occur when: (3-20-20)T

**a.** The resident's mental or physical condition deteriorates to a level requiring evaluation or services that cannot be met by the provider or reasonably accommodated by the home; or (3-20-20)T

**b.** Emergency conditions requiring the resident to transfer out of the home without thirty (30) calendar days' written notice to protect the resident or other residents, the provider, or other individuals living in the home from harm. (3-20-20)T

**07. Discharge Procedure.** The provider must immediately notify the Department upon the transfer or discharge of the resident according to Section 210 these rules. (3-20-20)T

**08. Return of Resident's Possessions.** The provider must document the return of the resident's personal possessions to the resident or resident's representative as agreed in the admission agreement according to Subsection 260.04.e. of this rule: (3-20-20)T

**a.** Return immediately upon discharge: (3-20-20)T

**i.** All personal funds belonging to the resident; and (3-20-20)T

- ii. Any medication, supplement, or treatment belonging to the resident; (3-20-20)T
- b.** Return within three (3) business days; (3-20-20)T
- i. If the provider, their relative, or any other member of the household was managing the resident's funds, a copy of the final accounting of the resident's funds; (3-20-20)T
- ii. All resident belongings as indicated on their belongings inventory; and (3-20-20)T
- iii. Any other items belonging solely to the resident, including personal documents. (3-20-20)T

**261. -- 269. (RESERVED)**

**270. RESIDENT RECORDS.**

The provider must maintain records for each resident admitted to the home as provided in this rule. (3-20-20)T

**01. Admission Records.** Records required for admission to the home must be maintained, updated, and kept confidential. The availability of the records without the consent of the resident, subject to IDAPA 16.05.01, "Use and Disclosure of Department Records," is limited to the resident and resident's representative, the provider, substitute caregivers, the resident's health care professionals, and representatives of the Department including certifying agents. All entries must be accurate and reflect updated information as changes occur, recorded legibly in ink, signed and dated, and must include: (3-20-20)T

- a.** The resident's full legal name; (3-20-20)T
- b.** The resident's permanent address if other than the home; (3-20-20)T
- c.** The resident's marital status and sex; (3-20-20)T
- d.** The resident's place and date of birth; (3-20-20)T
- e.** The name, address, and telephone number of an individual identified by the resident or the resident's representative who should be contacted in the event of an emergency or death of the resident; (3-20-20)T
- f.** The resident's personal health care professionals; (3-20-20)T
- g.** Admission date and name of the person who completed the admission form; (3-20-20)T
- h.** Results of a history and physical examination performed by a health care professional reflecting the resident's current health status and conducted no earlier than twelve (12) months prior to admission; (3-20-20)T
- i.** A list of medications, treatments, and special diets, if any, prescribed for the resident and signed and dated by their health care professional; (3-20-20)T
- j.** Religious affiliation if the resident so chooses to disclose; (3-20-20)T
- k.** Social information, obtained by the provider from the resident or resident's relatives, service coordinator, legal guardian or conservator, or other knowledgeable individuals to include the resident's social history, hobbies, and interests; (3-20-20)T
- l.** The written admission agreement as described in Section 260 of these rules; (3-20-20)T
- m.** A signed copy of the resident rights policy as described in Section 200 of these rules; (3-20-20)T
- n.** A copy of the resident's assessment as described in Section 225 of these rules; (3-20-20)T

- o.** A copy of the resident's signed and dated plan of service as described in Section 250 of these rules; (3-20-20)T
- p.** An inventory of the resident's belongings that may consist of photographs or a written descriptive list. The resident or the resident's representative may inventory any personal possession they so choose and expect returned upon the resident's transfer or discharge from the home. The belongings inventory may be updated at any time but must be updated at least annually; (3-20-20)T
- q.** Information about any specific health problems of the resident that may be useful in a medical emergency; (3-20-20)T
- r.** Any other health-related, emergency, or pertinent information that the resident requests the provider to keep on record; (3-20-20)T
- s.** If the resident has a representative, a copy of the document giving the representative legal authority to act on behalf of the resident, including guardianship or power of attorney for healthcare decisions; (3-20-20)T
- t.** Contact name, address, and telephone number of any individual or agency providing supportive services to the resident; and (3-20-20)T
- u.** Signed copy of any care plan that is prepared for the resident by an outside service provider. (3-20-20)T
- 02. Ongoing Resident Records.** Records must be kept by the provider for services to the resident showing accurate and updated information as services are rendered, including: (3-20-20)T

  - a.** Any incident or accident occurring while the resident is living in the home and the provider's response. If the incident or accident occurs while the resident is receiving supportive services, the provider must obtain a written report of the event from the service provider; (3-20-20)T
  - b.** The provider's written response to any grievance as described in Section 200 of these rules; (3-20-20)T
  - c.** Notes from the licensed nurse, home health agency, physical therapist, or any other service providers, documenting the services provided to the resident at each visit to the home; (3-20-20)T
  - d.** Documentation of significant changes in the resident's physical or mental status, and the provider's response; (3-20-20)T
  - e.** When the provider, a relative of the provider, or an individual living in the home other than the resident manages the resident's funds, financial accounting records for such funds as described in Section 275 of these rules; and (3-20-20)T
  - f.** Medication records as required in Sections 400 through 402 of these rules, as applicable. (3-20-20)T
- 03. Maintenance of Resident Records.** All records of services delivered by the provider must be maintained in the home for at least five (5) years from the date of service. (3-20-20)T

**271. -- 274. (RESERVED)**

**275. RESIDENT FUNDS AND FINANCIAL RECORDS.**

- 01. Resident Funds Policy.** Each provider must possess and implement a policy and procedure outlining how the resident's funds will be managed. This policy and procedure must include the following: (3-20-20)T

- a. Statement of whether the provider will or will not manage resident funds. (3-20-20)T
  - b. When the resident leaves the home under any circumstances, the provider must: (3-20-20)T
    - i. Only retain room and board funds prorated to the last day of the notice period as specified in the admission agreement, or upon the resident moving from the home, whichever is later; (3-20-20)T
    - ii. Immediately return all remaining resident funds to the resident or to the resident's representative as specified in the admission agreement according to Section 260 of these rules; and (3-20-20)T
    - iii. Only use the resident's funds for that resident's expenses until a new payee is appointed. (3-20-20)T
  - c. Prohibit personal loans to the resident from the provider, provider's relatives, and other members of the household unless the loan is from a relative of the resident. When such a loan is made, the provider must: (3-20-20)T
    - i. Ensure the terms of the loan are described in a written contract signed by the resident or resident's representative; (3-20-20)T
    - ii. Maintain a copy of the loan contract in the resident's record; and (3-20-20)T
    - iii. Immediately update documentation of repayments towards the loan. (3-20-20)T
- 02. Managing Resident Funds.** When the resident's funds are turned over to the provider for any purpose other than payment for services allowed under these rules, or if the provider, their relative, or an individual living in the home acts as the resident's payee, the provider is deemed to be managing the resident's funds. The provider who manages a resident's funds must: (3-20-20)T
- a. Establish a separate account at a financial institution for each resident to which use of the resident's funds may be reconciled by means of a financial statement; (3-20-20)T
  - b. Prohibit commingling of the resident's funds with the funds of any other person, including borrowing funds from the resident; (3-20-20)T
  - c. Upon request, notify the resident or the resident's representative the amount of the resident's funds in their account that are available for their use; (3-20-20)T
  - d. Charge the resident the amount agreed upon in the admission agreement as described in Section 260 of these rules for their certified family home services on a monthly basis from their funds; (3-20-20)T
  - e. Maintain accounting documentation, including financial statements, receipts and ledgers, for all financial transactions in excess of five dollars (\$5) in which the resident's funds were used. A separate transaction record must be maintained for each resident; (3-20-20)T
  - f. Restore funds to the resident if the provider cannot produce proper accounting records of resident's funds or property, including receipts for purchases made using the resident's personal funds. Restitution of the funds to the resident is a condition for continued operation of the home; (3-20-20)T
  - g. Not require the resident to purchase goods or services from or for the home other than those designated in Section 260 of these rules; (3-20-20)T
  - h. Provide the resident, their legal guardian, their representative with financial power of attorney, and conservator access to the resident's funds; (3-20-20)T
  - i. On the death of a private-pay resident, convey the resident's funds with a final accounting of those funds to the individual administering the resident's estate; within thirty (30) days as described in Section 210 of these

rules; (3-20-20)T

j. On the death of a publicly-funded resident, convey the resident's funds, with a final accounting of those funds, to the Department within thirty (30) days as described in Section 210 of these rules. (3-20-20)T

**276. -- 299. (RESERVED)**

**300. SHORT-TERM CARE AND SUPERVISION.**

When the provider is temporarily unavailable to provide care or supervision to the resident, they may designate another adult to provide care and supervision, or only supervision to the resident. The provider must assure that this short-term arrangement meets the needs of the resident and protects the resident from harm. (3-20-20)T

**01. Alternate Caregiver.** An alternate caregiver must be a certified family home provider. An alternate caregiver provides care and supervision in their home to a resident from another certified family home according to the resident's original plan of service and admission agreement. The following applies to an alternate care placement: (3-20-20)T

a. The Department must approve an alternate care placement using the process described in Section 260 of these rules. The alternate caregiver must: (3-20-20)T

i. Not exceed the number of residents for which their home is certified to provide care; (3-20-20)T

ii. Comply with Section 140 of these rules when the resident receiving alternate care will be the third or fourth resident in the alternate caregiver's home; (3-20-20)T

iii. Comply with Section 130 of these rules when the resident receiving alternate care requires nursing facility level of care and any other resident in the alternate caregiver's home requires nursing facility level of care. (3-20-20)T

b. Upon approval from the Department, alternate care may be provided for up to thirty (30) consecutive days; and (3-20-20)T

c. The provider must provide or arrange for resident-specific training to the alternate caregiver, including supplying copies of the resident's current assessment, plan of service, and admission agreement. (3-20-20)T

**02. Substitute Caregiver.** A substitute caregiver must be an adult designated by the provider to provide care and supervision to the resident in the provider's certified family home. The following apply to the designation of a substitute caregiver: (3-20-20)T

a. The provider is responsible to provide or arrange for resident-specific training for the substitute caregiver including reviewing copies of each resident's current assessment, plan of service, and admission agreement; (3-20-20)T

b. Staffing levels in the home must be maintained at the same level as when the provider is available to provide care and supervision; (3-20-20)T

c. Substitute care can be provided for up to thirty (30) consecutive days; and (3-20-20)T

d. The substitute caregiver must have the following qualifications: (3-20-20)T

i. Current certification in first aid and adult Cardio-Pulmonary Resuscitation (CPR) that meets the standards under Section 100 of these rules; (3-20-20)T

ii. A criminal history check as provided in Section 009 of these rules; and (3-20-20)T

iii. Completion of the "Assistance with Medications" course or other Department-approved training as

provided in Section 100 of these rules. (3-20-20)T

**03. Incidental Supervision.** An individual providing incidental supervision must be approved by the provider to supervise the resident. Incidental supervision must not include resident care. Incidental supervision may be provided for up to four (4) hours per week. (3-20-20)T

**301. -- 399. (RESERVED)**

**400. MEDICATION POLICY.**

The provider must possess and implement written medication policies and procedures that outline in detail how the home will assure appropriate assistance with and handling of and safeguarding of medications. These policies and procedures must be maintained in the home, and include the following: (3-20-20)T

**01. Following Orders.** Assistance given by the provider must only be as directed by the resident's health care professionals. (3-20-20)T

**02. Evidence of Orders.** Evidence of each resident's orders must be maintained in the home, regardless of whether the resident is able to self-administer, and may consist of the following: (3-20-20)T

**a.** Written instructions from the health care professional for the medication including the dosage, expected effects, potential adverse reactions or side effects, and actions to take in an emergency; (3-20-20)T

**b.** Medisets filled and appropriately labeled by a pharmacist or licensed nurse with the name of the medications, dosage, time to be taken, route of administration, and any special instructions; (3-20-20)T

**c.** An original prescription bottle labeled by a pharmacist describing the order and instructions for use; and (3-20-20)T

**d.** If the medication, supplement, or treatment is without a prescription, it will be listed among over-the-counter medications approved by the resident's health care professional as indicated by a signed statement. Over-the-counter medications will be given as directed on the packaging. (3-20-20)T

**03. Alteration of Orders.** The provider must not alter dosage, discontinue or add medications, including over-the-counter medications and supplements, or discontinue, alter, or add treatments or special diets without first consulting the resident's prescribing health care professional and obtaining an order for the change as required under Subsection 400.02 of this rule. (3-20-20)T

**04. Allergies.** The provider must list any known food or drug allergies for each resident and take precautions to guard against the resident ingesting such allergens. (3-20-20)T

**05. Training.** Each adult assisting with resident medications must have successfully completed the "Assistance with Medications" course, or other Department-approved training as described in Section 100 of these rules. Additionally: (3-20-20)T

**a.** Each resident's orders must be reviewed by each staff person assisting residents with medications prior to offering assistance; and (3-20-20)T

**b.** Written instructions must be in place that outline who to notify if any of the following occur: (3-20-20)T

**i.** Doses are not taken; (3-20-20)T

**ii.** Overdoses occur; or (3-20-20)T

**iii.** Side effects are observed. (3-20-20)T

**c.** The provider must ensure any staff assisting with medications has reviewed each resident's known

allergies and takes precautions against the resident ingesting such allergens. (3-20-20)T

**06. Self-administration.** When the provider cares for a resident who self-administers their own medications, the provider must follow the standards described under Section 401 of these rules. (3-20-20)T

**07. Assistance with Medication.** When the provider cares for a resident who needs assistance with medications, the provider must follow the standards described under Section 402 of these rules. (3-20-20)T

**401. SELF-ADMINISTRATION OF MEDICATION.**

If the resident is responsible for administering their own medication without assistance, the provider must ensure the following: (3-20-20)T

**01. Approval.** The provider must obtain written approval stating that the resident is capable of self-administration from the resident's health care professional; otherwise, the provider must comply with the standards in Section 402 of these rules. (3-20-20)T

**02. Evaluation.** The resident's record must include documentation that the resident's health care professional has evaluated the resident's ability to safely self-administer medication. The evaluation must include verification of the following: (3-20-20)T

**a.** The resident understands the purpose of each medication; (3-20-20)T

**b.** The resident is oriented to time and place and knows the appropriate dosage and times to take the medication; (3-20-20)T

**c.** The resident understands the expected effects, adverse reactions, or side effects, and knows what actions to take in case of an emergency; and (3-20-20)T

**d.** The resident is able to take the medication without assistance or reminders. (3-20-20)T

**03. Change in Condition.** Should the condition of the resident change such that it brings into question their ability to safely continue self-administration of medications, the provider must have a reevaluation and approval of the resident to self-administer as required in Subsections 401.01 and 401.02 of this rule. (3-20-20)T

**04. Safeguarding Medication.** The provider must ensure that the medications of a resident who self-administers are safeguarded, including providing a lockable storage cabinet or drawer to the resident as described in Section 175 of these rules. Notwithstanding, the resident must be allowed to maintain their medications under their own control and possession. (3-20-20)T

**402. ASSISTANCE WITH MEDICATION.**

The provider must offer assistance with medications to residents who need assistance; however, only a health care professional may administer medications. Prior to assisting residents with medication, the provider must ensure the following conditions are in place: (3-20-20)T

**01. Training.** Each person assisting with resident medications must be an adult who successfully completed and follows the "Assistance with Medications" course available through the Idaho Professional Technical Education Program approved by the Idaho State Board of Nursing, or other Department-approved training. (3-20-20)T

**02. Condition of the Resident.** The resident's health condition is stable. (3-20-20)T

**03. Nursing Assessment.** The resident's health status does not require nursing assessment before receiving the medication nor nursing assessment of the therapeutic or side effects after the medication is taken, unless the provider is a health care professional. (3-20-20)T

**04. Containers and Labels.** The medication is in the original pharmacy-dispensed container with proper label and directions or in an original over-the-counter container. (3-20-20)T

- a. Each medication must be packaged separately unless in a Mediset, blister pack, or similar system. (3-20-20)T
  - b. Medication may be placed in a unit container by a licensed nurse when the container is appropriately labeled with the name of the medications, dosage, time to be taken, route of administration, and any special instructions. (3-20-20)T
  - c. Proper measuring devices must be available for liquid medication that is poured from a pharmacy-dispensed container. (3-20-20)T
- 05. Safeguarding Medications.** The provider must take adequate precautions to safeguard the medications of each resident for whom they provide assistance. Safeguarding consists of the following: (3-20-20)T
- a. Storing each resident's medications in an area or container designated only for that particular resident including a label with the resident's name, except for medications that must be refrigerated or over-the-counter medications; (3-20-20)T
  - b. Keeping the designated area or container for the resident's medications under lock and key when either of the following apply: (3-20-20)T
    - i. The resident's medications include a controlled substance; or (3-20-20)T
    - ii. Any resident in the home or other member of the household has drug-seeking behaviors. (3-20-20)T
  - c. Ensuring each resident's designated medication area or container is clean and kept free of contamination, including disposal of loose pills in accordance with Subsection 402.08 of this rule; (3-20-20)T
  - d. Dispensing only one (1) resident's set of medications from its designated area or container at one (1) time, so as to mitigate medication errors; and (3-20-20)T
  - e. On at least a monthly basis, document an inventory of narcotic medications. (3-20-20)T
- 06. Administration of Medications.** Only a health care professional working within the scope of their license may administer medications. Administration of medications must comply with the Administrative Rules of the Board of Nursing, IDAPA 23.01.01, "Rules of the Idaho Board of Nursing." Some procedures are of such a technical nature that they must always be performed by, or under the direct supervision of, a health care professional. These procedures are outlined in IDAPA 23.01.01, "Rules of the Idaho Board of Nursing," Section 490. (3-20-20)T
- 07. Documentation of Assistance.** Documentation of assistance with medications must be maintained by the provider. The documentation must: (3-20-20)T
- a. Be logged concurrent with the time of assistance; (3-20-20)T
  - b. Contain at least the following information: (3-20-20)T
    - i. The name of the resident receiving the medication; (3-20-20)T
    - ii. The name of the medication given; (3-20-20)T
    - iii. The dosage of the medication given; and (3-20-20)T
    - iv. The time and date the medication was given. (3-20-20)T
  - c. Indicate the reason for assisting with any PRN medication, including both over-the-counter and prescription medication. (3-20-20)T



**08. Disposal of Medication.** Medication that has been discontinued as ordered by the resident's health care professional, or has expired, must be disposed of by the provider within thirty (30) days of the order or expiration date. A written record of all disposal of drugs must be maintained in the home and must include: (3-20-20)T

- a. The name of the medication; (3-20-20)T
- b. The amount of the medication, including the number of pills at each dosage, if applicable; (3-20-20)T
- c. The name of the resident for whom the medication was prescribed; (3-20-20)T
- d. The reason for disposal; (3-20-20)T
- e. The date on which the medication was disposed; (3-20-20)T
- f. The method of disposal; and (3-20-20)T
- g. A signed statement from the provider and a credible witness confirming the disposal of the medication. (3-20-20)T

**403. -- 499. (RESERVED)**

**500. ENVIRONMENTAL SANITATION STANDARDS.**

The provider is responsible for disease prevention and maintenance of sanitary conditions in the home. (3-20-20)T

**01. Water Supply.** The water supply for the home must be adequate, safe, and sanitary. (3-20-20)T

a. The home must use a public or municipal water supply or a Department-approved private water supply; (3-20-20)T

b. If water is from a private supply, water samples must be submitted to an accredited laboratory and show an absence of bacterial contamination at least annually, or more frequently if deemed necessary by the Department. Copies of the laboratory reports must be kept on file at the home; and (3-20-20)T

c. There must be adequate water pressure to meet sanitary requirements at all times. (3-20-20)T

**02. Sewage Disposal.** The sewage disposal system must be in good working order. All sewage and liquid wastes must be discharged, collected, treated, and disposed of in a manner approved by the local municipality or the Department. (3-20-20)T

**03. Nonmunicipal Sewage Disposal.** (3-20-20)T

a. For homes with nonmunicipal sewage disposal, at the time of the initial certification and at least every five (5) years thereafter, the provider must obtain proof that the septic tank has been pumped or that pumping was not necessary, or that the system is otherwise in good working condition. (3-20-20)T

b. The Department may require the provider to obtain a statement from the local or area health district indicating that the sewage disposal system meets local requirements. The statement must be kept on file at the home. (3-20-20)T

**04. Garbage and Refuse Disposal.** Garbage and refuse disposal must be provided by the home. (3-20-20)T

a. Garbage containers outside the home used for storage of garbage and refuse must be constructed of durable, nonabsorbent materials and be provided with tight-fitting lids. (3-20-20)T

- b.** Garbage containers must be maintained in good repair and must not leak or absorb liquids. (3-20-20)T
- c.** Sufficient containers must be available to hold all garbage and refuse that accumulates between periods of removal from the premises. (3-20-20)T
- d.** Storage areas must be kept free of excess refuse and debris. (3-20-20)T
- 05. Insect and Rodent Control.** The home must be maintained free from infestations of insects, rodents and other pests. Pesticides used in the control program must be selected, stored, and used safely. (3-20-20)T
- a.** The pesticide must be selected on the basis of the pest involved and used only in the manner prescribed by the manufacturer; (3-20-20)T
- b.** The provider must take necessary precautions to protect the resident from obtaining toxic chemicals, as appropriate for their functional and cognitive ability. (3-20-20)T
- 06. Yard.** The yard surrounding the home must be safe and maintained. (3-20-20)T
- 07. Laundry Facilities and Services.** A washing machine and dryer must be readily available for the proper and sanitary washing of linen and other washable goods. Laundry services must be offered on at least a weekly basis, or more frequently when soiled linens or clothing create a noticeable odor. (3-20-20)T
- 08. Housekeeping and Maintenance.** Sufficient housekeeping and maintenance must be provided to maintain the interior and exterior of the home in a clean, safe, and orderly manner. (3-20-20)T
- a.** Resident sleeping rooms must be thoroughly cleaned including the bed, bedding, furnishings, walls, and floors. Cleaning must occur on at least a weekly basis and immediately before being occupied by a new resident. (3-20-20)T
- b.** Deodorizers must not be used to cover odors caused by poor housekeeping or unsanitary conditions. (3-20-20)T
- c.** Cleaners and chemicals must be stored and used appropriately and safely. The provider must take necessary precautions to protect the resident from obtaining toxic chemicals, as appropriate for their functional and cognitive ability. (3-20-20)T
- 501. -- 599. (RESERVED)**
- 600. FIRE AND LIFE SAFETY STANDARDS.**  
Each home must meet all applicable requirements of local and state codes concerning fire and life safety. (3-20-20)T
- 01. General Requirements.** General requirements for the fire and life safety standards for a certified family home are: (3-20-20)T
- a.** The home must be structurally sound and equipped and maintained to assure the safety of residents; and (3-20-20)T
- b.** When natural or man-made hazards are present, suitable fences, guards, and railings must be provided to protect the residents according to their need for supervision as documented in the plan of service; and (3-20-20)T
- c.** The exterior and interior of the home must be kept free from the accumulation of weeds, trash, debris, rubbish, and clutter. (3-20-20)T
- 02. Fire and Life Safety Requirements.** (3-20-20)T

- a.** Smoke alarms must be installed in sleeping rooms, hallways, on each level of the home, and as recommended by the local fire district. (3-20-20)T
- b.** Carbon monoxide (CO) alarms must be installed as recommended when: (3-20-20)T

  - i. The home is equipped with gas or other fuel-burning appliances or devices; or (3-20-20)T
  - ii. An enclosed garage is attached to the home. (3-20-20)T
- c.** Unvented combustion devices of any kind are prohibited from use inside the home. (3-20-20)T
- d.** Any locks installed on exit doors must be easily opened from the inside without the use of keys or any special knowledge. (3-20-20)T
- e.** An electric portable heating device must only be used under the following conditions: (3-20-20)T

  - i. The unit is maintained in good working order and without obvious damage or fraying of the cord; (3-20-20)T
  - ii. The heating element does not exceed two hundred twelve degrees Fahrenheit (212°F); (3-20-20)T
  - iii. The user complies with safety labels, which are to remain on the unit; (3-20-20)T
  - iv. The unit is equipped with automatic shut-off protection when tipped over; and (3-20-20)T
  - v. The unit is operated under direct supervision and at least thirty-six (36) inches away from combustibles including furnishings, bedding, and blankets. (3-20-20)T
- f.** Homes that use fuel-fired stoves must provide adequate railings or other approved protection designed to prevent the resident from coming into contact with the stove surfaces, as appropriate for their functional and cognitive ability. (3-20-20)T
- g.** Each resident's sleeping room must have at least one (1) door or window that can be easily opened from the inside and leads directly to the outside. If a window is used as a means of egress/ingress, the following conditions must be met: (3-20-20)T

  - i. The window sill height must not be more than forty-four (44) inches above the finished floor; (3-20-20)T
  - ii. The window opening must be at least twenty (20) inches in width and twenty-four (24) inches in height; and (3-20-20)T
  - iii. If the sleeping room is in a below-ground basement, the window must open into a window well through which the resident can easily exit. (3-20-20)T
- h.** Flammable or highly combustible materials must be stored safely. The provider must take necessary precautions to protect the resident from obtaining flammable materials as appropriate for their functional and cognitive ability. (3-20-20)T
- i.** Boilers, hot water heaters, and unfired pressure vessels must be equipped with automatic pressure relief valves. (3-20-20)T
- j.** A portable fire extinguisher must be mounted on each level of the home. The location of fire extinguishers is subject to Department approval. All extinguishers must be at least five (5) pound dry chemical multipurpose 2A:10B:C type. (3-20-20)T
- k.** Electrical installations and equipment must comply with the applicable local and state electrical

- codes. (3-20-20)T
- board.
- l.** Fuel-fired heating devices must be approved by the local heating/venting/air conditioning (HVAC) board. (3-20-20)T
  - m.** Exits must be free from obstruction. (3-20-20)T
  - n.** Paths of travel to exits and all exit doorways must be at least twenty-eight (28) inches wide. (3-20-20)T
  - o.** The door into each bathroom and sleeping room must unlock from both sides, if equipped with a lock, in case of an emergency. (3-20-20)T
- 03. Smoking.** Smoking is a fire hazard. The provider may choose to allow or not allow smoking. If the provider chooses to allow smoking, they must reduce the risk of fire by: (3-20-20)T
- a.** Prohibiting smoking in any area where flammable liquids, gases, or oxidizers are in use or stored; (3-20-20)T
  - b.** Prohibiting residents from smoking in bed; and (3-20-20)T
  - c.** Prohibiting unsupervised smoking by the resident unless unsupervised smoking is specifically allowed in their plan of service. (3-20-20)T
- 04. Emergency Preparedness.** Each provider must develop and implement a written emergency preparedness plan. The provider must review the emergency plan with the resident(s), or their representative, at admission and at least every six (6) months thereafter. The plan must address the following: (3-20-20)T
- a.** Evacuation of the home, including: (3-20-20)T
    - i.** A floor plan of the home depicting at least two (2) routes of escape from each room; (3-20-20)T
    - ii.** A designated meeting area indicated on the floor plan where all members of the household will congregate upon evacuation of the home; and (3-20-20)T
    - iii.** The person responsible to take a head-count at the designated meeting area and relay information to firefighters regarding the probable whereabouts in the home of missing individuals. (3-20-20)T
  - b.** Emergency situations in which people are confined to the home for a period of at least seventy-two (72) hours and considering adequate food, water, and medications during that time; (3-20-20)T
  - c.** Emergency situations in which people are ordered evacuated from the home, including pre-arranged plans to shelter within the local community and in a town outside the local community, and considering the necessary supplies that will be kept in a state of preparedness for quick evacuation; and (3-20-20)T
  - d.** Procedures for any situation in which the provider is incapacitated and unable to provide services. (3-20-20)T
- 05. Fire Drills.** The provider must conduct and document fire drills at least quarterly. (3-20-20)T
- a.** The provider must demonstrate the ability to evacuate all persons from the home to a point of safety outside the home within three (3) minutes. (3-20-20)T
  - b.** Residents who are medically unable to exit unassisted are exempt from physical participation in the drill if the provider has an effective evacuation plan for such residents and discusses the plan with the resident at the time of the drill. (3-20-20)T

- c.** Documentation, which may consist of video recordings or written logs, must include the following: (3-20-20)T

  - i.** The date and time of the drill; (3-20-20)T
  - ii.** The length of time for all persons able to participate in the drill to evacuate from the home; (3-20-20)T
  - iii.** The name or likeness of each caregiver who participated in the drill; and (3-20-20)T
  - iv.** The name or likeness of each resident and whether the resident participated in the drill. (3-20-20)T
- 06. Report of Fire.** A report on each fire incident occurring within the home must be submitted to the Department as described in Section 210 of these rules. (3-20-20)T
- 07. Maintenance of Equipment.** The provider must assure that all equipment is properly maintained. (3-20-20)T

  - a.** Smoke and carbon monoxide alarms must be tested at least monthly and a written record of the test results maintained on file. (3-20-20)T
  - b.** If the smoke or carbon monoxide alarm has replaceable batteries, replacement of the batteries must occur at least every six (6) months or as indicated by a low battery, whichever occurs first. (3-20-20)T
  - c.** A smoke or carbon monoxide alarm must be replaced at the end of its useful life as indicated by the manufacturer. (3-20-20)T
  - d.** Portable fire extinguishers must be serviced every twelve (12) months by an outside servicing agency or when the quarterly examination reveals issues with the extinguisher as described under Subsection 600.07.e. of this rule, whichever occurs first. Fire extinguishers purchased in the last twelve (12) months must be serviced within twelve (12) months from the dated receipt on file. (3-20-20)T
  - e.** All portable fire extinguishers must be examined at least quarterly by the provider or a knowledgeable member of the household, as indicated by their initials and date on a log, to determine that: (3-20-20)T

    - i.** The extinguisher is in its designated location; (3-20-20)T
    - ii.** Seals or tamper indicators are not broken and the safety pin is in place; (3-20-20)T
    - iii.** The extinguisher has not been physically damaged; (3-20-20)T
    - iv.** The extinguisher does not have any obvious defects, such as leaks; (3-20-20)T
    - v.** The nozzle is unobstructed; and (3-20-20)T
    - vi.** Chemicals are prevented from settling and clumping by repeatedly tipping the extinguisher upside down and right-side up. (3-20-20)T
  - f.** Fuel-fired heating systems must be inspected for safe operation, serviced if necessary, and approved at least annually by person(s) in the business of servicing these systems. The inspection records must be maintained on file in the home. (3-20-20)T

**601. -- 699. (RESERVED)**

**700. HOME CONSTRUCTION AND PHYSICAL HOME STANDARDS.**

**01. General Requirements.** Any residence used as a certified family home must be suitable for that use. Certified family homes must only be located in buildings intended for residential use. (3-20-20)T

**a.** Remodeling or additions to the home must be consistent with residential use of the property and must conform to local building standards including obtaining building permits as required by the local jurisdiction. (3-20-20)T

**b.** All homes are subject to Department approval. (3-20-20)T

**02. Walls and Floors.** Walls and floors must withstand frequent cleaning. Walls in sleeping rooms must extend from floor to ceiling. (3-20-20)T

**03. Telephone.** There must either be a telephone or an enhanced 911-compliant cell phone available to the resident. (3-20-20)T

**a.** If the home provides a cell phone for the resident's use, the provider must obtain documentation from the service carrier that the cell phone is enhanced 911-compliant. (3-20-20)T

**b.** The telephone or cell phone must: (3-20-20)T

**i.** Be immediately available in case of an emergency; (3-20-20)T

**ii.** Be functional and operational at all times, including having dependable service; (3-20-20)T

**iii.** Be programmed with general emergency phone numbers and the emergency contacts for the resident, or alternatively, such numbers must be posted near the telephone; and (3-20-20)T

**iv.** Be accessible to the resident throughout the day, including night hours, with unlimited usage and adequate privacy. (3-20-20)T

**04. Toilet Facilities and Bathrooms.** The home must contain: (3-20-20)T

**a.** At least one (1) flush toilet, one (1) tub or shower, and one (1) sink with a mirror; (3-20-20)T

**b.** Toilet and shower or bathing facilities must be separated from all rooms by solid walls or partitions; (3-20-20)T

**c.** Each room containing a toilet, shower, or bath must have either a window that is easily opened to the outside, or forced ventilation to the outside; (3-20-20)T

**d.** Tubs, showers, and sinks must be connected to hot and cold running water; and (3-20-20)T

**e.** Access to toilet facilities and bathrooms designated for the resident's use must not require them to pass through another person's sleeping room. (3-20-20)T

**05. Accessibility for Residents with Physical and Sensory Impairments.** A provider choosing to provide services to a resident who has difficulty with mobility or who has sensory impairments must assure the physical environment meets the needs of the resident and maximizes independent mobility and use of appliances, bathroom facilities, and living areas. The home must provide necessary accommodations that meet the "American With Disabilities Act Accessibility Guidelines--Standards for Accessible Design (SFAD)," as incorporated by reference in Section 004 of these rules and as described below according to the individual resident's needs: (3-20-20)T

**a.** A ramp that complies with Section 405 of the SFAD. Elevators or lifts that comply with Sections 409 and 410, respectively, may be utilized in place of a ramp; (3-20-20)T

- b.** Doorways large enough to allow easy passage of a wheelchair and that comply with Subsection 404.2.3 of the SFAD; (3-20-20)T
- c.** Toilet and bathing facilities that comply with Sections 603 and 604 of the SFAD; (3-20-20)T
- d.** Sinks that comply with Section 606 of the SFAD; (3-20-20)T
- e.** Grab bars in resident toilet facilities and bathrooms that comply with Section 609 of the SFAD; (3-20-20)T
- f.** Bathtubs or shower stalls that comply with Sections 607 and 608 of the SFAD, respectively; (3-20-20)T
- g.** Non-retractable faucet handles that comply with Subsection 309.4 of the SFAD. Self-closing valves are not allowed; (3-20-20)T
- h.** Suitable handrails on both sides of all stairways leading into and out of the home that comply with Section 505 of the SFAD; and (3-20-20)T
- i.** Smoke and carbon monoxide alarms that comply with Section 702 of the SFAD. (3-20-20)T
- 06. Storage Areas.** Adequate storage must be provided in addition to the required storage in resident sleeping rooms. (3-20-20)T
- 07. Lighting.** Adequate lighting must be provided in all resident sleeping rooms and any other rooms accessed by the resident. (3-20-20)T
- 08. Ventilation.** The home must be well ventilated and the provider must take precautions to prevent offensive odors. (3-20-20)T
- 09. Heating and Cooling.** The temperature in the home must be maintained between sixty-five degrees Fahrenheit (65°F) and eighty degrees Fahrenheit (80°F) when residents or adult hourly care participants are at home. The thermostat for the primary source of heat must be located away from the wood stove, if applicable. (3-20-20)T
- 10. Plumbing.** All plumbing in the home must be in good working order and comply with local and state codes. All plumbing fixtures must be easily cleanable and maintained in good repair. (3-20-20)T
- 11. Resident Sleeping Rooms.** (3-20-20)T

  - a.** The sleeping room must not be in an attic, stairway, hall, or any room commonly used for other than bedroom purposes. (3-20-20)T
  - b.** The sleeping room may be in a below-ground basement or a room located on the second story or higher only if the following conditions are met: (3-20-20)T

    - i.** The resident is able to independently recognize an emergency and self-evacuate from their sleeping room without physical assistance or verbal cueing as assessed and indicated in their plan of service; or (3-20-20)T
    - ii.** The provider's sleeping room or the sleeping room of another responsible and able-bodied individual living in the home is located on the same level with the resident's sleeping room; and (3-20-20)T
    - iii.** The level of the home on which the resident's sleeping room is located has floors, ceilings, and walls that are finished to the same degree as the rest of the home. (3-20-20)T
  - c.** Walls must run from floor to ceiling and doors must be solid. (3-20-20)T
  - d.** The resident must not occupy the same bedroom as the provider. The resident must not occupy the

- same bedroom as a relative of the provider unless the relative is a sibling of the resident. (3-20-20)T
- e. The ceiling height in the sleeping room must be at least seven feet, six inches (7'6"). (3-20-20)T
  - f. The sleeping room must have a closet that must be equipped with a door if the resident so chooses. (3-20-20)T
  - i. Closet space shared by two (2) residents must have a substantial divider separating each resident's space. (3-20-20)T
  - ii. Free-standing closet space must be deducted from the square footage in the sleeping room. (3-20-20)T
  - g. The sleeping room must have at least one hundred (100) square feet of floor space in a one (1) person sleeping room and at least one hundred and sixty (160) square feet of floor space in a two (2) person sleeping room. (3-20-20)T

**701. MANUFACTURED HOMES AND MODULAR BUILDINGS.**

**01. Use of Manufactured Homes and Modular Buildings.** Idaho Division of Building Safety (DBS) approved modular buildings or U.S. Department of Housing and Urban Development (HUD) approved buildings may be approved for use as a certified family home when the home meets the following requirements: (3-20-20)T

- a. The manufactured or modular home meets the requirements of HUD or DBS requirements in accordance with state and federal regulations as of the date of manufacture. (3-20-20)T
- b. The manufactured or modular home meets the adopted standards and requirements of the local jurisdiction in which the home is located. (3-20-20)T
- c. Recreational vehicles, commercial coaches, unregulated or unapproved modifications or additions to approved manufactured housing or modular buildings will not be approved by the Department. (3-20-20)T
- d. Manufactured housing constructed prior to June 15, 1976, is prohibited for use as a certified family home without assessment and approval by the Department. (3-20-20)T

**02. Previously Certified.** A manufactured home approved for use as a certified family home before July 1, 2001, may continue to be certified when evaluated on a case-by-case basis. (3-20-20)T

**702. -- 709. (RESERVED)**

**710. SITE REQUIREMENTS FOR CERTIFIED FAMILY HOMES.**

In addition to the requirements of Section 700 of these rules, the home must comply with the following site requirements: (3-20-20)T

- 01. Fire District.** The home must be in a lawfully constituted fire district. (3-20-20)T
- 02. Accessible Road.** The home must be served by an all-weather road kept open to motor vehicles at all times of the year. (3-20-20)T
- 03. Emergency Medical Services.** The home must be accessible to emergency medical services. (3-20-20)T
- 04. Accessible to Services.** The home must be accessible to necessary social, medical, and rehabilitation services. (3-20-20)T
- 05. House Number.** The house number must be prominently displayed and plainly visible from the street. (3-20-20)T



**711. -- 899. (RESERVED)**

**900. EMERGENCY POWERS OF THE DIRECTOR.**

In the event of an emergency endangering the life or safety of a resident, the Director may summarily suspend or revoke any certified family home certificate. As soon thereafter as practical, the Director will provide an opportunity for a hearing in accordance with the provisions of IDAPA 16.05.03, "Contested Case Proceedings and Declaratory Rulings." (3-20-20)T

**901. ENFORCEMENT PROCESS.**

If the Department finds that the provider does not meet, or did not meet, a rule governing certified family homes, it may impose a remedy, independently or in conjunction with others, subject to the provisions of these rules for notice and appeal. (3-20-20)T

**01. Recommendation of Remedy.** In determining which remedy to recommend, the Department will consider the provider's compliance history, complaints, and the number, scope, and severity of the deficiencies. Subject to these considerations, the Department may impose any of the following remedies: (3-20-20)T

- a. Ban on all admissions in accordance with Section 910 of these rules; (3-20-20)T
- b. Ban on admissions of residents with certain diagnosis in accordance with Section 911 of these rules; (3-20-20)T
- c. Summarily suspend the certificate and transfer residents in accordance with Section 912 of these rules; (3-20-20)T
- d. Issue a provisional certificate in accordance with Section 909 of these rules; and (3-20-20)T
- e. Revoke the home's certificate in accordance with Section 913 of these rules. (3-20-20)T

**02. Notice of Enforcement Remedy.** The Department will give the provider written notice of an enforcement remedy by certified mail or by personal service upon its decision. The notice will include the decision, the reason for the Department's decision, and how to appeal the decision subject to the hearing provisions in IDAPA 16.05.03, "Contested Case Proceedings and Declaratory Rulings." (3-20-20)T

**902. FAILURE TO COMPLY.**

The Department may revoke the provider's certificate when it determines any of the following conditions exist: (3-20-20)T

**01. Out of Compliance.** The provider has not complied with any part of these rules within thirty (30) days of the date the home is found out of compliance with that requirement. (3-20-20)T

**02. Lack of Progress.** The provider has made little or no progress in correcting deficiencies within thirty (30) days from the date the Department accepted the provider's plan of correction. (3-20-20)T

**903. REPEATED NONCOMPLIANCE.**

When the Department determines that a provider has repeated noncompliance with any of these rules, it may impose any of the enforcement remedies listed in Sections 909 through 913 of these rules. (3-20-20)T

**904. -- 908. (RESERVED)**

**909. ENFORCEMENT REMEDY OF PROVISIONAL CERTIFICATION.**

When the Department finds that the provider is unable to meet a standard required under these rules because of conditions that are not anticipated to continue beyond six (6) months and do not jeopardize the health or safety of the residents, the Department may grant a provisional certificate to the provider as described under Section 110 of these rules. (3-20-20)T

**01. Conditions of Provisional Certification.** The Department, at its discretion, may impose conditions upon the provider, which will be included with the notice of provisional certification, if so imposed. Conditions are imposed to ensure the provider achieves compliance with the requirements of these rules and to aid the Department in monitoring the provider's performance during the provisional certification period. (3-20-20)T

**02. Failure to Meet Conditions of Provisional Certification.** Failure by the provider to meet the conditions of a provisional certificate is cause for the Department to revoke the provider's certificate. (3-20-20)T

**03. Certification or Revocation.** The Department, upon review of the provider's performance during the course of the provisional certification period, may either issue a certificate to the provider when the Department finds that the provider has achieved substantial compliance with these rules, or revoke the provider's certificate if the provider has failed to comply. (3-20-20)T

**910. ENFORCEMENT REMEDY OF BAN ON ALL ADMISSIONS.**

All admissions to the home are banned pending satisfactory correction of all deficiencies. Bans will remain in effect until the Department determines that the provider has achieved full compliance with all requirements of these rules, or until a substitute remedy is imposed. (3-20-20)T

**911. ENFORCEMENT REMEDY OF BAN ON ADMISSIONS OF RESIDENT WITH SPECIFIC DIAGNOSIS.**

The Department may ban admission into the home any resident with a specific diagnosis when the Department has determined the provider lacks the skill to provide adequate care to such a resident. A ban may be imposed for all prospective residents, both publicly and privately funded, and will prevent the home from admitting residents with a specific diagnosis for whom the provider has shown an inability to provide adequate care as described in Section 170 of these rules. (3-20-20)T

**912. ENFORCEMENT REMEDY OF SUMMARY SUSPENSION AND TRANSFER OF RESIDENT.**

The Department may summarily suspend the provider's certificate and transfer the resident when convinced by a preponderance of the evidence that the resident's health and safety are in immediate jeopardy. (3-20-20)T

**913. ENFORCEMENT REMEDY OF REVOCATION OF CERTIFICATE.**

**01. Revocation of the Certificate.** The Department may institute a revocation action when persuaded by a preponderance of the evidence that the provider is not in substantial compliance with these rules. (3-20-20)T

**02. Causes for Revocation of the Certificate.** The Department may revoke any certificate for any of the following causes: (3-20-20)T

**a.** The provider has willfully misrepresented or omitted any of the following: (3-20-20)T

**i.** Information pertaining to their certification; or (3-20-20)T

**ii.** Information obstructing an investigation. (3-20-20)T

**b.** The home is not in substantial compliance with these rules; (3-20-20)T

**c.** When persuaded by a preponderance of the evidence that such conditions exist which endanger the health or safety of any resident; (3-20-20)T

**d.** Any act adversely affecting the welfare of residents is being permitted, aided, performed, or abetted by the person or persons in charge of the home. Such acts may include, but are not limited to, neglect, physical abuse, mental abuse, emotional abuse, violation of civil rights, or exploitation; (3-20-20)T

**e.** The provider has demonstrated or exhibited a lack of sound judgment essential to the operation and management of a certified family home; (3-20-20)T

**f.** The provider has violated any of the conditions of a provisional certificate; (3-20-20)T

- g.** The provider has one (1) or more core issues; (3-20-20)T
- h.** An accumulation of minor violations that, when taken as a whole, constitute inadequate care; (3-20-20)T
- i.** Repeat violations of any requirement of these rules or of the Idaho Code; (3-20-20)T
- j.** The provider lacks the ability to properly care for the resident, as required by these rules, or as directed by the Department; (3-20-20)T
- k.** The provider is not in substantial compliance with the provisions for services, resident rights, or admissions; (3-20-20)T
- l.** The provider refuses to allow the certifying agent or other representative of the Department or protection and advocacy agencies full access to the home, records, or the residents; (3-20-20)T
- m.** The provider fails to pay the certification fee as specified in Section 109 of these rules. The certification fee is considered delinquent if not paid within thirty (30) days of due date on the invoice. (3-20-20)T

**914. (RESERVED)**

**915. TRANSFER OF RESIDENT.**

The Department may require transfer of a resident from a certified family home to an alternative placement on the following grounds: (3-20-20)T

**01. Violation of Rules.** As a result of a violation of a provision of these rules or standards, the provider is unable or unwilling to provide an adequate level of meals, lodging, personal assistance, or supervision of a resident. (3-20-20)T

**02. Violation of Resident's Rights.** A violation of a resident's rights provided in Section 39-3516, Idaho Code, or Section 200 of these rules. (3-20-20)T

**03. Immediate Jeopardy.** A violation of a provision of these rules, or applicable rules or standards, results in conditions that present an immediate jeopardy. (3-20-20)T

**916. -- 949. (RESERVED)**

**950. RIGHT TO SELL.**

Nothing contained in these rules limits the right of any home owner to sell, lease, mortgage, or close any certified family home in accordance with all applicable laws. (3-20-20)T

**951. -- 999. (RESERVED)**

## 16.03.22 – RESIDENTIAL ASSISTED LIVING FACILITIES

### 000. LEGAL AUTHORITY.

The Idaho Board of Health and Welfare is authorized under Sections 39-3305 and 39-3358, Idaho Code, to adopt and enforce rules to protect the health, safety, and individual rights for residents in residential assisted living facilities.

(3-20-20)T

### 001. TITLE, SCOPE, AND RESPONSIBILITIES.

**01. Title.** The title of this chapter of rules is IDAPA 16.03.22, “Residential Assisted Living Facilities.” (3-20-20)T

**02. Scope.** The purpose of a residential assisted living facility is to provide choice, dignity, and independence to residents while maintaining a safe, humane, and home-like living arrangement for individuals needing assistance with daily activities and personal care. These rules set standards for providing services that maintain a safe and healthy environment. (3-20-20)T

**03. General Provider Responsibilities.** The facility must ensure quality services by providing choices, dignity, and independence to residents. The facility must have an administrator and staff who have the knowledge and experience required to provide safe and appropriate services to all residents of the facility. The facility must be operated consistent with the rules and statutes as it conducts its work. (3-20-20)T

**04. General Department Responsibilities.** The Department is responsible for monitoring and enforcing the provisions of the statute and this chapter to protect residents in these facilities by providing information, education, and evaluating providers to ensure compliance with statute and these rules. This responsibility includes licensing facilities and monitoring the condition of facilities. (3-20-20)T

**05. Exemptions.** The provisions of these rules do not apply to any of the following: (3-20-20)T

**a.** The provisions of these rules do not apply to hospitals, nursing facilities, intermediate care facilities for persons with intellectual disabilities, or any other health facility as defined by Title 39, Chapter 13, Idaho Code. (3-20-20)T

**b.** The provisions of these rules do not apply to any house, institution, hotel, congregate housing project, retirement home, or other similar place that is limited to providing one (1) or more of the following: housing, meals, transportation, housekeeping, or recreational and social activities, or that have residents independently accessing supportive services from an entity approved to provide such services in Idaho and holding no legal ownership interest in the entity operating the facility. (3-20-20)T

**c.** The provisions of these rules do not apply to any arrangement for the receiving and care of persons by a relative, except when the caregiver is paid for the care through a state or federal program, in which case the caregiver relative and the care setting must meet all applicable requirements. (3-20-20)T

### 002. WRITTEN INTERPRETATIONS.

This agency has written statements which pertain to the interpretations of the rules of this chapter or to the documentation of compliance with the rules of this chapter. The document is available for public inspection on the program website [www.assistedliving.dhw.idaho.gov](http://www.assistedliving.dhw.idaho.gov). (3-20-20)T

### 003. ADMINISTRATIVE APPEALS, CONTESTED CASES, AND INFORMAL DISPUTE RESOLUTION.

**01. Administrative Appeals and Contested Cases.** Administrative appeals and contested cases are governed by IDAPA 16.05.03, “Contested Case Proceedings and Declaratory Rulings.” (3-20-20)T

**02. Informal Dispute Resolution Meeting.** If a facility disagrees with a finding of a core issue, it may request an informal dispute resolution meeting with the Residential Assisted Living Facilities Program. The policy and procedure for requesting informal dispute resolution is posted on the Residential Assisted Living Facilities Program website at <http://www.assistedliving.dhw.idaho.gov>. (3-20-20)T

### 004. INCORPORATION BY REFERENCE.

The documents referenced in this rule are incorporated by reference as provided by Section 67-5229(a), Idaho Code. These incorporated documents are available for public review upon request at the Department of Health and Welfare, 450 West State Street, Boise, Idaho 83702, or when available online at the websites provided in these rules.

(3-20-20)T

**01. National Fire Protection Association (NFPA) Documents.**

**a.** National Fire Protection Association (NFPA) Standard 101, The Life Safety Code, 2018 Edition, the occupancy chapters and all mandatory referenced documents contained therein under “Mandatory References.” (3-20-20)T

**b.** National Fire Protection Association (NFPA) Standard 99, Health Care Facilities Code, 2018 Edition. (3-20-20)T

**02. Idaho Diet Manual.** The manual is available from the Idaho Academy of Nutrition & Dietetics, Eleventh Edition, 2015, online at <http://eatrightidaho.org>. (3-20-20)T

**03. Idaho Food Code.** IDAPA 16.02.19, “Idaho Food Code.” These rules are available online at <http://adminrules.idaho.gov/rules/current/16/160219.pdf>. (3-20-20)T

**04. Americans with Disabilities Act Accessibility Guidelines.** 28 CFR Part 36, Appendix A. This code is available online at <http://www.ada.gov/1991standards/adastd94-archive.pdf>. (3-20-20)T

**05. Idaho Board of Nursing Rules.** IDAPA 23.01.01, “Rules of the Idaho Board of Nursing.” These rules are available online at <http://adminrules.idaho.gov/rules/current/23/>. (3-20-20)T

**06. International Building Code.** IDAPA 07.03.01, “Rules of Building Safety.” These rules are available online at <https://adminrules.idaho.gov/rules/current/07/070301.pdf>. (3-20-20)T

**005. OFFICE – OFFICE HOURS – MAILING ADDRESS – STREET ADDRESS – TELEPHONE -- INTERNET WEBSITE.**

**01. Office Hours.** Office hours are 8 a.m. to 5 p.m., Mountain Time, Monday through Friday, except holidays designated by the State of Idaho. (3-20-20)T

**02. Mailing Address.** (3-20-20)T

**a.** The mailing address of the Idaho Department of Health and Welfare is P.O. Box 83720, Boise, Idaho 83720-0036. (3-20-20)T

**b.** The mailing address of the Residential Assisted Living Facilities Program is P.O. Box 83720, Boise, Idaho 83720-0009. (3-20-20)T

**03. Street Address.** (3-20-20)T

**a.** The street address of the Idaho Department of Health and Welfare is 450 West State Street, Boise, Idaho 83702. (3-20-20)T

**b.** The street address of the Residential Assisted Living Facilities Program is 3232 Elder Street, Boise, Idaho 83705. (3-20-20)T

**04. Telephone.** (3-20-20)T

**a.** The telephone number of the Idaho Department of Health and Welfare is (208) 334-5500. (3-20-20)T

**b.** The telephone number of the Residential Assisted Living Facilities Program is (208) 364-1962. (3-20-20)T

**05. Internet Website Address.** (3-20-20)T

- a. The Department Internet website is <http://www.healthandwelfare.idaho.gov>. (3-20-20)T
- b. The Residential Assisted Living Facilities Program internet website is <http://www.assistedliving.dhw.idaho.gov>. (3-20-20)T
- c. The Public Portal internet website is <https://www.flareslive.com/portal/searchfacility.aspx>. (3-20-20)T

**006. CONFIDENTIALITY OF RECORDS AND PUBLIC RECORDS REQUESTS.**

**01. Confidential Records.** Any information about an individual covered by these rules and contained in Department records must comply with IDAPA 16.05.01, "Use and Disclosure of Department Records." (3-20-20)T

**02. Public Records Act.** The Department of Health and Welfare will comply with Title 74, Chapter 1, Idaho Code, when requests for the examination and copying of public records are made. Public records in the custody of the Department are subject to disclosure, unless otherwise exempted by state or federal law. (3-20-20)T

**03. Disclosure of Resident Identity.** Information received by the Department through filed reports, inspections, or as otherwise authorized under the law, will not be disclosed publicly in such a manner as to identify individual residents of facilities except as necessary in a proceeding involving a question of licensure. (3-20-20)T

**04. Public Availability of Survey Documents.** In accordance with Section 39-3355(6), Idaho Code, survey findings are posted on the Public Portal at <https://www.flareslive.com/portal/searchfacility.aspx>. The related survey documents are available to the public upon written request to the Department. (3-20-20)T

**007. -- 008. (RESERVED)**

**009. CRIMINAL HISTORY AND BACKGROUND CHECK REQUIREMENTS.**

**01. Criminal History and Background Check.** A residential assisted living facility must complete a criminal history and background check on employees and contractors hired or contracted with after October 1, 2005, who have direct resident access to residents in the residential assisted living facility. The Department check conducted under IDAPA 16.05.06, "Criminal History and Background Checks," satisfies this requirement. Other criminal history and background checks may be acceptable provided they meet the criteria in Subsection 009.02 of this rule and the entity conducting the check issues written findings. The entity must provide a copy of these written findings to both the facility and the employee. (3-20-20)T

**02. Scope of a Criminal History and Background Check.** The criminal history and background check must, at a minimum, be fingerprint-based and include a search of the following record sources: (3-20-20)T

- a. Federal Bureau of Investigation (FBI); (3-20-20)T
- b. Idaho State Police Bureau of Criminal Identification; (3-20-20)T
- c. Sexual Offender Registry; (3-20-20)T
- d. Office of Inspector General List of Excluded Individuals and Entities; and (3-20-20)T
- e. Nurse Aide Registry. (3-20-20)T

**03. Availability to Work.** Any direct resident access individual hired or contracted with on or after October 1, 2005, must self-disclose all arrests and convictions before having access to residents. (3-20-20)T

- a. If a disqualifying crime as described in IDAPA 16.05.06, "Criminal History and Background Checks," is disclosed, the individual must not have direct resident access to any resident. (3-20-20)T

**b.** The individual is only allowed to work under another employee who has a cleared criminal history and background check that meets the criteria in this rule. The cleared employee must keep the individual waiting for clearance in line-of-sight when the individual has direct resident access until the criminal history and background check is completed and the results are obtained by the facility, unless: (3-20-20)T

**i.** The individual has completed an alternative criminal history and background check that includes a search of the record sources listed in Subsection 009.02 except for Subsection 009.02.a. in this rule; (3-20-20)T

**ii.** The facility determines there is no potential danger to residents; and (3-20-20)T

**iii.** This alternative criminal history and background check is only in effect until the required criminal history and background check that meets the criteria in this rule is completed. The results must state whether the individual was cleared or denied based on the completed fingerprint-based background check. (3-20-20)T

**04. Submission of Fingerprints.** The individual's fingerprints must be submitted to the entity conducting the criminal history and background check within twenty-one (21) days of their date of hire. (3-20-20)T

**05. New Criminal History and Background Check.** An individual must have a criminal history and background check when: (3-20-20)T

**a.** Accepting employment with a new employer; and (3-20-20)T

**b.** The individual's last criminal history and background check was completed more than three (3) years prior to their date of hire. (3-20-20)T

**06. Use of Previous Criminal History and Background Check.** Any employer is allowed to use a previous criminal history and background check that meets the criteria in this rule if: (3-20-20)T

**a.** The individual has received a criminal history and background check within three (3) years of their date of hire; (3-20-20)T

**b.** Prior to the individual being granted unsupervised direct resident access, the employer obtains and retains the individual's previous criminal history and background check results; (3-20-20)T

**c.** The employer completes a state-only background check of the individual through the Idaho State Police Bureau of Criminal Identification, within thirty (30) days after obtaining the previous criminal history and background check results; and (3-20-20)T

**d.** No disqualifying crimes are found. (3-20-20)T

**07. Employer Discretion.** The new employer, at its discretion, may require an individual to complete a criminal history and background check at any time, even if the individual has received a criminal history and background check within three (3) years of their date of hire. (3-20-20)T

**010. DEFINITIONS AND ABBREVIATIONS A THROUGH E.**

**01. Abuse.** A non-accidental act of sexual, physical, or mental mistreatment or injury of a resident through the action or inaction of another individual. (3-20-20)T

**02. Accident.** An unexpected, unintended event that can cause a resident injury. (3-20-20)T

**03. Activities.** All organized and directed social and rehabilitative services a facility provides, arranges, or cooperates with. (3-20-20)T

**04. Activities of Daily Living.** Self-care actions necessary to sustain an individual in daily living, including bathing, dressing, toileting, grooming, eating, communicating, and managing medications. (3-20-20)T

- 05. Administrator.** An individual licensed by the Idaho Division of Occupational and Professional Licenses as a Residential Care Facility Administrator. (3-20-20)T
- 06. Administrator's Designee.** A person authorized in writing to act in the absence of the administrator who is knowledgeable of facility operations, the residents and their needs, emergency procedures, the location and operation of emergency equipment, and how the administrator can be reached in the event of an emergency. (3-20-20)T
- 07. Adult.** A person who has reached eighteen (18) years of age. (3-20-20)T
- 08. Advance Directive.** A written instruction, such as a living will or durable power of attorney for health care, recognized under state law, whether statutory or as recognized by the courts of the State, related to the provision of medical care when the individual is unable to communicate. (3-20-20)T
- 09. Advocate.** An authorized or designated representative of a program or organization operating under federal or state mandate to represent the interests of a population group served by a facility. (3-20-20)T
- 10. Ambulatory Person.** A person who, unaided by any other person, is physically and mentally capable of walking a normal path to safety, including the ascent and descent of stairs. (3-20-20)T
- 11. Assessment.** Information gathered that identifies resident strengths, weaknesses, risks, and needs, to include functional, social, medical, and behavioral needs. (3-20-20)T
- 12. Authentication.** The process or action of proving or showing authorship to be true, genuine, or valid. (3-20-20)T
- 13. Authorized Provider.** An individual who is a nurse practitioner, clinical nurse specialist, or physician assistant. (3-20-20)T
- 14. Behavior Plan.** A written plan that decreases the frequency, duration, or intensity of maladaptive behaviors, and increases the frequency of adaptive behaviors. (3-20-20)T
- 15. Call System.** A signaling system whereby a resident can contact staff directly from their sleeping room, toilet room, and bathing area. The system may be voice communication, or an audible or visual signal, and may include wireless technology. The call system cannot be configured in such a way as to breach a resident's right to privacy at the facility, including in the resident's living quarters, in common areas, during medical treatments, while receiving other services, in written and telephonic communications, or in visits with family, friends, advocates, and resident groups. (3-20-20)T
- 16. Chemical Restraint.** A medication used to control behavior or to restrict freedom of movement and is not a standard treatment for the resident's condition. (3-20-20)T
- 17. Cognitive Impairment.** When a person experiences loss of short or long-term memory, orientation to person, place, or time, safety awareness, or the ability to make decisions that affect everyday life. (3-20-20)T
- 18. Complaint.** A formal expression of dissatisfaction, discontent, or unhappiness by, or on behalf of, a resident concerning the care or conditions at the facility. This expression could be oral, in writing, or by alternative means of communication. (3-20-20)T
- 19. Complaint Investigation.** A survey to investigate the validity of allegations of noncompliance with applicable state requirements. Allegations will be investigated by the Licensing Agency as described in Section 39-3355, Idaho Code. (3-20-20)T
- 20. Core Issue.** A core issue is any one (1) of the following: (3-20-20)T
- a. Abuse;** (3-20-20)T



- b.** Neglect; (3-20-20)T
- c.** Exploitation; (3-20-20)T
- d.** Inadequate care; (3-20-20)T
- e.** A situation in which the facility has operated for more than thirty (30) days without a licensed administrator overseeing the day-to-day operations of the facility; (3-20-20)T
- f.** Inoperable fire detection or extinguishing systems with no fire watch in place pending the correction of the system; or (3-20-20)T
- g.** Surveyors denied access to records, residents, or facilities. (3-20-20)T
- 21. Criminal Offense.** Any crime as defined in Section 18-111, Idaho Code, 18 U.S.C. Section 4B1.2(a), and 18 U.S.C. Sections 1001 through 1027. (3-20-20)T
- 22. Deficiency.** A determination of non-compliance with a specific rule or part of a rule. (3-20-20)T
- 23. Dementia.** A chronic deterioration of intellectual function and other cognitive skills severe enough to interfere with the ability to perform activities of daily living. (3-20-20)T
- 24. Department.** The Idaho Department of Health and Welfare. (3-20-20)T
- 25. Developmental Disability.** A developmental disability, as defined in Section 66-402, Idaho Code, means a chronic disability of a person which appears before twenty-two (22) years of age and: (3-20-20)T
- a.** Is attributable to an impairment, such as an intellectual disability, cerebral palsy, epilepsy, autism, or other conditions found to be closely related or similar to one (1) of these impairments that requires similar treatment or services, or is attributable to dyslexia resulting from such impairments; (3-20-20)T
- b.** Results in substantial functional limitations in three (3) or more of the following areas of major life activity: self-care, receptive and expressive language, learning, mobility, self-direction, capacity of independent living, or economic self-sufficiency; and (3-20-20)T
- c.** Reflects the need for a combination and sequence of special, interdisciplinary or direct care, treatment, or other services which are of life-long or extended duration, and individually planned and coordinated. (3-20-20)T
- 26. Direct Resident Access.** In person access with any resident who resides at the facility, or any access to the residents' personal belongings or information. (3-20-20)T
- 27. Director.** The Director of the Idaho Department of Health and Welfare or their designee. (3-20-20)T
- 28. Electronic Signature.** The system for signing electronic documents by entering a unique code or password that verifies the identity of the person signing and creates an individual "signature" on the record. (3-20-20)T
- 29. Elopement.** When a resident who is cognitively, physically, mentally, emotionally, or chemically impaired, physically leaves the facility premises or the secured unit or yard without personnel's knowledge. (3-20-20)T
- 30. Exit Conference.** A meeting with the facility administrator or designee to: (1) provide review, discussion, and written documentation of non-core issues, and (2) to provide preliminary findings of core issues. (3-20-20)T

**31. Exploitation.** The misuse of a resident's funds, property, resources, identity, or person for profit or advantage. This includes charging a resident for services or supplies not provided or disclosed in the written admission agreement, and staff accepting gifts or money for extra services. (3-20-20)T

**011. DEFINITIONS AND ABBREVIATIONS F THROUGH N.**

**01. Follow-Up Survey.** A survey conducted to confirm that the facility is in compliance and has the ability to remain in compliance. (3-20-20)T

**02. Governmental Unit.** The state, any county, any city, or any department, division, board, or other agency. (3-20-20)T

**03. Hourly Adult Care.** Nonresident daily services and supervision provided by a facility to individuals who are in need of supervision outside of their personal residence(s) for a portion of the day. (3-20-20)T

**04. Immediate Danger.** Any resident is subject to an imminent or substantial danger. (3-20-20)T

**05. Inadequate Care.** When a facility fails to provide the services required to meet the terms of the Negotiated Service Agreement, or provide for room, board, activities of daily living, supervision, first aid, assistance and monitoring of medications, emergency intervention, coordination of outside services, a safe living environment, engages in violations of resident rights, or takes residents who have been admitted in violation of the provisions of Section 152 of these rules. (3-20-20)T

**06. Incident.** An event that can cause a resident injury. (3-20-20)T

**07. Independent Mobility.** A person's ability to move about freely of their own choice with or without the assistance of a mobility device such as a wheelchair, cane, crutches, or walker. (3-20-20)T

**08. Legal Guardian or Conservator.** A court-appointed individual designated to manage the affairs or finances of another person who has been found to be incapable of handling their own affairs. (3-20-20)T

**09. License.** A permit to operate a residential assisted living facility. (3-20-20)T

**10. Licensing Agency.** The Residential Assisted Living Facilities Program, a unit of the Division of Licensing and Certification within the Department of Health and Welfare, that conducts inspections and surveys of residential assisted living facilities and issues licenses based on compliance with this chapter of rules in which "Residential Assisted Living Facilities Program" and "Licensing Agency" are synonymous. (3-20-20)T

**11. Maladaptive Behavior.** Any behavior that interferes with resident care, infringes on any resident's rights, or presents a danger to the resident or others. Involuntary muscle movements are not considered maladaptive behaviors. (3-20-20)T

**12. Medication.** Any substance used to treat a disease, condition, or symptom, which may be taken orally, injected, or used externally, and is available through prescription or over-the-counter. (3-20-20)T

**13. Medication Administration.** The process where a prescribed medication is given by a licensed nurse to a resident through one (1) of several routes. (3-20-20)T

**14. Medication Assistance.** The process whereby a non-licensed care provider is delegated tasks by a licensed nurse, to aid a person who cannot independently self-administer medications. See IDAPA 23.01.01, "Rules of the Idaho State Board of Nursing," Section 010. (3-20-20)T

**15. Mental Disorders.** Health conditions that are characterized by alterations in thinking, mood, behavior, or some combination thereof, that are all mediated by the brain and associated with distress or impaired functioning. (3-20-20)T

**16. Mental Illness.** Refers collectively to all diagnosable mental disorders. (3-20-20)T

**17. Neglect.** Failure to provide food, clothing, shelter, or medical care necessary to sustain the life and health of a resident. (3-20-20)T

**18. Negotiated Service Agreement.** The plan reached by the resident or their representative and the facility which outlines services to be provided and the obligations of the facility and the resident. (3-20-20)T

**19. Non-Core Issue.** Any finding of deficient practice that is not a core issue. (3-20-20)T

**20. Nursing Assessment.** Information gathered related to a resident's health or medical status that has been reviewed, signed, and dated by a licensed registered nurse, as described in Section 305 of these rules. (3-20-20)T

**012. DEFINITIONS AND ABBREVIATIONS O THROUGH Z.**

**01. Outside Services.** Services provided to a resident by someone that is not a member of facility personnel. (3-20-20)T

**02. Owner.** Any person or entity having legal ownership of the facility as an operating business, regardless of who owns the real property. (3-20-20)T

**03. Personal Assistance.** The provision by the staff of the facility of one (1) or more of the following services: (3-20-20)T

**a.** Assisting the resident with activities of daily living; (3-20-20)T

**b.** Arranging for outside services; (3-20-20)T

**c.** Being aware of the resident's general whereabouts; or (3-20-20)T

**d.** Monitoring the activities of the resident while on the premises of the facility to ensure the resident's health, safety, and well-being. (3-20-20)T

**04. Personnel.** Paid individuals assigned the responsibility of providing care, supervision, and services to the facility and its residents. In this chapter of rules, "personnel" and "staff" are synonymous. (3-20-20)T

**05. Physical Restraint.** Any device or physical force that restricts the free movement of, normal functioning of, or normal access to, a portion or portions of an individual's body, except for the temporary treatment of a medical condition, such as the use of a cast for a broken bone. (3-20-20)T

**06. Portable Heating Device.** Any device designed to provide heat on a temporary basis that is not designed as part of a building's heating system, is not permanently affixed to the building, and, if electrical, is not hardwired to the building's electrical service. This does not include the use of therapeutic devices such as heating pads, heated mattress pads, and electric blankets, which require a physician or authorized provider's order. (3-20-20)T

**07. PRN.** Indicates that a medication or treatment prescribed by a medical professional to an individual may be given as needed. (3-20-20)T

**08. Pressure Injury.** Any lesion caused by unrelieved pressure that results in damage to the underlying tissue(s). (3-20-20)T

**09. Provisional License.** A license which may be issued to a facility not in compliance with the rules pending the satisfactory correction of all deficiencies. (3-20-20)T

**10. Publicly-Funded Program.** Any program funded in whole, or in part, by an appropriation of the U.S. Congress, the Idaho Legislature, or other governmental body. (3-20-20)T

- 11. Punishment.** The use of an adverse consequence with a resident, the administration of any noxious or unpleasant stimulus, or deprivation of a resident's rights or freedom. (3-20-20)T
- 12. Relative.** A person related by birth, adoption, or marriage. (3-20-20)T
- 13. Repeat Deficiency.** A deficiency found on a licensure survey, complaint investigation, or follow-up survey that was also found on the previous survey. (3-20-20)T
- 14. Reportable Incident.** A situation when a facility is required to report information to the Residential Assisted Living Facilities Program, including: (3-20-20)T
- a.** Any resident injury of unknown origin (i.e., an injury, the source of which was not observed by any person and could not be explained by the resident); (3-20-20)T
  - b.** Any resident injury of significant or suspicious nature (i.e., an injury that includes severe bruising, fingerprint bruises, laceration(s) larger than a minor skin tear, sprains, or fractured bones); (3-20-20)T
  - c.** Resident injury resulting from accidents involving facility-sponsored transportation. (i.e., falling from the facility's van lift, a wheelchair belt coming loose during transport, or a collision); (3-20-20)T
  - d.** Resident elopement of any duration; (3-20-20)T
  - e.** Any injury resulting from a resident-to-resident incident; (3-20-20)T
  - f.** An incident that results in the resident's need for assessment or treatment outside of the facility; or (3-20-20)T
  - g.** An incident that results in the resident's death. (3-20-20)T
- 15. Resident.** An adult, other than the owner, administrator, their immediate families, or employees, who lives in a residential assisted living facility. (3-20-20)T
- 16. Residential Assisted Living Facility.** A facility or residence, however named, licensed in the state of Idaho, operated on either a profit or nonprofit basis for the purpose of providing necessary supervision, personal assistance, meals, and lodging to three (3) or more adults not related to the owner. (3-20-20)T
- 17. Room and Board.** Lodging, meals, and utilities. (3-20-20)T
- 18. Scope.** The frequency or extent of the occurrence of a deficiency in a facility. (3-20-20)T
- 19. Self-Administration of Medication.** The act of a resident taking a single dose of their own medication from a properly labeled container and placing it internally in, or externally on, their own body as a result of an order by an authorized provider. (3-20-20)T
- 20. Story.** A level of rooms in a building. (3-20-20)T
- 21. Substantial Compliance.** The status of a facility that has no core issue deficiencies. (3-20-20)T
- 22. Substantial Evening Meal.** An offering of three (3) or more menu items at one time, one (1) of which is a high-quality protein such as meat, fish, eggs, or cheeses. The meal should represent no less than twenty percent (20%) of the day's total nutritional requirements. (3-20-20)T
- 23. Supervision.** A critical watching and directing activity which provides protection, guidance, knowledge of the resident's general whereabouts, and assistance with activities of daily living. The administrator is responsible for providing appropriate supervision based on each resident's Negotiated Service Agreement or other legal requirements. (3-20-20)T

**24. Survey.** A review conducted by a surveyor to determine compliance with statutes and rules. There are two (2) components to a survey: (1) health care and (2) fire, life, and safety. (3-20-20)T

**25. Surveyor.** A person authorized by the Department to conduct surveys or complaint investigations to determine compliance with statutes and rules. (3-20-20)T

**26. Therapeutic Diet.** A diet ordered by a physician or authorized provider as part of treatment for a clinical condition or disease, to eliminate or decrease specific nutrients in the diet (e.g. sodium), to increase specific nutrients in the diet (e.g. potassium), or to provide food the resident is able to eat (e.g. a mechanically-altered diet). (3-20-20)T

**27. Toxic Chemical.** A substance that is hazardous to health if inhaled, ingested, or absorbed through skin. (3-20-20)T

**28. Traumatic Brain Injury (TBI).** An acquired injury to the brain caused by an external physical force, resulting in total or partial functional disability or psychosocial impairment. The term applies to open or closed-head injuries resulting in impairments in one (1) or more areas. (3-20-20)T

**29. Unlicensed Assistive Personnel (UAP).** Staff, with or without formal credentials, employed to perform nursing care services under the direction and supervision of licensed nurses. (3-20-20)T

**30. Variance.** Permission by the Department to do something contrary to rule. (3-20-20)T

**013. -- 049. (RESERVED)**

**050. VARIANCES.**

The Licensing Agency may grant a variance provided the following criteria are met. (3-20-20)T

**01. Written Request.** A written request for a variance must be sent to the Licensing Agency. The request must include the following: (3-20-20)T

**a.** Reference to the rule for which the variance is requested; (3-20-20)T

**b.** Reasons that show good cause why the variance should be granted, the extenuating circumstances which caused the need for the variance, any compensating factors or conditions that may have bearing on the variance such as additional floor space or additional staffing; and (3-20-20)T

**c.** Written documentation that ensures residents' health and safety will not be jeopardized if a variance is granted. (3-20-20)T

**02. Temporary Variance.** A temporary variance may be granted for a specific resident or situation. The variance expires when the resident no longer lives at the facility or when the situation no longer exists. (3-20-20)T

**03. Continuing Temporary Variance.** The Licensing Agency reviews the appropriateness of continuing a variance during the survey process. If the facility administrator wishes to continue the variance, an annual request must be submitted to the Licensing Agency in writing. (3-20-20)T

**04. Decision to Grant a Variance.** The decision to grant a variance will not be considered as a precedent or be given any force or effect in any other proceeding. (3-20-20)T

**05. Revocation of Variance.** The Licensing Agency may revoke a variance if circumstances identify a risk to resident health and safety. (3-20-20)T

**051. -- 099. (RESERVED)**

**100. LICENSING REQUIREMENTS.**

**01. Current License.** No person, firm, partnership, association, corporation, or governmental unit can operate, establish, manage, conduct, or maintain a residential assisted living facility in Idaho without a license issued by the Department as required in Section 39-3340, Idaho Code. Any entity found operating as a residential assisted living facility without a license is subject to Section 39-3352, Idaho Code. (3-20-20)T

**02. Issuance of License.** Upon completion of the application process requirements, the Department will issue a residential assisted living license. (3-20-20)T

**03. Distinctive Business Name.** Every facility must use a distinctive name, which is registered with the Idaho Secretary of State. If a facility decides to change its name, it will only be changed upon written notification to the Licensing Agency confirming the registration of the name change with the Idaho Secretary of State. This notification needs to be received by the Licensing Agency at least thirty (30) calendar days prior to the date the proposed name change is to be effective. (3-20-20)T

**04. Administrator.** Each facility must have an administrator. (3-20-20)T

**05. Display of Facility License.** The current facility license must be posted in the facility and clearly visible to the general public. (3-20-20)T

**06. Change in Corporate Shares.** When there is a significant change in shares held by a corporate licensee of a residential assisted living facility, which does not alter the overall ownership or operation of the business, that change must be communicated to the Licensing Agency within (60) days of the effective date of change. (3-20-20)T

**07. Licensee Responsibility.** The licensee of the facility is responsible for the operation of the residential assisted living facility, even when a separate administrator is employed. (3-20-20)T

**101. -- 104. (RESERVED)**

**105. CHANGE OF OWNERSHIP.**

**01. Non-Transfer of Facility License.** A facility license is not transferable from one (1) individual to another, from one (1) business entity to another, or from one (1) location to another. When a change of licensee, ownership, lease, or location occurs, the facility must be re-licensed. The new licensee must follow the application procedures, and obtain a license, before commencing operation as a facility. (3-20-20)T

**02. Application for Change of Ownership.** The application for a change of ownership must be submitted to the Licensing Agency at least ninety (90) days prior to the proposed date of change. (3-20-20)T

**03. Change of Ownership for a Facility in Litigation.** An application for change of ownership of a facility from a person who is in litigation for failure to meet licensure standards, or who has had a license revoked, must include evidence that there is a bona fide, arms-length agreement and relationship between the two (2) parties. An entity purchasing a facility with an enforcement action acquires the enforcement action. (3-20-20)T

**106. -- 109. (RESERVED)**

**110. FACILITY LICENSE APPLICATION.**

**01. License Application.** License application forms are available online at the Licensing Agency's website at <http://www.assistedliving.dhw.idaho.gov>. The applicant must provide the following information: (3-20-20)T

**a.** A written statement that the applicant has thoroughly read and reviewed the statute, Title 39, Chapter 33, Idaho Code, and IDAPA 16.03.22, "Residential Assisted Living Facilities," and is prepared to comply with both; (3-20-20)T

**b.** A written statement and documentation that demonstrate no license revocation or other enforcement action has been taken, or is in the process of being taken, against a license held, or previously held, by the applicant in Idaho or any other state or jurisdiction; (3-20-20)T

**c.** When the applicant is a firm, association, organization, partnership, business trust, corporation, government entity, or company, the administrator and other members of the organization who directly influence the facility's operation must provide the information contained in this rule; (3-20-20)T

**d.** Each shareholder or investor holding ten percent (10%) or more interest in the business must be listed on the application; (3-20-20)T

**e.** A copy of the Certificate of Assumed Business Name from the Idaho Secretary of State; (3-20-20)T

**f.** A statement from the local fire authority that the facility is located in a lawfully constituted fire district or affirmation that a lawfully constituted fire authority will respond to a fire at the facility; (3-20-20)T

**g.** A statement from a licensed electrician or the local or state electrical inspector that all wiring in the facility complies with current electrical codes; (3-20-20)T

**h.** When the facility does not use an approved municipal water or sewage treatment system, a statement from a local environmental health specialist with the public health district indicating that the water supply and sewage disposal system meet the Department's requirements and standards; (3-20-20)T

**i.** A complete set of printed operational policies and procedures; (3-20-20)T

**j.** A detailed floor plan of the facility, including measurements of all rooms, or a copy of architectural drawings. See Sections 250 through 260, 400 through 410, and 430 of these rules. (3-20-20)T

**k.** A copy of the Purchase Agreement, Lease Agreement, or Deed; and (3-20-20)T

**l.** For facilities with nine (9) beds or more, signatures must be obtained from the following: (3-20-20)T

i. The local zoning official documenting that the facility meets local zoning codes for occupancy; (3-20-20)T

and ii. The local building official documenting that the facility meets local building codes for occupancy; (3-20-20)T

iii. The local fire official documenting that the facility meets local fire codes for occupancy. (3-20-20)T

**02. Written Request for Building Evaluation.** The applicant must request in writing to the Licensing Agency for a building evaluation of existing buildings. The request must include the physical address of the building that is to be evaluated and the name, address, and telephone number of the person who is to receive the building evaluation report. (3-20-20)T

**03. Building Evaluation Fee.** This application and request must be accompanied by a five hundred dollar (\$500) initial building evaluation fee. (3-20-20)T

**04. Identification of the Licensed Administrator.** The applicant must provide a copy of the administrator's license and criminal history background check, and the current address for the primary residence of the administrator. (3-20-20)T

**05. Failure to Complete Application Process.** Failure of the applicant to complete the Licensing

Agency's application process within six (6) months of the original date of application, may result in a denial of the application. If the application is denied, the applicant is required to initiate a new licensing application process. (3-20-20)T

**111. -- 114. (RESERVED)**

**115. EXPIRATION AND RENEWAL OF LICENSE.**

**01. Application for License Renewal.** The facility must submit to the Licensing Agency an annual report and application for renewal of a license at least thirty (30) days prior to the expiration of the existing license. (3-20-20)T

**02. Existing License.** The existing license, unless suspended, surrendered, or revoked, remains in force and effect until the Licensing Agency has acted upon the application renewal, when such application for renewal has been filed. (3-20-20)T

**116. -- 125. (RESERVED)**

**126. EFFECT OF ENFORCEMENT ACTION AGAINST A LICENSE.**

The Department will not review an application of an applicant who has an action, either current or in process, against a license held by the applicant either in Idaho or any other state or jurisdiction. (3-20-20)T

**127. -- 129. (RESERVED)**

**130. INSPECTION OF FACILITIES.**

**01. Surveys of Facilities.** As described in Section 39-3355, Idaho Code, the Licensing Agency will conduct inspections and investigations at specified intervals to determine compliance with this chapter of rules and Title 39, Chapter 33, Idaho Code. The intervals for surveys are as follows: (3-20-20)T

**a.** Initial surveys will be conducted within ninety (90) days of licensure, followed by a licensure survey within fifteen (15) months. (3-20-20)T

**b.** Facilities without core issue deficiencies during two (2) consecutive surveys, either initial or licensure surveys, will be inspected at least every thirty-six (36) months. For facilities with core issue deficiencies during any survey, surveys will be conducted at the discretion of the Licensing Agency, at least every twelve (12) months. (3-20-20)T

**c.** Complaint investigation surveys will occur based on the potential severity of the complaint. (3-20-20)T

**02. Unannounced Inspections.** Licensure, follow-up, and complaint investigation surveys are made unannounced and without prior notice. (3-20-20)T

**03. Inspection or Survey Services.** The Department may accept the services of any qualified person or organization, either public or private, to examine, survey, or inspect any entity requesting or holding a facility license, including as described in Section 39-3355(7), Idaho Code. (3-20-20)T

**04. Access and Authority to Entire Facility.** A surveyor must have full access and authority to examine: (3-20-20)T

**a.** Quality of care; (3-20-20)T

**b.** Service delivery; (3-20-20)T

**c.** Resident records; (3-20-20)T



**d.** Facility records, including any records or documents pertaining to any financial transactions between residents and the facility or any of its employees; (3-20-20)T

**e.** Resident accounts; (3-20-20)T

**f.** The physical premises, including buildings, grounds, equipment, food service, water supply, and housekeeping; and (3-20-20)T

**g.** Any other areas necessary to determine compliance with applicable statute, rules, and standards. (3-20-20)T

**05. Interview Authority.** A surveyor has the authority to interview any individual associated with the facility or the provision of care, including the licensee, administrator, staff, residents, residents' families, outside service providers, and authorized providers or physicians. Interviews are confidential and conducted privately unless otherwise specified by the interviewee. (3-20-20)T

**06. Access to Staff Living Quarters.** A surveyor has full authority to inspect the facility, including personal living quarters of the licensee, administrator, or staff living in the facility, to check for inappropriate storage of combustibles, faulty wiring, or other conditions that may have a direct impact on compliance with these rules. (3-20-20)T

**07. Written Report of Deficiencies.** The Licensing Agency will provide the facility a written report to support any deficiencies identified. (3-20-20)T

**a.** The Licensing Agency will provide the facility a written report specifying the non-core issue deficiencies at the time of the exit conference. (3-20-20)T

**b.** When core issues are identified during a survey, the Licensing Agency will provide a written report within ten (10) business days after the exit conference or the last day of receipt of additional material. (3-20-20)T

**c.** If any deficiencies pose an immediate danger to the residents, the Department requires immediate correction of the deficient practice. (3-20-20)T

**08. Plan of Correction for Core Issues.** The facility must develop and submit an acceptable plan of correction to the Licensing Agency within ten (10) calendar days of receipt of the written report of identified core issues. If an acceptable plan of correction is not submitted within the required time frame, the Department may initiate or extend enforcement actions as described in Sections 900 through 940 of these rules. An acceptable plan of correction must include: (3-20-20)T

**a.** A plan to ensure correction of each deficient practice and ongoing compliance; (3-20-20)T

**b.** A description of how, and at what frequency, corrective actions will be monitored to ensure that each deficient practice is corrected and will not recur, such as what program will be put into place to monitor the continued effectiveness of the systemic change; and (3-20-20)T

**c.** The completion date for correcting each deficiency. No correction date may be more than forty-five (45) days from the exit date printed on the written report except in unusual circumstances and only with the written approval of the Licensing Agency. (3-20-20)T

**09. Correction of Non-Core Issues.** The facility must correct non-core issues within thirty (30) calendar days of the exit conference. If there are non-core issues that the facility is unable to resolve due to extenuating circumstances, a written request for the delay must be submitted for Licensing Agency approval within thirty (30) days of the exit conference. The request must contain the following information: (3-20-20)T

**a.** The reason for the delay; (3-20-20)T

**b.** A plan for resolution; (3-20-20)T

- c. The date of the expected resolution, which may not exceed six (6) months; and (3-20-20)T
- d. A plan for ensuring the safety of the residents until resolution. (3-20-20)T

**10. Follow-Up Surveys.** The Licensing Agency will conduct follow-up surveys to ascertain corrections to issues that are made according to the time frames established in the plan of correction for core issues and within thirty (30) days for non-core issues. If the Department identifies repeat deficient facility practice(s) during any follow-up survey, the Department may initiate or extend enforcement actions as described in Sections 900 through 940 of these rules. (3-20-20)T

**131. -- 149. (RESERVED)**

**150. POLICIES AND PROCEDURES.**

The facility must develop a written, dated set of policies and procedures that are specific to the population served in the facility and are available to all staff at all times to direct and ensure compliance with these rules. Policy topics must include abuse, neglect, exploitation, incidents and accidents, activities, admissions, emergency preparedness, infection control, nursing, resident rights, staffing, and medications. (3-20-20)T

**151. ACTIVITY REQUIREMENTS.**

Each facility must develop and implement a written activity policy that assists, encourages, and promotes residents to maintain and develop their highest potential for independent living through their participation in planned, recreational, and other activities. The facility must provide opportunities for the following activities; (3-20-20)T

**01. Socialization.** Socialization through group discussion, conversation, recreation, visiting, arts and crafts, and music; (3-20-20)T

**02. Physical Activities.** Physical activities such as games, sports, and exercises which develop and maintain strength, coordination, and range of motion; and (3-20-20)T

**03. Education.** Education through special classes or events; and (3-20-20)T

**04. Facility.** The facility will utilize community resources to promote resident participation in integrated activities of their choice both in and away from the facility. (3-20-20)T

**152. ADMISSION REQUIREMENTS.**

**01. Admissions Policies.** Each facility must develop and implement written admission policies and procedures, which must include: (3-20-20)T

a. The purpose, quantity and characteristics of available services; (3-20-20)T

b. Limitations concerning delivery of routine personal care by persons of the opposite gender; (3-20-20)T

c. Notification to potential and existing residents and responsible parties if the facility accepts any residents who are on the sexual offender registry. The registry may be accessed online at [http://isp.idaho.gov/sor\\_id/search.html](http://isp.idaho.gov/sor_id/search.html); and (3-20-20)T

d. Notification to potential and existing residents if non-resident adults or children reside in the facility. (3-20-20)T

**02. Resident Admission, Discharge, and Transfer.** The facility must have policies addressing admission, discharge, and transfer of residents to, from, or within the facility. (3-20-20)T

**03. Policies of Acceptable Admissions.** Written descriptions of the conditions for admitting residents to the facility must include: (3-20-20)T

- a. A resident will be admitted or retained only when: (3-20-20)T
  - i. The facility has the capability, capacity, and services to provide appropriate care; (3-20-20)T
  - ii. The resident does not require a type of service for which the facility is not licensed to provide or which the facility does not provide or arrange for; or (3-20-20)T
  - iii. The facility has the personnel, appropriate in numbers and with appropriate knowledge and skills to provide such services. (3-20-20)T
- b. No resident will be admitted or retained who requires ongoing skilled nursing or care not within the legally licensed authority of the facility. Such residents include: (3-20-20)T
  - i. A resident who has a gastrostomy tube, arterial-venous (AV) shunt, or supra-pubic catheter inserted within the previous twenty-one (21) days; (3-20-20)T
  - ii. A resident who is receiving continuous total parenteral nutrition (TPN) or IV therapy; (3-20-20)T
  - iii. A resident who requires physical restraints, including bed rails; (3-20-20)T
  - iv. A resident who is comatose, except for a resident who has been assessed by a physician or authorized provider who has determined that death is likely to occur within thirty (30) days; (3-20-20)T
  - v. A resident who is on a mechanically supported breathing system, except for residents who use positive airway pressure devices only for sleep apnea, such as CPAP or BiPAP; (3-20-20)T
  - vi. A resident who has a tracheotomy who is unable to care for the tracheotomy independently; (3-20-20)T
  - vii. A resident who requires the use of a syringe to receive liquid or pureed nourishment directly into the mouth; (3-20-20)T
  - viii. A resident with open, draining wounds for which the drainage cannot be contained; (3-20-20)T
  - ix. A resident with a Stage 3 or 4 pressure injury or a pressure injury that is unstageable; (3-20-20)T
  - x. A resident with any type of pressure injury or open wound that is not improving bi-weekly; (3-20-20)T
  - xi. For any resident who is assessed to require nursing care, the facility must ensure a licensed nurse is available to meet the needs of the resident. (3-20-20)T
  - xii. A resident who has physical, emotional, or social needs that are not compatible with the other residents in the facility; (3-20-20)T
  - xiii. A resident who is violent or a danger to themselves or others; (3-20-20)T
  - xiv. Residents who are not capable of self evacuation must not be admitted or retained by a facility which does not comply with NFPA Standard 101 as referenced in Section 004 of these rules. (3-20-20)T

**153. FINANCIAL REQUIREMENTS.**

Each facility must develop and implement financial policies and procedures that include: (3-20-20)T

- 01. Statement.** A statement specifying if the facility does not manage resident funds. (3-20-20)T
- 02. Safeguarding of Funds.** Policies should specify how residents' funds will be handled and

safeguarded, if the facility does manage resident funds. Policies must address the following: (3-20-20)T

**a.** When a resident's funds are deposited with, or handled by the facility, the funds must be managed as described in Section 39-3316, Idaho Code, and Section 550 of these rules; (3-20-20)T

**b.** A description of how facility fees are handled; (3-20-20)T

**c.** Resident accounts and funds must be separate from any facility accounts; (3-20-20)T

**d.** The facility cannot require a resident to purchase goods or services from the facility, other than items specified in the admission agreement and facility policies; (3-20-20)T

**e.** Each transaction with resident funds must be documented at the time to include signatures of the resident and facility representative with copies of receipts; (3-20-20)T

**f.** Residents must have access to their personal funds during normal business hours; and (3-20-20)T

**g.** When a resident permanently leaves the facility, the facility can only retain room and board funds prorated to the last day of the thirty (30) day notice, except in situations described in Sections 217 and 550 of these rules. All remaining funds are the property of the resident. (3-20-20)T

**154. STAFF TRAINING REQUIREMENTS.**

The facility must develop and implement policies and procedures to address the following: (3-20-20)T

**01. Response of Staff to Accidents, Incidents, or Allegations of Abuse, Neglect, or Exploitation of Residents.** The facility must develop policies and procedures to ensure that accidents, incidents, or allegations of abuse, neglect, and exploitation are identified, documented, reported, investigated, and followed-up with interventions to prevent re-occurrence and ensure protection. (3-20-20)T

**02. Response of Staff to Emergencies.** How staff are to respond to emergency situations, including: (3-20-20)T

**a.** Medical and psychiatric emergencies; (3-20-20)T

**b.** Resident absence; (3-20-20)T

**c.** Criminal situations; and (3-20-20)T

**d.** Presence of law enforcement officials at the facility. (3-20-20)T

**03. Notification of Changes to Resident Health or Mental Status.** Who and how staff are to notify of any changes in residents' health or mental status. (3-20-20)T

**04. Provided Care and Services by Staff.** How staff are to provide care and services to residents in the following areas: (3-20-20)T

**a.** Activities of daily living; (3-20-20)T

**b.** Dietary and eating, including when a resident refuses to eat or follow a prescribed diet; (3-20-20)T

**c.** Dignity; (3-20-20)T

**d.** Ensuring each individual's rights; (3-20-20)T

**e.** Medication assistance; (3-20-20)T

**f.** Provision of privacy; (3-20-20)T

- g.** Social activities; (3-20-20)T
- h.** Supervision; (3-20-20)T
- i.** Supporting resident independence; and (3-20-20)T
- j.** Telephone access. (3-20-20)T
- 05. Intervention Procedures to Ensure Safety of Residents and Staff.** How to intervene to ensure resident and staff safety in unsafe situations that are physically or behaviorally caused. (3-20-20)T
- 06. Behavior Management for Residents.** The facility must have policies and procedures to ensure staff are trained and complete timely assessment, plan development, and documentation as described in Section 330 of these rules. (3-20-20)T
- 07. Facility Operations, Inspections, Maintenance, and Testing.** Plans and procedures for the operation, periodic inspection, and testing of the physical plant, which includes utilities, fire safety, and plant maintenance for all areas of the facility's campus. (3-20-20)T
- 08. Hazardous Materials.** The handling of hazardous materials. (3-20-20)T
- 09. Mechanical Equipment.** The handling of potentially dangerous mechanical equipment. (3-20-20)T
- 155. EMERGENCY PREPAREDNESS REQUIREMENTS.**  
Each facility must develop and implement an emergency preparedness plan to follow in the event of fire, explosion, flood, earthquake, high wind, or other emergency. (3-20-20)T

  - 01. Relocation Agreements.** Each facility must have a written agreement developed between the facility and two (2) separate locations to which residents would be relocated in the event the building is evacuated and cannot be reoccupied. The facility will review the agreements annually. (3-20-20)T
  - 02. Written Procedures.** The facility must have written procedures outlining steps to be taken in the event of an emergency including: (3-20-20)T

    - a.** Each person's responsibilities; (3-20-20)T
    - b.** Where and how residents are to be evacuated; and (3-20-20)T
    - c.** Notification of emergency agencies. (3-20-20)T
  - 03. Emergency Generators.** Facilities that elect to have an emergency generator must ensure that the system is designed to meet the applicable codes in NFPA Standard 110 (within NFPA Standard 101 as incorporated in Section 004 of these rules). (3-20-20)T
- 156. HOURLY ADULT CARE REQUIREMENTS.**  
Facilities offering hourly adult care must develop and implement written policies and procedures which include the following: (3-20-20)T

  - 01. Services Offered.** A description of hourly adult care services, including transportation services (if offered), meals, activities, and supervision. (3-20-20)T
  - 02. Individuals Accepted.** Types of individuals who may or may not be accepted for hourly adult care, See Section 152 of these rules. (3-20-20)T
  - 03. Cost of Hourly Adult Care.** Details of the cost of hourly adult care for the person receiving

services. (3-20-20)T

**04. Hours for Care.** The specific time periods of hourly adult care not to exceed fourteen (14) consecutive hours in a twenty-four (24) hour period. (3-20-20)T

**05. Assistance with Medications.** Assistance with medications in the facility must comply with IDAPA 23.01.01, "Rules of the Idaho Board of Nursing," including: (3-20-20)T

**a.** Copies of all physician or authorized provider orders, including orders for all prescribed medications and treatments. (3-20-20)T

**b.** Appropriately labeled medications and treatments the facility safeguards while the person receives hourly adult care. (3-20-20)T

**06. Staffing.** Staffing must be based on the needs of the entire facility, including those receiving hourly adult care and residents. Hourly adult care may be provided to as many individuals as possible without disrupting the day-to-day operations and normal activities of the facility. (3-20-20)T

**07. Accommodations.** The facility must provide accommodations appropriate to the time frame for those receiving hourly adult care, including: (3-20-20)T

**a.** Daytime accommodations such as recliners and couches for napping. Napping furniture must be spaced at least (3) feet apart. (3-20-20)T

**b.** Evening accommodations such as beds and bedrooms that are not used by facility residents. Any bed used overnight by a person receiving hourly adult care will not be counted as a licensed bed. (3-20-20)T

**08. Documentation.** Documentation requirements described in Section 330 of these rules. (3-20-20)T

**157. -- 160. (RESERVED)**

**161. SMOKING REQUIREMENTS.**

The facility must develop and implement written rules governing smoking. Nothing in this rule requires a facility to permit smoking. Smoking policies must be made known to all staff, residents, and visiting public and must ensure: (3-20-20)T

**01. Combustible Supplies and Flammable Items.** Smoking is prohibited in areas where combustible supplies or materials, flammable liquids, gases, or oxidizers are in use or stored; (3-20-20)T

**02. Smoking in Bed.** Smoking in bed is prohibited. (3-20-20)T

**03. Unsupervised Smoking.** Unsupervised smoking by residents classified as not mentally or physically responsible, sedated by medication, or taking oxygen is prohibited. (3-20-20)T

**04. Designated Smoking Areas.** If smoking is permitted, there must be designated smoking areas which are specified in policy and clearly marked. Designated smoking areas must have non-combustible disposal receptacles. (3-20-20)T

**162. -- 214. (RESERVED)**

**215. REQUIREMENTS FOR A FACILITY ADMINISTRATOR.**

Under Section 39-3321, Idaho Code, each facility must have one (1) licensed administrator assigned as the person responsible for the day-to-day operation of the facility. Multiple facilities under one (1) administrator may be allowed by the Department based on an approved plan of operation for up to three (3) buildings with a total of no more than fifty (50) beds, or up to two (2) buildings with a total of no more than eighty (80) beds. The criteria and procedure for requesting to have multiple facilities under one (1) administrator is posted on the Residential Assisted Living Facilities Program website. (3-20-20)T

**01. Administrator Responsibility.** The administrator is responsible for ensuring that policies and procedures are developed and implemented to fulfill the requirements in Title 39, Chapter 33, Idaho Code, and IDAPA 16.03.22, "Residential Assisted Living Facilities." (3-20-20)T

**02. Availability of Administrator.** The facility's administrator must be on-site sufficiently to ensure safe and adequate care of the residents. The facility's administrator or their designee must be available to be on-site at the facility within two (2) hours. The facility must continuously employ an administrator. (3-20-20)T

**03. Lapse of Administrator.** If the facility operates for more than thirty (30) days without a licensed administrator, it will result in a core issue deficiency. (3-20-20)T

**04. Representation of Residents.** The owner or administrator, their relatives, and employees cannot act as, or seek to become the legal guardian of, or have power of attorney for any resident. Specific limited powers of attorney to address emergency procedures where competent consent cannot otherwise be obtained, are permitted. (3-20-20)T

**05. Responsibility for Acceptable Admissions.** The administrator must ensure that no resident is knowingly admitted or retained who requires care as defined in Section 39-3307, Idaho Code, and Section 152 of these rules. (3-20-20)T

**06. Sexual Offender.** The administrator must ensure that a non-resident on the sexual offender registry is not allowed to live or work in the facility. (3-20-20)T

**07. Notification of Adult Protection and Law Enforcement.** The administrator must ensure that adult protection and law enforcement are notified in accordance with Sections 39-5303 and 39-5310, Idaho Code. (3-20-20)T

**08. Procedures for Investigations.** The administrator must ensure the facility procedures for investigation of complaints, incidents, accidents, and allegations of abuse, neglect, or exploitation are implemented to ensure resident safety. Procedures must include: (3-20-20)T

**a. Administrator Notification.** The administrator, or person designated by the administrator, must be notified of all incidents, accidents, allegations of abuse, neglect, or exploitation immediately, and notified of complaints within one (1) business day. (3-20-20)T

**b. Investigation within Thirty Days.** The administrator or designee must complete an investigation and written report of the findings within thirty (30) calendar days for each accident, incident, complaint, or allegation of abuse, neglect, or exploitation. (3-20-20)T

**c. Resident Protection.** Any resident involved must be protected during the course of the investigation. (3-20-20)T

**d. Written Response to Complaint within Thirty Days.** The person making the complaint must receive a written response from the facility of the action taken to resolve the matter, or the reason why no action was taken within thirty (30) days of the complaint. (3-20-20)T

**e. Corrective Action.** When abuse, neglect, exploitation, incidents, and accidents occur, corrective action must be immediately taken and monitored to ensure the problem does not recur. (3-20-20)T

**f. Notification of Licensing Agency within One Business Day.** When a reportable incident occurs, the administrator or designee must notify the Licensing Agency within one (1) business day of the incident. (3-20-20)T

**g. Identify and Monitor Patterns.** The administrator or designee must identify and monitor patterns of accidents, incidents, or complaints and must develop interventions to prevent recurrences. (3-20-20)T

**09. Administrator's Designee.** A person authorized in writing to act in the absence of the administrator. An administrator's designee may act in the absence of the administrator for no longer than thirty (30) consecutive days when the administrator is on vacation, has days off, is ill, or is away for training or meetings.

(3-20-20)T

**10. Ability to Reach Administrator or Designee.** The administrator or their designee must be reachable and available at all times.

(3-20-20)T

**11. Minimum Age of Personnel.** The administrator will ensure that no personnel providing hands-on care or supervision services will be under eighteen (18) years of age unless they have completed a certified nursing assistant (CNA) certification course.

(3-20-20)T

**12. Notification to Licensing Agency.** The facility must notify the Licensing Agency, in writing, within three (3) business days of a change of administrator.

(3-20-20)T

## **216. REQUIREMENTS FOR ADMISSION AGREEMENTS.**

**01. Initial Resident Assessment and Care Plan.** Prior to admission, each resident must be assessed by the facility to ensure the resident is appropriate for placement in their residential assisted living facility. The facility must develop an interim care plan to guide services until the facility can complete the resident assessment process. The result of the assessment will determine the need for specific services and supports.

(3-20-20)T

**02. Written Agreement.** Prior to, or on the day of admission, the facility and each resident or the resident's legal guardian or conservator must enter into a written admission agreement that is transparent, understandable, and is translated into a language the resident or their representative understands. The admission agreement will provide a complete reflection of the facility's charges, commitments agreed to by each party, and the actual practices that will occur in the facility. The agreement must be signed by all involved parties, and a complete copy provided to the resident and the resident's legal guardian or conservator prior to, or on the day of admission. The admission agreement may be integrated within the Negotiated Service Agreement (NSA), provided that all requirements for the NSA in Section 320 of these rules and the admission agreement are met. Admission agreements must include all items described under this rule.

(3-20-20)T

**03. Services, Supports, and Rates.** The facility must identify the following services, supports, and applicable rates:

(3-20-20)T

**a.** Unless otherwise negotiated with the resident, or the resident's legal guardian or conservator, the basic services must include the items specified in Section 430 of these rules.

(3-20-20)T

**b.** The resident's monthly charges, including a specific description of the services that are included in the basic services rate and the charged rate.

(3-20-20)T

**c.** All prices, formulas, and calculations used to determine the resident's basic services rate including:

(3-20-20)T

**i.** Service packages;

(3-20-20)T

**ii.** Fee-for-service rates;

(3-20-20)T

**iii.** Assessment forms;

(3-20-20)T

**iv.** Price per assessment point;

(3-20-20)T

**v.** Charges for levels of care determined with an assessment; and

(3-20-20)T

**vi.** Move-in fees or other similar charges.

(3-20-20)T

**d.** The services and rates charged for additional or optional services, supplies, or amenities that are



available through the facility or arranged for by the facility for which the resident will be charged additional fees. (3-20-20)T

**e.** Services or rates that are impacted by an updated assessment of the resident, the assessment tool, the assessor, and the frequency of the assessment, when the facility uses this assessment to determine rate changes. (3-20-20)T

**f.** The facility may charge residents for the use of personal furnishings, equipment, and supplies provided by the facility unless paid for by a publicly funded program. The facility must provide a detailed itemization of furnishings, equipment, supplies, and the rate for those items the resident will be charged. (3-20-20)T

**04. Staffing.** The agreement must identify staffing patterns and qualifications of staff on-duty during a normal day. (3-20-20)T

**05. Notification of Liability Insurance Coverage.** The administrator of a residential assisted living facility must disclose in writing at the time of admission or before a resident's admission if the facility does not carry professional liability insurance. If the facility cancels the professional liability insurance all residents must be notified of the change in writing. (3-20-20)T

**06. Medication Responsibilities.** The agreement must identify the facility's and resident's roles and responsibilities relating to assistance with medications including the reporting of missed medications or those taken on a PRN basis. (3-20-20)T

**07. Resident Personal Fund Responsibilities.** The agreement must identify who is responsible for the resident's personal funds. (3-20-20)T

**08. Resident Belongings Responsibility.** The agreement must identify responsibility for protection and disposition of all valuables belonging to the resident and provision for the return of resident's valuables if the resident leaves the facility. (3-20-20)T

**09. Emergency Transfers.** The agreement must identify conditions under which emergency transfers will be made as provided in Section 152 of these rules. (3-20-20)T

**10. Billing Practices, Notices, and Procedures for Payments and Refunds.** The facility must provide a description of the facility's billing practices, notices, and procedures for payments and refunds. The following procedures must be included: (3-20-20)T

**a.** Arrangement for payments; (3-20-20)T

**b.** Under what circumstances and time frame a partial month's resident fees are to be refunded when a resident no longer resides in the facility; and (3-20-20)T

**c.** Written notice to vacate the facility must be given thirty (30) calendar days prior to transfer or discharge on the part of either party, except in the case of the resident's emergency discharge or death. The facility may charge up to fifteen (15) days prorated rent from the date of the resident's emergency discharge or death. The agreement must disclose any charges that will result when a resident fails to provide a thirty (30) day written notice. (3-20-20)T

**11. Resident Permission to Transfer Information.** The agreement must specify permission for the facility to transfer information from the resident's records to any facility to which the resident transfers. (3-20-20)T

**12. Resident Responsibilities.** The agreement must specify resident responsibilities. (3-20-20)T

**13. Restrictions on Choice of Care or Service Providers.** The agreement must specify any restriction on choice of care or service providers, such as home health agency, hospice agency, or personal care services. (3-20-20)T

**14. Advance Directive.** The agreement must identify written documentation of the resident's preference regarding the formulation of an Advance Directive in accordance with Idaho state law. When a resident has an Advance Directive, a copy must be immediately available for staff and emergency personnel. (3-20-20)T

**15. Notification of Payee Requirements.** The agreement must identify if the facility requires as a condition of admission that the facility be named as payee. (3-20-20)T

**16. Contested Charges.** The facility must provide the methods by which a resident may contest charges or rate increases including contacting the ombudsman for the elderly. (3-20-20)T

**17. Transition to Publicly-Funded Program.** The facility must disclose the conditions under which the resident can remain in the facility if payment for the resident shifts to a publicly-funded program. (3-20-20)T

**18. Smoking Policy.** The admission agreement must include a copy of the facility's smoking policy. (3-20-20)T

**217. REQUIREMENTS FOR TERMINATION OF ADMISSION AGREEMENT.**

**01. Conditions for Termination of the Admission Agreement.** The admission agreement cannot be terminated, except under Section 39-3313, Idaho Code, as follows: (3-20-20)T

**a.** Giving the other party thirty (30) calendar days written notice; (3-20-20)T

**b.** The resident's death; (3-20-20)T

**c.** Emergency conditions that require the resident to be transferred to protect the resident or other residents in the facility from harm; (3-20-20)T

**d.** The resident's mental or medical condition deteriorates to a level requiring care as described in Section 39-3307, Idaho Code, and Section 152 of these rules; (3-20-20)T

**e.** Nonpayment of the resident's fees; (3-20-20)T

**f.** When the facility cannot meet resident needs due to changes in services, in-house or contracted, or inability to provide the services; or (3-20-20)T

**g.** Other written conditions as may be mutually established between the resident, the resident's legal guardian or conservator, and the administrator of the facility at the time of admission. (3-20-20)T

**02. Facility Responsibility During Resident Discharge.** The facility is responsible to assist the resident with transfer by providing a list of skilled nursing facilities, other residential assisted living facilities, and certified family homes that may meet the needs of the resident. The facility must provide a copy of the resident record, as described in Section 330 of these rules, within two (2) business days of receipt of a request signed and authorized by the resident or legal representative. (3-20-20)T

**03. Resident's Appeal of Involuntary Discharge.** A resident may appeal all discharges with the exception of an involuntary discharge in the case of non-payment or emergency conditions that require the resident to be transferred to protect the resident or other residents in the facility from harm. (3-20-20)T

**a.** Before a facility discharges a resident, the facility must notify the resident and their representative of the discharge and the cause. (3-20-20)T

**b.** This notice must be in writing and in a language and manner the resident or their representative can understand. (3-20-20)T

**04. Written Notice of Discharge.** The written notice of discharge must include the following: (3-20-20)T

- a. The specific reason for the discharge; (3-20-20)T
  - b. The effective date of the discharge; (3-20-20)T
  - c. A statement that the resident has the right to appeal the discharge to the Department within thirty (30) calendar days of receipt of written notice of discharge; (3-20-20)T
  - d. The Residential Assisted Living Facilities website, where the appeal must be submitted; (3-20-20)T
  - e. The name, address, and telephone number of the local ombudsman; (3-20-20)T
  - f. The name, address, and telephone number of Disability Rights Idaho (3-20-20)T
  - g. If the resident fails to pay fees to the facility, as agreed to in the admission agreement, during the discharge appeal process, the resident's appeal of the involuntary discharge becomes null and void and the discharge notice applies; and (3-20-20)T
  - h. When the notice does not contain all the above required information, the notice is void and must be reissued. (3-20-20)T
- 05. Receipt of Appeal.** Request for an appeal must be received by the Department within thirty (30) calendar days of the resident's or resident's representative's receipt of written notice of discharge to stop the discharge before it occurs. (3-20-20)T

**218. -- 249. (RESERVED)**

**250. REQUIREMENTS FOR BUILDING CONSTRUCTION AND PHYSICAL STANDARDS.**

Minimum Construction must meet all requirements of this rule to include codes and standards incorporated by reference in Section 004 of these rules, and all local and state codes that are applicable to Residential Assisted Living Facilities. Where there are conflicts between the requirements in the codes, the most restrictive condition must apply. (3-20-20)T

**01. Construction Changes.** For all new construction, change of occupancy, modifications, additions, or renovations to existing buildings, the facility must submit construction drawings with specifications to the licensing authority for review and approval prior to any work being started. All new construction and conversions must install audible and visual notification devices for fire alarm systems in all common areas and resident rooms no matter the size of facility. (3-20-20)T

**02. Plans and Specifications.** Plans must be prepared, signed stamped, and dated by an architect or engineer licensed in the state of Idaho. A variance of this requirement may be granted by the Licensing Agency when the size of the project does not necessitate involvement of an architect or engineer. This must include the following: (3-20-20)T

- a. Plans and specifications must be submitted to the Licensing Agency to ensure compliance with applicable construction standards, codes, and regulations; (3-20-20)T
- b. Plans must be drawn to scale, but no less than a scale of one-eighth (1/8) inch to one (1) foot; (3-20-20)T
- c. Plans must be submitted electronically; (3-20-20)T
- d. A physical address approved by the city; (3-20-20)T
- e. Life safety plans; (3-20-20)T

- f.** Fire alarm shop drawings; and (3-20-20)T
- g.** Fire sprinkler system drawings and calculations. (3-20-20)T
- 03. Approval.** All buildings, additions, and remodeling are subject to approval by the Licensing Agency and must meet applicable requirements. (3-20-20)T
- 04. Walls and Floor Surfaces.** Walls and floors must be of such character to permit cleaning. Walls and ceilings in kitchens, bathrooms, and utility rooms must have washable surfaces. (3-20-20)T
- 05. Toilets and Bathrooms.** Each facility must provide: (3-20-20)T
- a.** A toilet and bathroom for resident use so arranged that it is not necessary for an individual to pass through another resident's room to reach the toilet or bath; (3-20-20)T
- b.** Solid walls or partitions to separate each toilet and bathroom from all adjoining rooms; (3-20-20)T
- c.** Mechanical ventilation to the outside from all inside toilets and bathrooms not provided with an operable exterior window; (3-20-20)T
- d.** Each tub, shower, and lavatory with hot and cold running water; (3-20-20)T
- e.** At least one (1) flushing toilet for every six (6) residents; (3-20-20)T
- f.** At least one (1) tub or shower for every eight (8) residents; (3-20-20)T
- g.** At least one (1) lavatory with a mirror for each toilet; and (3-20-20)T
- h.** At least one (1) toilet, tub or shower, and lavatory in each building in which residents sleep, with additional units if required by the number of persons. (3-20-20)T
- 06. Accessibility for Persons with Mobility and Sensory Impairments.** For residents who have mobility or sensory impairments, the facility must provide a physical environment which meets the needs of the person for independent mobility and use of appliances, bathroom facilities, and living areas. New construction must meet the requirements of the Americans with Disabilities Act Accessibility Guidelines (ADAAG). Existing facilities must comply, to the maximum extent feasible, with 28 CFR Sections 36.304 and 36.305 regarding removal of barriers under the Americans with Disabilities Act, without creating an undue hardship or burden on the facility, and must provide as required, the necessary accommodations: (3-20-20)T
- a.** Ramps for residents who require assistance with ambulation must comply with the requirements of the ADAAG 4.8; (3-20-20)T
- b.** Bathrooms and doors large enough to allow the easy passage of a wheelchair as provided for in the ADAAG 4.13; (3-20-20)T
- c.** Grab bars in resident toilet and bathrooms in compliance with ADAAG 4.26; (3-20-20)T
- d.** Toilet facilities in compliance with ADAAG 4.16 and 4.23; (3-20-20)T
- e.** Non-retractable faucet handles in compliance with ADAAG 4.19, with the exception of self-closing valves under 4.19.5, and 4.27; and (3-20-20)T
- f.** A suitable hand railing must be provided on both sides of all stairs leading into and out of a building for residents who require the use of crutches, walkers, or braces. (3-20-20)T
- 07. Lighting.** The facility must provide adequate lighting in all resident sleeping rooms, dining rooms, living rooms, recreation rooms, and hallways. (3-20-20)T

- 08. Ventilation.** The facility must be ventilated, and precautions taken to prevent offensive odors. (3-20-20)T
- 09. Plumbing.** All plumbing in the facility must comply with local and state codes. All plumbing fixtures must be easily cleanable and maintained in good repair. The temperature of hot water at plumbing fixtures used by residents must be between one hundred five degrees Fahrenheit (105°F) and one hundred twenty degrees Fahrenheit (120°F). (3-20-20)T
- 10. Heating, Ventilation, and Air-Conditioning (HVAC).** Equipment must be furnished, installed, and maintained to meet all requirements of current state and local mechanical, electrical, and construction codes. An HVAC system must be provided for the facility that is capable of maintaining a minimum temperature of seventy degrees Fahrenheit (70°F) and a maximum temperature of seventy-eight degrees Fahrenheit (78°F) during the day, and a minimum of sixty-two degrees Fahrenheit (62°F) and a maximum temperature of seventy-five degrees Fahrenheit (75°F) during the night. Wood stoves, gas fireplaces, or solid burning fireplaces are not permitted as the sole source of heat, and the thermostat for the primary source of heat must be remotely located away from any of these sources. (3-20-20)T
- a.** Portable heating devices of any kind are prohibited. Portable electric space heaters and movable fuel-fired heaters are considered portable comfort heating devices. Exceptions are heated mattress pads, electric blankets, and heating pads when ordered by an authorized provider or physician; (3-20-20)T
- b.** All fireplaces must provide a safety barrier and have heat-tempered glass fireplace enclosures equivalent to ASTM Standard; (3-20-20)T
- c.** Boilers, hot water heaters, and unfired pressure vessels must be equipped with automatic pressure relief valves; (3-20-20)T
- d.** Fire and smoke dampers must be inspected, serviced, and cleaned once every four (4) years by a person professionally engaged in the business of servicing these devices or systems. A copy of these results must be kept in the facility. (3-20-20)T
- 11. Dining, Recreation, Shower, Bathing, and Living Space.** The total area set aside for these purposes must be no less than thirty (30) square feet per licensed bed. A hall or entry cannot be included as living or recreation space. (3-20-20)T
- 12. Resident Sleeping Rooms.** The facility must ensure that: (3-20-20)T
- a.** Resident sleeping rooms are not in attics, stairs, halls, or any other room commonly used for other than bedroom purposes; (3-20-20)T
- b.** A room with a window that opens into an exterior window well cannot be used for a resident sleeping room; (3-20-20)T
- c.** Not more than four (4) residents can be housed in any multi-bed sleeping room in facilities licensed prior to July 1, 1991. New facilities or building converted to a licensed facility after July 1, 1991, cannot have more than two (2) residents in any multi-bed sleeping room. When there is any change in ownership of the facility, the maximum number of residents allowed in any room is two (2); (3-20-20)T
- d.** Square footage requirements for resident sleeping rooms must provide for not less than one hundred (100) square feet of floor space per resident in a single-bed sleeping room and not less than eighty (80) square feet of floor space per resident in a multi-bed sleeping room. For facilities constructed after January 1, 2021, square footage requirements for resident sleeping rooms must provide at least one hundred (100) square feet of floor space per resident for both single bed and multi-bed sleeping rooms. (3-20-20)T
- e.** Each resident's sleeping room must be provided with an operable exterior window. An operable window is not required where there is a door directly to the outside from the sleeping room; (3-20-20)T

**f.** The operable window sill height must not exceed thirty-six (36) inches above the floor in new construction, additions, or remodeling; (3-20-20)T

**g.** The operable window sill height must not exceed forty-four (44) inches above the floor in existing buildings being converted to a facility; (3-20-20)T

**h.** Each resident sleeping room must provide a total window space that equals at least eight percent (8%) of the room's total square footage; (3-20-20)T

**i.** Window screens must be provided on operable windows; (3-20-20)T

**j.** Resident sleeping rooms must have walls that run from floor to ceiling, have doors that will limit the passage of smoke, and provide the resident(s) with privacy; (3-20-20)T

**k.** Ceiling heights in sleeping rooms must be at least seven (7) feet, six (6) inches; and (3-20-20)T

**l.** Closet space in each resident sleeping room must provide at least four (4) usable square feet per resident. Common closets used by two (2) or more residents must have substantial dividers for separation of each resident's clothing. All closets must be equipped with doors. Free-standing closets are deducted from the square footage of the sleeping room. (3-20-20)T

**13. Secure Environment.** If the facility accepts and retains residents who have cognitive impairment and have a history of elopement or attempted elopement, the facility must provide an interior environment and exterior yard that is secure and safe. Because measures to secure the environment may be effective for one (1) resident, but not another, the type of the security provided must be evaluated for effectiveness in protecting each resident, based on their individual needs and abilities, and adjusted as necessary. These measures must be incorporated into the NSA of each applicable resident. (3-20-20)T

**14. Call System.** The facility must have a call system available for each resident to call for assistance and still be ensured a resident's right to privacy at the facility, including the resident's living quarters, common areas, medical treatment, and other services, written and telephonic communications, or in visits with family, friends, advocates, and resident groups. The call system cannot be a substitute for supervision. For facilities licensed prior to January 1, 2006, when the current system is no longer operational or repairable the facility must install a call system as defined in Section 010 of these rules. (3-20-20)T

**15. Dietary Standards.** Each facility must have a full-service kitchen to meet the needs of the residents. Any satellite kitchen must meet all applicable requirements. (3-20-20)T

**251. -- 254. (RESERVED)**

**255. REQUIREMENTS FOR ADDITIONAL PHYSICAL STANDARDS.**

**01. Fire District.** The facility site must be in a lawfully constituted fire district. (3-20-20)T

**02. Roads.** The facility must be served by an all-weather road and kept open to motor vehicles at all times of the year. (3-20-20)T

**03. Medical Accessibility.** The facility site must be accessible to authorized providers or emergency medical services within thirty (30) minutes driving time. (3-20-20)T

**256. -- 259. (RESERVED)**

**260. REQUIREMENTS FOR ENVIRONMENTAL SANITATION.**

**01. Water Supply.** The facility must have an adequate water supply that is safe and of a sanitary quality. (3-20-20)T

- a.** The water supply must be from an approved private, public, or municipal water supply; (3-20-20)T
- b.** Water from a private supply must have water samples submitted annually to either a private accredited laboratory or to the Public Health District Laboratory for bacteriological examination. The Department may require more frequent examinations if warranted; and (3-20-20)T
- c.** There must be a sufficient amount of water under adequate pressure to meet sanitary and fire sprinkler system requirements of the facility at all times. (3-20-20)T
- 02. Sewage Disposal.** All sewage and liquid waste must be discharged into a municipal sewage system where such a system is available. If a municipal sewage system is not available, sewage and liquid waste must be collected, treated, and disposed of in a manner approved by the Department. (3-20-20)T
- 03. Garbage and Refuse Disposal.** Garbage and refuse disposal must be provided to ensure that: (3-20-20)T
- a.** The premises and all buildings must be kept free from the accumulation of weeds, trash, and rubbish; (3-20-20)T
- b.** Material not directly related to the maintenance and operation of the facility must not be stored on the premises; (3-20-20)T
- c.** All containers used for storage of garbage and refuse must be constructed of durable, nonabsorbent material, and must not leak. Containers must be provided with tight fitting lids unless stored in a vermin-proof room or enclosure; and (3-20-20)T
- d.** Garbage containers must be maintained in a sanitary manner. Sufficient containers must be afforded to hold all garbage and refuse which accumulates between periods of removal from the facility. Storage areas must be clean and sanitary. (3-20-20)T
- 04. Insect and Rodent Control.** A pest control program must be in effect at all times. This program must effectively prevent insects, rodents, and other pests from entrance to, or infestation of, the facility. (3-20-20)T
- 05. Linen and Laundry Facilities and Services.** (3-20-20)T
- a.** The facility must have available at all times a quantity of linen essential to the proper care and comfort of residents; (3-20-20)T
- b.** Linen must be of good quality, not thread-bare, torn, or stained; (3-20-20)T
- c.** Linens must be handled, processed, and stored in an appropriate manner that prevents contamination; (3-20-20)T
- d.** Adequate facilities must be provided for the proper and sanitary washing and drying of linen and other washable goods laundered in the facility; (3-20-20)T
- e.** The laundry must be situated in an area separate and apart from where food is stored, prepared, or served; (3-20-20)T
- f.** The laundry area must be well-lighted, ventilated, adequate in size for the needs of the facility, maintained in a sanitary manner, and kept in good repair; (3-20-20)T
- g.** Care must be taken to ensure soiled linen and clothing are properly handled to prevent contamination. Clean linen and clothing received from a laundry service must be stored in a proper manner to prevent contamination; and (3-20-20)T

**h.** Residents' and personnel's personal laundry must be collected, transported, sorted, washed, and dried in a sanitary manner and cannot be washed with general linens (e.g. towels and sheets). (3-20-20)T

**06. Housekeeping Services and Maintenance Services.** Housekeeping, maintenance personnel, and equipment must be provided to maintain the interior and exterior of the facility in a clean, safe, and orderly manner. Prior to occupancy of any sleeping room by a new resident, the room must be thoroughly cleaned including the bed, bedding, and furnishings. (3-20-20)T

**07. Toxic Chemicals.** All toxic chemicals must be properly labeled. Toxic chemicals cannot be stored where food is stored, prepared, or served, where medications are stored, and where residents with cognitive impairment have access. (3-20-20)T

**261. -- 299. (RESERVED)**

**300. REQUIREMENTS FOR NURSING SERVICES.**

The administrator must ensure policies and procedures are developed and implemented to ensure nursing services are performed in accordance with IDAPA 23.01.01, "Rules of the Idaho Board of Nursing" and this chapter of rules. The facility must have on staff sufficient nursing personnel to meet the requirements in this rule. (3-20-20)T

**01. Licensed Registered Nurse (RN).** A licensed registered nurse (RN) must visit the facility at least once every ninety (90) days to conduct initial and quarterly nursing assessments for each resident as described in Section 305 of these rules. The licensed registered nurse is responsible for delegation of nursing functions, according to IDAPA 23.01.01, "Rules of the Idaho Board of Nursing." (3-20-20)T

**02. Licensed Nurse.** The licensed nurse must be available to address changes in a resident's health or mental status, review and implement new orders, and notify the physician or authorized provider when a resident repeatedly refuses to follow physician orders. (3-20-20)T

**301. -- 304. (RESERVED)**

**305. REQUIREMENTS FOR THE LICENSED REGISTERED NURSING ASSESSMENT.**

For each resident the licensed registered nurse must assess and document, including date and signature, the following: (3-20-20)T

**01. Resident Medications and Therapies.** Each resident's use of, and response to all medications, (including over-the-counter, and prescribed therapies), the monitoring of side effects, interactions, abuse, or other adverse effects, and ensuring the resident's physician or authorized provider is notified of any identified concerns with medications and therapies. (3-20-20)T

**02. Current Medication Orders and Treatment Orders.** Each resident's medications and treatment orders are current and verified for the following: (3-20-20)T

**a.** The medication listed on the medication distribution container, including over-the-counter medications are consistent with physician or authorized provider orders; (3-20-20)T

**b.** The physician or authorized provider orders related to therapeutic diets, treatments, and medications for each resident are followed; and (3-20-20)T

**c.** A copy of the actual written, signed, and dated orders are present in each resident's care record. (3-20-20)T

**03. Resident Health Status.** The health status of each resident by conducting a physical assessment and identifying symptoms of illness, or any changes in mental or physical health status. (3-20-20)T

**04. Recommendations.** Recommendations to the administrator regarding any medication needs, other health needs requiring follow-up, or changes needed to the NSA. The nurse must notify the physician or authorized



provider of recommendations for medical care and services that are needed. (3-20-20)T

**05. Progress of Previous Recommendations.** The progress of previous recommendations regarding any medication needs or other health needs that require follow-up. (3-20-20)T

**06. Self-Administered Medication.** Each resident participating in a self-administered medication program at the following times: (3-20-20)T

a. Before the resident can self-administer medication to ensure resident safety; and (3-20-20)T

b. Every ninety (90) days to evaluate the continued validity of the assessment to ensure the resident is still capable to safely self-administer medication(s). (3-20-20)T

**07. Resident and Facility Staff Education.** Recommendations for any health care-related educational needs, for both the resident and facility staff, as the result of the nursing assessment or at the direction of the resident's health care provider. (3-20-20)T

**306. -- 309. (RESERVED)**

**310. REQUIREMENTS FOR MEDICATION.**

Facility policies and procedures must specify how medications will be handled. (3-20-20)T

**01. Medication Distribution System.** Each facility must use medi-sets or blister packs for prescription medications. The facility may use multi-dose medication distribution systems that are provided for resident's receiving medications from the Veterans Administration or Railroad benefits. The medication system must be filled by a pharmacist and appropriately labeled in accordance with pharmacy standards and physician or authorized provider instructions. The facility's licensed nurse may fill medi-sets, blister packs, or other Licensing Agency approved systems as described in Section 39-3326, Idaho Code. (3-20-20)T

a. All medications must be kept in a locked area such as a locked box or room; (3-20-20)T

b. Poisons, toxic chemicals, and cleaning agents must not be stored with medications; (3-20-20)T

c. Biologicals and other medications requiring cold storage must be maintained at thirty-eight degrees Fahrenheit to forty-five degrees Fahrenheit (38°F-45°F), and the temperature monitored and documented daily. (3-20-20)T

d. Assistance with medication must comply with the Board of Nursing requirements; (3-20-20)T

e. Each prescription medication must be given to the resident directly from the medi-set, blister pack, or medication container; (3-20-20)T

f. Each resident must be observed taking the medication; and (3-20-20)T

g. Each prescribed PRN must be available in the facility. (3-20-20)T

**02. Discontinued and Expired Prescriptions.** Discontinued or outdated medications and treatments must be removed from the resident's medication supply and cannot accumulate at the facility for longer than thirty (30) days. The unused medication must be disposed of in a manner that ensures it cannot be retrieved. The facility may enter into agreement, a copy of which must be maintained, with a pharmacy or other authorized entity to return unused, unopened medications for proper disposition. A written record of all drug disposals must be maintained in the facility and include: (3-20-20)T

a. A description of the drug, including the amount; (3-20-20)T

b. Name of the resident for whom the medication is prescribed; (3-20-20)T

- c. The reason for disposal; (3-20-20)T
  - d. The method of disposal; (3-20-20)T
  - e. The date of disposal; and (3-20-20)T
  - f. Signatures of responsible facility personnel and witness. (3-20-20)T
- 03. Controlled Substances.** The facility must track all controlled substances entering the facility, including the amount received, the date, a daily count, reconciliation of the number given or disposed, and the number remaining. (3-20-20)T
- 04. Psychotropic or Behavior Modifying Medication.** (3-20-20)T
- a. Psychotropic or behavior modifying medication intervention must not be the first resort to address behaviors. The facility must attempt non-drug interventions to assist and redirect the resident's behavior. (3-20-20)T
  - b. Psychotropic or behavior modifying medications must be prescribed by a physician or authorized provider. (3-20-20)T
  - c. The facility must monitor the resident to determine continued need for the medication based on the resident's demonstrated behaviors. (3-20-20)T
  - d. The facility must monitor the resident for any side effects that could impact the resident's health and safety. (3-20-20)T
  - e. The use of psychotropic or behavior modifying medications must be reviewed by the physician or authorized provider at least every six (6) months. The facility must provide behavior updates to the physician or authorized provider to help facilitate an informed decision on the continued use, and possible reduction, of the psychotropic or behavior modifying medication. (3-20-20)T

**311. -- 318. (RESERVED)**

**319. COMPREHENSIVE ASSESSMENT REQUIREMENTS.**

The facility must complete assessment information as described in Subsections 319.01 through 319.04 of this rule, prior to admitting the resident to the residential assisted living facility. The remainder of the comprehensive assessment must be completed within fourteen (14) days of admission. Comprehensive assessment information must be updated when there is a change, or at least every twelve (12) months. The comprehensive assessment must contain the following: (3-20-20)T

- 01. Resident Demographics.** Resident demographic information, including: (3-20-20)T
  - a. Date of birth; (3-20-20)T
  - b. Placement history; (3-20-20)T
  - c. Identification of any medical diagnoses, including any information about specific health problems, such as allergies, that may be useful in a medical emergency; (3-20-20)T
  - d. Prescription and over-the-counter medications and treatments; (3-20-20)T
  - e. Information related to cognitive function; (3-20-20)T
  - f. Legal status, to include copies of legal documents when applicable (e.g. guardianship or power of attorney); and (3-20-20)T
  - g. Names and contact information of representatives and emergency contacts. (3-20-20)T

**02. Level of Personal Assistance Required.** The facility must assess the level of assistance required to help the resident with the following: Activities of daily living, including bathing, dressing, toileting, grooming, eating, communicating, medications, and the use of adaptive equipment, such as hearing aids, walkers, or eyeglasses. (3-20-20)T

**03. Nursing Assessment.** Information related to the resident's health, medical status, and identification of any health services needed, including frequency and scope. (3-20-20)T

**04. Maladaptive Behaviors.** Evaluation of maladaptive behaviors, including: (3-20-20)T

- a. The resident's behavioral history, including any history of traumatic events; (3-20-20)T
- b. The intensity, duration, and frequency of each maladaptive behavior; (3-20-20)T
- c. Potential contributing environmental factors, such as heat, noise, or overcrowding; (3-20-20)T
- d. Any specific events that can trigger maladaptive behaviors; (3-20-20)T
- e. Potential contributing health factors, such as hunger, pain, constipation, infection, fever, or medication side effects; and (3-20-20)T

f. Recent changes in the resident's life, such as a death in the family or changes in care. (3-20-20)T

**05. Resident Preferences.** Resident preferences and historical information that includes: (3-20-20)T

- a. Religion and church attendance, including preferred church contact information; (3-20-20)T
- b. Historical information including significant life events and family, work, and education; and (3-20-20)T
- c. Hobbies or preferred activities. (3-20-20)T

**06. Outside Services.** Information related to outside services, including the service type being provided, when, and by whom. (3-20-20)T

**07. Assessment Results.** The results of the comprehensive assessment must be used to develop the NSA, identify training needs for staff, and evaluate the ability of an administrator and facility to meet the identified residents' needs. (3-20-20)T

**320. NEGOTIATED SERVICE AGREEMENT (NSA) REQUIREMENTS.**

Under Section 39-3309, Idaho Code, each resident must enter into an NSA completed, signed, and implemented no later than fourteen (14) calendar days from the date of admission. An interim plan must be developed and used while the NSA is being completed as described in Section 330 of these rules. (3-20-20)T

**01. Use of NSA.** The NSA provides for the coordination of services and instruction to the facility staff. Upon completion, the agreement must clearly identify the resident, describe services to be provided, the frequency of such services, and how such services are to be delivered. (3-20-20)T

**02. Key Elements of the NSA.** A resident's NSA must be based on the comprehensive assessment information described in Section 319 of these rules. NSAs must incorporate information from the resident's care record, described in Section 330 of these rules. (3-20-20)T

**03. Signature, Date, and Approval of Agreement.** The administrator, resident, and any legal representative must sign and date the NSA upon its completion. (3-20-20)T

**04. Review Date.** The NSA must include the next scheduled date of review. (3-20-20)T

**05. Development of the NSA.** The resident, and other relevant persons as identified by the resident, must be included in the development of the NSA. Licensed and professional staff must be involved in the development of the NSA as applicable. (3-20-20)T

**06. Copy of Initial Agreement.** Signed copies of the agreement must be given to the resident, their representative and their legal guardian, or conservator, and a copy placed in the resident's record, no later than fourteen (14) calendar days from admission. (3-20-20)T

**07. Resident Choice.** A resident must be given the choice and control of how and what services the facility or external vendors will provide, to the extent the resident can make choices. The resident's choice must not violate the provisions of Section 39-3307(1), Idaho Code. (3-20-20)T

**08. Periodic Review.** The NSA must be reviewed when there is a change in a diagnosis for a resident or other change in condition requiring different, additional, or replacement services, or at least every twelve (12) months. (3-20-20)T

**321. -- 329. (RESERVED)**

**330. REQUIREMENTS FOR FACILITY RECORDS.**

The facility must maintain complete, accurate, and authentic records which are preserved in a safe location protected from fire, theft, and water damage for a minimum of three (3) years. (3-20-20)T

**01. Paper Records.** All paper records must be recorded legibly in ink. (3-20-20)T

**02. Electronic Records.** Electronic records policies and procedures must be developed and implemented that specify which records will be maintained electronically. Policy development and implementation must ensure: (3-20-20)T

**a.** The facility must print and provide paper copies of electronic records upon the request of the resident, their legal guardian or conservator, advocacy and protection agencies, and the Department. (3-20-20)T

**b.** Security measures must be taken to protect the use of an electronic signature by anyone other than the person to which the electronic signature belongs and to protect that person's identity. The policy must specify how passwords are assigned, and the frequency they are changed. (3-20-20)T

**c.** Security measures must be taken to ensure the integrity of any electronic documentation. (3-20-20)T

**03. Record Confidentiality.** The facility must safeguard confidential information against loss, destruction, and unauthorized use. (3-20-20)T

**04. Resident Care Records.** An individual care record must be maintained for each resident with all entries kept current and completed by the person providing the care. (3-20-20)T

**a.** Entries must include the date, time, name, and title of the person making the entry. Staff must sign each entry made by them during their shift. (3-20-20)T

**b.** Care records of all current residents must be available to staff at all times. (3-20-20)T

**c.** In addition to an NSA, as described in Section 320 of these rules, each care record must include documentation of the following: (3-20-20)T

**i.** Comprehensive assessments, as described in Section 319 of these rules; (3-20-20)T

**ii.** Current medications, treatments, and diet prescribed, all signed and dated by the ordering physician or authorized provider; (3-20-20)T

- iii. Treatments, wound care, assistance with medications and any other delegated nursing tasks. Documentation must include any PRN medication use (if applicable), including the reason for taking the medication and the efficacy; (3-20-20)T
- iv. Times the NSA is not followed, such as during refusal of care or services. This includes any time a medication is refused by a resident, not taken by a resident, not given to a resident, and the reason for the omission; (3-20-20)T
- v. Calls to the resident's physician or authorized provider, including the reason for each call and the outcome; (3-20-20)T
- vi. Notification to the facility nurse of changes in the resident's physical or mental condition; (3-20-20)T
- vii. Nursing assessments, as described in Section 305 of these rules; (3-20-20)T
- viii. The results of any physician or authorized provider visits; (3-20-20)T
- ix. Copies of all signed and dated care plans prepared by outside service agencies; (3-20-20)T
- x. Notes regarding outside services and care provided to the resident, such as home health, hospice, or physical therapy; (3-20-20)T
- xi. Unusual events such as incidents, accidents, or altercations, and the facility's response; and (3-20-20)T
- xii. When a resident refuses medical treatment or physician's orders, the facility must document the resident and their legal guardian have been informed of the consequences of the refusal and the resident's physician or authorized provider has been notified of the refusal. (3-20-20)T

**05. Admission Records.** As described in Section 39-3315, Idaho Code, resident admission documentation must include: (3-20-20)T

- a. The resident's preferred providers and contact information, including physician or authorized provider, optometrist, dentist, pharmacy, and outside service providers. (3-20-20)T
- b. Results of the resident's last history and physical examination, performed by a physician or authorized provider. The examination must have been conducted no more than six (6) months prior to admission. (3-20-20)T
- c. Physician or authorized provider orders that are current, signed, and dated, including a list of medications, treatments, diet, and any limitations. (3-20-20)T
- d. A written admission agreement that is signed and dated by the administrator and the resident or their legal guardian or conservator, and meets the requirements of Section 216 of these rules. (3-20-20)T
- e. If separate from the admission agreement, a copy of the payment schedule and fee structure signed and dated by the resident or their legal guardian, or conservator. (3-20-20)T
- f. If the facility manages the resident's funds, a signed and dated written agreement between the facility and the resident, or their legal guardian, or conservator that specifies the terms. (3-20-20)T
- g. A signed copy of the resident's rights, as described in Sections 550 and 560 of these rules, or a signed and dated statement that the resident or their legal guardian, or conservator has read and understands their rights in a residential assisted living facility. (3-20-20)T

**h.** An interim care plan signed by the resident, responsible party, and the facility, completed prior to, or on the day of, admission. (3-20-20)T

**i.** Documentation indicating the resident has been informed of the facility's emergency procedures, including resident responsibility. (3-20-20)T

**06. Behavior Documentation.** For residents who exhibit maladaptive behaviors, behavior management records must be maintained in the resident record, including: (3-20-20)T

**a.** An assessment of maladaptive behaviors, as described in Section 319 of these rules: (3-20-20)T

**b.** A behavior plan that includes at least one (1) intervention specific to each maladaptive behavior. (3-20-20)T

**i.** Interventions must be the least restrictive possible; and (3-20-20)T

**ii.** Each intervention must be reviewed as appropriate, based on the severity of the behavior, to evaluate the effectiveness and continued need for the intervention. (3-20-20)T

**c.** Ongoing tracking of behaviors, including documentation of the date and time each maladaptive behavior was observed, the specific behavior that was observed, what interventions were used in response to the maladaptive behavior, and the effectiveness of each intervention. (3-20-20)T

**07. Discharge Records.** Resident discharge documentation must include: (3-20-20)T

**a.** When the discharge is involuntary, the facility's efforts to resolve the situation and a copy of the discharge notice, signed and dated by the resident and the facility. If the resident refuses, or is unable to sign the notice, the facility must maintain evidence that the notice was delivered to the resident and the responsible party; (3-20-20)T

**b.** The date and the location where the resident is discharged; and (3-20-20)T

**c.** The disposition of the resident's belongings. (3-20-20)T

**08. Additional Resident Records.** The facility must also maintain the following for each resident: (3-20-20)T

**a.** A record of all personal property that the resident has entrusted to the facility, including documentation to identify and track the property to ensure that personal items are kept safe and used only by the resident to which the items belong; and (3-20-20)T

**b.** Any complaints or grievances voiced by the resident including the date received, the investigation with outcome, and the response to the resident. (3-20-20)T

**09. Resident Admission and Discharge Register.** The facility must maintain an admission and discharge register listing the name of each resident, the date admitted, and the date discharged. The admission and discharge register must be produced as a separate document, apart from resident records, and kept current. (3-20-20)T

**10. Hourly Adult Care Documentation.** A log of those who have utilized hourly adult care must be maintained, including the dates the service was provided and individual records for each person utilizing hourly adult care. The individual record documentation must include: (3-20-20)T

**a.** Admission identification information, including contact information for the responsible party in an emergency, and the physician or authorized provider; (3-20-20)T

**b.** Information, such as medical and social, relevant to the supervision of the person; and (3-20-20)T

- c. Care and services provided during hourly adult care, including assistance with medications. (3-20-20)T
- 11. Dietary Records.** The facility must maintain on-site a minimum of three (3) months of dietary documentation, as follows: (3-20-20)T

  - a. Copies of planned menus, including therapeutic menus, that are approved, signed, and dated by a dietitian; and (3-20-20)T
  - b. Served menus, including therapeutic menus, which reflect substitutions made. (3-20-20)T
- 12. Records for Water Supply.** Copies of laboratory reports documenting the bacteriological examination of a private water supply must be kept on file in the facility. (3-20-20)T
- 13. Personnel Records.** A record for each employee must be maintained and available, which includes the following: (3-20-20)T

  - a. The employee's name, address, phone number, and date of hire; (3-20-20)T
  - b. A job description that includes the purpose, responsibilities, duties, and authority; (3-20-20)T
  - c. Evidence that on, or prior to hire, staff were notified in writing if the facility does or does not carry professional liability insurance. If the facility cancels existing professional liability insurance, all staff must be notified of the change in writing; (3-20-20)T
  - d. A copy of a current license for all nursing staff and verification from the Board of Nursing that the license is in good standing with identification of restrictions; (3-20-20)T
  - e. Signed evidence of training as described in Sections 620 through 641 of these rules; (3-20-20)T
  - f. Copies of CPR and first aid certifications; (3-20-20)T
  - g. Evidence of medication training as described in Section 645 of these rules; (3-20-20)T
  - h. Criminal history and background check results that meet Section 009 of these rules and state-only background check results; (3-20-20)T
  - i. Documentation by the licensed nurse of delegation to unlicensed staff who assist residents with medications and other nursing tasks; (3-20-20)T
  - j. When acting on behalf of the administrator, a signed document authorizing the responsibility; and (3-20-20)T
  - k. Copies of contracts with outside service providers and contract staff. (3-20-20)T
- 14. As Worked Schedules.** Work records must be maintained in written or electronic format which reflect: (3-20-20)T

  - a. Personnel on duty, at any given time; and (3-20-20)T
  - b. The first and last names of each employee and their position. (3-20-20)T
- 15. Fire and Life Safety Records.** The administrator must ensure the facility's records for fire and life safety are maintained. The facility must maintain on file: (3-20-20)T

  - a. Fire detection, alarm, and communication system reports: (3-20-20)T

- i. The results of the annual inspection and tests; and (3-20-20)T
- ii. Smoke detector sensitivity testing results (3-20-20)T
- b. The results of any weekly, monthly, quarterly, semi-annual, and annual sprinkler system inspections, maintenance, and tests; (3-20-20)T
- c. Records of the monthly examination of the portable fire extinguishers, documenting the following: (3-20-20)T
  - i. Each extinguisher is in its designated location; (3-20-20)T
  - ii. Each extinguisher seal or tamper indicator is not broken; (3-20-20)T
  - iii. Each extinguisher has not been physically damaged; (3-20-20)T
  - iv. Each extinguisher gauge shows a charged condition; and (3-20-20)T
  - v. The inspection tag or documentation for the extinguisher must show at least the initials of the person making the monthly examination and the date of the examination. (3-20-20)T
- d. Documentation for when a fire watch is instituted, a fire watch log for each round of patrol, identifying who conducted the fire watch, date, time, and situations encountered. (3-20-20)T

**331. -- 334. (RESERVED)**

**335. REQUIREMENTS FOR INFECTION CONTROL.**

The administrator is responsible for ensuring that policies and procedures consistent with recognized standards that control and prevent infections for both staff and residents are developed and implemented throughout the facility, to include: (3-20-20)T

**01. Staff with an Infectious Disease.** Staff with an infectious disease must not work until the infectious stage no longer exists or must be reassigned to a work area where contact with others is not expected and likelihood of transmission of infection is absent. (3-20-20)T

**02. Standard Precautions.** Standard precautions must be used in the care of residents to prevent transmission of infectious disease according to the Centers for Disease Control and Prevention (CDC) guidelines. These guidelines may be accessed on the CDC website at <http://www.cdc.gov/hai/>. (3-20-20)T

**03. Reporting of Individual with an Infectious Disease.** The name of any resident or facility personnel with a reportable disease listed in IDAPA 16.02.10, "Idaho Reportable Diseases," must be reported immediately to the local health district authority with appropriate infection control procedures immediately implemented as directed by that local health authority. (3-20-20)T

**336. -- 399. (RESERVED)**

**400. REQUIREMENTS FOR FIRE AND LIFE SAFETY STANDARDS.**

A facility's buildings must meet all requirements of the local and state codes that are applicable to residential assisted living facilities for fire and life safety standards. Facilities' evacuation capability is considered "impractical" as defined by NFPA Standard 101. (3-20-20)T

**401. FIRE AND LIFE SAFETY STANDARDS FOR NEW BUILDINGS HOUSING THREE THROUGH SIXTEEN RESIDENTS.**

A newly constructed facility, change of ownership, or a building converted to a residential assisted living facility on or after January 1, 2021, housing three (3) to sixteen (16) residents on the first story only must comply with NFPA, Standard 101, Chapter 32, Small Facilities. (3-20-20)T



**402. FIRE AND LIFE SAFETY STANDARDS FOR NEW BUILDINGS HOUSING SEVENTEEN OR MORE RESIDENTS AND MULTI-STORY BUILDINGS.**

A newly constructed facility, change of ownership, or a building converted to a residential assisted living facility on or after January 1, 2021, housing seventeen (17) residents or more, or any building housing residents on stories other than the first story must comply with requirements of NFPA, Standard 101, Chapter 32, Large Facilities. (3-20-20)T

**403. FIRE AND LIFE SAFETY STANDARDS FOR EXISTING BUILDINGS LICENSED FOR THREE THROUGH SIXTEEN RESIDENTS.**

Existing facilities licensed prior to January 1, 2021 housing three (3) to sixteen (16) residents on the first story only, must comply with the requirements of the NFPA, Standard 101, Chapter 33, Small Facilities. Existing buildings that are not sprinklered may continue to operate, except when Section 401 of these rules apply. (3-20-20)T

**404. FIRE AND LIFE SAFETY STANDARDS FOR EXISTING BUILDINGS LICENSED FOR SEVENTEEN OR MORE RESIDENTS AND MULTI-STORY BUILDINGS.**

Existing facilities licensed prior to January 1, 2021 housing seventeen (17) or more residents and multi-story buildings or any building housing residents on stories other than the first story must comply with NFPA, Standard 101, Chapter 33, Large Facilities. (3-20-20)T

**405. ADDITIONAL FIRE AND LIFE SAFETY STANDARDS FOR ALL BUILDINGS AND FACILITIES.**

**01. Electrical Installations and Equipment.** Electrical installations and equipment must comply with applicable local or state electrical requirements in NFPA, Standard 101, Mandatory References. (3-20-20)T

**a.** Extension cords and multi-plug adapters are prohibited; (3-20-20)T

**b.** Relocatable Power Taps (RPTs) must be Underwriter Laboratories (U/L) approved with the following requirements: (3-20-20)T

**i.** RPTs directly connected to a wall outlet; and (3-20-20)T

**ii.** Have a built-in surge protector. (3-20-20)T

**02. Prohibited Applications.** The following are prohibited uses of an RPT. (3-20-20)T

**a.** Medical equipment; (3-20-20)T

**b.** Daisy chain or plugging one (1) plug strip into a second plug strip; (3-20-20)T

**c.** Appliances; (3-20-20)T

**d.** As a convenience, in lieu of permanent installed receptacles; and (3-20-20)T

**e.** Extend through walls, ceilings, floors, under doors or floor coverings, or be subject to environmental of physical damage. (3-20-20)T

**03. Medical Gases.** Handling, use and storage of medical gas must be according to NFPA Standard 99, Chapter 11, Performance, Maintenance, and Testing as referenced in Section 004 of these rules. (3-20-20)T

**04. Fuel-Fired Heating.** Fuel-fired heating devices and systems must be inspected, serviced, and cleaned at least annually by a person professionally engaged in the business of servicing these devices or systems. (3-20-20)T

**05. Natural or Man-Made Hazards.** When natural or man-made hazards are present on the facility property or border the facility property, suitable fences, guards, railing, or a combination must be installed to provide protection for the residents. (3-20-20)T

**16. Telephone.** The facility must have a telephone on the premises available for staff use in the event of an emergency. Emergency telephone numbers must be posted near the telephone. (3-20-20)T

**406. -- 409. (RESERVED)**

**410. REQUIREMENTS FOR EMERGENCY ACTIONS AND FIRE DRILLS.**

Fire drills must be conducted not less than six (6) times a year on a bimonthly basis, with not less than two (2) conducted during the night when residents are sleeping. Records must be maintained on file at the facility and contain a description, date and time of the drill, response of the personnel and residents, problems encountered, and recommendations for improvement. (3-20-20)T

**01. Report of Fire.** A separate report on each fire incident occurring within the facility must be submitted to the Licensing Agency within thirty (30) days of the occurrence. The reporting form, "Facility Fire Incident Report," issued by the Licensing Agency is used to secure specific data concerning date, origin, extent of damage, method of extinguishment, and injuries, if any. A fire incident is considered any activation of the building's fire alarm system other than a false alarm, during testing of the fire alarm system, or during a fire drill. (3-20-20)T

**02. Fire Watch.** Where a required fire alarm system or fire sprinkler system is out of service for more than four (4) hours in a twenty-four (24) hour period, the authority having jurisdiction must be notified, and the building evacuated, or an approved fire watch provided for all parties left unprotected by the shutdown until the fire alarm system has been returned to service. (3-20-20)T

**411. -- 429. (RESERVED)**

**430. REQUIREMENTS FOR FURNISHINGS, EQUIPMENT, SUPPLIES, AND BASIC SERVICES.**

Each facility must provide to the resident: (3-20-20)T

**01. Common Shared Furnishings.** Appropriately designed and constructed furnishings to meet the needs of each resident, including reading lamps, tables, comfortable chairs, or sofas. All items must be in good repair, clean, safe, and provided at no additional cost to the resident. (3-20-20)T

**02. Resident Sleeping Room Furnishings.** Comfortable furnishings and individual storage, such as a dresser, for personal items for each resident in each sleeping room. All items must be in good repair, clean, and safe. (3-20-20)T

**03. Resident Bed.** Each resident must be provided their own bed, which will be at least thirty-six (36) inches wide, substantially constructed, clean, and in good repair. Roll-away beds, cots, futons, folding beds, or double bunks are prohibited. Bed springs must be in good repair, clean, and comfortable. Bed mattresses must be standard for the bed, clean, and odor free. A pillow must be provided. (3-20-20)T

**04. Resident Telephone Privacy.** The facility must have at least one (1) telephone that is accessible to all residents, and provide local calls at no additional cost. The telephone must be placed in such a manner as to provide the resident privacy while using the telephone. (3-20-20)T

**05. Basic Services.** The following are basic services to be provided to the resident by the facility within the basic services rate: (3-20-20)T

- a.** Rent; (3-20-20)T
- b.** Utilities; (3-20-20)T
- c.** Food; (3-20-20)T
- d.** Activities of daily living services; (3-20-20)T
- e.** Supervision; (3-20-20)T

- f. First aid; (3-20-20)T
- g. Assistance with and monitoring of medications; (3-20-20)T
- h. Laundering of linens owned by the facility; (3-20-20)T
- i. Emergency interventions and coordination of outside services; (3-20-20)T
- j. Routine housekeeping and maintenance of common areas; and (3-20-20)T
- k. Access to basic television in common areas. (3-20-20)T

**06. Basic Supplies.** The following are to be supplied by the facility at no additional cost to the resident: linens, towels, wash cloths, liquid hand soap, non-sterile exam gloves, toilet paper, and first aid supplies, unless the resident chooses to provide their own. (3-20-20)T

**07. Personal Supplies.** Soap, shampoo, hair brush, comb, electric razor, or other means of shaving, toothbrush, toothpaste, sanitary napkins, and incontinent supplies must be provided by the facility unless the resident chooses to provide their own. The facility may charge the resident for personal supplies the facility provides and must itemize each item being charged to the resident. (3-20-20)T

**08. Resident Supplies and Furnishings.** If a resident chooses to provide their own supplies or furnishings, the facility must ensure that the resident's supplies or furnishings meet the minimum standards as identified in this rule. (3-20-20)T

**431. -- 449. (RESERVED)**

**450. REQUIREMENTS FOR FOOD AND NUTRITIONAL CARE SERVICES.**

The facility food services must meet the standards in the Idaho Food Code, IDAPA 16.02.19, "Idaho Food Code," as incorporated in Section 004 of these rules. The facility must also implement operational policies for providing proper nutritional care for each resident, which includes procedures to follow if the resident refuses food or to follow a prescribed diet. (3-20-20)T

**451. MENU AND DIET PLANNING.**

The facility must provide each resident with at least the minimum food and nutritional needs in accordance with the Recommended Dietary Allowances established by the Food and Nutrition Board of the National Academy of Sciences. These recommendations are found in the Idaho Diet Manual incorporated by reference in Section 004 of these rules. The menu must be adjusted for age, sex, and activity as approved by a registered dietitian. (3-20-20)T

**01. Menu.** The facility must have a menu planned or approved, and signed and dated by a registered dietitian prior to being served to any resident. The planned menu must meet nutritional standards. (3-20-20)T

- a. Menus will provide a sufficient variety of foods in adequate amounts at each meal; (3-20-20)T
- b. Food selections must include foods that are served in the community and in season. Food selections and textures should account for residents' preferences, food habits, and physical abilities. (3-20-20)T
- c. The current weekly menu must be posted in a facility common area; and (3-20-20)T
- d. The facility must serve the planned menu. If substitutions are made, the menu must be modified to reflect the substitutions. (3-20-20)T

**02. Therapeutic Diets.** The facility must have a therapeutic diet menu planned or approved, and signed and dated by a registered dietitian prior to being served to any resident. (3-20-20)T

- a. The therapeutic diet planned menu, must meet nutritional standards; (3-20-20)T

- b. The therapeutic diet menu must be planned as close to a regular diet as possible; and (3-20-20)T
- c. The facility must have for each resident on a therapeutic diet, an order from a physician or authorized provider. (3-20-20)T

**03. Facilities Licensed for Sixteen Beds or Less.** In facilities licensed for sixteen (16) beds or less, menus must be planned in writing at least one (1) week in advance. (3-20-20)T

**04. Facilities Licensed for Seventeen Beds or More.** Facilities licensed for seventeen (17) beds or more must: (3-20-20)T

- a. Develop and implement a cycle menu which covers a minimum of two (2) seasons and is four (4) to five (5) weeks in length; (3-20-20)T
- b. Follow standardized recipes; and (3-20-20)T
- c. Have available in the kitchen a current copy of the Idaho Food Code and Idaho Diet Manual. (3-20-20)T

**452. -- 454. (RESERVED)**

**455. FOOD SUPPLY.**

The facility must maintain a seven (7) day supply of nonperishable foods and a two (2) day supply of perishable foods. The facility's kitchen must have the types and amounts of food to be served readily available to meet all planned menus during that time. (3-20-20)T

**456. -- 459. (RESERVED)**

**460. FOOD PREPARATION AND SERVICE.**

**01. Food Preparation.** Foods must be prepared by methods that conserve nutritional value, flavor, and appearance. (3-20-20)T

**02. Frequency of Meals.** Food must be offered throughout the day, as follows: (3-20-20)T

a. To provide residents at least three (3) meals daily, at regular times comparable to normal mealtimes in the community; (3-20-20)T

b. To ensure no more than fourteen (14) hours between a substantial evening meal and breakfast; (3-20-20)T

c. Ensure that residents who are not in the facility for the noon meal are offered a substantial evening meal; and (3-20-20)T

d. Offer snacks and fluids between meals and at bedtime. (3-20-20)T

**03. Food Preparation Area.** Any areas used for food preparation must be maintained as follows: (3-20-20)T

a. No live animals or fowl will be kept or maintained in the food service preparation or service area; and (3-20-20)T

b. Food preparation and service areas cannot be used as living quarters for staff. (3-20-20)T

**04. Disposable Items.** The facility will not use single use items except in unusual circumstances for a short period of time or for special events. (3-20-20)T

**461. -- 509. (RESERVED)**

**510. REQUIREMENTS TO PROTECT RESIDENTS FROM ABUSE.**

The administrator must ensure that policies and procedures are developed and implemented to ensure that all residents are free from abuse. These policies and procedures should be posted in a conspicuous place in the facility, shared with new residents, families upon admission, all residents annually thereafter, and made available upon request. (3-20-20)T

**511. -- 514. (RESERVED)**

**515. REQUIREMENTS TO PROTECT RESIDENTS FROM EXPLOITATION.**

The administrator must ensure that policies and procedures are developed and implemented to ensure that all residents are free from exploitation. These policies and procedures should be posted in a conspicuous place in the facility, shared with new residents, families upon admission, all residents annually thereafter, and made available upon request. (3-20-20)T

**516. -- 519. (RESERVED)**

**520. REQUIREMENTS TO PROTECT RESIDENTS FROM INADEQUATE CARE.**

The administrator must ensure that policies and procedures are developed and implemented to ensure that all residents are free from inadequate care. These policies and procedures should be posted in a conspicuous place in the facility, shared with new residents, families upon admission, all residents annually thereafter, and made available upon request. (3-20-20)T

**521. -- 524. (RESERVED)**

**525. REQUIREMENTS TO PROTECT RESIDENTS FROM NEGLECT.**

The administrator must ensure that policies and procedures are developed and implemented to ensure that all residents are free from neglect. These policies and procedures should be posted in a conspicuous place in the facility, shared with new residents, families upon admission, all residents annually thereafter, and made available upon request. (3-20-20)T

**526. -- 549. (RESERVED)**

**550. REQUIREMENTS FOR RESIDENTS' RIGHTS.**

The administrator must ensure that policies and procedures are developed and implemented to ensure that residents' rights are observed, promoted, and protected. (3-20-20)T

**01. Resident Records.** Upon request, a resident or others authorized by law, must be provided immediate access to information in their record, and copies of information within two (2) business days. The facility must maintain and keep current a record for each resident that contains the information specified in Section 330 of these rules and Section 39-3316, Idaho Code. (3-20-20)T

**02. Privacy.** Each resident must be ensured the right to privacy with accommodations, medical and other treatment, written and telephone communications, visits, and meetings of family and resident groups. (3-20-20)T

**03. Humane Care and Environment.** (3-20-20)T

**a.** Each resident has the right to humane care and a humane environment, including the following: (3-20-20)T

**i.** The right to a diet that is consistent with any religious or health-related restrictions; (3-20-20)T

**ii.** The right to refuse a restricted diet; and (3-20-20)T

- iii. The right to a safe and sanitary living environment. (3-20-20)T
- b. Each resident has the right to be treated with dignity and respect, including: (3-20-20)T
  - i. The right to be treated in a courteous manner by staff; (3-20-20)T
  - ii. The right to receive a response from the facility to any request of the resident within a reasonable time; and (3-20-20)T
  - iii. The right to be communicated with, orally or in writing, in a language they understand. If the resident's knowledge of English or the predominant language of the facility is inadequate for comprehension, a means to communicate in a language familiar to the resident must be available and implemented. There are many possible methods such as bilingual staff, electronic communication devices or family and friends to translate. The method implemented must ensure the resident's right of confidentiality, if the resident desires. (3-20-20)T
- 04. Personal Possessions.** Each resident has the right to: (3-20-20)T
  - a. Wear their own clothing; (3-20-20)T
  - b. Determine their own dress or hair style; (3-20-20)T
  - c. Retain and use their own personal property in their own living area so as to maintain individuality and personal dignity; and (3-20-20)T
  - d. Be provided a separate storage area in their own living area and at least one (1) locked cabinet or drawer for keeping personal property. (3-20-20)T
- 05. Personal Funds.** Residents whose board and care is paid for by public assistance will retain, for their personal use, the difference between their total income and the applicable board and care allowance established by Department rules. A facility must not require a resident to deposit their personal funds with the facility. (3-20-20)T
- 06. Management of Personal Funds.** Upon a facility's acceptance of written authorization of a resident, the facility must manage and account for the personal funds of the resident deposited with the facility as follows: (3-20-20)T
  - a. The facility must deposit any amount of a resident's personal funds more than five (5) times the personal needs allowance in an interest-bearing account (or accounts) that is separate from any of the facility's operating accounts and credit all interest earned on such separate account to the account. The facility must maintain any other personal funds in a non-interest-bearing account or petty cash fund; (3-20-20)T
  - b. The facility must ensure a full and complete separate accounting of each resident's personal funds, maintain a written record of all financial transactions involving each resident's personal funds deposited with the facility, and afford the resident (or a legal representative of the resident) reasonable access to such record; and (3-20-20)T
  - c. Upon the death of a resident with such an account, the facility must promptly convey the resident's personal funds (and a final accounting of such funds) to the individual administering the resident's estate. For clients of the Department, the remaining balance of funds must be refunded to the Department. (3-20-20)T
- 07. Access and Visitation Rights.** Each facility must permit: (3-20-20)T
  - a. Immediate access to any resident by any representative of the Department, by the local ombudsman for the elderly or their designees, or by the resident's physician or authorized provider; (3-20-20)T
  - b. Immediate access to a resident, subject to the resident's right to deny or withdraw consent at any time, by the resident's immediate family, significant other, or representative; (3-20-20)T

c. Immediate access to a resident, subject to reasonable restrictions and the resident's right to deny or withdraw consent at any time, by others who are visiting with the consent of the resident; and (3-20-20)T

d. Reasonable access to a resident by any entity or individual that provides health, social, legal, or other services to the resident, subject to the resident's right to deny or withdraw consent at any time. (3-20-20)T

**08. Employment.** Each resident must have the right to refuse to perform services for the facility except as contracted for by the resident and the administrator of the facility. If the resident is hired by the facility to perform services as an employee of the facility, the wage paid to the resident must be consistent with state and federal law. (3-20-20)T

**09. Confidentiality.** Each resident must have the right to confidentiality of personal and clinical records. (3-20-20)T

**10. Freedom from Abuse, Neglect, and Restraints.** Each resident must have the right to be free from physical, mental, or sexual abuse, neglect, corporal punishment, involuntary seclusion, and any physical or chemical restraints. (3-20-20)T

**11. Freedom of Religion.** Each resident must have the right to practice the religion of their choice or to abstain from religious practice. Residents must also be free from the imposition of the religious practices of others. (3-20-20)T

**12. Control and Receipt of Health-Related Services.** Each resident must have the right to control their receipt of health related services, including: (3-20-20)T

a. The right to retain the services of their own personal physician, dentist, and other health care professionals; (3-20-20)T

b. The right to select the pharmacy or pharmacist of their choice so long as it meets the statute and rules governing residential assisted living and the policies and procedures of the residential assisted living facility; (3-20-20)T

c. The right to confidentiality and privacy concerning their medical or dental condition and treatment; and (3-20-20)T

d. The right to refuse medical services based on informed decision making. Refusal of treatment does not relieve the facility of its obligations under this chapter. (3-20-20)T

i. The facility must document the resident and their legal guardian have been informed of the consequences of the refusal; and (3-20-20)T

ii. The facility must document that the resident's physician or authorized provider has been notified of the resident's refusal. (3-20-20)T

**13. Grievances.** Each resident must have the right to voice grievances with respect to treatment or care that is, or fails to be furnished, without threat of retaliation or voicing the grievances and the right to prompt efforts by the facility to resolve grievances the resident may have, including those with respect to the behavior of other residents. (3-20-20)T

**14. Participation in Resident and Family Groups.** Each resident must have the right to organize and participate in resident groups in the facility and the right of the resident's family to meet in the facility with the families of other residents in the facility. (3-20-20)T

**15. Participation in Other Activities.** Each resident must have the right to participate in social, religious, and community activities that do not interfere with the rights of other residents in the facility. (3-20-20)T

**16. Examination of Survey Results.** Each resident must have the right to examine, upon reasonable request, the results of the most recent survey of the facility conducted by the Licensing Agency with respect to the facility and any plan of correction in effect. (3-20-20)T

**17. Access by Advocates and Representatives.** A residential assisted living facility must permit advocates and representatives of community legal services programs, whose purposes include rendering assistance without charge to residents, to have access to the facility at reasonable times in order to: (3-20-20)T

**a.** Visit, talk with, and make personal, social, and legal services available to all residents; (3-20-20)T

**b.** Inform residents of their rights and entitlements, and their corresponding obligations, under state, federal, and local laws by distribution of educational materials and discussion in groups and with individuals; (3-20-20)T

**c.** Assist residents in asserting their legal rights regarding claims for public assistance, medical assistance, and social security benefits, and in all other matters in which residents are aggrieved, that may be provided individually, or in a group basis, and may include organizational activity, counseling, and litigation; (3-20-20)T

**d.** Engage in all other methods of assisting, advising, and representing residents so as to extend to them the full enjoyment of their rights; (3-20-20)T

**e.** Communicate privately and without restrictions with any resident who consents to the communication; and (3-20-20)T

**f.** Observe all common areas of the facility. (3-20-20)T

**18. Access by Protection and Advocacy System.** A residential assisted living facility must permit advocates and representatives of the protection and advocacy system designated by the governor under 29 U.S.C. 794e, 42 U.S.C. Section 15043 and 42 U.S.C. Section 10801 et seq., access to residents, facilities, and records in accordance with applicable federal statutes and regulations. (3-20-20)T

**19. Access by the Long-Term Care Ombudsman.** A residential assisted living facility must permit advocates and representatives of the long-term care ombudsman program pursuant to 42 U.S.C. Section 3058, Section 67-5009, Idaho Code, and IDAPA 15.01.03, "Rules Governing the Ombudsman for the Elderly Program," access to residents, facilities, and records in accordance with applicable federal and state law, rules, and regulations. (3-20-20)T

**20. Transfer or Discharge.** Each resident must have the right to be transferred or discharged only for medical reasons, for their welfare or that of other residents, or for nonpayment for their stay. In non-emergency conditions, the resident must be given at least thirty (30) calendar days notice of discharge. A resident has the right to appeal any involuntary discharge. (3-20-20)T

**21. Citizenship Rights.** Each resident has the right to be encouraged and assisted to exercise rights as a citizen, including the right to be informed and to vote. (3-20-20)T

**22. Advance Directives.** Each resident has the right to be informed, in writing, regarding the formulation of an advance directive as provided under Section 39-4510, Idaho Code. (3-20-20)T

**23. Fee Changes.** Each resident has the right to written notice of any fee change not less than thirty (30) days prior to the proposed effective date of the fee change, except: (3-20-20)T

**a.** When a resident needs additional care, services, or supplies, the facility must provide to the resident or the resident's legal guardian or conservator written notice within five (5) days of any fee change taking place; (3-20-20)T

**b.** The resident and the resident's legal guardian, or conservator must be given the opportunity to agree to an amended NSA. If the two parties do not reach an agreement on the proposed fee change, the facility is



entitled to charge the changed rate after five (5) days have elapsed from the date of the facility's written notice. (3-20-20)T

**551. -- 559. (RESERVED)**

**560. NOTICE OF RESIDENTS' RIGHTS.**

Each facility must: (3-20-20)T

**01. Inform Residents Orally and in Writing.** Inform each resident, orally and in writing at the time of admission to the facility, of their legal rights during the stay at the facility. (3-20-20)T

**02. Written Statements.** Make available to each resident, upon reasonable request, a written statement of such rights and when the rights change the resident is notified. (3-20-20)T

**03. Written Description of Rights.** Ensure the written description of legal rights in this rule includes a description of the protection of personal funds and a statement that a resident may file a complaint with the Department respecting resident abuse, neglect, and misappropriation of resident property in the facility. (3-20-20)T

**04. Posting of Resident Rights.** Conspicuously post the residents' rights in the facility at all times. (3-20-20)T

**561. -- 599. (RESERVED)**

**600. REQUIREMENTS FOR STAFFING STANDARDS.**

The administrator must develop and implement written staffing policies and procedures based on the numbers of residents, resident needs, and configuration of the facility, which include: (3-20-20)T

**01. On-Duty Staff Up and Awake During Residents' Sleeping Hours.** Qualified and trained staff must be up and awake, and immediately available in the facility during resident sleeping hours. (3-20-20)T

**02. Detached Buildings or Units.** Facilities with residents housed in detached buildings or units, must have at least one (1) staff present, and available in each building or unit when residents are present in the building or unit. The facility must also ensure that each building or unit complies with the requirements for on-duty staff during resident sleeping hours to be up, awake, and immediately available in accordance with the facility's licensed bed capacity as provided in this rule. The Licensing Agency will consider a variance based on the facility's written submitted plan of operation. (3-20-20)T

**03. Personnel Management.** The administrator is responsible for the management of all personnel to include contract personnel. (3-20-20)T

**04. Sufficient Personnel.** As described in Section 39-3322, Idaho Code, the facility will employ and the administrator will schedule sufficient personnel to: (3-20-20)T

**a.** Provide care and supervision, during all hours, as required in each resident's NSA, to ensure residents' health, safety, and comfort, and to ensure the interior and exterior of the facility is maintained in a safe and clean manner; and (3-20-20)T

**b.** To provide for at least one (1) direct care staff with certification in first aid and cardio-pulmonary resuscitation (CPR) in the facility at all times. Facilities with multiple buildings or units will have at least one (1) direct care staff with certification in first aid and CPR in each building or each unit at all times. (3-20-20)T

**601. -- 619. (RESERVED)**

**620. REQUIREMENTS FOR TRAINING OF FACILITY PERSONNEL.**

The facility must follow structured, written training programs designed to meet the training needs of personnel in relation to responsibilities, as specified in the written job description, to provide for quality of care and compliance with these rules. Signed evidence of personnel training, indicating hours and topic, must be retained at the facility.

(3-20-20)T

**621. -- 624. (RESERVED)**

**625. ORIENTATION TRAINING REQUIREMENTS.**

The administrator must ensure that each staff member completes orientation training specific to their job description as described in Section 39-3324, Idaho Code. Staff who have not completed the orientation training requirements must work with a staff who has completed the orientation training. (3-20-20)T

**01. Number of Hours of Training.** A minimum of sixteen (16) hours of job-related orientation training must be provided to all new personnel before they are allowed to provide unsupervised personal assistance to residents. The means and methods of training are at the facility's discretion. (3-20-20)T

**02. Timeline for Completion of Training.** All orientation training must be completed within thirty (30) days of hire. (3-20-20)T

**03. Content for Training.** Orientation training must include the following: (3-20-20)T

- a.** The philosophy of residential assisted living and how it guides care giving; (3-20-20)T
- b.** Resident rights; (3-20-20)T
- c.** Cultural awareness; (3-20-20)T
- d.** Providing personal assistance; (3-20-20)T
- e.** How to respond to emergencies; (3-20-20)T
- f.** Reporting and documentation requirements for resident care records, incidents, accidents, complaints, and allegations of abuse, neglect, and exploitation; (3-20-20)T
- g.** Identifying and reporting changes in residents' health or mental condition; (3-20-20)T
- h.** Advance Directives and do not resuscitate (DNR) orders; (3-20-20)T
- i.** Relevant policies and procedures; (3-20-20)T
- j.** The role of the NSA; and (3-20-20)T
- k.** All staff employed by the facility, including housekeeping personnel and contract personnel, must be trained in infection control procedures for universal precautions. (3-20-20)T

**626. -- 629. (RESERVED)**

**630. TRAINING REQUIREMENTS FOR FACILITIES ADMITTING RESIDENTS WITH DIAGNOSIS OF DEMENTIA, MENTAL ILLNESS, DEVELOPMENTAL DISABILITY, OR TRAUMATIC BRAIN INJURY.**

A facility admitting and retaining residents with diagnosis of dementia, mental illness, developmental disability, or traumatic brain injury must train all staff to meet the specialized needs of these residents. Staff must receive specialized training within thirty (30) days of hire or of admission of a resident with one (1) of these conditions. The means and methods of training are at the facility's discretion. The training should address the following areas: (3-20-20)T

**01. Dementia:** (3-20-20)T

- a.** Overview of dementia; (3-20-20)T

- b. Symptoms and behaviors of people with memory impairment; (3-20-20)T
- c. Communication with people with memory impairment; (3-20-20)T
- d. Resident's adjustment to the new living environment; (3-20-20)T
- e. Behavior management, including the consistent implementation of behavior interventions; (3-20-20)T
- f. Activities of daily living; and (3-20-20)T
- g. Stress reduction for facility personnel and resident. (3-20-20)T
- 02. Mental Illness:** (3-20-20)T
- a. Overview of mental illnesses; (3-20-20)T
- b. Symptoms and behaviors specific to mental illness; (3-20-20)T
- c. Resident's adjustment to the new living environment; (3-20-20)T
- d. Behavior management, including the consistent implementation of behavior interventions; (3-20-20)T
- e. Communication; (3-20-20)T
- f. Activities of daily living; (3-20-20)T
- g. Integration with rehabilitation services; and (3-20-20)T
- h. Stress reduction for facility personnel and resident. (3-20-20)T
- 03. Developmental Disability:** (3-20-20)T
- a. Overview of developmental disabilities; (3-20-20)T
- b. Interaction and acceptance; (3-20-20)T
- c. Promotion of independence; (3-20-20)T
- d. Communication; (3-20-20)T
- e. Behavior management, including the consistent implementation of behavior interventions; (3-20-20)T
- f. Assistance with adaptive equipment; (3-20-20)T
- g. Integration with rehabilitation services; (3-20-20)T
- h. Activities of daily living; and (3-20-20)T
- i. Community integration. (3-20-20)T
- 04. Traumatic Brain Injury:** (3-20-20)T
- a. Overview of traumatic brain injuries; (3-20-20)T

- b.** Symptoms and behaviors specific to traumatic brain injury; (3-20-20)T
- c.** Adjustment to the new living environment; (3-20-20)T
- d.** Behavior management, including the consistent implementation of behavior interventions; (3-20-20)T
- e.** Communication; (3-20-20)T
- f.** Integration with rehabilitation services; (3-20-20)T
- g.** Activities of daily living; (3-20-20)T
- h.** Assistance with adaptive equipment; and (3-20-20)T
- i.** Stress reduction for facility personnel and resident. (3-20-20)T

**631. -- 639. (RESERVED)**

**640. CONTINUED TRAINING REQUIREMENTS.**

Each employee must receive a minimum of eight (8) hours of job-related continued training per year. (3-20-20)T

**641. ADDITIONAL TRAINING RELATED TO CHANGES.**

When policies or procedures are added, modified, or deleted, the date of the change must be specified on the policy and staff must receive additional training relating to the changes. (3-20-20)T

**642. -- 644. (RESERVED)**

**645. ASSISTANCE WITH MEDICATIONS.**

**01. Training Requirements.** To provide assistance with medications, staff must have the following training requirements, and be delegated as described in this rule. (3-20-20)T

**a.** Before staff can begin assisting residents with medications, successful completion of an Idaho Board of Nursing approved medication assistance course. This training is not included as part of the minimum of sixteen (16) hours of orientation training or minimum of eight (8) hours of continuing training requirement per year. (3-20-20)T

**b.** Staff training on documentation requirements and how to respond when a resident refuses or misses a medication, receives an incorrect medication, or when medication is unavailable or missing. (3-20-20)T

**02. Delegation.** The facility nurse must delegate and document assistance with medications and other nursing tasks. Each medication assistant must be delegated individually, including skill demonstration, prior to assisting with medications, or nursing tasks, and any time the licensed nurse changes. (3-20-20)T

**646. -- 899. (RESERVED)**

**900. ENFORCEMENT ACTIONS.**

Enforcement actions, as described in Sections 901 through 940 of these rules and Sections 39-3357 and 39-3358, Idaho Code, are actions the Department can impose upon a facility. The Department will consider a facility's compliance history, change(s) of ownership, and the number, scope, and severity of the deficiencies when initiating or extending an enforcement action. The Department can impose any of the enforcement actions, independently or in conjunction with others. (3-20-20)T

**901. ENFORCEMENT ACTION OF SUMMARY SUSPENSION.**

When the Department finds that the facility's deficient practice(s) immediately place the health or safety of any residents in danger, the Department may take immediate action through summary suspension of the facility's license,

the imposition of temporary management, a limit on admissions, and transfer the residents. (3-20-20)T

**902. -- 909. (RESERVED)**

**910. ENFORCEMENT ACTION OF CONSULTANT.**

A consultant may be required when an acceptable plan of correction has not been submitted, as described in Section 130 of these rules, or if the Department identifies repeat deficient practice(s) in the facility. The consultant is required to submit periodic reports to the Licensing Agency. (3-20-20)T

**911. -- 919. (RESERVED)**

**920. ENFORCEMENT ACTION OF LIMIT ON ADMISSIONS.**

**01. Reasons for Limit on Admissions.** The Department may limit admissions for the following reasons: (3-20-20)T

- a. The facility is inadequately staffed or the staff is inadequately trained to handle more residents; (3-20-20)T
- b. The facility otherwise lacks the resources necessary to support the needs of more residents; (3-20-20)T
- c. The Department identifies repeat core issues during any follow-up survey; and (3-20-20)T
- d. An acceptable plan of correction is not submitted as described in Section 130 of these rules. (3-20-20)T

**02. Notification of Limit on Admissions.** The Department will notify the facility of the limit on admissions of residents (e.g. a full ban of admissions, a limit of admissions based on resident diagnosis, etc.) pending the correction of deficient practice(s). Limits on admissions to the facility remain in effect until the Department determines the facility has achieved full compliance with requirements or receives written evidence and statements from the outside consultant that the facility is in compliance. (3-20-20)T

**921. -- 924. (RESERVED)**

**925. ENFORCEMENT ACTION OF CIVIL MONETARY PENALTIES.**

**01. Civil Monetary Penalties.** May be issued when a facility is operating without a license, repeat deficiencies are identified, or the facility fails to comply with conditions of the provisional license. Actual harm to a resident or residents does not need to be shown. A single act, omission, or incident will not give rise to imposition of multiple penalties, even though such act, omission, or incident may violate more than one (1) rule. (3-20-20)T

**02. Assessment Amount for Civil Monetary Penalty.** When civil monetary penalties are imposed, such penalties are assessed for each day the facility is or was out of compliance. The amounts below are multiplied by the total number of occupied licensed beds according to the records of the Department at the time non-compliance is established. (3-20-20)T

- a. Repeat deficiency is ten dollars (\$10). Example below:

Number of Occupied Beds in Facility	Repeat Deficiency	Times Number of Days Out of Compliance	Amount of Penalty
11	\$10.00	30 days	\$3,300

(3-20-20)T

- b. In any ninety (90) day period, the penalty amounts may not exceed the limits shown in the

following table:

<b>Limits on Accruing Civil Monetary Amount.</b>		
<b>Number of Occupied Beds in Facility</b>	<b>Initial Deficiency</b>	<b>Repeat Deficiency</b>
3-4 Beds	\$1,440	\$2,880
5-50 Beds	\$3,200	\$6,400
51-100 Beds	\$5,400	\$10,800
101-150 Beds	\$8,800	\$17,600
151 or More Beds	\$14,600	\$29,200

(3-20-20)T

**03. Notice of Civil Monetary Penalties and Appeal Rights.** The Department will give written notice informing the facility of the amount of the penalty, the basis for its assessment and the facility's appeal rights.

(3-20-20)T

**04. Payment of Penalties.** The facility must pay the full amount of the penalty within thirty (30) calendar days from the date the notice is received, unless the facility requests an administrative review of the decision to assess the penalty. The amount of a civil monetary penalty determined through administrative review must be paid within thirty (30) calendar days of the facility's receipt of the administrative review decision unless the facility requests an administrative hearing. The amount of the civil monetary penalty determined through an administrative hearing must be paid within thirty (30) calendar days of the facility's receipt of the administrative hearing decision unless the facility files a petition for judicial review. Interest accrues on all unpaid penalties at the legal rate of interest for judgments. Such interest accrual will begin one (1) calendar day after the date of the initial assessment of the penalty;

(3-20-20)T

**05. Failure to Pay.** Failure of a facility to pay the entire penalty, together with any interest, is cause for revocation of the license or the amount will be withheld from Medicaid payments to the facility.

(3-20-20)T

**926. -- 929. (RESERVED)**

**930. ENFORCEMENT ACTION OF TEMPORARY MANAGEMENT.**

**01. Need for Temporary Management.** The Department may impose the action of temporary management in situations where there is a need to oversee operation of the facility and to ensure the health and safety of the facility's residents:

(3-20-20)T

**a.** During an orderly transfer of residents of the facility to other facilities; or (3-20-20)T

**b.** Pending improvements to bring the facility into compliance with program requirements. (3-20-20)T

**02. Notice of Temporary Management.** The Department will give written notice to the facility of the imposition of temporary management. (3-20-20)T

**03. Who May Serve as a Temporary Manager.** The Department may appoint any person or organization that meets the following qualifications: (3-20-20)T

**a.** The temporary manager must not have any financial interest in the facility to be managed; (3-20-20)T

**b.** The temporary manager must not be related, within the first degree of kinship, to the facility's

owner, manager, administrator, or other management principal; (3-20-20)T

**c.** The temporary manager must possess sufficient training, expertise, and experience in the operation of a facility as would be necessary to achieve the objectives of temporary management. If the temporary manager is to serve in a facility, the manager must possess an Idaho Residential Care Administrator's license; and (3-20-20)T

**d.** The temporary manager must not be an existing competitor of the facility who would gain an unfair competitive advantage by being appointed as temporary manager of the facility. (3-20-20)T

**04. Powers and Duties of the Temporary Manager.** The temporary manager has the authority to direct and oversee the management, and to hire and discharge any consultant or personnel, including the administrator of the facility. The temporary manager has the authority to direct the expenditure of the revenues of the facility in a reasonable and prudent manner, to oversee the continuation of the business and the care of the residents, to oversee and direct those acts necessary to accomplish the goals of the program requirements, and to direct and oversee regular accounting. When the facility fails or refuses to carry out the directions of the temporary manager, the Department will revoke the facility's license. (3-20-20)T

**a.** The temporary manager must observe the confidentiality of the operating policies, procedures, employment practices, financial information, and all similar business information of the facility, except that the temporary manager must make reports to the Department; (3-20-20)T

**b.** The temporary manager may be liable for gross, willful or wanton negligence, intentional acts of omissions, unexplained shortfalls in the facility's fund, and breaches of fiduciary duty; (3-20-20)T

**c.** The temporary manager does not have authority to cause or direct the facility, its owner, or administrator to incur debt, unless to bring the facility into compliance with these rules, or to enter into any contract with a duration beyond the term of the temporary management of the facility; (3-20-20)T

**d.** The temporary manager does not have authority to incur, without the permission of the owner, administrator, or the Department, capital expenditures in excess of two thousand dollars (\$2,000), unless the capital expenditures are directly related to correcting the identified deficiencies; (3-20-20)T

**e.** The temporary manager does not have authority to cause or direct the facility to encumber its assets or receivables; (3-20-20)T

**f.** The temporary manager does not have authority to cause or direct a facility, which holds liability or casualty insurance coverage, to cancel or reduce its liability or casualty insurance coverage; and (3-20-20)T

**g.** The temporary manager does not have authority to cause or direct the sale of the facility, its assets or the premises on which it is located. (3-20-20)T

**05. Responsibility for Payment of the Temporary Manager.** All compensation and per diem costs of the temporary manager must be paid by the licensee. (3-20-20)T

**06. Termination of Temporary Management.** A temporary manager may be replaced under the following conditions: (3-20-20)T

**a.** The Department may require replacement of any temporary manager whose performance is deemed unsatisfactory by the Department. No formal procedure is required for such removal or replacement, but written notice of any action will be given to the facility. (3-20-20)T

**b.** A facility subject to temporary management may petition the Department for replacement of a temporary manager whose performance it considers unsatisfactory. The petition must include why the replacement of a temporary manager is necessary or appropriate. (3-20-20)T

**931. -- 934. (RESERVED)**

**935. ENFORCEMENT ACTION OF PROVISIONAL LICENSE.**

A provisional license may be issued when a facility has one (1) or more core issues, when non-core issues have not been corrected, have become repeat deficiencies, or an acceptable plan of correction is not submitted as described in these rules. The provisional license will state the conditions the facility must follow to continue to operate.

(3-20-20)T

**936. -- 939. (RESERVED)**

**940. ENFORCEMENT ACTION OF REVOCATION OF FACILITY LICENSE.**

**01. Revocation of Facility's License.** The Department may revoke a license when the facility endangers the health or safety of residents, or when the facility is not in substantial compliance with the provisions of Title 39, Chapter 33, Idaho Code, or this chapter of rules.

(3-20-20)T

**02. Reasons for Revocation or Denial of a Facility License.** The Department may revoke or deny any facility license for any of the following reasons:

(3-20-20)T

**a.** The licensee has willfully misrepresented or omitted information on the application or other documents pertinent to obtaining a license;

(3-20-20)T

**b.** When persuaded by a preponderance of the evidence that such conditions exist which endanger the health or safety of any resident;

(3-20-20)T

**c.** Any act adversely affecting the welfare of residents is being permitted, aided, performed, or abetted by the person or persons in charge of the facility. Such acts may include, neglect, physical abuse, mental abuse, emotional abuse, violation of civil rights, criminal activity, or exploitation;

(3-20-20)T

**d.** The licensee has demonstrated or exhibited a lack of sound judgment essential to the operation and management of a facility;

(3-20-20)T

**e.** The licensee has violated any of the conditions of a provisional license;

(3-20-20)T

**f.** The facility lacks adequate personnel, as required by these rules or as directed by the Department, to properly care for the number and type of residents residing at the facility;

(3-20-20)T

**g.** Licensee refuses to allow the Department or the Protection and Advocacy agencies full access to the facility environment, facility records, and the residents as described in Sections 130 and 550 of these rules;

(3-20-20)T

**h.** The licensee has been guilty of fraud, gross negligence, abuse, assault, battery, or exploitation with respect to the operation of a health facility, residential assisted living facility, or certified family home;

(3-20-20)T

**i.** The licensee is actively affected in their performance by alcohol or the use of drugs classified as controlled substances;

(3-20-20)T

**j.** The licensee has been convicted of a criminal offense other than a minor traffic violation within the past five (5) years;

(3-20-20)T

**k.** The licensee is of poor moral and responsible character or has been convicted of a felony or defrauding the government;

(3-20-20)T

**l.** The licensee has been denied, or the licensee's wrong doing, has caused the revocation of any license or certificate of any health facility, residential assisted living facility, or certified family home;

(3-20-20)T

**m.** The licensee has previously operated any health facility or residential assisted living facility without a license or certified family home without a certificate;

(3-20-20)T



**n.** The licensee is directly under the control or influence of any person who has been the subject of proceedings as described in this rule; (3-20-20)T

**o.** The licensee is directly under the control or influence of any person who is of poor moral and responsible character or has been convicted of a felony or defrauding the government; (3-20-20)T

**p.** The licensee is directly under the control or influence of any person who has been convicted of a criminal offense other than a minor traffic violation in the past five (5) years; (3-20-20)T

**q.** The licensee fails to pay civil monetary penalties imposed by the Department as described in Section 925 of these rules; (3-20-20)T

**r.** The licensee fails to take sufficient corrective action as described in Section 130 of these rules; or (3-20-20)T

**s.** The number of residents currently in the facility exceeds the number of residents the facility is licensed to serve. (3-20-20)T

**941. -- 999. (RESERVED)**

## 16.04.07 – RULES GOVERNING FEES FOR STATE HOSPITAL NORTH

### 000. LEGAL AUTHORITY.

The Idaho Board of Health and Welfare is authorized under Section 66-118, Idaho Code, to adopt rules for establishing and charging fees for services provided at State Hospital North and State Hospital South. Under Section 56-1007, Idaho Code, the Department of Health and Welfare is authorized to charge and collect reasonable fees, established by rule, for such services. Section 66-354, Idaho Code, authorizes a state facility to cause an inquiry to be made and collect fees and charges for treatment. Under Sections 56-1003(3)(e), 66-116 and 66-118, Idaho Code, the Idaho Board of Health and Welfare and Director are jointly authorized to administer, manage, and control State Hospital North and State Hospital South. (3-20-20)T

### 001. TITLE AND SCOPE.

The scope of these rules is to establish fees for services provided at State Hospital North (SHN) or State Hospital South (SHS) and are titled IDAPA 16.04.07, "Fees for State Hospital North and State Hospital South." (3-20-20)T

### 002. POLICY.

Fees for services will be established and charged to all patients or responsible relatives. Further, SHN and SHS must not refuse service to any person because of race, color, religion, handicap, or ability or inability to pay. (3-20-20)T

### 003. -- 009 (RESERVED)

### 010. DEFINITIONS.

**01. Charge.** The dollar amount determined by costs per patient day for service received from SHN or SHS for specialized services. (3-20-20)T

**02. Cost Per Patient Day.** An accounting process of allocating all cost centers for the hospital to a twenty-four (24) hour period of time the patient occupies the hospital. (3-20-20)T

**03. Responsible Relatives.** Relatives as defined by Section 66-354, Idaho Code. (3-20-20)T

**04. Services.** May include reasonable and customary services such as: medical, nursing, pharmacy, individual and group counseling, etc. Services covered may differ between SHN and SHS. (3-20-20)T

**05. Third Party Payor.** A payor other than a patient or responsible relative who is legally liable for all or part of patient charge. (3-20-20)T

### 011. -- 029 (RESERVED)

### 030. FEES.

**01. State Hospital North (SHN) - Diagnostic and Treatment Unit Costs.** Costs per patient day for the diagnostic and treatment units will be determined by annual cost allocations and will be effective the first day of October of each calendar year. (3-20-20)T

**02. State Hospital South (SHS) - Nursing Facility and Treatment Unit Costs.** Costs per patient day for the nursing facility and individual treatment units will be determined by annual cost allocations and will be effective the first day of October of each calendar year. (3-20-20)T

**03. Specialized Service Costs.** Specialized services provided by the Hospital Mini Clinic will be billed in addition to the cost per patient day and receipts will be deducted from cost allocations. Specialized services provided outside SHN or SHS will be billed in addition to cost per patient day. (3-20-20)T

### 031. -- 049. (RESERVED)

### 050. CHARGES.

Charges will be established and billed based on fees calculated for services provided. The ability of a patient or responsible relative to pay charges will be determined from the following: (3-20-20)T

**01. Insurance.** (3-20-20)T

**a.** State Hospital North (SHN) - Claims will be itemized by cost per patient day unless the insurance requires a claim itemized by cost per service. No insurance claim will be filed without an assignment of insurance

benefits to the hospital. All benefits from insurance must be made available in total to be applied toward payment of fees set forth herein. (3-20-20)T

**b.** State Hospital South (SHS) - Patients with third-party insurance capability will be charged one hundred percent (100%) of cost. No insurance claims will be filed without an assignment of insurance benefits to SHS. All benefits from insurance must be made available in total to be applied toward payment of fees set forth herein. (3-20-20)T

**02. Other Benefits.** All patient benefits from Social Security, Veterans Administration, retirement, trust accounts, and other periodic benefits and earnings will be made available in total to SHN or SHS to be applied toward payment of fees set forth in this chapter unless otherwise dictated by benefit sources. (3-20-20)T

**051. -- 069. (RESERVED)**

**070. WAIVER.**

Upon a showing of good cause, the Administrators of SHN or SHS or a designee may waive a patient's fees for any given month or portion thereof. Also, the Administrator of State Hospital North or designee may increase or decrease the amount set aside for patient personal needs. (3-20-20)T

**071. -- 089. (RESERVED)**

**090. PERSONAL NEEDS ALLOWANCE.**

**01. State Hospital North (SHN).** (3-20-20)T

**a.** Set-Aside Amount. Excluded and set aside from all income or benefits for patients will be a personal needs allowance established by the hospital or as required by the benefit source. (3-20-20)T

**b.** Use of Monies. These moneys will not be applied toward payment of charges and will be accumulated and held for the patient to spend for his personal needs. (3-20-20)T

**02. State Hospital South (SHS).** (3-20-20)T

**a.** Set Aside Amount -- Nursing Facility. Excluded and set aside from all income or benefits for each patient on the Nursing Facility will be the amount of forty dollars (\$40) per month as a personal needs allowance. (3-20-20)T

**b.** Set Aside Amount -- Treatment Units. Excluded and set aside from all income or benefits for patients will be a personal needs allowance established by the hospital or as required by the benefit source. (3-20-20)T

**c.** Use of Monies. These monies will not be applied toward payment of charges and will be accumulated and held for the patient to spend for his personal needs. (3-20-20)T

**091. -- 999. (RESERVED)**

## 16.05.06 – CRIMINAL HISTORY AND BACKGROUND CHECKS

### 000. LEGAL AUTHORITY.

The Idaho Legislature has authorized the Department of Health and Welfare to promulgate rules to conduct criminal history and background checks under Sections 56-202(b), 56-203(2), 56-204A, 56-1004A, 56-1007, 39-1105, 39-1107, 39-1111, 39-1210(10), 39-1211(4), 39-3520, 39-5604, 39-9109, 66-404(7), 15-5-308(4), 15-5-311(5), and 15-5-316(5), Idaho Code. Under 42 USC Section 9858f, the Department is required to check certain records for federal child care programs. (3-20-20)T

### 001. TITLE, SCOPE AND POLICY.

**01. Title.** These rules are titled IDAPA 16.05.06, “Criminal History and Background Checks.” (3-20-20)T

**02. Scope.** These rules assist the Department in the protection of children and vulnerable adults by providing requirements to conduct criminal history and background checks of individuals licensed or certified by the Department, or who provide care or services to children or vulnerable adults. Individuals requiring a criminal history check are identified in Department rules. (3-20-20)T

**03. Policy.** It is the Department’s policy to conduct fingerprint-based criminal history and background checks on individuals who have completed a criminal history application. The criminal history applicant is required to disclose any pertinent information regarding crimes or findings that would disqualify the individual from providing care or services to children or vulnerable adults. The Department may obtain information for these criminal history and background checks from the following sources: (3-20-20)T

- a. Federal Bureau of Investigation; (3-20-20)T
- b. Idaho State Police Bureau of Criminal Identification; (3-20-20)T
- c. Any state or federal Child Protection Registry; (3-20-20)T
- d. Any state or federal Adult Protection Registry; (3-20-20)T
- e. Any state Sexual Offender Registry; (3-20-20)T
- f. Office of Inspector General List of Excluded Individuals and Entities; (3-20-20)T
- g. Idaho Department of Transportation Driving Records; (3-20-20)T
- h. Nurse Aide Registry; and (3-20-20)T
- i. Other states and jurisdictions records and findings. (3-20-20)T

### 002. -- 009. (RESERVED)

### 010. DEFINITIONS AND ABBREVIATIONS.

For the purposes of this chapter of rules, the following terms apply: (3-20-20)T

**01. Agency.** An administrative subdivision of government or an establishment engaged in doing business for another entity. This term is synonymous with the term employer. (3-20-20)T

**02. Application.** An individual’s request for a criminal history and background check in which the individual discloses any convictions, pending charges, or child or adult protection findings, and authorizes the Department to obtain information from available databases and sources relating to the individual. (3-20-20)T

**03. Clearance.** A clearance is a document designated by the Department as the official result of a completed criminal history and background check with no disqualifying crimes or relevant records found. (3-20-20)T

**04. Conviction.** An individual is considered to have been convicted of a criminal offense as defined in Subsections 010.04.a. through 010.04.d. of this rule: (3-20-20)T

a. When a judgment of conviction, or an adjudication, has been entered against the individual by any federal, state, military, or local court; (3-20-20)T

- b.** When there has been a finding of guilt against the individual by any federal, state, military, or local court; (3-20-20)T
- c.** When a plea of guilty or nolo contendere by the individual has been accepted by any federal, state, military, or local court; (3-20-20)T
- d.** When the individual has entered into or participated in first offender, deferred adjudication, or other arrangement or program where judgment of conviction has been withheld. This includes: (3-20-20)T
- i.** When the individual has entered into participation in a drug court; or (3-20-20)T
- ii.** When the individual has entered into participation in a mental health court. (3-20-20)T
- 05. Criminal History and Background Check.** A criminal history and background check is a fingerprint-based check of an individual's criminal record and other relevant records. (3-20-20)T
- 06. Criminal History Unit.** The Department's Unit responsible for processing fingerprint-based criminal history and background checks, conducting exemption reviews, and issuing clearances or denials according to these rules. (3-20-20)T
- 07. Denial.** A denial is issued by the Department when an individual has a relevant record or disqualifying crime. There are two (2) types of denials: (3-20-20)T
- a.** Conditional Denial. A denial of an applicant because of a relevant record found in Section 230 of these rules. (3-20-20)T
- b.** Unconditional Denial. A denial of an applicant because of a conviction for a disqualifying crime or a relevant record found in Sections 200 and 210 of these rules. (3-20-20)T
- 08. Department.** The Idaho Department of Health and Welfare or its designee. (3-20-20)T
- 09. Direct Patient Access Employee.** Any individual who has access to a patient or resident of a long-term care provider or facility, whether through employment or contract, and who has duties or performs tasks that involve (or may involve) one-on-one (1:1) contact with a patient or resident or has access to his personal belongings. Volunteers are not considered a Direct Patient Access employee of a long-term care provider or facility unless volunteers are required to undergo a criminal history background check per the rules applicable to that specific type of facility or provider. (3-20-20)T
- 10. Disqualifying Crime.** A disqualifying crime is a designated crime listed in Section 210 of these rules that results in the unconditional denial of an applicant. (3-20-20)T
- 11. Employer.** An entity that hires people to work in exchange for compensation. This term is synonymous with the term agency. (3-20-20)T
- 12. Enhanced Clearance.** An enhanced clearance is a clearance issued by the Department that includes a search of child protection registries in states or jurisdictions in which an applicant has resided during the preceding five (5) years. See Section 126 of these rules. (3-20-20)T
- 13. Exemption Review.** A review by the Department at the request of the applicant when a conditional denial has been issued. (3-20-20)T
- 14. Federal Bureau of Investigation (FBI).** The federal agency where fingerprint-based criminal history and background checks are processed. (3-20-20)T
- 15. Good Cause.** Substantial reason, one that affords a legal excuse. (3-20-20)T

**16. Idaho State Police Bureau of Criminal Identification.** The state agency where fingerprint-based criminal history and background checks are processed. (3-20-20)T

**17. Relevant Record.** A relevant record is a record that is found in a search of criminal records or registries checked by the Department as provided in Section 56-1004A, Idaho Code. (3-20-20)T

**011. -- 049. (RESERVED)**

**050. FEES AND COSTS FOR CRIMINAL HISTORY AND BACKGROUND CHECKS.**

The fee for a Department fingerprint-based criminal history and background check is up to seventy dollars (\$70) for an individual. The applicant is responsible for the cost of the criminal history and background check except where otherwise provided by Department rules. An applicant is responsible for any additional costs incurred by the Department paid to agencies, judicial, or law enforcement jurisdictions in other states. The Department will collect the additional funds to cover its costs. (3-20-20)T

**051. -- 059. (RESERVED)**

**060. EMPLOYER REGISTRATION.**

**01. Initial Registration.** Employers required to have Department criminal history and background checks on their employees, contractors, or staff must register with the Department and receive an employer identification number before criminal history and background check applications can be processed or accessed. (3-20-20)T

**02. Change in Name or Ownership.** An agency or facility must: (3-20-20)T

**a.** If acquired by another entity, the new ownership will register as a new employer and provide contact information to obtain a new employer identification number and website access within thirty (30) calendar days of acquisition. New ownership occurs when the agency obtains a new federal Employer Identification Number with the Internal Revenue Service. (3-20-20)T

**b.** If there is a change to its name or location, the employer will provide the new name, location, and contact information to the Department within thirty (30) calendar days of the change. (3-20-20)T

**061. EMPLOYER RESPONSIBILITIES.**

The criminal history and background check clearance is not a determination of suitability for employment. The Department's criminal history and background check clearance means that an individual was found to have no disqualifying crime or relevant record. Employers are responsible for determining the individual's suitability for employment as described in this rule. (3-20-20)T

**01. Screen Applicants.** The employer should screen applicants prior to initiating a criminal history and background check in determining the suitability of the applicant for employment. If an applicant discloses a disqualifying crime or offense, or discloses other information that would indicate a risk to the health and safety of children and vulnerable adults, a determination of suitability for employment should be made during the initial application screening. (3-20-20)T

**02. Maintain Printed Copy of Application.** The employer must maintain a copy of the printed, signed, and notarized criminal history and background check application for all individuals required to obtain a criminal history and background check. (3-20-20)T

**a.** The copy of the application must be readily available for inspection to verify compliance with this requirement. The document must be retained for a period consistent with the employer's own personnel documentation retention schedule. (3-20-20)T

**b.** An employer who chooses to use a criminal history and background check obtained for a previous employer must comply with Section 300 of these rules and maintain copies of the records identified in Subsections 190.01 and 300.02.c. of these rules. (3-20-20)T

**03. Ensure Time Frames Are Met.** The employer is responsible to ensure that the required time frames are met for completion and submission of the application and fingerprints to the Department as required in Section 150 of these rules. (3-20-20)T

**04. Employment Determination.** The employer is responsible for reviewing the results of the criminal history and background check even if a clearance that resulted in no disqualifying crimes or offenses found is issued by the Department. The employer will make a determination as to the ability or risk of the individual to provide care or services to children or vulnerable adults. (3-20-20)T

**062. -- 069. (RESERVED)**

**070. NON-COMPLIANCE WITH THESE RULES.**  
 The Department will report an individual's or an employer's non-compliance with these rules to the applicable licensing or certification unit. (3-20-20)T

**071. -- 099. (RESERVED)**

**100. INDIVIDUALS SUBJECT TO A CRIMINAL HISTORY AND BACKGROUND CHECK.**  
 Individuals subject to a Department criminal history and background check are those persons or classes of individuals who are required by statute, or Department rules to complete a criminal history and background check. (3-20-20)T

<b>Required Classes</b>	<b>Idaho Code and IDAPA Chapter(s)</b>
<b>01.</b> Adoptive Parent Applicants	IDAPA 16.06.01, "Child and Family Services" IDAPA 16.06.02, "Child Care Licensing"
<b>02.</b> Behavioral Health Programs	IDAPA 16.07.17, "Substance Use Disorders Services" IDAPA 16.07.33, "Adult Mental Health Services" IDAPA 16.07.37, "Children's Mental Health Services." IDAPA 16.07.39, "Appointment of Designated Examiners and Dispositioners."
<b>03.</b> Certified Family Homes	Section 39-3520, Idaho Code IDAPA 16.03.19, "Certified Family Homes" IDAPA 16.03.10, "Medicaid Enhanced Plan Benefits"
<b>04.</b> Children's Agency Facility Staff	IDAPA 16.06.02, "Child Care Licensing"
<b>05.</b> Children's Residential Care Facilities	Section 39-1210, Idaho Code IDAPA 16.06.02, "Child Care Licensing"
<b>06.</b> Children's Therapeutic Outdoor Programs	Section 39-1208, Idaho Code IDAPA 16.06.02, "Child Care Licensing"
<b>07.</b> Citizen Review Panel Members	Public health district volunteers who must comply with Section 16-1647, Idaho Code, "Citizen Review Panels - Child Protection Legislative Review Panel"
<b>08.</b> Contracted Non-Emergency Medical Transportation Providers	IDAPA 16.03.09, "Medicaid Basic Plan Benefits"
<b>09.</b> Court Appointed Guardians and Conservators	Title 15, Chapter 5, Idaho Code, & Title 66, Chapter 4, Idaho Code. Court required guardian and conservator criminal history and background checks are not provided Department clearances described in Section 180.01 of these rules
<b>10.</b> Designated Examiners and Dispositioners	IDAPA 16.07.39, "Appointment of Designated Examiners and Dispositioners"

<b>Required Classes</b>	<b>Idaho Code and IDAPA Chapter(s)</b>
11. Developmental Disabilities Agencies	IDAPA 16.03.21, "Developmental Disabilities Agencies" (DDA) IDAPA 16.03.10, "Medicaid Enhanced Plan Benefits"
12. Emergency Medical Services (EMS)	IDAPA 16.01.05, "Emergency Medical Services (EMS) -- Education, Instructor, and Examination Requirements"  IDAPA 16.01.07, "Emergency Medical Services (EMS) -- Personnel Licensing Requirements"
13. High Risk Providers of Medicaid	IDAPA 16.03.09, "Medicaid Basic Plan Benefits" The Medicaid Provider Handbook
14. Home and Community-Based Services (HCBS)	IDAPA 16.03.10, "Medicaid Enhanced Plan Benefits" IDAPA 16.04.17, "Residential Habilitation Agencies"
15. Home Health Agencies	IDAPA 16.03.07, "Home Health Agencies"
16. Idaho Behavioral Health Plan (IBHP)	IDAPA 16.03.09, "Medicaid Basic Plan Benefits"
17. Idaho Child Care Program (ICCP)	IDAPA 16.06.12, "Idaho Child Care Program"
18. Intermediate Care Facilities for Individuals with Intellectual Disabilities (ICF/IID)	IDAPA 16.03.11, "Intermediate Care Facilities for Individuals with Intellectual Disabilities (ICF/IID)"
19. Licensed Foster Care	Section 39-1211, Idaho Code IDAPA 16.06.02, "Child Care Licensing"
20. Licensed Day Care	Sections 39-1105, 39-1113, and 39-1114, Idaho Code IDAPA 16.06.02, "Child Care Licensing"
21. Mental Health Services	IDAPA 16.07.33, "Adult Mental Health Services" IDAPA 16.07.37, "Children's Mental Health Services"
22. Personal Assistance Agencies	IDAPA 16.03.10, "Medicaid Enhanced Plan Benefits"
23. Personal Care Service Providers	Section 39-5604, Idaho Code IDAPA 16.03.10, "Medicaid Enhanced Plan Benefits"
24. Residential Assisted Living Facilities	IDAPA 16.03.22, "Residential Assisted Living Facilities"
25. Service Coordinators and Paraprofessional Providers	IDAPA 16.03.10, "Medicaid Enhanced Plan Benefits"
26. Skilled Nursing Facilities	IDAPA 16.03.02, "Skilled Nursing Facilities"
27. Substance Use Disorders Services	IDAPA 16.07.17, "Substance Use Disorders Services"
28. Support Brokers and Community Support Workers	IDAPA 16.03.13, "Consumer-Directed Services"

(3-20-20)T

**101. DEPARTMENT INDIVIDUALS SUBJECT TO A CRIMINAL HISTORY AND BACKGROUND CHECK.**

The following Department employees, contractors, and volunteers are subject to criminal history and background checks.

(3-20-20)T

**01. Employees, Contractors, and Volunteers.** Employees, contractors, and volunteers, providing direct care services or who have access to children or vulnerable adults as defined in Section 39-5302(10), Idaho Code.

(3-20-20)T



- 02. Employees of Bureau of Audits and Investigations.** (3-20-20)T
    - a. Fraud Investigators; (3-20-20)T
    - b. Utilization Review Analysts; and (3-20-20)T
    - c. Criminal History Staff. (3-20-20)T
  - 03. Employees at State Institutions.** All employees of the following state funded institutions; (3-20-20)T
    - a. Southwest Idaho Treatment Center, Nampa, Idaho; (3-20-20)T
    - b. State Hospital North, Orofino, Idaho; and (3-20-20)T
    - c. State Hospital South, Blackfoot, Idaho. (3-20-20)T
  - 04. Emergency Medical Services (EMS) Employees.** EMS communication specialists and managers. (3-20-20)T
  - 05. Other Employees.** Other Department employees as determined by the Director. (3-20-20)T
- 102. -- 119. (RESERVED)**
- 120. APPLICATION FOR A CRIMINAL HISTORY AND BACKGROUND CHECK.**  
Individuals who are subject to a criminal history and background check must complete an application and have it notarized. The application must include disclosure of any disqualifying crimes, offenses, or relevant records. (3-20-20)T
- 01. Application Form.** The applicant must request a criminal history and background check by completing the Department's application form and submitting it on-line or by mail. The individual's application authorizes the Department to obtain information and release it as required in accordance with applicable state and federal law. The following information is required to complete the application: (3-20-20)T
    - a. Name, current and former names, or aliases; (3-20-20)T
    - b. Current and former addresses as requested in the application; (3-20-20)T
    - c. Date of birth, that appears on a valid identification document issued by a governmental entity; (3-20-20)T
    - d. State and country of birth; and (3-20-20)T
    - e. Driver's license number, if licensed, state where licensed, and whether a license has ever been revoked or suspended. (3-20-20)T
    - f. Other identifying information, including gender, race, height, weight, eye color, and hair color; (3-20-20)T
    - g. Employer information; (3-20-20)T
    - h. Any criminal record or criminal offense information; (3-20-20)T
    - i. Any pending charges or outstanding warrants; (3-20-20)T
    - j. Any child or adult protection involvement; (3-20-20)T

- k. Any Medicare or Medicaid Provider Exclusion; and (3-20-20)T
- l. Any other information requested on the application. (3-20-20)T

**02. Disclosures.** The individual must disclose any conviction, pending charges or indictment for crimes, and furnish a description of the crime and the particulars on the application. The individual must also disclose any notice by a state or local agency of substantiated child or substantiated vulnerable adult abuse, neglect, exploitation, or abandonment complaint, and any other information as required. (3-20-20)T

**03. Failure to Disclose Information.** (3-20-20)T

a. An applicant who falsifies or fails to disclose information on the application, may be subject to a conditional denial under Section 230.01 and prosecution under Sections 18-3203, 18-5401, and 56-227A, Idaho Code. (3-20-20)T

b. An applicant required to obtain a criminal history and background check under Section 126 of these rules that knowingly makes a materially false statement in connection to their background check will receive an unconditional denial as provided in Section 200 of these rules. (3-20-20)T

**121. -- 124. (RESERVED)**

**125. IDAHO CHILD PROTECTION CENTRAL REGISTRY CHECKS.**

The Department will provide the results of a check of the Idaho Child Protection Central Registry to any agency that requires it to comply with the provisions of applicable federal or state law. The Department will process those requests as described in this rule. (3-20-20)T

**01. Request for an Idaho Child Protection Central Registry Check.** A request for an Idaho Child Protection Central Registry check must be submitted by mail, facsimile transmission, or e-mail attachment on state or agency letterhead with the requesting authority contact information, and must include the following: (3-20-20)T

- a. Name of the subject of the check, and any aliases; (3-20-20)T
- b. Date of birth and Social Security Number of the subject of the check; and (3-20-20)T
- c. A notarized signature of the subject of the check authorizing the request. (3-20-20)T

**02. Fee Amount.** The fee for an Idaho Child Protection Central Registry check is twenty dollars (\$20) for each subject checked. (3-20-20)T

**03. Department Response.** A response will be returned to the agency initiating the request for the check within fourteen (14) days of receipt of the request. The Department's contact information will be included along with the result of the check. (3-20-20)T

**126. APPLICANTS RECEIVING A DEPARTMENT ENHANCED CLEARANCE.**

The following classes of individuals are required to provide their previous residence information for the preceding five (5) years in their application for a criminal history and background check as described in Section 100 of these rules. (3-20-20)T

- 01. Adoptive Parent Applicants.** (3-20-20)T
- 02. Behavioral Health Programs.** (3-20-20)T
- 03. Children's Agency Facility Staff.** (3-20-20)T
- 04. Children's Residential Care Facilities.** (3-20-20)T
- 05. Children's Therapeutic Outdoor Programs.** (3-20-20)T

- 06. Citizen Review Panel Members. (3-20-20)T
- 07. Idaho Child Care Program (ICCP). (3-20-20)T
- 08. Licensed Foster Care. (3-20-20)T
- 09. Licensed Day Care. (3-20-20)T
- 10. Mental Health Services. (3-20-20)T
- 11. Substance Use Disorders Services. (3-20-20)T

127. -- 129. (RESERVED)

**130. SUBMISSION OF APPLICATION.**

An application for a criminal history and background check must be initiated, submitted, and received on the Department's website before a criminal history and background check can be processed. The application is pending until the Department issues a clearance or denial, or the individual withdraws the application. (3-20-20)T

131. -- 139. (RESERVED)

**140. SUBMISSION OF FINGERPRINTS.**

The Department's criminal history and background check is a fingerprint-based check. Ten (10) rolled fingerprints must be collected from the individual and submitted to the Department within the time frame for submitting applications as provided in Section 150 of these rules in order for a criminal history and background check request to be processed. The Department obtains fingerprints electronically at each of its fingerprint locations, or the Department's fingerprint card must be used. A Department fingerprint card can be obtained by contacting the Criminal History Unit, described in Section 005 of these rules. (3-20-20)T

**01. Department Fingerprinting Locations.** A fingerprint appointment is scheduled at designated Department locations where the Department will collect the individual's fingerprints. Locations for the closest Department fingerprint collection office where an individual may submit fingerprints are listed on the Department's website. The applicant may contact the Criminal History Unit as described in Section 005 of these rules for additional guidance. (3-20-20)T

**02. Submitting Fingerprints by Mail.** When an individual elects to have fingerprints collected by a local law enforcement agency or by the applicant's employer, the Department's fingerprint card must be used. The fingerprint card must be completed in accordance with the instructions provided, signed, and mailed along with the completed notarized application and applicable fee to the address indicated on the Department's website. The notarized application and fees must be received by the Department in the time frame required in Section 150 of these rules. (3-20-20)T

**03. Submission of Reprints.** In the event that an individual's submitted fingerprints are deemed unreadable by the Department, Idaho State Police, or the FBI, the applicant must comply with a request for reprints from the Department within fifteen (15) calendar days from the date of the notice. Failure to comply with the Department's reprint request will result in the applicant being unavailable to provide services. (3-20-20)T

141. -- 149. (RESERVED)

**150. TIME FRAME FOR SUBMITTING APPLICATION AND FINGERPRINTS.**

The completed notarized application and fingerprints must be received by the Department within twenty-one (21) days from the date of submission in the Department background check system whether it is sent by mail or accepted at a Department fingerprinting location. If the Department does not receive the criminal history and background check application and applicant fingerprints within sixty (60) calendar days from its submission in the department website, the applicant must complete a new application. (3-20-20)T

**01. Availability to Provide Services.** The applicant may provide services on the day the application is signed and notarized, as long as the applicant has not disclosed any disqualifying crimes or relevant records. The applicant must provide the Department a copy of the signed and notarized application to validate the date of applicant's availability to provide services. (3-20-20)T

**02. Unavailability to Provide Services.** The applicant becomes unavailable to provide services or be licensed or certified when the notarized application is not received or fingerprints have not been collected within this timeframe, or the application is deemed inadequate or incomplete for processing by the Department. (3-20-20)T

**03. Incomplete Application.** The criminal history and background check is incomplete and will not be processed by the Department if this time frame is not met. (3-20-20)T

**04. No Extension of Time Frame.** The Department will not extend the twenty-one (21) day time frame, unless the applicant or employer provides just cause. An applicant for employment or employer can not submit a new application for the same purpose, or repeatedly re-sign and re-notarize the original application. (3-20-20)T

**151. -- 159. (RESERVED)**

**160. WITHDRAWAL OF APPLICATION.**

An individual may withdraw their application for a criminal history and background check at any time. An individual who withdraws their application cannot provide services, or receive licensure or certification. Fees paid for the cost of the criminal history and background check are non-refundable once the fingerprints have been submitted by the Department to the Idaho State Police. (3-20-20)T

**161. -- 169. (RESERVED)**

**170. AVAILABILITY TO PROVIDE SERVICES PENDING COMPLETION OF THE CRIMINAL HISTORY AND BACKGROUND CHECK.**

An individual is available to provide services pending completion of the criminal history and background check as described in Subsections 170.01 and 170.02 of this rule. The individual must have submitted a signed notarized application and fingerprints in the time frame required in Section 150 of these rules, in order to provide services. (3-20-20)T

**01. Employees of Providers, Contractors, Emergency Medical Services (EMS), or the Department.** An individual is available to provide services on a provisional basis at the discretion of the employer or EMS Bureau as long as no disqualifying crimes or relevant records are disclosed on the application. The employer must review the application for any disqualifying crimes listed in Section 210 of these rules or other relevant records listed in Sections 230 and 240 of these rules. The employer must determine whether the applicant poses a health or safety risk to vulnerable clients before allowing the individual to provide services until a clearance or denial is issued by the Department. (3-20-20)T

**02. Individuals Licensed or Certified by the Department.** Individuals applying for licensure or certification by the Department are not available to provide services or receive licensure or certification until the criminal history and background check is complete and a clearance is issued by the Department. The following are individuals required to have a clearance prior to providing services: (3-20-20)T

- a.** Adoption or foster care applicants and adults in the home; (3-20-20)T
- b.** Certification or licensure applicants; (3-20-20)T
  - i.** Certified family homes; (3-20-20)T
  - ii.** Licensed child care providers; (3-20-20)T

**171. -- 179. (RESERVED)**

**180. CRIMINAL HISTORY AND BACKGROUND CHECK RESULTS.**

The Department will issue a clearance or denial once the criminal history and background check is completed. (3-20-20)T

**01. Results of Criminal History and Background Checks.** The results may be accessed by the individual on the Department's website. The employer may access the information that is provided by the applicant and information obtained from the state, county, or through registries. (3-20-20)T

**02. Findings for Court Required Criminal History and Background Checks.** As required in Section 56-1004A(2)(b), Idaho Code, the Department will provide findings of a court ordered criminal history and background check to individuals appointed by the court according to Title 15, Chapter 5, or Title 66, Chapter 4, Idaho Code. (3-20-20)T

**181. APPLICATION STATUS.**

An individual and their employer may check on the criminal history and background check status and the individual's availability to work on the Department website at <https://chu.dhw.idaho.gov/>. (3-20-20)T

**182. -- 189. (RESERVED)**

**190. CRIMINAL HISTORY AND BACKGROUND CHECK CLEARANCE.**

**01. Clearance.** A criminal history and background check clearance is issued by the Department once all relevant records and findings have been reviewed and the Department has cleared the applicant. The clearance will be published on the Department's website and the individual may print copies of the clearance. The employer must print the clearance within fourteen (14) calendar days of the clearance being accessible on the Department's website, and maintain a copy readily available for inspection for a period consistent with the employer's own personnel documentation retention schedule. (3-20-20)T

**02. Clearance Types.** An applicant required to pass a criminal history and background must receive a clearance as provided below: (3-20-20)T

**a.** A clearance for an applicant who is not seeking an enhanced clearance for employment in classes listed in Section 126 of these rules, may receive a clearance for a criminal history and background check when a relevant record identified on any child protection registry is disclosed, but the applicant has no conviction of any crimes listed in Subsections 210.01 or 210.02 of these rules. (3-20-20)T

**b.** An applicant who receives an enhanced clearance has met the criteria to have obtained a clearance as provided in Subsection 190.02.a. of this rule. An enhanced clearance is required for each of the classes listed in Section 126 of these rules and requires searches from states and jurisdictions where the applicant has resided in the previous five (5) years. A relevant record on any child protection registry will result in a denial under Subsection 200.01 of these rules and no clearance will be issued. An applicant who applies to work in any of these classes must receive or have an enhanced clearance. (3-20-20)T

**03. Revocation of Clearance.** An individual's previously issued clearance may be revoked for the following: (3-20-20)T

**a.** The individual fails to comply with the Department's request to submit to a new criminal history and background check according to Subsection 300.04 of these rules. (3-20-20)T

**b.** The individual completes a new criminal history and background check and is found to have a criminal or relevant record that results in an inability to proceed action or in a denial as described in Sections 190 or 200 of these rules. (3-20-20)T

**c.** The criminal history and background check fees are not paid, or are insufficient to cover the costs of the background check. (3-20-20)T

**191. -- 199. (RESERVED)**

**200. UNCONDITIONAL DENIAL.**

An individual who receives an unconditional denial is not available to provide services, have access, or to be licensed or certified by the Department. (3-20-20)T

- 01. Reasons for an Unconditional Denial.** Unconditional denials are issued for: (3-20-20)T
- a.** Disqualifying crimes described in Section 210 of these rules; (3-20-20)T
  - b.** A relevant record on any Child Protection Registry for the classes of individuals listed in Section 126 of these rules; (3-20-20)T
  - c.** A relevant record on the Idaho Child Protection Central Registry with a Level one (1) or Level two (2) designation for all other applicants covered by these rules; (3-20-20)T
  - d.** A relevant record on the Nurse Aide Registry; (3-20-20)T
  - e.** A relevant record on either the state or federal sex offender registries; (3-20-20)T
  - f.** A relevant record on the state or federal Medicaid Exclusion List, described in Section 240 of these rules; or (3-20-20)T
  - g.** A materially false statement made knowingly in connection to the Department's criminal history and background check application for the classes of individuals listed in Section 126 of these rules will result in a five-year disqualification period for the applicant. (3-20-20)T

**02. Issuance of an Unconditional Denial.** The Department will issue an unconditional denial within fourteen (14) days of completion of a criminal history and background check. (3-20-20)T

**03. Challenge of Department's Unconditional Denial.** An individual has twenty-eight (28) days from the date the unconditional denial is issued to challenge the Department's unconditional denial. The individual must submit the challenge in writing and provide court records or other information which demonstrates the Department's unconditional denial is incorrect. These documents must be filed with the Criminal History Unit described in Section 005 of these rules. (3-20-20)T

**a.** If the individual challenges the Department's unconditional denial, the Department will review the court records, documents and other information filed by the individual. The Department will issue a decision within thirty (30) days of the receipt of the challenge. The Department's decision will be a final order under IDAPA 16.05.03, "Contested Case Proceedings and Declaratory Rulings," Section 152. (3-20-20)T

**b.** If the individual does not challenge the Department's unconditional denial within thirty (30) days, it becomes a final order of the Department under IDAPA 16.05.03, "Contested Case Proceedings and Declaratory Rulings," Section 152. (3-20-20)T

**04. No Exemption Review.** No exemption review, as described in Section 250 of these rules, is allowed for an unconditional denial. (3-20-20)T

**05. Appeal of an Unconditional Denial.** Following a challenge of the Department's unconditional denial, an individual may appeal the Department's decision under the provisions in IDAPA 16.05.03, "Contested Case Proceedings and Declaratory Rulings." The request to appeal an unconditional denial does not stay the action of the Department. (3-20-20)T

**201. -- 209. (RESERVED)**

**210. DISQUALIFYING CRIMES RESULTING IN AN UNCONDITIONAL DENIAL.**

An individual is not available to provide direct care or services when the individual discloses or the criminal history and background check reveals a conviction for a disqualifying crime on their record as described in this rule. (3-20-20)T

- 01. Disqualifying Crimes.** The disqualifying crimes, described in Subsection 210.01 of this rule, or any substantially conforming foreign criminal violation, will result in an unconditional denial being issued. (3-20-20)T
- a.** Crimes against vulnerable adults: (3-20-20)T
    - i.** Abuse, neglect, or exploitation of a vulnerable adult, as defined in Section 18-1505, Idaho Code; (3-20-20)T
    - ii.** Abandoning a vulnerable adult, as defined in Section 18-1505A, Idaho Code; (3-20-20)T
    - iii.** Sexual abuse and exploitation of a vulnerable adult, as defined in Section 18-1505B, Idaho Code. (3-20-20)T
  - b.** Aggravated, first-degree and second-degree arson, as defined in Sections 18-801 through 18-803, and 18-805, Idaho Code; (3-20-20)T
  - c.** Crimes against nature, as defined in Section 18-6605, Idaho Code; (3-20-20)T
  - d.** Forcible sexual penetration by use of a foreign object, as defined in Section 18-6608, Idaho Code; (3-20-20)T
  - e.** Hiring, employing, or using a minor to engage in certain acts, as defined in Section 18-1517A, Idaho Code; (3-20-20)T
  - f.** Human trafficking, as defined in Sections 18-8602 and 18-8603, Idaho Code; (3-20-20)T
  - g.** Incest, as defined in Section 18-6602, Idaho Code; (3-20-20)T
  - h.** Injury to a child, felony or misdemeanor, as defined in Section 18-1501, Idaho Code; (3-20-20)T
  - i.** Kidnapping, as defined in Sections 18-4501 through 18-4503, Idaho Code; (3-20-20)T
  - j.** Lewd conduct with a minor, as defined in Section 18-1508, Idaho Code; (3-20-20)T
  - k.** Mayhem, as defined in Section 18-5001, Idaho Code; (3-20-20)T
  - l.** Manslaughter: (3-20-20)T
    - i.** Voluntary manslaughter, as defined in Section 18-4006(1) Idaho Code; (3-20-20)T
    - ii.** Involuntary manslaughter, as defined in Section 18-4006(2), Idaho Code; (3-20-20)T
    - iii.** Felony vehicular manslaughter, as defined in Section 18-4006(3)(a) and (b), Idaho Code; (3-20-20)T
  - m.** Murder in any degree or assault with intent to commit murder, as defined in Sections 18-4001, 18-4003, and 18-4015, Idaho Code; (3-20-20)T
  - n.** Poisoning, as defined in Sections 18-4014 and 18-5501, Idaho Code; (3-20-20)T
  - o.** Rape, as defined in Section 18-6101, Idaho Code; (3-20-20)T
  - p.** Robbery, as defined in Section 18-6501, Idaho Code; (3-20-20)T
  - q.** Felony stalking, as defined in Section 18-7905, Idaho Code; (3-20-20)T

- r. Sale or barter of a child, as defined in Section 18-1511, Idaho Code; (3-20-20)T
  - s. Ritualized abuse of a child, as defined in Section 18-1506A, Idaho Code; (3-20-20)T
  - t. Sexual abuse or exploitation of a child, as defined in Sections 18-1506, Idaho Code; (3-20-20)T
  - u. Felony sexual exploitation of a child, as defined in Section 18-1507, Idaho Code; (3-20-20)T
  - v. Sexual battery of a minor child under sixteen (16) or seventeen (17) years of age, as defined in Section 18-1508A, Idaho Code; (3-20-20)T
  - w. Video voyeurism, as defined in Section 18-6609, Idaho Code; (3-20-20)T
  - x. Enticing of children, as defined in Sections 18-1509 and 18-1509A, Idaho Code; (3-20-20)T
  - y. Inducing individuals under eighteen (18) years of age into prostitution or patronizing a prostitute, as defined in Sections 18-5609 and 18-5611, Idaho Code; (3-20-20)T
  - z. Any felony punishable by death or life imprisonment; (3-20-20)T
  - aa. Attempted strangulation, as defined in Section 18-923, Idaho Code; (3-20-20)T
  - bb. Felony domestic violence, as defined in Section 18-918, Idaho Code; (3-20-20)T
  - cc. Battery with intent to commit a serious felony, as defined in Section 18-911, Idaho Code; (3-20-20)T
  - dd. Assault with intent to commit a serious felony, as defined in Section 18-909, Idaho Code; or (3-20-20)T
  - ee. Attempt, conspiracy, accessory after the fact, or aiding and abetting, as defined in Sections 18-205, 18-306, 18-1701, and 19-1430, Idaho Code, to commit any of the disqualifying designated crimes. (3-20-20)T
- 02. Disqualifying Five-Year Crimes.** The Department will issue an unconditional denial for an individual who has been convicted of the following described crimes for five (5) years from the date of the conviction for the crimes listed in this rule, or any substantially conforming foreign criminal violation: (3-20-20)T
- a. Any felony not described in Subsection 210.01, of this rule; (3-20-20)T
  - b. Misdemeanor domestic violence, as defined in Section 18-918, Idaho Code; (3-20-20)T
  - c. Failure to report abuse, abandonment or neglect of a child, as defined in Section 16-1605, Idaho Code; (3-20-20)T
  - d. Misdemeanor forgery of and fraudulent use of a financial transaction card, as defined in Sections 18-3123 through 18-3128, Idaho Code; (3-20-20)T
  - e. Misdemeanor forgery and counterfeiting, as defined in Sections 18-3601 through 18-3620, Idaho Code; (3-20-20)T
  - f. Misdemeanor identity theft, as defined in Section 18-3126, Idaho Code; (3-20-20)T
  - g. Misdemeanor insurance fraud, as defined in Sections 41-293 and 41-294, Idaho Code; (3-20-20)T
  - h. Public assistance fraud, as defined in Sections 56-227, 56-227A, 56-227D, 56-227E and 56-227F, Idaho Code; (3-20-20)T



- i. Sexual exploitation of a child by electronic means, felony or misdemeanor, as defined in Section 18-1507A, Idaho Code; (3-20-20)T
- j. Stalking in the second degree, as defined in Section 18-7906, Idaho Code; (3-20-20)T
- k. Misdemeanor vehicular manslaughter, as defined in Section 18-4006(3)(c), Idaho Code; (3-20-20)T
- l. Sexual exploitation by a medical care provider, as defined in Section 18-919, Idaho Code; (3-20-20)T
- or m. Operating a certified family home without certification, as defined in Section 39-3528, Idaho Code; (3-20-20)T
- n. Attempt, conspiracy, accessory after the fact, or aiding and abetting, as defined in Sections 18-205, 18-306, 18-1701, and 19-1430, Idaho Code, to commit any of the disqualifying five (5) year crimes. (3-20-20)T

**03. Underlying Facts and Circumstances.** The Department may consider the underlying facts and circumstances of felony or misdemeanor conduct including a guilty plea or admission in determining whether or not to issue a clearance, regardless of whether or not the individual received one (1) of the following: (3-20-20)T

- a. A withheld judgment; (3-20-20)T
- b. A dismissal, suspension, deferral, commutation, or a plea agreement where probation or restitution was or was not required; (3-20-20)T
- c. An order according to Section 19-2604, Idaho Code, or other equivalent state law; or (3-20-20)T
- d. A sealed record. (3-20-20)T

**211. -- 219. (RESERVED)**

**220. CONDITIONAL DENIAL.**

The Department may issue a conditional denial within fourteen (14) days of the completion of a criminal history and background check. An individual who receives a conditional denial is not available to provide services or be licensed or certified by the Department. (3-20-20)T

**01. Reasons for a Conditional Denial Issuance.** A conditional denial is issued when the criminal history and background check reveals a relevant record as described in Section 230 of these rules. (3-20-20)T

**02. Effective Date of a Conditional Denial.** A conditional denial is effective immediately. An applicant may not reapply for a criminal history and background check for three (3) years from the date of the conditional denial. (3-20-20)T

**03. Request an Exemption Review.** An individual may request an exemption review as described in Section 250 of these rules when a conditional denial has been issued. (3-20-20)T

**221. -- 229. (RESERVED)**

**230. RELEVANT RECORDS RESULTING IN A CONDITIONAL DENIAL.**

An individual is not available to provide direct care or services when the individual discloses or the criminal history and background check reveals a relevant record on their record as described Subsections 230.01 and 230.02 of this rule. (3-20-20)T

**01. Individuals Licensed or Certified by the Department or a Department Employee.** A conditional denial may be issued when an individual who is licensed or certified by the Department, or who is a

Department employee discloses, or the criminal history and background check reveals, a relevant record as defined in Subsections 230.01.a. through 230.01.d. of this rule: (3-20-20)T

- a. A substantiated child protection complaint or a substantiated adult protection complaint; (3-20-20)T
- b. The Department determines there is a potential health and safety risk to vulnerable adults or children; (3-20-20)T
- c. The individual has falsified or omitted information on the application form; or (3-20-20)T
- d. The Department determines additional information is required. (3-20-20)T

**02. Employees of Providers or Contractors.** A conditional denial may be issued when an individual who is employed by a provider or contractor discloses, or the criminal history and background check reveals, a relevant record as defined in Subsections 230.02.a. through 230.02.b. of this rule. (3-20-20)T

- a. A substantiated child protection complaint or a substantiated adult protection complaint; or (3-20-20)T
- b. The Department determines additional information is required. (3-20-20)T

**03. Underlying Facts and Circumstances.** The Department may consider the underlying facts and circumstances of felony or misdemeanor conduct including a guilty plea or admission in determining whether or not to issue a clearance, regardless of whether or not the individual received one (1) of the following: (3-20-20)T

- a. A withheld judgment; (3-20-20)T
- b. A dismissal, suspension, deferral, commutation, or a plea agreement where probation or restitution was or was not required; (3-20-20)T
- c. An order according to Section 19-2604, Idaho Code, or other equivalent state law; or (3-20-20)T
- d. A sealed record. (3-20-20)T

**231. -- 239. (RESERVED)**

**240. MEDICAID EXCLUSION.**

Individuals subject to these rules, who are excluded by the Office of the Inspector General, Department of Health and Human Services; or, are listed in the State of Idaho Medicaid Exclusion list, cannot provide Department funded services within the scope of these rules. At the expiration of the exclusion, the individual may reapply for a criminal history and background check. (3-20-20)T

**241. -- 249. (RESERVED)**

**250. EXEMPTION REVIEWS.**

An individual cannot request an exemption review for an unconditional denial. An individual may request an exemption review within fourteen (14) days from the date of the issuance of a conditional denial by the Department, unless good cause is shown for a delay. Once the Department receives the request for an exemption review, the Department will initiate a review for crimes or actions not designated in Section 210 of these rules. The review may consist of examining documents and supplemental information provided by the individual, a telephone interview, an in-person interview, or any other review the Department determines is necessary. Exemption reviews are governed and conducted as provided in Subsections 250.01 through 250.05 of this rule. (3-20-20)T

**01. Scheduling an Exemption Review.** Upon receipt of a request for an exemption review, the Department will determine the type of review and conduct the review within thirty (30) days from the date of the request. Where an in-person review is appropriate, the Department will provide the individual at least seven (7) days

notice of the review date unless the time is waived by the individual. When an in-person review is scheduled, the individual is notified by the Department that they are able to bring witnesses and present evidence during the review. (3-20-20)T

**02. Factors Considered at the Exemption Review.** The Department will consider the following factors or evidence during the exemption review: (3-20-20)T

- a.** The severity or nature of the crime or other findings; (3-20-20)T
- b.** The period of time since the incident under review occurred; (3-20-20)T
- c.** The number and pattern of incidents; (3-20-20)T
- d.** Circumstances surrounding the incident that would help determine the risk of repetition; (3-20-20)T
- e.** Relationship of the incident to the care of children or vulnerable adults; (3-20-20)T
- f.** Activities since the incident, such as continuous employment, education, participation in treatment, payment of restitution, or any other factors that may be evidence of rehabilitation; (3-20-20)T
- g.** Granting of a pardon by the Governor or the President; and (3-20-20)T
- h.** The falsification or omission of information on the application form and other supplemental forms submitted. (3-20-20)T

**03. Exemption Review Determination.** The Department determines the individual's suitability based upon the information provided during the exemption review. The Department will issue a notice of decision within fifteen (15) business days of the close of the review. (3-20-20)T

**04. Exemption Review Decision Effective Dates.** The Department's exemption review decision is effective for three (3) years from the date of the notice of decision. (3-20-20)T

**05. Exemption Review Appeal.** Exemption reviews conducted under this section of rule may be appealed under IDAPA 16.05.03, "Contested Cases Proceedings and Declaratory Rulings." The filing of a notice of appeal does not stay the action of the Department. The individual who files an appeal must establish that the Department's denial was arbitrary and capricious. (3-20-20)T

**251. -- 259. (RESERVED)**

**260. PREVIOUS EXEMPTION REVIEW DENIALS.**

The individual's current request for a criminal history and background check for any Department program when there has been a denial from an exemption review within the last three (3) years will automatically be denied. (3-20-20)T

**261. -- 269. (RESERVED)**

**270. CRIMINAL OR RELEVANT RECORD - ACTION PENDING.**

**01. Notice of Inability to Proceed.** When the applicant is identified as having a pending criminal action for a crime or relevant record that may disqualify them from receiving a clearance for the criminal history and background check, the Department may issue a notice of inability to proceed. (3-20-20)T

**02. Availability to Provide Services.** The applicant is not available to provide service when a notice of inability to proceed or denial is issued by the Department. Any previous clearance issued by the Department will be revoked as described in Section 190 of these rules. (3-20-20)T

**03. Reconsideration of Action Pending.** In the case of an inability to proceed status, the applicant can

submit documentation that the matter has been resolved to the Department for reconsideration within one hundred and twenty (120) calendar days from the date of notice. When the Department receives this documentation, the Department will notify the applicant of the reconsideration and issue a clearance or denial. When the Department's reconsideration results in a clearance after review, any previously revoked clearance will be restored as described in Section 190 of these rules. (3-20-20)T

**271. -- 299. (RESERVED)**

**300. UPDATING CRIMINAL HISTORY AND BACKGROUND CHECKS.**

The employer is responsible for confirming that the applicant has completed a criminal history and background check as provided in Section 190 of these rules. Once a clearance is issued by the Department, verifiable continuous employment of the applicant with the same employer eliminates the requirement for a new background check. (3-20-20)T

**01. New Criminal History and Background Check.** Any individual required to have a criminal history and background check under these rules must complete a new application, including fingerprints when: (3-20-20)T

**a.** Accepting employment with a new employer, and their last Department criminal history and background check was completed more than three (3) years prior to their employment date; or (3-20-20)T

**b.** Applying for licensure or certification with the Department, and their last Department criminal history and background check was completed more than three (3) years prior to their employment date or licensure application date; (3-20-20)T

**c.** If an applicant is terminated by the employer, is rehired by the same employer, and the applicant background check is older than three (3) years at the time of the rehire, the provisions of Subsections 300.01.a. through 300.01.b. of this rule apply. (3-20-20)T

**02. Use of Criminal History Check Within Three Years of Completion.** Any employer may use a Department criminal history and background check clearance obtained under these rules if: (3-20-20)T

**a.** The individual has received a Department's criminal history and background check clearance within three (3) years from the date of employment; (3-20-20)T

**b.** Prior to allowing the individual to provide services, the employer must obtain access to the individual's background check results and clearance through the Department's website by having the employer's identification number added to the individual's background check results, and (3-20-20)T

**c.** The employer completes a state-only background check of the individual through the Idaho State Police Bureau of Criminal Identification, and no disqualifying crimes are found. (3-20-20)T

**i.** The action must be initiated by the employer within thirty (30) calendar days of obtaining access to the individual's criminal history and background check clearance issued by the Department; and (3-20-20)T

**ii.** The employer must be able to provide proof of this action by maintaining a copy of the records required in Subsections 300.02.a. and 300.02.c. of this rule for a period consistent with the employer's own personnel documentation retention schedule. (3-20-20)T

**d.** If an applicant is terminated by the employer, is rehired by the same employer, and the applicant background check was completed less than three (3) years from the time of the rehire, the provisions of Subsections 300.02.b. and 300.02.c. of this rule apply. (3-20-20)T

**e.** An employer not listed in Section 126 of these rules, may use an individual's Department clearance or enhanced clearance that was obtained within three (3) years from date of employment. (3-20-20)T

**f.** An individual with a current clearance that is not Enhanced but is completed within three (3) years

from date of employment, who applies to a new agency or employer identified in Section 126 of these rules, must submit an application for a new criminal history and background check to obtain an enhanced clearance. An agency or employer identified in Subsections 126.07 and 126.09 of these rules may not hire an employee with a clearance obtained prior to January 1, 2020 unless the Enhanced clearance complies with the requirements found in 42 USC Section 9858. (3-20-20)T

**03. Employer Discretion.** Any agency or employer, at its discretion, may require an individual to complete a Department criminal history and background check at any time, even if the individual has received a criminal history and background check clearance within three (3) years. (3-20-20)T

**04. Department Discretion.** The Department may, at its discretion or as provided in program rules, require a criminal history and background check of any individual covered under these rules at any time during the individual's employment, internship, or while volunteering. Any individual required to complete a criminal history and background check under Sections 100 and 101 of these rules, must be fingerprinted within fourteen (14) days from the date of notification by the Department that a new criminal history and background check is required. (3-20-20)T

**301. -- 349. (RESERVED)**

**350. CRIMINAL HISTORY AND BACKGROUND CHECK RECORDS.**

Criminal history and background checks done under this chapter become the property of the Department and are held confidential. (3-20-20)T

**01. Release of Criminal History and Background Check Records.** A copy of the criminal history and background check as defined in Section 010 of these rules will be released: (3-20-20)T

**a.** To the individual who has requested the criminal history and background check and upon receipt of a written request to the Department, provided the individual releases the state from all liability; (3-20-20)T

**b.** In response to a subpoena issued by a court of competent jurisdiction; or (3-20-20)T

**c.** As otherwise required by law. (3-20-20)T

**02. Retention of Records.** (3-20-20)T

**a.** If an exemption is granted, the criminal history and background record, supplemental documentation received, notes from the review, and the decision will be retained by the Department for a period of at least five (5) years after the criminal history and background check is completed. (3-20-20)T

**b.** If an exemption is denied, the Department retains all records and electronic recordings pertaining to the review for five (5) years after the criminal history and background check is completed. (3-20-20)T

**03. Use and Dissemination Restrictions for FBI Criminal Identification Records.** According to the provisions under 28 CFR 50.12, the Department will: (3-20-20)T

**a.** Notify the individual fingerprinted that the fingerprints will be used to check the criminal history records of the FBI; (3-20-20)T

**b.** In determining the suitability for licensing or employment, provide the individual the opportunity to complete or challenge the accuracy of the information contained in the FBI identification record; (3-20-20)T

**c.** Notify the individual that they have fifteen (15) days to correct or complete the FBI identification record or to decline to do so; and (3-20-20)T

**d.** Advise the individual who wishes to correct the FBI identification record that procedures for changing, correcting, or updating are provided in 28 CFR 16.34. (3-20-20)T

**351. -- 999. (RESERVED)**

## 16.06.01 – CHILD AND FAMILY SERVICES

### 000. LEGAL AUTHORITY.

The Idaho Legislature has delegated to the Department, or the Board of Health and Welfare, or both jointly, the responsibility to establish and enforce such rules and methods of administration as may be necessary or proper to administer social services to people who are in need, under the following Sections: 16-1629, 16-1623, 16-2102, 16-2406, 16-2423, and 16-2433, 39-1209 through 1211, 39-5603, 39-7501, 56-202(b), 56-204A, 56-803, 56-1003, 56-1004, 56-1004A, and 56-1007, Idaho Code. (3-20-20)T

### 001. TITLE, SCOPE, AND GOAL.

**01. Title.** These rules are titled IDAPA 16.06.01, “Child and Family Services.” (3-20-20)T

**02. Scope.** These rules are established to govern the statewide provision of: (3-20-20)T

**a.** Services associated with child protection, alternate care, and adoption; and (3-20-20)T

**b.** As resources are available, services aimed at preventing child abuse, neglect, and abandonment. (3-20-20)T

**03. Goal.** The goal of all Child and Family Services programs is the safety, permanency, and well-being of children, as well as promoting the stability and security of Indian tribes and families. (3-20-20)T

### 002. -- 008. (RESERVED)

### 009. CRIMINAL HISTORY AND BACKGROUND CHECK REQUIREMENTS.

**01. Compliance With Department Criminal History and Background Check.** All current Department employees, applicants, transfers, reinstated former employees, student interns, contract employees, Certified Adoption Professionals, volunteers, and others assigned to programs that involve direct contact with children or vulnerable adults as described in Section 39-5302, Idaho Code, must comply with the provisions in IDAPA 16.05.06, “Criminal History and Background Checks.” (3-20-20)T

**02. Availability to Work or Provide Service.** Certain individuals are allowed to provide services after the self-declaration is completed as provided in Section 56-1004A, Idaho Code, except when they have disclosed a designated crime listed in IDAPA 16.05.06, “Criminal History and Background Checks.” The criminal history check requirements applicable to each provider type are found in the rules that state the qualifications or certification of those providers. (3-20-20)T

**03. Adoption.** An individual applying to the Department to be an adoptive parent or petitioning the court for the adoption of a child must comply with the provisions in IDAPA 16.05.06, “Criminal History and Background Checks.” (3-20-20)T

### 010. DEFINITIONS AND ABBREVIATIONS A THROUGH E.

For the purposes of these rules, the following terms are used: (3-20-20)T

**01. Adoption and Safe Families Act of 1997 (P.L. 105-89) (ASFA).** Federal law whose purpose is to improve the safety of children, to promote adoption and other permanent homes for children who need them, and to support families. (3-20-20)T

**02. Adoption Assistance.** Funds provided to adoptive parent(s) of a child who has special needs or who could not be adopted without financial or medical assistance. (3-20-20)T

**03. Adoption Services.** Protective services through which a child is provided with a permanent home, under new legal parentage, including transfer of the mutual rights and responsibilities that prevail in the parent-child relationship. (3-20-20)T

**04. Alternate Care.** Temporary living arrangements, when necessary for a child to leave their own home, through a variety of foster care, respite care, residential treatment, and institutional resources, under the protections established in Public Law 96-272, the federal “Adoption Assistance and Child Welfare Act of 1980” as amended by Public Law 105-89, the Adoption and Safe Families Act of 1997, the Child Protective Act, Section 16-1601 et seq., Idaho Code, and the Indian Child Welfare Act, 25 U.S.C. Sections 1901-1963. (3-20-20)T

**05. Alternate Care Plan.** A federally required component of the Family Plan for a child in alternate care. The alternate care plan contains elements related to reasonable efforts, the family's plan, the child's alternate care provider, compelling reasons for not terminating parental rights, Indian status, education, immunization, medical, and other information important to the day-to-day care of the child. (3-20-20)T

**06. Board.** The Idaho State Board of Health and Welfare. (3-20-20)T

**07. Case Management.** A change-oriented service to families that ensures and coordinates the provision of family ongoing assessment, family service planning, treatment, planning for permanency, protection, advocacy, review and reassessment, documentation, and timely closure of a case. (3-20-20)T

**08. Certified Adoption Professional (formerly "qualified individual").** An individual certified by the Department who meets the qualifications specified in Section 889 of these rules for completion of pre-placement adoption home studies, reports to the court under the Termination of Parent and Child Relationship and Adoption of Children Acts, and placement supervision reports. (3-20-20)T

**09. Child and Family Services (CFS).** Those programs and services provided to families and children, administered by the Department in accordance with these rules. (3-20-20)T

**10. Child Protection.** All children under eighteen (18) who have been harmed or threatened with harm by a person responsible for their health or welfare through non-accidental physical or mental injury, sexual abuse (as defined by state law) or negligent treatment or maltreatment, including the failure to provide adequate food, clothing, or shelter must be served without regard to income. (3-20-20)T

**11. Child Protective Services.** Services provided in response to potential, alleged, or actual abuse, neglect, or abandonment of individuals under the age of eighteen (18) in accordance with the provisions of Section 16-1601 et seq., Idaho Code, the "Child Protective Act." (3-20-20)T

**12. Compact Administrator.** The individual designated to coordinate interstate transfers of persons requiring special services in accordance with the provisions of Section 16-1901 et seq., Idaho Code, "Interstate Compact for Juveniles"; Section 16-2101 et seq., Idaho Code, "Interstate Compact on the Placement of Children"; or Section 39-7501 et seq., Idaho Code, "Interstate Compact on Adoption and Medical Assistance." (3-20-20)T

**13. Daycare for Children.** Care and supervision provided for compensation during part of a twenty-four (24) hour day, for a child or children not related by blood or marriage to the person or persons providing the care, in a place other than the child's or children's own home or homes. (3-20-20)T

**14. Department.** The Idaho Department of Health and Welfare. (3-20-20)T

**15. Deprivation.** One of the factors used in determining Aid to Families with Dependent Children -- Foster Care (AFDC-FC) eligibility for children in foster care. Deprivation is a lack of, or interruption in, the maintenance, physical care, and parental guidance a child ordinarily receives from one (1) or both parents. A child is deprived by the continued absence of a parent, incapacity of a parent, death of a parent, unemployment or underemployment of the principal wage earner parent. (3-20-20)T

**16. Director.** The Director of the Idaho Department of Health and Welfare or their designee. (3-20-20)T

**17. Extended Family Member of an Indian Child.** As defined by the law, or custom of an Indian child's tribe or, in the absence of such law or custom, a person who has reached the age of eighteen (18) and who is an Indian child's grandparent, aunt or uncle, brother or sister, brother-in-law or sister-in-law, niece or nephew, first or second cousin, or stepparent. (3-20-20)T

**011. DEFINITIONS AND ABBREVIATIONS F THROUGH K.**  
For the purposes of these rules, the following terms are used: (3-20-20)T

**01. Family.** Parent(s), legal guardian(s), related individuals including birth or adoptive immediate

family members, extended family members and significant other individuals, who are included in the family plan. (3-20-20)T

**02. Family Assessment.** An ongoing process based on information gained through a series of meetings with a family to gain mutual perception of strengths and resources that can support them in creating long-term solutions related to identified service needs and safety threats to family integrity, unity, or the ability to care for their members. (3-20-20)T

**03. Family Case Record.** Electronic and hard copy compilation of all documentation relating to a family, including legal documents, identifying information, and evaluations. (3-20-20)T

**04. Family (Case) Plan.** Also referred to as a family service plan. A written document that serves as the guide for provision of services. The plan, developed with the family, clearly identifies who does what, when, how, and why. The family plan incorporates any special plans made for individual family members. If the family includes an Indian child, or child's tribe, tribal elders or leaders should be consulted early in the plan development. (3-20-20)T

**05. Family Services Worker.** Any of the direct service personnel, including social workers, working in regional Child and Family Services Programs. (3-20-20)T

**06. Federally-Funded Guardianship Assistance for Relatives.** Benefits described in Subsection 702.04 and Section 703 of these rules provided to a relative guardian for the support of a child who is fourteen (14) years of age or older, who, without guardianship assistance, would remain in the legal custody of the Department of Health and Welfare. (3-20-20)T

**07. Field Office.** A Department of Health and Welfare service delivery site. (3-20-20)T

**08. Goal.** A statement of the long term outcome or plan for the child and family. (3-20-20)T

**09. Independent Living.** Services provided to eligible foster or former foster youth, ages fourteen (14) to twenty-one (21), designed to support a successful transition to adulthood. (3-20-20)T

**10. Indian.** Any person who is a member of an Indian tribe or who is an Alaska Native and a member of a Regional Corporation as defined in 43 U.S.C. 1606. (3-20-20)T

**11. Indian Child.** Any unmarried person who is under the age of eighteen (18) who is: (3-20-20)T

**a.** A member of an Indian tribe; or (3-20-20)T

**b.** Eligible for membership in an Indian tribe, and who is the biological child of a member of an Indian tribe. (3-20-20)T

**12. Indian Child Welfare Act (ICWA).** The Indian Child Welfare Act, 25 U.S.C. 1901, et seq. (3-20-20)T

**13. Indian Child's Tribe.** (3-20-20)T

**a.** The Indian tribe in which an Indian child is a member or eligible for membership, or (3-20-20)T

**b.** In the case of an Indian child who is a member of or eligible for membership in more than one (1) tribe, the Indian tribe with which the Indian child has the more significant contacts. (3-20-20)T

**14. Indian Tribe.** Any Indian Tribe, band, nation, or other organized group or community of Indians recognized as eligible for the services provided to Indians by the Secretary because of their status as Indians, including any Alaska Native village as defined in 43 U.S.C. 1602(c). (3-20-20)T

**15. Intercountry Adoption Act of 2000 (P.L. 106-279).** Federal law designed to protect the rights of, and prevent abuses against children, birth families, and adoptive parents involved in adoptions (or prospective



adoptions) subject to the Convention on Protection of Children and Cooperation in Respect of Intercountry Adoption, and to insure that such adoptions are in the children's best interests; and to improve the ability of the federal government to assist U.S. citizens seeking to adopt children from abroad and residents of other countries party to the Convention seeking to adopt children from the United States. (3-20-20)T

**16. Interethnic Adoption Provisions of 1996 (IEP).** IEP prohibits delaying or denying the placement of a child for adoption or foster care on the basis of race, color or national origin of the adoptive or foster parent(s), or the child involved. (3-20-20)T

**17. Interstate Compact on the Placement of Children (ICPC).** Interstate Compact on the Placement of Children (ICPC) in Title 16, Chapter 21, Idaho Code, ensures that the jurisdictional, administrative, and human rights obligations of interstate placement or transfers of children are protected. (3-20-20)T

**18. Kin.** Non-relatives who have a significant, family-like relationship with a child. Kin may include godparents, close family friends, clergy, teachers, and members of a child's Indian tribe. Also known as fictive kin. (3-20-20)T

**012. DEFINITIONS AND ABBREVIATIONS L THROUGH R.**

For the purposes of these rules, the following terms are used: (3-20-20)T

**01. Legal Guardianship.** A judicially-created relationship, in accordance with Title 15, Chapter 5, Part 2, Idaho Code, including one made by a tribal court, between a child and a relative or non-relative. (3-20-20)T

**02. Licensed.** Facilities or programs are licensed in accordance with the provisions of IDAPA 16.06.02, "Child Care Licensing." (3-20-20)T

**03. Licensing.** See IDAPA 16.06.02, "Child Care Licensing," Section 100. (3-20-20)T

**04. Medicaid.** See "Title XIX." (3-20-20)T

**05. Multiethnic Placement Act of 1994 (MEPA).** MEPA prohibits states or public and private foster care and adoption agencies that receive federal funds from delaying or denying the placement of any child solely on the basis of race, color, or national origin. (3-20-20)T

**06. Parent.** A person who, by birth or through adoption, is considered legally responsible for a child. The term "legal guardian" is not included in the definition of parent. (3-20-20)T

**07. Permanency Planning.** A primary function of family services initiated in all cases to identify programs, services, and activities designed to establish permanent home and family relationships for children within a reasonable amount of time. (3-20-20)T

**08. Personal Care Services (PCS).** Services to eligible Medicaid recipients that involve personal and medically-oriented tasks dealing with the physical or functional impairments of the individual. (3-20-20)T

**09. P.L. 96-272.** Public Law 96-272, the federal "Adoption Assistance and Child Welfare Act of 1980." (3-20-20)T

**10. P.L. 105-89.** Public Law 105-89, the federal "Adoptions and Safe Families Act of 1997," amends P.L. 96-272 and prohibits states from delaying or denying cross-jurisdictional adoptive placements with an approved family. (3-20-20)T

**11. Planning.** An orderly rational process that results in identification of goals and formulation of timely strategies to fulfill such goals, within resource constraints. (3-20-20)T

**12. Qualified Expert Witness--ICWA.** An individual who is an expert regarding tribal customs pertaining to family organization and child rearing practice, and is qualified to render an opinion as to whether

continued custody of the child by the parent(s), or Indian custodian(s), is likely to result in serious emotional or physical damage to the child. (3-20-20)T

**13. Relative.** Person related to a child by blood, marriage, or adoption. (3-20-20)T

**14. Relative Guardian.** A relative who is appointed a child's legal guardian in accordance with Title 15, Chapter 5, Part 2, Idaho Code, including a guardianship established by a tribal court. (3-20-20)T

**15. Reservation.** A reservation is an area of land "reserved" by or for an Indian band, village, or tribe(s) to live on and use. Reservations were created by treaty, by congressional legislation, or by executive order. Since 1934, the Secretary of the Interior has had the responsibility of establishing new reservations or adding land to existing reservations. (3-20-20)T

**16. Respite Care.** Time-limited care provided to children. Respite care is utilized in circumstances that require short term, temporary care of a child by a licensed or agency-approved caregiver different from their usual caregiver. The duration of an episode of respite care ranges from one (1) partial day up to fourteen (14) consecutive days. (3-20-20)T

**17. Responsible Party.** A Department social worker, clinician, or contracted service provider who maintains responsibility and authority for case planning and case management. (3-20-20)T

**013. DEFINITIONS AND ABBREVIATIONS S THROUGH Z.**  
For the purposes of these rules, the following terms are used: (3-20-20)T

**01. SSI (Supplemental Security Income).** Income maintenance grants for eligible persons who are aged, blind, or disabled. These grants are provided under Title VI of the Social Security Act and are administered by the Social Security Administration and local Social Security Offices. (3-20-20)T

**02. Safety Assessment.** A process and standardized tool for contact between a family services worker and a family to objectively determine if safety threats, or immediate service needs exist that require further Child and Family Services response. (3-20-20)T

**03. Safety Plan.** Plan developed by the Department and a family that assures the immediate safety of a child who has been determined to be conditionally safe or unsafe. (3-20-20)T

**04. Sibling.** One (1) of two (2) or more persons who shares the same biological or adoptive mother or father, or both. Siblings may be full-siblings or half-siblings. Siblings include those children who would be considered a sibling if not for the disruption in parental rights due to termination of parental rights or the death of a parent. (3-20-20)T

**05. State-Funded Guardianship Assistance.** Benefits described in Subsection 702.04 and Section 704 of these rules provided to a legal guardian for the support of a child who meets the eligibility criteria. (3-20-20)T

**06. TAFI.** Temporary Assistance to Families in Idaho. (3-20-20)T

**07. Title IV-E.** Title under the Social Security Act that provides funding for foster care maintenance and adoption assistance payments for certain eligible children. (3-20-20)T

**08. Title IV-E Foster Care.** Child care provided in lieu of parental care in a foster home, children's agency, or institution eligible to receive Aid to Dependent Children under Title IV-E of the Social Security Act. (3-20-20)T

**09. Title XIX (Medicaid).** Title under the Social Security Act that provides "Grants to States for Medical Assistance Programs." (3-20-20)T

**10. Title XXI.** (Children's Health Insurance Program). Title under the Social Security Act that provides access to health care for uninsured children under the age of nineteen (19). (3-20-20)T

**11. Tribal Court.** A court with jurisdiction over child custody proceedings including a Court of Indian Offenses, a court established and operated under the code or custom of an Indian tribe, or any other administrative body of a tribe vested with authority over child custody proceedings. (3-20-20)T

**12. Unmarried Parents' Services.** Services aimed at achieving or maintaining self-reliance or self-support for unmarried parents. These services include counseling for any unmarried parents who need such service in relation to their plans for their children and arranging for and paying for prenatal and confinement care for the well-being of the parent and infant. Services for unmarried parents are provided in accordance with Section 56-204A, Idaho Code. (3-20-20)T

**13. Voluntary Services Agreement.** A written and executed agreement between the Department and parents or legal guardians regarding the goal, areas of concern, desired results, and task responsibility, including payment. (3-20-20)T

**014. -- 019. (RESERVED)**

**GENERAL REQUIREMENTS AND SERVICES**  
**(Sections 020-239)**

**020. GENERAL REQUIREMENTS APPLICABLE TO ALL CHILD AND FAMILY SERVICES PROGRAMS.**

**01. Information, Referral and Screening.** All residents of the state of Idaho, regardless of the duration of their residency or their income are entitled to receive, upon referral or request: (3-20-20)T

**a.** Accurate and current information about services to children and families provided through the Department. (3-20-20)T

**b.** Referral to other appropriate public or private services available in the community; and (3-20-20)T

**c.** A screening to determine service needs and safety threats that can be addressed through Child and Family Services. (3-20-20)T

**02. Initiating Child and Family Services.** Child and Family Services are initiated upon referral for services that the program is legally mandated to provide or after completion of a written voluntary request for services. Efforts will be made to identify any Indian children in the family and all possible tribes in which a child may be a member or eligible for membership. (3-20-20)T

**03. Individual Authorized to Request Voluntary Services.** Requests for voluntary services must be made by a family member or by an authorized representative, or by someone acting on behalf of an incompetent or incapacitated person. (3-20-20)T

**04. Record of Request for Services.** The date of referral or request for services will be documented in the records of the field office. (3-20-20)T

**05. Information to Be Provided to Family.** Upon referral or application for services, the family services worker must inform the family that: (3-20-20)T

**a.** They have the right to accept or reject services offered by the Department, except those services imposed by law or by a court order; (3-20-20)T

**b.** Fees may be charged for certain services, and that the parent(s) has financial responsibility for the child in care; (3-20-20)T

**c.** They have the right to pursue an administrative appeal of any decision of Child and Family Services relating to them, including any decision not to provide services or to discontinue planned services; the

Department's failure to act upon a referral or request for services within thirty (30) days; or an decision to remove a child from an alternate care placement unless court-ordered or court-authorized. (3-20-20)T

**021. -- 029. (RESERVED)**

**030. CORE CHILD AND FAMILY SERVICES.**

The following core services are the state and federally mandated services provided by or through regional Child and Family Services offices: (3-20-20)T

**01. Crisis Services.** Crisis Services are an immediate response to ensure safety when a child is believed to be in imminent danger as a result of child abuse, neglect, or abandonment. Crisis services require immediate access to services, twenty-four (24) hours per day, seven (7) days per week to assess safety and place in alternate care, if necessary, to ensure safety for the child. (3-20-20)T

**02. Screening Services.** Initial contact with families and children to gather information to determine whether or not the child meets eligibility criteria to receive child protection or adoption services. When eligibility criteria is not met for Department mandated services, appropriate community referrals are made. (3-20-20)T

**03. Assessment and Safety/Service Planning Services.** Process in which the safety threats to the child, and the family's concerns, strengths, and resources are identified. Based on this assessment, a written plan is developed by the worker, together with the family and other interested parties. Each plan must have a long-term goal that identifies behaviorally-specific and measurable desired results and has specific tasks that identify who, how, and when the tasks will be completed. (3-20-20)T

**04. Preventative Services.** Community-based services that support children and families and are designed to reduce the risk of child abuse, neglect, or abandonment. These services can involve direct services, but are primarily implemented through community education, and partnerships with other community agencies such as schools and courts. (3-20-20)T

**05. Court-Ordered Services.** These services primarily involve court-ordered investigations or assessments of situations where children are believed to be at risk due to child abuse, neglect, or abandonment. (3-20-20)T

**06. Alternate Care (Placement) Services.** Temporary living arrangements outside of the family home for children and youth who are victims of child abuse, neglect, or abandonment. These out-of-home placements are arranged for and financed, in full or in part, by the Department. Alternate care is initiated through either a court order or voluntarily through an out-of-home placement agreement. Payment will be made on behalf of a child placed in the licensed home of an individual or relative, a public or private child care institution, a home licensed or approved by an Indian child's tribe, or in a state-licensed public child care institution accommodating no more than twenty-five (25) children. Payments may be made to individuals or to a public or private child placement or child care agency. (3-20-20)T

**07. Community Support Services.** Services provided to a child and family in a community-based setting designed to increase the strengths and abilities of the child and family and to preserve the family whenever possible. Services include respite care and family preservation. (3-20-20)T

**08. Interstate Compact on Out-of-State Placements.** Where necessary to encourage all possible positive contacts with family, including extended family, placement with family members or others who are outside the state of Idaho will be considered. On very rare occasion the Department may contract with a residential facility out of state if it best serves the needs of the child and is at a comparable cost to facilities within Idaho. When out-of-state placement is considered in the permanency planning for a child, such placement will be coordinated with the respective interstate compact administrator according to the provisions of Section 16-2101, et seq., Idaho Code, the "Interstate Compact on the Placement of Children." Placements must be in compliance with all state and federal laws. (3-20-20)T

**09. Independent Living.** Services, including assessment and planning, provided to eligible youth to promote self-reliance and successful transition to adulthood. (3-20-20)T

- a.** Eligibility Requirements for Current Foster Youth. To be eligible for independent living services, a current foster youth must: (3-20-20)T
- i.** Be fourteen (14) to nineteen (19) years of age; (3-20-20)T
  - ii.** Currently be under Department or tribal care and placement authority established by a court order or voluntary agreement with the youth's family, or be under a voluntary agreement for continued care if the youth is between eighteen (18) and nineteen (19) years of age; and (3-20-20)T
  - iii.** Have been in foster care or similar eligible setting for a minimum of ninety (90) total days. (3-20-20)T
- b.** Eligibility Requirements for Former Foster Youth. To be eligible for independent living services, a former foster youth must: (3-20-20)T
- i.** Be a former foster youth who is currently under twenty-one (21) years of age; and (3-20-20)T
  - ii.** Have been under Department or tribal care and placement authority established by a court order or voluntary agreement with the youth's family, or under a voluntary agreement for continued care after the youth has reached eighteen (18) years of age; and (3-20-20)T
  - iii.** Have been placed in foster care or similar eligible setting for a minimum of ninety (90) days total after reaching fourteen (14) years of age; or (3-20-20)T
  - iv.** Be eighteen (18) to twenty-one (21) years of age, provide verification of meeting the Independent Living eligibility criteria in another state, and currently be a resident of Idaho. (3-20-20)T
- c.** Eligibility Limit. Once established, a youth's eligibility is maintained up to their twenty-first birthday, regardless of whether they continue to be the responsibility of the Department, tribe, or be in foster care. (3-20-20)T

**10. Adoption Services.** Department services designed to promote and support the permanency of children with special needs through adoption. This involves the legal and permanent transfer of all parental rights and responsibilities to the family assessed as the most suitable to meet the needs of the individual child. Adoption services also seeks to build the community's capacity to deliver adoptive services. (3-20-20)T

**11. Administrative Services.** Regulatory activities and services that assist the Department in meeting the goals of safety, permanency, health and well-being for children and families. These services include: (3-20-20)T

- a.** Child care licensing; (3-20-20)T
- b.** Daycare licensing; (3-20-20)T
- c.** Community development; and (3-20-20)T
- d.** Contract development and monitoring. (3-20-20)T

**031. -- 049. (RESERVED)**

**050. PROTECTIONS AND SAFEGUARDS FOR CHILDREN AND FAMILIES.**

The federal and state laws that are the basis for these rules include a number of mandatory protections and safeguards intended to ensure timely permanency for children and to protect the rights of children, their families, and their tribes. (3-20-20)T

**01. Reasonable Efforts.** Services offered or provided to a family intended to prevent or eliminate the need for removal of the child from the family, to reunify a child with their family, and to finalize a permanent plan.

The following efforts must be made and specifically documented by the Department in reports to the court. The court will make the determination of whether or not the Department's efforts were reasonable. (3-20-20)T

- a. Efforts to prevent or eliminate the need for a child to be removed from their home; (3-20-20)T
- b. Efforts to return a child home are not required due to a judicial determination of aggravated circumstances; and (3-20-20)T
- c. Efforts to finalize a permanent plan, so that each child in the Department's care will have a family with whom the child can have a safe and permanent home. (3-20-20)T

**02. Active Efforts.** The efforts required under ICWA to provide remedial services and rehabilitative programs designed to prevent the breakup of an Indian family, or to reunify an Indian family. Active efforts must include contacts and work with an Indian child's tribe. (3-20-20)T

**03. ICWA Placement Preferences.** (3-20-20)T

- a. When the Indian child's permanency goal is reunification, the preferences are described in Section 402 of these rules. (3-20-20)T
- b. When the Indian child's permanency goal is adoption or guardianship, the preferences are described in Subsection 800.01 of these rules. (3-20-20)T
- c. When the placement preferences are not followed, the court must determine that good cause exists for not following the preferences. (3-20-20)T

**04. Least Restrictive Setting.** Efforts will be made to ensure that any child in the Department's care resides in the least restrictive, most family-like setting possible. Placement will be made in the least restrictive setting and in close proximity to the parent(s) or if not, written justification that the placement is in the best interest of the child. (3-20-20)T

**05. Legal Requirements for Indian Children.** When there is reason to believe that a child is an Indian child, notice of the pending proceeding must be sent according to the notice provisions specified in Section 051 of these rules. Notice must also include notice of the tribe's right to intervene; their right to twenty (20) days additional time to prepare for the proceeding; the right to appointment of counsel if the parent(s) or Indian custodian(s) is indigent; and the right to examine all documents filed with the court upon which placement may be based. (3-20-20)T

**06. Visitation for Child's Parent(s) or Legal Guardian(s).** Visitation arrangements must be provided to the child's parent(s) or legal guardian(s) unless visitation is contrary to the child's safety. (3-20-20)T

**07. Notification of Change in Placement.** Written notification must be made within seven (7) days of a change of placement of the foster child if a child is relocated to another foster care setting. Notification must be sent to the child's parent(s) or legal guardian(s). When the child is an Indian child, written notification must also be sent to the child's Indian custodian(s), if applicable, and to the child's tribe. (3-20-20)T

**08. Notification of Change in Visitation.** Written notification to the child's parent(s) or legal guardian(s) if there is to be a change in their visitation schedule with their child or ward in foster care. (3-20-20)T

**09. Notification of Right to Participate and Appeal.** Written notification to the child's parent(s) or legal guardian(s) must be made regarding their right to discuss any changes and the opportunity to appeal if they disagree with changes in placement or visitation. (3-20-20)T

**10. Qualified Expert Witness--ICWA.** The testimony of an expert witness is required at the hearing in which a child is placed in state custody, typically the adjudicatory, and at the hearing for termination of parental rights. A person who is most likely to be a qualified expert witness in the placement of an Indian child is: (3-20-20)T

**a.** A member of the Indian child's tribe who is recognized by the tribal community as knowledgeable in tribal customs pertaining to family organization and child rearing practices; (3-20-20)T

**b.** An individual who is not a tribal member who has substantial experience in the delivery of child and family services to Indians and extensive knowledge of prevailing social and cultural standards and child rearing practices within the Indian child's tribe; or (3-20-20)T

**c.** A professional person who has substantial education and experience in a pertinent specialty area and substantial knowledge of prevailing social and cultural standards and child rearing practices within the Indian community. (3-20-20)T

**11. Compliance with Requirements of the Multiethnic Placement Act of 1994 (MEPA) as Amended by the Interethnic Adoption Provisions (IEP) of 1996.** (3-20-20)T

**a.** The Department prohibits entities that are involved in foster care or adoption placements and that receive federal financial assistance under Title IV-E, Title IV-B, or any other federal program from delaying or denying a child's foster care or adoptive placement on the basis of the child's or the prospective foster or adoptive parent's race, color, or national origin. (3-20-20)T

**b.** The Department prohibits entities that are involved in foster care or adoption placements and that receive federal financial assistance under Title IV-E, Title IV-B, or any other federal program, from denying to any individual the opportunity to become a foster or adoptive parent on the basis of the prospective foster or adoptive parent's or the child's race, color, or national origin; (3-20-20)T

**c.** To remain eligible for federal assistance for their child welfare programs, the Department must diligently recruit foster and adoptive parents who reflect the racial and ethnic diversity of the children in the state who need foster and adoptive homes; (3-20-20)T

**d.** A child's race, color, or national origin cannot be routinely considered as a relevant factor in assessing the child's best interests; (3-20-20)T

**e.** Failure to comply with MEPA/IEP's prohibitions against discrimination is a violation of Title VI of the Civil Rights Act of 1964; and (3-20-20)T

**f.** Nothing in MEPA/IEP is to be construed to affect the application of the Indian Child Welfare Act of 1978. (3-20-20)T

**12. Family Decision-Making and Plan Development.** (3-20-20)T

**a.** A family plan will be completed within thirty (30) days of the date the case was opened. (3-20-20)T

**b.** Families will be given ample opportunity to participate in the identification of areas of concern, their strengths, and developing service goals and tasks. The family plan and any changes to it must be signed and dated by the family. If the family refuses to sign the plan, the reason for their refusal will be documented on the plan. (3-20-20)T

**c.** Plans are to be reviewed with the family no less frequently than once every three (3) months. When there are major changes to the plan including a change in the long term goal, the family plan must be renegotiated by the Department and the family as well as signed by the family. A new plan must be negotiated at least annually. (3-20-20)T

**13. Compelling Reasons.** Reasons why the parental rights of a parent of a child in the Department's care and custody should not be terminated when the child has been in the custody of the Department for fifteen (15) out of the most recent twenty-two (22) months. (3-20-20)T

**a.** These reasons must be documented in the Alternate Care Plan, in a report to the court, and the court

must make a determination if the reasons are sufficiently compelling. (3-20-20)T

**b.** A compelling reason must be documented when a child's plan for permanency is not adoption, guardianship, or return home. (3-20-20)T

**c.** When compelling reasons are not appropriate, the petition for termination of parental rights must be filed by the end of the child's fifteenth month in foster care. (3-20-20)T

**14. ASFA Placement Preferences.** The following placement preferences will be considered in the order listed below when recommending and making permanency decisions: (3-20-20)T

**a.** Return home if safe to do so; (3-20-20)T

**b.** Adoption or legal guardianship by a relative or kin; (3-20-20)T

**c.** Adoption or legal guardianship by non-relative; (3-20-20)T

**d.** Another planned permanent living arrangement such as long-term foster care. (3-20-20)T

**051. NOTICE REQUIREMENTS FOR ICWA.**

**01. Notice of Pending Proceedings -- Who is Notified.** When there is reason to believe that a child is an Indian child, the initial and any subsequent Notice of Pending Proceedings must be sent to the Indian child's parent(s), custodian(s), and tribe. Notices of Pending Proceedings must be sent to the ICWA Designated Agent for the child's tribe via Registered Mail, Return Receipt Requested. All Notices of Pending Proceedings must be received by the child's parent(s), Indian custodian(s) and tribe at least 10 (ten) days before the proceeding is scheduled to occur. Returned receipts are to be kept in the child's file and made available for review by the court. (3-20-20)T

**02. Rights Under a Notice of Pending Proceedings.** Notices of Pending Proceedings must also include notice of the tribe's right to intervene; their right to twenty (20) additional days to prepare for the proceedings; the right to appointment of counsel if the parent(s) or Indian custodian(s) are indigent; and the right to examine all documents filed with the court upon which placement may be based. (3-20-20)T

**03. Notice of Pending Proceedings--When Identity or Location of Parent(s), Indian Custodian(s), or Tribe is Unknown.** If the identity or location of the parent(s) or Indian custodian(s) or the tribe is unknown, the Notice of Pending Proceedings must be sent to the Secretary of the Interior by certified mail with a return receipt requested at the following address: Department of the Interior, Bureau of Indian Services, Division of Human Services, Code 450, Mail Stop, 1849 C Street N.W., Washington, D.C. 20240. (3-20-20)T

**052. -- 059. (RESERVED)**

**060. FAMILY CASE RECORDS.**

**01. Electronic and Physical Files.** The Department will maintain an electronic file and a physical file containing information on each family receiving services. The physical file will contain non-electronic documentation such as originals or original copies of all court orders, birth certificates, social security cards, and assessment information that is original outside the Department. (3-20-20)T

**02. Storage of Records.** All physical family case records must be stored in a secure file storage area, away from public access and retained not less than five (5) years after the case is closed, after which they may be destroyed. (3-20-20)T

**a.** Exception for Adoption Records. Complete family case records involving adoptive placements must be forwarded to the Department's central adoption unit for permanent storage. (3-20-20)T

**b.** Exception for Case Records Involving an Indian Child. A case record involving an Indian child must be available at any time at the request of an Indian child's tribe or the Secretary of the Interior. (3-20-20)T



061. -- 239. (RESERVED)

**REVIEWS AND HEARINGS**  
**(Sections 240-399)**

**240. SIX-MONTH REVIEWS FOR CHILDREN IN ALTERNATE CARE PLACEMENT.**

When a judicial review does not occur at the end of a six (6) month period for any child in alternate care placement, the Department will conduct a case review to assure compliance with all applicable state and federal laws, and to ensure the plan focuses on the goals of safety, permanency and well-being of the child. (3-20-20)T

**01. Notice of Six Month Review.** The parent(s) or legal guardian(s), foster parent(s) of a child, and any preadoptive parent(s) or relative(s) providing care for the child, are to be provided with notice of their right to be heard in the six-month review. In the case of an Indian child, the child's tribe and any Indian custodian must also be provided with notice. This must not be construed to require that any foster parent, preadoptive parent, or relative providing care for the child be made a party to the review solely on the basis of the receipt of such notice. Participants have the right to be represented by the individual of their choice. (3-20-20)T

**02. Procedure in the Six Month Review.** The parties who received notice will be given the opportunity to participate in the case review. (3-20-20)T

**03. Members of Six-Month Review Panel.** The six-month review panel must include a Department employee who is not in the direct line of supervision in the delivery of services to the child or parent(s) or legal guardian(s) being reviewed. The review panel may include agency staff, staff of other agencies, officers of the court, members of Indian tribes, and citizens qualified by experience, professional background, or training. Members of the panel will be chosen by and receive instructions from the Department's Child and Family Services Program Manager or their designee, to enable them to understand the review process and their roles as participants. (3-20-20)T

**04. Considerations in Six-Month Review.** Whether conducted by the court in a review hearing or a Department review panel, under State law, Federal law and regulation, each of the following must be addressed in a six-month review: (3-20-20)T

- a. Determine the extent of compliance with the family services plan; (3-20-20)T
- b. Determine the extent of progress made toward alleviating or mitigating the causes necessitating the placement; (3-20-20)T
- c. Review compliance with the Indian Child Welfare Act, when applicable; (3-20-20)T
- d. Determine the safety of the child, the continuing need for and appropriateness of the child's placement; and (3-20-20)T
- e. Project a date by which the child may be returned and safely maintained at home or placed for adoption, legal guardianship, or other permanent placement. (3-20-20)T

**05. Recommendations and Conclusions of Six-Month Review Panel.** Following the six-month review, written conclusions and recommendations will be provided to all participants, subject to Department safeguards for confidentiality. The document containing the written conclusions and recommendations must also include appeal rights. (3-20-20)T

241. -- 399. (RESERVED)

**ALTERNATE (OUT-OF-HOME) CARE**  
**(Sections 400-424)**

**400. AUTHORITY FOR ALTERNATE CARE SERVICES.**

Upon approval of the regional Child and Family Services Program Manager or their designee, the Department may provide or purchase alternative care under the following conditions: (3-20-20)T

- 01. Department Custody.** When the child is in the legal custody or guardianship of the Department; or (3-20-20)T
- 02. Voluntary Placement.** Upon agreement with the parent(s) or legal guardian(s) when circumstances interfere with their provision of proper care or they are no longer able to maintain a child in their home and they can benefit from social work and treatment services. (3-20-20)T
  - a.** A service plan and an out-of-home placement agreement must be developed between the Department and the family. The service plan will identify areas of concern, goals, desired results, time frames, tasks and task responsibilities. The out-of-home placement agreement will include the terms for reimbursement of costs with any necessary justification for deviation from Child Support guidelines. (3-20-20)T
  - b.** A voluntary agreement for out-of-home placement entered into between the Department and the parent(s) or legal guardian(s) of a minor child may be revoked at any time by the child's parent(s) or legal guardian(s) and the child must be returned to the parent or legal guardian upon their request. (3-20-20)T
  - c.** A contract between the Department and the service provider, if applicable, must also be in effect. (3-20-20)T
  - d.** Voluntary out-of-home placements exceeding one hundred eighty (180) days without a judicial determination that it is in the best interests of the child to continue their current placement cannot be reimbursed by Title IV-E funds. (3-20-20)T

**401. CONSIDERATIONS FOR PLACEMENT IN ALTERNATE CARE.**

The Department will make meaningful reasonable attempts, both verbally and in writing, to inform in priority order, individuals identified below of the potential imminent placement and the requirements for consideration as a placement resource. The Department will place children in a safe and trusted environment consistent with the best interest and special needs of the children as required by P.L.96-272, Section 475(5). Ideally, placement priority will be given in the following order: (a) Immediate family; (b) Extended family members; (c) Non-family members with a significant established relationship with the child; (d) other licensed foster parent(s). Upon immediate contact with persons in categories a) through d) above, and after preliminary screening, within seventy-two (72) hours of decision to place, Departmental staff will make reasonable attempts to inform immediate family members of the way to become a placement resource. Alternate care placement will in all cases include consideration of: (3-20-20)T

- 01. Family Assessment.** The family assessment conducted in accordance with the provisions of the CFS Practice Standards. (3-20-20)T
- 02. Ability of Providers.** The ability of potential alternate care providers to address and be sensitive to the unique and individual needs of the child and ability to comply and support the plan for the child and their family. (3-20-20)T
- 03. Family Involvement.** The involvement of the family in planning and selecting the placement. The Department will use a family unity meeting concept making reasonable efforts to gather immediate and extended family members and other significant supporters to identify family strengths relevant to creating a safe environment for the child. This process will be fully reported to the court along with resulting plans and commitments. (3-20-20)T

**402. INVOLUNTARY PLACEMENT OF INDIAN CHILDREN.**

Involuntary placement of an Indian child in foster care must be based upon clear and convincing evidence, including information from qualified expert witnesses, that the continued custody of the child by the parent(s) or Indian custodian(s) is likely to result in serious emotional or physical damage to the child. In the absence of good cause to the contrary, a preference must be given to placement with: (3-20-20)T

- 01. Extended Family.** A member of the Indian child's extended family; (3-20-20)T

- 02. Foster Home Approved by Tribe.** A foster home licensed or approved by the Indian child's tribe; (3-20-20)T
- 03. Licensed Indian Foster Home.** An Indian foster home licensed or approved by an authorized non-Indian licensing authority; or (3-20-20)T
- 04. Indian Institution.** An institution for children approved by an Indian tribe or operated by an Indian organization that has a program suitable to meet the child's needs. (3-20-20)T
- 403. DATE A CHILD ENTERED FOSTER CARE.**  
A child is considered to have entered foster care on the date the child is actually removed from their home. All foster care benefits and eligibility determinations must be based on this date. All periodic reviews, permanency hearings, and time frames for termination of parental rights must be based on the date the child entered foster care. (3-20-20)T
- 404. FOSTER CARE GOAL.**  
It is the goal of the Department that not more than twenty-five percent (25%) of foster youth will be in foster care longer than twenty-four (24) months. The Department will monitor this goal annually. (3-20-20)T
- 405. ALTERNATE CARE CASE MANAGEMENT.**  
Case management must continue while the child is in alternate care and must ensure the following: (3-20-20)T
- 01. Preparation for Placement.** Preparing a child for placement in alternate care is the joint responsibility of the child's family, the child (when appropriate), the family services worker, and the alternate care provider. (3-20-20)T
- 02. Information for Alternate Care Provider.** The Department and the family have informed the alternate care provider of their roles and responsibilities in meeting the needs of the child including: (3-20-20)T
- a.** Any medical, health and dental needs of the child including the names and address of the child's health and educational providers, a record of the child's immunizations, the child's current medications, the child's known medical problems, and any other pertinent health information concerning the child; (3-20-20)T
  - b.** The name of the child's doctor; (3-20-20)T
  - c.** The child's current functioning and behaviors; (3-20-20)T
  - d.** A copy of the child's portion of the service plan including any visitation arrangements; (3-20-20)T
  - e.** The case history of the child, including the reason the child came into foster care, the child's legal status, and the permanency goal for the child; (3-20-20)T
  - f.** A history of the child's previous placements and reasons for placement changes, excluding information that identifies or reveals the location of any previous alternate care providers without their consent; (3-20-20)T
  - g.** The child's cultural and racial identity; (3-20-20)T
  - h.** Any educational, developmental, or special needs of the child; (3-20-20)T
  - i.** The child's interest and talents; (3-20-20)T
  - j.** The child's attachment to current caretakers; (3-20-20)T
  - k.** The individualized and unique needs of the child; (3-20-20)T
  - l.** Procedures to follow in case of emergency; and (3-20-20)T

**m.** Any additional information, that may be required by the terms of the contract with the alternate care provider. (3-20-20)T

**03. Consent for Medical Care.** Parent(s) or legal guardian(s) have signed a Departmental form of consent for medical care and keep the family services worker advised of where they can be reached in case of an emergency. Any refusal to give medical consent must be documented in the family case record. (3-20-20)T

**04. Financial Arrangements.** The family services worker must assure that the alternate care provider understands the financial and payment arrangements and that necessary Department forms are completed and submitted. (3-20-20)T

**05. Contact with Child.** The family, the family services worker, and the alternate care provider have established a schedule for frequent and regular visits with the child by the family and by the family services worker or designee. (3-20-20)T

**a.** Face-to-face contact with a child by the responsible party must occur at least monthly or more frequently depending on the needs of the child or the provider, or both, and the stability of the placement. Face-to-face contact may be made in settings other than where the child resides as long as contact between the responsible party and the child occurs where the child resides a minimum of once every sixty (60) days. (3-20-20)T

**b.** The Department will have strategies in place to detect abuse, neglect, or abandonment of children in alternate care. (3-20-20)T

**c.** Face-to-face contact between the responsible party and a child placed in an in-state group or residential care facility, located a significant distance from the responsible party's office is required a minimum of once every ninety (90) days. Communication by phone between the responsible party and the child must occur at least monthly. (3-20-20)T

**d.** Frequent and regular contact between the child and parents and other family members will be encouraged and facilitated unless it is specifically determined not to be in the best interest of the child. Such contact will be face-to-face if possible, with this contact augmented by telephone calls, written correspondence, pictures, and the use of video and other technology as may be relevant and available. (3-20-20)T

**e.** Children who are in out-of-state placements through the Interstate Compact on the Placement of Children (ICPC) must be contacted face-to-face no less frequently than every six (6) months, by either the responsible party in Idaho, by a representative of the state in which the child is placed, or by a private agency contracted by either. Idaho will request the state in which the child is placed to have face-to-face contact with the child on a monthly basis. If the policy of the state in which the child is placed allows only for face-to-face contact every six (6) months, the responsible party in Idaho will contact the child and the child's caregiver each month by phone to confirm the child's safety and well-being. (3-20-20)T

**06. Discharge Planning.** Planning for discharge from alternate care are developed with all concerned parties. Discharge planning will be initiated at the time of placement and completed prior to the child's return home or to the community. (3-20-20)T

**07. Transition Planning.** Planning for discharge from alternate care into a permanent placement are developed with all concerned parties. Discharge planning will be initiated at the time of placement and completed prior to the child's return home or to the community. (3-20-20)T

**08. Financial and Support Services.** As part of the discharge planning, Departmental resources are coordinated to expedite access to Department financial and medical assistance and community support services. (3-20-20)T

**406. -- 421. (RESERVED)**

**422. ALTERNATE CARE PLANNING.** The elements of alternate care planning are mandated by the provisions of Title IV-E, Sections 471(a)(16), 475(1),

and 475(5)(A) and (D) of the Social Security Act. (3-20-20)T

**01. Alternate Care Plan Required.** Each child receiving alternate care under the supervision of the state must have a standardized written alternate care plan. (3-20-20)T

**a.** The purpose of the alternate care plan is to facilitate the safe return of the child to their own home as expeditiously as possible or to make other permanent arrangements for the child if such return is not feasible. (3-20-20)T

**b.** The alternate care plan must be included as part of the family service plan. (3-20-20)T

**02. Written Alternate Care Plan.** The Department must complete a written alternate care plan within thirty (30) days after a child has been placed in alternate care and at least every six (6) months thereafter. A copy of the alternate care plan will be provided to the child's parent, legal guardian, foster parent, Indian custodian, tribe, and to the child if they are over twelve (12) years of age. (3-20-20)T

**423. -- 424. (RESERVED)**

**ELIGIBILITY AND FUNDING INFORMATION**  
**(Sections 425-441)**

**425. TITLE IV-E ELIGIBILITY.**

The state will claim Title IV-E funding for a foster child who meets the following criteria: (3-20-20)T

**01. Physical or Constructive Removal of the Child.** The child was physically or constructively removed from the home: (3-20-20)T

**a.** Under a voluntary placement agreement; or (3-20-20)T

**b.** As the result of a judicial determination that: (3-20-20)T

**i.** Remaining in the home would be contrary to the child's welfare; or (3-20-20)T

**ii.** Placement in foster care would be in the best interest of the child. (3-20-20)T

**c.** The determination that a situation is contrary to the child's welfare must be made in the first court ruling that sanctions, even temporarily, the removal of a child from the home. (3-20-20)T

**02. Child's Residence.** The child has been living in the home of a parent or other relative specified at 45 CFR 233.90(c)(1)(v) either in the month of, or within six (6) months prior to the month: (3-20-20)T

**a.** Removal court proceedings were initiated; or (3-20-20)T

**b.** The voluntary placement agreement was signed. (3-20-20)T

**03. AFDC Eligibility.** The child was AFDC (Aid to Families with Dependent Children) eligible in the removal home during the month of the initiation of court proceedings that initiated the removal or the month the voluntary placement agreement is signed. AFDC eligibility is based upon the standards found in the State's IV-A Plan on July 16, 1996. (3-20-20)T

**04. "Removal From" and "Living With" Requirements.** The "removal from" (01. of this rule) and "living with" (Subsection 425.02. of this rule) requirements must be satisfied by the same specified relative who meets AFDC eligibility (Subsection 425.03. of this rule). (3-20-20)T

**05. Judicial Determination.** A judicial determination was obtained regarding reasonable efforts to prevent a child's removal from the home no later than sixty (60) days from the child's foster care entry date. When there is a judicial determination of "aggravated circumstances," the court order must state that no reasonable efforts to

reunify the family are required. (3-20-20)T

**06. Agency with Placement Care and Responsibility.** The IV-E agency, or another public agency or Tribe that has a plan approved under 42 U.S.C. 671 in accordance with 42 U.S.C. 679c with which the Title IV-E agency has a written agreement in effect, has placement and care responsibility. (3-20-20)T

**07. Child in Foster Care or Childcare Institution.** The child is in a fully licensed or approved foster family home, or childcare institution. (3-20-20)T

**08. Compliance with Safety Requirements.** Compliance with the safety requirements was documented for the prospective foster family home or childcare institution. (3-20-20)T

**09. Child's Age.** The child is under the age of eighteen (18), or up to age nineteen (19) if the youth is a full-time student in a secondary school or its equivalent level of vocational or technical training and is expected to complete the educational program before reaching age nineteen (19). (3-20-20)T

**10. Child's Citizenship Status.** The child is a US citizen or qualified immigrant under Sections 403, 431, and 432 of the Personal Responsibility Work Opportunity Reconciliation Act (P.L. 104-193). (3-20-20)T

**426. (RESERVED)**

**427. DETERMINATION OF ELIGIBILITY FOR TITLE IV-E.**

The family services workers must submit an application to the Child Welfare Funding Team to evaluate for Title IV-E eligibility. (3-20-20)T

**428. CUSTODY AND PLACEMENT.**

**01. Interstate Placements.** In interstate placements, a child may be placed with an approved unlicensed relative when delaying the placement would be harmful to the child's well-being. In those cases, a subsequent request for foster care licensure will be made through the Interstate Compact on the Placement of Children. However, in these instances, a child is ineligible for Title IV-E until the placement is licensed. (3-20-20)T

**02. Intrastate Placements That Become Interstate Placements.** If a foster care placement that was initially intrastate becomes an interstate placement because the family with whom the child is placed relocates to another state, a request for foster care licensure will be made through the Interstate Compact on the Placement of Children immediately upon the decision to move the child. If the state to which the family has moved accepts the family's Idaho foster care license as effective, the placement is considered licensed until a determination is made that the family is in compliance with the licensing and other applicable laws of the state to which the family has moved. (3-20-20)T

**429. EFFECTIVE DATE.**

Claims for Title IV-E maintenance may begin as early as the first day of placement in the month in which all initial Title IV-E eligibility factors are met. A child cannot receive SSI and Title IV-E foster maintenance payments during the same time period. (3-20-20)T

**430. ONGOING ELIGIBILITY.**

To continue eligibility for Title IV-E, a child must meet the following conditions: (3-20-20)T

**01. Child's Age.** The child is under the age of eighteen (18), or up to age nineteen (19) if the youth is a full-time student in a secondary school or its equivalent level of vocational or technical training and is expected to complete the educational program before reaching age nineteen (19). (3-20-20)T

**02. Department Custody.** The child remains in the Department's custody through either a current court order or a voluntary placement agreement that has not been in effect more than one hundred and eighty (180) days. (3-20-20)T

**03. Child's Residence.** The child continues to live in a fully licensed or approved foster family home,

or childcare institution, or on a court-ordered home visit. (3-20-20)T

**04. Redetermination.** A redetermination is used for a child who: (3-20-20)T

**a.** Left foster care; (3-20-20)T

**b.** Was placed in a Title IV-E ineligible living situation such as: unlicensed placement, a hospital, or a detention center; (3-20-20)T

**c.** Exceeded one hundred eighty (180) days in a voluntary placement agreement in which there was no judicial determination of “best interests.” The child’s Title IV-E eligibility ceases on the 181st day; and (3-20-20)T

**d.** Is on a home visit that exceeds the time specified in the court order signed by the Judge without a new judicial determination granting an extension. (3-20-20)T

**05. Annual Redetermination.** Annual redetermination is required to assure that the court has determined that the Department has made reasonable efforts to finalize a permanency plan for the child within twelve (12) months of the date the child is considered to have entered foster care and at least once every twelve (12) months thereafter while the child is in foster care. (3-20-20)T

**431. (RESERVED)**

**432. TITLE XIX FOSTER CHILD.**

For Title XIX Medicaid eligibility for a foster child, please refer to IDAPA 16.03.01, “Eligibility for Health Care Assistance for Families and Children,” Section 536. (3-20-20)T

**433. INCOME, BENEFITS AND SAVINGS OF CHILDREN IN FOSTER CARE.**

On behalf of the child and with the assistance of CWFT staff, family services workers are required to identify and apply for income or benefits from (one (1) or) every available source including Social Security, tribal benefits, or estates of deceased parents. The address of the payee must be DHW-FACS-CWFT, 450 West State Street, P. O. Box 83720 Boise, ID 83720-0036. (3-20-20)T

**434. FORWARDING OF BENEFITS.**

**01. Home Visit.** If the Department is receiving benefits and the child is returned to the home of the parent(s) or legal guardian(s) or relatives for a trial visit, Child Support Services must be notified by a family services worker giving the name and address of the person in order to discontinue accrual of child support owed to the State. (3-20-20)T

**02. Return to Foster Care.** If the child returns to foster care, the Department’s Child Support Unit must be notified immediately of the correct payee. (3-20-20)T

**435. (RESERVED)**

**436. PARENTAL FINANCIAL SUPPORT FOR CHILDREN IN ALTERNATE CARE.**

In accordance with Section 56-203B, Idaho Code, parents are responsible for costs associated with the care of their child in alternate care. (3-20-20)T

**01. Notice of Parental Responsibility.** The Department will provide the parents(s) with written notification of their responsibility to contribute toward the cost of their child’s support, treatment, and care, including clothing, medical, incidental, and educational costs. (3-20-20)T

**02. Financial Arrangements with Parent(s).** Parent(s) are responsible to reimburse the Department for the costs of alternate care when their child is placed in alternate care in accordance with a court order or voluntary placement agreement. (3-20-20)T

**a.** The amount of support is based on the parents’ income, the costs of care for the child, and any

unique circumstances affecting the parents' ability to pay. (3-20-20)T

**b.** Every parent is expected to contribute to the cost of their child's care, but no parent will be asked to pay more than the actual cost of care, including clothing, medical, incidental and educational costs. The cost of room and board must be paid by the parent(s) to the Department, and the Department will in turn reimburse the alternate care providers. (3-20-20)T

**437. ACCOUNTING AND REPORTING.**

The Department's Division of Family and Community Services, Child Welfare Funding Team must account for the receipt of funds and develop reports showing how much money has been received and how it has been utilized. (3-20-20)T

**438. SUPPORT AGREEMENT FOR VOLUNTARY PLACEMENTS.**

If the placement is voluntary, the parent(s) must sign an agreement that specifies the amount of support to be paid, when it is to be paid to the payee, and the address to which it is to be paid. (3-20-20)T

**439. SUPPORT IN COURT-ORDERED PLACEMENT.**

In the case of a court-ordered placement, if no support agreement has been reached with the parent(s) prior to the custody or commitment hearing, the Department's report to the Court will indicate the necessity to hold a support hearing. (3-20-20)T

**440. INSURANCE COVERAGE.**

The parent(s) or legal guardian(s) must inform the Department of all insurance policies covering the child, including names of carriers, and policy or subscriber numbers. If medical, health, and dental insurance coverage are available for the child, the parent(s) must acquire and maintain such insurance. (3-20-20)T

**441. REFERRAL TO CHILD SUPPORT SERVICES.**

The Department will refer the parent(s) to the Bureau of Child Support Services for support payment arrangements. (3-20-20)T

**01. Assignment of Child Support.** The Department through the Bureau of Child Support Services will secure assignment of any support due to the child while in alternate care. Social Security and Supplemental Security Income benefits are specifically aimed at meeting the child's needs and therefore will follow the child in placement and the Department must request to be named payee for all funds for placements extending over thirty (30) days. (3-20-20)T

**02. Collection of Child Support.** The Department must take action to collect any child support ordered in a divorce decree. (3-20-20)T

**MEDICAL AND DENTAL FOR CHILDREN IN OUT-OF-HOME CARE**  
**(Sections 442-479)**

**442. MEDICAID FOR CHILDREN IN ALTERNATE CARE.**

Every child placed in alternate care will receive a medical card each month. (3-20-20)T

**443. EPSDT SCREENING.**

Children in alternate care will receive the Early Periodic Screening, Diagnosis and Treatment (EPSDT) services allowable under Medicaid. Those children already receiving Medicaid at the time of placement will be screened within thirty (30) days after placement. Children not receiving Medicaid at the time of placement will receive a screening within thirty (30) days from the date Medicaid eligibility is established. (3-20-20)T

**444. MEDICAL EMERGENCIES.**

In case of serious illness, the alternate care provider must notify the child's doctor and the Department immediately. The parent(s) or legal guardian(s) or the court in an emergency, or the Department if it is the guardian of the child, have the authority to consent to major medical care or hospitalization. (3-20-20)T

**445. DENTAL CARE.**



Each child age three (3) who is placed in alternate care must receive a dental examination as soon as possible after placement, but not later than ninety (90) days, and thereafter according to a schedule prescribed by the dentist.

(3-20-20)T

**01. Costs Paid by Medicaid.** If dental care not included in the state medical assistance program is recommended, a request for payment must be submitted to the state Medicaid dental consultant.

(3-20-20)T

**02. Emergencies.** For children in shelter care, emergency dental services will be provided for and paid for by the Department, if there are no other financial resources available.

(3-20-20)T

**446. COSTS OF PRESCRIPTION DRUGS.**

The Department will purchase prescribed drugs, at the Medicaid rate, for a child in alternate care through participating pharmacists, in excess of the Medicaid monthly maximum.

(3-20-20)T

**447. MEDICAL EXAMINATION UPON ENTERING ALTERNATE CARE.**

Within thirty (30) days of entering alternate care, each child will receive a medical examination to assess the child's health status, and thereafter according to a schedule prescribed by the child's physician or other health care professional.

(3-20-20)T

**448. -- 450. (RESERVED)**

**451. DRIVERS' TRAINING, DRIVERS' LICENSES, AND PERMITS FOR CHILDREN IN ALTERNATE CARE.**

No Department employee or foster parent is allowed to sign for any foster child's driver's license or permit without written authorization from the Child and Family Services Program Manager. Any Department employee or foster parent signing for a foster child's driver's license or permit without the approval of the Child and Family Services Program Manager assumes full personal responsibility and liability for any driving related damages that may be assessed against the child. Those damages will not be covered by the Department's insurance.

(3-20-20)T

**01. Payments by Department.** Subject to existing appropriations, the Department may make payments for driver's training, driver's license, and permits for a child in the Department's legal custody when driver's training or obtaining a driver's license or permit is part of the child's Independent Living Plan. In addition, subject to existing appropriations, the Department may reimburse a foster parent, licensed by the Department, for the cost of procuring owner's or operator's insurance listing a child residing in their home as a named insured with respect to the operation of a motor vehicle subject to the limits exclusive of interest and costs with respect to each motor vehicle as provided in Section 49-117, Idaho Code.

(3-20-20)T

**02. Payment by Parent(s) or Legal Guardian(s).** The parent(s) or legal guardian(s) of children in foster care may authorize drivers' training, provide payment and sign for drivers' licenses and permits.

(3-20-20)T

**452. -- 479. (RESERVED)**

**LICENSURE AND REIMBURSEMENT OF ALTERNATE CARE PROVIDERS**

**(Sections 480-549)**

**480. ALTERNATE CARE LICENSURE.**

All private homes and facilities providing care for children under these rules must be licensed in accordance with IDAPA 16.06.02, "Child Care Licensing," unless foster care placement of an Indian child is made with a foster home licensed or approved by the Indian child's tribe, or an institution for children approved by an Indian tribe or operated by an Indian organization.

(3-20-20)T

**481. FACILITIES OPERATED BY THE STATE.**

Facilities operated by the State and providing care for children under these rules must meet the standards for child care licensure.

(3-20-20)T

**482. PAYMENT FOR SHELTER CARE.**

Payment for placement of children requiring temporary, emergency alternate care is twenty dollars (\$20) per day for

children from birth through age seventeen (17), for a maximum of thirty (30) days of shelter care for each uninterrupted placement. (3-20-20)T

**483. PAYMENT TO FAMILY ALTERNATE CARE PROVIDERS.**

Monthly payments for care provided by family alternate care providers are:

<b>Family Alternate Care Payments - Table 483</b>			
<b>Ages</b>	<b>0-5</b>	<b>6-12</b>	<b>13-18</b>
<b>Monthly Room and Board</b>	<b>\$395</b>	<b>\$439</b>	<b>\$584</b>

(3-20-20)T

**01. Gifts.** An additional thirty dollars (\$30) for Christmas gifts and twenty dollars (\$20) for birthday gifts will be paid in the appropriate months. (3-20-20)T

**02. Clothing.** Costs for clothing will be paid, based upon the Department's determination of each child's needs. All clothing purchased for a child in alternate care becomes the property of the child. (3-20-20)T

**03. School Fees.** School fees due upon enrollment will be paid directly to the school or to the alternate care providers, based upon the Department's determination of the child's needs. (3-20-20)T

**484. ADDITIONAL PAYMENTS TO FAMILY ALTERNATE CARE PROVIDERS.**

For those children who require additional care above room, board, shelter, daily supervision, school supplies, personal incidentals, the Department may pay the family alternate care provider an additional amount to the amount paid under Section 483 of these rules. This family alternate care rate is based upon a ongoing assessment of the child's circumstances that necessitate special rates as well as the care provider's ability, activities, and involvement in addressing those special needs. Additional payment will be made as follows: (3-20-20)T

**01. Lowest Level of Need.** Ninety dollars (\$90) per month for a child requiring a mild degree of care for documented conditions including: (3-20-20)T

- a.** Chronic medical problems; (3-20-20)T
- b.** Frequent, time-consuming transportation needs; (3-20-20)T
- c.** Behaviors requiring extra supervision and control; and (3-20-20)T
- d.** Need for preparation for independent living. (3-20-20)T

**02. Moderate Level of Need.** One hundred fifty dollars (\$150) per month for a child requiring a moderate degree of care for documented conditions including: (3-20-20)T

- a.** Ongoing major medical problems; (3-20-20)T
- b.** Behaviors that require immediate action or control; and (3-20-20)T
- c.** Alcohol or other substance use disorder. (3-20-20)T

**03. Highest Level of Need.** Two hundred forty dollars (\$240) per month for a child requiring an extraordinary degree of care for documented conditions including: (3-20-20)T

- a.** Severe emotional or behavioral disturbance; (3-20-20)T
- b.** Severe developmental disability; and (3-20-20)T

- c. Severe physical disability such as quadriplegia. (3-20-20)T

**04. Reportable Income.** Additional payments for more than ten (10) qualified children received during any calendar year must be reported as income to the Internal Revenue Service. (3-20-20)T

**485. TREATMENT FOSTER CARE.**

A family home setting in which treatment foster parents provide twenty-four (24) hour room and board as well as therapeutic services and a high level of supervision. Services provided in treatment foster care are at a more intense level than provided in foster care and at a lower level than provided in residential care. Services may include the following: participation in the development and implementation of the child's treatment plan, behavior modification, community supports, crisis intervention, documentation of services and the child's behavior, participation as a member of a multi-disciplinary team, and transportation. Placement into a treatment foster home for children in the custody of the Department under the purview of the Child Protective Act, is based on the documented needs of the child, the inability of less restrictive settings to meet the child's needs, and the clinical judgement of the Department. (3-20-20)T

**01. Qualifications.** Prior to being considered for designation and reimbursement as a treatment foster parent, each prospective treatment foster parent must accomplish the following: (3-20-20)T

a. Meet all foster family licensure requirements as set forth in IDAPA 16.06.02, "Child Care Licensing"; (3-20-20)T

b. Complete Department-approved treatment foster care initial training; and (3-20-20)T

c. Provide a minimum of two (2) references in addition to those provided to be licensed to provide foster care. The additional references must be from individuals who have worked with the prospective treatment foster parent. The additional references must verify that the prospective treatment foster parent has: (3-20-20)T

i. Training related to, or experience working with, children or youth with mental illness or behavior disorders; and (3-20-20)T

ii. Demonstrated cooperation and a positive working relationship with families and providers of child welfare or mental health services. (3-20-20)T

**02. Continuing Education.** Following designation as a treatment foster home, each treatment foster home parent must complete fourteen (14) hours of additional training per year as specified in an agreement developed between the treatment foster parents and the Department. (3-20-20)T

**03. Availability.** At least one (1) treatment foster parent, in each treatment family home, must be available twenty-four (24) hours a day, seven (7) days a week to respond to the needs of the foster child. (3-20-20)T

**04. Payment.** The Department will pay treatment foster parents up to one thousand eight hundred (\$1,800) dollars per month, per child, which includes the monthly payment rate specified in Sections 483 and 484 of these rules. The payment will be made to treatment foster parents in accordance with a contract with the Department. The purpose of the contract is to make clear that the treatment foster parents must fulfill the requirements for treatment foster parents under the child's treatment plan referenced in Subsection 485.06 of this rule. (3-20-20)T

**05. Payment to Contractors.** The Department may also provide treatment foster care through a contract with an agency that is a private provider of treatment foster care. The Department will specify the rate of payment in the contract with the agency. (3-20-20)T

**06. Treatment Plan.** The treatment foster parent(s) must implement the portions of the Department-approved treatment plan for which they are designated as responsible, for each child in their care. This plan is incorporated as part of the family services plan identified in Section 011.05 of these rules. (3-20-20)T

**486. GROUP FOSTER CARE.**

Group foster care is for children who generally require more structured activities and discipline than found in a family

setting. Examples are intermediate residential treatment, short-term group care, and emancipation homes. (3-20-20)T

**01. Referral -- Group Foster Care.** Any referral of a child to a group foster care facility where the Department would be making full or partial payment must be prior authorized by the Child and Family Services Program Manager or designee. (3-20-20)T

**02. Placement.** Placement is based on the documented service needs of each child and the ability of the group care provider to meet those needs. (3-20-20)T

**03. Payment -- Group Foster Care.** Payment will be in accordance with the contract authorized by the regional director or division administrator, based on the needs of the children being placed and the services to be provided. (3-20-20)T

**487. RESIDENTIAL CARE FACILITIES.**

Placement into a residential care facility for children with a severe emotional or behavioral problems is based on the documented needs of the child and the inability of less restrictive settings to meet the child's needs. (3-20-20)T

**01. Referral.** Any referral of a child to a residential care facility where the Department would be making full or partial payment must be prior authorized by the Child Services and Family Program Manager or designee. (3-20-20)T

**02. Payment.** When care is purchased from private providers, payment must be made in accordance with a contract authorized by the Child Services and Family Program Manager, based on the needs of each child being placed and the services to be provided. When care is provided in facilities operated by the Department, payment will be arranged in cooperation with Department fiscal officers. (3-20-20)T

**488. -- 491. (RESERVED)**

**492. REIMBURSEMENT IN THE HOME OF A RELATIVE.**

Relatives licensed as a foster family must be afforded the opportunity to receive foster care reimbursement for any child(ren) placed in their home through the Department. A relative foster family may choose not to accept a foster care reimbursement and apply for a TAFI grant or provide for the child's care using their own financial resources. (3-20-20)T

**493. -- 549. (RESERVED)**

**CHILD PROTECTION SERVICES**  
**(Sections 550-639)**

**550. CHILD PROTECTION SERVICES.**

Sections 56-204A, 56-204B, 16-1601, 16-1629 and 16-2001, Idaho Code, make the Department an official child protection agency of state government dealing with situations of reported child abuse, neglect, or abandonment. A respectful, non-judgmental approach should be the policy for assessments, especially during the initial contact with the family. Training in communication would include multicultural and diversity issues and interest-based conflict resolution. (3-20-20)T

**551. REPORTING ABUSE, NEGLECT, OR ABANDONMENT.**

Professionals and other persons identified in Section 16-1605, Idaho Code, have a responsibility to report abuse, neglect, or abandonment and are provided protection for reporters. (3-20-20)T

**01. Ministers.** Duly ordained ministers of religion are exempt from reporting child abuse, neglect, or abandonment if: (3-20-20)T

**a.** The church qualifies as tax-exempt under 26. U.S.C. 501(c)(3); (3-20-20)T

**b.** The confession or confidential communication was made directly to the duly ordained minister of religion; and (3-20-20)T

c. The confession was made in the manner and context that places the duly ordained minister of religion specifically and strictly under a level of confidentiality that is considered inviolate by canon law or church doctrine. (3-20-20)T

**02. Health and Welfare Employees.** All Department of Health and Welfare personnel are responsible for recognizing and immediately reporting to Child and Family Services or to law enforcement any concern regarding abuse, neglect, or abandonment of a child or children. Failure to report as required by Section 16-1605, Idaho Code, is a misdemeanor. (3-20-20)T

**552. REPORTING SYSTEM.**

Each region of the Department maintains a system for receiving and responding to reports or complaints on a twenty four (24) hour per day, seven (7) day per week basis throughout the entire region. The region will advertise the system to the public throughout the region and ensure the accurate recording of as many facts as possible at the time of the report. (3-20-20)T

**553. ASSIGNING REPORTS FOR SAFETY ASSESSMENT.**

The Department must assign all reports of possible abuse, neglect, or abandonment of children for safety assessment, unless the field office has knowledge or information that discredits the report beyond a reasonable doubt. (3-20-20)T

**554. RESPONSE PRIORITIES.**

The Department must use the following statewide standards for responding to allegations of abuse, neglect, or abandonment, using the determination of risk to the child as the primary criterion. Any variance from these response standards must be documented in the family's case file with a description of action taken, and must be reviewed and signed by the Child and Family Services Supervisor. (3-20-20)T

**01. Priority I.** The Department must respond immediately if a child is in immediate danger involving a life-threatening or emergency situation. Emergency situations include sexual abuse when a child may have contact with the alleged perpetrator and circumstances indicate a need for immediate response. Law enforcement must be notified and requested to respond or to accompany a family services worker. Every attempt should be made to coordinate the Department's assessment with law enforcement's investigation. The child must be seen by a Department family services worker, law enforcement, and medical personnel if applicable, immediately unless written regional protocol agreements direct otherwise. All allegations of physical abuse of a child through the age of six (6) or with profound developmental disabilities should be considered under Priority I unless there is reason to believe that the child is not in immediate danger. (3-20-20)T

**02. Priority II.** A child is not in immediate danger but allegations of abuse, including physical or sexual abuse, or serious physical or medical neglect are clearly defined in the referral. Law enforcement must be notified within twenty-four (24) hours. The child must be seen by the family services worker within forty-eight hours (48) of the Department's receipt of the referral. Law enforcement must be notified within twenty-four (24) hours of receipt of all Priority II referrals that involve concerns of abuse, neglect, or abandonment. (3-20-20)T

**03. Priority III.** A child may be in a vulnerable situation because of services needs which, if left unmet, may result in harm, or a child is without parental care for safety, health and well being. The child and parent(s) or legal guardian(s) will be interviewed for substantiation of the facts, and to assure that there is no abuse, neglect, or abandonment by parent(s) or legal guardian(s). A family services worker must respond within three (3) calendar days and the child must be seen by the worker within five (5) calendar days of the Department's receipt of the referral. (3-20-20)T

**04. Notification of the Person Who Made the Referral.** The Department must notify the person who made the child protection referral of the receipt of the referral within five (5) days. (3-20-20)T

**05. Disclosure of Information to Professionals.** The Department has the discretion to disclose, on a need-to-know basis, minimally necessary information to individuals who are professionally involved in the ongoing care of the child who is the subject of a report of abuse, neglect, or abandonment. This includes information that the professional will need to know in order to fulfill their role in maintaining the child's safety and well-being. This provision applies to: (3-20-20)T

- a. Physicians, residents on a hospital staff, interns, and nurses; (3-20-20)T
- b. School teachers, school staff, and day care personnel; and (3-20-20)T
- c. Mental health professionals, including psychologists, counselors, marriage and family therapists, and social workers. (3-20-20)T

**555. SUPERVISORY REVIEW - CERTAIN PRIORITY I AND II CASES.**

In all Priority I and II cases where the alleged victim of abuse, neglect, or abandonment is through the age of six (6), review by supervisory or team of all case documentation and other facts will be conducted within forty-eight (48) hours of initiation of the safety assessment. Such review will be documented in the file with the signature of the supervisor or team leader, time and date, whether additional safety-related issues will be pursued and by whom, and any planning for initiation of services. (3-20-20)T

**556. REPORTS INVOLVING INDIAN CHILDREN.**

Possible abuse, neglect, or abandonment of a child who is known or believed to be Indian will be reported to appropriate tribal authorities immediately. If the reported incident occurs off a reservation, the Department will perform the investigation. The Department will also investigate incidents reported on a reservation if requested to do so by appropriate authorities of the tribe. A record of any response will be maintained in the case record and written documentation will be provided to the appropriate tribal authorities. (3-20-20)T

**557. REPORTS INVOLVING MILITARY FAMILIES.**

Reports of possible child abuse, neglect, or abandonment involving a military family must be reported in accordance with the provisions of any agreement with the appropriate military family advocacy representative, in accordance with the provisions of Section 811 of Public Law 99-145. Child abuse, neglect, or abandonment of a child on a military reservation falls under federal jurisdiction. (3-20-20)T

**558. COMMUNITY RESOURCES.**

The Department will provide information and referral to community resources or may offer preventative services to the family. Information and referral services enable individuals to gain access to human services through providing accurate, current information on community and Department resources. (3-20-20)T

**559. CHILD PROTECTION SAFETY AND COMPREHENSIVE ASSESSMENTS.**

The Department's safety and comprehensive assessments must be conducted in a standardized format and utilize statewide assessment and multi-disciplinary team protocols. The assessment must include contact with the child(ren) involved and the immediate family and a records check for history with respect to child protection issues. (3-20-20)T

**01. Assessment of a Child.** The family services worker must make an assessment of every child of concern. When the child is interviewed as part of a safety and comprehensive assessment, the interview of a child concerning a child protection report must be conducted: (3-20-20)T

- a. In a manner that protects all children involved from undergoing any unnecessary traumatic experience, including multiple interviews; (3-20-20)T
- b. By a professional with specialized training in using techniques that consider the natural communication modes and developmental stages of children; and (3-20-20)T
- c. In a neutral, non-threatening environment, such as a specially equipped interview room, if available. (3-20-20)T

**02. Assessment of the Family.** The family services worker conducting the interview must: (3-20-20)T

- a. Immediately notify the parent(s) or legal guardian(s) of the purpose and nature of the assessment. (3-20-20)T
- b. Provide at the initial contact the name and work phone numbers of the family services worker and

their supervisor to ensure the family has a contact for questions and concerns that may arise following the visit; (3-20-20)T

- c. Inquire if the family is Indian, or has Indian heritage, for the purposes of ICWA; (3-20-20)T
- d. Interview siblings who are identified as being at risk; and (3-20-20)T
- e. Not divulge the name of the person making the report of child abuse or neglect. (3-20-20)T

**03. Collateral Interviews.** Any assessment of an abuse or neglect report must include at least one (1) collateral interview with a person who is familiar with the circumstances of the child or children involved. Collateral interviews will be conducted with discretion and preferably with the parent(s)' or legal guardian(s)' permission. (3-20-20)T

**04. Completion of a Comprehensive Assessment.** A Safety Assessment will be completed on each referral assigned for assessment of abuse or neglect, or both. When safety threats are identified in the safety assessment and the case remains open for services, a comprehensive assessment must be completed. (3-20-20)T

**05. Role of Law Enforcement.** Section 16-1617, Idaho Code, specifies that the Department may enlist the cooperation of peace officers for phases of the safety assessment for which they have the expertise and responsibility and consistent with the relevant multidisciplinary team protocol. Such areas include: (3-20-20)T

- a. Interviewing the alleged perpetrator; (3-20-20)T
- b. Removing the alleged perpetrator from the child's home in accordance with Section 16-1608(b), Idaho Code, the "Domestic Violence Act"; and (3-20-20)T
- c. Taking a child into custody in accordance with Section 16-1608, Idaho Code, where a child is endangered and prompt removal from their surroundings is necessary to prevent serious physical or mental injury. (3-20-20)T

**06. Notification of the Person Who Made the Referral.** The Department must notify the person who made the child protection referral when the safety assessment has been completed. (3-20-20)T

**560. DISPOSITION OF CHILD PROTECTION REPORTS.**

Within five (5) days following completion of safety assessments, the Department will determine whether the reports are substantiated or unsubstantiated. All persons who are the subject of a child protection safety assessment will be notified of the disposition of the assessment. (3-20-20)T

**01. Substantiated.** Child abuse, neglect, or abandonment reports are substantiated by one (1) or more of the following: (3-20-20)T

- a. Witnessed by a family services worker, as defined in Section 011 of these rules; (3-20-20)T
- b. A court determines, in an adjudicatory hearing, that a child comes within the jurisdiction of the Child Protective Act, Title 16, Chapter 16, Idaho Code; (3-20-20)T
- c. A confession; (3-20-20)T
- d. Corroborated by physical or medical evidence; or (3-20-20)T
- e. Established by evidence that it is more likely than not that abuse, neglect, or abandonment occurred. (3-20-20)T

**02. Unsubstantiated.** Child abuse, neglect, or abandonment reports are unsubstantiated when they are not found to be substantiated under Subsection 560.01 of this rule. For intradepartmental statistical purposes, the Department will indicate whether the unsubstantiated disposition of the safety assessment was due to: (3-20-20)T

- a. Insufficient evidence; or (3-20-20)T
- b. An erroneous report. (3-20-20)T

**561. CHILD PROTECTION CENTRAL REGISTRY.**

The Adam Walsh Child Protection and Safety Act of 2006, P.L. 109-248, July 27, 2006, 120 Stat. 587, has directed the states to establish a central registry for the purpose of sharing information about persons who have substantiated reports of abuse, neglect, or abandonment against children. The Child Protection Central Registry was established under the authority of Section 16-1629(3), Idaho Code. The primary purpose of the Child Protection Central Registry is to aid the Department in protecting children and vulnerable adults from individuals who have previously abused, neglected, or abandoned children. The Child Protection Central Registry maintained by the Department is separate and apart from the central registry for convicted sexual offenders maintained by the Idaho State Police under Title 18, Chapter 83, Idaho Code. The Child Protection Central Registry provisions in this chapter of rules apply to safety assessments conducted by the Department after October 1, 2007. (3-20-20)T

**562. CONFIDENTIALITY OF THE CHILD PROTECTION CENTRAL REGISTRY AND REQUESTS TO CHECK THE REGISTRY.**

**01. Confidentiality of Child Protection Central Registry.** The names on the Child Protection Central Registry are confidential and may only be released with the written consent of the individual on whom a criminal history and background check is being conducted, unless otherwise required by federal or state law. No information is released regarding the severity or type of child abuse, neglect, or abandonment. (3-20-20)T

**02. Child Protection Central Registry Check Fee.** The fee for requesting a name-based check of the Child Protection Central Registry is twenty (\$20) dollars. The request must be accompanied with a signed written consent by the individual whose name is being checked. (3-20-20)T

**563. LEVELS OF RISK ON THE CHILD PROTECTION CENTRAL REGISTRY.**

When an incident of abuse, neglect, or abandonment has been substantiated, a level of risk is assigned to the incident. The level of risk is determined by the severity and type of the abuse, neglect, or abandonment and the potential risk of future harm to a child. The highest level of risk is designated as Level One and the lowest level of risk is Level Three. (3-20-20)T

**01. Child Protection Level One.** An individual with a Level One designation has been determined to pose a high to severe risk to children. Names of individuals for whom an incident of abuse, neglect, or abandonment has been substantiated for any of the following will remain permanently on the Child Protection Central Registry at Level One. (3-20-20)T

- a. Sexual Abuse as defined in Sections 16-1602(1)(b) and 18-1506, Idaho Code; (3-20-20)T
- b. Sexual Exploitation as defined in Sections 18-1507 and 18-1507A, Idaho Code; (3-20-20)T
- c. Physical abuse as described in Section 16-1602(1)(a), Idaho Code, that causes life-threatening, disabling, or disfiguring injury or damage; (3-20-20)T
- d. Neglect as described in Section 16-1602(31), Idaho Code, that results in life-threatening, disabling, or disfiguring injury or damage; (3-20-20)T
- e. Abandonment as described in Section 16-1602(2), Idaho Code, that results in life-threatening, disabling, or disfiguring injury or damage; (3-20-20)T
- f. Death of a child; (3-20-20)T
- g. Torture of a child as described in Section 18-4001, Idaho Code; (3-20-20)T
- h. Aggravated Circumstances as described in Section 16-1602(6), Idaho Code; or (3-20-20)T



i. Occurrence of two (2) or more separate, substantiated incidents of abuse, neglect, or abandonment, each of which falls under the circumstances listed under Subsection 563.02 of this rule. (3-20-20)T

**02. Child Protection Level Two.** An individual with a Level Two designation has been determined to pose a medium to high risk to children and will remain on the Child Protection Central Registry for a minimum of ten (10) years. After the end of the ten-year (10) period, an individual may petition the Department to request their name be removed from the Child Protection Central Registry in accordance with Section 566 of these rules. Names of individuals for whom an incident of abuse, neglect, or abandonment has been substantiated for any of the following will be given the designation of Level Two. (3-20-20)T

a. Prenatal use of any controlled substance as defined under Section 37-2701(e), Idaho Code, except as prescribed by a medical professional; (3-20-20)T

b. Administering or knowingly allowing a child to absorb or ingest one (1) or more controlled substances as defined under Section 37-2701(e), Idaho Code, except in the amount prescribed for the child by a medical professional; (3-20-20)T

c. Child exposed to: (3-20-20)T

i. Drug paraphernalia, as defined in Section 37-2701(n), Idaho Code; (3-20-20)T

ii. Manufacture of controlled substances, as defined under Section 37-2701(e), Idaho Code, and Section 37-2701(s), Idaho Code; or (3-20-20)T

iii. Chemical components used in the manufacture of controlled substances, as defined under Section 37-2701(e), Idaho Code. (3-20-20)T

d. Failure to thrive caused by abuse, neglect, or abandonment, as established by medical evidence; (3-20-20)T

e. Physical abuse as described in Section 16-1602(1)(a), Idaho Code, abandonment as described in Section 16-1602(2), Idaho Code, or neglect as described in Section 16-1602(31), Idaho Code, that results in neither disabling nor disfiguring injury or damage, but may require medical or other treatment; (3-20-20)T

f. The restraint or confinement of a child that poses a substantial risk of causing life-threatening, disabling, or disfiguring injury or damage; (3-20-20)T

g. Medical neglect as described in Section 16-1602(31), Idaho Code, that poses a substantial risk of resulting in life-threatening, disabling, or disfiguring injury or damage; (3-20-20)T

h. Malnutrition as established by medical evidence; or (3-20-20)T

i. Occurrence of two (2) or more separate, substantiated incidents of abuse, neglect, or abandonment, each of which falls under the circumstances listed under Subsection 563.03 of this rule. (3-20-20)T

**03. Child Protection Level Three.** An individual with a Level Three designation has been determined to pose a mild to medium risk of harm to the health, safety, or well-being of a child. The name of that individual will remain on the Child Protection Central Registry for a minimum of five (5) years. After the end of the five-year (5) period, an individual may petition the Department to request their name be removed from the Child Protection Central Registry in accordance with Section 566 of these rules. Names of individuals for whom an incident of abuse, neglect, or abandonment has been substantiated for any of the following are given the designation of Level Three. (3-20-20)T

a. Lack of supervision; (3-20-20)T

b. Failure to protect from abuse, neglect, or abandonment as described in Section 16-1602, Idaho

Code; (3-20-20)T

c. Failure to discharge parental responsibilities described under Section 16-1602(31), Idaho Code; or (3-20-20)T

d. Physical abuse as described in Section 16-1602(1)(a), Idaho Code, or neglect as described in Section 16-1602(31), Idaho Code, that causes minor injuries or damage that does not require medical treatment. (3-20-20)T

**564. NOTIFICATION OF A SUBSTANTIATED INCIDENT OF ABUSE, NEGLECT, OR ABANDONMENT, AND RELATED ADMINISTRATIVE REVIEW AND CONTESTED CASE APPEAL RIGHTS.**

**01. Notification of Substantiated Incident.** Prior to placement on the Child Protection Central Registry, the Department will notify by certified mail, return receipt requested, each individual for whom an incident of abuse, neglect, or abandonment has been substantiated. The individual has twenty-eight (28) days from the date on the notification to file a request for an administrative review under the requirements in IDAPA 16.05.03, "Contested Case Proceedings and Declaratory Rulings." The Department's written notice will state: (3-20-20)T

a. The risk level assigned to the incident; (3-20-20)T

b. The basis for the Department's decision; (3-20-20)T

c. The individual's right to request an administrative review by the Department's Family and Community Services (FACS) Division Administrator of the Department's decision; and (3-20-20)T

d. The Department's contact information. (3-20-20)T

**02. Administrative Review Not Requested.** If the individual does not request an administrative review by the FACS Division Administrator within twenty-eight (28) days from the date on the notification, their name will automatically be entered on the Child Protection Central Registry without further notice or right for appeal. (3-20-20)T

**03. Administrative Review Requested.** If the individual requests an administrative review by the FACS Division Administrator within twenty-eight (28) days from the date on the notification, the incident will be reviewed by the FACS Division Administrator and a decision will be rendered to either affirm, reverse, or modify, the decision to substantiate the incident of abuse, neglect, or abandonment. The Department will notify the individual of the FACS Division Administrator's decision by mail. (3-20-20)T

**04. Reversal of Decision to Substantiate.** When the FACS Division Administrator completes the administrative review and reverses the decision to substantiate the incident of abuse, neglect, or abandonment, and determines that the incident is not substantiated, then no further action is required by the individual. The individual's name will not be placed on the Child Protection Central Registry. (3-20-20)T

**05. Contested Case Appeal.** When the FACS Division Administrator completes the administrative review and affirms the decision to substantiate the incident of abuse, neglect, or abandonment, the individual will be notified by mail that their name has been placed on the Child Protection Central Registry and informed of: (3-20-20)T

a. The basis for the Department's decision; (3-20-20)T

b. The procedures for filing a contested case appeal under IDAPA 16.05.03, "Contested Case Proceedings and Declaratory Rulings," Section 101; (3-20-20)T

c. The procedures for filing a petition for removal from the Child Protection Central Registry after the applicable minimum time has passed under Section 566 of these rules; and (3-20-20)T

- d. The Department's contact information. (3-20-20)T

**565. PETITION FOR REMOVAL OF AN INDIVIDUAL'S NAME ON THE CHILD PROTECTION CENTRAL REGISTRY PRIOR TO OCTOBER 1, 2007.**

After January 1, 2008, an individual whose name was placed on the Child Protection Central Registry prior to October 1, 2007, may file a petition to have their name removed from the registry in accordance with Subsection 566.01 of these rules. The petitioner will be assigned a child protection risk level in accordance with criteria under Section 563 of these rules and the case will be reviewed to determine if it meets the requirements for removal.

(3-20-20)T

**566. PETITION FOR REMOVAL OF AN INDIVIDUAL'S NAME FROM THE CHILD PROTECTION CENTRAL REGISTRY.**

Any individual whose name is on the Child Protection Central Registry and whose required minimum time on the registry has elapsed, may petition the Department to remove their name from the Registry. An individual whose name appears with a Level One designation on the Child Protection Central Registry is not eligible to petition for removal.

(3-20-20)T

**01. Petition for Removal From the Child Protection Central Registry.** Any individual whose name appears on the Child Protection Central Registry with a designation of either Level Two or Level Three, may petition to have their name removed from the Child Protection Central Registry after the minimum period of time has elapsed for the applicable level. The petition must include a written statement from the petitioner to the Department's FACS Division Administrator requesting that the petitioner's name be removed from the Child Protection Central Registry.

(3-20-20)T

**02. Criteria for Granting Petition for Removal From the Child Protection Central Registry.** The petition for removal from the Child Protection Central Registry will be granted if:

(3-20-20)T

a. There are no additional substantiated reports on the Child Protection Central Registry or that of other states in which the petitioner has resided since the last substantiated report of abuse, neglect, or abandonment in Idaho; and

(3-20-20)T

b. There are no convictions, adjudications, or withheld judgments for any of the crimes listed under Subsection 566.03 of this rule:

(3-20-20)T

i. On Idaho's central repository of criminal history records as established and maintained by the Idaho State Police under Title 67, Chapter 30, Idaho Code; or

(3-20-20)T

ii. On the criminal history repository of other states in which the petitioner has resided since the last substantiated report of abuse, neglect, or abandonment in Idaho.

(3-20-20)T

**03. Criminal History Checks.** It is the responsibility of the petitioner to request, pay for, and obtain the criminal history checks and submit them to the Department.

(3-20-20)T

a. The Department will not remove a petitioner from the Child Protection Central Registry if a criminal history check reveals any of the following, within five (5) years of the receipt of the petition:

(3-20-20)T

i. Physical Assault; (3-20-20)T

ii. Battery; or (3-20-20)T

iii. A drug-related offense. (3-20-20)T

b. The Department will not remove a petitioner from the Child Protection Central Registry if a criminal history check reveals any of the following:

(3-20-20)T

i. Child abuse or neglect; (3-20-20)T

- ii. Spousal abuse; (3-20-20)T
- iii. A crime against children, including child pornography; or (3-20-20)T
- iv. A crime involving violence, including rape, sexual assault, or homicide, but not including other physical assault or battery. (3-20-20)T

**04. Granting or Denying Removal From the Child Protection Central Registry.** The Department will issue a letter granting or denying removal of the petitioner’s name from the Child Protection Central Registry within twenty-eight (28) days of receipt of the petition. (3-20-20)T

**05. Appeal of a Denial of Removal From the Child Protection Central Registry.** The individual may appeal the denial of removal of their name from the Child Protection Central Registry under IDAPA 16.05.03, “Contested Cases Proceedings and Declaratory Ruling,” Section 101. (3-20-20)T

**567. “SAFE HAVEN” EXEMPTION FOR PARENTS OF CERTAIN ABANDONED INFANTS.** No disposition will be made on the parent(s) and no information will be entered into the Child Protection Central Registry when a parent(s) relinquishes their infant within the first thirty (30) days of life to a “Safe Haven” according to Title 39, Chapter 82, Idaho Code, Idaho Safe Haven Act. (3-20-20)T

**568. COURT-ORDERED CHILD PROTECTION SAFETY ASSESSMENT.** When, in any divorce proceeding or upon request for modification of a divorce decree, an allegation of child abuse or child sexual abuse is made, implicating either party, the court may order that an investigation/safety assessment be conducted by the Department. Court orders for preliminary child protective safety assessment and for any subsequent assessment the court may deem necessary will be served on the Department supervisor for child protection services in the field office in which the court has geographical jurisdiction. The child protection supervisor must immediately initiate the safety assessment and consult with the court promptly if there are any obstacles preventing its completion. Immediately upon completing the report, the Department must make a written report to the court. (3-20-20)T

**569. PETITION UNDER THE CHILD PROTECTIVE ACT.** If any incident of child abuse, neglect, or abandonment is substantiated through a safety or comprehensive assessment, or both, or during the provision of services, and cannot be resolved through informal processes or voluntary agreement that is adequate for protection of the child, the Department will request the prosecuting attorney to file a Child Protective Act petition. (3-20-20)T

**570. COOPERATION WITH LAW ENFORCEMENT.** The Department will cooperate with law enforcement personnel in their handling of criminal investigations and the filing of criminal proceedings. (3-20-20)T

**571. CHILD CUSTODY INVESTIGATIONS FOR THE DISTRICT COURT.** Where no other community resources are available and when ordered by the district courts, the Department will, for a fee of thirty-five dollars (\$35) per hour, conduct safety and comprehensive assessments and provide social information to assist the court in child custody actions, to assist the court to determine the most therapeutic placement for the child. (3-20-20)T

**01. Requests From Private Attorney.** If a parent’s attorney requests a safety or comprehensive assessment, or both, and a report of findings regarding the fitness of a parent, the attorney must be advised that such service is provided on behalf of a child but not on behalf of a litigant, and that any such assessment and report would be provided to the court pursuant to a court order. (3-20-20)T

**02. Conduct of the Assessment.** In conducting the assessment, the family services worker must explain to the family the purpose for which the information is being obtained. If the judge intends to treat the report as evidence, the family must be informed that any information they provide will be brought out at the court hearing. If the family refuses to give information to the family services worker, the Department has no authority to require cooperation. However, the judge may issue an order directing the family to provide information to the family services worker for the purpose of making a report to the court. (3-20-20)T

**03. Report to Court.** The family services worker will provide a report only to the Magistrate judge who ordered the assessment, and must use the Department's format for the assessment of need. The report must describe what was observed about the home conditions and the care of the child(ren). (3-20-20)T

**04. Department Clients.** If the family is or has been a client of the Department, disclosure of information must comply with IDAPA 16.05.01, "Use and Disclosure of Department Records." (3-20-20)T

**572. -- 699. (RESERVED)**

**ADOPTION SERVICES**  
**(Sections 700-710)**

**700. ADOPTION SERVICES POLICY.**

Where reasonable efforts to reunite or preserve a family are unsuccessful, or where relinquishment is requested by the parent(s), the Department will consider whether termination of parental rights is in the best interests of the child. The Department must make every effort to place any child legally free for adoption in an appropriate adoptive home. Each child will be placed with an adoptive family who can support the racial, ethnic or cultural identity of the child, and is able to cope with any forms of discrimination the child may experience. (3-20-20)T

**701. SERVICES TO BE PROVIDED IN ADOPTIONS.**

In addition to the core services provided under these rules, the Department must assure provision of the following: (3-20-20)T

**01. Response to Inquiries.** Written or personal inquiries from prospective adoptive families must be answered within two (2) weeks. (3-20-20)T

**02. Pre-Placement Child/Family Assessment.** An assessment of the child's family of origin history, needs as an individual and as part of a family, and completion of a life story book for each child preparing for adoptive placement. (3-20-20)T

**03. Compliance with Multi-Ethnic Placement Act and Interethnic Adoption Provisions.** Selection of the most appropriate adoptive family consistent with the Multi-Ethnic Placement Act and Interethnic Adoption Provisions, if the child is not an Indian. (3-20-20)T

**04. (Pre-Placement) Home Study.** An adoptive home study to ensure selection of an appropriate adoptive home. (3-20-20)T

**05. Preparation for Placement.** Preparation of the child by an assigned social worker who will assist the child in addressing anticipated grief and loss due to separation from their parents and assisting the child with the transition into an adoptive home. (3-20-20)T

**06. Technical Assistance.** Assistance in completing the legal adoption, including compliance with the Indian Child Welfare Act. (3-20-20)T

**07. Adoption Assistance.** A determination of eligibility for adoption assistance must be made for each child placed for adoption through the Department prior to the finalization of their adoption. Eligibility for adoption assistance is determined solely on the child's need. No means test may be applied to the adoptive family's income or resources. Once eligibility is established, the Division will negotiate a written agreement with the adoptive family. The agreement must be fully executed by all parties prior to the finalization of the adoption in order to be valid. (3-20-20)T

**08. Period of Support Supervision.** Once a child is placed with an adoptive family, a period of support and supervision by the Department lasting at least six (6) months must be completed prior to the finalization of the adoption. If the child has been a foster child placed with the family for a period of at least six (6) months, the family may submit a written request to the Department's Child and Family Services Program Manager to reduce the supervisory period to a minimum of three (3) months. (3-20-20)T

**09. Post Adoption Services.** Services after an adoption is final are provided within available resources. Children with negotiated adoption assistance agreements, whether from Idaho or from another state, are eligible for any services available to Idaho children. International adoptees residing in Idaho are also eligible for any services available to Idaho children under the Inter-Country Adoption of 2000 (P.L.106-279). Children with either IV-E or state adoption assistance agreements are eligible for Medicaid in Idaho. A referral from an Interstate Compact on Adoption and Medical Assistance member state will serve as a formal application for services in Idaho. Applications for Medicaid are made through the Department in accordance with IDAPA 16.03.01, "Eligibility for Health Care Assistance for Families and Children." (3-20-20)T

**702. CONDITIONS FOR GUARDIANSHIP ASSISTANCE.**

The following conditions must be met for a child to be eligible for federally-funded or state-funded guardianship assistance. (3-20-20)T

**01. Assessment of Suitability.** The Department or its contractor will determine the suitability of an individual to become a legal guardian for a specific child or sibling group through a guardianship study. (3-20-20)T

**02. Eligibility for Guardianship Assistance.** The Department will determine eligibility for guardianship assistance for each child placed in the legal custody of the Department prior to the finalization of the guardianship. The child will first be considered for eligibility for a federally-funded subsidy. Should the child be found ineligible for a federally-funded subsidy, the child will then be considered for a state-funded subsidy. (3-20-20)T

**03. Guardianship and Foster Care Licensure.** To receive guardianship assistance, a potential legal guardian must apply for and receive a foster care license. (3-20-20)T

**04. Guardianship Assistance Agreements and Payments.** The Department and the prospective legal guardian must enter into a written agreement prior to the finalization of the guardianship. Benefits may include both a monthly cash payment and Medicaid benefits. The cash payment may not exceed the published foster care rate a child would receive if living in family foster care in Idaho. Eligibility for guardianship assistance is based on the child's needs. No means test may be applied to the prospective legal guardian family's income or resources in a determination of eligibility. The Department will provide the prospective legal guardian with a copy of the agreement. All Guardianship Assistance Agreements must contain the following: (3-20-20)T

**a.** The amount and manner in which the guardianship assistance payment will be provided to the prospective legal guardian; (3-20-20)T

**b.** The manner in which the payment may be adjusted periodically in consultation with the legal guardian, based on the circumstances of the legal guardian and the needs of the child; (3-20-20)T

**c.** Any additional services and assistance for which the child and legal guardian will be eligible under the agreement; (3-20-20)T

**d.** The procedure by which the legal guardian may apply for additional services; (3-20-20)T

**e.** A statement that the agreement will remain in effect without regard to the state of residency of the legal guardian; (3-20-20)T

**f.** The procedure by which the Department will make a mandatory annual evaluation of the need for continued assistance and the amount of the assistance; and (3-20-20)T

**g.** Guardianship assistance payments are prospective only. There will be no retroactive benefits or payments. (3-20-20)T

**h.** In Title IV-E Relative Guardianship Assistance Agreements, the prospective relative guardian may identify a successor legal guardian to be appointed guardianship of the child due to the death or incapacitation of the relative legal guardian. (3-20-20)T

**05. Termination of Guardianship Assistance.** Federally-funded or state-funded guardianship assistance benefits and cash payments are automatically terminated when: (3-20-20)T

- a.** A court terminates the legal guardianship or removes the legal guardian; (3-20-20)T
- b.** The child no longer resides in the home of the legal guardian, and the legal guardian no longer provides financial support for the child; (3-20-20)T
- c.** The child has reached the age of eighteen (18) years, regardless of the child's educational status or physical or developmental delays; or (3-20-20)T
- d.** The child marries, dies, or enters the military. (3-20-20)T
- e.** Title IV-E relative guardianship assistance benefits do not end upon the death or incapacitation of the relative legal guardian if the relative legal guardian identified a successor legal guardian in the child's Title IV-E Relative Guardianship Assistance Agreement and the successor legal guardian assumes legal responsibility for the child. (3-20-20)T

**06. Administrative Review for Guardianship Assistance.** The prospective legal guardian has twenty-eight (28) days from the date of the Department's notification of the guardianship assistance determination, to request an administrative review. The determination will be reviewed by the FACS Division Administrator, and a decision will be rendered to either affirm, reverse, or modify, the decision. The Department will notify the individual, by mail, of the FACS Division Administrator's decision, of their right to appeal, and procedures for filing an appeal according to requirements in IDAPA 16.05.03, "Contested Case Proceedings and Declaratory Rulings." (3-20-20)T

**703. FEDERALLY-FUNDED GUARDIANSHIP ASSISTANCE ELIGIBILITY, REQUIREMENTS, AND BENEFITS.**

In addition to Section 702 of these rules, the following requirements and benefits are applicable to a federally-funded guardianship assistance for an eligible child and a relative guardian. (3-20-20)T

**01. Eligibility.** A child is eligible for a federally-funded guardianship if the Department determines the child meets the following: (3-20-20)T

- a.** Is fourteen (14) years of age, or older, sometime during the consecutive six- (6) month residence with the prospective relative legal guardian as specified in Subsection 703.01.c. of this rule; (3-20-20)T
- b.** Has been removed from their home under a voluntary placement agreement, or as a result of a judicial determination that continuation in the home would be contrary to the welfare of the child; (3-20-20)T
- c.** Being returned home or adopted are not appropriate permanency options for the child; (3-20-20)T
- d.** Has been eligible for Title IV-E foster care maintenance payments during at least six (6) consecutive months during which the child resided in the home of the prospective relative legal guardian who was licensed or approved as meeting the licensure requirements as a foster family home. While it is not required that Title IV-E foster care maintenance payments have been paid on behalf of the child during the six-month timeframe, it is required the child meet all Title IV-E foster care maintenance payment eligibility criteria in the home of the fully licensed or approved relative foster parent for a consecutive six- (6) month period to be eligible for Title IV-E guardianship assistance payment with that prospective relative legal guardian; (3-20-20)T
- e.** Has been consulted regarding the legal guardianship arrangement; and (3-20-20)T
- f.** Has demonstrated a strong attachment to the prospective relative legal guardian, and the relative legal guardian has a strong commitment to caring permanently for the child. (3-20-20)T
- g.** When a successor legal guardian has been named in the child's most recent Title IV-E Relative Guardianship Assistance Agreement, the child remains eligible for guardianship assistance benefits upon the death or incapacitation of the relative legal guardian with any cash assistance paid to the successor legal guardian. (3-20-20)T

**02. Siblings of an Eligible Child.** (3-20-20)T

**a.** The Department may make guardianship assistance payments in accordance with a guardianship assistance agreement on behalf of each sibling of an eligible child, under the age of eighteen (18), who is placed with the same relative under the same legal guardianship arrangement if the Department and the relative legal guardian agree that the placement is appropriate. (3-20-20)T

**b.** Nonrecurring expenses associated with obtaining legal guardianship of the eligible child's siblings are available to the extent the total cost does not exceed two thousand dollars (\$2,000). (3-20-20)T

**c.** The agency is not required to place siblings with the relative legal guardian of the child at the same time with the eligible child for the siblings to qualify for a cash payment. (3-20-20)T

**d.** A sibling of the eligible child does not have to meet the eligibility criteria for the relative legal guardian to receive a guardianship assistance payment or for the relative legal guardian to receive nonrecurring expenses. (3-20-20)T

**03. Medicaid.** A child who is eligible for federally-funded relative guardianship assistance is eligible for Title XIX Medicaid in the state where the child resides. (3-20-20)T

**04. Case Plan Requirements.** A child who is eligible for federally-funded relative guardianship assistance must have a case plan that includes: (3-20-20)T

**a.** How the child meets the eligibility requirements; (3-20-20)T

**b.** Steps the agency has taken to determine that return to the home or adoption is not appropriate; (3-20-20)T

**c.** The efforts the agency has made to discuss adoption with the child's relative foster parent and the reason why adoption is not an option; (3-20-20)T

**d.** The efforts the agency has made to discuss the legal guardianship and the guardianship assistance with the child's parent or parents, or the reason the efforts were not made; (3-20-20)T

**e.** The reason why a permanent placement with a prospective relative legal guardian and receipt of a guardianship assistance payment is in the child's best interests; and (3-20-20)T

**f.** If the child is not placed with siblings, a statement as to why the child is separated from their siblings. (3-20-20)T

**05. Criminal History and Background Checks.** To be eligible for a federally-funded guardianship assistance payment, all prospective legal guardians and other adult members of the household must receive a criminal history and background check clearance, according to the provisions in IDAPA 16.05.06, "Criminal History and Background Checks." As a licensed foster parent, if the prospective relative legal guardian has already received a clearance, another check is not necessary. (3-20-20)T

**06. Nonrecurring Expenses.** The Department will reimburse the cost, up to two thousand dollars (\$2,000), of nonrecurring expenses associated with obtaining a federally-funded legal guardianship for an eligible child. (3-20-20)T

**704. STATE-FUNDED GUARDIANSHIP ASSISTANCE ELIGIBILITY, REQUIREMENT, AND BENEFITS.**

In addition to Section 702 of these rules, the following requirements and benefits are applicable to a state-funded guardianship assistance for an eligible child and their legal guardian. (3-20-20)T

**01. Eligibility for State-Funded Guardianship Assistance.** A child is eligible for a state-funded



guardianship assistance if the Department determines the child meets the following: (3-20-20)T

- a. Assistance is based on the child's identified needs; (3-20-20)T
- b. The child's parents have had their parental rights legally terminated; and (3-20-20)T
- c. There is documentation of unsuccessful efforts to place the child for adoption. (3-20-20)T

**02. Limitations on State-Funded Guardianship Assistance.** State-funded guardianship assistance is subject to state appropriations and availability of state general funds. (3-20-20)T

**03. Medicaid Benefits Under State-Funded Guardianship Assistance.** State-funded guardianship assistance may include Medicaid benefits for the child(ren) receiving payment. These Medicaid benefits may only be used in Idaho. If the legal guardian moves to another state, they will be required to apply for Medicaid for the child(ren) in the new state of residency. (3-20-20)T

**04. Nonrecurring Expenses.** In cases where state-funded guardianship assistance is being considered, if the potential legal guardian is not able to afford the attorney and court costs to obtain legal guardianship of a child in the legal custody of the Department of Health and Welfare, financial assistance may be available from the Department. Financial assistance for legal fees may be provided regardless of the legal guardian's state of residence. (3-20-20)T

**705. -- 709. (RESERVED)**

**710. FAMILY HISTORY.**

If the family case plan is termination of parental rights and adoption is considered a part of the total planning for the child, the following information will be obtained and placed in the child's permanent adoption record: (3-20-20)T

- 01. Informational Forms.** Informational background forms regarding the birth mother, birth father, and the child. (3-20-20)T
- 02. Hospital Records.** Hospital birth records on child. (3-20-20)T
- 03. Evaluations/Assessments.** Evaluations/Assessments previously completed on child. (3-20-20)T
- 04. Current Picture.** Current picture of child. (3-20-20)T
- 05. Narrative Social History.** Child and family's narrative social history that addresses: (3-20-20)T
  - a. Family dynamics and history; (3-20-20)T
  - b. Child's current functioning and behaviors; (3-20-20)T
  - c. Interests, talents, abilities, strengths; (3-20-20)T
  - d. Child's cultural and racial identity needs. The ability to meet the cultural and racial needs of the child does not necessitate a family have the same culture or race as the child; (3-20-20)T
  - e. Life story, moves, reasons, key people; (3-20-20)T
  - f. Child's attachments to current caretakers, siblings and significant others; i.e., special friends, teachers, etc.; (3-20-20)T
  - g. Medical, developmental and educational needs; (3-20-20)T
  - h. Child's history, past experiences, and previous trauma; (3-20-20)T

- i.** Membership or eligibility for membership in, and social and cultural contacts with parent's tribe, if any, including names and addresses of extended family; (3-20-20)T
- j.** Indian child's Indian ancestry; (3-20-20)T
- k.** Individualized recommendations regarding each child's need for permanency; and (3-20-20)T
- l.** Reasons for requesting termination of parental rights. (3-20-20)T

**TERMINATION OF PARENT-CHILD RELATIONSHIP**  
**(Sections 711-749)**

**711. DECISION AND APPROVAL PROCESS FOR TERMINATION OF PARENT AND CHILD RELATIONSHIP (TPR).**

Any recommendation to the Child and Family Services Program Manager regarding the termination of parental rights will be based on the outcome of a team decision-making process and must receive written approval by the program manager before a petition may be filed. (3-20-20)T

**712. -- 713. (RESERVED)**

**714. VOLUNTARY TERMINATION.**

The Department becomes involved in voluntary terminations when a parent(s) requests the Department to place their special needs child or children for adoption and when voluntary termination is a goal in the family case plan. Parent(s) requesting placement of a potentially healthy unborn or healthy newborn child should be referred to the licensed private adoption agencies in Idaho. (3-20-20)T

**715. VOLUNTARY CONSENT.**

In obtaining a parent's consent to terminate their parental rights through the Department, a Consent to Terminate Parental Rights and Waiver of Rights to Hearing must be signed before the Magistrate Judge. Once a parent's consent has been given before the court, a corresponding petition under the Termination of Parent and Child Relationship Act will be filed by legal counsel representing the Department. (3-20-20)T

**716. VOLUNTARY TERMINATION OF PARENTAL RIGHTS TO AN INDIAN CHILD.**

Consent to voluntary termination of parental rights by the parent(s) or Indian custodian(s) of an Indian child is not valid unless executed in writing and recorded before a court of competent jurisdiction, which may be a tribal court. The written consent must be accompanied by the presiding judge's certificate that: (3-20-20)T

**01. Explanation of Consent.** The terms and consequences of the consent were fully explained in detail and were fully understood by the parent(s) or Indian custodian(s); and (3-20-20)T

**02. Interpretation If Necessary.** The parent(s) or Indian custodian(s) fully understood the explanation in English or it was interpreted into a language the parent(s) or Indian custodian(s) understood. (3-20-20)T

**717. FILING OF PETITION FOR VOLUNTARY TERMINATION.**

The petition for a voluntary termination of parental rights may be filed by an authorized agency, by the guardian(s) of the person or the legal custodian of the child or the person standing in loco parentis to the child, or by any other person having a legitimate interest in the matter. (3-20-20)T

**718. REPORT TO COURT -- VOLUNTARY TERMINATION.**

If a voluntary consent to termination has been signed by the parent(s) before the Magistrate Court, an investigation or Report to the Court under the Termination Act is at the court's discretion. If the petition has been filed by the Department of Health and Welfare, Division of Family and Community Services, a report is required to accompany the petition, under Section 16-2008(2), Idaho Code. (3-20-20)T

**719. INVESTIGATION.**

An investigation of the allegations in the petition and a report recommending disposition of the petition under the Termination of Parent and Child Relationship Act will be completed and submitted to the court within thirty (30)

days, unless an extension of time is granted by the court. The purpose of this investigation is to verify the allegations through all available sources, including the petitioner, parent(s) and possibly the extended family of the child. The Report to the Court under the Termination of Parent and Child Relationship Act, is to serve as an aid to the court in determining a disposition that complies with the Indian Child Welfare Act where applicable, or that will be in the best interest of the child. If a petition is filed by a party other than the Department, the court may order such an investigation by the Department. The law also allows completion of an investigation by an authorized agency or a certified adoption professional, prior to adjudication and disposition. If the Department is the petitioner, the report will accompany the petition. Reports submitted under the Termination of Parent and Child Relationship Act based on a parent's voluntary consent will include: (3-20-20)T

- 01. Description of Investigation.** The circumstances of the petition and the facts determined from the investigation; and (3-20-20)T
- 02. Child-Related Factors.** Child related factors, including: (3-20-20)T
  - a.** Child's current functioning and behaviors; (3-20-20)T
  - b.** Medical, educational and developmental needs of the child; (3-20-20)T
  - c.** Child's history and past experiences; (3-20-20)T
  - d.** Child's identity needs; (3-20-20)T
  - e.** Child's interests and talents; (3-20-20)T
  - f.** Child's attachments to current caretakers and any absent parent; (3-20-20)T
  - g.** Child's current living situation; (3-20-20)T
  - h.** Indian child's membership or eligibility for membership in tribe(s); (3-20-20)T
  - i.** Indian child's contacts with tribe(s); (3-20-20)T
  - j.** The present circumstances, history, condition and desire of the parent whose rights are being terminated regarding plans for the child; (3-20-20)T
  - k.** Such other facts as may be pertinent to the parent and child relationship and this particular case; i.e., compliance with Interstate Compact Placement on Children; and (3-20-20)T
  - l.** A recommendation and reasons as to whether or not the termination of the parent and child relationship should be granted. (3-20-20)T

**720. FILING OF A PETITION FOR INVOLUNTARY TERMINATION OF PARENT AND CHILD RELATIONSHIP.**

Unless there are compelling reasons it would not be in the interest of the child, the Department is required to file a Petition to Terminate the Parent and Child Relationship within sixty (60) days of a judicial determination that one (1) or more of the following has occurred: (3-20-20)T

- 01. Abandonment.** An infant has been abandoned; (3-20-20)T
- 02. Reasonable Efforts to Reunify the Family Are Not Required.** That reasonable efforts, as defined in Section 16-1610(2)(i)(iii), Idaho Code, are not required because the court determines the parent(s) has subjected a child or children to aggravated circumstances. (3-20-20)T

**721. REPORT TO THE COURT -- INVOLUNTARY TERMINATION.**

If a petition for an involuntary termination of parental rights has been brought before the Magistrate Court, an investigation or report to the court under the Termination Act is required. If the petition has been filed by the

Department, a report is required under Section 16-2008(2), Idaho Code. Reports submitted under the Termination Act based on an involuntary termination of parental rights must include: (3-20-20)T

- 01. Allegations.** The allegations contained in the petition. (3-20-20)T
- 02. Investigation.** The process of the assessment and investigation. (3-20-20)T
- 03. Family Circumstances.** The present condition of the child and parent(s), especially the circumstances of the parent(s) whose rights are being terminated and contact with the parent(s) of a minor parent, unless lack of contact is explained. (3-20-20)T
- 04. Medical Information.** The information forms regarding the child, birth mother, and birth father will be submitted with the Report to the Court. Reasonably known or available medical and genetic information regarding both birth parents and source of such information, as well as reasonably known or available providers of medical care and services to the birth parents. (3-20-20)T
- 05. Efforts to Maintain Family.** Other facts that pertain to the parent and child relationship including what reasonable efforts have been made to keep the child with the family, or what active efforts to prevent the breakup of the Indian family have been made. (3-20-20)T
- 06. Absent Parent.** Reasonable efforts made by the petitioner to locate an absent parent(s) and provision of notification to an unmarried father of the paternity registry requirement under Section 16-1513, Idaho Code. (3-20-20)T
- 07. Planning.** Proposed plans for the child consistent with: (3-20-20)T
  - a.** The Indian Child Welfare Act, including potential for placement with the Indian child's extended family, other members of the Indian child's tribe, or other Indian families; and (3-20-20)T
  - b.** The Adoption and Safe Families Act of 1997, which prohibits states from delaying or denying cross-jurisdictional adoptive placements with an approved family, and requires individualized documentation regarding the child's needs in permanent placement. (3-20-20)T
- 08. Compliance with the Indian Child Welfare Act.** Documentation of compliance with the Indian Child Welfare Act, including identification of whether the child is Indian and if so: (3-20-20)T
  - a.** Notification of the pending proceedings to the parent(s) or Indian custodian(s) and the Indian child's tribe, or to the Secretary of the Interior if their identity or location is unknown according to Section 051 of these rules; (3-20-20)T
  - b.** Notification of the right of the parent(s) or Indian custodian(s), and the Indian child's tribe, to intervene in the proceeding and their right to be granted up to twenty (20) additional days to prepare for the proceeding; (3-20-20)T
  - c.** Notification that if the court determines indigency, the parent(s) or Indian custodian(s) have the right to court-appointed counsel; (3-20-20)T
  - d.** Evidence, including identity and qualifications of expert witnesses, that continued custody of the child by the parent(s) or Indian custodian(s) is likely to result in serious emotional or physical damage to the child; (3-20-20)T
- 09. Termination of Parent-Child Relationship.** (3-20-20)T
  - a.** A recommendation and the reasons whether or not termination of the parent and child relationship is in the best interest of the child; and (3-20-20)T
  - b.** Upon the court's written decision to terminate parental rights, two certified copies of the "Findings

of Fact, Conclusions of Law and Decree” are to be placed in the child’s permanent record. (3-20-20)T

722. -- 749. (RESERVED)

**BECOMING AN ADOPTIVE PARENT**  
**(Sections 750-850)**

**750. APPLICATION TO BE ADOPTIVE PARENT(S).**

Each field office is responsible for compiling the names and addresses of adoptive applicant(s), along with the dates of inquiry and membership in an Indian tribe, if any. A database or register must be maintained in order to assure the orderly completion of home studies. (3-20-20)T

**01. Initial Application.** Each adoptive applicant must: (3-20-20)T

**a.** Cooperate with and allow the Department, or certified adoption professional, to determine compliance with these rules to conduct an adoption home study; (3-20-20)T

**b.** Inform the Department, or certified adoption professional, if the applicant has previously applied to become a foster or adoptive parent, is currently licensed as a foster parent, or has been involved in the care and supervision of children or adults; (3-20-20)T

**c.** Provide a medical statement for each applicant, signed by a qualified medical professional, within the twelve (12) months period prior to application for adoption, indicating the applicant is in such physical and mental health so as to not adversely affect either the health or quality of care of the adopted child; (3-20-20)T

**d.** Provide the name of, and a signed release to obtain the following information about, each member of the household: (3-20-20)T

**i.** Admission to, or release from, a facility, hospital, or institution for the treatment of an emotional, intellectual, or substance abuse issue; (3-20-20)T

**ii.** Outpatient counseling, treatment, or therapy for an emotional, intellectual, or substance abuse issue. (3-20-20)T

**e.** Provide three (3) satisfactory references, one (1) of which may be from a person related to the applicant. Each applicant must provide additional references upon the request of the Department or certified adoption professional; (3-20-20)T

**f.** All applicants for adoption and other adult members of the household must comply with the provisions in IDAPA 16.05.06, “Criminal History and Background Checks” and IDAPA 16.06.02, “Child Care Licensing,” Section 404. (3-20-20)T

**02. Psychological Evaluation.** An evaluation by a psychologist or a psychiatrist can be required by the family services worker or certified adoption professional when an applicant has received or is currently receiving treatment for psychological problems or mental illness or when the family services worker, or certified adoption professional, in consultation with their supervisor, determines that there appear to be emotional problems in the family that merit further evaluation. (3-20-20)T

**03. Orientation of Potential Applicants.** Initial meetings with groups of applicants, or with individual families, must be scheduled promptly by the Department or the certified adoption professional, whichever received the inquiry and initial application from the family. These initial meetings must be used to explain policies and procedures regarding adoptive placement, the kinds of children available, and the nature of the home study. (3-20-20)T

**04. Denial of Application.** Following an initial interview, an applicant who does not appear to meet the Department's requirements at the time of initial application may be denied a full home study. The family will be advised why they were ineligible for a full home study and notice provided to the applicant of their right to appeal

this decision. Upon resolution of the factors leading to the denial, the applicant may again file an application and receive a home study. (3-20-20)T

**05. Application for Subsequent Adoptions.** Following the finalization of an adoption, a family may apply to be considered for another placement. (3-20-20)T

**a.** Adoptive parents who have experienced a successful adoption and wish to reapply must complete an adoption application and financial statement, complete a Criminal History and Background Check, and submit medical reports and three (3) personal references. One (1) reference may be from a person related to the applicant. When requested by the Department, an applicant must provide additional references. (3-20-20)T

**b.** The prospective adoptive family will assist in amending the original adoption study to include information concerning the acceptance and adjustment of the child previously placed in the home and their request for another placement. (3-20-20)T

**c.** Prospective adoptive parent(s) applying for subsequent adoption with an agency with whom they have maintained a foster care license since their previous adoption may have the requirement for a new Criminal History and Background Check, medical reports and personal references waived by the agency. (3-20-20)T

**751. -- 761. (RESERVED)**

**762. COMPLETING THE ADOPTION HOME STUDY.**

Upon application by a potential adoptive family, the family services worker or certified adoption professional will conduct the pre-placement adoptive home study and issue a recommendation. The home study must be completed prior to placement of any child for adoption in that home. (3-20-20)T

**01. Interviews.** Family assessment interviews as well as individual interviews must be held with the prospective adoptive parent(s). (3-20-20)T

**02. Content.** Adoption home studies for foster care, special needs, independent, relative, and step-parent adoptions must include an assessment of the following: (3-20-20)T

**a.** Names, including maiden or other names used by the applicant(s); (3-20-20)T

**b.** Legal verification that the person(s) adopting is at least fifteen (15) years older than the child, or twenty-five (25) years of age or older, except in cases where the adopting person is a spouse of the child's parent, must be accomplished by: (3-20-20)T

**i.** Viewing a certified copy of the birth certificate filed with the Bureau of Vital Statistics; or (3-20-20)T

**ii.** Viewing one (1) of the following documents for which a birth certificate was presumably required prior to its issuance, such as: armed services or other governmental identification, including a valid Idaho driver's license, passport, visa, alien identification cards, or naturalization papers. (3-20-20)T

**iii.** If verifying documentation is not available, the report must indicate the date and place of birth and reason for lack of verification. (3-20-20)T

**c.** Verification that the family has resided and maintained a dwelling within the State of Idaho for at least six (6) consecutive months prior to the filing of the petition; (3-20-20)T

**d.** Adequacy of the family's house, property, and neighborhood for the purpose of providing adoptive care as determined by on-site observations; (3-20-20)T

**e.** Educational background of the applicant(s); (3-20-20)T

**f.** A statement of employment, family income, and financial resources, including access to health and

- life insurance and the family's management of these resources; (3-20-20)T
- g.** Current and historical mental illness, drug or alcohol abuse, and medical conditions and how they may impact the adoptive parent(s) ability to care for an adopted child; (3-20-20)T
  - h.** Previous criminal convictions and history of child abuse and neglect; (3-20-20)T
  - i.** Family history, including childhood experience and the applicant(s) parents' methods of discipline and problem-solving; (3-20-20)T
  - j.** Verification of marriages and divorces; (3-20-20)T
  - k.** Decision-making, communication, and roles within the marital relationship, if applicable; (3-20-20)T
  - l.** The names, ages, and addresses of all biological and adopted children currently residing inside or outside the home. Information regarding the current adjustment and special needs of the applicant(s) children; (3-20-20)T
  - m.** The religious and cultural practices of the family, including their ability to nurture and validate a child's particular cultural, racial, religious, and ethnic background; (3-20-20)T
  - n.** For an Indian child, the study will also determine the prevailing social and cultural standards of the Indian community in which the parent(s) or extended family resides or maintains social and cultural ties. (3-20-20)T
  - o.** Individual and family functioning including inter-relationships with each member of the household and the family's ability to help a child integrate into the family; (3-20-20)T
  - p.** Activities, interests, and hobbies; (3-20-20)T
  - q.** Child care and parenting skills, including historical and current methods of discipline used in the home; (3-20-20)T
  - r.** Reasons for applying for adoption; (3-20-20)T
  - s.** The family's prior and current experiences with adoption, understanding of adoption, and ability to form relationships and bond with a specific child or general description of children; (3-20-20)T
  - t.** The attitudes toward adoption by immediate and extended members of the family and other persons who reside in the home; (3-20-20)T
  - u.** Specifications of the child preferred by the family that include the number of children, age, gender, race, ethnic background, social, emotional, and educational characteristics. The family's ability to accept the behavior and personality of a specific child (if known) or general description of children and their ability to meet the child's particular educational, developmental, and psychological needs; (3-20-20)T
  - v.** Emotional stability and maturity in dealing with the needs, challenges, and related issues associated with the placement of a child into the applicant(s) home; (3-20-20)T
  - w.** The family's attitude about an adopted child's birth family including: (3-20-20)T
    - i.** Their ability to accept a child's background and help the child cope with their past; and (3-20-20)T
    - ii.** Their willingness to work with the child's family or tribe; (3-20-20)T
  - x.** Training needs of the applicant(s); and (3-20-20)T

y. A recommendation regarding the family's ability to provide adoptive care to a specific child (if known) or general description of children. (3-20-20)T

**763. PRE-ADOPTIVE PARENT RESPONSIBILITIES.**

The pre-adoptive parent is responsible to keep the agency or Certified Adoption Professional that completed the home study informed of any changes in the family's circumstances, or of any subsequent decision against adoption. (3-20-20)T

**764. ADOPTIVE HOME STUDY.**

An adoption home study is valid for the purposes of new adoptive placement for a period of one (1) year following the date of completion. Upon completion of an adoptive placement agreement, an adoption home study remains valid for a period of two (2) years from the date of completion for the purpose of finalizing the adoption of the child(ren) for whom the adoptive placement agreement was written. (3-20-20)T

**765. -- 769. (RESERVED)**

**770. CLOSURE OF ADOPTIVE HOME STUDIES.**

Upon pre-adoptive placement of a child or children in the home of a pre-adoptive parent, the parent's adoption home study closes for the placement of an additional child or children for the purpose of adoption until a home study update is completed. (3-20-20)T

**771. HOME STUDY UPDATE.**

An adoptive home study must be updated on an annual basis. A current home study is defined as a home study completed within the previous twelve (12) months. Home study updates must include the following: (3-20-20)T

**01. Initial Adoption Home Study and Subsequent Home Study Updates.** All Changes to the Information Contained in the Initial Adoption Home Study and Subsequent Home Study Updates. (3-20-20)T

**02. Family Functioning and Inter-Relationships.** All Information on any Changes in Family Functioning and Inter-Relationships. (3-20-20)T

**03. Circumstances Adversely Impacting Child Placed for Adoption.** Any Information Regarding Circumstances Within the Family that may Adversely Impact a Child Placed for Adoption. (3-20-20)T

**04. A Home Study Update Completed for the Purpose of Adoptive Placement of an Additional Child or Children in the Home.** A home study update completed for the purpose of adoptive placement of an additional child or children in the home where a child or children are already placed for adoption and that adoption has not yet finalized must include agreement for the placement of the additional child or children by the individual or agency responsible for the placement of the initial child or children, and the individual or agency responsible for the additional child or children. (3-20-20)T

**772. -- 789. (RESERVED)**

**790. FOSTER PARENT ADOPTIONS.**

The procedure and requirements are the same for all adoptive applicants. This includes foster parents who want to be considered as adoptive parents for a child who has a plan of adoption. These requirements include compliance with the Indian Child Welfare Act, the Multi-Ethnic Placement Act of 1994 and the Interethnic Adoption Provisions of 1996. (3-20-20)T

**791. -- 799. (RESERVED)**

**800. PLACEMENT OF THE CHILD.**

Adoptive placement of a child in the custody or guardianship of the Department will be determined as follows: (3-20-20)T

**01. Factors to be Considered in Determining Suitability of Adoptive Placements.** (3-20-20)T



- a.** For an Indian child, absent good cause to the contrary, the following preferences for placement under the Indian Child Welfare Act must be followed: (3-20-20)T
  - i. Extended family; (3-20-20)T
  - ii. Other members of the child’s tribe; or (3-20-20)T
  - iii. Other Indian families. (3-20-20)T
- b.** The primary factor in the review of a prospective adoptive family’s eligibility is the ability to protect and promote the best interests of a child to be placed in their home. (3-20-20)T
- c.** The Department will not delay or deny the placement of a child with an approved family that is located outside of the jurisdiction responsible for the care and planning for the child. (3-20-20)T

**02. Selection of Adoptive Placement.** The adoptive placement of a child in the custody or legal guardianship of the Department will be selected using a committee process of no less than three (3) individuals and be approved by a field program manager as described by the practice standards of the Department. (3-20-20)T

**03. Disclosure.** The field office must provide full confidential background information and discuss the child’s history fully with the prospective adoptive parent(s) prior to the placement. The disclosure of background information must be confirmed at the time of placement by a written statement from the family services worker to the prospective adoptive family, which they will be asked to acknowledge and sign. A copy of this statement must be provided to the adoptive family and one (1) copy will be kept in the child’s permanent record. (3-20-20)T

**801. -- 829. (RESERVED)**

**830. ADOPTION APPLICATION FEE.**

The adoption application fee covers the costs of processing the adoption application and does not guarantee that the applicant family will receive a child for adoption. The application fee is non-refundable. Money collected through the Department’s adoption program may be utilized to pay state adoption assistance payments for children with special needs and pay the service fees, recruitment costs, and placement fees for private agencies serving children who have special needs. (3-20-20)T

**831. HOME STUDY, SUPERVISORY REPORTS, AND REPORTS OF THE COURT FEES.**

A family who cares for a child, or children, with special needs who is in the custody of the Department is not required to pay the costs of the Department adoption services identified in Section 832 of these rules for the adoption of that child, or children. A relative or kin family being considered by the Department for adoption of a child from foster care who is their relative or kin, is not required to pay the costs referenced in Section 832 of these rules. If a family who did not pay the fee uses that home study to pursue adoption of a child not in the Department's custody, the family must pay the Department for the full cost of the study and any other applicable fees identified in Section 832 of these rules. (3-20-20)T

**832. FEE SCHEDULE - ADOPTIONS THROUGH DEPARTMENT.**

<b>TABLE 832</b>	
<b>Service</b>	<b>Fee</b>
General Information/Adoption Inquiries	No Charge
Health and Welfare Application:	
Couple	\$50
Single Parent	\$25
Second Placement or Reapplication	\$25
Pre-placement Home Study - Payment due at time of study or per agreement	\$450

<b>TABLE 832</b>	
<b>Service</b>	<b>Fee</b>
Report to Court under the Adoption Act	\$150
Second Placement	\$150
Placement Supervision Fee - Charged at the time of placement	\$300
Closed Adoption Home Study/Court Report Retrieval Fee	\$50
Report to the Court Under the Termination Act	\$40 per hour

(3-20-20)T

**833. PLACEMENT SUPERVISION -- TRANSFER FROM OUT OF STATE PRIVATE AGENCY.**

When a prospective adoptive parent(s) moves to Idaho, with a child who has been placed with them by a private agency in their former state of residency, the sending state agency must arrange through the Interstate Compact on the Placement of Children, services through one of Idaho's private, licensed adoption agencies, or a certified adoption professional. (3-20-20)T

**834. -- 849. (RESERVED)**

**850. INDEPENDENT, RELATIVE AND STEPPARENT ADOPTIONS.**

Independent adoptive placements are handled under Section 16-1506, Idaho Code. (3-20-20)T

**851. -- 859. (RESERVED)**

**THE ADOPTIVE PLACEMENT**  
**(Sections 860-888)**

**860. PROCEDURES FOLLOWING THE ADOPTIVE PLACEMENT.**

Following the adoptive placement, a period of support and supervision by the Department lasting at least six (6) months must be completed prior to the finalization of the adoption. In situations where a foster family has a significant relationship with a child and the child has been placed in their home for at least the last six (6) months, the supervisory period may be reduced to a minimum of three (3) months. The family services worker will make scheduled visits to the home at least monthly during this period to assist the child and the family in their adjustment to each other and will update the child's permanent record by means of monthly progress reports. When completion of the adoption is recommended by the field office and approved by the Permanency Program Specialist, the Department will request the prospective adoptive parent(s) contact their attorney. The regional family services worker will provide the attorney with the necessary documentation to file the petition for adoption. (3-20-20)T

**861. PROGRESS REPORTS.**

Progress reports will be prepared regularly and will be based on the family services worker's or certified adoption professional's findings. (3-20-20)T

**01. Initial and Subsequent Reports.** Progress reports must be made at intervals not to exceed thirty (30) days. These reports will include the family services worker's or certified adoption professional's observation of each child and the prospective adopting parent(s), with emphasis on: (3-20-20)T

- a.** Special needs, special circumstances, or both, of each child at time of placement; (3-20-20)T
- b.** Services provided to each child and the family during the report period; (3-20-20)T
- c.** Services to be provided to each child and the family; (3-20-20)T
- d.** General appearance and adjustment of each child during the report period (may include eating,

- sleep patterns, responsiveness, bonding); (3-20-20)T
- e. Adjustment of each child to all of the following that apply: school, daycare, and day treatment program; (3-20-20)T
  - f. Health and developmental progress, and medical practitioner information for each child; (3-20-20)T
  - g. Whether each child has been accepted for coverage on the family's medical insurance, when coverage begins, and whether there will be any limitations, exclusions, or both; (3-20-20)T
  - h. Family's adjustment to adoptive placement; (3-20-20)T
  - i. Adoption assistance negotiation; (3-20-20)T
  - j. Changes in family situation or circumstances; (3-20-20)T
  - k. Areas of concern during the report period as addressed by each child and the adoptive parent(s); (3-20-20)T
- and
- l. The date of the next required six (6) month review or twelve (12) month permanency hearing. (3-20-20)T

**02. Monthly Foster Care Payments -- Pre-Adoptive Placement.** To receive Title IV-E monthly foster care payments during the period pending completion of adoption, the prospective adoptive parent(s) must have a foster care license. (3-20-20)T

**862. PETITION TO ADOPT UNDER THE ADOPTION OF CHILDREN ACT.**

**01. Filing a Petition.** When the family and the child who was placed for adoption in that home are ready to finalize the adoption, the family's attorney files a petition to adopt with the court. A copy of that petition is served upon the director of the Department. Upon receipt of a copy of the petition to adopt, the family services worker, licensed children's adoption agency worker or certified adoption professional verifies the allegations set forth in the petition and make a thorough investigation of the matter and report the findings in writing to the court within thirty (30) days. (3-20-20)T

**02. Registration and Acknowledgment.** Upon receipt of the petition to adopt, the field office registers the petition and acknowledge receipt to the court and to the petitioner(s) or private adoption agency. If the licensed adoption agency or certified adoption professional who completed the pre-placement home study is not identified, the information should be obtained from the petitioner(s)' attorney. The register will indicate the date the petition was received, the date the study is due in court, the date the completed study was sent to the court, whether an Indian child is involved, and other pertinent data. (3-20-20)T

**863. INVESTIGATION OF PETITION TO ADOPT AND REPORT TO THE COURT.**

According to Section 16-1506, Idaho Code, an investigation regarding the allegations stated in the petition and subsequent written report of findings must be filed with the court unless the investigation is waived by order of the court. The prospective adoptive family's pre-placement home study will be filed at the same time as the written report of investigation. If the family services worker, licensed child placing agency staff, or certified adoption professional is unable to complete the study within thirty (30) days, an extension of time must be requested in writing of the court, stating the reasons for the request. If the worker has reason to believe that the child may be an Indian child and the child's tribe or the Secretary of the Interior has not received written Notice of Pending Proceedings, the worker must inform the court and the petitioner's attorney and the independent agency of the need to comply with the Indian Child Welfare Act. This adoption report to the court must address the following: (3-20-20)T

**01. Legal Availability of the Child.** It is the responsibility of the petitioners, through their attorney, to present documentary evidence to the court so the judge can examine it and be satisfied that the identity, birthdate, and parentage of the child are as represented in the petition. The family services worker or certified adoption professional

will interview the family and any other person(s) having knowledge in the matter, review all documentary evidence presented by the petitioner(s), record the information and source of the information, noting any discrepancies. Such documentary evidence must include the following: (3-20-20)T

- a. The birth certificate of the child; (3-20-20)T
- b. The consent(s) of the child's parent(s) to terminate their parental rights, termination decrees for any parent(s) whose parental rights have been terminated involuntarily by the court, and documentation of marriage and divorce; (3-20-20)T
- c. If the child is an Indian child, a copy of the Notice of Pending Proceedings for Termination of Parental Rights, and the return receipts showing that the notice was received by the Indian child's parent(s) or Indian custodian(s), and the child's tribe; (3-20-20)T
- d. Consent to adoption has been secured for all persons from whom it is required, including a legal guardian(s), to make the child legally available for adoption; (3-20-20)T
- e. The death certificate of a deceased parent; (3-20-20)T
- f. Verification from the Bureau of Vital Statistics of the registry of any putative father; and (3-20-20)T
- g. The Interstate Compact on the Placement of Children Form 100-A, for a child born outside of the state of Idaho, to determine if required state authorizations have been given, or if the Compact does not apply. (3-20-20)T

**02. Needs of the Child.** The report to the court must address the needs of the child, including but: (3-20-20)T

- a. The history of the child and the child's birth family; (3-20-20)T
- b. The family history for a child who has been previously adopted, should include information about the child's previous adoptive family and the circumstances of the disruption; (3-20-20)T
- c. A detailed description of the circumstances that brought about the placement with the prospective adoptive family; (3-20-20)T
- d. The state of Idaho Social, Medical, and Genetic History forms must be completed and submitted to the court, showing reasonably known or available medical and genetic information regarding both birth parents and the child, as well as reasonably known or available providers of medical care and services to birth parents and child; and (3-20-20)T
- e. The appropriateness of the prospective adoptive family for the particular child or children who are the subject of the petition. (3-20-20)T

**03. Degree of Relationship of the Child to Petitioners.** In those cases where the court has ordered an investigation of petitions to adopt by relatives or step parents, the study must record such alleged relationship and specify the documentary evidence the petitioners have of that relationship. (3-20-20)T

**04. Evaluation and Recommendation.** The family services worker or certified adoption professional must provide a brief summary of data presented in prior sections and the pre-placement home study, supporting the recommendation regarding the adoption. (3-20-20)T

**05. Medical Information.** A copy of medical and genetic information compiled in the investigation must be made available to the prospective adoptive family by the family services worker or certified adoption professional prior to the final order of adoption. (3-20-20)T

**06. Confidentiality of Information.** The family services worker must exercise caution in discussing identifying information and avoid revealing that information in the petition while attempting to secure the necessary facts for the study. (3-20-20)T

**07. Financial Accounting.** A financial accounting must be approved by the court of any financial assistance given to the birth parent(s) that exceeds five hundred dollars (\$500), in accordance with Section 18-1511, Idaho Code. (3-20-20)T

**864. -- 869. (RESERVED)**

**870. REMOVAL OF A CHILD FROM A PROSPECTIVE ADOPTIVE HOME.**

Despite careful assessment of the child and the family prior to placement, circumstances may arise that make it necessary to remove the child from the prospective adoptive home prior to adoption. The child may manifest problems the family is unable to accept or to handle constructively; or changed circumstances may develop that make it inadvisable for the placement to continue. The final decision to remove a child from a prospective adoptive home will be made by the Department as the legal guardian of the child. (3-20-20)T

**871. TEMPORARY REPLACEMENT AFTER DISRUPTION.**

When a disruption occurs and it becomes necessary to remove a child from a prospective adoptive home, the field office where the child has been placed is responsible for finding a temporary arrangement for the child until another permanent placement can be arranged. In the case of the adoption of an Indian child, the consent of the parent(s) may be withdrawn for any reason at any time prior to the entry of a final decree of adoption, and the child returned to the parent(s). (3-20-20)T

**872. -- 880. (RESERVED)**

**881. CLOSURE OF CASE.**

The family services worker must request from the adopting parent(s)' attorney, a certified copy of the final order of adoption, and a copy of the family service worker's executed consent to adoption taken at the time of the adoption finalization. These documents are necessary to close the adoption file and initiate the child's adoption assistance benefits. (3-20-20)T

**882. RECORDS OF PLACEMENT.**

Upon finalization of the adoption, the complete record from the local field office, regarding the child and family will be requested by the State Adoption Program Specialist for permanent storage. Records of adoption involving Indian children must be forwarded by the State Adoption Program Specialist to the Secretary of the Interior. (3-20-20)T

**883. POST-LEGAL ADOPTION SERVICES.**

Upon finalization of the adoption, the Department can offer post-legal adoption services upon request, including case management services, referrals for counseling or other supportive services. (3-20-20)T

**884. OPENING SEALED RECORDS OF ADOPTIONS.**

In addition to the exceptions noted in Section 16-1511, Idaho Code, a sealed adoption proceedings may be opened in the following circumstances according to the Indian Child Welfare Act: (3-20-20)T

**01. Motion of an Indian Individual.** Upon motion of an Indian individual who has reached the age of eighteen (18) and was the subject of an adoption, the court must provide tribal affiliation, if any, of the individual's biological parent(s) and other information necessary to protect any rights flowing from the individual's tribal relationship. (3-20-20)T

**02. Request From the Secretary of the Interior or the Indian Child's Tribe.** Upon request of the Secretary of the Interior or the Indian child's tribe, evidence of efforts to comply with the Indian Child Welfare Act must be made available to the parties requesting such information. (3-20-20)T

**885. -- 888. (RESERVED)**

**CERTIFIED ADOPTION PROFESSIONAL**  
**(Sections 889-899)**

**889. CERTIFIED ADOPTION PROFESSIONAL REQUIREMENTS.**

An applicant requesting to become a Certified Adoption Professional must meet the following criteria: (3-20-20)T

**01. College Degree.** A minimum of a bachelor's degree in a field deemed related to adoptions by the Department's Child and Family Services Program, such as social work, psychology, family counseling or other related behavioral science; (3-20-20)T

**02. Adoption Training.** Must have completed a minimum of twenty (20) hours of training in adoption services within the last four (4) years; (3-20-20)T

**03. Department Criminal History and Background Clearance.** Must complete a Department criminal history and background check in accordance with IDAPA 16.05.06, "Criminal History and Background Checks," and receive a clearance; (3-20-20)T

**04. License.** A current license to practice social work in the state of Idaho; (3-20-20)T

**05. Experience.** A minimum of two (2) years experience as a paid full-time employee providing adoption services with a licensed private or public children's agency; (3-20-20)T

**06. References.** Three (3) satisfactory references, one (1) of which must be from a previous employer for whom the applicant worked providing adoption services; (3-20-20)T

**07. Insurance.** Verification of malpractice insurance that will provide coverage for the applicant's work as a certified adoption professional; and (3-20-20)T

**08. Application Fee.** An application fee of one hundred dollars (\$100) to be reimbursed, less a twenty-five dollar (\$25) processing fee, in the event the application is denied. (3-20-20)T

**890. TERMS OF CERTIFICATION FOR ADOPTION PROFESSIONALS.**

**01. Certification.** Certification for adoption professionals will be completed through the Division of Family and Community Services and will be effective for a period of two (2) years. (3-20-20)T

**02. Types of Certification.** Certified adoption professionals may be certified for any, some, or all of the following services: (3-20-20)T

**a.** Adoption home studies for families seeking domestic infant adoption. (3-20-20)T

**b.** Adoption home studies for families seeking domestic special needs adoption. (3-20-20)T

**c.** Adoption home studies for families seeking step-parent or relative adoption. (3-20-20)T

**d.** Court ordered investigations for termination of parental rights for domestic private or independent adoptions. (3-20-20)T

**e.** Court reports for domestic private or independent adoptions. (3-20-20)T

**f.** Supervision of adoptive placements for domestic private or independent adoptions. (3-20-20)T

**03. Limits of Certification.** Certified adoption professionals may not provide the following services: (3-20-20)T

**a.** Birth parent education or counseling. (3-20-20)T

- b.** Services related to international adoption. (3-20-20)T
- 04. Recertification.** Certified adoption professionals must apply for renewal of their certificate every two (2) years and must provide the following: (3-20-20)T
- a.** Documentation of ten (10) hours of adoption training taken during the previous two (2) years; (3-20-20)T
- b.** Verification of malpractice insurance; (3-20-20)T
- c.** A satisfactory recommendation from the Division of Family and Community Services designee responsible for the review of the certified adoption professional's work; (3-20-20)T
- d.** Satisfactory recommendations from a minimum of two (2) families for whom the certified adoption professional has provided adoption services during the previous two (2) years; and (3-20-20)T
- e.** A certification fee of one hundred dollars (\$100) to be reimbursed, less a twenty-five dollar (\$25) processing fee, in the event the recertification is denied. (3-20-20)T
- 05. Lapse of Certification.** If a certified adoption professional does not apply for recertification within two (2) years in accordance with Subsection 890.04 of this rule, this will result in a lapse of certification. Any lapse in certification will require completion of a new certified adoption professional application, documentation of ten (10) hours of adoption training during the two (2) years previous to this new application, and a new criminal history and background check. (3-20-20)T
- a.** If the individual applying for certification has received a Department criminal history and background check clearance within three (3) years of the date of this application and has not lived outside the state of Idaho since their last criminal history and background check, all of the following must be conducted and no disqualifying crimes or appearance on a registry found: (3-20-20)T
- i.** A name-based background check by the Idaho State Police; (3-20-20)T
- ii.** A check of the Idaho Child Protection Central Registry; (3-20-20)T
- iii.** A check of the Idaho Adult Protection Registry; and (3-20-20)T
- iv.** A check of the Idaho Sexual Offender Registry. (3-20-20)T
- b.** If the individual has lived outside the state of Idaho for any amount of time during the three (3) years since the previous Department criminal history and background check clearance was completed, they must get a new Department criminal history and background check clearance. (3-20-20)T
- 06. Denial of Recertification.** The Department may choose not to recertify a certified adoption professional. Notification of denial will be made by the Department by certified mail. The notice will state the specific grounds for denial of recertification. This decision may be appealed within twenty-eight (28) days of receipt of notification under the provisions in IDAPA 16.05.03, "Contested Case Proceedings and Declaratory Rulings." Grounds for denial of recertification are one (1) or more of the following: (3-20-20)T
- a.** Substandard quality of work following the development of a quality improvement plan; (3-20-20)T
- b.** Failure to gain ten (10) additional hours of adoption continuing education required for recertification; or (3-20-20)T
- c.** A demonstrated pattern of negligence or incompetence in performing the duties of a certified adoption professional. (3-20-20)T
- d.** Failure to maintain malpractice insurance; (3-20-20)T

e. Failure to maintain a license to practice social work in the state of Idaho. This requirement does not apply to a certified adoption professional who has maintained their initial certification that occurred prior to July 1, 2012. (3-20-20)T

**07. Decertification.** A certified adoption professional can be decertified by the Department at any time during a two (2) year period of certification. Notification of decertification will be made by the Department by certified mail. The notice will state the specific grounds for decertification. This decision may be appealed within twenty-eight (28) days of receipt of notification under the provisions in IDAPA 16.05.03, "Contested Case Proceedings and Declaratory Rulings." Grounds for decertification are one (1) or more of the following: (3-20-20)T

- a. Conviction for a felony; (3-20-20)T
- b. Negligence in carrying out the duties of a certified adoption professional; (3-20-20)T
- c. Misrepresentation of facts regarding their qualifications or the qualifications of a prospective adoptive family to adopt, or both; (3-20-20)T
- d. Failure to obtain Departmental review and approval of pre-placement homestudies and court reports or placement supervision reports, or both, on more than one (1) occasion; (3-20-20)T
- e. Failure to maintain malpractice insurance; (3-20-20)T
- f. Suspension or loss of a license to practice social work in Idaho; or (3-20-20)T
- g. Practice as a certified adoption professional outside the scope of the certification. (3-20-20)T

**891. CERTIFIED ADOPTION PROFESSIONAL'S CLIENT RELATIONSHIP.**

A certified adoption professional may not assume a legal relationship with any child for whom they have been contracted to perform services and may not provide services for anyone with whom they have had a personal or professional relationship during the previous two (2) years. (3-20-20)T

**892. MINIMUM STANDARDS FOR SERVICE.**

A certified adoption professional must meet the following service requirements: (3-20-20)T

**01. Description of Services Available.** A written description of services will be provided to families by the certified adoption professional before any work is completed. The description of services must include information regarding Department oversight of the certified adoption professional and any limitations related to the use of the completed home study; (3-20-20)T

**02. Education.** Provision of, or referral to, educational resources to adoptive applicants requesting non-relative adoption; (3-20-20)T

**03. Content.** Standards for pre-placement home studies, home study updates, court reports, and supervisory reports must, at a minimum, meet the standards for adoption services established by the Department in these rules; (3-20-20)T

**04. Release of Information.** A written release of information that gives consent to the exchange of information between the certified adoption professional and Child and Family Services must be obtained from a family that receives services from a certified adoption professional; and (3-20-20)T

**05. Disclosure of Non-Identifying Information.** When providing adoption supervision or adoption finalization court report services, the certified adoption professional must provide disclosure of all known non-identifying information about the child, the child's birth parents, and the circumstances leading to the decision to place the child for adoption. (3-20-20)T

**893. RECORDS OF THE CERTIFIED ADOPTION PROFESSIONAL.**



Records of the pre-placement home studies, court reports, and supervisory reports provided by the certified adoption professional must be made available to the Division of Family and Community Services designee two (2) weeks prior to the required court filing date. The designee will be responsible for monitoring of quality of the services provided. (3-20-20)T

**894. FEES CHARGED BY THE DEPARTMENT.**

Monitoring fees will accompany the submission of each report and be paid directly to the Department through the Division of Family and Community Services as follows:

<b>Table 894 - Qualified Individuals</b>	
Home Study or Court Report	\$50
Supervision Report or Home Study Update	\$30

(3-20-20)T

**895. DEPARTMENT RESPONSIBILITY TO CERTIFIED ADOPTION PROFESSIONAL.**

The Division of Family and Community Services is responsible for: (3-20-20)T

- a. Reviewing and responding to submitted reports within five (5) business days; (3-20-20)T
- b. Initiation of corrective action plans when the documentation of a certified adoption professional is determined to be incorrect or substandard; and (3-20-20)T
- c. Dissemination of information to certified adoption professionals that may impact provided services. (3-20-20)T

**896. -- 899. (RESERVED)**

**ADOPTION ASSISTANCE**  
**(Sections 900-999)**

**900. ADOPTION ASSISTANCE.**

The purpose of the adoption assistance program is to encourage the legal adoption of children with special needs who would not be able to have the security of a permanent home without support payments. Applications are made through the Division of Family and Community Services, Resource Development Unit for a determination of eligibility. Once an application for adoption assistance is submitted to the Division of Family and Community Services, the Division will respond with a determination of the child's eligibility within forty-five (45) days. (3-20-20)T

**01. Determination of Eligibility for Title IV-E Adoption Assistance.** Child and Family Services will determine whether a child is a child with special needs. Children applying for adoption assistance benefits must meet Idaho's definition of a child with special needs according to Section 473 (c) of P.L. 96-272 (The Adoption Assistance and Child Welfare Act of 1980). There are five (5) ways a child can be eligible for Title IV-E adoption assistance: (3-20-20)T

- a. Child is Aid to Families with Dependent Children (AFDC) eligible, is in the custody or care of the public child welfare agency or an Indian tribe with whom the state has a IV-E agreement and meets the definition of a child with special needs. For children whose adoption assistance eligibility is based on the child's AFDC eligibility, the child must meet the AFDC criteria at the time of removal from their home. (3-20-20)T
  - i. If the child is removed from their home in accordance with the first judicial determination, such determination must indicate that it was contrary to the welfare of the child to remain in the home. (3-20-20)T
  - ii. If the child is removed from the home in accordance with a voluntary out-of-home placement

agreement, the child must receive at least one (1) Title IV-E foster care payment to be eligible for Title IV-E adoption assistance. (3-20-20)T

**b.** Child is eligible for Supplemental Security Income (SSI) benefits and meets the definition of a child with special needs. (3-20-20)T

**i.** A child is eligible for adoption assistance if, at the time the adoption petition is filed, the child has met the requirements for Title XVI (SSI) benefits; (3-20-20)T

**ii.** The circumstances of a child's removal from their home or whether the public child welfare agency has responsibility for the child's placement and care are not relevant. (3-20-20)T

**c.** Child has been voluntarily relinquished to a private non-profit adoption agency and meets the definition of a child with special needs. (3-20-20)T

**i.** The child must meet the requirements, or would have met the requirements, of the AFDC program as such sections were in effect on July 16, 1996, in or for the month in which the relinquishment occurred, or court proceedings were held that led to the removal of the child from their home; (3-20-20)T

**ii.** At the time of the voluntary relinquishment, the court must make a judicial determination that it would be contrary to the welfare of the child for the child to remain in the home. (3-20-20)T

**d.** Child is eligible for Title IV-E adoption assistance as a child of a minor parent and at the time of the adoption petition the child meets the definition of a child with special needs. (3-20-20)T

**i.** The child's parent is in foster care and receiving Title IV-E foster care maintenance payments that cover both the minor parent and child at the time the adoption petition is filed; and (3-20-20)T

**ii.** The child continues to reside in the foster home with their minor parent until the adoption petition has been filed. If the child and minor parent have been separated in foster care prior to the time of the adoption petition, the child's eligibility for Title IV-E adoption assistance must be determined based on the child's current and individual circumstances. (3-20-20)T

**e.** Child is eligible due to prior Title IV-E adoption assistance eligibility and meets the definition of a child with special needs. (3-20-20)T

**i.** A child whose adoption later dissolves or the adoptive parent(s) die, may continue to be eligible for Title IV-E adoption assistance in a subsequent adoption. (3-20-20)T

**ii.** The subsequent adoption of a child may be arranged through an independent adoption, private agency, or state agency. (3-20-20)T

**iii.** No needs or eligibility redetermination is to be made upon a subsequent adoption. The child's need and eligibility remain unchanged from what they were prior to the initial adoption. (3-20-20)T

**iv.** It is the responsibility of the placing state to determine whether the child meets the definition of special needs and to pay the subsidy in a subsequent adoption. (3-20-20)T

**02. Special Needs Criteria.** The definition of special needs includes the following factors: (3-20-20)T

**a.** The child cannot or should not be returned to the home of the parents as evidenced by an order from a court of competent jurisdiction terminating parents rights or its equivalent; and (3-20-20)T

**b.** The child has a physical, mental, emotional, or medical disability, or is at risk of developing such disability based on the child's experience of documented physical, emotional, or sexual abuse, or neglect; or (3-20-20)T

- c. The child's age makes it difficult to find an adoptive home; or (3-20-20)T
- d. The child is being placed for adoption with at least one (1) sibling; and (3-20-20)T
- e. The State must make a reasonable but unsuccessful effort to place the child with special needs without a subsidy, except in cases where it is not in the best interests of the child due to their significant emotional ties with the foster parent(s) or relative(s) who are willing to adopt the child. (3-20-20)T

**03. Determination of Eligibility for State Funded Adoption Assistance.** Children in state custody who meet the special needs criteria found in Subsection 900.02 of these rules and do not meet any of the criteria for Title IV-E adoption assistance found at Subsection 900.01 in these rules, may be eligible for state-funded adoption assistance benefits. If the child is determined ineligible for Title IV-E adoption assistance, the application will be evaluated for a state-funded subsidy. (3-20-20)T

**04. Interjurisdictional Adoptions.** When a child's adoption is arranged through the care and placement of a private non-profit adoption agency in another state and the adoptive family are residents of Idaho, the state of Idaho is responsible for the eligibility determination, negotiation, and payment of any subsequent Title IV-E adoption assistance benefits. (3-20-20)T

**05. International Adoptions and Adoption Assistance.** A child who meets the criteria for special needs under Subsection 900.02 of this rule, who is not a citizen or resident of the United States, and who was adopted outside of the United States or was brought into the United States for the purpose of being adopted, is not eligible to receive adoption assistance. This restriction does not prohibit adoption assistance payments for a child described in this Subsection who is placed in foster care subsequent to the failure, as determined by the State, of the initial adoption of the child by the adoptive parents. (3-20-20)T

**901. ATTEMPT TO PLACE WITHOUT ADOPTION ASSISTANCE.**

The Department is required to attempt to place all children for adoption without adoption assistance. However, all adoptive families are entitled to full information and disclosure regarding the adoption assistance program. Once the most suitable family is located for the child, the family will be informed of the needs and history of the child and asked if they can adopt the child without adoption assistance. If the family indicates that they need adoption assistance, the Department will begin the process of determining the amount and type of benefits for the child. (3-20-20)T

**902. -- 909. (RESERVED)**

**910. TYPES AND AMOUNTS OF ASSISTANCE.**

The needs of the child and the family, including any other children in the family, will be considered in determining the amount and type of support to be provided. Assistance may include the following: (3-20-20)T

**01. Nonrecurring Adoption Reimbursement.** Payment for certain one-time expenses necessary to finalize the adoption may be paid when a family adopts a special needs child. The child's eligibility must be determined and the contract for reimbursement must be fully executed prior to the finalization of the adoption. The reimbursement is paid only after the adoption finalizes. (3-20-20)T

**a.** The expenses are defined as reasonable and necessary adoption fees, court costs, attorney fees, and other expenses that are directly related to the legal adoption finalization of a child with special needs and which are not incurred in violation of state or federal law. They may include mileage and lodging involved in visiting the child before placement occurs. These expenses cannot be reimbursed if they are paid for the adoptive parents by other sources such as an employer. (3-20-20)T

**b.** Documentation of expenses must be submitted. (3-20-20)T

**c.** Costs are reimbursable up to two thousand dollars (\$2,000) per child and are entered on the Adoption Assistance Program Agreement. (3-20-20)T

**d.** Children for whom the adoption has been finalized without a negotiated Nonrecurring Expenses

Reimbursement Agreement are not eligible to apply for these benefits. (3-20-20)T

**02. Monthly Cash Payment.** Financial assistance in the form of a monthly cash payment may be established to assist the adoptive family in meeting the additional expenses of the child's special needs. The amount of the payment must be negotiated with the family by the adoption worker and based on the family's circumstances and what additional resources are needed to incorporate the child into the adoptive family. (3-20-20)T

**a.** The amount must not exceed the rate for family foster care found in Subsections 483 and 484 of these rules, which would be made if the child were in a family foster home in Idaho. (3-20-20)T

**b.** Payments received for treatment foster care, gifts, clothing, and school fees are not considered part of the family foster care rate. (3-20-20)T

**c.** For children who meet the definition of special needs at Subsection 900.02 of these rules, no monthly cash payment is allowable until such time as the specific disability for which the child is known to be at risk becomes evident. (3-20-20)T

**d.** For children who are currently eligible for Personal Care Services (PCS), the treatment foster care rate of up to a maximum of one thousand dollars (\$1,000) per month may be used in negotiating the adoption assistance upon prior approval of the Department's Family and Community Services (FACS) Division Administrator. (3-20-20)T

**e.** Benefits will continue until the child reaches eighteen (18) years, based upon an annual determination of continuing need. (3-20-20)T

**03. Title XIX -- Medicaid Coverage.** Any child with special needs who has an adoption assistance agreement in effect is also eligible for medical coverage. (3-20-20)T

**a.** A Title IV-E adoption assistance agreement provides Medicaid coverage in the state of Idaho and in all other states. Under a state-funded adoption assistance agreement, a child living in Idaho is eligible for Medicaid. If the family moves to another state, Medicaid may or may not be available. If Medicaid is not available in the new state, provisions for medical coverage must be contained in the adoption assistance agreement or in an amendment to the agreement. (3-20-20)T

**b.** Families enrolled in a group health plan who plan to request to use Medicaid as the child's primary health care coverage must apply to the Idaho Health Insurance Premium Payment (HIPP) program at the time of benefit negotiation. Medicaid provides secondary coverage after the family's health insurance has reached its benefit limit. (3-20-20)T

**c.** All services reimbursed by Medicaid must be determined to be medically necessary. (3-20-20)T

**d.** Prior authorization may be required for some Medicaid reimbursable services. (3-20-20)T

**e.** Medicaid benefits are available until the child reaches the age of eighteen (18), based upon an annual determination of continuing need. (3-20-20)T

**04. Title XX -- Social Services.** Any child with special needs who has an Adoption Assistance Agreement is also eligible for state-authorized Title XX - Federal Social Services Block Grant funded services. (3-20-20)T

**911. ADOPTION ASSISTANCE PROGRAM AGREEMENT.**

A written agreement must be negotiated and fully executed between the Department and adopting family prior to the finalization of adoption and implementation of benefits. (3-20-20)T

**01. Agreement Specifications.** The agreement specifies the following: (3-20-20)T

**a.** The type and amount of assistance to be provided; (3-20-20)T

b. That there will be an annual review of each agreement by the Department to evaluate the need for continued subsidy and the amount of the subsidy; (3-20-20)T

c. That the agreed upon type and amount of assistance may be adjusted only with the concurrence of the adoptive parent(s) based upon changes in the needs of the child or changes in the circumstances of the adoptive family; (3-20-20)T

d. That the adoptive parent(s) are required to inform the Department of any circumstances that would make them ineligible for adoption assistance payments, or eligible for adoption assistance payments in a different amount. (3-20-20)T

**02. Termination of Adoption Assistance.** Adoption assistance will be terminated if the adoptive parent(s) no longer have legal responsibility for the child as a result of termination of parental rights, the child is no longer receiving any financial support from the parents, or the child has reached the age of eighteen (18) years regardless of the child's educational status. (3-20-20)T

**03. Adoption Assistance Follows the Child.** If the adoptive parents are located in a state other than Idaho, or move out of Idaho with the child, the adoption assistance payments initiated by Idaho will continue for the child. If the child is IV-E or state-funded adoption assistance eligible, referral for Medicaid or other state medical insurance and social service benefits will be forwarded to the new state of residence through the Interstate Compact on Adoption and Medical Assistance. Non IV-E eligible children receiving a state adoption subsidy, may not be eligible for Medicaid in a state other than Idaho. (3-20-20)T

**912. -- 919. (RESERVED)**

**920. REQUEST FOR RECONSIDERATION FOR ADOPTION ASSISTANCE.**

Families who adopted a child, or children with special needs on or after April 1, 1982, through either the Department or a licensed Idaho children's adoption agency, may be eligible for benefits through the Adoption Assistance program. Persons who adopted their relative children, may also be eligible for these adoption assistance benefits. (3-20-20)T

**01. Adoption Assistance Agreement.** Per Public Law 96-272, the adoptive family must sign an adoption assistance agreement prior to the finalization of the adoption in order for the child to receive benefits. Adoptive families who were not informed of these benefits or who were wrongly denied these benefits may submit an application to the Department prior to the eighteenth birthday of the adopted child for a determination of eligibility for these benefits. (3-20-20)T

**02. Eligibility Determination.** The Division of Family and Community Services determines eligibility based on the eligibility factors determining a special needs child that were in effect at the time of the child's adoption. (3-20-20)T

a. If the IV-E eligibility determination finds that a child was eligible for these benefits at the time of the child's adoption, and an agreement was not signed prior to the finalization, the Department is required to deny benefits to the child, since no contract was in effect at the time of the adoption finalization. (3-20-20)T

b. The adoptive family may request a fair hearing for adoption assistance IV-E eligibility determination. (3-20-20)T

i. The determinations to be made at this hearing are whether extenuating circumstances exist or whether the family was wrongly denied eligibility, or both. (3-20-20)T

ii. The Division of Family and Community Services may not change its eligibility determination for a child eligible for IV-E adoption assistance benefits and provide adoption assistance based on extenuating circumstances without obtaining a favorable ruling from a fair hearing officer. (3-20-20)T

**921. BURDEN OF PROOF -- EXTENUATING CIRCUMSTANCES.**

The family has the burden of proving extenuating circumstances at the fair hearing, although, if the state agency is in agreement that the family had erroneously been denied benefits, the agency may provide such facts to the family or present corroborating facts on behalf of the family to the fair hearing officer. Once the hearing officer rules in favor of a family that extenuating circumstance exist and that the child is eligible for IV-E adoption assistance benefits, the agency must negotiate an agreement with the adoptive family consistent with these rules. (3-20-20)T

**922. RETROACTIVE ADOPTION ASSISTANCE BENEFITS.**

The Department of Health and Welfare, Division of Family and Community Services may negotiate retroactive adoption assistance benefits for a maximum of twenty-four (24) months from the date of adoption assistance application, identified in Section 920 of these rules. (3-20-20)T

**923. DISRUPTION OF INTERNATIONAL ADOPTIONS.**

The Intercountry Adoption Act of 2000 (P.L. 106-279) requires that each state make an annual report of children who were adopted from other countries who enter state guardianship as a result of termination of the parental rights of the adoptive parent and the dissolution of the adoption. The report will include the name of the agency who handled the placement or the adoption, the plans for the child, and the reasons for the disruption or dissolution. Each region will collect this information and send it to the Department's Permanency Program Specialist in January of each year. (3-20-20)T

**924. -- 999. (RESERVED)**

**16.06.02 – RULES GOVERNING STANDARDS FOR CHILD CARE LICENSING**

**000. LEGAL AUTHORITY.**

Under Sections 39-1107, 39-1111, 39-1207, 39-1209, 39-1210, 39-1211, 39-1213, 56-1003, 56-1004A, 56-1005(8), and 56-1007, Idaho Code, the Idaho Legislature authorizes the Department of Health and Welfare and the Board of Health and Welfare to adopt and enforce rules governing standards and procedures for licensing daycare centers, group daycare facilities, family daycare homes, foster homes, children’s agencies, children’s residential care facilities, children’s camps, and children’s therapeutic outdoor programs that are maintained or operated within Idaho. (3-20-20)T

**001. TITLE, SCOPE, POLICY, PURPOSE, EXCEPTIONS, AND EXEMPTIONS TO LICENSING.**

**01. Title.** These rules are titled IDAPA 16.06.02, “Child Care Licensing.” (3-20-20)T

**02. Scope.** These rules establish minimum standards and procedures for licensing, maintaining, and operating the following facilities or programs within Idaho: (3-20-20)T

- a.** Daycare centers; (3-20-20)T
- b.** Group daycare facilities; (3-20-20)T
- c.** Family daycare homes, voluntarily; (3-20-20)T
- d.** Foster homes; (3-20-20)T
- e.** Children’s agencies; (3-20-20)T
- f.** Children’s residential care facilities, including non-accredited residential schools; (3-20-20)T
- g.** Children’s camps providing child care for any one (1) child for more than nine (9) consecutive weeks in any one (1) year period; (3-20-20)T
- h.** Children's therapeutic outdoor programs; (3-20-20)T
- i.** Alcohol-drug abuse treatment facilities for adolescents certified according to IDAPA 16.07.17, “Substance Use Disorders Services”; and (3-20-20)T
- j.** Facilities specializing in maternity care for minors. (3-20-20)T

**03. Policy.** It is the policy of the Department to assure that children of this state receive adequate substitute parental care in the event of absence, temporary or permanent inability of parents to provide care and protection for their children or the parents are seeking alternative twenty-four (24) hour long-term care for their children. This policy is based on the fact that children are vulnerable and not capable of protecting themselves. When parents, for any reason have relinquished their children’s care to others, there arises the possibility of certain risks to those children's lives, health and safety which the community as a whole must protect against. This requires the offsetting statutory protection of review and, in certain instances, licensing or registration. (3-20-20)T

**04. Purpose.** The Department issues a license to assure, as is reasonably practicable, that the care, services, and physical surroundings of each program or facility are in substantial compliance with these rules and minimum standards. (3-20-20)T

**a.** According to Section 39-1117, Idaho Code, a daycare license does not constitute a representation affirming to any person that the program or facility is free from risk. A daycare license does not guarantee adequacy of care, services, safety, or the well-being of any child, staff, contractor, volunteer, or visitor of a daycare facility. It is the parent’s primary responsibility for evaluation and selection of daycare services. (3-20-20)T

**b.** The state, its employees or agents of the state or its political subdivisions, will not be liable for nor will a cause of action exist for any loss or damage based upon the failure of any daycare facility to meet the minimum standards contained in these rules. (3-20-20)T

**05. Exceptions and Exemptions to Daycare Licensing.** Under Section 39-1103, Idaho Code, the minimum standards and licensing requirements in these rules do not apply to: (3-20-20)T

- a.** Daycare facilities regulated, licensed, or certified by a city or county in accordance with local

options under Section 39-1108, Idaho Code; (3-20-20)T

**b.** The occasional or irregular care of a neighbor's, relative's, or friend's child or children by a person not ordinarily in the business of providing daycare; (3-20-20)T

**c.** The operation of a private school or religious school for educational purposes for children over four (4) years of age, or a religious kindergarten; (3-20-20)T

**d.** The provision of occasional care exclusively for children of parents who are simultaneously in the same building; (3-20-20)T

**e.** The operation of day camps, programs and religious schools for less than twelve (12) weeks during a calendar year or not more often than once a week; or (3-20-20)T

**f.** The provision of care for children of a family within the second degree of relationship as defined in Section 011 of these rules. (3-20-20)T

**06. Exceptions and Exemptions to Child Care Licensing.** Under Sections 39-1206, 39-1213(b), and 39-1211, Idaho Code, the minimum standards and licensing requirements in these rules do not apply to: (3-20-20)T

**a.** Foster homes that have been approved by a licensed children's agency provided the standards for approval by such agency are no less restrictive than the rules and standards established by the Board and that such agency is maintained, operated, and conforms with these rules and standards; (3-20-20)T

**b.** The occasional or irregular care of a neighbor's, relative's, or friend's child or children by a person not ordinarily engaged in child care; or (3-20-20)T

**c.** Children's camps which only provide child care for any one (1) child for less than nine (9) consecutive weeks in any one (1) year period. A children's camp which provides child care for any one (1) child for more than nine (9) consecutive weeks in any one (1) year period constitutes a children's residential care facility and is subject to the minimum standards and licensing requirements in these rules. (3-20-20)T

**002. INCORPORATION BY REFERENCE.** The following documents are incorporated by reference in this chapter of rules. (3-20-20)T

**01. Occupational Safety Health Act (OSHA).** A copy of OSHA may be obtained at the Idaho Industrial Commission, 317 Main Street., P.O. Box 83720, Boise, Idaho, 83720-0041. (3-20-20)T

**02. Crib Safety.** Consumer Product Safety Commission, Crib Safety Tips can be found on the Internet at <https://www.cpsc.gov/Regulations-Laws--Standards/Rulemaking/Final-and-Proposed-Rules/Full-Size-Cribs>. (3-20-20)T

**003. -- 008. (RESERVED)**

**009. CRIMINAL HISTORY AND BACKGROUND CHECK REQUIREMENTS.**

**01. Compliance with Department Criminal History and Background Check.** Criminal history and background checks are required for individuals who are licensed under these rules. Individuals who are required to have a criminal history check must comply with IDAPA 16.05.06, "Criminal History and Background Checks," with the exception of those individuals described in Subsection 009.04 of this rule. (3-20-20)T

**02. When License is Granted.** The applicant must have a completed criminal history and background check, including clearance, prior to licensure. Any other adult living in the home must complete a criminal history application, must be fingerprinted, and must not have any disqualifying crimes listed in IDAPA 16.05.06, "Criminal History and Background Checks." (3-20-20)T

**03. Individuals Subject to Criminal History Check Requirements.** The following individuals must



receive a criminal history and background check clearance prior to licensure: (3-20-20)T

**a.** Adoptive Parents. The criminal history and background check requirements applicable to adoptive parents are found in Subsection 671.02 of these rules. (3-20-20)T

**b.** Child Care Facility Staff. The criminal history and background check requirements applicable to a child care facility are found in Section 109 of these rules. (3-20-20)T

**c.** Children's Agency Facility Staff. The criminal history and background check requirements for a children's agency facility are found in Section 109 of these rules and in Section 39-1210(10), Idaho Code. (3-20-20)T

**d.** Children's Residential Care Facility and Children's Camp Staff. The criminal history and background check requirements for a children's residential care facility or children's camp are found in Section 109 of these rules and in Section 39-1210(10), Idaho Code. (3-20-20)T

**e.** Children's Therapeutic Outdoor Program Staff. The criminal history and background check requirements for a children's therapeutic outdoor program are found in Section 810 of these rules and in Section 39-1208(8), Idaho Code. (3-20-20)T

**f.** Daycare Center, Group Daycare Facility, and Family Day Care Home. The criminal history and background check requirements applicable to a daycare center, group daycare facility, and family daycare home are found in Section 309 of these rules and in Sections 39-1105, 39-1113, and 39-1114, Idaho Code. (3-20-20)T

**g.** Licensed Foster Care Home. The criminal history and background check requirements applicable to licensed foster care are found in Section 404 of these rules and in Section 39-1211(4), Idaho Code. (3-20-20)T

**04. Exceptions to Criminal History and Background Checks for Certain Youths.** Criminal history and background checks are optional for certain youth placed in licensed foster homes and licensed residential care facilities. (3-20-20)T

**a.** Youth in foster care who reach the age of eighteen (18) and continue to reside in the same licensed foster home. (3-20-20)T

**b.** Youth in a children's residential care facility who reach the age of eighteen (18) and continue to live in the same licensed residential facility. (3-20-20)T

**05. Criminal History and Background Check at Any Time.** The Department can require a criminal history and background check at any time on any individual who: (3-20-20)T

**a.** Is a resident or an adult living in a licensed foster home; (3-20-20)T

**b.** Is a resident or adult living in, employee, contractor, volunteer, or staff member of a licensed residential facility; or (3-20-20)T

**c.** Is an owner, operator, or staff of a daycare center, group daycare facility, family daycare home, and all other individuals who are thirteen (13) years of age or older who have unsupervised direct contact with children or who are regularly on the premises. (3-20-20)T

**010. DEFINITIONS A THROUGH M.** For the purposes of these rules, the following terms apply. (3-20-20)T

**01. Accredited Residential School.** A residential school for any number of children subject to the jurisdiction of the Idaho Department of Education that has been certified as accredited according to the accrediting standards promulgated by the Idaho State Board of Education or a secular or religious accrediting association recognized by the Idaho Department of Education. (3-20-20)T

- 02. Alcohol-Drug Abuse Treatment Facility.** A children’s residential care facility specializing in providing programs of treatment for children whose primary problem is alcohol or drug abuse, certified according to IDAPA 16.07.17, “Substance Use Disorders Services.” (3-20-20)T
- 03. Attendance.** For requirements of Title 39, Chapter 11, Idaho Code, and Sections 300 through 399 of these rules, “attendance” means the number of children present at a daycare facility at any given time. (3-20-20)T
- 04. Board.** The Idaho State Board of Health and Welfare. (3-20-20)T
- 05. Chief Administrator.** The duly authorized representative of an organization responsible for day-to-day operations, management and compliance with these rules and Title 39, Chapter 12, Idaho Code. (3-20-20)T
- 06. Child.** (3-20-20)T
- a.** For requirements of Title 39, Chapter 12, Idaho Code, and Sections 400 through 999 of these rules, “child” means an individual less than eighteen (18) years of age, synonymous with juvenile or minor. (3-20-20)T
- b.** For requirements of Title 39, Chapter 11, Idaho Code, and Sections 300 through 399 of these rules, “child” means an individual less than thirteen (13) years of age. (3-20-20)T
- 07. Child Care.** The care, control, supervision or maintenance of children for twenty-four (24) hours a day which is provided as an alternative to parental care. (3-20-20)T
- 08. Child-Staff Ratio.** “Child-staff ratio” means the maximum number of children allowed under the care and supervision of one (1) staff person. (3-20-20)T
- 09. Children's Agency.** A person who operates a business for the placement of children in foster homes, children's residential care facilities or for adoption in a permanent home and who does not provide child care as part of that business. A children’s agency does not include a licensed attorney or physician assisting or providing natural and adoptive parents with legal services or medical services necessary to initiate and complete adoptive placements. (3-20-20)T
- 10. Children's Camp.** A program of child care at a location away from the child’s home, which is primarily recreational and includes the overnight accommodation of the child and is not intended to provide treatment, therapy or rehabilitation for the child. A children’s camp which only provides child care for any one (1) child for less than nine (9) consecutive weeks in any one (1) year period is exempt from the licensure and disclosure provisions of this chapter. A children’s camp which provides child care for any one (1) child for more than nine (9) consecutive weeks in any one (1) year period constitutes a children’s residential care facility. (3-20-20)T
- 11. Children's Institution.** A person defined herein, who operates a residential facility for unrelated children, for the purpose of providing child care. Children’s institutions include foster homes, children's residential care facilities, maternity homes, or any residential facility providing treatment, therapy or rehabilitation for children, or any children's therapeutic outdoor program. (3-20-20)T
- 12. Children's Residential Care Facility.** A facility that provides residential child care, excluding foster homes, residential schools, juvenile detention centers and children's camps that: (3-20-20)T
- a.** Seeks, receives or enrolls children for treatment of special needs such as substance abuse, mental illness, emotional disturbance, developmental disability, mental retardation, or children who have been identified by the judicial system as requiring treatment, therapy, rehabilitation or supervision; (3-20-20)T
- b.** Receives payment, including payment from health insurance carriers, for identified treatment needs such as substance abuse, mental illness, emotional disturbance, developmental disability or mental retardation; or (3-20-20)T
- c.** Represents to the payor of the child care services provided by the children’s facility that such payment may qualify for health insurance reimbursement by the payor’s carrier or may qualify for tax benefits

- relating to medical services; and (3-20-20)T
- d.** May include a children's therapeutic outdoor program whether or not that program operates out of a standard facility. (3-20-20)T
- 13. Children's Therapeutic Outdoor Program.** A program which is designed to provide behavioral, substance abuse, or mental health services to minors in an outdoor setting and serves either adjudicated or non-adjudicated youth. Children's Therapeutic Outdoor programs do not include outdoor programs for minors that are primarily designed to be educational or recreational that may include Boy Scouts, Girl Scouts, 4-H and other youth organizations. (3-20-20)T
- 14. Continued Care.** The ongoing placement of an individual in a foster home, children's residential care facility, children's therapeutic outdoor program, or transitional living placement who reaches the age of eighteen (18) years but is less than twenty-one (21) years of age. (3-20-20)T
- 15. Contraband.** Goods or merchandise, the possession of which is prohibited, such as weapons and drugs. (3-20-20)T
- 16. Daycare.** The care and supervision provided for compensation during part of a twenty-four (24) hour day, for a child or children not related by blood, marriage, adoption, or legal guardianship to the person or persons providing the care, in a place other than the child's or children's own home or homes. (3-20-20)T
- 17. Daycare Center.** A place or facility providing daycare for compensation for thirteen (13) or more children. (3-20-20)T
- 18. Department.** The Idaho Department of Health and Welfare. (3-20-20)T
- 19. Direct Care Staff.** An employee who has direct personal interaction with children in the provision of child care and is included as staff in meeting the minimum staff-child ratio requirements. (3-20-20)T
- 20. Director.** Director of the Idaho Department of Health and Welfare or designee. (3-20-20)T
- 21. Family Daycare Home.** A home, place, or facility providing daycare for six (6) or fewer children. (3-20-20)T
- 22. Foster Care.** The twenty-four (24) hour substitute parental care of children by persons who may or may not be related to a child. (3-20-20)T
- 23. Foster Home.** The private home of an individual or family licensed or approved as meeting the standards for foster care and providing twenty-four (24) hour substitute parental care to six (6) or fewer children. (3-20-20)T
- 24. Foster Parent.** A person or persons residing in a private home under their direct control to whom a foster care license has been issued. (3-20-20)T
- 25. Group Daycare Facility.** A home, place, or facility providing daycare for seven (7) to twelve (12) children. (3-20-20)T
- 26. Inter-Country Adoption.** The placement of a child from one (1) country to another for the purpose of adoption. (3-20-20)T
- 27. International Fire Code.** The International Fire Code as outlined by Section 41-253, Idaho Code. The addition for the year prior to the issuance of the license will be used. Published by the International Code Council. A copy is available at any public library in Idaho. (3-20-20)T
- 28. International Building Code.** The International Building Codes as outlined in Section 39-4109, Idaho Code. The addition for the year prior to the issuance of the license will be used. Published by the International

Code Council. A copy is available at any public library in Idaho. (3-20-20)T

**29. Mechanical Restraint.** Devices used to control the range and motion of an individual, including handcuffs, restraint boards, restraint chairs, and restraint jackets. (3-20-20)T

**30. Medical Professionals.** Persons who have received a degree in nursing or medicine and licensed registered nurse, licensed nurse practitioner, physician's assistant, and medical doctor. (3-20-20)T

**31. Member of the Household.** Any person, other than a foster child, who resides in, or on the property of, a foster home. (3-20-20)T

**011. DEFINITIONS N THROUGH Z.**

For the purposes of these rules, the following terms apply. (3-20-20)T

**01. Nonaccredited Residential School.** A residential school for any number of children that is not certified or accredited pursuant to Section 39-1207, Idaho Code, or has lost accreditation and is subject to the jurisdiction of the Department as a children's residential care facility pursuant to Section 39-1210, Idaho Code, unless and until accreditation is certified by the Idaho Department of Education. (3-20-20)T

**02. Non-Compliance.** Violation of, or inability to meet the requirements of, the act or a rule promulgated under the act, or terms of licensure. (3-20-20)T

**03. Operator.** An individual who operates or maintains within Idaho a daycare center, group daycare facility, family daycare home voluntarily licensed by the Department, children's residential care facility, children's agency, children's therapeutic outdoor program, or children's camp. (3-20-20)T

**04. Organization.** A children's agency or a children's residential care facility. (3-20-20)T

**05. Person.** Any individual, group of individuals, associations, partnerships or corporations. (3-20-20)T

**06. Physical Intervention.** Physical restraint utilized to control the range and motion of an individual. (3-20-20)T

**07. Placement.** The activities and arrangements related to finding a suitable licensed home or facility in which a child will reside for purposes of care, treatment, adoption, or other services. (3-20-20)T

**08. Plan of Correction.** The detailed procedures and activities developed between the licensing authority and caregiver required to bring a daycare center, group daycare facility, family daycare home voluntarily licensed by the Department, foster family, children's residential care facility, children's agency, children's therapeutic outdoor program, or children's camp into conformity with these licensing rules. (3-20-20)T

**09. Regularly on the Premises.** For the purposes of Sections 009 and 309 of these rules, regularly on the premises means twelve (12) hours or more in any one (1) month, or daily during any hours of operation. (3-20-20)T

**10. Relative.** Under Section 39-1202, Idaho Code, "relative" means a child's grandparent, great grandparent, aunt, great aunt, uncle, great uncle, brother-in-law, sister-in-law, first cousin, sibling, and half-sibling. (3-20-20)T

**11. Representative.** An employee of the Department of Health and Welfare. (3-20-20)T

**12. Residential School.** A residential facility for any number of children which: (3-20-20)T

**a.** Provides a planned, scheduled, regular, academic or vocational program for students in the elementary, middle or secondary grades as defined in Section 33-1001, Idaho Code; and (3-20-20)T

- b.** Provides services substantially comparable to those provided in nonresidential public schools where the primary purpose is the education and academic pursuits of the students; and (3-20-20)T
- c.** Does not seek, receive or enroll students for treatment of such special needs as substance abuse, mental illness, emotional disturbance, developmental disability or mental retardation; and (3-20-20)T
- d.** Does not receive payment, including payment from health insurance carriers, for identified treatment needs such as substance abuse, mental illness, emotional disturbance, developmental disability, or mental retardation; and (3-20-20)T
- e.** Does not represent to the payor of child care services provided that such payment may qualify for health insurance reimbursement by the payor's carrier or may qualify for tax benefits relating to medical services. (3-20-20)T
- 13. Restraint.** Interventions to control the range and motion of a child. (3-20-20)T
- 14. Seclusion.** A room within a facility designed to temporarily isolate an individual in order to gain emotional or physical control by means of structure and minimal stimulation. (3-20-20)T
- 15. Second Degree of Relationship.** The second degree of relationship refers to persons related consanguineally ("blood relative") and affinally ("relative by marriage") and includes their spouses. The number of degrees between two (2) relatives is calculated by summing the number of ties between each relative and the common ancestor. (3-20-20)T
- 16. Secure.** A physically restrictive setting, as in a locked or guarded residential facility. (3-20-20)T
- 17. Security Risk.** An individual who presents the possibility by actions, behavior or emotional reaction that may result in harm to self or others, or escape from physical control. (3-20-20)T
- 18. Service Worker.** An employee of an organization who has obtained at a minimum, a Bachelor's degree in a behavioral science, including social work, sociology, psychology, criminal justice, counseling, or a related field, whose duties may include assessment, service planning, supervision and support. (3-20-20)T
- 19. Shelter Care.** The temporary or emergency out-of-home care of children in a foster home or residential facility. (3-20-20)T
- 20. Social Worker.** An individual licensed by the state of Idaho in compliance with Title 54, Chapter 32, Idaho Code, and IDAPA 24.14.01, "Rules of the State Board of Social Work Examiners." (3-20-20)T
- 21. Soft Restraints.** Mechanical restraints made of leather, cloth or other combinations of fibers, utilized to control the range of motion of an individual. (3-20-20)T
- 22. Staff.** For requirements of Title 39, Chapter 11, Idaho Code, and Sections 300 through 399 of these rules, "staff" means a person who is sixteen (16) years of age or older and employed by a daycare owner or operator to provide care and supervision at a daycare facility. (3-20-20)T
- 23. Supervision.** For requirements of Title 39, Chapter 11, Idaho Code, and Sections 300 through 399 of these rules, supervision is defined as within sight and normal hearing range of the child or children being cared for. (3-20-20)T
- 24. Time-Out.** Separation of a child from group activity as a means of behavior management. (3-20-20)T
- 25. Training.** The preparation, instruction and education related to child care that increases the knowledge, skill and abilities of a foster parent, agency and residential care facility staff or volunteers. (3-20-20)T
- 26. Transitional Living.** Living arrangements and aftercare services for children, or as continued care,

to gain experience living on their own in a supportive and supervised environment prior to emancipation (3-20-20)T

**27. Variance.** The means of complying with the intent and purpose of a child care licensing rule in a manner acceptable to the Department other than that specifically prescribed in the rule. (3-20-20)T

**28. Waiver.** The non-application of a child care licensing rule, except those related to safety, extended to a relative foster home by the licensing authority which serves to promote child health, well-being, and permanence while not compromising safety. (3-20-20)T

**012. -- 099. (RESERVED)**

**LICENSING AND CERTIFICATION**  
**(Sections 100-299)**

**100. LICENSING.**

The purpose of licensing is to set minimum standards and to monitor compliance. Persons applying for licensure need to be physically and emotionally suited to protect the health, safety and well-being of the children in their care. Physical surroundings must present no hazards to the children in care. (3-20-20)T

**01. Responsibilities of the Foster Parent or Operator.** A foster parent or operator must conform to the terms of the license. (3-20-20)T

**02. Responsible for Knowledge of Standards.** The foster parent or operator is responsible for knowing the standards and rules applying to the type of foster home, children's residential care facility, children's agency, children's therapeutic outdoor program, children's camp, daycare center, group daycare facility, family daycare home voluntarily licensed by the Department, covered by the license, and for conforming to them at all times. (3-20-20)T

**03. Responsible for Agency Staff Knowledge.** The operator of a child care facility or agency is responsible for ensuring that all staff members are familiar with the applicable rules governing the children's residential care facility, children's therapeutic outdoor program, children's agency, children's camp, daycare center, group daycare facility, or family daycare home voluntarily licensed by the Department. A copy of these rules is available from the Office of the Administrative Rules Coordinator, 650 W. State Street, Boise ID 83720, or on the Office of the Administrative Rules Coordinator's website, <http://adminrules.idaho.gov/>. (3-20-20)T

**04. Return of License.** The foster parent or operator must immediately return their license to the Department under any of the following circumstances: (3-20-20)T

- a.** Changes of management or address; (3-20-20)T
- b.** Upon suspension or revocation of the license by the Department; or (3-20-20)T
- c.** Upon voluntary discontinuation of service. (3-20-20)T

**101. APPLICATIONS FOR LICENSE.**

An application for a license must be submitted to the Department. Licensing studies will follow the format of these rules and will contain a specific recommendation regarding the terms of the license. All foster homes, children's agencies, children's therapeutic outdoor programs, children's camps, daycare centers, group daycare facilities, family daycare homes voluntarily licensed by the Department, and children's residential care facilities must also comply with applicable Idaho city and county ordinances. (3-20-20)T

**102. DISPOSITION OF APPLICATIONS.**

The Department will initiate action on each completed application within thirty (30) days after receipt that addresses each requirement for the specific type of home, facility, or agency. Upon receipt of a completed application and study, the licensing authority will review the materials for conformity with these rules. (3-20-20)T

**01. Approval of Application.** A license will be issued to any daycare center, group daycare facility,

family daycare home voluntarily licensed by the Department, foster home, children's residential facility, children's therapeutic outdoor program, children's camp, or children's agency found to be in conformity with these rules governing the home or facility. The license is issued according to the terms specified in the licensing study and will be mailed to the applicant. (3-20-20)T

**02. Regular License.** A regular license will be issued to any daycare center, group daycare facility, family daycare home voluntarily licensed by the Department, foster home, children's residential care facility, children's therapeutic outdoor program, children's camp, or children's agency found to be in conformity with these rules governing the facility and will specify the terms of licensure, such as: (3-20-20)T

- a.** Full time or daycare; (3-20-20)T
- b.** The number of children who may receive care at any one (1) time; and (3-20-20)T
- c.** Age range and gender, if there are conditions in the foster home or children's residential care facility making such limitations necessary; (3-20-20)T
- d.** The regular license for a foster home, children's agency, children's residential care facility, children's therapeutic outdoor program, or children's camp is in effect for one (1) year from the date of issuance unless suspended or revoked earlier; (3-20-20)T
- e.** A regular license for a daycare center, group daycare facility, or family daycare home voluntarily licensed by the Department is in effect for two (2) years from the date of issuance unless suspended or revoked earlier; and (3-20-20)T
- f.** If the license for a foster home is for a specific child only, the name of that child will be shown on the foster home license. (3-20-20)T

**03. Waiver.** A regular license may be issued to the foster home of a relative who has received a waiver of licensing rules provided: (3-20-20)T

- a.** The waiver is considered on an individual case basis; (3-20-20)T
- b.** The waiver is approved only for non-safety foster care rules; (3-20-20)T
- c.** All other licensing requirements have been met; (3-20-20)T
- d.** The approval of a waiver of any foster home rules requires the licensing authority to document a description of the reasons for issuing a waiver, the rules being waived, and assurance that the waiver will not compromise the child's safety; and (3-20-20)T
- e.** The approved waiver must be reviewed for continued need and approval at regular intervals not to exceed six (6) months. (3-20-20)T

**04. Variance.** A regular license will be issued to a foster home, children's residential care facility or children's agency approved for a variance of a licensing rule provided: (3-20-20)T

- a.** The variance is considered on an individual case basis; (3-20-20)T
- b.** The variance is approved for a non-safety licensing rules; (3-20-20)T
- c.** The approval of a variance must have no adverse effect on the health, safety, and well-being of any child in care at the foster home or facility; (3-20-20)T
- d.** The approval of a variance is documented by the licensing agency and includes a description of the reasons for issuing a variance and assurances that the variance will not compromise any child's health, safety, and well-being; and (3-20-20)T

- e. The approved variance must be reviewed for continued need and approval annually. (3-20-20)T

**05. Provisional License.** A provisional license may be issued to a foster home, children's residential care facility, children's therapeutic outdoor program, children's camp, or children's agency when a licensing standard cannot be met but can be expected to be corrected within six (6) months, provided this does not affect the health, safety and well-being of any child in care at the home or facility. (3-20-20)T

- a. A provisional license will be in effect for not more than six (6) months. (3-20-20)T

b. Only one (1) provisional license will be issued to a foster home, children's residential care facility, children's agency, children's therapeutic outdoor program, or children's camp in any twelve-month period of time under Section 39-1216, Idaho Code. (3-20-20)T

**06. Limited License.** A limited license for a foster home may be issued for the care of a specific child in a home which may not meet the requirements for a license, provided that: (3-20-20)T

- a. The child is already in the home and has formed strong emotional ties with the foster parents; and (3-20-20)T

b. It can be shown that the child's continued placement in the home would be more conducive to their welfare than would removal to another home. (3-20-20)T

**07. Denial of Application.** In the event that an application is denied, a signed letter will be sent directly to the applicant by registered or certified mail, advising the applicant of the denial and stating the basis for such denial. An applicant whose application has been denied may not reapply until after one (1) year has elapsed from the date on the denial of application. (3-20-20)T

- 08. Failure to Complete Application Process.** (3-20-20)T

a. Failure of the applicant to complete the application process within six (6) months of the original date of application will result in a denial of the application. (3-20-20)T

b. An applicant whose application has been denied for being incomplete may not reapply until after one (1) year has elapsed from the date on the denial of application. (3-20-20)T

### **103. RESTRICTIONS ON APPLICABILITY AND NONTRANSFER.**

**01. Issued License.** A license applies only to the foster home, child care facility, daycare center, group daycare facility, family daycare home voluntarily licensed by the Department, children's residential care facility, children's agency, children's therapeutic outdoor program, children's camp, or the person and premises designated. Each license is issued in the name of the individual, firm, partnership, association, corporation, or governmental unit identified on the application and only to a specified address of the facility or program stated in the application for the period and services specified. A license issued in the name of a foster parent, child care facility, daycare center, group daycare facility, family daycare home voluntarily licensed by the Department, children's therapeutic outdoor program, children's camp, or children's agency applies only to the services specified in the license. Any change in management or address renders the license null and void, and the foster parent or operator must immediately return the license to the licensing agency as required in Section 100 of these rules. (3-20-20)T

**02. Nontransferable.** A license is nontransferable or assignable from one (1) individual to another, from one (1) business entity or governmental unit to another, or from one (1) location to another. (3-20-20)T

**03. Change in Ownership, Operator, or Location.** When there is a change in ownership, operator, or a change in location occurs, the facility or program must reapply for a license as required in Section 101 of these rules. The new owner or operator must obtain a license before starting operations. (3-20-20)T

### **104. MANDATORY VISITATIONS.**

In accordance with Section 39-1217, Idaho Code, the Department or other licensing authority must visit, and must be



given access to, the premises of each licensed foster home, licensed children's agency, licensed children's therapeutic outdoor program, and licensed children's residential care facility as often as deemed necessary or desirable by the Department to assure conformity with the requirements in this chapter of rules but, in any event, at intervals not to exceed twelve (12) months. (3-20-20)T

**105. REVISIT AND RELICENSE.**

Revisit and relicense studies will document how the daycare center, group daycare facility, family daycare home voluntarily licensed by the Department, foster home, children's residential care facility, children's therapeutic outdoor program, children's camp, or children's agency continues to meet the standards for licensing. Consideration must be given to each point of the standards, including a review of the previous study and original application to determine what changes have occurred. An application for renewal of a license must be made by the operator on the form furnished by the Department, and filled out prior to the expiration date of the license currently in force. When such application for renewal has been made in the proper manner and form, the existing license will, unless officially revoked, remain in force until the Department has acted on the application for renewal. (3-20-20)T

**106. COMPLAINTS AGAINST DAYCARE CENTERS, GROUP DAYCARE FACILITIES, FAMILY DAYCARE HOMES, FOSTER HOMES, CHILDREN'S RESIDENTIAL CARE FACILITIES, CHILDREN'S THERAPEUTIC OUTDOOR PROGRAMS, CHILDREN'S CAMPS, AND CHILDREN'S AGENCIES.**

**01. Investigation.** The Department will investigate complaints regarding daycare centers, group daycare facilities, family daycare homes voluntarily licensed by the Department, foster homes, children's residential care facilities, children's therapeutic outdoor programs, children's camps, or children's agencies. The investigation may include further contact with the complainant, scheduled or unannounced visits to the children's residential care facility, foster home, daycare center, group daycare facility, family daycare home voluntarily licensed by the Department, children's therapeutic outdoor program, children's camp, or children's agency, collateral contacts including interviews with the victim, parents or guardian, children's residential care facility or children's agency administrator, operator, staff, consultants, children in care, other persons who may have knowledge of the complaint, and inspections by fire or health officials. (3-20-20)T

**02. Informed of Action.** If an initial preliminary investigation indicates that a more complete investigation must be made, the foster parents, operator, daycare center, group daycare facility, family daycare home voluntarily licensed by the Department, children's residential care facility, children's therapeutic outdoor program, children's camp, or children's agency will be informed of the investigation, and any action to be taken, including referral for civil or criminal action. (3-20-20)T

**107. SUSPENSION FOR CIRCUMSTANCES BEYOND CONTROL OF FOSTER PARENT OR OPERATOR.**

When circumstances occur over which the foster parent or operator has no control including illness, epidemics, fire, flood, or contamination, which temporarily place the operation of the foster home, child care facility, daycare center, group daycare facility, family daycare home voluntarily licensed by the Department, children's residential care facility, children's therapeutic outdoor program, children's camp, or children's agency out of conformity with Idaho law or with these rules, the license must be suspended until the nonconformity is remedied. (3-20-20)T

**108. SUSPENSION OR REVOCATION FOR INFRACTIONS.**

A license may be suspended for infractions of these rules. Such suspension may lead to revocation if the foster parent or operator fails to satisfy the Director that the infractions have been corrected sufficiently to assure conformity with the rules. (3-20-20)T

**109. NON-RENEWAL, DENIAL, REVOCATION, OR SUSPENSION OF LICENSE.**

If, upon investigation, it is found that an applicant, foster parent, or operator has failed or refused to comply with any of the provisions of the Basic Daycare License Law, Sections 39-1101 through 39-1120, Idaho Code, or the Child Care Licensing Reform Act, Sections 39-1201 through 39-1224, Idaho Code, or with these rules, or with any provision of the license, the Director may deny, suspend, revoke, or not renew a license. The Department may also deny, suspend, revoke, or deny renewal of a license for any daycare center, group daycare facility, family daycare home voluntarily licensed by the Department, child care facility, children's residential care facility, children's agency, children's therapeutic outdoor program, children's camp, or foster home when any of the following in Subsection

109.01 and 109.02 of this rule is determined. (3-20-20)T

**01. Criminal Conviction or Relevant Record.** Anyone providing direct care or working onsite under these rules is denied clearance or refuses to comply with the requirements in IDAPA 16.05.06, "Criminal History and Background Checks." (3-20-20)T

**02. Other Misconduct.** The applicant, foster parent, operator, or the person proposed as chief executive officer: (3-20-20)T

**a.** Fails to furnish any data, statistics, records or information requested by the Department without good cause or provides false information; (3-20-20)T

**b.** Has been found guilty of or is under investigation for fraud, deceit, misrepresentation or dishonesty associated with the operation of a children's residential care facility or children's agency; (3-20-20)T

**c.** Has been found guilty of or is under investigation for the commission of any felony; (3-20-20)T

**d.** Has failed to exercise fiscal accountability toward a client or the Department regarding payment for services; or (3-20-20)T

**e.** Has knowingly permitted, aided or abetted the commission of any illegal act on the premises of the daycare center, group daycare facility, family daycare home voluntarily licensed by the Department, foster home, children's residential care facility, children's therapeutic outdoor program, children's camp, or children's agency. (3-20-20)T

**110. ENFORCEMENT REMEDY OF BAN ON ADMISSIONS.**

The Department may summarily ban admissions, in whole or in part, pending satisfactory correction of all deficiencies. Bans will remain in effect until the Department determines that the organization has achieved full compliance with all program requirements, or until a substitute remedy is imposed. (3-20-20)T

**111. ENFORCEMENT REMEDY OF SUMMARY SUSPENSION AND TRANSFER OF RESIDENTS OR CHILDREN.**

The Department may summarily suspend a daycare center, group daycare facility, family daycare home voluntarily licensed by the Department, foster home, children's agency, children's therapeutic outdoor program, children's camp, or a children's residential care facility license and require the program to transfer residents or children when the Department has determined a resident's or child's health and safety are in immediate jeopardy. Children in a daycare center, group daycare facility, or family daycare home voluntarily licensed by the Department, will not be transported from the facility, instead the parent or legal guardian will be contacted. (3-20-20)T

**112. ENFORCEMENT REMEDY REVOCATION OF LICENSE AND TRANSFER OF RESIDENTS OR CHILDREN.**

The Department may revoke the license of a daycare center, group daycare facility, family daycare home voluntarily licensed by the Department, foster home, children's agency, children's therapeutic outdoor program, or children's residential care facility when the Department determines the operator is not in compliance with these rules. Children in a daycare center, group daycare facility, or family daycare home voluntarily licensed by the Department, will not be transported from the facility, instead the parent or legal guardian will be contacted. Revocation and transfer of residents or children may occur under the following circumstances: (3-20-20)T

**01. Endangers Health or Safety.** Any condition that endangers the health or safety of any resident or child. (3-20-20)T

**02. Not in Substantial Compliance.** A foster home, children's agency, daycare center, group daycare facility, family daycare home voluntarily licensed by the Department, children's therapeutic outdoor program, children's camp, or children's residential care facility is not in substantial compliance with these rules. (3-20-20)T

**03. No Progress to Meet Plan of Correction.** A foster home, children's agency, daycare center, group daycare facility, family daycare home voluntarily licensed by the Department, children's therapeutic outdoor

program, children's camp, or children's residential care facility has made little or no progress in correcting deficiencies within thirty (30) days from the date the Department accepted a plan of correction. (3-20-20)T

**04. Repeat Violations.** Repeat violations of any requirement of these rules or provisions of Title 39, Chapters 11 and 12, Idaho Code. (3-20-20)T

**05. Misrepresented or Omitted Information.** A foster home, children's agency, daycare center, group daycare facility, family daycare home voluntarily licensed by the Department, children's therapeutic outdoor program, children's camp, or children's residential care facility has knowingly misrepresented or omitted information on the application or other documents pertinent to obtaining a license. (3-20-20)T

**06. Refusal to Allow Access.** Refusal to allow Department representatives full access to the foster home, children's agency, daycare center, group daycare facility, family daycare home voluntarily licensed by the Department, children's therapeutic outdoor program, children's camp, or children's residential care facility and its grounds facilities and records. (3-20-20)T

**07. Violation of Terms of Provisional License.** A children's agency, foster home, children's therapeutic outdoor program, children's camp, or children's residential care facility that has violated any of the terms or conditions of a provisional license. (3-20-20)T

**113. EFFECT OF PREVIOUS REVOCATION OR DENIAL OF A LICENSE.**

An organization cannot apply and the licensing authority will not accept an application from any person, corporation, or partnership, including any owner with a ten percent (10%) or more interest, who has had a license denied or revoked, until five (5) years has elapsed from the date of denial, revocation, or conclusion of a final appeal, whichever occurred last. (3-20-20)T

**114. -- 299. (RESERVED)**

**STANDARDS FOR DAYCARE**  
**(Sections 300-399)**

**300. STANDARDS FOR DAYCARE.**

**01. Daycare Standards.** In addition to meeting the rules and minimum standards required in Sections 000 through 199 of these rules, each owner, operator, or applicant seeking licensure from the Department as a daycare center, group daycare facility, or family daycare home voluntarily licensed by the Department, must also meet the requirements under Title 39, Chapter 11, Idaho Code, and Sections 300 through 399 of these rules. (3-20-20)T

**02. Minimum Age of Applicant.** An individual, submitting an application to the Department to be licensed for a daycare center, group daycare facility, or family daycare home, must be a minimum of eighteen (18) years of age. (3-20-20)T

**301. TYPES OF DAYCARE LICENSES.**

Subject to meeting all requirements under Title 39, Chapter 11, Idaho Code, and the rules and minimum standards in this chapter, the Department will determine the type of daycare license required by an owner or operator providing daycare by counting each child in attendance, regardless of relationship to the person or persons providing the care. The following types of daycare licenses may be issued by the Department. (3-20-20)T

**01. Daycare Center License.** A daycare center license is issued for a place or facility providing daycare, where thirteen (13) or more children, regardless of relationship to the person or persons providing the care, are in attendance. (3-20-20)T

**02. Group Daycare Facility.** A group daycare facility license is issued for a place or facility providing daycare, where seven (7) to twelve (12) children, regardless of relationship to the person or persons providing the care, are in attendance. (3-20-20)T

**03. Family Daycare Home.** A family daycare home is not required to be licensed. However, a family

daycare home may voluntarily elect to be licensed by the Department. (3-20-20)T

**302. -- 308. (RESERVED)**

**309. CRIMINAL HISTORY AND BACKGROUND CHECK FOR DAYCARE STANDARDS.**

**01. Criminal History and Background Check for Daycare Centers and Group Daycare Facilities.**

Each owner, operator, or applicant seeking licensure for a daycare center, group daycare facility, or a family daycare home must submit evidence that is satisfactory to the Department that the following individuals have successfully completed and received a clearance for a Department criminal history and background check under the provisions of Sections 39-1105 and 39-1113, Idaho Code: (3-20-20)T

- a. Owners, operators, and staff; (3-20-20)T
- b. All other individuals thirteen (13) years of age or older who have unsupervised direct contact with children; or (3-20-20)T
- c. All other individuals thirteen (13) years of age or older who are regularly on the premises. (3-20-20)T

**02. Juvenile Justice Records.** The criminal history and background check for any individual under eighteen (18) years of age, must include a check of the juvenile justice records, as authorized by the minor and their parent or guardian. Records must be checked for each jurisdiction in which the individual has resided since becoming thirteen (13) years of age through eighteen (18) years of age. Each owner, operator, or applicant is responsible for requesting a check of the juvenile justice record, paying for the costs of a check of the juvenile justice records, and submitting them to the Department for review. A check of the juvenile justice records must include the following: (3-20-20)T

- a. Juvenile justice records of adjudication of the magistrate division of the district court; (3-20-20)T
- b. County probation services; and (3-20-20)T
- c. Department records. (3-20-20)T

**03. Criminal History and Background Check for Family Daycare Homes.** Under Section 39-1114, Idaho Code, any person providing daycare for four (4) or more children in a family daycare home is required to comply with the requirements of Sections 39-1105 and 39-1113, Idaho Code. (3-20-20)T

**04. Criminal History and Background Check for Private Schools and Private Kindergartens.** Under Section 39-1105, Idaho Code, any person who owns, operates, or is employed by a private school for educational purposes for children four (4) through six (6) years of age or a private kindergarten is required to comply with the requirements of Sections 39-1105 and 39-1113, Idaho Code. (3-20-20)T

**05. Cost of Criminal History and Background Check and Juvenile Justice Records.** Each individual who requests and obtains a Department criminal history and background check is responsible for the cost of the criminal history and background check and check of juvenile justice records. (3-20-20)T

**06. On-going Duty to Report Convictions.** Following completion of a criminal history and juvenile justice background check and clearance, additional criminal convictions and juvenile justice adjudications for disqualifying crimes under Section 39-1113, Idaho Code, must be self-disclosed by the individual to the owner or operator of a daycare center, group daycare facility, or family daycare home. The owner or operator must report these additional convictions and adjudications to the Department within five (5) days of learning of the conviction or adjudication. (3-20-20)T

**310. -- 319. (RESERVED)**

**320. DAYCARE LICENSING MAXIMUM TOTAL FEES.**

A nonrefundable licensing fee must be paid to the Department prior to the issuance or renewal of a daycare license. (3-20-20)T

**01. Daycare Licensing Maximum Total Fee Amounts.** The maximum total fee for initial licensure or renewal of a daycare center, group daycare facility, or family daycare home voluntarily licensed must not exceed the following amounts: (3-20-20)T

**a.** For a daycare center with more than twenty-five (25) children in attendance at any given time - three hundred twenty-five dollars(\$325). (3-20-20)T

**b.** For a daycare center with thirteen (13) to twenty-five (25) children in attendance at any given time - two hundred fifty dollars (\$250). (3-20-20)T

**c.** For a group daycare facility - one hundred dollars (\$100). (3-20-20)T

**d.** For a family daycare home voluntary license - one hundred dollars (\$100). (3-20-20)T

**02. Daycare Fire Inspection Fee.** Daycare fire inspection fees are payable to the local fire department or fire district official. (3-20-20)T

**321. APPLICATION FOR DAYCARE LICENSE OR RENEWAL.**

Any individual applying for licensure as a daycare center, group daycare facility, or family daycare home voluntarily licensed by the Department must be at least eighteen (18) years of age. The applicant must apply on forms provided by the Department and must provide information required by the Department set forth in the following Subsections 321.01 through 321.10. (3-20-20)T

**01. Completed and Signed Application.** A completed application form signed and dated by the applicant. (3-20-20)T

**02. Licensing Fee.** The applicant must pay the appropriate licensing fee prior to the issuance of a daycare license by the Department. (3-20-20)T

**03. Inspection Reports.** The following reports must be submitted to the Department with the application: (3-20-20)T

**a.** Proof that the proposed facility meets local building code, where required; (3-20-20)T

**b.** Proof that the proposed facility meets local electrical code, where required; (3-20-20)T

**c.** Proof that the proposed facility meets fire code, where required; and (3-20-20)T

**d.** Proof that the facility meets local planning and zoning requirements. (3-20-20)T

**04. Proof of Insurance.** The applicant must provide proof of current fire and liability insurance coverage for the daycare facility. (3-20-20)T

**05. Criminal History and Background Clearance.** Evidence that the applicant and all individuals required to have a criminal history and background check have received a clearance from the Department required in Section 309 of these rules. (3-20-20)T

**06. Statement to Comply.** The applicant must provide a written statement that these rules have been thoroughly read and reviewed and the applicant is prepared to comply with all of its provisions. (3-20-20)T

**07. Statement Disclosing Revocation or Disciplinary Actions.** A written statement that discloses any revocation or other disciplinary action taken or in the process of being taken against the applicant as a daycare provider in Idaho or any other jurisdiction, or a statement from the applicant stating he has never been involved in any such action. (3-20-20)T

**08. Other Information as Requested.** The applicant must provide other information that may be requested by the Department for the proper administration and enforcement of the provisions of this chapter. (3-20-20)T

**09. Additional Requirements for License Renewal.** A daycare license must be renewed every two (2) years. The daycare operator must submit to the Department the renewal application, fee, and all required documentation in this section of rule at least forty-five (45) days prior to the expiration of the current daycare license. (3-20-20)T

**10. Termination of Application Process.** Failure of the applicant to cooperate with the Department in the application process may result in the termination of the application process. Failure to cooperate means that the information requested is not provided within ninety (90) days, or not provided in the form requested by the Department, or both. (3-20-20)T

**322. -- 324. (RESERVED)**

**325. ISSUANCE OF LICENSE.**

**01. Department Action.** The Department will order a health and safety inspection of the daycare facility once the application for licensure is complete and the licensing fee has been paid. (3-20-20)T

**02. Issuance of a Regular License.** If the Department determines the applicant is in compliance with the rules and minimum standards set forth in these rules, the Department will, within sixty (60) days from the date the completed application is submitted, issue one (1) of the following licenses: (3-20-20)T

**a.** Daycare Center License, stating the type of facility, the number of children who may be in attendance, and the length of time the license is in effect; (3-20-20)T

**b.** Group Daycare Facility License, stating the type of facility, the number of children who may be in attendance, and the length of time the license is in effect; or (3-20-20)T

**c.** Family Daycare Home License, stating the type of facility, the number of children who may be in attendance, and the length of time the license is in effect. (3-20-20)T

**03. Denial of Licensure.** If the Department determines the applicant is not in compliance with the rules and minimum standards set forth in this chapter and further determines not to issue a regular license or provisional license, the Department will, within thirty (30) days from the date the completed application is submitted, issue a letter of denial of licensure stating the basis for the denial. (3-20-20)T

**04. Incomplete Application.** The Department is not required to take any action on an application until the application is complete. (3-20-20)T

**05. Notification of License Renewal.** The Department will notify the licensed daycare operator at least ninety (90) days prior to expiration of the license. (3-20-20)T

**06. List of Licensed Daycare Facilities.** The Department will maintain a list of all licensed daycare facilities for public use. (3-20-20)T

**326. -- 329. (RESERVED)**

**330. STAFF AND OTHER INDIVIDUAL RECORD REQUIREMENTS.**

Each owner or operator of a daycare center, group daycare facility, or family daycare home voluntarily licensed by the Department must maintain a current list covering the previous twelve-month period of all staff and other individuals thirteen (13) years of age or older who have unsupervised direct contact with children, or are regularly on the premises. The list must specify, at a minimum, the following: (3-20-20)T

- 01. **Legal Name.** (3-20-20)T
- 02. **Proof of Age.** (3-20-20)T
- 03. **Phone Number.** (3-20-20)T
- 04. **Record of Training.** (3-20-20)T
- 05. **Verification of Criminal History and Background Check Clearance.** (3-20-20)T
- 06. **Results of Juvenile Justice Records.** The results of juvenile justice records, when applicable. (3-20-20)T
- 07. **Certification.** Verification of Pediatric Rescue Breathing, Infant-Child CPR, and First Aid Treatment certification from a certified instructor, when applicable. (3-20-20)T
- 08. **Record of Hours.** The times, dates, and records of hours on the premises each day. (3-20-20)T

**331. CHILD RECORD CONTENT REQUIREMENTS.**

Each owner or operator of a daycare center, group daycare facility, or family daycare home voluntarily licensed by the Department, must maintain a record for each child in attendance covering the previous twelve-month period. The record must contain, at a minimum, the following: (3-20-20)T

- 01. **Child's Full Name.** (3-20-20)T
- 02. **Date of Birth.** (3-20-20)T
- 03. **Parent or Guardian's Name, Address, and Contact Information.** (3-20-20)T
- 04. **Emergency Contact Information.** (3-20-20)T
- 05. **Child's Health Information.** (3-20-20)T
  - a. Immunization record or waiver of exemption form or statement; (3-20-20)T
  - b. Any medical conditions that could affect the care of the child; (3-20-20)T
  - c. Medications the child is taking or may be allergic to. (3-20-20)T
- 06. **Record of Attendance.** The times, dates, and record of attendance each day. (3-20-20)T

**332. -- 334. (RESERVED)**

**335. CHILD-STAFF RATIO.**

Under Section 39-1109, Idaho Code, the Department determines the maximum allowable child-staff ratio based on a point system. (3-20-20)T

**01. Daycare Child-Staff Ratio Point System.**

The maximum allowable points for each staff member is twelve (12), using the following point system which is based on the age of each child in attendance: (3-20-20)T

- a. Under the age of twenty-four (24) months, each child equals two (2) points. (3-20-20)T
- b. From the age of twenty-four (24) months to under the age of thirty-six (36) months, each child equals one and one-half (1 1/2) points. (3-20-20)T
- c. From the age of thirty-six (36) months to under the age of five (5) years, each child equals one (1)

point. (3-20-20)T

d. From the age of five (5) years to under the age of thirteen (13) years, each child equals one-half (1/2) point. (3-20-20)T

**02. Compliance with Child-Staff Ratios.** Child-staff ratios must be maintained at all times during all hours of operation when children are in attendance and when transporting children. (3-20-20)T

a. Each child in attendance is counted by the Department for the purposes of calculating maximum allowable points, counting the number of children in attendance, and for determining compliance with child-staff ratios; (3-20-20)T

b. Each adult staff member who is providing direct care for a child or children is counted by the Department as one (1) staff member for the purposes of counting the number of staff on-duty and determining compliance with child-staff ratios; and (3-20-20)T

c. Each staff member sixteen (16) and seventeen (17) years of age under the supervision of an adult staff member, when providing direct care for a child or children, may be counted by the Department as one (1) staff member for the purposes of counting the number of staff on-duty and determining compliance with child-staff ratios. (3-20-20)T

**03. Supervision of Children.** The owner or operator and all staff are responsible for the direct care, protection, supervision, and guidance of children through active involvement or direct observation. In addition to meeting all of the minimum requirements of child-staff ratio, the owner or operator of a daycare center, group daycare facility, or family daycare home licensed by the Department must ensure that at least one (1) adult staff member is: (3-20-20)T

a. Awake and on duty on the premises at all times during regular business hours or when children are in attendance, and (3-20-20)T

b. Currently certified in pediatric rescue breathing, infant-child CPR, and first-aid treatment. (3-20-20)T

**04. Napping Children.** Napping children who are not within sight of a staff member must be within easy hearing distance at all times. (3-20-20)T

**05. Overnight Daycare.** For daycare operators providing overnight care of children, the following must apply: (3-20-20)T

a. A sleeping child must sleep on the same level as the staff member who must be able to hear the child; and (3-20-20)T

b. A staff member must be awake and on duty to release and receive a child. (3-20-20)T

**336. -- 339. (RESERVED)**

**340. DAYCARE CENTER TRAINING REQUIREMENTS.**

Each owner or operator of a daycare center licensed by the Department must receive and ensure that each staff member receives and completes four (4) hours of ongoing training every twelve (12) months after the staff member's date of hire. (3-20-20)T

**01. Child Development Training.** Training must be related to continuing education in child development. (3-20-20)T

**02. Documented Training.** It is the responsibility of the owner or operator of the daycare center to ensure that each staff member has completed four (4) hours of training each year. The training must be documented in the staff member's record. (3-20-20)T



**03. Pediatric Rescue Breathing, Infant-Child CPR and First Aid Treatment Training.** Pediatric rescue breathing, infant-child CPR, and first aid treatment training will not count towards the required four (4) hours of annual training. (3-20-20)T

**04. Staff Training Records.** Each owner or operator of the daycare center is responsible for maintaining documentation of staff's training and may be asked to produce documentation at the time of license renewal. (3-20-20)T

**341. -- 344. (RESERVED)**

**345. MANDATORY REPORTING OF ABUSE, ABANDONMENT, OR NEGLECT.**

Under Section 16-1605, Idaho Code, daycare personnel, including the owners, operators, staff, and any other person who has reason to believe that a child has been abused, abandoned, or neglected or is being subjected to conditions or circumstances which would reasonably result in abuse, abandonment, or neglect, must report or cause to be reported within twenty-four (24) hours, such conditions or circumstances to the Department or the proper law enforcement agency. (3-20-20)T

**346. VISITATION AND ACCESS.**

**01. Visitation Rights.** Parents and guardians have the absolute right to enter the daycare premises when their child is in the care of the daycare operator. Failure or refusal to allow parental or guardian entry to the daycare premises or access to their child may result in the suspension or revocation of a daycare license. (3-20-20)T

**02. Denied or Limited Visitation Rights by Court Order.** If a parent or guardian has been granted limited or has been denied visitation rights by a court of competent jurisdiction, and the daycare operator has written documentation from the court, Subsection 346.01 of this rule does not confer a right to visitation upon the parent or guardian. (3-20-20)T

**03. Department Access.** The owner or operator of a daycare center, group daycare facility, or family daycare home voluntarily licensed by the Department, must allow the Department access to the premises for re-inspection at any time during the licensing period. (3-20-20)T

**347. -- 349. (RESERVED)**

**350. FIRE SAFETY STANDARDS.**

Each daycare center, group daycare facility, or family daycare home voluntarily licensed by the Department, must comply with the fire safety standards outlined in Subsections 350.01 and 350.02 of this rule. (3-20-20)T

**01. Inspections.** Inspections must be completed by the local fire official or designee. For a daycare located outside of the area of authority outlined in Section 39-1109, Idaho Code, the Department can designate an approved inspector for daycare licensing purposes only. (3-20-20)T

**02. Unobstructed Exits.** Required exits must be located in such a way that an unobstructed path outside the building is provided to a public way or area of refuge. (3-20-20)T

**a.** Exit doors must open from the inside without the use of a key or any special knowledge or effort. (3-20-20)T

**b.** There must be at least two (2) exits located a distance apart of not less than one-half (1/2) the diagonal dimension of the building or portion used for daycare, but not to exceed seventy-five (75) feet. An exception may be made for the following: (3-20-20)T

**i.** The distance between exits may be extended to ninety (90) feet if the building is totally protected throughout with smoke detectors; or (3-20-20)T

**ii.** The distance between exits may be increased to one hundred ten (110) feet if the building is

equipped with an automatic fire sprinkler system. (3-20-20)T

**c.** The required dimensions of exits must not be less than thirty-two (32) inches of clear exit width and not be less than six (6) feet, eight (8) inches in height. An exception for sliding patio doors will be accepted as a required second exit in a family daycare home and group daycare facilities only. (3-20-20)T

**d.** Sleeping room exits must be provided with at least one (1) emergency egress window having at least a minimum single net clear opening of five point seven (5.7) square feet, minimum height twenty-four (24) inches, minimum width twenty (20) inches, and maximum finished sill height not over forty-four (44) inches. (3-20-20)T

**i.** Approved egress windows from sleeping areas must be operable from the inside without the use of separate tools. (3-20-20)T

**ii.** In lieu of egress windows, an approved exit door is acceptable. (3-20-20)T

**iii.** An approved piece of furniture or platform, if anchored in place, may be approved to sit in front of a window if the sill height is over forty-four (44) inches. (3-20-20)T

**e.** Where children are located on a story below the level of exit discharge (basement), there must be at least two (2) exits, one (1) of which must open directly to the outside. More than one (1) exit from the basement opening directly to the outside may be required, depending on the structure of the building, in order to ensure the safety of the occupants. (3-20-20)T

**f.** Where children are located on a story above the level of exit discharge, there must be two (2) exits, one (1) of which must open directly to the outside and be in compliance with building codes. (3-20-20)T

**351. FACILITY CAPACITY AND DETERMINING OCCUPANT LOAD.**

Occupant load is determined by the local fire official or designee. (3-20-20)T

**01. Area for Daycare Use Only.** The local fire official or designee will only use those areas used for daycare purposes when determining the occupant load. (3-20-20)T

**02. Facilities with an Occupancy Load of Fifty or More.** Facilities with an occupancy load of fifty (50) or more occupants must meet the requirements in Section 350 of these rules in addition to Subsections 351.01 through 351.03 of this rule. (3-20-20)T

**a.** Exit doors must swing in the direction of egress. (3-20-20)T

**b.** Exit doors from rooms, if provided with a latch, must have panic hardware installed. (3-20-20)T

**03. Exit Signs.** Exit signs must be installed at required exit doorways and wherever else necessary to clearly indicate the direction of egress. (3-20-20)T

**352. FIRE EXTINGUISHERS AND SAFETY REQUIREMENTS.**

Each daycare center, group daycare facility, or family daycare home voluntarily licensed by the Department, must comply with the fire extinguisher and safety requirements in this section of rule as applicable for size and type of facility. (3-20-20)T

**01. Portable Fire Extinguisher.** There must be an approved portable fire extinguisher (minimum 2A-10BC) mounted securely in a visible location not to exceed five (5) feet from the floor to the top of the extinguisher and not more than seventy five (75) feet travel distance to an extinguisher and maintained properly. (3-20-20)T

**02. Kitchen Area.** An approved fire extinguisher must be present or a hood-type fire suppression system must be installed in the kitchen area. (3-20-20)T

**03. Fire Extinguishers.** Approved fire extinguishers must be maintained properly. (3-20-20)T

**04. Facilities Over Three Thousand Square Feet.** Each daycare facility over three thousand (3,000) square feet is required to have additional fire extinguishers as approved by the local fire official or designee.

(3-20-20)T

**05. Fire Alarm System.** Each daycare facility with over fifty (50) children, must have an approved fire alarm system installed.

(3-20-20)T

**06. Smoke Detectors.** Smoke detectors must be installed and maintained in the following locations:

(3-20-20)T

**a.** On the ceiling or wall outside or each separate sleeping area in the immediate vicinity of bedrooms;

(3-20-20)T

**b.** In each room used for sleeping purposes; and

(3-20-20)T

**c.** In each story within a facility including basements.

(3-20-20)T

**d.** If there is a basement, there must be a smoke detector installed in the basement having a stairway which opens from the basement into the facility. Such detector must be connected to a sounding device or other detector to provide an alarm which is audible in the sleeping area.

(3-20-20)T

**07. Automatic Sprinkler Systems.** An automatic sprinkler system must be provided in all daycare facilities greater than twenty thousand (20,000) square feet in area or when the number of children under the age of eighteen (18) months exceeds one hundred (100).

(3-20-20)T

**353. FIRE SAFETY AND EVACUATION PLANS.**

Each daycare center, group daycare facility, or family daycare home voluntarily licensed by the Department, must have an approved fire safety and evacuation plan prepared. Fire evacuation and safety plans must include the following:

(3-20-20)T

**01. Evacuation.** Procedures and policies for accounting for staff and children after an evacuation is completed.

(3-20-20)T

**02. Assembly Point.** Evacuation plan and assembly point for children and staff.

(3-20-20)T

**03. Locations of Facility Exits.**

(3-20-20)T

**04. Evacuation Routes.**

(3-20-20)T

**05. Location of Fire Alarms.**

(3-20-20)T

**06. Location of Fire Extinguishers.**

(3-20-20)T

**07. Annual Review.** Fire safety and evacuation plans must be reviewed or updated annually and available in the facility for reference and review.

(3-20-20)T

**08. Frequency of Fire and Emergency Evacuation Drills.** Fire and evacuation drills must be conducted on a routine schedule and all staff and children must participate.

(3-20-20)T

**354. -- 359. (RESERVED)**

**360. HEALTH STANDARDS.**

Each daycare center, group daycare facility, or family daycare home voluntarily licensed by the Department, must comply with the health standards in Subsections 360.01 through 360.19 of this rule. Health inspections will be completed by a qualified inspector designated by the Department.

(3-20-20)T

- 01. Food Source.** Food must be from an approved source as defined in IDAPA 16.02.19, “The Idaho Food Code.” Food must not be served past expiration or “use by date.” (3-20-20)T
- 02. Food Preparation.** Food for use in daycare facilities must be prepared and served in a sanitary manner with sanitized utensils and on surfaces that have been cleaned, rinsed, and sanitized prior to use to prevent cross-contamination. (3-20-20)T
- a.** Frozen food must be thawed in the refrigerator, under cold running water, or as part of the cooking process. Food must be cooked to proper temperatures according to IDAPA 16.02.19, “The Idaho Food Code.” (3-20-20)T
- b.** Individuals preparing food must use proper hand-washing techniques, minimize bare hand contact with food, and wear clean clothes. (3-20-20)T
- 03. Food Temperatures.** Potentially hazardous foods must be kept refrigerated at forty-one degrees Fahrenheit (41°F) or below, held hot at one hundred thirty-five degrees Fahrenheit (135°F) or more, and reheated or cooled at safe temperatures according to IDAPA 16.02.19, “The Idaho Food Code.” Refrigerators must be equipped with an accurate thermometer. (3-20-20)T
- 04. Food Storage.** All food that is served in daycare facilities must be stored in such a manner that protects it from potential contamination. There must be no evidence of pests present in the daycare facility. (3-20-20)T
- 05. Food Contact Surfaces.** Food contact surfaces must be kept clean and sanitized, including counters, serving tables, high chair trays, and cutting boards. (3-20-20)T
- 06. Dishwashing Sanitizing.** Dishes, glasses, utensils, silverware and all other objects used for food preparation and eating must be sanitized using appropriate sanitizing procedures. (3-20-20)T
- 07. Utensil Storage.** Clean utensils must be stored on clean shelves or drawers and not subject to recontamination. Sharp knives and other sharp objects must be kept out of reach of children. (3-20-20)T
- 08. Garbage.** Garbage must be kept covered or inaccessible to children. (3-20-20)T
- 09. Hand Washing.** Children and facility staff must be provided with individual or disposable towels for hand drying. The hand washing area must be equipped with soap and warm and cold running water. (3-20-20)T
- 10. Diaper Changing.** Diaper changing must be conducted in such a manner as to prevent the spread of communicable diseases. A diaper-changing area must be separate from food preparation and serving areas and have easy access to a hand-washing sink. (3-20-20)T
- 11. Sleeping Areas.** Children sleeping at the facility must have separate cots, mats, or beds and blankets. (3-20-20)T
- 12. Restrooms, Water Supply, and Sewage.** All daycare facilities must have restrooms. (3-20-20)T
- a.** Each facility must have at least one (1) flushable toilet and at least one (1) hand washing sink with warm and cold water per restroom. (3-20-20)T
- b.** Plumbing and bathroom fixtures must be in good condition. (3-20-20)T
- c.** In addition, daycare centers must comply with requirements of the state-adopted International Building Code. (3-20-20)T
- 13. Water Supply.** The facility's water supply must meet one (1) of the following requirements: (3-20-20)T

**a.** Be from a public water system which is maintained according to IDAPA 58.01.08, "Idaho Rules for Public Drinking Water Systems," at the time of initial application and application for license renewal; or (3-20-20)T

**b.** Be from a private source, such as well or spring, and must be tested annually for bacteria and nitrate, and approved by the Department. (3-20-20)T

**c.** Water used for consumption at a daycare facility must be from an acceptable source,. Temporary use of bottled water or boiled water may be allowed for a period specified by the by the Department. (3-20-20)T

**14. Sewage Disposal.** Facility sewage must be disposed of through a public system, or in the absence of a public system, in a manner approved by the local health authority, according to IDAPA 58.01.03 "Individual/ Subsurface Sewage Disposal Rules." (3-20-20)T

**15. Use of Alcohol and Illegal Drugs.** Alcohol and illegal drugs must not be used by operators, children, staff, volunteers, or visitors at daycare facilities or in the presence of children during hours of operation or in vehicles while transporting children. (3-20-20)T

**a.** Any individual under the influence of alcohol or drugs must not be permitted at or in the daycare facility. (3-20-20)T

**b.** Illegal drugs are prohibited by law and therefore must not be allowed on the premises of a licensed daycare facility at anytime whether the facility is open or closed. (3-20-20)T

**16. Smoke Free Environment.** Children must be afforded a smoke-free environment during all daycare hours, whether indoors or outdoors. While children are in care, the operator and all staff must ensure that no smoking or other tobacco use occurs within the facility, in outdoor areas, or in vehicles when children are present. (3-20-20)T

**17. Medication.** No person can administer any medication to a child without it first being authorized by a parent or caretaker. All medications, refrigerated or unrefrigerated, must be in a locked box or otherwise inaccessible to children. (3-20-20)T

**18. Adequate Heat, Light and Ventilation.** A daycare facility must have adequate heat, light and ventilation. Window and doors must be screened if used for ventilation. (3-20-20)T

**19. Immunizations.** Daycare operators must comply with the immunizations requirements provided in IDAPA 16.02.11, "Immunization Requirements for Children Attending Licensed Day Care Facilities in Idaho." (3-20-20)T

**361. MISCELLANEOUS SAFETY REQUIREMENTS.**

Each daycare center, group daycare facility, or family daycare home voluntarily licensed by the Department must comply with the miscellaneous safety standards in Subsections 361.01 through 361.07 of this rule. (3-20-20)T

**01. Telephone.** An operable telephone or cell phone must be available on the facility at all times and the following conditions must apply: (3-20-20)T

**a.** The telephone number used to meet this standard must be made available to parents and guardians. (3-20-20)T

**b.** Emergency phone numbers to include 911, an adult emergency substitute operator, as well as the address and phone number of the facility, must be posted by the telephone or in a location that is immediately visible at all times. (3-20-20)T

**02. Heat Producing Equipment.** A furnace, fireplace, wood-burning stove, water heater and other flame or heat-producing equipment must be installed and maintained as recommended by the manufacturer and protected on all surfaces by screens or other means. (3-20-20)T

**03. Portable Heating Devices.** Portable heating devices must be limited and approved for use and location by the Fire Inspector prior to use within a facility. (3-20-20)T

**04. Storage of Weapons, Firearms, and Ammunition.** Firearms or other weapons which are stored at a daycare facility must be kept in a locked cabinet or other container that is inaccessible to children, including a locked gun safe, while children are in attendance. (3-20-20)T

**a.** Ammunition must be stored in a locked container separate from firearms. (3-20-20)T

**b.** Matches, lighters, and any other means of starting fires must be kept away from and out of the reach of children. (3-20-20)T

**c.** Other weapons that could cause harm to children must be stored out of reach of children. (3-20-20)T

**05. Animals and Pets.** Any pet or animal present at the facility, indoors or outdoors, must be in good health, show no evidence of carrying disease, and be a friendly companion of the children. The operator must maintain the animal's vaccinations and vaccination records. These records must be made available to the Department upon request. (3-20-20)T

**06. Storage of Hazardous Materials.** Cleaning materials, flammable liquids, detergents, aerosol cans, pesticides, and other poisonous and toxic materials must be kept in their original containers and in a place inaccessible to children. They must be used in such a way that will not contaminate play surfaces, food, food preparation areas or constitute a hazard to the children. (3-20-20)T

**362. -- 364. (RESERVED)**

**365. BUILDINGS, GROUNDS, FURNISHINGS, AND EQUIPMENT.**

Each daycare center, group daycare facility, or family daycare home voluntarily licensed by the Department must comply with these minimum standards in Subsections 365.01 through 365.08 of this rule. (3-20-20)T

**01. Appliances and Electrical Cords.** All appliances, lamp cords, exposed light sockets and electrical outlets must be protected to prevent electrocution. (3-20-20)T

**02. Balconies and Stairways.** Balconies and stairways accessible to children must have substantial railings as required by the state-adopted International Building Code. (3-20-20)T

**03. Stairway Protection.** Where an operator cares for children less than three (3) years of age, stairways must be protected to prevent child access to stairs. (3-20-20)T

**04. Hazard Areas Restrictions.** Based on the age and functioning level of children in care and the type of hazard, any outdoor hazard area must be restricted to prevent easy access to the hazard. (3-20-20)T

**05. Fueled Equipment.** Fueled equipment including, but not limited to, motorcycles, mopeds, lawn-care equipment and portable cooking equipment may not be stored or repaired in areas where children are present. (3-20-20)T

**06. Water Hazards.** Above and below ground pools, hot tubs, ponds, and other bodies of water that are on the daycare facility premises must provide the following safeguards: (3-20-20)T

**a.** The area surrounding the body of water must be fenced and locked in a manner that prevents access by children and meets the following requirements: (3-20-20)T

**i.** The fence must be at least four (4) feet high with no vertical opening more than four (4) inches wide and be designed so that a young child cannot climb or squeeze under or through the fence. The fence must surround all sides of the pool and have a self-closing gate that has a self latching mechanism in proper working order that is out of the reach of young children. (3-20-20)T

ii. If the house forms one (1) side of the barrier for the pool, all doors that provide unrestricted access to the pool must have alarms that produce an audible sound when the door is opened. (3-20-20)T

b. Furniture or other large objects must not be left near the fence in a manner that would enable a child to climb on the furniture or other large object and gain access to the pool. If the area surrounding a pool, hot tub, pond or other body of water is not fenced and locked, there must be a secured protective covering that will prevent access by a child. (3-20-20)T

c. Wading pools and buckets must be empty when not in use. (3-20-20)T

d. Children must be under direct supervision of an adult staff member who is certified in pediatric rescue breathing, infant-child CPR, and first aid treatment while using a bath tub, pool, hot tub, pond, or other body of water. (3-20-20)T

e. A minimum of a four (4) foot high fence must be present that prevents access from the daycare facility premises, if the daycare premises are adjacent to a body of water. (3-20-20)T

**07. Indoor Play Areas and Toys.** The indoor play areas must be clean, reasonably neat and free from accumulation of dirt, rubbish or other health hazards. (3-20-20)T

**08. Outdoor Play Areas and Toys.** Any outdoor play area must be maintained free from hazards such as wells, machinery and animal waste. (3-20-20)T

a. If any part of the play area is adjacent to a busy roadway, drainage or irrigation ditch, stream, large holes, or other hazardous areas, the play area must be enclosed with a fence in good repair that is at least four (4) feet high without any holes or spaces greater than four (4) inches in diameter. (3-20-20)T

b. Outdoor equipment, such as climbing apparatus, slides and swings, must be anchored firmly and placed in a safe location and in accordance with the manufacturer's instructions. (3-20-20)T

c. Outdoor play areas must be designed so that all parts are always visible and are easily supervised by a staff member. (3-20-20)T

d. Toys, play equipment, and any other equipment used by the children must be of substantial construction and free from rough edges and sharp corners. Unguarded ladders on slides must be kept in good repair and well maintained. (3-20-20)T

e. Toys and objects with a diameter of less than one (1) inch (two point five (2.5) centimeters), objects with removable parts that have a diameter of less than one (1) inch (two point five (2.5) centimeters), plastic bags, styrofoam objects and balloons must not be accessible to children ages three (3) and under or children who are known to place such objects in their mouths. (3-20-20)T

**366. -- 389. (RESERVED)**

**390. CONTINUED COMPLIANCE, REPORTING CHANGES, AND CRITICAL INCIDENTS.**

Each daycare owner or operator must remain in compliance at all times with fire, safety, and health requirements as required in this chapter of rules. (3-20-20)T

**01. Posting of License and Other Information.** (3-20-20)T

a. A daycare license issued by the Department to operators meeting the standards in these rules must be posted in plain view where it can be seen by parents and the public upon entering the facility. (3-20-20)T

b. A daycare must post contact information of the Department and the statewide number to file daycare complaints. (3-20-20)T

**02. Reporting Changes.** The Department must be notified of any changes that would affect the terms of licensure or could affect the health, well-being, or safety of children. (3-20-20)T

**03. Critical Incidents.** A daycare operator must report any of the following to the Department within twenty-four (24) hours: (3-20-20)T

**a.** Serious injury or death of a child at the facility; (3-20-20)T

**b.** Any arrests, citations, withheld judgments, or criminal convictions of disqualifying crimes associated with Section 39-1113, Idaho Code, of an operator or any other individual regularly on the premises of the facility and provide documentation that the individual is not working with children or is not on the premises. (3-20-20)T

**391. -- 394. (RESERVED)**

**395. FAILURE TO COMPLY.**

**01. Misdemeanors to Operate Without a License.** It is a misdemeanor to operate a daycare center or group daycare facility within this state without first obtaining a daycare license from the Department or to operate a daycare center or group daycare facility without posting the license in a place easily seen by a parent or the general public. (3-20-20)T

**a.** The Department may grant a grace period of no more than sixty (60) days to allow the daycare facility to come into compliance with the minimum standards in this chapter and with Title 39, Chapter 11, Idaho Code. (3-20-20)T

**b.** The operator or owner must agree to begin the application process as described in Section 321 of these rules within one (1) business day of identification by the Department that a daycare owner or operator is not in compliance with Title 39, Chapter 11, Idaho Code or this chapter of rules. (3-20-20)T

**02. Misdemeanor to Operate a Family Daycare Home for Four or More Children Without Obtaining a Criminal History Check.** It is a misdemeanor to operate a family daycare home caring for four (4) or more children without obtaining the required criminal history check in Section 39-1105, Idaho Code. In the event of an initial citation for violation of the provisions of Section 39-1115, if a person makes the applications required within twenty (20) days, the complaint will be dismissed. Operating a family daycare home for four (4) or more children after failure to pass the required criminal history check is a misdemeanor. (3-20-20)T

**03. Misdemeanor to Provide Daycare if Guilty of Certain Offenses.** It is a misdemeanor to provide daycare services if found guilty of any offenses listed in Section 39-1113, Idaho Code. (3-20-20)T

**396. -- 399. (RESERVED)**

**STANDARDS FOR FOSTER HOMES**  
**(Sections 400-499)**

**400. STANDARDS FOR FOSTER HOMES.**

The standards for licensing foster homes are intended to insure that children of the state who must live away from their parents receive adequate substitute parental care to address their need for safety, health, and well being, that the persons providing this care are capable and suitable to meet the protection needs of children living in foster homes, and the physical environment in which these children reside is a safe setting. (3-20-20)T

**401. LICENSING PROVISIONS RELATED TO THE INDIAN CHILD WELFARE ACT.**

These rules do not supercede the licensing authority of Indian tribes pursuant to the Indian Child Welfare Act, P.L. 95-608, 25 USC, Sections 1901 – 1963. (3-20-20)T

**402. FOSTER PARENT QUALIFICATIONS AND SUITABILITY.**

Foster parents must be physically and emotionally suited to care for children and to deal with the problems presented



by children placed away from their own parents, family and homes. An applicant for licensure as a foster parent must meet all of the following qualifications: (3-20-20)T

- 01. Minimum Age.** Be twenty-one (21) years of age or older. (3-20-20)T
- 02. Character.** Be of good character. (3-20-20)T
- 03. Personal Attributes and Experiences.** Have the maturity, interpersonal qualities, temperament and life experiences that prepare the foster parent to provide foster care. (3-20-20)T
- 04. Availability for Child Placement.** Express a willingness to provide care for the kind of children the children's agency has available for placement. (3-20-20)T
- 05. Knowledge and Skill.** Demonstrate an understanding of the care that must be provided to the children served by the children's agency or express a willingness to learn how to provide that care. (3-20-20)T
- 06. Child Care and Supervision.** Have adequate time to provide care and supervision for children. (3-20-20)T
- 07. Income and Resources.** Have a defined and sufficient source of income and be capable of managing that income to meet the needs of the foster family without relying on the payment made for the care of a foster child. (3-20-20)T
- 08. Health.** Have the physical, intellectual, and emotional health to assure appropriate care of children. (3-20-20)T
- 09. Harmonious Home Life.** Establish and maintain a harmonious home life to give children the emotional stability they need. No marital or personal problems may exist within the family that would result in undue emotional strain in the home or be harmful to the interest of children placed in the home. (3-20-20)T
- 10. Acceptance of Foster Children.** Express a willingness and demonstrate the ability to accept a child into the home as a member of the family. (3-20-20)T
- 11. Family Supports.** Express a willingness, and demonstrate the ability, to work with a foster child's legal family, future family, or Indian tribe. (3-20-20)T
- 12. Compliance with Licensing Rules.** Demonstrate a willingness and ability to comply with the licensing rules for foster homes. (3-20-20)T

**403. MEMBER OF HOUSEHOLD QUALIFICATIONS AND SUITABILITY.**

To assure the safety and well-being of children, a member of the household must be in compliance with the requirements specified in these rules. (3-20-20)T

**404. CRIMINAL HISTORY AND BACKGROUND CHECKS FOR FOSTER CARE LICENSE.**

All applicants for a foster care license and other adult members of the household must comply with the provisions in IDAPA 16.05.06, "Criminal History and Background Checks," and the following requirements: (3-20-20)T

- 01. Required Procedures.** Each applicant for a foster home license, and any other adult member of the household, must participate in a criminal history and background check as required by Section 39-1211(4), Idaho Code. (3-20-20)T
- 02. Change in Household Membership.** By the next working day after another adult begins residing in a licensed foster home, a foster parent must notify the children's agency of the change in household membership and assure that the new adult member of the household will participate in a criminal history and background check as required by Section 39-1211(4), Idaho Code. (3-20-20)T
- 03. Foster Parent's Child Turns Eighteen.** A foster parent's child who turns eighteen (18) and lives

continuously in the home is not required to have a criminal history and background check except as specified in Subsection 404.03.c. of this rule. (3-20-20)T

**a.** After turning eighteen (18) years of age, if the foster parent's adult child no longer lives in the foster parent's home and subsequently resumes living in the licensed foster home, he will be considered an adult member of the household and must complete a criminal history and background check within fifteen (15) days from the date he became an adult member of the household. (3-20-20)T

**b.** If the adult child leaves the foster home for the purpose of higher education or military service, and periodically returns to the home for less than ninety (90) days, he is not considered to be an adult member of the household and is not required to complete a criminal history and background check. While in the home, he cannot have any unsupervised direct care responsibilities for any foster children in the home. Should he remain in the foster home for more than ninety (90) days, he will immediately be considered an adult member of the household and must complete a criminal history and background check within fifteen (15) days from the date he became an adult member of the household. (3-20-20)T

**c.** If the adult child continues to live in their parent's licensed foster home or on the same property, he must complete a criminal history and background check within fifteen (15) days of turning twenty-one (21). This requirement is not necessary if the adult child has completed a criminal history and background check between the ages of eighteen (18) and twenty-one (21). (3-20-20)T

**04. Criminal History and Background Check at Any Time.** The Department retains the authority to require a criminal history and background check at any time on individuals who are residing in a licensed foster home or on the foster parent's property. (3-20-20)T

**405. INITIAL EVALUATION.**

An applicant must participate in the process and tasks to complete an initial evaluation for foster care licensure. (3-20-20)T

**01. Applicant Participation.** The applicant must do all of the following: (3-20-20)T

**a.** Cooperate with and allow the children's agency to determine compliance with these rules to conduct an initial foster home study; (3-20-20)T

**b.** Inform the children's agency if the applicant is currently licensed or has been previously licensed as a foster parent or the applicant has been involved in the care and supervision of children or adults; (3-20-20)T

**c.** Provide a medical statement for each applicant, signed by a qualified medical professional, within the twelve (12) month period prior to initial licensure for family foster care, indicating the applicant is in such physical and mental health so as to not adversely affect either the health or quality of care for children placed in the home; (3-20-20)T

**d.** Provide the name of, and a signed release to obtain the following information about, each member of the household: (3-20-20)T

**i.** Admission to or release from a facility, hospital, or institution for the treatment of an emotional, intellectual, or substance abuse issue; (3-20-20)T

**ii.** Outpatient counseling, treatment, or therapy for an emotional, intellectual, or substance abuse issue; and (3-20-20)T

**e.** Provide three (3) satisfactory references, one (1) of which may be from a person related to the applicant(s). An applicant will provide additional references upon the request of the children's agency. (3-20-20)T

**02. Members of the Household Physical and Mental Health.** All members of the household must be in such physical and mental health that the health, safety, or well-being of a foster child will not be adversely affected. A report of the member of the household's physical and mental health status may be required from a qualified

medical professional if this appears advisable to the children's agency. (3-20-20)T

**03. Disclosure of Information.** An applicant must provide the children's agency with the following information and any other information the children's agency deems necessary to complete the initial family home study: (3-20-20)T

- a.** The names, including maiden or other names used, and ages of the applicant(s); (3-20-20)T
- b.** Social security number; (3-20-20)T
- c.** Education; (3-20-20)T
- d.** Verification of marriages and divorces; (3-20-20)T
- e.** Religious and cultural practices of the applicant including their willingness and ability to accommodate or provide care to a foster child of a different race, religion, or culture; (3-20-20)T
- f.** A statement of income and financial resources and the family's management of these resources; (3-20-20)T
- g.** Marital relationship, if applicable, including decision making, communication, and roles within the family; (3-20-20)T
- h.** Individual and family functioning and inter-relationships with each member of the household; (3-20-20)T
- i.** Any current family problems, including mental illness, drug and alcohol abuse, and medical conditions; (3-20-20)T
- j.** Previous criminal convictions and valid incidents of child abuse and neglect; (3-20-20)T
- k.** Family history, including childhood experiences and the applicant's parents' methods of discipline and problem solving; (3-20-20)T
- l.** Child care and parenting skills; (3-20-20)T
- m.** Current methods of discipline; (3-20-20)T
- n.** The names, ages, and addresses of all biological and adopted children currently residing in or outside the home; (3-20-20)T
- o.** Adjustment and special needs of the applicant's children; (3-20-20)T
- p.** Interests and hobbies; (3-20-20)T
- q.** Reasons for applying to be a foster parent; (3-20-20)T
- r.** Understanding of the purpose and goals of foster care; (3-20-20)T
- s.** Prior and current experiences with foster care; (3-20-20)T
- t.** Emotional stability and maturity in dealing with the needs, challenges, and related issues associated with the placement of a child into applicant(s) home; (3-20-20)T
- u.** The attitudes toward foster care by immediate and extended members of the family and other persons who reside in the home; (3-20-20)T

v. The applicant's attitudes about a foster child's family and the applicant's willingness to work with the child's family and tribe; (3-20-20)T

w. Specifications of the children preferred by the family that include the number of children, age, gender, race, ethnic background, social, emotional and educational characteristics of children preferred; (3-20-20)T

x. Adequacy of the applicant's house, property, and neighborhood for the purpose of providing foster care as determined by on-site observations; (3-20-20)T

y. The applicant(s) willingness to abide by the children's agency policies and procedures for discipline; (3-20-20)T

z. Three (3) personal references, at least two (2) that are from persons not related to the applicants, reflecting the applicants to be of good character and habits; (3-20-20)T

aa. Training needs of the applicant(s); and (3-20-20)T

bb. The capacity and willingness to transport a foster child in a motor vehicle. (3-20-20)T

**406. SUBSEQUENT EVALUATIONS.**

A foster parent must comply with the following requirements for the subsequent evaluation required for a foster care license: (3-20-20)T

**01. Reasonable Access.** A foster parent will allow the children's agency reasonable access to the foster home, including interviewing each foster parent, each foster child and any member of the household to determine continued compliance with licensing standards, for child supervision purposes, and to conduct a re- certification study. (3-20-20)T

**02. Update Information.** Provide all changes to the information contained in the initial evaluation and subsequent evaluations. (3-20-20)T

**03. Family Functioning.** Provide information on any changes in family functioning and inter-relationships. (3-20-20)T

**04. Other Circumstances.** Provide the children's agency with any information regarding circumstances within the family that may adversely impact the foster child. (3-20-20)T

**05. Written Plan of Correction.** Cooperate with the children's agency in developing and carrying out a written plan required to correct any rule non-compliance identified by any evaluation conducted by the children's agency. (3-20-20)T

**407. FOSTER PARENT DUTIES.**

A foster parent must carry out the following functions: (3-20-20)T

**01. Service Plan Implementation.** Cooperate with, and assist the children's agency in, the implementation of the service plan for children and their families. (3-20-20)T

**02. Reporting Progress and Problems.** Promptly and fully disclose to the children's agency information concerning a child's progress and problems. (3-20-20)T

**03. Termination of Placement by the Foster Family.** Provide notification to the children's agency of the need for a child to be moved from the foster home not less than fourteen (14) calendar days before the move, except when a delay would jeopardize the child's care or safety or the safety of members of the foster family. (3-20-20)T

**04. Written Policies and Procedures for Foster Families.** Maintain a copy of, be familiar with, and follow these rules and any other rules, policies, or procedures which an agency may require for foster parents and

foster care. (3-20-20)T

**408. FOSTER PARENT TRAINING.**

Each foster parent must comply with the following training requirements: (3-20-20)T

**01. Orientation.** Each applicant for a foster home license will receive an orientation related to the children's agency foster care program and services. (3-20-20)T

**02. Initial Training.** Complete not less than ten (10) hours of training no later than one (1) year following the issuance of an initial foster care license. (3-20-20)T

**03. Annual Training.** Complete not less than ten (10) hours of training on an annual basis following the initial training specified in these rules. (3-20-20)T

**04. Individualized Training.** Complete training identified by the children's agency as meeting the individual needs of the foster parent(s). (3-20-20)T

**05. Required Training.** Complete any additional training as required by the children's agency foster parent training plan. (3-20-20)T

**409. -- 429. (RESERVED)**

**430. CHILD CARE AND SAFETY REQUIREMENTS.**

The property, structure, premises, and furnishings of a foster home must be constructed and maintained in good repair, in a clean condition, free from safety hazards and dangerous machinery and equipment. Areas and equipment that present a hazard to children must not be accessible by children. (3-20-20)T

**01. Pools, Hot Tubs, Ponds, and Other Bodies of Water.** Any licensed foster home with a body of water on or adjacent to their property must provide the following safeguards: (3-20-20)T

**a.** Around any body of water, a foster child must have appropriate adult supervision consistent with the child's age, physical ability, and developmental level; (3-20-20)T

**b.** The area surrounding a body of water must be fenced and locked in a manner that prevents access by children; or (3-20-20)T

**c.** If the area surrounding a body of water is not fenced and locked, there must be a secured protective covering that will not allow access by a child; (3-20-20)T

**i.** Pool or hot tub covers must be completely removed when in use; (3-20-20)T

**ii.** When the pool or hot tub cover is in place, the cover must be free from standing water; (3-20-20)T

**iii.** Covers must be kept locked at all times when the pool or hot tub is not in use; and (3-20-20)T

**iv.** Exterior ladders on above ground pools must be removed when the pool is not in use. (3-20-20)T

**02. Access by Children Five Years of Age and Under.** Any licensed foster home that cares for children five (5) years of age and under and chooses to prevent access to a body of water by fencing must provide a fence that meets the following requirements: (3-20-20)T

**a.** The fence must be at least four (4) feet high with no vertical opening more than four (4) inches wide, be designed so that a young child cannot climb or squeeze under or through the fence, and surround all sides of the pool or pond; (3-20-20)T

**b.** The gate must be self-closing and have a self-latching mechanism in proper working order out of the reach of young children; (3-20-20)T

c. If the house forms one (1) side of the barrier for the pool, doors that provide unrestricted access to the pool must have alarms that produce an audible sound when the doors are opened; and (3-20-20)T

d. Furniture or other large objects must not be left near the fence that would enable a child to climb on the furniture and gain access to the pool. (3-20-20)T

**03. Irrigation Canals or Similar Body of Water.** A licensed foster home caring for a child five (5) years of age and under or a child who is physically or developmentally vulnerable, whose property adjoins an irrigation canal or similar body of water, must have fencing that prevents access to the canal or similar body of water by the child. (3-20-20)T

**04. Other Safety Water Precautions.** (3-20-20)T

a. Wading pools must be empty when not being used; (3-20-20)T

b. Children must be under direct supervision of an adult while using a wading pool; (3-20-20)T

c. Toys that attract young children to the pool area must be kept picked up and away for the pool area when not in use; and (3-20-20)T

d. A child who does not know how to swim must use an approved lifesaving personal flotation device. (3-20-20)T

**431. INSTALLATION, MAINTENANCE AND INSPECTION OF FLAME AND HEAT PRODUCING EQUIPMENT.**

A foster parent must assure: (3-20-20)T

**01. Installation and Maintenance of Flame and Heat-Producing Equipment.** That a furnace, fireplace, wood-burning stove, water heater and other flame or heat-producing equipment is installed and maintained as recommended by the manufacturer, and fireplaces are protected by screens or other means. (3-20-20)T

**02. Portable Heating Devices.** That portable heating devices will not be used during sleeping hours. (3-20-20)T

**03. Fire Inspections.** An inspection by a certified fire inspector may be required at the discretion of the children's agency. (3-20-20)T

**432. SMOKE AND CARBON MONOXIDE DETECTING DEVICES.**

Each foster home must meet the following standards: (3-20-20)T

**01. Smoke Detecting Devices.** That there will be at least one (1) single-station smoke detector (approved by a nationally recognized testing laboratory) that is installed and maintained as recommended by the manufacturer and as follows: (3-20-20)T

a. One (1) smoke detector on each floor of the home, including the basement; (3-20-20)T

b. One (1) smoke detector in each bedroom used by a foster child; and (3-20-20)T

c. One (1) smoke detector in areas of the home that contain flame or heat-producing equipment other than domestic stoves and clothes dryers. (3-20-20)T

**02. Carbon Monoxide Detecting Devices.** That there will be at least one (1) carbon monoxide detecting device (approved by a nationally recognized testing laboratory) that is installed and maintained as recommended by the manufacturer. A house that does not have equipment which produces carbon monoxide or does not have an attached garage is exempt from this requirement. (3-20-20)T

**433. EXITS.**

There must be at least two (2) exits from each floor level used by a family member that are remote from each other, one (1) of which provides a direct safe means of unobstructed travel to the outside at street or ground level. A window may be used as a second exit if it is in compliance with these rules. (3-20-20)T

**434. DANGEROUS AND HAZARDOUS MATERIALS.**

Dangerous and hazardous materials, objects or equipment, including but not limited to poisonous, explosive or flammable substances that could present a risk to a child placed in a foster home, must be stored securely and out of reach of a child, as appropriate for the age and functioning level of the child. (3-20-20)T

**435. FIREARMS AND AMMUNITION.**

Firearms at a foster home must be stored: (3-20-20)T

- 01. Trigger Locks.** Unloaded and equipped with a trigger lock; (3-20-20)T
- 02. Unassembled and Inoperable.** Unloaded, fully inoperable and incapable of being assembled and fired; (3-20-20)T
- 03. Locked Cabinet or Container.** Unloaded and locked in a cabinet or storage container that is inaccessible to children; or (3-20-20)T
- 04. Gun Safe.** Locked in a gun safe that is inaccessible to children. (3-20-20)T

**436. PETS AND DOMESTIC ANIMALS.**

Any pet or domestic animal that is suspected or known to be dangerous must be kept in an area inaccessible to children. (3-20-20)T

**437. ADEQUATE HEAT, LIGHT, AND VENTILATION.**

A foster home must have adequate heat, light, and ventilation and windows and doors will be screened if used for ventilation. (3-20-20)T

**438. BATHROOMS, WATER SUPPLY, AND SEWAGE DISPOSAL.**

A foster home must meet the following standards: (3-20-20)T

- 01. Toilet Facilities.** A foster home will have a minimum of one (1) flush toilet, one (1) washbasin that has warm and cold running water, and one (1) bathtub or shower that has warm and cold running water, all of which are in good working order. (3-20-20)T
- 02. Water Supply.** The water supply will meet one (1) of the following requirements: (3-20-20)T
  - a.** That it is from a source approved for a private home by the health authority according to IDAPA 58.01.08, "Idaho Rules for Public Drinking Water Systems," at the time of application and for annual renewal of such licenses; or (3-20-20)T
  - b.** Water used for consumption at a foster home is from an acceptable source, bottled water from an acceptable source, or boiled for a period specified by the local health authority according to IDAPA 58.01.08, "Idaho Rules for Public Drinking Water Systems." (3-20-20)T
- 03. Sewage Disposal.** Sewage will be disposed of through a public system, or in the absence of a public system, in a manner approved by the local health authority, according to IDAPA 58.01.03 "Individual/Subsurface Sewage Disposal Rules." (3-20-20)T

**439. TRANSPORTATION.**

A foster parent must comply with the requirements related to child transportation that include: (3-20-20)T

- 01. Legal Requirements for Transporting Children.** A foster parent, or any person acting on behalf of a foster parent, that transports a child, will possess a valid Idaho driver's license, be insured in accordance with

Idaho Law, and abide by all traffic laws including the requirement that all children are in proper safety restraints while being transported. (3-20-20)T

**02. Reliable Transportation.** A foster parent will arrange for safe, reliable transportation of any foster child in their care to assure the child has access to school, community services, and the children's agency. (3-20-20)T

**03. Prohibitions of Foster Child Transportation.** A foster parent will not transport a foster child while impaired by any substance including alcohol, prescription medication, or any illegal substances. (3-20-20)T

**440. TELEPHONE.**  
Unless previously approved by the licensing agency, there must be an operating telephone in a foster home. (3-20-20)T

**441. WHEELCHAIR ACCESS.**  
A foster home that provides care to a child who regularly requires the use of a wheelchair, must be wheelchair accessible. (3-20-20)T

**442. CHILD PLACEMENT REQUIREMENTS.**  
A foster family must accept the placement of children into the home within the terms of the foster home license or certification and the children's agency placement agreement. The following provisions will be considered for determining placement: (3-20-20)T

**01. Determining Factors.** The number and the age group of children placed in a foster home will be determined by all of the following: (3-20-20)T

- a.** The accommodations and the space in the home; (3-20-20)T
- b.** The interest of the foster family; and (3-20-20)T
- c.** The experience or skill of the foster family. (3-20-20)T

**02. Maximum Number of Children.** Except as specified, the maximum number of children in care at any time, including the foster family's own children, or daycare children, will be limited to not more than six (6) children. (3-20-20)T

**03. Children Under Two Years of Age.** Except as specified in Subsection 442.04 of these rules, the maximum number of children under two (2) years of age, including those of the foster family, will be limited to not more than two (2) children. (3-20-20)T

**04. Special Circumstances Regarding Maximum Numbers of Children.** The maximum number of children in care at any time may be increased to not more than two (2) additional children, based on any of the following: (3-20-20)T

- a.** The increased capacity would allow for siblings to remain together; or (3-20-20)T
- b.** The increased capacity would allow a family to provide care to a child who has an established, meaningful relationship with the family; or (3-20-20)T
- c.** The foster home offers unusual space, skill, or experience. (3-20-20)T

**05. Continued Care.** A foster child who reaches the age of eighteen (18) years may continue in foster care placement until the age of twenty-one (21) years if the safety, health and well-being of other foster children residing in the home is not jeopardized. Not more than two (2) such individuals receiving continued care may reside in the foster home at the same time. (3-20-20)T

**443. INTERAGENCY PLACEMENT OF CHILDREN.**  
A foster family must only accept for placement children referred from the children's agency that licenses or certifies



the foster home. A foster family may accept for placement a foster child from another children's agency only if that children's agency and the foster family have received prior approval for the placement of a child from the children's agency that licensed or certified the home. (3-20-20)T

**444. SUBSTITUTE CARE PLACEMENT AND CHILDREN'S AGENCY NOTIFICATION.**  
A foster parent must: (3-20-20)T

**01. Substitute Care.** Place a child in substitute care only with the prior knowledge and consent of the children's agency. (3-20-20)T

**02. Notification to Agency.** Notify the children's agency before the beginning of any planned absence that requires substitute care of a child for a period of twenty-four (24) hours or more. (3-20-20)T

**445. BEDROOMS.**  
A foster parent must comply with the following rules: (3-20-20)T

**01. Sleeping Arrangements.** A bedroom occupied by a foster child will: (3-20-20)T

**a.** Provide an adequate opportunity for both rest and privacy for each child; (3-20-20)T

**b.** Be readily accessible to adult supervision as appropriate for the age and functioning level of each child; (3-20-20)T

**c.** Have sufficient floor space to provide two (2) feet of space between beds; (3-20-20)T

**d.** Have sufficient space for the storage of clothing and personal belongings; (3-20-20)T

**e.** Have a finished ceiling, permanently affixed floor-to-ceiling walls, and finished flooring; (3-20-20)T

**f.** Have a latchable door that leads to an exit from the foster home; (3-20-20)T

**g.** Have at least one (1) outside window that complies with the following: (3-20-20)T

**i.** Is readily accessible to children and the foster parent; (3-20-20)T

**ii.** Is readily opened from the inside of the room; and (3-20-20)T

**iii.** Is of sufficient size and design to allow for the evacuation of children and caregivers. (3-20-20)T

**h.** Is free of all of the following: (3-20-20)T

**i.** Household heating equipment excluding baseboard heating systems; (3-20-20)T

**ii.** Water heater; and (3-20-20)T

**iii.** Clothes washer and dryer. (3-20-20)T

**02. Non-Ambulatory Child.** A child who is non-ambulatory and cannot readily be carried by one (1) member of the household will sleep in a bedroom located at ground level. (3-20-20)T

**03. Sharing Bedroom with a Non-Parent Adult.** A child will not share a bedroom with a non-parent adult unless the child and adult are of the same gender and there is not more than four (4) years difference in age between the adult and the youngest child in the bedroom. (3-20-20)T

**04. Sharing a Bedroom with a Foster Parent.** A child three (3) years of age or older will not routinely share the bedroom with a foster parent unless the child has special health or emotional needs that require the

attention of the foster parent(s) during sleeping hours. (3-20-20)T

**05. Maximum Number of Children in a Bedroom.** No more than four (4) children will occupy a bedroom. The placement of more than any one (1) child in a bedroom will be based on the age, behavior, functioning, individual needs of each child, and sufficient available space. (3-20-20)T

**06. Children of the Opposite Gender.** Children of the opposite gender, any of whom are more than five (5) years of age, will not share the same bedroom. (3-20-20)T

**07. Number of Children in a Bed.** Each child will have an individual bed, except that two (2) brothers or two (2) sisters of comparable age may share a bed if they have previously shared a bed or when there are no health, behavioral or other factors indicating this is undesirable. (3-20-20)T

**08. Restrictions on Sleeping Arrangements.** The following must not be used for sleeping purposes: (3-20-20)T

- a. A room or area of the foster home that is primarily used for purposes other than sleeping; (3-20-20)T
- b. A room or space, including an attic, that is accessible only by a ladder, folding stairway, or through a trapdoor; or (3-20-20)T
- c. A detached building, except in the case of an older child preparing for emancipation when it can be documented that the child's needs can best be met by that arrangement. (3-20-20)T

**09. Appropriate Bedding.** A child will have a bed that is appropriate for the age and development of the child. Beds will be equipped with a clean and comfortable mattress, pillow, linens, and blankets appropriate for the weather. (3-20-20)T

**446. BEHAVIOR MANAGEMENT AND DISCIPLINE.**

Methods of behavior management and discipline for children must be positive and consistent. These methods must be based on each child's needs, stage of development, and behavior. Discipline is to promote self-control, self-esteem, and independence. (3-20-20)T

- 01. Prohibitions.** All of the following types of punishment of a foster child are prohibited: (3-20-20)T
- a. Physical force or any kind of punishment inflicted on the body, including spanking; (3-20-20)T
  - b. Cruel and unusual physical exercise or forcing a child to take an uncomfortable position; (3-20-20)T
  - c. Use of excessive physical labor with no benefit other than for punishment; (3-20-20)T
  - d. Mechanical, medical, or chemical restraint; (3-20-20)T
  - e. Locking a child in a room or area of the home; (3-20-20)T
  - f. Denying necessary food, clothing, bedding, rest, toilet use, bathing facilities, or entrance to the foster home; (3-20-20)T
  - g. Mental or emotional cruelty; (3-20-20)T
  - h. Verbal abuse, ridicule, humiliation, profanity, threats or other forms of degradation directed at a child or a child's family; (3-20-20)T
  - i. Threats of removal from the foster home; (3-20-20)T

**j.** Denial of visits or communication with a child's family unless authorized by a children's agency in its service plan for the child and family; and (3-20-20)T

**k.** Denial of necessary educational, medical, counseling, or social services. (3-20-20)T

**02. Restraint.** A foster parent who has received specific training in the use of child restraint may use reasonable restraint methods, approved by the children's agency, to prevent a child from harming himself, other persons or property, or to allow a child to gain control of himself. (3-20-20)T

**03. Authority.** The authority for the discipline of a foster child must not be delegated by a foster parent to other members of the household. (3-20-20)T

**04. Agency Consultation.** A foster parent must consult with the children's agency prior to using any behavior management or discipline technique that exceeds the scope of these rules. (3-20-20)T

#### **447. MEDICAL AND DENTAL CARE.**

**01. Health Care Services.** A foster parent must follow and carry out the health or dental care plan for a child as directed by a qualified medical professional. (3-20-20)T

**02. Child Injury and Illness.** Follow the children's agency approved policies for medical care of a child who is injured or ill. (3-20-20)T

**03. Dispensing of Medications.** Provide prescription medication as directed by a qualified medical professional. A foster parent must not discontinue or in any way change the medication provided to a child unless directed to do so by a qualified medical professional. (3-20-20)T

**04. Storage of Medication.** A foster parent must store medications in an area that is inaccessible to a child. (3-20-20)T

#### **448. PERSONAL CARE AND HYGIENE.**

A foster parent must instruct the child in personal care, hygiene and grooming and provide the child with necessary personal care, hygiene and grooming products appropriate to the age, gender, and needs of the child. The foster parents will seek approval from the children's agency before altering a child's physical appearance including haircuts, body piercing and tattooing. (3-20-20)T

#### **449. FOOD AND NUTRITION.**

A foster parent must provide a foster child with meals that are nutritious, well-balanced, of sufficient quantity and serve the foster child the same meals as other members of the household unless a special diet has been prescribed by a medical professional, or unless otherwise dictated by differing needs based on a child's age, medical condition, or cultural or religious beliefs. A foster child is required to eat with other members of the family, unless the child's medical condition dictates a different arrangement. Perishable foods must be refrigerated. Milk provided to foster children must be pasteurized, from a licensed dairy or come from an animal that is documented to be free from tuberculosis, brucellosis, or other conditions that could be injurious to a child's health. (3-20-20)T

#### **450. NECESSARY CLOTHING.**

A foster parent must provide a child with sufficient, clean, properly fitting clothing appropriate for the child's age, gender, individual needs, and season with clothing reflecting cultural and community standards. (3-20-20)T

#### **451. PERSONAL POSSESSIONS, ALLOWANCES, AND MONEY.**

A foster parent must follow the children's agency policy regarding a child's personal possessions, allowance, and money and when a child moves from a foster home, the foster parent will provide the child or the children's agency with all of the child's possessions, including money. (3-20-20)T

#### **452. CHILD TASKS.**

A parent must permit a child to perform only those routine tasks that are within the child's ability, are reasonable, and are similar to the routine tasks expected of other members of the household of similar age and ability. (3-20-20)T

**453. EDUCATION.**

A foster parent must cooperate with the children's agency and applicable educational organizations to implement the education and training plan for each child. (3-20-20)T

**454. RELIGIOUS AND CULTURAL PRACTICES.**

A foster parent must provide a child in care with opportunity for spiritual development and cultural practices in accordance with the wishes of the child and the child's parent or tribe. (3-20-20)T

**455. RECREATION.**

A foster parent must provide or arrange access to a variety of indoor and outdoor recreational activities and encourage a child to participate in recreational activities that are appropriate for the child's age, interests, and ability. (3-20-20)T

**456. MAIL.**

A foster parent must permit a child to send and receive mail in accordance with the mail policy of the children's agency. (3-20-20)T

**457. REASONABLE AND PRUDENT PARENT STANDARD.**

A caregiver must follow the reasonable and prudent parent standard. (3-20-20)T

**01. Reasonable and Prudent Parent Standard Defined.** The reasonable and prudent parent standard means the standard characterized by careful and sensible parental decisions that maintain the health, safety, and best interests of a child while at the same time encouraging the emotional and developmental growth of the child that a caregiver must use when determining whether to allow a child in foster care under the responsibility of the state to participate in extracurricular, enrichment, cultural, or social activities. (3-20-20)T

**a.** "Caregiver" means a foster parent with whom a child in foster care has been placed or a designated official for a child care institution in which a child in foster care has been placed. (3-20-20)T

**b.** "Age or developmentally appropriate" means: (3-20-20)T

**i.** Activities or items that are generally accepted as suitable for children of the same chronological age or level of maturity or that are determined to be developmentally appropriate for a child, based on the development of cognitive, emotional, physical, and behavioral capacities that are typical for an age or age group; and (3-20-20)T

**ii.** In the case of specific child, activities or items that are suitable for the child based on the developmental stages attained by the child with respect to the cognitive, emotional, physical, and behavioral capacities of the child. (3-20-20)T

**02. Training.** Each caregiver will complete training to include knowledge and skills relating to the reasonable and prudent parent standard for the participation of the child in age or developmentally appropriate activities, including knowledge and skills relating to the developmental stages of the cognitive, emotional, physical, and behavioral capacities of a child, and applying the standard to decisions such as whether to allow the child to engage in social, extracurricular, enrichment, cultural, and social activities, including sports, field trips, and overnight activities lasting one (1) or more days, and involving the signing of permission slips and arranging transportation for the child to and from extracurricular enrichment and social activities. (3-20-20)T

**458. -- 469. (RESERVED)**

**470. RECORD MANAGEMENT AND REPORTING REQUIREMENTS.**

A foster parent must maintain a record for each child in the home that will include all written material provided to the foster home by the children's agency and additional information gathered by the foster parent that includes the following: (3-20-20)T

**01. Personal Data.** The child's name, gender, date of birth, religion, race and tribe, if applicable; (3-20-20)T

- 02. History of Abuse and Neglect.** Any known history of abuse or neglect of the child; (3-20-20)T
- 03. Emotional and Psychological Needs.** Any known emotional and psychological needs of the child; (3-20-20)T
- 04. Health.** Any information known about the child's health; and (3-20-20)T
- 05. Behavioral Problems.** Any known behavioral problems of the child; (3-20-20)T

**471. REPORTING FOSTER HOME CHANGES.**

A foster parent must report to the children's agency any significant change in the foster home by the next working day from the time a foster parent becomes aware of a change, including the following: (3-20-20)T

- 01. Illness, Injury, or Death.** Serious illness, injury, or death of a foster parent or a member of the household. (3-20-20)T
- 02. Arrests, Citations, Withheld Judgments, or Criminal Convictions.** Any arrests, citations, withheld judgments, or criminal convictions of a foster parent or member of the household. (3-20-20)T
- 03. Parole and Probation.** Initiation of court-ordered parole or probation of a foster parent or member of the household. (3-20-20)T
- 04. Admission or Release From Facilities.** Admission to, or release from, a correctional facility, a hospital, or an institution for the treatment of an emotional, mental health, or substance abuse issue of a foster parent or member of the household. (3-20-20)T
- 05. Employment.** A change of employment status of a foster parent. (3-20-20)T
- 06. Counseling, Treatment or Therapy.** Counseling or other methods of therapeutic treatment on an outpatient basis for an emotional, mental, or substance abuse issue of a foster parent or member of the household. (3-20-20)T
- 07. Change of Residence.** A foster parent will inform the children's agency of any planned change in residence and submit an application for licensure at the new address not less than two (2) weeks prior to a change in residence. (3-20-20)T
- 08. Additional Licensing Application.** A foster parent will notify the children's agency within five (5) calendar days after filing an application for a certified family home, daycare, or group daycare license. (3-20-20)T

**472. CONFIDENTIALITY.**

A foster parent must maintain the confidentiality of any information and records regarding a foster child and the child's parents and relatives, and a foster parent will release information about the foster child only to persons authorized by the children's agency responsible for the foster child. (3-20-20)T

**473. UNUSUAL INCIDENT NOTIFICATION.**

The foster parent must immediately notify the responsible children's agency of any of the following incidents: (3-20-20)T

- 01. Death.** Death of a child in care. (3-20-20)T
- 02. Suicide.** Suicidal ideation, threats, or attempts to commit suicide by the foster child. (3-20-20)T
- 03. Missing.** When a foster child is missing from a foster home. (3-20-20)T
- 04. Illness.** Any illness or injury that requires hospitalization of a foster child. (3-20-20)T

**05. Law Enforcement Authorities.** A foster child's detainment, arrest, or other involvement with law enforcement authorities. (3-20-20)T

**06. Removal of Child.** Attempted removal or removal of a foster child from the foster home by any person who is not authorized by the children's agency. (3-20-20)T

**474. -- 499. (RESERVED)**

**CHILDREN'S AGENCIES AND CHILDREN'S RESIDENTIAL CARE FACILITIES**  
**(Sections 500-599)**

**500. GENERAL STANDARDS FOR ORGANIZATIONS KNOWN AS CHILDREN'S AGENCIES AND CHILDREN'S RESIDENTIAL CARE FACILITIES.**  
(Sections 500 through 599, see also Sections 000 through 299) (3-20-20)T

**501. ACCESS BY DEPARTMENT AUTHORIZED AGENTS.**  
The Department's representatives must be provided access to the children's agency, children's therapeutic outdoor program, or children's residential care facility and its grounds, facilities, and records for determining compliance with applicable rules and investigation of complaints against the organization. (3-20-20)T

**502. COMPLIANCE REQUIRED.**  
Before being licensed as an organization, the applicant must comply with all applicable rules where compliance can be achieved prior to being licensed and must demonstrate intent to comply with the applicable rules where compliance can only be achieved once the program has become fully operational. (3-20-20)T

**503. NOTIFICATION TO THE LICENSING AUTHORITY.**  
An organization must notify the licensing authority a minimum of thirty (30) days prior to a change in the name of the organization, type of service, type of children being served, an increase in licensed capacity of a child care facility or children's residential care facility, or the organization closes, moves or changes ownership. (3-20-20)T

**504. NOTIFICATION TO THE LICENSING AUTHORITY NO LATER THAN ONE WORKING DAY.**  
An organization must notify the licensing authority no later than one (1) working day of any circumstance in Subsections 504.01 through 504.04 of this rule: (3-20-20)T

**01. Fire.** There is a fire in a structure housing residents that requires the services of a fire company. (3-20-20)T

**02. Injured Child.** A child is injured and requires in-patient hospital treatment. (3-20-20)T

**03. Change in Administrator.** There is a change in chief administrator for the organization. (3-20-20)T

**04. Employee Investigated.** An employee is the subject of an investigation for child abuse or neglect. (3-20-20)T

**505. UNAUTHORIZED ABSENCES.**  
Upon an unauthorized absence of a child in care, an organization must immediately notify the parent, guardian or placing children's agency and law enforcement. Clothing and other personal belongings must be secured immediately until the child returns or other arrangements are made, according to organization standards. (3-20-20)T

**506. DEATH OF A CHILD IN CARE NOTIFICATION.**  
An organization must immediately notify the parent, guardian or placing children's agency and the licensing authority upon the death of a child in care. In the event of a sudden death, or if the death occurs as a result of a crime or accident, the appropriate law enforcement agency must be contacted immediately by the organization. (3-20-20)T

**507. -- 519. (RESERVED)**

**520. WRITTEN BYLAWS.**

Except for an organization operated by a governmental entity, an organization must have written bylaws defining the board structure, philosophy and program. (3-20-20)T

**521. GOVERNING BODY REQUIRED.**

An organization must have an identifiable functioning governing body. The governing body must designate a person to function as the chief administrator of the organization, who is competent to administer the organization and delegate the overall day to day responsibility for the administration and operation of the organization. There must be a written plan for the delegation of authority in the absence of the chief administrator. (3-20-20)T

**522. DELINEATION OF JOB RESPONSIBILITIES.**

An organization must delineate, in writing, the job responsibilities and functions of the chief administrator. The chief administrator must adopt and implement lines of responsibility that ensure the proper and effective supervision and monitoring of employees and volunteers. (3-20-20)T

**523. ORGANIZATIONAL CHART, POLICIES AND PROCEDURES.**

An organization must have an organizational chart identifying the job positions, individuals in each position, and the lines of authority within the organization. (3-20-20)T

**524. INSURANCE COVERAGE.**

An organization must secure and maintain on file copies of current motor vehicle, fire, comprehensive general liability, and professional liability insurance. (3-20-20)T

**525. QUALITY OF SERVICES ENVIRONMENT.**

An organization must carry out its licensed programs in an environment that is safe, accessible, and appropriate for the needs of those served and with due regard for the rights and protections of those persons receiving services. (3-20-20)T

**01. Assess Compliance.** The organization's administration must assess compliance with the applicable rules annually. (3-20-20)T

**02. Corrective Action for Non-Compliance.** For each item of non-compliance, within thirty (30) days of notification by the licensing authority, the organization must have developed and implemented a plan approved by the licensing authority to correct each item within six (6) months. (3-20-20)T

**03. Expeditious Correction.** The licensing authority may require a more expeditious correction when it determines there is a health and safety risk to children. Imminent risk to a child requires the corrective action be completed within twenty-four (24) hours of discovery of the non-compliance by the licensing authority. (3-20-20)T

**04. Assess Disrupted Placement.** The organization must also assess all disrupted placements and unplanned removals of children from foster homes, transitional living, adoptive homes, children's therapeutic outdoor program, and children's residential care facilities. Corrective action must be implemented to correct causes of disrupted and unplanned removals. (3-20-20)T

**526. RESEARCH PROTECTIONS FOR PERSONS SERVED.**

An organization must have a mechanism for reviewing and recommending approval and denial of research proposals involving past or present persons served. When an organization or another acting on its behalf participates in research involving its clients, the organization must maintain the privacy and right of refusal of any person to participate. (3-20-20)T

**527. CONFIDENTIALITY AND PRIVACY PROTECTIONS OF PERSONS SERVED.**

An organization must have and follow written policies and procedures governing access to, use of, and release of information about a person served. The privacy of a child and their family must be protected. The identity of a child used in any form of publicity must be given only when written consent of the child's parent or guardian has been obtained prior to using or allowing to be used a child, picture of a child, or a child's name. Written consent is not required for publicity specifically used to locate an adoptive placement for a child. (3-20-20)T

**528. DESCRIPTION OF SERVICES.**

An organization must have and follow a written description of the services and fees the organization charges including those provided by the licensee or arranged through other sources. This information must be factual and available to the public. The description must include policies governing eligibility for service, age, specific characteristics, and treatment needs of children served, accommodation of cultural sensitivity, and the geographic area served. (3-20-20)T

**529. INTAKE POLICY.**

An organization must have and follow a written intake policy that sets forth the criteria for admitting children for care or services. The policy must be in keeping with the organization's purpose and services provided. Except for an emergency placement, the intake policy must include a requirement that sufficient information on each child admitted for care or services is obtained to determine that the child can be appropriately served by the organization. For an emergency placement the policy must require that the information needed to determine the appropriateness of continuing the placement or services is obtained within seven (7) days of the child's admission or placement. (3-20-20)T

**530. CONTINUED CARE.**

Continued care is permitted as defined and authorized in the Idaho Child Care Licensing Reform Act Sections 39-1202 and 39-1213, Idaho Code, and Section 531 of these rules for individuals eighteen (18) to twenty-one (21) years of age. (3-20-20)T

**01. Department or Department of Juvenile Corrections (DJC) Placed Individuals.** Continued care is permitted for individuals receiving services by, through, or with the authorization of the Department or the Department of Juvenile Corrections (DJC) prior to their eighteenth birthday. (3-20-20)T

**02. Individuals Not Placed by Department or DJC.** Individuals who are in the care of a licensed child care program prior to turning eighteen (18) years of age may remain in the program for up to ninety (90) days after their eighteenth birthday, or, until the close of the current school year for individuals attending school. (3-20-20)T

**531. DOCUMENTATION REQUIREMENTS FOR CONTINUED CARE.**

Prior to accepting an individual into continued care the following requirements must be met: (3-20-20)T

**01. Voluntary Agreement.** A signed voluntary agreement to remain in the program, or a copy of a court order authorizing continued placement after the individual's eighteenth birthday. (3-20-20)T

**02. Assessment for Others Safety.** An assessment to assure that an individual in continued care does not jeopardize the health, safety and well being of the children in care of the organization. (3-20-20)T

**03. Additional Continued Care Plans.** A plan that prohibits individuals in continued care from sharing a bedroom or other sleeping quarters with a child as defined in Section 010 of these rules. (3-20-20)T

**04. Documentation of Care Prior to Eighteenth Birthday.** Documentation verifying the individual in continued care was in the care of the organization prior to eighteenth birthday. (3-20-20)T

**05. Documentation of Need for Continued Care.** Documentation verifying the individual in continued care needs to remain in order to complete treatment, education, or other similar needs. (3-20-20)T

**532. -- 534. (RESERVED)**

**535. SUFFICIENT FINANCIAL RESOURCES.**

An organization must have sufficient financial resources to implement and deliver its programs. It must initially and annually develop and implement a plan of financing to carry out its programs, to ensure that children receive safe and appropriate care and needed services, and to ensure applicable licensing requirements are met. The plan of financing must include realistic projected income and expenditures. (3-20-20)T

**536. ANNUAL AUDIT.**



An organization must provide the licensing authority a copy of an annual audit, an auditor's report, or a current federal tax return. (3-20-20)T

**537. -- 543. (RESERVED)**

**544. HUMAN RESOURCES NEEDED.**

An organization must determine, organize and deploy the human resources needed to provide services subject to applicable rules and to promote optimum outcomes for persons served. An organization must have an adequate number of qualified administrative, supervisory, social service, direct care staff and other staff to perform the prescribed functions required by applicable rules to provide for the needs, safety, protection and supervision of children served. (3-20-20)T

**545. SERVICE WORKER OR SOCIAL WORKER.**

An organization must employ, at a minimum, one (1) service or social worker, as defined in Section 011 of these rules, for a minimum of thirty-two (32) hours per week. (3-20-20)T

**546. STAFF RECRUITMENT, HIRING, SUPERVISION, TRAINING, EVALUATION, PROMOTION AND DISCIPLINE.**

An organization must have and follow written policies and procedures governing recruitment, screening, hiring, supervision, training, evaluation, promotion, and discipline of employees and volunteers. An organization must employ persons and use volunteers who have an understanding and respect for children and their needs, the child's family and culture; are physically and emotionally suited to provide, services to unrelated children and the problems they present; and are capable of performing activities related to their job. (3-20-20)T

**01. Job Descriptions.** An organization must have and follow written job descriptions for every position identifying necessary qualifications, including education, experience, training, duties, and lines of authority. (3-20-20)T

**02. Personnel Records.** An organization must have a personnel record for every employee and volunteer. The record must contain the following: (3-20-20)T

- a.** Employment application; (3-20-20)T
- b.** Name, date of birth, current address and home phone number; (3-20-20)T
- c.** Documents verifying education, certification, and license when the person fills a position requiring a minimum level of education, applicable certification or license; (3-20-20)T
- d.** Verification of child care work history; (3-20-20)T
- e.** Three (3) references from persons who are unrelated to the employee or volunteer. For a job applicant who has worked for an organization which provides care or services to children, one (1) of the references must be from a prior child care provider for whom the employee or volunteer worked; (3-20-20)T
- f.** Verified documentation of a complete criminal history record check as required by Section 39-1210, Idaho Code; (3-20-20)T
- g.** Verification by the employee or volunteer of receipt of the organization's behavior management policy; (3-20-20)T
- h.** Copy of the current job description and verification that the employee has been provided a copy of their current job description; (3-20-20)T
- i.** The date the person was employed and the date they began their current job; (3-20-20)T
- j.** For staff and volunteers who transport children, a copy of a valid driver's license for the type of vehicle used while transporting children. If they use their own vehicle to transport children, the record must include

proof that the vehicle is properly insured. (3-20-20)T

**k.** A performance evaluation within a probationary period and annual performance evaluations thereafter; and (3-20-20)T

**l.** Documentation of any disciplinary actions. (3-20-20)T

**547. PERSON FILLING MORE THAN ONE POSITION.**  
A person filling more than one (1) position must meet the requirements for each position. (3-20-20)T

**548. (RESERVED)**

**549. TUBERCULOSIS SCREENING.**  
Staff and volunteers who have contact with children for four (4) or more hours per week for two (2) or more consecutive weeks must have documentation in their personnel file that they are free from communicable tuberculosis. The screening and documentation must be updated every three (3) years. (3-20-20)T

**550. VOLUNTEER SUPERVISION.**  
A designated employee of the organization must supervise a volunteer. (3-20-20)T

**551. EMPLOYEE AND VOLUNTEER ORIENTATION.**  
An organization must document that each new employee, contractor, and volunteer participates in an orientation that includes the information described as follows in Subsections 551.01 through 551.04 of this rule: (3-20-20)T

**01. Organization.** The purpose of the organization. (3-20-20)T

**02. Job Function.** The policies and procedures of the organization as they relate to their job function. (3-20-20)T

**03. Job Responsibilities.** The employee's, contractor's, or volunteer's role and responsibilities. (3-20-20)T

**04. Child Abuse, Neglect, and Abandonment Reporting.** The requirement to report suspected incidents of child abuse, neglect, and abandonment. (3-20-20)T

**552. EMPLOYEE AND VOLUNTEER TRAINING.**  
Except for a licensed professional under contract with the organization, an organization must document that each new employee and volunteer, and current employee and volunteer whose job function significantly changes, and whose primary role requires interaction with children, receive at least twenty-five (25) hours of planned training before working independently. Orientation cannot be counted toward the required training hours. The training must include specific instruction in job responsibilities, policies and procedures, emergency procedures, child safety, child abuse, neglect, or abandonment, and the applicable licensing requirements. (3-20-20)T

**553. -- 559. (RESERVED)**

**560. PERMANENT REGISTER.**  
Child agencies and child residential care facilities must maintain a permanent register of all children admitted into care. The permanent register must include each child's full name, gender, date and place of birth, parents or guardian, and address of the parent or guardian, who placed the child, the date of placement, date of discharge, and to whom the child was discharged. (3-20-20)T

**561. CONTENT OF CHILD'S RECORD.**  
At the time of a child's placement, the person admitting the child must document in the child's record the child's physical and emotional state at the time of placement. In addition, at the time of placement and if not available at the time of an emergency placement, then within seven (7) days, an organization must document complete biographical and identifying information on each child admitted into care. (3-20-20)T

- 01. Minimum Information.** The record must contain at a minimum the following: (3-20-20)T
- a.** Child's full name; (3-20-20)T
  - b.** Date and place of birth; (3-20-20)T
  - c.** Gender; (3-20-20)T
  - d.** Height, weight, hair color, eye color, race, and identifying marks; (3-20-20)T
  - e.** Last known address and with whom the child lived; (3-20-20)T
  - f.** Last school attended including previous grade level, current grade level and scholastic performance; (3-20-20)T
  - g.** Parents' full names, marital status, and addresses and if known to be separated or divorced, proof of custody; (3-20-20)T
  - h.** Guardian's name and address; (3-20-20)T
  - i.** Date of admission; (3-20-20)T
  - j.** Name of the person who placed the child in care; (3-20-20)T
  - k.** For children's residential care facilities which provide treatment, the child's primary diagnosis; (3-20-20)T
  - l.** The nature of the child's problems or the reason for being served; (3-20-20)T
  - m.** Documentation of authority to accept and care for the child; (3-20-20)T
  - n.** Child's and parent's religious preference; (3-20-20)T
  - o.** Where it has been determined that a child is of applicable Indian heritage, compliance with the Indian Child Welfare Act; (3-20-20)T
  - p.** Evaluation of the child's physical, social and emotional development and any special problems and needs he has, including medical, surgical and dental care needs; (3-20-20)T
  - q.** Reports of psychological tests and psychiatric examinations and follow-up treatment if obtained; (3-20-20)T
  - r.** Record of the child's contacts with their family; (3-20-20)T
  - s.** Projected discharge date; (3-20-20)T
  - t.** Discharge date and after care plan summary; and (3-20-20)T
  - u.** The assigned social worker or service worker. (3-20-20)T
- 02. Child's Health Record.** There must be a health record for each child, available to appropriate staff for emergency use and to provide for the child's routine care. The record must contain at a minimum the following: (3-20-20)T
- a.** The child's health history and initial health screening, including known allergies; (3-20-20)T
  - b.** A list of all medications the child is taking at the time of admission and any medication prescribed

- for the child while in care including the date prescribed and the prescribing physician; and (3-20-20)T
- c. A copy of the child's medical provider's name, address and telephone number. (3-20-20)T

**562. AUTHORIZATIONS REQUIRED.**

Written authorization must be obtained from the parent, guardian or court of jurisdiction to obtain and provide routine medical care, emergency medical and surgical care, and mental health care for the child. (3-20-20)T

**563. SERVICE PLANS.**

An organization must develop and follow a written service plan for a child admitted into care unless otherwise provided for in Sections 564, and 790 through 794 of these rules. (3-20-20)T

**01. Initial Service Plan.** The initial service plan must be developed and recorded in the child's record within thirty (30) days after admission and must: (3-20-20)T

- a. Identify the needs of the child and family and provide goals and a time frame to achieve the goals; (3-20-20)T
- b. Document services the organization will provide to assure the safety, health, permanency, and well-being of the child; (3-20-20)T
- c. Establish and document criteria for discharge; (3-20-20)T
- d. Demonstrate the service plan was developed in a process that included participation of the child's parent, guardian, or legal custodian, and the child. A child may be excluded from participation in development of the service plan if he is under nine (9) years of age or not capable of understanding the purpose of the planned services; and (3-20-20)T
- e. Identify the persons responsible for coordinating and implementing the child's and family's treatment goals. (3-20-20)T

**02. Updated Service Plan.** A service plan must be updated every ninety (90) days and must: (3-20-20)T

- a. Assess the appropriateness of continuing the current placement; (3-20-20)T
- b. Document services the organization will provide to assure the safety, health, permanency, and well-being of the child; (3-20-20)T
- c. Document progress towards achieving the goals in the service plan; (3-20-20)T
- d. Demonstrate the service plan was developed in a process that included participation of the child's parent, guardian, or legal custodian, and the child. A child may be excluded from participation in development of the service plan if he is under nine (9) years of age or not capable of understanding the purpose of the planned services. (3-20-20)T

**564. SHELTER CARE ADMISSION AND PLANS.**

The organization must develop and follow a written plan within seven (7) days of admission to shelter care. The plan must assess the child's immediate and specific needs and identify the specific services to be provided by the organization and other resources to meet the needs. (3-20-20)T

**01. Shelter Care in Excess of Thirty Days.** The organization must re-assess and update the written plan for each child remaining in shelter care for thirty (30) days and at forty-five (45) days. The plan must include: (3-20-20)T

- a. The reason for continued care; (3-20-20)T

- b. Plans for other placement; and (3-20-20)T
- c. Barriers to other placement and the plans to eliminate the barriers. (3-20-20)T

**02. Shelter Care More Than Sixty Days.** The organization must develop and follow service plans that comply with these rules, except the initial service plan must be developed after sixty (60) days of admission. The service plan must be updated every ninety (90) days thereafter. (3-20-20)T

**565. MAINTENANCE OF RECORDS.**

An organization must have and follow written policies and procedures for the maintenance and security of records. The policy and procedures must: (3-20-20)T

- 01. Record Storage.** Ensure that the records are stored in a secure manner. (3-20-20)T
- 02. Record Confidentiality.** Ensure confidentiality of and prevent unauthorized access to the records. (3-20-20)T
- 03. Organization of Record.** Require that similar type records be maintained in a uniform and organized manner. (3-20-20)T
- 04. Record Storage for Closed Organizations.** Before an organization ceases operations, it must arrange with the Department for the storage of all child and adoptive family records required to be maintained by rules. (3-20-20)T

**566. RECORD RETENTION.**

Except for an adoptive record, records must be maintained for at least seven (7) years after the child has been released from the organization's care or until the child reaches the age of twenty-five (25), which ever is longer. A record for an adopted child and adoptive parent must be kept forever. The record for each applicant for a foster care license or certification or an application to adopt where there was no adoptive placement must be maintained for at least seven (7) years after provision of services has ended. (3-20-20)T

**567. -- 569. (RESERVED)**

**570. REPORTING OF CHILD ABUSE, NEGLECT, AND ABANDONMENT.**

All suspected incidents of child abuse, neglect, or abandonment must be reported immediately to law enforcement or the Department as required by Section 16-1605, Idaho Code. The chief administrator or designee of the children's agency or facility must ensure the safety and protection of children when the allegation is against an organization's staff or volunteer and must initiate a thorough investigation and administer appropriate disciplinary action, when indicated. (3-20-20)T

**571. HEALTH SERVICES.**

The organization must provide a physical exam within the last year by a licensed physician when the child has been in continuous care. If a child has not been in continuous care, a physical must be done within thirty (30) days of admission by a licensed physician. Annual physical exams must be provided for a child two (2) years of age and older, and on a schedule determined by a pediatrician for a child under two (2) years of age. Documentation must be maintained of current immunizations or provisions for immunizations as required by Section 39-4801, Idaho Code, within thirty (30) days of admission. The organization must provide documentation of medical care for the treatment of illnesses, carrying out corrective measures and treatment, and for the administration of medication as ordered by the physician. (3-20-20)T

**572. DENTAL SERVICES.**

For children three (3) years of age and older, the organization must ensure and document the child has had a dental exam within the last nine (9) months or a dental exam within three (3) months of admission, a yearly dental exam and necessary dental treatment, including prophylaxis, extraction, repair and restoration. The organization must make provisions for appropriate dental care for a child under the age of three (3) when the child's dental needs indicate. Documentation of all medical treatment provided while the child is in care and documentation of applicable medical insurance provider, policy numbers and who holds the policy must be maintained. (3-20-20)T

**573. NON-VIOLENT PHYSICAL INTERVENTION.**

An organization must have written policies and procedures governing the appropriate use of non-violent physical restraint intervention strategies. The policies and procedures must be according to non-violent physical restraint intervention strategies of a nationally recognized program. Non-violent physical restraint intervention strategies must include the following: (3-20-20)T

**01. Protection from Harm to Self or Others.** Be used only when a child's behavior is out of control and could physically harm himself or others, or to prevent the destruction of property when the child fails to respond to non-physical behavior management interventions. (3-20-20)T

**02. Intervention Time Guidelines.** Be used only until the child has regained control and must not exceed fifteen (15) consecutive minutes, include written documentation of attempts made to release the child from the restraint if more than fifteen (15) minutes is required. (3-20-20)T

**03. Intervention Training Requirements.** Be used only by employees or volunteers documented to have been specifically trained in its use and authorized to apply such strategies. (3-20-20)T

**04. Conditions Limiting Restraint Use.** Prohibit the application of a non-violent physical restraint intervention if a child has a documented physical condition that would contraindicate its use, unless a qualified medical professional has previously and specifically authorized its use in writing. Documentation must be maintained in the child's record. (3-20-20)T

**05. Prohibition of Prone Restraints.** Prohibit the use of prone restraints. (3-20-20)T

**06. Intervention Documentation.** Require documentation of the behavior which required the non-violent physical restraint intervention strategy, the specific attempts to de-escalate the situation before using physical restraint, the length of time of the non-violent physical restraint intervention strategy was applied which includes documentation of the time started and completed, and the debriefing completed with the staff and child involved in the non-violent physical restraint intervention strategy. (3-20-20)T

**07. Subsequent Review.** Require that whenever the non-violent physical intervention policy and procedures have been used on a child more than two (2) times in one (1) week, there is a review by the chief administrator or their designee. Appropriate action must be taken based on the findings of the review. (3-20-20)T

**574. CLIENT GRIEVANCE POLICY.**

An organization must develop and follow a written grievance policy for clients that is written in simple and clear language, requires prompt investigation of the grievance by a person who can be objective, and provides at least one (1) level of appeal. Clients must be made aware of the grievance policy and this must be documented. The policy must be shared in a manner appropriate to the child's age and their ability to understand. The policy must require monitoring to ensure there is no retaliation against the child or the person who files a grievance. (3-20-20)T

**575. SUICIDE PREVENTION PLAN.**

An organization must develop and follow a written suicide prevention plan that addresses the needs of the population the organization serves. (3-20-20)T

**576. CLOTHING.**

An organization must ensure that each child in care has sufficient clean, properly fitting clothing, appropriate for the child's age, gender, individual needs, program and season. (3-20-20)T

**577. VISITATION POLICY.**

An organization must have and follow a written visitation policy. The policy will encourage visits between a child in care and family members and others significant to the child except when visitation is contraindicated and is documented in the child's record or a court order. The policy must require the maintenance of a log of visitation for each child in residential care which includes the name of the person visiting and the date and time of the visit. (3-20-20)T

**578. CORRESPONDENCE POLICY.**

An organization must have and follow a written correspondence policy that specifies the conditions under which the organization restricts the receipt of correspondence to or from a child. The conditions must require that the child and parent or guardian be informed of the restriction, the reason for the restriction, and that the restriction be documented in the child's record. The policy must prohibit staff and foster parents from reading children's correspondence except where there is a legitimate documented reason to do so. When staff or foster parents read a child's correspondence, the child must be present. Packages may be exempt from the prohibition against inspection. (3-20-20)T

**579. RELIGIOUS AND CULTURE POLICY.**

An organization must have and follow a written policy regarding religious participation, religious training, cultural heritage, and cultural practices of children in its care. Before placement of any child with the organization, the child's parents or guardians must receive a copy of the religious and cultural policy and acknowledge receipt of the policy with their signature and date. (3-20-20)T

**01. Organizations That Accept State Placements.** An organization providing services to a child placed by the state must include in its policy a requirement to provide reasonable attempts to accommodate the religious and cultural preferences of the child and the child's parents. The organization will also commit in policy to assurances of respect for the religious and cultural beliefs and practices of all children placed in their program. (3-20-20)T

**02. Organizations That Accept Only Private Placements.** An organization that accepts only private placements and requires each child to participate in specific religious practices must include this requirement in their written religious and cultural policy signed by the child's parents or guardians. (3-20-20)T

**580. EDUCATION POLICY.**

An organization must have and follow an education policy. The policy will require that within five (5) school days after a child's placement, each child of school age, as defined by state law, be enrolled in an appropriate school program or document why the child was unable to enroll. (3-20-20)T

**581. PERSONAL POSSESSIONS, ALLOWANCE, AND MONEY POLICY.**

An organization must have and follow a personal possessions, allowance and money policy. The policy will include: (3-20-20)T

**01. Financial Accounting.** Payment of, and accounting for any allowance, social security benefits, and other financial benefits to a child in care. (3-20-20)T

**02. Child's Personal Possessions.** Documented accounting for a child's personal possessions, including clothing with which the child came into care and items which were obtained while he is in care and documented return of all inventoried items, to the child, parent, or guardian at discharge from care, except illegal contraband and contraband prohibited by the organization in its policy which may be exempt from return. (3-20-20)T

**03. Signature Required.** The organization must obtain the signature of the parent, guardian or child over eight (8) years of age who is capable of understanding the purpose of the inventory at the time of inventory and when the items are returned. (3-20-20)T

**582. EMERGENCY POLICIES.**

An organization must have and follow an emergency policy and procedures. The policy must contain provisions for ensuring that a caregiver has and follows the organization's approved written procedures for the following emergencies: (3-20-20)T

**01. Fire.** (3-20-20)T

**02. Natural Disasters.** (3-20-20)T

**03. Serious Accident or Injury.** (3-20-20)T

- |            |   |            |
|------------|---|------------|
| <b>04.</b> | <b>Medical.</b>   | (3-20-20)T |
| <b>05.</b> | <b>Missing Child.</b>   | (3-20-20)T |
| <b>06.</b> | <b>Power Outage.</b>  | (3-20-20)T |
| <b>07.</b> | <b>Bomb Threat.</b>   | (3-20-20)T |
| <b>08.</b> | <b>Severe Weather.</b>  | (3-20-20)T |
| <b>09.</b> | <b>Hostage Taking.</b>  | (3-20-20)T |
| <b>10.</b> | <b>Other Dangers Unique to the Location of an Organization.</b> | (3-20-20)T |

**583. REASONABLE AND PRUDENT PARENT STANDARD FOR AN ORGANIZATION PROVIDING SERVICES TO CHILDREN PLACED BY THE DEPARTMENT.**

An organization providing services to children placed by the Department's Child and Family Service Program must designate at least one (1) on-site official who is authorized to apply the reasonable and prudent parent standard as described in Section 457 of these rules. (3-20-20)T

**584. -- 599. (RESERVED)**

**ADDITIONAL STANDARDS FOR CHILDREN'S AGENCIES**  
**(Sections 600-699)**

**600. ADDITIONAL STANDARDS FOR CHILDREN'S AGENCIES.**  
(Sections 600 through 699, see also Sections 500 through 599.) (3-20-20)T

**601. CHIEF ADMINISTRATOR POSITION AND QUALIFICATIONS.**  
The children's agency must employ or contract for a chief administrator who has at the time of appointment, at a minimum: (3-20-20)T

**01. Master's Degree.** A Master's degree from an accredited college or university in a field related to behavioral science, two (2) years of experience working with families or children in a social services setting, and three (3) years of experience in staff supervision and administration; or (3-20-20)T

**02. Bachelor's Degree.** A Bachelor's degree from an accredited college or university in a field related to behavioral science, five (5) years of experience working with families or children in a social services setting and three (3) years of experience in staff supervision and administration. (3-20-20)T

**602. SERVICE WORKER SUPERVISOR POSITION.**  
The children's agency may employ a service worker supervisor who possesses either: (3-20-20)T

**01. Master's Degree Provision.** A Service Worker Supervisor must be a certified social worker or a person who possesses a Master's degree from an accredited college or university in a related field with appropriate licensure as required by state law, and have demonstrated experience of not less than five (5) years in adoptions or foster care; or (3-20-20)T

**02. Bachelor's Degree Provision.** A Bachelor's degree from an accredited college or university in a behavioral science, or in another major where twenty-five percent (25%) of the course credits earned toward the degree are in behavioral sciences, and five (5) years of experience working with families or children in a social service setting and three (3) years in staff supervision and administration. (3-20-20)T

**603. (RESERVED)**

**604. SOCIAL WORKER POSITION AND QUALIFICATIONS.**  
A children's agency may employ or contract for a licensed social worker who possesses at least a bachelor's degree



from an accredited college or university with a major in a social work. (3-20-20)T

**605. SERVICE WORKER POSITION AND QUALIFICATIONS.**

A children's agency that does not employ or contract for a social worker must employ or contract for a service worker. (3-20-20)T

**01. Qualification.** Qualifications of the service worker must be verified through written documentation of work experience and education. The service worker will have at a minimum: (3-20-20)T

**a.** Twenty (20) hours of completed training in adoption or foster care services specific to the assigned duties; or (3-20-20)T

**b.** One (1) year of full-time paid experience in adoption or foster care services specific to assigned duties. (3-20-20)T

**02. Training.** Service Workers must document twenty (20) hours of completed training every four (4) years in adoption or foster care services specific to the assigned duties. (3-20-20)T

**606. SOCIAL WORKER OR SERVICE WORKER RESPONSIBILITIES.**

The responsibilities of a social worker or service worker employed or contracted by a children's agency will include child assessment, service plan development, child placement, foster or adoptive home assessment, supportive services for children and families, and transitional living services. (3-20-20)T

**607. SELF-SUPERVISION PROHIBITED.**

Neither a service worker supervisor nor a social worker is allowed to supervise their own work. (3-20-20)T

**608. STAFF WORKLOADS.**

A children's agency must have identified workload standards for each staff member. (3-20-20)T

**01. Supervisor to Staff Ratio.** Service Worker Supervisors must not supervise more than eight (8) workers made up of the following: social workers, service workers, and social service aides. (3-20-20)T

**02. Caseload Limitations.** At the discretion of the supervisor, a social worker or service worker may be assigned a caseload of twenty (20) families with an adoption placement, active child foster care, or transitional living cases; or forty (40) adoptive families being studied or awaiting an adoptive placement or foster home certification cases, or a proportionate combination of these functions. (3-20-20)T

**609. -- 614. (RESERVED)**

**615. ADDITIONAL PROVISIONS FOR FOSTER HOME CERTIFICATION.**

A children's agency that licenses or certifies foster homes must have policies to comply with foster care rules, Sections 400 through 499 of these rules and may require that additional foster care standards be met if the agency deems appropriate. (3-20-20)T

**616. PROGRAM DESCRIPTION.**

A children's agency providing foster care must include information in their brochure and their licensing application of the types of foster care provided, the type and number of homes needed, and the type of support services provided to foster parents. (3-20-20)T

**617. LICENSING AND CERTIFICATION AGENCY POLICIES AND PROCEDURES FOR FOSTER HOMES.**

In addition to meeting the general requirements for policies in Sections 500 through 616 of these rules, a children's agency which licenses or certifies foster homes must have policies and procedures for Sections 618 through 649 of these rules. (3-20-20)T

**618. APPLICATION REQUEST PROCESS.**

A children's agency that licenses or certifies foster homes must document that a person who has requested an

application has been given a copy of the foster care rules found in Sections 400 through 499 of these rules and has been provided a copy of the foster parent training requirements for children's agencies. (3-20-20)T

**619. (RESERVED)**

**620. INITIAL AND SUBSEQUENT FAMILY FOSTER HOME EVALUATION STUDY PROCESS AND CONTENTS.**

The children's agency must conduct an appropriate home study based on the foster care Sections 400 through 499 of these rules, to determine if the family meets required licensing standards to be issued a foster care license, and must maintain a copy of the study on file. (3-20-20)T

**621. TRAINING.**

The children's agency must have and follow a training policy that includes meeting the orientation and ongoing training requirements of Sections 400 through 499 of these rules, and must include additional information on the requirements unique to the particular agency program. All foster care training must be documented in the foster parents case file record. (3-20-20)T

**622. PLACEMENT AGREEMENT REQUIRED CONTENTS.**

The children's agency must use a placement agreement that is signed by the foster parents and the children's agency before placing a child in a foster home. The placement agreement must identify the responsibilities of the children's agency including supervision and support services for the foster family and the responsibilities of the foster family. The foster family must be informed and agree to follow the children's agency policies and procedures. A children's agency must review the agreement with the foster family at least annually and, when needed, develop a new agreement. The children's agency must provide the foster family with a copy of the signed current placement agreement and maintain a copy in the foster home record. (3-20-20)T

**623. COMPLAINT INVESTIGATION, BASIS, TIME REQUIREMENTS, NOTIFYING FOSTER PARENTS, CONTENTS, AND PROCESS.**

When a complaint is received that relates to possible foster parent noncompliance with any provisions in Sections 400 through 499 of these rules, a children's agency must initiate a complaint investigation as soon as is indicated, based on seriousness of the allegation received, no later than seven (7) calendar days after receipt of the allegation. A children's agency must inform a foster parent that a complaint has been received, provide a clear description of the allegations, and allow a representative of the foster parent in interviews regarding the complaint before they are questioned or interviewed. (3-20-20)T

**01. Investigation Timeline and Extension.** A children's agency must complete a complaint investigation within forty-five (45) calendar days after receipt of the allegation. If additional time is required, the children's agency must inform the foster parent, in writing, of the basis for the extension. (3-20-20)T

**02. Summary of Findings.** Before completion of a written report, a children's agency must provide a verbal summary of the preliminary findings with the foster parent. (3-20-20)T

**03. Agency Written Report.** Upon completion of the investigation, a children's agency must prepare a written report that includes date and report source, identification of the source of the allegation, unless anonymous or confidential, as specified in the Child Protective Act, Title 16, Chapter 16, Idaho Code. The report must also include: (3-20-20)T

- a.** The specific allegations; (3-20-20)T
- b.** Dates and places of contacts, names of persons interviewed, and names of the interviewers. If children are interviewed, their names must be coded in the report; (3-20-20)T
- c.** Findings of fact, based on the investigation; (3-20-20)T
- d.** Conclusions regarding compliance or noncompliance with Sections 400 through 499 of these rules, based on the findings of the investigation summarized in the report; (3-20-20)T

e. Any changes in the children's agency decision regarding placement specifications that are based on the findings of the investigation summarized in the report; and (3-20-20)T

f. Recommendations regarding licensing or certification action and any required corrective action. (3-20-20)T

**04. Conclusion of Investigation.** A children's agency must provide a copy of the complaint investigation report, excluding the source of the allegation to the foster parent, within ten (10) calendar days of its completion. The foster parent must be allowed to attach their written response to the report. The children's agency must document any identified corrective action required of the foster family. (3-20-20)T

**624. RECORDS MANAGEMENT, MAINTENANCE, AVAILABILITY TO FOSTER PARENT, AND CONTENTS.**

A children's agency must maintain a foster home record for each foster home and may make copies of a record available to the applicant or licensed or certified foster parent upon request except for medical documents specifically identified as confidential, pending complaint investigation reports and documents, records of privileged communications and criminal records, police reports, and child protective service information. Social security numbers from any source cannot be provided, except a social security number needed by a foster parent to provide needed services for a foster child. (3-20-20)T

**01. Record Contents.** The record must contain all documents pertaining to licensing or certification of the home, any complaint investigation reports, and placement agreements between a foster parent and the children's agency. (3-20-20)T

**02. Placement Record.** A complete record identifying all children placed in the foster home and removed from the home, including: full name, age, gender, and race of the child; date of the placement; date and reasons for a foster child's departure from the foster home; any written response from a foster parent to a complaint investigation or response to a cited rule compliance; and any corrective action plans. (3-20-20)T

**625. -- 629. (RESERVED)**

**630. ADDITIONAL PLACEMENT CONSIDERATIONS.**

A children's agency must follow the provisions of Sections 400 through 499 of these rules and have a policy on the following placement considerations. (3-20-20)T

**01. Child Placement Preparation.** Before the placement of a child, the children's agency must prepare the child for the placement consistent with the child's age, individual needs, the circumstances necessitating placement, and identified special problems presented. (3-20-20)T

**02. Placement Emergency Change.** If an emergency change in placement is necessary, within fourteen (14) days of the placement change, documentation must be included in the child's record. (3-20-20)T

**03. Placement Service Termination.** If a children's agency is no longer providing services to the child in a foster home, the following information must be documented within fourteen (14) days of the service termination that includes a summary of the services provided, the needs that remain, and provision for any continuing services with another children's agency. (3-20-20)T

**631. EMERGENCY EVACUATION PLAN.**

A children's agency must have a policy to require and approve a written evacuation plan for a foster home. (3-20-20)T

**632. UNUSUAL INCIDENT POLICY.**

The children's agency must have a policy to notify the state licensing authority within one (1) working day of the occurrence of an incident as outlined in Section 473 of these rules. The policy must require the children's agency to notify the Department immediately, the foster child's parents, and the responsible children's agency of the death of a foster child. (3-20-20)T

**633. SERVICE PLANS AND PARTICIPANTS.**

A children's agency must develop initial and updated service plans on behalf of the child through a team approach which includes the child, the child's parents or legal guardian, the foster parents, the referring children's agency, others identified in providing needed placement services and the assigned social worker or service worker, as appropriate. A service plan must include behavioral management procedures with the placing agency, if appropriate, and with the foster parents and a copy must be maintained in the child's file. (3-20-20)T

**634. CHILDREN'S AGENCY SUPERVISION OF CHILD.**

A children's agency must develop a plan of supervisory visits with a child in foster care consistent with the child's service plan, as required by these rules. The child's record must contain documentation that the assigned social worker or service worker personally visited the foster child at least once each month. A children's agency may reduce the number of social worker or service worker visits with a child to once every ninety (90) days if there is documentation and justification in the service plan that a child's placement in a foster home is a long-term planned placement. At least one-half (1/2) of the visits must occur in the foster home. (3-20-20)T

**635. -- 649. (RESERVED)**

**ADDITIONAL PROVISIONS FOR TRANSITIONAL LIVING SERVICES**  
**(Sections 650-659)**

**650. ADDITIONAL PROVISIONS FOR TRANSITIONAL LIVING SERVICES.**

(Sections 650 through 659, see also Sections 500 through 599) (3-20-20)T

**651. PROGRAM STATEMENT FOR TRANSITIONAL LIVING SERVICES.**

A children's agency which provides transitional living services must develop a program statement describing the specific services it will provide to youth. Services are limited to those identified youth who are at least sixteen (16) years of age and for whom family reunification, placement with previous care givers or extended family, and adoption have been found and documented to be inappropriate. (3-20-20)T

**652. POLICIES AND PROCEDURES FOR TRANSITIONAL LIVING SERVICES.**

In addition to the requirements for policies in Sections 500 through 651 of these rules. The children's agency must have policies and procedures for selecting youth for placement, orientation of youth before placement, approval and oversight of living arrangements, provision of support services or arranging for these services, and termination of services. (3-20-20)T

**653. RECORD MANAGEMENT.**

In addition to the general record requirements in Section 561 of these rules, an agency record must be updated annually and include the youth's social security number, current address, telephone number, a photograph, and the names and addresses of known offspring. (3-20-20)T

**654. SERVICE COMPONENTS.**

An agency licensed to provide transitional living services must provide or arrange for the following service components as appropriate to the youth's needs: (3-20-20)T

- 01. Planning.** Individualized, youth-centered placement planning. (3-20-20)T
- 02. Counseling.** Counseling and support groups as appropriate to individual needs. (3-20-20)T
- 03. Skills.** Life skills, self-care, daily living skills, money management, and housing. (3-20-20)T
- 04. Training.** Education, vocational, or technical training. (3-20-20)T
- 05. Medical Care.** Health and medical care. (3-20-20)T
- 06. Legal.** Legal services. (3-20-20)T
- 07. Activities.** Socialization, cultural, religious, and recreational activities. (3-20-20)T

- 08. Aftercare.** Aftercare following termination of transitional services. (3-20-20)T

**655. TRANSITIONAL LIVING PLACEMENT.**

Before a youth is placed in a transitional living program, a children's agency must document in the youth's record:  
(3-20-20)T

- 01. Basis.** The basis for determining this is an appropriate program for the youth; (3-20-20)T

- 02. Self-Care.** That a youth exhibits self-care potential: (3-20-20)T

**03. Youths Need for Supervision.** An evaluation of and a plan for a youth's need for supervision and support services; (3-20-20)T

**04. Living Arrangements.** The assigned social worker or service worker has personally observed the living arrangement and determined it is safe and appropriate; and (3-20-20)T

**05. Essential Services.** There are specific and essential services to provide for suitable social, physical, vocational and emotional needs of the youth as appropriate. (3-20-20)T

**656. SUPERVISION AND SUPPORT.**

A children's agency must develop and follow a plan of supervision and support services for a youth in transitional living consistent with the youth's needs as follows: (3-20-20)T

- 01. Plan of Supervision.** The plan will include: (3-20-20)T

**a.** Current documentation of financial support sufficient to meet the youth's housing, clothing, food, and miscellaneous expenses; and (3-20-20)T

**b.** The date, location, documented purpose, and a summary of the findings of each contact between social worker or service worker and the youth describing the youth's adjustment, relationship with family members, and the children's agency efforts to resolve any conflicts. (3-20-20)T

**02. Written Contract and Reviews.** A children's agency will have a mutually agreed upon contract between the youth and the children's agency that specifies the responsibilities of the children's agency and the youth, which is signed and dated by the youth and the assigned social worker. The contract will be reviewed and updated at least once every ninety (90) calendar days. A copy of the contract and any amendments to the contract will be maintained in the case record. (3-20-20)T

**03. Monthly Contact.** There will be face-to-face contact at least monthly with the youth by the assigned social worker or service worker to assess that the youth is functioning at an acceptable level, is carrying out prescribed expectations, is managing their money, and is residing in a safe and acceptable environment. (3-20-20)T

**04. Contact Documentation.** At least once every two (2) months there will be documentation of an on-site contact with the youth at their place of residence by the assigned social worker or service worker. (3-20-20)T

**05. Twenty-Four Hour Agency Telephone Access.** Youth will have twenty-four (24) hour, seven (7) days-a-week telephone access to contact the children's agency. (3-20-20)T

**657. TERMINATION OF TRANSITIONAL LIVING SERVICES.**

When a children's agency terminates its transitional living services for a youth, the reason for the termination, the youth's new location, a summary of the needs that have been addressed and remain to be met, and identified referral services must be documented in the youth's case record within thirty (30) days after the youth leaves the program. (3-20-20)T

**658. REQUIRED INFORMATION FOR YOUTH AT SERVICE TERMINATION.**

A children's agency must document that each youth who ends transitional living services is provided with basic

information on health care, housing, counseling services, and emergency resources, and will be provided their birth certificate, Social Security card, funds, and personal property held by the children's agency. (3-20-20)T

**659. (RESERVED)**

**ADDITIONAL PROVISIONS FOR ADOPTION SERVICES**  
**(Sections 660-679)**

**660. ADDITIONAL PROVISIONS FOR ADOPTION SERVICES.**  
(Sections 600 through 679, see also Sections 500 through 599) (3-20-20)T

**661. ADOPTION SERVICES - NONPROFIT STATUS.**  
A children's agency which provides adoptions services must provide documentation that it is incorporated as a non-profit corporation. (3-20-20)T

**662. PROGRAM STATEMENT.**  
A children's agency that provides adoption services must include in its program statement the following: (3-20-20)T

**01. Description of Services Available.** A written description of services provided directly by the children's agency or through another organization for a child, a birth parent, an adoptive applicant and an adoptive family. (3-20-20)T

**02. Eligibility.** The general criteria by which the children's agency determines eligibility for adoptive parenthood. (3-20-20)T

**03. Delineation of Expenses.** A clear delineation of fees, charges, and other consideration for adoption services. The delineation will include: (3-20-20)T

**a.** Specific charges for expenses and services provided within the children's agency; (3-20-20)T

**b.** Chronological itemization of fees for expenses and services provided by other identified sources; (3-20-20)T

**c.** Identification of the charges that are refundable and the charges that are not refundable; and (3-20-20)T

**d.** The manner and timing of payments. (3-20-20)T

**663. WRITTEN POLICIES AND PROCEDURES - ADOPTION.**  
A children's agency must have and follow written policies and procedures for the adoption services it provides or facilitates and that these cover services for children, birth parents, adoptive applicants and parents, post placement services, and post-finalization services. (3-20-20)T

**664. SERVICES FOR CHILDREN AS THE PRIMARY CONSIDERATION.**  
A child in need of adoption must be the primary consideration of adoption services provided by a children's agency. The choice of adoptive placement will be in the best interest of the child and include consideration of previous caretakers. This will include the foster parents where a child has established a bonded relationship. For children under the supervision of the children's agency and are awaiting adoptive placement, there must be a review by the agency administrator, or their designee, every month for an infant one (1) year of age or younger, and every three (3) months for a child over one (1) year of age, to determine what needs to be done to locate an adoptive placement for the child. (3-20-20)T

**665. SERVICES FOR CHILD'S BIRTH PARENTS.**  
A children's agency that accepts custody of a child from a birth parent or parents must provide services for the parent or parents either directly or through cooperative arrangements. The children's agency must ensure that the legal rights of the birth parents are protected throughout the decision-making about release of records, as required by statutes governing Termination of Parental Rights and Adoptions (see Title 16, Chapter 15, Idaho Code, and Title 16, Chapter

20, Idaho Code). The children's agency will respect the expressed desires of either or both birth parents to provide for continuity of identity of the child's religious, cultural, racial, linguistic, and ethnic background, provided the desired request does not deny or delay placement of the child for adoption in accordance with the Multi-ethnic Placement Act (MEPA), P.L. 103-382 and P.L. 104-188, 42 USC, Section 622, and such considerations are legal. (3-20-20)T

**666. SERVICES FOR ADOPTIVE APPLICANTS.**

A children's agency must provide the following services to its adoptive applicant clients: (3-20-20)T

**01. Orientation.** Orientation to adoption, its meaning, the children's agency adoption process and procedures, and the availability of children for adoption; (3-20-20)T

**02. Suitability Criteria.** Information about the specific criteria by which the children's agency determines suitability as adoptive parents and the areas the children's agency assesses to determine the ability of the adoptive applicants to meet the needs of an adopted child; (3-20-20)T

**03. Termination of Services.** The children's agency procedures for termination of services for an applicant found to be unsuited for adoptive parenthood or for an applicant found suited to adopt but for whom a child cannot be found; (3-20-20)T

**04. Selections and Services for a Specific Child.** The children's agency procedures for selection of adoptive applicants to meet the needs of a specific child and, where indicated, assistance in obtaining resources and services to meet the continuing needs of the child; (3-20-20)T

**05. Legal Assessment.** The children's agency procedures for assuring that a child placed is legally free for adoption or an explanation that the placement is a legal-risk placement of the child and what efforts are made to free the child; (3-20-20)T

**06. Preparation for Placement.** The children's agency procedures for preparing an applicant for parenting and placement of a child; and (3-20-20)T

**07. Counseling.** The children's agency may provide or arrange counseling for prospective adoptive parents including assistance in understanding a child's religion, culture, ethnic, or linguistic background and the impact of leaving familiar ties and surroundings, including attachment issues and living in an institution, as appropriate to the age of the child. (3-20-20)T

**667. RECRUITMENT OF ADOPTIVE APPLICANTS.**

A children's agency must recruit adoptive applicants at a level that ensures the availability of a sufficient number and diversity of adoptive families to meet the needs of children available for adoption under the care of the children's agency. (3-20-20)T

**668. PAYMENT LIMITATIONS IN ADOPTION.**

A children's agency must prohibit the actual or promised payment or other material consideration to any party directly or indirectly involved in the administration of an adoption service, whether acting as an employee or independent contractor, except for the performance of routine professional duties necessary to complete the adoption process. (3-20-20)T

**669. PROHIBITION OF CONTRIBUTIONS IN ADOPTIONS.**

A children's agency must not accept contributions from adoptive applicants or from persons acting on the applicant's behalf during the period of application or before an adoption has been finalized, nor accept a commitment to make a contribution after an adoptive placement. (3-20-20)T

**670. PROHIBITION OF STAFF ADOPTIONS.**

A children's agency must not do an adoption study or placement for its own staff, board member, or person with whom the children's agency contracts to provide services for the agency. (3-20-20)T

**671. (RESERVED)**

**672. SERVICES FOR ADOPTIVE PARENTS.**

A children's agency must provide or arrange for the following services to adoptive parents served by the children's agency: (3-20-20)T

**01. Specific Training.** The children's agency will provide or arrange specific training related to the culture and race of the child who is of a different culture or race from the adoptive parents. (3-20-20)T

**02. Disclosure of Non-Identifying Child Information.** Disclosure of all non-identifying information known to the children's agency about the child, the child's birth parents, and the circumstances leading to the decision to place for adoption. (3-20-20)T

**03. Post-Placement Services.** Post-placement services related to support to the family and supervision of the placement. (3-20-20)T

**04. Provision of Resources.** Provision of resources or arranging for the provision of resources to effect a safe, stable and suitable placement for the child and the family, including information regarding the federal adoption assistance program. (3-20-20)T

**05. Adoption Finalization Assistance.** Help in finalizing the legal adoption of the child. (3-20-20)T

**06. Post-Finalization Services.** Upon request, the children's agency, either directly or by referral to a resource, will assist the family with any identified problems associated with the adoption. (3-20-20)T

**673. SELECTION OF AN ADOPTIVE PLACEMENT.**

The factors listed are in random order and are not intended to reflect relative priority. A children's agency must consider the following factors in selecting suitable adoptive parents for a child: (3-20-20)T

**01. Child's Needs.** The physical, emotional, medical, and educational needs of the child. (3-20-20)T

**02. Continued Contact.** The child's needs for continued contact with the birth parent(s), siblings, relatives, foster parents, and other persons significant to the child. (3-20-20)T

**03. Racial, Ethnic, and Cultural Considerations.** In accordance with the Multiethnic Placement Act (MEPA), P.L. 103-382 and P.L. 104-188, 42 USC, Section 622, the child's racial, ethnic, cultural identity, heritage, and background may only be considered if a written assessment of the child indicates that such consideration is in the best interest of the child. (3-20-20)T

**04. Authorized Placement on Approved Recommendations.** The children's agency must require authorization by a chief administrator after the recommendations of approval are given by a service worker supervisor. The approval or denial must be documented in the case record. (3-20-20)T

**05. Placement.** A children's agency will place a child with children's agency-approved adoptive parents consistent with the recommendations specified in the adoptive family study and the needs of the child identified in these rules. (3-20-20)T

**674. CONDITIONS FOR PLACEMENT IN AN ADOPTIVE HOME.**

A children's agency may place a child in a home for the purposes of adoption if the adoptive parents have received orientation in accordance with the requirements of Sections 660 through 699 of these rules, an adoptive family study has been completed, supervisory approval of the placement has been obtained, and all applicable parties have signed the adoptive placement agreement. (3-20-20)T

**675. ADOPTIVE PARENT INFORMATION.**

A children's agency must provide adoptive parents with the following information before the placement of a child: (3-20-20)T

**01. Name.** Child's name as permitted by law or disclosure agreement. (3-20-20)T



- 02. Date, Time, and Location of Birth.** Date, time and place of birth, including hospital, city, state, and country. (3-20-20)T
- 03. Racial, Ethnic, and Religious Considerations.** Child's racial, ethnic, and religious background. (3-20-20)T
- 04. Medical Records.** Child's physical and mental health records and where applicable, special needs. (3-20-20)T
- 05. Family of Origin.** Description of the child's family of origin, including age and gender of each family member, their relationship to the child, and medical and mental health history, social, and education history of each member of the family. (3-20-20)T
- 06. Circumstances of the Placement.** Description of the circumstances necessitating placement of the child. (3-20-20)T
- 07. Preparation for Placement.** Child's preparation for placement and attitude towards adoption. (3-20-20)T
- 08. Other Information.** Any other information to enable the adoptive parent to provide a stable, safe, and healthy environment for the child. (3-20-20)T

**676. SUPERVISION.**

A children's agency social worker or service worker must provide post placement supervision to the adoptive family at the family's home at least once every three (3) months after the placement of a child and before the final order of adoption. These supervisory contacts will include: (3-20-20)T

- 01. Documentation of Adjustment.** Assessment and documentation of the child's and adoptive family's adjustment and, where indicated, plans to assist the child and adoptive family. (3-20-20)T
- 02. Results of Assessment.** Keeping the adoptive parents informed of the results of the children's agency's continuing assessment of the placement at the conclusion of each supervisory contact. (3-20-20)T
- 03. Special Needs Adoption.** Supervision by the children's agency for at least six (6) month duration and as frequently as needed before finalization for special needs adoptions. (3-20-20)T

**677. -- 679. (RESERVED)**

**ADDITIONAL PROVISIONS FOR INTER-COUNTRY ADOPTION SERVICES**  
**(Sections 680-699)**

**680. ADDITIONAL PROVISIONS FOR INTER-COUNTRY ADOPTION SERVICES.** (Sections 680 through 699, see also Sections 000 through 299) (3-20-20)T

**681. INTER-COUNTRY ADOPTION SERVICES.**

A children's agency that provides inter-country adoption services must include in its program statement a description of inter-country adoptive placement services it provides either directly or through collaboration with other agencies or individuals with proper credentials. (3-20-20)T

**682. LEGAL REQUIREMENTS FOR INTER-COUNTRY ADOPTION SERVICES.**

A children's agency that arranges or engages in inter-country adoption must provide the following: (3-20-20)T

- 01. Legal Rights Protection.** Provide protection of the legal rights for the child, the child's birth parents, adoptive applicants, and adoptive parents. (3-20-20)T
- 02. Licensing Standard Compliance Requirement.** Collaborate with and accept adoptive family studies and post-placement services only from other providers who comply with applicable state licensing standards

and the laws from the child's country of origin. (3-20-20)T

**03. Children's Agency, Foreign Government Agreement Review.** Maintain a file and provide for review to prospective adoptive families an English-translated copy of any agreement that exists between a foreign government and the children's agency. (3-20-20)T

**04. Adoptive Home Standards.** Conduct adoptive family studies in accordance with these rules and the minimum standards established for international adoption studies by the United States Immigration and Naturalization Service. (3-20-20)T

**05. Citizenship.** Inform families about how to obtain citizenship for a foreign born adopted child. (3-20-20)T

**683. FINANCIAL.**

A children's agency must establish and follow a written schedule of fees, estimated or actual expenses of what a family will be charged for services, fees, and costs in the child's country of origin. (3-20-20)T

**684. INTER-COUNTRY ADOPTION SERVICES TO ADOPTIVE PARENTS.**

A children's agency that provides or arranges for inter-country adoption services must: (3-20-20)T

**01. Inter-Country Adoption Orientation.** Provide orientation to prospective adoptive families regarding inter-country adoption, its meaning, the adoption process, children's agency procedures, and the characteristics of children needing adoption. (3-20-20)T

**02. Eligibility Criteria Disclosure.** Disclose the general criteria by which the children's agency determines eligibility for applicants for inter-country adoption. (3-20-20)T

**03. Determination of Adoptive Applicant's Ability.** Determine the ability of adoptive applicants to meet the needs of an internationally adopted child and prepare an adoptive family study report. (3-20-20)T

**04. Documenting Child's Legal Status.** Acquire documentation that, at placement, the child is legally free for inter-country adoption. (3-20-20)T

**05. Procedures for United States Placement.** Follow Immigration and Naturalization procedures to ensure that the child is or will be authorized to enter and reside permanently in the United States. (3-20-20)T

**06. Information Disclosure.** Fully disclose all information available to the children's agency, based on a diligent effort to obtain pertinent information regarding the child's medical and social history as part of the referral information. (3-20-20)T

**07. Post-Placement Supervision.** Provide post-placement supervision as required by the adoptive child's country of origin. (3-20-20)T

**08. Adoption Finalization.** Ensure that the adoption of the child is finalized. (3-20-20)T

**685. COLLECTING AND EXCHANGING INFORMATION ABOUT A CHILD.**

A children's agency must collect and exchange information about the child's background with the prospective adoptive parents and ensure that information held by the children's agency regarding the child's origin, the identity of their birth parents, and medical history is retained. (3-20-20)T

**686. POST-PLACEMENT AND POST-FINALIZATION ADOPTION SERVICES.**

A children's agency must provide or arrange for the following post-placement and post-finalization adoption services by persons with prior experience in post finalization services and who are knowledgeable about the legal, social, cultural, and emotional issues pertinent to adoption. (3-20-20)T

**01. Post-Placement Reports.** Provide post-placement and post-finalization reports on the progress of a child when requested by the country of origin when not in conflict with laws or public policies of the United States or

Idaho. (3-20-20)T

**02. Crisis Counseling.** Counseling or referral for counseling for the adoptive parents and the adoptee, when a placement or an adoption is in crisis. (3-20-20)T

**03. Adoption Disruption Re-Placement.** Re-placement of the child if the adoptive placement is disrupted before finalization. (3-20-20)T

**04. Child Origin Information Access.** Procedures as permitted by law to ensure access by the child or their representative to information regarding the child's origins that is held by the children's agency. (3-20-20)T

**05. Post-Finalization Counseling.** Post-finalization counseling when requested by the family. (3-20-20)T

**687. -- 699. (RESERVED)**

**ADDITIONAL STANDARDS FOR CHILDREN'S RESIDENTIAL CARE FACILITIES**  
**(Sections 700-769)**

**700. ADDITIONAL STANDARDS FOR CHILDREN'S RESIDENTIAL CARE FACILITIES.** (Sections 700 through 769, see also Sections 500 through 599.) (3-20-20)T

**701. -- 704. (RESERVED)**

**705. CHIEF ADMINISTRATOR QUALIFICATIONS.**

A children's residential treatment care facility must employ or contract with a full time chief administrator. At the time of appointment, the chief administrator must, at a minimum, possess at least one (1) of the following in Subsection 705.01 or 705.02 of this rule. (3-20-20)T

**01. Bachelor's Degree.** A Bachelor's degree in a relevant discipline, two (2) years of experience working with children, and three (3) years experience in staff supervision and administration. (3-20-20)T

**02. Career Development Program.** Completed a career development program which includes work-related experience, training or college credits, or a combination of these, that provide a level of achievement equivalent to the Bachelor's degree. Work experience must include two (2) years of experience working with children, and three (3) years of experience in staff supervision and administration. (3-20-20)T

**706. SERVICE WORKER SUPERVISOR QUALIFICATIONS.**

A service worker supervisor, at the time of appointment, must possess at least one (1) of the following in Subsection 706.01 or 706.02 of this rule. (3-20-20)T

**01. Master's Degree.** A Master's degree from an accredited college or university in a behavioral science and one (1) year of experience as a service worker. (3-20-20)T

**02. Bachelor's Degree.** Bachelor's degree from an accredited college or university in a behavioral science, including social work, sociology, psychology, criminal justice, counseling, or a related field, and four (4) years of experience working with children, of which two (2) years must have been as a service worker. (3-20-20)T

**707. DIRECT CARE STAFF SUPERVISOR QUALIFICATIONS.**

A direct care staff supervisor, at the time of appointment, must possess at least one (1) of the following in Subsection 707.01 through 707.03 of this rule. (3-20-20)T

**01. Bachelor's Degree.** A Bachelor's degree from an accredited college and one (1) year of full-time experience in a children's residential care facility. (3-20-20)T

**02. Associate's Degree.** An Associate's degree or a minimum of forty-eight (48) credit hours from an accredited college and two (2) years of full-time experience in a children's residential care facility. (3-20-20)T

**03. Experience.** A high school diploma or equivalent and three (3) years of full-time experience in a children's residential care facility. (3-20-20)T

**708. (RESERVED)**

**709. DIRECT CARE STAFF QUALIFICATIONS.**

Direct care staff must be at least nineteen (19) years of age at the time of appointment and possess a high school diploma or equivalent. (3-20-20)T

**710. REQUIRED STAFF RATIOS.**

There must be written staff ratios for direct care staff to children and service workers to children. Unless otherwise specified in these rules, staff ratios must be as described in Subsections 710.01 through 710.06 of this rule.

(3-20-20)T

**01. Supervisor-Staff Ratio.** At least one (1) staff supervisor for every twenty (20) direct care staff or fraction thereof. (3-20-20)T

**02. Staff-Child Ratio-Daytime.** At least one (1) direct care staff to every eight (8) children when children are awake and present, unless the presenting problems of the children in care are such that a ratio of one (1) to eight (8) is not sufficient to provide for the safety and treatment needs of the children. In that case, the ratio of direct care staff to children ratio must be increased to ensure the safety and treatment needs of the children are met.

(3-20-20)T

**03. Staff-Child Ratio-Sleeping Hours.** At least one (1) awake direct care staff to twenty (20) children or fraction thereof during the children's normal sleeping hours in buildings housing children's sleeping quarters. If the presenting problems of the children in care are such that a ratio of one (1) to twenty (20) is not sufficient to provide for the safety and treatment needs of the children, then the ratio of direct care staff to children ratio must be increased to ensure the safety and treatment needs of the children are met.

(3-20-20)T

**04. Medical Emergency.** At least one (1) staff on duty in a children's residential care facility who is certified to provide cardiopulmonary resuscitation (CPR) and first aid for the age of the children in care. (3-20-20)T

**05. Emergency Staff Access.** When only one (1) direct care worker is on duty, an additional staff person must be available within ten (10) minutes or if assistance from law enforcement is available within ten (10) minutes an additional staff person must be available within thirty (30) minutes to assist with an emergency.

(3-20-20)T

**06. Service Worker or Social Worker Ratios.** Except for non-accredited children's residential schools, at least one (1) service worker or social worker as defined in Section 011 of these rules needs to be available for every twenty (20) children in care or fraction thereof. (3-20-20)T

**711. HOUSE PARENT RELIEF STAFF.**

Where house parents are used to provide direct care staff functions, they must be provided time off in accordance with the Idaho Department of Commerce and Labor requirements in Section 44-1202, Idaho Code. (3-20-20)T

**712. STAFF TRAINING.**

Unless otherwise specified in these rules, an employee or volunteer whose primary job function requires interaction with children and who works twenty-four (24) or more hours a week must receive at least twenty (20) hours of training annually. An employee or volunteer whose primary job function requires interaction with children and who works less than twenty-four (24) hours a week must receive at least ten (10) hours of training annually. The training must include cultural sensitivity and diversity, behavior management, and child development issues appropriate to the population served. Training must also include instruction in administering cardiopulmonary resuscitation (CPR) and administering first aid appropriate to the age of the children in care within ninety (90) days after employment.

(3-20-20)T

**713. -- 714. (RESERVED)**

**715. COMPLIANCE WITH APPLICABLE LAWS.**

Children's residential care facilities must comply with the applicable Idaho state and local zoning, fire, health, construction laws, ordinances and regulations. (3-20-20)T

**01. Sanitation Inspection.** The applicant must request and obtain a sanitation inspection and written report from the applicable Idaho Public Health District. (3-20-20)T

**02. Fire Inspection.** The applicant must request and obtain a fire safety inspection and written report from the office of the Idaho State Fire Marshall, or local fire department. (3-20-20)T

**03. Corrective Action and Fees.** The applicant must correct all deficiencies noted in the sanitation and fire reports (in order to provide documentation that the applicant has passed the inspections) and is responsible to pay any fees charged. (3-20-20)T

**04. Planning and Zoning.** The applicant must provide documentation demonstrating it meets planning and zoning requirements of the applicable Idaho city or county. (3-20-20)T

**716. CHILDREN'S RESIDENTIAL CARE FACILITY BUILDING REQUIREMENTS.**

A children's residential care facility building must meet the requirements in Subsection 716.01 through 716.03 of this rule: (3-20-20)T

**01. Access to Community Resources.** The facility must have access to school facilities, hospitals, churches, recreational and other community resources. (3-20-20)T

**02. Occupancy Restrictions.** The facility must house only the number of persons for which it is rated, given its type of construction and size. (3-20-20)T

**03. Location Restrictions.** The facility must not be located within three hundred (300) feet of an aboveground storage tank containing flammable liquids or gases used in connection with a bulk plant, marine terminal, aircraft refueling or bottling plant of a liquefied gas installation, or similar hazard. (3-20-20)T

**717. NATIONAL ELECTRICAL CODE COMPLIANCE.**

A building used to house children must comply with the National Electrical Code adopted by the Department of Building Safety in Section 54-1001, Idaho Code, or authorized local jurisdiction. (3-20-20)T

**718. FIRE SAFETY REQUIREMENTS.**

A building that houses children must be inspected by a state certified fire inspector before being occupied and on an annual basis thereafter for compliance with the applicable **International** Fire Code. A copy of the inspection must be maintained at the facility. (3-20-20)T

**01. Fire Extinguishers.** Each building used to house children must have a minimum of one (1) 2-A-10BC type per floor, and if there is a kitchen on the floor, a fire extinguisher must be in or immediately adjacent to the kitchen. Each fire extinguisher must be inspected annually by a fire extinguisher service agency. (3-20-20)T

**02. Smoke Detecting Devices.** There must be at least one (1) smoke detector on each floor of the facility, approved by a nationally recognized testing laboratory, installed and maintained as recommended by the manufacturer. (3-20-20)T

**03. Carbon Monoxide Detecting Devices.** There must be at least one (1) carbon monoxide detecting device that is approved by a nationally recognized testing laboratory that is installed and maintained as recommended by the manufacturer. A facility that does not have equipment which produces carbon monoxide or does not have an attached garage is exempt from this requirement. (3-20-20)T

**719. EMERGENCY PROCEDURES.**

A children's residential care facility must have and follow written policies and procedures governing the handling of emergencies which include emergency evacuation plans, telephone numbers for contacting ambulances, emergency

medical personnel, fire departments, hospitals, poison control centers, police, location and use of first aid kits, and roster and telephone numbers of staff to be contacted during an emergency, and other emergency services as appropriate. (3-20-20)T

**720. EMERGENCY DRILLS.**

**01. Fire Drills.** Fire drills must be conducted and recorded monthly, with each work shift participating in a drill a minimum of once every three (3) months. Emergency evacuation routes must be posted in conspicuous locations on each floor of a building housing children. (3-20-20)T

**02. Disaster Drill.** A disaster drills must be conducted and recorded annually. The annual disaster drill cannot be a fire drill. (3-20-20)T

**721. PUBLIC HEALTH DISTRICT INSPECTION.**

The facility must provide documentation of an initial and annual inspection and approval by the applicable Idaho Public Health District addressing the following health and safety standards before a license for a facility used to house children will be issued. A copy of the inspection must be maintained at the children's residential care facility. (3-20-20)T

**01. Food Safety and Sanitation Standards.** The facility must comply with IDAPA 16.02.19, "Food Safety and Sanitation Standards for Food Establishments." (3-20-20)T

**02. Drinking Water Systems.** The facility must comply with IDAPA 58.01.08, "Idaho Rules for Public Drinking Water Systems." (3-20-20)T

**722. BUILDINGS, GROUNDS, FURNISHINGS AND EQUIPMENT.**

Buildings used to house children must be furnished with comfortable furniture, in good repair and appropriate to the age, size and capabilities of the children. (3-20-20)T

**723. MAINTENANCE.**

Buildings, grounds, furnishings and equipment must be kept clean, free of clutter, and in good repair in a scheduled or routine manner. (3-20-20)T

**724. EQUIPMENT STORAGE.**

All facility cleaning equipment must be stored separate from the kitchen, food preparation, serving, and storage areas. Kitchen and bathroom sinks must not be used for cleaning mops, emptying mop buckets, or for any other purpose not connected with food preparation, or personal hygiene. (3-20-20)T

**725. SERVICE SINK.**

A building housing more than twelve (12) persons must have a service sink used for general maintenance purposes such as floor mopping and not used for food preparation or dish washing. (3-20-20)T

**726. HAZARDOUS MATERIALS OR TOXINS.**

Buildings used to house children must be free from hazardous materials and toxins. An organization must provide documentation of testing for radon gas, materials containing asbestos, and lead paint. Documentation must be maintained at the facility confirming any hazardous material or toxins have been removed or do not pose a threat to the children served. Hazardous materials or toxins are not limited to lead paint, asbestos, and radon. (3-20-20)T

**727. LIGHTING.**

All rooms used by children must be appropriately lighted for safety and comfort. (3-20-20)T

**728. HEATING.**

Heating and ventilation equipment must be properly installed, inspected annually, and kept in good repair. Portable fuel burning and wood burning heating appliances are prohibited. Portable electric heaters must not be used in children's residential sleeping quarters. Local fire officials must approve portable heaters used in other areas. (3-20-20)T

**729. BATHROOM FACILITIES.**

A building used to house children must have adequate, clean and easily accessible bathroom facilities. The number of toilets is one (1) per eight (8) females and one (1) per ten (10) males; bathtubs or showers is one (1) for each ten (10) individuals; washstands is one (1) for every five (5) individuals according to the International Building Code applicable for the type of building and its use. There must be separate use of bathroom facilities for boys and girls over six (6) years of age. There must be separate bathroom facilities for staff. (3-20-20)T

**730. SLEEPING ROOMS.**

Sleeping rooms in a building used to house children must meet the requirements in Subsections 730.01 through 730.03 of this rule. (3-20-20)T

**01. Size.** At least seventy (70) square feet, exclusive of closet space, in a single occupancy room. In a multiple occupancy room, there must be at least forty-five (45) square feet per occupant, exclusive of closet space. Existing multiple occupancy sleeping rooms, may be approved relative to square feet per occupant until the room is remodeled or the building is extensively remodeled. There must be a minimum of three (3) feet between the sides of beds and two (2) feet at the end of the beds. (3-20-20)T

**02. Window Space.** There must be sufficient window space for adequate natural light and ventilation. Emergency egress or rescue windows must comply with the State-adopted **International Building Code**. (3-20-20)T

**03. Restrictions.** A child and an adult cannot share a sleeping room except that a child under one (1) year of age may sleep in a room with an adult. A sleeping room must not be in a stairway, hallway, unfinished attic, unfinished basement, or in a separate building apart from staff supervision. There must be separate rooms for male and female residents. Sleeping rooms must be in close proximity to adult supervision. (3-20-20)T

**731. BEDS.**

Each child must have their own bed that has substantial support, a comfortable non-neoprene mattress and seasonally appropriate non-neoprene bedding. The bed must be equipped with railings when used for children under two (2) years of age. Over-and-under bunk beds must not be used for children under eight (8) years of age. Cribs must meet Consumer Product Safety Commission, Crib Safety Tips available at: <https://www.cpsc.gov/Regulations-Laws--Standards/Rulemaking/Final-and-Proposed-Rules/Full-Size-Cribs>. (3-20-20)T

**732. STORAGE OF POISONOUS AND TOXIC MATERIALS.**

Poisonous and toxic materials must be stored under lock and key and distinctly labeled as poisonous, toxic and stored so as not to contaminate food and not to be a hazard to children. (3-20-20)T

**733. FLAMMABLE LIQUIDS.**

Flammable liquids, including gasoline and kerosene, must be stored only in appropriate containers and kept separate from any building housing children. (3-20-20)T

**734. FIREARMS.**

Firearms are not allowed in a children's residential care facility. (3-20-20)T

**735. SUFFICIENT RECREATIONAL SPACE.**

Sufficient indoor and outdoor recreational space is needed so the number of children in care can participate in a wide range of physical and individual activities. (3-20-20)T

**736. GENERAL SAFETY PROVISIONS.**

**01. Reasonable Precaution.** Reasonable precautions must be taken to prevent children from having unauthorized access to machinery, tools, irrigation ditches, and hazardous materials. (3-20-20)T

**02. Balconies and Stairways.** Balconies and stairways accessible to children must have substantial railings as required by the State-adopted **International Building Code**. (3-20-20)T

**03. Stairway Protection.** Where a children's residential care facility provides care to children under three (3) years of age, stairways must be protected to prevent children from falling down the stairs. (3-20-20)T

**04. Hazard Areas Restrictions.** Based on the age and functioning level of children in care and the type of hazard, an outdoor hazard area must be restricted to prevent easy access to the hazard. (3-20-20)T

**737. DIAPERING AND SANITATION.**

A diaper-changing area must be separate from food preparation and serving areas and be easily accessible to a hand-washing sink. The area must have non-absorbent and washable surfaces, and must be disinfected between uses by different children or protected by a disposable covering discarded after each use. (3-20-20)T

**738. -- 744. (RESERVED)**

**745. EDUCATION PROGRAM.**

Each child of school age must attend either an on-grounds or community-based education program that is approved by the Idaho Department of Education, excluding children in a non-accredited children's residential school. When the education program is provided directly by the children's residential care facility, the education program must meet the requirements in Subsections 745.01 through 745.08 of this rule. (3-20-20)T

**01. Teacher Ratio.** At least one (1) Idaho certified teacher for every twenty (20) children or fraction thereof. (3-20-20)T

**02. Teacher Qualifications.** Teachers must possess a current Idaho certification. (3-20-20)T

**03. Minimum Hours.** Operate for at least as many school days and clock hours as are required by Section 33-512, Idaho Code. (3-20-20)T

**04. Core Curriculum.** Provide core curriculum appropriate to the population served. (3-20-20)T

**05. Special Education.** Provide special education services to a child in care who requires special education. (3-20-20)T

**06. Written Transcripts and an Individual Education Plan (IEP).** Maintain transcripts and IEP's for each child as appropriate. (3-20-20)T

**07. Grading System.** Use a uniform grading system. (3-20-20)T

**08. Release of Records.** Process for transfer and release of education records to and from other schools and children's residential care facilities. (3-20-20)T

**746. WORK.**

Children may be given a non-vocational work assignment as a constructive experience in compliance with child labor laws, which are age appropriate and within the child's capabilities. The primary purpose of work must not be to substitute for paid labor. (3-20-20)T

**747. RECREATION, PHYSICAL EXERCISE, AND LEISURE TIME ACTIVITIES.**

An organization must have a policy requiring children have the opportunity for daily participation in recreation, physical exercise and leisure time activities. The organization must document both individual and group activities, including one (1) hour of large muscle activity each day. Participation must be encouraged but not forced. (3-20-20)T

**748. SLEEP.**

A children's residential care facility must have and follow policies and procedures governing time to be set aside so that each child is given the opportunity for at least eight (8) hours of uninterrupted rest at night and more time if the service plan or health needs of the child require. (3-20-20)T

**749. SWIMMING POOL, POND, OR OTHER BODY OF WATER.**

An above-ground or in-ground swimming pool, pond, or other body of water on the premises of a children's residential care facility for use by children must comply with Section 56-1003(3)(d), Idaho Code, and applicable



swimming pool construction, sanitation, water quality standards, water temperature, recreational bathing and life saving provisions of federal, state, county and municipal laws, regulations and ordinances. (3-20-20)T

**01. Staff Person with Lifesaving or Lifeguard Certificate.** The facility must maintain at least one (1) staff person who has a valid lifesaving or lifeguard certificate issued by a nationally recognized organization. This certified staff person must be on duty at all times when children are in the water. (3-20-20)T

**02. Pools, Hot Tubs, Ponds, and Other Bodies of Water.** The facility must maintain the pools, hot tubs, ponds, and other bodies of water on its property in good repair, in a clean condition, and free from safety hazards and dangerous machinery and equipment. Areas and equipment that present a hazard to children must not be accessible by children. The following safeguards must be provided: (3-20-20)T

**a.** The area surrounding a body of water must be fenced and locked in a manner that prevents access by children; or (3-20-20)T

**b.** If the area surrounding a body of water is not fenced and locked, there must be a secured protective covering that will not allow access by a child; (3-20-20)T

**i.** Pool or hot tub covers must be completely removed when in use; (3-20-20)T

**ii.** When the pool or hot tub cover is in place, the cover must be free from standing water; (3-20-20)T

**iii.** Covers must be kept locked at all times when the pool or hot tub is not in use; and (3-20-20)T

**c.** A reaching pole with a hook and a ring buoy must be accessible; and (3-20-20)T

**d.** Exterior ladders on above ground pools must be removed when the pool is not in use. (3-20-20)T

**03. Access by Children Five Years of Age and Under.** Any children's residential care facility that cares for children five (5) years of age and under, and chooses to prevent access to a body of water by fencing must provide a fence that meets the following requirements: (3-20-20)T

**a.** The fence must be at least four (4) feet high with no vertical opening more than four (4) inches wide, be designed so that a young child cannot climb or squeeze under or through the fence, and surround all sides of the pool or pond; (3-20-20)T

**b.** The gate must be self-closing and have a self-latching mechanism in proper working order out of the reach of young children; (3-20-20)T

**c.** If a building forms one (1) side of the barrier for the pool, doors that provide unrestricted access to the pool must have alarms that produce an audible sound when the doors are opened; and (3-20-20)T

**d.** Furniture or other large objects must not be left near the fence that would enable a child to climb on the furniture and gain access to the pool. (3-20-20)T

**04. Irrigation Canals or Similar Body of Water.** A children's residential care facility caring for a child five (5) years of age and under or a child who is physically or developmentally vulnerable whose property adjoins an irrigation canal must have fencing that prevents access to the canal or similar body of water by the child. (3-20-20)T

**05. Other Water Safety Precautions.** (3-20-20)T

**a.** Wading pools must be empty when not being used; (3-20-20)T

**b.** Children must be under the direct supervision of an adult while using a wading pool; (3-20-20)T

**c.** Toys that attract young children to the pool area must be kept picked up and away from the pool

area when not in use; and (3-20-20)T

- d. A child who does not know how to swim must use an approved lifesaving personal flotation device. (3-20-20)T

**750. WATER FRONT.**

At a waterfront used for swimming, there must be available a whistle, an assist pole or other appropriate reaching device, a rope attached to a ring buoy or other appropriate throwing assist device, a backboard that has appropriate rigid cervical collars and a minimum of six (6) straps, a first aid kit and a rescue tube. (3-20-20)T

**751. SUPERVISION OF RECREATIONAL ACTIVITY.**

Staff conducting or supervising a recreational activity must have knowledge of and enforce appropriate safety techniques for the activity as described in Subsections 751.01 through 751.05 of this rule. (3-20-20)T

- 01. **Instruction.** Instruct each participant in the appropriate safety procedures. (3-20-20)T
- 02. **Safety Equipment.** Ensure that each participant uses adequate and appropriate safety equipment for the activity and the child's ability. (3-20-20)T
- 03. **Rescue Equipment.** Ensure that there is proper rescue equipment available and easily accessible. (3-20-20)T
- 04. **Cardiopulmonary Resuscitation (CPR) and First Aid.** Ensure that at least one (1) staff has current cardiopulmonary resuscitation (CPR) and first aid certification appropriate to the age of the children in the facility. (3-20-20)T
- 05. **Staff Coverage.** Ensure that there are adequate members of staff for the activity and children involved. (3-20-20)T

**752. MEDICATION STORAGE AND ADMINISTRATION.**

A children's residential care facility must have and follow policies and procedures on the storage and administration of prescription and non-prescription medication. The policy must address the requirements in Subsections 752.01 through 752.06 of this rule. (3-20-20)T

- 01. **Medication Storage and Administration.** Require prescription and over-the-counter medication be stored under lock and key and the keys safe guarded from children. For medications taken on field outings, storage of medication must be in the possession of a staff member qualified to administer medications. (3-20-20)T
- 02. **Trained Staff.** Require that staff who administer and assist with self-administration of medications be trained by a qualified medical professional. (3-20-20)T
- 03. **Psychotropic Medication:** (3-20-20)T
  - a. Prohibit the administration of psychotropic medication unless a qualified medical professional determines that the medication is clinically indicated; and (3-20-20)T
  - b. Prohibit the administration of psychotropic medications for disciplinary purposes, for the convenience of staff, or as a substitute for appropriate treatment services; (3-20-20)T
- 04. **Documentation.** Required documentation for all prescription medication issued by a qualified medical professional's valid order that includes the dosage to be given, and documentation of each dose given, including: (3-20-20)T
  - a. The child's name; (3-20-20)T
  - b. The date and time; (3-20-20)T

- c. The amount of dosage given and whether the child did not take the medication; and (3-20-20)T
- d. The person who administered or assisted in self-administration of the medication. (3-20-20)T

**05. Medication Changes.** Require that prescribed medication not be stopped or changed in dosage or administration without consulting with a qualified medical professional and documenting the consultation and the change. (3-20-20)T

**06. Disposal of Unused Medication.** Require that all unused and expired medication be disposed of so they are not available to children. (3-20-20)T

**753. UNIVERSAL PRECAUTIONS.**

Universal precautions must be taken for spills of body fluids such as blood, blood containing body fluids, eye discharge, feces, body tissue discharge, nasal discharge, saliva, urine, vomit, contaminated material and diapers, which must be disposed of in a plastic bag that is secured with a tie. The disinfectant solution used to clean up body fluids must be a commercially prepared spill kit or a disinfectant solution made from one-fourth (1/4) cup of household bleach to one (1) gallon of water. A person doing the cleaning and disinfecting must wear non-porous disposable gloves. Mops and other cleaning devices and fluids used to clean up body fluid spills must be disinfected, properly dried and stored. Syringes must be disposed of in accordance with Occupational Safety and Health Act (OSHA) standards and not to be accessible to children. A copy of OSHA may be obtained at the Idaho Industrial Commission, 317 Main Street., P.O. Box 83720, Boise, Idaho, 83720-0041. (3-20-20)T

**754. FIRST AID KIT.**

A first aid kit which is approved by a physician or nationally recognized accrediting body, must be readily available at all times, containing materials to sufficiently meet the needs of a child's medical needs until other medical treatment is obtained, if needed. The contents, location and use of first aid kits must be reviewed annually with all staff. The content of the kits must be inventoried monthly and restocked as needed. (3-20-20)T

**755. NUTRITION.**

Children must be provided three (3) nutritionally balanced meals in appropriate intervals and in amounts appropriate to their size and age, and that are in accordance with the Dietary Reference Intakes (DRIs) of the National Research Council [Dietary Reference Intakes Essential Guide Nutrient Requirements](#) or its equivalent. A child must be provided a qualified medical professional prescribed diet or special diet based on religious beliefs. A nutritional or dietitian professional must approve menus annually. The current menu must be readily available and any change or substitution noted on the menu. Menus must be maintained on file for at least six (6) months. (3-20-20)T

**756. ANIMALS AND PETS.**

Animals and household pets must be free from disease and cared for in a safe and clean manner. All domestic animals and pets must be vaccinated against rabies. Documentation of the vaccination against rabies must be kept on file at the children's residential care facility. (3-20-20)T

**757. USE OF TOBACCO PRODUCTS, ALCOHOL, AND ILLEGAL DRUGS PROHIBITED.**

Tobacco products, alcohol and illegal drugs must not be used by children, staff, volunteers, or visitors in any building used to house children or in the presence of children or in vehicles used to transport children. (3-20-20)T

**758. TRANSPORTING CHILDREN.**

**01. Vehicle.** Transportation of children in a children's residential care facility vehicle must be in a vehicle that is: (3-20-20)T

- a. Properly registered; (3-20-20)T
- b. Covered by insurance for personal injury and liability; (3-20-20)T

c. Driven by a person with a valid driver's license for the type of vehicle who complies with all applicable traffic laws while transporting children; (3-20-20)T

- d. Maintained in a clean and safe condition; (3-20-20)T
- e. Equipped with a red triangular reflector device for use in emergency; (3-20-20)T
- f. Equipped with a first aid kit; and (3-20-20)T
- g. Equipped with a fire extinguisher that is properly secured and not readily available to children. (3-20-20)T
- 02. Proper Seating of Children and Adults:** (3-20-20)T
  - a. A child must ride in an age appropriate vehicle restraint seat, properly secured, or if the child is large enough, in a vehicle manufactured seat and properly use the passenger restraint device; and (3-20-20)T
  - b. Adults riding in the vehicle must occupy a manufactured seat and use the passenger restraint device. (3-20-20)T

**759. CONTRABAND.**

A children's residential care facility must define prohibited contraband in a written policy. Contraband found in the possession of children or staff must be confiscated by staff and secured in a location inaccessible to children. Local law enforcement must be notified in the event that illegal contraband is confiscated. It is the responsibility of the administrator or designee to dispose of all contraband not confiscated by law enforcement, in accordance with the children's residential care facility contraband policy. (3-20-20)T

**760. SEARCHES.**

If a children's residential care facility conducts searches of children, the children's residential care facility, staff or visitors, it must have and follow written policies and procedures. Searches must be completed in the least intrusive manner possible for the type of search being conducted. All contraband will be disposed of in accordance with these rules. The policies and procedures at a minimum require the following procedures. (3-20-20)T

**01. Pat Down Searches.** Pat down searches of children may only be conducted when the children's residential care facility feels it is necessary to discourage the introduction of contraband into the children's residential care facility, or to promote the safety of staff and other children. Pat down searches are conducted as follows: (3-20-20)T

- a. By staff trained in proper search techniques; (3-20-20)T
- b. By a staff member of the same sex as the child being searched, and must be in the presence of another staff member; (3-20-20)T
- c. The child is told he is about to be searched; (3-20-20)T
- d. The child should remove all outer clothing (gloves, coat, hat and shoes) and empty all pockets; (3-20-20)T
- e. The staff person must then pat the clothing of the child using only enough contact to conduct an appropriate search; (3-20-20)T
- f. If the staff detects anything unusual, the child must be asked to identify the item and appropriate steps taken to remove the item for inspection; (3-20-20)T
- g. If the child refuses to comply, the administrator or designee will be notified immediately and be responsible to resolve the matter; and (3-20-20)T
- h. All searches must be documented in writing. (3-20-20)T
- 02. Strip Searches are Prohibited.** (3-20-20)T

**03. Body Cavity Searches are Prohibited.** (3-20-20)T

**761. BEHAVIOR MANAGEMENT AND DISCIPLINE POLICY.**

**01. Behavior Management.** A children's residential care facility must have and follow a behavior management and discipline policy for children which identifies appropriate and specific methods of behavior management and discipline, and ensures that the methods of behavior management and discipline are positive and consistent. Individualized behavior management must be based on an assessment of the child's needs, stage of development and behavior to promote self control, self direction, self esteem, and an acceptable pattern of social behavior appropriate to the age and development level of the child. The policy must include the concept and application of least restrictive effective treatment and positive reinforcements and prohibits the following:

(3-20-20)T

- a.** Physical force, except as permitted under the restraint Sections 766 and 767 of these rules; (3-20-20)T
- b.** Any kind of punishment inflicted on the body, including spanking, hitting, slapping, spitting, kicking, shaking, pulling hair, pinching skin, twisting of an arm or leg in a way that would cause pain or injury to the child, kneeling and sitting on the chest of a child, placing a choke hold on a child, bending back a finger, and shoving or pushing a child into the wall, floor or other stationary object; (3-20-20)T
- c.** Cruel and unusual physical exercise, including forcing the child to take an uncomfortable position; (3-20-20)T
- d.** Verbal abuse, ridicule, humiliation, profanity and other forms of degradation directed at a child or a child's family; (3-20-20)T
- e.** Locked confinement in an area except an area approved by the Department for confinement of a child as provided in these rules; (3-20-20)T
- f.** Withholding of necessary food, clothing, bedding, rest, toilet use, bathing facilities, and entrance to a children's residential care facility housing a child; (3-20-20)T
- g.** Denial of visits or communication with the child's family except as specified in the child's service plan or court order; (3-20-20)T
- h.** Denial of necessary educational, medical, counseling, and social services; (3-20-20)T
- i.** Disciplining a child or group of children for the actions of one (1) child, unless the organization's policies and procedures for group behavior management and discipline are based on a nationally recognized peer group treatment model and clearly prescribe the circumstances and safeguards under which disciplining the group is allowed and is supervised directly by staff; (3-20-20)T
- j.** The placing of anything in or on a child's mouth; and (3-20-20)T
- k.** A physical work assignment that produces unreasonable discomfort. (3-20-20)T

**02. Documentation.** An organization must document that the policy has been provided to a resident capable of reading it or is explained to the resident appropriate to their age and level of understanding and is made available to parents, guardians, and referral sources. (3-20-20)T

**762. TIME-OUT.**

A children's residential care facility must have and follow written policy and procedures governing the appropriate use of time-out, as required in Subsections 762.01 through 762.08 of this rule. (3-20-20)T

**01. Use.** Time-out is only used when a child's behavior is disruptive to the child's ability to learn, to

participate appropriately, or to function appropriately with other children or the activity. (3-20-20)T

**02. Children Under Six Years of Age.** For children under six (6) years of age, the period of time for time-out is not to exceed one (1) minute for each year of the child's age and is used as a supplement to, but not a substitute for other developmentally appropriate positive methods of behavior management. (3-20-20)T

**03. Children Six Years of Age or Older.** For children six (6) years of age and older the time duration cannot exceed sixty (60) consecutive minutes. (3-20-20)T

**04. Prohibited Locations.** The time-out cannot be in a closet, bathroom, unfinished basement, or attic and cannot be in a locked area or box. (3-20-20)T

**05. Documentation.** A description in sufficient detail to provide a clear understanding of the incident which resulted in the child being placed in time-out, and the staff's attempts to help the child avoid time-out. (3-20-20)T

**06. Observations.** A staff person is designated to be responsible for visually observing the child at random intervals not to exceed fifteen (15) minutes. (3-20-20)T

**07. Re-Introduction to the Group.** The child is re-introduced to the group in a sensitive and non-punitive manner as soon as control is regained. (3-20-20)T

**08. Review.** If there are more than ten (10) time-outs for a child in a twenty-four (24) hour period, a review is conducted by the chief administrator or designee, to determine the suitability of the child remaining in the children's residential care facility, whether modifications to the child's service plan are warranted, or whether staff need additional training in alternative therapeutic behavior management techniques and appropriate action taken is based on the findings of the review. (3-20-20)T

### **763. UNLOCKED SECLUSION.**

If a children's residential care facility uses seclusion there must be written policies and procedures, which at a minimum requires: (3-20-20)T

**01. Use of Unlocked Seclusion.** Unlocked seclusion must not be used as punishment or to substitute for other developmentally appropriate positive methods of behavior management. Seclusion may only be used as a means of intervention when the child's behavior is so violent or disruptive that it presents a high risk of physical or emotional harm to self or others, and less restrictive and less punitive interventions have been applied without success. (3-20-20)T

**02. Time Needed.** Seclusion must be used only for the time needed to change the behavior compelling it. (3-20-20)T

**03. Children Under Six Years of Age.** For children under six (6) years of age, the period of time is not to exceed one (1) minute for each year of the child's age and is used as a supplement to, not a substitute for, other developmentally appropriate positive methods of behavior management. For children six (6) years of age and older the time duration cannot exceed sixty (60) consecutive minutes. (3-20-20)T

**04. Restrictions on Seclusion.** The seclusion must not be in a box, closet, bathroom, unfinished basement or attic. (3-20-20)T

**05. Staff Supervision.** A staff person is designated to be responsible for visually observing the child at random intervals, which are not to exceed fifteen (15) minutes throughout the period of seclusion, and must be recorded in a log. (3-20-20)T

**06. Supervisory Approval.** Supervisory approval is required for a period of seclusion of one (1) child that exceeds two (2) hours, or the total seclusion time exceeds three (3) hours in a twenty-four (24) hour period, or more than four (4) separate seclusion incidents in a twenty-four (24) hour period. (3-20-20)T

**07. Documentation.** Each seclusion must be documented in writing and include the child's name, reason for the seclusion, date and start and end time of the seclusion and the staff assigning the seclusion. (3-20-20)T

**08. Re-Introduction.** The child is re-introduced to the group in a sensitive and non-punitive manner as soon as he can participate appropriately. (3-20-20)T

**09. Review.** If there are more than ten (10) seclusion's for a child in a twenty-four (24) hour period, there must be a review by the chief administrator or their designee. The review is to determine whether modifications to the child's service plan are warranted and whether staff needs additional training in alternative therapeutic behavior management techniques or disciplinary action. Appropriate action must be taken based on the findings of the review. (3-20-20)T

**764. LOCKED SECLUSION.**

Locked seclusion is used only when a child's behavior is so violent or disruptive that it presents a high risk of physical or emotional harm to the child or others and other less restrictive and less punitive interventions have been applied without success. Locked seclusion is prohibited for: non-violent and non-assaultive offenses and behaviors; practices designed to prevent children from running away; secluding a child who is ill; as a punishment; and facilitating supervision for the convenience of staff. No more than one (1) child can be in a locked seclusion room at a time. Supervisory staff must be notified at the time the locked seclusion begins. (3-20-20)T

**01. Duration.** Locked seclusion must be used only for the time needed to change the behavior compelling its use. Locked seclusion cannot exceed two (2) consecutive hours or a total of four (4) non-consecutive hours within any twenty-four (24) hour period, unless approved by a qualified medical professional. (3-20-20)T

**02. Potentially Harmful Objects.** A child placed in locked seclusion must not be in possession of belts, matches, weapons or any other potentially harmful objects or materials that could present a risk of harm to the child. (3-20-20)T

**03. Observation.** A child in locked seclusion must be observed by staff at random intervals, not to exceed every ten (10) minutes to assure that the child is safe. (3-20-20)T

**04. Locked Seclusion Log.** A locked seclusion room log must be maintained and at a minimum includes: (3-20-20)T

**a.** The child's name; (3-20-20)T

**b.** The date and time of placement in locked seclusion; (3-20-20)T

**c.** The name of the staff who requested the child's locked seclusion; (3-20-20)T

**d.** The name of the supervisory staff notified and the time and date notified. (3-20-20)T

**e.** A description in sufficient details, to provide a clear understanding, of the incident which resulted in the child being placed in locked seclusion and the staff's attempts to help the child avoid locked seclusion; (3-20-20)T

**f.** A record of observations; and (3-20-20)T

**g.** The date and time of removal from locked seclusion. (3-20-20)T

**05. Re-Introduction.** The child must be re-introduced to the group in a sensitive and non-punitive manner as soon as he has re-gained control. (3-20-20)T

**06. Review.** When a child is in locked seclusion for a total of two (2) cumulative hours or four (4) non-cumulative hours within a twenty-four (24) hour period, there must be a review by the chief administrator or their

designee within one (1) working day. The review is to determine whether modifications to the child's service plan is warranted, and whether staff need additional training in alternative therapeutic behavior management techniques or disciplinary action. Appropriate action must be taken based on the findings of the review. (3-20-20)T

**765. LOCKED SECLUSION ROOM REQUIREMENTS.**

Rooms used for locked seclusion must measure at least seventy-five (75) square feet with a ceiling height of at least seven (7) feet. They must have either natural or mechanical ventilation and be equipped with a break resistant window, or a mirror or camera that allows for full observation of the room. Locked seclusion rooms must have no hardware, equipment or furnishings that obstruct observing the child or that present a physical hazard or a suicide risk. Rooms used for locked seclusion must be inspected and approved by a fire inspector and the Department. (3-20-20)T

**766. MECHANICAL RESTRAINT.**

If a children's residential care facility uses mechanical restraint, it must have and follow written mechanical restraint policies and procedures. The policies must at a minimum require those described in Subsections 766.01 through 766.13 of this rule. (3-20-20)T

**01. Mechanical Restraint Use as a Last Resort.** Mechanical restraint must only be used as a last resort when other therapeutic techniques have not worked and less restrictive interventions have been tried and have been found to be ineffective, and only after at least one (1) of the following has been determined: (3-20-20)T

**a.** The child is emotionally or physically uncontrollable and constitutes a serious and evident danger to self or others; (3-20-20)T

**b.** The child is causing serious property damage; or (3-20-20)T

**c.** An attempted escape is imminent and the child is out of control and poses a danger to self or others. (3-20-20)T

**02. Staff Training.** All staff who apply mechanical restraints must be trained in the proper and safe use of the mechanical restraint device used and training must be current and documented. (3-20-20)T

**03. Intervention.** Staff must inform the child that if their behavior continues, staff will have to intervene by placing them in mechanical restraint to help them regain control. (3-20-20)T

**04. Administrator Approval.** The administrator or designee must approve the use of mechanical restraint for the specific child for the specific behavior before each application of mechanical restraint. (3-20-20)T

**05. Restraint Type.** Restraints must be of a soft type when used to restrain the child's wrists to their side, secure the child's ankles together, or both; or be in or on a mechanical restraint device specifically designed for restraint which is recognized as safe and is made by a nationally recognized restraint device manufacturer. A restraint device must be used only in accordance with the manufacturer's written instructions for the device, except that handcuffs may not be used for more than five (5) minutes when it has been determined that the child may harm himself or others while the mechanical restraint is being applied. Handcuffs may only be used for the time needed to apply the mechanical restraints. (3-20-20)T

**06. Used Only Until Child Has Regained Control.** A mechanical restraint is used only until the child has regained control. (3-20-20)T

**07. Prohibitions on Mechanical Restraints.** Mechanical restraints are prohibited when there are specified medical reasons pursuant to a qualified medical professional's order. A child must not be mechanically restrained to a fixed object except one that was specifically designed for the purpose, meets nationally recognized standards and has been approved by the Department. Mechanical restraints must not be used for non-violent and non-assaultive offenses and behaviors as punishment to facilitate supervision for the convenience of staff or as a substitute for a treatment program. (3-20-20)T

**08. Monitoring.** A staff assigned to monitor a child placed in mechanical restraint must have no other



immediate responsibility and must be in visual and auditory contact with the child at all times to ensure that all personal needs of the child are met, including access to toilet facilities as needed. (3-20-20)T

**09. Professional Opinion.** After one (1) hour has elapsed with the child in mechanical restraint, or if the child is released from mechanical restraint and has to be placed back in mechanical restraint, the supervisor must obtain a qualified medical or mental health professional's opinion regarding continuation of the restraint. The professional giving the opinion must be thoroughly familiar with the proper use of the mechanical restraint device being used. It is the qualified medical or mental health professional's responsibility to assess the problem requiring the use of restraint and amass any resources necessary to eliminate the problem. (3-20-20)T

**10. Mechanical Restraint Log.** There must be a mechanical restraint log documenting each use of mechanical restraint that includes: (3-20-20)T

**a.** The child's name; (3-20-20)T  
**b.** The date and time of placement in mechanical restraint; (3-20-20)T  
**c.** The name of the staff who requested the mechanical restraint of the child; (3-20-20)T  
**d.** The name of the administrator or designee who approved the use of mechanical restraint of the child; (3-20-20)T

**e.** A description in sufficient details to provide a clear understanding of the incident which resulted in the child being placed in mechanical restraint and the staff's attempts to help the child avoid mechanical restraint; (3-20-20)T

**f.** Detailed observation notes by the person assigned to monitor the child while in mechanical restraint; (3-20-20)T

**g.** Documentation of the professional opinion required if a restraint lasts for more than one (1) hour or is returned to mechanical restraint; and (3-20-20)T

**h.** The date and time of removal from mechanical restraint. (3-20-20)T

**11. Counsel.** When the child has been released from mechanical restraint, staff must counsel with the child about the behavior and problems experienced that resulted in the mechanical restraint. (3-20-20)T

**12. Re-Introduction.** The child must be re-introduced to the group in a sensitive and non-punitive manner as soon as he has regained control. (3-20-20)T

**13. Review.** When the child is in mechanical restraint there must be a review by the chief administrator or designee within twenty-four (24) hours. The review is to determine the suitability of the child remaining in the children's residential care facility, whether modifications to the child's service plan is warranted and if staff need further training or disciplinary action. Appropriate action must be taken based on the findings of the review. The person doing the review must be knowledgeable about the proper use of the mechanical restraint device and its impact on the child. (3-20-20)T

**767. ALTERNATIVE FORMS OF RESTRAINT.**

A children's residential facility must have and follow written policies and procedures governing the appropriate use of alternative forms of restraint. The policies and procedures must be in accordance with the restraint intervention strategies of a nationally recognized program and approved by the Department. The policies must at a minimum require those described in Subsections 767.01 through 767.11 of this rule. (3-20-20)T

**01. Restraint Used as a Last Resort.** Restraint is only to be used as a last resort when other therapeutic techniques have not worked and less restrictive interventions have been tried and have been found not to be effective and only after one (1) of the following has been determined: (3-20-20)T

- a.** The child is emotionally or physically uncontrollable and constitutes a serious and evident danger to self or others; (3-20-20)T
- b.** The child is causing serious property damage; or (3-20-20)T
- c.** An attempted escape is imminent and poses a serious and evident danger to self or to the community. (3-20-20)T
- 02. Staff Training.** All staff who apply restraints are trained in the proper and safe use of the restraint device used and the training is current and documented, including any special certification required to apply the restraint. (3-20-20)T
- 03. Intervention.** Staff informs the child that if their behavior continues, staff will have to intervene by use of restraint to help them gain control. (3-20-20)T
- 04. Restraint Approval.** Administrative or designee approves the restraint for the specific child for the specific behavior before each application of restraint. (3-20-20)T
- 05. Used Only Until the Child Has Regained Control.** Restraint must only be used until the child has regained control. (3-20-20)T
- 06. Restraint Is Prohibited:** (3-20-20)T
- a.** When there are specific medical reasons pursuant to a medical professional's order; (3-20-20)T
- b.** For non-violent and non-assaultive behaviors; (3-20-20)T
- c.** As punishment; (3-20-20)T
- d.** To facilitate supervision for the convenience of staff; and (3-20-20)T
- e.** As a substitute for other more effective treatment methods. (3-20-20)T
- 07. Monitoring.** A staff assigned to monitor a child in restraint must have no other immediate responsibility and must be in visual and auditory contact with the child at all times to ensure that all personal needs of the child are met, including access to toilet facilities as needed. (3-20-20)T
- 08. Restraint Log.** A restraint log documenting each use of restraint which includes: (3-20-20)T
- a.** The child's name; (3-20-20)T
- b.** The time and date of initiation of the restraint; (3-20-20)T
- c.** The name of the staff who requested the restraint of the child; (3-20-20)T
- d.** The name of the administrator or designee who approved the use of the restraint of the child; (3-20-20)T
- e.** A description in sufficient details to provide a clear understanding of the incident which resulted in the child being restrained and the staff's attempts to help avoid the restraint; (3-20-20)T
- f.** Detailed observation notes by the person assigned to monitor the child while in restraint; and (3-20-20)T
- g.** The time and date of termination of the restraint. (3-20-20)T
- 09. Counsel.** When a child has been released from restraint, staff must counsel with the child about

behavior and problems experienced which resulted in the restraint use. (3-20-20)T

**10. Re-Introduction.** The child is re-introduced to the group in a sensitive and non-punitive manner as soon as he has regained control. (3-20-20)T

**11. Review.** When a child has been in restraint, there must be within twenty-four (24) hours a review by the chief administrator or their designee. The review is to determine the suitability of the child remaining in the children's residential care facility and whether modifications to the child's service plan is warranted and if staff need further training or disciplinary action. Appropriate action must be taken based on the findings of the review. The person doing the review must be knowledgeable about the proper use of the restraint device and its impact on the child. (3-20-20)T

**768. TRANSPORTATION OF CHILDREN IN RESTRAINTS PROHIBITED.**  
A children's residential facility or its agents are prohibited from transporting children in restraints. (3-20-20)T

**769. (RESERVED)**

**ADDITIONAL PROVISIONS FOR CHILDREN'S RESIDENTIAL MATERNITY CARE**  
**(Sections 770-779)**

**770. ADDITIONAL PROVISIONS FOR CHILDREN'S RESIDENTIAL MATERNITY CARE.**  
(Sections 770 through 779, see also Sections 500 through 599 and 700 through 769.) (3-20-20)T

**771. SERVICE WORKER AVAILABLE.**  
A service worker must be available to each pregnant minor and minor mother to provide information on options open to her and to assist her in making decisions that are in her best interest and her child. The decision for final plans for the minor mothers child rests with the minor parent. A pregnant minor is prohibited from signing a statement committing to any definitive plan prior to the birth of her child and must not be subject to coercion to release her child before or after the birth of her child. (3-20-20)T

**772. PRENATAL AND POSTPARTUM CARE.**  
Prenatal and postpartum care for residents and newborns must be performed only by a physician licensed to practice medicine in Idaho and include: (3-20-20)T

**01. Obstetric History.** The obtaining of an obstetric history; (3-20-20)T

**02. Obstetrical Exam.** Within ten (10) days of entering care, a complete obstetrical exam; (3-20-20)T

**03. Ongoing Medical Care.** Ongoing medical care with examinations as prescribed by the physician; (3-20-20)T

**04. Infant Medical Care Plan.** A planned program of medical and nursing care of all infants in care, approved by the physician; (3-20-20)T

**05. Hospital Delivery Required.** Infants must only be delivered in a hospital licensed by the state of Idaho; and (3-20-20)T

**06. Prenatal and Postnatal Education.** A pregnant resident must be provided educational information on prenatal and postnatal care as appropriate. (3-20-20)T

**773. DISCHARGE PLANS.**  
Discharge plans must be developed in a timely manner with the service worker and the new parent to ensure an infant does not remain in a children's residential maternity care facility apart from parental care and supervision. (3-20-20)T

**774. -- 779. (RESERVED)**

**ADDITIONAL PROVISIONS FOR CHILDREN'S ALCOHOL-DRUG  
ABUSE RESIDENTIAL CARE FACILITIES**  
**(Sections 780-789)**

**780. ADDITIONAL PROVISIONS FOR CHILDREN'S ALCOHOL-DRUG ABUSE RESIDENTIAL CARE FACILITIES.**

In addition to complying with Sections 500 through 599, 700 through 769, and 800 through 899 of these rules, children's alcohol and drug abuse residential care facilities must be approved under IDAPA 16.07.17, "Substance Use Disorders Services"; and IDAPA 16.07.15, "Behavioral Health Programs." (3-20-20)T

**781. --789. (RESERVED)**

**ADDITIONAL PROVISIONS FOR NON-ACCREDITED CHILDREN'S RESIDENTIAL SCHOOLS**  
**(Sections 790-793)**

**790. ADDITIONAL PROVISIONS FOR NON-ACCREDITED CHILDREN'S RESIDENTIAL SCHOOLS.**

(Sections 790 through 793, see also Sections 500 through 599 and 700 through 769.) (3-20-20)T

**791. APPLICATION PROCESS.**

A non-accredited children's residential school must file with the Division of Family and Community Services of the Department, an affidavit addressing the following elements and the listed attachments: (3-20-20)T

**01. Affidavit Statement.** Affiant will make this affidavit based upon their own personal knowledge and belief. (3-20-20)T

**02. Affiant Administrative Employees.** Affiants state that they are the administrative employees responsible for operation of the school and the head of the governing body of the named school. (3-20-20)T

**03. School Administrative Description.** The school is a non-accredited children's residential school as defined in this Chapter and as demonstrated by the attached by-laws or an attached organizational statement of purpose detailing organizational structure, philosophy, program, intake and enrollment policy, services, geographic area served, and children served according to their legal status, physical, intellectual, and behavioral characteristics. (3-20-20)T

**792. STAFF RATIOS REQUIRED.**

Non-accredited children's residential schools must have at least one (1) staff member on duty and one (1) on call and available within (10) minutes for each twenty-five (25) children or fraction thereof, when children are awake and present. During normal sleeping hours, children in each sleeping quarters will be under close supervision and within easy call of a staff member, with one (1) on-call staff available within ten (10) minutes. The facility must at all times have a staff coverage plan to ensure the safety and needs of the children that is approved by the Department. (3-20-20)T

**793. CHILD'S RECORD.**

The school must maintain a record on each child with the following: (3-20-20)T

**01. Content.** The child's record will contain the following information: (3-20-20)T

**a.** Child's full name; (3-20-20)T

**b.** Birth date; (3-20-20)T

**c.** Gender; (3-20-20)T

**d.** Height, weight, hair color, eye color, race, and identifying marks; (3-20-20)T

- child;
- e. Name, address and telephone number of responsible parent, guardian or legal custodian of the child; (3-20-20)T
  - f. Documentation of authority to accept and care for the child; (3-20-20)T
  - g. Medical care authorizations; (3-20-20)T
  - h. School reports including grades and adjustment; (3-20-20)T
  - i. Reason for referral or placement; and (3-20-20)T
  - j. Special problems and needs. (3-20-20)T
- 02. Record Entries.** For record entries by professional and clinical staff, the entries will be signed and dated by the person providing the service. (3-20-20)T

**794. -- 799. (RESERVED)**

**ADDITIONAL STANDARDS FOR CHILDREN'S THERAPEUTIC OUTDOOR PROGRAMS**  
**(Sections 800-899)**

**800. ADDITIONAL STANDARDS FOR CHILDREN'S THERAPEUTIC OUTDOOR PROGRAMS.**  
(See sections 800 through 899, also see Sections 500 through 599.) (3-20-20)T

**801. (RESERVED)**

**802. POLICIES AND PROCEDURES.**

In addition to the requirements for policies in Sections 500 through 599 of these rules, a children's therapeutic outdoors program must have policies and procedures in place addressing the licensing standards required in Sections 800 through 899 of these rules. (3-20-20)T

**803. -- 804. (RESERVED)**

**805. BASE CAMP REQUIREMENTS.**

**01. Base Camp.** A children's therapeutic outdoor program must have a base camp or field office in Idaho, here after referred to as a base camp. Base camp at a minimum must: (3-20-20)T

- a. Be staffed and monitored twenty-four (24) hours a day when there are children in care in the base camp or on expeditions; (3-20-20)T
- b. Have current staff personnel files; (3-20-20)T
- c. Have a current list of the names of staff and children in each field group; (3-20-20)T
- d. Have a master map of all activity areas used by the program; (3-20-20)T
- e. Have copies of each group's expeditionary route with its schedule and itinerary, copies of which must be provided to the Department and local law enforcement when requested; (3-20-20)T
- f. Maintain current logs of all communications with each field group away from the base camp; and (3-20-20)T
- g. Have an emergency response plan that is developed by the organization and updated annually. (3-20-20)T

**02. Proof of Compliance.** A children's therapeutic outdoor program which operates in Idaho must

comply with federal, state, and local regulations and must maintain proof of compliance at the base camp. (3-20-20)T

**806. HIGH ADVENTURE REQUIREMENTS.**

- 01. High Adventure Activities.** High adventure activities may include the following: (3-20-20)T
  - a.** Target sports; (3-20-20)T
  - b.** Aquatics; (3-20-20)T
  - c.** Hiking; (3-20-20)T
  - d.** Adventure challenge courses; (3-20-20)T
  - e.** Climbing and rappelling; (3-20-20)T
  - f.** Winter camping; (3-20-20)T
  - g.** Soloing; (3-20-20)T
  - h.** Spelunking; (3-20-20)T
  - i.** Expeditioning; (3-20-20)T
  - j.** Swimming in a river, stream, lake, or pond; (3-20-20)T
  - k.** White water activities; and (3-20-20)T
  - l.** Animal related activities. (3-20-20)T

**02. High Adventure Activity Policy and Procedures.** For the high adventure activities identified in Subsection 806.01 of this rule and for any activity identified by the children’s therapeutic outdoor program or the Department as a high adventure activity, there must be a written policy and procedure to be followed which include: (3-20-20)T

- a.** Training, experience, and qualifications for leader and staff; (3-20-20)T
- b.** Specific staff-to-participant ratios appropriate to the activity; (3-20-20)T
- c.** Classification and limitations for each child’s participation; (3-20-20)T
- d.** Arrangement, maintenance, and inspection of the activity area; (3-20-20)T
- e.** Appropriate equipment and the inspection and maintenance of the equipment; and (3-20-20)T
- f.** Safety precautions to reduce the possibility of an accident or injury. (3-20-20)T

**03. High Adventure Activities Leader.** An activity leader who is at least twenty-one (21) years of age and who has documented training and experience in conducting the activity must conduct high adventure activities. (3-20-20)T

**807. -- 809. (RESERVED)**

**810. STAFF QUALIFICATIONS FOR CHILDREN’S THERAPEUTIC OUTDOOR PROGRAMS.**

Qualifications of staff, interns, and volunteers must be verified through written verification of a completed criminal history and background check as required by IDAPA 16.05.06, “Criminal History and Background Checks,” work

experience, education, and classroom instruction. A program which provides children's therapeutic outdoor programs must have the following staff: (3-20-20)T

**01. Chief Administrator.** A children's therapeutic outdoor program must have a chief administrator who is primarily responsible for ensuring that the program is at all times in compliance with applicable licensing rules and that staff are familiar with all program policies and procedures. The chief administrator may also function as the field director. The chief administrator must: (3-20-20)T

- a. Be at least twenty-five (25) years of age; (3-20-20)T
- b. Have two (2) years experience working with children and three (3) years experience in staff supervision and administration; and either; (3-20-20)T
  - i. At the time of appointment, at a minimum, have a Bachelor's degree in a relevant discipline; or (3-20-20)T
  - ii. Have completed a career development program which includes work related experience, training, or college credits that provide a level of achievement equivalent to the Bachelor's degree; and (3-20-20)T
- c. Have a minimum of thirty (30) semester hours or forty-five (45) quarter hours in recreational therapy or related experience, or one (1) year of outdoor youth program field experience; and (3-20-20)T
- d. Demonstrate or obtain proficiency in the required training criteria described in Subsection 812.02 of this rule. (3-20-20)T

**02. Field Director.** A children's therapeutic outdoor program must have a field director who is primarily responsible for the quality of the field activities, coordinates field operation, supervises direct care staff, and manages the field office. The field director is responsible for compliance with applicable licensing rules and ensure that staff are familiar with all program policies and procedures. The field director must: (3-20-20)T

- a. Be at least twenty-five (25) years of age; (3-20-20)T
- b. Have a minimum of thirty (30) semester hours or forty-five (45) quarter hours in recreational therapy or related experience, or one (1) year of outdoor youth program field experience; (3-20-20)T
- c. Have a minimum of forty (40) twenty-four (24) hour field days of program experience or equivalent experience in outdoor programs documented in their personnel file; and (3-20-20)T
- d. Demonstrate or obtain proficiency in the required training criteria described in Subsection 812.02 of these rules within ninety (90) days of assuming administrative responsibilities and prior to any provision of direct care to children; and (3-20-20)T
- e. Be certified to provide cardiopulmonary resuscitation (CPR) and first aid. (3-20-20)T

**03. Senior Field Staff.** A children's therapeutic outdoor program must have a senior field staff working directly with each group of program participants. Each senior field staff must: (3-20-20)T

- a. Be at least twenty-one (21) years of age; (3-20-20)T
- b. Have an associate degree or high school diploma or equivalent with thirty (30) semester hours or forty-five (45) quarter hours of education and training or comparable experience and training in a field related to recreation and adventure activities; (3-20-20)T
- c. Have a minimum of forty (40) twenty-four (24) hour field days of program experience or equivalent experience in outdoor programs documented in their personnel file; (3-20-20)T
- d. Demonstrate or obtain proficiency in the required training criteria described in Subsection 812.02

of these rules prior to assuming direct care responsibilities; and (3-20-20)T

e. Be Certified to provide cardiopulmonary resuscitation (CPR) and first aid. (3-20-20)T

**04. Field Staff.** Each field staff must: (3-20-20)T

a. Be at least twenty-one (21) years of age; (3-20-20)T

b. Have a high school diploma or equivalent; (3-20-20)T

c. Have completed staff training and field course work as required by Subsection 812.02 of these rules prior to assuming direct care responsibilities; and (3-20-20)T

d. Be certified to provide cardiopulmonary resuscitation (CPR) and first aid. (3-20-20)T

**05. Program Consultants.** A children's therapeutic outdoor program must have a multidisciplinary staff or program consultants that have knowledge of the physical and emotional demands of the program and be available to program participants upon the recommendation of the field director or senior field staff. At a minimum the team must consist of: (3-20-20)T

a. A licensed physician; and (3-20-20)T

b. A licensed treatment professional including either a licensed psychologist, certified social worker, marriage and family counselor, or professional counselor. (3-20-20)T

**06. Intern.** Each intern must: (3-20-20)T

a. Be in a learning program to meet personal educational goals; (3-20-20)T

b. Be at least nineteen (19) years of age; (3-20-20)T

c. Have at least a high school diploma or its equivalent; (3-20-20)T

d. Have completed staff training and field course work as required by Subsection 812.02 of these rules prior to assuming direct care responsibilities; and (3-20-20)T

e. Be under the supervision of a licensed therapist if they are in a clinical internship pursuing a professional degree or license. (3-20-20)T

**07. Volunteers.** Each volunteer must: (3-20-20)T

a. Be at least eighteen (18) years of age; (3-20-20)T

b. Be under the direct, constant supervision of qualified staff; and (3-20-20)T

c. Have completed the staff training and course work required by Subsection 812.02 of these rules prior to assuming direct care responsibilities. (3-20-20)T

**811. STAFF HEALTH REQUIREMENTS.**

Prior to engaging in any field activities with children, staff, interns, and volunteers must have a written statement from a licensed physician, physician's assistant or nurse practitioner verifying they are physically fit to perform the duties of the job. A new written physician's statement must be obtained at least every three (3) years. The medical professional who provides the written statement must be given a form to use which clearly describes the physical demands for the job and the environmental conditions the person being evaluated is required to work in. The administrator or designee must review the form and maintain it in the individual's personnel file. (3-20-20)T

**812. SKILLS AND TRAINING.**



Skills and training for each staff, intern, and volunteer must be documented and kept on file at the base camp. (3-20-20)T

**01. Skills.** Each staff must demonstrate specific skills to the administrator or designee, prior to assuming field supervision. The skill assessment procedures must be approved by the agency and results of the assessment must be documented and kept on file at the base camp. (3-20-20)T

**02. Training.** Training must supplement any deficiencies. The curriculum will include at a minimum: (3-20-20)T

- a.** Four (4) days of practicum field training; (3-20-20)T
- b.** Supervision of program participants; (3-20-20)T
- c.** Water, food, and shelter procurement, preparation and conservation; (3-20-20)T
- d.** Low impact wilderness expedition and environmental conservation skills and procedures; (3-20-20)T
- e.** Child management including containment control, safety, conflict resolution, and behavior management; (3-20-20)T
- f.** Instruction in safety procedures and safe equipment use of fuel, fire, and life protection; (3-20-20)T
- g.** Sanitation procedures related to food, water, and waste; (3-20-20)T
- h.** Special instruction for staff who conduct and staff who supervise high adventure activities; (3-20-20)T
- i.** Wilderness medicine, including health issues related to acclimation, exposure to the environment, and environmental elements; (3-20-20)T
- j.** First aid kit contents and use; (3-20-20)T
- k.** Navigation skills including map and compass use, contour and celestial navigation, and Global Positioning System (GPS); (3-20-20)T
- l.** Local environmental precautions, including terrain, weather, insects, poisonous plants, wildlife, and proper response to adverse situations; (3-20-20)T
- m.** Report writing, including development and maintenance of logs and journals; (3-20-20)T
- n.** Federal, state, and local regulations including Idaho State Department of Health and Welfare, Idaho State Department of Fish and Game, Idaho Outfitters and Guides, and State and Federal land use agencies; and (3-20-20)T
- o.** Ongoing training for direct care staff to upgrade their skills, including mandatory training to maintain skills, certifications and licenses. (3-20-20)T

**813. STAFF RATIOS AND GROUP SIZE.**

**01. Staffing Ratio.** Each group of children must be staffed as follows: (3-20-20)T

- a.** One (1) staff for every four (4) children or fraction thereof, but where there are less than four (4) children there must be at least two (2) staff; and (3-20-20)T
- b.** Where the gender of a group is mixed, there must be at least one (1) female staff and one (1) male

staff member. (3-20-20)T

**02. Interns and Volunteers.** Interns and volunteers must never be counted in the staff ratio and never have sole responsibility to supervise the youth. (3-20-20)T

**814. STAFF USE OF ALCOHOL OR CONTROLLED SUBSTANCES PROHIBITED.**

Staff engaging in field activities, whether on or off duty, are prohibited from using alcohol or controlled substances, or any other substance that impairs their ability to function and ensure the health and safety of the children in the program. (3-20-20)T

**815. -- 820. (RESERVED)**

**821. ASSESSMENTS.**

Preadmission and subsequent assessments must be performed for each child. (3-20-20)T

**01. Preadmission Assessment.** Admission assessments must be done for each child by a qualified treatment professional familiar with the children's therapeutic outdoor program prior to enrollment. This must include a review of the child's social and psychological history. (3-20-20)T

**02. Subsequent Assessments.** Subsequent assessments must be done at least one (1) week before the child leaves for the field portion of the program away from the main base of operations. The assessment must include: (3-20-20)T

**a.** An interview with the child by the senior field staff assigned to the child's field experience prior to entrance into the field; and (3-20-20)T

**b.** A review of the child's health history and physical examination by a medically trained field staff assigned to the child's field experience. (3-20-20)T

**03. Psychological Problems.** For a child with a history of psychological problems, a psychological evaluation must be obtained and reviewed by the multidisciplinary team prior to the child's entrance into the field portion of the program. (3-20-20)T

**822. PHYSICAL EXAMINATION.**

A child must have a physical examination within thirty (30) days prior to entrance into the children's therapeutic outdoor program. (3-20-20)T

**01. Standard Physical Examination Requirements.** The result of the physical exam must be recorded on a standard form provided by the program. The form must clearly document the type and extent of physical activity in which the child will be engaged. The exam must be completed by a licensed physician, physician's assistant, or nurse practitioner, who signs the form, and includes: (3-20-20)T

**a.** A urinalysis; (3-20-20)T

**b.** A pregnancy test for each female participant; (3-20-20)T

**c.** A physical assessment to determine fitness given the climate and temperature in which the child will be participating, and the child's age, weight, and physical condition; and (3-20-20)T

**d.** A determination whether detoxification is indicated for the child prior to entrance into the field portion of the program. (3-20-20)T

**02. Prior Physical Examination.** A physical examination of a child who is coming into a children's therapeutic outdoor program directly from a children's residential care facility, must be acceptable provided the physical examination is current as required by Section 571 of these rules, meets the criteria provided in Subsection 822.01 of this rule, and occurred prior to entrance into the field. (3-20-20)T

**03. Medical Special Needs.** If a child is currently taking or has been taking prescribed medication within the past six (6) months prior to placement in the children's therapeutic outdoor program, a specific notation must be made on the physical examination form by the medical professional. The medical professional must also include approval for the child's participation in an outdoor, high impact environment and a description of any possible special needs due to the use of medication in said environment. (3-20-20)T

**04. Physical Examination Availability.** The physical examination form must be copied and the original maintained at the base camp and a copy carried by staff in a waterproof container when the child is away from the base camp. The physical examination form must be maintained in a manner that assures the confidentiality of all medical and identifying information. (3-20-20)T

**823. GROUPING BY AGE.**

Children must be assigned to groups according to age and ability. (3-20-20)T

**01. Age.** A child must be at least eleven (11) years of age and less than eighteen (18) years of age unless the individual meets the definition of continued care as provided in Sections 010, 530, and 531 of these rules. (3-20-20)T

**02. Placement.** A licensed treatment professional familiar with the children's therapeutic outdoor program must determine whether children eleven (11) years of age through thirteen (13) years of age are to be placed in a younger program group or in an older program group. The decision must be based upon the child's needs and level of maturity, both physical and mental. The basis for the decision must be documented in the child's record. (3-20-20)T

**824. EXPEDITIONS.**

Expeditions include any excursion that will take the children away from the base camp. (3-20-20)T

**01. Written Description.** There must be a written description of expedition programming, approved by the organization's governing body and signed by the Chief Administrator. The expedition must not expose children to unreasonable risk. (3-20-20)T

**02. Group Size.** For an expedition group, the number of participants must not exceed fifteen (15) children. (3-20-20)T

**03. Wilderness First Responder (WFR).** At least one (1) staff member per expedition group must have a current WFR Certificate. (3-20-20)T

**04. Global Positioning System (GPS).** Each group must be equipped with a GPS system for use on all expeditions. (3-20-20)T

**05. Staff Briefing.** Staff must be briefed prior to any expedition. The briefing at a minimum must include: (3-20-20)T

**a.** The expedition route, terrain, time schedule, weather forecast and any potential hazards; (3-20-20)T

**b.** Any procedures unique to that expedition; and (3-20-20)T

**c.** Participant backgrounds and any potential problems. (3-20-20)T

**06. Expedition Evaluations.** Each expedition must be evaluated at least every seven (7) days, either in person by a field director or as detailed in the organization's approved policies and procedures. If the expedition is longer in duration than three (3) weeks, on-site visits by a field director must occur at minimum increments of three (3) weeks. (3-20-20)T

**07. Staff De-Briefing.** Staff must be de-briefed after returning from any expedition. (3-20-20)T

**08. Participant De-Briefing.** Children must be de-briefed after returning from any expedition. The de-briefing must include a written summary of the child's participation and progress achieved and be retained in the child's record. (3-20-20)T

**09. Expedition Summary.** Results of the evaluation of the conditions of the children, interactions of children and staff, briefings, de-briefings, and compliance with program policies and procedures must be summarized, documented, and records retained for seven (7) years. (3-20-20)T

**825. SAFETY.**

Each children's therapeutic outdoor program must have appropriate safety procedures and equipment. (3-20-20)T

**01. Environmental Hazards.** Each program participant must have instruction on environmental hazards and precautions. (3-20-20)T

**02. First Aid Kit.** There must be a first aid kit with sufficient supplies available at all times. The first aid kit must at a minimum: (3-20-20)T

**a.** Meet the standards of an appropriate national organization for the activity being conducted and the location and environment being used; (3-20-20)T

**b.** Be reviewed with new staff for contents and use; (3-20-20)T

**c.** Be reviewed at least annually with all staff for contents and use; and (3-20-20)T

**d.** Be inventoried after each expedition and restocked as needed. (3-20-20)T

**826. COMMUNICATIONS.**

**01. Communication Support System.** There must be a communication system that includes: (3-20-20)T

**a.** A reliable two (2) way radio communication with extra charged battery packs for each group away from the base camp; and (3-20-20)T

**b.** A back up plan for re-establishing communication to be implemented in the event regular communication fails. (3-20-20)T

**02. Communication Requirements.** There must be daily verbal communication between each field group and the base camp unless alternative arrangements have been made and documented in a communications log maintained at the base camp and must never exceed seventy-two (72) hours. (3-20-20)T

**03. Emergencies.** The base camp support personnel must have immediate access to emergency telephone numbers, contact personnel and procedures for an emergency evacuation or field incident requiring emergency medical support. (3-20-20)T

**827. EMERGENCY PLAN.**

A children's therapeutic outdoor program must have and follow a written emergency plan and specific procedures for evacuations, disasters, medical emergencies, hostage situations, casualties, and missing children. (3-20-20)T

**01. Written Plan.** The plan must at a minimum include: (3-20-20)T

**a.** Designation of authority and staff assignments; (3-20-20)T

**b.** Transportation and relocation of program participants when necessary; (3-20-20)T

**c.** Instruction to all participants on how to respond in the event of an emergency; (3-20-20)T

- d.** Notification to the base camp of the nature of the emergency and an accounting of each participant's location and status; (3-20-20)T
- e.** Supervision of program participants after an evacuation or a relocation; and (3-20-20)T
- f.** Arrangements for medical care and notification of a child's physician and identified parent or guardian. (3-20-20)T
- 02. Emergency Drills.** Emergency plan drills must be conducted and recorded at least annually. (3-20-20)T

**828. EXPEDITION AND HIKING LIMIT REQUIREMENTS.**

- 01. Physical Capability.** Hiking must not exceed the physical capability of the weakest member of the group. (3-20-20)T
- 02. Maximum Temperature.** There must be no hiking when the temperature is above ninety-five (95) degrees Fahrenheit. (3-20-20)T
- 03. Inability or Refusal to Hike.** When a child cannot or refuses to hike, the group cannot continue hiking unless it is necessary for obvious safety reasons, and a contingency plan, based on preapproved policies and procedures, must be used. The contingency plan must ensure there is staff coverage for each group, if the group is split, and that communication between the groups is maintained. (3-20-20)T
- 04. Maps and Itinerary.** Copies of map routes, anticipated schedules including arrival and departure times must be maintained by the field staff and base camp when a group is on an outing away from the base camp. (3-20-20)T
- 05. Acclimation to Environment.** Staff must closely monitor children for acclimation to the temperature, climate, altitude, environment and situation. (3-20-20)T
- 06. Log.** There must be a common written log that is signed and dated by the participating staff immediately following the termination of an outing away from the base camp. The log must contain information on health problems, accidents, injuries, medications used, behavioral problems, and unusual occurrences. The log must be recorded in permanent ink with any corrections initialed and dated. (3-20-20)T

**829. WATER REQUIREMENTS.**

- 01. Water.** Children must have access to potable water while hiking. At a minimum the program must: (3-20-20)T

  - a.** Provide each child with six (6) quarts of potable water a day, unless a child's weight exceeds one hundred fifty (150) pounds, then one (1) additional quart of potable water will be provided for every twenty-five (25) pounds of body weight over one hundred fifty (150) pounds; and (3-20-20)T
  - b.** Encourage each child to consume at least three (3) quarts of potable water per day. (3-20-20)T
- 02. Water for Cooling.** When the temperature is eighty (80) degrees Fahrenheit or higher, adequate water must be available for coating each child's body for the purpose of cooling when needed. (3-20-20)T
- 03. Water Caches.** When water caches are used, each water cache must be placed at predetermined sites prior to the day the group leaves the camp. Field staff must verify the water cache locations before the group leaves the base camp each day. (3-20-20)T
- 04. Aerial Water Drops.** An expedition group must not depend on aerial drops for its water supply. Aerial water drops must be used only in the event of an emergency. (3-20-20)T

**05. Water From a Natural Source.** Water from a natural source used for drinking or cooking must be treated to eliminate health hazards. (3-20-20)T

**06. Electrolyte Replacement.** Each group must have a supply of electrolyte replacement, quantities to be determined by group size and environment conditions. (3-20-20)T

**830. NUTRITIONAL AND SANITARY REQUIREMENTS.**

**01. Menu.** There must be a written menu approved annually by a professional nutritionist or dietitian with knowledge of program activity levels and environmental factors. The menu will list the necessary or recommended food supplies and caloric intake for each group. The current menu must be readily available and any change or substitution noted on the menu. Menus must be maintained on file for six (6) months. (3-20-20)T

**02. Food.** Each child must be provided a sufficient amount of food and calories based on the approved menu. The food provided must include fresh fruit and vegetables at least twice a week. (3-20-20)T

**03. Special Needs.** The menu must take into consideration a child's special nutritional needs, including food allergies or religious restrictions. (3-20-20)T

**04. Fasting.** There must be no imposed food fasting. (3-20-20)T

**05. Cleansing of Hands.** Cleansing of hands is required after each latrine use and prior to food preparation and food consumption. (3-20-20)T

**831. -- 834. (RESERVED)**

**835. HEALTH CARE.**

**01. First Aid.** First aid treatment must be provided in as prompt a manner as the location and circumstances allow. (3-20-20)T

**02. Field Treatment.** A child with an illness or physical complaint needing care or treatment beyond what can be provided in the field must be immediately transported to appropriate medical care. (3-20-20)T

**03. Documentation.** Complaints or reports by a child of illness and injuries must be recorded in the daily log along with any treatment provided. (3-20-20)T

**04. Negative Consequences.** There must be no negative consequences imposed on a child for reporting an injury or illness or for requesting to see a health care professional. (3-20-20)T

**05. Daily Physical Assessment.** Children's hydration, skin condition, extremities, and general physical condition must be evaluated and recorded by field staff in the daily log on a daily basis. (3-20-20)T

**06. Weekly Physical Assessment.** At least every seven (7) days, each child's physical condition must be assessed by a Wilderness First Responder (WFR), an Emergency Medical Technician (EMT), or a qualified medical professional. The results of the assessment must be recorded in the daily log and at a minimum includes: (3-20-20)T

**a.** Blood pressure; (3-20-20)T

**b.** Heart rate; (3-20-20)T

**c.** Condition of extremities; (3-20-20)T

**d.** Condition of skin; (3-20-20)T

**e.** Hydration level; (3-20-20)T

- f. Allergies, if any; (3-20-20)T
- g. General physical condition; and (3-20-20)T
- h. Provision of appropriate medical treatment if needed. (3-20-20)T

**836. MEDICATION STORAGE AND ADMINISTRATION.**

A children's therapeutic outdoor program must have and follow policies and procedures on the storage, administration, and disposal of prescription and nonprescription medication. (3-20-20)T

**01. Medication Storage and Administration.** Prescription and over-the-counter medication must be stored under lock and key safeguarded from children. For medications taken on field outings, all medication must be in the possession of a staff member qualified to administer medications. (3-20-20)T

**02. Trained Staff.** Staff who administer and assist with self-administration of medications must be trained by a qualified medical professional. (3-20-20)T

**03. Prescription Medication.** All prescription medications must be issued by a qualified medical professional's valid order that includes the dosage to be given. (3-20-20)T

**04. Psychotropic Medication.** The administration of psychotropic medication is prohibited unless a qualified medical professional determines that the medication is clinically indicated. Under no circumstances will psychotropic medication be administered for disciplinary purposes, for the convenience of staff, or as a substitute for appropriate treatment services. (3-20-20)T

**05. Documentation.** There must be a written record of all medications given to the child. The record must include: (3-20-20)T

- a. The child's name; (3-20-20)T
- b. The name of the medication; (3-20-20)T
- c. The date and time the medication was given; (3-20-20)T
- d. The dosage given and whether the child did or did not take the medication; and (3-20-20)T
- e. The person who administered or assisted in self-administration of the medication. (3-20-20)T

**06. Medication Changes.** Prescribed medication must not be stopped or changed in dosage or administration without consulting with the prescribing physician. If the prescribing physician is not available, a qualified medical professional must be consulted. Results of the consultation and any resulting medication changes must be recorded in the child's record. (3-20-20)T

**07. Disposal of Unused Medication.** All unused and expired medication must be disposed of so it is not available to anyone. When medication is disposed of, this must be witnessed by at least one (1) other staff member and the disposal documented in the child's record. (3-20-20)T

**837. -- 839. (RESERVED)**

**840. PARTICIPANT CLOTHING, EQUIPMENT AND SUPPLIES.**

Each program participant must have appropriate clothing, equipment and supplies appropriate for the types of activities and for the weather conditions likely to be encountered. (3-20-20)T

**01. Clothing, Equipment, and Supplies Requirements.** Clothing, equipment and supplies include at a minimum: (3-20-20)T

- a. Sunscreen; (3-20-20)T
- b. Insect repellent; (3-20-20)T
- c. A commercially available backpack or the materials to construct a safe backpack or bedroll; (3-20-20)T
- d. Personal hygiene items necessary for cleansing; (3-20-20)T
- e. Appropriate feminine hygiene supplies; (3-20-20)T
- f. Wool blankets or an appropriate sleeping bag and a tarp or poncho when the average nighttime temperature is expected to be forty (40) degrees Fahrenheit or higher; (3-20-20)T
- g. Shelter, appropriate sleeping bag and ground pad when the average night time temperature is expected to be thirty-nine (39) degrees Fahrenheit or lower; (3-20-20)T
- h. Clothing appropriate for temperature changes generally expected for the area; (3-20-20)T
- i. Each child must be provided a clean change of clothing at least once a week or an opportunity to wash their clothes at least once a week; and (3-20-20)T
- j. Each child must be provided clean undergarments and a means to clean their body at least twice a week. Additional clean undergarments must be provided to a child as may be needed for health or sanitary reasons. (3-20-20)T

**02. Denial of Clothing, Equipment, and Supplies.** Appropriate clothing, equipment, and supplies must not be removed, denied, or made unavailable for any reason. (3-20-20)T

**841. CONTRABAND.**  
A children's therapeutic outdoor program must define prohibited contraband in a written policy. (3-20-20)T

**01. Confiscation.** Contraband found in the possession of children or staff must be confiscated by staff and secured in a location inaccessible to children. (3-20-20)T

**02. Law Enforcement Notification.** Local law enforcement must be notified when illegal contraband is confiscated. (3-20-20)T

**03. Disposal.** It is the responsibility of the administrator or designee to dispose of all contraband not confiscated by law enforcement, in accordance with the program's contraband policy. When contraband is disposed of, this must be witnessed by at least one (1) other staff member and the disposal documented in the child's record. (3-20-20)T

**842. SEARCHES.**  
If a children's therapeutic outdoor program conducts searches of children, staff or visitors, it must have and follow written policies and procedures. Searches must be completed in the least intrusive manner possible for the type of search being conducted. All contraband will be disposed of in accordance with Section 841 of these rules. All searches must be documented, including the reasons for the search, the persons conducting the search, and any results. The policies and procedures at a minimum must include those in Subsections 842.01 and 842.02 of this rule. (3-20-20)T

**01. Pat Down Searches.** Pat down searches of children may only be conducted when the therapeutic outdoor program feels it is necessary to discourage the introduction of contraband or to promote the safety of staff and other children. Pat down searches must be conducted as follows: (3-20-20)T

- a. Staff must be trained in proper search techniques; (3-20-20)T



- b.** There must be a staff member of the same sex as the child being searched and the presence of another staff member; (3-20-20)T
- c.** The child must be told he is about to be searched; (3-20-20)T
- d.** The child must remove all outer clothing (gloves, coat, hat, and shoes) and empty all pockets; (3-20-20)T
- e.** The staff person must pat the clothing of the child using only enough contact to conduct an appropriate search; (3-20-20)T
- f.** If the staff detects anything unusual, the child will be asked to identify the item and appropriate steps taken to remove the item for inspection; (3-20-20)T
- g.** If the child refuses to comply, the administrator or designee must be notified immediately and is responsible for resolving the matter; and (3-20-20)T
- h.** All searches must be documented in writing. (3-20-20)T
- 02. Strip Searches are Prohibited.** (3-20-20)T
- 03. Body Cavity Searches are Prohibited.** (3-20-20)T

**843. BEHAVIOR MANAGEMENT AND DISCIPLINE POLICY.**

**01. Behavior Management.** A children's therapeutic outdoor program must have and follow a behavioral management and discipline policy which identifies appropriate methods of behavioral management and ensures that any discipline is positive and consistent. Individual behavioral management must be based on an assessment of the child's needs, behavior, and stage of development with the goal of promoting self-control, self-direction, self-esteem, and an acceptable pattern of social behavior appropriate to the age and development level of the child. The policy must include the concept and application of least restrictive effective treatment and positive reinforcement and prohibit the following: (3-20-20)T

- a.** Physical force, except as permitted under Section 573 of these rules; (3-20-20)T
- b.** Any kind of punishment inflicted on the body, including spanking, hitting, slapping, spitting, kicking, shaking, pulling hair, pinching skin, twisting of an arm or leg in a way that would cause pain or injury to the child, kneeling and sitting on the chest of a child, placing a choke hold on a child, bending back a finger, and shoving or pushing a child into a stationary object; (3-20-20)T
- c.** The placing of anything in or over a child's mouth; (3-20-20)T
- d.** Cruel or excessive physical exercise, prolonged positions, or work assignments that produce unreasonable discomfort; (3-20-20)T
- e.** Verbal abuse, ridicule, humiliation, profanity, and other forms of degradation directed at a child or a child's family; (3-20-20)T
- f.** Locked seclusion as described under Section 764 of these rules; (3-20-20)T
- g.** Mechanical restraint as described under Section 766 of these rules; (3-20-20)T
- h.** Alternative forms of restraint as described in Section 767 of these rules; (3-20-20)T
- i.** Withholding of necessary food, clothing, shelter, bedding, rest, medical care, and toilet use; (3-20-20)T

**j.** Denial of visits or communication with the child's family except as specified in the child's plan or court order; and (3-20-20)T

**k.** Disciplining a child or group of children for actions of one (1) child, unless the organization's policies and procedures for group behavior management and discipline are based on a nationally recognized peer group treatment model and clearly prescribe the circumstances and safeguards under which disciplining the group is allowed and is supervised by staff. (3-20-20)T

**02. Documentation.** An organization must document that the policy has been provided to a child and is made available to parents, guardians, and referral sources. (3-20-20)T

**844. TIME-OUT.**

A children's therapeutic outdoor program must have and follow written policy and procedures governing the appropriate use of time-out as required in Subsections 844.01 through 844.06 of this rule. (3-20-20)T

**01. Use.** Time-out is only used when a child's behavior is disruptive to the child's ability to learn, to participate appropriately, or to function appropriately with other children or the activity. (3-20-20)T

**02. Duration.** Time duration cannot exceed sixty (60) consecutive minutes. (3-20-20)T

**03. Observation.** A staff person is designated to be responsible for visually observing the child at random intervals at least every fifteen (15) minutes. (3-20-20)T

**04. Documentation.** A written description in sufficient detail to provide a clear understanding of the incident or behavior which resulted in the child being placed in time-out, and staff's attempts to help the child avoid time-out, and observations by staff maintained in the child's file. (3-20-20)T

**05. Reintroduction to the Group.** The child is reintroduced to the group in a sensitive and nonpunitive manner as soon as control is regained. (3-20-20)T

**06. Review.** If there are more than ten (10) time-outs for a child in a twenty-four (24) hour period, a review is conducted by the chief administrator or designee to determine the suitability of the child remaining in the program, whether modification to the child's plan is warranted, whether staff need additional training in alternative therapeutic behavior management techniques, and to ensure that appropriate action is taken as a result of the review. (3-20-20)T

**845. WORK.**

Children may be given a non-vocational work assignment as a constructive experience in compliance with child labor laws, which are age appropriate and within the child's capabilities. The primary purpose of work cannot be used as a substitute for paid labor. (3-20-20)T

**846. ANIMALS AND PETS.**

Animals, including pets, must be free from disease and cared for in a safe and clean manner. All domestic animals and pets must be vaccinated against rabies. Documentation of the vaccination against rabies will be kept on file at the base camp. (3-20-20)T

**847. TRANSPORTING CHILDREN.**

**01. Vehicle.** Transportation of children in a therapeutic outdoor program must be in a vehicle that is: (3-20-20)T

**a.** Properly registered; (3-20-20)T

**b.** Covered by insurance for personal injury and liability; (3-20-20)T

**c.** Driven by a person with a valid driver's license for the type of vehicle and who complies with all applicable traffic laws while transporting children; (3-20-20)T

- d. Maintained in a safe condition; (3-20-20)T
- e. Equipped with a red triangle reflector device for use in an emergency; (3-20-20)T
- f. Equipped with a first aid kit; and (3-20-20)T
- g. Equipped with a fire extinguisher that is properly secured and not readily available to children. (3-20-20)T

**02. Proper Seating of Children and Adults.** The driver and all passengers must ride in a vehicle manufactured seat and properly use a passenger restraint device. (3-20-20)T

**848. FIREARMS.** Firearms are not allowed in children's therapeutic outdoor programs. (3-20-20)T

**849. (RESERVED)**

**850. PROGRAM SUMMARY.** The organization must provide the child's parent or guardian a written summary of the child's participation and progress upon completion of the therapeutic outdoor program. The parents or guardian and child must be given the opportunity and encouraged to submit a written evaluation of the therapeutic outdoor experience. (3-20-20)T

**851. -- 859. (RESERVED)**

**ADDITIONAL STANDARDS FOR SOLO EXPERIENCES IN  
CHILDREN'S THERAPEUTIC OUTDOOR PROGRAMS**

**(See also Sections 500-599, Rules Governing General Standards for Organizations Known  
as Children's Agencies and Children's Residential Care Facilities, and Sections 800-859,  
Rules Governing Standards for Children's Therapeutic Outdoor Programs)**

**860. STANDARDS FOR SOLO EXPERIENCES IN CHILDREN'S THERAPEUTIC OUTDOOR PROGRAMS.**

If a children's therapeutic outdoor program conducts a solo component for children as part of the therapeutic process during expeditions, they must have and follow written policies and procedures. Every children's therapeutic outdoor program that includes a solo component will include a written description of the solo component as required in Section 528 of these rules. (3-20-20)T

**861. PLAN.**

For a children's therapeutic outdoor program that conducts a solo component as part of the therapeutic process there must be a plan for the solo component, as well as an individual solo plan for each child. The plans will be documented and approved by the senior field staff to ensure that the children are not exposed to unreasonable risks. The plans must include the following: (3-20-20)T

**01. Individual Solo Plan.** The goals, methods, techniques to be used, and time frames will be listed for each participant and each individual plan will be reviewed with the child and signed and dated by the child and the designated staff member. (3-20-20)T

**02. Ability.** There will be consideration of the maturity level, health, physical ability, and emotional state of the child. (3-20-20)T

**03. Preparation.** The child will be instructed on the solo experience, including expectations, restrictions, communication, environment, and emergency procedures. (3-20-20)T

**04. Back Up Plan.** There will be documented instructions for a back up plan in case the child's plan does not work. (3-20-20)T

**05. Responsible Staff.** A designated staff member will be responsible for coordination and implementation of the plan. (3-20-20)T

**862. SOLO SITES.** Staff must be familiar with the site chosen to conduct solos. The following requirements apply: (3-20-20)T

**01. Pre-Site Investigation.** A pre-site investigation will be conducted and mapped prior to the solo. The site will be checked at the time the child is placed to assure that no changes in the environment have taken place since the pre-site investigation that may put the child at risk. (3-20-20)T

**02. Hazardous Conditions.** Any hazardous conditions, including terrain, are to be considered prior to the selection of a solo site, taking into account the age, physical, developmental and psychological issues of the children served in the solo experience. (3-20-20)T

**03. Mapping and Site Coordinates.** The site selected for the solo will be mapped and the site coordinates will be recorded. The map and the site coordinates will be maintained at the solo site and communicated to the base camp prior to leaving for the solo component. (3-20-20)T

**04. Supplies.** Arrangements will be made prior to the solo for medication, food, and water drop offs if needed. (3-20-20)T

**863. SUPERVISION.** Plans for supervision must be in place during the solo, and at a minimum require the following: (3-20-20)T

**01. Assigned Staff.** The assignment of a specific staff member to be responsible for the supervision of each solo participant. (3-20-20)T

**02. Observation.** A predetermined procedure for observation, that ensures the health, safety, and well being of the child at all times, that includes: (3-20-20)T

**a.** Placing children at a distance from each other and the central staff site to allow for appropriate supervision and emergency communication; (3-20-20)T

**b.** Placing children requiring special attention closer to the central staff site; (3-20-20)T

**c.** Clearly defining physical boundaries and any other restrictions; (3-20-20)T

**d.** Instructing children to not participate in potentially dangerous activities; (3-20-20)T

**e.** Notification and check in systems; (3-20-20)T

**f.** Visual checks; and (3-20-20)T

**g.** Checking the participant's emotional and physical condition daily. (3-20-20)T

**864. EMERGENCY PROCEDURES.** In addition to the requirements of Section 827 of these rules, solo emergency plans must include: (3-20-20)T

**01. Instruction.** Instructing the participant on the safety and emergency procedures, including evacuation routes. (3-20-20)T

**02. Communication.** Providing each participant with signaling capabilities, including a whistle, for emergency notification. (3-20-20)T

**03. Participant Response.** Instruction to all participants on how to respond if the emergency notification system is put into use, including each participants requirement to check in to the central staff site. (3-20-20)T

**04. Check In.** Provide a check-in system should an emergency occur, which includes notification to the base camp and an accounting of each participant's whereabouts and safety. (3-20-20)T

**865. -- 869. (RESERVED)**

**ADDITIONAL STANDARDS FOR STATIONARY  
CHILDREN'S THERAPEUTIC OUTDOOR PROGRAMS  
(Sections 870-872, see also Sections 500-599 and 800-869.)**

**870. ADDITIONAL PROVISIONS FOR STATIONARY CHILDREN'S THERAPEUTIC OUTDOOR PROGRAMS.**

A children's therapeutic outdoor program that maintains a designated location for the housing of children is considered stationary and must be subject to additional fire, health, and safety standards. (3-20-20)T

**871. FIRE SAFETY REQUIREMENTS.**

A stationary children's therapeutic outdoor camp must be inspected by a state certified fire inspector before being occupied and on an annual basis thereafter, and a copy of the inspection will be maintained at the children's therapeutic outdoor camp. The inspection requires: (3-20-20)T

**01. Fire Extinguishers.** One (1) 2-A-10BC type fire extinguisher must, at minimum, be in each of the following locations: (3-20-20)T

**a.** On each floor in any building that houses children; (3-20-20)T

**b.** In any room where cooking or heating takes place; (3-20-20)T

**c.** In a group of tents within a seventy-five (75) foot travel distance; and (3-20-20)T

**d.** Each fire extinguisher will be inspected annually by a fire extinguisher service agency. (3-20-20)T

**02. Smoke Detectors.** A smoke detector will be in buildings where children sleep. (3-20-20)T

**03. Escape Routes.** A minimum of two (2) escape routes from buildings where children sleep. (3-20-20)T

**04. Flammable Liquids.** Flammable liquids will not be used to start fires, be stored in structures that house children, or be stored near ignition sources. If generators are used, they will only be refueled by staff when the generator is not running and cool to the touch. (3-20-20)T

**05. Electrical.** Wiring will be properly attached and fused to prevent overloads. (3-20-20)T

**872. HEALTH SAFETY REQUIREMENTS.**

A stationary children's therapeutic outdoor camp must be inspected by the District Health Department before being occupied and on an annual basis, and a copy of the inspection maintained at the site of the camp. The inspection requires the following: (3-20-20)T

**01. Food.** Food be stored, prepared, and served in a manner that is protected from contamination. (3-20-20)T

**02. Water Supply.** The water supply will be from a source that is accepted by the local health authority according to IDAPA 58.01.08, "Idaho Rules for Public Drinking Water Systems," at the time of application and for annual renewal of such licenses. (3-20-20)T

**03. Sewage Disposal.** Sewage will be disposed of through a public system, or in absence of a public system, in a manner approved by the local health authority, according to IDAPA 58.01.03, "Individual/Subsurface Sewage Disposal Rules." (3-20-20)T

**873. -- 999. (RESERVED)**

## 16.07.01 – BEHAVIORAL HEALTH SLIDING FEE SCHEDULES

### 000. LEGAL AUTHORITY.

Under Sections 16-2433, 19-2524, 20-511A, and 39-3137, Idaho Code, the Director is authorized to promulgate, adopt, and enforce rules for the charging of fees for services provided by mental health and substance use disorders providers. Under Section 39-309, Idaho Code, the Board of Health and Welfare is authorized to promulgate, adopt, and enforce rules for the charging of fees for services provided by mental health and substance use disorders providers. (3-20-20)T

### 001. TITLE AND SCOPE.

**01. Title.** These rules are titled IDAPA 16.07.01, “Behavioral Health Sliding Fee Schedules.” (3-20-20)T

**02. Scope.** These rules provide the sliding fee schedules, based on federal poverty guidelines, and fee determination process for the adult mental health, children’s mental health, and substance use disorders programs within the Department. This chapter of rules applies both to voluntary and court-ordered recipients. (3-20-20)T

### 002. -- 009. (RESERVED)

### 010. DEFINITIONS.

For the purposes of this chapter, the following definitions apply. (3-20-20)T

**01. Ability to Pay.** The financial capacity that is available to pay for the program services after allowable deductions in relation to gross income and family size exclusive of any liability of third party payor sources. (3-20-20)T

**02. Adjusted Gross Income.** Total family annual income less allowable annual deductions. (3-20-20)T

**03. Adult.** An individual eighteen (18) years of age or older. (3-20-20)T

**04. Adult Mental Health Program.** A program administered by the Idaho Department of Health and Welfare to serve seriously mentally ill and severely and persistently mentally ill adults. (3-20-20)T

**05. Allowable Annual Deductions.** In determining the family's ability to pay for behavioral health services, the following are allowable annual deductions: (3-20-20)T

**a.** Court-ordered obligations; (3-20-20)T

**b.** Dependent support; (3-20-20)T

**c.** Child care payments necessary for parental employment; (3-20-20)T

**d.** Medical expenses; (3-20-20)T

**e.** Transportation; (3-20-20)T

**f.** Extraordinary rehabilitative expenses; and (3-20-20)T

**g.** State and federal tax payments, including FICA taxes. (3-20-20)T

**06. Behavioral Health Services.** Services offered by the Department to improve mental health and substance use disorders issues. (3-20-20)T

**07. Child.** An individual who is under the age of eighteen (18) years. (3-20-20)T

**08. Children’s Mental Health Program.** A program as defined in IDAPA 16.07.37, “Children’s Mental Health Services,” administered by the Idaho Department of Health and Welfare. (3-20-20)T

**09. Court-Ordered Obligations.** Financial payments which have been ordered by a court of law. (3-20-20)T

- 10. Court-Ordered Recipient.** A person receiving behavioral health services under Sections 19-2524, 20-520(i), and 20-511A, Idaho Code. (3-20-20)T
- 11. Department.** The Idaho Department of Health and Welfare. (3-20-20)T
- 12. Dependent Support.** An individual that is dependent on their family's income for over fifty percent (50%) of his financial support. (3-20-20)T
- 13. Extraordinary Rehabilitative Expenses.** Those payments incurred as a result of the disability needs of the person receiving services. They include annual costs for items including wheelchairs, adaptive equipment, medication, treatment, or therapy which were not included in the medical payments deduction and the annual estimate of the cost of services received. (3-20-20)T
- 14. Family.** A family is an adult, or married adults, or adult(s) with children, living in a common residence. (3-20-20)T
- 15. Family Household.** Persons in a family related by blood, marriage, or adoption. Adult siblings who are not claimed as dependents and individuals receiving Supplemental Security Income (SSI) or Supplemental Security Disability Income (SSDI) are excluded from consideration as a member of the household for income and counting purposes. Income from minor siblings is excluded from household income. The term "family household" is synonymous with the term "family unit." (3-20-20)T
- 16. Federal Poverty Guidelines.** Guidelines issued annually by the Federal Department of Health and Human Services establishing the poverty income limits. The federal poverty guidelines for the current year may be found online at <http://aspe.hhs.gov/poverty>. (3-20-20)T
- 17. Management Service Contractor (MSC).** An independent contractor with whom the Department contracts to manage a statewide network of Department-approved facilities and programs to deliver substance use disorders treatment and recovery support services. (3-20-20)T
- 18. Parent.** The person who, by birth or through adoption, is legally responsible for a child. (3-20-20)T
- 19. Recipient.** The person receiving services. The term "recipient" is synonymous with the terms: "patient," "participant," "resident," "consumer," or "client." (3-20-20)T
- 20. Sliding Fee Scale.** A scale used to determine an individual's financial obligation for services based on Federal Poverty Guidelines and the number of persons in the family household. (3-20-20)T
- 21. Substance Use Disorders Program.** A program administered by the Idaho Department of Health and Welfare to serve adolescents and adults with alcohol or substance use disorders. (3-20-20)T
- 22. Third-Party Payor.** A payor other than a person receiving services or a responsible party who is legally liable for all or part of the person's care. (3-20-20)T

**011. -- 099. (RESERVED)**

**100. FINANCIAL RESPONSIBILITY OF PARENTS FOR CHILDREN'S MENTAL HEALTH SERVICES.**

Parents of children eligible for services under IDAPA 16.07.37, "Children's Mental Health Services," Section 407 who receive services either directly from the Department's Children's Mental Health program or through Department contracts with private providers are responsible for paying for services provided to their child and to their family. Financial responsibility of the child's parent(s) for each service not covered by third party liable resources or payments, including private insurance and Medicaid will be established in accordance with the child's parent(s) ability to pay as determined by the sliding fee scale in Section 300 of these rules. (3-20-20)T

**101. -- 199. (RESERVED)**

**200. FINANCIAL RESPONSIBILITY FOR ADULT MENTAL HEALTH SERVICES.**

Adults receiving services either directly from the Department's Adult Mental Health program or through Department contracts with private providers are responsible for paying for services they receive. Financial responsibility for each service not covered by third party liable resources or payments, including private insurance and Medicaid will be established in accordance with the individual's ability to pay as determined by the sliding fee scale in Section 300 of these rules. (3-20-20)T

**201. -- 299. (RESERVED)**

**300. SLIDING FEE SCHEDULE FOR CHILDREN'S MENTAL HEALTH, ADULT MENTAL HEALTH, AND SUBSTANCE USE DISORDERS SERVICES.**

Following is the sliding fee schedule for children's mental health, adult mental health, and substance use disorders services:

<b>TABLE 300 - SLIDING FEE SCHEDULE FOR CHILDREN'S MENTAL HEALTH, ADULT MENTAL HEALTH, AND SUBSTANCE USE DISORDERS SERVICES.</b>	
<b>Percent Federal of Poverty Guidelines</b>	<b>Percentage of Cost Sharing Responsibility of a Parent, or Adult Services Recipient</b>
0% - 99%	0%
100%-109%	5%
110%-119%	10%
120%-129%	15%
130%-139%	20%
140%-149%	25%
150%-159%	30%
160%-169%	35%
170%-179%	40%
180%-189%	45%
190%-199%	50%
200% - 209%	55%
210% - 219%	60%
220% - 229%	65%
230% - 239%	70%
240% - 249%	75%
250% - 259%	80%
260% - 269%	85%
270% - 279%	90%
280% - 289%	95%
290% - and above	100%

(3-20-20)T



**301. -- 399. (RESERVED)**

**400. CALCULATING INCOME TO APPLY THE SLIDING FEE SCHEDULE FOR CHILDREN'S MENTAL HEALTH AND ADULT MENTAL HEALTH SERVICES.**

The fee determination process includes consideration of the following subsections in this rule. (3-20-20)T

**01. Application and Fee Determination Form.** Prior to the delivery of behavioral health services, an application for services and a "Fee Determination" form must be completed. (3-20-20)T

**a.** A child's parent(s) must complete the application and fee determination form when requesting Children's Mental Health services. (3-20-20)T

**b.** An adult requesting Adult Mental Health services must complete the application and fee determination form. (3-20-20)T

**02. Ability to Pay.** Financial obligations are based upon the number of persons in the family household and the adjusted gross income of those persons as determined using the following: (3-20-20)T

**a.** An ability to pay determination will be made at the time of the voluntary request for services or as soon as possible, thereafter. (3-20-20)T

**b.** Redetermination of ability to pay will be made at least annually or upon request or at any time changes occur in family size, income, or allowable deductions. (3-20-20)T

**c.** In determining the family's ability to pay for services, the Department will deduct annualized amounts for the following: (3-20-20)T

i. Court-ordered obligations; (3-20-20)T

ii. Dependent support; (3-20-20)T

iii. Child care expenses necessary for parental employment; (3-20-20)T

iv. Medical expenses; (3-20-20)T

v. Transportation; (3-20-20)T

vi. Extraordinary rehabilitative expenses; and (3-20-20)T

vii. State and federal tax payments, including FICA taxes. (3-20-20)T

**03. Required Information.** Information regarding third-party payors and other resources, including Medicaid or private insurance, must be identified and developed in order to fully determine the child's parent(s) or adult individual's ability to pay and to maximize reimbursement for the cost of services provided. It is the responsibility of the parents, legal guardian, or adult individual to obtain and provide information not available at the time of the initial financial interview whenever that information becomes available. (3-20-20)T

**04. Time of Payment.** Payment for services will be due upon delivery of services unless other arrangements are made. (3-20-20)T

**05. Financial Obligation.** A financial obligation for each service not covered by third party liable resources or payments, including private insurance and Medicaid, will be established in accordance with Section 300 and Subsection 400.01 of these rules but in no case will the amount owed exceed the cost of the service. In no case will the annual financial obligation exceed five percent (5%) of adjusted gross income of the family household. (3-20-20)T

**06. Fees Established by the Department.** The maximum hourly fees or flat fees charged for Behavioral Health services are established by the Department of Health and Welfare. (3-20-20)T

**a.** The fees for Children's Mental Health Services and Adult Mental Health Services are based on the cost for services set in Department contracts with service providers. Current information regarding services and fee charges can be obtained from regional Children's Mental Health and Adult Mental Health offices specified online. (3-20-20)T

**b.** The fees for Substance Use Disorders Services are based on the cost for services set in Department contracts with the Management Services Contractor. Current information regarding services and fee charges can be obtained from the Department office described in Section 005 of these rules. (3-20-20)T

**401. -- 999. (RESERVED)**

## IDAPA 17 – INDUSTRIAL COMMISSION

### DOCKET NO. 17-0000-2000F (FEE RULE)

#### NOTICE OF OMNIBUS RULEMAKING – ADOPTION OF TEMPORARY RULE

**EFFECTIVE DATE:** The effective date of the temporary rules being adopted through this omnibus rulemaking is the adjournment date of the second regular session of the 65th Idaho State Legislature - March 20, 2020.

**AUTHORITY:** In compliance with Sections 67-5226, Idaho Code, notice is hereby given this agency has adopted a temporary rule. The action is authorized pursuant to Sections 72-301, 72-301A, 72-304, 7-327, 72-432, 72-508, 72-528, 72-602, 72-606, and 72-803, Idaho Code.

**DESCRIPTIVE SUMMARY:** The following is the required finding and concise statement of its supporting reasons for adopting the temporary rule:

This temporary rulemaking adopts the following chapter under IDAPA 17:

#### **IDAPA 17**

- 17.01.01, *Administrative Rules Under the Worker's Compensation Law*

**TEMPORARY RULE JUSTIFICATION:** Pursuant to Sections 67-5226(1) and 67-5226(2), Idaho Code, the Governor has found that temporary adoption of the rule is appropriate for the following reasons:

These temporary rules are necessary to protect the public health, safety, and welfare of the citizens of Idaho and confer a benefit on its citizens. These temporary rules implement the duly enacted laws of the state of Idaho, provide citizens with the detailed rules and standards for complying with those laws, and assist in the orderly execution and enforcement of those laws. The expiration of these rules without due consideration and processes would undermine the public health, safety, and welfare of the citizens of Idaho and deprive them of the benefit intended by these rules.

**FEE SUMMARY:** Pursuant to Section 67-5226(2), the Governor has found that the fee or charge being imposed or increased is justified and necessary to avoid immediate danger and the fee is described herein:

The fees or charges, authorized in Section 72-301, Idaho Code, are part of the agency's 2021 budget that relies upon the existence of these fees or charges to meet the state's obligations and provide necessary state services. Failing to reauthorize these temporary rules would create immediate danger to the state budget, immediate danger to necessary state functions and services, and immediate danger of a violation of Idaho's constitutional requirement that it balance its budget.

The following is a specific description of the fees or charges:

The \$250 application fees charged to employers seeking approval to become self-insured is needed to defray added costs incurred by the Commission in evaluating these applications.

**ASSISTANCE ON TECHNICAL QUESTIONS:** For assistance on technical questions concerning the temporary rule, contact Kamerron Monroe, Commission Secretary, (208) 334-6017 or [kamerron.monroe@iic.idaho.gov](mailto:kamerron.monroe@iic.idaho.gov).

DATED this February 18, 2020.

Mindy Montgomery, Director  
Industrial Commission  
11321 W. Chinden Blvd.  
P.O. Box 83720  
Boise, Idaho 83720-0041  
Phone: 208-334-6000  
Fax: 208-334-2321

# IDAPA 17 – INDUSTRIAL COMMISSION

## 17.01.01 – ADMINISTRATIVE RULES UNDER THE WORKER'S COMPENSATION LAW

### 000. LEGAL AUTHORITY.

This chapter is adopted under the legal authority of 72-301, 72-301A, 72-304, 72-327, 72-432, 72-508, 72-528, 72-602, 72-803, and 72-806, Idaho Code. (3-20-20)T

### 001. TITLE AND SCOPE.

**01. Title.** The title of this chapter is “Administrative Rules Under the Worker's Compensation Law” IDAPA 17, Title 01, Chapter 01. (3-20-20)T

**02. Scope.** This chapter includes the Industrial Commission's worker's compensation rules. (3-20-20)T

### 002. WRITTEN INTERPRETATIONS.

The Industrial Commission uses the following guidelines for implementing the EDI reporting requirements set out in this Chapter: (3-20-20)T

**01. EDI Guide and Tables.** The Idaho Industrial Commission Claims EDI Implementation Guide and Trading Partner Tables (“EDI Guide and Tables”). The Idaho Industrial Commission Claims EDI Implementation Guide and Trading Partner Tables are available on the Commission's website at <https://iic.idaho.gov/>. (3-20-20)T

**02. EDI Implementation Guide.** International Association of Industrial Accidents Boards and Commissions (IAIABC) EDI Claims Release 3.0 Implementation Guide (“EDI Implementation Guide”). The IAIABC Claims Release 3.0 Implementation Guide is available at the IAIABC website at <https://www.iaiacb.org>. (3-20-20)T

### 003 -- 009. (RESERVED)

### 010. DEFINITIONS.

The definitions set forth in Chapter 72, Idaho Code apply to these rules. In addition, the following terms have the meaning set forth below: (3-20-20)T

**01. Adjustor.** Means an individual who adjusts worker's compensation claims. (3-20-20)T

**02. Ambulatory Payment Classification.** Means the payment system adopted by CMS for outpatient services (3-20-20)T

**03. Available Funds.** Means a sum of money to which a Charging Lien may attach. It does not include any compensation paid or not disputed to be owed prior to Claimant's agreement to retain the attorney. (3-20-20)T

**04. Ambulatory Surgery Center.** Means a facility providing medical services on an outpatient basis only. (3-20-20)T

**05. Approval by Commission.** Means the Commission has approved attorney fees in conjunction with an award of compensation or an LSS or otherwise in accordance with Section 802 of this rule upon a proper showing by the attorney seeking to have the fees approved. (3-20-20)T

**06. Average Wholesale Price.** Means the average wholesale price for medicine obtained from pricing data provided by the original manufacturer of that medicine to industry-wide compilers of drug prices, e.g., Red Book and Medi-Span. (3-20-20)T

**07. Charge.** Means the expense or cost. For hospitals and ASCs, “charge” means the total charge. (3-20-20)T

**a.** Acceptable charge. Means a charge calculated in compliance with Section 803 of this rule or as billed by the Provider, whichever is lower, or the charge agreed to pursuant to a written contract. (3-20-20)T

**b.** Customary charge. Means a charge that has an upper limit no higher than the 90th percentile, as determined by the Commission, of usual charges made by Idaho Providers for a given medical service. (3-20-20)T

c. Reasonable charge. Means a charge that does not exceed the Provider's “usual” charge and does not exceed the “customary” charge. (3-20-20)T

d. Usual charge. Means the most frequent charge made by an individual Provider for a given medical service to non-industrially injured patients. (3-20-20)T

**08. Charging Lien.** Means a lien against a Claimant's right to any compensation under the Worker's Compensation Law, which may be asserted by an attorney who is able to demonstrate that: (3-20-20)T

a. There are compensation benefits available for distribution on equitable principles; (3-20-20)T

b. The services of the attorney operated primarily or substantially to secure the fund out of which the attorney seeks to be paid; (3-20-20)T

c. It was agreed that counsel anticipated payment from compensation funds rather than from the client; (3-20-20)T

d. The Claim is limited to costs, fees, or other disbursements incurred in the case through which the fund was raised; and (3-20-20)T

e. There are equitable considerations that necessitate the recognition and application of the Charging Lien. (3-20-20)T

**09. Claim.** Means filing for worker's compensation benefits through a Form 1A-1, First Report of Injury or Illness (FROI) or an application for hearing, referred to as a Complaint, with the Commission. (3-20-20)T

**10. Claims Administrator.** Means an organization, including insurers, third party administrators, independent adjusters, or self-insured employers, that services worker's compensation claims. (3-20-20)T

**11. Claimant.** Means a person who has filed a Claim for worker's compensation benefits and includes their agents, such as attorneys. (3-20-20)T

**12. Commission.** Means the Idaho Industrial Commission. (3-20-20)T

**13. Critical Access Hospital.** Means a hospital currently designated as a critical access hospital by CMS. (3-20-20)T

**14. Current Procedural Terminology.** Means the medical code published by the American Medical Association. (3-20-20)T

**15. Death Claim.** Means a Claim arising from the death of a worker as a result of a work-related injury or occupational disease. (3-20-20)T

**16. Electronic Data Interchange.** Means a computer to computer exchange of data in a standardized format. (3-20-20)T

**17. Fee Agreement.** Means a written agreement between a worker and an attorney in conformity with the Idaho Rules of Professional Conduct. (3-20-20)T

a. Reasonable, as used in Section 802 of this rule, means that an attorney's fees are consistent with the fee agreement and are to be satisfied from Available Funds, subject to the element of reasonableness contained in Idaho Rules of Professional Conduct 1.5. (3-20-20)T

**18. First Degree of Consanguinity.** Means the relationship between parents and their children whether related by blood or affinity. Adopted or step children and their adoptive or step parents are deemed to be within the first degree of consanguinity. (3-20-20)T

19. **First Report of Injury.** Means the first filing of information with the Industrial Commission that a reportable workplace injury has occurred or an occupational disease has been manifested, as required by Section 72-602(1), Idaho Code; filed in accordance with these rules. (3-20-20)T
20. **Gross Direct Premiums Written.** Means the gross sum of premiums on policies written, without any deduction for refunds or repayments resulting from cancellations. It does not include premiums on contracts between insurers or reinsurers. For all policies written, gross direct premiums written may reflect experience modifications, deviations, and retrospective rating. (3-20-20)T
21. **Healthcare Common Procedure Coding System.** Means the set of healthcare procedure codes based on the American Medical Association's Current Procedural Terminology. (3-20-20)T
22. **Hospital.** Means an acute care facility providing medical or rehabilitation services on an inpatient and outpatient basis. (3-20-20)T
23. **IAIABC EDI Release 3.0.** Means the IAIABC authored EDI Release 3.0 standards that cover the transmission of claims (FROI and SROI) information through electronic reporting. (3-20-20)T
24. **Impairment Rated Claim.** Means those claims in which the Provider establishes an impairment rating for the injured worker. (3-20-20)T
25. **Implantable Hardware.** Means objects or devices that are made to support, replace, or act as a missing anatomical structure or to support or manage proper biological functions or disease processes and where surgical or medical procedures are needed to insert or apply such devices and surgical or medical procedures are required to remove such devices. The term also includes equipment necessary for the proper operation of the implantable hardware, even if not implanted in the body. (3-20-20)T
26. **Indemnity Benefits.** Means payments made to or on behalf of worker's compensation Claimants, including temporary or permanent total or partial disability benefits, death benefits paid to dependents, retraining benefits, and any other type of income benefits, but excluding medical and related benefits. (3-20-20)T
27. **Indemnity Claim.** Means any claim made for the payment of indemnity benefits. (3-20-20)T
28. **Legacy Claim.** Means a FROI that was filed prior to the EDI implementation. (3-20-20)T
29. **Litigated Case.** Means a case in which a complaint has been filed. (3-20-20)T
30. **Medical Only Claim.** Means the injured worker will not suffer a disability lasting more than five (5) calendar days as a result of a job-related injury or occupational disease, nor be admitted to a hospital as an inpatient. (3-20-20)T
31. **Medical Report.** Means and includes without limitation, all bills, chart notes, surgical records, testing results, treatment records, hospital records, prescriptions, and medication records. (3-20-20)T
32. **Medicare Severity - Diagnosis Related Group.** Means a system adopted by CMS that groups hospital admissions based on diagnosis codes, surgical procedures, and patient demographics. (3-20-20)T
33. **Net Premiums Written.** Means the amount of gross direct premiums on policies written less returned premiums and premiums on policies not taken. Paid dividends shall not be deducted for the purposes of calculating net premiums written. (3-20-20)T
34. **Payor.** Means the entity that is responsible for making payment to a Provider for services rendered to treat an industrially injured patient and includes self-insured employers, sureties, adjusters, and their agents. (3-20-20)T
35. **Payroll.** Means the gross amount paid by an employer for salaries, wages, or commissions earned

by its own direct employees, but not including any money paid to another entity or received from another entity for leased employees. (3-20-20)T

**36. Pharmacy.** Means a facility as defined in Section 54-1705(29), Idaho Code. (3-20-20)T

**37. Supplemental or Subsequent Report of Injury.** Means the filing of additional information with the Industrial Commission, regarding benefits paid or changes in the status or condition of an injured worker, of a Claim for benefits, as required by Sections 72-602(2), (3), and (4), Idaho Code; filed in accordance with these rules. (3-20-20)T

**38. Termination of Disability.** Means the date upon which the obligation of the Employer/Surety becomes certain as to duration and amount whether by settlement, decision, or periodic payments in the ordinary course of claims processing. If resolved by LSS, the termination of disability shall occur on the date the LSS is approved and an order approving is filed by the Industrial Commission. If resolved by decision, the termination of disability shall occur on the date the decision resolving all issues becomes final. (3-20-20)T

**39. Time Loss Claim.** Means the injured worker will suffer, or has suffered, a disability that lasts more than five (5) calendar days as a result of a job-related injury or occupational disease, or the injured worker requires, or required, in-patient treatment as a result of such injury or disease. (3-20-20)T

**40. Trading Partner.** Means an insurance carrier, self-insured employer, or Claims Administrator that has entered into a Trading Partner Agreement with the Industrial Commission. (3-20-20)T

**41. Trading Partner Agreement.** Means an agreement between the Industrial Commission and a Trading Partner that sets out the terms and conditions for the electronic reporting of information to the Commission. (3-20-20)T

**011. ABBREVIATIONS.**

The following abbreviations have the meaning set forth below: (3-20-20)T

**01. APC.** Means Ambulatory Payment Classification. (3-20-20)T

**02. ASC.** Means Ambulatory Surgery Center. (3-20-20)T

**03. AWP.** Means Average Wholesale Price. (3-20-20)T

**04. CMS.** Means Centers for Medicare and Medicaid Services. (3-20-20)T

**05. CPT.** Means Current Procedural Terminology. (3-20-20)T

**06. EDI.** Means Electronic Data Interchange. (3-20-20)T

**07. FROI.** Means First Report of Injury. (3-20-20)T

**08. HCPCS.** Means Healthcare Common Procedure Coding System. (3-20-20)T

**09. IAIABC.** Means International Association of Industrial Accident Boards and Commissions. (3-20-20)T

**10. ISIF.** Means the Industrial Special Indemnity Fund, which is commonly referred to as the Second Injury Fund. (3-20-20)T

**11. LSS.** Means Lumps Sum Settlement. (3-20-20)T

**12. MSDRG.** Means Medicare Severity Diagnosis Related Group. (3-20-20)T

**13. NCCI.** Means National Council on Compensation Insurance. (3-20-20)T

- 14. NDC. Means National Drug Code. (3-20-20)T
- 15. RBRVS. Means Resource-Based Relative Value Scale. (3-20-20)T
- 16. RVU. Means Relative Value Unit. (3-20-20)T
- 17. SROI. Means Supplemental or Subsequent Report of Injury. (3-20-20)T

**012. LIBERAL CONSTRUCTION.**

Rulemaking before the Industrial Commission should be just, speedy, and economical; unless prohibited by statute, the Industrial Commission may permit deviation from these rules when it finds compliance with them is impracticable, unnecessary, or not in the public interest. (3-20-20)T

**013. -- 200. (RESERVED)**

**201. RULE GOVERNING 72-212(5) EXEMPTIONS.**

**01. Exemptions.** Each person who elects to exempt themselves from coverage or revoke their exemption under Section 72-212(5), Idaho Code, must file an IC53 Declaration form with the Industrial Commission. The form is available on the Commission's website. (3-20-20)T

**02. Form.** The form must be signed by both the employee and the employer. An original and one (1) copy of the IC53 form shall be filed with the Commission. Upon approval by the Commission, the copy will be returned to the employee filing for an exemption or revocation of an exemption. (3-20-20)T

**03. Approval by Commission.** The Commission must approve the exemption or revocation of exemption. The Commission may require verification of information submitted. Fraud or misrepresentation in the information provided will void the exemption or revocation. (3-20-20)T

**04. IC53 Form.** If the employer is insured, it is the employer's responsibility to file a copy of the IC53 form with the employer's insurance company. (3-20-20)T

**05. Effective Date.** The effective date of the exemption or revocation of exemption shall be the date the properly completed form is received by the Commission. (3-20-20)T

**06. Exemption Effective.** The exemption shall remain in effect until a revocation of exemption is filed with the Commission, or, termination of employment with the designated employer, or upon the death of the employee, whichever occurs first. (3-20-20)T

**202. -- 300. (RESERVED)**

**301. RULES GOVERNING QUALIFICATIONS TO WRITE INSURANCE OR SELF-INSURE.**

**01. Insurance Carriers.** In order to gain approval from the Industrial Commission to underwrite worker's compensation insurance under Section 72-301, Idaho Code, an insurance carrier shall comply with the following requirements: (3-20-20)T

**a. Deposit With State Treasurer.** The carrier must receive approval from the Director of the Idaho Department of Insurance to underwrite casualty and surety insurance under Sections 41-506 and 41-507, Idaho Code, and shall initially deposit security in the amount of two hundred fifty thousand dollars (\$250,000) with the State Treasurer, under the provisions of Section 72-302, Idaho Code. (3-20-20)T

**b. Application.** To receive approval from the Industrial Commission, an insurance carrier must supply an application with: (3-20-20)T

- i. A statement from the Director of the Idaho Department of Insurance documenting compliance with



- Paragraph 01.a, above; (3-20-20)T
- ii. The latest audited financial statement of said carrier; (3-20-20)T
  - iii. The name and address of the agent for service of process in Idaho; (3-20-20)T
  - iv. The name and address of the Claims Administrator employing an Idaho licensed resident adjuster or the insurance carrier's own in-house Idaho adjusting staff with authority to make compensation payments and adjustments of claims arising under the Act. Each Claims Administrator shall have only one (1) mailing address on record at the Commission for claims adjusting purposes. If more than one (1) Claims Administrator is utilized in Idaho, a list of every such Claims Administrator and all corresponding policyholders shall be provided; (3-20-20)T
  - v. A statement that the carrier will distribute blank forms that are prescribed by the Commission to its insured; (3-20-20)T
  - vi. A statement that all surety bonds covering the payment of compensation will be filed with the Idaho State Treasurer for all employers insured. All carriers will use the continuous bond form set out on the Commission's website. (3-20-20)T
  - vii. A statement that renewal certificates on said bonds will be issued and filed with the Industrial Commission immediately, when and if renewed; (3-20-20)T
  - viii. A statement that all surety contract cancellations will be canceled in compliance with Section 72-311, Idaho Code; (3-20-20)T
  - ix. A statement that said carrier will deposit, in addition to other security required by this rule, further security equal to all unpaid outstanding awards of compensation; (3-20-20)T
  - x. A statement that said carrier will comply with the statutes of the state of Idaho and rules of the Industrial Commission and that payments of compensation shall be sure and certain and not unnecessarily delayed; and (3-20-20)T
  - xi. A statement that the carrier will make reports to the Commission as are required. (3-20-20)T
- 02. Self-Insured Employers.** In order to gain approval from the Industrial Commission to self-insure under Section 72-301, Idaho Code, an employer shall comply with the following requirements: (3-20-20)T
- a.** Payroll. Have an average annual Idaho Payroll over the preceding three (3) years of at least four million dollars (\$4,000,000). (3-20-20)T
  - b.** Application. Submit a completed application, available from the Industrial Commission's Fiscal Department, along with the application fee of two hundred fifty dollars (\$250), to the Idaho Industrial Commission, Attention: Fiscal Department. (3-20-20)T
  - c.** Documentation. Submit documentation demonstrating the sound financial condition of the employer, such as the most recent CPA reviewed or, if available, audited, financial statement. (3-20-20)T
  - d.** Claims Adjusting. Designate in writing a Claims Administrator employing an Idaho licensed resident adjuster including name and address. Each Claims Administrator shall have only one (1) mailing address on record at the Commission for claims adjusting purposes. (3-20-20)T
  - e.** Previous Claims. Provide a history of all worker's compensation claims filed with the employer or the employer's worker's compensation carrier, as well as all compensation paid, during the previous five (5) calendar years. (3-20-20)T
  - f.** Excess Insurance. Provide an insurance plan that must include excess insurance coverage and copies of all proposed policies of excess worker's compensation insurance coverage. (3-20-20)T

- g.** Actuarial Study. Provide an actuarial study prepared by a qualified actuary determining adequate rates for the proposed self-funded worker's compensation plan based upon a fifty percent (50%) confidence level. (3-20-20)T
- h.** Feasibility Study. Provide a self-insurance feasibility study that includes an analysis of the advantages and disadvantages of self insurance as compared to current coverage, and the related costs and benefits. (3-20-20)T
- i.** Custodial Agreement. Set up a custodial agreement with the State Treasurer for securities required to be deposited under Sections 72-301 and 72-302, Idaho Code. (3-20-20)T
- j.** Supplemental Information. Provide supplemental information as requested. (3-20-20)T
- k.** Initial Security Deposit. Prior to final approval, deposit an initial security deposit with the Idaho State Treasurer in the form permitted by Section 72-301, Idaho Code, or a self-insurer's bond in substantially the form as the Commission's self-insurer's compensation bond, available on the Commission's website, in the amount of one hundred fifty thousand dollars (\$150,000), plus five percent (5%) of the first ten million dollars (\$10,000,000) of the employer's average annual Payroll in the state of Idaho for the three (3) preceding years; along with such additional security as may be required by the Commission based on prior claims history. (3-20-20)T
- l.** Initial Guaranty Agreement. The Commission may allow or, where financial reports or other factors such as the high risk industry of the employer indicate the need, require an employer that is organized as a joint venture or a wholly owned subsidiary to provide a guaranty agreement from each member of the joint venture or the parent company. This guaranty agreement confirms the continuing agreement of each of the joint venture members or the parent company to guarantee the payment of all Idaho worker's compensation claims of employees of that joint venture or subsidiary employer. The guaranty agreement shall be in substantially the same form as the current sample Indemnity and Guaranty Agreement and, as applicable, the companion Consent of the Board of Directors, available on the Commission's website. (3-20-20)T
- m.** Written Approval. Obtain written approval from the Industrial Commission. (3-20-20)T
- n.** Idaho National Laboratory. An employer meeting the requirements of Section 72-301A, Idaho Code, does not have to comply with the requirements of Paragraphs 302.02.a., 02.f., 02.i., and 02.k., above. (3-20-20)T

**302. RULES GOVERNING CONTINUING REQUIREMENTS TO UNDERWRITE INSURANCE OR SELF-INSURE.**

- 01. Insurance Carriers.** An insurance carrier approved under IDAPA 17.01.01.301.01 shall comply with the following requirements: (3-20-20)T

  - a.** Maintain Statutory Security Deposits with the State Treasurer. (3-20-20)T

    - i.** Each insurance carrier shall maintain with the Idaho State Treasurer a security deposit in the amount of twenty-five thousand dollars (\$25,000) if approved by the Commission prior to July 15, 1988, or two hundred and fifty thousand dollars (\$250,000) if approved subsequently. (3-20-20)T
    - ii.** In addition to the security required in Subsection 01.a.i, of this rule, each insurance carrier shall deposit an amount equal to the total unpaid outstanding awards of said insurance carrier. Such deposit shall be in the form permitted by Section 72-301, Idaho Code. Surety bonds shall be in the form available on the Commission's website. If a surety bond is deposited, the surety company shall be completely independent of the principal and authorized to transact such business in the state of Idaho. A partial release of security deposited hereunder must be requested in writing and approved by the Commission. (3-20-20)T
    - iii.** Securities which are maintained to satisfy the requirements of this rule may be held in the federal reserve book-entry system, as defined in Section 41-2870(4), Idaho Code, and interests in such securities may be

transferred by bookkeeping entry in the federal reserve book-entry system without physical delivery of certificates representing such securities. (3-20-20)T

**b.** Appoint Agent for Service of Process. Each insurance carrier shall appoint the Director of the Department of Insurance as its agent to receive service of legal process. (3-20-20)T

**c.** Maintain Resident Idaho Office. Each insurance carrier shall maintain a Claims Administrator employing an Idaho licensed resident adjuster or the carrier's own adjusting offices or officers residing in Idaho. (3-20-20)T

**i.** Each authorized insurance carrier shall notify the Commission Secretary in writing of any change of the designated resident adjuster(s) for every insured Idaho employer within fifteen (15) days of such change. (3-20-20)T

**ii.** Each authorized insurance carrier will ensure that every in-state adjuster can classify and identify all claims adjusted on behalf of said insurance carrier, and that the in-state adjuster will provide such information to the Industrial Commission upon request. Further each in-state Adjustor must have full authority to: (3-20-20)T

(1) Investigate and adjust all claims for compensation; (3-20-20)T

(2) Pay all compensation benefits due; (3-20-20)T

(3) Accept service of claims, applications for hearings, orders of the Commission, and all process which may be issued under the Worker's Compensation Law; (3-20-20)T

(4) Enter into compensation agreements and LSSs with Claimants; (3-20-20)T

(5) Provide at the employer's expense necessary forms to any employee who wishes to file a Claim under the Worker's Compensation Law. (3-20-20)T

**d.** Supply Forms. Each insurance carrier shall distribute the required forms prescribed by the Commission to all employers it insures. A list of required forms is available on the Commission's website. (3-20-20)T

**e.** Comply with Industrial Commission Reporting Requirements. Each insurance carrier shall, within the time prescribed, file such reports and respond to such information requests as the Commission may require from time to time concerning matters under the Worker's Compensation Law. (3-20-20)T

**f.** Report Proof of Coverage. (3-20-20)T

**i.** Each insurance carrier shall report all proof of coverage to NCCI. NCCI is the designated agent to receive, process, and forward the proof of coverage information required by these rules to the Commission. The address of the Commission's designated agent is available on the Commission's website. (3-20-20)T

**ii.** The Industrial Commission adopts the IAIABC's electronic proof of coverage record layout and transaction standards as the required reporting mechanism for new policies, renewal policies, endorsements, cancellations, and non-renewals of policies. A copy of the record layout, data element requirements, and transaction standards is available on the Commission's website. Each insurance carrier shall report data for all mandatory elements in the current IAIABC proof of coverage record layout and transaction standards on each policy reported. (3-20-20)T

**iii.** The most recent proof of coverage information contained in the Industrial Commission's database shall be presumed to be correct for the purpose of determining the insurance carrier providing coverage. (3-20-20)T

**g.** Report New Policy, Renewal Policy, and Endorsement Information Within Thirty Days. Each insurance carrier shall report the issuance of any new worker's compensation policy, renewal policy, or endorsement to the Industrial Commission or its designated agent within thirty (30) days of the effective date of the transaction.

(3-20-20)T

**h.** Report Cancellation and Non-Renewal of Policy Within Time Prescribed by Statute. Each insurance carrier shall report the cancellation and/or nonrenewal of any worker's compensation insurance policy to the Industrial Commission or its designated agent within the time frames prescribed by Section 72-311, Idaho Code. Receipt of cancellation or nonrenewal notices by the Commission's designated agent shall be deemed to have been received by the Commission. (3-20-20)T

**i.** Report Election of Coverage on Form IC52 or Similar Format. Each insurance carrier shall report election of coverage or revocation of election of coverage on or in a format substantially the same as Form IC52, "Election of Coverage," available on the Commission's website. (3-20-20)T

**j.** Report Deductible Policy. On or before March 3rd of each year, every insurance carrier shall submit a report of all deductible policies that were issued and in effect during the previous calendar year. That report shall be submitted in a form substantially similar to the current "Deductible Policy Report" available on the Commission's website. The report shall include the following information: insured name, policy number, effective and expiration dates, deductible amount, the premium charged for the policy before credit for the deductible, and the final premium after credit for the deductible. (3-20-20)T

**k.** Report Outstanding Awards. Each insurance carrier shall report to the Industrial Commission at the end of each calendar quarter, or more often as required by the Commission, any outstanding award. (3-20-20)T

**i.** The report of outstanding awards shall be filed with the Industrial Commission by the end of the month following the end of each calendar quarter. (3-20-20)T

**ii.** The report shall be filed even if there are no outstanding awards. In that event, the carrier shall certify the fact that there are no outstanding awards to be reported. (3-20-20)T

**iii.** The report shall be submitted on or in a format that is substantially the same as the current Form IC36A, "Report of Outstanding Awards - Insurance Carriers" available on the Commission's website. The report may be produced as a computerized spreadsheet or database printout. (3-20-20)T

**iv.** The report shall be signed and certified to be correct by a corporate officer. If an insurance carrier has designated more than one adjuster for worker's compensation claims in Idaho, a corporate officer of the insurance carrier shall prepare, certify, and file a consolidated report of outstanding awards. (3-20-20)T

**v.** The report shall list all outstanding awards, commencing with the calendar quarter during which the award is made or benefits are first paid, whichever occurs earlier. (3-20-20)T

**l.** Comply with Law and Rules. Each insurance carrier shall comply with the statutes of the state of Idaho and the rules of the Industrial Commission to ensure that payments of compensation shall be sure and certain and not unnecessarily delayed. (3-20-20)T

**02. Self-Insured Employers.** A self-insured employer approved under Subsection 301.02 shall comply with the following requirements: (3-20-20)T

**a.** Payroll Requirements. Maintain an average annual Idaho Payroll over the preceding three (3) years of at least four million dollars (\$4,000,000). Any self-insured employer that does not meet the Payroll requirement of this rule for two consecutive semi-annual premium tax reporting periods shall be allowed to maintain their self-insured status for six (6) months from the end of the last reporting period in order to permit them time to increase their Payroll or obtain worker's compensation coverage with an insurance carrier authorized to write worker's compensation insurance in the state of Idaho. (3-20-20)T

**b.** Security Deposit with Treasurer. (3-20-20)T

**i.** Maintain a primary security deposit with the Idaho State Treasurer in the form permitted by Section 72-301, Idaho Code, a self-insurer's bond form available on the Commission's website, or in substantially the same

form, or in such other form approved by the Commission, in the amount of one hundred fifty thousand dollars (\$150,000), plus five percent (5%) of the employers' average annual Payroll in the state of Idaho for the three (3) preceding years, not in excess of ten million dollars (\$10,000,000). If a surety bond is deposited, the surety company shall be completely independent of the principal and authorized to transact such business in the state of Idaho. In addition thereto, the self-insured employer shall deposit additional security in such amount as the Commission determines is necessary to secure the self-insured employer's total unpaid liability for compensation under the Worker's Compensation Law. No approved security shall be accepted for deposit above its par value. Additional deposits of approved security may be required semi-annually if the market value of an approved investment falls below its par value or if the total value of the employer's security deposit falls below the total security required to be maintained on deposit when calculated in accordance with this rule. (3-20-20)T

ii. Self-insured employers shall receive a credit for the primary security deposit against the self-insured employer's obligation to post the additional security required by Subparagraph 302.02.b.i. of this rule. (3-20-20)T

iii. Excess insurance coverage approved by the Commission may apply as a credit against the self-insured employer's obligation to post the additional security required by Subparagraph 302.02.b.i. of this rule. The Commission must be provided with thirty (30) days advance written notice of any change or cancellation of an approved excess insurance policy. No credit will be given for any excess insurance coverage provided by a surplus lines carrier, as described in Chapter 12, Title 41, Idaho Code. (3-20-20)T

iv. All security deposited by the self-insured employer shall be maintained as provided by Section 72-302, Idaho Code. (3-20-20)T

v. Any withdrawal or partial release of security deposited hereunder must be requested in writing and approved by the Commission. (3-20-20)T

**c. Continue or Provide Guaranty Agreement.** (3-20-20)T

i. A self-insured employer that is organized as a joint venture or a wholly owned subsidiary shall continue in effect any guaranty agreement that the Commission has previously allowed or required, until termination is permitted by the Commission. (3-20-20)T

ii. Where an adverse change in financial condition or other relevant factors such as claims history or industry risk indicates the need, a self-insured employer that is organized as a joint venture or a wholly owned subsidiary may be allowed to, or shall upon request, provide a guaranty agreement from each member of the joint venture or the parent company. This guaranty agreement confirms the continuing agreement of each of the joint venture members or the parent company to guarantee the payment of all Idaho worker's compensation claims of employees of that joint venture or subsidiary self-insured employer. The guaranty agreement shall be in substantially the same form as the current sample Indemnity and Guaranty Agreement, and as applicable, the companion Consent of the Board of Directors, available on the Commission's website. (3-20-20)T

**d. Maintain a Licensed Resident Adjuster.** Maintain an Idaho licensed, resident claims adjuster located within the state of Idaho who shall have full authority to make decisions and to authorize the payment of all compensation on said claims on behalf of the employer including, but not limited to, the following: (3-20-20)T

i. Investigate and adjust all claims for compensation; (3-20-20)T

ii. Pay all compensation benefits due; (3-20-20)T

iii. Accept service of claims, applications for hearings, orders of the Commission, and all process which may be issued under the Worker's Compensation Law; (3-20-20)T

iv. Enter into compensation agreements and LSSs with Claimants; (3-20-20)T

v. Provide at the employer's expense necessary forms to any employee who wishes to file a Claim under the Worker's Compensation Law. (3-20-20)T

e. File Reports. Report to the Industrial Commission semi-annually, or more often as required by the Commission, total unpaid liability on all open claims. (3-20-20)T

i. The semi-annual report of total unpaid liability shall be filed with the Industrial Commission by the end of the months of January and July. (3-20-20)T

ii. The report shall provide the aggregate number of open claims, including indemnity with medical and Medical Only Claims, along with the amount of any compensation paid on open claims, as of the end of each June and December. (3-20-20)T

iii. The report shall be filed even if there are no open claims. In that event, the employer shall certify the fact that there are no open claims to be reported. (3-20-20)T

iv. The report shall be submitted on or in a format that is substantially the same as the current Form IC-211, "Self-Insured Employer Report of Total Unpaid Liability," available on the Commission's website. The report may be produced as a computerized spreadsheet or database printout. (3-20-20)T

v. The report shall be signed and certified to be correct by a corporate officer. If an employer has designated more than one adjuster for worker's compensation claims in Idaho, a corporate officer of the employer shall prepare, certify, and file a consolidated report of all unpaid liability. (3-20-20)T

vi. A self-insured employer shall also make, within the time prescribed, such other reports and respond to such information requests as the Commission may require from time to time concerning matters under the Worker's Compensation Law. (3-20-20)T

f. Submit to Audits by Industrial Commission. Each year a self-insured employer shall provide the Industrial Commission with a copy of its annual financial statements, or other acceptable documentation. Each self-insured employer shall submit to audit by the Commission or its designee at any time and as often as it requires to verify the amount of premium such self-insured employer would be required to pay as premium to the State Insurance Fund, and to verify compliance with the provisions of these rules and the Idaho Worker's Compensation Law. For the purpose of determining such premium for uninsured contractors of a self-insured employer, the most recent proof of coverage information contained in the Industrial Commission's database shall be presumed to be correct for the purpose of determining such coverage. (3-20-20)T

g. Comply with Law and Rules. Comply with the statutes of the state of Idaho and the rules of the Industrial Commission to the end that payment of compensation shall be sure and certain and not unnecessarily delayed. The Commission may withdraw its approval of any employer to operate as a self-insurer if it shall appear to the Commission that workers secured by said self-insured employer are not adequately protected and served, or the employer is failing to comply with the provisions of these rules or the Worker's Compensation Law. (3-20-20)T

h. Idaho National Laboratory. An employer meeting the requirements of Section 72-301A, Idaho Code, does not have to comply with Paragraph 303.02.a. and 302.02.b., above. (3-20-20)T

**303. RULE GOVERNING THE COLLECTION OF PREMIUM TAX ON WORKER'S COMPENSATION INSURANCE POLICIES.**

This rule governs the collection of premium tax on worker's compensation insurance policies. This procedure applies to all worker's compensation policies. (3-20-20)T

**01. Procedure for Submitting Premium Tax Forms.** The form IC 4008, available on the Commission's website, shall be used to report numbers of policies and the total gross premiums written. The original shall be sent to the Commission; a copy shall also be attached to the reporting entity's annual premium tax statement that is filed with the Idaho Department of Insurance. This form is due to the Commission by July 31 for the reporting period of January 1 through June 30; it is due by March 3 for the reporting period of July 1 through December 31. (3-20-20)T

**304. RULE GOVERNING PREMIUM TAX COMPUTATION FOR SELF-INSURED EMPLOYERS.**

**01. Payroll Reports.** No later than March 3rd and July 31st, self-insured employers shall file a semi-annual premium tax report with the Fiscal Department of the Commission. Self-insured employers shall use the Commission's current report form IC 4010, along with the accompanying computation form IC 4010a, available on the Commission's website. The premium tax payment due from a self-insured employer shall be based upon the manual premium calculated for each reporting period, as modified by an experience modification factor calculated by NCCI and submitted to the Commission in accordance with Subsection 304.02 of this rule. No other rating factor shall be allowed. If the self-insured employer elects to not provide such experience modification factor, the premium tax will be computed based upon the manual premium only. (3-20-20)T

**02. Experience Modification.** A self-insured employer that elects to use an experience modification factor in computing premium tax shall make an annual application to NCCI for an experience modification factor using the NCCI form ERM-6 and paying to NCCI any fees charged for providing that calculation. An NCCI experience modification factor may only be based on the employer's Idaho operations for which self-insured status is authorized. In order to have an experience modification factor considered for any reporting period, an employer must timely submit to the Commission's Fiscal Department: (3-20-20)T

- a. A copy of the completed form ERM-6 filed with NCCI; (3-20-20)T
- b. The resulting experience modification factor received from NCCI; and (3-20-20)T
- c. The completed IC 4010 Semi-Annual Premium Tax Form for Self-Insurers and IC 4010a Computation Form. (3-20-20)T

**305. REQUIREMENTS FOR MAINTAINING IDAHO WORKER'S COMPENSATION CLAIMS FILES.**

All insurance carriers, self-insured employers, and licensed adjusters servicing Idaho worker's compensation claims shall comply with the following requirements: (3-20-20)T

**01. Idaho Office.** (3-20-20)T

a. All insurance carriers, self-insured employers, and licensed adjusters servicing Idaho worker's compensation claims shall maintain an office within the state of Idaho. The offices shall be staffed by adequate personnel to conduct business. (3-20-20)T

b. The insurance carrier or self-insured employer shall authorize and require a member of its in-state staff or an Idaho licensed resident adjuster to service and make decisions regarding claims pursuant to Section 72-305, Idaho Code. (3-20-20)T

c. As staffing changes occur and, at least annually, the insurance carrier, self-insured employer, or licensed adjuster shall submit to the Commission Secretary the names of those authorized to make decisions regarding claims pursuant to Section 72-305, Idaho Code. Each authorized insurance carrier shall designate only one (1) Claims Administrator for each policy of worker's compensation insurance. (3-20-20)T

**02. Claim Files.** All Idaho worker's compensation claim files shall be maintained within the state of Idaho in either hard copy or immediately accessible electronic format. Claim files shall include, but are not limited to: (3-20-20)T

- a. FROI and Claim for Benefits; (3-20-20)T
- b. Copies of bills for medical care; (3-20-20)T
- c. Copy of lost-time computations, if applicable; (3-20-20)T
- d. Correspondence reflecting reasons for any delays in payments, the resolution of such delays, and acceptance or denial of compensability; (3-20-20)T

- e. Employer's Supplemental Report; and (3-20-20)T
- f. Medical reports. (3-20-20)T
- 03. Correspondence.** All original correspondence involving adjusting decisions regarding Idaho worker's compensation claims shall be authorized from and maintained at in-state offices. (3-20-20)T
- 04. Date Stamp.** Each of the documents listed in Subsections 305.02 and 305.03, above, shall be date-stamped with the name of the receiving office on the day received, and by each receiving agent or vendor acting on behalf of the claims office. (3-20-20)T
- 05. Notice and Claim.** All First Reports of Injury, Claims for Benefits, notices of occupational illnesses, and fatalities shall be sent directly to the in-state adjuster for the insurance carrier or self-insured employer. The original copy of the FROI, Claim for Benefits, and notices of occupational illness and fatality shall be sent directly to the Industrial Commission. (3-20-20)T
- 06. Compensation Payments - Generally.** (3-20-20)T
  - a. All compensation, as defined by Section 72-102, Idaho Code, must be issued from the in-state office. (3-20-20)T
  - b. Except as ordered otherwise by the Commission, the insurance carrier or self-insured employer may make compensation payments by either: (3-20-20)T
    - i. Check or other readily negotiable instrument; (3-20-20)T
    - ii. When requested by the Claimant, electronic transfer payment to an account designated by the Claimant in accordance with the requirements of Subsection 305.07; or (3-20-20)T
    - iii. When requested by the Claimant, electronic transfer payments made through an access card; if that option is made available by the carrier or self-insured employer, in accordance with the requirements of Subsection 305.08. (3-20-20)T
  - c. If the Claimant is represented by an attorney who may have an attorney's lien for fees due on such compensation payments, the attorney must agree to payment by electronic transfer to Claimant's account or payment through an access card before such compensation may be paid other than by a check made payable to the Claimant and the attorney. (3-20-20)T
- 07. Electronic Transfer Payments.** (3-20-20)T
  - a. A Claimant may request that the insurance carrier or self-insured employer make compensation payments by electronic transfer to a personal bank account by providing the insurance carrier or self-insured employer in writing: the name and routing transit number of the financial institution and the account number and type of account to which the Claimant wants to have the compensation electronically transferred. The insurance carrier or self-insured employer shall provide the Claimant with a written form to fill out the required information by this subsection within seven (7) days of receiving a request for electronic transfer of payments from the Claimant unless the Claimant has already completed an on-line electronic form provided by the carrier or employer. (3-20-20)T
  - b. The insurance carrier or self-insured employer may make compensation payments to the Claimant by electronic transfer to an account designated by the Claimant if the Claimant: (3-20-20)T
    - i. Requests in writing that payment be made by electronic transfer; (3-20-20)T
    - ii. Provides the information required by Paragraph 305.07.a. above; and (3-20-20)T
    - iii. Is reasonably expected to be entitled to receive compensation payments for a period of eight (8) weeks or more from the point that Subparagraphs 305.07.b.i. and 07.b.ii. are satisfied. (3-20-20)T



**c.** The insurance carrier or self-insured employer shall initiate payment by electronic transfer starting with the first benefit payment due on or after the twenty first day after the requirements of Paragraph 305.07.b., above are met, but shall continue to make timely payments by check until the insurance carrier or self-insured employer initiates benefit payment delivery by electronic transfer. (3-20-20)T

**d.** If the Claimant has previously been receiving benefit payments by electronic transfer and wants to receive benefits by check, the insurance carrier or self-insured employer shall initiate benefit payment delivery by check starting with the first benefit payment due to the Claimant on or after the seventh day after receiving a written request for such payments. (3-20-20)T

**08. Access Card Payments. (3-20-20)T**

**a.** Access card means any card or other payment method that may be used by a Claimant to initiate electronic fund transfer from an insurance carrier's or a self-insured employer's bank account. The term “access card” does not include stored value cards or prepaid cards that store funds directly on the card and that are not linked to an insurance carrier's or a self-insured employer's bank account. (3-20-20)T

**b.** An insurance carrier or a self-insured employer may pay compensation through an access card to a Claimant if there is written mutual agreement signed by the insurance carrier or self-insured employer and the Claimant. The insurance carrier or self-insured employer shall maintain accurate records of the mutual agreement for, at a minimum, four hundred and one (401) weeks from the date of injury. The written agreement shall contain an acknowledgment that the Claimant received and agreed to the written disclosure required by Paragraph 305.08.d. (3-20-20)T

**c.** An insurance carrier or a self-insured employer providing compensation payments to a Claimant through an access card shall: (3-20-20)T

**i.** Permit the Claimant to withdraw the entire amount of the balance of an access card in one transaction; (3-20-20)T

**ii.** Not reduce compensation payments paid to a Claimant through an access card for the following fees, surcharges, and adjustments: (3-20-20)T

(1) Overdraft services under which a financial institution pays a transaction (including a check or other item) when the Claimant has insufficient or unavailable funds in the account; (3-20-20)T

(2) ATM withdrawal or point of sale purchase for more than the card holds and the transaction is denied; (3-20-20)T

(3) ATM balance inquiries; (3-20-20)T

(4) Withdrawing money from network ATMs; (3-20-20)T

(5) Withdrawing money from a teller; (3-20-20)T

(6) Customer service calls; (3-20-20)T

(7) Activating the card; (3-20-20)T

(8) Fees for card inactivity; (3-20-20)T

(9) Closing account; (3-20-20)T

(10) Access card replacement through standard mail; (3-20-20)T

(11) Withdrawing the entire payment in one transaction; (3-20-20)T

- (12) Point of sale purchases, or (3-20-20)T
- (13) Any other fees or charges that are not authorized under Subparagraph 305.08.c.iii., and (3-20-20)T
- iii. Only permit a Claimant to be charged for the following: (3-20-20)T
  - (1) Fees for access card replacement through an expedited mail service; (3-20-20)T
  - (2) International transaction fees, and (3-20-20)T
  - (3) Out-of-network ATM fees. (3-20-20)T
- d.** Insurance carriers or self-insured employers shall provide a written disclosure to the Claimant contemporaneously with the written mutual agreement required under Paragraph 305.08.b. that includes: (3-20-20)T
  - i. A summary of the Claimant's liability for unauthorized electronic fund transfers; (3-20-20)T
  - ii. The telephone number and address of the person or office to be notified when the Claimant believes that an unauthorized electronic fund transfer has been or may be made; (3-20-20)T
  - iii. The type of electronic fund transfers that the Claimant may make and any limitations on the frequency of transfers; (3-20-20)T
  - iv. Any fees imposed for electronic fund transfers or for the right to make transfers, including a statement that fees may be imposed by an ATM operator that is out-of-network; (3-20-20)T
  - v. Fees for expedited card replacement or international transaction fees will be removed from the balance maintained in the bank account linked to the access card; (3-20-20)T
  - vi. A summary of the Claimant's right to receipts and periodic statements; (3-20-20)T
  - vii. All bank locations and network ATMs in the United States where the Claimant may access his or her funds at no cost; (3-20-20)T
  - viii. A statement informing the Claimant that they have a right to receive payments directly into their personal bank account through direct deposit or by check. (3-20-20)T
- e.** An insurance carrier or a self-insured employer shall provide the written disclosure and any notice of term or condition changes required under Paragraph 305.08.d. that: (3-20-20)T
  - i. Are printed in not less than twelve (12) point font; (3-20-20)T
  - ii. Include the full text to communicate all terms and conditions; (3-20-20)T
  - iii. Are written in a clear and coherent manner and wherever practical, words with common and everyday meaning shall be used to facilitate readability; and (3-20-20)T
  - iv. Are appropriately divided and captioned in a meaningful sequence such that each section contains an underlined, boldfaced, or otherwise conspicuous title or caption at the beginning of the section that indicates the nature of the subject matter included in or covered by the section. (3-20-20)T
- f.** An access card issued to a Claimant under this Subsection 305.08 shall: (3-20-20)T
  - i. Not bear any information that could reasonably identify the Claimant as a participant in the worker's compensation system; and (3-20-20)T

ii. Include on the front or back of the access card a toll-free customer service number and website address. Customer service personnel shall be available by phone Monday through Friday during normal business hours (9 a.m. to 6 p.m. Mountain Time). (3-20-20)T

g. The insurance carrier or self-insured employer shall provide a written notice to the Claimant at least twenty one (21) days before the effective date of any change in a term or condition of the mutual agreement or disclosure, including terminating the access card program, increased fees, or liability for unauthorized electronic fund transfers. Any terms or conditions that violate the requirements of this Subsection 305.08 are null and void and may result in administrative action against the carrier or employer. An insurance carrier or employer shall provide a written notice of term or condition changes that: (3-20-20)T

i. Provides a comparison of the current terms and the changes; and (3-20-20)T

ii. References the Claimant's ability to request a change in method of payment to electronic fund transfer to his or her personal bank account in accordance with Subsection 305.07 or to payment by check. (3-20-20)T

h. An insurance carrier or a self-insured employer may close the access card account by issuing a check to the Claimant with the remaining balance of the access card if the account has been inactive for twelve (12) months or longer. (3-20-20)T

i. The insurance carrier or self-insured employer shall not remove money from the Claimant's account or access card except to remove permitted fees under Subparagraph 305.08.c.iii. or to close the account for inactivity of a period of twelve (12) months or more. An insurance carrier or a self-insured employer seeking to recoup overpayments shall follow the requirements of section 72-316, Idaho Code. (3-20-20)T

j. An insurance carrier or a self-insured employer is considered to have made a compensation payment the date the payment is available on the Claimant's access card. (3-20-20)T

**09. Checks and Drafts.** Checks must be signed and issued within the state of Idaho; drafts are prohibited. (3-20-20)T

a. The Commission may, upon receipt of a written Application for Waiver, grant a waiver from the provisions of Subsections 305.06 and 305.09 of this rule to permit an insurance carrier or a self-insured employer to sign and issue checks outside the state of Idaho. (3-20-20)T

b. An Application for Waiver must be accompanied by an affidavit signed by an officer or principal of the insurance carrier or self-insured employer, attesting to the fact that the insurance carrier or self-insured employer is prepared to comply with all statutes and rules pertaining to prompt payments of compensation. (3-20-20)T

c. All waivers shall be effective from the date the Commission issues the order granting the waiver. A waiver shall remain in effect until revoked by the Industrial Commission. At least annually, staff of the Industrial Commission may review the performance of any insurance carrier or self-insured employer for which a waiver under this rule has been granted to assure that the insurance carrier or self-insured employer is complying with all statutes and rules pertaining to prompt payments of compensation. (3-20-20)T

d. If at any time after the Commission has granted a waiver, the Commission receives information permitting the inference that the insurance carrier or self-insured employer has failed to provide timely benefits to any Claimant, the Commission may issue an order to show cause why the Commission should not revoke the waiver; and, after affording the insurance carrier or self-insured employer an opportunity to be heard, may revoke the waiver and order the insurance carrier or self-insured employer to comply with the requirements of Subsections 305.06 and 305.09 of this rule. (3-20-20)T

**10. Copies of Checks.** Copies of checks and/or electronically reproducible copies of the information contained on the checks must be maintained in the in-state files for Industrial Commission audit purposes. A copy of the first income benefit check, showing signature and date, shall be sent to the Industrial Commission the same day of issuance. (3-20-20)T

**11. Prompt Claim Servicing.** Prompt claim servicing includes, but is not limited to: (3-20-20)T

**a.** Making an initial decision to accept or deny a Claim for an injury or occupational disease within thirty (30) days of the date the Claims Administrator receives knowledge of the same. The worker shall be given notice of that initial decision in accordance with Section 72-806, Idaho Code. Nothing in this rule shall be construed as amending the requirement to start payment of income benefits no later than four (4) weeks or twenty-eight (28) days from the date of disability under the provisions of Section 72-402, Idaho Code. (3-20-20)T

**b.** Payment of medical bills in accordance with the provisions of Section 803 of these rules. (3-20-20)T

**c.** Payment of income benefits on a weekly basis, unless otherwise approved by the Commission. (3-20-20)T

**i.** The first payment of income benefits under Section 72-408, Idaho Code, shall constitute application by the insurance carrier or self-insured employer for a waiver to pay Temporary Total Disability (TTD) benefits on a bi-weekly basis, Temporary Partial Disability (TPD) benefits on other than a weekly basis, Permanent Partial Disability (PPD) benefits based on permanent impairment and Permanent Total Disability (PTD) benefits every twenty-eight (28) days, rather than on a weekly basis. (3-20-20)T

**ii.** Such waiver application shall be granted upon receipt and remain in effect unless revoked by the Industrial Commission in accordance with Subparagraph 305.11.c.iii. (3-20-20)T

**iii.** If at any time after a waiver has been granted pursuant to this section the Commission receives information permitting the inference that the insurance carrier or self-insured employer has failed to service claims in accordance with Idaho law, or that such waiver has created an undue hardship on a Claimant, the Commission may issue an order to show cause why the Commission should not revoke that waiver, and after affording the insurance carrier or employer an opportunity to be heard, may revoke the waiver with respect to all or certain Claimants and order the insurance carrier or self-insured employer to comply with the requirements of Subsection 305.11.c. of this rule. (3-20-20)T

**d.** Payment of the first Permanent Partial Disability (PPD) benefit based on permanent impairment no later than fourteen (14) days after receipt of the Medical Report providing the impairment rating. The first payment shall include payment of benefits retroactive to the date of medical stability. (3-20-20)T

**e.** Temporary Partial Disability (TPD) payments shall be calculated using the employee's pay period, whether weekly, bi-weekly, or semi-monthly. For employees paid pursuant to any other schedule, TPD benefits shall be calculated semi-monthly. TPD payments owed for a particular pay period shall issue no later than seven (7) days following the date on which employee is ordinarily paid for that pay period. (3-20-20)T

**12. Audits.** The Industrial Commission will perform periodic audits to ensure compliance with the above requirements. (3-20-20)T

**13. Non-Compliance.** Non-compliance with the above requirements may result in the revocation of the authority of an insurance carrier to write worker's compensation insurance or self-insured employer to self-insure its worker's compensation insurance obligations in the state of Idaho, or such lesser sanctions as the Industrial Commission may impose. (3-20-20)T

**306. RULE PROHIBITING USE OF SICK LEAVE OR OTHER ALTERNATIVE COMPENSATION.**

**01. Employee Not Required to Take Sick Leave in Lieu of Compensation.** No employer obligated to pay worker's compensation benefits to an employee as provided by the Worker's Compensation Law may require an employee to accept “sick leave” or other comparable benefit in lieu of the worker's compensation benefits provided by law. Section 72-318(2), Idaho Code, specifically provides that no agreement by an employee to waive his rights to compensation under the Worker's Compensation Law shall be valid. (3-20-20)T

**02. Election of Sick Leave or Alternative Compensation Prohibited.** Further, an employee may not elect to accept "sick leave" or other comparable benefit from an employer in lieu of worker's compensation benefits to which the employee is entitled under the Worker's Compensation Law. (3-20-20)T

**307. RULE GOVERNING REPORTING INDEMNITY AND MEDICAL PAYMENTS AND MAKING PAYMENT OF INDUSTRIAL SPECIAL INDEMNITY FUND ASSESSMENT.**

Pursuant to Section 72-327, Idaho Code, the state insurance fund, every authorized insurance carrier, and self-insured employer in Idaho shall report annually to the Industrial Commission the total gross amount of medical only and Indemnity Benefits paid on Idaho worker's compensation claims during the applicable reporting period. This report is used to calculate the pro rata share of the annual assessment for the ISIF, under Section 72-327, Idaho Code. (3-20-20)T

**01. Filing.** The report of indemnity and medical payments shall be filed with the Industrial Commission simultaneously with the first Semi-Annual Premium Tax Report; which, pursuant to Section 72-523, Idaho Code, is due each year on March 3rd. (3-20-20)T

**02. Form.** The report of indemnity and medical payments shall be submitted in writing on, or in a format substantially the same as the current Form IC2-327, available on the Commission's website. (3-20-20)T

**03. Report Required When No Indemnity Paid.** If an entity required to report under this rule has no claims against which indemnity or medical payments have been made during the reporting period, a report shall be filed so indicating. (3-20-20)T

**04. Penalty for Late Filing.** A penalty shall be assessed by the Commission for filing the report of indemnity and medical payments later than March 3rd each year. (3-20-20)T

**a.** A penalty of two hundred dollars (\$200) for late filing of seven (7) days or less. (3-20-20)T

**b.** A penalty of one hundred dollars (\$100) per day for late filing of more than seven (7) days. (3-20-20)T

**c.** A penalty assessed by the Commission shall be payable to the Industrial Commission and be submitted with the April 1 payment of the ISIF assessment, following notice by the Commission of the penalty assessment. (3-20-20)T

**05. Estimating Indemnity Payments for Entities That Fail to Report Timely.** If an entity required to report indemnity payments under these rules fails to report within the time allowed in these rules, the Commission will estimate the indemnity payments for that entity by using the indemnity amount reported for the preceding reporting period and adding twenty percent (20%). (3-20-20)T

**06. Adjustment for Overpayments or Underpayments.** Overpayments or underpayments, including those resulting from estimating the indemnity payments of entities that fail to report timely, will be adjusted on the billing for the subsequent period. (3-20-20)T

**308. – 400. (RESERVED)**

**401. RULE GOVERNING COMPUTATION OF AVERAGE WEEKLY WAGE.**

**01. Amounts Paid over Base Rate.** Sums paid by an employer to an employee, over and above the base rate of compensation agreed upon by the employer and the employee in a contract of hire, which are contingent and dependent upon the employee's increased physical exertion and/or efficiency shall be included in computing the employee's average weekly wage pursuant to Section 72-419(4)(a), Idaho Code. Said sums shall not be considered premium pay. (3-20-20)T

**02. Fringe Benefits.** Also, in computing the average weekly wage, it shall be presumed that wages include, but are not limited to, cost of living increases, vacation pay, holiday pay, and sick leave. (3-20-20)T

**03. Premium Pay.** Further, in computing the average weekly wage, it shall be presumed that premium pay includes, but is not limited to, shift differential pay and overtime pay. (3-20-20)T

**04. Examples Not Exclusive.** The above-listed examples shall not be taken as exclusive in computing the average weekly wage. (3-20-20)T

**402. RULE GOVERNING CONVERSION OF IMPAIRMENT RATINGS TO “WHOLE MAN” STANDARD.**

**01. Converting Single Rating of Body Part to Whole Person Rating.** Impairment ratings shall be converted in accordance with the Industrial Commission Schedule, Section 72-428, Idaho Code, with the base of five hundred (500) weeks for the whole man. (3-20-20)T

**02. Averaging Multiple Ratings.** Where more than one (1) evaluating physician has given ratings, these shall be converted to the statutory percentage of the whole man, and averaged for the applicable rating. (3-20-20)T

**03. Correcting Manifest Injustice.** In the event that the Commission deems a manifest injustice would result from the above ruling, it may at its discretion take steps necessary to correct such injustice. (3-20-20)T

**403. RULE GOVERNING COMPENSATION FOR DISABILITY DUE TO LOSS OF TEETH.**

**01. Compensation for Disability.** A Claimant under the Worker's Compensation Law shall be entitled to compensation for permanent disability for the loss of each tooth other than wisdom teeth at the rate of one tenth of one percent (.1%) of the whole man. The loss of wisdom teeth shall not constitute any permanent disability. Compensation hereunder shall be in addition to payments for medical services including dental appliances and bridgework necessitated by the injury and any income benefits during the period of Claimant's recovery to which the Claimant be entitled. (3-20-20)T

**02. Prima Facie Evidence.** This rule and schedule shall be prima facie evidence of the percentage of permanent disability to be attributed to the loss of teeth. (3-20-20)T

**404. SUBMISSION OF MEDICAL REPORTS FROM PROVIDERS**

This procedure applies to all open worker's compensation claims where medical services are provided and which have not been denied by the Payor. (3-20-20)T

**01. Procedure.** In all cases in which a particular injury or occupational disease results in a worker's compensation Claim, the Provider shall submit written Medical Reports for each medical visit to the Payor. Payers and Providers may contract with one another to identify specific records that will be provided in support of billings. The Provider shall also submit the same written Medical Reports to the Claimant upon request. These reports shall be submitted within fourteen (14) days following each evaluation, examination, and/or treatment. The first copy of any such reports shall be provided to the Payor and the Claimant at no charge. If duplicate copies of reports already provided are requested by either the Payor or the Claimant, the Provider may charge the requesting party a reasonable charge to provide the additional reports. Whenever possible, billing information shall be coded using CPT. In the case of Hospitals, reports shall include a Uniform Billing Form 04. In the case of physicians and other Providers supplying outpatient services, this reporting requirement shall include a CMS 1500 form. (3-20-20)T

**a.** If an injury or occupational disease results in a Claim, the Employer/Surety or Provider shall submit written reports to the Commission upon request. Such request may either be in writing or telephonic. If a Claim is referred to the Rehabilitation Division, Medical Reports shall be furnished by the Payor or Provider directly to the office that requests such reports. The Payor or Provider shall consider this an on-going request until notice is received that the reports are no longer required. (3-20-20)T

**b.** If the injury or occupational disease results in a time-loss Claim, the Payor shall submit copies of medical records containing information regarding the beginning and ending of disability, releases to work whether light duty or regular duty, impairment ratings, physical restrictions to the Commission. Other Medical Reports shall be submitted to the Commission only upon request. (3-20-20)T

c. ISIF shall receive all copies of Medical Reports, without charge, from either the Claimant or the Payor, depending upon who seeks to join it as a party to a worker's compensation Claim. (3-20-20)T

d. If the Commission requests Medical Reports from the Payor or Provider, the information shall be provided within a reasonable time period without charge. If information is received for which the Commission has no need, the information may be discarded or destroyed. (3-20-20)T

**02. Report Form and Content.** Upon approval of the Commission, Medical Reports may be submitted in electronic or other machine-readable form usable to all parties. (3-20-20)T

**03. Timely Response Requirement.** When the Commission requests a Medical Report from a Payor or Provider for use in monitoring a worker's compensation Claim, the Payor or Provider shall provide the requested information promptly. (3-20-20)T

**04. Forfeiture of Payment.** If a Provider fails to give records to the Payor or Claimant, the Payor or Claimant may petition the Commission for an order requiring the Provider to provide the requested information. The petition shall set forth the Petitioner's efforts to obtain the information, the responses to those efforts, and why the Petitioner believes that the Provider has the information. In response to the petition, the Commission may enter an order requiring the Provider to furnish the requested records or demonstrate that the records are not available. If a Provider fails to provide records when ordered by the Commission, the Commission may enter an Order of Forfeiture. In the event such an order is entered, the Provider will forfeit its right to payment from both the Payor and Claimant, until such time as the records are provided. (3-20-20)T

**405. RULE GOVERNING REIMBURSEMENT FOR TRAVEL EXPENSES.**

**01. Mileage Rate.** If Claimant has access to, and is able to operate, a vehicle for transportation covered by Sections 72-432(13) or 72-433(3), Idaho Code, employer shall reimburse Claimant at the mileage rate then allowed by the State Board of Examiners for State employees. Such rate shall be published annually by the Industrial Commission, together with the average state wage for the upcoming period. All such miles shall be reimbursed, with fractions of a mile greater than one-half (1/2) mile rounded to the next higher mile and fractions of a mile below one-half (1/2) mile disregarded. (3-20-20)T

**02. Commercial Transportation.** If Claimant has no vehicle, or has access to a vehicle and is reasonably unable to utilize the vehicle for transportation covered by Sections 72-432(13) or 72-433(3), Idaho Code, Claimant's employer shall reimburse Claimant the actual cost of commercial transportation as evidenced by actual receipts. Notwithstanding the above provision, no Claimant shall be eligible for reimbursement of the actual cost of commercial transportation where such Claimant is unable to operate a motor vehicle due to the revocation or suspension of driving privileges because Claimant was under the influence of alcohol and/or drugs. (3-20-20)T

**03. Request for Reimbursement.** It shall be Claimant's responsibility to submit a travel reimbursement request to the employer. Such request shall be made on a form substantially the same as Industrial Commission Form IC 432(1), posted on the Commission's website. The Claimant must attach to the form a copy of a bill or receipt showing that the visit occurred. The employer shall furnish the Claimant with copies of this form. (3-20-20)T

**04. Frequency of Requests.** Claimant shall not request transportation reimbursement more frequently than once every thirty (30) days. However, notwithstanding this provision, should a Claimant request transportation reimbursement more frequently than every thirty (30) days, employer need not issue more than one reimbursement check in any thirty-day (30) period. (3-20-20)T

**406. -- 500. (RESERVED)**

**501. RULE GOVERNING PROTECTION AND DISCLOSURE OF REHABILITATION DIVISION RECORDS.**

**01. Request for Disclosure.** Pursuant to Section 74-105(10), Idaho Code, a party requesting

rehabilitation records shall do so in writing and identify which provision of 74-105(10), Idaho Code, authorizes their request. (3-20-20)T

**02. Requests from Other Agencies.** If records are in the possession of the Rehabilitation Division by reason of an agreement to comply with valid confidentiality regulations of any agency of the state of Idaho, or agency of the United States, then disclosure shall be requested from the source agency, and not from the Rehabilitation Division. (3-20-20)T

**502. RULE GOVERNING REPORTS OF ATTORNEY COSTS AND FEES IN LITIGATED CASES.**  
When requested by the Commission, parties to a Litigated Case shall provide the Commission the information required by Section 72-528, Idaho Code. The form for Sureties is Form 1022 and the form for Claimant's attorneys is Form 1023; both are available on the Commission's website. (3-20-20)T

**503. -- 600. (RESERVED)**

**601. SUBMISSION OF FROI AND SROI.**

**01. Purpose.** Pursuant to Sections 72-602(1)-(2), Idaho Code, employers must submit a FROI and/or SROI in accordance with these rules. (3-20-20)T

**02. EDI Reporting.** The Commission requires electronic submission of FROIs and SROIs in accordance with the most current versions of the IAIABC EDI Release 3.0 and the Commission's EDI Guides and Tables from any employer not otherwise exempt by these rules. Each FROI and SROI must comply with formatting requirements and must contain the information identified as mandatory or mandatory conditional, as applicable. (3-20-20)T

**03. Trading Partner Agreements.** Before commencing with electronic reporting, Trading Partners shall sign a Trading Partner Agreement with the Commission, which the Commission must approve prior to submitting reports. This agreement must provide the effective date to send and receive electronic reports, the acceptable data to be sent and received, the method of transmission to be used, and other pertinent elements. This agreement will identify the insurance carrier, the Claims Administrator, the sender of the electronic files, and the electronic filing method. To ensure the accuracy of reported data, the Trading Partner must maintain their profile to reflect changes as they occur and the Commission may make periodic audits of Trading Partner files. In the event that a Trading Partner Agreement is entered into by a Claims Administrator, notice to the Trading Partner of a FROI shall be deemed to be notice to the underlying insurance carrier or self-insured employer. (3-20-20)T

**04. Report Form and Content for Parties Exempt from EDI Requirements.** (3-20-20)T

**a.** Individual injured workers, injured worker's legal counsel, and employers that are not insured are not required to comply with EDI requirements for FROIs and SROIs. SROIs filed on Legacy Claims will not be accepted via EDI. (3-20-20)T

**b.** Parties exempt from EDI requirements must submit FROIs on a form 1A-1 and SROIs on a form SROI-1, or in a format substantially similar. Both forms are available on the Commission's website. (3-20-20)T

**05. Retaining Claims Files.** Upon request of the Commission, insurance carriers, Claims Administrators, or employers shall provide to the Commission, in whole or in part according to the request, a copy of the claim file at no cost to the Commission. All insurance carriers, Claims Administrators, or employers shall retain complete copies of claims files for the life of the Claim and a minimum of five (5) years from the date of closure. (3-20-20)T

**06. Filing Not an Admission.** Filing a FROI is not an admission of liability and is not conclusive evidence of any fact stated therein. If a Claim is submitted electronically, no signatures are required. (3-20-20)T

**07. Filing Considered Authorization.** Filing of a Claim shall be considered an authorization for the release of medical records that are relevant to or bearing upon the particular injury or occupational disease for which the Claimant is seeking compensation. (3-20-20)T



**08. Timely Response Requirement.** When the Commission requests additional information in order to process the Claim, the Claimant or employer shall provide the requested information promptly. The Commission request may be either in writing or telephonic. (3-20-20)T

**602. SUMMARIES OF PAYMENTS.**

**01. Summaries Requirement.** A summary of payment shall be filed, in duplicate, by the surety or self-insured employer within one hundred twenty (120) days of Termination of Disability for all legacy indemnity claims upon which a surety or self-insured employer has made payments, except for those claims which are resolved by LSS. If all claim information has been provided via EDI as prescribed by Commission rules, an electronic summary of payment transaction must be filed within one hundred twenty (120) days of Termination of Disability for all Indemnity Claims. In the case of medical-only claims, no summaries of payment need to be filed. In the context of Death Claims and permanent total disability claims, interim summaries of payments shall be filed annually within the first quarter of each calendar year. Interim summaries shall be submitted setting forth substantially the same information required by Final Summaries of Payment, including the balance of payments made to the beginning of the current calendar year, payments during the calendar year, and a total of payments made. This total balance shall be carried forward as the amount of payments made to the beginning of the current year. The Final Summary shall be so designated. Supporting documentation shall be attached to any Legacy Claim summary of payment filed with the Commission. If all claim information has been filed electronically, supporting documentation must be provided upon Commission request. (3-20-20)T

**02. Form.** The summary of payment for Legacy Claims shall be submitted in a format substantially similar to IC Form 6, available on the Commission's website. The final SROI transaction shall be reported electronically for non-Legacy Claims. (3-20-20)T

**03. Approval.** Within ninety (90) days of receipt of the Legacy Claim Summary of Payment or SROI electronic transaction as set forth above, the Industrial Commission shall notify the surety or self-insured employer of any inability to reconcile the summary to its records and request additional information. If the surety or self-insured employer does not receive a request for additional information within the ninety (90) day period, the surety or self-insured employer may proceed with closure. In the event the Commission requests additional information, whether in writing or telephonic, the surety or self-insured employer shall submit the requested information within fifteen (15) working days. If the surety or self-insured employer is unable to furnish the requested information, the surety or self-insured employer shall notify the Commission, in writing, of its inability to respond and the reasons therefor within the fifteen (15) working days. The Commission may schedule a show cause hearing to determine whether or not the surety or self-insured employer should be allowed to continue its status under the worker's compensation laws, including whether the employer should be allowed to continue self-insured status. (3-20-20)T

**04. Change in Status of Employer.** In case of any default by the Employer or in the event the Employer shall fail to pay any final award or awards, by reason of insolvency or because a receiver has been appointed, the Employer shall submit a summary of payments for every time-loss and Death Claim within one hundred twenty (120) days of the default, insolvency, or appointment of a receiver. This summary will be designated as an interim summary and does not relieve the Employer, successor or receiver from continued reporting requirements. The receiver or successor shall continue to report to the Commission, including the submission of summaries of payments and schedules of outstanding awards. (3-20-20)T

**603. -- 800. (RESERVED)**

**801. RULE GOVERNING CHANGE OF STATUS NOTICE TO CLAIMANTS.**

**01. Notice of Change of Status.** As required and defined by Section 72-806, Idaho Code, a worker shall receive written notice within fifteen (15) days of any change of status or condition, including, but not limited to, whenever there is an acceptance, commencement, denial, reduction, or cessation of medical or monetary compensation benefits to which the worker might presently or ultimately be entitled. Such notice is required when benefits are curtailed to recoup any overpayment of benefits in accordance with the provisions of Section 72-316, Idaho Code. (3-20-20)T

**02. By Whom Given.** Any notice to a worker required by Section 72-806, Idaho Code, shall be given by: the surety if the employer has secured Worker's Compensation Insurance; or the employer if the employer is self-insured; or the employer if the employer carries no Worker's Compensation Insurance. (3-20-20)T

**03. Form of Notice.** Any notice to a worker required by Section 72-806, Idaho Code, shall be mailed within ten (10) days by regular United States Mail to the last known address of the worker, as shown in the records of the party required to give notice as set forth above. The Notice shall be given in a format substantially similar to IC Form 8, available on the Commission's website. (3-20-20)T

**04. Medical Reports.** As required by Section 72-806, Idaho Code, if the change is based on a Medical Report, the party giving notice shall attach a copy of the report to the notice. (3-20-20)T

**05. Copies of Notice.** The party giving notice pursuant to Section 72-806, Idaho Code, shall send a copy of any such notice to the Industrial Commission, the employer, and the worker's attorney, if the worker is represented, at the same time notice is sent to the worker. The party giving notice may supply the copy to the Industrial Commission in accordance with the Commission's rule on electronic submission of documents. (3-20-20)T

**802. RULE GOVERNING APPROVAL OF ATTORNEYS FEES**

**01. Purpose.** The Industrial Commission promulgates this rule to govern the approval of attorney fees. (3-20-20)T

**02. Charges Presumed Reasonable:** (3-20-20)T

**a.** In a case in which no hearing on the merits has been held, twenty-five percent (25%) of Available Funds shall be presumed reasonable; or (3-20-20)T

**b.** In a case in which a hearing has been held and briefs submitted (or waived) under Judicial Rules of Practice and Procedure (JRP), Rules X and XI, thirty percent (30%) of Available Funds shall be presumed reasonable; or (3-20-20)T

**c.** In any case in which compensation is paid for total permanent disability, fifteen percent (15%) of such disability compensation after ten (10) years from date such total permanent disability payments commenced. (3-20-20)T

**03. Statement of Charging Lien.** (3-20-20)T

**a.** All requests for approval of fees shall be deemed requests for approval of a Charging Lien. (3-20-20)T

**b.** An attorney representing a Claimant in a Worker's Compensation matter shall in any proposed LSS, or upon request of the Commission, file with the Commission, and serve the Claimant with a copy of the Fee Agreement, and an affidavit or memorandum containing: (3-20-20)T

**i.** The date upon which the attorney became involved in the matter; (3-20-20)T

**ii.** Any issues which were undisputed at the time the attorney became involved; (3-20-20)T

**iii.** The total dollar value of all compensation paid or admitted as owed by employer immediately prior to the attorney's involvement; (3-20-20)T

**iv.** Disputed issues that arose subsequent to the date the attorney was hired; (3-20-20)T

**v.** Counsel's itemization of compensation that constitutes Available Funds; (3-20-20)T

**vi.** Counsel's itemization of costs and calculation of fees; and (3-20-20)T

vii. Counsel's itemization of medical bills for which Claim was made in the underlying action, but which remain unpaid by employer/surety at the time of LSS, along with counsel's explanation of the treatment to be given such bills/claims following approval of the LSS. (3-20-20)T

viii. The statement of the attorney identifying with reasonable detail his or her fulfillment of each element of the Charging Lien. (3-20-20)T

c. Upon receipt and a determination of compliance with this Rule by the Commission by reference to its staff, the Commission may issue an Order Approving Fees without a hearing. (3-20-20)T

**04. Procedure if Fees Are Determined Not to Be Reasonable. (3-20-20)T**

a. Upon receipt of the affidavit or memorandum, the Commission will designate staff members to determine reasonableness of the fee. The Commission staff will notify counsel in writing of the staff's informal determination, which shall state the reasons for the determination that the requested fee is not reasonable. Omission of any information required by Paragraph 802.02.b may constitute grounds for an informal determination that the fee requested is not reasonable. (3-20-20)T

b. If counsel disagrees with the Commission staff's informal determination, counsel may file, within fourteen (14) days of the date of the determination, a Request for Hearing for the purpose of presenting evidence and argument on the matter. Upon receipt of the Request for Hearing, the Commission shall schedule a hearing on the matter. A Request for Hearing shall be treated as a motion under Rule III(e), JRP. (3-20-20)T

c. The Commission shall order an employer to release any Available Funds in excess of those subject to the requested Charging Lien and may order payment of fees subject to the Charging Lien which have been determined to be reasonable. (3-20-20)T

d. The proponent of a fee which is greater than the percentage of recovery stated in Subsection 802.02 shall have the burden of establishing by clear and convincing evidence entitlement to the greater fee. The attorney shall always bear the burden of proving by a preponderance of the evidence his or her assertion of a Charging Lien and reasonableness of his or her fee. (3-20-20)T

**05. Disclosure Statement.** Upon retention, the attorney shall provide to Claimant a copy of a disclosure statement. No fee may be taken from a Claimant by an attorney on a contingency fee basis unless the Claimant acknowledges receipt of the disclosure by signing it. Upon request by the Commission, an attorney shall provide a copy of the signed disclosure statement to the Commission. The terms of the disclosure may be contained in the Fee Agreement, so long as it contains the following text: (3-20-20)T

a. In worker's compensation matters, attorney's fees normally do not exceed twenty-five percent (25%) of the benefits your attorney obtains for you in a case in which no hearing on the merits has been completed. In a case in which a hearing on the merits has been completed, attorney's fees normally do not exceed thirty percent (30%) of the benefits your attorney obtains for you. (3-20-20)T

b. Depending upon the circumstances of your case, you and your attorney may agree to a higher or lower percentage which would be subject to Commission approval. Further, if you and your attorney have a dispute regarding attorney fees, either of you may petition the Industrial Commission, PO Box 83720, Boise, ID 83720-0041, to resolve the dispute. (3-20-20)T

**803. MEDICAL FEES.**

**01. General Provisions for Medical Fees.** The following provisions shall apply to Commission approval of claims for medical benefits. (3-20-20)T

a. Acceptable Charge. Payors shall pay Providers the acceptable charge for medical services. (3-20-20)T

b. Coding. The Commission will generally follow the coding guidelines published by CMS and by the

American Medical Association, including the use of modifiers. (3-20-20)T

**c.** Disputes. Disputes between Providers and Payors are governed by Subsection 803.06 of this rule and JRP 19. (3-20-20)T

**d.** Outside of Idaho. Reimbursement for medical services provided outside the state of Idaho may be based upon the agreement of the parties. If there is no agreement, services shall be paid in accordance with the worker's compensation fee schedule in effect in the state in which services are rendered. If there is no fee schedule in effect in such state, or if the fee schedule in that state does not allow reimbursement for the services rendered, reimbursement shall be paid in accordance with these rules. (3-20-20)T

**02. Acceptable Charges For Medical Services Provided By Physicians Under The Idaho Worker's Compensation Law.** (3-20-20)T

**a.** The Commission adopts the RBRVS, published by CMS, as amended, as the standard to be used to determine acceptable charges by physicians. (3-20-20)T

**b.** Modifiers. Modifiers for physicians will be reimbursed as follows: (3-20-20)T

**i.** Modifier 50: Additional fifty percent (50%) for bilateral procedure. (3-20-20)T

**ii.** Modifier 51: Fifty percent (50%) of secondary procedure. This modifier will be applied to each medical or surgical procedure rendered during the same session as the primary procedure. (3-20-20)T

**iii.** Modifier 80: Twenty-five percent (25%) of coded procedure. (3-20-20)T

**iv.** Modifier 81: Fifteen percent (15%) of coded procedure. This modifier applies to MD and non-MD assistants. (3-20-20)T

**c.** Conversion Factors. The standard for determining the acceptable charge for a medical service, identified by a code assigned to that service in the latest edition of the Physician's CPT, published by the American Medical Association, as amended, is calculated by the application of the total facility or non-facility RVU for services as determined by place of service in the latest RBRVS in effect on the first day of January of the current calendar year, to the following corresponding conversion factors. The procedure with the largest RVU will be the primary procedure and will be listed first on the claim form. (3-20-20)T

<b>MEDICAL FEE SCHEDULE</b>			
<b>SERVICE CATEGORY</b>	<b>CODE RANGE(S)</b>	<b>DESCRIPTION</b>	<b>CONVERSION FACTOR</b>
Anesthesia	00000 - 09999	Anesthesia	\$60.33
Surgery - Group One	22000 - 22999	Spine	\$135.00
	23000 - 24999	Shoulder, Upper Arm, & Elbow	
	25000 - 27299	Forearm, Wrist, Hand, Pelvis & Hip	
	27300 - 27999	Leg, Knee, & Ankle	
	29800 - 29999	Endoscopy & Arthroscopy	
	61000 - 61999	Skull, Meninges & Brain	
	62000 - 62259	Repair, Neuroendoscopy & Shunts	
Surgery - Group Two	63000 - 63999	Spine & Spinal Cord	\$124.00
	28000 - 28999	Foot & Toes	
	64550 - 64999	Nerves & Nervous System	

<b>MEDICAL FEE SCHEDULE</b>			
<b>SERVICE CATEGORY</b>	<b>CODE RANGE(S)</b>	<b>DESCRIPTION</b>	<b>CONVERSION FACTOR</b>
Surgery - Group Three	10000 - 19999	Integumentary System	\$88.54
	20000 - 21999	Musculoskeletal System	
	29000 - 29799	Casts & Strapping	
	30000 - 39999	Respiratory & Cardiovascular	
	40000 - 49999	Digestive System	
	50000 - 59999	Urinary System	
	60000 - 60999	Endocrine System	
	62260 - 62999	Spine & Spinal Cord	
	64000 - 64549	Nerves & Nervous System	
	65000 - 69999	Eye & Ear	
Radiology	70000 - 79999	Radiology	\$88.54
Pathology & Laboratory	80000 - 89999	Pathology & Laboratory	To Be Determined
Medicine - Group One	90000 - 90749	Immunization, Injections, & Infusions	\$49.00
	94000 - 94999	Pulmonary / Pulse Oximetry	
	97000 - 97799	Physical Medicine & Rehabilitation	
	97800 - 98999	Acupuncture, Osteopathy, & Chiropractic	
Medicine - Group Two	90750 - 92999	Psychiatry & Medicine	\$70.00
	93000 - 93999	Cardiography, Catheterization, Vascular Studies	
	95000 - 96020	Allergy / Neuromuscular Procedures	
	96040 - 96999	Assessments & Special Procedures	
	99000 - 99607	E / M & Miscellaneous Services	

(3-20-20)T

**d.** Anesthesiology. The Conversion Factor for the Anesthesiology CPT Codes shall be multiplied by the current Anesthesia Base Units assigned to that CPT Code by CMS, plus the allowable time units reported for the procedure. Time units are computed by dividing reported time by fifteen (15) minutes. Time units will not be used for CPT Code 01996. (3-20-20)T

**e.** Services Without CPT Code, RVU or Conversion Factor. The acceptable charge for medical services that do not have a current CPT code, a currently assigned RVU, or a conversion factor will be the reasonable charge for that service, based upon the usual and customary charge and other relevant evidence, as determined by the Commission. Where a service with a CPT Code, RVU, and conversion factor is, nonetheless, claimed to be exceptional or unusual, the Commission may, notwithstanding the conversion factor for that service set out in Paragraph 02.c, above, determine the acceptable charge for that service, based on all relevant evidence in accordance with the procedures set out in Subsection 06, below. (3-20-20)T

**f.** Medicine Dispensed by Physicians. Reimbursement to physicians for any medicine shall not exceed the acceptable charge calculated for that medicine as if provided by a Pharmacy under Subsection 04 of this rule without a dispensing or compounding fee. Reimbursement to physicians for repackaged medicine shall be the AWP for the medicine prior to repackaging, identified by the NDC reported by the original manufacturer. Reimbursement may be withheld until the original manufacturer's NDC is provided by the physician. (3-20-20)T

**g.** Adjustment of Conversion Factors. The conversion factors set out in this rule may be adjusted each fiscal year (FY) by the Commission to reflect changes in inflation or market conditions in accordance with Section 72-803, Idaho Code. (3-20-20)T

**03. Acceptable Charges For Medical Services Provided By Hospitals And Ambulatory Surgery Centers Under The Idaho Worker's Compensation Law.** The following standards shall be used to determine the acceptable charge for Hospitals and ASCs. (3-20-20)T

**a. Critical Access Hospitals.** The standard for determining the acceptable charge for inpatient and outpatient services provided by a Critical Access Hospital is ninety percent (90%) of the reasonable charge. Implantable hardware charges shall be reimbursed at the rate of the actual cost plus fifty percent (50%). (3-20-20)T

**b. Hospital Inpatient Services.** The standard for determining the acceptable charge for inpatient services provided by Hospitals, other than Critical Access Hospitals, is calculated by multiplying the base rate by the current MS-DRG weight for that service. The base rate for inpatient services is ten thousand two hundred dollars (\$10,200). Inpatient services that do not have a relative weight shall be paid at eighty-five percent (85%) of the reasonable charge; however, Implantable Hardware charges billed for services without an MS-DRG weight shall be reimbursed at the rate of actual cost plus fifty percent (50%). (3-20-20)T

**c. Hospital Outpatient and ASC Services.** The standard for determining the acceptable charge for outpatient services provided by Hospitals (other than Critical Access Hospitals) and for services provided by ASCs is calculated by multiplying the base rate by the Medicare Hospital Outpatient Prospective Payment System APC weight in effect on the first day of January of the current calendar year. The base rate for Hospital outpatient services is one hundred forty dollars and seventy-five cents (\$140.75). The base rate for ASC services is ninety-one dollars fifty cents (\$91.50). (3-20-20)T

**i. Medical services for which there is no APC weight listed shall be reimbursed at seventy-five percent (75%) of the reasonable charge.** (3-20-20)T

**ii. Status code N items or items with no CPT or HCPCS code shall receive no payment except as provided in Subparagraph 803.03.c.ii.(1) or 803.03.c.ii.(2) of this rule.** (3-20-20)T

**(1) Implantable Hardware may be eligible for separate payment under Subparagraph 03.d.iii. of this rule.** (3-20-20)T

**(2) Outpatient laboratory tests provided with no other Hospital outpatient service on the same date, or outpatient laboratory tests provided on the same date of service as other Hospital outpatient services that are clinically unrelated may be paid separately if billed with modifier L1. Payment shall be made in the same manner that services with no APC weight are paid under Subparagraph 803.03.c.i. of this rule.** (3-20-20)T

**iii. When no medical services with a status code J1 appears on the same Claim, two (2) or more medical procedures with a status code T on the same Claim shall be reimbursed with the highest weighted code paid at one hundred percent (100%) of the APC calculated amount and all other status code T items paid at fifty percent (50%). When a medical service with a status code J1 appears on the same Claim, all medical services with a status code T shall be paid at fifty percent (50%).** (3-20-20)T

**iv. When no medical services with a status code J1 appears on the same Claim, status code Q items with an assigned APC weight will not be discounted. When a medical service with a status code J1 appears on the same Claim, status code Q items shall be paid at fifty percent (50%).** (3-20-20)T

**d. Additional Hospital Payments.** When the charge for a medical service provided by a Hospital (other than a Critical Access Hospital) meets the following standards, additional payment shall be made for that service, as indicated. (3-20-20)T

**i. Inpatient Threshold Exceeded.** When the charge for a Hospital inpatient MS-DRG coded service exceeds the sum of thirty thousand dollars (\$30,000) plus the payment calculated under the provisions of Paragraph 03.b. of this rule, then the total payment for that service shall be the sum of the MS-DRG payment and the amount charged above that threshold multiplied by seventy-five percent (75%). Implantable charges shall be excluded from the calculation for an additional inpatient payment under this Subparagraph. (3-20-20)T

**ii. Inpatient Implantable Hardware.** Hospitals may seek additional reimbursement beyond the

MSDRG payment for invoiced Implantable Hardware where the aggregate invoice cost is greater than ten thousand dollars (\$10,000). Additional reimbursement shall be the invoice cost plus an amount which is equal to ten percent (10%) of the invoice cost, but which does not exceed three thousand dollars (\$3,000). Handling and freight charges shall be included in invoice cost. (3-20-20)T

iii. Outpatient Implantable Hardware. Hospitals and ASCs may seek additional reimbursement beyond the APC payment for invoiced Implantable Hardware where the aggregate invoice cost is greater than five hundred dollars (\$500). Additional reimbursement shall be the invoice cost plus an amount which is equal to ten percent (10%) of the invoice cost, but which does not exceed one thousand dollars (\$1,000). Handling and freight charges shall be included in invoice cost. (3-20-20)T

e. Adjustment of Hospital and ASC Base Rates. The Commission may periodically adjust the base rates set out in Paragraphs 803.03.b. and 803.03.c. of this rule to reflect changes in inflation or market conditions. (3-20-20)T

**04. Acceptable Charges For Medicine Provided By Pharmacies.** The following standards shall be used to determine the acceptable charge for medicine provided by pharmacies. (3-20-20)T

a. Brand/Trade Name Medicine. The standard for determining the acceptable charge for brand/trade name medicine shall be the AWP, plus a five dollar (\$5) dispensing fee. (3-20-20)T

b. Generic Medicine. The standard for determining the acceptable charge for generic medicine shall be the AWP, plus an eight dollar (\$8) dispensing fee. (3-20-20)T

c. Compound Medicine. The standard for determining the acceptable charge for compound medicine shall be the sum of the AWP for each drug included in the compound medicine, plus a five dollar (\$5) dispensing fee and a two dollar (\$2) compounding fee. All components of the compound medicine shall be identified by their original manufacturer's NDC when submitted for reimbursement. Payors may withhold reimbursement until the original manufacturer's NDC assigned to each component of the compound medicine is provided by the Pharmacy. Components of a compound medicine without an NDC may require medical necessity confirmation by the treating physician prior to reimbursement. (3-20-20)T

d. Prescribed Over-the Counter Medicine. The standard for determining the acceptable charge for prescribed over-the-counter medicine filled by a Pharmacy shall be the reasonable charge plus a two dollar (\$2) dispensing fee. (3-20-20)T

**05. Acceptable Charges For Medical Services Provided By Other Providers Under The Idaho Worker's Compensation Law.** The standard for determining the acceptable charge for Providers other than physicians, Hospitals or ASCs shall be the reasonable charge. (3-20-20)T

**06. Billing And Payment Requirements For Medical Services And Procedures Preliminary To Dispute Resolution.** This rule governs billing and payment requirements for medical services provided under the Worker's Compensation Law and the procedures for resolving disputes between Payors and Providers over those bills or payments. (3-20-20)T

a. Time Periods. None of the periods herein shall begin to run before the Notice of Injury/Claim for Benefits has been filed with the Employer as required by law. (3-20-20)T

b. Provider to Furnish Information. A Provider, when submitting a bill to a Payor, shall inform the Payor of the nature and extent of medical services furnished and for which the bill is submitted. This information shall include, but is not limited to, the patient's name, the employer's name, the date the medical service was provided, the diagnosis, if any, and the amount of the charge or charges. Failure to submit a bill complying with this Paragraph 06.b to the Payor within one hundred twenty (120) days of the date of service will result in the ineligibility of the Provider to utilize the dispute resolution procedures of the Commission set out in Paragraph 803.06.i. of this rule for that service. (3-20-20)T

i. A Provider's bill shall, whenever possible, describe the Medical Service provided, using the

American Medical Association's appropriate CPT coding, including modifiers, the appropriate HCPCS code, the diagnostic and procedure code set version required by CMS and the original NDC for the year in which the service was performed. (3-20-20)T

ii. The bill shall also contain the name, address and telephone number of the individual the Payor may contact in the event the Payor seeks additional information regarding the Provider's bill. (3-20-20)T

iii. If requested by the Payor, the bill shall be accompanied by a written report as defined by Subsection 010.31 and required by Section 404 of these rules. Where a bill is not accompanied by such Report, the periods expressed in Paragraphs 803.06.c and 803.06.e. of this rule, shall not begin to run until the Payor receives the Report. (3-20-20)T

**c. Prompt Payment.** Unless the Payor denies liability for the Claim or, pursuant to Paragraph 803.06.e. of this rule, sends a Preliminary Objection, a Request for Clarification, or both, as to any charge, the Payor shall pay the charge within thirty (30) calendar days of receipt of the bill or upon acceptance of liability, if made after bill is received from Provider. (3-20-20)T

**d. Partial Payment.** If the Payor acknowledges liability for the Claim and, pursuant to Paragraph 803.06.e. of this rule, sends a Preliminary Objection, a Request for Clarification, or both, as to only part of a Provider's bill, the Payor must pay the charge or charges, or portion thereof, as to which no Preliminary Objection or Request for Clarification has been made, within thirty (30) calendar days of receipt of the bill. (3-20-20)T

**e. Preliminary Objections and Requests for Clarification.** (3-20-20)T

i. Whenever a Payor objects to all or any part of a Provider's bill on the ground that such bill contains a charge or charges that do not comport with the applicable administrative rule, the Payor shall send a written Preliminary Objection to the Provider within thirty (30) calendar days of the Payor's receipt of the bill explaining the basis for each of the Payor's objections. (3-20-20)T

ii. Where the Payor requires additional information, the Payor shall send a written Request for Clarification to the Provider within thirty (30) calendar days of the Payor's receipt of the bill, and shall specifically describe the information sought. (3-20-20)T

iii. Each Preliminary Objection and Request for Clarification shall contain the name, address, and phone number of the individual located within the state of Idaho that the Provider may contact regarding the Preliminary Objection or Request for Clarification. (3-20-20)T

iv. Where a Payor does not send a Preliminary Objection to a charge set forth in a bill or a Request for Clarification within thirty (30) calendar days of receipt of the bill, or provide an in-state contact in accord with Subparagraph 06.e.iii., it shall be precluded from objecting to such charge as failing to comport with the applicable administrative rule. (3-20-20)T

**f. Provider Reply to Preliminary Objection or Request for Clarification.** (3-20-20)T

i. Where a Payor has timely sent a Preliminary Objection, Request for Clarification, or both, the Provider shall send to the Payor a written Reply, if any it has, within thirty (30) calendar days of the Provider's receipt of each Preliminary Objection or Request for Clarification. (3-20-20)T

ii. If a Provider fails to timely reply to a Preliminary Objection, the Provider shall be deemed to have acquiesced in the Payor's objection. (3-20-20)T

iii. If a Provider fails to timely reply to a Request for Clarification, the period in which the Payor shall pay or issue a Final Objection shall not begin to run until such clarification is received. (3-20-20)T

**g. Payor Shall Pay or Issue Final Objection.** The Payor shall pay the Provider's bill in whole or in part or send to the Provider a written Final Objection, if any it has, to all or part of the bill within thirty (30) calendar days of the Payor's receipt of the Reply. (3-20-20)T



**h.** Failure of Payor to Finally Object. Where the Payor does not timely send a Final Objection to any charge or portion thereof to which it continues to have an objection, it shall be precluded from further objecting to such charge as unacceptable. (3-20-20)T

**i.** Dispute Resolution Process. If, after completing the applicable steps set forth above, a Payor and Provider are unable to agree on the appropriate charge for any Medical Service, a Provider which has complied with the applicable requirements of this rule may move the Commission to resolve the dispute as provided in the Judicial Rule Re: Disputes Between Providers and Payors, as referenced in Paragraph 803.01.c. of this rule. If Provider's motion disputing CPT or MS-DRG coded items prevails, Payor shall pay the amount found by the Commission to be owed, plus an additional thirty percent (30%) of that amount to compensate Provider for costs and expenses associated with using the dispute resolution process. For motions filed by a Provider disputing items without CPT or MS-DRG codes, the additional thirty percent (30%) shall be due only if the Payor does not pay the amount found due within thirty (30) days of the administrative order. (3-20-20)T

**804. – 999. (RESERVED)**

## IDAPA 18 – IDAHO DEPARTMENT OF INSURANCE

DOCKET NO. 18-0000-2000F (FEE RULE)

### NOTICE OF OMNIBUS RULEMAKING – ADOPTION OF TEMPORARY RULE

**EFFECTIVE DATE:** The effective date of the temporary rules being adopted through this omnibus rulemaking is the adjournment date of the second regular session of the 65th Idaho State Legislature - March 20, 2020.

**AUTHORITY:** In compliance with Sections 67-5226, Idaho Code, notice is hereby given this agency has adopted temporary rules. The action is authorized pursuant to Sections 41-211, 41-254, and 41-401, Idaho Code.

**DESCRIPTIVE SUMMARY:** The following is the required finding and concise statement of its supporting reasons for adopting a temporary rule:

This temporary rulemaking adopts the following chapters under IDAPA 18:

**IDAPA 18**

**All Lines:**

- 18.01.02, *Schedule of Fees, Licenses, and Miscellaneous Charges*

**State Fire Marshal:**

- 18.08.02, *Fire Protection Sprinkler Contractors*

**TEMPORARY RULE JUSTIFICATION:** Pursuant to Sections 67-5226(1) and 67-5226(2), Idaho Code, the Governor has found that temporary adoption of the rules is appropriate for the following reasons:

These temporary rules are necessary to protect the public health, safety, and welfare of the citizens of Idaho and confer a benefit on its citizens. These temporary rules implement the duly enacted laws of the state of Idaho, provide citizens with the detailed rules and standards for complying with those laws, and assist in the orderly execution and enforcement of those laws. The expiration of these rules without due consideration and processes would undermine the public health, safety, and welfare of the citizens of Idaho and deprive them of the benefit intended by these rules.

**FEE SUMMARY:** Pursuant to Section 67-5226(2), the Governor has found that the fees or charges being imposed or increased is justified and necessary to avoid immediate danger and the fees described herein:

The fees or charges, authorized in Section 41-404, Idaho Code, are part of the agency's 2021 budget that relies upon the existence of these fees or charges to meet the state's obligations and provide necessary state services. Failing to reauthorize these temporary rules would create immediate danger to the state budget, immediate danger to necessary state functions and services, and immediate danger of a violation of Idaho's constitutional requirement that it balance its budget.

The following is a specific description of the fees or charges: The fees within the rulemaking on 18.01.02 apply to insurers and related entities (020), producers and other licensees (030), and miscellaneous fees (040). The fees within the rulemaking on 18.08.02 apply to the State Fire Marshal's actions on applications and licenses (015).

**ASSISTANCE ON TECHNICAL QUESTIONS:** For assistance on technical questions concerning the temporary rule, contact Weston Trexler, (208) 334-4214, [weston.trexler@doi.idaho.gov](mailto:weston.trexler@doi.idaho.gov).

Dated this 7th day of February, 2020.

Dean L. Cameron, Director  
Idaho Department of Insurance  
700 W. State Street, 3rd Floor  
P.O. Box 83720, Boise, ID 83702-0043  
Phone: (208) 334-4250  
Fax: (208) 334-4398

**18.01.02 – SCHEDULE OF FEES, LICENSES, AND MISCELLANEOUS CHARGES**

**000. LEGAL AUTHORITY.**

Title 41, Chapters 2 and 4, Idaho Code, Idaho Code. (3-20-20)T

**001. TITLE AND SCOPE.**

**01. Title.** IDAPA 18.01.02, “Schedule of Fees, Licenses, and Miscellaneous Charges.” (3-20-20)T

**02. Scope.** The purpose of this rule is to provide for the amounts to be collected for fees, licenses and miscellaneous charges. (3-20-20)T

**002. -- 010. (RESERVED)**

**011. FEES PAYABLE IN ADVANCE.**

The director will collect in advance fees, licenses, and miscellaneous charges as outlined in this rule. (3-20-20)T

**012. -- 019. (RESERVED)**

**020. INSURER FEES.**

**01. Annual Continuation Fee.** All insurers and other entities (set forth in Section 020) licensed, listed, or approved to do business in the state of Idaho will pay an annual continuation fee. (3-20-20)T

**a.** The annual continuation fee is due on March 1st each year and is payment of the insurer’s fees due through the following February. (3-20-20)T

**b.** The annual continuation fee is charged at the time the insurer applies for admission to do business in the state of Idaho. If the application is approved, the fee paid will cover the insurer’s fees through the following February. (3-20-20)T

**02. Fee for Insurers.** For all insurance companies receiving a certificate of authority pursuant to Title 41, Chapter 3, Idaho Code, the annual continuation fee is as follows: (3-20-20)T

**a.** If insurer’s policy holders’ surplus at the preceding December 31 is less than ten million dollars (\$10,000,000) - One thousand dollars (\$1,000). (3-20-20)T

**b.** If insurer’s policy holders’ surplus at the preceding December 31 is ten million (\$10,000,000) or more, but less than one hundred million (\$100,000,000) -- Two thousand five hundred dollars (\$2,500). (3-20-20)T

**c.** If insurer’s policy holders’ surplus at the preceding December 31 is one hundred million (\$100,000,000) or greater - Four thousand five hundred dollars (\$4,500). (3-20-20)T

**03. Fees of Other Entities.** The following entities will be assessed an annual continuation fee: (3-20-20)T

**a.** Five hundred dollars (\$500): (3-20-20)T

i. All reinsurers, listed pursuant to Section 41-515, Idaho Code. (3-20-20)T

ii. Authorized surplus line insurers. (3-20-20)T

iii. County mutual insurers. (3-20-20)T

iv. Fraternal benefit societies. (3-20-20)T

v. Hospital and/or professional service corporations. (3-20-20)T

vi. Self-funded health care plans. (3-20-20)T

vii. Domestic Risk retention groups. (3-20-20)T

viii. Petroleum clean water trusts. (3-20-20)T

- ix. Rating organizations. (3-20-20)T
- x. Advisory organizations. (3-20-20)T
- b. One hundred dollars (\$100): Purchasing groups. (3-20-20)T
- 04. Fees Provide.** The annual continuation fee includes, but is not limited to, the following: (3-20-20)T
  - a. Certificate of authority renewal, license renewal, and annual registration. (3-20-20)T
  - b. Arson, fire and fraud investigation costs. (3-20-20)T
  - c. Annual statement filing. (3-20-20)T
  - d. Agent appointment and renewal of appointment. (3-20-20)T
  - e. Filings under Title 41, Chapter 38, Idaho Code, Acquisitions of Control and Insurance Holding Company Systems. (3-20-20)T
  - f. Filing of amendments to Articles of Incorporation. (3-20-20)T
  - g. Filing of amendments to Bylaws. (3-20-20)T
  - h. Amendments to Certificate of Authority. (3-20-20)T
  - i. Filing of notice of significant transactions pursuant to Section 41-345, Idaho Code. (3-20-20)T
  - j. Quarterly statement filing. (3-20-20)T
  - k. Examination expenses. (3-20-20)T
- 05. Not Provided in Fees.** Payment of the annual continuation fee will not exempt the insurer or entity from the following: (3-20-20)T
  - a. Fees for application for producer license. (3-20-20)T
  - b. Costs incurred by the Department for investigation of an applicant for producer license. (3-20-20)T
  - c. Attorney's fees and costs incurred by the Department when allowed pursuant to Idaho Code. (3-20-20)T
  - d. Costs incurred for experts and consultants when allowed by Idaho Code. (3-20-20)T
  - e. Penalties or fines levied by or payable to the Department of Insurance. (3-20-20)T
  - f. All fees set forth under Section 040. (3-20-20)T
- 06. Failure to Pay Fee.** Failure to pay the annual continuation fee on or before March 1st each year will result in the expiration of the insurer's or entity's authority to do business in the state of Idaho pursuant to Section 41-324, Idaho Code. (3-20-20)T
- 07. Reinstatement Fee.** The reinstatement fee referenced in Section 41-324(3), Idaho Code, is the amount referenced above for the insurer or entity continuation fee. (3-20-20)T
- 021. -- 029. (RESERVED)**

**030. PRODUCER AND MISCELLANEOUS LICENSING FEES.**

**01. Original License Application.** The following fees are due and needs to be paid with the filing application for original license: (3-20-20)T

- a. Administrators -- three hundred dollars (\$300). (3-20-20)T
- b. Producers -- eighty dollars (\$80). (3-20-20)T
- c. Designation as a managing general agent -- eighty dollars (\$80). (3-20-20)T
- d. Adjusters and public adjusters -- eighty dollars (\$80). (3-20-20)T
- e. Reinsurance intermediary -- eighty dollars (\$80). (3-20-20)T
- f. Surplus line brokers -- eighty dollars (\$80). (3-20-20)T
- g. Life settlement providers -- five hundred dollars (\$500). (3-20-20)T
- h. Life settlement brokers -- three hundred dollars (\$300). (3-20-20)T
- i. Independent review organization -- five hundred dollars (\$500). (3-20-20)T
- j. Vendor of portable electronics insurance, a type of limited lines producer: (3-20-20)T
  - i. A vendor of portable electronic insurance who is engaged in portable electronic transactions at more than ten (10) locations in the state of Idaho -- one thousand dollars (\$1,000). (3-20-20)T
  - ii. A vendor of portable electronic insurance who is engaged in portable electronic transactions at ten (10) or fewer locations in the state of Idaho -- one hundred dollars (\$100). (3-20-20)T

**02. Examination Fees.** Each time a producer or adjuster's examination is taken for licensing under Title 41, Chapters 10 and 11, Idaho Code, the applicant may pay a fee to a third-party testing vendor in the amount established by contract between the department and the vendor. (3-20-20)T

**03. Fingerprint Processing.** Processing fingerprints (as applicable) -- not to exceed eighty dollars (\$80). (3-20-20)T

**04. License Renewal.** The following fees are due and needs to be paid for each license to renew or continue: (3-20-20)T

- a. Adjusters, public adjusters, and producers (biennial) -- eighty dollars (\$80), or sixty dollars (\$60) if renewed electronically. (3-20-20)T
  - i. A vendor of portable electronic insurance who is engaged in portable electronic transactions at more than ten (10) locations in the state of Idaho -- five hundred dollars (\$500). (3-20-20)T
  - ii. A vendor of portable electronic insurance who is engaged in portable electronic transactions at ten (10) or fewer locations in the state of Idaho -- one hundred dollars (\$100). (3-20-20)T
- b. Redesignation as managing general agent (annual) -- eighty dollars (\$80). (3-20-20)T
- c. Administrators (biennial) -- eighty dollars (\$80). (3-20-20)T
  - i. Renewal form is filed on or before December 31. (3-20-20)T

- ii. Any renewal form postmarked after December 31 includes a penalty in an amount equal to the renewal fee. (3-20-20)T
- iii. A renewal form postmarked after January 31 needs to be submitted as a new application with supporting documents and the full application fee. (3-20-20)T
- d. Surplus line brokers (biennial) -- eighty dollars (\$80), or sixty dollars (\$60) if renewed electronically. (3-20-20)T
- e. Life settlement providers (biennial) -- three hundred dollars (\$300). (3-20-20)T
- f. Life settlement brokers (biennial) -- eighty dollars (\$80). (3-20-20)T
- g. Independent review organization (biennial) -- three hundred dollars (\$300). (3-20-20)T

**031. -- 039. (RESERVED)**

**040. MISCELLANEOUS FEES.**

- 01. Certified Copy.** Certified copy of certificate of authority, license or registration - Fifty dollars (\$50). (3-20-20)T
- 02. Certificate Under Seal.** Director's certificate under seal (except for those under Subsection 040.01 of this rule) - Twenty dollars (\$20). (3-20-20)T
- 03. Documents Filed.** For each copy of a document filed in the DOI, a reasonable cost as fixed by the director. For rate and form filings not submitted electronically through the national System for Electronic Rate and Form Filing (SERFF) -- Twenty dollars (\$20) for each rate or form filed in excess of ten (10) per calendar year. (3-20-20)T
- 04. Insurer Service of Process.** For receiving and forwarding copy of summons or other process served upon the director as process agent of an insurer -- Thirty dollars (\$30). (3-20-20)T
- 05. Agent Service of Process.** For receiving and forwarding copy of summons or other process served upon the director as process agent of a nonresident producer or other person for which the director is authorized to serve as statutory agent for service of process -- Thirty dollars (\$30). (3-20-20)T
- 06. Continuing Education.** Filing continuing education applications for approval and certification of subjects of courses (each application) -- Twenty-five dollars (\$25). (3-20-20)T

**041. -- 049. (RESERVED)**

**050. REFUNDS.**

All fees, licenses, and miscellaneous charges are non-refundable except as noted. (3-20-20)T

**051. OVERPAYMENTS.**

Overpayments of published fees will be returned only when such overpayments exceed twenty dollars (\$20), or upon request of the payor. (3-20-20)T

**052. -- 999. (RESERVED)**

## 18.08.02 – FIRE PROTECTION SPRINKLER CONTRACTORS

### 000. LEGAL AUTHORITY.

Title 41, Chapter 2, Section 41-254(2), (3) and Chapter 9 International Fire Code. (3-20-20)T

### 001. TITLE AND SCOPE.

01. **Title.** IDAPA 18.08.02, “Fire Protection Sprinkler Contractors.” (3-20-20)T

02. **Purpose.** This rule is to assure the people of Idaho that fire sprinkler systems and their appurtenances are being installed and maintained by qualified persons and organizations that contract to sell, design, modify, install, service, or maintain such systems; to safeguard lives and property and protect the public interest; to require insurance, and bonding to register such persons and organizations; to establish regulation by the State Fire Marshal; and to set penalties and fees for the administration of this rule. (3-20-20)T

03. **Persons Affected.** This rule will affect any person, individual, partnership, joint venture, corporation, or any combination thereof, association, business trust or organized group of persons, who by themselves or through others, offers to undertake, represents themselves as being able to undertake, or does undertake contracting for the sale, design, installation, modification, alteration, repair, maintenance, or maintenance inspection of any fire protection sprinkler system or its appurtenances. (3-20-20)T

### 002. -- 009. (RESERVED)

### 010. DEFINITIONS.

01. **Fire Protection Sprinkler System.** An integrated system of underground and overhead piping designed in accordance with fire protection engineering standards. This installation includes a water supply, such as a gravity tank, fire pump, reservoir or pressure tank and/or connection by underground piping to a water supply. The portion of the sprinkler system above ground is a network of specially sized, or hydraulically designed, piping installed in a building, structure or area, generally overhead, and to which sprinklers are connected in a systematic pattern. The system include a controlling valve and a device for actuating an alarm when the system is in operation. The system is usually activated by heat from a fire and discharges water over the fire area. (3-20-20)T

02. **Fire Protection Sprinkler Contractor.** Those persons described in Subsection 001.02 of this rule who contract to install, repair, modify, or maintain fire sprinkler systems. (3-20-20)T

03. **Fitters.** Those persons who install and maintain fire sprinkler systems and who work under the supervision of a Fire Protection Sprinkler Contractor. (3-20-20)T

04. **Responsible Maintenance Employee.** Any person who is employed by an owner of a premises that has a fire sprinkler system installed and who regularly inspects and maintains such system as follows: Inspects and maintains fire sprinkler system as detailed in the maintenance checklist provided by the State Fire Marshal; said checklist will follow the guidelines of National Fire Protection Association Standard 25 for the “Inspection, Testing, and Maintenance of Water-Based Fire Protection Systems.” (3-20-20)T

### 011. POWERS AND DUTIES OF THE STATE FIRE MARSHAL.

In addition to the powers and duties prescribed in this rule, the State Fire Marshal will: (3-20-20)T

01. **Assistants, Inspectors and Other Employees.** Appoint an adequate number of assistants, inspectors and other employees that may be necessary to carry out the provisions of this rule, prescribe their duties, and fix their compensation within the amount appropriated. (3-20-20)T

02. **Licensing Procedures.** Establish procedures for licensing of fire protection sprinkler contractors and fitters, set forth the form and content of applications, and investigate and examine all applicants as to their qualifications and fitness for such licensing. (3-20-20)T

03. **Records.** Keep records of all licenses issued, suspended or revoked. (3-20-20)T

04. **Suspension or Revocation of License.** Suspend or revoke any license for any cause prescribed by this rule, and refuse to grant any license for any cause which would be grounds for revocation or suspension. (3-20-20)T

05. **Examinations.** Prepare, administer, and grade such applicable examinations and tests for

applicants as may be needed for the purposes of this rule, and determine the score that will be deemed a passing score. (3-20-20)T

**06. Fees.** Collect fees, including applications, testing, licensing, renewals, and duplication fees from the applicants, and license holders for the purpose of administering and funding this rule. (3-20-20)T

**012. QUALIFICATIONS FOR CONTRACTORS LICENSE.**

Applicants seeking registration to obtain licenses as fire protection sprinkler contractors will meet the following minimum qualifications: (3-20-20)T

**01. Owner, Officer or Manager.** The applicant is an owner, officer or manager of their company, corporation, partnership or proprietorship. (3-20-20)T

**02. Examination, Education or Experience.** The applicant needs to: (3-20-20)T

**a.** Satisfactorily pass an examination prescribed by the State Fire Marshal and provide proof to the effect that the applicant has supervised or installed at least four (4) fire sprinkler systems of more than two hundred (200) heads each (complete with name, description and location of each); or (3-20-20)T

**b.** Provide proof of successful attainment of Level III Certification in fire protection, Automatic Sprinkler System Design from the National Institute for Certification in Engineering Technologies or equivalent. (3-20-20)T

**013. LICENSE REQUISITE.**

No person within the purview of this rule may act, or assume to act, or advertise, as a fire protection sprinkler contractor without a license obtained under and in compliance with this rule. (3-20-20)T

**014. LICENSE, DISPLAY, RENEWALS, DUPLICATES, APPLICATIONS.**

**01. Time Period.** All licenses will be valid for a period of not longer than one (1) year and expire on the 31st day of December of each year, regardless of the month issued. (3-20-20)T

**02. Posting of License.** Each license issued pursuant to this rule needs to be posted in a conspicuous place in the contractor's place of business. (3-20-20)T

**03. Renewal.** Any license which has not been suspended or revoked may, upon payment of the renewal fees prescribed, be renewed for an additional period of one (1) year from its expiration upon filing an application for renewal on forms prescribed by the State Fire Marshal. (3-20-20)T

**04. Duplicate License.** A duplicate license may be issued for one lost, destroyed, or mutilated upon application for such a form prescribed by the State Fire Marshal and the payment of the fee prescribed. Each duplicate license will have the word "duplicate" stamped across the face and bear the same number as the one it replaced. (3-20-20)T

**05. Bids Will Bear License Number.** All written bids, proposals and offers, and all shop and field installation drawings will bear the contractor's license number. (3-20-20)T

**06. Forms and Fees.** Application for a license will be made on forms prescribed by the State Fire Marshal. Each application will be accompanied by the prescribed fee. (3-20-20)T

**015. ACTION ON APPLICATIONS AND LICENSE FEES.**

Within one hundred and twenty (120) days after the filing of a complete application for a license and the payment of the prescribed fees, the State Fire Marshal will: (3-20-20)T

**01. Investigation of Applicants.** Conduct an investigation of applicants. Such investigation may inquire the name and address of the applicant; whether the applicant is associated in any partnership, corporation or other entity; the names, addresses, and official capacities of all such associates; and any other pertinent information as



the State Fire Marshal may deem relevant. (3-20-20)T

**02. Fees.** License fees for fire protection sprinkler contractors are as follows: (3-20-20)T

**a.** Examination Fee -- Twenty-five dollars (\$25). (3-20-20)T

**b.** License Fee -- Four hundred dollars (\$400). (3-20-20)T

**c.** Annual License Renewal Fee -- One hundred dollars (\$100). (3-20-20)T

**d.** Duplicate License Fee -- Ten dollars (\$10). (3-20-20)T

**e.** Branch Office Fee -- One hundred dollars (\$100). (3-20-20)T

**f.** Examination fees, when paid, are earned and are not subject to refund. (3-20-20)T

**03. Branch Office License.** Branch offices of a licensed firm doing business in this state need obtain a branch office license. Each license needs to provide a shop or a vehicle as a place of business properly equipped and subject to inspection by the authority. A separate license is needed for each business location. Any advertisement that the services of installing or maintaining fire protection sprinkler systems constitutes prima facie evidence that the premises, building, room, shop, store, or establishment in or upon which it appears or to which it refers is a separate business location. (3-20-20)T

**04. Arson, Fire, and Fraud Prevent Account.** All license fees collected will be deposited in the Arson, Fire, and Fraud Prevention Account as per Section 41-268(d), Idaho Code. (3-20-20)T

**016. FINANCIAL RESPONSIBILITY.**

**01. Bonding.** (3-20-20)T

**a.** The State Fire Marshal will require each applicant, individual or corporation who is a contractor to put up a license bond in an amount not less than two thousand dollars (\$2,000) in favor of the state of Idaho by a surety company authorized to do business in the state of Idaho. (3-20-20)T

**b.** The bond remains in full force until released by the State Fire Marshal, or until canceled by the surety. Without prejudice to liability previously incurred, the surety may cancel the bond upon thirty (30) days advance notice to both the contractor and the State Fire Marshal. (3-20-20)T

**02. Insurance.** Prior to issuance of a license as a fire protection sprinkler contractor, the applicant will obtain and maintain at all times will a full term comprehensive general liability insurance policy from an insurance company authorized to do business in the state of Idaho, which policy will have aggregate limits of not less than two hundred fifty thousand dollars (\$250,000) and including the following: (3-20-20)T

**a.** Comprehensive Form. (3-20-20)T

**b.** Premises Operations. (3-20-20)T

**c.** Products/Completed Operations Hazard. (3-20-20)T

**d.** Contractual Insurance. (3-20-20)T

**e.** Broad Form Property Damage. (3-20-20)T

**f.** Independent Contractors. (3-20-20)T

**g.** Personal Injury. (3-20-20)T

- h.** Evidence of such insurance should be filed with the State Fire Marshal's Office. (3-20-20)T

**017. REVOCATION, SUSPENSION, AND NON-RENEWAL OF LICENSE.**

**01. Causes for Revocation, Suspension, or Refusal to Renew License.** The State Fire Marshal may revoke any license issued, or suspend the right of the license holder to use such license, or refuse to renew any such license for any of the following causes: (3-20-20)T

**a.** Fraud, bad faith, misrepresentation, or bribery, either in securing a license or in the conduct of business under a license. (3-20-20)T

**b.** The making of any false statement as to a material matter in any application for license. (3-20-20)T

**c.** Failure by the contractor to perform their contract with the property owner. (3-20-20)T

**d.** The manipulation of assets or of any accounts covering the subject matter of this rule, or by fraud or bad faith. (3-20-20)T

**e.** Failure to display the license as provided in Subsection 013.02 of this rule. (3-20-20)T

**f.** Failure to secure or maintain workmen's compensation insurance when not authorized to act as a self-insurer. (3-20-20)T

**g.** Knowingly entering into a contract with an unregistered contractor involving the performance of work or activity which requires a license under this rule. (3-20-20)T

**h.** The licensee has pled guilty to, or was found guilty of, a felony. (3-20-20)T

**i.** Violation of any provision of this rule. (3-20-20)T

**02. Length of Suspension.** No license will be suspended for longer than two (2) years. (3-20-20)T

**03. Eligibility to Reapply After Revocation.** No person whose license is revoked will be eligible to apply for a new license until the expiration of two (2) years. (3-20-20)T

**018. HEARINGS.**

In every case where it is proposed to refuse to grant a license, revoke a license, or to refuse to renew a license, the State Fire Marshal will give adequate notice and provide a hearing if requested. Notice of hearing will be given in writing by registered or certified mail with return receipt requested at least fifteen (15) days prior to the hearing. (3-20-20)T

**019. APPROVED EQUIPMENT AND MATERIALS.**

No component or devices of an automatic fire sprinkler system may be sold, leased, or installed in this state unless it has been approved, labeled, or listed by Underwriters Laboratories, Inc., Underwriters Laboratories of Canada, Factory Mutual Laboratories, or other testing laboratories approved by the State Fire Marshal. (3-20-20)T

**01. Sprinklers.** Only new standard commercial or other listed sprinklers may be employed in the installation of a sprinkler system. (3-20-20)T

**02. Minimum Requirements.** Automatic fire sprinkler systems installed in the State will meet the minimum NFPA standards. Partial installations prescribed for compliance with life safety codes need to be approved by the local fire department or the State Fire Marshal. (3-20-20)T

**020. SERVICE EVIDENCE.**

**01. Submission of Plans.** Where automatic fire sprinkler systems are installed, the installer completes the contractor's material and test certificates NFPA 13 1-10.1. All systems need to be under the supervision of a

contractor or a R.M.E. These persons will conduct proper tests and inspections at prescribed intervals and have general charge of all alterations and additions to the systems under their supervision. (3-20-20)T

**02. Conformance to Standards.** A service tag conforming to the requirements of this chapter will be attached to all systems. (3-20-20)T

**021. DESIGN REQUIREMENTS.**

**01. Submission of Plans.** Detailed plans in accordance with applicable NFPA standards are submitted by a licensed contractor for approval to the local fire department and to the State Fire Marshal. (3-20-20)T

**02. Conformance to Standards.** The specifications will state that the installation will conform to the applicable standards listed in this rule and be approved by the local fire department and the State Fire Marshal. (3-20-20)T

**03. Tests.** The specifications need to include the specific tests needed to meet the standards for approval of the local fire department and the State Fire Marshal. (3-20-20)T

**04. Scale.** Plans need to be drawn to an indicated scale or be suitably dimensioned, and made so that they can be easily reproduced. (3-20-20)T

**05. Detail.** Plans need to contain sufficient detail to evaluate the effectiveness of the system. (3-20-20)T

**06. Prior Approval of Plans.** Plans need to be submitted to the State Fire Marshal and the local fire department and approved, before work starts. Work may start prior to final plans submitted based on conceptual drawings if approved by the local fire department and the State Fire Marshal. A plan's review fee of two dollars (\$2) per sprinkler head up to one thousand (1000) heads per fire protection sprinkler system (maximum two thousand dollars (\$2,000)) or one hundred dollars (\$100) per fire protection sprinkler system if less than fifty (50) sprinkler heads. The applicable fee needs to accompany the plans sent to the State Fire Marshal. Two (2) sprinkler heads on an arm-over will be considered as one (1) sprinkler head for fee purposes. (3-20-20)T

**07. Corrected Plans.** Where field conditions necessitate any substantial change from the approved plan, the corrected plan showing the system as installed need to be submitted to the local fire department and the State Fire Marshal for approval. (3-20-20)T

**08. Exemption.** A City or County may request an exemption from the requirements of this Section that plans be submitted to the State Fire Marshal for review and approval. A request for exemption will be made in writing signed by the Fire Chief, designated representative or elected local official and set forth the reasons for the request. If the State Fire Marshal determines the request is justified, the requesting party will be provided a written notice of exemption. The exemption will continue until terminated by the State Fire Marshal. Any such exemption will not apply to plans or inspections relating to structures owned, leased or controlled by the state or any state agency. (3-20-20)T

**022. SERVICE TAG.**

**01. Form.** Automatic fire sprinkler service tags need to be in a form prescribed by the State Fire Marshal and a new tag installed each time work is performed on the system. (3-20-20)T

**02. Control Valve Not Electrically Supervised.** In the event the control valve is not electrically supervised, the service tag will serve as a seal for the valve. (3-20-20)T

**03. Electrically Supervised Control Valve.** In the event the control valve is electrically supervised, the service tag will be attached in such a manner that the valve may be closed for testing of the supervision without removing the tag. (3-20-20)T

**023. FITTERS.**

All fitters, as described in Subsection 004.03 may be licensed under this rule as follows: (3-20-20)T

**01. Examination.** Show proof by affidavit signed by a licensed fire protection sprinkler contractor that he has worked as a fitter for at least one thousand (1,000) hours per year for three (3) consecutive years and then take and pass a written examination given by the State Fire Marshal, and pay the appropriate fee. (3-20-20)T

**02. Fees.** The State Fire Marshal collects in advance fees, license fees and miscellaneous charges as follows: (3-20-20)T

**a.** Examination Fee -- Twenty-five dollars (\$25). (3-20-20)T

**b.** Original License Fee -- Fifty dollars (\$50). (3-20-20)T

**c.** Annual License Renewal Fee -- Twenty-five dollars (\$25). (3-20-20)T

**d.** Duplicate License Fee -- Ten dollars (\$10). (3-20-20)T

**e.** All license fees collected are to be deposited to the Arson, Fire, and Fraud Prevention Account as per Section 41-268(d), Idaho Code. No examination will be taken or license issued pursuant to this rule until the appropriate fees, as listed above, are paid. Examination fees, when paid, are earned and are not subject to refund. (3-20-20)T

**03. Period of Time.** No fitters license is valid for a period of longer than one (1) year and expires on the 31st day of December of each year regardless of the month issued. (3-20-20)T

**04. Renewal.** Any license which has not been suspended or revoked may, upon payment of the renewal fee prescribed, be renewed for an additional period of one (1) year from its expiration upon filing an application for such renewal on forms prescribed by the State Fire Marshal. (3-20-20)T

**05. Duplicate License.** A duplicate license may be issued for one lost, destroyed, or mutilated upon application for such on a form to be prescribed by the State Fire Marshal, and the payment of the fee prescribed. Each such duplicate license will have the word "duplicate" stamped across the face and bear the same number as the one it replaced. (3-20-20)T

**024. -- 999. (RESERVED)**

## IDAPA 19 – IDAHO STATE BOARD OF DENTISTRY

DOCKET NO. 19-0101-2000F (FEE RULE)

### NOTICE OF OMNIBUS RULEMAKING – ADOPTION OF TEMPORARY RULE

**EFFECTIVE DATE:** The effective date of the temporary rule being adopted through this omnibus rulemaking is the adjournment date of the second regular session of the 65th Idaho State Legislature - March 20, 2020.

**AUTHORITY:** In compliance with Sections 67-5226, Idaho Code, notice is hereby given this agency has adopted a temporary rule. The action is authorized pursuant to Section 54-912, Idaho Code.

**DESCRIPTIVE SUMMARY:** The following is the required finding and concise statement of its supporting reasons for adopting a temporary rule:

This temporary rulemaking adopts the following chapter under IDAPA 19:

**IDAPA 19**

- 19.01.01, *Rules of the Idaho State Board of Dentistry*

**TEMPORARY RULE JUSTIFICATION:** Pursuant to Sections 67-5226(1) and 67-5226(2), Idaho Code, the Governor has found that temporary adoption of the rule is appropriate for the following reasons:

These temporary rules are necessary to protect the public health, safety, and welfare of the citizens of Idaho and confer a benefit on its citizens. These temporary rules implement the duly enacted laws of the state of Idaho, provide citizens with the detailed rules and standards for complying with those laws, and assist in the orderly execution and enforcement of those laws. The expiration of these rules without due consideration and processes would undermine the public health, safety, and welfare of the citizens of Idaho and deprive them of the benefit intended by these rules.

**FEE SUMMARY:** Pursuant to Section 67-5226(2), the Governor has found that the fees or charges being imposed or increased is justified and necessary to avoid immediate danger and the fees is described herein:

The fees or charges, authorized in Sections 54-916 and 54-920, Idaho Code, are part of the agency's 2021 budget that relies upon the existence of these fees or charges to meet the state's obligations and provide necessary state services. Failing to reauthorize these temporary rules would create immediate danger to the state budget, immediate danger to necessary state functions and services, and immediate danger of a violation of Idaho's constitutional requirement that it balance its budget.

The following is a specific description of the fees or charges: application and licensure fees.

**ASSISTANCE ON TECHNICAL QUESTIONS:** For assistance on technical questions concerning the temporary rule, contact Susan Miller, Executive Director, (208) 334-2369.

DATED this 14th day of February, 2020.

Susan Miller  
Executive Director  
Idaho State Board of Dentistry  
350 N. 9th Street, Suite M100  
PO Box 83720  
Boise, ID 83720-0021  
Phone: (208) 334-2369  
Fax: (208) 334-3247

# IDAPA 19 – IDAHO STATE BOARD OF DENTISTRY

## 19.01.01 – RULES OF THE IDAHO STATE BOARD OF DENTISTRY

### 000. LEGAL AUTHORITY.

This Chapter is adopted under the legal authority of Chapter 9, Title 54, Idaho Code. (3-20-20)T

### 001. TITLE AND SCOPE.

These rules are titled IDAPA 19.01.01, “Rules of the Idaho State Board of Dentistry.” These rules constitute the minimum requirements for licensure and regulation of dentists, dental hygienists, and dental therapists. (3-20-20)T

### 002. INCORPORATION BY REFERENCE.

Pursuant to Section 67-5229, Idaho Code, this chapter incorporates by reference the following documents: (3-20-20)T

01. **Professional Standards.** (3-20-20)T
- a. AAOMS, Office Anesthesia Evaluation Manual, 8th Edition, 2012. (3-20-20)T
- b. CDC, Guidelines for Infection Control in Dental Health-Care Settings, 2003. (3-20-20)T
- c. ADA, Principles of Ethics, Code of Professional Conduct and Advisory Opinions, January 2009. (3-20-20)T
- d. ADHA Hygienists’ Association, Standards for Clinical Dental Hygiene Practice, 2016. (3-20-20)T

### 003. -- 009. (RESERVED)

### 010. DEFINITIONS AND ABBREVIATIONS.

01. **ACLS.** Advanced Cardiovascular Life Support or Pediatric Advanced Life Support. (3-20-20)T
02. **ADA.** American Dental Association. (3-20-20)T
03. **ADHA.** American Dental Hygienists Association. (3-20-20)T
04. **AAOMS.** American Association of Oral and Maxillofacial Surgeons. (3-20-20)T
05. **Analgesia.** The diminution or elimination of pain. (3-20-20)T
06. **BLS.** Basic Life Support. (3-20-20)T
07. **CDC.** Centers for Disease Control and Prevention. (3-20-20)T
08. **CE.** Continuing Education: one (1) hour of instruction equals one (1) CE credit. (3-20-20)T
09. **CODA.** Commission on Dental Accreditation. (3-20-20)T
10. **CRNA.** Certified Registered Nurse Anesthetist. (3-20-20)T
11. **Deep Sedation.** A drug-induced depression of consciousness during which patients cannot be easily aroused but respond purposefully following repeated or painful stimulation. The ability to independently maintain ventilator function may be impaired. Patients may require assistance in maintaining a patent airway, and spontaneous ventilation may be inadequate. Cardiovascular function is usually maintained. (3-20-20)T
12. **Enteral.** Administration of a drug in which the agent is absorbed through the GI or mucosa. (3-20-20)T
13. **EPA.** United States Environmental Protection Agency. (3-20-20)T
14. **General Anesthesia.** A drug-induced loss of consciousness during which patients are not

arousable, even by painful stimulation. The ability to independently maintain ventilator function is often impaired. Patients often require assistance in maintaining a patent airway, and positive pressure ventilation may be required because of depressed spontaneous ventilation or drug-induced depression of neuromuscular function. Cardiovascular function may be impaired. (3-20-20)T

15. **GI.** Gastrointestinal tract. (3-20-20)T

16. **Inhalation.** Administration of a gaseous or volatile agent introduced into the lungs and whose primary effect is due to absorption through the gas/blood interface. (3-20-20)T

17. **Local Anesthesia.** The elimination of sensation, especially pain, in one (1) part of the body by the topical application or regional injection of a drug. (3-20-20)T

18. **Minimal Sedation.** A minimally depressed level of consciousness that retains the patient's ability to independently and continuously maintain an airway and respond normally to tactile stimulation and verbal command. Although cognitive function and coordination may be modestly impaired, ventilator and cardiovascular functions are unaffected. In accord with this particular definition, the drugs and/or techniques used should carry a margin of safety wide enough never to render unintended loss of consciousness. Further, patients whose only response is reflex withdrawal from repeated painful stimuli would not be considered to be in a state of minimal sedation. (3-20-20)T

19. **Moderate Sedation.** A drug-induced depression of consciousness during which patients respond purposefully to verbal commands, either alone or accompanied by light tactile stimulation. No interventions are required to maintain a patent airway, and spontaneous ventilation is adequate. Cardiovascular function is usually maintained. (3-20-20)T

20. **Monitor or Monitoring.** The direct clinical observation of a patient during the administration of sedation by a person trained to observe the physical condition of the patient and capable of assisting with emergency or other procedures. (3-20-20)T

21. **MRD.** Maximum FDA-recommended dose of a drug, as printed in FDA-approved labeling for unmonitored home use. (3-20-20)T

22. **NBDE.** National Board Dental Examination. (3-20-20)T

23. **NBDHE.** National Board Dental Hygiene Examination. (3-20-20)T

24. **Operator.** The supervising dentist or another person who is authorized by these rules to induce and administer sedation. (3-20-20)T

25. **Parenteral.** Administration of a drug which bypasses the GI tract [i.e., intramuscular, intravenous, intranasal, submucosal, subcutaneous, intraosseous]. (3-20-20)T

26. **PMP.** Idaho Prescription Monitoring Program. (3-20-20)T

27. **Sedation.** The administration of minimal, moderate, and deep sedation and general anesthesia. (3-20-20)T

**011. APPLICATION AND LICENSE FEES.**

Application fees are not refunded. A license shall not be issued or renewed unless fees have been paid. License fees are prorated from date of initial licensure to the next successive license renewal date. The application fees and license fees are as follows:

License/Permit Type	Application Fee	License/Permit Fee
Dentist/Dental Specialist	\$300	Active Status: \$375 Inactive Status: \$160
Dental Hygienist	\$150	Active Status: \$175 Inactive Status: \$85
Dental Therapist	\$200	Active Status: \$250 Inactive Status: \$125
Sedation Permit	\$300	\$300

(3-20-20)T

**012. EXAMINATIONS FOR LICENSURE.**

**01. Written Examination.** Successful completion of the NBDE may be required of all applicants for a license to practice dentistry or a dental specialty. Successful completion of the NBDHE may be required of all applicants for a license to practice dental hygiene. Dental therapists must successfully complete a board-approved written examination. Any other written examination will be specified by the Board. (3-20-20)T

**02. Clinical Examination.** All applicants for a license to practice general dentistry, dental hygiene or dental therapy are required to pass a Board-approved clinical examination upon such subjects as specified by the Board. Applicants for dental hygiene and dental therapy licensure must pass a clinical local anesthesia examination. Clinical examination results will be valid for licensure by examination for a period of (5) five years from the date of successful completion of the examination. (3-20-20)T

**013. REQUIREMENTS FOR LICENSURE.**

Applicants for licensure to practice dentistry must furnish proof of graduation from a school of dentistry accredited by CODA at the time of applicant's graduation. Applicants for licensure to practice dental hygiene must furnish proof of graduation from a dental hygiene program accredited by CODA at the time of applicant's graduation. Applicants for licensure to practice dental therapy must furnish proof of graduation from a dental therapy program accredited by CODA at the time of applicant's graduation. (3-20-20)T

**014. REQUIREMENT FOR BLS.**

Applicants for initial licensure will provide proof of current BLS certification. Practicing licensees must maintain current BLS certification. (3-20-20)T

**015. CONTINUING EDUCATION REQUIREMENTS.**

A licensee renewing an active status license shall report to the Board completion of verifiable CE or volunteer practice which meets the following requirements: (3-20-20)T

**01. Number of Credits.**

License/Endorsement Type	Requirements
Dentist/Dental Specialist	30 credits - one of the credits must be related to opioid prescribing
Dental Hygienist	24 credits
Dental Hygienist with Extended Access License Endorsement	28 credits - four of the credits must be in the specific practice areas of medical emergencies, local anesthesia, oral pathology, care and treatment of geriatric, medically compromised or disabled patients and treatment of children.
Dental Therapist	30 credits

(3-20-20)T



**02. Nature of Education.** Continuing education must be oral health/health-related for the licensee's professional development. (3-20-20)T

**03. Volunteer Practice.** Licensees are allowed one (1) credit of continuing education for every two (2) hours of verified volunteer practice performed during the biennial renewal period up to a maximum of ten (10) credits. (3-20-20)T

**04. Prorated Credits.** Any person who is granted a license with active during any biennial renewal period shall be required at the time of the next successive license renewal to report a prorated amount of continuing education credits as specified by the Board. (3-20-20)T

**05. Documentation.** In conjunction with license renewal, the licensee shall provide a list of continuing education credits obtained and verification of hours of volunteer practice performed and certify that the minimum requirements were completed in the biennial renewal period. (3-20-20)T

**016. – 020. (RESERVED)**

**021. PROVISIONAL LICENSURE.**

This type of license may be granted at the Board's discretion to applicants who meet the following requirements: (3-20-20)T

**01. Active Practice.** Active practice within the previous two (2) years. (3-20-20)T

**02. Current Licensure.** Current licensure in good standing in another state. (3-20-20)T

**03. Evidence.** Evidence that the applicant has not failed an exam given by the Board or its agent. (3-20-20)T

**04. Provisional License.** The provisional license will be valid for the period of time specified on the provisional license which may not exceed one (1) year from the date of issuance. (3-20-20)T

**022. VOLUNTEER DENTAL HYGIENE SERVICES.**

A person holding an unrestricted active status dental hygiene license issued by the Board may provide dental hygiene services in an extended access oral health care setting without being issued an extended access license endorsement under the following circumstances: (3-20-20)T

**01. Extended Access Oral Health Care Setting.** The dental hygiene services must be performed in an extended access oral health care setting under the supervision of a dentist who has issued written orders to the dental hygienist; (3-20-20)T

**02. Dental Hygiene Services Performed.** The dental hygiene services performed are limited to oral health screening and patient assessment, preventive and oral health education, preparation and review of health history, non-surgical periodontal treatment, oral prophylaxis, the application of caries preventive agents including fluoride, the application of pit and fissure sealants with recommendation that the patient will be examined by a dentist; (3-20-20)T

**03. Volunteers.** The dental hygienist must perform the dental hygiene services on a volunteer basis and may not accept any form of remuneration for providing the services; and (3-20-20)T

**04. Volunteer Time Limit.** The dental hygienist may not provide dental hygiene services under this provision for more than five (5) days within any calendar month. (3-20-20)T

**023. DENTAL HYGIENISTS – LICENSE ENDORSEMENTS.**

The Board may grant license endorsements to qualified dental hygienists as follows: (3-20-20)T

**01. Extended Access Endorsement.** Upon application, the Board may grant an extended access

endorsement to a person holding an unrestricted active status dental hygienist's license issued by the Board who provides satisfactory proof that all of the following requirements are met: (3-20-20)T

**a.** The person has been licensed as a dental hygienist during the two (2) year period immediately prior to the date of application for an extended access endorsement; (3-20-20)T

**b.** For a minimum of one thousand (1000) total hours within the previous two (2) years, the person has either been employed as a dental hygienist in supervised clinical practice or has been engaged as a clinical practice educator in an approved dental hygiene school; (3-20-20)T

**c.** The person has not been disciplined by the Board or another licensing authority upon grounds that bear a demonstrable relationship to the ability of the dental hygienist to safely and competently practice under general supervision in an extended access oral health care setting; and (3-20-20)T

**d.** Any person holding an unrestricted active status dental hygienist's license issued by the Board who is employed as a dental hygienist in an extended access oral health care setting in this state may be granted an extended access endorsement without being required to satisfy the experience requirements specified in this rule. (3-20-20)T

**02. Extended Access Restorative Endorsement.** Notwithstanding any other provision of these rules, a qualified dental hygienist holding an extended access restorative endorsement may perform specified restorative functions under the direct supervision of a dentist in an extended access oral health care setting. Permissible restorative functions under this endorsement are limited to the placement of a restoration into a tooth prepared by a dentist and the carving, contouring and adjustment of the contacts and occlusion of the restoration. Upon application, the Board may grant an extended access restorative endorsement to a person holding an unrestricted active status dental hygienist's license issued by the Board who provides satisfactory proof that the following requirements are met: (3-20-20)T

**a.** The person has successfully completed the Western Regional Examining Board's restorative examination or an equivalent restorative examination approved by the Board; and (3-20-20)T

**b.** The person has not been disciplined by the Board or another licensing authority upon grounds that bear a demonstrable relationship to the ability of the dental hygienist to safely and competently practice under in an extended access oral health care setting. (3-20-20)T

**03. Renewal.** Upon payment of the appropriate license fee and completion of required CE credits specified for a license endorsement, a person meeting all other requirements for renewal of a license to practice dental hygiene is also entitled to renewal of a license endorsement for the effective period of the license. An endorsement immediately expires and is cancelled at such time as a person no longer holds an unrestricted active status dental hygienist's license issued by the Board or upon a person's failure to complete the required CE. (3-20-20)T

## **024. LICENSURE OF DENTAL SPECIALISTS.**

**01. Requirements for Specialty Licensure.** Each applicant for specialty licensure must have graduated from a CODA accredited dental school and hold a license to practice general dentistry in the state of Idaho or another state. The Board may grant licensure in specialty areas of dentistry for which a dentist has completed a CODA accredited postdoctoral advanced dental education program of at least two full-time academic years. (3-20-20)T

**02. Examination.** Specialty licensure in those specialties recognized may be granted solely at the discretion of the Board. An examination covering the applicant's chosen field may be required and, if so, will be conducted by the Board or a testing agent. Applicants who have met the requirements for licensure as a specialist may be required to pass an examination as follows: (3-20-20)T

**a.** Applicants who have passed a general licensure examination acceptable to the Board may be granted specialty licensure by Board approval. (3-20-20)T

**b.** Applicants who have passed a general licensure examination not acceptable to the Board may be required to pass a specialty examination. (3-20-20)T

**c.** Applicants who are certified by the American Board of that particular specialty as of the date of application for specialty licensure may be granted specialty licensure by Board approval. (3-20-20)T

**03. Limitation of Practice.** No dentist may announce or otherwise hold himself out to the public as a specialist unless he has first complied with the requirements established by the Board for such specialty and has been issued a specialty license authorizing him to do so. Any individual granted a specialty license must limit his practice to the specialty(s) in which he is licensed. (3-20-20)T

**025. SPECIALTY ADVERTISING.**

The specialty advertising rules are intended to allow the public to be informed about dental specialties and to require appropriate disclosures to avoid misperceptions on the part of the public. (3-20-20)T

**01. Recognized Specialty License.** An advertisement may not state that a licensee is a specialist unless the licensee has been granted a license in that specialty area of dental practice by the Board. Use of words or terms in advertisements such as “Specialist,” “Board Certified,” “Diplomate,” “Practice Limited To,” and “Limited To Specialty Of” shall be prima facie evidence that the licensee is holding himself out to the public as a licensed specialist in a specialty area of dental practice. (3-20-20)T

**02. Disclaimer.** A licensee who has not been granted a specialty license by the Board may advertise as being qualified in a recognized specialty area of dental practice so long as each such advertisement, regardless of form, contains a prominent, clearly worded disclaimer that the licensee is “licensed as a general dentist” or that the specialty services “will be provided by a general dentist.” Any disclaimer in a written advertisement must be in the same font style and size as that in the listing of the specialty area. (3-20-20)T

**03. Unrecognized Specialty.** A licensee may not advertise as being a specialist in or as specializing in any area of dental practice which is not a Board recognized and licensed specialty area unless the advertisement, regardless of form, contains a prominent, clearly worded disclaimer that the advertised area of dental practice is not recognized as a specialty area of dental practice by the Idaho Board of Dentistry. Any disclaimer in a written advertisement shall be in the same font style and size as that in the listing of the specialty area. (3-20-20)T

**026. PATIENT RECORDS.**

**01. Individual Records.** Each licensee must prepare and maintain a record for each person receiving dental services, regardless of whether any fee is charged. The record shall contain the name of the licensee rendering the service and include: (3-20-20)T

**a.** Name and address of patient and, if a minor, name of guardian; (3-20-20)T

**b.** Date and description of examination and diagnosis; (3-20-20)T

**c.** An entry that informed consent has been obtained and the date the informed consent was obtained. Documentation may be in the form of an acronym such as “PARQ” (Procedure, Alternatives, Risks and Questions) or “SOAP” (Subjective Objective Assessment Plan) or their equivalent. (3-20-20)T

**d.** Date and description of treatment or services rendered; (3-20-20)T

**e.** Date and description of treatment complications; (3-20-20)T

**f.** Date and description of all radiographs, study models, and periodontal charting; (3-20-20)T

**g.** Health history; and (3-20-20)T

**h.** Date, name of, quantity of, and strength of all drugs dispensed, administered, or prescribed. (3-20-20)T

**02. Charges and Payments.** Each dentist must prepare and maintain a record of all charges and payments for services including source of payments. (3-20-20)T

**03. Record Retention.** Each dentist must maintain patient records for no less than seven (7) years from the date of last entry unless: (3-20-20)T

- a. The patient requests the records be transferred to another dentist who will maintain the records. (3-20-20)T
- b. The dentist gives the records to the patient; or (3-20-20)T
- c. The dentist transfers the dentist's practice to another dentist who will maintain the records. (3-20-20)T

**027. – 030. (RESERVED)**

**031. INFECTION CONTROL.**

In determining what constitutes unacceptable patient care with respect to infection control, the Board may consider current infection control guidelines such as those of the Centers for Disease Control and Prevention. Additionally, licensees and dental assistants must comply with the following requirements: (3-20-20)T

**01. Gloves.** Disposable gloves shall be worn whenever placing fingers into the mouth of a patient or when handling blood or saliva contaminated instruments or equipment. Appropriate hand hygiene shall be performed prior to gloving. (3-20-20)T

**02. Masks and Eyewear.** Masks and protective eyewear or chin-length shields shall be worn when spattering of blood or other body fluids is likely. (3-20-20)T

**03. Instrument Sterilization.** Between each patient use, instruments and other equipment that come in contact with body fluids shall be sterilized. (3-20-20)T

**04. Sterilizing Devices Testing.** Heat sterilizing devices shall be tested for proper function by means of a biological monitoring system that indicates micro-organisms kill. Devices shall be tested each calendar week in which scheduled patients are treated. Testing results shall be retained by the licensee for the current calendar year and the two (2) preceding calendar years. (3-20-20)T

**05. Non-Critical Surfaces.** Environmental surfaces that are contaminated by blood or saliva shall be disinfected with an EPA registered hospital disinfectant. (3-20-20)T

**06. Clinical Contact Surfaces.** Impervious backed paper, aluminum foil, or plastic wrap should be used to cover surfaces that may be contaminated by blood or saliva. The cover shall be replaced between patients. If barriers are not used, surfaces shall be cleaned and disinfected between patients by using an EPA registered hospital disinfectant. (3-20-20)T

**07. Disposal.** All contaminated wastes and sharps shall be disposed of according to any governmental requirements. (3-20-20)T

**032. EMERGENCY MEDICATIONS OR DRUGS.**

The following emergency medications or drugs are required in all sites where anesthetic agents of any kind are administered: anti-anaphylactic agent, antihistaminic, aspirin, bronchodilator, coronary artery vasodilator, and glucose. (3-20-20)T

**033. DENTAL HYGIENISTS – PRACTICE.**

Dental hygienists are hereby authorized to perform the activities specified below: (3-20-20)T

- 01. General Supervision.** A dental hygienist may perform specified duties under general supervision

- as follows: (3-20-20)T
- a. Oral prophylaxis (removal of stains and plaque biofilm and if present, supragingival and/or subgingival calculus); (3-20-20)T
  - b. Medical history assessments and intra-oral and extra-oral assessments (including charting of the oral cavity and surrounding structures, taking case histories and periodontal assessment); (3-20-20)T
  - c. Developing patient care plans for prophylaxis, non-surgical periodontal therapy and supportive and evaluative care in accordance with the treatment parameters set by supervising dentist; (3-20-20)T
  - d. Root planing; (3-20-20)T
  - e. Non-surgical periodontal therapy; (3-20-20)T
  - f. Closed subgingival curettage; (3-20-20)T
  - g. Administration of local anesthesia; (3-20-20)T
  - h. Removal of marginal overhangs (use of high speed handpieces or surgical instruments is prohibited); (3-20-20)T
  - i. Application of topical antibiotics or antimicrobials (used in non-surgical periodontal therapy); (3-20-20)T
  - j. Provide patient education and instruction in oral health education and preventive techniques; (3-20-20)T
  - k. Placement of antibiotic treated materials pursuant to dentist authorization; (3-20-20)T
  - l. Administration and monitoring of nitrous oxide/oxygen; and (3-20-20)T
  - m. All duties which may be performed by a dental assistant. (3-20-20)T
02. **Direct Supervision.** A dental hygienist may perform specified duties under direct supervision as follows: (3-20-20)T
- a. Use of a laser restricted to gingival curettage and bleaching. (3-20-20)T
- 034. DENTAL HYGIENISTS – PROHIBITED PRACTICE.**
- 01. **Diagnosis and Treatment.** Definitive diagnosis and dental treatment planning. (3-20-20)T
  - 02. **Operative Preparation.** The operative preparation of teeth for the placement of restorative materials. (3-20-20)T
  - 03. **Intraoral Placement or Carving.** The intraoral placement or carving of restorative materials unless authorized by issuance of an extended access restorative endorsement. (3-20-20)T
  - 04. **Anesthesia.** Administration of any general anesthesia or moderate sedation. (3-20-20)T
  - 05. **Final Placement.** Final placement of any fixed or removable appliances. (3-20-20)T
  - 06. **Final Removal.** Final removal of any fixed appliance. (3-20-20)T
  - 07. **Cutting Procedures.** Cutting procedures utilized in the preparation of the coronal or root portion of the tooth, or cutting procedures involving the supportive structures of the tooth. (3-20-20)T

- 08. **Root Canal.** Placement of the final root canal filling. (3-20-20)T
- 09. **Occlusal Equilibration Procedures.** Occlusal equilibration procedures for any prosthetic restoration, whether fixed or removable. (3-20-20)T
- 10. **Other Final Placement.** Final placement of prefabricated or cast restorations or crowns. (3-20-20)T

**035. DENTAL THERAPISTS – PRACTICE.**

Subject to the provisions of the Dental Practice Act, Chapter 9, Title 54, Idaho Code, dental therapists are hereby authorized to perform activities specified by the supervising dentist who practices in the same practice setting in conformity with a written collaborative practice agreement at the supervision levels set forth in the agreement. The dental therapist and the supervising dentist must sign and maintain a copy of the agreement and provide attestation to the board in writing when entering into a written collaborative practice agreement. Such attestation need only be submitted once each renewal period thereafter. (3-20-20)T

**036. DENTAL THERAPISTS – PROHIBITED PRACTICE.**

- 01. **Sedation.** Administration of minimal, moderate or deep sedation or general anesthesia except as otherwise allowed by these rules; (3-20-20)T
- 02. **Cutting Procedures.** Cutting procedures involving the supportive structures of the tooth including both the soft and hard tissues. (3-20-20)T
- 03. **Periodontal Therapy.** Periodontal scaling and root planing, including the removal of subgingival calculus. (3-20-20)T
- 04. **All Extractions with Exception.** All extractions except: (3-20-20)T
  - a. Under direct supervision. (3-20-20)T
    - i. Non-surgical extractions. (3-20-20)T
  - b. Under general supervision or as specified in Section 035. (3-20-20)T
    - i. Removal of periodontally diseased teeth with class III mobility. (3-20-20)T
    - ii. Removal of coronal remnants of deciduous teeth. (3-20-20)T
- 05. **Root Canal Therapy.** (3-20-20)T
- 06. **All Fixed and Removable Prosthodontics** (except stainless steel crowns). (3-20-20)T
- 07. **Orthodontics.** (3-20-20)T

**037. DENTAL ASSISTANTS – PRACTICE.**

Pursuant to Section 54-903(4), Idaho Code, and these rules, dental assistants are authorized to perform dental services for which they are trained unless prohibited by these rules. Dental assistants must be directly supervised by a dentist when performing intraoral procedures except when providing palliative care as directed by the supervising dentist. (3-20-20)T

- 01. **Prohibited Duties.** A dental assistant is prohibited from performing the following duties: (3-20-20)T
  - a. The intraoral placement or carving of permanent restorative materials. (3-20-20)T

- b. Any irreversible procedure. (3-20-20)T
- c. The administration of any sedation or local injectable anesthetic. (3-20-20)T
- d. Removal of calculus. (3-20-20)T
- e. Use of an air polisher. (3-20-20)T
- f. Any intra-oral procedure using a high-speed handpiece, except for the removal of orthodontic cement or resin. (3-20-20)T
- g. Any dental hygiene prohibited duty. (3-20-20)T

**038. – 040. (RESERVED)**

**041. LOCAL ANESTHESIA.**

Dental offices in which local anesthesia is administered to patients shall, at a minimum, have and maintain suction equipment capable of aspirating gastric contents from the mouth and pharynx, a portable oxygen delivery system including full face masks and a bag-valve mask combination capable of delivering positive pressure, oxygen-enriched ventilation to the patient, a blood pressure cuff of appropriate size and a stethoscope. (3-20-20)T

**042. NITROUS OXIDE/OXYGEN.**

Persons licensed to practice and dental assistants certified in accordance with these rules may administer nitrous oxide/oxygen to patients. Nitrous oxide/oxygen when used in combination with other sedative agents may produce an alteration of the state of consciousness in a patient to the level of moderate sedation, general anesthesia, or deep sedation. A dentist must first qualify for and obtain the appropriate permit from the Board of Dentistry to be authorized to sedate patients to the level of moderate sedation, general anesthesia, or deep sedation. (3-20-20)T

- 01. Patient Safety.** In connection with the administration of nitrous oxide/oxygen, a dentist shall: (3-20-20)T
  - a. Evaluate the patient to insure that the patient is an appropriate candidate for nitrous/oxygen; and (3-20-20)T
  - b. Insure that any patient under nitrous/oxygen be continually monitored; and (3-20-20)T
  - c. Insure that a second person be in the practice setting who can immediately respond to any request from the person administering the nitrous/oxygen. (3-20-20)T

**02. Required Facilities and Equipment.** Dental offices in which nitrous oxide/oxygen is administered to patients shall, at a minimum and in addition to emergency medications, maintain appropriate facilities and have equipment on site for immediate use as follows: (3-20-20)T

- a. A nitrous oxide delivery system with a fail-safe system that is maintained in working order: (3-20-20)T
    - i. A functioning device that prohibits the delivery of less than thirty percent (30%) oxygen; or (3-20-20)T
    - ii. An appropriately calibrated and functioning in-line oxygen analyzer with audible alarm; and (3-20-20)T
  - b. An appropriate scavenging system must be available; and (3-20-20)T
  - c. A positive-pressure oxygen delivery system suitable for the patient being treated. (3-20-20)T
- 03. Personnel.** For nitrous oxide/oxygen administration, personnel shall include: (3-20-20)T

- a. An operator; and (3-20-20)T
- b. An assistant currently certified in BLS. (3-20-20)T
- c. Auxiliary personnel must have documented training in BLS, have specific assignments, and have current knowledge of the emergency cart inventory. The dentist and all office personnel must participate in periodic reviews of office emergency protocol. (3-20-20)T

**043. MINIMAL SEDATION.**

Persons licensed to practice dentistry in accordance with the Idaho Dental Practice Act and these rules may administer minimal sedation to patients of sixteen (16) years of age or older. When the intent is minimal sedation, the appropriate dosing of a single enteral drug is no more than the MRD. In cases where the patient weighs less than one hundred (100) pounds, or is under the age of sixteen (16) years, minimal sedation may be administered without a permit by use of nitrous oxide, or with a single enteral dose of a sedative agent administered in the dental office. (3-20-20)T

**01. Patient Safety.** The administration of minimal sedation is permissible so long as it does not produce an alteration of the state of consciousness in a patient to the level of moderate sedation, general anesthesia, or deep sedation. A dentist must qualify for and obtain a permit from the Board to be authorized to sedate patients to the level of moderate sedation, general anesthesia, or general anesthesia. Nitrous oxide/oxygen may be used in combination with a single enteral drug in minimal sedation, except as described in Section 043 of these rules. Notwithstanding any other provision in these rules, a dentist must initiate and regulate the administration of nitrous oxide/oxygen when used in combination with minimal sedation. (3-20-20)T

**02. Personnel.** At least one (1) additional person currently certified in BLS must be present in addition to the dentist. (3-20-20)T

**044. MODERATE SEDATION, GENERAL ANESTHESIA AND DEEP SEDATION.**

Dentists licensed in the state of Idaho cannot administer moderate sedation, general anesthesia, or deep sedation in the practice of dentistry unless they have obtained a permit from the Board. A moderate sedation permit may be either enteral or parenteral. A dentist may not administer moderate sedation to children under sixteen (16) years of age and one hundred (100) pounds unless they have qualified for and been issued a moderate parenteral sedation permit. A moderate enteral sedation permit authorizes dentists to administer sedation by either enteral or combination inhalation-enteral routes of administration. A moderate parenteral, general anesthesia, or deep sedation permit authorizes a dentist to administer sedation by any route of administration. To qualify for a moderate, general anesthesia, or deep sedation permit, a dentist must provide proof of the following: (3-20-20)T

**01. Training Requirements.** (3-20-20)T

a. For Moderate Sedation Permits, completion of training in the administration of moderate sedation to a level consistent with requirements established by the Board within the five (5) year period immediately prior to the date of application for a moderate sedation permit. The five (5) year requirement is not applicable to applicants who hold an equivalent permit in another state which has been in effect for the twelve (12) month period immediately prior to the application date. Qualifying training courses must be sponsored by or affiliated with a dental school accredited by CODA, or be approved by the Board. (3-20-20)T

i. For a moderate enteral sedation permit, the applicant must provide proof of a minimum of twenty-four (24) hours of instruction plus management of at least ten (10) adult case experiences by the enteral and/or enteral-nitrous oxide/oxygen route. These ten (10) cases must include at least three live clinical dental experiences managed by participants in groups no larger than five (5). The remaining cases may include simulations and/or video presentations but must include one experience in returning a patient from deep to moderate sedation. (3-20-20)T

ii. For a moderate parenteral sedation permit, the applicant must provide proof of a minimum of sixty (60) hours of instruction, plus management of at least twenty (20) patients by the intravenous route. (3-20-20)T

b. For General Anesthesia and Deep Sedation Permits, completion of an advanced education program



accredited by CODA that affords comprehensive training necessary to administer and manage deep sedation or general anesthesia within the five (5) year period immediately preceding the date of application. The five (5) year requirement is not applicable to applicants who hold an equivalent permit in another state which has been in effect for the twelve (12) month period immediately prior to the application date. (3-20-20)T

**02. ACLS.** Verification of current certification in ACLS or PALS, whichever is appropriate for the patient being sedated. (3-20-20)T

**03. General Requirements** The qualified dentist is responsible for the sedative management, adequacy of the facility and staff, diagnosis and treatment of emergencies related to the administration of moderate sedation, general anesthesia, or deep sedation and providing the equipment, drugs and protocol for patient rescue. Evaluators appointed by the Idaho State Board of Dentistry will periodically assess the adequacy of the facility and competence of the sedation team. For general anesthesia and deep sedation, the Board adopts the standards incorporated by reference in these rules, as set forth by the AAOMS in their office anesthesia evaluation manual. (3-20-20)T

**a. Facility, Equipment and Drug Requirements.** The following facilities, equipment and drugs must be available for immediate use during the sedation and recovery phase: (3-20-20)T

i. An operating room large enough to adequately accommodate the patient on an operating table or in an operating chair and to allow an operating team of at least two (2) individuals to freely move about the patient; (3-20-20)T

ii. An operating table or chair that permits the patient to be positioned so the operating team can maintain the patient's airway, quickly alter the patient's position in an emergency, and provide a firm platform for the administration of basic life support; (3-20-20)T

iii. A lighting system that permits evaluation of the patient's skin and mucosal color and a backup lighting system of sufficient intensity to permit completion of any operation underway in the event of a general power failure; (3-20-20)T

iv. Suction equipment that permits aspiration of the oral and pharyngeal cavities and a backup suction device which will function in the event of a general power failure; (3-20-20)T

v. An oxygen delivery system with adequate full face mask and appropriate connectors that is capable of delivering high flow oxygen to the patient under positive pressure, together with an adequate backup system; (3-20-20)T

vi. A recovery area that has available oxygen, adequate lighting, suction and electrical outlets. The recovery area can be the operating room (3-20-20)T

vii. A sphygmomanometer, pulse oximeter, oral and nasopharyngeal airways, supraglottic airway devices, and automated external defibrillator (AED); and (3-20-20)T

viii. Emergency drugs including, but not limited to, pharmacologic antagonists appropriate to the drugs used, bronchodilators, and antihistamines. (3-20-20)T

ix. Additional emergency equipment and drugs required for moderate parenteral sedation permits include precordial/pretracheal stethoscope or end-tidal carbon dioxide monitor, intravenous fluid administration equipment, vasopressors, and anticonvulsants. (3-20-20)T

x. Additional emergency equipment and drugs required for general anesthesia and deep sedation permits include precordial/pretracheal stethoscope and end-tidal carbon dioxide monitor, intravenous fluid administration equipment, vasopressors, and anticonvulsants. (3-20-20)T

**b. Personnel** (3-20-20)T

i. For moderate sedation, the minimum number of personnel is two (2) including: the operator and one (1) additional individual currently certified in BLS. (3-20-20)T

ii. For general anesthesia or deep sedation, the minimum number of personnel is three (3) including: the operator and two (2) additional individuals currently certified in BLS. When the same individual administering the general anesthesia or deep sedation is performing the dental procedure one (1) of the additional individuals must be designated for patient monitoring. (3-20-20)T

iii. Auxiliary personnel must have documented training in BLS, will have specific assignments, and shall have current knowledge of the emergency cart inventory. The dentist and all office personnel must participate in documented periodic reviews of office emergency protocol, including simulated exercises, to assure proper equipment function and staff interaction. (3-20-20)T

c. Pre-sedation Requirements. Before inducing moderate sedation, general anesthesia, or deep sedation a dentist must: (3-20-20)T

i. Evaluate the patient's medical history and document, using the American Society of Anesthesiologists Patient Physical Status Classifications, that the patient is an appropriate candidate for moderate sedation, general anesthesia, or deep sedation; (3-20-20)T

ii. Give written preoperative and postoperative instructions to the patient or, when appropriate due to age or psychological status of the patient, the patient's guardian; (3-20-20)T

iii. Obtain written informed consent from the patient or patient's guardian for the sedation; and (3-20-20)T

iv. Maintain a sedation record and enter the individual patient's sedation into a case/drug log. (3-20-20)T

d. Patient Monitoring. Patients must be monitored as follows: (3-20-20)T

i. For moderate sedation the patient must be continuously monitored using pulse oximetry. For general anesthesia or deep sedation, the patient must be continuously monitored using pulse oximetry and end-tidal carbon dioxide monitors. (3-20-20)T

ii. The patient's blood pressure, heart rate, and respiration must be recorded every five (5) minutes during the sedation and then continued every fifteen (15) minutes until the patient meets the requirements for discharge. These recordings must be documented in the patient record. The record must also include documentation of preoperative and postoperative vital signs, all medications administered with dosages, time intervals and route of administration. If this information cannot be obtained, the reasons must be documented in the patient's record. (3-20-20)T

iii. During the recovery phase, the patient shall be monitored by an individual trained to monitor patients recovering from sedation; (3-20-20)T

iv. A dentist will not release a patient who has undergone sedation except to the care of a responsible third party; (3-20-20)T

v. The dentist will assess the patient's responsiveness using preoperative values as normal guidelines and discharge the patient only when the following criteria are met: vital signs are stable, patient is alert and oriented, and the patient can ambulate with minimal assistance; and (3-20-20)T

vi. A discharge entry will be made by the dentist in the patient's record indicating the patient's condition upon discharge and the name of the responsible party to whom the patient was discharged. (3-20-20)T

e. Sedation of Other Patients. The permit holder must not initiate sedation on another patient until the previous patient is in a stable monitored condition and in the recovery phase following discontinuation of their

sedation. (3-20-20)T

**045. SEDATION PERMIT RENEWAL.**

**01. Permit Renewal.** Before the expiration date of a permit, the board will provide notice of renewal to the licensee. Failure to timely submit a renewal application and permit fee shall result in expiration of the permit and termination of the licensee's right to administer sedation. Failure to submit a complete renewal application and permit fee within thirty (30) days of expiration of the permit shall result in cancellation of the permit. Renewal of the permit will be required every five (5) years. Proof of a minimum of twenty-five (25) continuing education credit hours in sedation which may include training in medical/office emergencies will be required to renew a permit. In addition to the continuing education credit hours, a dentist must: (3-20-20)T

**a.** For a moderate enteral sedation permit, maintain current certification in BLS or ACLS. (3-20-20)T

**b.** For a moderate parenteral, general anesthesia, or deep sedation permit, maintain current certification in ACLS. (3-20-20)T

**02. Reinstatement.** A dentist may apply for reinstatement of a canceled or surrendered permit issued by the Board within five (5) years of the date of the permit's cancellation or surrender. Applicants for reinstatement of a sedation permit must satisfy the facility and personnel requirements and verify they have obtained an average of five (5) continuing education credit hours in sedation for each year subsequent to the date upon which the permit was canceled or surrendered. A fee for reinstatement will be assessed. (3-20-20)T

**046. SUSPENSION, REVOCATION OR RESTRICTION OF SEDATION PERMIT.**

The Board may, at any time and for just cause, institute proceedings to revoke, suspend, or otherwise restrict a sedation permit issued pursuant to Section 045 of these rules. If the Board determines that emergency action is necessary to protect the public, summary suspension may be ordered pending further proceedings. Proceedings to suspend, revoke or restrict a permit shall be subject to applicable statutes and rules governing administrative procedures before the Board. (3-20-20)T

**047. DETERMINATION OF DEGREE OF SEDATION BY THE BOARD.**

In any matter under review or in any proceeding being conducted in which the Board must determine the degree of central nervous system depression, the Board may base its findings or conclusions on, among other matters, the type, and dosages, and routes of administration of drugs administered to the patient and what result can reasonably be expected from those drugs in those dosages and routes administered in a patient of that physical and psychological status. (3-20-20)T

**048. USE OF OTHER ANESTHESIA PERSONNEL.**

A dentist who does not hold a sedation permit may perform dental procedures in a dental office on a patient who receives sedation induced by an anesthesiologist, a CRNA, or another dentist with a sedation permit as follows: (3-20-20)T

**01. Facility, Equipment, Drugs, and Personnel Requirements.** The dentist will have the same facility, equipment, drugs, and personnel available during the procedure and during recovery as required of a dentist who has a permit for the level of sedation being provided. (3-20-20)T

**02. Patient's Condition Monitored Until Discharge.** The qualified sedation provider who induces sedation will monitor the patient's condition until the patient is discharged and record the patient's condition at discharge in the patient's dental record as required by the rules applicable to the level of sedation being induced. The sedation record must be maintained in the patient's dental record and is the responsibility of the dentist who is performing the dental procedures. (3-20-20)T

**03. Use of Services of a Qualified Sedation Provider.** A dentist who intends to use the services of a qualified sedation provider must notify the Board in writing of his intent. Such notification need only be submitted once every licensing period. (3-20-20)T

**04. Advertising.** A dentist who intends to use the services of a qualified sedation provider may

advertise the service provided so long as each such advertisement contains a prominent disclaimer that the service “will be provided by a qualified sedation provider.” (3-20-20)T

**049. INCIDENT REPORTING.**

Dentists must report to the Board, in writing, within seven (7) days after the death or transport to a hospital or emergency center for medical treatment for a period exceeding twenty-four (24) hours of any patient to whom sedation was administered. (3-20-20)T

**050. – 054. (RESERVED)**

**055. TELEHEALTH SERVICES.**

Definitions applicable to these rules are those definitions set forth in the Idaho Telehealth Access Act and in Section 54-5703, Idaho Code. (3-20-20)T

**01. Licensure and Location.** Any dentist who provides any telehealth services to patients located in Idaho must hold an active Idaho license. (3-20-20)T

**02. Additional Requirements.** In addition to the requirements set forth in Section 54-5705, Idaho Code, during the first contact with the patient, a dentist licensed by the Board who is providing telehealth services must:

- a. Verify the location and identity of the patient; (3-20-20)T
- b. Disclose to the patient the dentist’s identity, their current location, telephone number, and Idaho license number; and (3-20-20)T
- c. Obtain appropriate consents from the patient after disclosures regarding the delivery models and treatment methods or limitations, including a special informed consent regarding the use of telehealth technologies. (3-20-20)T

**03. Standard of Care.** A dentist providing telehealth services to patients located in Idaho must comply with the applicable Idaho community standard of care. If a patient's presenting symptoms and conditions require a physical examination in order to make a diagnosis, the dentist may not provide diagnosis or treatment through telehealth services unless or until such information is obtained. (3-20-20)T

**04. Informed Consent.** In addition to the requirements of Section 54-5708, Idaho Code, evidence documenting appropriate patient informed consent for the use of telehealth technologies must be obtained and maintained at regular intervals consistent with the community standard of care. Appropriate informed consent should, at a minimum, include the following terms: (3-20-20)T

- a. Verification. Identification of the patient, the dentist, and the dentist’s credentials; (3-20-20)T
- b. Telehealth Determination. Agreement of the patient that the provider will determine whether or not the condition being diagnosed and/or treated is appropriate for telehealth services; (3-20-20)T
- c. Security Measures Information. Information on the security measures taken with the use of telehealth technologies, such as encrypting data, password protected screen savers and data files, or utilizing other reliable authentication techniques, as well as potential risks to privacy and notwithstanding such measures; (3-20-20)T
- d. Potential Information Loss. Disclosure that information may be lost due to technical failures. (3-20-20)T

**056. UNPROFESSIONAL CONDUCT.**

A licensee shall not engage in unprofessional conduct in the course of his practice. Unprofessional conduct by a person licensed under the provisions of Title 54, Chapter 9, Idaho Code, is defined as, but not limited to, one (1) of the following: (3-20-20)T

- 01. Fraud.** Obtaining fees by fraud or misrepresentation, or over-treatment either directly or through an insurance carrier. (3-20-20)T
- 02. Unlicensed Practice.** Employing directly or indirectly any suspended or unlicensed individual as defined in Title 54, Chapter 9, Idaho Code. (3-20-20)T
- 03. Unlawful Practice.** Aiding or abetting licensed persons to practice unlawfully. (3-20-20)T
- 04. Dividing Fees.** A dentist shall not divide a fee for dental services with another party, who is not a partner or associate with him in the practice of dentistry, unless: (3-20-20)T
- a.** The patient consents to employment of the other party after a full disclosure that a division of fees will be made; (3-20-20)T
- b.** The division is made in proportion to the services performed and responsibility assumed by each dentist or party. (3-20-20)T
- 05. Prescription Drugs.** Prescribing or administering prescription drugs not reasonably necessary for, or within the scope of, providing dental services for a patient. A dentist may not prescribe or administer prescription drugs to himself. A dentist shall not use controlled substances as an inducement to secure or maintain dental patronage or aid in the maintenance of any person's drug addiction by selling, giving or prescribing prescription drugs. (3-20-20)T
- 06. Harassment.** The use of threats or harassment to delay or obstruct any person in providing evidence in any possible or actual disciplinary action, or other legal action; or the discharge of an employee primarily based on the employee's attempt to comply with the provisions of Title 54, Chapter 9, Idaho Code, or the Board's Rules, or to aid in such compliance. (3-20-20)T
- 07. Discipline in Other States.** Conduct himself in such manner as results in a suspension, revocation or other disciplinary proceedings with respect to his license in another state. (3-20-20)T
- 08. Altering Records.** Alter a patient's record with intent to deceive. (3-20-20)T
- 09. Office Conditions.** Unsanitary or unsafe office conditions, as determined by the customary practice and standards of the dental profession in the state of Idaho and current recommendations of the American Dental Association and the Centers for Disease Control as referred to in Section 004. (3-20-20)T
- 10. Abandonment of Patients.** Abandonment of patients by licensees before the completion of a phase of treatment, as such phase of treatment is contemplated by the customary practice and standards of the dental profession in the state of Idaho, without first advising the patient of such abandonment and of further treatment that is necessary. (3-20-20)T
- 11. Use of Intoxicants.** Practicing while under the influence of an intoxicant or controlled substance where the same impairs the licensee's ability to practice with reasonable and ordinary care. (3-20-20)T
- 12. Mental or Physical Condition.** The inability to practice with reasonable skill and safety to patients by reason of age, illness, or as a result of any mental or physical condition. (3-20-20)T
- 13. Consent.** Revealing personally identifiable facts, data or information obtained in a professional capacity without prior consent of the patient, except as authorized or required by law. (3-20-20)T
- 14. Scope of Practice.** Practicing or offering to practice beyond the scope permitted by law, or accepting and performing professional responsibilities that the licensee knows or has reason to know that he or she is not competent to perform. (3-20-20)T
- 15. Delegating Duties.** Delegating professional responsibilities to a person when the licensee

delegating such responsibilities knows, or with the exercise of reasonable care and control should know, that such a person is not qualified by training or by licensure to perform them. (3-20-20)T

**16. Unauthorized Treatment.** Performing professional services that have not been authorized by the patient or his legal representative. (3-20-20)T

**17. Supervision.** Failing to exercise appropriate supervision over persons who are authorized to practice only under the supervision of a licensed professional. (3-20-20)T

**18. Legal Compliance.** Failure to comply with any provisions of federal, state or local laws, statutes, rules, and regulations governing or affecting the practice of dentistry or dental hygiene. (3-20-20)T

**19. Exploiting Patients.** Exercising undue influence on a patient in such manner as to exploit a patient for the financial or personal gain of a practitioner or of a third party. (3-20-20)T

**20. Misrepresentation.** Willful misrepresentation of the benefits or effectiveness of dental services. (3-20-20)T

**21. Disclosure.** Failure to advise patients or their representatives in understandable terms of the treatment to be rendered, alternatives, the name and professional designation of the provider rendering treatment, and disclosure of reasonably anticipated fees relative to the treatment proposed. (3-20-20)T

**22. Sexual Misconduct.** Making suggestive, sexual or improper advances toward a patient or committing any lewd or lascivious act upon or with a patient. (3-20-20)T

**23. Patient Management.** Use of unreasonable and/or damaging force to manage patients, including but not limited to hitting, slapping or physical restraints. (3-20-20)T

**24. Compliance with Dentist Professional Standards.** Failure by a dentist to comply with professional standards applicable to the practice of dentistry, as incorporated by reference in this chapter. (3-20-20)T

**25. Compliance with Dental Hygienist Professional Standards.** Failure by a dental hygienist to comply with professional standards applicable to the practice of dental hygiene, as incorporated by reference in this chapter. (3-20-20)T

**26. Failure to Provide Records to a Patient or Patient's Legal Guardian.** Refusal or failure to provide a patient or patient's legal guardian legible copies of dental records. Failure to provide a patient or patient's legal guardian with records under Subsection 040.26 within five (5) business days shall be considered unprofessional conduct. A patient or patient's legal guardian may not be denied a copy of his records for any reason, regardless of whether the person has paid for the dental services rendered. A person may be charged for the actual cost of providing the records but in no circumstances may a person be charged an additional processing or handling fee or any charge in addition to the actual cost. (3-20-20)T

**27. Failure to Cooperate with Authorities.** Failure to cooperate with authorities in the investigation of any alleged misconduct or interfering with a Board investigation by willful misrepresentation of facts, willful failure to provide information upon request of the Board, or the use of threats or harassment against any patient or witness to prevent them from providing evidence. (3-20-20)T

**28. Advertising.** Advertise in a way that is false, deceptive, misleading or not readily subject to verification. (3-20-20)T

**057. – 999. (RESERVED)**

## IDAPA 20 – IDAHO DEPARTMENT OF LANDS

### DOCKET NO. 20-0000-2000F (FEE RULE)

#### NOTICE OF OMNIBUS RULEMAKING – ADOPTION OF TEMPORARY RULE

**EFFECTIVE DATE:** The effective date of the temporary rules being adopted through this omnibus rulemaking is the adjournment date of the second regular session of the 65th Idaho State Legislature - March 20, 2020.

**AUTHORITY:** In compliance with Section 67-5226, Idaho Code, notice is hereby given this agency has adopted temporary rules. The action is authorized pursuant to:

- Sections 38-132 and 38-402, Idaho Code;
- Title 38, Chapter 12, including Section 38-1208, Idaho Code;
- Title 47, Chapters 3, 7, 8, 15, 16 and 18, including Sections 47-314(8), 47-315(8), 47-328(1), 47-710, 47-714, and 47-1316, Idaho Code;
- Title 58, Chapters 1, 3, 6, 12 and 13, including Sections 58-104, 58-105, 58-127, and 58-304 through 58-312, Idaho Code;
- Title 67, Chapter 52, Idaho Code;
- Article IX, Sections 7 and 8 of the Idaho Constitution; and
- The Equal Footing Doctrine (Idaho Admission Act of July 3, 1890, 26 Stat. 215, Chapter 656).

**DESCRIPTIVE SUMMARY:** The following is the required finding and concise statement of its supporting reasons for adopting temporary rules:

This temporary rulemaking adopts the following chapters under IDAPA 20:

#### **IDAPA 20**

- 20.02.14, *Rules for Selling Forest Products on State-Owned Endowment Lands*
- 20.03.01, *Rules Governing Dredge and Placer Mining Operations in Idaho*
- 20.03.02, *Rules Governing Mined Land Reclamation*
- 20.03.03, *Rules Governing Administration of the Reclamation Fund*
- 20.03.04, *Rules for the Regulation of Beds, Waters, and Airspace Over Navigable Lakes in the State of Idaho*
- 20.03.05, *Riverbed Mineral Leasing in Idaho*
- 20.03.08, *Easements on State Owned Lands*
- 20.03.09, *Easements on State Owned Submerged Lands and Formerly Submerged Lands*
- 20.03.13, *Administration of Cottage Site Leases on State Lands*
- 20.03.14, *Rules Governing Grazing, Farming, Conservation, Noncommercial Recreation, and Communication Site Leases*
- 20.03.15, *Rules Governing Geothermal Leasing on Idaho State Lands*
- 20.03.16, *Rules Governing Oil and Gas Leasing on Idaho State Lands*
- 20.03.17, *Rules Governing Leases on State-Owned Submerged Lands and Formerly Submerged Lands*
- 20.04.02, *Rules Pertaining to the Idaho Forestry Act and Fire Hazard Reduction Laws*

The **Idaho Board of Scaling Practices** adopts the following temporary rule under IDAPA 20.06:

- 20.06.01, *Rules of the Idaho Board of Scaling Practices*

The **Oil and Gas Conservation Commission** adopts the following temporary rule under IDAPA 20.07:

- 20.07.02, *Rules Governing Conservation of Oil and Natural Gas in the State of Idaho*

**TEMPORARY RULE JUSTIFICATION:** Pursuant to Sections 67-5226(1) and 67-5226(2), Idaho Code, the Governor has found that temporary adoption of the rules is appropriate for the following reasons:

These temporary rules are necessary to protect the public health, safety, and welfare of the citizens of Idaho and confer a benefit on its citizens. These temporary rules implement the duly enacted laws of the state of Idaho, provide citizens with the detailed rules and standards for complying with those laws, and assist in the orderly execution and enforcement of those laws. The expiration of these rules without due consideration and processes would undermine the public health, safety, and welfare of the citizens of Idaho and deprive them of the benefit intended by these rules.

**FEE SUMMARY:** Pursuant to Section 67-5226(2), the Governor has found that the fees or charges being imposed or increased is justified and necessary to avoid immediate danger and the fees is described herein:

The fees or charges, authorized in Sections 38-122, 38-404, 38-1209, 47-315(5)(e), 47-316, 47-710, 47-1506(g), 47-1508(f), 47-1316, 47-1803, 58-104, 58-105, 58-127, 58-304, 58-601, 58-603, and 58-1307, Idaho Code, are part of the agency's 2020 budget that relies upon the existence of these fees or charges to meet the state's obligations and provide necessary state services. Failing to reauthorize these temporary rules would create immediate danger to the state budget, immediate danger to necessary state functions and services, and immediate danger of a violation of Idaho's constitutional requirement that it balance its budget.

The following is a specific description of the fees or charges:

- 20.02.14 – Stumpage payments and associated bonding for removal of state timber from endowment land pursuant to timber sales.
- 20.03.01 – Application fee, amendment fee, assignment fee, and inspection fee for all dredge and placer permits in the state of Idaho.
- 20.03.02 – Application fee for permanent closure plans and assignment fee for reclamation plans and permanent closure plans.
- 20.03.03 – Annual payment for Reclamation Fund participation.
- 20.03.04 – Application fees for encroachment permits and deposits toward the cost of newspaper publication.
- 20.03.05 – Fees for applications, advertising applications, exploration locations, and approval of assignments for riverbed mineral leasing.
- 20.03.08 – Application fee, easement consideration fee, appraisal costs, and assignment fee for easements on state-owned lands.
- 20.03.09 – Administrative fee, appraisal costs, and assignment fee for easements on state-owned submerged lands and formerly submerged lands.
- 20.03.13 – Annual rental payment paid to the endowment for which the property is held.
- 20.03.14 – Lease application fee, full lease assignment fee, partial lease assignment fee, mortgage agreement fee, sublease fee, late rental payment fee, minimum lease fee, and lease payment extension request fee on state endowment trust lands.
- 20.03.15 – Application fee, assignment fee, and late payment fee for geothermal leases on state-owned lands.
- 20.03.16 – Exploration location permit fee, nomination fee, and processing fee for oil and gas leases on endowment lands.
- 20.03.17 – Application fee, rental rate, and assignment fee for leases on state-owned submerged lands and formerly submerged lands.
- 20.04.02 – Fee imposed upon the harvest and sale of forest products to establish hazard management performance bonds for the abatement of fire hazard created by a timber harvest operation, and fees imposed upon contractors for transferring fire suppression cost liability back to the State.
- 20.06.01 – Scaling assessment fee paid to a dedicated scaling account for all scaled timber harvested within the state of Idaho; administrative fees for registration, renewal, and transfer of log brands; fees for testing and issuance of a temporary scaling permit, specialty scaling license, and standard scaling license; fee to renew a specialty or standard scaling license; and fee for a requested check scale involving a scaling dispute.
- 20.07.02 – Bonding for oil and gas activities in Idaho and application fees for seismic operations; permit to drill, deepen or plug back; multiple zone completions; well treatment; pits and directional deviated wells.

**ASSISTANCE ON TECHNICAL QUESTIONS:** For assistance on technical questions concerning the temporary rule, contact Amy Johnson at (208) 334-0255 or [rulemaking@idl.idaho.gov](mailto:rulemaking@idl.idaho.gov).

DATED this 21st day of February, 2020.

Dustin Miller, Director  
Idaho Department of Lands  
300 N. 6th St, Suite 103  
P.O. Box 83720

Boise, Idaho 83720-0050  
Phone: (208) 334-0242  
Fax: (208) 334-3698  
[rulemaking@idl.idaho.gov](mailto:rulemaking@idl.idaho.gov)



**20.02.14 – RULES FOR SELLING FOREST PRODUCTS ON STATE-OWNED ENDOWMENT LANDS**

**000. LEGAL AUTHORITY.**

This chapter is adopted under the legal authority of Sections 38-1201, et seq.; 58-104(6); 58-105; 67-5201, et seq.; Idaho Code. (3-20-20)T

**001. TITLE AND SCOPE.**

**01. Title.** These rules are titled IDAPA 20.02.14 “Rules for Selling Forest Products on State-Owned Endowment Lands”. (3-20-20)T

**02. Scope.** These rules govern the selling of forest products from state endowment lands. (3-20-20)T

**002. INCORPORATION BY REFERENCE.**

The following document is incorporated by reference into these rules: American National Standard Institute, 05.1, 2002 Edition, published by the Alliance for Telecommunication Industry Solutions and available to purchase on the Internet at <http://www.atis.org>. (3-20-20)T

**003. -- 009. (RESERVED)**

**010. DEFINITIONS.**

**01. Board.** The Idaho State Board of Land Commissioners. (3-20-20)T

**02. Contract.** Timber sale contract in a form prescribed by the Department. (3-20-20)T

**03. Department.** The Idaho Department of Lands. (3-20-20)T

**04. Development Credits.** A stumpage credit received by the purchaser for the construction or reconstruction of roads, bridges, or other permanent improvements. (3-20-20)T

**05. Director.** The director of the Idaho Department of Lands or his authorized representative. (3-20-20)T

**06. Forest Products.** Marketable forest materials. (3-20-20)T

**07. Net Appraised Value.** The minimum estimated sale value of the forest products after deducting the development credit. (3-20-20)T

**08. Net Sale Value.** The final sale bid value of the forest products after deducting the development credit. (3-20-20)T

**09. Purchaser.** A successful bidder for forest products from a state sale who has executed a timber sale contract. (3-20-20)T

**10. Roads.** Forest access roads used for the transportation of forest products. (3-20-20)T

**011. -- 018. (RESERVED)**

**019. FIREWOOD AND OTHER PERSONAL USE PRODUCT PERMITS.**

Forest product permits for personal use will be sold on a charge basis. The Director will determine permit rates and maximum permit values. (3-20-20)T

**020. DIRECT SALES.**

The sale of forest products without advertisement may be authorized by the Director if the net appraised value does not exceed the maximum value established by the Board. This type of sale is to be used to harvest isolated or by-passed parcels of timber of insufficient value and volume to justify a timber sale (refer to Section 021). The direct sale will not be used when two (2) or more potential purchasers may be interested in bidding on the forest products offered for sale. The initial duration of a direct sale is six (6) months with a provision for one six (6) month extension. The purchaser must furnish an acceptable performance bond in the amount of thirty percent (30%) of the sale value with a minimum bond of one hundred dollars (\$100). Advance payment will be required and all sales will be on a lump sum basis. (3-20-20)T

**021. TIMBER SALES.**

Timber sales exceed the net appraised value or volume for direct sales established by the Board. (3-20-20)T

**022. -- 025. (RESERVED)**

**026. ANNUAL SALES PLAN.**

The Department will prepare an annual sales plan which will describe the timber sales to be offered for sale during the forthcoming fiscal year. The plan will be based on recommended annual harvest volumes utilizing inventory data, local stand conditions, special management problems, and economic factors. The plan will be presented to the Board for approval annually and upon approval made available to all interested parties. The plan may be altered to respond to changing market conditions or to expedite the sale of damaged or insect-infested forest products. (3-20-20)T

**027. -- 030. (RESERVED)**

**031. TIMBER SALE AUCTIONS.**

**01. Requirements.** Timber and Delivered Products sales must be sold at public auction. (3-20-20)T

**02. Requirements for Bidding.** Bidders must: (3-20-20)T

**a.** Present a bid deposit in a form acceptable to the State in the amount of ten percent (10%) of the net appraised value. (3-20-20)T

**b.** Not be delinquent on any payments to the State at the time of sale. (3-20-20)T

**c.** Not be a minor as defined in Section 32-101, Idaho Code. (3-20-20)T

**d.** If a foreign corporation, have a completed and accepted foreign registration statement with the secretary of state and comply with Title 30, Chapter 21, Part 5, Idaho Code in order to do business in Idaho and be eligible to bid on and purchase State timber. (3-20-20)T

**032. INITIAL DEPOSIT AND BONDS.**

**01. Initial Deposit.** The initial deposit (ten percent (10%) of net sale value) is paid in cash and retained by the state as a cash reserve for the duration of the contract; the purchaser is not entitled to any interest earned thereon. All or a portion of the initial deposit may be applied to charges as the contract nears completion. Any remaining initial deposit will be forfeited in the event the contract is terminated without being completed. (3-20-20)T

**02. Performance Bond.** A bond of sufficient amount for carrying out in good faith all applicable laws and all the terms and conditions imposed by the Board and the sale contract or fifteen percent (15%) of the net sale value of the forest products (whichever is greater) is to be executed within thirty (30) days from the date of sale and prior to execution of the contract. Failure to perform on the contract may result in forfeiture of all or a portion of the performance bond. (3-20-20)T

**03. Guarantee of Payment.** Prior to cutting of any forest products, the purchaser must provide a bond acceptable to the Department as assurance of payment for products to be cut or removed, or both, during the next ninety (90) days. Guarantee of payment on delivered product sales will be as determined by the Department. This bond is in addition to the required initial deposit. Failure to make full and timely payment as per contract terms may result in forfeiture of all or a portion of the guarantee of payment. (3-20-20)T

**033. -- 040. (RESERVED)**

**041. STUMPAGE AND INTEREST PAYMENT.**

A stumpage summary of forest products measured during the prior month and a statement of account will be prepared by the Department and forwarded to the purchaser monthly. The statement will include interest computed from the date of sale to the date of the billing at a rate specified in the contract. The purchaser must make payments within thirty (30) days of the end of the billing period or the payment is considered delinquent. Interest will not be charged on delivered

product sales. (3-20-20)T

**042. TIMBER SALE CANCELLATION.**

It is the purchaser's responsibility to initiate cancellation by submitting such request in writing to the respective supervisory area office. When all contractual requirements have been completed, final payments have been received, all load tickets have been accounted for, and a written request for cancellation has been received by the Department, any credit balances and all cash bonds will be returned and/or transferred to other timber sale accounts within forty-five (45) days, as requested by the purchaser. (3-20-20)T

**043. PREMATURE TIMBER SALE TERMINATION.**

**01. Request.** A timber sale purchaser may, for reasons of hardship, make written request to terminate a timber sale contract before harvesting is completed. In such cases, the Board will determine if a hardship exists and if the contract should be terminated. (3-20-20)T

**02. Termination Policy.** (3-20-20)T

**a.** The Board may authorize premature termination of any sale under any terms considered reasonable and appropriate. Any remaining amount of the ten percent (10%) initial deposit will be retained in full and applied towards assessed damages and may not be used as payment for forest products cut and/or removed. Assessed damages in excess of the initial deposit will be applied against the performance bond. (3-20-20)T

**b.** The following damages will be assessed by the Board for premature sale terminations. (3-20-20)T

**i.** The Board will seek payment of the value of the overbid for the uncut residual volume. For example, if white pine had been bid up by five dollars (\$5) per thousand board feet over the appraised price and there are one hundred thousand (100,000) board feet of white pine remaining on the sale area, the purchaser will be assessed five hundred dollars (\$500) upon termination. (3-20-20)T

**ii.** The Board will seek payment of the accrued stumpage interest due the endowed institutions based on the interest rate specified in the contract and calculated on all remaining volume from the date of sale to the date the Board approved termination of the contract. (3-20-20)T

**iii.** The Board will seek payment for any credits given for developments that remain incomplete at the time of termination. (3-20-20)T

**iv.** The Board will seek payment for estimated Department costs associated with reoffering the timber sale. (3-20-20)T

**v.** The Board may also seek payment for other expenses including, but not limited to, legal costs and Department staff time. (3-20-20)T

**c.** If logging has occurred on the sale, the purchaser must complete the units that have been partially logged according to contract standards and complete all development work as specified in the contract to the extent of allowances that have been credited to the purchaser. (3-20-20)T

**d.** The purchaser who has terminated a timber sale contract is not eligible to rebid that particular sale unless specifically authorized to do so by the Board. (3-20-20)T

**044. -- 999. (RESERVED)**

## 20.03.01 – RULES GOVERNING DREDGE AND PLACER MINING OPERATIONS IN IDAHO

### 000. LEGAL AUTHORITY.

These rules are promulgated by the Idaho State Board of Land Commissioners pursuant to Section 47-1316, Idaho Code. The Board has delegated to the Director of the Department of Lands (“department”) the duties and powers under the act and these rules; provided that the Board retains responsibility for approval of permit and administrative review. (3-20-20)T

### 001. TITLE AND SCOPE.

**01. Title.** These rules are titled IDAPA 20.03.01 “Rules Governing Dredge and Placer Mining Operations in Idaho.” (3-20-20)T

**02. Scope.** These rules constitute the Idaho Department of Lands’ administrative procedures for implementation of the Idaho Dredge and Placer Mining Protection Act with the intent and purpose to protect the lands, streams and watercourses within the state, from destruction by dredge mining and by placer mining, and to preserve the same for the enjoyment, use and benefit of all of the people, and that clean water in the streams of Idaho is in the public interest. (3-20-20)T

### 002. ADMINISTRATIVE APPEALS.

**01. Procedures for Appeals:** (3-20-20)T

**a.** Any applicant or permit holder aggrieved by any final decision or order of the Board is entitled to judicial review in accordance with the provisions and standards set forth in Title 67, Chapter 52, Idaho Code, the Administrative Procedures Act. (3-20-20)T

**b.** When the Director or the Board finds that justice so requires, it may postpone the effective date of a final order pending judicial review. The reviewing court, including the court to which a case may be taken on appeal, may issue all necessary and appropriate orders to postpone the effective date of any final order pending conclusion of the review proceedings. (3-20-20)T

**c.** Notwithstanding any other provisions of these rules concerning administrative or judicial proceedings, whenever the Board determines that a Permittee has not complied with the provisions of the act or these rules, the Board may file a civil action in the district court for the county wherein the violation or some part occurred, or in the district court for the county where the defendant resides. The Board may request the court to issue an appropriate order to remedy any alleged violation. (3-20-20)T

### 003. -- 009. (RESERVED)

### 010. DEFINITIONS.

**01. Act.** The Idaho Placer and Dredge Mining Protection Act, Title 47, Chapter 13, Idaho Code. (3-20-20)T

**02. Approximate Previous Contour.** A contour reasonably comparable to that contour existing prior to disturbance, or that blends with the adjacent topography. (3-20-20)T

**03. Best Management Practices.** Methods, measures, or practices to prevent or reduce nonpoint source (NPS) water pollution, including, but not limited to, structural and nonstructural controls, and operation and maintenance procedures. Usually, BMPs are applied as a system of practices rather than a single practice. BMPs are selected on the basis of site-specific conditions that reflect natural background conditions; political, social, economic, and technical feasibility; and stated water quality goals. (3-20-20)T

**04. Board.** The State Board of Land Commissioners or any department, commission, or agency that may lawfully succeed to the powers and duties of such Board. (3-20-20)T

**05. Department.** The Idaho Department of Lands. (3-20-20)T

**06. Director.** The Director of the Department of Lands or such representative as may be designated by the Director. (3-20-20)T

**07. Disturbed Land or Affected Land.** Land, natural watercourses, or existing stockpiles and waste

piles affected by placer or dredge mining, re-mining, exploration, stockpiling of ore wastes from placer or dredge mining, or construction of roads, tailings ponds, structures, or facilities appurtenant to placer or dredge mining operations. (3-20-20)T

**08. Final Order of the Board.** A written notice of rejection or approval, the order of a hearing officer at the conclusion of a hearing, or any other order of the Board where additional administrative remedies are not available. (3-20-20)T

**09. Hearing Officer.** That person duly appointed by the Board to hear proceedings under Section 47-1320, Idaho Code. It also means that person selected by the Director to hear proceedings initiated under Section 030 or Section 051 of these rules. (3-20-20)T

**10. Mine Panel.** That area designated by the Permittee as an identifiable portion of a placer or dredge mine on the map submitted pursuant to Section 47-1317, Idaho Code. (3-20-20)T

**11. Mineral.** Any ore, rock or substance extracted from a placer deposit or from an existing placer stockpile or wastepile, but does not include coal, clay, stone, sand, gravel, phosphate, uranium, oil or gas. (3-20-20)T

**12. Motorized Earth-Moving Equipment.** Backhoes, bulldozers, front-loaders, trenchers, core drills, draglines, and suction dredges with an intake diameter exceeding eight (8) inches, and other similar equipment. (3-20-20)T

**13. Mulch.** Vegetation residues or other suitable materials to aid in the stabilization of soil and soil moisture conservation. (3-20-20)T

**14. Natural Watercourse.** Any stream in the state of Idaho having definite bed and banks, and which confines and conducts continuously flowing water. (3-20-20)T

**15. Overburden.** Material extracted by a Permittee which is not a part of the material ultimately removed from a placer or dredge mine and marketed by a Permittee, exclusive of mineral stockpiles. Overburden is comprised of topsoil and waste. (3-20-20)T

**16. Overburden Disposal Area.** Land surface upon which overburden is piled or planned to be piled. (3-20-20)T

**17. Permanent Cessation.** Mining operations as to the whole or any part of the permit area have stopped and there is substantial evidence that such operations will not resume within one (1) year. The date of permanent cessation is the last day when mining operations are known or can be shown to have occurred. (3-20-20)T

**18. Permit Area.** That area designated under Section 021 as the site of a proposed placer or dredge mining operation, including all lands to be disturbed by the operation. (3-20-20)T

**19. Permittee.** The person in whose name the permit is issued and who is to be held responsible for compliance with the conditions of the permit by the department. (3-20-20)T

**20. Person.** Any person, corporation, partnership, association, or public or governmental agency engaged in placer or dredge mining, whether individually, jointly, or through subsidiaries, agents, employees, or contractors. (3-20-20)T

**21. Pit.** An excavation created by the extraction of minerals or overburden during placer mining or exploration operations. (3-20-20)T

**22. Placer Deposit.** Naturally occurring unconsolidated surficial detritus containing valuable minerals, whether located inside or outside the confines of a natural watercourse. (3-20-20)T

**23. Placer Stockpile.** Placer mineral extracted during past or present placer or dredge mining operations and retained at the mine for future rather than immediate use. (3-20-20)T

**24. Placer or Dredge Exploration Operation.** Activities including, but not limited to, the construction of roads, trenches, and test holes performed on a placer deposit for the purpose of locating and determining the economic feasibility of extracting minerals by placer or dredge mining. (3-20-20)T

**25. Placer or Dredge Mining or Dredge or Other Placer Mining.** The extraction of minerals from a placer deposit, including remining for sale, processing, or other disposition of earth material excavated from previous placer or dredge mining. (3-20-20)T

**26. Placer or Dredge Mining Operation.** Placer or dredge mining which disturbs in excess of one-half (1/2) acre of land during the life of the operation. (3-20-20)T

**27. Reclamation.** The process of restoring an area disturbed by a placer or dredge mining operation or exploration operation to its original or another beneficial use, considering land uses, possible future uses, and surrounding topography. The objective is to re-establish a diverse, self-perpetuating plant community, and to minimize erosion, remove hazards, and maintain water quality. (3-20-20)T

**28. Revegetation.** The establishment of the premining vegetation or a comparable vegetative cover on the land disturbed by placer or dredge mining operations. (3-20-20)T

**29. Road.** A way including the bed, slopes, and shoulders constructed within the circular tract circumscribed by a placer or dredge mining operation, or constructed solely for access to a placer or dredge mining operation or placer or dredge exploration operation. A way dedicated to public multiple use or being used by a governmental land manager or private landowner at the time of cessation of operations and not constructed solely for access to a placer or dredge mining operation or exploration operation, is not considered a road. (3-20-20)T

**30. Settling Pond.** A manmade enclosure or natural impoundment structure constructed and used for the purpose of treating mine process water and/or runoff water from adjacent disturbed areas by the removal or settling of sediment particles. Several types of settling ponds or a series of smaller ponds may be used in water management. The most common type is a recycle or recirculation pond which is used to pump clarified water back to the wash plant operation. (3-20-20)T

**31. Surface Waters.** The surface waters of the state of Idaho. (3-20-20)T

**32. Topsoil.** The unconsolidated mineral and organic matter naturally present on the surface of the earth that is necessary for the growth and regeneration of vegetation. (3-20-20)T

**011. ABBREVIATIONS.**

**01. BMP.** Best Management Practices. (3-20-20)T

**02. DEQ.** Department of Environmental Quality. (3-20-20)T

**012. PURPOSE AND GENERAL PROVISIONS.**

**01. Policy.** It is the policy of the state of Idaho to protect the lands, streams, and watercourses within the state from destruction by placer mining, and to preserve them for the enjoyment, use, and benefit of all of the people, and that clean water in the streams of Idaho is in the public interest. (3-20-20)T

**02. Purpose.** These rules are intended to implement the requirements for operation and reclamation of placer and dredge mining set forth in the Idaho Code. Compliance with these rules will allow removal of minerals while preserving water quality and ensuring rehabilitation for beneficial use of the land following mining. Placer and dredge mining is expressly prohibited upon certain waterways included in the federal wild and scenic rivers system. It is also the purpose of these rules to implement the state of Idaho's antidegradation policy as set out in Executive Order No. 88-23 as it pertains to placer mining and exploration operations. (3-20-20)T

**03. General Provisions.** In general, these rules establish: (3-20-20)T

- a. Requirements for placer mine exploration operations; (3-20-20)T
- b. Procedures for securing a placer and dredge mining permit; (3-20-20)T
- c. The requirements for posting a performance bond as a condition of such permit to ensure the completion of rehabilitation operations; (3-20-20)T
- d. Procedures for initial and periodic inspection of placer and dredge mining operations to ensure compliance with these rules; (3-20-20)T
- e. Prohibition of placer and dredge mining on designated watercourses (see Section 060); and (3-20-20)T
- f. Prohibitions against placer and dredge mining on certain lands when not in the public interest. (3-20-20)T

**04. Compliance with Other Laws.** Placer and dredge exploration operations and mining operations must comply with all applicable rules and laws of the state of Idaho including, but not limited to, the following: (3-20-20)T

- a. Idaho Environmental Protection and Health Act, Title 39, Chapter 1, Idaho Code, and rules as promulgated and administered by the Idaho Department of Environmental Quality. (3-20-20)T
- b. Idaho Stream Channel Protection Act, Title 42, Chapter 38, Idaho Code, and applicable rules as promulgated and administered by the Idaho Department of Water Resources. (3-20-20)T
- c. Idaho Dam Safety Act, Section 42-1710 through 42-1721, Idaho Code, and applicable rules and regulations as promulgated and administered by the Idaho Department of Water Resources. (3-20-20)T

**013. APPLICABILITY.**

**01. All Lands in State.** These rules apply to all lands within the state, including private and federal lands, which are disturbed by placer or dredge mining conducted after November 24, 1954. (3-20-20)T

**02. Types of Operations.** These rules apply to placer and dredge mining operations and placer and dredge exploration operations as defined under Section 47-1313, Idaho Code, and Subsections 010.24, 010.25, and 010.26 and to the following activities: (3-20-20)T

- a. The extraction of minerals from a placer deposit, including the removal of vegetation, topsoil, overburden, and minerals; construction, and operation of on-site processing equipment; disposal of overburden and waste materials; design and operation of siltation and other water quality control facilities; and other activities contiguous to the mining site that disturb land and affect water quality and/or water quantity. (3-20-20)T
- b. All exploration activities conducted upon a placer deposit using motorized earth-moving equipment. (3-20-20)T

**03. Nonapplicability.** These rules do not apply to mining operations regulated by the Idaho Surface Mining Act; neither do they apply to surface disturbance caused by the underground mining of a placer deposit, unless the deposit outcrops on or near the surface and the operation will result in the probable subsidence of the land surface. (3-20-20)T

**04. Stream Channel Alterations.** These rules do not exempt the Permittee from obtaining a stream channel alteration permit if required by the Idaho Department of Water Resources. (3-20-20)T

**05. Navigational Improvements.** These rules do not apply to dredging operations conducted for the sole purpose of establishing and maintaining a channel for navigation. (3-20-20)T

**06. Suction Dredges.** These rules do not apply to dredging operations in streams or riverbeds using suction dredges with an intake diameter of eight (8) inches or less. However, these rules do not affect or exempt the applicability of Section 47-701, Idaho Code, regarding leasing of the state-owned beds of navigable lakes, rivers, and streams, Section 47-703A, Idaho Code, regarding exploration on navigable lakes and streams, and Section 39-118, Idaho Code, regarding review of plans for waste treatment or disposal facilities such as settling or recycle ponds. (3-20-20)T

**014. ADMINISTRATION.**

The Department of Lands shall administer these rules under the direction of the director. (3-20-20)T

**015. -- 019. (RESERVED)**

**020. PLACER OR DREDGE EXPLORATION OPERATIONS.**

**01. Notice.** Any person desiring to conduct placer or dredge exploration operations using motorized earth-moving equipment must, within seven (7) days of commencing exploration, notify the Director. The notice includes the following: (3-20-20)T

**a.** The name and address of the operator; (3-20-20)T

**b.** The legal description of the exploration operation and its starting and estimated completion date; (3-20-20)T  
and

**c.** The anticipated size of the exploration operation and the general method of operation. (3-20-20)T

**02. Confidentiality.** The exploration notice will be treated confidential pursuant to Sections 74-107 and 47-1314, Idaho Code. (3-20-20)T

**03. One-Half Acre Limit.** Any placer or dredge exploration operation that causes a cumulative surface disturbance in excess of one-half (1/2) acre of land, including roads, is considered a placer or dredge mining operation and subject to the requirements outlined in Sections 021 through 065. Lands disturbed by any placer or dredge exploration operation that causes a cumulative surface disturbance of less than one-half (1/2) acre of land, including roads, must be restored to conditions reasonably comparable to conditions existing prior to the placer or dredge exploration operation and as outlined in Subsection 020.04. (3-20-20)T

**04. Reclamation Required.** The following reclamation activities, required to be conducted on exploration sites, must be performed in a workmanlike manner with all reasonable diligence, and as to a given exploration drill hole, road, pit, or trench, within one (1) year after abandonment thereof: (3-20-20)T

**a.** Drill holes must be plugged within one (1) year of abandonment with a permanent concrete or bentonite plug. (3-20-20)T

**b.** Restore all disturbed lands, including roads, to conditions reasonably comparable to conditions existing prior to the placer or dredge exploration operations. (47-1314(b)) (3-20-20)T

**c.** Conduct revegetation activities in accordance with Subsection 040.17. Unless otherwise required by a federal agency, one (1) pit or trench on a federal mining claim showing discovery, may be left open pending verification by federal mining examiners. Such abandoned pits and trenches must be reclaimed within one (1) year of verification; (3-20-20)T

**d.** If water runoff from exploration operations causes siltation or other pollution of surface waters, the operator will prepare disturbed lands and adjoining lands under his or her control, as is necessary to meet state water quality standards. (3-20-20)T

**e.** Abandoned lands disturbed by an exploration operation must be top-dressed to the extent that such overburden is reasonably available from any pit or other excavation created by the exploration operation, with that



type of overburden that is conducive to the control of erosion or the growth of vegetation that the operator elects to plant thereon; (3-20-20)T

f. Any water containment structure created in connection with exploration operations will be constructed, maintained, and reclaimed so as not to constitute a hazard to human health or the environment. (3-20-20)T

**021. APPLICATION PROCEDURE FOR PLACER OR DREDGE MINING PERMIT.**

**01. Approved Reclamation Plan Required.** No Permittee may conduct placer or dredge mining operations, as defined in these rules, on any lands in the state of Idaho until the placer mining permit has been approved by the Board, the department has received a bond meeting the requirements of these rules, and the permit has been signed by the Director and the Permittee. (3-20-20)T

**02. Application Package.** The Permittee must submit a complete application package, for each separate placer mine or mine panel, before the placer permit will be reviewed. Separate placer mines are individual, physically disconnected operations. The complete application package consists of: (3-20-20)T

a. An application completed by the applicant on a form provided by the Director; (3-20-20)T

b. A map or maps of the proposed mining operation which includes the information required under Subsection 021.04; (3-20-20)T

c. A reclamation plan, in map and narrative form, which includes the information required under Subsection 021.06. The map and reclamation plan may be combined on one (1) sheet if practical; (3-20-20)T

d. Document(s) identifying and assessing foreseeable, site-specific nonpoint sources of water quality impacts upon adjacent surface waters, and the best management practices the applicant will take to control such nonpoint source impacts; (3-20-20)T

e. When the Director determines, after consultation with DEQ, that there is an unreasonably high potential for nonpoint source pollution of adjacent surface waters, the Director will request, and the applicant will provide to the Director, baseline pre-project surface water monitoring information and furnish ongoing monitoring data during the life of the project. This provision does not require any additional baseline preproject surface water monitoring information or ongoing monitoring data where such information or data is already required to be provided pursuant to any federal or state law and is available to the Director; (3-20-20)T

f. An out-of-state Permittee must designate an in-state agent authorized to act on behalf of the Permittee. In case of an emergency requiring action to be taken to prevent environmental damage, the authorized agent will be notified as well as the Permittee; and (3-20-20)T

g. An application fee of fifty dollars (\$50) for each ten (10) acres or fraction of land included in an application for a new mining permit, or of land to be affected or added in an amended application to an existing mining permit, must be included with the application. No application fee will exceed one thousand dollars (\$1,000). (3-20-20)T

**03. Incomplete Applications.** An application for a permit may be returned for correction if the information provided on the application form or associated mine map(s) or reclamation plan is incomplete or otherwise unsatisfactory. The Director will not proceed on the application until all necessary information is submitted. (3-20-20)T

a. If the applicant is not the owner of the lands described in the application, or any part thereof, the land owner must endorse his approval of the application prior to issuance of a permit. The federal government, as a property owner, will be notified of the application, and asked to endorse the application as property owner. For mining operations proposed upon land under a mining lease, either the signature of the lessor must be affixed to the application or a copy of the complete lease attached to the application. (3-20-20)T

**04. Requirements of Maps.** Vicinity maps must be prepared on standard United States Geological Survey, seven and one-half (7.5) minute quadrangle maps, or equivalent. In addition, maps of the proposed placer mining operation site will be of sufficient scale to adequately show the following: (3-20-20)T

**a.** The location of existing roads and anticipated access and main haulage roads planned for construction in connection with the mining operation, along with approximate dates for construction, reconstruction, and abandonment; (3-20-20)T

**b.** The approximate location, and the names of all known streams, creeks, springs, wells, or bodies of water within one thousand (1,000) feet of the mining operation; (3-20-20)T

**c.** The approximate boundaries of all lands to be disturbed in the process of mining, including legal description to the quarter-quarter section; (3-20-20)T

**d.** The approximate boundaries and acreage of the lands that will become disturbed land as a result of the placer or dredge mining operation during the first year of operations following issuance of a placer mining permit; (3-20-20)T

**e.** The planned location and configuration of pits, mineral stockpiles, topsoil stockpiles, and waste dumps within the mining property; (3-20-20)T

**f.** Scaled cross-sections, of length and width, which are representative of the placer or dredge mining operation, showing the surface contour prior to mining and the expected surface contour after reclamation activities have been completed; (3-20-20)T

**g.** The location of required settling ponds, the design plans, construction specifications and narrative to show they meet both operating requirements and protection from erosion, seepage, and flooding that can be anticipated in the area. Where a dredge is operating in a stream, describe by drawing and narrative, the operation of the filtration equipment to be used to clarify the water. (3-20-20)T

**h.** Surface and mineral control or ownership of appropriate scale for boundary identification. (3-20-20)T

**05. Settling Ponds.** Detailed plans and specifications for settling ponds must be drawn to a scale of one (1) inch = ten (10) feet and include the following: (3-20-20)T

**a.** A detailed map of the settling pond location, including: (3-20-20)T

**i.** Dimensions and orientation of the settling ponds and/or other wastewater treatment components of the operation; (3-20-20)T

**ii.** Distance from surface waters; (3-20-20)T

**iii.** Pond inlet/outlet locations including emergency spillways and detailed description of control structures and piping; (3-20-20)T

**iv.** Location of erosion control structures; and (3-20-20)T

**v.** Ten (10) year flood elevation (probable high water mark). (3-20-20)T

**b.** A detailed cross-section of the pond(s) including: (3-20-20)T

**i.** Dimensions and orientation; (3-20-20)T

**ii.** Proposed sidewall elevations; (3-20-20)T

**iii.** Proposed sidewall slope; (3-20-20)T

- iv. Sidewall width; (3-20-20)T
- v. Distance from and elevation above all surface water; and (3-20-20)T
- vi. Slope of settling pond location. (3-20-20)T
- c.** Narrative of the construction method(s) describing: (3-20-20)T
  - i. Bottom material; (3-20-20)T
  - ii. Sidewall material; (3-20-20)T
  - iii. Pond volume; (3-20-20)T
  - iv. Volume of water to be used in the wash plant; (3-20-20)T
  - v. Discharge or land application requirements; (3-20-20)T
  - vi. Any pond liners or filter materials to be installed; and (3-20-20)T
  - viii. Compaction techniques. (3-20-20)T
- d.** If the proposed ponds are: (3-20-20)T
  - i. Less than two thousand five hundred (2,500) feet square surface area; (3-20-20)T
  - ii. Less than four (4) feet high; (3-20-20)T
  - iii. Greater than fifty (50) feet from surface water; and (3-20-20)T
  - iv. Constructed on slopes of three: one (3:1) or flatter, the plans and specifications for settling ponds must contain information in Subparagraphs 021.05.a.i., 021.05.a.ii., and 021.05.a.iv.; 021.05.b.i., 021.05.b.ii., 021.05.b.v. and 021.05.b.vi. This information may be prepared as a sketch map showing appropriate elevations, distances and other required details. (3-20-20)T

**06. Requirements for Reclamation Plan.** A reclamation plan must be submitted in map and narrative form and include the following: (3-20-20)T

**a.** Show how watercourses disturbed by the mining operation will be replaced on meander lines with a pool structure conducive to good fish and wildlife habitat and recreational use. Show how and where riprap or other methods of bank stabilization will be used to ensure that, following abandonment, the stream erosion will not exceed the rate normally experienced in the area. If necessary, show how the replaced watercourse will not contribute to degradation of water supplies; (3-20-20)T

**b.** Describe and show the contour of the proposed mine site after final backfilling and/or grading, with grades listed for slopes after mining; (3-20-20)T

**c.** On a drainage control map, show the best management practices to be utilized to minimize erosion on disturbed lands; (3-20-20)T

**d.** Show roads to be reclaimed upon completion of mining; (3-20-20)T

**e.** Show plans for both concurrent and final revegetation of disturbed lands. Indicate soil types, slopes, precipitation, seed rates, species, topsoil, or other growth medium storage and handling, time of planting, method of planting and, if necessary, fertilizer and mulching rates; (3-20-20)T

- f.** The planned reclamation of tailings or sediment ponds; (3-20-20)T
- g.** An estimate of total reclamation cost to be used in establishing bond amount. The cost estimate should include the approximate cost of grading, revegetation, equipment mobilization, labor, and administrative overhead. (3-20-20)T
- h.** Make a premining estimate of trees on the site by species and forest lands utilization consideration in reclamation. (3-20-20)T

**07. State Approval Required.** Approval of a placer mining permit must be obtained under these rules, even if approval of such plan has been or is obtained from an appropriate federal agency. (3-20-20)T

**08. Application Review and Inspection.** If the Director determines that an inspection is necessary, the applicant may be contacted and asked that he or his duly authorized employee or representative be present for inspection at a reasonable time. An inspection may be required prior to issuance of the permit. The applicant must make such persons available for the purpose of inspection (see Subsection 051.01). Failure to provide a representative does not mean that the state will not conduct such inspection. (3-20-20)T

## **022. PROCEDURES FOR REVIEW AND DECISION UPON AN APPLICATION.**

**01. Decision on Application.** Following the Director's review of an application for a new permit, or to amend an existing permit and provide an opportunity to correct any deficiencies, the Board will approve or disapprove the application and the Director will notify the applicant of the Board's decision by mail. Such notice will contain any reservations conditioned with the approval, or the information required to be given under Subsections 022.07 and 022.09 if disapproved. If approved, a permit will be issued after the bonding requirements of Section 035 are met. No mining is allowed until the permit is bonded and applicant is notified by mail or telephone of approval. (3-20-20)T

**02. Public Hearings.** For the purpose of determining whether a proposed application complies with these rules, the Director may call for a public hearing, as described in Section 030. (3-20-20)T

**03. Adverse Weather.** If weather conditions prevent the Director from inspecting the proposed mining site to acquire the information required to evaluate the application, the application may be placed in suspense, pending improved weather conditions. The applicant will be notified in writing of this action. (3-20-20)T

**04. Interagency Comment.** Nonconfidential materials submitted under Section 021 will be forwarded by the Director to the Departments of Water Resources, Environmental Quality, and Fish and Game for review and comment. If operations are to be located on federal lands, the department will notify the U. S. Bureau of Land Management or the U.S. Forest Service. The Director may provide public notice on receipt of a reclamation plan. In addition, a copy of an application will be provided to individuals who request the information in writing, subject to Title 9, Chapter 3, Idaho Code. (3-20-20)T

**05. Stream Alteration Permits.** No permit will be issued proposing to alter, occupy or to dredge any stream or watercourse without notification to the Department of Water Resources of the pending application. The Department of Water Resources will respond to said notification within twenty (20) days. If a stream channel alteration permit is required, it must be issued prior to issuance of the placer and dredge permit. (3-20-20)T

**06. Water Clarification.** No permit will be issued until the Director is satisfied that the methods of water clarification proposed by the applicant are of sound engineering design and capable of meeting the water quality standards established under Title 39, Chapter 1, Idaho Code, and IDAPA 58.01.02, "Water Quality Standards," IDAPA, 58.01.11. "Ground Water Quality Rule." (3-20-20)T

**07. Permit Denial Authority.** The Board has the power to deny any application for a permit on state lands, streams, or riverbeds, or on any unpatented mining claims, upon its determination that a placer or dredge mining operation on the area proposed would not be in the public interest, giving consideration to economic factors, recreational use for such lands, fish and wildlife habitat, and other factors which in the judgement of the Board may be pertinent, and may deny any application upon notification by the Department of Water Resources that the granting

of such permit would result in permanent damage to the stream channel. (Section 47-1317(j), Idaho Code)  
(3-20-20)T

**08. Permit Conditions.** If an application fails to meet the requirements of these rules, the Board may issue a permit subject to conditions that bring the application into compliance with these rules. The applicant may accept or refuse the permit. Refusal to accept the permit is considered a denial under Subsection 022.09. (3-20-20)T

**09. Amended Applications.** If the Board disapproves the application, the applicant will be informed of the rules that have not been complied with, the manner in which they have not been complied with, and the requirements necessary to correct the deficiencies. The applicant may then submit an amended application, which will be processed as described in Section 022. (3-20-20)T

**10. Permit Offering.** Upon approval by the Board, the applicant will be notified of the action and the amount of bond required. Upon receipt of the required bond, the permit will be sent to the applicant for signature. If the bond and the permit, signed by the applicant, are not received within twelve (12) months of Board action, the approval will be automatically rescinded, except that upon written request of the applicant, and for good cause, the Director may defer decision of the Board's approval for a reasonable period of time not to exceed one (1) year. The Director will notify the applicant of his decision in writing. (3-20-20)T

**11. Reclamation Obligations.** The permit issued by the Board governs and determines the nature and extent of the reclamation obligations of the Permittee. (3-20-20)T

**023. -- 024. (RESERVED)**

**025. AMENDING AN APPROVED PERMIT.**

**01. Application to Amendment.** If circumstances arise that require significant change in the reclamation plan, method of operation, increase in acreage, or other details associated with an approved permit, the Permittee will submit an application on a department form or exact copy to amend the permit. Application fees are to be submitted with amended applications pursuant to Subsection 021.02.g. (3-20-20)T

**02. Processing.** An application to amend a permit will be processed in accord with Section 022. (3-20-20)T

**026. DEVIATION FROM AN APPROVED PERMIT.**

**01. Unforeseen Events.** If a Permittee finds that unforeseen events or unexpected conditions require immediate deviation from an approved permit, the Permittee may continue mining in accord with the procedures dictated by the changed conditions, pending submission and approval of an amended permit, even though such operations do not comply with the current approved permit. This does not excuse the Permittee from complying with the BMPs and reclamation requirements of Sections 020 and 040. (3-20-20)T

**02. Notification.** Notification of such unforeseen events must be given to the department within forty-eight (48) hours after discovery, and an application to amend the permit must be submitted within thirty (30) days of deviation from the approved permit by the Permittee. (3-20-20)T

**027. TRANSFER OF PERMITS.**

Placer and dredge mining permits may be transferred from an existing Permittee to a new Permittee. Transfer is made by the new Permittee filing a notarized Department Transfer of Permit form. The new Permittee is then responsible for the past Permittee's obligations under Title 47, Chapter 13, Idaho Code, these rules, the reclamation plan, and permit. When a replacement bond is submitted relative to an approved placer/dredge mining permit, the following rider must be filed with the department as part of the replacement bond before the existing bond will be released:

"(Surety company or principal) understands and expressly agrees that the liability under this bond shall extend to all acts for which reclamation is required on areas disturbed in connection with placer/dredge mining permit No., both prior and subsequent to the date of this rider." (3-20-20)T

**028. -- 029. (RESERVED)**

**030. PUBLIC HEARING FOR PERMIT APPLICATION.**

**01. Public Hearings.** During any stage of the application process the Director may conduct a public hearing. (3-20-20)T

**02. Basis for Hearing.** This action will be based upon the preliminary review of the application and upon any concern registered with the Director by the public, affected land owners, federal agencies having surface management of the affected lands, other interested entities, or upon request by the applicant. (3-20-20)T

**03. Hearing for Water Degradation** The Director will call for a public hearing when he determines, after consultation with the Departments of Water Resources, Environmental Quality, Fish and Game, and affected Indian tribes (pursuant to Paragraph 021.02.e.), that proposed placer or dredge mining operations can reasonably be expected to significantly degrade adjacent surface waters. A hearing held under this subsection will be conducted to receive comment on the measures the applicant will use to protect surface water quality from nonpoint source water pollution. (3-20-20)T

**04. Site of Hearing.** The hearing will be held, upon the record, in the locality of the proposed operation, or in Ada County, at a reasonable time and place. (3-20-20)T

**05. Hearing Notice.** The Director will give notice of the date, time, and place of the hearing to the applicant, to federal, state, local agencies, and Indian tribes which may have an interest in the decision, as shown on the application; to all persons petitioning for the hearing, if any; and to all persons identified by the applicant pursuant to Subsection 021.03.a. as an owner of the specific acreage to be affected by the proposed placer or dredge mining operation. Such hearing notice will be sent by certified mail and postmarked not less than thirty (30) days before the scheduled date of the public hearing. (3-20-20)T

**06. Public Notice.** The Director will notify the general public of the date, time, and place of the hearing by placing a newspaper advertisement once a week, for two (2) consecutive weeks, in the locale of the area covered by the application. The two (2) consecutive weekly advertisements begin between seven (7) and twenty (20) days prior to the scheduled date of the hearing. A copy of the application is to be placed for review in a conspicuous place in the local area of the proposed mining operations, in the nearest department's area office, and the department's administrative office in Boise. (3-20-20)T

**07. Description of Effects.** In the event a hearing is ordered under Subsection 030.03, the notice to the public will describe the potentially significant surface water quality degradation and contain the applicant's description of the measures that will be taken to prevent degradation of adjacent surface waters from nonpoint sources of pollution. The foregoing is to be discussed at the public hearing. (3-20-20)T

**08. Hearing Officer.** The hearing will be conducted by the Director or his duly authorized representative. Both oral and written testimony will be accepted. (3-20-20)T

**031. -- 034. (RESERVED)**

**035. PERFORMANCE BOND REQUIREMENTS.**

**01. Submittal of Bond.** Prior to issuance of a placer or dredge mining permit, an applicant must submit to the Director, on a placer or dredge mining bond form, a performance bond meeting the requirements of this rule. (3-20-20)T

**a.** The amount of the initial bond is in the amount determined by the Board to be the estimated reasonable costs of reclamation of lands proposed to be disturbed in the permit area, plus ten percent (10%). The determination by the Board of the bond amount constitutes a final decision subject to judicial review as set forth in Section 002 of these rules. The bond may be submitted in the form of a surety, cash, certificate of deposit, or other bond acceptable to the Director. (3-20-20)T

**b.** Acreage on which reclamation is completed must be reported in accord with Subsections 035.06

and 035.07. Acreage may be released upon approval by the Director. The bond may be reduced by the amount appropriate to reflect the completed reclamation. (3-20-20)T

**02. Form of Performance Bond.** (3-20-20)T

**a.** Corporate surety bond: This is an indemnity agreement executed for the Permittee by a corporate surety licensed to do business in the state of Idaho submitted on a placer and dredge mining bond form, or exact copy, supplied by the Director. The bond is to be conditioned upon the Permittee faithfully performing all requirements of the act, these rules, the permit, and reclamation plan, and must be payable to the state of Idaho. (3-20-20)T

**b.** Collateral bond: This is an indemnity agreement executed by or for the Permittee, and payable to the Idaho Department of Lands, pledging cash deposits, governmental securities, or negotiable certificates of deposit of any financial institution doing business in the United States. Collateral bonds are subject to the following conditions: (3-20-20)T

i. The Director will obtain possession, and upon receipt of such collateral bonds, deposit such cash or securities with the state treasurer to hold in trust for the purpose of bonding reclamation performance; (3-20-20)T

ii. The Director will value collateral at its current market value, not face value; (3-20-20)T

iii. Certificates of deposit will be issued or assigned to the Department, in writing, and upon the books of the financial institution issuing such certificates. Interest will be allowed to accrue and may be paid by the bank, upon demand, to the Permittee, or other person which posted the collateral bond; (3-20-20)T

iv. Amount of an individual certificate may not exceed the maximum amount insured by the Federal Deposit Insurance Corporation or Federal Savings and Loan Insurance Corporation or their successors; (3-20-20)T

v. Financial institutions issuing such certificates will waive all rights of set-off or liens which it has or might have against such certificates; (3-20-20)T

vi. Any such certificates will be automatically renewable; and (3-20-20)T

vii. The certificate of deposit will be of sufficient amount to ensure that the Director would be able to liquidate such certificates prior to maturity, upon forfeiture, for the amount of the required bond, including any penalty for early withdrawal. (3-20-20)T

**c. Letters of credit:** (3-20-20)T

i. A letter of credit ("credit") is an instrument executed by a bank doing business in Idaho, made at the request of a customer, that states that the issuing bank will honor drafts for payment upon compliance with the terms of the credit; (3-20-20)T

ii. All credits are irrevocable and prepared in a format prescribed by the Director; (3-20-20)T

iii. All credits must be issued by an institution authorized to do business in the state of Idaho or through a confirming bank authorized to do business in the state of Idaho which engages that it will itself honor the credit in full. In the alternative, a foreign bank may execute or consent to jurisdiction of Idaho courts on a form prescribed by the Director; and (3-20-20)T

iv. The account party on all credits must be identical to the entity identified on the placer mining permit as the Permittee. (3-20-20)T

**03. Blanket Bond.** Where a Permittee is involved in numerous placer or dredge operations, the Director may accept a blanket bond in lieu of separate bonds under approved permits. The amount of such bond must comply with other applicable provisions of Section 035 and are equal to the total of the penalties of the separate bonds being combined into a single bond. (3-20-20)T

**04. Bond Cancellation.** Any surety company canceling a bond must give the department at least one

hundred twenty (120) days' notice prior to cancellation. The Director will not release a surety from liability under an existing bond until the Permittee has submitted to the Director an acceptable replacement bond or reclaimed the site. Replacement bonds must cover any liability accrued against the bonded principal under the permit. If a Permittee fails to submit an acceptable replacement bond prior to the effective date of cancellation of the original bond, or within thirty (30) days following written notice of cancellation by the Director, whichever is later, the Director may issue a cease and desist order and seek injunctive relief to stop the Permittee from conducting placer or dredge mining operations on the lands covered by the bond until such replacement has been received by the department. The Permittee must cease mining operations on lands covered by the bond until a suitable bond is filed. (3-20-20)T

**05. Substitute Surety.** If a surety's Idaho business license is suspended or revoked, the Permittee must, within thirty (30) days after notice by the department, find a substitute for such surety. The substitute surety must be licensed to do business in Idaho. If the Permittee fails to secure such substitute surety, the Director may issue a cease-and-desist order and seek injunctive relief to stop the Permittee from conducting placer and dredge mining operations on the lands covered by the bond until a substitution has been made. The Permittee must cease mining operations on lands covered by the bond until a bond acceptable to the department is filed. (3-20-20)T

**06. Bond Reduction.** Upon finding that any land bonded under a placer or dredge mining permit will not be affected by mining, the Permittee must notify the Director by submitting an application amending the permitted acreage, pursuant to Section 025. When the Director has verified that the bonding requirement for the amended permit is adequate, any excess reclamation bond will be released. Any request for bond reduction will be answered by the Director within thirty (30) days of receiving such request unless weather conditions prevent inspection. (3-20-20)T

**07. Bond Release.** Upon completion of the reclamation, specified in the permit, the Permittee must notify the Director in writing, of his desire to secure release from bonding. When the Director has verified that the requirements of the placer or dredge mining permit have been met, as stated in the permit, the bond will be released. (3-20-20)T

**a.** Any request for bond release will be answered by the Director within thirty (30) days of receiving such request unless weather conditions prevent inspection. (3-20-20)T

**b.** If the Director finds that a specific portion of the reclamation has been satisfactorily completed, the bond may be reduced to the amount required to complete the remaining reclamation. The following schedule will be used to complete these bond reductions unless the Director determines in a specific case that this schedule is not appropriate and specifies a different schedule: (3-20-20)T

**i.** Sixty percent (60%) of the bond may be released when the Permittee completes the required backfilling, regrading, topsoil replacement, and drainage control of the bonded area in accordance with the approved placer mining permit; and (3-20-20)T

**ii.** After revegetation activities have been performed by the Permittee on the regraded lands according to the approved placer mining permit and Section 040, the department may release an additional twenty-five percent (25%) of the bond. (3-20-20)T

**c.** The remaining bond will not be released: (3-20-20)T

**i.** As long as the disturbed lands are contributing sediment or other pollution to surface waters outside the disturbed land in excess of state water quality standards established under Title 39, Chapter 1, Idaho Code; (3-20-20)T

**ii.** Until final removal of equipment and structures related to the mining activity, or until any remaining equipment and structures are brought under an approved placer or dredge mining permit and bond by a new Permittee (this rule does not require a Permittee to remove equipment or structures from patented lands when the landowner has authorized the equipment and structures to remain on the site); (3-20-20)T

**iii.** Until all temporary sediment or erosion control structures have been removed and reclaimed or until such structures are brought under an approved placer mining permit and bond by a new Permittee; and (3-20-20)T



iv. Until vegetation productivity is returned to levels of yields at least comparable to productivity which the disturbed lands supported prior to the permitted mining, except as stated in Subsection 040.17.b.

(3-20-20)T

**08. Forfeiture.** In accord with Subsection 050.02, a bond may be forfeited if the Director determines that the Permittee has not conducted the placer and dredge mining and reclamation in accord with the act, these rules, the approved permit, and the reclamation plan.

(3-20-20)T

**09. Correction of Deficiencies.** The Director may, through cooperative agreement with the Permittee, devise a schedule to correct deficiencies in complying with the permit and thereby postpone action to recover the bond.

(3-20-20)T

**10. Bonding Rate.** A Permittee may petition the Director for a change in the initial bond rate. The Director will review the petition, and if satisfied with the information presented, a special bond rate will be set based upon the estimated cost that the Director would incur should a forfeiture of bond occur and it becomes necessary for the Director to complete reclamation to the standards established in the permit and reclamation plan.

(3-20-20)T

**11. Federal Bonds Recognized.** The Director may accept as a bond, evidence of a valid reclamation bond with the United States government. The bond must equal or exceed the amount determined in Subsection 035.01.a. This does not release a Permittee from bonding under these rules if the Permittee fails to continuously maintain a valid federal bond.

(3-20-20)T

**12. Insufficient Bond.** In the event the amount of the bond is insufficient to reclaim the land in compliance with the act, these rules, the approved permit, and the reclamation plan, the attorney general is empowered to commence legal action against the Permittee in the name of the Board to recover the amount, in excess of the bond, necessary to reclaim the land in compliance with the act, these rules, the approved permit, and the reclamation plan.

(3-20-20)T

**036. -- 039. (RESERVED)**

**040. BEST MANAGEMENT PRACTICES AND RECLAMATION FOR PLACER AND DREDGE MINING OPERATION.**

**01. Nonpoint Source Sediment Control.** (3-20-20)T

**a.** Appropriate best management practices for nonpoint source sediment or other pollution controls must be designed, constructed, and maintained with respect to site-specific placer or dredge mining operations. Permittees will utilize best management practices designed to achieve state water quality standards and protect existing beneficial uses of adjacent surface waters.

(3-20-20)T

**b.** State water quality standards, including protection of existing beneficial uses, are the standard that must be achieved by best management practices. In addition to proper mining techniques and reclamation measures, the Permittee will take necessary steps at the close of each operating season to assure that sediment movement or other pollution associated with surface runoff over the area is minimized in order to achieve water quality standards.

(3-20-20)T

**c.** Sediment or pollution control measures refer to best management practices that are carried out within and, if necessary, adjacent to the disturbed land and consist of utilization of proper mining and reclamation measures, as well as specific necessary pollution control methods, separately or in combination. Specific pollution control methods may include, but are not limited to:

(3-20-20)T

i. Keeping the disturbed land to a minimum at any given time through concurrent reclamation;

(3-20-20)T

ii. Shaping waste to help reduce the rate and volume of water runoff by increasing infiltration;

(3-20-20)T

- iii. Retaining sediment within the disturbed land; (3-20-20)T
- iv. Diverting surface runoff to limit water coming into the disturbed land and settling ponds; (3-20-20)T
- v. Routing runoff through the disturbed land using protected channels or pipes so as not to increase sediment load; (3-20-20)T
- vi. Use of riprap, straw dikes, check dams, mulches, temporary vegetation, or other measures to reduce overland flow velocities, reduce runoff volume, or retain sediment; and (3-20-20)T
- vii. Use of adequate sediment ponds, with or without chemical treatment. (3-20-20)T

**02. Modification of Management Practices.** If best management practices utilized by the Permittee do not result in compliance with Subsection 040.01, the Director will require the Permittee to modify or improve such best management practices to meet state water quality standards. (3-20-20)T

**03. Clearing and Grubbing.** Clearing and grubbing of land in preparation for mining exposes mineral soil to the erosive effects of moving water. Permittees are cautioned to keep such areas as small as possible (preferably no more than one (1) year's mining activity) as the Permittee is required to meet state water quality standards. Trees and slash should be stockpiled for use in seedbed protection and erosion control and such stockpiling may be a requirement of the approved permit. (3-20-20)T

**04. Overburden/Topsoil.** To aid in the revegetation of disturbed land, where placer or dredge mining operations result in the removal of substantial amounts of overburden, including any topsoil, the Permittee must remove, where practicable, the available topsoil or other growth medium as a separate operation for such area. Unless there are previously disturbed lands which are graded and immediately available for placement of the newly removed topsoil or other growth medium, the topsoil or other growth medium must be stockpiled and protected from erosion and contamination until such areas become available. (3-20-20)T

- a. Overburden/topsoil removal: (3-20-20)T
  - i. Any overburden/topsoil to be removed will be removed prior to any other mining activity to prevent loss or contamination; (3-20-20)T
  - ii. Where overburden/topsoil removal exposes land area to potential erosion, the Director may, as a condition of a permit, limit the size of any one (1) area having topsoil removed at any one (1) time. (3-20-20)T
  - iii. Where the Permittee can show that an overburden material other than topsoil is more conducive to plant growth, or where overburden other than topsoil is the only material reasonably available, such overburden may be allowed as a substitute for or a supplement to the available topsoil. (3-20-20)T

**b. Topsoil storage.** Topsoil stockpiles must be placed to minimize rehandling and exposure and to avoid excessive wind and water erosion. Topsoil stockpiles must be protected, as necessary, from erosion by use of temporary vegetation or by other methods which will control erosion; including, but not limited to, silt fences, chemical binders, seeding, and mulching. (3-20-20)T

**c. Overburden storage.** Stockpiled ridges of overburden must be leveled to a minimum width of ten (10) feet at the top. Peaks of overburden must be leveled to a minimum width of fifteen (15) feet at the top. The overburden piles must be reasonably prepared to control erosion using best management practices such as terracing, silt fences, chemical binders, seeding, and mulching. (3-20-20)T

**05. Roads.** (3-20-20)T

**a.** Roads must be constructed to minimize soil erosion. Such construction may require, but is not limited to, restrictions on length and grade of roadbed, surfacing of roads with durable non-toxic material,

stabilization of cut and fill slopes, and other techniques designed to control erosion. (3-20-20)T

**b.** All access and haul roads must be adequately drained. Drainage structures may include, but are not limited to, properly installed ditches, water-bars, cross drains, culverts, and sediment traps. (3-20-20)T

**c.** Culverts that are to be maintained for more than one (1) year must be designed to pass peak flows from not less than a twenty (20) year, twenty-four (24) hour precipitation event and have a minimum diameter of eighteen (18) inches. (3-20-20)T

**d.** Roads and water control structures must be maintained at periodic intervals as needed. Water control structures serving to drain roads may not be blocked or restricted in any manner to impede drainage or significantly alter the intended purpose of the structure. (3-20-20)T

**e.** Roads that are to be abandoned must be cross-ditched, ripped, and revegetated or otherwise obliterated to control erosion. (3-20-20)T

**f.** Roads, not abandoned, which are to continue in use under the jurisdiction of a governmental or private landowner, are the Permittee's responsibility to comply with the nonpoint source sediment control provisions of Subsection 040.01 until the successor assumes control. (3-20-20)T

**06. Settling Ponds -- Minimum Criteria.** (3-20-20)T

**a.** Settling ponds must provide adequate sediment storage capacity to achieve compliance with applicable water quality standards and protect existing beneficial uses, and may require periodic cleaning and proper disposal of sediment. (3-20-20)T

**b.** No settling pond, used for process water clarification, must be constructed to block a surface water drainage. (3-20-20)T

**c.** All settling ponds must be constructed and designed to prevent surface water runoff from entering the pond. (3-20-20)T

**d.** All settling ponds must be constructed and maintained to contain direct precipitation to the pond surface from a fifty (50) year twenty-four (24) hour storm event. (3-20-20)T

**e.** No chemicals may be used for water clarification or on site gold recovery without prior notification to, and approval from, the DEQ. (3-20-20)T

**07. Dewatering Settling Ponds.** Upon reclamation, settling ponds must be dewatered, detoxified, and stabilized. Stabilization includes regrading the site for erosion control, to the approximate original contour, and may require removal and disposal of settling pond contents. (3-20-20)T

**08. Topsoil Replacement.** Following completion of the requirements of Subsection 040.07, the settling ponds must be retopped with stockpiled topsoils or other soils conducive to plant growth. Where such soils are limited in quantity or not available, physical or chemical methods of erosion control may be used. All such areas are to be revegetated in accord with Subsection 040.17, unless otherwise specified in the placer mining permit. (3-20-20)T

**09. Dam Safety.** Settling ponds must conform with the Idaho Dam Safety Act, Section 42-1710 through 42-1721, Idaho Code and with the Environmental Protection and Health Act, Section 39-118, Idaho Code, requiring plan and specification review and approval for waste treatment facilities. (3-20-20)T

**10. Backfilling and Grading.** (3-20-20)T

**a.** Every operator who conducts placer mining exploration operations that disturb less than one-half (1/2) acre must contour the disturbed land to its approximate previous contour. These lands must be revegetated in accordance with Subsection 040.17. For showing discovery on federal mining claims, unless otherwise required by a

federal agency, one (1) pit may be left open on each claim pending verification by federal mining examiners, but must not create a hazard to humans or animals. Such pits and trenches must be reclaimed within one (1) year of verification. (3-20-20)T

**b.** Every Permittee who disturbs more than one-half (1/2) acre must shape and smooth the disturbed ground to a grade reasonably comparable with the natural contour of the ground prior to mining, and to a condition that promotes the growth of vegetation except as provided in Paragraph 040.17.m. or minimize erosion through other means. Any disturbed natural watercourse must be restored to a configuration and structure conducive to good fish and wildlife habitat and recreational use. (3-20-20)T

**c.** Backfill materials must be compacted in a manner to ensure stability of the fill. (3-20-20)T

**d.** After the disturbed land has been graded, slopes will be measured by the department for compliance with the requirements of the act, these rules, the placer or dredge mining permit, and the reclamation plan. (3-20-20)T

**11. Waste Disposal - Disposal of Waste in Areas Other Than Mine Excavations.** Waste materials not used in backfilling mined areas must be placed, stabilized, and revegetated to ensure that drainage is compatible with the surrounding drainage and to ensure long-term stability. (3-20-20)T

**a.** The Permittee may, if appropriate, use terraces to stabilize the face of any fill. Slopes of the fill material may not exceed the angle of repose. (3-20-20)T

**b.** Unless adequate drainage is provided through a fill area, all surface water above a fill must be diverted away from a fill area into protected channels, and drainage may not be directed over the unprotected face of a fill. (3-20-20)T

**12. Topsoil Redistribution.** Topsoil must be spread to achieve a thickness over the regraded area, adequate to support plant life. Excessive compaction of overburden and topsoil is to be avoided. Topsoil redistribution must be timed so that seeding or other protective measures can be readily applied to prevent compaction and erosion. Final grading must be along the contour unless such grading will expose equipment operators to hazardous operating conditions, in which case the best alternative method must be used in grading. (3-20-20)T

**13. Soil Amendments.** Nutrients and soil amendments must, if necessary, be applied to the graded areas to successfully achieve the revegetation requirements of the permit and reclamation plan. (3-20-20)T

**14. Revegetating Waste Piles.** The Permittee must conduct revegetation activities with respect to such waste piles in accordance with Subsection 040.17. (3-20-20)T

**15. Mulching.** Mulch must be used on severe sites and may be required by the approved placer or dredge mining permit. Nurse crops such as rye, oats, and wheat may be used as a substitute for mulch where they will provide adequate protection and will be replaced by permanent species within a reasonable length of time. (3-20-20)T

**16. Permanent Cessation and Time Limits for Planting.** (3-20-20)T

**a.** Wherever possible, but not later than one (1) year after grading, seeding and planting of disturbed lands must be completed during the first favorable growth period after seedbed preparation. If permanent vegetation is delayed or slow in establishment, temporary cover of small annual grains, grasses, or legumes may be used to control erosion until adequate permanent cover is established. (3-20-20)T

**b.** Reclamation activities should be concurrent with the mining operation and may be included in the approved placer or dredge mining permit and reclamation plan. Final reclamation must begin within one (1) year after the placer or dredge mining operations have permanently ceased on a mine panel. If the Permittee permanently ceases disposing of overburden on a waste area or permanently ceases removing minerals from a pit or permanently ceases using a road or other disturbed land, the reclamation activity on each given area must start within one (1) year of such

cessation, despite the fact that all operations as to the mine panel, which included such pit, road, overburden pile, or other disturbed land, has not permanently ceased. (3-20-20)T

**c.** A Permittee will be presumed to have permanently ceased placer or dredge mining operations on a given portion of disturbed land where no substantial amount of mineral or overburden material has been removed or overburden placed on an overburden dump, or no significant use has been made of a road during the previous one (1) year. (3-20-20)T

**d.** If a Permittee does not plan to use disturbed land for one (1) or more years but intends thereafter to use the disturbed land for placer or dredge mining operations and desires to defer final reclamation until after its subsequent use, the Permittee must submit a notice of intent and request for deferral of reclamation to the Director, in writing. If the Director determines that the Permittee plans to continue the operation within a reasonable period of time, the Director will notify the Permittee and may require actions to be taken to reduce degradation of surface resources until operations resume. If the Director determines that the use of the disturbed land for placer or dredge mining operations will not be continued within a reasonable period of time, the Director will proceed as though the placer or dredge mining operation has been abandoned, but the Permittee will be notified of such decision at least thirty (30) days before taking any formal administrative action. (3-20-20)T

**17. Revegetation Activities.** (3-20-20)T

**a.** The Permittee must select and establish plant species that can be expected to result in vegetation comparable to that growing on the disturbed lands prior to placer or dredge mining operations or other species that will be conducive to the post-mining use of the disturbed lands. The Permittee may use available technical data and results of field tests for selecting seeding practices and soil amendments that will result in viable revegetation. (3-20-20)T

**b.** Standards for success of revegetation. Revegetative success, unless otherwise specified in the approved placer mining permit and reclamation plan, is measured against the existing vegetation at the site prior to mining, or an adjacent reference area supporting similar vegetation. (3-20-20)T

**c.** The ground cover of living plants on the revegetated area must be comparable to the ground cover of living plants on the adjacent reference area for two (2) full growing seasons after cessation of soil amendment or irrigation. (3-20-20)T

**d.** For purposes of this rule, ground cover is considered comparable if it has, on the area actually planted, at least seventy percent (70%) of the premining ground cover for the mined land or adjacent reference area. (3-20-20)T

**e.** For locations with an average annual precipitation of more than twenty-six (26) inches, the Director, in approving a placer mining permit, may set a minimum standard for success of revegetation as follows: (3-20-20)T

**i.** Vegetative cover of seventy percent (70%) for two (2) full growing seasons in areas planted to herbaceous species only; or (3-20-20)T

**ii.** Fifty percent (50%) vegetative cover for two (2) full growing seasons and six hundred (600) woody plants per acre in areas planted to a mixture of herbaceous and woody species. (3-20-20)T

**f.** As used in this section, “herbaceous species” means grasses, legumes, and other forbs; “woody plants” means woody shrubs, trees, and vines; and “ground cover” means the area of the ground surface covered by the combined aerial parts of vegetation and the litter that is produced naturally on-site, expressed as a percentage of the total area measurement. Rock surface areas, composed of rock three plus (3+) inches in diameter will be excluded from this calculation. For purposes of measuring ground cover, rock greater than three (3) inches in diameter is considered as ground cover. (3-20-20)T

**g.** For previously mined areas that were not reclaimed to the standards required by Section 040, and that are disturbed by the placer or dredge mining operations, vegetation must be established to the extent necessary to

control erosion, but not be less than that which existed before redisturbance. (3-20-20)T

**h.** Introduced species may be planted if they are comparable to previous vegetation, or if known to be of equal or superior use for the approved post-mining use of the disturbed land, or, if necessary, to achieve a quick, temporary cover for soil stabilization purposes. Species classified as poisonous or noxious weeds may not be used in revegetation. (3-20-20)T

**i.** By mutual agreement of the Director, the landowner, and the Permittee, a site may be converted to a different, more desirable, or more economically suitable habitat. (3-20-20)T

**j.** Planting of grasses and forbs should be done in a manner which promotes rapid stabilization of the soil surface. Wherever terrain permits, grasses and forbs should be drilled or compacted into the ground using agricultural grass planting equipment or other seeders specifically designed for mine revegetation applications. Broadcast and hydroseeding may be used on areas where other methods are impractical or unavailable. (3-20-20)T

**k.** The Permittee should plant shrubs or shrub seed, as required, where shrub communities existed prior to mining. Shrub seed may be planted as a portion of a grass seed mix or planted as bare-root transplants after grass seeding. Where the landowner desires a specific land use such as grazing or cropland, shrubs will not be required in the revegetation species mix. Shrub lands undergoing revegetation with shrubs must be protected from erosion by vegetation, chemical, or other acceptable means during establishment of the shrubs. (3-20-20)T

**l.** Reforestation -- Tree stocking of forestlands should meet the following criteria: (3-20-20)T

**i.** Trees that are adapted to the site should be planted on the land to be revegetated, in a density which can be expected over time to yield a timber stand comparable to premining timber stands. This in no way is to exclude the conversion of sites to a different, more desirable, or more economically suited species; (3-20-20)T

**ii.** Trees must be established for two (2) full growing seasons after cessation of any soil amendments and irrigation before they are considered to be established; and (3-20-20)T

**iii.** Forest lands undergoing revegetation with trees should be protected from erosion by vegetation, chemical binders, or other acceptable means during seedling establishment. (3-20-20)T

**m.** Revegetation is not required on the following areas: (3-20-20)T

**i.** Disturbed lands, or portions thereof, where planting is not practicable or reasonable because the soil is composed of excessive amounts of sand, gravel, shale, stone, or other material to such an extent to prohibit plant growth; (3-20-20)T

**ii.** Any mined land or overburden piles proposed to be used in the mining operations; (3-20-20)T

**iii.** Any mined land or overburden pile, where lakes are formed by rainfall or drainage run-off from adjoining lands; (3-20-20)T

**iv.** Any mineral stockpile; (3-20-20)T

**v.** Any exploration trench which will become a part of any pit or overburden disposal area; and (3-20-20)T

**vi.** Any road which is to be used in mining operations, so long as the road is not abandoned. (3-20-20)T

**041. -- 049. (RESERVED)**

**050. TERMINATION OF A PERMIT.**

**01. Completion of Reclamation.** A placer or dredge mining permit terminates upon completion of all

reclamation activity to the standards specified in the permit and reclamation plan, and final inspection and approval has been granted by the Director. Upon termination, the Director will release the remaining portion of the bond.

(3-20-20)T

**02. Involuntary Termination.** For continuous operation, the bonded permit will remain valid. Administrative action may be taken to terminate a placer and dredge mining permit if:

(3-20-20)T

**a.** The permit does not remain bonded; (3-20-20)T

**b.** The placer and dredge mining operations are not commenced within two (2) years of the date of Board approval; (3-20-20)T

**c.** The placer and dredge mining operations are permanently ceased and final reclamation has not commenced within one (1) year of the date of permanent cessation; (3-20-20)T

**d.** Inspection costs are delinquent; or (3-20-20)T

**e.** Permittee fails to comply with the act, these rules, the permit, or the reclamation plan. (3-20-20)T

**051. ENFORCEMENT AND FAILURE TO COMPLY.**

**01. Inspection.** The Director may inspect the operation under permit from time to time to determine compliance with the act, these rules, the permit, and the reclamation plan. The cost and expense of such inspections will be borne by the Permittee. (3-20-20)T

**a.** Cost of inspection is assessed at a flat rate of two hundred and fifty dollars (\$250) per year for each permit. Permits upon U.S. Forest Service administered lands is assessed at a flat rate of one hundred dollars (\$100) per year for each permit, to reflect the reduced inspection work for the department. (3-20-20)T

**b.** A billing for inspection costs will be made in advance each May 1, with the costs due and payable within thirty (30) days of receipt of an inspection cost statement. Inspection fees become delinquent if not paid on or before June 1, and the department may assess the greater of the following; either a twenty-five dollars (\$25) late payment charge or penalty at the rate of one percent (1%) for each calendar month or fraction thereof, compounded monthly, for late payments from the date the inspection fee is due. Such costs constitute a lien upon equipment, personal property, or real property of the Permittee and upon minerals produced from the permit area. Should inspection fees be delinquent, the department will send a single notice of delinquent payment by certified mail, return receipt requested, to the Permittee. If payment is not received by the department within thirty (30) days from the date of receipt, the department may take appropriate administrative action to cancel the permit as provided by Subsection 050.02. (3-20-20)T

**c.** Inspection costs related to a reported violation are assessed at actual costs and in addition to those costs in Paragraph 051.01.a. Costs include mileage to and from the mine site, employee meals, lodging, personnel costs, and administrative overhead. Costs are due and payable thirty (30) days after receipt of the inspection cost statement. (3-20-20)T

**02. Department Remedies.** Without affecting the penal and injunctive provisions of these rules, the department may pursue the following remedies: (3-20-20)T

**a.** When the Director determines that a Permittee has not complied with the act, these rules, the permit, or the reclamation plan, the Director will notify the Permittee in writing and set forth the violations claimed and the corrective actions needed. (3-20-20)T

**b.** If the Permittee fails to commence and diligently proceed to complete the requested corrective action within a specified number of days after notice of the violation, unless a cooperative agreement has been reached pursuant to Subsection 035.09, the Director may take administrative action as provided within this rule to terminate the permit and forfeit the bond. (3-20-20)T

**c.** The Board may cause to have issued and served upon the Permittee alleged to be committing such violation, a formal complaint that specifies the provisions of the act, the permit, the reclamation plan, or these rules which the Permittee allegedly is violating, and a statement of the manner in and the extent to which said Permittee is alleged to be violating the provisions of the act, the permit, the reclamation plan, or these rules. Such complaint may be served by certified mail, and return receipt, signed by the Permittee, an officer of a corporate Permittee, or the designated agent of the Permittee, will constitute service. (3-20-20)T

**d.** The Permittee is required to answer the formal complaint and request a hearing before a hearing officer appointed by the Director, which authority to appoint is hereby delegated by the Board to the Director, within thirty (30) days of receipt of the complaint if matters asserted in the complaint are disputed. The hearing will be held at a time not less than thirty (30) days after the date the Permittee requests such a hearing. The Board will issue subpoenas at the request of the Director and at the request of the charged Permittee. The hearing will be conducted in accordance with Sections 67-5209 through 67-5213, Idaho Code, and these rules. (3-20-20)T

**e.** The hearing officer will enter an order in accordance with Section 67-5212, Idaho Code, that, if adverse to the Permittee, will designate a time period within which prescribed corrective action, if any, should be taken. The designated time period will be sufficient to allow a reasonably diligent Permittee to correct any violation. Procedure for appeal of an order is outlined in Subsection 002.01. (3-20-20)T

**f.** Upon the Permittee's compliance with the order, the Director will consider the matter resolved and take no further action with respect to such noncompliance. (3-20-20)T

**g.** If the Permittee fails to answer the complaint and request a hearing, the matters asserted in the complaint will be deemed admitted by the Permittee, and the Director may proceed to cancel the placer mining permit and forfeit the bond in the amount necessary to pay all costs and expense of restoring the lands and beds of streams damaged by dredge or other placer mining of said defaulting Permittee and covered by such bond and remaining unrestored, including the department's administrative costs. (3-20-20)T

**03. Violation of an Order.** Upon request of the Director, the attorney general may institute proceedings to have the bond of a Permittee forfeited for violation of an order entered pursuant to Subsection 051.02.e. (3-20-20)T

**04. Injunctive Procedures.** (3-20-20)T

**a.** The Director may seek injunctive relief, as provided by Section 47-1324(b), Idaho Code, against any Permittee who is conducting placer mining or exploration operations when: (3-20-20)T

**i.** Under an existing approved permit, reclamation plan, and bond, a Permittee violates or exceeds the terms of the permit; (3-20-20)T

**ii.** A Permittee violates a provision of the act or these rules; or (3-20-20)T

**iii.** The bond, if forfeited, would not be sufficient to adequately restore the land; (3-20-20)T

**b.** The Director may seek injunctive relief to enjoin a placer mining operation for the Permittee's violation of the terms of an existing approved permit, the reclamation plan, the act, and these rules, and if immediate and irreparable injury, loss, or damage to the state may be expected to occur. (3-20-20)T

**c.** The Director will request the court to terminate any injunction when he determines that all conditions, practices, or violations listed in the order have been abated. Termination will not affect the right of the department to pursue civil penalties for these violations in accordance with Subsection 051.06. (3-20-20)T

**05. Civil Action.** In addition to the injunctive provisions above, the Board may maintain a civil action against any person who violates any provision of the act or these rules, to collect civil damages in an amount sufficient to pay for all the damages to the state caused by such violation, including but not limited to, costs of restoration in accordance with Section 47-1314, Idaho Code, where a person is conducting placer or dredge mining without an approved permit or bond. (3-20-20)T



**06. Civil Penalty.** (3-20-20)T

**a.** Pursuant to Section 47-1324(d), Idaho Code, any person violating any of the provisions of the placer and dredge mining act or these rules or violating any determination or order pursuant to these rules, is liable for a civil penalty of not less than five hundred dollars (\$500) nor more than two thousand five hundred dollars (\$2,500) for each day during which such violation continues. Such penalty is recoverable in an action brought in the name of the state of Idaho by the attorney general. (3-20-20)T

**b.** Pursuant to Section 47-1324(d), Idaho Code, any person who willfully or knowingly falsifies any records, plans, specifications, or other information required by the Board or willfully fails, neglects, or refuses to comply with any of the provisions of these rules, is guilty of a misdemeanor and will be punished by a fine of not less than one thousand dollars (\$1,000) or more than five thousand dollars (\$5,000) or imprisonment, not to exceed one (1) year, or both. (3-20-20)T

**07. Hearing Procedures.** (3-20-20)T

**a.** Process and procedures under these rules will be as summary and simple as may be possible. The Director, Board, or any member thereof, or the hearing officer designated by the Director, has the power to subpoena witnesses and administer oaths. The District Court will enforce the attendance and testimony of witnesses and the production for examination of books, papers, and records. A stenographic record or other recording of the hearing will be made. Witnesses subpoenaed by the Director or the hearing officer will be allowed such fees and traveling expenses as are allowed in civil actions in the District Court, to be paid by the party in whose interest such witnesses are subpoenaed. The Board, Director, or hearing officer will make such inquiries and investigations as deemed relevant. Each hearing will be held at the county seat in the county where any of the lands involved in the hearing are situate, or in the County of Ada, as the Board or Director may designate. (3-20-20)T

**b.** A notice of hearing will be served by certified mail to the last known address of the Permittee or his agent at least twenty (20) days prior to the hearing. A certified return receipt signed by the Permittee or his agent constitutes service and time thereof. (3-20-20)T

**c.** The cost of such hearing including, but not limited to, room rental, hearing officer fees, and transcript will be assessed against the defaulting Permittee. The Director may designate a hearing officer to conduct any hearings and make findings of fact, conclusions of law, and decision on issues involving the administration of the act and these rules. (3-20-20)T

**d.** If the hearing involves a permit or application for a permit, the decisions of the Board or the hearing officer, together with the transcript of the evidence, findings of fact, and any other matter pertinent to the questions arising during any hearing will be filed in the office of the Director. A copy of the findings of fact and decision will be sent to the applicant or holder of the permit involved in such hearing, by U.S. mail. If the matter has been assigned for hearing and a claim for review is not filed by any party in the proceeding within thirty (30) days after his decision is filed, the decision may be adopted as the decision of the Board and notice thereof will be sent to the applicant or permit holder involved in such hearing by U. S. mail. (3-20-20)T

**052. -- 054. (RESERVED)**

**055. COMPUTATION OF TIME.**

Computation of time for these rules will be based on calendar days. In computing any period of prescribed time, the day on which the designated period of time begins is not included. The last day of the period is included unless it is a Saturday, Sunday, or legal state holiday. In such a case, the period runs until the end of the next day which is not a Saturday, Sunday, or legal holiday. Intermediate Saturdays, Sundays, or legal holidays are excluded from the computation when the period of prescribed time is seven (7) days or less. (3-20-20)T

**056. -- 059. (RESERVED)**

**060. PLACER OR DREDGE MINING OF CERTAIN WATERBODIES PROHIBITED.**

**01. Prohibited Areas.** Placer or dredge mining in any form is prohibited on water bodies making up the national wild and scenic river system: (3-20-20)T

**a.** The Middle Fork of the Clearwater River, from the town of Kooskia upstream to the town of Lowell; the Lochsa River from its junction with the Selway at Lowell forming the Middle Fork upstream to the Powell Ranger Station; and the Selway River from Lowell upstream to its origin; (3-20-20)T

**b.** The Middle Fork of the Salmon River, from its origin to its confluence with the main Salmon River; (3-20-20)T

**c.** The St. Joe River, including tributaries, from its origin to its confluence with Coeur d'Alene Lake, except for the St. Maries River and its tributaries. (3-20-20)T

**02. Mining Withdrawals.** The Board, under authority provided by Title 47, Chapter 7, Idaho Code, has withdrawn certain other lands from placer and dredge mining. A listing of such withdrawals is available from the administrative offices of the Department. (3-20-20)T

**061. -- 064. (RESERVED)**

**065. DEPOSIT OF FORFEITURES AND DAMAGES.**

**01. Mining Account.** All monies, forfeitures, and penalties collected under the provisions of these rules will be deposited in the Placer and Dredge Mining Account to be used by the Director for placer and dredge mine reclamation purposes and related administrative costs. (3-20-20)T

**02. Funds for Reclamation.** Upon approval of the Board, monies in the account may be used to reclaim lands for which the forfeited bond was insufficient to reclaim in accord with these rules, or for placer or dredge mine sites for which the bond has been released and which have resulted in subsequent damage. Monies received from inspection fees are to be kept separate and used for costs incurred by the Director in conducting such inspections. (3-20-20)T

**066. -- 069. (RESERVED)**

**070. COMPLIANCE OF EXISTING PLANS WITH THESE RULES.**

These rules, upon their adoption, apply as appropriate to all existing placer or dredge mining operations, but will not affect the validity or modify the duties, terms, or conditions of any existing approved placer or dredge mining permits or impose any additional obligations with respect to reclamation upon any Permittee conducting placer or dredge mining operations pursuant to a placer or dredge mining permit approved prior to adoption of these rules. (3-20-20)T

**071. -- 999. (RESERVED)**

## 20.03.02 – RULES GOVERNING MINED LAND RECLAMATION

### 000. LEGAL AUTHORITY.

Title 47, Chapter 15 (“chapter”), Idaho Code, authorizes the Board to promulgate rules pertaining to mineral exploration; mining operations; reclamation of lands affected by exploration and mining operations, including review and approval of reclamation and permanent closure plans; requirements for financial assurance for reclamation and permanent closure, and to establish a reasonable fee for reviewing and approving reclamation plans and permanent closure plans, including the reasonable cost to employ a qualified independent party, acceptable to the applicant and the Board, to review reclamation plans and permanent closure plans and to verify the accuracy of cost estimates. The Board has delegated to the director of the Department the duties and powers under the chapter and these rules, however the Board retains responsibility for administrative review. (3-20-20)T

### 001. TITLE AND SCOPE.

**01. Title.** These rules are titled IDAPA 20.03.02, “Rules Governing Mined Land Reclamation,” IDAPA 20, Title 03, Chapter 02. (3-20-20)T

**02. Purpose.** These rules are intended to provide for the protection of public health, safety, and welfare, by ensuring that all the lands within the state disturbed by exploration and mining operations are properly reclaimed and ensuring the proper permanent closure of cyanidation facilities and thereby conserve natural resources; aid in the protection of wildlife, domestic animals, and aquatic resources; and reduce soil erosion. It is also the purpose of these rules to implement the State of Idaho’s antidegradation policy as set forth in Executive Order No. 88-23 as it pertains to exploration and mining operations and cyanidation facilities operating in the state. These rules are not intended to require reclamation or permanent closure activities in addition to those required by the chapter. (3-20-20)T

**03. Scope.** These rules establish the notification requirements for exploration and the application, operation, and reclamation requirements for mined lands. In addition, they establish the application and closure requirements for cyanidation facilities. These rules also establish the reclamation and financial assurance requirements for all these activities, and describe the processes used to administer the rules in an orderly and predictable manner. (3-20-20)T

**04. Other Laws.** Operators engaged in exploration, mining operation, and operation of a cyanidation facility shall comply with all applicable laws and rules of the state of Idaho including, but not limited to the following: (3-20-20)T

**a.** Idaho water quality standards established in Title 39, Chapter 1, Idaho Code; IDAPA 58.01.02, “Water Quality Standards”; and IDAPA 58.01.11, “Ground Water Quality Rule,” administered by the Department of Environmental Quality (DEQ). (3-20-20)T

**b.** Requirements and procedures for hazardous and solid waste management, as established in Title 39, Chapter 44, Idaho Code, and rules promulgated thereunder including, IDAPA 58.01.05, “Rules and Standards for Hazardous Waste” and IDAPA 58.01.06, “Solid Waste Management Rules,” administered by the DEQ. (3-20-20)T

**c.** Section 39-118A, Idaho Code, and applicable rules for ore processing by cyanidation as promulgated and administered by the DEQ as defined in IDAPA 58.01.13, “Rules for Ore Processing by Cyanidation.” (3-20-20)T

**d.** Section 39-175, Idaho Code, and applicable rules for the discharge of pollutants to waters of the United States as promulgated and administered by DEQ in IDAPA 58.01.25, “Rules Regulating the Idaho Pollutant Discharge Elimination System Program.” (3-20-20)T

**e.** Idaho Stream Channel Protection Act, Title 42, Chapter 38, Idaho Code, and applicable rules as promulgated and administered by the Idaho Department of Water Resources. (3-20-20)T

**f.** Idaho Dam Safety Act, Sections 42-1710 through 42-1721, Idaho Code, and applicable rules promulgated and administered by the Idaho Department of Water Resources. (3-20-20)T

**05. Applicability.** These rules are to be read and applied in conjunction with the chapter. These rules apply to all exploration, mining operations, and permanent closure of cyanidation facilities on all lands in the state, regardless of ownership. (3-20-20)T

**a.** These rules apply to mining operations or exploration operations conducted on all lands within the

state, regardless of ownership, commenced after the effective date of these rules. These rules in no way affect, alter, or modify the terms or conditions of any approved reclamation plan or approved amendment thereto or financial assurance for reclamation obtained prior to January 1, 1997. If a material change arises and is regulated in accordance with Subsection 090.01, then the operator shall submit a supplemental reclamation plan. (3-20-20)T

**b.** These rules do not apply to: (3-20-20)T

i. Any surface mining operations performed prior to May 31, 1972. An operator will not be required to perform reclamation activities on any pit or overburden pile as it existed prior to May 31, 1972. (3-20-20)T

ii. Mining operations for which the Idaho Dredge and Placer Mining Protection Act requires a permit, or which are otherwise regulated by that act. (3-20-20)T

iii. Extraction of minerals from within the right-of-way of a public highway by a public or governmental agency for maintenance, repair or construction of a public highway, provided the affected land is an integral part of such highway. (3-20-20)T

iv. Underground mines that existed prior to July 1, 2019, and have not expanded their surface disturbance by 50% or more after that date. (3-20-20)T

**c.** Sand and gravel mining operations in state-owned beds of navigable lakes, rivers or streams shall constitute an approved mining plan for the purpose of these rules if they are covered by a valid lease granted by the Board in accordance with Title 47, Chapter 7, Idaho Code and IDAPA 20.03.05, "Rules Governing Riverbed Mineral Leasing," and a valid mineral lease bond; have a valid stream channel alteration permit issued by the Idaho Department of Water Resources; and have a plan of operation for the mineral lease approved by the Department. (3-20-20)T

**d.** Surface mining operations, conducted by a public or governmental agency for maintenance, repair, or construction of a public highway, which: (3-20-20)T

i. Disturb more than two (2) acres will comply with the provisions of Section 069; or (3-20-20)T

ii. Disturb less than two (2) acres will comply with Subsections 060.06.a. through 060.06.c. (3-20-20)T

**e.** A cyanidation facility with a permit approved by the DEQ prior to July 1, 2005, shall be subject to the applicable laws and rules for ore processing by cyanidation in effect on June 30, 2005; however, if there is a material modification or material expansion to a cyanidation facility after July 1, 2005, these rules shall apply to the modification or expansion. (3-20-20)T

**002. -- 009. (RESERVED)**

**010. DEFINITIONS.**

In addition to the definitions set forth in the chapter, the following definitions apply to these rules: (3-20-20)T

**01. Approximate Previous Contour.** A contour that is reasonably comparable to that contour existing prior to disturbance, or that blends with the adjacent topography. (3-20-20)T

**02. Best Management Practices (BMP).** Practices, techniques or measures developed or identified by the designated agency as described in IDAPA 58.01.02, "Water Quality Standards," which are determined to be a cost-effective and practicable means of preventing or reducing pollutants generated from nonpoint sources to a level compatible with water quality goals. (3-20-20)T

**03. Chapter.** The Mined Land Reclamation Act, Title 47, Chapter 15, Idaho Code. (3-20-20)T

**04. Department.** The Idaho Department of Lands. (3-20-20)T

**05. Discharge.** With regard to cyanidation facilities, when used without qualification, any spilling, leaking, emitting, escaping, leaching, or disposing of a pollutant into the waters of the state. (3-20-20)T

**06. Groundwater.** Any water of the state which occurs beneath the surface of the earth in a saturated geological formation of rock or soil. (3-20-20)T

**07. Land Application.** A process or activity involving application of process water, wastewater, surface water, or semi-liquid material to the land for the purpose of disposal, pollutant removal, or groundwater recharge. (3-20-20)T

**08. Material Change.** (3-20-20)T

**a.** A change which deviates from the approved reclamation plan or permanent closure plan and causes one (1) of the following to occur: (3-20-20)T

i. Results in a substantial adverse effect to the geotechnical stability of overburden disposal areas, topsoil, stockpiles, roads, embankments, tailings facilities, cyanidation facilities or pit walls; (3-20-20)T

ii. Substantially modifies surface water management or a water management plan, not to include routine implementation and maintenance of BMPs; (3-20-20)T

iii. Exceeds the permitted acreage; or (3-20-20)T

iv. Increases overall estimated reclamation costs by more than fifteen percent (15%). (3-20-20)T

**b.** For underground mines with an approved reclamation plan, a new opening to an underground mine is also a material change. (3-20-20)T

**09. Material Modification or Material Expansion.** With regard to cyanidation facilities: (3-20-20)T

**a.** The addition of a new beneficiation process, or a significant change in the capacity of an existing beneficiation process, which was not identified in the original application and that significantly increases the potential to degrade the waters of the state. Such process could include, but is not limited to, heap leaching and process components for milling; or (3-20-20)T

**b.** A significant change in the location of a proposed process component or site condition which was not adequately described in the original application; or (3-20-20)T

**c.** A change in the beneficiation process that alters the characteristics of the waste stream in a way that significantly increases the potential to degrade the waters of the state. (3-20-20)T

**d.** For a cyanidation facility with an existing permit that did not actively add cyanide after January 1, 2005, reclamation and closure related activities shall not be considered to be material modifications or material expansions of the cyanidation facility. (3-20-20)T

**10. Material Stabilization.** Managing or treating spent ore, tailings, other solids and/or sludges resulting from the cyanidation process in such a manner to minimize waters or all other applied solutions from migrating through the material and transporting pollutants associated with the cyanidation facility ensuring that all discharges comply with all applicable standards and criteria. (3-20-20)T

**11. Motorized Earth-Moving Equipment.** Backhoes, bulldozers, front-loaders, trenchers, core drills, and other similar equipment. (3-20-20)T

**12. Neutralization.** Treatment of process waters such that discharge or final disposal of those waters does not violate the applicable surface or ground water quality standards or permits issued by DEQ. (3-20-20)T

**13. Permanent Closure.** Those activities which result in neutralization, material stabilization, and

decontamination of cyanidation facilities or the facilities' final reclamation. (3-20-20)T

**14. Permit.** When used without qualification, any written authorization, license, or equivalent control document issued by the DEQ. This includes authorizations issued pursuant to the application, public participation, and appeal procedures in IDAPA 58.01.13, "Rules for Ore Processing by Cyanidation," and those issued pursuant to the application, public participation, and appeal procedures in IDAPA 58.01.25. (3-20-20)T

**15. Pilot Facility.** (3-20-20)T

**a.** A testing cyanidation facility that is constructed primarily to obtain data on the effectiveness of the beneficiation process to determine: (3-20-20)T

i. The feasibility of metals recovery from an ore; or (3-20-20)T

ii. The optimum operating conditions for a predetermined process to extract values from an ore. (3-20-20)T

**b.** A pilot or testing cyanidation facility operated for one (1) year for a single test or two (2) years for multiple tests, during which time no more than ten thousand (10,000) tons of ore are evaluated for the testing process(es), unless the applicant can demonstrate that a greater amount is necessary for a specific purpose in the testing process. (3-20-20)T

**16. Pollutant.** Chemicals, chemical waste, process water, biological materials, radioactive materials, or other materials which, when discharged, cause or contribute to water pollution, or may otherwise impact the surface or ground waters of the state. (3-20-20)T

**17. Process Waters.** Any liquids which are intentionally or unintentionally introduced into any portion of the cyanidation process. These liquids may contain cyanide or other minerals, meteoric water, ground or surface water, elements and compounds added to the process solutions for leaching or the general beneficiation of ore, or hazardous materials that result from the combination of these materials. (3-20-20)T

**18. Real Property.** Land and appurtenances as defined in Section 55-101, Idaho Code. (3-20-20)T

**19. Reclamation.** The process of restoring an area affected by a mining operation or cyanidation facility to its original or another beneficial use, considering previous uses, possible future uses, and surrounding topography. The objective is to re-establish a diverse, self-perpetuating plant community, and to minimize erosion, remove hazards, and maintain water quality. (3-20-20)T

**20. Revegetation.** The establishment of the premining vegetation or a comparable vegetative cover on the land disturbed by mining operations. (3-20-20)T

**21. Small Cyanidation Processing Facility.** A cyanidation facility which chemically processes less than thirty-six thousand five hundred (36,500) tons of ore per year and no more than one hundred twenty thousand (120,000) tons of ore for the life of the project at any one (1) permitted cyanidation facility. No person or operator may concurrently hold more than one (1) small cyanidation processing facility permit, if located within ten (10) miles of each other. (3-20-20)T

**22. Surface Waters.** The surface waters of the state of Idaho. (3-20-20)T

**23. Treatment.** Any method, technique or process designed to change the physical, chemical, or biological character or composition of a waste for the purpose of disposal. (3-20-20)T

**24. Water Balance.** An inventory and accounting process capable of being reconciled that integrates all potential sources of water that are entrained in the cyanidation facility or may enter into or exit from the cyanidation facility. The inventory must include the water holding capacity of specific structures within the facility that contain process water. The water balance is used to ensure that all process water and other pollutants can be contained as engineered and designed within a factor of safety as determined in the permanent closure plan. (3-20-20)T

**25. Water Management Plan.** A document that describes the results of the water balance and the methods that will be used to ensure that pollutants are not discharged from a cyanidation facility into waters of the state, unless permitted or otherwise approved by the DEQ. (3-20-20)T

**26. Waters of the State.** All the accumulations of water, surface and underground, natural and artificial, public or private, or parts thereof which are wholly or partially within, which flow through or border upon the state. These waters shall not include municipal or industrial wastewater treatment or storage structures or private reservoirs, the operation of which has no effect on waters of the state. (3-20-20)T

**27. Weak Acid Dissociable Cyanide.** The cyanide concentration as determined by Method C, Weak Acid Dissociable Cyanide, D2036, the American Society of Testing Materials Book of Standards, "Standard Methods for the Examination of Water and Wastewater," Method 4500 CN<sup>-</sup> I, or other methods accepted by the scientific community and deemed appropriate by the DEQ. (3-20-20)T

**011. ABBREVIATIONS.**

**01. BMP.** Best Management Practices. (3-20-20)T

**02. DEQ.** Department of Environmental Quality. (3-20-20)T

**03. U.S.C.** United States Code. (3-20-20)T

**04. WAD.** Weak Acid Dissociable. (3-20-20)T

**012. -- 049. (RESERVED)**

**050. ADMINISTRATION.**

The Department will administer these rules under the direction of the director. (3-20-20)T

**051. -- 059. (RESERVED)**

**060. EXPLORATION OPERATIONS AND REQUIRED RECLAMATION.**

**01. Diligence.** All reclamation activities required to be conducted on exploration sites shall be performed in a good, workmanlike manner with all reasonable diligence, and as to a given exploration drill hole, road, or trench, within one (1) year after abandonment thereof. (3-20-20)T

**02. When Exploration Is Mining.** Exploration operations may under some circumstances constitute mining operations as described in Section 47-1503(7), Idaho Code. (3-20-20)T

**03. Notification.** Any operator desiring to conduct exploration using motorized earth-moving equipment to locate minerals for immediate or ultimate sale shall notify the Department within seven (7) days after beginning exploration operations. (3-20-20)T

**04. Contents of Notification.** The notification shall include: (3-20-20)T

**a.** The name and address of the operator; (3-20-20)T

**b.** The legal description of the exploration and its starting and estimated completion date; and (3-20-20)T

**c.** The anticipated size of the exploration and the general method of operation. (3-20-20)T

**05. Confidentiality.** Any such notification shall be treated as confidential in accord with Section 180. (3-20-20)T

**06. Exploration Reclamation (Less Than Two Acres).** Every operator who conducts exploration affecting less than two (2) acres shall: (3-20-20)T

**a.** Wherever possible, contour the affected lands to their approximate previous contour; and (3-20-20)T

**b.** Conduct revegetation activities in accordance with Subsection 140.11. Unless otherwise required by a federal agency, one (1) pit or trench on a federal mining claim showing discovery, may be left open pending verification by federal mining examiners. (3-20-20)T

**c.** Abandoned exploration drill holes shall be plugged, or otherwise left so as to eliminate hazards to humans and animals. Pits or trenches on mining claims showing discovery may be left open pending verification by federal mining examiners but shall not create a hazard to humans or animals. Such abandoned pits and trenches shall be reclaimed within one (1) year of verification. (3-20-20)T

**d.** If water runoff from exploration causes siltation of surface waters in amounts more than normally results from runoff, the operator shall reclaim affected lands and adjoining lands under his control as is necessary to meet state water quality standards. (3-20-20)T

**07. Exploration Reclamation (More Than Two Acres).** Reclamation of lands where exploration has affected more than two (2) acres shall be completed as set forth in Subsection 060.06 and the following additional requirements: (3-20-20)T

**a.** Abandoned exploration roads shall be cross-ditched as necessary to minimize erosion. The director may request in writing, or may be petitioned in writing, that a given road or road segment be left for a specific purpose and not be cross-ditched or revegetated. If the director approves the petition, the operator cannot thereafter be required to conduct reclamation activities with respect to that given road or road segment. (3-20-20)T

**b.** Ridges of overburden shall be leveled so as to have a minimum width of ten (10) feet at the top. (3-20-20)T

**c.** Peaks of overburden shall be leveled so as to have a minimum width of fifteen (15) feet at the top. (3-20-20)T

**d.** Overburden piles shall be reasonably prepared to control erosion. (3-20-20)T

**e.** Abandoned lands affected by exploration shall be top-dressed to the extent that such overburden is reasonably available from any pit or other excavation created by the exploration, with that type of overburden that is conducive to the control of erosion or the growth of vegetation that the operator elects to plant thereon. (3-20-20)T

**f.** Any water containment structure created in connection with exploration, shall be reasonably prepared so as not to constitute a hazard to humans or animals. (3-20-20)T

**08. Additional Reclamation.** The operator and the director may agree, in writing, to complete additional reclamation beyond the requirements established in the chapter and these rules. (3-20-20)T

**061. -- 067. (RESERVED)**

**068. APPLICATION FEES**

The following fee schedule will be used for all reclamation plan and cyanide closure plans and amendments to those plans. The applicable acreage is based on the permitted area identified in the application:



<b>Type of Plan</b>	<b>Fee (Dollars)</b>
Section 069 of these rules, Reclamation Plan 0 to 5 acres	Five hundred (\$500)
Section 069 of these rules, Reclamation Plan >5 to 40 acres	Six hundred (\$600)
Section 069 of these rules, Reclamation Plan over 40 acres	Seven hundred fifty (\$750)
Section 070 of these rules, Reclamation Plan 0 to 100 acres	One thousand (\$1,000)
Section 070 of these rules, Reclamation Plan >100 to 1,000 acres	One thousand five hundred (\$1,500)
Section 070 of these rules, Reclamation Plan >1,000 acres	Two thousand (\$2,000)
Section 071 of these rules, Permanent Closure Plan	Five thousand (\$5,000)

(3-20-20)T

**069. APPLICATION PROCEDURE AND REQUIREMENTS FOR QUARRIES, DECORATIVE STONE, BUILDING STONE, AND AGGREGATE MATERIALS INCLUDING SAND, GRAVEL AND CRUSHED ROCK.**

**01. Approval Required.** Approval of a reclamation plan by the Department is required even if approval of such plan has been or will be obtained from a federal agency. (3-20-20)T

**02. No Operator Shall Conduct Mining Operations.** No operator shall conduct mining operations on any lands in the state until the reclamation plan has been approved by the director, and the operator has filed financial assurance that meets the requirements of the chapter and these rules. (3-20-20)T

**03. Application Package.** The operator must submit a complete application package, for each separate mine or mine panel, before the reclamation plan will be approved. Separate mines are individual, physically disconnected operations. A complete application package consists of: (3-20-20)T

**a.** An application provided by the director; (3-20-20)T

**b.** A map or maps of the proposed mining operation which includes the information required under Subsection 069.04; (3-20-20)T

**c.** A reclamation plan, in map and narrative form, which includes the information required under Subsection 069.05; and (3-20-20)T

**d.** An out-of-state operator shall designate an in-state agent authorized to act on behalf of the operator. In case of an emergency that requires an action or actions to prevent environmental damage, both the operator and the authorized agent will be notified. (3-20-20)T

**e.** The correct fee listed in Section 068 of these rules. (3-20-20)T

**04. Map Requirements.** A vicinity map shall be prepared on standard United States Geological Survey ("USGS") seven and one-half (7.5) minute quadrangle maps or equivalent. A map of the proposed mining operation site shall be of sufficient scale to show: (3-20-20)T

**a.** The location of existing roads, access, and main haul roads to be constructed or reconstructed in conjunction with the mining operation and the approximate dates for construction, reconstruction, and abandonment; (3-20-20)T

**b.** The approximate location and names, if known, of drainages, streams, creeks, or water bodies within one thousand (1,000) feet of the mining operation; (3-20-20)T

**c.** The approximate boundaries of the lands to be utilized in the mining operations, including a legal description to the quarter-quarter section; (3-20-20)T

**d.** The approximate boundaries and acreage of the lands that will become affected land as a result of the mining operation during the first year of operations; (3-20-20)T

**e.** The currently planned storage locations of fuel, equipment maintenance products, wastes, and chemicals that will be utilized in the mining operation; (3-20-20)T

**f.** The currently planned location and configuration of pits, overburden piles, crusher reject materials, topsoil storage, wash plant ponds and sediment ponds that will be utilized; (3-20-20)T

**g.** Scaled cross-sections by length and height showing surface profiles prior to mining; and (3-20-20)T

**h.** A surface and mineral control or ownership map of appropriate scale for boundary identification; (3-20-20)T

**05. Reclamation Plan Requirements.** Reclamation plans must be submitted in map and narrative form and include the following: (3-20-20)T

**a.** Where surface waters are likely to be impacted and when requested by the director, documents identifying and assessing foreseeable, site-specific nonpoint sources of water quality impacts upon adjacent surface waters and the BMPs the operator will use to control such impacts during surface mining and reclamation; (3-20-20)T

**b.** Scaled cross-sections by length and height, showing planned surface profiles and slopes after reclamation; (3-20-20)T

**c.** Roads to be reclaimed; (3-20-20)T

**d.** A plan for revegetation of affected lands including soil types, slopes, precipitation, seed rates, species, handling of topsoil or other growth medium, time of planting, method of planting and, if necessary, fertilizer and mulching rates; (3-20-20)T

**e.** The planned reclamation of wash plant or sediment ponds; (3-20-20)T

**f.** A drainage control map which identifies the location of BMPs that will be implemented to control erosion and water quality impacts during mining and reclamation activities; (3-20-20)T

**g.** The location of any current 100-year floodplain in relation to the mining facilities if the floodplain is within one hundred (100) feet of the facilities, and the BMPs to be implemented that will keep surface waters from entering any pits and potentially changing course. (3-20-20)T

**h.** For operations over five (5) acres, an estimate of total reclamation cost to be used in establishing a financial assurance amount. The cost estimate will include, but is not limited to, the approximate cost of grading, revegetation, equipment mobilization, labor, and other pertinent direct and indirect costs of a third-party to complete reclamation. (3-20-20)T

**070. APPLICATION PROCEDURE AND REQUIREMENTS FOR OTHER MINING OPERATIONS INCLUDING HARDROCK, UNDERGROUND AND PHOSPHATE MINING.**

**01. Reclamation Plan Approval Required.** Approval of a reclamation plan by the Department is required even if approval of such plan has been or will be obtained from a federal agency. No operator shall conduct mining operations on any lands in the state until the reclamation plan has been approved by the director, and the operator has filed the required financial assurance. (3-20-20)T

**02. Application Package.** The operator must submit a complete application package for each separate mine or mine panel before the reclamation plan will be approved. Separate mines are individual, physically

- disconnected operations. A complete application package consists of: (3-20-20)T
- a.** All items and information required under Section 069 of these rules; (3-20-20)T
  - b.** Any additional information required by Subsection 070.04; and (3-20-20)T
  - c.** An operating plan, if required by Section 47-1506(b), Idaho Code, prepared in accordance with Subsection 070.05 of these rules. (3-20-20)T
- 03. Map Requirements.** Maps shall be prepared in accordance with Subsection 069.04 of these rules. (3-20-20)T
- 04. Reclamation Plan Requirements.** Reclamation plans must include all of the information required under Subsection 069.05 and the following additional information: (3-20-20)T
- a.** A description of the planned reclamation of tailings or sediment ponds; and (3-20-20)T
  - b.** An estimate of total reclamation cost to be used in establishing the financial assurance amount. The cost estimate should include the approximate cost of grading, revegetation, equipment mobilization, labor, and other pertinent costs. (3-20-20)T
  - c.** A description of foreseeable, site-specific impacts from acid rock drainage and the BMPs that will be used to mitigate any impacts from such acid rock drainage. (3-20-20)T
  - d.** Underground mines must provide the following additional information: (3-20-20)T
    - i.** Location and dimensions of all underground mine openings at the ground surface, including but not limited to vents, shafts, adits, or stopes; and (3-20-20)T
    - ii.** A description of how each mine opening in subparagraph 070.04.d.i of these rules will be secured during reclamation to eliminate hazards to human health and safety. (3-20-20)T
  - e.** A description of post-closure activities. (3-20-20)T
  - f.** Other pertinent information the Department has determined is necessary to ensure that the operator will comply with the requirements of the chapter. (3-20-20)T
- 05. Operating Plan Requirements.** A complete operating plan shall consist of: (3-20-20)T
- a.** Maps showing: (3-20-20)T
    - i.** The location of existing roads and anticipated access and principal haul roads planned to be constructed for mining operations. (3-20-20)T
    - ii.** The boundaries and acreage of the affected lands. (3-20-20)T
    - iii.** The planned location of pits, mineral stockpiles, overburden piles and tailings ponds for the mining operation. (3-20-20)T
    - iv.** The location and, if known, the names of all streams, creeks, or water bodies within the area of the affected lands. (3-20-20)T
    - v.** The drainage adjacent to the area where the surface is being utilized by mining operations. (3-20-20)T
    - vi.** The approximate boundaries and acreage of the lands that will become affected during the first year of mining operations. (3-20-20)T

**b.** Additional information regarding coarse and durable rock armor, if any, is proposed to be used for reclamation of mine facilities. The director may, after considering the type, size, and potential environmental impact of the facility, require the operator to include additional information in the operating plan. Such information may include, but is not limited to, one (1) or more of the following: (3-20-20)T

**i.** A description of the quantities, size, geologic characteristics, and durability of the materials to be used for final reclamation and armoring. (3-20-20)T

**ii.** A description of how the coarse and durable materials will be handled and/or stockpiled, including a schedule for such activities that will ensure adequate quantities are available during reclamation. (3-20-20)T

**c.** The director may, after considering the type, size, and potential environmental impact of the facility, require the operator to prepare a geotechnical analysis and report, signed by an engineer registered in the state of Idaho, which shows that (1) any waste rock or overburden stockpiles, (2) any pit walls proposed to be more than one hundred (100) feet high, or (3) any pit walls where geologic conditions could lead to failure of the wall regardless of the height will be constructed in a manner that is consistent with industry standards to minimize the potential for failure. If failure of these structures can reasonably be expected to impact adjacent surface or ground waters or adjacent private or state-owned lands, the analysis may be required to consider the long-term stability of these structures, the potential for groundwater accumulation, and the expected seismic accelerations at the site. (3-20-20)T

**071. APPLICATION PROCEDURE AND REQUIREMENTS FOR PERMANENT CLOSURE OF CYANIDATION FACILITIES.**

**01. Permanent Closure Plan Approval Required.** No operator shall construct or operate a new cyanidation facility or materially modify or materially expand an existing cyanidation facility prior to obtaining a permit, approval from the director and before the operator has filed financial assurance, as required by these rules. (3-20-20)T

**02. Permanent Closure Plan Requirements.** A permanent closure plan shall: (3-20-20)T

**a.** Identify the current owner of the cyanidation facility and the party responsible for the permanent closure and the long-term care and maintenance of the cyanidation facility; (3-20-20)T

**b.** Include a timeline showing: (3-20-20)T

**i.** The schedule to complete permanent closure activities, including neutralization of process waters and material stabilization, and the time period for which the operator shall be responsible for post-closure activities; and (3-20-20)T

**ii.** If the operator plans to complete construction, operation, and/or permanent closure of the cyanidation facility in phases, the schedule to begin each phase of construction, operation, and/or permanent closure activities and any associated post-closure activities. (3-20-20)T

**c.** Provide the objectives, methods, and procedures that will achieve neutralization of process waters and material stabilization during the closure period and through post-closure; (3-20-20)T

**d.** Provide a water management plan from the time the cyanidation facility is in permanent closure through the defined post-closure period. The plan shall be prepared in accordance with IDAPA 58.01.13, "Rules for Ore Processing by Cyanidation," administered by the DEQ, as required to meet the objectives of the permanent closure plan. (3-20-20)T

**e.** Include the schematic drawings for all BMPs that will be used during the closure period, through the defined post-closure period, and a description of how the BMPs support the water management plan, and an explanation of the water conveyance systems that are planned for the cyanidation facility. (3-20-20)T

**f.** Provide proposed post-construction topographic maps and scaled cross-sections showing the

configuration of the final heap or tailing facility, including the final cap and cover designs and the plan for long-term operation and maintenance of the cap. Caps and covers used as source control measures for cyanidation facilities must be designed to minimize the interaction of meteoric waters, surface waters, and groundwaters with wastes containing pollutants that are likely to be mobilized and discharged to waters of the state. Prior to approval of a permanent closure plan, engineering designs and specifications for caps and covers must be signed and stamped by a professional engineer registered in the state of Idaho; (3-20-20)T

**g.** Include monitoring plans for surface and ground water during closure and post-closure periods, adequate to demonstrate water quality trends and to ensure compliance with the stated permanent closure objectives and the requirements of the chapter; (3-20-20)T

**h.** Provide an assessment of the potential impacts to soils, vegetation, and surface and ground waters for all areas to be used for the land application system and provide a mitigation plan, as appropriate. (3-20-20)T

**i.** Provide information on how the operator will comply with the Resource Conservation and Recovery Act, 42 U.S.C. Section 6901 et seq.; Idaho Hazardous Waste Management Act, Chapter 44, Title 39, Idaho Code; Idaho Solid Waste Management Act, Chapter 74, Title 39, Idaho Code; and appropriate state rules, during operation and permanent closure; (3-20-20)T

**j.** Provide sufficient detail to allow the operator to prepare an estimate of the reasonable costs to implement the permanent closure plan; (3-20-20)T

**k.** Provide an estimate of the reasonable estimated costs to complete the permanent closure activities specified in the permanent closure plan in the event the operator fails to complete those activities. The estimate shall: (3-20-20)T

**i.** Identify the incremental costs of attaining critical phases of the permanent closure plan and a proposed financial assurance release schedule; (3-20-20)T

**ii.** Assume that permanent closure activities will be completed by a third party whose services are contracted for by the Board as a result of a financial assurance forfeiture under Section 47-1513, Idaho Code, and include: (3-20-20)T

**(1)** All direct and indirect costs expected to be incurred by a third party including, but not limited to, mobilization, labor, materials, equipment, engineering, and demobilization costs; and (3-20-20)T

**(2)** An amount acceptable to the Department but not to exceed ten percent (10%) of the total estimated closure costs, which is intended to cover costs the Department will incur in association with contract administration. (3-20-20)T

**l.** If the proposal is to complete cyanidation facility construction, operation, and/or permanent closure activities in phases: (3-20-20)T

**i.** Describe how these activities will be phased and how, after the first phase of activities, each subsequent phase will be distinguished from the previous phase or phases; and (3-20-20)T

**ii.** Describe how any required post-closure activities will be addressed during and after each subsequent phase has begun. (3-20-20)T

**m.** Provide any additional information that may be required by the Department to ensure compliance with the objectives of the permanent closure plan and the requirements of the chapter. (3-20-20)T

**03. Preapplication Conference.** Prospective applicants are encouraged to meet with the Department well in advance of preparing and submitting an application package to discuss the anticipated application requirements and application procedures, and to arrange for a visit or visits to the proposed location of the cyanidation facility. The preapplication conference may trigger a period of collaborative effort between the Department, the DEQ, and the applicant in developing checklists to be used by the agencies in reviewing an

application for completion, accuracy, and protectiveness. (3-20-20)T

**04. Application Package for Permanent Closure.** An application and its contents submitted to the Department shall be used to determine whether an applicant can complete all permanent closure activities in conformance with all applicable state laws. An application must provide information in sufficient detail to allow the director to make necessary application review decisions regarding cyanidation facility closure and protection of public health, safety, and welfare, in accordance with the chapter. A complete application package must be submitted to the Department. A complete application package for an operator proposing to use cyanidation shall consist of:

(3-20-20)T

**a.** A Department application form completed, signed, and dated by the applicant. This form shall contain the following information: (3-20-20)T

**i.** Name, location, and mailing address of the cyanidation facility; (3-20-20)T

**ii.** Name, mailing address, and phone number of the operator. An out-of-state operator shall designate an in-state agent authorized to act on his behalf. In case of an emergency that requires actions to prevent environmental damage, both the operator and his agent will be notified; (3-20-20)T

**iii.** Land ownership status (federal, state, private or public); (3-20-20)T

**iv.** The legal description to the quarter-quarter section of the location of the proposed cyanidation facility; and (3-20-20)T

**v.** The legal structure (corporation, partnership, etc.) and primary place of business of the operator. (3-20-20)T

**b.** Evidence that the applicant is authorized by the Secretary of State to conduct business in the state of Idaho; (3-20-20)T

**c.** A permanent closure plan as prescribed in Subsection 071.02; (3-20-20)T

**d.** The DEQ application and supporting materials; (3-20-20)T

**e.** The five thousand dollar (\$5,000) application processing and review fee, as defined in Subsection 071.05.a. (3-20-20)T

**05. Application Fee.** The application fee shall consist of two (2) parts: (3-20-20)T

**a.** Processing and review fee. (3-20-20)T

**i.** The applicant shall pay a nonrefundable five thousand dollar (\$5,000) fee upon submission of an application. Within thirty (30) days of receiving an application and this fee, the director shall provide a detailed cost estimate to the operator which includes a description of the scope of the Department's review; the assumptions on which the Department's estimate is based; and an itemized accounting of the anticipated number of labor hours, hourly labor rates, travel expenses and any other direct expenses the Department expects to incur, and indirect expenses equal to ten percent (10%) of the Department's estimated direct costs, as required to satisfy its statutory obligation pursuant to the chapter. (3-20-20)T

**ii.** If the Department's estimate is greater than five thousand dollars (\$5,000), the applicant may agree to pay a fee equal to the difference between five thousand dollars (\$5,000) and the Department's estimate, or may commence negotiations with the Department to establish a reasonable fee. (3-20-20)T

**iii.** If, within twenty (20) days from issuance of the Department's estimate, the Department and applicant cannot agree on a reasonable application processing and review fee, the applicant may appeal to the Board. The Board shall: (3-20-20)T

- (1) Review the Department's estimate; (3-20-20)T
- (2) Conduct a hearing where the applicant is allowed to give testimony to the Board concerning the Department's estimate; and (3-20-20)T
- (3) Establish the amount of the application review and processing fee. (3-20-20)T
  - iv. If the fee is more than five thousand dollars (\$5,000), the applicant shall pay the balance of the fee within fifteen (15) days of the Board's decision or withdraw the application. (3-20-20)T
  - v. Nothing in this section shall extend the time in which the Board must act on a plan submitted. (3-20-20)T
- b.** Permanent closure cost estimate verification fee. (3-20-20)T
  - i. Pursuant to Sections 47-1506(g) and 47-1513(j), Idaho Code, the Department may employ a qualified independent party, acceptable to the operator and the Board, to verify the accuracy of the permanent closure cost estimate. (3-20-20)T
  - ii. The applicant shall be solely responsible for paying the Department's cost to employ a qualified independent party to verify the accuracy of the permanent closure cost estimate. The applicant may participate in the Department's processes for identifying qualified parties and selecting a party to perform this work. (3-20-20)T
  - iii. If a federal agency has responsibility to establish the financial assurance amount for permanent closure of a cyanidation facility on federal land, the Department may employ the firm retained by the federal agency to verify the accuracy of the permanent closure cost estimate. If the director chooses not to employ the firm retained by the federal agency, he shall provide a written justification explaining why the firm was not employed. (3-20-20)T

**072. -- 079. (RESERVED)**

**080. PROCEDURES FOR REVIEW AND DECISION UPON AN APPLICATION FOR A RECLAMATION PLAN OR PERMANENT CLOSURE PLAN.**

- 01. Return of Application.** (3-20-20)T
  - a.** Mine reclamation. Within thirty (30) days after receipt of a reclamation plan by the Department, an application for mining reclamation may be returned for correction and resubmission if either the reclamation plan or mine map(s) are incomplete. Return of an application by the director shall constitute a rejection in accordance with Section 47-1507(b), Idaho Code. (3-20-20)T
  - b.** Permanent closure plans for cyanidation facilities. Within thirty (30) days after receipt of a permanent closure plan by the Department, an application for permanent closure of a cyanidation facility may be returned for correction and resubmission, if the permanent closure plan does not meet the requirements of Section 071 of these rules. Return of an application by the director shall constitute a rejection in accordance with Section 47-1507(b), Idaho Code. (3-20-20)T
- 02. Agency Notification and Comments.** (3-20-20)T
  - a.** Nonconfidential materials submitted under Sections 069, 070, and 071 shall be forwarded by the director to the Idaho Departments of Water Resources, Environmental Quality, and Fish and Game for review and comment. The director may decide not to circulate applications submitted under Section 069 if the director determines the impacts of the proposed activities are minor and do not involve surface or ground waters. The director may provide public notice on receipt of a reclamation plan or permanent closure plan. In addition, nonconfidential contents of an application will be provided to individuals who request the information in writing, as required by the Idaho Public Records Act. (3-20-20)T
  - b.** Upon receipt of a complete application for a reclamation plan or a permanent closure plan, the

director shall provide notice to the cities and counties where the surface mining or cyanidation facility operation is proposed, in accordance with Section 47-1505(7), Idaho Code. The notice shall include the name and address of the operator, the procedure and schedule for the Department's review, and an invitation to review nonconfidential portions of the application, if requested in writing. Such notice will be provided upon receipt of a reclamation plan, a permanent closure plan, or an amended or supplemental plan for an existing operation, or an amended cost estimate to complete permanent closure of a cyanidation facility, if required under the chapter and these rules.. (3-20-20)T

**03. Decision on Reclamation Plans.** The director shall review a new reclamation plan or an amended or supplemental reclamation plan pursuant to Sections 47-1507 and 47-1508, Idaho Code. (3-20-20)T

**a.** Approval. (3-20-20)T

i. Within sixty (60) days of receipt of an application that complies with Subsections 069 and 070 of these rules, the Department shall provide written notice to the applicant that the reclamation plan or any amendment(s) or supplementary plan(s) to an approved reclamation plan is approved or denied and, if approved, the amount of the financial assurance required; or (3-20-20)T

ii. If the director does not take action within sixty (60) days, a reclamation plan or any amendments or supplementary plans thereof shall be deemed to comply with the chapter, unless the sixty (60) day time period is extended pursuant to Section 47-1507(c), Idaho Code. (3-20-20)T

iii. The operator and director may agree, in writing, to implement additional actions with respect to reclamation that extend beyond the requirements set forth in these rules. (3-20-20)T

**b.** Inspections. The director may determine that an inspection of the proposed mining site location is necessary if the inspection will provide additional information or otherwise aid in processing of the application. (3-20-20)T

i. If the director decides to perform an inspection, the applicant will be contacted and asked that he or an authorized employee or agent be present. This rule shall not prevent the Department from making an inspection of the site if the applicant does not appear. (3-20-20)T

ii. If weather conditions preclude an inspection of a proposed mining operation, the director shall provide written notice to the applicant that review of the reclamation plan or an amended or supplementary plan has been suspended until weather conditions permit an inspection, and that the schedule for a decision shall be extended for up to thirty (30) days after weather conditions permit such inspection in accordance with Section 47-1507(c), Idaho Code. (3-20-20)T

**04. Decision on Cyanidation Facility Permanent Closure Plans.** Pursuant to Sections 47-1507 and 47-1508, Idaho Code, following review of a complete application, the director shall: (3-20-20)T

**a.** Coordination with DEQ. Initiate a coordinated interagency review of the application by providing a notice in writing to the DEQ director that the Department has received an application for permanent closure of a cyanidation facility; (3-20-20)T

**b.** Approval. (3-20-20)T

i. Within one-hundred eighty (180) days of receipt of an application that complies with Subsection 071.04 of these rules, the Department shall provide written notice to the applicant that the permanent closure plan is approved or denied and, if approved, the amount of the permanent closure financial assurance required; or (3-20-20)T

ii. If the director does not take action within one-hundred eighty (180) days, a permanent closure plan, or any amendments or supplementary plans thereof, shall be deemed to comply with the provisions of the chapter, unless the one hundred eighty (180) day time period shall be extended in accordance with Section 47-1507(c), Idaho Code. (3-20-20)T



**c.** Inspections. The director may determine that it is necessary to inspect the proposed cyanidation facility location if the inspection will provide additional information or otherwise aid in processing of the application. (3-20-20)T

**i.** If the director determines to inspect the site, the applicant will be contacted and asked that he or an authorized employee or agent be present. The Department may proceed with an inspection if the applicant or his designated employee or agent does not appear. (3-20-20)T

**ii.** If weather conditions preclude an inspection of the proposed cyanidation facility, the director shall provide written notice to the applicant that processing of the application has been suspended until weather conditions permit an inspection, and that the schedule for a decision shall be extended for up to thirty (30) days after weather conditions permit such inspection in accordance with Section 47-1507(c), Idaho Code. (3-20-20)T

**05. Monitoring Data.** When the director determines, after consultation with the DEQ, that there is a reasonable potential for pollution of adjacent surface and ground waters, the director shall require the operator to provide baseline preproject surface and ground water monitoring information, and furnish additional monitoring data during the life of the project. This provision shall not require any additional baseline preproject monitoring information or ongoing monitoring data where such data is already required to be provided under any federal or state law and is available to the director. (3-20-20)T

**06. Permanent Closure Plan Approval.** (3-20-20)T

**a.** The Department may condition its approval on issuance of a permit by the DEQ for the cyanidation facility. (3-20-20)T

**b.** Except for the concurrent and additional permanent closure requirements that may be established in a permit issued by the DEQ pursuant to Section 39-118A, Idaho Code and IDAPA 58.01.13, "Rules for Ore Processing by Cyanidation," an approved permanent closure plan shall define the nature and extent of the operator's obligation under the chapter. (3-20-20)T

**c.** The permanent closure plan, as approved by the Department in coordination with the DEQ, shall be incorporated by reference into the cyanidation facility permit issued by DEQ as a permit condition and shall be enforceable as such. The operator shall ensure that closure complies with the approved plan and any additional permanent closure requirements as outlined in the permit issued by DEQ. (3-20-20)T

**d.** No sooner than one hundred and twenty (120) days after an application for a permanent closure plan has been submitted to the Department, the applicant may submit a reclamation plan as required by Section 070 of these rules. The Department will review and approve the reclamation plan in accordance with Subsection 080. (3-20-20)T

**e.** Approval of a permanent closure plan by the Department is required even if approval of such plan has been or will be obtained from an appropriate federal agency. (3-20-20)T

**07. Denial of an Application.** If the director rejects an application, the director shall deliver in writing to the applicant a statement of the reasons the application has been rejected, the factual findings upon which the rejection is based, a statement of the applicable statute(s) and rule(s), the manner in which the application failed to fulfill the requirements of these rules, and the action that must be taken or conditions that must be satisfied to meet the requirements of the chapter and these rules. The applicant may submit an amended application in accordance with Sections 069, 070 or 071 for review and, if appropriate, approval by the Department. The director shall deny a reclamation plan, permanent closure plan, or any amendments or supplementary plans thereof if: (3-20-20)T

**a.** The application is inaccurate or incomplete; (3-20-20)T

**b.** The cyanidation facility as proposed cannot be conditioned for construction, operation, and closure to protect public safety, health, and welfare, in accordance with the scope and intent of these rules, or to protect beneficial uses of the waters of the state, as determined by the DEQ pursuant to Section 39-118A, Idaho Code and IDAPA 58.01.13, "Rules for Ore Processing by Cyanidation" and other DEQ rules cited therein. (3-20-20)T

**08. Public Hearing.** The director may call a public hearing to determine whether a proposed application complies with the chapter and these rules. A hearing shall be conducted in accordance with Section 110. (3-20-20)T

**09. Referral to Board.** The director may refer the decision concerning an application to the Board. This action will not extend the time period for a decision to approve or deny an application. (3-20-20)T

**10. Appeal of Final Order.** Any final order of the Board regarding an application for a mining reclamation plan or for permanent closure of a cyanidation facility may be appealed as set forth in Section 47-1514, Idaho Code. (3-20-20)T

**081. -- 089. (RESERVED)**

**090. AMENDING AN APPROVED RECLAMATION PLAN.**

**01. Cause for Reclamation Plan Amendment.** In the event circumstances arise that necessitate amendments to an approved reclamation plan, the operator shall submit an application to amend the plan and state the reasons the amendment is necessary. Either the operator or the director may initiate a process to amend an approved reclamation plan. If the director identifies a material change he believes requires a change in the reclamation plan, the director must deliver in writing to the operator a detailed statement identifying the material change and the action(s) necessary to address the material changes. Plan amendments have the same requirements as described in Section 069 and 070 of these rules. (3-20-20)T

**02. Review of Amendment.** The director will process an application to amend a plan in accordance with Sections 080 and 110, provided, however, that no land or aspect or provision of an approved reclamation plan that would not be affected by the proposed amendment, shall be subject to the amendment, review or reapproval in connection with processing the application. Approval of an amendment shall not be conditioned upon the performance of any actions not required by the approved reclamation plan or the proposed amendment itself, unless the operator agrees to perform such actions. (3-20-20)T

**03. Adjustments.** Adjustments to an approved reclamation plan may be made by agreement between the director and the operator, if the adjustment is consistent with the overall objectives of the approved reclamation plan and so long as surface and ground water quality standards will be met. Adjustments are due to changes that are smaller than material changes. (3-20-20)T

**091. AMENDING AN APPROVED PERMANENT CLOSURE PLAN.**

**01. Cause for Permanent Closure Plan Amendment.** In the event circumstances arise that necessitate amendments to an approved permanent closure plan, the operator shall submit an application to amend the permanent closure plan and state the reasons the amendment is necessary. Either the operator or the director may initiate a process to amend an approved permanent closure plan. Circumstances that could require a permanent closure plan to be amended include: (3-20-20)T

**a.** A material modification or material expansion in the cyanidation facility design or operation for which the approved permanent closure plan is no longer adequate. (3-20-20)T

**b.** Conditions substantially different from those anticipated in the original permit for which the approved permanent closure plan is no longer adequate. (3-20-20)T

**c.** A material change as defined in Subsection 010.08 of these rules. (3-20-20)T

**02. Modifications at an Operator's Request.** Requests from an operator to modify a permanent closure plan shall be submitted to the Department in writing. The director shall process an application for amendment in accordance with Section 080. An application to amend a permanent closure plan shall include: (3-20-20)T

**a.** A written description of the circumstances that necessitate the amendment; (3-20-20)T

- b.** Data supporting the request; (3-20-20)T
- c.** The proposed amendment; (3-20-20)T
- d.** A description of how the amendment will impact the estimated cost to complete permanent closure pursuant to the chapter; (3-20-20)T
- e.** A cost estimate to implement the amended permanent closure plan, prepared in accordance with Subsection 071.02 of these rules; and (3-20-20)T
- f.** Payment of a reasonable fee as may be determined by the director in accordance with Section 47-1508, Idaho Code. (3-20-20)T

**03. Modification at Request of Director.** If, following consultation with the DEQ, the director determines that cause exists to amend the permanent closure plan the director shall notify the operator in writing of his determination and explain the circumstances that have arisen which require the permanent closure plan to be amended. Within thirty (30) days or as agreed by the operator and the Department, the operator shall submit an application to amend the permanent closure plan in accordance with Subsection 091.02. (3-20-20)T

**04. Adjustment.** Adjustments to an approved permanent closure plan may be made by agreement between the director and the operator, if the adjustment is consistent with the overall objectives of the approved permanent closure plan and so long as surface and ground water quality standards will be met. (3-20-20)T

**092. -- 099. (RESERVED)**

**100. DEVIATION FROM AN APPROVED RECLAMATION PLAN.**

**01. Unforeseen Events.** If a mining operator finds that unforeseen events or unexpected conditions require immediate change from an approved plan, the operator may continue mining in accordance with the procedures dictated by the changed conditions, pending submission and approval of an amended plan, even though operations do not comply with the approved reclamation plan on file with the Department. This shall not excuse the operator from complying with the requirements of Sections 140 and 120. (3-20-20)T

**02. Notification.** The operator shall notify the director, in writing, within ten (10) days of the discovery of conditions that require deviation from the approved plan. A proposed amendment to the plan shall be submitted by the operator within thirty (30) days of the discovery of those conditions. (3-20-20)T

**101. -- 109. (RESERVED)**

**110. PUBLIC HEARING.**

**01. Call for a Hearing.** A public hearing called by the director following receipt of a complete application submitted in accordance with Sections 069, 070, or 071 shall be conducted in accordance with Section 47-1507(d), Idaho Code. The director may call for a hearing following his preliminary review of an application for a new operation or a supplemental application of an existing operation when one (1) or more of the following circumstances arises: (3-20-20)T

**a. Public Concern.** The public, potentially affected landowners, any governmental entity, or any other interested parties who may be affected by the operations proposed under the chapter have registered, in writing, a concern with the director regarding the proposed operations or cyanidation facility. The purpose of the public hearing shall be to gather written and oral comments as to whether the proposed reclamation plan or permanent closure plan meets the requirements of the chapter and these rules. (3-20-20)T

**b. Agency Concern.** The director determines, after consultation with the Department of Water Resources, DEQ, the Department of Fish and Game, and affected Indian tribes that the proposed mining or cyanidation facility operations could reasonably be expected to significantly degrade adjacent surface and/or ground

waters or otherwise threaten public health, safety or welfare. The purpose of a public hearing held under this subsection will be to receive written and oral comments on the measures the operator is proposing to use to protect surface and/or ground water quality from nonpoint source pollution. (3-20-20)T

**02. Consolidation.** If the director determines that a hearing should be held, he shall order that such proceedings be consolidated. The applicant and the public must be advised of the specific subjects to be discussed at the hearing at least twenty (20) days prior to the hearing. The Department will coordinate with the DEQ, as appropriate, for any hearings relating to permanent closure of a cyanidation facility to streamline application processing. (3-20-20)T

**03. Location.** A hearing shall be held in the locality of the proposed mine or a proposed cyanidation facility at a reasonably convenient time and place for public participation. The director may call for more than one hearing when conditions warrant. (3-20-20)T

**04. Notice of Hearing.** The director shall provide at least twenty (20) days' advance notice of the date, time, and place of the hearing to: federal, state, and local governmental agencies, Indian tribes who may have an interest in the decision as shown on the application, and the public; to all persons who petitioned for a hearing; and to any person identified by the applicant under Subsection 070.02 as a legal owner of the land that will likely be affected by the proposed operations. Notice to the applicant must be sent by certified mail and postmarked not less than twenty (20) days before the scheduled public hearing date. (3-20-20)T

**05. Publication of Notice.** The director shall provide at least twenty (20) days advance notice to the general public of the date, time, and place of the hearing. A newspaper advertisement will be placed once a week, for two (2) consecutive weeks, in the locale of the area covered by the application. (3-20-20)T

**a.** In the event a hearing is ordered under Section 110, the notice shall describe: (3-20-20)T

**i.** The potentially significant surface water quality impacts from the proposed mining operation and the operator's description of the measures that will be used to prevent degradation of adjacent surface and ground waters from sources of pollution; or (3-20-20)T

**ii.** The objectives of a permanent closure plan that have been submitted for review. (3-20-20)T

**b.** A copy of the application shall be placed for review in a public place in the local area of the proposed mining operation or cyanidation facility, in the closest Department area office, and the Department's administrative office in Boise. (3-20-20)T

**06. Hearing Officer.** The hearing shall be conducted by the director or his designated representative. Both oral and written testimony will be accepted. Proceedings of the hearing will be recorded on audio tape and a verbatim transcript will be prepared. (3-20-20)T

**07. Consideration of Hearing Record.** The Department shall consider the hearing record when reviewing reclamation plans or permanent closure plans for final approval or rejection. (3-20-20)T

## **111. COMPLETION OF PERMANENT CLOSURE.**

**01. Implementation of a Permanent Closure Plan.** Unless otherwise specified in the approved permanent closure plan, an operator must begin implementation of the approved permanent closure plan. (3-20-20)T

**a.** Within one (1) year of the final addition of new cyanide to the ore process circuit for small cyanidation processing or pilot facilities; or (3-20-20)T

**b.** Within two (2) years of the final addition of new cyanide to the ore process circuit for all other cyanidation facilities; or (3-20-20)T

**c.** If the product recovery phase of the cyanidation facility has been suspended for a period of more than two (2) years. (3-20-20)T

**02. Submittal of a Permanent Closure Report.** The operator shall submit a permanent closure report to the Department for review and approval. A permanent closure report shall be of sufficient detail for the directors of the Department and DEQ to issue a determination that permanent closure, as defined by Subsection 010.13 of these rules, has been achieved. The permanent closure report shall address: (3-20-20)T

- a.** The effectiveness of material stabilization. (3-20-20)T
- b.** The effectiveness of the water management plan and the adequacy of the monitoring plan. (3-20-20)T
- c.** The final configuration of the cyanidation facility and its operational/closure status. (3-20-20)T
- d.** The post-closure operation, maintenance, and monitoring requirements, and the estimated reasonable cost to complete those activities. (3-20-20)T
- e.** The operational/closure status of any land application site of the cyanidation facilities. (3-20-20)T
- f.** Source control systems that have been constructed or implemented to eliminate, mitigate, or contain short- and long-term discharge of pollutants from the cyanidation facility, unless otherwise permitted. (3-20-20)T
- g.** The short- and long-term water quality trends in surface and ground water through the statistical analysis of the existing monitoring data pursuant to the ore-processing by cyanidation permit. (3-20-20)T
- h.** Ownership and responsibility for the site upon permanent closure during the defined post-closure period. (3-20-20)T
- i.** The future beneficial uses of the land, surface and ground waters in and adjacent to the closed cyanidation facilities. (3-20-20)T
- j.** How the permanent closure of the cyanidation facility complies with the Resource Conservation and Recovery Act, Hazardous Waste Management Act, Solid Waste Management Act, and appropriate rules. (3-20-20)T

**112. DECISION TO APPROVE OR DISAPPROVE OF A PERMANENT CLOSURE REPORT.**

**01. Receipt of a Permanent Closure Report.** Within sixty (60) days of receipt of a permanent closure report, the director shall issue to the operator a director's determination of approval or disapproval of the permanent closure report. (3-20-20)T

**02. Permanent Closure Report Is Disapproved.** The director's determination to approve or disapprove a permanent closure report shall be based on the permanent closure report's demonstration that permanent closure has resulted in long-term neutralization of process waters and material stabilization. If a permanent closure report is disapproved, the director shall provide in writing identification of: (3-20-20)T

- a.** Errors or inaccuracies in the permanent closure report. (3-20-20)T
- b.** Issues or details which require additional clarification. (3-20-20)T
- c.** Failures to fully implement the approved permanent closure plans. (3-20-20)T
- d.** Failures to ensure protection for public health, safety, and welfare or to prevent degradation of waters of the state. (3-20-20)T
- e.** Outstanding violations or other noncompliance issues. (3-20-20)T

f. Other issues supporting the Department's disagreement with the contents, final conclusions or recommendations of the permanent closure report. (3-20-20)T

**113. -- 119. (RESERVED)**

**120. FINANCIAL ASSURANCE REQUIREMENTS FOR MINING.**

**01. Submittal of Financial Assurance Before Mining.** Prior to beginning any mining on a mine panel covered by a reclamation plan, an operator shall submit to the director, on a Department mine reclamation financial assurance form, financial assurance meeting the requirements of this rule. If financial assurance is not received by the Department within eighteen (18) months of reclamation plan approval and operations have not begun, the Department will cancel the reclamation plan without prejudice. The operator must then resubmit the reclamation plan application and correct application fee to restart the approval process prior to mining. An extension to the eighteen (18) month period may be granted by the Department for reasonable cause given if the request is received prior to the end of that period. (3-20-20)T

**02. Financial Assurance for Operations With Five (5) or Less Disturbed Acres.** Financial assurance will be a minimum of five thousand dollars (\$5,000) per acre unless the operator or the Department determine that the estimated reasonable costs of reclamation require a different amount. No financial assurance may exceed fifteen thousand dollars (\$15,000) for a given acre of affected land unless: (3-20-20)T

a. The Board has determined that such financial assurance is necessary to meet the requirements of Sections 47-1506, 47-1509, 47-1510, and 47-1511, Idaho Code. (3-20-20)T

b. The Board has delivered to the operator, in writing, a notice setting forth the reasons it believes such financial assurance is necessary. (3-20-20)T

c. The Board has conducted a hearing where the operator is allowed to give testimony to the Board concerning the amount of the proposed financial assurance, as provided by Section 47-1512(c), Idaho Code. This requirement for a hearing may be waived, in writing, by the operator. (3-20-20)T

**03. Financial Assurance for Operation With More Than Five (5) Disturbed Acres.** The amount of financial assurance shall be the amount necessary for the Board to pay the estimated reasonable costs of reclamation required under the reclamation plan, including indirect costs in subsection 120.04 of these rules. (3-20-20)T

**04. Indirect Costs for Reclamation Cost Calculations.** Reclamation cost calculations shall include the following indirect costs: (3-20-20)T

a. Mobilization and demobilization costs from the nearest community that has at least two (2) contractors able to perform the reclamation; (3-20-20)T

b. Contractor profit as a percentage of direct costs; (3-20-20)T

c. Contractor overhead as a percentage of direct costs; (3-20-20)T

d. Contractor insurance as a percentage of labor costs; (3-20-20)T

e. Contractor bonding as a percentage of direct costs; (3-20-20)T

f. Contract administration as a percentage of direct costs; (3-20-20)T

g. Re-engineering for mines with direct reclamation costs over five hundred thousand dollars (\$500,000). Re-engineering will be determined as a percentage of direct costs; (3-20-20)T

h. Contingency as a percentage of direct costs; and (3-20-20)T

i. Other site specific costs as appropriate. (3-20-20)T

**05. Salvage Value Not Allowed.** Reclamation costs will not be reduced by assigning a salvage value to structures or fixtures to be removed during reclamation. (3-20-20)T

**06. Mining Operation Conducted by Public or Government.** Notwithstanding any other provision of law to the contrary, the financial assurance provisions of the chapter and these rules do not apply to any surface mining operations conducted by a public or governmental agency for maintenance, repair, or construction of a public highway. (3-20-20)T

**07. Annual Financial Assurance Review.** At the beginning of each calendar year, the operator shall notify the director of any increase in the acreage of affected land which will result from planned mining activity within the next twelve (12) months. A commensurate increase in the financial assurance will be required for an increase in affected acreage. Any additional financial assurance required shall be submitted on the appropriate form within ninety (90) days of operator's receipt of notice from the Department that an additional amount is required. In no event will mining operations be conducted that would affect additional acreage until the appropriate form and financial assurance has been with the Department. Acreage on which reclamation is complete will be reported in accordance with Subsection 120.10 and after release of this acreage from the plan by the director, the financial assurance will be reduced by the amount appropriate to reflect the completed reclamation. (3-20-20)T

**08. Financial Assurance to the Federal Government.** Any financial assurance provided to the federal government that also meets the requirements of Section 120 shall be sufficient for the purposes of these rules. (3-20-20)T

**09. Financial Assurance Reduction.** (3-20-20)T

**a.** An operator may petition the director for a change in the initial financial assurance amount. The director will review the petition and if satisfied with the information presented a revised financial assurance amount will be determined. The revised amount will be based upon the estimated cost that the director would incur should a forfeiture of financial assurance occur and it became necessary for the director, through contracting with a third party, to complete reclamation to the standards established in the plan. (3-20-20)T

**b.** Upon finding that any land covered by financial assurance will not be affected by mining, the operator will notify the director. The amount of the financial assurance will be reduced by the amount being held to reclaim those lands. (3-20-20)T

**c.** Any request for financial assurance reduction will be answered by the director within thirty (30) days of receiving such request unless weather conditions prevent inspection. (3-20-20)T

**10. Financial Assurance Release Following Reclamation.** Upon completion of the reclamation specified in the plan, the operator may notify the director of his desire to secure release from financial assurance. When the director has verified that the requirements of the reclamation plan have been substantially met as stated in the plan, the financial assurance will be released. (3-20-20)T

**a.** Any request for financial assurance release will be answered by the director within thirty (30) days of receiving such request unless weather conditions prevent inspection. (3-20-20)T

**b.** If the director finds that a specific portion of the reclamation has been satisfactorily completed, the financial assurance may be reduced to the amount required to complete the remaining reclamation. The following schedule will be used to complete these financial assurance reductions unless the director determines in a specific case that this schedule is not appropriate and specifies a different schedule: (3-20-20)T

**i.** Sixty percent (60%) of the financial assurance may be released when the operator completes the required backfilling, regrading, topsoil replacement, and drainage control of a specific area in accordance with the approved reclamation plan; and (3-20-20)T

**ii.** After revegetation activities have been performed by the operator on the regraded lands, according to the approved reclamation plan, the Department may release an additional twenty-five percent (25%) of the

financial assurance. (3-20-20)T

c. The remaining financial assurance shall not be released: (3-20-20)T

i. As long as the affected lands are contributing suspended solids to surface waters outside the affected area in excess of state water quality standards and in greater quantities than existed prior to the commencement of mining operations; (3-20-20)T

ii. Until final removal of equipment and structures related to the mining activity or until any remaining equipment and structures are brought under an approved reclamation plan and financial assurance by a new operator; and (3-20-20)T

iii. Until all temporary sediment or erosion control structures have been removed and reclaimed or until such structures are brought under an approved reclamation plan and financial assurance by a new operator. (3-20-20)T

d. If an operator provides part of a mine's financial assurance through a corporate guarantee, then the corporate guarantee will be released prior to any other type of financial assurance being released. Other types of financial assurance will only be released after the corporate guarantee has been completely released. (3-20-20)T

**11. Cooperative Agreements.** The director may through private conference, conciliation, and persuasion reach a cooperative agreement with the operator to correct deficiencies in complying with the reclamation plan and thereby postpone action to forfeit the financial assurance and cancel the reclamation plan if all deficiencies are satisfactorily corrected within the time specified by the cooperative agreement. (3-20-20)T

**12. Liabilities for Reclamation Costs Not Covered by Financial Assurance.** An operator who is in violation of the following rules may be subject to civil penalty under Section 47-1513(c), Idaho Code. The amount of civil penalty will be the estimated cost of reasonable reclamation of affected lands as determined by the director. Reasonable reclamation of the site will be presumed to be in accordance with the standards established in the approved reclamation plan. The amount of the civil penalty is in addition to those described in Section 47-1513(f), Idaho Code. These violations include: (3-20-20)T

a. Departs from his approved reclamation plan by performing an act or omission and such deviation is not subsequently approved; (3-20-20)T

b. Does not furnish financial assurance required by these rules; or (3-20-20)T

c. Is not required to furnish financial assurance by these rules, but fails to reclaim; (3-20-20)T

**121. FINANCIAL ASSURANCE REQUIREMENTS FOR CYANIDATION FACILITIES.**

**01. Submittal of Financial Assurance Before Operating a Cyanidation Facility.** Prior to beginning construction or operation of a cyanidation facility, but no later than ninety (90) days after approval of a permanent closure plan, an operator will submit to the director, on a Department permanent closure plan financial assurance form, financial assurance meeting the requirements of Section 47-1512(a)(2), Idaho Code. The financial assurance will be in an amount equal to the total costs estimated under subsection 071.02.k. of these rules. Upon application to the Department, the operator may apply and the director may approve financial assurance for each phase of closure on an incremental basis. If the Department authorizes phased financial assurance, then financial assurance may increase incrementally commensurate with the additional permanent closure liability. After construction and operation of the initial phase of a cyanidation facility has commenced and after filing by an operator of the initial permanent closure financial assurance, an operator will not construct any component of a subsequent phase or phases of the subject cyanidation facility before filing the additional permanent closure financial assurance amount that is required by the Board. If phased financial assurance is not authorized, the operator is required to file the financial assurance amount required to complete permanent closure of all planned phases prior to any construction. (3-20-20)T

**02. Financial Assurance for Permanent Closure Plans Affecting Five (5) or Less Disturbed Acres.** The Board may require financial assurance in excess of five million dollars (\$5,000,000) if the following conditions



have been met: (3-20-20)T

**a.** The Board has determined that such a financial assurance is necessary to meet the requirements of the chapter; (3-20-20)T

**b.** The Board has delivered to the operator, in writing, a notice explaining the reasons such financial assurance is necessary; and (3-20-20)T

**c.** The operator is allowed to give testimony to the Board concerning the amount of the proposed financial assurance, as provided by Section 47-1512(d)(3), Idaho Code. This requirement for a hearing may be waived, in writing, by the operator. (3-20-20)T

**03. Financial Assurance for Permanent Closure Plans Affecting More Than Five (5) Disturbed Acres.** The amount of financial assurance shall be the amount necessary for the Board to pay the estimated reasonable costs of reclamation required under the permanent closure plan, including indirect costs in subsection 121.04 of these rules. (3-20-20)T

**04. Indirect Costs for Permanent Closure Cost Calculations.** Permanent closure cost calculations shall include the following indirect costs: (3-20-20)T

**a.** Mobilization and demobilization costs from the nearest community that has at least two (2) contractors able to perform the reclamation; (3-20-20)T

**b.** Contractor profit as a percentage of direct costs; (3-20-20)T

**c.** Contractor overhead as a percentage of direct costs; (3-20-20)T

**d.** Contractor insurance as a percentage of labor costs; (3-20-20)T

**e.** Contractor bonding as a percentage of direct costs; (3-20-20)T

**f.** Contract administration as a percentage of direct costs; (3-20-20)T

**g.** Re-engineering for cyanidation facilities with direct reclamation costs over five hundred thousand dollars (\$500,000). Re-engineering will be determined as a percentage of direct costs; (3-20-20)T

**h.** Contingency as a percentage of direct costs; and (3-20-20)T

**i.** Other site specific costs as appropriate. (3-20-20)T

**05. Salvage Value Not Allowed.** Reclamation costs may not be reduced by assigning a salvage value to structures or fixtures to be removed during reclamation. (3-20-20)T

**06. Other Government Agency Financial Assurance.** Upon a finding by the director that the financial assurance amount established by a federal agency is inadequate because it has not included one (1) or more permanent closure tasks required by the state, the Department may require the operator to file an additional financial assurance amount, as necessary, to satisfy the requirements of the chapter. (3-20-20)T

**07. Financial Assurance Review.** The Department will periodically review all financial assurances filed for permanent closure to determine their sufficiency to complete the work required by an approved permanent closure plan. (3-20-20)T

**a.** Once every three (3) years, the operator shall submit an updated permanent closure cost estimate to the Department for review. The director will review the updated estimate to determine whether the existing financial assurance amount is adequate to implement the permanent closure plan, as approved by the Department. Any resulting change in the financial assurance amount does not in and of itself require an amendment to the permanent closure plan as may be required by Section 091 of these rules. The director will review the estimate to determine

whether the existing financial assurance amount is adequate to complete permanent closure of the cyanidation facility. (3-20-20)T

**b.** When the director determines that there has been a material change in the estimated reasonable costs to complete permanent closure: (3-20-20)T

**i.** The director will notify the operator in writing of his intent to reevaluate the financial assurance amount. Within a reasonable time period determined by the Department, the operator will provide to the Department a revised cost estimate to complete permanent closure as approved by the Department. (3-20-20)T

**ii.** Within thirty (30) days of receipt of the revised cost estimate the director will notify the operator in writing of his determination of financial assurance adequacy. (3-20-20)T

**iii.** Within ninety (90) days of notification of the director's assessment, the operator will make the appropriate adjustment to the financial assurance or the director will reduce the financial assurance as appropriate. (3-20-20)T

**c.** The Department may conduct an internal review of the amount of each financial assurance annually to determine whether it is adequate to complete permanent closure. (3-20-20)T

**d.** For closure cost reviews conducted pursuant to Subsections 121.07.a. and 121.07.b., the director may employ a qualified independent party to verify the accuracy of the revised estimated costs to complete permanent closure. The qualified independent party will be employed and the operator will pay a reasonable fee pursuant to Subsection 071.05.b. (3-20-20)T

**08. Financial Assurance Reduction.** A financial assurance for permanent closure may be reduced if, during the Department's review of the financial assurance pursuant to Subsection 121.07, the estimated costs to complete permanent closure of the subject cyanidation facility will be lower than the amount held at that time. (3-20-20)T

**09. Financial Assurance Release During Permanent Closure.** (3-20-20)T

**a.** A financial assurance filed for permanent closure of a cyanidation facility will be released according to the schedule in the permanent closure plan. The schedule will include provisions for the release of the post closure monitoring and maintenance portions of the financial assurance. The schedule may be adjusted to reflect the operator's performance of permanent closure activities and their demonstrated effectiveness. (3-20-20)T

**b.** Upon completion of an activity required by an approved permanent closure plan, the operator may request in writing a financial assurance reduction for that activity. When the director, in consultation with DEQ, has verified that the activity meets the requirements of the permanent closure plan, the financial assurance will be reduced by an amount to reflect the activity completed. (3-20-20)T

**c.** Upon the director's determination that all activities specified in the permanent closure plan have been successfully completed, the Department will, in accordance with Section 47-1512(i), Idaho Code, release the balance remaining after partial financial assurance releases. (3-20-20)T

**d.** If an operator provides part of a cyanidation facility's financial assurance through a corporate guarantee, then the corporate guarantee will be released prior to any other type of financial assurance being released. Other types of financial assurance will only be released after the corporate guarantee has been completely released. (3-20-20)T

**10. Liabilities for Permanent Closure Costs Not Covered by Financial Assurance.** An operator who is in violation of the chapter or any provision of these rules may be subject to civil penalties under Section 47-1513, Idaho Code. (3-20-20)T

**122. FORM OF FINANCIAL ASSURANCE.**

**01. Corporate Surety Bond.** (3-20-20)T

**a.** A corporate surety bond is an indemnity agreement executed for the operator and a corporate surety licensed to do business in the state of Idaho, filed on the appropriate form supplied by the director. The bond shall be payable to the state of Idaho and conditioned to require the operator to faithfully perform all requirements of the chapter, and the rules in effect on the date that a reclamation plan or a permanent closure plan was approved by the Department. (3-20-20)T

**b.** The surety company issuing the bond must, at a minimum, be among those listed as acceptable sureties in Circular 570 of the U.S. Department of the Treasury. (3-20-20)T

**c.** When replacement financial assurance is submitted, the following rider must be filed with the Department as part of the replacement before the existing financial assurance will be released: “[Surety company or principal] understands and expressly agrees that the liability under this bond shall extend to all acts for which reclamation is required on areas disturbed in connection with reclamation plan or closure plan [number], both prior to and subsequent to the date of this rider.” (3-20-20)T

**02. Collateral Bond.** A collateral bond is an indemnity agreement executed by or for the operator, payable to the state of Idaho, pledging cash deposits, government securities, real property, time deposit receipts, or certificates of deposit of any financial institution authorized to do business in the state. Collateral bonds shall be subject to the following conditions. (3-20-20)T

**a.** The director shall obtain possession of cash or other negotiable collateral bonds, and, upon receipt, deposit them with the state treasurer to hold them in trust for the purpose of bonding reclamation or permanent closure performance. (3-20-20)T

**b.** The director shall value the collateral at its current market value minus any penalty for early withdrawal, not its face value. (3-20-20)T

**c.** Certificates of deposit or time deposit receipts shall be issued or assigned, in writing, to the state of Idaho and upon the books of the financial institution issuing such certificates. Interest will be allowed to accrue and may be paid by the bank, upon demand and after written release by the Department, to the operator or another person who posted the collateral bond. (3-20-20)T

**d.** Amount of an individual certificate of deposit or time deposit receipt may not exceed the maximum amount insured by the Federal Deposit Insurance Corporation or Federal Savings and Loan Insurance Corporation or their successors. (3-20-20)T

**e.** Financial institutions issuing certificates of deposit or time deposit receipts will waive all rights of set-off or liens which it has or might have against such certificates, and will place holds on those funds that prevent the operator from withdrawing funds until the Department sends a written release to the bank. (3-20-20)T

**f.** Certificates of deposit and time deposit receipts shall be automatically renewable. (3-20-20)T

**03. Letters of Credit.** A letter of credit is an instrument executed by a bank doing business in Idaho, made at the request of a customer. A letter of credit states that the issuing bank will honor drafts for payment upon compliance with the terms of the credit. Letters of credit shall be subject to the following conditions. (3-20-20)T

**a.** All credits shall be irrevocable and prepared in a format prescribed by the director. (3-20-20)T

**b.** All credits must be issued by an institution authorized to do business in the state of Idaho or through a correspondent bank authorized to do business in the state of Idaho. (3-20-20)T

**c.** The account party on all credits must be identical to the entity identified in the reclamation plan or in the permanent closure plan and on the cyanidation facility permit as the party obligated to complete reclamation or permanent closure. (3-20-20)T

**04. Real Property.** Real property used as a collateral bond must be a perfected, first lien security interest in real property located within the state of Idaho, in favor of the state of Idaho, which meets the requirements of these rules using a deed of trust form acceptable to the Department for all lands 40 acres or less, or a mortgage form approved by the Department. (3-20-20)T

**a.** The following information must be submitted for real property collateral: (3-20-20)T

**i.** The value of the real property. The property will be valued at the difference between the fair market value and any reasonable expense anticipated by the Department in selling the property. The fair market value will be determined by an appraisal conducted by a licensed appraiser. The appraiser will be selected by the Department and the Department will provide appraisal instructions; however, the operator may propose an appraiser to the Department. The appraisal will be performed in a timely manner, and a copy sent to the Department and the operator. The expense of the appraisal will be borne by the operator. The real property will be reappraised every three (3) years; (3-20-20)T

**ii.** A description of the property and a site improvement survey plat to verify legal descriptions of the property and to identify the existence of recorded easements; (3-20-20)T

**iii.** Proof of ownership and title to the real property; (3-20-20)T

**iv.** A current title binder which provides evidence of clear title containing no exceptions, or containing only exceptions acceptable to the director; and (3-20-20)T

**v.** Phase I environmental assessment. (3-20-20)T

**b.** Real property will not include any lands in the process of being mined, reclaimed, or planned to be mined under an approved reclamation plan. The operator may offer any lands within a reclamation plan that have received full release of financial assurances. In addition, any land used as a security will not be mined or otherwise disturbed while it is a security. The acceptance of real property within the permit boundary will be at the discretion of the Director. (3-20-20)T

**05. Trusts.** Trusts are subject to the requirements of Sections 47-1512(l) and 68-1, Idaho Code. The proposed trustee, range of investments, initial funding, schedule of payments, trustee fees, and expected rate of return are subject to review and approval by the Department through a memorandum of agreement with the operator. Trusts are also subject to the following conditions: (3-20-20)T

**a.** The joint party on the trust must be identical to the entity identified in the reclamation plan or in the permanent closure plan as the party obligated to complete reclamation or permanent closure. (3-20-20)T

**b.** The trustee must be an entity which has the authority to act as a trustee and whose trust operations are regulated and examined by a federal or state agency. (3-20-20)T

**c.** Equities may include stock funds or stock index funds, but not individual stocks or direct investments in the operator's company or parent company. Corporate equities must not exceed seventy percent (70%) of the total value of the trust fund. (3-20-20)T

**d.** Bonds or money market funds must be investment-grade rated securities having a Standard and Poor's rating of AAA or AA or an equivalent rating from a nationally recognized securities rating service. (3-20-20)T

**e.** Payments into the trust will be made as follows: (3-20-20)T

**i.** When used to cover reclamation costs, the trust fund will be initially funded in an amount at least equal to the costs estimated in the approved reclamation plan for reclamation of existing surface disturbances covered by the chapter and any surface disturbances to occur in the first year of the trust fund. Annual payments to keep pace with increased disturbance and reclamation costs will occur as needed no later than thirty (30) days after each annual anniversary of the date of the initial payment. (3-20-20)T

ii. When used to cover a portion of reclamation costs in combination with other types of financial assurance, the initial and annual payments will be the pro-rata amount of the reclamation costs as described in subparagraph 122.05.e.i of these rules. (3-20-20)T

iii. When used to cover the anticipated post-closure costs, a payment schedule will be created in the memorandum of agreement. The post-closure costs must be fully funded by the time the post-closure period occurs. (3-20-20)T

f. Disbursements from the trust will only occur upon written authorization of the Department. (3-20-20)T

g. Trusts will be irrevocable. (3-20-20)T

h. Income accrued on trust funds will be retained in the trust, except as otherwise agreed by the director under the terms of an agreement governing the trust. (3-20-20)T

**06. Corporate Guarantees.** (3-20-20)T

a. Up to fifty percent (50%) of required financial assurance for reclamation costs may be provided by a corporate guarantee. Post-closure costs for reclamation plans and permanent closure plans cannot be covered by a corporate guarantee. (3-20-20)T

b. Only operators who submit plans under Sections 070 or 071 of these rules may provide a corporate guarantee. (3-20-20)T

c. Operators who want to provide financial assurance through a corporate guarantee must provide an audited financial statement from a third-party certified public accountant licensed in Idaho that the operator meets two (2) of the following three (3) criteria and the criteria in paragraph d of this section: (3-20-20)T

i. Ratio of total liabilities to stockholder's equity is less than two (2) to one (1); (3-20-20)T

ii. Ratio of sum of net income plus depreciation, depletion, and amortization to total liabilities greater than ten one-hundredths (0.1) to one (1); or (3-20-20)T

(1). iii. Ratio of current assets to current liabilities greater than one and fifty one-hundredths (1.5) to one (3-20-20)T

d. The following financial criteria must also be met for a corporate guarantee: (3-20-20)T

i. Net working capital and tangible net worth are each equal to or greater than the total reclamation or permanent closure cost estimate; (3-20-20)T

ii. Tangible net worth of at least ten million dollars (\$10,000,000); and (3-20-20)T

iii. At least ninety percent (90%) of the corporation's total assets are in the United States, or the total assets in the United States are at least six (6) times greater than total reclamation or permanent closure cost estimate. (3-20-20)T

e. If the operator is a partnership or joint venture, each partner or member of the entity will sign an indemnity agreement in favor of the State of Idaho that binds each partner or member who has a beneficial interest, directly or indirectly, in the operator. The indemnity agreement must be signed by the partners or members who are authorized to bind their partnership or joint venture. The indemnity agreement will bind each partner or member jointly and severally. The operator must provide a copy of the agreement to the Department with an affidavit certifying that such an agreement is valid under all applicable federal and state laws. (3-20-20)T

f. A corporate guarantee can be provided by a parent company guarantor if that guarantor meets the conditions of paragraphs (c) and (d) in this section as if it were the operator. The terms of this corporate guarantee

will provide for the following: (3-20-20)T

i. The operator and the parent company will submit to the Department an indemnity agreement signed by corporate officers from both companies who are authorized to bind their corporations. The operator or parent company must also provide an affidavit certifying that such an agreement is valid under all applicable federal and state laws. The indemnity agreement will bind each party jointly and severally; (3-20-20)T

ii. If the operator fails to complete reclamation or permanent closure, the parent company guarantor will do so or the guarantor will be liable under the indemnity agreement to provide funds to the Department sufficient to complete reclamation or permanent closure as per the plan, but not to exceed the financial assurance amount; (3-20-20)T

iii. The corporate guarantee will remain in force unless the parent company guarantor sends notice of cancellation by certified mail to the operator and to the Department at least ninety (90) days in advance of the cancellation date, and the Department accepts the cancellation; and (3-20-20)T

iv. The cancellation will be accepted by the Department only if the operator obtains replacement financial assurance before the cancellation date or if the lands for which the corporate guarantee, or portion thereof, was accepted have not been disturbed. (3-20-20)T

g. The operator, or parent company guarantor, is required to either complete the approved reclamation or closure plan for the lands in default, or pay to the Department an amount necessary to complete the approved reclamation, not to exceed the amount established in Sections 120 or 121 of these rules. Any indemnity agreement under forfeiture will operate as a judgment against those parties liable under the indemnity agreement. (3-20-20)T

h. The operator or parent company guarantor will submit an annual update of the information required under paragraphs (c) and (d) of this section by April 1 following the issuance of the corporate guarantee. (3-20-20)T

i. If the operator or parent company guarantor's financial fitness falls below the eligibility for providing a corporate guarantee they will immediately notify the Department, and the Department will require the operator to submit replacement financial assurance within ninety (90) days of being notified. (3-20-20)T

j. The Department may require the operator or parent company guarantor to provide an update of the information in paragraphs (c) and (d) in this section at any time. The update must be provided within thirty (30) days of being requested. The requirements of paragraph (i) in this Section will then apply. (3-20-20)T

**07. Blanket Financial Assurance.** Where an operator is involved in more than one (1) reclamation plan or permanent closure plan permitted by the Department, the director may accept a blanket financial assurance in lieu of separate reclamation or permanent closure financial assurances under the approved plans. The amount of such financial assurance shall be equal to the total of the requirements of the separate financial assurances being combined into a single financial assurance, as determined pursuant to Section 47-1512, Idaho Code, and in accordance with Sections 120 and 121 of these rules. The principal shall be liable for an amount no more than the financial assurance filed for completion of reclamation activities or permanent closure activities if the Department takes action against the financial assurance pursuant to Section 47-1513, Idaho Code and Section 123 of these rules. (3-20-20)T

**08. Reclamation Fund.** Reclamation plans processed under Section 069 of these rules may provide financial assurance through the Reclamation Fund established by Section 47-18, Idaho Code, and IDAPA 20.03.03. If financial assurance is provided through the Reclamation Fund, no other type of financial assurance may be combined with it on an individual mine site. (3-20-20)T

**123. FORFEITURE OF FINANCIAL ASSURANCE.**

A financial assurance may be forfeited in accordance with Section 47-1513, Idaho Code, when the operator has not conducted the reclamation or has not conducted permanent closure in accord with an approved plan and the applicable requirements of these rules. (3-20-20)T

**124. -- 129. (RESERVED)**

**130. TRANSFER OF APPROVED PLANS.**

**01. Reclamation Plans.** A reclamation plan may be transferred from one (1) operator to another only after the Department's approval. To complete a transfer, the new applicant must file a notarized assumption of reclamation plan form as prescribed by the Department and provide replacement financial assurance. The new operator then shall be responsible for the past operator's obligations under the chapter, these rules, and the reclamation plan. (3-20-20)T

**02. Permanent Closure Plans.** An approved permanent closure plan permit may be transferred to a new operator if he provides written notice to the director that includes a specific date for transfer of permanent closure responsibility, coverage, and liability between the old and new operators no later than ten (10) days after the date of closure. An operator shall be required to provide such notice at the same time he provides notice to the DEQ as required IDAPA 58.01.13, "Rules for Ore Processing by Cyanidation." To complete a transfer, the new applicant must: (3-20-20)T

- a.** File a notarized assumption of permanent closure plan form as prescribed by the Department; and (3-20-20)T
- b.** File a replacement permanent closure plan financial assurance on a form approved by the Department. (3-20-20)T

**131. -- 139. (RESERVED)**

**140. BEST MANAGEMENT PRACTICES AND RECLAMATION FOR MINING OPERATION AND PERMANENT CLOSURE OF CYANIDATION FACILITIES.**

These are the minimum standards expected for all activities covered by these rules. Specific standards for individual mines may be appropriate based on site specific circumstances, and must be described in the plan. (3-20-20)T

**01. Nonpoint Source Control.** (3-20-20)T

**a.** Appropriate BMPs for nonpoint source controls shall be designed, constructed, and maintained with respect to site-specific mining operations or permanent closure activities. Operators shall utilize BMPs designed to achieve state water quality standards and to protect existing beneficial uses of adjacent waters of the state. State water quality standards, as administered by DEQ, shall be the standard that must be achieved by BMPs. (3-20-20)T

**b.** If the BMPs utilized by the operator do not result in compliance with Subsection 140.01.a., the director shall require the operator to modify or improve such BMPs to meet the controlling, water quality standards as set forth in current laws, rules, and regulations. (3-20-20)T

**02. Sediment Control.** In addition to proper mining techniques and reclamation measures, the operator shall take necessary steps at the close of each operating season to assure that sediment movement associated with surface runoff over the area is minimized in order to achieve water quality standards, or to preserve the condition of water runoff from the mined area prior to commencement of the subject mining or exploration operations, whichever is the more appropriate standard. Sediment control measures refer to best management practices carried out within and, if necessary, adjacent to the disturbed area and consist of utilization of proper mining and reclamation measures, as well as specific necessary sediment control methods, separately or in combination. Specific sediment control methods may include, but are not limited to: (3-20-20)T

- a.** Keeping the disturbed area to a minimum at any given time through progressive reclamation; (3-20-20)T
- b.** Shaping waste to help reduce the rate and volume of water runoff by increasing infiltration; (3-20-20)T
- c.** Retaining sediment within the disturbed area; (3-20-20)T
- d.** Diverting surface runoff around the disturbed area; (3-20-20)T

e. Routing runoff through the disturbed area using protected channels or pipes so as not to increase sediment load; (3-20-20)T

f. Use of riprap, straw dikes, check dams, mulches, temporary vegetation, or other measures to reduce overland flow velocities, reduce runoff volume, or retain sediment; and (3-20-20)T

g. Use of adequate sediment ponds, with or without chemical treatment. (3-20-20)T

**03. Clearing and Grubbing.** Clearing and grubbing of land in preparation for mining exposes mineral soil to the erosive effects of moving water. Operators are cautioned to keep such areas as small as possible (preferably no more than one (1) year's mining activity) as the operator shall be required to meet the applicable surface water quality standards on all such areas. Where practicable, trees and slash should be stockpiled for use in seedbed protection and erosion control. (3-20-20)T

**04. Overburden/Topsoil.** To aid in the revegetation of affected lands where mining operations result in the removal of substantial amounts of overburden including any topsoil, the operator should remove the available topsoil or other growth medium as a separate operation for such area. Unless there are previously affected lands which are graded and immediately available for placement of the newly removed topsoil or other growth medium, the topsoil or other growth medium shall be stockpiled and protected from erosion and contamination until such areas become available. (3-20-20)T

a. Overburden/Topsoil Removal. (3-20-20)T

i. Any overburden/topsoil to be removed should be removed prior to any other mining activity to prevent loss or contamination; (3-20-20)T

ii. Where overburden/topsoil removal exposes land area to potential erosion, the director, under the reclamation plan, may require BMPs necessary to prevent violation of water quality standards; and (3-20-20)T

iii. Where the operator can show that an overburden material other than topsoil is conducive to plant growth, or where overburden other than topsoil is the only material reasonably available, such overburden may be allowed as a substitute for or a supplement to the available topsoil. (3-20-20)T

b. Topsoil Storage. Topsoil stockpiles shall be placed to minimize rehandling and exposure to excessive wind and water erosion. Topsoil stockpiles shall be protected as necessary from erosion by use of temporary vegetation or by other methods which will control erosion, including, but not limited to, silt fences, chemical binders, seeding, and mulching. (3-20-20)T

c. Overburden Storage. Stockpiled ridges of overburden shall be leveled in such a manner as to have a minimum width of ten (10) feet at the top. Peaks of overburden shall be leveled in such a manner as to have a minimum width of fifteen (15) feet at the top. The overburden piles shall be reasonably prepared to control erosion using best management practices; such activities may include terracing, silt fences, chemical binders, seeding, mulching or slope reduction. (3-20-20)T

d. Topsoil Placement. Abandoned affected lands shall be covered with topsoil or other type of overburden that is conducive to plant growth, to the extent such materials are readily available, in order to achieve a stable uniform thickness. Excessive compaction of overburden and topsoil is to be avoided. Topsoil redistribution shall be timed so that seeding, or other protective measures, can be readily applied to prevent compaction and erosion. (3-20-20)T

e. Fill. Backfill and fill materials should be compacted in a manner to ensure stability. (3-20-20)T

**05. Roads.** (3-20-20)T

a. Roads must be constructed to minimize soil erosion, which may require restrictions on the length and grade of the roadbed, surfacing of roads with durable non-toxic material, stabilization of cut and fill slopes, and



other techniques designed to control erosion. (3-20-20)T

**b.** All access and haul roads must be adequately drained. Drainage structures may include, but are not limited to, properly installed ditches, water-bars, cross drains, culverts, and sediment traps. (3-20-20)T

**c.** Culverts that are to be maintained for more than one (1) year must be designed to pass peak flows from not less than a twenty (20) year, twenty-four (24) hour precipitation event and have a minimum diameter of eighteen (18) inches. (3-20-20)T

**d.** Roads and water control structures will be maintained at periodic intervals as needed. Water control structures serving to drain roads must not be blocked or restricted in any manner to impede drainage or significantly alter the intended purpose of the structure. (3-20-20)T

**e.** Roads that will not be recontoured to approximate original contours upon abandonment will be cross-ditched and revegetated, as necessary, to control erosion. (3-20-20)T

**f.** Roads that are not abandoned and continue to be used under the jurisdiction of a governmental or private landowner, will comply with the nonpoint source sediment control provisions of Subsection 140.02 until the successor assumes control. (3-20-20)T

**06. Backfilling and Grading.** (3-20-20)T

**a.** Every operator who conducts mining or cyanidation facility operations which disturb less than two (2) acres shall, where possible, contour the disturbed land to its approximate previous contour. These lands shall be revegetated in accordance with Subsection 140.11. (3-20-20)T

**b.** An operator who conducts mining or cyanidation facility operations which disturb two (2) acres or more shall reduce all waste piles and depressions to the lowest practicable grade. This grade shall not exceed the angle of repose or maximum slope of natural stability for such waste or generate erosion in which sediment enters waters of the state. (3-20-20)T

**c.** Backfill and fill materials should be compacted in a manner to ensure mass and surface stability. (3-20-20)T

**d.** After the disturbed area has been graded, slopes will be measured for consistency with the approved reclamation plan or the permanent closure plan. (3-20-20)T

**07. Disposal of Waste in Areas Other Than Mine Excavation.** Waste material not used to backfill mined areas shall be transported and placed in a manner designed to stabilize the waste piles and control erosion. (3-20-20)T

**a.** The available disposal area should be on a moderately sloped, naturally stable area. The site should be near the head of a drainage to reduce the area of watershed above the fill. (3-20-20)T

**b.** All surface water flows within the disposal area shall be diverted and drained using accepted engineering practices such as a system of French drains, to keep water from entering the waste pile. These measures shall be implemented in accordance with standards prescribed by the Idaho Stream Channel Protection Act, Title 42, Chapter 38, Idaho Code, and the Idaho Dam Safety Act, Sections 42-1710 through 42-1721, Idaho Code, if applicable. (3-20-20)T

**c.** The waste material not used in backfilling mined areas should be compacted, where practical, and should be covered and graded to allow surface drainage and ensure long-term stability. (3-20-20)T

**d.** The operator may, if appropriate, use terraces or slope reduction to stabilize the face of any fill. Slopes of the fill material should not exceed angle of repose or generate erosion in which sediment enters waters of the state. (3-20-20)T

e. Unless adequate drainage is provided through a fill area, all surface water above the fill shall be diverted away from the fill area into protected channels, and drainage shall not be directed over the unprotected face of the fill. (3-20-20)T

f. The operator shall conduct revegetation activities with respect to such waste piles in accordance with Subsection 140.11. (3-20-20)T

**08. Settling Ponds; Minimum Criteria.** (3-20-20)T

a. Sediment Storage Volume. Settling ponds shall provide adequate sediment storage capacity to achieve compliance with applicable water quality standards and protect existing beneficial uses, and may require periodic cleaning and proper disposal of sediment. (3-20-20)T

b. Water Detention Time. Settling ponds shall have an adequate theoretical detention time for water inflow and runoff entering the pond, but theoretical detention time may be reduced by improvements in pond design, chemical treatment, or other methods. (3-20-20)T

c. Emergency Spillway. In addition to the sediment storage volume and water detention time, settling ponds shall be designed to withstand and release storm flows as required by the Idaho Dam Safety Act, Section 42-1710 through 42-1721, Idaho Code, and Safety of Dams Rules, where applicable. (3-20-20)T

**09. Tailings Impoundments.** All tailings, dams, or other types of tailings impoundments shall be designed, constructed, operated, and decommissioned so that upon their abandonment, the dam and impoundment area will not constitute a hazard to human or animal life. (3-20-20)T

a. Design criteria, construction techniques, and decommission techniques for tailings dams and impoundments shall comply with the Idaho Dam Safety Act, Sections 42-1710 through 42-1721, Idaho Code, and applicable rules and regulations. (3-20-20)T

b. Topsoil shall be removed from the area to be affected by the impounding structure and tailings reservoir in accordance with Subsection 140.04. (3-20-20)T

c. Abandonment and Decommissioning of Tailings Impoundments. (3-20-20)T

i. Dewatering. Tailings ponds shall be dewatered to the extent necessary to provide an adequate foundation for the approved post-mining use. (3-20-20)T

ii. Control of surface waters. Surface waters shall either be channeled around the reservoir and impoundment structure or through the reservoir and breached structure. Permanent civil structures shall be designed and constructed to implement either method of channeling. The structure shall provide for erosion-free passage of waters and adequate energy dissipation prior to entry into the natural drainage below the impounding structure. (3-20-20)T

iii. Detoxification. Hazardous chemical residues within the tailings pond shall be detoxified or covered with an adequate thickness of non-toxic material, to the extent necessary to achieve water quality standards in adjacent surface waters. (3-20-20)T

iv. Reclamation. After implementing the required dewatering, detoxification, and surface drainage control measures, the reservoir and impounding structure shall be covered with topsoil or other material conducive to plant growth, in accordance with Subsection 140.04. Where such soils are limited in quantity or not available, and upon approval by the Department, physical or chemical methods for erosion control may be used. All such areas are to be revegetated in accordance with Subsection 140.11, unless specified otherwise. (3-20-20)T

d. When the operator requests termination of its reclamation or permanent closure plan, pursuant to Section 150 of these rules, impoundment structures and any reservoirs retained as fresh water reservoirs after final reclamation or permanent closure shall be required to conform with the Idaho Dam Safety Act, Sections 42-1710 through 42-1721, Idaho Code, if applicable. (3-20-20)T

**10. Permanent Cessation and Time Limits for Planting.** (3-20-20)T

**a.** Seeding and planting of affected lands and/or a permanently closed cyanidation facility should be conducted during the first normal period for favorable planting conditions after final seedbed preparation. (3-20-20)T

**b.** Reclamation activities, where possible, are encouraged to be concurrent with the mining operation and may be included in the approved reclamation plan. Final reclamation must begin within one (1) year after the mining operations have permanently ceased on a mine panel. If the operator permanently ceases disposing of overburden on a waste area or permanently ceases removing minerals from a pit or permanently ceases using a road or other affected land, the reclamation activity on each given area must start within one (1) year of such cessation, despite the fact that all operations as to the mine panel, which included such pit, road, overburden pile, or other affected land, has not permanently ceased. (3-20-20)T

**c.** An operator shall be presumed to have permanently ceased mining operations on a given portion of affected land when no substantial amount of mineral or overburden material has been removed or overburden placed on an overburden dump, or no significant use has been made of a road during the prior three (3) years. If an operator does not plan to use an affected area for three (3) or more years but intends thereafter to use the affected area for mining operations and desires to defer final reclamation until after its subsequent use, the operator must submit a notice of intent and request for deferral of reclamation to the director, in writing. If the director determines that the operator plans to continue the operation within a reasonable period of time, the director shall notify the operator and may require actions to be taken to reduce degradation of surface resources until operations resume. If the director determines that use of the affected land for mining operations will not be continued within a reasonable period of time, the director may proceed as though the mining operation has been abandoned, but the operator will be notified of such decision at least thirty (30) days before taking any formal administrative action. (3-20-20)T

**11. Revegetation Activities.** (3-20-20)T

**a.** The operator shall select and establish plant species that can be expected to result in vegetation comparable to that growing on the affected lands or on a closed cyanidation facility prior to mining or cyanidation facility operations, respectively. Certified weed free seed should be used in revegetation. The operator may use available technical data and results of field tests for selecting seeding practices and soil amendments which will result in viable revegetation. These practices of selection may be included in an approved reclamation plan or permanent closure. (3-20-20)T

**b.** Unless otherwise specified in the approved reclamation or permanent closure plan, the success of revegetation efforts shall be measured against the existing vegetation on site prior to the mining or cyanidation facility operation, or against an adjacent reference area supporting similar types of vegetation. (3-20-20)T

**i.** The ground cover of living plants on the revegetated area should be comparable to the ground cover of living plants on the adjacent reference area for two (2) full growing seasons after cessation of soil amendment or irrigation. (3-20-20)T

**ii.** For purposes of this rule, ground cover shall be considered comparable if it has, on the area actually planted at least seventy percent (70%) of the premining ground cover for the mined area or adjacent reference area; (3-20-20)T

**iii.** For locations with an average annual precipitation of more than twenty-six (26) inches, the director, in approving a reclamation or permanent closure plan, may set a minimum standard for success of revegetation as follows: Vegetative cover of seventy percent (70%) for two (2) full growing seasons in areas planted to herbaceous species only; or fifty percent (50%) vegetative cover for two (2) full growing seasons and six hundred (600) woody plants per acre in areas planted to a mixture of herbaceous and woody species. (3-20-20)T

**iv.** As used in this section, "herbaceous species" means grasses, legumes, and other forbs; "woody plants" means woody shrubs, trees, and vines; and "ground cover" means the area of the ground surface covered by the combined aerial parts of vegetation and the litter that is produced naturally on-site, expressed as a percentage of the total area measured. Rock surface areas will be excluded from this calculation. (3-20-20)T

- v. For previously mined areas that were not reclaimed to the standards required by Section 140, and which are affected by the mining or cyanidation facility operations, vegetation should be established to the extent necessary to control erosion, but shall not be less than that which existed before redisturbance; and (3-20-20)T
- vi. Vegetative cover shall not be less than that required to control erosion. (3-20-20)T
- c. Introduced species may be planted if they are known to be comparable to previous vegetation, or if known to be of equal or superior use for the approved post-mining use of the affected land, or, if necessary, to achieve a quick, temporary cover for soil stabilization purposes. Species classified as poisonous or noxious weed species shall not be used in revegetation. (3-20-20)T
- d. By mutual agreement of the director, the landowner, and the operator, a site may be converted to a different, more desirable or more economically suitable habitat. (3-20-20)T
- e. Planting of grasses and forbs should be done in a manner which promotes rapid stabilization of the soil surface. Wherever terrain permits, grasses and forbs should be drilled or compacted into the ground using agricultural grass planting equipment or other seeders specifically designed for mine revegetation applications. Broadcast and hydroseeding may be used on areas where other methods are impractical or unavailable. (3-20-20)T
- f. The operator should plant shrubs or shrub seed, as required, where shrub communities existed prior to mining. Shrub seed may be planted as a portion of a grass seed mix or planted as bare-root transplants after grass seeding. Where the landowner desires a specific land use such as grazing or cropland, shrubs will not be required in the revegetation species mix. Shrub lands undergoing revegetation with shrubs shall be protected from erosion by vegetation, chemical, or other acceptable means during establishment of the shrubs. (3-20-20)T
- g. Reforestation. Tree stocking of forestlands should meet the following criteria: (3-20-20)T
- i. Trees that are adapted to the site should be planted on the area to be revegetated in a density which can be expected over time to yield a timber stand comparable to premining timber stands; (3-20-20)T
- ii. Trees shall be established for two (2) full growing seasons after cessation of any soil amendments and irrigation before they are considered to be established; and (3-20-20)T
- iii. Forestlands undergoing revegetation with trees should be protected from erosion by vegetation, chemical binders, or other acceptable means during seedling establishment. (3-20-20)T
- h. Revegetation is not required on the following areas: (3-20-20)T
- i. Affected lands, or portions thereof, where planting is not practicable or reasonable because the soil is composed of excessive amounts of sand, gravel, shale, stone, or other material to such an extent to prohibit plant growth; (3-20-20)T
- ii. Any mined area or overburden stockpiles proposed to be used in the mining operations for haulage roads, so long as those roads are not abandoned; (3-20-20)T
- iii. Any mined area or overburden stockpile, where lakes are formed by rainfall or drainage runoff from adjoining lands; (3-20-20)T
- iv. Any mineral stockpile; (3-20-20)T
- v. Any exploration trench which will become a part of a pit or an overburden disposal area; and (3-20-20)T
- vi. Any road which is to be used in mining operations, so long as the road is not abandoned. (3-20-20)T

i. Mulching. Mulch should be used on severe sites and may be required by the reclamation or permanent closure plan where slopes are steeper than three to one (3:1) or the mean annual rainfall is less than twelve (12) inches. When used, straw or hay mulch should be obtained from certified weed free sources. "Mulch" means vegetation residues or other suitable materials to aid in the stabilization of soil and soil moisture conservation which will provide a micro-climate more suitable for germination and growth on severe sites. Annual grains such as rye, oats, and wheat may be used as a substitute for mulch where they will provide adequate protection and will be replaced by permanent species within a reasonable length of time. (3-20-20)T

**12. Petroleum-Based Products and Chemicals.** All refuse, chemical and petroleum products and equipment should be stored and maintained in a designated location away from surface water and disposed of in such a manner as to prevent their entry into a waterway. (3-20-20)T

**141. -- 149. (RESERVED)**

**150. TERMINATION OF A PLAN.**

**01. Terminate upon Request of the Operator.** A reclamation plan shall terminate upon request of the operator, upon inspection by the director, and a determination that all reclamation activity has been completed to the standards specified in the plan, and following final approval by the director. Upon termination, the director will release the remaining financial assurance, notify the operator, and any authority to conduct any mining operations under the subject plan shall terminate. (3-20-20)T

**02. Terminate a Permanent Closure Plan.** The director shall terminate a permanent closure plan upon request of the operator, provided all the provisions and objectives of the permanent closure plan have been met, as determined by the director under Sections 111 and 112 of these rules. Upon a determination that permanent closure has been completed in accordance with the approved permanent closure plan and upon consultation with the DEQ that the operator's request to terminate a plan should be approved, the director will notify the operator that any authority to continue cyanidation operations shall cease and he will release the balance of the financial assurance in accordance with Subsection 121.09. (3-20-20)T

**151. -- 154. (RESERVED)**

**155. FIVE (5) YEAR UPDATES AND PERIODIC INSPECTIONS.**

**01. Five (5) Year Updates.** The Department may require permitted mines to submit an update on their mining operation at least every five (5) years. The update will be on a Department form, and will be used to assist the Department in determining whether or not adjustments are needed for financial assurance or if a plan amendment is required due to a material change. Failure by an operator to complete the form and return it to the Department, or an operator providing false statements on the form, may result in the penalties in Section 47-1513(g), Idaho Code. (3-20-20)T

**02. Right of Inspection.** Authorized representatives of the Department have the right to enter upon lands affected or proposed to be affected by exploration, mining operations, or cyanidation facilities to determine compliance with the reclamation or permanent closure plans and these rules. Inspections will be conducted at reasonable times in the presence of the operator or his authorized representative. The operator shall make such a person available for the purpose of inspection. This rule does not prevent the Department from making an inspection of the site if the operator fails to make a representative available on request. (3-20-20)T

**03. Frequency of Inspection.** (3-20-20)T

a. Mining operations with an approved reclamation plan will be inspected at least once every five (5) years to determine compliance with the approved plan and adequacy of the financial assurance. Inspections may need to be more frequent due to the large size, rapid pace of mining, complexity of an operation, or high financial assurance. (3-20-20)T

b. Cyanidation facilities with an approved closure plan will be inspected as often as is needed, but at least once a year. (3-20-20)T

**156. -- 159. (RESERVED)**

**160. ENFORCEMENT AND FAILURE TO COMPLY.**

**01. Financial Assurance Forfeiture.** Upon request by the director, the attorney general may institute proceedings to have the financial assurance for reclamation or permanent closure forfeited for violation of an order entered pursuant to Section 47-1513, Idaho Code and these rules. (3-20-20)T

**02. Civil Penalty.** An operator with no financial assurance, or an operator who violates these rules by performing an act which is not included in an approved reclamation plan or an approved permanent closure plan that is not subsequently approved by the Department, will be subject to a civil penalty as authorized by Section 47-1513(c), Idaho Code. (3-20-20)T

**03. Injunctive Procedures.** The director may seek injunctive relief and proceed with legal action, if necessary, to enjoin a mine operator or cyanidation facility operator who violates the provisions of the chapter, these rules, or the terms of an existing approved reclamation or permanent closure plan. Any such action will follow the procedures established in Section 47-1513, Idaho Code. (3-20-20)T

**04. Appeal of Final Order.** An operator dissatisfied with a final order of the Board may within sixty (60) days after receiving the order, file an appeal in accordance with Section 47-1514, Idaho Code. (3-20-20)T

**161. -- 169. (RESERVED)**

**170. COMPUTATION OF TIME.**

Computation of time will be based on calendar days. In computing any period of time prescribed by the chapter, the day on which the designated period of time begins is excluded. The last day of the period is included unless it is a Saturday, Sunday or legal holiday when the Department is not open for business. In such a case, the time period runs until the end of the next day which is not a Saturday, Sunday or legal holiday. Intermediate Saturdays, Sundays or legal holidays are excluded from the computation when the period of prescribed time is seven (7) days or less. (3-20-20)T

**171. -- 179. (RESERVED)**

**180. PUBLIC AND CONFIDENTIAL INFORMATION.**

**01. Information Subject to Disclosure.** Information obtained by the Department pursuant to the chapter and these rules is subject to disclosure under Title 74, Chapter 1, Idaho Code ("Public Records Act"). (3-20-20)T

**02. Use by Board.** Any plans, documents, or materials submitted as confidential and held as such shall not prohibit the Board, director, or Department from using the information in an administrative hearing or judicial proceeding initiated pursuant to Section 47-1514, Idaho Code. (3-20-20)T

**03. Plans and BMPs.** An operator will not unreasonably designate as confidential portions of reclamation or permanent closure plans which detail proposed BMPs to meet state surface and ground water quality standards. Confidential portions of reclamation or permanent closure plans may be shared with DEQ in its coordinating role under these rules, as reasonably necessary. (3-20-20)T

**181. -- 189. (RESERVED)**

**190. DEPOSIT OF FORFEITURES AND DAMAGES.**

All fees, penalties, forfeitures, and civil damages collected pursuant to the chapter, will be deposited with the state treasurer in the following accounts as appropriate: (3-20-20)T

**01. Mine Reclamation Fund.** The mine reclamation fund to be used by the director for mined land reclamation purposes and to administer the reclamation provisions of the chapter and these rules. (3-20-20)T

**02. Cyanidation Facility Closure Fund.** The cyanidation facility closure fund to be used by the director to complete permanent closure activities and to administer the permanent closure provisions of the chapter and these rules. (3-20-20)T

**191. -- 199. (RESERVED)**

**200. COMPLIANCE OF EXISTING RECLAMATION PLANS.**

**01. Applicability.** These rules, upon their adoption, apply as appropriate to all existing mining operations, but will not affect the validity or modify the duties, terms, or conditions of any existing approved reclamation plan or impose any additional obligations with respect to reclamation upon any operator conducting mining operations pursuant to a reclamation plan approved prior to adoption of these rules unless amended under Section 090 of these rules. (3-20-20)T

**02. Approval.** Reclamation plans approved prior to July 1, 2019, or reclamation plans that have permanently ceased operations prior to July 1, 2019, are not subject to the 2019 legislative amendments to the chapter regarding financial assurance and post-closure. New reclamation plans or plan amendments received after July 1, 2019, will be subject to the 2019 legislative amendments to the chapter. (3-20-20)T

**03. Submittal.** Reclamation plan applications submitted prior to July 1, 2019, but not yet approved, have until July 1, 2020 to submit post-closure plans and financial assurances as described in the 2019 legislative amendments to the chapter. (3-20-20)T

**201. -- 999. (RESERVED)**

## 20.03.03 – RULES GOVERNING ADMINISTRATION OF THE RECLAMATION FUND

### 000. LEGAL AUTHORITY.

These rules are promulgated by the Idaho State Board of Land Commissioners under Sections 58-104(3) and (6), Idaho Code, and Title 47, Chapter 18, Idaho Code. The Board has delegated to the Director of the Idaho Department of Lands the duties and powers under Title 47, Chapter 18, Idaho Code and these rules, except that the Board retains responsibility for administrative review. (3-20-20)T

### 001. TITLE AND SCOPE.

**01. Title.** These rules are titled IDAPA 20.03.03, “Rules Governing Administration of the Reclamation Fund,” IDAPA 20, Title 03, Chapter 03. (3-20-20)T

**02. Scope.** These rules constitute the Department’s administrative procedures and participation criteria for the Reclamation Fund, which is an alternative form of financial assurance for certain mines in Idaho. These rules are to be construed in a manner consistent with the duties and responsibilities of the Board and of operators, permit holders, or lessees as set forth in Title 47, Chapter 7, Idaho Code, “Mineral Rights in State Lands;” Title 47, Chapter 13, Idaho Code, “Dredge Mining;” Title 47, Chapter 15, Idaho Code, “Mined Land Reclamation;” Title 47, Chapter 18, Idaho Code, “Financial Assurance;” IDAPA 20.03.01, “Dredge and Placer Mining Operations in Idaho;” IDAPA 20.03.02, “Rules Governing Mined Land Reclamation;” and IDAPA 20.03.05, “Riverbed Mineral Leasing In Idaho.” (3-20-20)T

### 002. ADMINISTRATIVE APPEALS.

Any person aggrieved by a final agency action or a party aggrieved by a final order of the Board arising from its administration of the Reclamation Fund Act is entitled to judicial review pursuant to the provisions of Title 67, Chapter 52, Idaho Code, “Administrative Procedure Act,” and IDAPA 20.01.01, “Rules of Practice and Procedure Before the State Board of Land Commissioners.” (3-20-20)T

### 003. -- 009. (RESERVED)

### 010. DEFINITIONS.

Except as provided in these rules, the Board adopts the definitions set forth in the Mineral Leasing Act, the Dredge Mining Act, and the Mined Land Reclamation Act. As used in these rules: (3-20-20)T

**01. Actual Allowable Cost.** The allowable total reclamation cost as set by the Board to allow participation in the Reclamation Fund. (3-20-20)T

**02. Actual Allowable Disturbance.** The area of disturbed acres or affected land as set by the Board to allow participation in the Reclamation Fund. (3-20-20)T

**03. Board.** The Idaho State Board of Land Commissioners or its authorized representative. (3-20-20)T

**04. Department.** The Idaho Department of Lands. (3-20-20)T

**05. Disturbed Acres; Affected Lands.** Any land, natural watercourses, or existing stockpiles or waste piles affected by placer or dredge mining, remining, exploration, stockpiling of ore, waste from placer or dredge mining, or construction of roads, settling ponds, structures, or facilities appurtenant to a placer or dredge mine. The land area included in overburden disposal areas, mined areas, mineral stockpiles, roads, tailings ponds, and other areas disturbed at a mine. The land area disturbed by motorized exploration of state land under a mineral lease. (3-20-20)T

**06. Dredge Mining Act.** Title 47, Chapter 13, Idaho Code, and IDAPA 20.03.01, “Dredge and Placer Mining Operations in Idaho.” (3-20-20)T

**07. Financial Assurance.** Cash, corporate surety bond, collateral bond, or letter of credit as described in the Dredge Mining Act, the Mineral Leasing Act, or a mineral lease. Financial assurance as defined in the Mined Land Reclamation Act. (3-20-20)T

**08. Mine; Mine Panel.** All areas designated by the operator on the map or plan submitted pursuant to Section 47-703A, Idaho Code, or Section 47-1506, Idaho Code, or as an identifiable portion of a placer or dredge mine on the map submitted under Section 47-1317, Idaho Code. (3-20-20)T

**09. Mined Land Reclamation Act.** Title 47, Chapter 15, Idaho Code, and IDAPA 20.03.02, “Rules



- Governing Mined Land Reclamation.” (3-20-20)T
- 10. Mineral Lease.** Lease executed by the Board and the mineral lessee pursuant to the Mineral Leasing Act. (3-20-20)T
- 11. Mineral Lessee.** The lessee of a mineral lease. (3-20-20)T
- 12. Mineral Leasing Act.** Title 47, Chapter 7, Idaho Code. (3-20-20)T
- 13. Mining Reclamation Plan.** Any reclamation plan approved pursuant to the Mined Land Reclamation Act. (3-20-20)T
- 14. Motorized Exploration.** Exploration which may appreciably disturb or damage the land or resources thereon. Motorized exploration includes, but is not limited to, drilling, trenching, dredging, or other techniques which employ the use of earth moving equipment, seismic operations using explosives, and includes sampling with a suction dredge having an intake diameter greater than two (2) inches when operated in a perennial stream. When operated in an intermittent stream, suction dredges shall be considered motorized exploration regardless of intake size. (3-20-20)T
- 15. Operator.** Any person or entity authorized to conduct business in Idaho, partnership, joint venture, or public or governmental agency required to have any reclamation plan under the Mined Land Reclamation Act or the Mineral Leasing Act, or a permit under the Dredge Mining Act, whether individually or jointly through subsidiaries, agents, employees, or contractors. (3-20-20)T
- 16. Permit.** Dredge or placer mining permit issued pursuant to the Dredge Mining Act. (3-20-20)T
- 17. Reclamation Fund.** The interest-bearing dedicated fund authorized pursuant to the Reclamation Fund Act. (3-20-20)T
- 18. Reclamation Fund Act.** Title 47, Chapter 18, Idaho Code, and IDAPA 20.03.03, “Rules Governing Administration of the Reclamation Fund.” (3-20-20)T
- 011. -- 015. (RESERVED)**
- 016. REQUIRED PARTICIPANTS.**  
Any operator, with the exception of the mines and operators listed in Section 017 of these rules, shall be required to provide alternative financial assurance through the Reclamation Fund to assure the reclamation of disturbed acres or affected lands. Alternative financial assurance pursuant to the Reclamation Fund Act is in lieu of other types of financial assurance as set forth in the Mined Land Reclamation Act, the Mineral Leasing Act, or the Dredge Mining Act. (3-20-20)T
- 017. INELIGIBLE MINES OR OPERATORS.**  
The following types of mines and operators are not allowed to participate in the Reclamation Fund and must file proof of other acceptable financial assurance as required by the Department. (3-20-20)T
- 01. Disturbed Acres Limit.** A mine or mineral lease with un-reclaimed disturbed acres in excess of the actual allowable disturbance may not provide alternative financial assurance through the Reclamation Fund. Un-reclaimed disturbance is that which does not meet the final financial assurance release criteria in the Dredge Mining Act, the Mined Land Reclamation Act or a mineral lease. (3-20-20)T
- 02. Reclamation Cost Limit.** Operators with an estimated reclamation cost in excess of the actual allowable reclamation cost, regardless of the disturbed acres. (3-20-20)T
- 03. Phosphate Mines.** Operators or mineral lessees of phosphate mines. (3-20-20)T
- 04. Hardrock Mines.** Operators or mineral lessees of hardrock mines such as gold, silver, molybdenum, copper, lead, zinc, cobalt, and other precious metal mines. (3-20-20)T

**05. Potential Heavy Metal Releases.** Operators of mines with a reasonable potential to release heavy metals or other substances harmful to human health or the environment, but not including substances such as fuels and other materials commonly used in excavation or construction. (3-20-20)T

**06. Oil and Gas Conservation.** Oil and gas exploration and development under Title 47, Chapter 3, Idaho Code. (3-20-20)T

**07. Oil and Gas Leasing.** Oil and gas leases and associated exploration and development under Title 47, Chapter 8, Idaho Code. (3-20-20)T

**08. Geothermal.** Operators or mineral lessees of geothermal wells and development under Title 47, Chapter 16, Idaho Code. (3-20-20)T

**09. Off Lease Exploration.** Motorized exploration on state lands that are not under a mineral lease or exploration location. (3-20-20)T

**10. Violators.** Mines or operators in violation of the Reclamation Fund Act, Dredge Mining Act, Mined Land Reclamation Act, Mineral Leasing Act, or a mineral lease. (3-20-20)T

**11. Reclamation Fund Forfeitures.** Operators, permittees or lessees who have not reimbursed the Reclamation Fund for a forfeiture from the Reclamation Fund due to their violations of the Reclamation Fund Act, Dredge Mining Act, Mined Land Reclamation Act, Mineral Leasing Act, or a mineral lease. (3-20-20)T

**12. Other Forfeitures.** An operator who has forfeited any financial assurance. (3-20-20)T

**13. Operators Providing Acceptable Financial Assurance.** An operator who provides proof of financial assurance accepted by the Department that is greater than or equal to the minimum dollar per acre for each acre of affected land at a mine. (3-20-20)T

**018. ACREAGE AND RECLAMATION COST LIMITATIONS.**

**01. Actual Allowable Participation.** The Board will establish by policy the actual allowable disturbance, actual allowable reclamation cost, and the minimum dollar per acre of disturbance in order to provide financial assurance to opt out of participation in the Reclamation Fund. (3-20-20)T

**02. Maximum Disturbance and Reclamation Cost.** The maximum disturbance and maximum reclamation costs in these rules are maximums. The maximum allowable disturbance is eighty (80) acres; the maximum allowable reclamation cost is four hundred forty thousand dollars (\$440,000). (3-20-20)T

**03. Multiple Plans or Permits.** An operator who has multiple mining reclamation plans or permits that have a total disturbance in excess of the actual allowable disturbance, or with total reclamation costs in excess of the actual allowable reclamation cost, may participate in the Reclamation Fund with one (1) or more sites that together contain less than both of the Board-established actual allowable limits. (3-20-20)T

**019. OPTIONAL PARTICIPATION.**

Operators who have one (1) or more mines or mineral leases that are ineligible to participate in the Reclamation Fund as set forth in Section 017 or 018 of these rules may choose to not participate in the Reclamation Fund with respect to all other eligible mines or mineral leases in their name. An operator who does not participate in the Reclamation Fund must secure all mines with other types of financial assurance approved by the Department. (3-20-20)T

**020. FEDERAL AGENCY NON-ACCEPTANCE OF RECLAMATION FUND.**

If a federal agency will not accept an operator's participation in the Reclamation Fund as proof of reclamation security, the operator will be required to provide the Department with proof of other types of financial assurance acceptable to the Department. (3-20-20)T

**021. -- 025. (RESERVED)**

**026. PAYMENT.**

**01. Board Approved Payment Schedule.** The Board will adopt a payment schedule that determines the annual Reclamation Fund payment for each operator participating in the Reclamation Fund. Any changes to the payment schedule will be approved by the Board. Participating operators shall pay all required payments annually. (3-20-20)T

**02. Acreage Calculation.** The annual payment for each participant in the Reclamation Fund will be established based upon the number of disturbed acres at each mine. The acres used to calculate the annual payment will include the total current disturbed acres of affected lands and the acres planned to be disturbed or affected during the next twelve (12) months. The total acreage calculation will not be rounded when determining annual payments. (3-20-20)T

**03. Annual Payments Non-Refundable.** Payments to the Reclamation Fund are non-refundable. Payments will be billed annually and, if not timely paid, will accrue late fees and interest as established by the Board. New participants will be assessed a pro-rated payment based on the Department's established billing cycle. (3-20-20)T

**04. Supplemental Payments.** If an operator affects more acreage than the acreage secured through the Reclamation Fund for a current period, the Department may require supplemental Reclamation Fund payments. (3-20-20)T

**05. Assignment.** When a mineral lease, mining reclamation plan, or permit is assigned, all financial assurance requirements must be assumed by the new operator. No Reclamation Fund payments will be refunded following an assignment. If the new operator is ineligible to participate in the Reclamation Fund, the new operator must provide proof of other acceptable financial assurance before the assignment may be approved. (3-20-20)T

**06. Non-Payment Constitutes Lack of Bonding.** For any operator participating in the Reclamation Fund, non-payment of the annual payment shall be considered a failure to provide financial assurance as required by the Dredge Mining Act, the Mined Land Reclamation Act, Mineral Leasing Act, or a mineral lease. (3-20-20)T

**027. -- 030. (RESERVED)**

**031. ENFORCEMENT AND FAILURE TO COMPLY.**

**01. Forfeiture.** Prior to withdrawing monies from the Reclamation Fund due to a violation of the Dredge Mining Act, the Mined Land Reclamation Act, Mineral Leasing Act, or a mineral lease, the Department will comply with the respective financial assurance forfeiture procedures. (3-20-20)T

**02. Penalties.** If an operator fails to provide financial assurance as required by these rules or has forfeited monies from the Reclamation Fund and has not repaid those monies, the Board shall be authorized to file liens against personal property and equipment of the operator to recover costs. The operator shall be liable for actual costs of all unpaid annual payments, interest, and late payment charges, the actual reclamation costs, and administrative costs incurred by the Department in reclaiming the disturbed or affected lands. Authorization to obtain a lien under these rules and Section 47-1804, Idaho Code, shall be in addition to, not in lieu of, any other legal remedy available to the Board and the Department pursuant to the Dredge Mining Act, Mined Land Reclamation Act, Mineral Leasing Act, or a mineral lease. (3-20-20)T

**032. MINIMUM BALANCE FOR THE RECLAMATION FUND.** The Board will determine a reasonable minimum balance for the Reclamation Fund. (3-20-20)T

**033. -- 999. (RESERVED)**

**20.03.04 – RULES FOR THE REGULATION OF BEDS, WATERS, AND AIRSPACE  
OVER NAVIGABLE LAKES IN THE STATE OF IDAHO**

**000. LEGAL AUTHORITY.**

This Chapter is adopted under the legal authorities of Sections 58-104(6), 58-104(9), 58-105, and 58-127, Idaho Code; Title 58, Chapter 13, Idaho Code; and Title 67, Chapter 52, Idaho Code. (3-20-20)T

**001. TITLE AND SCOPE.**

**01. Title.** These rules are titled IDAPA 20.03.04, “Rules for the Regulation of Beds, Waters, and Airspace Over Navigable Lakes in the State of Idaho.” (3-20-20)T

**02. Scope.** These rules govern encroachments on, in, or above navigable lakes in the state of Idaho. (3-20-20)T

**002. ADMINISTRATIVE APPEALS.**

Any person aggrieved by any final decision or order of the board is entitled to judicial review pursuant to the provisions of Title 67, Chapter 52, Idaho Code, IDAPA 20.01.01, Title 58, Chapter 13, Sections 58-1305 and 58-1306, Idaho Code, and Sections 025, 030, and 080 of these rules. (3-20-20)T

**003. INCORPORATION BY REFERENCE.**

The following documents are incorporated by reference into these rules: (3-20-20)T

**01. IDAPA 07.01.01, “Rules of the Electrical Board.”** IDAPA 07.01.01 is available at <https://adminrules.idaho.gov/rules/current/07/070101.pdf>. (3-20-20)T

**02. IDAPA 07.02.06, “Rules Concerning Idaho State Plumbing Code.”** This rule is available at <https://adminrules.idaho.gov/rules/current/07/070206.pdf>. (3-20-20)T

**03. 33 CFR Part 62, revised as of July 27, 2015 (United States Aids to Navigation System).** The Electronic Code of Federal Regulations (eCFR) is available at <http://www.ecfr.gov/cgi-bin/ECFR>. (3-20-20)T

**004. -- 009. (RESERVED)**

**010. DEFINITIONS.**

**01. Adjacent.** Contiguous or touching, and with regard to land or land ownership having a common boundary. (3-20-20)T

**02. Aids to Navigation.** Buoys, warning lights, and other encroachments in aid of navigation intended to improve waterways for navigation. (3-20-20)T

**03. Artificial High Water Mark.** The high water elevation above the natural or ordinary high water mark resulting from construction of man-made dams or control works and impressing a new and higher vegetation line. (3-20-20)T

**04. Beds of Navigable Lakes.** The lands lying under or below the “natural or ordinary high water mark” of a navigable lake and, for purposes of these rules only, the lands lying between the natural or ordinary high water mark and the artificial high water mark, if there be one. (3-20-20)T

**05. Board.** The Idaho State Board of Land Commissioners or its designee. (3-20-20)T

**06. Boat Garage.** A structure with one (1) or more slips that is completely enclosed with walls, roof, and doors, but no temporary or permanent residential area. (3-20-20)T

**07. Boat Lift.** A mechanism for mooring boats partially or entirely out of the water. (3-20-20)T

**08. Boat Ramp.** A structure or improved surface extending below the ordinary or artificial high water mark whereby watercraft or equipment are launched from land-based vehicles or trailers. (3-20-20)T

**09. Commercial Marina.** A commercial navigational encroachment whose primary purpose is to provide moorage for rental or for free to the general public. (3-20-20)T

- 10. Commercial Navigational Encroachment.** A navigational encroachment used for commercial purposes. (3-20-20)T
- 11. Community Dock.** A structure that provides private moorage for more than two (2) adjacent littoral owners, or other littoral owners possessing a littoral common area with littoral rights including, but not limited to homeowner’s associations. No public access is required for a community dock. (3-20-20)T
- 12. Covered Slip.** A slip, or group of slips, with a frame, fabric canopy, and eaves that do not extend beyond the underlying dock. (3-20-20)T
- 13. Department.** The Idaho Department of Lands or its designee. (3-20-20)T
- 14. Director.** The head of the Idaho Department of Lands or his designee. (3-20-20)T
- 15. Encroachments in Aid of Navigation.** Includes docks, piers, jet ski and boat lifts, buoys, pilings, breakwaters, boat ramps, channels or basins, and other facilities used to support water craft and moorage on, in, or above the beds or waters of a navigable lake. The term “encroachments in aid of navigation” is used interchangeably with the term “navigational encroachments.” (3-20-20)T
- 16. Encroachments Not in Aid of Navigation.** Includes all other encroachments on, in, or above the beds or waters of a navigable lake, including landfills, bridges, utility and power lines, or other structures not constructed primarily for use in aid of navigation, such as float homes and boat garages. The term “encroachments not in aid of navigation” is used interchangeably with the term “nonnavigational encroachments.” (3-20-20)T
- 17. Floating Home or Float Home.** A structure that is designed and built to be used, or is modified to be used, as a stationary waterborne residential dwelling and is not self-propelled. These structures are usually dependent for utilities upon a continuous utility linkage to a source originating on shore, and must have either a permanent continuous connection to a sewage system on shore, or an alternative method of sewage disposal that does not violate local, state, or federal water quality and sanitation regulations. (3-20-20)T
- 18. Floating Toys.** Trampolines, inflatable structures, water ski courses, and other recreational equipment that are not permanently anchored to the lake bed or an encroachment and are either located between the shoreline and the line of navigability or are waterward of the line of navigability for less than twenty-four (24) consecutive hours. (3-20-20)T
- 19. Jet Ski Ramp, Port, or Lift.** A mechanism for mooring jet skis or other personal watercraft similar to a boat lift. The lifts may be free standing or attached to a dock or pier. (3-20-20)T
- 20. Line of Navigability.** A line located at such distance waterward of the low water mark established by the length of existing legally permitted encroachments, water depths waterward of the low water mark, and by other relevant criteria determined by the board when a line has not already been established for the body of water in question. (3-20-20)T
- 21. Low Water Mark.** That line or elevation on the bed of a lake marked or located by the average low water elevations over a period of years, and marks the point to which the riparian rights of adjoining landowners extend as a matter of right, in aid of their right to use the waters of the lake for purposes of navigation. (3-20-20)T
- 22. Moorage.** A place to secure float homes and watercraft including, but not limited to, boats, personal watercraft, jet skis, etc. (3-20-20)T
- 23. Natural or Ordinary High Water Mark.** The high water elevation in a lake over a period of years, uninfluenced by man-made dams or works, at which elevation the water impresses a line on the soil by covering it for sufficient periods to deprive the soil of its vegetation and destroy its value for agricultural purposes. (3-20-20)T
- 24. Navigable Lake.** Any permanent body of relatively still or slack water, including man-made reservoirs, not privately owned and not a mere marsh or stream eddy, and capable of accommodating boats or canoes.

This definition does not include man-made reservoirs where the jurisdiction thereof is asserted and exclusively assumed by a federal agency. (3-20-20)T

**25. Party.** Each person or agency named or admitted as a party or properly seeking and entitled as of right to be admitted as a party. (3-20-20)T

**26. Person.** A partnership, association, corporation, natural person, or entity qualified to do business in the state of Idaho and any federal, state, tribal, or municipal unit of government. (3-20-20)T

**27. Piling.** A metal, concrete, plastic, or wood post that is placed into the lakebed and used to secure floating docks and other structures. (3-20-20)T

**28. Plans.** Maps, sketches, engineering drawings, aerial and other photographs, word descriptions, and specifications sufficient to describe the extent, nature and approximate location of the proposed encroachment and the proposed method of accomplishing the same. (3-20-20)T

**29. Public Hearing.** The type of hearing where members of the public are allowed to comment, in written or oral form, on the record at a public meeting held at a set time and place and presided over by a designated representative of the Department who acts as the hearing coordinator. This type of hearing is an informal opportunity for public comment and does not involve the presentation of witnesses, cross examination, oaths, or the rules of evidence. A record of any oral presentations at such hearings will be taken by the Department by tape recorder. The hearing coordinator exercises such control at hearings as necessary to maintain order, decorum and common courtesy among the participants. (3-20-20)T

**30. Public Trust Doctrine.** The duty of the State to its people to ensure that the use of public trust resources is consistent with identified public trust values. This common law doctrine has been interpreted by decisions of the Idaho Appellate Courts and is codified at Title 58, Chapter 12, Idaho Code. (3-20-20)T

**31. Pylon.** A metal, concrete, or wood post that is placed into the lakebed and used to support fixed piers. (3-20-20)T

**32. Riparian or Littoral Rights.** The rights of owners or lessees of land adjacent to navigable waters of the lake to maintain their adjacency to the lake and to make use of their rights as riparian or littoral owners or lessees in building or using aids to navigation but does not include any right to make any consumptive use of the waters of the lake. (3-20-20)T

**33. Riparian or Littoral Owner.** The fee owner of land immediately adjacent to a navigable lake, or his lessee, or the owner of riparian or littoral rights that have been segregated from the fee specifically by deed, lease, or other grant. (3-20-20)T

**34. Riparian or Littoral Right Lines.** Lines that extend waterward of the intersection between the artificial or ordinary high water mark and an upland ownership boundary to the line of navigation. Riparian or littoral right lines will generally be at right angles to the shoreline. (3-20-20)T

**35. Side Tie.** Moorage for watercraft where the dock or pier is on only one (1) side of the watercraft. (3-20-20)T

**36. Single-Family Dock.** A structure providing noncommercial moorage that serves one (1) waterfront owner whose waterfront footage is no less than twenty-five (25) feet. (3-20-20)T

**37. Slip.** Moorage for boats with pier or dock structures on at least two (2) sides of the moorage. (3-20-20)T

**38. Submerged Lands.** The state-owned beds of navigable lakes, rivers and streams below the natural or ordinary high water marks. (3-20-20)T

**39. Two-Family Dock.** A structure providing noncommercial moorage that serves two (2) adjacent

waterfront owners having a combined waterfront footage of no less than fifty (50) feet. Usually the structure is located on the common littoral property line. (3-20-20)T

**40. Upland.** The land bordering on navigable lakes, rivers, and streams. (3-20-20)T

**011. ABBREVIATIONS.**

**01. ATON.** Aids to Navigation. (3-20-20)T

**02. HDPE.** High-Density Polyethylene. (3-20-20)T

**012. POLICY.**

**01. Environmental Protection and Navigational or Economic Necessity.** It is the express policy of the State of Idaho that the public health, interest, safety and welfare requires that all encroachments upon, in or above the beds or waters of navigable lakes of the state be regulated in order that the protection of property, navigation, fish and wildlife habitat, aquatic life, recreation, aesthetic beauty and water quality be given due consideration and weighed against the navigational or economic necessity or justification for, or benefit to be derived from the proposed encroachment. Moreover, it is the responsibility of the State Board of Land Commissioners to regulate and control the use or disposition of state-owned lake beds, so as to provide for their commercial, navigational, recreational or other public use. (3-20-20)T

**02. No Encroachments Without Permit.** No encroachment on, in or above the beds or waters of any navigable lake in the state may be made unless approval has been given as provided in these rules. An encroachment permit does not guarantee the use of public trust lands without appropriate compensation to the state of Idaho. (3-20-20)T

**03. Permitting of Existing Encroachments.** (3-20-20)T

**a.** The provisions of Title 58, Chapter 13, Section 58-1312, Idaho Code, apply. (3-20-20)T

**b.** Any new encroachments, or any unpermitted encroachments constructed after January 1, 1975, are subject to these rules. (3-20-20)T

**013. -- 014. (RESERVED)**

**015. ENCROACHMENT STANDARDS.**

**01. Single-Family and Two-Family Docks.** The following parameters govern the size and dimensions of single-family docks and two-family docks. (3-20-20)T

**a.** No part of the structure waterward of the natural or ordinary high water mark or artificial high water mark may exceed ten (10) feet in width, excluding the slip cut out. (3-20-20)T

**b.** Total surface decking area waterward of the natural or ordinary or artificial high water mark may not exceed seven hundred (700) square feet, including approach ramp and walkway for a single-family dock and may not exceed one thousand one hundred (1,100) square feet, including approach ramp and walkway for a two-family dock. (3-20-20)T

**c.** No portion of the docking facility may extend beyond the line of navigability. Shorter docks are encouraged whenever practical and new docks normally will be installed within the waterward extent of existing docks or the line of navigability. (3-20-20)T

**d.** A variance to the standards in this Subsection 015.01 may be approved by the Department when justified by site specific considerations, such as the distance to the established line of navigability. (3-20-20)T

**02. Community Docks.** (3-20-20)T

**a.** A community dock is considered a commercial navigational aid for purposes of processing the application. (3-20-20)T

**b.** No part of the structure waterward of the natural or ordinary high water mark or artificial high water mark may exceed ten (10) feet in width except breakwaters when justified by site specific conditions and approved by the Department. (3-20-20)T

**c.** A community dock may not have less than fifty (50) feet combined shoreline frontage. Moorage facilities will be limited in size as a function of the length of shoreline dedicated to the community dock. The surface decking area of the community dock is limited to the product of the length of shoreline multiplied by seven (7) square feet per lineal feet or a minimum of seven hundred (700) square feet. However, the Department, at its discretion, may limit the ultimate size when evaluating the proposal and public trust values. (3-20-20)T

**d.** If a breakwater will be incorporated into the structure of a dock, and a need for the breakwater can be demonstrated, the Department may allow the surface decking area to exceed the size limitations of Paragraph 015.02.c of these rules. (3-20-20)T

**e.** A person with an existing community dock that desires to change the facility to a commercial marina must submit the following information to the Department: (3-20-20)T

**i.** A new application for an encroachment permit. (3-20-20)T

**ii.** Text and drawings that describe which moorage will be public and which moorage will be private. (3-20-20)T

**03. Commercial Marina.** (3-20-20)T

**a.** Commercial marinas must have a minimum of fifty percent (50%) of their moorage available for use by the general public on either a first come, first served basis for free or rent, or a rent or lease agreement for a period of time up to one (1) year. Moorage contracts may be renewed annually, so long as a renewal term does not exceed one (1) year. Moorage for use by the general public may not include conditions that result in a transfer of ownership of moorage or real property, or require membership in a club or organization. (3-20-20)T

**b.** Commercial marinas that are converted to a community dock must conform to all the community dock standards, including frontage requirements and square footage restrictions. This change of use must be approved by the Department through a new encroachment permit prior to implementing the change. (3-20-20)T

**c.** If local city or county ordinances governing parking requirements for marinas have not been adopted, commercial marinas must provide a minimum of upland vehicle parking equivalent to one (1) parking space per two (2) public watercraft or float home moorages. If private moorage is tied to specific parking spaces or designated parking areas, then one (1) parking space per one (1) private watercraft or float home moorage must be provided. In the event of conflict, the local ordinances prevail. (3-20-20)T

**d.** If a commercial marina can be accessed from a road, marina customers must be allowed access via that road. (3-20-20)T

**e.** Moorage that is not available for public use as described in Paragraph 015.03.a. of these rules is private moorage. (3-20-20)T

**f.** When calculating the moorage percentage, the amount of public moorage is to be compared to the amount of private moorage. Commercial marinas with private float home moorage are required to provide either non-private float home moorage or two (2) public use boat moorages for every private float home moorage in addition to any other required public use boat moorages. (3-20-20)T

**g.** When private moorage is permitted, the public moorage must be of similar size and quality as private moorage, except for float home moorage as provided in Paragraph 015.03.f. (3-20-20)T



**h.** Commercial marinas with private moorage must form a condominium association, co-op, or other entity that owns and manages the marina, littoral rights, upland property sufficient to maintain and operate a marina, and private submerged land, if present. This entity is responsible for obtaining and maintaining an encroachment permit under these rules and a submerged lands lease under IDAPA 20.03.17, “Rules Governing Leases on State-Owned Submerged lands and Formerly Submerged Lands.” (3-20-20)T

**i.** Existing commercial marinas that desire to change their operations and convert some of their moorage to private use must keep at least fifty percent (50%) of their moorage available for use by the general public. This change in operations must be approved by the Department through a new encroachment permit prior to implementation of the change. The permit application must describe, in text and in drawings, which moorage will be public and which moorage will be private. (3-20-20)T

**04. Covered Slip.** (3-20-20)T

**a.** Covered slips, regardless of when constructed, may not have a temporary or permanent residential area. (3-20-20)T

**b.** Slip covers should have colors that blend with the natural surroundings and are approved by the Department. (3-20-20)T

**c.** Covered slips may not be supported by extra piling nor constructed with hard roofs. (3-20-20)T

**d.** Slip covers with permanent roofs and up to three (3) walls may be maintained or replaced at their current size if they were previously permitted or if they were constructed prior to January 1, 1975. These structures may not be expanded nor converted to boat garages. (3-20-20)T

**e.** Fabric covered slips must be constructed as canopies without sides unless the following standards are followed: (3-20-20)T

**i.** At least two (2) feet of open space is left between the bottom of the cover and the dock or pier surface; and (3-20-20)T

**ii.** Fabric for canopy and sides will transmit at least seventy-five percent (75%) of the natural light. (3-20-20)T

**05. Boat Garage.** (3-20-20)T

**a.** Boat garages are considered nonnavigational encroachments. (3-20-20)T

**b.** Applications for permits to construct new boat garages, expand the total square footage of the existing footprint, or raise the height will not be accepted unless the application is to support local emergency services. (3-20-20)T

**c.** Existing permitted boat garages may be maintained or replaced with the current square footage of their existing footprint and height. (3-20-20)T

**d.** Relocation of an existing boat garage will require a permit. (3-20-20)T

**06. Breakwaters.** Breakwaters built upon the lake for use in aid of navigation will not be authorized below the level of normal low water without an extraordinary showing of need, provided, however that this does not apply to floating breakwaters secured by piling and used to protect private property from recurring wind, wave, or ice damage, or used to control traffic in busy areas of lakes. The breakwater must be designed to counter wave actions of known wave heights and wave lengths. (3-20-20)T

**07. Seawalls.** Seawalls should be placed at or above the ordinary high water mark, or the artificial high water mark, if applicable. Seawalls are not an aid to navigation, and placement waterward of the ordinary or artificial

high water mark will generally not be allowed. (3-20-20)T

**08. Riprap.** (3-20-20)T

**a.** Riprap used to stabilize shorelines will consist of rock that is appropriately sized to resist movement from anticipated wave heights or tractive forces of the water flow. The rock must be sound, dense, durable, and angular rock resistant to weathering and free of fines. The riprap must overlie a distinct filter layer which consists of sand, gravel, or nonwoven geotextile fabric. The riprap and filter layer must be keyed into the bed below the ordinary or artificial high water mark, as applicable. If the applicant wishes to install riprap with different standards, they must submit a design that is signed and stamped for construction purposes by a professional engineer registered in the state of Idaho. (3-20-20)T

**b.** Riprap used to protect the base of a seawall or other vertical walls may not need to be keyed into the bed and may not require a filter layer, at the Department's discretion. (3-20-20)T

**09. Mooring Buoys.** Buoys must be installed a minimum of thirty (30) feet away from littoral right lines of adjacent littoral owners. One (1) mooring buoy per littoral owner may be allowed. (3-20-20)T

**10. Float Homes.** (3-20-20)T

**a.** Applications for permits to construct new float homes, or to expand the total square footage of the existing footprint, will not be accepted. (3-20-20)T

**b.** Applications for relocation of float homes within a lake or from one (1) lake to another are subject to the following requirements: (3-20-20)T

**i.** Proof of ownership or long term lease of the uplands adjacent to the relocation site must be furnished to the Department. (3-20-20)T

**ii.** The applicant must show that all wastes and waste water will be transported to shore disposal systems by a method approved by the Idaho Department of Environmental Quality or the appropriate local health authority. Applicant must either obtain a letter from the local sewer district stating that the district will serve the float home or demonstrate that sewage will be appropriately handled and treated. Applicant must also provide a statement from a professional plumber licensed in the state of Idaho that the plumbing was designed in accordance with IDAPA 07.02.06, "Rules Concerning the Idaho State Plumbing Code," as incorporated by reference in Section 003 of these rules, installed properly, and has been pressure tested. (3-20-20)T

**c.** Encroachment applications and approved local permits are required for replacement of, or adding another story to, a float home. (3-20-20)T

**d.** All plumbing work on float homes must be done in accordance with IDAPA 07.02.06, "Rules Concerning the Idaho State Plumbing Code" and IDAPA 07.01.01, "Rules of the Electrical Board," as incorporated by reference in Section 003 of these rules. (3-20-20)T

**e.** All float homes in Idaho that connect with upland sewer or septic systems must implement the following standards by December 31, 2012: (3-20-20)T

**i.** The holding tank with pump or grinder unit must be adequately sealed to prevent material from escaping and to prevent lake water from entering. The tank lid must have a gasket or seal, and the lid must be securely fastened at all times unless the system is being repaired or maintained. An audible overflow alarm must also be installed. (3-20-20)T

**ii.** Grinders or solids handling pumps must be used to move sewage from the float home to the upland system. (3-20-20)T

**iii.** If solids handling pumps are used, they must have a minimum two (2) inch interior diameter discharge, and the pipe to the shoreline must also have a minimum two (2) inch interior diameter. Connectors used on

either end of this pipe may not significantly reduce the interior diameter. (3-20-20)T

iv. The pipeline from the float home to the shoreline must be a continuous line with no mechanical connections. Check valves and manual shutoff valves must be installed at each end of the line. Butt fused HDPE, two hundred (200) psi black polyethylene pipe, or materials with similar properties must be used. The pipeline must contain sufficient slack to account for the maximum expected rise and fall of the lake or river level. The pipeline must be buried in the lakebed for freeze protection where it will be exposed during periods of low water. Pipelines on the bed of the lake must be appropriately located and anchored so they will not unduly interfere with navigation or other lake related uses. (3-20-20)T

v. Manifolds below the ordinary, or artificial if applicable, high water mark that collect two (2) or more sewer lines and then route the discharge to the shore through a single pipe are not allowed. All float homes must have an individual sewer line from the float home to a facility on the shore. (3-20-20)T

f. All float home permittees will have their float homes inspected by a professional plumber licensed in the state of Idaho by December 31, 2012. The inspection will be documented with a report prepared by the inspector. The report will document whether or not the float homes meet the standards in Paragraph 015.10.e. of these rules, and will be provided to the Department before the above date. (3-20-20)T

g. A float home permittee must request an extension, and give cause for the extension, if their float home does not meet the standards in paragraph 015.01.e. of these rules by December 31, 2012. Extensions beyond December 31, 2016 will not be allowed. A permittee's failure to either request the extension, if needed, or to meet the December 31, 2016 deadline will be a violation subject to the provisions of Section 080 of these rules. (3-20-20)T

h. Construction or remodel work on a float home that costs fifty percent (50%) or more of its assessed value will require an encroachment application and construction drawings stamped by an engineer licensed in the state of Idaho. (3-20-20)T

**11. Excavated or Dredged Channel. (3-20-20)T**

a. Excavating, dredging, or redredging channels require an encroachment permit and are processed in accordance with Section 030 of these rules. (3-20-20)T

b. An excavated or dredged channel or basin to provide access to navigable waters must have a clear environmental, economic, or social benefit to the people of the state, and must not result in any appreciable environmental degradation. A channel or basin will not be approved if the cumulative effects of these features in the same navigable lake would be adverse to fisheries or water quality. (3-20-20)T

c. Whenever practical, such channels or basins must be located to serve more than one (1) littoral owner or a commercial marina; provided, however, that no basin or channel will be approved that will provide access for watercraft to nonlittoral owners. (3-20-20)T

**12. ATONs. Aids to Navigation will conform to the requirements established by the United States Aid to Navigation system. (3-20-20)T**

**13. General Encroachment Standards. (3-20-20)T**

a. Square Footage. The square footage limitations in Subsections 015.01 and 015.02 include all structures beyond the ordinary or artificial high water mark such as the approach, ramp, pier, dock, and all other floating or suspended structures that cover the lake surface, except for: (3-20-20)T

i. Boat lifts as allowed pursuant to Paragraph 015.13.b. (3-20-20)T

ii. Jet ski ramp, port, or lift as allowed pursuant to Paragraph 015.13.b. (3-20-20)T

iii. Slip covers. (3-20-20)T

- iv. Undecked portions of breakwaters. (3-20-20)T
- b. Boat Lifts and Jet Ski Lifts.** (3-20-20)T
- i. Single-family docks are allowed a single boat lift and two (2) jet ski lifts, or two (2) boat lifts, without adding their footprint to the dock square footage. Additional lifts will require that fifty percent (50%) of the footprint of the largest lifts be included in the allowable square footage of the dock or pier as per Subsection 015.01. (3-20-20)T
- ii. Two-family docks are allowed two (2) boat lifts and four (4) jet ski lifts, or four (4) boat lifts, without adding their footprint to the dock square footage. Additional lifts will require that fifty percent (50%) of the footprint of the largest lifts be included in the allowable square footage of the dock or pier as per Subsection 015.01. (3-20-20)T
- iii. A boat lift or jet ski lift within lines drawn perpendicular from the shore to the outside dock edges will not require a separate permit if the lift is outside the ten (10) foot adjacent littoral owner setback, the lift does not extend beyond the line of navigability, and the lift does not count toward the square footage of the dock as outlined in Subparagraphs 015.13.b.i. and 015.13.b.ii. The permittee must send a revised permit drawing with the lift location as an application to the Department. If the lift meets the above conditions, the application will be approved as submitted. Future applications must include the lifts. (3-20-20)T
- iv. Community docks are allowed one (1) boat lift or two (2) jet ski lifts per moorage. Boat lifts placed outside of a slip must be oriented with the long axis parallel to the dock structure. Additional lifts will require that fifty percent (50%) of their footprint be included in the allowable square footage of the dock or pier as per Subsection 015.02. (3-20-20)T
- c. Angle from Shoreline.** (3-20-20)T
- i. Where feasible, all docks, piers, or similar structures must be constructed so as to protrude as nearly as possible at right angles to the general shoreline, lessening the potential for infringement on adjacent littoral rights. (3-20-20)T
- ii. Where it is not feasible to place docks at right angles to the general shoreline, the Department will work with the applicant to review and approve the applicant's proposed configuration and location of the dock and the dock's angle from shore. (3-20-20)T
- d. Length of Community Docks and Commercial Navigational Encroachments.** Docks, piers, or other works may extend to a length that will provide access to a water depth that will afford sufficient draft for water craft customarily in use on the particular body of water, except that no structure may extend beyond the normal accepted line of navigability established through use unless additional length is authorized by permit or order of the Director. If a normally accepted line of navigability has not been established through use, the Director may from time to time as he deems necessary, designate a line of navigability for the purpose of effective administration of these rules. (3-20-20)T
- e. Presumed Adverse Effect.** It will be presumed, subject to rebuttal, that single-family and two-family navigational encroachments will have an adverse effect upon adjacent littoral rights if located closer than ten (10) feet from adjacent littoral right lines, and that commercial navigational encroachments, community docks or nonnavigational encroachments will have a like adverse effect upon adjacent littoral rights if located closer than twenty-five (25) feet to adjacent littoral right lines. Written consent of the adjacent littoral owner or owners will automatically rebut the presumption. All boat lifts and other structures attached to the encroachments are subject to the above presumptions of adverse affects. (3-20-20)T
- f. Weather Conditions.** Encroachments and their building materials must be designed and installed to withstand normally anticipated weather conditions in the area. Docks, piers, and similar structures must be adequately secured to pilings or anchors to prevent displacement due to ice, wind, and waves. Flotation devices for docks, float homes, etc. must be reasonably resistant to puncture and other damage. (3-20-20)T

**g.** Markers. If the Department determines that an encroachment is not of sufficient size to be readily seen or poses a hazard to navigation, the permit will specify that aids to navigation be used to clearly identify the potential hazard. (3-20-20)T

**h.** Overhead Clearance. (3-20-20)T

**i.** Overhead clearance between the natural or ordinary high water mark or the artificial high water mark, if there be one, and the structure or wires must be sufficient to pass the largest vessel that may reasonably be anticipated to use the subject waters in the vicinity of the encroachment. In no case will the clearance be required to exceed thirty (30) feet unless the Department determines after public hearing that it is in the overall public interest that the clearance be in excess of thirty (30) feet. Irrespective of height above the water, approval of structures or wires presenting a hazard for boating or other water related activities may be conditioned upon adequate safety marking to show clearance and otherwise to warn the public of the hazard. The Department will specify in the permit the amount of overhead clearance and markings required. (3-20-20)T

**ii.** When the permit provides for overhead clearance or safety markings under Paragraph 015.13.h., the Department will consider the applicable requirements of the United States Coast Guard, the Idaho Transportation Department, the Idaho Public Utilities Commission and any other applicable federal, state, or local regulations. (3-20-20)T

**i.** Beaded Foam Flotation. Beaded foam flotation must be completely encased in a manner that will maintain the structural integrity of the foam. The encasement must be resistant to the entry of rodents. (3-20-20)T

**14. Floating Toys.** (3-20-20)T

**a.** Encroachment permits are not required for floating toys, except where noted in Paragraph 015.14.b. Counties and cities may regulate floating toys for public safety and related concerns. (3-20-20)T

**b.** A floating toy becomes a nonnavigational encroachment, and an encroachment permit is required, when one (1) of the following occurs: (3-20-20)T

**i.** It is anchored to the bed of the lake with a device that requires equipment to remove it from the bed of the lake, or; (3-20-20)T

**ii.** It is located waterward of the line of navigability for more than twenty-four (24) consecutive hours. (3-20-20)T

**15. Lake Specific Encroachment Permit Terms.** (3-20-20)T

**a.** The Department may use encroachment permit conditions specific to individual lakes if the permit conditions are needed to protect public trust values and the permit condition is approved by the Land Board. (3-20-20)T

**b.** Lake specific encroachment permit conditions may supplement, negate, or alter encroachment standards established in Section 015 of these rules. (3-20-20)T

**c.** Lake specific encroachment permit conditions will be used to assist with implementing lake management plans authorized by Title 39, Chapter 66, Idaho Code; Title 39, Chapter 85, Idaho Code; Title 67, Chapter 43, Idaho Code; and Title 70, Chapter 2, Idaho Code. The purpose for using such lake specific permit conditions is to address lake specific environmental concerns that require attention and create a need for a variance from what is allowed on other lakes. (3-20-20)T

**d.** Lake specific encroachment permit terms may be read at the Idaho Department of Lands website: <http://www.idl.idaho.gov/>. (3-20-20)T

**016. -- 019. (RESERVED)**

**020. APPLICATIONS.**

**01. Encroachment Applications.** No person shall hereafter make or cause to be made any encroachment on, in or above the beds or waters of any navigable lake in the state of Idaho without first making application to and receiving written approval from the department. The placing of dredged or fill material, refuse or waste matter intended as or becoming fill material, on or in the beds or waters of any navigable lake in the state of Idaho shall be considered an encroachment and written approval by the department is required. If demolition is required prior to construction of the proposed encroachment, then the application must describe the demolition activities and the steps that will be taken to protect water quality and other public trust values. No demolition activities may proceed until the permit is issued. (3-20-20)T

**02. Signature Requirement.** Only persons who are littoral owners or lessees of a littoral owner shall be eligible to apply for encroachment permits. A person who has been specifically granted littoral rights or dock rights from a littoral owner shall also be eligible for an encroachment permit; the grantor of such littoral rights, however, shall no longer be eligible to apply for an encroachment permit. Except for waterlines or utility lines, the possession of an easement to the shoreline does not qualify a person to be eligible for an encroachment permit. (3-20-20)T

**03. Other Permits.** Nothing in these rules shall excuse a person seeking to make an encroachment from obtaining any additional approvals lawfully required by federal, local or other state agencies. (3-20-20)T

**04. Repairs, Reinstallation of Structures.** No permit is required to clean, maintain, or repair an existing permitted encroachment, but a permit is required to completely replace, enlarge, or extend an existing encroachment. Replacement of single-family and two-family docks may not require a permit if they meet the criteria in Section 58-1305(e), Idaho Code. Reinstalling the top or deck of a dock, wharf or similar structure shall be considered a repair; reinstallation of winter damaged or wind and water damaged pilings, docks, or float logs shall be considered a repair. Repairs, or replacements under Section 58-1305(e), Idaho Code, that adversely affect the bed of the lake will be considered a violation of these rules. (3-20-20)T

**05. Dock Reconfiguration.** (3-20-20)T

**a.** Rearrangement of single-family and two-family docks will require a new application for an encroachment permit. (3-20-20)T

**b.** Rearrangement of community docks and commercial navigational encroachments may not require a new application for an encroachment permit if the changes are only internal. The department shall be consulted prior to modifications being made, and shall use the following criteria to help determine if a new permit must be submitted: (3-20-20)T

i. Overall footprint does not change in dimension or orientation; (3-20-20)T

ii. No increase in the square footage, as described in the existing permit and in accordance with Paragraph 015.13.a., occurs. This only applies to community docks; (3-20-20)T

iii. The entrances and exits of the facility do not change. (3-20-20)T

**06. Redredging.** Redredging a channel or basin shall be considered a new encroachment and a permit is required unless redredging is specifically authorized by the outstanding permit. Water quality certification from the Idaho Department of Environmental Quality is required regardless of how redredging is addressed in any existing or future permit. (3-20-20)T

**07. Forms, Filing.** Applications and plans shall be filed on forms provided by the Department together with filing fees and costs of publication when required by these rules. Costs of preparation of the application, including all necessary maps and drawings, shall be paid by the applicant. (3-20-20)T

**a.** Plans shall include the following information at a scale sufficient to show the information requested: (3-20-20)T

- i. Lakebed profile in relationship to the proposed encroachment. The lakebed profile shall show the summer and winter water levels. (3-20-20)T
  - ii. Copy of most recent survey or county plat showing the full extent of the applicant's lot and the adjacent littoral lots. (3-20-20)T
  - iii. Proof of current ownership or control of littoral property or littoral rights. (3-20-20)T
  - iv. A general vicinity map. (3-20-20)T
  - v. Scaled air photos or maps showing the lengths of adjacent docks as an indication of the line of navigability, distances to adjacent encroachments, and the location and orientation of the proposed encroachment in the lake. (3-20-20)T
  - vi. Total square footage of proposed docks and other structures, excluding pilings, that cover the lake surface. (3-20-20)T
  - vii. Names and current mailing addresses of adjacent littoral landowners. (3-20-20)T
- b.** Applications must be submitted or approved by the littoral owner or, if the encroachment will lie over or upon private lands between the natural or ordinary high water mark and the artificial high water mark, the application must be submitted or approved by the owner of such lands. When the littoral owner is not the applicant, the application shall bear the owner's signature as approving the encroachment prior to filing. (3-20-20)T
- c.** If more than one (1) littoral owner exists, the application must bear the signature of all littoral owners, or the signature of an authorized officer of a designated homeowner's or property management association. (3-20-20)T
- d.** Applications for noncommercial encroachments intended to improve waterways for navigation, wildlife habitat and other recreational uses by members of the public must be filed by any municipality, county, state, or federal agency, or other entity empowered to make such improvements. Application fees are not required for these encroachments. (3-20-20)T
- e.** The following applications shall be accompanied by the respective nonrefundable filing fees together with a deposit toward the cost of newspaper publication, which deposit shall be determined by the director at the time of filing: (3-20-20)T
- i. Nonnavigational encroachments require a fee of one thousand dollars (\$1,000); except that nonnavigational encroachments for bank stabilization and erosion control require a fee of five hundred fifty dollars (\$550). (3-20-20)T
  - ii. Commercial navigational encroachments require a base fee of two thousand dollars (\$2,000). If the costs of processing an application exceed this amount, then the applicant may be charged additional costs as allowed by Title 58, Chapter 13, Section 58-1307, Idaho Code; (3-20-20)T
  - iii. Community navigational encroachments require a fee of two thousand dollars (\$2,000); and (3-20-20)T
  - iv. Navigational encroachments extending beyond the line of navigability require a fee of one thousand dollars (\$1,000). (3-20-20)T
- f.** Applicants shall pay any balance due on publication costs before written approval will be issued. The Department shall refund any excess at or before final action on the application. (3-20-20)T
- g.** Application for a single-family or two-family dock not extending beyond the line of navigability or a nonnavigational encroachment for a buried or submerged water intake line serving four or less households shall be accompanied by a nonrefundable filing fee of four hundred twenty-five dollars (\$425). (3-20-20)T

**h.** No publication cost is required for application for noncommercial navigational encroachment not extending beyond the line of navigability or for application for installation of buried or submerged water intake lines and utility lines. (3-20-20)T

**i.** Applications and plans shall be stamped with the date of filing. (3-20-20)T

**j.** Applications that are incomplete, not in the proper form, not containing the required signature(s), or not accompanied by filing fees and costs of publication when required, shall not be accepted for filing. The department shall send the applicant a written notice of incompleteness with a listing of the application's deficiencies. The applicant will be given thirty (30) days from receipt of the notice of incompleteness to resubmit the required information. The deadline may be extended with written consent of the department. If the given deadline is not met, the department will notify the applicant that the application has been denied due to lack of sufficient information. The applicant may reapply at a later date, but will be required to pay another filing fee and publication fee, if applicable. (3-20-20)T

**021. -- 024. (RESERVED)**

**025. PROCESSING OF APPLICATIONS FOR SINGLE-FAMILY AND TWO-FAMILY NAVIGATIONAL ENCROACHMENTS WITHIN LINE OF NAVIGABILITY.**

**01. Single-Family and Two-Family Navigational Encroachments.** Applications for single-family and two-family navigational encroachments not extending beyond the line of navigability will be processed with a minimum of procedural requirements and shall not be denied except in the most unusual of circumstances. No newspaper publication, formal appearance by the applicant, or hearing is contemplated. (3-20-20)T

**02. Notification of Adjacent Littoral Owners.** The department will provide a copy of the application to the littoral owners immediately adjacent to the applicant's property. If the applicant owns one (1) or more adjacent lots, the department shall notify the owner of the next adjacent lot. If the proposed encroachment may infringe upon the littoral rights of an adjacent owner, the department will provide notice of the application by certified mail, return receipt requested; otherwise, the notice will be sent by regular mail. Notification will be mailed to the adjacent littoral owners' usual place of address, which, if not known, will be the address shown on the records of the county treasurer or assessor. The applicant may submit the adjacent littoral owners' signatures, consenting to the proposed encroachment, in lieu of the department's notification. (3-20-20)T

**03. Written Objections.** (3-20-20)T

**a.** If an adjacent littoral owner files written objections to the application with the department within ten (10) days from the date of service or receipt of notice of the completed application, the department shall fix a time and a place for a hearing. In computing the time to object, the day of service or receipt of notice of the application shall not be counted. Objections must be received within the ten (10) day period by mail or hand delivery in the local department office or the director's office in Boise. If the last day of the period is Saturday, Sunday or a legal holiday, the time within which to object shall run until the end of the first business day thereafter. (3-20-20)T

**b.** The applicant and any objectors may agree to changes in the permit that result in the objections being withdrawn. Department employees may facilitate any such agreement. Participation by department personnel in this informal mediation shall not constitute a conflict of interest for participation in the hearing process. A withdrawal of objections must be in writing, completed prior to a scheduled hearing, and contain: (3-20-20)T

**i.** Signatures of the applicant and the objecting party; (3-20-20)T

**ii.** A description of the changes or clarifications to the permit that are acceptable to the applicant, the objecting party, and the department. (3-20-20)T

**04. Unusual Circumstances.** Even though no objection is filed by an adjacent littoral owner to a noncommercial navigational encroachment, if the director deems it advisable because of the existence of unusual circumstances, he may require a hearing. (3-20-20)T



**05. Hearings.** Hearings fixed by the director following an objection pursuant to Subsection 025.03 or the Director's own determination pursuant to Subsection 025.04 shall be fixed as to time and place, but no later than sixty (60) days from date of acceptance for filing of the application. At the hearing the applicant and any adjacent riparian owner filing timely objections may appear personally or through an authorized representative and present evidence. The department may also appear and present evidence at the hearing. In such hearings the hearing coordinator shall act as a fact finder and not a party. The Director, at his discretion, will designate a Department representative to sit as the hearing coordinator. Provided, however, that the parties may agree to informal disposition of an application by stipulation, agreed settlement, consent order, or other informal means. (3-20-20)T

**06. Decision Following a Hearing.** The director shall, within forty-five (45) days after close of the hearing provided for in Subsections 025.03 or 025.04 render a final decision and give notice thereof to the parties appearing before him either personally or by certified or registered mail. The final decision shall be in writing. (3-20-20)T

**07. Disposition Without Hearing.** If a hearing is not held under Subsection 025.03 or Subsection 025.04, then the department shall act upon a complete application filed under Subsection 025.01 as expeditiously as possible but no later than sixty (60) days from acceptance of the application. Failure to act within this sixty (60) day timeframe shall constitute approval of the application. Applications determined to be incomplete under Subsection 020.07 are not subject to the sixty (60) day timeframe until the information requested by the department and required by the rules has been submitted. (3-20-20)T

**08. Judicial Review.** Any applicant aggrieved by the Director's final decision, or an aggrieved party appearing at a hearing, shall have a right to have the proceedings and final decision reviewed by the district court in the county where the encroachment is proposed by filing a notice of appeal within thirty (30) days from the date of the final decision. An adjacent littoral owner shall be required to deposit an appeal bond with the court, in an amount to be determined by the court but not less than five hundred dollars (\$500) insuring payment to the applicant of damages caused by delay and costs and expenses, including reasonable attorney fees, incurred on the appeal in the event the district court sustains the action of the director. The applicant need post no bond with the court to prosecute an appeal. (3-20-20)T

**026. -- 029. (RESERVED)**

**030. PROCESSING OF APPLICATIONS FOR ALL OTHER TYPES OF ENCROACHMENTS.**

**01. Nonnavigational, Community, and Commercial Navigational Encroachments.** Within ten (10) days of receiving a complete application for a nonnavigational encroachment, a community dock, a commercial navigational encroachment, or a navigational encroachment extending beyond the line of navigability, the Department will cause to be published a notice of application once a week for two (2) consecutive weeks in a newspaper of general circulation in the county in which the encroachment is proposed. If, however, the Director orders a hearing on the application within the time for publication of the above notice, the Department will dispense with publication of the notice of the application and proceed instead to publish a notice of the public hearing as provided in Subsection 030.05. Applications for installation of buried or submerged water intake lines and utility lines are exempt from the newspaper publication process. (3-20-20)T

**02. Encroachments Not in Aid of Navigation.** Encroachments not in aid of navigation in navigable lakes will normally not be approved by the Department and will be considered only in cases involving major environmental, economic, or social benefits to the general public. Approval under these circumstances is authorized only when consistent with the public trust doctrine and when there is no other feasible alternative with less impact on public trust values. (3-20-20)T

**03. Notifications.** Upon request or when the Department deems it appropriate, the Department may furnish copies of the application and plans to federal, state and local agencies and to adjacent littoral owners, requesting comment on the likely effect of the proposed encroachment upon adjacent littoral property and public trust values such as navigation, fish and wildlife habitat, aquatic life, recreation, aesthetic beauty, water quality, etc. (3-20-20)T

**04. Written Comments or Objections.** Within thirty (30) days of the first date of publication, an agency, adjacent littoral owner or lessee, or any resident of the state of Idaho may do one (1) of the following: (3-20-20)T

**a.** Notify the Department of their opinions and recommendation, if any, for alternate plans they believe will be economically feasible and will accomplish the purpose of the proposed encroachment without unreasonably adversely affecting adjacent littoral property or public trust values; or (3-20-20)T

**b.** File with the Department written objections to the proposed encroachment and request a public hearing on the application. The hearing must be specifically requested in writing. Any person or agency requesting a hearing on the application must deposit and pay to the Department an amount sufficient to cover the cost of publishing notice of hearing provided in Subsection 030.05. (3-20-20)T

**05. Hearing.** Notice of the time and place of public hearing on the application will be published by the Director once a week for two (2) consecutive weeks in a newspaper in the county in which the encroachment is proposed, which hearing will be held within ninety (90) days from the date the application is accepted for filing. (3-20-20)T

**06. Hearing Participants.** Any person may appear at the public hearing and present oral testimony. Written comments will also be received by the Department. (3-20-20)T

**07. Decision After Hearing.** The Director will render a final decision within thirty (30) days after close of the public hearing. A copy of his final decision will be mailed to the applicant and to each person or agency appearing at the hearing and giving oral or written testimony in support of or in opposition to the proposed encroachment. (3-20-20)T

**08. Decision Where No Hearing.** (3-20-20)T

**a.** In the event no objection to the proposed encroachment is filed with the Department and no public hearing is requested under Subsection 030.04, or ordered by the Director under Subsection 030.01, the Department, based upon its investigation and considering the economics of the navigational necessity, justification or benefit, public or private, of such proposed encroachment as well as its detrimental effects, if any, upon adjacent real property and public trust values such as navigation, fish and wildlife habitat, aquatic life, recreation, aesthetic beauty, water quality, etc. will prepare and forward to the applicant its decision. (3-20-20)T

**b.** The applicant, if dissatisfied with the Director's decision, has twenty (20) days from the date of the Director's decision to request reconsideration thereof. If reconsideration is required, the Director will set a time and place for a reconsideration hearing, not to exceed thirty (30) days from receipt of the request, at which time and place the applicant may appear in person or through an authorized representative and present briefing and oral argument. Upon conclusion of reconsideration, the Director will, by personal service or by registered or certified mail, notify the applicant of his final decision. (3-20-20)T

**09. Judicial Review.** Any applicant aggrieved by the Director's final decision, or an aggrieved party who appeared at a hearing, has the right to have the proceedings and final decision of the Director reviewed by the district court in the county in which the encroachment is proposed by filing a notice of appeal within thirty (30) days from the date of the final decision. The applicant need post no bond with the court to prosecute an appeal. Any other aggrieved party is required to deposit an appeal bond with the court, in an amount to be determined by the court but not less than five hundred dollars (\$500), insuring payment to the applicant of damages caused by delay and costs and expenses, including reasonable attorney fees, incurred on the appeal in the event the district court sustains the action of the Director. (3-20-20)T

**10. Factors in Decision.** In recognition of continuing private property ownership of lands lying between the natural or ordinary high water mark and the artificial high water mark, if present, the Department will consider unreasonable adverse effect upon adjacent property and undue interference with navigation the most important factors to be considered in granting or denying an application for either a nonnavigational encroachment or a commercial navigational encroachment not extending below the natural or ordinary high water mark. If no objections have been filed to the application and no public hearing has been requested or ordered by the Director, or,

if upon reconsideration of a decision disallowing a permit, or following a public hearing, the Department determines that the benefits, whether public or private, to be derived from allowing such encroachment exceed its detrimental effects, the permit will be granted. (3-20-20)T

**031. -- 034. (RESERVED)**

**035. TEMPORARY PERMITS.**

**01. Applicability.** Temporary permits are used for construction, temporary activities related to permitted encroachments, or other activities approved by the Department. (3-20-20)T

**02. Permit Term.** These permits are generally issued for less than one (1) year, but longer terms may be approved by the Department and permits may be extended with Department approval. (3-20-20)T

**03. Bonding.** The Department may require bonds for temporary permits. (3-20-20)T

**04. Fee.** The board sets fees for temporary permits, but the fees will not be greater than the amounts listed for the respective permit types in Subsection 020.07. Fee information is available on the Internet at [www.idl.idaho.gov](http://www.idl.idaho.gov). (3-20-20)T

**05. Processing.** These permits may be advertised if the Department deems it appropriate, with the applicant paying the advertising fee as per Subsection 020.07. (3-20-20)T

**036. -- 049. (RESERVED)**

**050. RECORDATION.**

Recordation of an issued permit in the records of the county in which an encroachment is located is a condition of issuance of a permit and proof of recordation must be furnished to the Department by the permittee before a permit becomes valid. Such recordation is at the expense of the permittee. Recordation of an issued permit serves only to provide constructive notice of the permit to the public and subsequent purchasers and mortgagees, but conveys no other right, title, or interest on the permittee other than validation of said permit. (3-20-20)T

**051. -- 054. (RESERVED)**

**055. LEASES AND EASEMENTS.**

**01. Lease or Easement Required.** As a condition of the encroachment permit, the Department may require a submerged land lease or easement for use of any part of the state-owned bed of the lake where such lease or easement is required in accordance with “Rules Governing Leases on State-owned Submerged Lands and Formerly Submerged Lands,” IDAPA 20.03.17, or “Rules For Easements On State-owned Submerged Lands And Formerly Submerged Lands,” IDAPA 20.03.09. A lease or easement may be required for uses including, but not limited to, commercial uses. Construction of an encroachment authorized by permit without first obtaining the required lease or easement constitutes a trespass upon state-owned public trust lands. This rule is intended to grant the state recompense for the use of the state-owned bed of a navigable lake where reasonable and it is not intended that the Department withhold or refuse to grant such lease or easement if in all other respects the proposed encroachment would be permitted. (3-20-20)T

**02. Seawalls, Breakwaters, Quays.** Seawalls, breakwaters, and quays on or over state-owned beds, designed primarily to create additional land surface, will be authorized, if at all, by an encroachment permit and submerged land lease or easement, upon determination by the Department to be an appropriate use of submerged lands. (3-20-20)T

**056. -- 059. (RESERVED)**

**060. INSTALLATION.**

**01. Installation Only After Permit Issued.** Installation or on site construction of an encroachment

may commence only when the permit is issued or when the department notifies the applicant in writing that installation may be commenced or when the department has failed to act in accordance with Subsection 025.07.

(3-20-20)T

**02. Removal of Construction Waste.**

(3-20-20)T

**a.** Pilings, anchors, old docks, and other structures or waste at the site of the installation or reinstallation and not used as a part of the encroachment shall be removed from the water and lakebed at the time of the installation or reinstallation to a point above normal flood water levels; provided, however, that this shall not be construed to prevent the use of trash booms for the temporary control of floatable piling ends and other floatable materials in a securely maintained trash boom, but approval for a trash boom shall be required as part of a permit.

(3-20-20)T

**b.** Demolition of encroachments shall be done in a manner that does not unnecessarily damage the lakebed or shoreline. Demolition work must comply with water quality standards administered by the Department of Environmental Quality.

(3-20-20)T

**03. Compliance with Permit.** All work shall be done in accordance with these rules, and the application submitted, and is subject to any condition specified in the permit.

(3-20-20)T

**04. Sunset Clause.** All activities authorized within the scope of the encroachment permit must be completed within three (3) years of issuance date. If the activities are not completed within three (3) years, the permit shall automatically expire unless it was previously revoked or extended by the department. The department may issue a permit with an initial sunset clause that exceeds three (3) years, if the need is demonstrated by the applicant.

(3-20-20)T

**061. -- 064. (RESERVED)**

**065. ASSIGNMENTS.**

**01. Assignment of Encroachment Permit.** Encroachment permits may be assigned upon approval of the department provided that the encroachment conforms with the approved permit. The assignor and assignee must complete a department assignment form and forward it to the appropriate area office.

(3-20-20)T

**02. Assignment Fee.** The assignment fee is three hundred dollars (\$300) and is due at the time the assignment is submitted to the department.

(3-20-20)T

**03. Approval Required for Assignment.** An assignment is not valid until it has been approved by the department.

(3-20-20)T

**04. Assignment With New Permit.** Encroachments not in compliance with the approved permit may be assigned only if:

(3-20-20)T

**a.** An application for a new permit to correct the noncompliance is submitted at the same time.

(3-20-20)T

**b.** The assignee submits written consent to bring the encroachment permit into compliance.

(3-20-20)T

**066. -- 069. (RESERVED)**

**070. MISCELLANEOUS.**

**01. Water Resources Permit.** A permit to alter a navigable stream issued by the Department of Water Resources pursuant to Title 42, Chapter 38, Idaho Code, may, in appropriate circumstances, contain language stating the approval of the Department of Lands to occupy the state-owned bed of the navigable stream.

(3-20-20)T

**02. Dredge and Placer Mining.** Department authorization is required for dredge and placer mining in the lands, lakes and rivers within the state, whether or not the state owns the beds, pursuant to Title 47, Chapter 13, Idaho Code. (3-20-20)T

**03. Mineral Leases.** Littoral rights do not include any right to remove bed materials from state-owned lakebeds. Applications to lease minerals, oil, gas and hydrocarbons, and geothermal resources within the state-owned beds of navigable lakes will be processed by the Department pursuant to Title 47, Chapters 7, 8 and 16, Idaho Code, and rules promulgated thereunder. (3-20-20)T

**04. Other Laws and Rules.** The permittee must comply with all other applicable state, federal and local rules and laws insofar as they affect the use of public trust resources. (3-20-20)T

**071. -- 079. (RESERVED)**

**080. VIOLATIONS - PENALTIES.**

**01. Cease and Desist Order.** When the Department determines that a violation of these rules is occurring due to the ongoing construction of an unauthorized encroachment or an unauthorized modification of a permitted encroachment, it may provide the landowner, contractor, or permittee with a written cease and desist order that consists of a short and plain statement of what the violation is, the pertinent legal authority, and how the violation may be rectified. This order will be served by personal service or certified mail. The cease and desist order is used to maintain the status quo pending formal proceedings by the Department to rectify the violation. (3-20-20)T

**02. Notice of Noncompliance/Proposed Permit Revocation.** When the Department determines that these rules have been violated, a cause exists for revocation of a lake encroachment permit, or both of these have occurred, it will provide the permittee or offending person with a notice of noncompliance/proposed permit revocation that consists of a short and plain statement of the violation including any pertinent legal authority. This notice also informs the permittee or offending person of what steps are needed to either bring the encroachment into compliance, if possible, or avoid revocation, or both. (3-20-20)T

**03. Noncompliance Resolution.** The Department will attempt to resolve all noncompliance issues through conference with the permittee or other involved party. Any period set by the parties for correction of a violation is binding. If the Department is unsuccessful in resolving the violations, then the Department may pursue other remedies under Section 080 of these rules. (3-20-20)T

**04. Violations.** The following acts or omissions subject a person to a civil penalty as allowed by Title 58, Chapter 13, Section 58-1308, Idaho Code: (3-20-20)T

**a.** A violation of the provisions of Title 58, Chapter 13, Idaho Code, or of the rules and general orders adopted and applicable to navigable lakes; (3-20-20)T

**b.** A violation of any special order of the Director applicable to a navigable lake; or (3-20-20)T

**c.** Refusal to cease and desist from any violation in regards to a navigable lake after having received a written cease and desist order from the Department by personal service or certified mail, within the time provided in the notice, or within thirty (30) days of service of such notice if no time is provided. (3-20-20)T

**d.** Willfully and knowingly falsifying any records, plans, information, or other data required by these rules. (3-20-20)T

**e.** Violating the terms of an encroachment permit. (3-20-20)T

**05. Injunctions, Damages.** The Board expressly reserves the right, through the Director, to seek injunctive relief under Title 58, Chapter 13, Section 58-1308, Idaho Code and mitigation of damages under Title 58, Chapter 13, Section 58-1309, Idaho Code, in addition to the civil penalties provided for in Subsection 080.04 of these rules. (3-20-20)T

**06. Mitigation, Restoration.** The board expressly reserves the right, through the Director, to require mitigation and restoration of damages under Title 58, Chapter 13, Section 58-1309, Idaho Code, in addition to the civil penalties and injunctive relief provided for in Subsections 080.04 and 080.05 of these rules. The Department may consult with other state agencies to determine the appropriate type and amount of mitigation and restoration required. (3-20-20)T

**07. Revocation of Lake Encroachment Permits.** (3-20-20)T

**a.** The Department may institute an administrative action to revoke a lake encroachment permit for violation of the conditions of a permit, or for any other reason authorized by law. All such proceedings will be conducted as contested case hearings subject to the provisions of Title 67, Chapter 52, Idaho Code, and IDAPA 20.01.01, “Rules of Practice and Procedure before the State Board of Land Commissioners.” (3-20-20)T

**b.** A hearing officer appointed to conduct the revocation hearing prepares recommended findings of fact and conclusions of law and forward them to the Director for final adoption or rejection. (3-20-20)T

**c.** An aggrieved party who appeared and testified at a hearing has the right to have the proceedings and final decision of the Director reviewed by the district court of the county in which the violation or revocation occurred by filing a notice of appeal within twenty-eight (28) days from the date of the final decision. (3-20-20)T

**081. -- 999. (RESERVED)**

## 20.03.05 – RIVERBED MINERAL LEASING IN IDAHO

### 000. AUTHORITY.

**01. Statutory Authority.** These rules are promulgated by the Idaho State Board of Land Commissioners pursuant to Title 47 and 58, Chapters 7 and 1, Sections 47-710, 47-714 and 58-104, Idaho Code. (3-20-20)T

**02. Discretionary Powers.** The Board of Land Commissioners is delegated discretionary power to regulate and control the use or disposition of lands in the beds of navigable lakes, rivers, and streams, to the natural or ordinary high water mark thereof, so as to provide for their commercial, navigational, recreational or other public use; provided that the Board will take no action in derogation of or seeking to interfere with the riparian or littoral rights of the owners of upland property abutting or adjoining such lands. (Section 58-104(9), Idaho Code). (3-20-20)T

### 001. TITLE AND SCOPE.

**01. Title.** These rules are titled IDAPA 20.03.05, “Riverbed Mineral Leasing in Idaho.” (3-20-20)T

**02. Where Applicable.** These rules apply to the exploration and extraction of precious metals, minerals, and construction materials from a placer deposit situated in state-owned submerged lands. (3-20-20)T

**03. Where Not Applicable.** These rules do not apply to the application and leasing of geothermal resources by title 47, Chapter 16, Idaho Code, or to the application and leasing of oil and gas resources covered by Title 47, Chapter 8, Idaho Code. (3-20-20)T

### 002. -- 009. (RESERVED)

### 010. DEFINITIONS.

**01. Available State Lands.** All lands between the ordinary high water marks of a navigable river which have not been located, leased, or withdrawn. (3-20-20)T

**02. Board.** The State Board of Land Commissioners or its authorized representative. (3-20-20)T

**03. Casual Exploration.** Entry and/or exploration which does not appreciably disturb or damage the land or resources thereon. Casual exploration includes, but is not limited to, geochemical and/or geophysical exploration techniques, sampling with hand tools, and entry using wheeled vehicles for transportation to conduct such exploration. Exploration using suction dredges having an intake diameter of two inches (2”) or less are considered casual exploration when operated in a perennial stream and authorized under the stream protection act, Title 42, Chapter 38, Idaho Code. Refer to Section 015 for further clarification regarding casual exploration and recreational mining. (3-20-20)T

**04. Commercial.** The type of operation that engages in the removal of construction materials or uses suction dredges with an intake diameter larger than five inches (5”) or attendant power sources rated at greater than fifteen (15) horsepower and/or other motorized equipment. (3-20-20)T

**05. Construction Materials.** Sand, gravel, cobble, boulders, and other similar materials. (3-20-20)T

**06. Director.** The Director of the Idaho Department of Lands or his authorized representative. (3-20-20)T

**07. Motorized Exploration.** Exploration that may appreciably disturb or damage the land or resources thereon. Motorized exploration includes, but is not limited to, drilling, trenching, dredging, or other techniques that employ the use of earth moving or other motorized equipment, seismic operations using explosives, and sampling with suction dredges having an intake diameter greater than two inches (2”) when operated in a perennial stream. When operated in an intermittent stream, suction dredges are considered motorized exploration regardless of the intake size. (3-20-20)T

**08. Natural or Ordinary High Water Mark.** The line that the water impresses upon the soil by covering it for sufficient periods to deprive the soil of its vegetation and destroy its value for agricultural purposes. (3-20-20)T

**09. Person.** (3-20-20)T

- a. An individual of legal age; (3-20-20)T
- b. Any firm, association or corporation qualified to do business in the state of Idaho; or (3-20-20)T
- c. Any public agency or government unit, including without limitation, municipalities. (3-20-20)T
- 10. Recreational Mining.** Mining with a suction dredge having an intake diameter of five inches (5") or less, and attendant power sources, rated at fifteen (15) horsepower or less, pans, rockers, hand tools, hand operated sluices and other similar equipment. (3-20-20)T
- 11. River Mile.** Five thousand two hundred eighty (5,280) feet of contiguous riverbed as measured along the approximate center of the river. (3-20-20)T
- 12. Navigable River.** A natural water course of perceptible extent, with definite bed and banks, which confine and conducts continuously flowing water, and the bed of which is owned by the state of Idaho in trust. (3-20-20)T
- 13. Submerged Lands.** All state-owned beds of navigable lakes, rivers, and streams between the natural or ordinary high water marks. (3-20-20)T
- 011. -- 014. (RESERVED)**
- 015. CASUAL EXPLORATION AND RECREATIONAL MINING.**
- 01. Lands Open.** All beds of navigable rivers that have not been located, leased or withdrawn in accordance with statute or the terms of these rules, are free and open to casual exploration and recreational mining on a nonexclusive and first come basis. (3-20-20)T
- 02. Equipment Limitations.** Mining equipment for casual exploration that may occur prior to the filing of a location or lease application is limited to suction dredges with a two (2") inch intake or less, pans, rockers, hand tools, hand operated sluices and other similar equipment. (3-20-20)T
- 03. No Approval for Casual Exploration Required.** No written approval is required from the Director for casual exploration. (3-20-20)T
- 04. Recreational Mining Equipment.** Mining equipment for recreational mining is limited to suction dredges with an intake diameter of five (5") inches or less with attendant power sources rated at fifteen (15) horse power or less, pans, rockers, hand tools, hand operated sluices and other similar equipment. (3-20-20)T
- 05. Department of Water Resources Permits.** Possession of a valid Stream Protection Act Permit issued by the Idaho Department of Water Resources and a Recreational Mining Permit issued by the Idaho Department of Lands constitutes the Board's waiver of bond, waiver of royalty, and written approval to engage in recreational mining under Section 47-704(6), Idaho Code, and Title 47, Chapter 13, Idaho Code. (3-20-20)T
- 016. EXPLORATION LOCATIONS.**
- 01. Lands Open.** The beds of navigable rivers that have not been located or withdrawn, or are not under application to lease, in accordance with statute or the terms of these rules, are available for exploration location; provided that salable minerals are not subject to exploration location. Details of exploration locations on state lands can be found in Title 47, Chapter 7, Idaho Code. (3-20-20)T
- 02. Size of Location.** Each exploration location is limited to one-half (1/2) mile in length. (3-20-20)T
- 03. Record Keeping Requirement.** A locator must keep a record of all minerals recovered during exploration operations and must pay to the state a royalty of five percent (5%) of the gross value of the minerals recovered. Payment must be made each year with the filing of the assessment work report. (3-20-20)T



**04. When No Written Approval Required.** No written approval is required from the Director for exploratory activity on an exploration location when such exploration is limited to mining equipment such as suction dredges with a five (5") inch intake diameter or less and attendant power sources rated at fifteen (15) horsepower or less, pans, rockers, hand operated sluices, and other similar equipment; provided however, that recreational mining activity performed under a Recreational Mining Permit as authorized under Section 015 does not serve to establish any basis for an exploration location. (3-20-20)T

**05. When Written Approval Required.** Written approval is required from the Director prior to entry for operators conducting motorized exploration except as allowed in Subsection 016.04. Approved operations must be bonded as outlined in Subsection 040.03. (3-20-20)T

**017. -- 019. (RESERVED)**

**020. RIVERBED MINERAL LEASE.**

**01. Limitations on Suction Dredges.** Operators may not use suction dredges with an intake diameter larger than five inches (5") or attendant power sources rated greater than fifteen (15) horsepower, except under lease. (3-20-20)T

**02. Approval Required Before Operations.** Prior to entry upon navigable rivers, operators are required to have written approval from the Director. (3-20-20)T

**03. Bonding.** Approved operations must be bonded as outlined in Subsection 040.01. (3-20-20)T

**04. Simultaneous Filings.** Two (2) or more lease applications received on the same date and hour, covering the same lands, are considered simultaneous filings. Simultaneous filings will be resolved by competitive bidding. (3-20-20)T

**021. -- 024. (RESERVED)**

**025. PUBLIC NOTICE AND HEARING.**

**01. Publication of Notice.** Upon receipt by the Board of an application to lease any lands that may belong to the state of Idaho by reason of being situated between the high water marks of navigable rivers of the state, the Board will cause at the expense of the applicant, a notice of such application to be published once a week for two (2) issues in a newspaper of general circulation in the county or counties in which said lands described in said application are situated. (3-20-20)T

**02. Public Hearing.** The Board may order a public hearing on an application if it deems this action is in the best interest of the public. (3-20-20)T

**03. Petition for Hearing.** The Board or its authorized representative will hold a public hearing on the application, if requested in writing no later than thirty (30) days after the last published notice by ten (10) person whose lawful rights to use the waters applied for may be injured thereby, or by an association presenting a petition with signatures of not less than ten (10) such aggrieved parties; provided that the Board may order a public hearing in the first instance. The Board will consider fully all written and oral submissions respecting the application. (3-20-20)T

**026. -- 029. (RESERVED)**

**030. RENTAL AND ROYALTY AND LATE PAYMENTS.**

**01. Minimum Annual Rental.** The minimum annual rental is one hundred sixty dollars (\$160) for any area up to one hundred sixty (160) acres, and one dollar (\$1) for each additional acre. (3-20-20)T

**02. Minimum Annual Royalty.** In addition to the annual rental, the commercial lessee pays an annual

minimum royalty of five hundred dollars (\$500) per year and all other lessees pay an annual minimum royalty of three hundred forty dollars (\$340) per year. (3-20-20)T

**03. Deduction of Royalty.** The annual minimum royalty and the annual rental for any year is deducted from the actual production royalty as it accrues for that year. (3-20-20)T

**04. Royalty Schedule.** The appropriate Board approved royalty schedule for the commodity mined must be attached and made a part of the mineral lease. (3-20-20)T

**05. Late Payments.** Rental or royalty not paid by the due date is considered late. A twenty-five dollars (\$25) late payment charge or penalty interest from the due date, whichever is greater, will be added to the rental or royalty amount. The penalty interest is one percent (1%) for each calendar month or fraction thereof. (3-20-20)T

**031. SIZE AND COMPOSITION OF LEASABLE TRACT.**

**01. One Mile Limitation.** A riverbed lease may not exceed one (1) contiguous river mile in length or all the riverbed within one (1) section should all the available state lands within the section exceed one (1) river mile. (3-20-20)T

**02. Construction Materials.** Leases for construction materials may be limited to a smaller size tract at the Board's discretion. (3-20-20)T

**032. -- 034. (RESERVED)**

**035. ASSIGNMENTS.**

**01. Prior Written Approval.** No location or lease assignment is be valid until approved in writing by the Director, and no assignment takes effect until after the first day of the month following its approval. (3-20-20)T

**02. Partition.** A location or lease may be assigned to any person qualified to hold a state location or lease, provided that in the event an assignment partitions leased lands between two (2) or more persons, both the assigned and the retained part created by the assignment contain not less than one-half (1/2) mile length of river bed land. (3-20-20)T

**03. Segregation of Lease.** If an assignment partitions leased lands between two (2) or more persons, it must clearly segregate the assigned and retained portions of the leasehold. Resulting segregated leases continue in full force and effect for the balance of the term of the original lease or as further extended pursuant to statute and these rules. (3-20-20)T

**036. -- 039. (RESERVED)**

**040. BOND.**

**01. Minimum Bond.** Concurrent with the execution of the lease by the lessee, lessee must furnish to the Director a good and sufficient bond or undertaking on a Department form in the amount of five thousand dollars (\$5,000) for commercial operations and one thousand dollars (\$1,000) for all other operations, in favor of the state of Idaho, conditioned on the payment of all damages to the land and all improvements thereon which result from the lessee's operation and conditioned on complying with statute, these rules and the lease terms. This bond is in addition to the bonds required by the Idaho Dredge and Placer Mining Protection Act (Title 47, Chapter 13, Idaho Code). (3-20-20)T

**02. Statewide Bond.** In lieu of the above bond, the lessee may furnish a good and sufficient "statewide" bond conditioned as above in the amount of fifty thousand dollars (\$50,000) in favor of the state of Idaho, to cover all lessee's leases and operations carried on under statute and these rules. (3-20-20)T

**03. Motorized Exploration.** Motorized exploration on a site under location is subject to a minimum bond in the amount of seven hundred fifty dollars (\$750). A larger bond not exceeding seven hundred fifty dollars

(\$750) per acre may be required by the Department depending on the size and scope of the operation. (3-20-20)T

**041. -- 044. (RESERVED)**

**045. FEES.**

The following fees apply: (3-20-20)T

**01. Nonrefundable Application Fee for Lease.** Fifty dollars (\$50) per application. (3-20-20)T

**02. Nonrefundable Fee for Advertising Application.** Forty-five dollars (\$45) per application. (3-20-20)T

**03. Exploration Location Fee.** Two hundred fifty dollars (\$250) per location. (3-20-20)T

**04. Application Fee for Approval of Assignment.** Fifty dollars (\$50) per lease or location involved in the assignment. (3-20-20)T

**046. -- 999. (RESERVED)**

## 20.03.08 – EASEMENTS ON STATE-OWNED LANDS

### 000. LEGAL AUTHORITY.

These rules are promulgated pursuant to and are to be construed in a manner consistent with the duties and responsibilities of the Idaho State Board of Land Commissioners as set forth in Idaho Code Title 58, Chapters 1 and 6, and Article IX, Sections 7 and 8 of the Idaho Constitution. (3-20-20)T

### 001. TITLE AND SCOPE.

**01. Title.** These rules are titled IDAPA 20.03.08, “Easements on State-Owned Lands.” (3-20-20)T

**02. Scope.** These rules set forth procedures concerning the issuance of easements on all lands within the jurisdiction of the Idaho State Board of Land Commissioners except for state-owned submerged lands and formerly submerged lands. Further, these rules do not apply to easements for hydroelectric projects. (3-20-20)T

**03. Valid Existing Rights.** These rules are not be construed as affecting any valid existing rights. (3-20-20)T

### 002. ADMINISTRATIVE APPEALS.

An applicant aggrieved by a decision of the Director under these rules may request a hearing before the Board, but must do so within thirty (30) days after receipt of written notice of the Director’s decision. (3-20-20)T

### 003. -- 009. (RESERVED)

### 010. DEFINITIONS.

**01. Board.** The Idaho State Board of Land Commissioners or such representative as may be designated by the Board. (3-20-20)T

**02. Damage or Impairment of Rights to the Remainder of the Property.** The diminution of the market value of the remainder area, in the case of a partial taking. (3-20-20)T

**03. Department.** The Idaho Department of Lands. (3-20-20)T

**04. Director.** The Director of the Department of Lands or such representative as may be designated by the Director. (3-20-20)T

**05. Easement.** A non-possessory interest in land for a specific purpose. Such interest may be limited to a specified term. (3-20-20)T

**06. Endowment Lands.** Land grants made to the state of Idaho by the Congress of the United States, or real property subsequently acquired through land exchange or purchase, for the sole use and benefit of the public schools and certain other institutions of the state, comprising nine (9) grants altogether. (3-20-20)T

**07. Market Value.** The most probable price at a specified date, in cash, or on terms reasonably equivalent to cash, for which the property should bring in a competitive and open market under all conditions requisite to a fair sale, the buyer and seller each acting prudently and knowledgeably, and assuming the price is not affected by undue stimulus. (3-20-20)T

**08. State-Owned Lands.** All lands within the jurisdiction of the Idaho State Board of Land Commissioners except for state-owned submerged lands or formerly submerged lands. (3-20-20)T

**09. Temporary Permit.** An instrument authorizing a specific use on state land usually issued for five (5) years or less, but that may be issued for up to ten (10) years. (3-20-20)T

### 011. -- 019. (RESERVED)

### 020. POLICY.

**01. Easements Required.** Easements are required for all rights-of-way of a permanent nature over state-owned land. Easements will not be granted when temporary permits will serve the required purpose or when a lease is appropriate. (3-20-20)T

**02. Prior Grants.** The Director will recognize easements on state endowment lands by grant of the federal government, or subsequent landowners, prior to title vesting with the State or by eminent domain. (3-20-20)T

**03. Existing Easements.** These rules do not apply to any use, facility or structure described in an existing easement. For amendment of an existing easement, see Section 025. (3-20-20)T

**04. Director's Discretion.** The Director may grant an easement over state-owned land for any legitimate public or private purpose upon payment of appropriate compensation. (3-20-20)T

**05. Reciprocal Easements.** The Director may seek reciprocal easements for access to state-owned lands from applicants for easements over state-owned lands. The value of the easement acquired by the state may be applied towards the cost of the easement acquired from the state. (3-20-20)T

**06. Interest Granted.** An easement grants only such interest to the grantee as is specified in the instrument, including the right to use the property for the specified purpose without interference by the grantor. The right to use the property for all other purposes not inconsistent with the grantee's interest remains with the grantor. (3-20-20)T

**07. Limit of Director's Discretion.** The Director may grant and renew easements in all cases except when the compensation will exceed twenty-five thousand dollars (\$25,000) exclusive of the value of timber and payment for any damage or impairment of rights to the remainder of the property. (3-20-20)T

**08. Width of Easement.** The width of any easement granted may not be less than eight (8) feet. (3-20-20)T

**09. Recordation.** The Department will record the easement, or easement release, with the appropriate county recorder's office. (3-20-20)T

**10. Term Easement.** The Director may grant an easement that is issued for a specific time period of ten (10) to fifty-five (55) years. (3-20-20)T

**021. FEES AND COMPENSATION.**

**01. Application Fee.** The application fee for new, renewed, or amended easements is one hundred dollars (\$100) and is collected from all applicants. This application fee is in addition to the easement compensation and appraisal costs, and is non-refundable unless the Director determines that the land applied for is not under the jurisdiction of the Board. (3-20-20)T

**02. Easement Fee.** The compensation for permanent easements over state-owned lands covered by these rules is as follows:

	<b>COMPENSATION</b>
Highways, roads, railroads, reservoirs, trails, canals, ditches, or any other improvements that require long term, exclusive or near exclusive use and occupation of the right of way	Up to 100% of land value plus payment for any damage or impairment of rights to the remainder of the property as determined by the Director and supported by specific data such as an appraisal
Overhead transmission and power lines	Up to 100% of land value depending on the exclusivity of use as determined by the Director and supported by specific data such as an appraisal plus payment for any damage or impairment of rights to the remainder of the property as determined by the Director and supported by data such as an appraisal

	<b>COMPENSATION</b>
Buried installations - cables, pipelines, sewerlines, waterlines	Up to 100% of land value, depending on the exclusivity use as determined by the Director and supported by specific data such as an appraisal plus payment for any damage or impairment of rights to the remainder of the property, as determined by the Director and supported by specific data such as an appraisal

(3-20-20)T

**03. Appraisal Required.** An appraisal of an easement may be required where, in the opinion of the Director, the easement value will exceed the minimum compensation fee of five hundred dollars (\$500). (3-20-20)T

**04. Performance of Appraisal.** The appraisal of the easement will normally be performed by qualified department staff. If so desired by the applicant, and agreed to by the Director, the applicant may provide the appraisal that is acceptable to and meets the specifications set by the Director. (3-20-20)T

**05. Appraisal Costs.** Where the appraisal is performed by department staff, the appraisal is two hundred fifty dollars (\$250) for a market analysis, five hundred dollars (\$500) for a short form appraisal, and one thousand dollars (\$1,000) for appraisals of easements requiring Board approval. The appraisal cost is in addition to those costs outlined in Subsections 021.01 and 021.02. In no case will an applicant be charged more than one thousand dollars (\$1000) for an appraisal of an easement conducted by departmental staff. (3-20-20)T

**06. Term Easements.** Compensation for term easements will be established by appraisal. (3-20-20)T

**07. Minimum Compensation.** The minimum compensation for any easement is five hundred dollars (\$500), not including the application fee and appraisal costs. (3-20-20)T

**022. -- 024. (RESERVED)**

**025. EASEMENT AMENDMENT.**

Amendment of an existing easement must be processed in the same manner as a new application. Amendment includes change of use, widening the easement area, or changing the location of the easement area. Amendment does not include ordinary maintenance, repair, or replacement of existing structures such as poles, wires, cables, and culverts. (3-20-20)T

**026. -- 029. (RESERVED)**

**030. EMERGENCY WORK.**

The grantee is authorized to enter upon endowment lands and other lands managed by the Department for the purpose of performing emergency repairs on an easement for damage due to floods, high winds and other acts of God, provided that the grantee provides written notice to the Director within forty-eight (48) hours of the time work commences. Thereupon, the Director is authorized to assess any damages to the state lands and seek reimbursement. (3-20-20)T

**031. -- 034. (RESERVED)**

**035. COOPERATIVE USE AND RECIPROCAL USE AGREEMENTS.**

**01. Joint Agreements.** The Director may, subject to the approval of the Board, enter into joint ownership and use agreements with persons for roads providing access to state endowment lands and other lands managed by the Department. Such agreements must provide that all landowners share proportionately in the cost of building and maintaining the shared road. The proportionate shares are calculated on timber volume, acreage or other unit of value. (3-20-20)T

**02. Reciprocal Use Agreements.** The Director may enter into reciprocal use agreements with persons

for existing roads where such agreements will enhance the management of state endowment lands or other lands managed by the Department. (3-20-20)T

**03. Applicability.** Where the Director has entered into such agreements mentioned in Subsections 035.01 and 035.02 above, Sections 021, 040, and 046 do not apply. (3-20-20)T

**036. -- 039. (RESERVED)**

**040. ASSIGNMENTS.**

**01. Fee.** Easements issued by the Director or by the Board are assignable provided that the assignor and assignee complete the Department's standard assignment form and forward it and the non-refundable assignment fee of fifty dollars (\$50) to any department office. (3-20-20)T

**02. Prior Written Consent.** An assignment is not valid without the prior written consent of the Director. Such consent will not be unreasonably withheld. (3-20-20)T

**03. Multiple Assignments.** If all state easements held by a grantee are assigned at one time, only one (1) assignment fee is required. (3-20-20)T

**041. ABANDONMENT, RELINQUISHMENT, AND TERMINATION.**

**01. Section 58-603, Idaho Code.** The provisions of Idaho Code Section 58-603 apply to all easements over state-owned lands. (3-20-20)T

**02. Non-Use.** An easement not used for the purpose for which it was granted, for five (5) consecutive years, is presumed abandoned and automatically terminates. The Director will notify the grantee in writing of the termination. The grantee has thirty (30) days from the date of notification to reply in writing to the Director to show cause why the easement should be reinstated. Within sixty (60) days of receipt of the statement to show cause, the Director will notify the grantee in writing as to the Director's decision concerning reinstatement. The grantee has thirty (30) days of receipt of the Director's decision to appeal an adverse decision to the Board. (3-20-20)T

**03. Removal of Improvements.** Upon termination, the grantee has twelve (12) months from the date of final notice to remove any facilities and improvements. (3-20-20)T

**04. Voluntary Relinquishment.** The grantee may voluntarily relinquish the easement at any time by completing an easement relinquishment form. The Department will pay the grantee one dollar (\$1) for the relinquishment. (3-20-20)T

**042. -- 045. (RESERVED)**

**046. PROCEDURE.**

**01. Contents of Application.** An easement application contains. (3-20-20)T

**a.** A letter of request stating the purpose of the easement; (3-20-20)T

**b.** A map of right-of-way in triplicate; and (3-20-20)T

**c.** One (1) copy of an acceptable written description based on a centerline survey or a metes and bounds survey of the perimeter of the easement tract. The applicant may also describe the area occupied by existing uses, facilities or structures by platting the state-owned land affected by the use and showing surveyed or scaled ties (to a legal corner) at the points where the use enters and leaves the parcel. (3-20-20)T

**02. Engineer Certification.** As required in Section 58-601, Idaho Code, for any application for a ditch, canal or reservoir, the plats and field notes must be certified by the engineer under whose direction such surveys or plans were made and four (4) copies filed with the Department and one (1) copy with the Director, Department of

Water Resources. (3-20-20)T

**03. Where to Submit Application.** An easement application may be submitted to any office of the Department. (3-20-20)T

**04. Notification of Approval.** If approved, the applicant will be notified of the amount due to the Department. (3-20-20)T

**05. Notification of Denial.** If the application is denied, the applicant will be notified in writing of such decision. (3-20-20)T

**047. EASEMENTS ON STATE LAND UNDER LAND SALE CONTRACT.**

**01. Approval of Contract Purchaser.** The Director will not approve an easement on lands under contract of sale (land sale certificate) without the approval of the contract sale purchaser or without reviewing the consideration received to insure that the state's interests are protected. (3-20-20)T

**02. Compensation.** The compensation for easements on lands under land sale contract will be as set out in Section 021 except that "land value" may be the sale value. These moneys will be applied to the principal balance on the land sale contract. Additionally, the Department will collect the one hundred dollar (\$100) application fee. (3-20-20)T

**03. Co-Signature of Contract Purchaser.** The contract sale purchaser must co-sign the easement to validate the document. (3-20-20)T

**048. -- 999. (RESERVED)**



**20.03.09 – EASEMENTS ON STATE-OWNED SUBMERGED LANDS  
AND FORMERLY SUBMERGED LANDS**

**000. LEGAL AUTHORITY.**

These rules are promulgated pursuant to, and are to be construed in a manner consistent with, the duties and responsibilities of the Idaho State Board of Land Commissioners as set forth in Title 58, Chapters 1, 6, and 13, Idaho Code, and the Equal Footing Doctrine (Idaho Admission Act of July 3, 1890, 26 Stat. 215, Chapter 656). (3-20-20)T

**001. TITLE AND SCOPE.**

**01. Title.** These rules are titled IDAPA 20.03.09, “Easements on State-Owned Submerged Lands and Formerly Submerged Lands.” (3-20-20)T

**02. Purpose.** These rules set forth procedures concerning the issuance of easements on state-owned submerged and formerly submerged lands. (3-20-20)T

**03. Scope.** These rules apply to the issuance of easements for all uses, other than irrigation facilities, diversion facilities, temporary irrigation berms, headgates, turnouts, and domestic water supply intake lines capable of drawing less than five (5) cubic feet per second of water; except that dams that span the entire width of a navigable stream channel regardless of their purpose are subject to these rules. (3-20-20)T

**04. Exceptions; Permits Required.** Easements will not be granted where temporary permits will serve the required purpose or when a lease is more usual and customary, such as for marinas, docks, float homes, and similar facilities. (see IDAPA 20.03.17, “Rules Governing Leases on State-owned Submerged Lands and Formerly Submerged Lands.”) (3-20-20)T

**05. Exceptions; Temporary Structures.** These rules do not apply to uses, facilities, and structures considered to be temporary in nature; more specifically, those uses that will be in effect for a period of ten (10) years or less or those facilities or structures with a lifespan of ten (10) years or less. Such uses, facilities, and structures may be authorized by revocable temporary permits. (3-20-20)T

**002. (RESERVED)**

**003. ADMINISTRATIVE APPEALS.**

An applicant aggrieved by a decision of the Director under these rules may request a hearing before the board, but must do so within thirty (30) calendar days after receipt of written notice of the Director’s decision. Failure to make said request within the thirty (30) day period constitutes a waiver of the applicant’s right to a hearing before the board. Pursuant to Title 67, Chapter 52, Idaho Code, the applicant may appeal an adverse decision of the Board. (3-20-20)T

**004. -- 009. (RESERVED)**

**010. DEFINITIONS.**

**01. Artificial High Water Mark.** The high water elevation above the natural or ordinary high water mark resulting from construction of man-made dams or control works and impressing a new and higher vegetation line (Section 58-1302(d), Idaho Code). (3-20-20)T

**02. Board.** The Idaho State Board of Land Commissioners or such representative as may be designated by the board. (3-20-20)T

**03. Dam.** Any artificial barrier, placed across a navigable stream channel or watercourse. (3-20-20)T

**04. Department.** The Idaho Department of Lands. (3-20-20)T

**05. Director.** The Director of the Idaho Department of Lands or such representative as may be designated by the Director. (3-20-20)T

**06. Easement.** A nonpossessory interest held by one person in land of another person whereby the first person is accorded use for a portion of such land for a specific purpose. (3-20-20)T

**07. Formerly Submerged Lands.** Formerly submerged beds of state-owned navigable lakes, rivers, and streams which have either been filled or have subsequently become uplands because of human activities, i.e.,

dikes, berms, seawalls, etc. Included are islands that have been created on submerged lands by natural processes or human activities since the date of statehood (July 3, 1890). (3-20-20)T

- 08. Grantee.** The party to whom the easement is granted and their assigns and successors in interest. (3-20-20)T
- 09. Grantor.** The State of Idaho and its assigns and successors in interest (3-20-20)T
- 10. Hydroelectric Facilities.** The dam, diversion, penstock, transmission lines, water storage area, powerhouse and other facilities related to generating electric energy from water power. (3-20-20)T
- 11. Market Value.** The amount in cash, or on terms reasonably equivalent to cash, for which in all probability the property would be sold by a knowledgeable owner willing but not obligated to sell to a knowledgeable purchaser who desired but is not obligated to buy. (3-20-20)T
- 12. Natural or Ordinary High Water Mark.** The line which the water impresses upon the soil covering it for a sufficient period of time to deprive the soil of its vegetation and destroy its value for agricultural purposes (Section 58-104(9), Idaho Code). When the soil, configuration of the surface, or vegetation has been altered by man's activity, the natural or ordinary high water mark shall be located where it would have been if this alteration had not occurred. (3-20-20)T
- 13. Person.** A partnership, an association, a joint venture or a corporation qualified to do business in the State of Idaho, any federal, state, county or local unit of government, or an individual. (3-20-20)T
- 14. Right-of-Way.** The privilege that one (1) person, or persons particularly described, may have of passing over the land of another in some particular line. Usually an easement over the land of another. (3-20-20)T
- 15. Submerged Lands.** The state-owned beds of navigable lakes, rivers, and streams lying below the natural or ordinary high water marks. (3-20-20)T
- 16. Uplands.** The land bordering on navigable lakes, rivers, and streams. (3-20-20)T

**011. POLICY.**

- 01. Regulation of the Beds of Navigable Waters.** It is the policy of the State of Idaho to regulate and control the use or disposition of lands in the beds of navigable lakes, rivers, and streams to the natural or ordinary high water mark thereof, so as to provide for their commercial, navigational, recreational or other public use; provided, that the board shall take no action in derogation of or seeking to interfere with the riparian or littoral rights of the owners of upland property abutting or adjoining such lands (Section 58-104, Idaho Code). (3-20-20)T
- a.** These rules shall not be construed as adversely affecting any valid existing rights. (3-20-20)T
- b.** The board or Director shall not grant an easement for any use, facility, or structure that would impair those uses of submerged and formerly submerged lands protected under the public trust doctrine. (3-20-20)T
- 02. Exercise of State Title.** The state exercises its title over the beds of all lakes, rivers, and streams that are navigable in fact. The department will respond to requests or inquiries as to which lakes, rivers, and streams are deemed navigable in fact. Additional information about streams deemed navigable by the state of Idaho is available from the Department. (3-20-20)T
- 03. Stream Channel and Encroachment Permits.** Issuance of an easement shall be contingent upon the applicant first obtaining a stream channel alteration permit if required by the Idaho Department of Water Resources, pursuant to Title 42, Chapter 38, Idaho Code, or a lake encroachment permit if required by the Department, pursuant to the Lake Protection Act, Section 58-1301, Idaho Code. (3-20-20)T
- 04. Other Permits.** Issuance of an easement shall not relieve an applicant of acquiring other permits and licenses that are required by law. (3-20-20)T

**05. Existing Easements.** These rules apply to existing easements on submerged or formerly submerged lands. However, it shall not be necessary for a person possessing a valid easement on the effective date of these rules to file a new application pursuant to these rules. (3-20-20)T

**06. Existing Permits.** Any person holding a permit, issued after May 23, 1984 during the pendency of the promulgation of these rules, for right-of-way on submerged or formerly submerged lands shall convert the permit to an easement upon payment of fees and compensation in the amount provided for by these rules. (3-20-20)T

**07. Limitation on Easement Grant.** An easement grants only such interest to the grantee as is specified within the document, including the legal right to occupy and use the submerged or formerly submerged lands for the specified purpose in the easement without interference by the grantor, except as otherwise provided by law. The legal right to use the submerged or formerly submerged lands for all other purposes not inconsistent with the grantee's interest remains with the grantor. (3-20-20)T

**08. Minimum Width.** The minimum width of any easement granted shall be eight (8) feet. (3-20-20)T

**012. -- 019. (RESERVED)**

**020. FEES AND COMPENSATION.**

**01. Administrative Fee.** There shall be a one-time nonrefundable administrative fee of three hundred dollars (\$300) for any use, facility, or structure requiring an easement under these rules. No supplemental compensation, in excess of the one-time administrative fee, shall be required for: (3-20-20)T

**a.** An easement for a use, facility, or structure for which the navigable lake, river, or stream poses an obstacle or barrier for construction or operation of the use, facility, or structure, or where the applicant demonstrates, and the Director or Board concurs, that the impact of the use, facility, or structure on the submerged lands is less than the impact on the other values associated with the adjacent upland such as conservation of resources, significant cost savings to the public, or accessibility. (3-20-20)T

**b.** An easement for a dam that does not produce hydroelectric power and is less than ten (10) feet in height (as measured from the natural stream bed at the downstream side). (3-20-20)T

**02. Supplemental Compensation.** In addition to the one-time nonrefundable administrative fee of three hundred dollars (\$300), supplemental compensation will be required for: (3-20-20)T

**a.** New and renewed easements for all dams of any size that produce hydroelectric power and all dams that are ten (10) feet and higher (as measured from the natural stream bed at the downstream side). Supplemental compensation for such easements shall be one thousand dollars (\$1,000), and for a dam including associated hydroelectric facilities, there shall be an additional one-time payment of five dollars (\$5) per megawatt of installed capacity per the nameplate rating of said facility. If the facility is situated on a Snake River segment that is a common border with the state of Oregon or the state of Washington, the installed capacity shall be prorated based on the location of the common border for the purpose of calculating the compensation. Total compensation for a new or renewed easement issued for a dam including associated hydroelectric facilities shall not exceed twenty thousand dollars (\$20,000). If an easement for a hydroelectric facility has been issued prior to relicensing, the fee will be prorated based on a fifty (50) year use period. The fee for annual extensions that are frequently issued by FERC because of permitting delays prior to issuance of the major FERC license will be prorated based on a fifty (50) year use period. (3-20-20)T

**b.** An easement over submerged and formerly submerged lands, for any use, facility, or structure, that is not a dam or hydroelectric facility, which would use submerged or formerly submerged lands as a substitute for or to reduce or eliminate the use of uplands. Supplemental compensation for such easements shall be a one-time payment based on the market value of the submerged or formerly submerged lands. The compensation shall be determined by appraisal. For purposes of this subsection, the per acre value of the submerged or formerly submerged lands shall be the same as the per acre value of the adjacent uplands for which the submerged or formerly submerged lands shall serve as a substitute or in the case of filled lands, the per acre value shall be based on its highest and best

use. Adjacent uplands are uplands bordered on one (1) side by the water body and extending landward at least one (1) lot in depth or three hundred (300) feet, whichever is greater. (3-20-20)T

**03. Appraisal.** The appraisal of the easement normally will be performed by qualified Department staff. If so desired by the applicant and agreed to by the Director, the applicant may provide the appraisal, which must be acceptable to and meet the specifications set by the Director. (3-20-20)T

**04. Cost of Appraisal.** Where the appraisal is performed by department staff, the appraisal costs shall be the actual cost and shall be charged to the applicant in addition to those costs outlined in Subsections 020.01 and 020.02. These costs shall include transportation, personnel costs (including per diem), and administrative overhead. An itemized statement of these costs shall be provided to the applicant. The appraisal fee shall be billed separately from the nonrefundable administrative fee established in Subsection 020.01. (3-20-20)T

**021. -- 029. (RESERVED)**

**030. TERM OF EASEMENT.**

**01. Permanent Uses.** A permanent easement will be issued for uses, facilities, and structures that are normally considered permanent in nature, such as bridges, utility crossings, highway fills, and dams. (3-20-20)T

**02. Term Easements.** A term easement will be issued for a specific time period of ten (10) to fifty-five (55) years and will be issued for those uses, facilities, and structures not normally considered permanent in nature. (3-20-20)T

**03. Federally Licensed Facilities.** The term of an easement for all federally licensed hydroelectric facilities on submerged or formerly submerged lands shall be run concurrently with the term of such license issued by the United States Federal Energy Regulatory Commission (FERC), or its successor, authorizing the facility. Easements for hydroelectric facilities for which FERC has issued a conduit exemption shall not exceed fifty-five (55) years. (3-20-20)T

**031. -- 039. (RESERVED)**

**040. USE, FACILITY, OR STRUCTURE MODIFICATION.**

Modification of an existing use, facility, or structure shall require an easement or an amendment to an existing easement and shall be processed in the same manner as a new application. Modification includes expanding the use or easement area, or changing the location of the use or easement area. Modification does not include ordinary maintenance, repair, or replacement of existing structures such as poles, wires, and cables. (3-20-20)T

**041. -- 049. (RESERVED)**

**050. ASSIGNMENTS.**

**01. Assignment Fee.** Easements may be assigned upon approval of the Director. The assignor and assignee must complete the department's standard assignment form and forward it and the nonrefundable assignment fee of fifty dollars (\$50) to any department office. (3-20-20)T

**02. Prior Written Consent.** An assignment is not valid without the written consent of the Director which shall not be unreasonably withheld. The Department shall work diligently to complete assignments within sixty (60) days after receipt of the standard assignment forms and all associated information. (3-20-20)T

**03. Multiple Assignments.** If all state easements held by a grantee are assigned at one time, only one (1) assignment fee shall be required. (3-20-20)T

**051. -- 059. (RESERVED)**

**060. ABANDONMENT, RELINQUISHMENT, AND TERMINATION.**

**01. Section 58-603, Idaho Code.** The provisions of Section 58-603, Idaho Code relating to rights-of-way apply to all easements over state-owned submerged and formerly submerged lands. (3-20-20)T

**02. Non-Use.** Upon termination of an easement for any cause, the Director shall provide the grantee with a specific, but reasonable, period of time (up to twelve (12) months) to remove all facilities or structures. Failure to remove all facilities or structures within such time period established by the Director shall be deemed a trespass on submerged or formerly submerged lands. (3-20-20)T

**03. Voluntary Relinquishment.** The grantee may voluntarily relinquish the easement at any time by submitting a letter or relinquishment form in recordable format to the state of Idaho. Voluntary relinquishment of an easement does not waive or forgive the obligation of the easement holder to remove facilities as required in Subsection 060.02. (3-20-20)T

**061. -- 069. (RESERVED)**

**070. PROCEDURE.**

**01. Contents of Application.** An easement application shall contain: (3-20-20)T

**a.** A letter of request stating the purpose of the easement; (3-20-20)T

**b.** A plat of right-of-way in triplicate; and (3-20-20)T

**c.** One (1) copy of an acceptable written description based on a survey of the centerline or a metes and bounds survey of the easement tract. The applicant may also describe the area occupied by existing uses, facilities or structures by platting the state-owned submerged or formerly submerged lands affected by the use and showing surveyed or scaled ties (to a legal corner) at the points where the use enters and/or leaves the parcel. (3-20-20)T

**02. Engineer Certification.** All maps, plans, and field notes attached to an application for rights-of-way for ditches and reservoirs governed by Section 58-601, Idaho Code, shall be certified by the engineer under whose direction such surveys or plans were made and four (4) copies filed with the Department and one (1) copy filed with the Idaho Department of Water Resources. (3-20-20)T

**03. Decision on Application.** Upon proper application and payment of the nonrefundable administrative fees, appraisal costs, and supplemental compensation required pursuant to these rules, the Director may, after appropriate review and consideration of the facts and the law, grant an easement on and over submerged or formerly submerged lands for any public or private purpose. The Director may deny an application for easement upon a finding that issuance would not be consistent with law or these rules. Such denial or approval shall be in writing within six (6) months of the receipt of the application. (3-20-20)T

**04. Director's Decision.** The Director may grant and renew easements in all cases except when the compensation will exceed ten thousand dollars (\$10,000), exclusive of the payment for any damage or impairment of rights to the remainder of the property. (3-20-20)T

**05. Board Decision.** Easement applications where compensation exceeds ten thousand dollars (\$10,000), or that are of a complex and unusual nature as determined by the Director, shall be presented to the Board for appropriate action. (3-20-20)T

**06. Where to Submit.** An easement application may be submitted to any office of the Department. (3-20-20)T

**07. Notification of Approval.** If the application is approved, the applicant shall be notified in writing of the amount due to the Department. (3-20-20)T

**08. Denial of Application.** If the application is denied, the applicant shall be notified in writing of the reasons for the denial. (3-20-20)T

**071. -- 079. (RESERVED)**

**080. EASEMENT ACCESS AND EMERGENCY WORK.**

**01. Use of Land.** The grantee has the right to use such portion of the lands adjacent to and along said easement as may be reasonably necessary in connection with the installation, repair, and replacement of the use, facility, or structure authorized by the easement. If such activities cause soil disturbance, the destruction of vegetation, and/or entering the navigable stream bed below the natural or ordinary high water mark, the grantee will obtain written authorization from the grantor. (3-20-20)T

**02. Emergency Work.** The grantee is authorized to enter upon lands lying outside the easement area, including submerged or formerly submerged lands and other lands managed by the Department, for the purpose of performing emergency repairs on an easement for damage due to floods, high winds, and other acts of God, provided that the grantee provides written notice to the Director within forty-eight (48) hours of the time work commences. The grantee shall be responsible for any damage to lands or other resources outside the easement area. (3-20-20)T

**081. -- 999. (RESERVED)**

**20.03.13 – ADMINISTRATION OF COTTAGE SITE LEASES ON STATE LANDS**

**000. LEGAL AUTHORITY.**

The State Board of Land Commissioners has adopted these rules in accordance with Article IX, Section 8 of the Idaho Constitution and Sections 58-104(1) and 58-304, Idaho Code. (3-20-20)T

**001. TITLE AND SCOPE.**

**01. Title.** These rules are titled IDAPA 20.03.13, “Administration of Cottage Site Leases on State Lands.” (3-20-20)T

**02. Scope.** It is the intent and express policy of the Board in administration of cottage site leases located on state-owned lands administered by the Board, to provide for a reasonable rental income from those lands in accordance with the requirements of the Constitution of the State of Idaho. (3-20-20)T

**002. -- 009. (RESERVED)**

**010. DEFINITIONS.**

For the purposes of these rules, unless otherwise indicated by express term or by context, the term: (3-20-20)T

**01. Annual Rental.** The rental paid on or before January 1, in advance, for the following year. (3-20-20)T

**02. Board.** The State Board of Land Commissioners. (3-20-20)T

**03. Cottage Site.** Any state-owned lot that is leased for recreational residential purposes. (3-20-20)T

**04. Department.** The Idaho Department of Lands. (3-20-20)T

**05. Lessee.** A tenant of a cottage site. (3-20-20)T

**011. -- 019. (RESERVED)**

**020. SALE AND ASSIGNMENT - REQUIRED DOCUMENTATION.**

**01. Documentation of Sale.** The lessee must provide the Department, at their expense, the following documents concerning a cottage site sale prior to assignment of the cottage site lease. (3-20-20)T

**a.** The original of the current lease; or (3-20-20)T

**b.** A signed and notarized Affidavit of Loss if the current lease has been lost. (3-20-20)T

**02. Assignments.** A lease may only be assigned to an individual or to a husband or wife. The Board will not recognize assignments to corporations, partnerships, or companies. Leases may be assigned to and held by an estate only if one (1) individual or husband or wife are designated as the sole contact for all billing and correspondence. A lessee may only hold one (1) cottage site lease at a time. (3-20-20)T

**021. -- 024. (RESERVED)**

**025. LEASE RATE DETERMINATION -- ANNUAL RENTAL.**

Annual rental is set by the Board from time to time as deemed necessary. It is the intent of the State Board of Land Commissioners that those rental rates be determined through market indicators of comparable land values. (3-20-20)T

**026. -- 999. (RESERVED)**

**20.03.14 – RULES GOVERNING GRAZING, FARMING, CONSERVATION, NONCOMMERCIAL  
RECREATION, AND COMMUNICATION SITE LEASES**

**000. LEGAL AUTHORITY.**

These rules are promulgated by the Idaho State Board of Land Commissioners pursuant to Section 58-104, Idaho Code. (3-20-20)T

**001. TITLE AND SCOPE.**

**01. Title.** These rules are titled IDAPA 20.03.14, “Rules Governing Grazing, Farming, Conservation, Noncommercial Recreation, and Communication Site Leases.” (3-20-20)T

**02. Scope.** These rules constitute the Department’s administrative procedures for leasing of state endowment trust land for grazing, farming, conservation, noncommercial recreation, communication sites and other uses that are treated similarly under the provisions of Section 58-307, Idaho Code, regarding a lease term for no longer than twenty (20) years, and under the provisions of Section 58-310, Idaho Code regarding lease auctions. These rules are to be construed in a manner consistent with the duties and responsibilities of the Idaho State Board of Land Commissioners as set forth in Title 58, Chapter 3, Idaho Code; Article 9, Sections 3, 7 and 8, of the Idaho Constitution; and Section 5 of the Idaho Admission Bill. (3-20-20)T

**002. ADMINISTRATIVE APPEALS.**

**01. Board Appeal.** All decisions of the Director are appealable to the Board. An aggrieved party desiring to make such an appeal must, within twenty (20) days after receiving notice of the final decision being appealed or in case of a conflict auction within twenty (20) days after the auction is held, file with the Director a written notice of appeal setting forth the basis for the appeal. The Board has the discretion to accept or reject any timely appeal. In the event that the Board rejects hearing the appeal, the decision of the Director will be deemed final. (3-20-20)T

**02. Board Decision.** In the event the Board hears an appeal, it will do so at the earliest practical time or, in its discretion, appoint a Board sub-committee or a hearing officer to hear the appeal. The Board sub-committee or hearing officer will make findings and conclusions which the Board accepts, rejects or modifies. The decision of the Board after a hearing, or upon a ruling concerning the Board sub-committee or hearing officer’s findings and conclusions, are final. (3-20-20)T

**03. Judicial Review.** Judicial review of the final decision of the Board is in accord with the Administrative Procedure Act, Title 67, Chapter 52, Idaho Code. (3-20-20)T

**003. -- 009. (RESERVED)**

**010. DEFINITIONS.**

**01. Amortization.** The purchase of Department authorized, lessee installed, lease improvements by the Department through allowance of credit to the lessee’s annual lease payments. (3-20-20)T

**02. Animal Unit Month (AUM).** The amount of forage necessary to feed one (1) cow or one (1) cow with one (1) calf under six (6) months of age or one (1) bull for one (1) month. One (1) yearling is considered seven tenths (.7) of an AUM. Five (5) head of sheep, or five (5) ewes with lambs are considered one (1) AUM. One (1) horse is considered one and one-half (1 1/2) AUM. (3-20-20)T

**03. Assignment.** The Department approved transfer of all, or a portion of, a lessee’s right to another person wherein the second person assumes the lease contract with the Department. (3-20-20)T

**04. Board.** The Idaho State Board of Land Commissioners or such representatives as may be designated. (3-20-20)T

**05. Conflict Application.** An application to lease state endowment trust land for grazing, farming, conservation, noncommercial recreation or communication site use when one (1) or more applications have been submitted for the same parcel of state endowment trust land and for the same or an incompatible use. (3-20-20)T

**06. Department.** The Idaho Department of Lands. (3-20-20)T

**07. Director.** The Director of the Department of Lands, or such representative as may be designated by



the Director. (3-20-20)T

**08. Extension.** An approved delay in the due date of the rental owed on a farming lease without risk of loss of the lease. (3-20-20)T

**09. Improvement Valuation.** The process or processes of estimating the value of Department authorized improvements associated with a lease, as defined in Section 102. (3-20-20)T

**10. Lease.** A written agreement between the Department and a person containing the terms and conditions upon which the person will be authorized to use state endowment trust land. (3-20-20)T

**11. Herd Stock.** Livestock leased or managed, but not owned, by the lessee. (3-20-20)T

**12. Lease Application.** An application to lease state endowment trust land for grazing, farming, conservation, noncommercial recreation, or communication site purposes. (3-20-20)T

**13. Manageable Unit.** A unit of state endowment trust land designated by the Department, geographically configured and sufficiently large to achieve the proposed use. (3-20-20)T

**14. Management Plan.** The signed state endowment trust land lease for grazing, farming and conservation, and any referenced attachments such as annual operating plans or federal allotment management plans, is considered the management plan. (3-20-20)T

**15. Mortgage Agreement.** Department authorization for the lessee to obtain a mortgage on a state endowment trust land lease. (3-20-20)T

**16. Person.** An individual, partnership, association, corporation or any other entity qualified to do business in the state of Idaho and any federal, state, county, or local unit of government. (3-20-20)T

**17. Proposed Management Plan.** A document written and submitted by the lease applicant detailing the management objectives and strategies associated with their proposed activity. (3-20-20)T

**18. Sublease.** An agreement in which the state endowment trust land lease holder conveys the right of use and occupancy of the property to another party on a temporary basis. (3-20-20)T

**011. -- 018. (RESERVED)**

**019. LESSEE MAILING ADDRESS.**  
Unless otherwise notified by the lessee, all lease correspondence from the Department will be sent to the name and address as it appears on the lease application. It is the lessee's duty to notify the Department, in writing, of any change in mailing address. (3-20-20)T

**020. APPLICATIONS AND PROCESSING.**

**01. Eligible Applicant.** Any person legally competent to contract may submit an application to lease state endowment trust land provided such person is not then in default of any contract with the Department of Lands; provided further, that the Department may, in its discretion, exclude any person in breach of any contract with the state of Idaho or any department or agency thereof. (3-20-20)T

**02. Application Process.** All lease applications must be submitted to the Department on the appropriate Department form. The applications must be signed by the applicant, must be submitted in such manner as determined by the Department, and must meet the following criteria: (3-20-20)T

**a. Non-refundable Fee.** Each application for a lease must be accompanied by a non-refundable application fee in the amount specified by the Board. (3-20-20)T

**b. Application Deadline.** The deadline to apply to lease a parcel of state endowment trust land already

covered by a lease is as established by the Department for the year the existing lease expires. Applications to lease unleased state endowment trust land may be submitted at any time, or at such time as designated by the Department. (3-20-20)T

**c.** Proposed Management Plan. All applicants for state grazing, farming and conservation leases must submit a proposed management plan with their application. Where current lessee is an applicant, the Department will recognize the existing management plan, as described by the existing lease provisions, as the proposed management plan required to complete the lease application. The Department may require amendments to the proposed management plan in accordance with Subsections 020.02.e. and 020.02.f. (3-20-20)T

**d.** Legal Description on Application. All applications must include a legal description of the state endowment trust land applied on. The Department reserves the right to require an amendment of the legal description of state endowment trust lands identified in a lease application to ensure the parcel is a manageable unit or for any other reason deemed appropriate by the Department. If the applicant fails to provide an amended application, referencing a manageable unit as designated by the Department, the application is considered invalid. (3-20-20)T

**e.** Nonconflicted Applications. (3-20-20)T

**i.** If the current lessee is the only applicant and the Department does not have concerns with the lessee's current management of the leased state endowment trust land, a new lease will be issued. (3-20-20)T

**ii.** If the current lessee is the only applicant and the Department has concerns with the lessee's current management of the state endowment trust lands, the Department will request in writing a new proposed management plan and meet with the current lessee to develop terms and conditions of a proposed lease. (3-20-20)T

**f.** Conflicted Applications. (3-20-20)T

**i.** All applicants submitting conflict applications must meet with the Department to develop the terms and conditions of a proposed lease specific to each applicant's proposed management plan. (3-20-20)T

**ii.** The Department will provide all applicants for conflicted leases with the list of criteria that will be used to develop lease provisions. Among the factors to be addressed in the criteria are the following: (3-20-20)T

(1) The applicant's proposed use and the compatibility of that use of the state endowment trust land with preserving its long-term leasing viability for purposes of generating maximum return to trust beneficiaries; i.e., the impact of the proposed use and any anticipated improvements on the parcel's future utility and leasing income potential. (3-20-20)T

(2) The applicant's legal access to and/or control of land or other resources that will facilitate the proposed use and is relevant to generating maximum return to trust beneficiaries. (3-20-20)T

(3) The applicant's previous management of land leases, land management plans, or other experience relevant to the proposed use or ability/willingness to retain individuals with relevant experience. (3-20-20)T

(4) Potential environmental and land management constraints that may affect or be relevant to assessing the efficacy or viability of the proposed use. (3-20-20)T

(5) Mitigation measures designed to address trust management concerns such as: (3-20-20)T

(a) Construction of improvements at lessee's expense. (3-20-20)T

(b) Payment by lessee of additional or non-standard administrative costs where the nature of the proposed use and/or the applicant's experience raises a reasonable possibility that greater monitoring or oversight by the Department than historically provided will be necessary to ensure lease-term compliance. (3-20-20)T

(c) Bonding to ensure removal of any improvements installed for the lessee's benefit only and which would impair the future utility and leasing income potential of the state endowment trust land. (3-20-20)T

(d) Bonding to ensure future rental payments due under the lease in cases where the lessee is determined by the Department to pose a significant financial risk because of lack of experience or uncertain financial resources. (3-20-20)T

(6) Any other factors the Department deems relevant to the management of the state endowment trust land for the proposed use. (3-20-20)T

**g.** Proposed Lease. Within ten (10) days of the final meeting with the applicant to discuss lease provisions, the Department will provide the applicant with a proposed lease containing those terms and conditions upon which it will lease the state endowment trust land. If the applicant does not accept in writing the lease as proposed by the Department within seven (7) days of receipt, the application will be rejected in writing by the Department. Within twenty (20) days of the date of mailing of the rejection notice, the applicant may appeal the Department's determination as to the lease's terms and conditions to the Land Board. If the appeal is denied, the applicant may continue with the auction process by accepting the lease terms and conditions initially offered by the Department. No auction may be held until the Land Board resolves any such appeal. (3-20-20)T

**03. Expiring Leases.** Lease applications will be mailed by the Department to all holders of expiring leases no less than thirty (30) days prior to the application deadline. Signed applications and the application fee must be returned to the Department by the established deadline or postmarked no later than midnight of that date. It is the lessee's responsibility to ensure applications are delivered or postmarked by the deadline. (3-20-20)T

**04. Rental Deposit.** (3-20-20)T

**a.** Existing Lessee. If the existing lessee is the sole applicant, the lessee may submit the rental deposit at the normal due date. If a conflict application is also filed on the expiring lease and the existing lessee is awarded the lease by the Land Board, the lessee must deposit, with the Department, the estimated first year's rental for the lease at the time the lease is submitted to the Department with lessee's signature. (3-20-20)T

**b.** New Applicants. (3-20-20)T

**i.** Expiring Lease. New applicants for expiring leases must submit the estimated first year's rental to the Department at the time of the application's submission. (3-20-20)T

**ii.** Unleased State Endowment Trust Land. All applicants for unleased state endowment trust land are deemed new applicants. If an applicant for unleased state endowment trust land is the sole applicant, the applicant may submit the rental deposit at the normal billing cycle, unless the time of application and desired time of use do not coincide with the normal billing cycle, in which case payment must be rendered at the direction of the Department. (3-20-20)T

**021. LENGTH OF LEASE.**  
The Department may issue a lease for any period of time up to the maximum term provided by law. (3-20-20)T

**022. -- 029. (RESERVED)**

**030. CHANGE IN LAND USE.**  
The Director may change the use of any state endowment trust land, in whole or in part, for other uses that will better achieve the objectives of the Board. (3-20-20)T

**031. -- 039. (RESERVED)**

**040. RENTAL.**

**01. Rental Rates.** The methodology used to calculate rental rates is determined by the Board. (3-20-20)T

**02. Special Uses.** Fees for special uses requested by the lessee and approved by the Department are

determined by the Department. (3-20-20)T

**03. Rental Due Date.** Lease rentals are due in accordance with the terms of the lease. (3-20-20)T

**041. CHANGE OF RENTAL.**

The Department reserves the right to increase the annual lease rental. Notice of any increase will be provided in writing to the lessee at least one hundred eighty (180) days prior to the lease rental due date. (3-20-20)T

**042. LATE PAYMENTS.**

Rental not paid by the due date is considered late. Late payment charges from the due date forward are specified in the lease. (3-20-20)T

**043. -- 048. (RESERVED)**

**049. BREACH.**

**01. Non-Compliance.** A lessee is in breach if the lessee's use is not in compliance with the provisions of the lease. (3-20-20)T

**02. Damages for Breach.** A lessee is responsible for all damages resulting from breach and other damages as provided by law. (3-20-20)T

**050. LEASE CANCELLATION.**

Leases may be canceled by the Director for the following reasons: (3-20-20)T

**01. Non-Compliance.** If the lessee is not complying with the lease provisions or if resource damage attributable to the lessee's management is occurring to state endowment trust land within a lease, the lessee will be provided written notification of the violation by regular and certified mail. The letter will set forth the reasons for the Department's cancellation of the lease and provide the lessee thirty (30) days' notice of the cancellation. (3-20-20)T

**02. Change in Land Use.** A lease may be canceled in whole or in part upon one hundred eighty (180) days written notice by the Department if the state endowment trust lands are to be leased for any other use as designated by the Board or the Department and the new use is incompatible with the existing lease. In the event of early cancellation due to a change in land use, the lessee will be entitled to a prorated refund of the premium bid for a conflicted lease. (3-20-20)T

**03. Land Sale.** The Department reserves the right to sell state endowment trust lands covered under the lease. The lessee will be notified that the state endowment trust lands are being considered for sale prior to submitting the sales plan to the Board for approval. The lessee will also be notified of a scheduled sale at least thirty (30) days prior to sale. In the event of early cancellation due to land sale, the lessee will be entitled to a prorated refund of the premium bid for a conflicted lease. (3-20-20)T

**04. Mutual Agreement.** Leases may be canceled by mutual agreement between the Department and the lessee. (3-20-20)T

**051. LEASE ADJUSTMENTS.**

**01. Department Required.** The Department may make adjustments to the lease for resource protection or resource improvement. (3-20-20)T

**02. Lessee Requested.** Lessee requested changes in lease conditions must be submitted in writing and must receive written approval from the Department before implementation. (3-20-20)T

**052. EXTENSIONS OF ANNUAL FARMING LEASE PAYMENT.**

**01. Farming Lease Extensions.** An extension of the annual lease payment may be approved for farming leases only. Each lease is limited to no more than two (2) successive or five (5) total extensions during any

ten (10) year lease period. Requests for extensions must be submitted in writing and must include the extension fee determined by the Board. The lessee must provide a written statement from a financial institution verifying that money is not available for the current year's farming operations. (3-20-20)T

**02. Liens.** When an extension is approved, the Department will file a lien on the lessee's pertinent crop in a manner provided by Idaho Code. (3-20-20)T

**03. Due Date.** Rental plus interest at a rate established by the Board will be due not later than November 1 of the year the extension is granted. (3-20-20)T

**053. -- 059. (RESERVED)**

**060. FEES.**

Fees for lease administration will be periodically set by the Board and must be paid in full before a transaction can occur. All lease administration fees are non refundable. The Board has the authority to set fees related to administration of the leasing process including, but not limited to the following: lease applications; full lease assignment; partial lease assignment; mortgage agreement; subleases; late rental payment; minimum lease fee; and lease payment extension request. (3-20-20)T

**061. -- 069. (RESERVED)**

**070. SUBLEASING.**

A lessee may not authorize another person to use state endowment trust land without prior written approval from the Department. The lessee must provide the name and address of sublessee, purpose of sublease, and a copy of the proposed sublease agreement. Lessee controlled herd stock does not require sublease approval. (3-20-20)T

**071. ASSIGNMENTS.**

The lessee may not assign a lease, or any part thereof, without prior written approval of the Department. (3-20-20)T

**072. MORTGAGE AGREEMENTS.**

The lessee may not enter into a mortgage agreement that involves state endowment trust land lease without prior written approval of the Department. The lessee must submit the required filing fee. The term of a mortgage agreement may not exceed the lease term. (3-20-20)T

**073. -- 079. (RESERVED)**

**080. MANAGEMENT PLANS.**

**01. Federal Plan.** When state endowment trust land is managed in conjunction with federal land, the management plan prepared for the federal land may be deemed by the Department, at its discretion, the management plan. (3-20-20)T

**02. Modification of Plan.** The Department may review and modify any grazing management plan upon changes in conditions, laws, or regulations, provided that the Department will give the lessee thirty (30) days notice of any such modifications prior to the effective date thereof. Modifications mutually agreeable to both the Department and lessee may be made at any time and may be initiated by lessee's request. (3-20-20)T

**081. -- 089. (RESERVED)**

**090. TRESPASS.**

**01. Loss or Waste.** The lessee must use the property within the lease in such manner as will best protect the state of Idaho against loss or waste. Unauthorized activities occurring on state endowment trust land are considered trespass; these include dumping of garbage, constructing improvements without a permit, and other unauthorized actions. (3-20-20)T

**02. Civil Action by Lessee.** The lessee is encouraged to take civil action against owners of trespass

livestock on state endowment trust lands to recover damages to the lessee for lost forage or other values incurred by the lessee. (3-20-20)T

**03. Continuing Trespass.** When continued trespass causes resource damage, the Department will initiate proceedings to restrict further trespass and recover damages as necessary. (3-20-20)T

**04. Trespass Claims.** Trespass claims initiated by the Department will be assessed as triple the current State AUM rate for forage taken. (3-20-20)T

**091. -- 099. (RESERVED)**

**100. CONSTRUCTION AND MAINTENANCE OF IMPROVEMENTS.**

**01. Prior Written Approval.** The lessee must secure the written approval of the Department prior to constructing any improvements or buildings, or clearing any state endowment trust land. Failure to secure such approval eliminates any right to an improvement credit and may, at the Department’s discretion, be deemed a material breach of the lease and cause for cancellation. Any arrangement for cost sharing or improvement crediting will be identified in the improvement permit. Routine farming practices identified in a farm plan will not require prior approval. (3-20-20)T

**02. Maintenance.** All authorized improvements must be maintained in functional condition by the lessee. The lessee may be required to remove or reconstruct improvements in poor or non-serviceable condition. Existing maintenance agreements on lands acquired from the federal government remain in effect until amended by the parties involved. If maintenance is not being accomplished, the Department will provide a certified letter to the lessee informing the lessee of the rule violation. If work is not begun within thirty (30) days, the Department may contract repairs and add the amount to the annual rental. (3-20-20)T

**03. Bond.** The Department may require the lessee to furnish a bond prior to constructing improvements as deemed necessary to protect endowment assets or to ensure performance under the lease. (3-20-20)T

**101. IMPROVEMENT CREDIT.**

**01. Sale or Auction.** In the event of sale of the state endowment trust land covered under the lease or if the existing lessee is not the successful bidder at the auction of the lease, the creditable value of the authorized improvements, as determined by the Department, will be paid to the former lessee by the Department or the purchaser where a sale occurs or by the successful bidder where a new lease is issued. (3-20-20)T

**02. Exchange.** In the event of exchange of the state endowment trust land covered under the lease, the creditable value of authorized improvements, as determined by the Department, will be paid to the former lessee by the acquiring party, if other than the existing lessee. (3-20-20)T

**03. Crediting.** Improvement credit may be allowed when the Department determines that such credit would further the objective of maximizing long-term financial return to trust beneficiaries if the improvements are: (3-20-20)T

**a.** Authorized in writing by the Department or lacking written authorization, but in existence prior to 1970; (3-20-20)T

**b.** Not expressly permitted “for lessee’s benefit only”; and (3-20-20)T

**c.** Maintained during the lease term. (3-20-20)T

**04. Value Only to Lessee.** Where improvements are approved, but due to their nature, are not acceptable to receive improvement credit because no value exists for a future lessee, a notation will be made in the permit, “For lessee’s benefit only.” If the succeeding lessee or assignee chooses not to purchase the non-creditable improvements, the former lessee will be required to remove them. (3-20-20)T

**05. Maintenance Costs.** Maintenance of improvements will be considered a normal cost of doing business and no improvement credit will be allowed, except that, with prior written approval from the Department, improvement crediting may be allowed for materials used for the maintenance of Department-funded improvements. (3-20-20)T

**06. Unauthorized Improvements.** No credit will be allowed for unauthorized improvements. At the discretion of the Department, the lessee may be required to remove unauthorized improvements. (3-20-20)T

**07. Cost Sharing.** Federal or state cost-share amounts are not included in the allowable improvement credit. (3-20-20)T

**102. VALUATION OF IMPROVEMENTS.**

Credited improvements will be valued on the basis of replacement cost, including lessee provided labor, equipment and materials, less depreciation based on loss of utility. Improvements cannot be appraised higher than current market value, regardless of lessee's cost. Any improvement amortization or cost limitations identified by the Department will be considered in determining a final value. (3-20-20)T

**01. Applicant Review of Department Improvement Credit Valuation.** All applicants for a conflicted lease will be provided a copy of the Department's improvement credit valuation for review and a notice of objection form. Any applicant objecting to the appraisal will have twenty-one (21) days from the date of the valuation mailing to submit the notice of objection form to the Department. If no objections are received during the twenty-one (21) day review period, the lease auction will be scheduled and will proceed using the Department's improvement credit valuation. (3-20-20)T

**02. Failure to File a Timely Notice of Objection.** Failure to submit a notice of objection within the specified twenty-one (21) day period will preclude any applicant from further administrative remedies and the auction will proceed using the Department's improvement credit valuation. (3-20-20)T

**03. Notice of Objection.** Any applicant objecting to the Department improvement credit valuation must submit a complete and timely notice of objection form, and payment of two thousand five hundred dollars (\$2,500) or ten percent (10%) of the total Department improvement credit valuation whichever is greater, to pay for the services of an independent third party. Within five (5) days of receipt of the notice of objection, the Department will notify all applicants in writing that an objection has been received and provide them with a list of certified appraisers. (3-20-20)T

**04. Selection of an Independent Third Party.** The applicants will have twenty-one (21) days from the date of the Department's notification of an objection to select by mutual agreement, one individual from the list of certified appraisers to serve as an independent third party. If the applicants cannot agree on an independent third party within the twenty-one (21) day time period, the Department will randomly select one individual from the list to serve as the independent third party. (3-20-20)T

**05. Duties of the Independent Third Party.** The independent third party will review the Department improvement credit valuation and alternate valuations provided by the applicants. Following this review, the independent third party will select from among the Department valuation and alternate valuations, the one value that (s)he determines is the most accurate value of the improvements. The independent third party will notify the Department of this value in writing. (3-20-20)T

**06. Notification of Final Improvement Value.** Within five (5) days of receiving the independent third party's final determination of improvement credit value, the Department will mail to each applicant an auction notice that will reference the independent third party's determined value of improvements. The determination by the independent third party of the improvement value will be deemed final, and the appraised value of improvements will not be allowed as a basis for appeal of the auction. (3-20-20)T

**103. -- 104. (RESERVED)**

**105. CONFLICT AUCTIONS.**

**01. Two or More Applicants.** When two (2) or more eligible applicants apply to lease the same state endowment trust land for grazing, farming conservation, noncommercial recreation, or communication site purposes and the Department determines the proposed uses are not compatible, the Department will hold an auction. (3-20-20)T

**02. Minimum Bid.** Bidding begins at two hundred fifty dollars (\$250) or the cost of preparing any required improvement valuation in connection with the expiring lease, whichever is greater. (3-20-20)T

**03. Auction Bidding.** Each applicant who appears in person or by proxy at the time and place so designated in said notice and bids for the lease is deemed to have participated in the auction. A proxy must be authorized by the lease applicant in writing prior to the start of the auction. (3-20-20)T

**04. Withdrawal Prior to or Failure to Participate in an Auction.** Applicants who either withdraw their applications after accepting the Department offered lease per Subsection 020.02 of this rule and prior to the auction that results in no need to schedule an auction or cancellation of a scheduled auction; or applicants who fail to participate at the auction by not submitting a bid which results in only one (1) participant at the scheduled auction, forfeit an amount equal to the lesser of the following: (3-20-20)T

a. The Department’s cost of making any required improvement credit valuation; (3-20-20)T

b. For existing lessee applicants, any improvement credit payment that would otherwise be due if not awarded the lease; or (3-20-20)T

c. For conflict applicants, the rental deposit made. (3-20-20)T

**05. High Bid Deposit.** The high bidder is required to submit payment in the amount of the high bid at the conclusion of the auction. (3-20-20)T

**06. Auction Procedures.** The Department will prescribe the procedures for conducting conflicted lease auctions. (3-20-20)T

**07. Withdrawal After Auction.** (3-20-20)T

a. If the high bidder withdraws or refuses to accept the lease, the high bid payment will be retained by the Department. (3-20-20)T

i. If the auction involved only two (2) participants, the second high bidder will be awarded the lease. (3-20-20)T

ii. If the auction involved more than two (2) participants, the lease will be reauctioned. (3-20-20)T

b. If an auction bidder other than the high bidder withdraws a bid before Land Board review and action on the auction results, no adjustment will be made in the payment deposited by the high bidder. (3-20-20)T

**106. BOARD REVIEW OF AUCTION.**

The Board will review the proposed leases and auction results and make the determination required under Section 58-310, Idaho Code, consistent with its obligations under Article IX, Section 8 of the Idaho Constitution and all relevant statutory provisions. (3-20-20)T

**107. -- 110. (RESERVED)**

**111. NOXIOUS WEED CONTROL.**

**01. Weed Control.** The lessee must cooperate with the Department, or any other authorized agency, to undertake programs for control or eradication of noxious weeds on state endowment trust land. The lessee will take measures to control noxious weeds on the leased state endowment trust land in accordance with Title 22, Chapter 24, Idaho Code. (3-20-20)T



**02. Responsibility.** The lessee will not be held responsible for the control of noxious weeds resulting from other land management activities such as temporary permits, easements, special leases and timber sales. Control of noxious weeds on state grazing lands will be shared by the lessee and Department, with the Department's share subject to funds appropriated for that purpose. (3-20-20)T

**112. LIVESTOCK QUARANTINE.**

**01. Cooperation.** The lessee must cooperate with the state/ federal agency responsible for the control of livestock diseases. (3-20-20)T

**02. Non-Compliance.** Non-compliance with state/federal regulations will be considered a lease violation and may result in cancellation of the lease. (3-20-20)T

**113. ANIMAL DAMAGE CONTROL.**

The lessee may request the services of USDA Animal and Plant and Health Inspection Service-Wildlife Services to remove animals causing crop damage or harassing/killing the lessee's livestock. The Department is liable for any consequence from any animal control actions. (3-20-20)T

**114. LIABILITY (INDEMNITY).**

The lessee must indemnify and hold harmless the state of Idaho, its departments, agencies and employees for any and all claims, actions, damages, costs and expenses which may arise by reason of lessee's occupation of the leased state endowment trust land, or the occupation of the leased parcel by any of the lessee's agents or by any person occupying the same with the lessee's permission. (3-20-20)T

**115. RULES AND LAWS OF THE STATE.**

The lessee must comply with all applicable rules, regulations and laws of the state of Idaho and the United States insofar as they affect the use of the state endowment trust lands described in the lease. (3-20-20)T

**116. -- 999. (RESERVED)**

## 20.03.15 – RULES GOVERNING GEOTHERMAL LEASING ON IDAHO STATE LANDS

### 000. LEGAL AUTHORITY.

This Chapter is adopted under the legal authorities of Sections 58-104(1), 58-104(6), 58-104(9), 58-105, and 58-127, Idaho Code; Section 58-307, Idaho Code; Title 47, Chapter 7, Idaho Code; Title 47, Chapter 16, Idaho Code; and Title 67, Chapter 52, Idaho Code. (3-20-20)T

### 001. TITLE AND SCOPE.

**01. Title.** These rules are titled IDAPA 20.03.15, “Rules Governing Geothermal Leasing on Idaho State Lands.” (3-20-20)T

**02. Scope.** These rules apply to the exploration and extraction of any and all geothermal resources situated in state-owned mineral lands. (3-20-20)T

**03. Other Laws.** In addition to these rules, the Lessee must comply with all applicable federal, state and local laws, rules and regulations. The violation of any applicable law, rule or regulation constitutes a breach of any lease issued in accordance with these rules. (3-20-20)T

### 002. ADMINISTRATIVE APPEALS.

Any person aggrieved by any final agency action will be entitled to judicial review pursuant to the provisions of Title 67, Chapter 52, Idaho Code, IDAPA 20.01.01, and Title 47, Chapter 16, Idaho Code. (3-20-20)T

### 003. -- 009. (RESERVED)

### 010. DEFINITIONS.

**01. Associated By-Products or By-Product:** (3-20-20)T

**a.** Any mineral or minerals (exclusive of oil, hydrocarbon gas, and helium) that are found in solution or developed in association with geothermal resources; or (3-20-20)T

**b.** Demineralized or mineralized water. (3-20-20)T

**02. Board.** The Idaho State Board of Land Commissioners or its designee. (3-20-20)T

**03. Casual Exploration.** Casual exploration means entry and/or exploration that does not appreciably disturb or damage the land or resources thereon. Casual exploration includes, but is not limited to, geochemical and/or geophysical exploration techniques, sampling with hand tools, and entry using wheeled vehicles for transportation to conduct such exploration. (3-20-20)T

**04. Completion.** A well is considered to be completed thirty (30) days after drilling operations have ceased and the drill rig is removed from the premises or thirty (30) days after the initial production or injection test has been completed, whichever occurs last. (3-20-20)T

**05. Department.** The Idaho Department of Lands or its designee. (3-20-20)T

**06. Director.** The director of the Idaho Department of Lands or his designee. (3-20-20)T

**07. Direct Use.** The use of geothermal resources for direct applications, including, but not limited to, road surface heating, resorts, hot spring bathing and spas, space heating of buildings, recreation, greenhouse warming, aquaculture, or industrial applications where geothermal heat is used in place of other energy inputs. (3-20-20)T

**08. Electrical Generation.** The use of geothermal resources to either directly generate electricity or to heat a secondary fluid and use it to generate electricity. (3-20-20)T

**09. Field.** A geographic area overlying a geothermal system with one (1) or more geothermal reservoirs or pool, including any porous, permeable geologic layer, that may be formed along one (1) fault or fracture, or a series of connected faults or fractures. (3-20-20)T

**10. Geothermal Resources.** The natural heat energy of the earth, the energy, in whatever form, that may be found in any position and at any depth below the surface of the earth present in, resulting from, or created by,

or that may be extracted from such natural heat, and all minerals in solution or other products obtained from the material medium of any geothermal resource. When used without restriction, it includes associated by-products.

(3-20-20)T

11. **Lease.** A lease covering the geothermal resources and associated by-products in state lands. (3-20-20)T
12. **Lessee.** The person to whom a geothermal lease has been issued and his successor in interest or assignee. It also means any agent of the Lessee or an operator holding authority by or through the Lessee. (3-20-20)T
13. **Market Value.** The most probable price at a specified date, in cash, or on terms reasonably equivalent to cash, for which the property or commodity should bring in a competitive and open market under all conditions requisite to a fair sale, the buyer and seller each acting prudently and knowledgeably, and assuming the price is not affected by undue stimulus. (3-20-20)T
14. **Motorized Earth-Moving Equipment.** Backhoes, bulldozers, front-loaders, trenchers, core drills, drill rigs, power augers, and other similar equipment. (3-20-20)T
15. **Navigable Water Courses.** The state owned beds of active lakes, rivers and streams that do not include formerly submerged lands where the state retains ownership. (3-20-20)T
16. **Operator.** The person having control or management of operations on the leased lands or a portion thereof. The operator may be the Lessee, designated operator, or agent of the Lessee, or holder of rights under an approved operating agreement. (3-20-20)T
17. **Overriding Royalty.** An interest in the geothermal resource produced at the surface free of any cost of production. It is a royalty in addition to the royalty reserved to the state. (3-20-20)T
18. **Person.** Any natural person, corporation, association, partnership, or other entity recognized and authorized to do business in Idaho, receiver, trustee, executor, administrator, guardian, fiduciary, or other representatives of any kind, and includes any government or any political subdivision of any agency thereof. The masculine gender, in referring to a person, includes the feminine and the neuter genders. (3-20-20)T
19. **Record Title.** The publicly recorded lease that is the evidence of right that a person has to the possession of the leased property. (3-20-20)T
20. **Reservoir or Pool.** A porous, permeable geologic layer containing geothermal resources. (3-20-20)T
21. **Shut In.** To close the valves at the wellhead so that the well stops flowing or producing. Also describes a well on which the valves have been closed. (3-20-20)T
22. **State Lands.** Without limitation, lands in which the title to the mineral rights are owned by the state of Idaho and are under the jurisdiction and control of the Board or under the jurisdiction and control of any other state body or agency, having been obtained from any source and by any means whatsoever, including the beds of navigable waters of the state of Idaho. (3-20-20)T
23. **Waste.** Any physical loss of geothermal resources including, but not limited to: (3-20-20)T
  - a. Underground loss of geothermal resources resulting from inefficient, excessive, or improper use, or dissipation of geothermal energy, or of any geothermal resource pool, reservoir, or other source; or the locating, spacing, constructing, equipping, operating, or producing of any well in a manner that results, or tends to result in, reducing the quantity of geothermal energy to be recovered from any geothermal area in the state; (3-20-20)T
  - b. The inefficient above-ground transporting and storage of geothermal energy; and the locating, spacing, equipping, operating, or producing of any well or injection well in a manner causing or tending to cause unnecessary or excessive surface loss or destruction of geothermal energy; the escape into the open air from a well of

steam or hot water in excess of what is reasonably necessary in the efficient development or production of a well. (3-20-20)T

**011. ABBREVIATIONS.**

**01. IDWR.** Idaho Department of Water Resources. (3-20-20)T

**012. -- 019. (RESERVED)**

**020. QUALIFIED APPLICANTS AND LESSEES.**

Any person legally competent to contract may submit an application to lease state land provided such person is not then in default of any contract with the state of Idaho or any department or agency thereof. (3-20-20)T

**021. LEASE AWARD THROUGH AUCTION.**

If more than one (1) application is received for geothermal development on the same parcel of land, a lease auction will be held. (3-20-20)T

**022. -- 029. (RESERVED)**

**030. TERM.**

**01. Lease Term.** All leases may be for a term of up to forty-nine (49) years from the effective date of the lease. (3-20-20)T

**02. Diligence in Utilization.** Lessee will use due diligence to market or utilize geothermal resources in paying quantities. If leased land is capable of producing geothermal resources in paying quantities, but production is shut-in, the lease will continue in force upon payment of rentals for the duration of the lease term or two (2) years after shut-in, whichever is shorter. If the Department determines that the Lessee is proceeding diligently to acquire a contract to sell or to utilize the production or is progressing with installations needed for production, the lease may continue in force for one (1) additional year if rental payments are kept current. The Department will continue to review a shut-in lease every year until production and payment of royalties takes place, or the lease is terminated for Lessee's lack of due diligence or surrendered by the Lessee. (3-20-20)T

**03. Yearly Reporting.** A report of all exploration, development, and production activities must be submitted to the Department at the close of each lease year. (3-20-20)T

**031. -- 034. (RESERVED)**

**035. RENTALS.**

**01. Advance Annual Rental.** Lessee will pay to the Department in advance each year an annual rental. The annual rental for the first year of the term will be due and payable and will be received by the Department, together with a lease agreement executed by Lessee within thirty (30) days of the date of notice of approval or award. Second year and subsequent rental payments must be received by the Department on or before the anniversary date of the lease. (3-20-20)T

**02. Amount.** Annual rentals will be set by the Board through competitive bidding, negotiation, fixed amounts, formulas, or some other method of valuation that a prudent investor might reasonably apply to establish such rental amounts. (3-20-20)T

**036. ROYALTIES.**

**01. Royalty Payments.** The Lessee will cause to be paid to the Department royalties on the value of geothermal production from the leased premises. The royalty rate will be established by the Board based on the market value of the geothermal resources produced from the lands under lease. The royalties specified in geothermal leases will be fixed in any manner by the Board, including but not limited to competitive bidding, negotiation, fixed amounts, or formulas. Royalty rates may be adjusted through the term of the lease in order to keep pace with market

values. When leases are issued, the following guidelines will be used for royalty rates not subject to competitive bidding: (3-20-20)T

**a.** A royalty of between five percent (5%) and twenty percent (20%) of the amount or value of geothermal resources, or any other form of heat or energy excluding electrical power generation, derived from production under the lease and sold or utilized by the Lessee or reasonably susceptible to sale or utilization by the Lessee; (3-20-20)T

**b.** A royalty of between two percent (2%) and fifteen percent (15%) of the amount or value of any associated by-product derived from production under the lease and sold or utilized or reasonably susceptible of sale or utilization by the Lessee, including commercially demineralized water. (3-20-20)T

**c.** A royalty of between two percent (2%) and five percent (5%) of gross receipts for sale of electrical power. (3-20-20)T

**02. Calculation of Value.** The value of geothermal production from the leased premises for the purpose of computing royalties is based on a total of the following: (3-20-20)T

**a.** The total consideration accruing to the Lessee from the sale of geothermal resources to another party in an arms-length transaction; and (3-20-20)T

**b.** The value of the end product attributable to the geothermal resource produced from a particular lease where geothermal resources are not sold by the Lessee before being utilized, but are instead directly used in manufacturing power production, or other industrial activity; and (3-20-20)T

**c.** The value of all renewable energy credits or similar incentives based on a proportionate share of the leased lands in the entire project area qualifying for the credits. (3-20-20)T

**03. Due Date.** Royalties will be due and payable monthly to the Department on or before the last day of the calendar month following the month in which the geothermal resources and/or their associated by-products are produced and utilized or sold. (3-20-20)T

**04. Utilization of Geothermal Resources.** The Lessee must file with the Department within thirty (30) days after execution a copy of any contract for the utilization of geothermal resources from the lease. Reports of sales or utilization by Lessee and royalty for each productive lease must be filed each month once production begins, even though production may be intermittent, unless otherwise authorized by the Department. Total volumes of geothermal resources produced and utilized or sold, including associated by-products, the value of production, and the royalty due the state of Idaho must be shown. This report is due on or before the last day of the month following the month in which production was obtained and sold or utilized, together with the royalties due the state of Idaho. (3-20-20)T

**05. Measurement.** The Lessee will measure or gauge all production in accordance with methods approved by the Department. The quantity and quality of all production will be determined in accordance with the standard practices, procedures and specifications generally used in industry. All measuring equipment must be tested consistent with industry practice and, if found defective, the Department will determine the quantity and quality of production from the best evidence available. (3-20-20)T

**06. By-Product Testing.** The Lessee will periodically furnish the Department the results of periodic tests showing the content of by-products in the produced geothermal resources. Such tests will be taken as specified by the Department and by the method of testing approved by him, except that tests not consistent with industry practices will be conducted at the expense of the Department. (3-20-20)T

**07. Commingling.** The Department may authorize a Lessee to commingle production from wells on his State lease(s) with production from non-state lands. Department approval of commingling will not be unreasonably withheld, and will consider the following: (3-20-20)T

**a.** The operator's economic necessity of commingling; (3-20-20)T

- b.** The type of geothermal use proposed for the commingled waters; and (3-20-20)T
- c.** Sufficient measurement and accounting of all the commingled waters to ensure that the Department is appropriately compensated by royalties. (3-20-20)T

**037. -- 039. (RESERVED)**

**040. SIZE OF A LEASABLE TRACT.**

**01. Surface Area.** Geothermal leases are not limited in surface area. The Board will determine the surface area of a lease after consultation with other state agencies and prospective Lessees. The probable extent of a geothermal reservoir, the surface area needed for a viable project, and other relevant factors will be used to help determine lease surface area. (3-20-20)T

**02. Navigable Water Courses.** Geothermal resources leases may be issued for state lands underlying navigable water courses in Idaho. Such lands are considered “state lands” and will be leased in accordance with these rules. Operations in the beds of navigable water courses will not be authorized except in necessary circumstances and then only with express written approval of the Board upon such conditions and security as the Department deems appropriate. (3-20-20)T

**041. -- 049. (RESERVED)**

**050. LAND SURFACE USE RIGHTS AND OBLIGATIONS.**

**01. Use and Occupancy.** (3-20-20)T

**a.** Lessee will be entitled to use and occupy only so much of the surface of the leased lands as may be required for all purposes reasonably incident to exploration for, drilling for, production and marketing or geothermal resources and associated by-products produced from the leased lands, including the right to construct and maintain thereon all works, buildings, plants, waterway, roads, communication lines, pipelines, reservoirs, tanks, pumping stations or other structures necessary to the full enjoyment and development thereof, consistent with a plan of operations and amendments thereto, as approved by the Department. (3-20-20)T

**b.** Uses occurring on the leased area related to exploration, development, production, or marketing of geothermal resources and associated by-products produced from off-lease lands may require the Lessee to pay additional rent. (3-20-20)T

**02. Supervision.** Uses of state lands within the jurisdiction and control of the Board are subject to the supervision of the Department. Other state lands are subject to the supervision of the appropriate state agency consistent with these rules. (3-20-20)T

**03. Distance from Residence.** No well may be drilled within two hundred (200) feet of any house or barn on the premises, without the written consent of the Department and its surface Lessees, grantees or contract purchasers. (3-20-20)T

**04. Disposal of Leased Land.** The Board reserves the right to sell or otherwise dispose of the surface of the lands embraced with a lease, insofar as said surface is not necessary for the use of the Lessee in the exploration, development and production of the geothermal resources and associated by-products, but any sale of surface rights made subsequent to execution of a lease will be subject to all the terms and provisions of that lease during the life thereof. (3-20-20)T

**05. Damage.** Lessee must pay to the Board, its surface Lessees or grantees or contract purchasers, for any damage done to the surface of said lands and improvements thereon, including without limitation growing crops, by reason of Lessee’s operations. (3-20-20)T

**051. -- 053. (RESERVED)**

**054. EXPLORATION UNDER THE LEASE.**

**01. Diligent Exploration.** Lessees must perform diligent exploration and development activities in the first five (5) years of the initial lease term or as otherwise extended by lease provision. Diligent exploration includes seismic, gravity, and other geophysical surveys, geothermometry studies, drilling temperature gradient wells, or similar activities that seek to determine the presence or extent of geothermal resources. This exploration may occur off-lease if it is being done on the same geothermal field. Failure to perform diligent exploration as described may result in lease cancellation. (3-20-20)T

**02. Casual Exploration.** At any time after formal approval by the Board of a lease application, Lessee may enter upon the leased lands for casual exploration or inspection without notice to the department. As an express condition of an application to lease and of the right of casual inspection without notice, Lessee agrees to the indemnity conditions provided in Section 102 of these rules without a formally executed lease. (3-20-20)T

**03. Plan Required.** Lessee must submit a Research and Analysis Plan to the Department before any exploration using motorized equipment or before otherwise engaging in operations that may lead to an appreciable disturbance or damage to lands, timber, other resources, or improvements on or adjacent to the leased lands. The proposed activities may not start until the Department approves the plan and the applicable preconditions in Sections 100 and 101 of these rules have been satisfied. The plan of operations may be amended as needed with Department approval. The plan includes all items that the Department deems necessary or useful in managing the geothermal resources including, but not limited to, the following: (3-20-20)T

**a.** A narrative statement describing the proposed measures to be taken for protection of the environment, including, but not limited to the prevention or control of: (3-20-20)T

i. Fires; (3-20-20)T

ii. Soil loss and erosion; (3-20-20)T

iii. Pollution of surface and ground waters; (3-20-20)T

iv. Damage to fish and wildlife or other natural resources; (3-20-20)T

v. Air and noise pollution; and (3-20-20)T

vi. Hazards to public health and safety during lease activities. (3-20-20)T

**b.** All pertinent information or data that the department may require to support the plan of operations for the utilization of geothermal resources and the protection of the environment; (3-20-20)T

**055. DEVELOPMENT AND PRODUCTION UNDER THE LEASE.**

**01. Diligent Development of Lease and Production.** Lessee must develop the geothermal resources on their lease area and start production within the first ten (10) years of the initial lease term or as otherwise extended by lease provision. Development of the lease area requires wells to be drilled and other necessary infrastructure to be built. Production on the lease area means that geothermal fluids are being used and royalties are being paid to the state. Failure to develop the lease and start production as described may result in lease cancellation unless the Lessee applies to the Department for an extension and the extension is granted. (3-20-20)T

**02. Best Practices.** All operations will conform to the best practice and engineering principles in use in the industry. Operations must be conducted in such a manner as to protect the natural resources on the leased lands, including without limitation geothermal resources, and to result in the maximum ultimate recovery of geothermal resources with a minimum of waste, and be consistent with the principles of the use of the land for other purposes and of the protection of the environment. Lessee must promptly remove from the leased lands or store, in an orderly manner, all scraps or other materials not in use and not reasonably incident to the operation. (3-20-20)T

**03. Plans Required.** Prior to development, Lessee must submit a Development Plan, Operating Plan,

and Decommissioning and Reclamation Plan for the leased lands. All plans must be approved by the Department, in writing, prior to Lessee beginning a phase of the lease in which those plans are performed or as otherwise required by the lease. All required plans must include all items that the Department deems necessary or useful in managing the geothermal resources, including, but not limited to, those items referred to in Paragraphs 054.03.a. and 054.03.b. of these rules. (3-20-20)T

**04. Waste and Damage.** (3-20-20)T

**a.** Lessee must take all reasonable precautions to prevent the following: (3-20-20)T

i. Waste; (3-20-20)T

ii. Damage to other natural resources; (3-20-20)T

iii. Injury or damage to persons, real or personal property; and (3-20-20)T

iv. Any environmental pollution or damages that may constitute a violation of state or federal laws. (3-20-20)T

**b.** The Department may inspect Lessee's operations and issue such orders as are necessary to accomplish the purposes in Paragraph 055.04.a. Any significant effect on the environment created by the Lessee's operations or failure to comply with environmental standards must be reported to the Department by Lessee within twenty-four (24) hours and confirmed in writing within thirty (30) days. (3-20-20)T

**05. Notice of Production.** Lessee must notify the department within sixty (60) days before any geothermal resources are used or removed for commercial purposes. (3-20-20)T

**06. Amendments.** The plan of operations must be amended by the Lessee for the Department's approval to reflect changes in operations on the leased lands, including the installation of works, buildings, plants or structures for the production, marketing or utilization of geothermal resources. (3-20-20)T

**056. WASTE PREVENTION, DRILLING AND PRODUCTION OBLIGATIONS.**

**01. Waste.** All leases are subject to the condition that the Lessee will, in conducting his exploration, development and producing operations, use all reasonable precautions to prevent waste of geothermal resources and other natural resources found or developed in the leased lands. (3-20-20)T

**02. Diligence.** The Lessee must, subject to the right to surrender the lease, diligently drill and produce, or unitize such wells as are necessary to protect the Board from loss by reason of production on other properties. (3-20-20)T

**03. Prevention of Waste Through Reinjection.** Geothermal Lessees must return geothermal waters to the geothermal aquifer in a manner that supports geothermal development. (3-20-20)T

**04. Additional Requirements.** The selection of the types and weights of drilling fluids and provisions for controlling fluid temperatures, blowout preventers and other surface control equipment and materials, casing and cementing programs, etc., to be used must be based on sound engineering principles and must take into account apparent geothermal gradients, depths and pressures of the various formations to be penetrated and other pertinent geologic and engineering data and information about the area. In addition, the Lessee must do the following: (3-20-20)T

**a.** Take all necessary precautions to keep all wells under control at all times; (3-20-20)T

**b.** Utilize trained and competent personnel; (3-20-20)T

**c.** Utilize properly maintained equipment and materials; and (3-20-20)T



- d. Use operating practices that ensure the safety of life and property. (3-20-20)T

**05. Unused Wells.** Except as provided in Subsection 070.02 of these rules, the Lessee must promptly plug and abandon any well on the leased land that is not used or useful in conformity with regulations promulgated by the IDWR or its successor agency. No production well will be abandoned until its lack of capacity for further profitable production of geothermal resources has been demonstrated to the satisfaction of the Department and the Department has been given an opportunity to either acquire the well permit or assign it to another party. A producible well may be abandoned only after receipt of written approval by the Department. Equipment will be removed, and premises at the well site will be restored as near as reasonably possible to its original condition immediately after plugging operations are completed on any well except as otherwise authorized by the Department. Drilling equipment must not be removed from any suspended drilling well without taking adequate measures to close the well and protect subsurface resources. Upon failure of Lessee to comply with any requirements under this rule, the Department is authorized to cause the work to be performed at the expense of the Lessee and the surety. (3-20-20)T

**057. -- 059. (RESERVED)**

**060. EXPLORATION AND OPERATION RECORDS, CONFIDENTIALITY.**

**01. Drilling Records.** Lessee must keep or cause to be kept and filed with the IDWR such careful and accurate well drilling records as are now or may hereafter be required by that Department. Lessee must file with the Department such production records and exploration evidence as required by Sections 030, 036, and 055 of these rules, which records will be subject to inspection by the public at the offices of the Department during regular business hours under such conditions as the Department deems appropriate, subject, however, to exemptions from disclosure as set forth in Section 74107, Idaho Code. As an express condition of the lease, the Department may inspect and copy well drilling records filed with the IDWR at any time after the records are filed. (3-20-20)T

**02. Continuing Obligations.** Unless Lessee is specifically released in writing by the Department of all or any portion of its obligations under the lease upon the assignment, surrender, termination or expiration of the lease, Lessee's obligations under this rule will continue beyond assignment, surrender, termination or expiration of the lease. Lessee must, within thirty (30) days after assignment, surrender, termination or expiration or such additional time as the Department may grant, file all outstanding data and records required by this rule with the Department. (3-20-20)T

**03. Well Logs.** The confidentiality of well logs is limited to one year from well completion as stated in Section 42-4010(b), Idaho Code. (3-20-20)T

**061. -- 064. (RESERVED)**

**065. LESSEE'S RECORDS, RIGHT OF INSPECTION BY DEPARTMENT.**

Lessee will permit the Department to examine during reasonable business hours all books, records and other documents and matters pertaining to operations under a lease, in Lessee's custody or control, and to make copies of and extracts therefrom. (3-20-20)T

**066. -- 069. (RESERVED)**

**070. WATER RIGHTS.**

**01. Water Rights.** Lessee must comply with all applicable federal and state laws, rules and regulations regarding the appropriation of public waters of Idaho to beneficial uses. The establishment of any new water rights on state lands must be by and for the Lessor and no claim thereto may be made by the Lessee. Such water rights will attach to and become appurtenant to the state lands, and the Lessor will be the owner thereof. (3-20-20)T

**02. Potable Water Discovery.** All leases issued under these rules will be subject to the condition that, where the Lessee finds only potable water of no commercial value as a geothermal resource in any well drilled for exploration or production of geothermal resources, and when the water is of such quality and quantity as to be valuable and usable for agricultural, domestic, or other purpose, the Board, or where appropriate, the surface Lessee, grantee or contract purchaser, will have the right to acquire the well with whatever casing is installed in the well at the

fair market value of the casing, and upon the assumption of all future liabilities and responsibilities for the well, with the approval of the director of the IDWR. (3-20-20)T

**071. -- 074. (RESERVED)**

**075. ASSIGNMENTS.**

**01. Prior Written Approval.** In order for Lessee to effect an assignment, Lessee must, prior to the consummation of an effective sale, transfer or assignment of the lease between Lessee and its proposed assignee, provide to the Department certain information about the proposed assignment, including identification of the proposed assignee and general terms of the proposed assignment on assignment application forms provided by the Department. Any proposed total or partial assignment of a lease must be preapproved in writing by the Department prior to any proposed sale, transfer or assignment of the lease is consummated between Lessee and the proposed assignee. Approval will not be unreasonably withheld. Following the Department's written preapproval of the proposed assignee and general terms of the proposed assignment, Lessee and assignee may consummate any such sale, transfer or assignment of Lessee's leasehold interest in the lease. The consummation of any assignment agreement by the Lessee without the Department's prior written preapproval constitutes a default of the lease, and such sale, transfer or assignment may be rejected in the Department's sole discretion; and, such assignment will only be effective if the default is expressly waived in writing by the Department. In order for an assignment of Lessee's interest in the lease to be acceptable for approval by the Department, the consummated sale, transfer or assignment must include provisions wherein Lessee has sold, transferred or assigned to the assignee any and all interest that Lessee has in the lease together with any and all interest Lessee has in any and all improvements located upon the leased premises, and assignee must assume all liabilities of Lessee under the lease together with ownership of all improvements owned by Lessee. An assignment between Lessee and its assignee will only take effect following the Department's final written approval of the assignment following receipt of copies of the final, consummated sale, transfer or assignment agreement between Lessee and assignee. (3-20-20)T

**02. Full or Partial.** A lease may be assigned as to all or part of the acreage included therein to any person qualified to hold a state lease, provided that neither the assigned nor the retained part created by the assignment contains less than forty (40) acres. No undivided interest in a lease of less than ten percent (10%) may be created by assignment. (3-20-20)T

**03. Overriding Royalty Disclosure.** Overriding royalty interests created by an assignment are subject to the requirements in Section 080 of these rules. (3-20-20)T

**04. Responsibility.** In an assignment of a partial or complete interest in all of the lands in a lease, the assignor and its surety continue to be responsible for performance of any and all obligations under the lease until such time as the Department, in writing, releases Lessee and its surety from obligations arising under the lease after the Department accepts any such assignment and provides a release of any or all obligations in writing. After the effective date of any assignment, the assignee and its surety will be bound by the terms of the lease to the same extent as if the assignee were the original Lessee, any conditions in the assignment to the contrary notwithstanding. (3-20-20)T

**05. Segregation of Assignment.** An assignment of all or any portion of Lessee's record title of the complete interest in a portion of the lands in a lease must clearly identify and segregate the assigned and retained portions. After the effective date, the assignor will be released and discharged from any obligations thereafter accruing with respect to the assigned portion of the leased lands. Such segregated leases continue in full force and effect for the primary term of the original lease or as further extended pursuant to the terms of these rules. (3-20-20)T

**06. Joint Principal.** Where an assignment does not segregate the record title to the lease, the assignee, if the assignment so provides, may become a joint principal on the bond with the assignor. The application must also be accompanied by a consent of assignor's surety to remain bound under the bond of record, if the bond, by its terms, does not contain such consent. If a party to the assignment has previously furnished a statewide bond, no additional showing by such party is necessary as to the bond requirement. (3-20-20)T

**07. Application.** The application for approval of an assignment must be on forms approved by the Department. (3-20-20)T

**08. Denial.** If the Lessee is in default of the lease at the time of a request for assignment approval, the Department may, at its sole discretion, reject any proposed assignment until the lease is brought into full compliance. The approval of an assignment of lease in good standing will not be unreasonably withheld provided such consent of the Department is requested and obtained prior to any assignment. (3-20-20)T

**076. -- 079. (RESERVED)**

**080. OVERRIDING ROYALTY INTERESTS.**

**01. Statements.** An overriding royalty interest, or any similar interest whereby an agreement is made to pay a percentage based on production, must be disclosed at the time of assignment or transfer by filing a statement of such interest with the Department. Assignees must meet the requirements of Section 021 of these rules. All assignments of overriding royalty interests without a working interest and otherwise not contemplated by Section 075 of these rules, must be filed with the Department within ninety (90) days from the date of execution. (3-20-20)T

**02. Maximum Amount.** No overriding royalty on the production of geothermal resources created by an assignment contemplated by Section 075 of these rules or otherwise will exceed five percent (5%) nor will an overriding royalty, when added to overriding royalties previously created, exceed five percent (5%). (3-20-20)T

**03. Conformance with Rules.** The creation of an overriding royalty interest that does not conform to the requirements of this rule is be deemed a violation of the lease terms, unless the agreement creating overriding royalties provides for a prorated reduction of all overriding royalties so that the aggregate rate of overriding royalties does not exceed five percent (5%). (3-20-20)T

**04. Director's Authority.** In addition to the foregoing limitations, any agreement to create or any assignment creating royalties or payments out of production from the leased lands is subject to the authority of the Director, after notice and hearing, to require the proper parties thereto to suspend or modify such royalties or payments out of production in such manner as may be reasonable when and during such periods of time as they may constitute an undue economic burden upon the reasonable operations of such lease. (3-20-20)T

**081. -- 084. (RESERVED)**

**085. UNIT OR COOPERATIVE PLANS OF DEVELOPMENT OR OPERATION.**

**01. IDWR Approval.** Nothing in this rule will excuse the parties to a unit agreement from procuring the approval of the IDWR pursuant to Section 42-4013, Idaho Code, if approval is required. (3-20-20)T

**02. Unit Plan.** For the purpose of conserving the natural resources of any geothermal pool, field or like area, Lessees under lease issued by the Board are authorized, with the written consent of the Department, to commit the state lands to unit, cooperative or other plans of development or operation with other state lands, federal lands, privately-owned lands or Indian lands. Departmental consent will not be unreasonably withheld. Applications to unitize, or a copy of the application filed with IDWR, will be filed with the Department who will certify whether such plan is necessary or advisable in the public interest. The Department may require whatever documents or data that the Department deems necessary in its reasonable discretion. To implement such unitization, the Board may with the consent of its Lessees modify and change any and all terms of leases issued by it that are committed to such unit, cooperative or other plans of development or operations. (3-20-20)T

**03. Contents.** The agreement must describe the separate tracts comprising the unit, disclose the apportionment of the production of royalties and costs to the several parties, and the name of the operator, and must contain adequate provisions for the protection of the interests of all parties, including the state of Idaho. The agreement should be signed by or in behalf of all interested necessary parties before being submitted to the Department. It will be effective only after approval by the Department. The unit operator must be a person as defined by these rules and must be approved by the Department. (3-20-20)T

**04. Lease Modification.** Any modification of an approved agreement will require approval of the Department under procedures similar to those cited in Subsection 085.02 of these rules. (3-20-20)T

**05. Term.** At the sole discretion of the Department, the term of any leases included in any cooperative or unit plan of development or operation may be extended for the term of such unit or cooperative agreement, but in no event beyond that time provided in Subsection 030.01 of these rules. Rentals or royalties on leases so extended may be reassessed for such extended term of the lease. (3-20-20)T

**06. Continuation of Lease.** Any lease that will be eliminated from any such cooperative or unit plan of development or operation, or any lease that will be in effect at the termination of any such cooperative or unit plan of development or operation, unless relinquished, will continue in effect for the term of the lease. (3-20-20)T

**07. Evidence of Agreement.** Before issuance of a lease for lands within an approved unit agreement, the lease applicant or successful bidder will be required to file evidence that they have entered into an agreement with the unit operator for the development and operation of the lands in a lease if issued to him under and pursuant to the terms and provisions of the approved unit agreement, or a statement giving satisfactory reasons for the failure to enter into such agreement. If such statement is acceptable, the lease applicant or successful bidder will be permitted to operate independently, but will be required to perform his operations in a manner that the Department deems to be consistent with the unit operations. (3-20-20)T

**086. -- 094. (RESERVED)**

**095. SURRENDER, TERMINATION, EXPIRATION OF LEASE.**

**01. Procedure.** A lease, or any surveyed subdivision of the area covered by such lease, may be surrendered by the record title holder by filing a written relinquishment in the office of the Department, on a form furnished by the Department, provided that a partial relinquishment does not reduce the remaining acreage in the lease to less than forty (40) acres. The minimum acreage provision of this section may be waived by the Department where the Department finds such exception is justified on the basis of exploratory and development data derived from activity on the leasehold. The relinquishment must: (3-20-20)T

**a.** Describe the lands to be relinquished; (3-20-20)T

**b.** Include a statement as to whether the relinquished lands had been disturbed and, if so, whether they were restored as prescribed by the terms of the lease; and (3-20-20)T

**c.** State whether wells had been drilled on the lands and, if so, whether they have been plugged and abandoned pursuant to the rules of the IDWR. (3-20-20)T

**02. Continuing Obligations.** A relinquishment takes effect on the date it is filed, subject to the continued obligation of the Lessee and his surety: (3-20-20)T

**a.** To make payments of all accrued rentals and royalties; (3-20-20)T

**b.** To place all wells on the land to be relinquished in condition for suspension of operations or abandonment; (3-20-20)T

**c.** To restore the surface resources in accordance with these rules and the terms of the lease; and (3-20-20)T

**d.** To comply with all other environmental stipulations provided for by these rules or lease. (3-20-20)T

**03. Failure to Pay Rental or Royalty.** The Director may terminate a lease for failure to pay rentals or royalties thirty (30) days after mailing a notice of delinquent payment. However, if the time for payment falls upon any day in which the office of the Department is not open, payment received on the next official working day will be deemed to be timely. The termination of the lease for failure to pay the rental will be noted on the official records of the Department. Upon termination the lands included in such lease may become subject to leasing as provided by these rules. (3-20-20)T

**04. Termination for Cause.** A lease may be terminated by the Department for any violation of these rules, or the lease terms, sixty (60) days after notice of the violation has been given to Lessee by personal service or certified mail, return receipt requested, to the address of record last appearing in the files of the Department, unless: (3-20-20)T

**a.** The violation has been corrected; or (3-20-20)T

**b.** The violation is one that cannot be corrected within the notice period and the Lessee has in good faith commenced within the notice period to correct the violation and thereafter proceeds diligently to complete the correction. (3-20-20)T

**05. Equipment Removal.** Prior to the expiration of the lease, or the earlier termination or surrender thereof pursuant to this rule, and provided the Lessee is not in default, the Lessee will have the privilege at any time during the term of the lease to remove from the leased premises any materials, tools, appliances, machinery, structures, and equipment other than improvements needed for producing wells. Any materials, tools, appliances, machinery, structures and equipment subject to removal, but not removed prior to any termination of the lease or any extension thereof that may be granted because of adverse climatic conditions during that period, will, at the option of the Department, become property of the state of Idaho, but the Lessee must remove any or all such property where so directed by the Department. (3-20-20)T

**06. Surrender After Termination.** Upon the expiration or termination of a lease, the Lessee will quietly and peaceably surrender possession of the premises to the state, and if the Lessee is surrendering the leased premises or any portion thereof, the Lessee must deliver to the state a good and sufficient release on a form furnished by the Department. (3-20-20)T

**096. -- 099. (RESERVED)**

## **100. BOND REQUIREMENTS.**

**01. Minimum Bond.** Prior to initiation of operations using motorized earth-moving equipment Lessee must furnish a bond. This bond will be in favor of the state of Idaho, conditioned on the payment of all damages to the land surface and all improvements thereon, including without limitation crops on the lands, whether or not the lands under this lease have been sold or leased by the Board for any other purpose; conditioned also upon compliance by Lessee of his obligations under this lease and these rules. The Department may require a new bond in a greater amount at any time after operations have begun, upon a finding that such action is reasonably necessary to protect state resources. (3-20-20)T

**02. Statewide Bond.** In lieu of the aforementioned bonds, Lessee may furnish a good and sufficient "statewide" bond conditioned as in Subsection 100.01. This bond will cover all Lessee's leases and operations carried on under all geothermal resource leases issued and outstanding to Lessee by the Board at any given time during the period when the "statewide" bond is in effect. The amount of such bond will be equal to the total of the requirements of the separate bonds being combined into a single bond. (3-20-20)T

**03. Period of Liability.** The period of liability of any bond will not be terminated until all lease terms and conditions have been fulfilled and the bond is released in writing by the Department. (3-20-20)T

**04. Operator Bond.** In the event suit is filed to enforce the terms of any bond furnished by an operator in which the Lessee (if a different person) is not a named party, the Department may, in its sole discretion, join the Lessee as a party to such suit. (3-20-20)T

## **101. LIABILITY INSURANCE.**

**01. Liability Insurance Required.** The Department will require the Lessee to purchase and maintain suitable insurance for the duration of the lease prior to entry upon the leased lands for other than casual exploration or inspection as contemplated by Subsection 054.02 of these rules. (3-20-20)T

**02. Insurance Certificate Required.** No work under this lease will commence prior to the Department's receipt of a certificate, signed by a licensed insurance agent, evidencing existence of insurance as required above. Further, such certificate must reflect that no change or cancellation in such coverage will become effective until after the Department receives written notice of such change or cancellation. (3-20-20)T

**102. -- 104. (RESERVED)**

**105. TITLE.**

The state of Idaho does not warrant title to the leased lands or the geothermal resources and associated by-products that may be discovered thereon; the lease is issued only under such title as the state of Idaho may have as of the effective date of the lease or thereafter acquire. If the interest owned by the state in the leased lands includes less than the entire interest in the geothermal resources and associated by-products for which royalty is payable, then the royalties provided for in the lease will be paid to the state only in the proportion that its interest bears to said whole and undivided interest in said geothermal resources and associated by-products for which royalty is payable; provided, however, that the state is not liable for any damages sustained by the Lessee, nor is the Lessee entitled to or may claim any refund of rentals or royalties therefore paid to the state in the event that the state does not own title to said geothermal resources and associated by-products, or if its title thereto is less than whole and entire. (3-20-20)T

**106. -- 110. (RESERVED)**

**111. TAXES.**

Lessee must pay, when due, all taxes and assessments of any kind lawfully assessed and levied against Lessee's interests or operations under the laws of the state of Idaho. (3-20-20)T

**112. RENTAL NOTICES.**

Advance notice of rental due is usually sent to the Lessee by the Department, but failure to receive such notices does not act to relieve the Lessee from the payment of the rental and the lease will be in default if such payment is not made as provided in these rules. (3-20-20)T

**113. OUTSTANDING LEASES.**

No right to seek, obtain or use geothermal resources has passed or will pass with any existing or future license, permit or lease of state lands, including without limitation, mineral leases and oil and gas development leases, except upon the issuance of a geothermal resources lease. (3-20-20)T

**114. -- 119. (RESERVED)**

**120. FEES.**

The following fees apply: (3-20-20)T

**01. Non-Refundable Application Fee for Lease.** Two hundred fifty dollars (\$250) per application. (3-20-20)T

**02. Application Fee for Approval of Assignment.** One hundred fifty dollars (\$150) per lease involved in the assignment. (3-20-20)T

**03. Late Payment Fee.** The greater of the following: (3-20-20)T

**a.** Twenty-five dollars (\$25); or (3-20-20)T

**b.** One percent (1%) per month (or portion thereof) on the unpaid balance. (3-20-20)T

**121. -- 999. (RESERVED)**

## 20.03.16 – RULES GOVERNING OIL AND GAS LEASING ON IDAHO STATE LANDS

### 000. LEGAL AUTHORITY.

This Chapter is adopted under the legal authorities of Sections 58-104(1), 58-104(6), 58-104(9), 58-105, and 58-127, Idaho Code; Section 58-307, Idaho Code; Title 47, Chapter 7, Idaho Code; Title 47, Chapter 8, Idaho Code; and Title 67, Chapter 52, Idaho Code. (3-20-20)T

### 001. TITLE AND SCOPE.

**01. Title.** These rules are titled IDAPA 20.03.16, “Rules Governing Oil and Gas Leasing on Idaho State Lands.” (3-20-20)T

**02. Scope.** These rules apply to the exploration and extraction of oil and gas resources situated in state-owned mineral lands. (3-20-20)T

**03. Other Laws.** In addition to these rules, the lessee must comply with all applicable federal, state and local laws, rules and regulations. The violation of any applicable law, rule or regulation constitutes a breach of any lease issued in accordance with these rules. (3-20-20)T

### 002. ADMINISTRATIVE APPEALS.

**01. Appeal to Board.** All decisions of the Director are appealable to the Board. An aggrieved party desiring to take such an appeal must, within thirty (30) days after notice of the Director’s decision, file with the Director a written notice of appeal setting forth the basis for the appeal. (3-20-20)T

**02. Hearing.** The Board will hear the appeal at the earliest practical time or in its discretion appoint a hearing officer to hear the appeal, within sixty (60) days after filing of the notice of appeal. The hearing officer will make findings and conclusions that the Board may accept, reject or modify. The decision of the Board after hearing or upon a ruling concerning the hearing officer’s findings and conclusions is final. (3-20-20)T

**03. Judicial Review.** Judicial review of the final decision of the Board will be in accord with the Administrative Procedure Act, Title 67, Chapter 52, Idaho Code, by filing a petition in the district court in Ada County, or the county where the Board heard the appeal and made its final decision, within thirty (30) days after notice of the Board’s decision. Service of the Board’s decision may be by personal service or by certified mail to the lessee. (3-20-20)T

### 003. -- 009. (RESERVED)

### 010. DEFINITIONS.

**01. Board.** The Idaho State Board of Land Commissioners or its authorized representative, or where appropriate, the state of Idaho. (3-20-20)T

**02. Commission.** The Idaho Oil and Gas Conservation Commission. (3-20-20)T

**03. Collateral Surety Bond and Corporate Surety Bond.** See Subsections 080.04.a. and 080.04.b. (3-20-20)T

**04. Department.** The Idaho Department of Lands. (3-20-20)T

**05. Director.** The Director of the Idaho Department of Lands or his authorized representative. (3-20-20)T

**06. Discretion.** Exercising authority to make a decision, choice or judgment without being arbitrary, capricious or illegal. (3-20-20)T

**07. Exploration.** Activities related to the various geological and geophysical methods used to detect and determine the existence and extent of hydrocarbon deposits. (3-20-20)T

**08. Final Board Approval.** Approval of a lease occurs after the lease is signed by the Governor, the Secretary of State and the Director on behalf of the Board after approval of the lease by a majority of the Board. All approved leases must first be signed by the Lessee and then by the above-entitled state officials. (3-20-20)T

- 09. Lease.** A written agreement between the Department and a person containing the terms and conditions upon which the Person will be authorized to use state lands. (3-20-20)T
- 10. Legal Subdivision.** See Subsection 071.04. (3-20-20)T
- 11. Lessee.** The person to whom a lease has been issued and his successor in interest or assignee(s). More than one (1) person may be entered as an applicant on the application form but only one (1) person shall be designated in the application for lease or assignment as the lessee of record with sole responsibility for the lease under these rules. (3-20-20)T
- 12. Lessor.** The Board on behalf of the state of Idaho. (3-20-20)T
- 13. Motorized Exploration Equipment.** The equipment used in exploration that may appreciably disturb or damage the land or resources thereon as defined in Section 47-703(a), Idaho Code. (3-20-20)T
- 14. Natural Gas Plant Liquids.** Hydrocarbon compounds in raw gas that are separated as liquids at gas processing plants, fractionating plants, and cycling plants. Includes ethane, liquefied petroleum gases (propane and the butanes), and pentanes plus any heavier hydrocarbon compounds. Component products may be fractionated or mixed. (3-20-20)T
- 15. Oil and Gas.** Oil and gas means oil or gas, or both. (3-20-20)T
- 16. Person.** (3-20-20)T
- a.** An individual of legal age; (3-20-20)T
- b.** Any firm, association or corporation that is qualified to do business in the state of Idaho; (3-20-20)T
- c.** Or any public agency or governmental unit, including without limitation, municipalities. (3-20-20)T
- 17. Production in Paying Quantities.** That gross income from oil and/or gas produced and saved (after deduction of taxes and royalty) that exceeds the cost of operation. (3-20-20)T
- 18. State Lands.** Lands, including the beds of navigable waters within Idaho in which the title to mineral rights is owned by the state of Idaho, that are under the jurisdiction and control of the Board or any other state agency. (3-20-20)T
- 19. Tract.** An expanse of land representing the surface expression of the underlying mineral estate, which includes oil and gas rights owned by the State, that: (3-20-20)T
- a.** May be identified by its public land survey system of rectangular surveys that subdivides and describes land in the United States in the public domain and is regulated by the U.S. Department of the Interior, Bureau of Land Management; (3-20-20)T
- b.** Is of no particular size; (3-20-20)T
- c.** Is a maximum size of six hundred forty (640) acres or one section, unless otherwise determined by the Director; (3-20-20)T
- d.** May be irregular in form; (3-20-20)T
- e.** Is contiguous; (3-20-20)T
- f.** May lie in more than one township or one section; (3-20-20)T



- g.** May have a boundary defined entirely or in part by natural monuments such as streams, divides, or straight lines connecting prominent features of topography; (3-20-20)T
- h.** May include the mineral estate beneath navigable waters of the State; and (3-20-20)T
- i.** May be combined with other tracts to form a lease. (3-20-20)T

**011. -- 014. (RESERVED)**

**015. CONTROL OF STATE LANDS.**

The Director will regulate and supervise pursuant to law and these rules all state lands within the custody and control of the Board. State lands subject to the custody and control of other state agencies will be regulated and supervised by the respective agency in accord with state laws and rules; provided that any lease for oil and gas thereon complies with these rules. (3-20-20)T

**016. WITHDRAWAL OF LANDS.**

At any time prior to final Board approval of a lease, the Board reserves the right to withdraw state lands entirely from oil and gas leasing if consistent with its constitutional and statutory duties and in the state's best interests. (3-20-20)T

**017. -- 019. (RESERVED)**

**020. QUALIFIED APPLICANTS AND LESSEES.**

Any person who is not then in default of any contract with the state of Idaho or any department or agency thereof is a qualified applicant and lessee. No member of the Board or employee of the Department may take or hold such lease. (3-20-20)T

**021. EXPLORATION.**

**01. Written Permit Required.** Any appreciable surface disturbing activity, including, but not limited to, motorized exploration on state lands is prohibited except by written permit for exploration for a period of time as determined by the Director. This permit is in addition to any permit required by the Commission. (3-20-20)T

**02. Permit Conditions.** The permit will contain such conditions as the Director determines will protect the existing surface uses and resources of the state. The permit applicant must pay in advance the fee required by Section 120. (3-20-20)T

**022. LEASE ACQUISITION PROCESS.**

**01. Acquiring a Lease.** A lease may be acquired for the exclusive right and privilege to explore for and produce oil and gas by oral auction, online auction, or such other method of competitive bidding authorized by the Board, in its discretion, determined to be in the best interest of the state, and will be awarded to the winning bidder at close of auction. The winning bidder at auction will be issued the lease by the Department on the first day of the month following Final Board Approval. The Board and Department reserve the right to reject any or all nominations or bids, and expressly disclaim any liability for inconvenience or loss caused by errors that may occur concerning lease offerings. (3-20-20)T

**02. Lease Provisions.** (3-20-20)T

**a. Advance Annual Rental.** The Lessee must pay to the state of Idaho an advance annual rental for each lease of three dollars (\$3) per acre with a minimum of two hundred fifty dollars (\$250) per lease. (3-20-20)T

**b. Diligent Drilling.** Diligent and continuous drilling operations means no delay or cessation of drilling for a period greater than one hundred twenty (120) days, unless extended in writing by the Director. The Director must receive a written request for an extension at least ten (10) days prior to the expiration of the one hundred twenty (120) day period. (3-20-20)T

**c. Notification at End of Lease Period.** The Lessee must notify the Director in writing prior to the

expiration of the final year of his lease that drilling or reworking operations has commenced and will extend beyond the expiration date of the lease. Advance Annual Rental, in the amount required by Section 022 for any additional and each succeeding year, must be received by the Department prior to the expiration date and entitles the Lessee to hold the lease only as long as drilling or rework operations are pursued in accord with these rules. There will be no refund of unused rental. (3-20-20)T

**d.** Abandonment. During any additional or succeeding year of any lease, cessation of production for a period of six (6) months is considered as abandonment. The lease will then automatically terminate at its next anniversary date unless the Director determines that such cessation of production is justified or the well meets the requirements of a shut in well under Subsection 022.02.e. (3-20-20)T

**e.** Suspension of Production. The Director may grant a suspension of production not to exceed one (1) year upon a written application showing that the lessee is unable to market oil or gas from a well located on the leased premises capable of oil and gas production in paying quantities due to a lack of suitable production facilities or a suitable market for the oil or gas and such conditions are outside the reasonable control of lessee and the lease is not being otherwise maintained in force and effect. If such well is shut in and the Director approves the application for suspension of production requirements prior to the expiration or termination of the lease, then the lease will be extended in accordance with the terms of Section 47-801, Idaho Code, for a period of one (1) year if the lessee timely submits an application in a form approved by the Director and, upon approval of said application, pays a shut-in royalty in the amount equal to double the annual rental provided for by these rules for each well capable of producing oil or gas in paying quantities. The lessee must remit the shut-in royalty payment while the lease is otherwise maintained in force and effect. Payment of shut-in royalty after the expiration or other termination of the lease will not revive or extend the lease. The Lessee may request continuation of this suspension of production, provided such request is received in writing by the Director at least thirty (30) days prior to the expiration date of the period of suspension. (3-20-20)T

**03. Nominating a Tract for Auction.** A tract may be nominated for auction either by application to the Department at least ninety (90) days prior to a Department-defined close of auction date, or by Department nomination at least ninety (90) days prior to a Department- defined close of auction date. Any qualified person may nominate a tract for lease auction by submitting a nomination to the Department, and paying the nomination fee in an amount determined by the Board, during regular business hours on the Department nomination form. Each nominated tract must be a maximum size of six hundred forty (640) acres or one section. The nominating person may propose that multiple tracts be included in a single lease. Each nomination for a tract for auction is deemed an offer by the nominating person to lease the tract for the advance annual rental amount as defined in Subsection 022.02 above. (3-20-20)T

**04. Withdrawing a Tract for Auction.** Any person nominating a tract for auction may withdraw their nomination if a request for such withdrawal is received by the Department at least ten (10) business days prior to the opening date of auction. The nomination fee will not be refunded. (3-20-20)T

**05. Auction Conditions.** The Department will determine the conditions associated with the auction including, but not limited to, the following: when or if a tract will be offered for auction; whether the tract is to be removed from the auction; whether multiple tracts will be combined in a single lease at the discretion of the Department; and any disclaimers, additional information, and any other such terms and conditions associated with the auction of the tracts. Any such terms and conditions, disclaimers, and additional information will be posted on the Department's website. (3-20-20)T

**06. Lease Information for Auction.** For each lease to be auctioned, the Department will provide on the website the following: a lease number designated by the Department; the legal description; the lease length; the number of acres; a minimum bid per acre; a lease template; any lease stipulations; any other lease information; a specific date designated for the beginning and ending dates that a bidder may conduct due diligence; a specific date designated for the opening of auction; and a close of auction date. A notice of lease auction will be published at least once per week for the four (4) consecutive weeks prior to the date of auction in a newspaper in general circulation in the county in which the nominated lease is located and in a newspaper in general circulation in Ada County. (3-20-20)T

**07. Auction Procedure.** The Department will determine the procedures associated with the auction,

including, but not limited to place of auction, time of auction, and bidder registration procedure. Additional auction procedures are as follows. (3-20-20)T

**a.** Bid Increments. The minimum bid increment is one dollar (\$1). (3-20-20)T

**b.** Winning Bid. At close of auction, the winning bid for a Lessee is the number of dollars bid multiplied by the number of acres in the lease, with fractions of an acre rounded up to the next whole acre. If, at close of auction, a bid for a lease has not been submitted by a bidder, then the lease will be awarded to the nominating applicant. The entry of a bid constitutes an enforceable contractual obligation. (3-20-20)T

**c.** Amount Due. The amount due for a lease is the winning bid, plus the first year's annual rental amount as per Subsection 022.02, plus the nomination fee. If the winning bid was submitted by the nominator of the tract(s), then the nomination fee will already have been submitted to the Department and will not be included in the amount due. The nominator will be refunded the nomination fee if they are not the winning bidder. (3-20-20)T

**d.** Transfer of Funds. Unless otherwise required in the notice of auction, the winning bidder for each lease has five (5) full business days after close of auction to complete the transfer of funds to the Department. Failure of the winning bidder to transfer funds within the period specified constitutes a breach of contract, and the state may pursue any action or remedy at law or in equity against the winning bidder. (3-20-20)T

**08. Execution of Lease.** The completed lease will be executed by the winning bidder within thirty (30) days from the date of mailing after close of auction, or if personally delivered to the applicant or his agent by the Department, within thirty (30) days from the date of receipt. An individual who executes a lease on behalf of another Person must submit a power of attorney outlining such delegated authority. (3-20-20)T

**023. -- 044. (RESERVED)**

**045. ROYALTIES.**

**01. Royalty Payments.** Unless otherwise specified by the Board, the lessee will pay to the state of Idaho in money or in kind to the state at its option a royalty of no less than twelve and one-half percent (12.5%) of the oil and/or gas or natural gas plant liquids produced and saved. The lessee will make payments in cash unless written instructions for payment in kind are received from the state. Royalty is due on all production from the leased premises except that consumed for the direct operation of the producing wells and that lost through no fault of the lessee. (3-20-20)T

**02. Royalty Not Reduced.** Where royalties are paid in cash, costs of marketing, transporting and processing oil and/or gas or natural gas plant liquids or all of them produced are borne entirely by the lessee, and such cost will not reduce the lessor's royalty directly or indirectly. If the Director elects to take royalty in kind, the state will reimburse the lessee for reasonable additional storage and transportation costs. (3-20-20)T

**03. Oil, Gas, and Natural Gas Plant Liquids Royalty Calculation and Reporting.** All royalty owed to the lessor hereunder and not paid in kind at the election of the lessor will be paid to the lessor in the following manner: (3-20-20)T

**a.** Payment of royalty on production of oil is due and must be received by the lessor on or before the 65th day after the month of production; (3-20-20)T

**b.** Payment of royalty on production of gas and natural gas plant liquids is due and must be received by the lessor on or before the 95th day after the month of production; (3-20-20)T

**c.** All royalty payments must be completed in the form and manner approved by the Department including, but not limited to, the gross amount and disposition of all oil, gas, and natural gas plant liquids produced and the market value of the oil, gas, and natural gas plant liquids; (3-20-20)T

**d.** Lessee must maintain, and make available to the lessor upon request, copies of all documents, records or reports confirming the gross production, disposition and market value, including gas meter readings,

pipeline receipts, gas line receipts and other checks or memoranda of the amount produced and put into pipelines, tanks, or pools and gas lines or gas storage, and any other reports or records that the lessor may require to verify the gross production, disposition and market value; and (3-20-20)T

e. Each royalty payment must be accompanied by a check stub, schedule, summary or other remittance advice showing, by the assigned lessor lease number, the amount of royalty being paid on each lease. (3-20-20)T

**04. Overriding Royalty.** All assignments of overriding royalty without a working interest made directly by the lessee and not included with an assignment of lease must be filed with the Department with the processing fee within ninety (90) days from the date of execution; provided that it is the lessee's responsibility, and not the Department's, to process such assignments by third parties. Any assignment that creates an overriding royalty exceeds the royalty previously payable to the state by greater than five percent (5%), is deemed a violation of the terms of the lease unless such an assignment expressly provides that the obligation to pay such excess overriding royalty is suspended when the average production of oil per well per day, averaged on a monthly basis, is fifteen (15) barrels or less. (3-20-20)T

**046. -- 049. (RESERVED)**

**050. LAND USE, SURFACE RIGHTS AND OBLIGATIONS.**

**01. Use and Occupancy.** Notwithstanding other leases for other uses of state lands, the lessee is entitled to use and occupy as much of the surface of the leased lands as may be required for all purposes reasonably incident to exploration, drilling and production and marketing of oil and gas produced from the leased land, including the right to construct and maintain all works, buildings, plants, waterways, roads, communication lines, pipelines, reservoirs, tanks pumping stations or other structures necessary to full enjoyment and development; provided that lessee's operation does not unreasonably interfere with or endanger operations under any lease, license, claim, permit or other authorized, lawful use. (3-20-20)T

**02. Prevention of Injury or Damage.** The lessee, its assignees, agents, and/or contractors must take all reasonable precautions to prevent injury or damage to persons, real and personal property and to prevent waste or damage to the oil, gas and other surface and subsurface natural resources and the surrounding environment including but not limited to, vegetation, livestock, fish and wildlife and their natural habitat, streams, rivers, lakes, timber, forest and agricultural resources. The Lessee, his assignees, agents and/or contractors will compensate the Board, his surface lessees, grantees or contract purchasers for any damage resulting by reason of their operations or any damage resulting from their failure to take all reasonable precautions to prevent injury or damage to persons, real and personal property and to prevent waste or damage to the oil, gas and other surface and subsurface natural resources and surrounding environment as set forth above. The lessee, its assignees, agents and/or contractors must comply with all environmental laws, rules and regulations as they pertain to its operation. (3-20-20)T

**03. Blowout or Spill.** The lessee must report to the Director any blowout, fire, uncontrolled venting, or oil spill on the leased land within twenty-four (24) hours and confirm this report in writing within ten (10) days. (3-20-20)T

**04. Fences.** The lessee may not at any time fence any watering place upon leased lands where it is the only accessible and feasible watering place upon the lands within a radius of one (1) mile, without first having secured the written consent of the Director. (3-20-20)T

**05. Timber Removal.** The lessee may not unreasonably interfere with the removal of timber purchased prior or subsequent to the issuance of an oil and gas lease. The lessee may remove any timber required for ingress or egress or necessary for operations. The lessee must pay for any timber cut or removed on a current stumpage price basis as determined by the Director, and proceeds therefrom accrue to the state agency that has custody and control over the leased lands. (3-20-20)T

**06. Potable Water Discovery.** If the lessee finds only potable water in any well drilled for exploration or production of oil and gas, and the water is of such quality and quantity as to be valuable and usable for agricultural, domestic, or other purposes, the Board may acquire the well with whatever casing is installed in the well at the fair

market value of the casing upon the assumption by its surface lessee, grantee, or contract purchaser of all future liabilities and responsibilities for the well, with the approval of the commission and in compliance with Section 058; provided that the surface lessee, grantee, or contract purchaser also complies with applicable laws and rules of the Department of Water Resources. (3-20-20)T

**07. Reclamation.** The lessee must reclaim all state lands disturbed by its exploration and operations at least consistent with previous use by the surface owner, including segregating and protecting topsoil and regrading to approximate previous contour. If substantial removal of topsoil has occurred as determined by the Director, the lessee will replace the topsoil and revegetate to the extent necessary to minimize erosion. (3-20-20)T

**08. Entry by Director.** The Director is permitted at all reasonable times to go in and upon the leased lands and premises to inspect the operations and the products obtained and to post any lawful notice. The Director may at any time require that reasonable tests, surveys, samples, etc., be taken in accord with his instruction, without cost to the state of Idaho, to assure compliance with these rules. The Director may at any reasonable time inspect and copy at his own expense all of lessee's books and records pertaining to a lease under these rules. Upon failure of lessee to take timely, corrective measures ordered by the Director or the Board or the commission, the Director may shut down lessee's operations if he determines they are unsafe or are causing or may cause waste or pollution to oil, gas or other resources; or the Director may terminate the lease and cause damage or unsafe conditions to be repaired or corrected at the expense of the lessee and forfeiture of bond in accordance with these rules. (3-20-20)T

**09. Other Uses.** Subject to Subsection 050.01, the Director may issue leases for other uses of state lands leased under these rules. All lessees have the right of reasonable ingress and egress at all times during the term of the lease. (3-20-20)T

**10. Disposal of Leased Lands.** The Board reserves the right to sell or otherwise dispose of the surface of the leased lands; provided that any sale of surface rights made subsequent to execution of the lease is subject to all terms and provisions of the oil and gas lease during its life including extensions and continuations under Section 040. (3-20-20)T

**051. DILIGENT EXPLORATION REQUIRED.**

The lessee must perform diligent exploration during the entire term of a lease. Diligent exploration means that the lessee provides continuing efforts as a reasonably prudent operator toward achieving production, including, without limitation, performing geological and geophysical surveys and/or the drilling of a test well. (3-20-20)T

**052. -- 054. (RESERVED)**

**055. OPERATIONS UNDER THE LEASE.**

**01. Best Practices.** The lessee will at all times conduct exploration, development, drilling and all operations as a reasonably prudent operator and conform to the best practice and engineering principles in use in the oil and gas industry. (3-20-20)T

**02. Compliance with Rules.** The lessee will comply with all rules of the oil and gas commission, including amendments promulgated pursuant to Title 67, Chapter 52, Idaho Code, and any violations of the commission's rules or other applicable state laws and rules may constitute a violation of the lease under these rules. (3-20-20)T

**03. Designation of Operator.** In all cases where operations are not conducted by the lessee but are to be conducted under authority of an approved operating agreement, assignment or other arrangement, a designation of operator must be submitted to the Director prior to commencement of operations. Such a designation authorizes the operator or his local representative to act for the lessee and to sign any papers or reports required under these rules. The lessee must immediately report to the Director all changes of address and termination of the authority of the operator. (3-20-20)T

**04. Legal Representative.** When required by the Director, the lessee must designate a local representative empowered to receive service of civil or criminal process and notices and orders of the Director issued pursuant to these rules. (3-20-20)T

**05. Diligence.** The lessee will, subject to the right to surrender the lease, diligently drill and produce such wells as are necessary to protect the Board from loss by reason of production on other properties, or with the consent of the Director, compensate the Board for failure to drill and produce any such well. All wells under lease must be drilled, maintained and operated to produce the maximum amount of oil and/or gas that can be secured without injury to the well. (3-20-20)T

**06. Loss Through Waste or Failure to Produce.** The Director will determine the value of production accruing to the Board where there is loss through waste or failure to drill and produce protection wells on the leased lands and the compensation due to the Board as reimbursement for such loss. Payment for such losses must be made within sixty (60) days after the date of billing. The value of production resulting from a loss through waste or failure to take corrective measures to protect a well is calculated at ninety percent (90%) of the last year's actual production royalty or a minimum royalty of five dollars (\$5) per acre or fraction thereof, whichever is greater. (3-20-20)T

**07. By-Products.** Where production, use or conversion of oil and gas under a lease, is susceptible of producing a valuable by-product or by-products, including, without limitation, commercially demineralized water, carbon dioxide or helium, the lessee must submit to the Director all available information concerning the potential by-product. The Department may conduct tests or studies at its expense and may issue reasonable orders to produce and preserve such by-product. (3-20-20)T

**08. Geothermal Information.** Prior to abandoning any well, the lessee must submit to the Director all available information concerning geothermal resource potential. The Department may conduct tests or studies at its expense prior to the abandoning of any well to determine geothermal resource potential. Except as provided in Subsection 040.05, the lessee must promptly plug and abandon any well on the leased land that is not used or useful, in accord with these rules and the rules of the commission, and any applicable rules and regulations of the Department of Water Resources. When drilling in a known geothermal resources area, the applicant may need a geothermal resource well permit from the Department of Water Resources. (3-20-20)T

**056. WATER RIGHTS.**

The lessee will comply with all state laws and rules regulating the appropriation of water rights. No water rights developed or obtained by the lessee in conjunction with operations under a lease may be sold, assigned or otherwise transferred without written approval of the Director. Upon surrender, termination or expiration of the lease, the lessee must take all actions required by the Director to assign to the Board all water rights, including applications and permits, subject to applicable laws regarding the transfer or assignment of permits to appropriate water. (3-20-20)T

**057. -- 059. (RESERVED)**

**060. ASSIGNMENTS.**

**01. Prior Written Approval.** No lease assignment is valid until approved in writing by the Director, and no assignment takes effect until the first day of the month following its approval. (3-20-20)T

**02. Qualified Assignee.** A lease may be assigned to any person qualified to hold a state lease, provided that in the event an assignment partitions leased lands between two (2) or more persons, neither the assigned nor the retained part created by the assignment may contain less than forty (40) acres or a government lot, whichever is less. (3-20-20)T

**03. Responsibilities.** In an assignment of the complete interest of the leasehold, the assignor and his surety continue to comply with the lease and these rules until the effective date of the assignment. After the effective date of any assignment, the assignee and his surety are bound by the lease and these rules to the same extent as if the assignee were the original lessee, notwithstanding any conditions in the assignment to the contrary; however, the assignor-lessee remains liable for rentals and royalties due and damages accruing prior to the effective date of the assignment. (3-20-20)T

**04. Segregation of Assignment.** If an assignment partitions leased lands between two (2) or more persons, it must clearly segregate the assigned and retained portions of the leasehold. Resulting segregated leases continue in full force and effect for the balance of the ten-year term of the original lease or as further extended

pursuant to these rules.

(3-20-20)T

**05. Joint Principal.** Where an assignment does not segregate the record title to the lease, the assignee, if the assignment so provides, may become a joint principal on the bond with the assignor. The application must be accompanied by a consent of assignor's surety to remain bound under the bond of record, if the bond by its terms does not contain such consent. If a party to the assignment has previously furnished a statewide bond, no additional showing by such party is necessary as to the bond requirement.

(3-20-20)T

**06. Form of Assignment.** An assignment is a valid legal instrument, properly executed and acknowledged, setting forth the number of the lease, a legal description of the land involved, the name and address of the assignee, the interest transferred and the consideration. A fully executed copy of the instrument of assignment must be filed with the application for approval pursuant to Subsection 060.07. An assignment may affect or concern more than one (1) lease.

(3-20-20)T

**07. Application.** The application for approval of an assignment must be submitted in duplicate on forms of the Department or exact copies of such forms. The "lessee/assignee of record" must be designated in accordance with Subsection 010.11. If payments out of production are reserved, a statement must be submitted stating the amount, method of payment, and other pertinent items. The statement must be filed with the Department no later than fifteen (15) days after the filing of the application for approval.

(3-20-20)T

**08. Denial.** The Director may deny an application for assignment if the lessee or the assignee is delinquent in payment of rentals or royalties or otherwise has violated these rules.

(3-20-20)T

**09. Fee.** All applications for approval of assignment must be accompanied by the fee required by Section 120.

(3-20-20)T

**061. -- 069. (RESERVED)**

**070. SURRENDER - RELINQUISHMENT.**

**01. Procedure.** The lessee may surrender its lease or any surveyed subdivision of the area covered by such lease, by filing a written relinquishment with the Department, provided that a partial relinquishment does not reduce the remaining acreage in the lease to less than forty (40) acres or a government lot, whichever is less. The Director may waive the minimum acreage provision of this rule if he finds it is justified on the basis of exploratory and development data derived from activity on the leasehold.

(3-20-20)T

**02. Effective Date.** A relinquishment takes effect thirty (30) days after it is received by the Department. Thereafter the lessee is relieved of liability under these rules except for the continued obligation of the lessee and his surety to:

(3-20-20)T

- a.** Make payments of all accrued rentals and royalties; (3-20-20)T
- b.** Place all wells on the land to be relinquished in condition for suspension of operations or abandonment; (3-20-20)T
- c.** Comply with all rules of the commission for plugging of abandoned wells; (3-20-20)T
- d.** Comply with applicable laws and rules of the Department of Water Resources; and (3-20-20)T
- e.** Reclaim the surface and natural resources in accord with these rules. (3-20-20)T

**03. Partial Surrender.** In the event of a partial surrender of the land covered by such lease, the annual rental thereafter payable will be reduced proportionately.

(3-20-20)T

**071. TERMINATION - CANCELLATION OF LEASE.**

- 01. Cause.** Except as otherwise provided in these rules, the Director may terminate the lease for any

substantial violation of these rules, the lease, or the rules of the commission, ninety (90) days after notice of the violation has been given to lessee by personal service or by certified mail to the lessee, unless: (3-20-20)T

a. The violation has been corrected; or (3-20-20)T

b. The violation is one that cannot be corrected within the notice period and the lessee has in good faith commenced within the notice period to correct the violation and proceeds diligently to complete corrective action within a time period set by the Director. If sent by certified mail, such notice will be deemed served upon mailing. (3-20-20)T

**02. Surrender After Termination.** Upon the expiration or termination of the lease, the lessee will quietly and peaceably surrender possession of the premises to the state. Thereafter, lessee's obligations under these rules that have accrued prior to the date of expiration or termination continue in full force and effect. (3-20-20)T

**03. Other Wells.** Default by the lessee in the performance of any of the conditions or provisions of the lease concerning a well or wells on any legal subdivision of the leasehold do not affect the right of the lessee to continue the possession or operation of any other well or wells, situated upon any other legal subdivision of the leasehold. The term "legal subdivision" as herein used means a subdivision as established by the United States land survey that most nearly approximates in size the area allocated to one well under any approved well spacing program; provided that if no special program has been approved, "legal subdivision" means the parcel upon which such well is located, but in any event not less than forty (40) acres surrounding such well. Where such a default involving one (1) or more wells results in cancellation, and the lessee has other wells on the lease not in default, such cancellation will result in the division of the defaulting acreage from the lease and resultant reduction in the size of the lease held by the lessee. (3-20-20)T

**04. Equipment Removal.** Upon the expiration of the lease, or its earlier termination or surrender pursuant to these rules, the lessee must, within a period of ninety (90) days, remove from the premises all materials, tools, appliances, machinery, structures. Equipment subject to removal but not removed within the ninety (90) day period or any extension that may be granted because of adverse climatic conditions during that period, may, at the option of the Director, become property of the state of Idaho, or the Director may cause the property to be removed at the lessee's expense. (3-20-20)T

**072. -- 079. (RESERVED)**

**080. BOND REQUIREMENTS.**

**01. Minimum Bond.** Prior to entry with motorized exploration equipment upon leased lands, the surface of which has been sold or leased, the lessee must submit to the Director a corporate surety bond or collateral bond in the amount of one thousand dollars (\$1,000) in favor of the state of Idaho conditioned upon the payment of all damages to the surface that result from the lessee's operation. Prior to entry upon the leased land with drilling equipment or prior to commencing any construction in preparation for drilling upon leased lands, the lessee must submit to the Director a corporate security bond or collateral bond in the amount of six thousand dollars (\$6,000) in favor of the state of Idaho bond will be conditioned upon compliance with the lease, these rules, the removal of all materials, etc. per Subsection 071.04, and the payment of all damages to the land surface and all improvements thereon, including crops, which result from the lessee's operation, regardless of whether the lands under this lease have been sold or leased by the Board for any other purpose. This bond is in addition to the drilling bond pursuant to commission rules. This rule notwithstanding, the oil and gas lessee may be required on a case-by-case basis to post a bond in excess of six thousand dollars (\$6,000) to protect a surface lessee's or surface owner's interests pursuant to Section 47-708, Idaho Code. (3-20-20)T

**02. Statewide Bond.** In lieu of the aforementioned bonds, the lessee may furnish a good and sufficient "statewide" bond conditioned as above in the amount of fifty thousand dollars (\$50,000) in favor of the state of Idaho to cover all lessee's leases and operations carried on under these rules. (3-20-20)T

**03. Period of Liability.** The period of liability of any bond is not be terminated until all obligations under the lease and these rules have been fulfilled and the bond is released in writing by the Director. (3-20-20)T



**04. Form of Performance Bond.** (3-20-20)T

**a.** Corporate surety bond means an indemnity agreement executed by or for the lessee and a corporate surety licensed to do business in the state of Idaho on an oil and gas lease bond form supplied by the Department conditioned in accord with Subsection 080.01, and payable to the state of Idaho. (3-20-20)T

**b.** Collateral bond means an indemnity agreement executed by or for the lessee and payable to the state of Idaho, pledging cash deposits, negotiable bonds of the United States, state or municipalities, or negotiable certificates of deposit of any bank doing business in the United States. Collateral bonds are subject to the following conditions: The Department obtains possession and deposits such with the state treasurer. The Department will value collateral at its current market value, not face value. Certificates of deposit are made payable to the "State of Idaho or the lessee." Amount of an individual certificate may not exceed the maximum amount insured by the Federal Deposit Insurance Corporation or Federal Savings and Loan Insurance Corporation or their successors. Banks issuing such certificates waive all rights of set-off or liens that they have of may have against such certificates. Any such certificates are automatically renewable. The certificate of deposit must be of sufficient amount to ensure that the Department would be able to liquidate such certificates prior to maturity, upon forfeiture, for the amount of the required bond including any penalty for early withdrawal. (3-20-20)T

**05. Bond Cancellation.** Any surety company or indemnitor canceling a bond must give the Department at least sixty-days' (60) notice prior to cancellation. The Department will not release a surety or indemnitor from liability under existing bonds until the lessee has submitted to the Department an acceptable replacement bond. Such replacement bond must cover any liability accrued against the bonded principal on the lease covered by the previous bond. (3-20-20)T

**06. Surety License.** If the license to do business in Idaho of any surety is suspended or revoked, the lessee must find a substitute for such surety within thirty (30) days after notice by the Department. If the lessee fails to secure a substitute surety, he must cease operation upon the lease. The substitute surety must be licensed to do business in Idaho. (3-20-20)T

**07. Form.** All bonds furnished must be on the Department bond form or exact copy of it. (3-20-20)T

**081. -- 089. (RESERVED)**

**090. UNIT OR COOPERATIVE PLANS OF DEVELOPMENT OR OPERATION.**

**01. Unit Plan.** For the purpose of properly conserving the natural resources of any oil and gas pool, field or like area, the lessee may, with the written consent of the Director, commit the leased lands to a unit, cooperative or other plan of development or operation with other state, federal, Indian, or privately-owned lands. (3-20-20)T

**02. Contents.** An agreement to unitize must: describe the separate tracts comprising the unit; disclose the apportionment of the production of royalties and costs to the several parties; the name of the operation; and contain adequate provisions for the protection of the interests of all parties, including the state. The agreement must: be signed by or in behalf of those persons or entities having effective control of the geologic structure; submitted to the Director with the application to unitize; and effective only after approval by the Director. (3-20-20)T

**03. Interested Parties.** The owners of any right, title or interest in the oil and gas resources to be developed or operated under an agreement may be regarded as interested parties to a proposed unitization agreement. Signature of a party with only an overriding royalty interest in unnecessary. (3-20-20)T

**04. Collective Bond.** In lieu of separate bonds for each lease committed to a unit agreement, the unit operator may furnish and maintain a collective corporate surety bond or a collateral bond conditioned upon faithful performance of the duties and obligations of the agreement, the lease subject to the agreement and these rules. The liability under the bond will be for such amount the Director determines to be adequate to protect the interests of the state. If the unit operator is changed, a new bond or consent of surety to the change in principal under the existing bond must be filed within thirty (30) days of assignment. (3-20-20)T

**05. Lease Modification.** The terms of any lease included in any cooperative or unit plan of development or operation may be modified by the Director with approval of the lessee, except that a unit agreement must have final approval by the Director for a state cooperative plan or the final approval by the secretary of interior for a federal cooperative plan prior to extending any lease into its eleventh year and each year thereafter. A lease so extended expires two (2) years after the unit plan expires provided the lessee continues to pay the annual rental as outlined in Subsection 041.03. (3-20-20)T

**06. Rentals.** Rentals and royalties on leases so extended are at the rates specified in these rules. Advanced rental must be paid on or before the extended lease's anniversary date. Any unused portion of annual rental will not be refunded. (3-20-20)T

**07. Evidence of Agreement.** Before issuance of a lease for lands within an approved unit agreement, the lease applicant must file with the Department evidence that he has entered into an agreement with the unit operator for the development and operation of the lands in a lease, or a statement giving satisfactory reasons for the failure to enter into such agreement. If such statement is acceptable, the applicant will be permitted to operate independently but be required to perform its operations in a manner that the Director deems to be consistent with the unit operations. (3-20-20)T

**08. Segregation Prohibited.** A lease may not be segregated if any part thereof is included in a cooperative plan until the pool or field has been defined. Once defined, those areas outside the unit area or pool boundary can be surrendered as provided in Section 070. (3-20-20)T

**091. -- 094. (RESERVED)**

**095. LIABILITY INSURANCE; SPECIAL ENDORSEMENTS.**

**01. Liability Insurance Required.** Prior to entry upon the leased lands for any reason other than casual exploration or inspection pursuant to Section 021, the lessee must secure and maintain during the term of this lease, public liability, property damage, and products liability insurance in the sum of four hundred thousand dollars (\$400,000) for injury or death for each occurrence; in the aggregate sum of two million dollars (\$2,000,000) for injury or death; and in the sum of four hundred thousand dollars (\$400,000) for damages to property and products damages caused by any occupancy, use, operations of any other activity on leased lands carried on by the lessee, its assigns, agents, operators or contractors. The lessee must insure against explosion, blow out, collapse, fire, oil spill and underground hazards and submit evidence of such insurance to the Director. If the land surface and improvements thereon covered by the lease have been sold or leased by the state of Idaho, the owner or lessee of the surface rights and improvements will be an additional named insured. The state of Idaho is a named insured in all instances. This policy or policies of liability insurance must contain the following special endorsement:

“The state of Idaho, the Idaho State Board of Land Commissioners, the Director of the Department of Lands, the Department of Lands, (or other state agency exercising custody and control over the lands), and (herein insert name of owner or lessee of surface rights, if applicable) and the officers, employees and agents of each and every of the foregoing are additional insureds under the terms of this policy: Provided, however, these additional insureds shall not be insured hereunder for any primary negligence or misconduct on their part, but such additional insureds shall be insured hereunder for secondary negligence or misconduct, which shall be limited to failure to discover and cause to be corrected the negligence or misconduct of the lessee, its agents, operators or contractors. This insurance policy shall not be canceled without thirty (30) days prior written notice to the Idaho Department of Lands. None of the foregoing additional insureds is liable for the payment of premiums or assessments of this policy.”

No cancellation provision in any insurance policy is in derogation of the continuous duty of the lessee to furnish insurance during the term of this lease. Such policy or policies must be underwritten to the satisfaction of the Director. A signed complete certificate of insurance, with the endorsement required by this paragraph, must be submitted to the Director prior to entry upon the leased land with motorized exploration equipment after award of a lease and may be required prior to such entry under Rule 021. (3-20-20)T

**02. Certificate of Insurance.** At least thirty (30) days prior to the expiration of any such policy, a signed complete certificate of insurance, with the endorsement required by Subsection 095.01, showing that such insurance coverage has been renewed or extended, must be filed with the Director. (3-20-20)T

**096. HOLD HARMLESS.**

The state of Idaho, the Board, the Director, the Department, and any other state agency that may have custody or control of the leased lands, and the owner of the surface rights and improvements, if not the state of Idaho, or state lessee of surface rights, if there be one, the officers, agents and employees of each of the foregoing, are free from any and all liabilities and claims for damages and/or suits for or by reason of death or injury to any person or damage of property of any kind whatsoever, caused by a negligent or otherwise wrongful act or omission of the lessee, its assigns, agents, operators, employees or contractors; and lessee covenants and agrees to indemnify and to save harmless the state of Idaho, the Board, the Director, the Department, or other state agency, or the lessee of surface rights if there be one, and their officers, agents, and employees from all liabilities, charges, expense, including attorney fees, claims, suits or losses caused by a negligent or otherwise wrongful act or omission of the lessee, its assigns, agents, operators, employees or contractors. The lessee's signature to a lease under these rules constitutes express agreement to this rule. (3-20-20)T

**097. -- 099. (RESERVED)**

**100. TITLE.**

The state of Idaho does not warrant title to the leased lands or the oil and gas resources that may be discovered thereon; the lease is issued only under such title as the state of Idaho may have as of the effective date of the lease or thereafter acquires. (3-20-20)T

**101. IMPOSSIBILITY OF PERFORMANCE.**

Whenever, as a result of any act of God, or law, order or regulation of any governmental agency, it becomes impossible for the lessee to perform or to comply with any obligation under the lease or these rules, other than payment of rentals or royalties, the Director in his discretion, may by written order excuse lessee from damages or forfeiture of the lease, and the lessee's obligations may be suspended and the term of the lease may be extended provided that the Director finds that good cause exists. (3-20-20)T

**102. TAXES.**

The lessee pays, when due, all taxes and assessments of any kind lawfully assessed and levied against the lessee's interest or operations under the laws of the state of Idaho. (3-20-20)T

**103. -- 119. (RESERVED)**

**120. FEES.**

**01. Exploration Permit.** One hundred dollars (\$100) per linear mile or a minimum of one hundred dollars (\$100) per section. (3-20-20)T

**02. Nonrefundable Nomination Fee.** The nomination fee is set by the Board at a minimum of two hundred fifty dollars (\$250) per tract. (3-20-20)T

**03. Processing Fee.** The processing fee is set by the Board at a minimum of one hundred dollars (\$100) per each document. (3-20-20)T

**04. Fee Adjustment.** The Board may annually adjust these fees without formal rulemaking procedures. (3-20-20)T

**121. -- 999. (RESERVED)**

**20.03.17 – RULES GOVERNING LEASES ON STATE-OWNED SUBMERGED  
LANDS AND FORMERLY SUBMERGED LANDS**

**000. LEGAL AUTHORITY.**

This Chapter is adopted under the legal authorities of Title 58, Chapter 1, Idaho Code, Sections 58-104(6), 58-104(9), and 58-105; Title 58, Chapter 3, Idaho Code, Sections 58-304 through 58-312; Title 58, Chapter 6, Idaho Code; Title 58, Chapter 12; and Title 67, Chapter 52, Idaho Code. (3-20-20)T

**001. TITLE AND SCOPE.**

**01. Title.** These rules are titled IDAPA 20.03.17, “Rules Governing Leases on State-Owned Submerged Lands and Formerly Submerged Lands.” (3-20-20)T

**02. Scope.** These rules govern the issuance of leases on state-owned submerged lands. (3-20-20)T

**a.** These rules also apply to state-owned islands raised from submerged lands, or filled submerged lands, or other formerly submerged lands that are no longer covered by water at any time during an ordinary year. (3-20-20)T

**b.** While the State asserts the right to issue leases for all encroachments, navigational or non-navigational, upon, in or above the beds or waters of navigable lakes and rivers, nothing in these rules may be construed to vest in the state of Idaho any property, right or claim of such right to any private lands lying above the natural or ordinary high water mark of any navigable lake or river. (3-20-20)T

**002. ADMINISTRATIVE APPEALS.**

Any person aggrieved by any final decision or order of the Board is entitled to judicial review pursuant to the provisions of Title 67, Chapter 52, Idaho Code, and IDAPA 20.01.01, “Rules of Practice and Procedure Before the State Board of Land Commissioners.” (3-20-20)T

**003. -- 009. (RESERVED)**

**010. DEFINITIONS.**

**01. Artificial High Water Mark.** The high water elevation above the natural or ordinary high water mark resulting from construction of man-made dams or control works and impressing a new and higher vegetation line. (3-20-20)T

**02. Board.** The Idaho State Board of Land Commissioners or its designee. (3-20-20)T

**03. Commercial Marina.** A commercial navigational encroachment whose primary purpose is to provide moorage for rental or for free to the general public. (3-20-20)T

**04. Commercial Navigational Encroachment.** A navigational encroachment used for commercial purposes. (3-20-20)T

**05. Community Dock.** A structure that provides private moorage for more than two (2) adjacent littoral owners, or other littoral owners possessing a littoral common area with littoral rights including, but not limited to, homeowners’ associations. No public access is required for a community dock. (3-20-20)T

**06. Department.** The Idaho Department of Lands or its designee. (3-20-20)T

**07. Director.** The director of the Idaho Department of Lands or his designee. (3-20-20)T

**08. Dock Surface Area.** Includes docks, slips, piers, and ramps and is calculated in square feet. Dock surface area does not include pilings, submerged anchors, or undecked breakwaters. (3-20-20)T

**09. Encroachments in Aid of Navigation.** Includes docks, piers, jet ski and boat lifts, buoys, pilings, breakwaters, boat ramps, channels or basins, and other facilities used to support water craft and moorage on, in, or above the beds or waters of a navigable lake, river or stream. The term “encroachments in aid of navigation” may be used interchangeably herein with the term “navigational encroachments.” (3-20-20)T

**10. Encroachments Not in Aid of Navigation.** Includes all other encroachments on, in, or above the beds or waters of a navigable lake, river or stream, including landfills, bridges, utility and power lines, or other

structures not constructed primarily for use in aid of navigation. It also includes float homes and floating toys. The term “encroachments not in aid of navigation” may be used interchangeably herein with the term “non-navigational encroachments.” (3-20-20)T

**11. Formerly Submerged Lands.** The beds of navigable lakes, rivers, and streams that have either been filled or subsequently became uplands because of human activities including construction of dikes, berms, and seawalls. Also included are islands that have been created on submerged lands through natural processes or human activities since statehood, July 3, 1890. (3-20-20)T

**12. Market Value.** The most probable price at a specified date, in cash, or on terms reasonably equivalent to cash, for which the property should bring in a competitive and open market under all conditions requisite to a fair sale, the buyer and seller each acting prudently and knowledgeably, and assuming the price is not affected by undue stimulus. (3-20-20)T

**13. Natural or Ordinary High Water Mark.** The line that the water impresses upon the soil by covering it for a sufficient period of time to deprive the soil of its vegetation and destroy its value for agricultural purposes. If, however, the soil, configuration of the surface, or vegetation has been altered by man’s activity, the ordinary high water mark is located where it would have been if the alteration had not occurred. (3-20-20)T

**14. Person.** A partnership, association, corporation, natural person, or entity qualified to do business in the state of Idaho and any federal, state, tribal, or municipal unit of government. (3-20-20)T

**15. Riparian or Littoral Rights.** The rights of owners or lessees of land adjacent to navigable lakes, rivers or streams to maintain their adjacency to the lake, river, or stream and to make use of their rights as riparian or littoral owners or lessees in building or using aids to navigation but does not include any right to make any consumptive use of the waters. (3-20-20)T

**16. Single-Family Dock.** A structure providing noncommercial moorage that serves one (1) waterfront owner whose waterfront footage is no less than twenty-five (25) feet. (3-20-20)T

**17. Submerged Lands.** The state-owned beds of navigable lakes, rivers, and streams below the natural or ordinary high water marks. (3-20-20)T

**18. Two-Family Dock.** A structure providing noncommercial moorage that serves two (2) adjacent waterfront owners having a combined waterfront footage of no less than fifty (50) feet. Usually the structure is located on the common littoral property line. (3-20-20)T

**19. Upland.** The land bordering on navigable lakes, rivers, and streams. (3-20-20)T

**011. -- 019. (RESERVED)**

**020. APPLICABILITY.**

Leases are required for all encroachments on, in, or over state-owned submerged land except: (3-20-20)T

**01. Single -Family or Two-Family Docks.** Single-family or two-family docks that were constructed on or before July 1, 1993, that occupy less than eleven hundred (1,100) square feet of dock surface area lakeward of the ordinary high water mark, and for which all required permits and approvals have been obtained. (3-20-20)T

**02. Single-Family Docks.** Single-family docks that were constructed after July 1, 1993, that occupy less than seven hundred (700) square feet of dock surface area lakeward of the ordinary high water mark, and for which all required permits and approvals have been obtained. (3-20-20)T

**03. Two-Family Docks.** Two-family docks that were constructed after July 1, 1993, that occupy less than eleven hundred (1,100) square feet of dock surface area lakeward of the ordinary high water mark, and for which all required permits and approvals have been obtained. (3-20-20)T

**04. Encroachments Free to the Public.** Encroachments in aid of navigation for which the complete

use is offered free to the public. (3-20-20)T

**05. Temporary Permits or Easements.** Uses or encroachments that are customarily authorized by temporary permits or easements, such as roads, railroads, overhead utility lines, submerged cables, and pipelines. Information on easements can be found in IDAPA 20.03.09, “Easements on State-Owned Submerged Lands and Formerly Submerged Lands.” (3-20-20)T

**021. -- 024. (RESERVED)**

**025. POLICY.**

**01. Policy of the State of Idaho.** It is the policy of the state of Idaho to regulate and control the use and disposition of lands in the beds of navigable lakes, rivers and streams to the natural or ordinary high water mark thereof, so as to provide for their commercial, navigational, recreational or other public use; provided that the Board will take no action in derogation of or seeking to interfere with the riparian or littoral rights of the owners of upland property abutting or adjoining such lands. (3-20-20)T

**02. Director May Grant Leases.** The Director may grant leases for uses that are in the public interest and consistent with these rules. (3-20-20)T

**03. Requests or Inquiries Regarding Navigability.** The State owns the beds of all lakes, rivers, and streams that were navigable in fact at statehood. The Department will respond to requests or inquiries as to which lakes, rivers, and streams are deemed navigable in fact. Additional information about streams deemed navigable by the State of Idaho is available from the Department. (3-20-20)T

**04. Stream Channel Alteration Permit or Encroachment Permit.** Issuance of a lease is contingent upon the applicant obtaining a stream channel alteration permit if required by the Idaho Department of Water Resources, pursuant to Title 42, Chapter 38, Idaho Code, or an encroachment permit if required by the Department pursuant to the Lake Protection Act, Title 58, Chapter 13, Idaho Code, and compliance with local planning and zoning regulations if applicable. (3-20-20)T

**05. Other Permits and Licenses.** Issuance of a lease does not relieve an applicant from acquiring other permits and licenses that are required by law. (3-20-20)T

**06. Submerged Lands Lease Required Upon Notification.** All persons using submerged lands in a manner that requires a submerged land lease must obtain such a lease from the Director when notified to do so. (3-20-20)T

**07. Term of Lease, Renewal of Lease.** Leases are issued for a term of ten (10) years or as determined by the Board. Leases may be renewed for additional periods to be determined by the Department based upon satisfactory performance during the present term. Renewals will be processed with a minimum of procedural requirements and will not be denied except in the most unusual circumstances or noncompliance with the terms and conditions of the previous lease. Lease renewals are initiated by the Department. (3-20-20)T

**08. Director’s Authorization to Issue and Renew Leases.** The Director is authorized to issue and renew leases for the use of submerged lands in accordance with these rules. (3-20-20)T

**09. Rights Granted.** The lease grants only such rights as are specified in the lease. The right to use the submerged or formerly submerged lands for all other purposes that do not interfere with the rights authorized in the lease remains with the state. (3-20-20)T

**10. Rules Applicable to All Existing and Proposed Uses and Encroachments.** These rules apply to all existing and proposed uses and encroachments, whether or not authorized by permit under the Lake Protection Act, Title 58, Chapter 13, Idaho Code, or the Stream Channel Protection Act, Title 42, Chapter 38, Idaho Code. These rules provide that a lease may be required in addition to existing permits. See Section 020 of these rules for information about exceptions to lease requirements. (3-20-20)T

**11. Waiver of Lease Requirements.** The Director may, in his discretion, waive lease requirements for single-family or two-family dock encroachments whose dock surface areas exceed square footages described in Subsections 020.01 through 020.03 of these rules when the additional dock surface area square footage is necessary to gain or maintain access to water of sufficient depth to sustain dock use for water craft customarily in use on that particular lake. (3-20-20)T

**12. Private Moorage at Commercial Marinas.** (3-20-20)T

**a.** This Subsection (025.12) does not apply to community docks. (3-20-20)T

**b.** Private moorage at commercial marinas is allowed as long as the requirements of IDAPA 20.03.04, “Rules for the Regulation of Beds, Waters, and Airspace Over Navigable Lakes in the State of Idaho,” Subsection 015.03 are met. (3-20-20)T

**c.** The sale, lease, or rental of private moorage is in no way an encumbrance on any underlying public trust land. All transactions related to private moorage are subject to the limitations of the associated submerged lands lease. (3-20-20)T

**d.** Acquisition of private moorage must be documented with a disclosure that the transaction does not convey public trust lands and only conveys the right to use the designated portion of the marina. (3-20-20)T

**e.** The Department will make no policy regarding the cost of private moorage and the resolution of disputes between the involved parties. (3-20-20)T

**026. -- 029. (RESERVED)**

**030. LEASE APPLICATION, FEE, AND PROCEDURE.**

**01. Fee.** The lease application fee is one hundred fifty dollars (\$150). (3-20-20)T

**02. Fee Is Required.** A lease application and nonrefundable fee is required for new and existing encroachments. A lease application fee is required for leases that are renewed upon expiration. (3-20-20)T

**03. Application to Lease and Fee.** The lease application and fee must be submitted with the information from Subsections 030.03.a. through 030.03.c., in sufficient detail for the Department to determine an appropriate lease rate based on numbers of slips, square footage, or other permit information: (3-20-20)T

**a.** A letter of request stating the purpose of the lease. (3-20-20)T

**b.** A scale drawing of the proposed lease area with plans detailing all intended improvements, including reference to the nearest known property corner(s). An encroachment permit may satisfy this requirement. (3-20-20)T

**c.** The permit number of each existing applicable encroachment permit. (3-20-20)T

**04. Submittal of Application to Lease and Fee.** The lease application and fee must be filed in the local office of the Department or the Director’s office. (3-20-20)T

**05. Notification of Approval or Denial.** The applicant will be notified in writing if the lease application is approved or denied. The applicant will also be notified of any additional requirements. (3-20-20)T

**06. Request for Reconsideration.** Any applicant aggrieved with the Director’s determination of rent or denial of a lease application may request reconsideration by the Director. (3-20-20)T

**031. -- 034. (RESERVED)**

**035. RENTAL.**

The rental rate policy for submerged land leases is set by the Board. This policy is available on the Department website at <http://www.idl.idaho.gov/>. (3-20-20)T

**01. Standardized Rental Rates.** The Board sets standard submerged land lease rental rates for common uses such as commercial marinas, community docks, floathomes, restaurants, and retail stores. Rental rates for commercial marinas and other uses that produce revenue for the lessee will commonly be calculated as a percentage of gross receipts, however, other methods may be used as determined appropriate by the Board. (3-20-20)T

**02. Nonstandard Rental Rates.** The Board directs the Department to use a percentage of market value or gross receipts, or other methods determined appropriate by the Board, as the submerged lands lease rental rate for uses that are uncommon, especially for non-navigational encroachments. (3-20-20)T

**036. YEARLY REPORTING.**

**01. Annual Report.** Lessees must provide an annual report to the Department that includes: (3-20-20)T

**a.** A schedule of moorage rental rates, including moorage sizes and types. (3-20-20)T

**b.** The number and size of all public boat and float home moorages. (3-20-20)T

**c.** The number and size of all private boat and float home moorages. (3-20-20)T

**d.** Current proof of insurance that is required by the lease. (3-20-20)T

**02. Failure to Report.** Failure to provide the annual report information is a violation of these rules. (3-20-20)T

**037. -- 039. (RESERVED)**

**040. LATE PAYMENT, EXTENSIONS OF PAYMENT.**

**01. Penalty for Late Payment of Rent.** Rent not paid by the due date is considered late. A penalty, calculated from the day after which payment was due, will be added to the rent. The penalty will be determined by the Board for the first month or any portion thereof and one percent (1%) of the rent due, including penalty, per month thereafter. (3-20-20)T

**02. Extension in Time for Payment of Rent.** An extension in time in which to submit payment of rent may be granted for commercial submerged lands leases only. Such extensions may not exceed two (2) successive years, as required by Title 58, Chapter 3, Idaho Code, Section 58-305. (3-20-20)T

**03. Request for Extension in Time for Payment of Rent.** Lessees must request extensions on forms supplied by the lessor and pay an extension fee to be determined by the Board. The lessee must also provide a statement from his banker or accountant verifying that money is not available for the payment of rent. (3-20-20)T

**04. Interest Rate for Extension in Time for Payment of Rent.** If an extension is granted, rent plus interest at a rate established by the Board will be due no later than October 1 of the rent year. Specifically, interest will be the average monthly rate for conventional mortgages as quoted in the Federal Reserve Statistical Report; the rate to be rounded downward to the nearest one quarter percent (1/4%) on the tenth of each month following the release of data. (3-20-20)T

**041. -- 044. (RESERVED)**

**045. APPRAISAL PROCEDURES.**

Appraisals may be used to determine the market value of adjacent uplands for calculating submerged lease rental rates. (3-20-20)T



**01. Appraisal.** An appraisal will either be performed by qualified Department staff or an independent contract appraisal. Any appraisal must be under the control of the Department. (3-20-20)T

**02. Cost of Appraisal.** The appraisal costs are the actual cost for Department personnel plus transportation, including per diem and administrative overhead, or the bid amount for the contract appraiser. An itemized statement of these costs will be provided to the applicant. The cost of the appraisal is in addition to those costs outlined in Section 035 of these rules and is billed separately from the application fee and rent. (3-20-20)T

**046. -- 049. (RESERVED)**

**050. LEASE MODIFICATION OR AMENDMENT.**

**01. Encroachment Amendment.** A lease modification or amendment must first be permitted through an amendment to the lake encroachment permit or stream alteration permit, if needed. (3-20-20)T

**02. Modification of Existing Lease.** Modification or amendment of an existing lease will be processed in the same manner as a new lease application, but no fee will be required. Modification or amendment includes change of use, location, size or scope of the lease site, but does not include ordinary maintenance, repair or replacement of existing structures or facilities. (3-20-20)T

**03. Modification of Interior Facilities.** If the proposed changes to a facility do not require a new encroachment permit, a lease modification may still be needed as described in Subsection 050.02 of these rules. The lessee must give written notice to the Department at least ten (10) days in advance of making such changes. The Department will determine if a lease modification is needed due to the proposed changes. When requested, the lessee must also furnish one (1) set of as-built plans to the Department within thirty (30) days following completion of changes. (3-20-20)T

**051. -- 054. (RESERVED)**

**055. ASSIGNMENTS, ASSIGNMENT FEE.**

**01. Assignment of Lease.** Leases may be assigned upon approval of the Director provided that the lease conforms with Subsection 025.02 and all other provisions of these rules. The assignor and assignee must complete the Department's standard assignment form and forward it to any Department office. (3-20-20)T

**02. Assignment Fee.** The assignment fee is one hundred fifty dollars (\$150). (3-20-20)T

**03. Permit Assignment.** The encroachment permit/stream alteration permit pertinent to a lease must be assigned to a purchaser simultaneously with a lease assignment. A lease assignment will not be approved unless the permit is assigned. (3-20-20)T

**04. Approval Required for Assignment.** An assignment is not valid until it has been approved by the Director. (3-20-20)T

**056. -- 059. (RESERVED)**

**060. CANCELLATION AND ADDITIONAL REMEDIES.**

**01. Cancellation of Lease for Violation of Terms.** Any violation of the terms of the lease by the lessee, including non-payment of rent or any violation by lessee of any rule now in force or hereafter adopted by the Board may subject the lease to cancellation. The lessee will be provided written notification of any violation. The letter will specify the violation, corrective action necessary, and specify a reasonable time to make the correction. If the corrective action is not taken within the specified reasonable period of time, the Department will notify the lessee of cancellation of the lease; provided, however, that the notice is provided to lessee no later than thirty (30) days prior to the effective date of such cancellation. (3-20-20)T

**02. Reinstatement of Lease.** A lease may be reinstated within ninety (90) days after cancellation for non-payment by paying the rental, plus interest, and a reinstatement fee to be determined by the Board. (3-20-20)T

**03. Cancellation of Lease for Use Other Than Intended Purpose.** A lease not used for the purpose for which it was granted may be canceled. The Department will notify the lessee in writing of any proposed cancellation. The lessee has thirty (30) days to reply in writing to the Department to show cause why the lease should not be canceled. Within sixty (60) days, the Department will notify the lessee in writing as to the Department's decision concerning cancellation. The lessee has thirty (30) days to appeal an adverse decision to the Director. (3-20-20)T

**04. Removal of Improvements Upon Cancellation.** Upon cancellation, the Director will provide the lessee with a specific amount of time, not to exceed six (6) months from the date of final notice, to remove any facilities and improvements. Failure to remove any facilities or structures within such time period established by the Director will be deemed a trespass on submerged or formerly submerged lands. (3-20-20)T

**05. Additional Remedies Available.** In addition to termination of the lease for the material default of the lessee, the lease may provide for other remedies to non-monetary breach of the lease including, but not limited to: (3-20-20)T

**a.** Civil penalties as determined by the Board and to be collected as additional rent; (3-20-20)T

**b.** The reasonable costs of remedial action undertaken by the Department as a result of the lessee's failure to perform a requirement of the lease. These costs will be collected as additional rent; and (3-20-20)T

**c.** Such other remedies as the Board deems appropriate. (3-20-20)T

**061. -- 064. (RESERVED)**

**065. BOND.**

**01. Bond Requirement Determined by Director.** Bonds may be required for commercial navigational, community dock, and nonnavigational leases. The need for bond will be at the discretion of the Director who will consider the potential for abandonment of the facility, harm to state-owned submerged land and water resources, the personal and real property of adjacent upland owners and the personal and real property owned by the encroachment owner that is appurtenant to and supportive of the encroachment. (3-20-20)T

**02. Performance Bond.** In the event a bond is necessary, the lessee must submit a performance bond in favor of the state of Idaho and in a format acceptable to the Director before a lease is issued. Acceptable bonds include surety, collateral, and letters of credit. The amount of bond is the estimated cost of restoration as established by the Director in consultation with the lease applicant on a case by case basis. To determine restoration costs, the Director may consider the potential for damage to land, to improvements, and the cost of structure removal. (3-20-20)T

**066. -- 069. (RESERVED)**

**070. LIABILITY AND INDEMNITY.**

A lessee will indemnify and hold harmless the lessors, its departments, agencies and employees for any and all claims, actions, damages, costs, and expenses that may arise by reason of lessee's occupation of the leased premises, or the occupation of the leased premises by any of the lessee's agents, or by any person occupying the same with the lessee's permission. (3-20-20)T

**071. -- 074. (RESERVED)**

**075. OTHER RULES AND LAWS.**

The lessee will comply with all applicable state, federal, and local rules and laws insofar as they affect the use of the lands described in the lease. (3-20-20)T

**076. -- 079. (RESERVED)**

**080. BINDING ON HEIRS.**

All of the terms, covenants, and conditions in a state lease are binding upon the heirs, executors, and assigns of the lessee. (3-20-20)T

**081. -- 084. (RESERVED)**

**085. CIVIL RIGHTS.**

The lessee may not discriminate against any person on the basis of such person's race, creed, color, sex, national origin or handicap. (3-20-20)T

**086. -- 999. (RESERVED)**

## 20.04.02 – RULES PERTAINING TO THE IDAHO FORESTRY ACT AND FIRE HAZARD REDUCTION LAWS

### 000. LEGAL AUTHORITY.

These rules are adopted pursuant to the rulemaking authority granted in Sections 38-132 and 38-402, Idaho Code. (3-20-20)T

### 001. TITLE AND SCOPE.

01. **Title.** These rules are titled IDAPA 20.04.02, “Rules Pertaining to the Idaho Forestry Act and Fire Hazard Reduction Laws.” (3-20-20)T

02. **Scope.** These rules implement the provisions of the Idaho Forestry Act and Fire Hazard Reduction Laws. (3-20-20)T

### 002. -- 009. (RESERVED)

### 010. DEFINITIONS.

Unless otherwise required by context, as used in these rules: (3-20-20)T

01. **Agreement.** The Certificate of Compliance-Fire Hazard Management Agreement (Department of Lands Form 715) required by Section 38-122, Idaho Code. (3-20-20)T

02. **Contract Area.** The legal description of the land given on the agreement. (3-20-20)T

03. **Contractor.** The person who enters into the Certificate of Compliance-Fire Hazard Management Agreement. (3-20-20)T

04. **Department.** The Idaho Department of Lands. (3-20-20)T

05. **Director.** The Director of the Idaho Department of Lands or his authorized representative. (3-20-20)T

06. **District.** A designated forest protective district. (3-20-20)T

07. **Fire Line.** A line dug to mineral soil which is intended to control a fire. (3-20-20)T

08. **Fire Warden.** A duly appointed fire warden or deputy. (3-20-20)T

09. **Fuel.** Any slash or woody debris that will contribute to the spread or intensity of a wildfire. (3-20-20)T

10. **Fuel Break.** An area in which all slash and dead woody debris have been removed or piled and burned. (3-20-20)T

11. **Hazard Reduction.** The burning or physical reduction of fire hazards by treatment in a manner that will reduce the intensity and/or spread of a wildfire after treatment is completed. (3-20-20)T

12. **Initial Purchaser or Purchaser.** The first person, company, partnership, corporation or association of whatever nature who purchases a forest product after it is harvested. (3-20-20)T

13. **Operational Period.** A standard twelve (12) hour fire control shift. (3-20-20)T

14. **Slash or Slashing.** Brush, severed limbs, poles, tops and/or other waste material incident to such cutting or to the clearing of land, which are four (4) inches and under in diameter. However, for the purpose of these rules and to correspond with standard fire classifications, slash will only include material less than or equal to three (3) inches in diameter. (3-20-20)T

15. **Slash Load.** Slash resulting from timber harvesting that has occurred under a current agreement, exclusive of natural mortality. (3-20-20)T

16. **State.** The state of Idaho. (3-20-20)T

**011. -- 029. (RESERVED)**

**030. CERTIFICATE OF COMPLIANCE-FIRE HAZARD MANAGEMENT AGREEMENT.**

**01. Contents.** A Certificate of Compliance-Fire Hazard Management Agreement must be obtained by anyone who conducts an operation involving the harvesting of forest products or potential forest products. Such Agreement provides the option of entering into a contract as provided in Section 38-404, Idaho Code or posting of a cash or surety bond to the State. The Certificate of Compliance required by Section 38-122, Idaho Code, must be in substantially the same form as Department of Lands Form No. 715 -- "Certificate of Compliance-Fire Hazard Management Agreement." (3-20-20)T

**02. Period of Time.** The period set forth within the Agreement is based upon such considerations as the size of the contract area, the volume of the timber to be harvested or the silvicultural objectives of the landowner. However, in no case may a single Agreement exceed a period of twenty four (24) months unless the contractor and the fire warden mutually agree upon a plan for the timely abatement of the hazard during a period that may exceed twenty four (24) months. (3-20-20)T

**03. Extensions.** If the contractor cannot meet the standard required to obtain a clearance within the period specified above, the contractor may apply to the fire warden for an extension. The application must be in writing, received at the district office thirty (30) working days before the Agreement expires, and show good reason other than financial hardship, why an extension should be given. The fire warden will acknowledge receipt of the request prior to the expiration of the Agreement. (3-20-20)T

**04. Responsibility.** The contractor named in the Agreement will be responsible for managing the fire hazard created by the harvesting and will receive the clearance if the slash treatment meets standards, or will carry the liability for suppressing wildfire for five (5) full years following the expiration of the Agreement. (3-20-20)T

**031. -- 039. (RESERVED)**

**040. ADDENDUM TO CERTIFICATE OF COMPLIANCE-FIRE HAZARD MANAGEMENT AGREEMENT.**

In those instances where a contractor indicates an intent to accomplish only the piling portion of the total slash hazard reduction job, an addendum to the Agreement must be executed specifying precisely the portion of slash withholding money that will be refunded. The addendum must be in substantially the same form as Department of Lands Form No. 715.1 -- "Addendum to Certificate of Compliance-Fire Hazard Management Agreement." (3-20-20)T

**041. -- 049. (RESERVED)**

**050. BOND.**

**01. Amount of Bond.** The bond specified in Section 38-122 and Section 38-404, Idaho Code, must be in the amount of four dollars (\$4) per thousand board feet (MBF), or equivalent measure as shown in Table I below, of forest products harvested, and may take the form of cash, surety bond or irrevocable letter of credit. Surety bonds must be in substantially the same form as Department of Lands Form No. 707 - "Bond." (3-20-20)T

**02. Rates.** Rates and amounts listed in Table I will be used as a minimum in calculating hazard reduction bonds for products cut from all state and private lands in Idaho.

TABLE I	
PRODUCT	BOND RATE
(1) MBF Measurement	
All Products	\$4.00 MBF
OR	

<b>TABLE I</b>	
<b>PRODUCT</b>	<b>BOND RATE</b>
(2) Other Measurement	
Green pulp, stud timber, etc.	\$2.00 Cord
Lineal Foot Measure	
Utility poles and pilings, all species	\$.014 LF
Stulls, corral poles, cellar timbers, fence rails, round posts	\$.01 LF
Piece Measure	
100 inch bolt material	\$.08 ea.
Split posts	\$.02 ea.
Tree stakes	\$.02 ea.
Shake boards	\$.02 ea.
Ton Measurement	
Green or Dead Pulp, Chips, etc.	\$.70 Ton

(3-20-20)T

**03. Exceeding Minimum Bond.** The minimum bond rate will only be exceeded when the landowner or operator requests that higher rate to accomplish additional hazard reduction. (3-20-20)T

**051. -- 059. (RESERVED)**

**060. CONTRACTS WITH FOREST LANDOWNERS OR OPERATORS.**

Forest landowners and operators who engage in timber harvesting operations may enter into an optional Agreement with the Director as provided in Section 38-404, Idaho Code. Under the terms of such an optional Agreement, the Director may assume all responsibility for the management and reduction of fire hazards to be created in return for a stipulated amount to be paid to the Director by the landowner or operator. Such optional Agreement must be in substantially the same form as Department of Lands Form No. 720 -- "Contract for Management, Reduction and/or Removal of Fire Hazards Created by the Harvesting of Timber Within the State of Idaho," or Department of Lands Form No 725 - "Contract for Management of Fire Hazards Created By the Harvesting of Timber Within the State of Idaho." (3-20-20)T

**061. -- 069. (RESERVED)**

**070. CASH BOND RELEASE.**

Contractors who elect under Section 38-122, Idaho Code, to have hazard reduction money withheld, but who do not intend to dispose of the hazard themselves, must release the withheld monies to the Director of the Department of Lands. Such release must be in substantially the same form as Department of Lands Form No. 761 -- "Release of Cash Bond Withheld to Assure Slash Disposal." (3-20-20)T

**071. -- 079. (RESERVED)**

**080. ADDED PROTECTION IN LIEU OF HAZARD REDUCTION.**

As provided in Section 38-401, Idaho Code, fire hazard management methods may include or be limited to the taking of additional protective measures in lieu of actual disposal of the slash hazard. Any funds coming into district hazard management accounts through contract, cash bond release or forfeiture, may be used for added protection provided that the expenditure meets specifications outlined in Section 38-401, Idaho Code. (3-20-20)T

**081. -- 089. (RESERVED)**

**090. PURCHASER REQUIREMENTS.**

**01. Initial Purchaser.** Initial purchasers of forest products, in accordance with Section 38-122, Idaho Code, must withhold and remit to the State slash management monies as appropriate for the slash management option chosen by the contractor. Such option must be clearly identified on the purchaser's copy of the Agreement. Slash monies withheld in any one (1) calendar month must be remitted to the Director on or before the end of the next calendar month. Such remittance must be in substantially the same form as Department of Lands Form No. 740 -- "Hazard Reduction Payment Record." (3-20-20)T

**02. Duty of Initial Purchaser.** Initial purchasers of forest products must make certain that all contractors from whom they purchase forest products have obtained a proper Agreement. (3-20-20)T

**091. -- 099. (RESERVED)**

**100. INJUNCTION AGAINST FURTHER CUTTING.**

Any person who cuts timber or other forest products of any kind, without having first secured an Agreement in accordance with Section 38-122, Idaho Code, may be enjoined from continuing such cutting and will be required to immediately dispose of all slash created. If the person responsible fails to properly dispose of the slash within thirty (30) days after being notified to do so, the State may dispose of the slash and such costs of disposal, plus twenty percent (20%) as a penalty, may be collected as a prior lien against the products harvested. (3-20-20)T

**101. -- 109. (RESERVED)**

**110. BURNING OF SLASH.**

**01. Permits.** Any burning operation conducted for the purpose of hazard reduction must be in accordance with the law requiring burning permits during the closed fire season. Persons conducting burning operations must have sufficient men, tools and equipment on hand to immediately stop the uncontrolled spread of any fire. Burning operations must be planned, prepared and executed in such a manner that forest resources are not damaged and air quality standards are met. (3-20-20)T

**02. Burn Plan.** Burning of specifically designated blocks or areas of forest land for any purpose must be conducted in accordance with a prescribed burn plan approved by the fire warden in whose area of responsibility the burn occurs. (3-20-20)T

**111. -- 119. (RESERVED)**

**120. STANDARDS -- TREATMENT OF HAZARDS.**

**01. Purpose.** To provide standards for hazard reduction and the release of liability for the contractor who is working under a valid Agreement with the State. (3-20-20)T

**02. Reduction of Total Hazard Points.** The contractor must reduce the total hazard points charged against the contract area to five (5) points or less (see Table II) on or before the expiration date on the Agreement in order to receive a refund of slash monies withheld (less three (3) percent for the fire suppression fund, ref. Rule150) or, to clear any demands that might be made against the surety bond and to receive a release of liability against any fires that start on or pass through the contract area.

<b>TABLE II - HAZARD CHARACTERISTICS AND OFFSET SLASH LOAD MAXIMUM 20 POINTS</b>	
<b>RATING (POINTS)</b>	<b>ADJECTIVE DESCRIPTION</b>
LOW (0-5)	Associated with low harvest volumes per acre such as; selection cutting, light commercial thinning, sanitation/salvage operations, tree length skidding with tops and limbs and little or no breakage. Slash is broken up; slash is in many islands over the operating area.
MODERATE (6-10)	Operation types similar to those listed above except that harvest volume per acre is higher or utilization standards are lower, or timber has higher proportion of unusable top and crown (commonly associated with partial cutting in second growth stands of mixed timber). Most diameter limit cutting falls in this category. Slash is distributed with some clear or very light areas intermingled with heavy islands of slash over the operating area, slash is not continuous.
HIGH (11-15)	Usually associated with regeneration harvest methods such as shelterwood, seed tree and most clearcuts, or any partial cut with a high harvest volume per acre. Slash is nearly continuous through the operating area frequently with heavier islands intermingled with light continuous slash.
EXTREME (16-20)	Any operation with very high cut volume, and/or low utilization standards, and/or many slashed or broken stems. Slash is continuous over the operating area with few light areas.
<b>TECHNICAL SPECIFICATIONS</b>	
LOW (0-5)	Slash load less than or equal to 3 inch diameter materials not to exceed 3.0 tons/acre.
MODERATE (6-10)	Slash load less than or equal to 3 inch diameter materials greater than 3.0 tons/acre but less than 6.0 tons/acre.
HIGH (11-15)	Slash load less than or equal to 3 inch diameter materials greater than 6.0 tons/acre but less than 12.0 tons/acre.
EXTREME (16-20)	Slash load less than or equal to 3 inch diameter materials exceeds 12.0 tons/acre.

Slash loads can be determined by using any standard photo series appropriate for the habitat type represented by the contract area, or by using USDA Forest Service General Technical Report INT-16, 1974 (HANDBOOK FOR INVENTORYING DOWNED WOODY MATERIAL). If the contractor insists upon the latter, sampling intensity will be one (1) point per two (2) acres through the area in question. The inventory cost is paid by the contractor. All slash made available as a result of the current harvest will be included in the inventory except that slash that has been piled and will be burned by the contractor before the expiration date on the Agreement or such extensions granted by the fire warden.

<b>SITE FACTORS - MAXIMUM 10 POINTS</b>						
<b>ASPECT</b>	<b>PERCENT SLOPE</b>					
	<b>0-10</b>	<b>11-20</b>	<b>21-30</b>	<b>31-40</b>	<b>41-50</b>	<b>&gt;50</b>
N-NE	0	0	1	2	4	5
E,NW	0	0	1	3	6	7
W,SE	0	1	2	5	8	9
S-SW	1	2	4	7	9	10



<b>UNIT SIZE - MAXIMUM 5 POINTS</b>						
<b>ACRES</b>	<b>&lt;40</b>	<b>40-160</b>	<b>161-320</b>	<b>321-480</b>	<b>481-640</b>	<b>&gt;640</b>
<b>PT VALUE</b>	0	1	2	3	4	5

<b>OTHER FACTORS - MAXIMUM 7 POINTS</b>	
Pre-existing slash from operations in the past five years	0-2
Proximity to structures, highways and recreational areas (e.g., parks, established campgrounds, etc).	Add Points
330 feet	5
660 feet	4
990 feet	3
1320 feet	2
2640 feet	1

In applying offset points to large, complex contract areas, or contract areas with highly variable hazard characteristics, hazard offset techniques must first be applied toward that portion of the contract area which will do the most to reduce the hazard by optimizing fire control effects.

<b>HAZARD OFFSETS</b>		
<b>ALL POINTS ARE DEDUCTIONS</b>		
<b>DISPOSAL</b>	Piling and Burning, Broadcast Burning, etc.	0-42
<p>If disposal reduces slash load in the contract area to &lt;3 tons, deduct hazard points to five (5) or less. If disposal does not reduce slash load to that level, points should be assigned as a proportion of the area treated. For example, if twenty-five percent (25%) of the area is dozer piled and the piles burned, but the slash load in the contract area still exceeds three (3) tons, twenty-five percent (25%) of the total points charged against the job should be deducted. However, if the disposal effectively isolates the untreated portion of the slash, or is otherwise placed to optimize fire control effects the proportion of points deducted may be increased to an amount to be determined by the district fire warden.</p>		
<b>MODIFICATION:</b>	Chipping	0-42
	Crushing	0-20
	Lopping	0-10
<p>Lopping standards: All material less than three (3) inches in diameter will be cut so that it does not extend more than twenty (20) inches of the mean height above the ground. In addition, all boles greater than three (3) inches in diameter intersecting another bole will be completely severed.</p> <p>Assign points as a proportion of the contract area treated.</p>		
<b>ISOLATION</b>	Fuel Breaks	0-20

<b>HAZARD OFFSETS</b>	
<b>ALL POINTS ARE DEDUCTIONS</b>	
<p>To qualify as a fuel break, all slash and available fuels (Ref. Subsection 010.10) must be removed, or piled and burned, or treated sufficiently to prevent a fire from carrying through the area, for a minimum width of one chain (66 feet). In addition, the breaks must be placed to take advantage of terrain, manmade or natural barriers and to provide for optimum fire control effect.</p>	
Fire Lines	0-5
<p>All vegetative material must be removed to expose mineral soil. Minimum width of dozer line must be the width of the dozer blade with all dirt pushed in one direction and all vegetative debris to the other. Handlines must be eighteen (18) inches wide; additionally all fuels must be cleared for eight (8) feet. Lines must be tied to an anchor point except that they are not required to be built through a riparian management zone. In addition, the lines must be placed to take advantage of terrain, manmade or natural barriers, and to provide for optimum fire control effect. Maximum points allowed only if combined with an approved fuel break.</p>	

<b>ASSIGNING POINTS FOR ISOLATION</b>			
<b>Isolation techniques will usually be used to break the area into subunits or isolate the area from adjacent stands. Hazard offsets can be deducted for both if, in the opinion of the fire warden, both objectives are met and the total isolation points do not exceed 25 offset points.</b>			
<b>ACTIVITY</b>	<b>FUEL BREAK ONLY</b>	<b>FIRE LINE ONLY</b>	<b>BOTH</b>
Isolates contract area into subunits:			
A. Partial isolation or incomplete units	1-5	1	1-6
B. Complete isolation of area into 1 to 2 subunits	6-10	2	6-12
C. Complete isolation of area into 3 to 5 subunits	11-15	3	11-18
D. Complete isolation of area into 6 or more subunits	16-20	4	16-25
OR			
Isolates contract area from adjacent stands:			
A. One third of the contract area boundary isolated	1-5	1	1-6
B. Two thirds of the contract area boundary isolated	6-10	2	6-12
C. Entire contract area boundary isolated	11-15	3	11-18
ACCESS CONTROL	0-2		
Locked gate system controls access on all secondary roads with slash treated on main road			1
Locked gate system controls all road access into unit			2
AVAILABILITY OF WATER			0-3
The water supply must provide water availability for engines within one road mile of operating area or within three air miles for helicopter bucket use. The water supply must be sufficient to supply 10,000 gallons in an operational period during the fire season.			
Water supply for engine only or helicopter only (capacity 10,000 gallons during fire season).			1

ASSIGNING POINTS FOR ISOLATION			
Isolation techniques will usually be used to break the area into subunits or isolate the area from adjacent stands. Hazard offsets can be deducted for both if, in the opinion of the fire warden, both objectives are met and the total isolation points do not exceed 25 offset points.			
ACTIVITY	FUEL BREAK ONLY	FIRE LINE ONLY	BOTH
Water supply for engine and helicopter (capacity 10,000 gallons) or; for engine or helicopter and which replenishes itself every operational period.			2
Water supply for engine and helicopter which replenishes itself every operational period.			3

(3-20-20)T

121. -- 129. (RESERVED)

130. LIABILITY.

01. **State Liability.** With the exception of cases of negligence on the part of the landowner, operator or their agents, liability for the cost of suppressing fires that originate on or pass through a slashing area remains with the State if one of the following alternatives is executed by the contractor: (3-20-20)T

a. The contract area is covered by a Certificate of Compliance-Fire Hazard Management Agreement and all hazard money payments are current or a proper bond is in place. (3-20-20)T

b. The contractor treats the slash in accordance with the standards outlined in the Section 120, Table II within the time period specified on the Agreement or approved extensions. (3-20-20)T

c. The landowner or operator elects to enter into a contract with the State for management of the slash and liability of fire suppression costs in accordance with Section 38-404, Idaho Code. (3-20-20)T

02. **Contractor Liability.** Should the contractor choose not to treat the slash or not enter into a contract with the State in accordance with Subsection 130.01, the contractor, in addition to forfeiting any applicable bond, is liable for fire suppression costs for all fires that originate on or pass through the contractor's slashing area. The contractor retains the full liability for five (5) years from the time the Agreement or any extension thereof expires, unless a clearance has been issued. (3-20-20)T

03. **Failure to Treat.** Any contractor who fails to treat the fire hazard as outlined in Subsection 130.02, is liable for the actual costs of suppressing any wildfire that may occur on or pass through the area covered by the Agreement for an amount up to two hundred fifty thousand dollars (\$250,000). If the same wildfire occurs on or passes through several areas covered by separate agreements or if several Agreements cover the same area, the contractor is liable for the actual cost of suppression up to one million dollars (\$1,000,000). If a wildfire occurs on or passes through an area covered by separate Agreements with different contractors, the actual cost of suppression up to one million dollars (\$1,000,000) will be shared by the contractors prorated on acreage included in their Agreements. (3-20-20)T

04. **Fees.** Upon payment of the fees set forth in Table III, the State will assume liability for the cost of suppressing fires that originate on or pass through the contract area.

<b>TABLE III - ADDITIONAL FEE TO TRANSFER LIABILITY BY HAZARD POINTS</b>	
<b>POINTS</b>	<b>RATE</b>
6-10	\$1.00/MBF
11-20	\$2.00/MBF
21-30	\$3.00/MBF
>30	\$4.00/MBF

Additional fee rates for measurement other than board foot measurement are available upon request from any Department of Lands office. (3-20-20)T

**05. Additional Fee.** If the contractor is unable to reduce the hazard points on a contract area to the standards required for a clearance, but has completed some hazard reduction work, that contractor can discharge the remainder of his hazard obligation by returning a portion of his bond to the district and paying an additional fee to transfer liability. Use the following formula: [One minus (the acceptable hazard point or five, divided by the residual, or untreated hazard points)] multiply that ratio times the slash rate. This dollar amount should be multiplied by the total volume removed from the contract area. Add to that the additional fee to transfer liability (for the untreated hazard points, from Table III) times the total volume. When this amount is paid to the State the contract area can be cleared. Which can also be expressed as:

$$(1-(5/U)) * B * V + (A*V) = \text{Formula to transfer liability for a partially completed job.}$$

Where:

- U = Untreated or residual hazard points
- B = Bond rate (usually \$4.00 MBF) Ref. Section 050, Table I
- A = Additional fee to transfer liability, Table III
- V = Total volume removed from the contract areas

(3-20-20)T

**131. -- 139. (RESERVED)**

**140. CERTIFICATE OF CLEARANCE.**

The Certificate of Clearance is the instrument used to certify that hazard reduction has been accomplished, a contract entered into with the Director to ensure hazard management, or an additional fee has been paid. Anyone who has been issued an Agreement for the cutting of any forest product or potential forest product and who has met standards outlined in Section 120, or has made payment for hazard reduction under a contract with the Director, as provided in Section 38-404, Idaho Code, or has paid an additional fee in accordance with Section 38-122, Idaho Code, must apply in writing to the Director for a Certificate of Clearance. Within thirty (30) days after receipt of such written request for a Certificate of Clearance, the Director will cause the area covered by the request to be inspected. If it is found that the fire hazard has been properly disposed of, the Director will issue a Certificate of Clearance. The Certificate of Clearance must be substantially the same form as Department of Lands Form No. 760 - "Certificate of Clearance."

(3-20-20)T

**141. -- 149. (RESERVED)**

**150. FIRE SUPPRESSION AND FOREST PRACTICES ASSESSMENT.**

**01. Withholding.** An amount of three percent (3%) of the slash management rate (twelve cents (\$.12)/MBF) will be withheld from all slash management monies received and dedicated to suppression of wildfires on forest lands. For harvest from private land, an additional amount not to exceed three percent (3%) of the slash

management rate (twelve cents (\$.12)/MBF) can be withheld from slash management monies received and will be dedicated to Forest Practices support on forest lands. (3-20-20)T

**02. Assessment Costs.** Fire suppression assessment costs on operations covered by surety bond or irrevocable letter of credit or other form of bond is paid at the rate specified in Subsection 150.01. (3-20-20)T

**151. -- 159. (RESERVED)**

**160. PRELOGGING CONFERENCE AND AGREEMENT.**

Prelogging conferences and hazard reduction agreements are encouraged, however, the hazard reduction agreement will be canceled or modified if significant operational changes occur during the harvesting of forest products or potential forest products. (3-20-20)T

**161. -- 999. (RESERVED)**

## 20.06.01 – RULES OF THE IDAHO BOARD OF SCALING PRACTICES

### 000. LEGAL AUTHORITY.

In accordance with Section 38-1208, Idaho Code, the Board has the power to adopt and amend rules. (3-20-20)T

### 001. TITLE AND SCOPE.

01. **Title.** These rules are titled IDAPA 20.06.01, “Rules of the Idaho Board of Scaling Practices.” (3-20-20)T

02. **Scope.** These rules constitute the levy of assessment, payment for logging and hauling, licensing standards and renewals, method of scaling forest products for commercial purposes, check scaling operations, and informal hearings. (3-20-20)T

### 002. INCORPORATION BY REFERENCE.

01. **Incorporated Document.** The “Idaho Log Scaling Manual,” 2008 Edition, published by the Idaho Board of Scaling Practices is herein incorporated by reference. (3-20-20)T

02. **Availability of Referenced Documents.** The “Idaho Log Scaling Manual,” 2008 Edition, is available on the Board’s website at <http://www.ibsp.idaho.gov/>. (3-20-20)T

### 003. -- 009. (RESERVED)

### 010. DEFINITIONS.

01. **Board.** The Idaho Board of Scaling Practices. (3-20-20)T

02. **Check Scaling.** The comparison of scaling practices between a Board-appointed check scaler and any other scaler. (3-20-20)T

03. **Combination Log.** Any multiple-segment log involving more than one (1) product classification. (3-20-20)T

04. **Complaint.** A written statement alleging a violation of the Idaho Scaling Law, Title 38, Chapter 12, Idaho Code. (3-20-20)T

05. **Complainant.** A person or entity who submits a complaint to the Board. (3-20-20)T

06. **Cubic Volume.** A log rule that uses cubic feet as its basic unit of measure, determined on the basis of a mathematical formula. (3-20-20)T

07. **Decimal “C.”** A log rule that uses tens of board feet as its basic unit of measure; one (1) decimal “C” equals ten (10) board feet. The Idaho Scribner decimal “C” volumes as listed in the Appendix of the “Idaho Log Scaling Manual.” (3-20-20)T

08. **Gross Scale.** The log rule volume of timber products before deductions are made for defects. (3-20-20)T

09. **Informal Hearing.** Any hearing before the Board of Scaling Practices, as opposed to a formal hearing before a hearing officer designated by the Board. (3-20-20)T

10. **Log Brands.** A unique symbol or mark placed on or in forest products for the purpose of identifying ownership. (3-20-20)T

11. **Net Scale.** The remaining log rule volume of timber products after deductions are made for defects, based on the product classification that is used. (3-20-20)T

12. **Official Seal.** An official seal of the Idaho Board of Scaling Practices is hereby adopted. The seal must be round, of a diameter of at least one and one-half inches (1-1/2”), and so constructed that it may readily be imprinted on paper. (3-20-20)T

13. **Prize Logs.** As described in Section 38-809, Idaho Code. (3-20-20)T

**14. Product Classification.** Classification as sawlog, pulp log, or cedar products log for purposes of net scale determination or check scaling. (3-20-20)T

**15. Purchaser.** The principal individual, partnership, or corporation entitled to ownership at the first determination of scale for forest products harvested in Idaho. Purchaser also includes the owner of the timber as provided in Section 38-1209(b), Idaho Code. (3-20-20)T

**16. Requested Check Scale.** A check scale performed pursuant to Section 820 of these rules. (3-20-20)T

**17. Relicense Check Scale.** A check scale requested and scheduled in advance, by a licensed scaler, for purposes of license renewal. (3-20-20)T

**18. Routine Check Scale.** A check scale that is not a relicense, temporary permit, or requested check scale. (3-20-20)T

**19. Respondent.** The person or entity accused of violating the Idaho Scaling Law, Title 38, Chapter 12, Idaho Code. (3-20-20)T

**20. Temporary Permit Check Scale.** A check scale performed pursuant to provisions of Section 240 of these rules. (3-20-20)T

**21. Written Scaling Specifications.** A written document provided to the scaler that states the information necessary to scale logs in accordance with a contractual scaling agreement. (3-20-20)T

**011. -- 049. (RESERVED)**

**050. ASSESSMENT.**

In accordance with provisions of Section 38-1209, Idaho Code, the Board is authorized and directed to levy an assessment. (3-20-20)T

**01. Purchaser.** The purchaser, as defined in Subsection 010.15, pays the assessment levied by the Board. (3-20-20)T

**02. Assessment.** The assessment must be transmitted to the Board on or before the twentieth (20th) day of each month for all timber harvested during the previous month. Forms provided by the Board must be completed and submitted with the assessment. (3-20-20)T

**03. Weight.** On forest products harvested and purchased solely on the basis of weight, no levy of assessment is applicable. (3-20-20)T

**051. -- 059. (RESERVED)**

**060. LOG BRANDS.**

In accordance with the provisions of Section 38-808, Idaho Code, the Board is responsible for approval and registration of all log brands. (3-20-20)T

**01. Applications.** All applications for log brands or renewals must be submitted and approved prior to use. (3-20-20)T

**02. Fees.** Log brand registration, renewal, and transfer of ownership fees are twenty-five dollars (\$25) for each log brand. (3-20-20)T

**061. -- 069. (RESERVED)**

**070. PRIZE LOGS.**

In accordance with provisions of Section 38-809, Idaho Code, the Board is responsible for the disposition of prize logs. (3-20-20)T

**071. -- 099. (RESERVED)**

**100. PAYMENT FOR LOGGING OR HAULING.**

Provisions of Section 38-1220(b), Idaho Code, govern payment for logging or hauling. (3-20-20)T

**01. Gross Scale Determination.** Gross scale is determined by the methodology stated in Chapter Two (2) of the "Idaho Log Scaling Manual." (3-20-20)T

**02. Compliance with Gross Scale Determination.** Notwithstanding the methodology criteria contained in the "Idaho Log Scaling Manual," compliance will be determined to have been met when check scale results on gross scale comparisons are within allowable standards of variation as provided in these rules. (3-20-20)T

**101. -- 199. (RESERVED)**

**200. LICENSES.**

**01. Application Form.** Application for a scaling license is made on a form prescribed and furnished by the Board. (3-20-20)T

**02. Revocation or Suspension for Incompetency.** If check scale results on three (3) occasions in any twelve (12) month period are found unacceptable based on standards of variation established under Section 810, the scaler's license may be revoked or suspended as provided in Section 38-1218, Idaho Code. (3-20-20)T

**201. -- 219. (RESERVED)**

**220. APPRENTICESHIP CERTIFICATE.**

**01. General.** Is issued at no charge to those individuals with no previous scaling experience who wish to practice scaling techniques in view of becoming a licensed scaler. (3-20-20)T

**02. Procedure to Obtain Certificate.** After submitting the application form, a candidate will be required to take the written examination. Upon passing the written examination, the Apprenticeship Certificate will then be issued. (3-20-20)T

**03. Regulations Governing Use of Certificate.** The apprentice is authorized to scale only under the direct supervision of a licensed scaler. The scale determined by the apprentice will, under no circumstances, be used as the sole basis for payment. (3-20-20)T

**221. -- 239. (RESERVED)**

**240. TEMPORARY PERMIT.**

**01. General.** Is issued for a period of time, not to exceed three (3) months, to individuals with previous scaling experience who need to scale for commercial purposes. (3-20-20)T

**02. Procedure to Obtain.** Submit the application form; remit the required twenty-five dollar (\$25) fee; submit a letter from the employer requesting the temporary permit and identifying where the permittee would be scaling; take and pass the written portion of the scaler's examination, and demonstrate practical scaling abilities in the form of an acceptable check scale. (3-20-20)T

**03. Regulations Governing Use of Temporary Permit.** (3-20-20)T

**a.** Permits expire the date of the next practical examination in the area or three (3) months from the date of issuance, whichever comes first. The scale determined by the holder of a temporary permit may be used as a



basis for payment. (3-20-20)T

**b.** Should the holder of a temporary permit fail to appear to take the practical portion of the scaler's examination after being notified in writing of the time and place of said examination, the temporary permit will be canceled. (3-20-20)T

**c.** Temporary permits will not be issued to applicants or relicensees who have failed the practical examination two (2) or more times until thirty (30) days following the individual's last exam failure. (3-20-20)T

**241. -- 259. (RESERVED)**

**260. SPECIALTY LICENSE.**

**01. General.** Is issued to handle situations where the applicant would not be required to possess the exacting skills needed to scale sawlogs. (3-20-20)T

**02. Procedure to Obtain.** Submit the application form, remit the required twenty-five dollar (\$25) fee, submit a letter from the employer describing scaling that would justify the issuance of a specialty license. and successfully complete the examination as may be devised by the Board. (3-20-20)T

**03. Regulations Governing Use of Specialty License.** The holder is only allowed to scale the products specified on the individual's license. (3-20-20)T

**261. -- 279. (RESERVED)**

**280. STANDARD LICENSE.**

**01. General.** Is issued to individuals who demonstrate competency in scaling principles and techniques. (3-20-20)T

**02. Procedure to Obtain.** Submit the application form, remit the required twenty-five dollar (\$25) fee, and take and pass the examination as described under Section 300. (3-20-20)T

**03. Regulations Governing Use of Standard License.** The holder is qualified to scale all species and products. (3-20-20)T

**281. -- 299. (RESERVED)**

**300. STANDARD LICENSE EXAMINATION.**

To be taken by all persons applying for the standard license. (3-20-20)T

**01. Written Examination.** (3-20-20)T

**a.** Will be based upon Chapters 1, 2, and 3 of the "Idaho Log Scaling Manual." (3-20-20)T

**b.** Any score of seventy percent (70%) or better is a passing grade. (3-20-20)T

**c.** The written test must be taken and passed before the practical examination can be attempted. (3-20-20)T

**02. Practical Examination.** (3-20-20)T

**a.** The practical examination for a scaler's license will consist of scaling a minimum of not less than two hundred (200) logs with a net decimal "C" scale determination for sawlogs of not less than twenty thousand (20,000) board feet, or not less than fifteen thousand (15,000) board feet in the southeast Idaho area. (3-20-20)T

**b.** The logs will first be scaled by three (3) qualified check scalers, except the southeast Idaho area

will be two (2) or more qualified check scalers, and the agreed-upon results will be the basis for grading the examination. (3-20-20)T

c. To obtain a passing grade, a scaler must be within allowable limits of variation in the following categories:

CATEGORY		ALLOWABLE VARIATION
<b>Gross Volume</b>	For logs in round form	+/- 2.0%
	For logs in fractional or slab form	+/- 5.0%
<b>Net Volume</b>	Check scale percent of defect on logs checked	
	Up to 10	+/- 2.0%
	10.1 to 15	+/- 3.0%
	15.1 to 20	+/- 0.2% for each percent of defect
	Over 20	+/- 5.0%
	Species identification errors	3.0%

(3-20-20)T

**301. -- 399. (RESERVED)**

**400. RENEWAL OF STANDARD AND SPECIALTY LICENSES.**

For scalers who hold "Standard" and "Specialty" licenses, the process for renewal will consist of the following. (3-20-20)T

**01. To Renew a License by the Expiration Date.** Receive an acceptable check scale performed by a Board check scaler and pay renewal fee of twenty-five dollars (\$25). (3-20-20)T

**02. To Renew a License Within Two Years After The Expiration Date:** (3-20-20)T

a. Request and receive an acceptable check scale performed by a Board check scaler. When the check scale is unacceptable, the individual is required to reapply for the standard license. (3-20-20)T

b. Pay renewal fee of twenty-five dollars (\$25). (3-20-20)T

**03. To Renew a License More Than Two Years After The Expiration Date.** An individual is required to reapply for the standard license. (3-20-20)T

**04. Option to a Check Scale for Standard License Renewal.** A practical examination successfully completed may be used in-lieu-of a check scale for renewal. (3-20-20)T

**05. Option to a Check Scale for Specialty License Renewal.** An examination as may be devised by the Board may be used in-lieu-of a check scale for renewal of specialty licenses. (3-20-20)T

**401. -- 499. (RESERVED)**

**500. METHOD OF SCALING FOREST PRODUCTS FOR COMMERCIAL PURPOSES.**

**01. Scribner Decimal "C".** Log scaling by the Scribner decimal "C" method must be made according to scaling practices and procedures described in the "Idaho Log Scaling Manual" and Sections 501 through 504 of these rules. (3-20-20)T

**02. Cubic Volume.** Log scaling by a cubic volume method must be made according to scaling practices and procedures agreed upon in writing between parties to a scaling agreement. (3-20-20)T

**03. Other Scaling Methods.** Log scaling by any method other than Scribner decimal “C” or cubic volume will be considered and determined by the Board upon written request. (3-20-20)T

**501. GROSS VOLUME CONVERSIONS.**

**01. Conversion to Gross Decimal “C” or Gross Cubic Volume.** Gross volume measurement determined in a manner other than decimal “C” or cubic volume will be converted to an equivalent decimal “C” or cubic volume gross scale. (3-20-20)T

**02. Conversion Factors.** Measurement procedures and converting factors described in the Special Situations Measurement section, Chapter Two (2) of the “Idaho Log Scaling Manual,” may be used to express decimal “C” board foot equivalents. (3-20-20)T

**03. Other Conversion Factors.** Measurement procedures and converting factors not listed in the “Idaho Log Scaling Manual” will be considered and determined by the Board upon written request. (3-20-20)T

**502. GENERAL SCALING REQUIREMENTS.**

**01. Written Scaling Specifications.** At any scaling site, licensed scalers will be provided with a written document that states the information necessary to scale logs in accordance with a contractual scaling agreement. (3-20-20)T

**02. Recording Measurements on Scale Tickets.** For each log scaled, scalers must record a combination of data from which both gross and net volume can be derived. This data includes scaling length and scaling diameter(s). (3-20-20)T

**03. Load Identification.** Scalers must ensure that all loads are readily identifiable upon completion of scaling. (3-20-20)T

**503. GROSS DECIMAL “C” SCALE DETERMINATION.**

Contractual scaling agreements relating to determination of Scribner decimal “C” gross scale may not establish any scaling requirement that differs from those stated in the “Idaho Log Scaling Manual” except for a minimum top diameter that may be smaller than five and fifty-one hundredths inches (5.51”) actual measure. Licensed scalers will be provided with written scaling specifications that denote any minimum top diameter that is smaller than five and fifty-one hundredths inches (5.51”) actual measure. (3-20-20)T

**504. NET DECIMAL “C” SCALE DETERMINATION.**

Contractual scaling agreements relating to determination of Scribner decimal “C” net scale may establish scaling requirements that differ from those stated in the “Idaho Log Scaling Manual.” Licensed scalers will be provided with written scaling specifications that clearly describe any changes in net scale scaling practices. (3-20-20)T

**505. -- 799. (RESERVED)**

**800. CHECK SCALING PROCEDURES.**

**01. Valid Check Scale.** (3-20-20)T

**a.** Check scaling requires a minimum of fifty (50) logs containing a decimal “C” gross scale of at least ten thousand (10,000) board feet. When other methods of measurement are used, the check scaler will investigate the situation and determine the most logical method of check scaling. (3-20-20)T

**b.** Check scaling will be performed without scaler’s knowledge, when possible. (3-20-20)T

**c.** Check scales are performed only on logs that are in the same position as presented to the scaler. (3-20-20)T

**d.** Check scales will not be performed if the logs are not spread adequately enough, in the check scaler’s discretion, to allow for accurate scaling. If these conditions arise, the check scaler makes a written report describing the conditions and surrounding circumstances. The Board will make a decision as to the disposition of these conditions and direct the check scaler accordingly. (3-20-20)T

**e.** The check scaler must use the written scaling specifications that have been provided to the scaler. In the absence or omission of written scaling specifications, logs will be check scaled according to scaling methodology stated within the “Idaho Log Scaling Manual.” (3-20-20)T

**02. Cooperative Scaling.** Cooperative scaling involves two (2) scalers, using different scaling specifications, working together to determine the log scale volume. In these instances, each scaler is individually responsible for the scale recorded. (3-20-20)T

**03. Team Scaling.** Team scaling is two (2) scalers, using the same scaling specifications, working together to determine the log scale volume. In these instances, both scalers are responsible for the scale recorded, except that if one (1) of the individuals is an apprentice scaler, the licensed scaler is responsible for the scale recorded. (3-20-20)T

**04. Holding Check Scale Log Loads.** All log loads involved in an unacceptable check scale will be held at the point of the check scale until such time as the logs have been reviewed with the scaler, or for a period up to forty-eight (48) hours. (3-20-20)T

**a.** During this period the load(s) may not be moved or tampered with in any way. (3-20-20)T

**b.** The Board’s check scaler will mark all loads that must be held, and notify the scaler and landing supervisors respectively. (3-20-20)T

**801. -- 809. (RESERVED)**

**810. CHECK SCALING STANDARDS OF VARIATION.**

**01. Allowable Limits of Variation.** To determine a check scale as acceptable or unacceptable for Board consideration, and when the method of measurement is the Coconino Scribner decimal C log rule, a scaler must be within allowable limits of variation in the following categories:

CATEGORY		ALLOWABLE VARIATION
<b>Gross Volume</b>	For logs in round form	+/- 2.0 percent
	For logs in fractional or slab form	+/- 5.0 percent
<b>Net Volume</b>	Check scale percent of defect on logs checked	
	Sawlogs	
	Up to 10	+/- 2.0 percent
	10.1 to 15	+/- 3.0 percent
	15.1 to 20	+/- 0.2 percent for each percent of defect
	Over 20	+/- 5.0 percent
	Pulp Logs	+/- 5.0 percent
	Cedar Product Logs	+/- 8.0 percent
	Species Identification Errors	3.0 percent
	Product Classification Errors	3.0 percent

(3-20-20)T

**02. Combination Logs.** For purposes of determining product classification errors, combination logs are counted as one-half (1/2), one-third (1/3), one-fourth (1/4) -- depending on the number of scaling segments -- to arrive at a piece or log count variation. Combination logs will be considered only when provided for in a contractual scaling agreement or written scaling specifications. (3-20-20)T

**03. Check Scales Involving Multiple Variations.** Some check scales will involve more than one (1) parameter of variation. The overall allowable limit of variation to determine acceptability or unacceptability of the total gross or net scales is determined by the following formula:

OAV =	$\frac{(a \times E) + (b \times E) + (c \times F)}{(D + E + F)}$
OAV =	overall allowable percentage variation
A =	allowable percentage variation for gross/net sawlog scale
B =	allowable percentage variation for gross/net pulp log scale
C =	allowable percentage variation for gross/net cedar products scale
D =	check scaler's gross/net sawlog scale
E =	check scaler's gross/net pulp log scale
F =	check scaler's gross/net cedar products log scale

(3-20-20)T

**811. -- 819. (RESERVED)**

**820. REQUESTED CHECK SCALE.**

A check scale may be performed upon request of any individual, company, or corporation. (3-20-20)T

**01. Submission of Request.** (3-20-20)T

**a.** The request must be in writing and approved by the Board's executive director. (3-20-20)T

**b.** The request must be made by a party directly affected and involve disputes on scaling. (3-20-20)T

**02. Cost of a Requested Check Scale.** The fee is two hundred dollars (\$200) for each day, or part of a day, that the check scaler is scaling the logs. (3-20-20)T

**821. -- 829. (RESERVED)**

**830. CHECK SCALE REPORT.**

**01. Check Scale Results.** The check scaler will make a report of his findings to the Board. (3-20-20)T

**02. Persons Entitled to a Copy of the Check Scale Report.** (3-20-20)T

**a.** Persons directly affected and entitled to a copy of the check scale report on temporary permits and relicensure check scales are the scaler and the scaler's employer(s). (3-20-20)T

**b.** Persons directly affected and entitled to a copy of the check scale report on routine and requested check scales include the scaler, the scaler's employer(s), the scaler's supervisor(s), the logging contractor(s), or other persons directly affected by the check scale report as determined by the Board's executive director. (3-20-20)T

**831. -- 909. (RESERVED)**

**910. INFORMAL HEARINGS -- SCOPE AND AUTHORITY.**

Sections 910 through 980 apply to all informal hearings before the Board. These rules are adopted pursuant to Sections 38-1208 and 67-5201, et seq., Idaho Code, and are intended to facilitate the Board in executing its duties and responsibilities under Title 38, Chapter 12, Idaho Code. These rules are construed to effectuate the intent of the legislature in adopting the Idaho Scaling Law in a reasonable, fair and expeditious manner. (3-20-20)T

**911. -- 919. (RESERVED)**

**920. COMPLAINTS.**

- 01. Submittal of Complaint.** Is submitted in writing in the name of the primary complainant. (3-20-20)T
- 02. Contents of Complaint.** Must state: (3-20-20)T
- a.** The name and address of the person or entity actually aggrieved; (3-20-20)T
- b.** A short and plain statement of the nature of the complaint, including the location and date of the alleged violation; (3-20-20)T
- c.** The complainant's notarized signature; (3-20-20)T
- d.** The complainant must submit written or documentary evidence in support of the alleged violation; and (3-20-20)T
- e.** In the case of a gross scale complaint, which alleges violations of Section 38-1220(b), Idaho Code, the complainant must also provide a readable copy of the contract, payment slips, and scale tickets for each transaction involved in the alleged complaint. (3-20-20)T

**921. -- 929. (RESERVED).**

**930. RESPONSE TO COMPLAINT.**

- 01. Response.** The respondent must submit to the Board a written response to the allegations of the complaint, with supporting evidence, within thirty (30) days after receiving a copy of the same from the Board. The Board will presume that the respondent received such complaint and evidence within three (3) days after mailing by the Board, unless the respondent submits evidence to the contrary to the Board. (3-20-20)T
- 02. Consideration of Complaint.** The Board will consider a complaint in its next meeting following the timely response of the respondent or the respondent's failure to respond within the time limit of Subsection 930.01. (3-20-20)T

**931. ACCESS TO RECORDS.**

The Board will provide to the respondent or his counsel a copy of the complaint and any supporting evidence to which the respondent does not have access, at the earliest date after the Board has received the same. The Board will provide the complainant or his counsel a copy of any answer or response and supporting evidence thereof to which the complainant does not have access, at the earliest date after the Board has received the same. (3-20-20)T

**932. -- 939. (RESERVED).**

**940. CONDUCT OF INFORMAL HEARINGS.**

- 01. Hearing Procedure.** The chairman of the Board will minimize, where possible, the use or application of formal court rules of procedure and evidence in the spirit of an informal hearing consistent with the intent of these rules, fairness to the parties, and the interests of justice. (3-20-20)T
- 02. Statements.** The complainant and the respondent may make a brief statement concerning the allegation(s) and may introduce new evidence in support of or in opposition to the allegation(s). Statements must be

concise, specific, relevant to the allegation(s), and limited to ten (10) minutes per party, unless the specific allegation(s) as determined by the chairman clearly requires greater time to address the same. (3-20-20)T

**03. Questions Directed to the Board.** All questions at the hearing are directed to the Board. The Board will consider written or oral questions from the complainant or respondent at the hearing or take such questions under advisement. (3-20-20)T

**04. Questions Asked by the Board.** Only the Board may ask questions of the complainant or respondent and may call witnesses. (3-20-20)T

**05. Representation by Counsel.** The complainant and the respondent may be represented by counsel. (3-20-20)T

**941. -- 949. (RESERVED)**

**950. TIME FOR BOARD DETERMINATION.**

After submission of the complaint and supporting documentation for evidence in accord with Section 930, and after an informal hearing on a complaint wherein the parties have had opportunity to respond to these allegations and to present testimony, documentation, or other evidence thereon in accord with Section 940, the Board may thereafter make its determination or take the matter under advisement and reach its determination within thirty (30) days. (3-20-20)T

**951. -- 959. (RESERVED).**

**960. FINAL DETERMINATION.**

The Board's determination is final, subject to appeal pursuant to Title 67, Chapter 52, Idaho Code. (3-20-20)T

**961. -- 969. (RESERVED).**

**970. BOARD ACTION UPON DETERMINATION OF PROBABLE VIOLATION.**

In the event that the Board determines that the complaint and supporting evidence indicate a probable violation of the Idaho Scaling Law, the Board will, within thirty (30) days after that determination, transmit the complaint and supporting documentation to the prosecutor of the county where the violation occurred. (3-20-20)T

**971. -- 999. (RESERVED).**

**20.07.02 – RULES GOVERNING CONSERVATION OF OIL AND NATURAL GAS  
IN THE STATE OF IDAHO**

**SUBCHAPTER A – GENERAL PROVISIONS**

**000. LEGAL AUTHORITY.**

This Chapter is adopted under the legal authorities of Title 47, Chapter 3, Idaho Code; and Title 67, Chapter 52, Idaho Code. (3-20-20)T

**001. TITLE AND SCOPE.**

**01. Title.** These rules are titled IDAPA 20.07.02, “Rules Governing Conservation of Oil and Natural Gas in the State of Idaho.” (3-20-20)T

**02. Scope.** These rules apply to the exploration and extraction of any and all crude oil and natural gas resources in the state of Idaho, not including biogas, manufactured gas, or landfill gas, regardless of ownership. (3-20-20)T

**03. Other Laws.** Owners or operators engaged in the exploration and extraction of crude oil and natural gas resources will comply with all applicable laws and rules of the state of Idaho including, but not limited to the following: (3-20-20)T

**a.** Idaho water quality standards and waste water treatment requirements established in Title 39, Chapter 1, Idaho Code; IDAPA 58.01.02, “Water Quality Standards”; IDAPA 58.01.16, “Wastewater Rules”; and IDAPA 58.01.11, “Ground Water Quality Rule,” administered by the IDEQ. (3-20-20)T

**b.** Idaho air quality standards established in Title 39, Chapter 1, Idaho Code and IDAPA 58.01.01 “Rules for the Control of Air Pollution in Idaho,” administered by the IDEQ. (3-20-20)T

**c.** Requirements and procedures for hazardous and solid waste management, as established in Title 39, Chapter 44, Idaho Code, and rules promulgated thereunder including IDAPA 58.01.05, “Rules and Standards for Hazardous Waste”; IDAPA 58.01.06, “Solid Waste Management Rules”; and IDAPA 58.01.10, “Rules Regulating the Disposal of Radioactive Materials Not Regulated Under the Atomic Energy Act of 1954, As Amended,” administered by the IDEQ. (3-20-20)T

**d.** Idaho Stream Channel Protection Act, Title 42, Chapter 38, Idaho Code, and rules promulgated thereunder including IDAPA 37.03.07, “Stream Channel Alteration Rules,” administered by the IDWR. (3-20-20)T

**e.** Injection Well Act, Title 42, Chapter 39, Idaho Code and rules promulgated thereunder including IDAPA 37.03.03, “Rules and Minimum Standards for the Construction and Use of Injection Wells,” administered by the IDWR. (3-20-20)T

**f.** Department of Water Resources – Water Resource Board Act, Title 42, Chapter 17, Idaho Code and rules promulgated thereunder including IDAPA 37.03.06, “Safety of Dams Rules,” administered by the IDWR. (3-20-20)T

**002. ADMINISTRATIVE APPEALS.**

Any person aggrieved by any final decision or order of the Commission shall be entitled to judicial review pursuant to the provisions of Title 67, Chapter 52, Idaho Code, Title 47, Chapter 3, Idaho Code, and IDAPA 20.07.01, “Rules of Practice and Procedure before the Idaho Oil and Gas Conservation Commission.” (3-20-20)T

**003. INCORPORATION BY REFERENCE.**

The following documents are incorporated by reference into these rules: (3-20-20)T

**01. API Bulletin E3, Well Abandonment and Inactive Well Practices for U.S. Exploration and Production Operations, Environmental Guidance Document.** 1st Edition, January 1993 and Reaffirmed June 2000 available at the office of the Idaho Department of Lands at 300 North 6th Street, Suite 103. (3-20-20)T

**02. API SPEC 5CT, Specifications for Casing and Tubing.** The 8th edition dated July, 1, 2005 and the amendments dated March, 31, 2006 and April, 7, 2006 are available at the office of the Idaho Department of Lands at 300 North 6th Street, Suite 103. (3-20-20)T

**03. API SPEC 10a, Specification for Cements and Materials for Well Cementing.** The 24th Edition



dated December, 2010 is available at the office of the Idaho Department of Lands at 300 North 6th Street, Suite 103. (3-20-20)T

**04. ASTM D698-07e1, Standard Test Methods for Laboratory Compaction Characteristics of Soil Using Standard Effort (12,400 ft-lbf/ft<sup>3</sup> (600 kN-m/m<sup>3</sup>)).** 2007 revision. Available at the office of the Idaho Department of Lands at 300 North 6th Street, Suite 103. (3-20-20)T

**05. ASTM D1250-08, Standard Guide for Use of the Petroleum Measurement Tables.** 2008 revision. Available at the office of the Idaho Department of Lands at 300 North 6th Street, Suite 103. (3-20-20)T

**06. ASTM D1557-09, Standard Test Methods for Laboratory Compaction Characteristics of Soil Using Modified Effort (56,000 ft-lbf/ft<sup>3</sup> (2,700 kN-m/m<sup>3</sup>)).** 2009 revision. Available at the office of the Idaho Department of Lands at 300 North 6th Street, Suite 103. (3-20-20)T

**07. EPA SW-846 Method 9090A, Compatibility Test for Wastes and Membrane Liners.** Revision 1, July 1992. Available at the office of the Idaho Department of Lands at 300 North 6th Street, Suite 103 and this website: <http://www.epa.gov/osw/hazard/testmethods/sw846/pdfs/9090a.pdf>. (3-20-20)T

**08. OSHA Standard 1910.1200 (Hazard Communication).** Last revised 1996. Available at the office of the Idaho Department of Lands at 300 North 6th Street, Suite 103 and this website: [http://www.osha.gov/pls/oshaweb/owadisp.show\\_document?p\\_table=standards&p\\_id=10099](http://www.osha.gov/pls/oshaweb/owadisp.show_document?p_table=standards&p_id=10099). (3-20-20)T

**004. -- 009. (RESERVED)**

**010. DEFINITIONS.**

**01. Act.** The Idaho Oil and Gas Conservation Act, Title 47, Chapter 3, Idaho Code. (3-20-20)T

**02. Active Well.** A permitted well used for production, disposal, or injection that is not idled for more than twenty-four (24) continuous months. (3-20-20)T

**03. Barrel.** Forty-two (42) U. S. gallons at sixty (60) Degrees F at atmospheric pressure. (3-20-20)T

**04. Blowout.** An unplanned sudden or violent escape of fluids from a well. (3-20-20)T

**05. Blowout Preventer.** A casinghead control equipped with special gates or rams that can be closed and sealed around the drill pipe, or that otherwise completely closes the top of the casing. (3-20-20)T

**06. Bonus Payment.** Monetary consideration that is paid by the lessee to the lessor for the execution of an oil and gas lease. (3-20-20)T

**07. Casing Pressure.** The pressure within the casing or between the casing, tubing, or drill pipe. (3-20-20)T

**08. Casinghead.** A metal flange attached to the top of the conductor pipe that is the primary interface for the diverter system during drilling out for surface casing. (3-20-20)T

**09. Casinghead Gas.** Any gas or vapor, or both, indigenous to an oil stratum and produced from such stratum with oil. (3-20-20)T

**10. Common Source of Supply.** The geographical area or horizon definitely separated from any other such area or horizon and which contains, or from competent evidence appears to contain, a common accumulation of oil or gas or both. Any oil or gas field or part thereof which comprises and includes any area which is underlaid, or which from geological or other scientific data or experiments or from drilling operations or other evidence appears to be underlaid by a common pool or accumulation of oil or gas or both oil and gas. (3-20-20)T

**11. Completion.** An oil well is considered completed when the first new oil is produced through

wellhead equipment into lease tanks from the ultimate producing interval after the production casing has been run. A gas well is considered completed when the well is capable of producing gas through wellhead equipment from the ultimate producing zone after the production casing has been run. (3-20-20)T

**12. Conductor Pipe.** The first and largest diameter string of casing to be installed in a well. This casing extends from land surface to a depth great enough to keep surface waters from entering and loose earth from falling in the hole and to provide anchorage for the diverter system prior to setting surface casing. (3-20-20)T

**13. Cubic Foot of Gas.** The volume of gas contained in one (1) cubic foot of space at a standard pressure base and a standard temperature base. The standard pressure base shall be fourteen and seventy-three hundredths (14.73) pounds per square inch absolute and the standard temperature base shall be sixty (60) Degrees F. (3-20-20)T

**14. Day.** A period of twenty-four (24) consecutive hours from 8 a.m. one day to 8 a.m. the following day. (3-20-20)T

**15. Development.** Any work that actively promotes bringing in production. (3-20-20)T

**16. Director.** The head of the Idaho Department of Lands and secretary to the Oil and Gas Conservation Commission, or his designee. (3-20-20)T

**17. Drilling Logs.** The recorded description of the lithologic sequence encountered in drilling a well, and any electric, gamma ray, geophysical, or other logging done in the hole. (3-20-20)T

**18. Fresh Water.** All surface waters and those ground waters that are used, or may be used in the future, for drinking water, agriculture, aquaculture, or industrial purposes other than oil and gas development. The possibility of future use is based on hydrogeologic conditions, water quality, future land use activities, and social/economic considerations. (3-20-20)T

**19. Gas-Oil Ratio.** The volume of gas produced in standard cubic feet to each barrel of oil or condensate produced concurrently during any stated period. (3-20-20)T

**20. Gas Processing Facility.** A facility that conditions liquids or gas by compression, dehydration, refrigeration, or by other means. (3-20-20)T

**21. Gas Well.** (3-20-20)T

**a.** A well that produces primarily natural gas; (3-20-20)T

**b.** Any well capable of producing gas in commercial quantities and also producing oil from the same common source of supply but not in commercial quantities; or (3-20-20)T

**c.** Any well classed as a gas well by the Commission for any reason. (3-20-20)T

**22. Geophysical or Seismic Operations.** Any geophysical method performed on the surface of the land utilizing certain instruments operating under the laws of physics respecting vibration or sound to determine conditions below the surface of the earth that may contain oil or gas and is inclusive of, but not limited to, the preliminary line survey, the acquisition of necessary permits, the selection and marking of shot-hole locations, necessary clearing of vegetation, shot-hole drilling, implantation of charge, placement of geophones, detonation and backfill of shot-holes, and vibroseis. (3-20-20)T

**23. Hydraulic Fracturing, or Fracing.** A method of stimulating or increasing the recovery of hydrocarbons by perforating the production casing and injecting fluids or gels into the potential target reservoir at pressures greater than the existing fracture gradient in the target reservoir. (3-20-20)T

**24. Inactive Well.** An unplugged well that has no reported production, disposal, injection, or other permitted activity for a period of greater than twenty-four (24) continuous months, and for which no extension has

- been granted. (3-20-20)T
25. **Intermediate Casing.** The casing installed within the well to seal intermediate zones above the anticipated bottom hole depth. The casing is generally set in place after the surface casing and before the production casing. (3-20-20)T
26. **Junk.** Debris in a hole that impedes drilling or completion. (3-20-20)T
27. **Lease.** A tract(s) of land that by virtue of an oil and gas lease, fee or mineral ownership, a drilling, pooling or other agreement, a rule, regulation or order of a governmental authority, or otherwise constitutes a single tract or leasehold estate for the purpose of the development or operation thereof for oil or gas or both. (3-20-20)T
28. **Mechanical Integrity Test.** A test designed to determine if there is a significant leak in the casing, tubing, or packer of a well. (3-20-20)T
29. **Oil Well.** Any well capable of primarily producing oil in paying quantities, but not a gas well. (3-20-20)T
30. **Pit.** Any excavated or constructed depression or reservoir used to contain reserve, drilling, well treatment, produced water, or other fluids at the drill site. This does not include enclosed, mobile, or portable tanks used to contain fluids. (3-20-20)T
31. **Pollution.** Constituents of oil, gas, salt water, or other materials used in oil and gas extraction, occurring in fresh water supplies at levels that exceed the standards in IDAPA 58.01.02, "Water Quality Standards," and IDAPA 58.01.11, "Ground Water Quality Rules," as the result of the drilling, casing, treating, operation or plugging of wells. (3-20-20)T
32. **Pressure Maintenance.** The injection of gas, water, or other fluids into oil or gas reservoirs to maintain pressure or retard pressure decline in the reservoir for the purpose of increasing the recovery of oil or other hydrocarbons therefrom. (3-20-20)T
33. **Produced Water.** Water that is produced along with oil or gas. (3-20-20)T
34. **Production Casing.** The casing set across the reservoir interval and within which the primary completion components are installed. (3-20-20)T
35. **Proppant.** Sand or other materials used in hydraulic fracturing to prop open fractures. (3-20-20)T
36. **Release.** Any unauthorized spilling, leaking, emitting, discharging, escaping, leaching, or disposing into soil, ground water, or surface water. (3-20-20)T
37. **Spud.** To start the drilling process by removing rock, dirt, and other sedimentary material with the drill bit. (3-20-20)T
38. **Surface Casing.** The first casing that is run after the conductor pipe to anchor blow out prevention equipment and seals out fresh water zones. (3-20-20)T
39. **Surface Water.** Rivers, streams, lakes, and springs when flowing in their natural channels. (3-20-20)T
40. **Systems Approach.** The disclosure of chemical information by chemical abstract service name only, without disclosing component percentages or chemical relationships. (3-20-20)T
41. **Tank.** A concrete, metal, or plastic stationary vessel used to contain fluids. (3-20-20)T
42. **Tank Battery.** One (1) or more tanks that are connected to receive crude oil, condensate, or produced waters from a well(s) and that serves as the point of collection and disbursement of oil or gas from a well(s).

- (3-20-20)T
- 43. Tank Dike.** An impermeable man-made structure constructed around a tank to contain leakage from the tank. (3-20-20)T
- 44. Tubing.** Pipe used inside the production casing to convey oil or gas from the producing interval to the surface. (3-20-20)T
- 45. Volatile Organic Compound.** Organic chemical compounds whose composition makes it possible for them to evaporate under normal indoor atmospheric conditions of sixty-eight (68) degrees F and an absolute pressure of fourteen point seven (14.7) psi atmospheric. (3-20-20)T
- 46. Waterflooding.** The injection into a reservoir through one (1) or more wells with volumes of water for the purpose of increasing the recovery of oil therefrom. (3-20-20)T
- 47. Well Report.** The written record progressively describing the strata, water, oil, or gas encountered in drilling a well with such additional information as to give volumes, pressures, rate of fill-up, water depths, casing strata, casing record, etc., as is usually recorded in normal procedure of drilling; also, it includes electrical radioactivity, or other similar logs run, lithologic description of all cores, and all drill-stem tests, including depth-tested, cushion-used, time tool open, flowing and shut-in pressures and recoveries. (3-20-20)T
- 48. Well Site.** The areas that are directly disturbed during the drilling and subsequent operation of, or affected by production facilities directly associated with, any oil well, gas well, or injection well, and its associated well pad. (3-20-20)T
- 49. Well Treatment.** Actions performed on a well to acidize, fracture, or stimulate the target reservoir. (3-20-20)T
- 50. Wildcat Well.** An exploratory well drilled in an area of unknown subsurface conditions. (3-20-20)T
- 011. ABBREVIATIONS.**
- 01. API.** American Petroleum Institute. (3-20-20)T
- 02. ASTM.** American Society for Testing and Materials. (3-20-20)T
- 03. BBL.** Oilfield Barrel. (3-20-20)T
- 04. BOP.** Blowout Preventer. (3-20-20)T
- 05. CAS.** Chemical Abstracts Service. (3-20-20)T
- 06. EPA.** United States Environmental Protection Agency. (3-20-20)T
- 07. F.** Fahrenheit. (3-20-20)T
- 08. GPS.** Global Positioning System. (3-20-20)T
- 09. HDPE.** High Density Polyethylene. (3-20-20)T
- 10. IDAPA.** Idaho Administrative Procedure Act. (3-20-20)T
- 11. IDEQ.** Idaho Department of Environmental Quality. (3-20-20)T
- 12. IDWR.** Idaho Department of Water Resources. (3-20-20)T

- 13. MCF. One thousand cubic foot. (3-20-20)T
- 14. MSDS. Material Safety Data Sheet. (3-20-20)T
- 15. OSHA. Occupational Safety & Health Administration. (3-20-20)T
- 16. PSI. Pounds per Square Inch. (3-20-20)T
- 17. PVC. Polyvinyl Chloride. (3-20-20)T

**012. -- 014. (RESERVED)**

**015. PROTECTION OF CORRELATIVE RIGHTS.**

The Commission and the Department should afford a reasonable opportunity to each person entitled thereto to recover or receive the oil or gas in such person's tract(s) or the equivalent thereof, without being required to drill unnecessary wells or to incur other unnecessary expense to recover or receive such oil or gas or its equivalent. (3-20-20)T

**016. -- 019. (RESERVED)**

**020. APPLICABILITY.**

**01. Oil and Gas Development.** These rules apply to oil and gas development and carry out the Commission's duty to prevent waste, protect correlative rights, and prevent pollution of fresh water supplies through activities authorized by these rules. (3-20-20)T

**02. Exclusions.** These rules do not apply to the exploration and development of other mineral resources covered by Title 47, Chapter 13, Idaho Code; Title 47, Chapter 15, Idaho Code; or Title 42, Chapter 40, Idaho Code. (3-20-20)T

**021. CLASS II INJECTION WELLS.**

Class II injection wells, as described in IDAPA 37.03.03, "Rules and Minimum Standards for the Construction and Use of Injection Wells," are currently not authorized under this rule. Permits for Class II injection wells must be obtained through IDAPA 37.03.03. (3-20-20)T

**022. -- 029. (RESERVED)**

**030. NOTICES - GENERAL.**

**01. Written Authorization Required.** Any written notice of intention to do work or to change plans previously approved must be filed with the Department, unless otherwise directed, and must be approved before the work is begun. Such approval may be given orally and, if so given, shall thereafter be confirmed by the Department in writing. Written notices may be submitted to the Department by e-mail or facsimile. (3-20-20)T

**02. Emergency Authorization.** In case of emergency, or a situation where operations might be unduly delayed, any written notice required by these rules and regulations to be given the Department may be given orally or by wire and if approval is obtained, the transaction shall be confirmed in writing, as a matter of record. (3-20-20)T

**03. Publication of Legal Notices.** Whenever these rules require a legal notice to be published in a newspaper, the notice must be published once a week for two (2) consecutive weeks. (3-20-20)T

**031. FORMS.**

The Department will adopt such forms of notices, requests, permits, and reports as it may deem advisable or necessary in carrying out the provisions of law and its rules. (3-20-20)T

**032. ORGANIZATION REPORTS.**

**01. Required Content.** Before any person engages in any activity covered by the statutes and rules of the Commission, that person must file an organization report with the Department. The organization report must include the following information: (3-20-20)T

- a.** The person's name and the type of the business being operated or conducted; (3-20-20)T
- b.** The mailing address to which all correspondence from the Department is to be sent; (3-20-20)T
- c.** The telephone number(s), facsimile number(s), and e-mail address(es) for which contact by the Department may be made; (3-20-20)T
- d.** The names of persons authorized to submit required forms, reports, and other documents to the Department; and (3-20-20)T
- e.** If a legal entity, proof the person is authorized to transact business within the state. (3-20-20)T

**02. Updates.** A supplementary report must be filed with the Department within thirty (30) days of any change to facts stated in a previously-filed organization report. (3-20-20)T

**033. DESIGNATION OF AGENT.**

A "Designation of Agent" must be submitted to the Department in a manner and form approved by the Department prior to the commencement of operations. A Designation of Agent(s) will be accepted as authority of agent to fulfill the obligations of the owner and to sign any papers or reports required under these oil and gas operating regulations, and all authorized orders or notices given by the Department when given in the manner hereinafter provided will be deemed service of such orders or notices upon the owner and the lessee. All changes of address and any termination of the agent's authority must be immediately reported in writing to the Department and, in the latter case, the designation of a new agent(s) must be immediately made. If the designated agent(s) is at any time incapacitated for duty or absent from the address provided, the owner must designate in writing a substitute to serve in his or their stead, and in the absence of such owner or of notice of appointment of a substitute then, in such case, notices may be given by the Department by delivering a registered letter to the United States Post Office at Boise, Idaho, directed to the agent(s) at the address shown on the current Designation of Agent on file in the Department's office, and such notice will be deemed service upon the owner and lessee. (3-20-20)T

**034. -- 039. (RESERVED)**

**040. PUBLIC COMMENT.**

Applications submitted under Sections 100, 200, 210, 230 and 330 of these rules will be posted on the Department's website for a fifteen-day (15) written comment period. The Department will also send an electronic copy of the application to the respective county, and city if applicable, where the proposed operation is located. The purpose of the comment period is to receive written comments on whether a proposed application complies with these rules. These comments will be considered by the Department prior to permit approval or denial. Relevant comments will be posted on the Department's website following the comment period. (3-20-20)T

**041. -- 049. (RESERVED)**

**050. ENFORCEMENT.**

The Department enforces these rules pursuant to Section 47-325, Idaho Code. (3-20-20)T

**051. -- 099. (RESERVED)**

**SUBCHAPTER B – EXPLORATION AND DEVELOPMENT**

**100. GEOPHYSICAL OPERATIONS.**

**01. Permit Required.** Before beginning seismic operations in the state of Idaho, a representative of the client company and the seismic contractor will meet with the staff of the Department, file an application for a permit to conduct seismic operations, and pay an application fee. No seismic operation may be conducted without such a

permit. The Department has discretion to waive the requirement of the pre-permit meeting for the client company. The permit for seismic operations may be revoked or suspended or the application for the permit denied by the Department for failure to comply with the Commission's rules, statutes, and orders. The Department may revoke, suspend, or deny the application for a seismic permit without a hearing; provided that the seismic contractor will be given an opportunity for a hearing at the next regularly scheduled Commission meeting. The fact that a permit is revoked or suspended does not excuse the seismic contractor or client company from properly plugging existing seismic holes but does prohibit the person(s) from drilling any more. The application for a permit for seismic operations must include: (3-20-20)T

**a.** The proposed route of the seismic line on a topographic or recent air photo base map at a sufficient scale to show roads, buildings, surface waters, and Section, Township, and Range lines. The map must also show additional area as needed for any alternative routing. The alternative routing must be within at least one-half (1/2) mile of the proposed route. Reapplication must be made if the final route strays from the proposed route and outside the designated alternative routing areas; and (3-20-20)T

**b.** The energy sources proposed to be used for the seismic operation, such as vibroseis, shot holes, surface shot, or others. (3-20-20)T

**c.** The approximate number, depth, and location of the seismic holes and the size of the explosive charges. The application must be accompanied by a map with a scale of one inch equaling two (2) miles that shows the depth and location of the shotholes. (3-20-20)T

**d.** The name and permanent address of the client company the Department may contact about the seismic operation. (3-20-20)T

**e.** The name, permanent address, and phone number of the seismic contractor and his local representative whom the Department may contact about the seismic activity. (3-20-20)T

**f.** The name, phone number, and permanent address of the hole plugging contractor, if different from the seismic contractor. (3-20-20)T

**g.** A detailed description of the hole plugging procedures, and a description of the surface reclamation procedures, if such reclamation is needed. (3-20-20)T

**h.** The anticipated starting date of seismic operations. (3-20-20)T

**i.** The anticipated completion date of seismic operations, and the anticipated date of any required reclamation or hole plugging. (3-20-20)T

**j.** A description of the identifying mark that will be on the hat or nonmetallic plug to be used in the plugging of the seismic hole. (3-20-20)T

**02. Operating Requirements.** All geophysical operations must comply with the following requirements: (3-20-20)T

**a.** All vehicles utilized by the permit holder, or its agents or contractors, shall be clearly identified by signs or markings utilizing letters or numbers, or a combination thereof, a minimum of three (3) inches in height and one-half (1/2) inch wide, indicating the name of such agent. (3-20-20)T

**b.** No seismic source generation from vibroseis, shot holes, surface shot, or other method shall be conducted within two hundred (200) feet of any residence, water well, oil well, gas well, injection well or other structure without having first secured the express written authority of the owner(s) thereof and the permit holder shall be responsible for any resulting damages. (3-20-20)T

**c.** Written authority from the owner of a residence, water well, oil well, gas well, injection well or other structure must also be obtained from the owner(s) if any explosive charge exceeds the maximum allowable charge within the scaled distance below:

<b>DISTANCE TO STRUCTURE (Feet)*</b>	<b>MAXIMUM ALLOWABLE CHARGE WEIGHTS (Pounds)*</b>
50	0.5
100	2.0
150	4.5
200	8.0
250	12.0
300	18.0
350	25.0
* Based upon a charge weight of seventy (70) Foot/Pound <sup>1/2</sup>	

(3-20-20)T

**d.** The maximum allowable charge weight is twenty-five (25) pounds, unless the permit holder requests and secures the prior written authorization from the Department. (3-20-20)T

**e.** All seismic sources placed for detonation shall contain additives to accelerate the biodegradation thereof and shall be handled with due care in accordance with industry standards. The cap leads for any seismic sources that fail to detonate shall be buried at least three (3) feet deep. (3-20-20)T

**f.** All vegetation cleared to the ground shall be cleared in a competent and workmanlike manner in the exercise of due care. (3-20-20)T

**g.** Unless otherwise consented to by the surface owner in writing, permit holder shall not cut down any tree measuring six (6) inches or more in diameter, as measured at a height of three (3) feet from the ground surface, unless there are no reasonable alternatives to the removal of such tree(s) available to permit holder. Permit holder shall compensate surface owner the value of all such trees. (3-20-20)T

**h.** All excessive rutting or soil disturbances shall be repaired or restored to the original condition and contour to the extent reasonable, unless otherwise agreed to by the permit holder and the surface owner in writing. (3-20-20)T

**i.** All fences removed shall be replaced, unless otherwise agreed to by the permit holder and the surface owner in writing. (3-20-20)T

**j.** All debris associated with the seismic activity shall be removed and properly disposed. (3-20-20)T

**03. Bond Required.** (3-20-20)T

**a.** Before beginning geophysical operations, the geophysical contractor must file and have approved by the Department a bond in the amount of at least ten thousand dollars (\$10,000). The Department may increase this bonding requirement for geophysical contractors based on the amount of potential damage from the contemplated operation. The condition of such bond shall comply with the Act, the rules and orders of the Commission, and orders of the Department. The obligation of the bond shall not be discharged until one (1) year from completion of the survey or until the geophysical contractor has complied with the Oil and Gas Conservation Law, the Commission's rules, and the orders of the Commission and the Department. (3-20-20)T

**b.** Persons or other entities who engage in the plugging of seismic holes and are not a regular full-time employee of the seismic company, owner, or operator shall have posted with the director a surety bond in favor of the Department. Said bond shall be on a form prescribed by the Department and in the amount of five thousand dollars (\$5,000). The condition of the bond shall comply with the Oil and Gas Conservation Law and the regulations and



orders of the Commission and the Department. (3-20-20)T

**04. Newspaper Notice.** Before a geophysical contractor conducts the geophysical operation, the contractor shall publish a legal notice in a newspaper of general circulation in the county where the survey will be conducted. The notice shall state the nature and approximate time period of the seismic operations. These requirements do not apply to operations conducted within a well or conducted by aerial surveys. (3-20-20)T

**05. Owner and Occupant Notification.** No entry shall be made by any person to conduct seismic operations, upon the lands where such seismic operations are to be conducted, without the permit holder having first given notice at least thirty (30) calendar days prior to commencement of field seismic operations. (3-20-20)T

**a.** The notice shall be in writing and given either personally or by certified United States mail to the following persons: (3-20-20)T

**i.** Surface owners reflected in the tax records of the counties where the lands are located, at the mailing addresses identified for such surface owners in such records; (3-20-20)T

**ii.** Occupants residing on the lands who are not the surface owners, if it can be reasonably ascertained that there are such occupants; and (3-20-20)T

**iii.** Owners or operators of oil and gas wells within the seismic survey area, as reflected in Department records. (3-20-20)T

**b.** The notice shall contain the following: (3-20-20)T

**i.** Name of the person or entity that is conducting the seismic operations; (3-20-20)T

**ii.** Proposed location of the seismic operations; and (3-20-20)T

**iii.** Approximate date the person or entity proposes to commence seismic operations. (3-20-20)T

**06. Department Notifications.** (3-20-20)T

**a.** The permit holder shall also notify the Department within five (5) business days of the commencement and completion of each seismic operation. (3-20-20)T

**b.** Before beginning geophysical operations other than seismic operations, the geophysical contractor shall file a notice of intention to do so with the Department. Said notice shall describe the geophysical method to be used and be accompanied by a map of a scale of one (1) inch equals two (2) miles showing the location of the project. (3-20-20)T

**07. Reports and Notices Required.** (3-20-20)T

**a.** Activity Report. Upon completion of the seismic activity or at thirty (30) day intervals after the work has commenced, whichever occurs first, the seismic contractor shall file with the Department a report of the completion or progress of the seismic project. The final completion report shall be in affidavit form and shall include a seven and one-half (7.5) - or fifteen (15) minute United States Geological Survey topographic quadrangle map (at a scale of one (1) inch equals two thousand (2,000) feet or one (1) inch equals four thousand (4,000) feet that shows section, township, and range) and the location of each survey so that the shotholes and other potential impacts can be easily located. The final completion report shall also include a statement that all work has been performed in compliance with the application for a permit to perform seismic activity, Section 100 of these rules, and permit provisions. Said maps, applications, and reports shall be kept confidential by the Department for a period of one (1) year from the date of receipt, subject to the needs of the Department to use them to enforce these regulations, the Act, and the orders of the Commission or the Department. Also, the owner of the surface of the land may be advised of the location of seismic lines or seismic holes on his land and of the exploration method used. (3-20-20)T

**b.** Plugging Notice. Seismic contractors shall give the Department at least twenty-four (24) hours

advance notice of shothole plugging operations, provided that notice of plugging operations planned for Sunday or Monday may be given on the previous Friday. (3-20-20)T

**08. Client-Contractor Responsibility.** The client company may be held responsible along with the seismic contractor for conducting the operation in compliance with the Commission's rules and orders, the Department's orders, and the Act for the seismic contractor's failure to comply with such rules, statutes, and orders. The hats used in the plugging of seismic holes shall be imprinted with the name of the contractor responsible for the plugging of the hole. (3-20-20)T

**09. Plugging.** Unless the seismic contractor can prove to the satisfaction of the Department that another method will provide better protection to ground water and long-term land stability, seismic shothole operations shall be conducted in the following manner: (3-20-20)T

**a.** When water is used in conjunction with the drilling of seismic shotholes and artesian flow is not encountered at the surface, seismic holes are to be filled with a high grade bentonite/water slurry mixture. Said slurry shall have a density that is at least four percent (4%) greater than the density of fresh water; said slurry shall also have a Marsh funnel viscosity of at least sixty (60) seconds per quart. Density and viscosity are to be measured prior to adding cuttings to the slurry. Cuttings not added to the slurry are to be disposed of in accordance with Paragraph 100.09.f. of this rule. Any other suitable plugging material commonly used in the industry may be substituted for the bentonite/water slurry as long as the physical characteristics of said substitute are at least comparable to those of the bentonite/water slurry. Between November 1 and May 1, coarse ground bentonite approved by the Department shall be used as a plugging material. (3-20-20)T

**b.** The hole will be filled with the slurry from the bottom up to a depth of three (3) feet (three (3) feet below ground level). A nonmetallic plug will be set at this depth of three (3) feet, and the remaining hole will be filled and tamped to the surface with cuttings and native soil. (3-20-20)T

**c.** When drilling with air and nonartesian water is encountered, the hole shall be plugged with the slurry mixture, or coarse ground bentonite, as specified in Paragraph 100.09.a., supra. (3-20-20)T

**d.** When drilling with air only and in completely dry holes, plugging may be accomplished by returning the cuttings to the hole, tamping the returned cuttings to the above-referenced depth of three (3) feet, and setting the permaplug topped with more cuttings and soil as per Paragraph 100.09.b. above. A small mound will be left over the hole for settling allowance. Auger holes twenty (20) feet or less in depth may be plugged in this same manner. (3-20-20)T

**e.** The foregoing seismic holes shall be properly plugged and abandoned as soon as practical after the shot has been fired; however, a shot hole shall not be left unplugged for more than thirty (30) days without approval of the Department. (3-20-20)T

**f.** Any slurry, drilling fluid, or cuttings which are deposited on the surface around the seismic hole will be raked or otherwise spread out to at least within one (1) inch of the surface, so that the growth of the natural grasses or foliage will not be impaired. (3-20-20)T

**g.** The requirements of Paragraphs 100.09.a. through 100.09.f. of this rule may be modified by any reasonable written agreement between the seismic company and the surface owner. (3-20-20)T

**h.** If artesian flow (water flowing at the surface) is encountered in the drilling of any seismic hole, cement will be used to seal off the water flow thereby preventing cross-flow, erosion, and/or contamination of freshwater supplies. Said holes shall be cemented immediately. (3-20-20)T

**i.** After completing the plugging of seismic shot holes and spreading the cuttings as required by this rule, the seismic contractor shall record the GPS location of the seismic hole, and the contractor shall provide the location data to the Department. (3-20-20)T

**10. Forfeiture of Geophysical Exploration Bond.** The Department may forfeit the bond submitted under Subsection 100.03 of this rule upon failure of the owner or operator to conduct the seismic survey and complete

reclamation in conformance with Section 100 of this rule. The owner or operator will be given an opportunity to address compliance issues prior to the Department taking action against the bond. (3-20-20)T

**101. -- 199. (RESERVED)**

**SUBCHAPTER C – DRILLING, WELL TREATMENT, AND PIT PERMITS**

**200. PERMIT TO DRILL, DEEPEN, OR PLUG BACK.**

**01. Permits Required.** Prior to the commencement of operations to drill, deepen, or plug back to any source of supply other than the existing producing horizon, application shall be delivered to the Department of intention to drill, deepen, or plug back any well for oil or gas, and approval obtained. (3-20-20)T

**02. Fees.** An application fee must accompany each application for permit to drill, deepen, or plug back. No service fee is required for a permit to deepen or plug back in a well for which the fee has been paid for permit to drill unless the drilling permit has expired. (3-20-20)T

**03. Time Required to Commence Operations; Term of Permit.** On the first anniversary of the date of issuance of a permit to drill, deepen, or plug back, said permit will expire and be of no further force or effect, unless the work for which the permit was issued has been started. Prior to the anniversary date, the owner or operator may apply for a one-time, six-month extension if work has not started. If conditions have not changed and no changes to the permit are requested, the extension may be approved by the Department. If a permit expires due to the failure to commence operations, then reapplication is required prior to commencing operations. (3-20-20)T

**04. Application.** The Application for Permit to Drill shall include a Department approved form and the following: (3-20-20)T

**a.** An accurate plat showing the location of the proposed well with reference to the nearest lines of an established public survey. (3-20-20)T

**b.** The location of the nearest structure with a water supply, or the nearest water well as shown on the IDWR registry of water rights or well log database. (3-20-20)T

**c.** Information on the type of tools to be used and the proposed logging program. (3-20-20)T

**d.** Proposed total depth to which the well will be drilled, estimated depth to the top of the important geologic markers, and the estimated depth to the top of the target formations. (3-20-20)T

**e.** The proposed casing program, including size and weight thereof, the depth at which each casing type is to be set. (3-20-20)T

**f.** The type and amount of cement to be used, and the intervals cemented. (3-20-20)T

**g.** Information on the drilling plan. (3-20-20)T

**h.** Best management practices to be used for erosion and sediment control. (3-20-20)T

**i.** Plan for interim reclamation of the drill site after the well is completed, and a plan for final reclamation of the drill site following plugging and abandonment of the well. These plans must contain the information needed to implement reclamation as described in Subsection 310.16 and Section 510 of these rules. (3-20-20)T

**j.** Applications that include the following actions must also provide the information from the respective Section of these rules: (3-20-20)T

**i.** Well treatments require the submittal of the information in Section 210. (3-20-20)T

- ii. Pit construction and use requires the submittal of the information in Section 230. (3-20-20)T
- iii. Directional or horizontal drilling requires the submittal of the information in Section 330. (3-20-20)T
- k. Any other information which may be required by the Department based on site specific reasons. (3-20-20)T
- 05. Permit Denial.** Applications may be denied for the following reasons: (3-20-20)T
  - a. Application fee was not submitted. (3-20-20)T
  - b. Application is incomplete. (3-20-20)T
  - c. Failure to post required bonds. (3-20-20)T
  - d. Proposed well will result in a waste of oil or gas, a violation of correlative rights, or the pollution of fresh water supplies. (3-20-20)T

**201. MULTIPLE ZONE COMPLETIONS.**

**01. Requirements of the Owner or Operator; Request for Approval.** A multiple zone completion may be approved by the Department upon application by the owner or operator and payment of an application fee, as herein provided. The application shall be accompanied by an exhibit showing the location of wells on applicant's lease and all offset wells on leases, and shall set forth all material facts involved and the manner and method of completion proposed, including a diagrammatic sketch of the mechanical installation of the proposed well. The application fee may not exceed that required by Subsection 200.02 of these rules. Notice of the filing of such application shall be given by the applicant by mailing to each offset operator a notice containing a full description of the proposed completion for which approval is requested, and proof of mailing such notice shall be made by affidavit, which shall be attached to the application showing names and addresses of those to whom notice was mailed. (3-20-20)T

**02. Conditions for Approval; Cause for Hearing.** In the event the Department is in agreement with the application and that no offset operator files a written objection to the application with the Department within fifteen (15) days of the date of the offset operator's receipt of application, the application shall be approved as an amendment to the drilling permit. If any offset operator shall file in writing with the Department an objection to such multiple completion, or if the Department is not in agreement with the application, the matter shall be immediately set for hearing and Notice of Hearing duly given by the Department. (3-20-20)T

**03. Zone Effectiveness; Requirement for Production Testing.** The Department may require such tests as necessary to determine the effectiveness of the segregation of the different productive zones. (3-20-20)T

**04. Commingling Production.** The Department may require that oil or gas from multiple zones be produced through different sets of tubing, if needed to protect correlative rights or to prevent waste. (3-20-20)T

**202. -- 209. (RESERVED)**

**210. WELL TREATMENTS.**

**01. Application Required.** An Application for Permit to Drill required by Section 200 must include any plans for well treatment if they are known before the well is drilled. If well treatments are not covered in the original drilling permit, then an application to amend the permit must be made to the Department with an application fee. Approval by the Department is required prior to the well treatments being implemented. Actions to clean the casing or perforations not in excess of pressures sufficient to overcome the fracture gradient in the surrounding formation are not considered to be well treatments, but operators must notify the Department when such actions occur. Applications for well treatments must include the permit number, well name, well location, as-built description if drilling has been completed, and the following: (3-20-20)T

- a. Depth to perforations or the openhole interval; (3-20-20)T
- b. The source of water or type of base fluid; (3-20-20)T
- c. Additives, meaning any substance or any combination of substances including proppant, having a specified purpose that is combined with base treatment fluid by trade name, if available, and MSDS for each additive; (3-20-20)T
- d. Type of proppant(s); (3-20-20)T
- e. Anticipated percentages by volume and total volumes of base treatment fluid, individual additives, and proppant(s); (3-20-20)T
- f. Estimated pump pressures; (3-20-20)T
- g. Method and timeline for the management, storage, and disposal of well treatment fluids, including anticipated disposal site of treatment fluids or plans for reuse; (3-20-20)T
- h. Size and design of storage pits, if proposed, in conformance with Section 230 of these rules; (3-20-20)T
- i. Information specific to hydraulic fracturing as described in Section 211 of these rules; (3-20-20)T
- j. Summary identifying all water bearing zones from the surface down to the bottom of the well; (3-20-20)T
- k. Fresh water protection plan that describes the proposed site specific measures to protect water quality from activities associated with well treatments. The Department will review this plan in consultation with the IDEQ. The Fresh Water Protection Plan shall include the following information: (3-20-20)T
  - i. Ground water and storm water best management practices; (3-20-20)T
  - ii. Statement certifying that the owner or operator is complying with Spill Prevention, Control, and Countermeasures (SPCC) requirements administered by the EPA; (3-20-20)T
  - iii. A preconstruction topographic site map or aerial photos identifying all habitable structures, wells, perennial and intermittent springs, surface waters, and irrigation ditches within one-quarter (1/4) mile of the oil or gas well. The distance or location may be changed based on site specific factors such as horizontal drilling, the expected length of fractures, or lack of suitable water sample locations within one-quarter (1/4) mile; (3-20-20)T
  - iv. A brief description of the structural geology that may influence ground water flow and direction; (3-20-20)T
  - v. The general hydrogeological characteristics of the treatment area and surrounding land. (3-20-20)T
- l. Certification by the owner or operator that all aspects of the well construction, including the suitability and integrity of the cement used to seal the well, are designed to meet the requirements of proposed well treatments; (3-20-20)T
- m. Affidavit signed by the owner or operator stating that all home owners and water well owners within one-quarter (1/4) mile of the oil or gas well, and all owners of a public drinking water system that have a IDEQ recognized source water assessment or protection area within one-quarter (1/4) mile of the oil or gas well, have been notified of the proposed treatment. If a well deviates from the vertical, these surface distances will be from the entire length of the wellbore from the surface to total depth. The notification will also offer an opportunity to have the owner or operator sample and test the water, at the owner or operator's cost, prior to and after the oil or gas well being treated. Notification shall be by certified mail to the surface owner as identified by the county assessor's records, or to

the well owner as identified on the IDWR registry of water rights or well log database; (3-20-20)T

**n.** Proof of publication in a newspaper of general circulation in the county where the well is located of a legal notice briefly describing the well treatment to be performed. Notice shall also advise all water well or public drinking water system owners, as described in Paragraph 210.01.m. of these rules, of the opportunity to have their water tested at the owner's or operator's cost before and after the well treatment; and (3-20-20)T

**o.** Additional information as required by the Department. (3-20-20)T

**02. Master Drilling/Treatment Plans.** Where multiple stimulation activities will be undertaken for several wells proposed to be drilled in the same field within an area of geologic similarity, approval may be sought from the Department for a comprehensive master drilling/treatment plan containing the information required. The approved master drilling/treatment plan must then be referenced on each individual well's Application for Permit to Drill. (3-20-20)T

**03. Application Denial.** The Department may deny well treatment applications for one (1) or more of the following reasons: (3-20-20)T

**a.** Application does not contain the information in Subsection 210.01 of these rules; (3-20-20)T

**b.** Application fee was not submitted. (3-20-20)T

**c.** Proposed treatment will result in a waste of oil or gas, a violation of correlative rights, or the pollution of fresh water supplies. (3-20-20)T

**04. Time Limit.** If a treatment approved in a drilling permit or amended drilling permit is not started within one (1) year of the approval of the well treatment, the well treatment permit will expire and reapplication will be required prior to conducting the well treatment. Prior to the anniversary date, the owner or operator may apply for a six-month (6) extension. If conditions have not changed, and no changes to the permit are requested, the extension may be approved by the Department. (3-20-20)T

**05. Inspections.** The Department may conduct inspections prior, during, and after well treatments. (3-20-20)T

**06. Reporting Requirements.** A report on the well treatment must be submitted within thirty (30) days of the treatment. The report shall present a detailed account of the work done and the manner in which such work was performed, including: (3-20-20)T

**a.** The daily production of oil, gas, and water both prior to and after the operation. (3-20-20)T

**b.** The size and depth of perforations. (3-20-20)T

**c.** Percentages by volume and total volumes of base treatment fluid, individual additives, and proppant(s). This requirement can be met by the submittal of well completion field tickets if they contain this information. (3-20-20)T

**d.** Documentation demonstrating the chemicals used in the well treatment have been reported to the website [www.fracfocus.org](http://www.fracfocus.org), its successor website, or another publicly accessible database approved by the Department. The chemical information must be reported in a systems approach. (3-20-20)T

**e.** Information specific to hydraulic fracturing, as described in Section 211 of these rules. (3-20-20)T

**f.** Static pressure testing results before and after the well treatment. (3-20-20)T

**g.** The amounts, handling, and if necessary, disposal at an identified appropriate disposal facility, or reuse of the well stimulation fluid load recovered during flow back, swabbing, and/or recovery from production facility vessels. Reporting of recovered fluids shall be included with other monthly production reports required by the

Department. Storage of such fluid shall be protective of ground water as demonstrated by the use of either tanks or authorized lined pits as described in Section 230 of these rules. (3-20-20)T

**h.** Any other information related to operations which alter the performance or characteristics of the well. (3-20-20)T

**07. Fresh Water Protections for Well Treatments.** (3-20-20)T

**a.** The Department will not authorize pits, lagoons, ponds, or other methods of subsurface storage for treatment fluids within IDEQ recognized source water assessment or protection areas for public drinking water systems. Owners or operators must store and transport treatment fluids using above ground storage facilities and tanker trucks for well treatments in these locations. (3-20-20)T

**b.** The Department will not authorize well treatments to create fractures within five hundred (500) vertical feet above or below fresh water aquifers. (3-20-20)T

**c.** The Department shall require the owner or operator to complete fresh water monitoring at the owner's or operator's cost before and after a well treatment unless the Department, in consultation with the IDEQ, determines that the proposed treatment does not pose a threat of pollution to fresh waters. The Department will review and approve all monitoring proposals with the IDEQ. The monitoring will be done using representative existing water wells or surface waters within one-quarter (1/4) horizontal mile of the treated well. For wells that deviate from the vertical, sampling may be required within one-quarter (1/4) horizontal mile of the wellbore's projected location on the surface. If no water wells or surface waters are present in this area, the sampling area may be enlarged as needed with approval by the Department. If the Department determines that existing water wells are not representative of the ground waters that could be impacted, then the Department may require the owner or operator to install one (1) or more ground water monitoring wells at the owner's or operator's cost. The owner or operator must obtain consent from appropriate property owners to gain access prior to any sampling or well construction. When monitoring is required by the Department, the operator will prepare a monitoring plan that includes the following: (3-20-20)T

**i.** Location of proposed monitoring sites; (3-20-20)T

**ii.** Construction details of any sampled or constructed wells including total well depth, depth of screened interval(s), screen size, and drilling log. For existing wells, the operator must make every reasonable attempt to locate this information; (3-20-20)T

**iii.** When possible, data from the existing wells collected within the last five (5) years and analyzed in a state or EPA certified drinking water lab; (3-20-20)T

**iv.** List of proposed analytes, testing methods, and their detection limits; (3-20-20)T

**v.** Additional tests such as stable isotopic analysis; and (3-20-20)T

**vi.** Pre-treatment sampling and analysis when no relevant data exists, and a schedule for post-treatment sampling and analysis. (3-20-20)T

**d.** The owner or operator will provide the Department with copies of any analysis or reports within thirty (30) days of samples being taken. All samples must be analyzed in a state or EPA certified drinking water lab. (3-20-20)T

**e.** Pollution of fresh water supplies due to a well treatment is a violation of these rules and Title 47, Chapter 3, Idaho Code. (3-20-20)T

**211. HYDRAULIC FRACTURING.**

**01. Application Requirements.** In addition to the information required by Subsection 210.01 of this rule, the owner or operator shall provide the following application information regarding hydraulic fracturing:

(3-20-20)T

a. The geological names and descriptions of the formation into which well stimulation fluids are to be injected; (3-20-20)T

b. Detailed information on the base stimulation fluid source. For each stage of the well stimulation program, provide the chemical additives and proppants and concentrations or rates proposed to be mixed and injected, including: (3-20-20)T

i. Stimulation fluid identified by additive type (such as but not limited to acid, biocide, breaker, brine, corrosion inhibitor, crosslinker, demulsifier, friction reducer, gel, iron control, oxygen scavenger, pH adjusting agent, proppant, scale inhibitor, surfactant); (3-20-20)T

ii. The chemical compound name and Chemical Abstracts Service (CAS) number as found on the previously submitted MSDS shall be identified (such as the additive biocide is glutaraldehyde, or the additive breaker is ammonium persulfate, or the proppant is silica or quartz sand, and so on for each additive used); (3-20-20)T

iii. The proposed rate or concentration for each additive and the total volume of each shall be provided (such as gel as pounds per thousand gallons, or biocide at gallons per thousand gallons, or proppant at pounds per gallon, or expressed as percent by weight or percent by volume, or parts per million, or parts per billion); and (3-20-20)T

iv. The formulary disclosure of the chemical compounds used in the well stimulation(s) for the purpose of protecting public health and safety. (3-20-20)T

c. A detailed description of the proposed well stimulation design that shall include: (3-20-20)T

i. The anticipated surface treating pressure range; (3-20-20)T

ii. The maximum injection treating pressure, which shall be within accepted safety limits. Accepted safety limits are generally eighty percent (80%) of the maximum pressure rating of the pressurized system; (3-20-20)T

iii. The estimated or calculated fracture height in both the horizontal and vertical directions. (3-20-20)T

**02. Volatile Organic Compounds and Petroleum Distillates.** The injection of volatile organic compounds, such as benzene, toluene, ethyl benzene and xylene, also known as BTEX compounds, or any petroleum distillates into ground water in excess of the applicable ground water quality standards is prohibited. Volatile organic compounds or petroleum distillates may be appropriate as additives, but they are not appropriate for use as the base fluids. The proposed use of volatile organic compounds or any petroleum distillates for well stimulation into hydrocarbon bearing zones may be authorized with prior approval of the director. Water that is produced with oil and gas, and which may contain small amounts of naturally occurring volatile organic compounds or petroleum distillates, may be used as well stimulation fluid in hydrocarbon bearing zones. (3-20-20)T

**03. Well Integrity.** Prior to the well stimulation, the owner or operator will perform a suitable mechanical integrity test of the casing or of the casing-tubing annulus or other mechanical integrity test methods and submit an affidavit certifying that the well was tested in anticipation of proposed treatment pressures. The owner or operator will notify the Department of this test twelve (12) to twenty-four (24) hours in advance. (3-20-20)T

**04. Pressure Monitoring.** During the well stimulation operation, the owner or operator shall monitor and record the annulus pressure at the casinghead. If intermediate casing has been set on the well being stimulated, the pressure in the annulus between the intermediate casing and the production casing shall also be monitored and recorded. If the annulus pressure increases by more than five hundred (500) psi gauge as compared to the pressure immediately preceding the stimulation, the owner or operator shall verbally notify the Department as soon as practicable but no later than twenty-four (24) hours following the incident. (3-20-20)T



**05. Post Treatment Report.** In addition to the information required by Subsection 210.06 of this rule, the owner or operator shall provide the following post-treatment reporting: (3-20-20)T

- a.** The actual total well stimulation treatment volume pumped; (3-20-20)T
- b.** The actual surface pressure and rate at the end of each fluid stage and the actual flush volume, rate and final pump pressure; (3-20-20)T
- c.** The instantaneous shut-in pressure, and the actual fifteen (15) minute and thirty (30) minute shut-in pressures when these pressure measurements are available; (3-20-20)T
- d.** A continuous record of the annulus pressure during the well stimulation; (3-20-20)T
- e.** A copy of the well stimulation service contractor's job log, without any cost/pricing data from the field ticket, in lieu of paragraphs (a) through (d) above. If the job log does not contain all the needed information, it must be supplemented with additional information needed to satisfy Paragraphs 211.05.a. through 211.05.d. of this rule. (3-20-20)T
- f.** A report containing all details pertaining to any annulus pressure increases of more than five hundred (500) psi gauge as described in Subsection 211.04 of this rule. The report shall include corrective actions taken, if necessary. (3-20-20)T
- g.** Results of post treatment fluid analysis used to help determine where the fluid can be disposed. (3-20-20)T

**212. -- 219. (RESERVED)**

**220. BONDING.**

**01. Individual Bond.** The Department shall, except as hereinafter provided, require from the owner or operator a good and sufficient bond in the sum of not less than ten thousand dollars (\$10,000) plus one dollar (\$1) for each foot of planned well length in favor of the Department. The bond shall be conditioned upon the performance of the owner's or operator's duty to comply with the requirements of the Act and the rules of the Commission, with respect to the drilling, maintaining, operating, and plugging of each well drilled for oil and gas and the reclamation of surface disturbance associated with these activities. Said bond shall remain in force and effect until the plugging of said well is approved by the Department and the well site is reclaimed as described in Section 510 of these rules, or the bond is released by the Department. (3-20-20)T

**02. Blanket Bond.** In lieu of the bond in Subsection 220.01 of this rule, any owner or operator may file with the Department a good and sufficient blanket bond covering all active wells drilled or to be drilled in the state of Idaho. The amount of the blanket bond will be as follows according to the number of active wells covered by the bond: (3-20-20)T

- a.** Up to ten (10) wells, fifty thousand dollars (\$50,000); (3-20-20)T
- b.** Eleven (11) to thirty (30) wells, one hundred thousand dollars (\$100,000); or (3-20-20)T
- c.** More than thirty (30) wells, one hundred fifty thousand dollars (\$150,000). (3-20-20)T

**03. Inactive Well Bond.** An owner or operator must provide the Department with a bond of at least ten thousand dollars (\$10,000) plus eight dollars (\$8) for each foot of planned well length for each inactive well conditioned upon the performance of the duty to comply with the requirements of the Act and the rules of the Commission, with respect to the drilling, maintaining, operating, and plugging of each well drilled for oil and gas. Said bond shall remain in force and effect until the plugging of said well is approved by the Department, or the bond is released by the Department. Inactive wells may not be covered by a blanket bond as provided in Subsection 220.02 of this rule. (3-20-20)T

**04. Additional Bonding.** The Department may impose additional bonding on an owner or operator given sufficient reason, such as non-compliance, unusual conditions, horizontal drilling, or other circumstances that suggest a particular well or group of wells has potential risk or liability in excess of that normally expected. The owner or operator may request a hearing to appeal either the decision to impose an additional bond or the proposed amount of the bond. (3-20-20)T

**05. Authorized Bonds.** The bond(s) referred to in Section 220 must be by a corporate surety authorized to do business in the state of Idaho or in cash. If cash is used to satisfy the bonding requirements in these rules, interest on the cash will be allocated to the general fund. (3-20-20)T

**221. TRANSFER OF DRILLING PERMITS.**

No person to whom a permit has been issued shall transfer the permit to any other location or to any other person until the following requirements have been complied with: (3-20-20)T

**01. Prior to Drilling Well.** If, prior to the drilling of a well, the person to whom the permit was originally issued desires to change the location, he shall submit a letter so stating and another application properly filled out showing the new location. Drilling shall not be started until the transfer has been approved and the new permit posted at the new location. (3-20-20)T

**02. During Drilling or After Completion.** If, while a well is being drilled or after it has been completed, the person to whom the permit was originally issued disposes of his interest in the well, he shall submit a written statement to the Department setting forth the facts and requesting that the permit be transferred to the person who has acquired the well. (3-20-20)T

**03. Terms for Acceptance of Transfer.** Before the transfer of a drilling permit shall be recognized, the person who has acquired the well must submit a written statement setting forth that he has acquired such well and assumes full responsibility for its operation and abandonment in conformity with the law, rules, regulations, and orders issued by the Commission. If bond is required to guarantee compliance with the rules and regulations of the Commission, the person acquiring such well shall furnish bond. (3-20-20)T

**222. -- 229. (RESERVED)**

**230. PIT REQUIREMENTS.**

**01. Plans Required.** If pits are proposed to be constructed in connection with another permit application required by these rules, then the owner or operator must include plans for pit construction in the application. If a pit is needed after the other permits have been approved, then an application to amend the permit must be made to the Department with an application fee. Approval by the Department is required prior to the pit being constructed unless the pit is necessary for an emergency action. Pit applications must include the permit number, well name, well location, as-built description if drilling has been completed, proposed pit location, and plans for pit construction, operation, and reclamation. (3-20-20)T

**02. Location.** (3-20-20)T

**a.** Pits must be located where they are structurally sound and the liner systems can be adequately protected against factors such as wild fires, floods, landslides, surface and ground water systems, equipment operation, and public access. (3-20-20)T

**b.** Pits located in a one hundred-year floodplain must be in conformance with any applicable floodplain ordinances pertaining to activities within the one hundred-year floodplain. (3-20-20)T

**c.** Pits shall not be located within an IDEQ recognized source water assessment or protection areas for public drinking water systems. (3-20-20)T

**03. Site Preparation.** All sites must be properly prepared prior to pit construction. Vegetation, roots, brush, large woody debris and other deleterious materials, topsoil, historic foundations and plumbing, or other materials that may adversely affect appropriate construction, must be removed from the footprint of the pit unless

approved by the Department. (3-20-20)T

**04. Pit Sizing Criteria.** (3-20-20)T

**a.** Pits that have constructed berms ten (10) or more feet in height or hold fifty (50) acre-feet or more of fluid must also comply with the dam safety requirements of IDAPA 37.03.06, "Safety of Dams Rules." (3-20-20)T

**b.** Pits must be designed to hold the maximum volume of fluids being used for drilling or well treatment and the volume of water associated with a one hundred-year, twenty-four-hour precipitation event. (3-20-20)T

**c.** Snowmelt events shall be considered in determining the containment capacity. (3-20-20)T

**d.** Pits that are left over winter must be able to contain one hundred twenty-five percent (125%) of the average annual precipitation that falls from October through May. (3-20-20)T

**e.** Pits must be designed to maintain a minimum two (2) foot freeboard at all times. Contingency plans for managing excesses of fluids shall be described in the application. At no time shall fluids in a pit be allowed to escape from the impoundment. (3-20-20)T

**05. Minimum Plans and Specifications for Reserve, Well Treatment, and Other Short Term Pits.**

Pits used for one (1) year or less, not including extensions, are short term pits. Construction plans and specifications for short term pits must include the requirements under Subsections 230.02 through 230.04 of this rule and the following: (3-20-20)T

**a.** A prepared subbase, which shall be free of plus three (3) inch rocks, roots, brush, trash, debris or other deleterious materials, and compacted to ninety-five percent (95%) of Standard Proctor Test ASTM D698-07e1 or ninety-five percent (95%) of Modified Proctor Test ASTM D1557-09; (3-20-20)T

**b.** Slopes of two (2) feet horizontal to one (1) foot vertical (2H:1V) or flatter for all interior and exterior pit walls. The top of a bermed pit wall must be a minimum of two (2) feet wide; (3-20-20)T

**c.** A primary liner system consisting of a synthetic liner of at least twenty (20) mils thickness and constructed according to manufacturers' standards with at least four (4) inches of welded seam overlap and complete coverage on the floor and inside walls of the pit. Seams must run parallel to the line of maximum slope so they do not traverse across the slope. The liner edges shall be anchored in a compacted earth filled trench at least eighteen (18) inches in depth. The liner must be protected against cracking, sun damage, ice, frost penetration or heaving, wildlife and wildfires, and damage that may be caused by personnel or equipment operating in or around these facilities. Liner compatibility shall comply with EPA SW-846 method 9090A. Alternative liner systems with similar standards may be proposed by the owner or operator and approved at the Department's discretion; (3-20-20)T

**d.** Minimum factors of safety, and the logic behind their selection, for the stability of the earthworks and the lining system of the pit; (3-20-20)T

**e.** Site-specific methods for excluding people, terrestrial animals, and avian wildlife from the pits; (3-20-20)T

**f.** Segregation and stockpiling of topsoil in a manner that will support reestablishment of the pre-disturbance land use after pit closure; and (3-20-20)T

**g.** A closure plan including the following: (3-20-20)T

**i.** Testing of residual fluids and any accumulated solids, if anything other than water based drilling fluid was placed in the pit; (3-20-20)T

**ii.** Plans for removal and disposal of residual fluids and accumulated solids, with the liner material, at an appropriate facility; (3-20-20)T

- iii. Regrading plan, replacement of topsoil, and erosion control measures; and (3-20-20)T
- iv. Reseeding and Revegetation. (3-20-20)T

**06. Minimum Plans and Specifications for Long Term Pits.** Pits used for more than one (1) year, not including extensions, are long term pits. Construction plans and specifications for long term pits must include the requirements under Subsections 230.02 through 230.05 of this rule and the following: (3-20-20)T

- a. A quality control/quality assurance construction and installation plan; (3-20-20)T
- b. Type of fluids to be contained in the pit; (3-20-20)T
- c. Secondary containment synthetic liners, which shall have a minimum thickness of sixty (60) mils consisting of HDPE and a maximum coefficient of permeability of  $10^{-9}$  cm/sec, or comparable liners approved by the Department; (3-20-20)T
- d. Leak detection and collection systems. The plans and specifications shall: (3-20-20)T
  - i. Provide a material between primary and secondary containment synthetic liners to collect, transport and remove all fluids that pass through the primary containment synthetic liner at such a rate as to prevent hydraulic head from developing on the secondary containment synthetic liner to the level at which it may be reasonably expected to result in discharges through the secondary containment synthetic liner; (3-20-20)T
  - ii. Provide routines and schedules for the evaluation of the efficiency and effectiveness of the removal of fluids from the layer placed between primary and secondary containment synthetic liners. The properly working system shall continually relieve head pressures on the secondary containment synthetic liner; (3-20-20)T
  - iii. Provide specific triggers for maintenance routines, which shall be initiated in response to inadequate performance of primary or secondary containment synthetic liners; and (3-20-20)T
  - iv. Specify operation and maintenance procedures, which shall be initiated in response to inadequate performance of primary and secondary containment or leak detection and collection systems. (3-20-20)T
- e. All piping, including that contained in the leak detection and collection system, shall have a minimum wall thickness of PVC Schedule 80 and be designed to: (3-20-20)T
  - i. Withstand chemical attack from oil field waste or leachate; (3-20-20)T
  - ii. Withstand structural loading from stresses and disturbances from cover materials or equipment operation; and (3-20-20)T
  - iii. Facilitate clean-out and maintenance. (3-20-20)T
- f. Protections for the liner from excessive hydrostatic force or mechanical damage at the point of discharge into, or suction from, the pit. External discharge or suction lines shall not penetrate the liner; (3-20-20)T
- g. Plans for erosion control during and immediately following construction; and (3-20-20)T
- h. Operating and maintenance plans. (3-20-20)T

**07. Time Limits for Short Term Pits.** Reserve, well treatment, and other short term pits must be closed out and reclaimed within one (1) year of being constructed. The owner or operator may request a one-time extension for up to six (6) months. The Department may grant the request if the owner or operator gives sufficient cause and presents a plan for ensuring that the pit is adequately monitored and maintained. (3-20-20)T

- a. Fluids may be left in a pit for up to six (6) months after the associated well activities are conducted.

The owner or operator may request a one-time extension for up to one (1) year. The Department may grant the request if the owner or operator gives sufficient cause and presents a plan for keeping the fluids in a usable state. (3-20-20)T

**b.** Notwithstanding the above time limits, the owner or operator may request additional time based upon conditions wholly outside of the owner's or operator's control including, but not limited to, governmental lease requirements and delays related to difficult drilling conditions. The Department may impose additional construction or monitoring requirements prior to granting additional time. (3-20-20)T

**08. Emergency Pits.** Pits constructed during an emergency situation may be approved by an after-the-fact application submitted to the Department. The requirements in Subsections 230.02 through 230.05 of this rule shall apply, and the pit must be closed out and reclaimed within six (6) months of being constructed. The Department must be notified within twenty-four (24) hours of an emergency situation requiring an emergency pit. (3-20-20)T

**09. Operating Requirements.** (3-20-20)T

**a.** Waste oil, hydraulic fluid, transmission fluids, trash, or any other miscellaneous waste products must not be disposed of in a pit. Placement of these materials into a pit may result in the creation of a mixed waste that requires handling and disposal as a hazardous waste. (3-20-20)T

**b.** If a pit liner's integrity is compromised, or if any penetration of the liner occurs above the liquid's surface, then the owner or operator shall notify the appropriate Department area office within forty-eight (48) hours of the discovery and repair the damage or replace the liner. (3-20-20)T

**c.** If a pit or closed-loop system develops a leak, or if any penetration of the pit liner occurs below the liquid's surface, then the owner or operator shall remove all liquid above the damage or leak line within forty-eight (48) hours, notify the appropriate Department area office within forty-eight (48) hours of the discovery, and repair the damage or replace the pit liner. (3-20-20)T

**d.** The owner or operator shall install, or maintain on site, an oil absorbent boom or other device to contain and remove oil from a pit's surface. Visible oil must be removed from short term pits immediately following the cessation of activity for which the pit was constructed. Visible oil must be removed from long term pits as soon as it is discovered. (3-20-20)T

**10. Closure of Pits.** (3-20-20)T

**a.** The owner or operator shall remove all liquids from the pit prior to closure and dispose of them at an appropriate facility or reuse them at a different location. If the nature of the fluids has substantially altered during their use, then the fluids must be sampled and tested to determine which disposal facility can accept them. (3-20-20)T

**b.** Any solids that have been accumulated in the bottom of the pit will be tested to determine which disposal facility can accept the material. The solid material and liner will then be removed and disposed of at an appropriate facility. (3-20-20)T

**c.** The owner or operator must notify the Department at least forty-eight (48) hours prior to removal of the pit liner so an inspection may be conducted. (3-20-20)T

**d.** The pit foundation will be inspected for signs of leakage. If evidence of leakage is observed, the owner or operator must contact the Department and the IDEQ within twenty-four (24) hours and report the type of fluids released and the estimated extent of release. The owner or operator must then remediate the site in conformance with the applicable standards administered by IDEQ in IDAPA 58.01.02," Water Quality Standards," Sections 850 through 852. (3-20-20)T

**e.** After addressing any pit leakage concerns, the owner or operator shall perform the activities described in Subsections 510.04 through 510.08 of these rules. (3-20-20)T

**11. Condemnation Due to Improper Impoundment.** The Department shall have authority to

condemn any pit that does not properly impound fluids and order the disposal of such fluids in conformance with IDAPA 58.01.16, "Wastewater Rules," and other applicable rules. (3-20-20)T

**231. -- 299. (RESERVED)**

**SUBCHAPTER D – WELL SITES AND DRILLING**

**300. IDENTIFICATION OF WELLS.**

**01. Signs; Lease Access Roads.** To identify all producing leases the owner or operator thereof shall cause a sign to be placed where the principal lease road enters the lease and such sign shall show the name of the lease and the owner or operator thereof and the section, township, and range. (3-20-20)T

**02. Signs; Well Sites.** Prior to spud activity, a legible sign must be placed near the well to identify the operator, permit number, well name, and emergency telephone number. If a multiple completion, each well head connection shall be identified. (3-20-20)T

**301. WELL SITE OPERATIONS.**

The owner or operator must conduct all operations and maintain the well site at all times in a safe and workmanlike manner. Best management practices and good housekeeping practices must be used at well sites. (3-20-20)T

**01. Fencing.** Within sixty (60) days after completion of the well, the owner or operator must install a fence around the well site to maintain safe working conditions, secure the well site, and prevent access by wildlife and livestock. The fence design must be acceptable to both the landowner and owner or operator. (3-20-20)T

**02. Storage.** All chemicals must be stored and maintained in accordance with the applicable MSDS requirements. Materials related to operations must be palletized where applicable. Vehicles and materials not in use must be removed from the well site. (3-20-20)T

**03. Vegetation.** All well sites must be kept free of excessive vegetation. (3-20-20)T

**04. Trash.** All trash, debris, and scrap metal must be removed from the well site. Pending removal, any trash or debris that might constitute a fire hazard shall be removed to a distance of at least one hundred (100) feet from the well location, tanks, and separator. (3-20-20)T

**302. ACCIDENTS AND FIRES.**

The owner or operator shall take all reasonable precautions to prevent accidents and fires. An emergency response plan will be prepared and available at the well for use or inspection. Coordination with local emergency responders and the Idaho Bureau of Homeland Security is recommended prior to rig set up. The following actions must be taken in event of a release, industrial accident, or fire of major consequence: (3-20-20)T

**01. Provide Information to Emergency Response.** Emergency workers will be given information on all fluids or chemicals involved in a spill or accident as needed according to OSHA Standard 1910.1200 (Hazard Communication). Nothing in this rule shall authorize any person to withhold information that is required by state or federal law to be provided to a health care professional, a doctor, or a nurse. All information required by a health care professional, a doctor, or a nurse shall be supplied, immediately upon request, by the owner or operator, or their contractors, directly to the requesting health care professional, doctor, or nurse, including the percent by volume of the chemical constituents (and associated CAS numbers) in the fluids and the additives; (3-20-20)T

**02. Initiate Spill Response and Corrective Actions.** Owner or operator must comply with the requirements of IDAPA 58.01.02, "Water Quality Standards," Sections 850 through 852; and (3-20-20)T

**03. Notify the Department.** Notify the Department within twenty-four (24) hours and submit a full report thereon within fifteen (15) days. (3-20-20)T

**303. -- 309. (RESERVED)**

310. GENERAL DRILLING RULES.

**01. General Design Requirements for Casing and Cementing.** Casing and cementing programs adopted for wells must be so planned as to protect any potential oil- or gas-bearing horizons penetrated during drilling from infiltration of injurious waters from other sources, and to prevent the migration of oil or gas from one horizon to another. Owners and operators shall follow the standards for casing and tubing in API SPEC 5CT and the standards for cementing in API SPEC 10A. (3-20-20)T

**02. Wildcat and High-Pressure Conditions.** When drilling wildcat territory or in any field where high pressures are likely to exist, the owner or operator shall take all necessary precautions to keep the well under control at all times and shall use proper high-pressure fittings and equipment at the time the well is started. Under such conditions all strings of casings must be securely anchored. (3-20-20)T

**03. High Temperature Conditions.** Due to high geothermal gradients in Idaho, the temperature of the return drilling mud shall be monitored daily during the drilling of the surface casing hole and all deeper holes. The owner or operator must use cements appropriate for the temperatures expected or encountered. (3-20-20)T

**04. Conductor Pipe or Casing Requirements.** A minimum of forty (40) feet of conductor pipe shall be installed. If geologic conditions are such that forty (40) feet is not feasible, the owner or operator may request a variance from the Department. The annular space is to be cemented solid to the surface. A twenty-four (24) hour cure period for the grout must be allowed prior to drilling out the shoe unless sufficient additives, as determined by the Department, are used to obtain early strength. (3-20-20)T

**05. Surface Casing Requirements.** (3-20-20)T

**a.** The Department must be notified in writing seventy-two (72) hours in advance of planned spud activity for surface casing. The Department will post the spud activity notice on its website and send an electronic copy of the notice to the county where the well is located. (3-20-20)T

**b.** Surface casing must be set at a minimum depth equal to ten percent (10%) of the proposed total depth of the well. In areas where pressures and formations are unknown, a minimum of two hundred (200) feet of surface casing shall be set. (3-20-20)T

**c.** Surface casing shall provide for control of formation fluids, protection of fresh water, and for adequate anchorage of blow out prevention equipment. The casing must be seated through a sufficient series of low permeability, competent lithologic units such as claystone, siltstone, basalt, etc., to insure a solid anchor for blow out prevention equipment and to protect usable ground water from contamination. Additional surface casing may be required if the first string has not been cemented through a sufficient series of low permeability, competent lithologic units, or rapidly increasing thermal gradients or formation pressures are encountered. (3-20-20)T

**d.** All surface casing shall be cemented solid to the surface by pump and plug, displacement, or other approved method. When surface samples are cured, additional drilling activities may commence. (3-20-20)T

**e.** The Department must be notified in writing twenty-four (24) hours in advance of planned cementing activity for surface casing. The Department will witness and document all surface casing cementing activities. (3-20-20)T

**06. Requirements for BOP Equipment.** Unless altered, modified, or changed for a particular pool(s) upon hearing before the Commission, BOP and related equipment shall be installed and maintained during the drilling of all wells in accordance with the following rules: (3-20-20)T

**a.** BOP equipment installed on wells in which formation pressures to be encountered are abnormal or unknown shall consist of a double-gate, hydraulically operated preventer with pipe and blind rams or two (2) single-ram-type preventers; one (1) equipped with pipe rams, the other with blind rams and an annular type preventer. In addition, upper and lower kelly cocks, pit level indicators with alarms and/or flow sensors with alarms, and surface facilities to handle pressure kicks shall be installed prior to drilling any formation with known abnormal pressure. (3-20-20)T

- i. Accumulators shall maintain a pressure capacity reserve at all times to provide for operation of the hydraulic preventers and valves with no outside source. (3-20-20)T
- ii. In all other drilling operations, BOP equipment shall consist of at least one (1) double-gate preventer with pipe and blind rams or two (2) single-ram-type preventers, one (1) equipped with pipe rams, the other with blind rams, and sufficient valving to permit fluid circulation at the surface. (3-20-20)T
- b. All BOP equipment, choke lines, and manifolds shall be installed above ground level. Casing heads and optional spools may be installed below ground level provided they are visible and accessible. (3-20-20)T
- c. BOP equipment and related casing heads and spools shall have a vertical bore no smaller than the inside diameter of the casing to which they are attached. (3-20-20)T
- d. The working pressure rating of all BOP and related equipment shall equal or exceed the maximum anticipated pressure to be contained at the surface. (3-20-20)T
- e. All ram-type BOP and related equipment, including casing, shall be tested to the full working pressure rating of said equipment upon installation, provided that components need not be tested to levels higher than the lowest working pressure rated component. Annular type BOP and related equipment must be tested in conformance with the manufacturer's published recommendations. If, for any reason, a pressure seal in the assembly is disassembled, a test to a full working pressure rating of that seal shall be conducted prior to the resumption of any drilling operation. In addition to the initial pressure tests, ram-type BOP shall be checked for physical operation at least once per week and all components, again with exception of the annular-type BOP, tested at least once every twenty-one (21) days to at least fifty percent (50%) of the rated pressure of the BOP equipment and/or to the maximum anticipated pressure to be contained at the surface, whichever is greater. (3-20-20)T
- f. The Department will require an affidavit covering the initial pressure tests after installation signed by the owner, operator, or contractor attesting to the satisfactory pressure tests. The Department must be advised at least twenty-four (24) hours in advance of all tests. The Department may inspect and witness all BOP operations and testing. (3-20-20)T
- g. A schematic diagram of the BOP and well head assembly shall be submitted to the Department upon application for a permit to drill. The schematic diagram should indicate the minimum size and pressure rating of all components of the well head and BOP assembly. (3-20-20)T
- h. Studs on all well head and BOP flanges shall be checked for tightness each week. Hand wheels for locking screws shall be installed and operational, and the entire BOP and well head assembly shall be kept clean of mud and ice. (3-20-20)T
- i. A drillstem safety valve shall be available on the rig floor at all times with correct thread for the pipe in use. (3-20-20)T
- j. A drillstem float valve shall be installed in bit sub or as close to bit as reasonably possible. (3-20-20)T
- 07. Intermediate Casing.** (3-20-20)T
- a. Intermediate casing, if installed, shall be cemented solidly to the surface or to the top of the casing. (3-20-20)T
- b. Intermediate casing not run to surface will be lapped into at least one hundred (100) feet of the surface casing, or at least one hundred (100) feet of the next larger casing to provide overlap and secure a seal. (3-20-20)T
- c. Such casing shall be cemented and pressure tested before cement plugs are drilled. (3-20-20)T



**d.** The Department must be notified in writing twenty-four (24) hours in advance of planned cementing activity for intermediate casing. The Department may witness and document all intermediate casing cementing activities. (3-20-20)T

**08. Production Casing; Cementing and Testing Requirements.** (3-20-20)T

**a.** If and when it becomes necessary to run a production casing, such casing shall be cemented and pressure tested before cement plugs are drilled. (3-20-20)T

**b.** The Department must be notified in writing twenty-four (24) hours in advance of planned cementing activity for production casing. The Department may witness and document all production casing cementing activities. (3-20-20)T

**c.** When not run to the surface, production casing will be cemented from the bottom of the hole up into at least one hundred (100) feet of the next larger casing to provide overlap and secure a seal. (3-20-20)T

**d.** If the bottom plug will be drilled out, the open hole interval must be completed to protect any potential oil-bearing or gas-bearing horizons penetrated during drilling from infiltration of injurious waters from other sources, and to prevent the migration of oil or gas from one horizon to another. (3-20-20)T

**09. Step-off.** An owner or operator may submit to the Department a step-off request to complete a new borehole from surface if a borehole without production casing deviates from vertical plumb by more than five (5) degrees. A step-off borehole must be drilled within the existing pad of the permitted well. The incomplete borehole must be plugged and abandoned in accordance with Section 502 of these rules. (3-20-20)T

**10. Well Control (Rotary Tools); Reserve Mud Tanks.** When drilling with rotary tools, the owner or operator shall provide, as required by the Department, a reserve mud pit or tank of suitable capacity for the anticipated depth of the well and maintain an on-site supply of mud additives that can raise the mud weight by one (1) pound per gallon in case of loss of well control. (3-20-20)T

**11. Mud Pits.** Before commencing to drill, proper and adequate mud pits shall be constructed for the reception and confinement of mud and cuttings and to facilitate the drilling operation. Special precautions shall be taken, if necessary, to prevent contamination of fresh waters. These pits must conform to the standards in Section 230 of these rules. If tanks will be used, then mud pits may not be required. (3-20-20)T

**12. Well Control (Cable Tools); Fluid Containment.** Natural gas or oil which may be encountered in a substantial quantity in any section of a cabletool drilled hole above the ultimate objective shall be shut off with reasonable diligence either by mudding or by casing, or other approved method, and confined to its original source to the satisfaction of the Department. The use of cable tools for drilling activities requires written approval by the Department prior to spud activities. A request to use cable tools must include the following: (3-20-20)T

**a.** Proposed pressure control measures; (3-20-20)T

**b.** Diversion and disposal methods for stray gas; (3-20-20)T

**c.** Safety protocols for mud weights and well controls; and (3-20-20)T

**d.** Annual drill rig safety inspection information, including the date of last replacement of cables, draw works inspection report, and metallurgic report of safety compliance for structural integrity of the drill rig. (3-20-20)T

**13. Drilling Mud Disposal.** Drilling mud will be disposed of at an appropriate facility in compliance with applicable state and federal requirements. (3-20-20)T

**14. Report of Water Encountered; Owner's or Operator's Duties.** It shall be the duty of any owner or operator drilling an oil or gas well or drilling a seismic, core or other exploratory hole to report to the Department all potential water bearing zones encountered; such report shall be in writing and give the location of the well or hole,

the depth at which the zones were encountered, the thickness of such zones, and the rate of flow of water if known. This requirement can be met by the submittal of the logs required in Section 340 of this rule. (3-20-20)T

**15. Spill Prevention, Control, and Countermeasures Plan.** The owner or operator must have a Spill Prevention, Control, and Countermeasures Plan in conformance with the requirements of the EPA. This plan must be updated as needed when facilities or activities change. (3-20-20)T

**16. Interim Drill Site Clean Up.** If a well is completed for production or other purposes, interim reclamation must be completed within six (6) months of the rig being removed. Interim reclamation includes the following activities: (3-20-20)T

**a.** Debris and waste materials including, but not limited to, concrete, sack bentonite and other drilling mud additives, sand, plastic, pipe, and cable associated with the drilling, re-entry, or completion operations shall be removed and disposed of properly. (3-20-20)T

**b.** All disturbed areas affected by drilling or subsequent operations, except areas reasonably needed for production operations or for subsequent drilling operations to be commenced within twelve (12) months, shall be reclaimed and revegetated to approximately the pre-drilling condition or to the condition specified in an agreement with the surface owner. The reclamation standards in Subsections 510.04 through 510.07 of these rules, shall apply. (3-20-20)T

**311. LOSS OF TOOL WITH RADIOACTIVE MATERIAL.**

**01. Recovery or Cementing of Tool.** If a gamma ray tool, or some other tool containing radioactive material, becomes lost in a well, the owner or operator shall make every reasonable attempt to retrieve the tool from the well. If the tool cannot be recovered, the owner or operator must immediately cover the tool with cement sufficient to secure it in place and prevent it from contacting any fluids in the well. A whipstock or other approved deflection device shall be placed on top of the cement plug to prevent accidental or intentional mechanical disintegration of the radioactive source. (3-20-20)T

**02. Sidetracking.** If the hole is later sidetracked above the radioactive material, the sidetracked hole must be at least fifteen (15) feet from the original hole with the lost radioactive material. (3-20-20)T

**03. Reporting.** A report must be sent to the Department and IDEQ within thirty (30) days of cementing the tool. The report must describe the tool that was lost, the depth it was lost at, the specific type and amount of radioactive material in the tool, and an estimate of the length of cement covering the tool. This report may be included in a plugging report if the well will be plugged. (3-20-20)T

**312. CHOKES.**

All flowing wells shall be equipped with adequate chokes or beans to properly control the flow thereof. (3-20-20)T

**313. USE OF EARTHEN RESERVOIRS.**

Oil shall not be produced, stored, or retained in earthen reservoirs or in open receptacles. (3-20-20)T

**314. VACUUM PUMPS PROHIBITED.**

The use of vacuum pumps or other devices for the purpose of placing a vacuum on any gas- or oil-bearing stratum is prohibited; however, the Department may upon application and hearing and for good cause shown permit the use of vacuum pumps. (3-20-20)T

**315. PULLING OUTSIDE STRINGS OF CASING.**

Casing shall not be recovered if its recovery will expose any abnormal pressure, lost circulation, oil, gas, or water zone. In pulling outside strings of casing from any oil or gas well, the space outside the casing left in the hole shall be kept and left full of mud-laden fluid of adequate specific gravity to seal off all fresh and saltwater strata and any strata bearing oil or gas which is not producing. Casing may not be pulled without first making application to the Department and receiving approval. The application must describe how fresh waters will be protected. (3-20-20)T

**316. -- 319. (RESERVED)**

**320. MECHANICAL INTEGRITY TESTING.**

**01. Mechanical Integrity Testing.** (3-20-20)T

**a.** The mechanical integrity test shall include one (1) of the following tests to determine whether leaks are present in the casing, tubing, or packer: (3-20-20)T

i. A pressure test with liquid or gas at a pressure of not less than three hundred (300) psi or the minimum injection pressure, whichever is greater, and not more than the maximum injection pressure; or (3-20-20)T

ii. The monitoring and reporting to the Department, on a monthly basis for sixty (60) consecutive months, of the average casing-tubing annulus pressure, following an initial pressure test; or (3-20-20)T

iii. In lieu of Subparagraphs 320.01.a.i. and 320.01.a.ii. of this rule, any equivalent test or combinations of tests approved by the Department. (3-20-20)T

**b.** The mechanical integrity test shall include one (1) of the following tests to determine whether there are fluid movements in vertical channels adjacent to the well bore: (3-20-20)T

i. Tracer surveys; (3-20-20)T

ii. Cement bond log or other acceptable cement evaluation log; (3-20-20)T

iii. Temperature surveys; or (3-20-20)T

iv. In lieu of Subparagraphs 320.01.b.i. through 320.01.b.iii. of this rule, any other equivalent test or combination of tests approved by the Department. (3-20-20)T

**c.** Mechanical integrity tests shall be performed at the rate of not less than one (1) test every five (5) years, regardless of well status. The first five-year period shall commence on the date the initial mechanical integrity test is performed. (3-20-20)T

**02. Inactive Wells.** If, at any time, surface equipment excluding the wellhead is removed or the well becomes incapable of production, a mechanical integrity test shall be performed within thirty (30) days. The mechanical integrity test for an inactive well shall be isolation of the wellbore with a bridge plug or similar approved isolating device set one hundred (100) feet or less above the highest perforations and a pressure test with liquid or gas at a pressure of not less than three hundred (300) psi surface pressure or any equivalent test or combination of tests approved by the Department. (3-20-20)T

**03. Prior Notification.** Not less than ten (10) days prior to the performance of any mechanical integrity test required by this rule, any person required to perform the test shall notify the Department, in writing, of the scheduled date on which the test will be performed. (3-20-20)T

**04. Reporting Requirements.** Mechanical integrity test results shall be submitted to the Department within thirty (30) days of testing. (3-20-20)T

**05. Mechanical Integrity Required.** All wells shall maintain mechanical integrity. All wells that fail a mechanical integrity test, or that are determined through any other means to lack mechanical integrity, shall immediately be investigated by the owner or operator. The well shall be repaired or immediately shut down following the investigation. Repairs shall be completed within six (6) months, or the well shall be plugged and abandoned. If the repair cannot be completed within six (6) months, the owner or operator may request an extension and provide a plan for the repair. (3-20-20)T

**321. -- 329. (RESERVED)**

**330. WELL DIRECTIONAL CONTROL.**

**01. General Restrictions; Allowable Deviation.** The maximum point at which a well penetrates the producing formation shall not unreasonably vary from the vertical drawn from the center of the hole at the surface. Deviation is permitted without special permission to remedy blowouts and, for short distances, to straighten the hole, sidetrack junk, or correct other mechanical difficulties. (3-20-20)T

**02. Controlled Directional Drilling.** Except for the purposes recited in Subsection 330.01, no well hereafter drilled may be intentionally directionally deviated from the vertical unless the owner or operator thereof shall first file an application and application fee to amend the drilling permit and receive approval from the Department. Such application shall contain the following information: (3-20-20)T

- a.** Name and address of the owner or operator. (3-20-20)T
- b.** Lease name, well number, name of field and reservoir and county. (3-20-20)T
- c.** Description of surface location and proposed location of the producing interval (footage from lease and section or block and survey lines). (3-20-20)T
- d.** Reason for intentional deviation. (3-20-20)T
- e.** List of offset operators and statement that each has been furnished a copy of the application by registered mail. (3-20-20)T
- f.** Signature of representative of owner or operator. (3-20-20)T
- g.** Notification to offset operators that any objection they may have to the proposed intentional deviation of the well must be filed with the Department within fifteen (15) days of receipt of a copy of the application. (3-20-20)T
- h.** The application shall be accompanied by a neat, accurate plat or sketch of the lease and all offset leases showing the names of all offset operators and the surface and proposed producing interval locations of the well. Plat shall be drawn to a scale which will permit facile observation of all pertinent data. (3-20-20)T

**03. Copy of Application to Offset Operators.** At the time the application is filed with the Department, a copy of the application and the plat shall be forwarded by registered mail to all offset operators to the lease on which the well is to be drilled. (3-20-20)T

**04. Department Action.** Upon receipt, the Department will hold the application for fifteen (15) days. If objection from any offset operator to the proposed intentional deviation is received within fifteen (15) days of receipt of the application by said operator, or if the Department is not in agreement with the proposed deviation, the application shall be set down for public hearing. If no objection from either an offset operator or the Department is interposed within the fifteen (15) day period, the application shall be approved and permit issued by the Department. If written consent of the offset operator(s) is filed concurrently with the application to drill directionally, the Department may immediately approve the application without waiting fifteen (15) days. (3-20-20)T

**05. Angular Deviation and Directional Survey.** Upon completion, a complete angular deviation and directional survey of the well obtained by an approved well surveying company shall be filed with the Department, together with other regularly required reports. (3-20-20)T

**06. Application for Exceptions.** In the event the proposed, or final, location of the producing interval of the directionally deviated well is not in agreement with spacing or other rules of the Commission applicable to the reservoir, proper applications shall be made to obtain approval of exceptions to such rules. Such approval shall be granted or denied at the discretion of the Department, and shall be accorded with the same consideration and treatment as if the well had been drilled vertically to the producing interval. (3-20-20)T

**331. -- 339. (RESERVED)**

**340. WELL COMPLETION/RECOMPLETION REPORT AND WELL REPORT.**

Within thirty (30) days after the completion of a well drilled for oil or gas, or the recompletion of a well into a different source of supply, or where the producing interval is changed, a completion report shall be filed with the Department, on a form prescribed by the Department. Such report shall include name, number, and exact location of the well; lease name, date of completion and date of first production, if any; name and depth of hydrocarbon reservoir(s), if a multiple completion, from which well is producing; annulus pressure test; initial production test, including oil, gas, and water, if any; a well report as defined in Section 010; and such other relevant information as the Department may require. (3-20-20)T

**341. DRILLING LOGS.**

**01. Minimum Required Logs.** All wells shall have a lithologic log from the bottom of the hole to the top, to the extent practicable. (3-20-20)T

**02. Bottom Hole Survey.** All wells shall have a bottom hole location survey. (3-20-20)T

**03. Cement Bond Log.** All wells that are cased and cemented shall have a cement bond log run across the casing. (3-20-20)T

**04. Other Logs.** If other logs are run, including, but not limited to, resistivity, gamma-neutron log, sonic log, etc., then the owner or operator shall retain a copy regardless of results. (3-20-20)T

**05. Log Submittal.** The above logs shall be submitted to the Department in paper and digital formats within thirty (30) days of the log being run. If logs were run in color, then the submitted copies shall also be in color. Digital formats must be Tiff and LAS 2.0 or higher. Logs submitted to the Department must have a scale of one (1) inch for correlation logs and five (5) inches for detail logs. (3-20-20)T

**342. -- 399. (RESERVED)**

**SUBCHAPTER E – PRODUCTION**

**400. PRODUCTION REPORTS.**

**01. Required Content.** An owner or operator must report production on a form created by the Department. Production reports submitted to the Department must include gas quantities sold in thousand cubic feet (mcf), condensate sold in barrel quantities (bbl), oil sold in barrel quantities (bbl), and formational waters produced in barrel quantities (bbl). (3-20-20)T

**02. Annual Production Report.** By January 31 of each year, an owner or operator must submit to the Department an aggregated report of all hydrocarbons and formational waters produced and sold or disposed of for each well during the previous calendar year. (3-20-20)T

**401. MEASUREMENT OF OIL.**

The volume of production of oil shall be computed in terms of barrels of clean oil on the basis of meter measurements or tank measurements of oil-level difference made and recorded to the nearest quarter-inch (1/4") of one hundred percent (100%) capacity tables, subject to the following corrections: (3-20-20)T

**01. Correction for Impurities.** The percentage of impurities (water, sand, and other foreign substances, not constituting a natural component part of the oil) shall be determined to the satisfaction of the Department, and the observed gross volume of oil shall be corrected to exclude the entire volume of such impurities. (3-20-20)T

**02. Temperature Correction.** The observed volume of oil corrected for impurities shall be further corrected to the standard volume at sixty (60) Degrees F in accordance with ASTM D-1250-08, Table 7, or any revisions thereof and any supplements thereto, or any close approximation thereof approved by the Department. (3-20-20)T

**03. Gravity Determination.** The gravity of oil at sixty (60) degrees F shall be determined in accordance with ASTM D-1250-08, Table 5, or any revisions thereof and any supplements thereto approved by the Department. (3-20-20)T

**402. MEASUREMENT OF GAS.**

**Gas Measurement.** For computing volume of gas to be reported to the Department, the standard of pressure shall be fourteen point seventy-three (14.73) psi atmospheric, and the standard of temperature shall be sixty (60) Degrees F. All volumes of gas to be reported to the Department shall be adjusted by computation to these standards, unless otherwise authorized by the Department. (3-20-20)T

**403. GAS-OIL RATIO FOR WELL CLASSIFICATIONS.**

In the absence of an order by the Commission setting a field-specific oil-gas ratio, a well that produces gas of five thousand (5,000) cubic feet or greater to one (1) bbl of oil at standard temperature and pressure will be classified as a gas well. (3-20-20)T

**404. GAS-OIL RATIO LIMITATION.**

**01. Waste Prevention; Conditions for Emergency Order.** To further prevent waste resulting from the production of wells with inefficient gas-oil ratios, the Department may enter an emergency order temporarily prohibiting the production of oil or gas from all wells in a pool producing both oil and gas when the Department believes that waste may be occurring or is imminent in said pool by reason of the operation of wells with inefficient gas-oil ratios. The order shall specify a date for the hearing described in Subsection 404.02 of these rules. The Department may use information provided by an offset operator or an owner or operator in a common source of supply to determine if waste is occurring. (3-20-20)T

**02. Notice and Cause for Hearing.** The Department will notify all offset operators and owners or operators in the common source of supply of the hearing date. A hearing regarding waste due to inefficient gas-oil ratios will held for any of the following reasons: (3-20-20)T

i. If an emergency order is issued as described in Subsection 404.01 of these rules. The hearing will be scheduled between five (5) and fifteen (15) days after the effective date of the order. (3-20-20)T

ii. Upon application to the Department from any person with an ownership interest in the common source of supply who believes that waste is occurring due to inefficient oil and gas ratios. The application must include credible evidence of such waste. The hearing shall be held within thirty (30) days of the Department receiving the application. (3-20-20)T

iii. Prior to an emergency situation and upon its own motion with reasonable cause, the Department may schedule a hearing regarding potential waste due to inefficient gas-oil ratios. (3-20-20)T

**03. Determination of Inefficient Ratios; Power to Limit Production.** If the Department after notice and hearing, whether held upon its own motion, upon the application of an interested party, or pursuant to an emergency order entered as hereinafter provided for, shall find that a well(s) in the pool are operating with inefficient gas-oil ratios, and that waste is occurring or is imminent as a result thereof, it shall enter an order limiting the production of oil and gas from said pool to that amount which the pool can produce without waste and in accordance with sound engineering practice. The order shall also limit the amount of oil or gas, or both, that may be produced from any well in the pool, so that each owner or operator is given an opportunity to produce his just and equitable share in the pool in accordance with sound engineering practice. (3-20-20)T

**405. GAS-OIL RATIO SURVEYS AND REPORTS.**

Within thirty (30) days following the completion or recompletion of each well producing oil and gas and thereafter as the Department may require, the owner or operator of such well shall make a gas-oil ratio test of such well and the results of such test shall be reported to the Department within twenty (20) days after the test is made. Certain wells may be excepted from this rule by the Department upon written request. Entire fields may be excepted from this rule after notice and hearing. (3-20-20)T

**406. -- 409. (RESERVED)**

**410. METERS.**

**01. General Requirements.** Meter fittings of adequate size to measure the gas efficiently for the purpose of obtaining gas-oil ratios shall be installed on the gas vent line of every separator or proper connections made for orifice well tester. Well-head equipment shall be installed and maintained in excellent condition. Valves shall be installed so that pressures can be readily obtained on both casing and tubing. (3-20-20)T

**02. Visibility.** All required meters shall be accessible and viewable by the Department for the purpose of monitoring daily, monthly and/or cumulative production volumes from individual wells. (3-20-20)T

**411. SEPARATORS.**

All flowing oil wells must be produced through an adequate oil and gas separator or emulsion treater, provided, however, the director may approve producing wells without a separator or emulsion treater. (3-20-20)T

**412. PRODUCING FROM DIFFERENT POOLS THROUGH THE SAME CASING STRING.**

No well shall be permitted to produce either oil or gas from different pools through the same string of casing without first receiving written permission from the Department. (3-20-20)T

**413. GAS UTILIZATION.**

After a well is completed and while it is being tested, the owner or operator may flare gas for no more than fourteen (14) days without paying royalties and severance taxes on the flared gas. Under no conditions may gas be flared for more than sixty (60) days after a well is completed or recompleted. Prior to flaring gas, owners or operators must notify the county in which the well is located and all owners of occupied structures within one-quarter (1/4) mile radius of the well. After the owner or operator has tested a well, no gas from such well shall be permitted to escape into the air, and all gas produced therefrom shall be utilized without waste. (3-20-20)T

**414. -- 419. (RESERVED)**

**420. TANK BATTERIES.**

Tank batteries must meet the following requirements. (3-20-20)T

**01. Containment Requirements.** All tank batteries consisting of tanks containing produced fluids or crude oil storage tanks or containing tanks equipped to receive produced fluids must be surrounded by tank dikes that meet the following requirements: (3-20-20)T

**a.** Tank dikes must be designed to have a capacity of at least one and one-half (1½) times the volume of the largest tank which the dike surrounds. (3-20-20)T

**b.** The material used to construct a tank dike and the material used to line the bottom and sides of the containment reservoir must have a maximum coefficient of permeability of 10<sup>-9</sup> cm/sec so as to contain fluids and resist erosion. An operator must submit proof of compliance for tank dike liner construction to the Department in the form of a manufacturer's statement of design or a nuclear density test performed by a third party trained to perform the test. (3-20-20)T

**c.** All piping and manmade improvements that perforate the tank dike wall or tank battery floor must be sealed to a minimum radius of twelve (12) inches from the outside edge of the piping or improvement. (3-20-20)T

**d.** Valves and quick-connect couplers on tank batteries must be at least eighteen (18) inches from the inside wall of the tank dike. (3-20-20)T

**e.** Vegetation on the top and outside surface of tank dike must be properly maintained so as to not pose a fire hazard. (3-20-20)T

**f.** A ladder or other permanent device must be installed over the tank dike to access the containment reservoir. (3-20-20)T

**g.** The containment reservoir must be kept free of vegetation, stormwater, produced fluids, other oil and gas field related debris, general trash, or any flammable material. Drain lines installed through the tank dike for the purpose of draining storm water from the containment reservoir must have a valve installed which must remain closed and capped when not in use. Any fluids collected, spilled or discharged within the containment reservoirs must be removed as soon as practical, characterized, treated if necessary, and disposed in conformance with IDAPA 58.01.16, "Wastewater Rules," and other applicable rules. (3-20-20)T

**421. -- 429. (RESERVED)**

**430. GAS PROCESSING FACILITIES.**

Gas processing facilities must meet the following requirements. (3-20-20)T

**01. Operations.** Operators of gas processing facilities must notify the Department which wells, by API number, are served by a gas processing facility. All gas processing facilities not constructed on a well site must comply with the requirements in Sections 301 and 302 of these rules. (3-20-20)T

**02. Meters and Facility Plans.** Gas processing facilities must account for all liquids and gas entering and leaving the facility with accurate meters. A supervisory control and data acquisition systems or other data recording system must be used to monitor the liquids and gas in the facility. Operators of gas processing facilities must submit an as-built facility design plan to the Department upon completion of the facility, a facility design plan must contain at the minimum: (3-20-20)T

- a.** Site layout; (3-20-20)T
- b.** Piping and instrumentation diagram; (3-20-20)T
- c.** Process Flow schematics; (3-20-20)T
- d.** Electronic controls and sensing schematic; (3-20-20)T
- e.** Equipment operations and maintenance manuals for, pumps, meters, heat exchangers and any other operationally critical equipment that requires periodic maintenance and calibration; (3-20-20)T
- f.** Periodic maintenance schedule for critical equipment; (3-20-20)T
- g.** Troubleshooting metric; and (3-20-20)T
- h.** Other information or documentation necessary for the safe and continued operation of a gas processing facility. (3-20-20)T

**03. Flaring.** Flaring at gas processing facilities must be in conformance with IDAPA 58.01.01, Rules for the Control of Air Pollution in Idaho, and any permit issued by the IDEQ. (3-20-20)T

**04. Inspections.** Gas processing facilities must have site specific facility design plans and a log book of gas metered in and out of the facility available for review by Department staff during the inspections of gas processing facilities. During inspections, gas process facility staff must demonstrate knowledge of all operations and the location of all emergency shut off equipment, direction of flow lines, and heat exchangers. The Department will conduct quarterly inspections of facilities. (3-20-20)T

**431. -- 499. (RESERVED)**

**SUBCHAPTER F – WELL ACTIVITY AND RECLAMATION**

**500. ACTIVE WELLS.**

**01. Gas Storage Wells.** Gas storage wells are to be considered active at all times unless physically plugged. (3-20-20)T



**02. Extension of Active Status.** An owner or operator may request an extension of active well status for wells that are idled for more than twenty-four (24) continuous months. The owner or operator shall provide a written request to the Department stating the reason for the extension, the length of extension, the method used to close the well to the atmosphere, and the plans for future operation. The Department shall review the request for approval, modification, or denial, and shall set the duration of the extension if approved. An extension shall not exceed five (5) years and may be renewed upon request. (3-20-20)T

**03. Annual Reports for Active Wells.** The owner or operator shall submit an annual report to the Department describing the current status of the well and the plans for future well operation by January 31 of each year. Failure to submit the annual report may result in the Department declaring the well inactive. (3-20-20)T

## **501. INACTIVE WELLS.**

**01. Determination of Inactive Status.** The Department shall declare a well inactive after twenty-four (24) continuous months of inactivity if the owner or operator has not received approval for an extension of active status, or after an owner or operator fails to submit an annual report for an active well. The Department will immediately notify an owner or operator of this determination by certified mail, and the owner or operator may appeal this determination to the Commission. (3-20-20)T

**02. Owner's or Operator's Responsibility for Inactive Wells.** The owner or operator must plug and abandon an inactive well in accordance with Section 502 of these rules within six (6) months of being notified by the Department unless the owner or operator supplies the following information within the six-month time period: (3-20-20)T

- a.** A written request to extend inactive status; (3-20-20)T
- b.** An individual bond, as provided for in Subsection 220.03 of these rules, if the well was covered by a blanket bond; and (3-20-20)T
- c.** A description of how the well is closed to the atmosphere with a swedge and valve, packer, or other approved method, and how the well is to be maintained. (3-20-20)T

**03. Inactive Review and Decision.** The Department shall review the request for approval, modification, or denial, and shall set the duration of the extension if approved. An extension shall not exceed three (3) years and may be renewed upon request. (3-20-20)T

**04. Testing of Inactive Wells.** In addition to the requirements of Section 320 of these rules, inactive wells shall have a mechanical integrity test performed within two (2) years after the date of last use in order to retain inactive status. (3-20-20)T

**05. Converting Inactive Wells to Active Wells.** The owner or operator must apply to the Department to change the status of a well from inactive to active. The Department shall review the request for approval, modification, or denial. A mechanical integrity test may be required by the Department if the well has been worked over or if a test has not been conducted for five (5) years or longer. If approved, the well may again be covered by a blanket bond. (3-20-20)T

## **502. WELL PLUGGING.**

**01. Plugging Required.** The operator or owner shall not permit any well drilled for oil, gas, saltwater disposal or any other purpose in connection with the production of oil and gas, to remain unplugged after such well is no longer used for the purpose for which it was drilled or converted. (3-20-20)T

**02. Notice of Intention to Abandon Well.** Before beginning abandonment work on an oil or gas well, a Notice of Intention to Abandon shall be filed with the Department and approval obtained as to the method of abandonment before the work is started. The notice must show the reason for abandonment and must give a detailed statement of the proposed work, including such information as kind, location, and length of plugs (by depths), and

plans for mudding, cementing, shooting, testing, and removing casing as well as any other pertinent information. (3-20-20)T

**03. Plugging Dry Holes.** If a nonproductive well, or dry hole, is drilled and not needed for any specific purpose, it must be plugged and abandoned prior to removal of the drill rig. A verbal notification and approval may be used for dry holes in lieu of the written notification referenced in Subsection 502.02 of these rules. The standards in Subsections 502.04 through 502.06 of these rules will still apply. (3-20-20)T

**04. Plugging of Wells.** The owner or operator of any well drilled for oil or gas, or any seismic, core, or other exploratory holes, whether cased or uncased, and regardless of diameter shall be responsible for the plugging of said hole in a manner sufficient to properly protect all freshwater-bearing and possible or probable oil- or gas-bearing formations. The material used in plugging, whether cement, mechanical plug, or some other equivalent method approved in writing by the Director, must be placed in the well in a manner to permanently prevent migration of oil, gas, water, or other substance from the formation or horizon in which it originally occurred. The preferred plugging cement slurry is that recommended in API Bulletin E3. Pozzolan, gel, and other approved extenders may be used if the owner or operator can document to the Department's satisfaction that the slurry design will achieve a minimum compressive strength of three hundred (300) psi after twenty-four (24) hours, and eight hundred (800) psi after seventy-two (72) hours measured at ninety-five (95) degrees F and at eight hundred (800) psi. No substances of any nature or description other than those normally used in plugging operations shall be placed in any well at any time during plugging operations. (3-20-20)T

**05. Plugged Intervals.** The following plugging standards shall be followed for all wells: (3-20-20)T

**a.** Cement must be placed for a length of at least one hundred (100) feet on either side of each casing shoe, or casing bottom if no shoe is present. If the bottom of the hole is less than one hundred (100) feet from the bottom of the lowest casing, then the entire length of the uncased hole below the casing will be cemented. (3-20-20)T

**b.** In the uncased portions of a well, cement plugs must be placed to extend from one hundred (100) feet below the bottom up to one hundred (100) feet above the top of any oil, gas, and abnormally high pressure zones, so as to isolate fluids in the strata in which they are found and to prevent them from escaping into other strata. (3-20-20)T

**c.** A cement plug shall be placed a minimum of one hundred (100) feet above all producing zones in uncased portions of a well. (3-20-20)T

**d.** A cement plug shall be placed a minimum of fifty (50) feet above and below the following intervals: (3-20-20)T

**i.** Where the casing is perforated or ruptured. If no cement is present behind the casing, then cement must also be squeezed out the perforations or ruptures and into the annular space between the casing and the borehole. (3-20-20)T

**ii.** Top and bottom of fresh water zones. If fresh water zone is less than one hundred (100) feet thick, then continuous cement must be placed from fifty (50) feet below the zone upward to fifty (50) feet above the zone. (3-20-20)T

**e.** The top of all cement plugs will be tagged to verify their depth. (3-20-20)T

**f.** The owner or operator shall have the option as to the method of placing cement in the hole by: (3-20-20)T

**i.** Dump bailer; (3-20-20)T

**ii.** Pumping a balanced cement plug through tubing or drill pipe; (3-20-20)T

**iii.** Pump and plug; or (3-20-20)T

iv. Equivalent method approved by the Director prior to plugging. (3-20-20)T

g. Unless prior approval is given, all wellbores shall have water based drilling muds, high viscosity pills, or other approved fluids between all plugs. (3-20-20)T

h. All abandoned wells shall have a plug or seal placed at the surface of the ground or the bottom of the cellar in the hole in such manner as not to interfere with soil cultivation or other surface use. The top of the pipe must be sealed with either a cement plug and a screw cap, or cement plug and a steel plate welded in place or by other approved method, or in the alternative be marked with a permanent monument which shall consist of a piece of pipe not less than four (4) inches in diameter and not less than ten (10) feet in length, of which four (4) feet shall be above the general ground level, the remainder to be embedded in cement or to be welded to the surface casing. (3-20-20)T

**06. Subsequent Report of Abandonment.** If a well is plugged or abandoned, a subsequent record of work done must be filed with the Department. This report shall be filed separately within thirty (30) days after the work is done. The report shall give a detailed account of the manner in which the abandonment of plugging work was carried out, including the weight of mud, the nature and quantities of materials used in plugging, the location and extent (by depths) of the plugs of different materials, and the records of any tests or measurements made and of the amount, size, and location (by depths) of casing left in the well. If an attempt was made to part any casing, a complete report of the method used and the results obtained must be included. (3-20-20)T

**07. Wells Used for Fresh Water (Cold Water < 85 degrees Fahrenheit), Low Temperature Geothermal (85 - 212 Degrees Fahrenheit) or Geothermal Wells (>212 Degrees Fahrenheit).** (3-20-20)T

a. Oil and gas wells, seismic, core or other exploratory holes no longer being used for their original purpose may not be converted into fresh water, low temperature geothermal, or geothermal wells unless the following actions occur: (3-20-20)T

i. Owner, operator, or surface owner files an application with the IDWR describing the conversion and the proposed use for the water or geothermal resource and any modifications necessary to meet the applicable well construction standards; (3-20-20)T

ii. The surface owner provides written documentation assuming responsibility for the converted well including, should it become necessary, decommissioning (plugging) of the converted well in accordance with applicable law; (3-20-20)T

iii. IDWR issues a permit for a geothermal resource well, a water right, or recognizes a domestic exemption authorizing the withdrawal of water from the converted well; and (3-20-20)T

iv. A licensed driller in Idaho inspects and certifies that the converted well meets all well construction standards for its intended purpose. (3-20-20)T

b. The Department's bond may not be released, and the oil and gas permit cancelled, until all requirements in Paragraph 502.07.a. of these rules are met. (3-20-20)T

**503. -- 509. (RESERVED)**

**510. SURFACE RECLAMATION.**

**01. Timing of Reclamation.** After the plugging and abandonment of a well or closure of other oil and gas facilities, all reclamation work described in this Section shall be completed within twelve (12) months. The Director may grant an extension where unusual circumstances are encountered, but every reasonable effort shall be made to complete reclamation before the next local growing season. (3-20-20)T

**02. General Clean Up.** All debris, abandoned gathering line risers and flowline risers, surface equipment, supplies, rubbish, and other waste materials shall be removed within three (3) months of plugging a well. The burning or burial of such material on the premises shall be performed in accordance with applicable local, state, or federal solid waste disposal and air quality regulations. In addition, material may be burned or buried on the

premises only with the prior written consent of the surface owner. (3-20-20)T

**03. Road Removal.** All access roads to plugged and abandoned wells and associated production facilities shall be ripped, regraded, and recontoured unless otherwise specified in a surface use agreement. Culverts and any other obstructions that were part of the access road(s) shall be removed. Roads to be left will be graded to drain and prepared with rolling dips or other best management practices to minimize erosion. (3-20-20)T

**04. Regrading.** Drill pads, pits, berms, cut and fill slopes, and other disturbed areas will be regraded to approximate the original contour. Where possible, slopes should be reduced to three (3) horizontal feet to one (1) vertical foot (3H:1V) or flatter. (3-20-20)T

**05. Compacted Areas.** All areas compacted by drilling and subsequent oil and gas operations that are no longer needed following completion of such operations shall be cross-ripped. Ripping shall be undertaken to a depth of eighteen (18) inches or bedrock, whichever is reached first. (3-20-20)T

**06. Topsoiling.** Stockpiled topsoil shall be replaced in a manner that will support reestablishment of the pre-disturbance land use and contoured to control erosion and provide long-term stability. If necessary, topsoiled areas shall be tilled adequately in order to establish a proper seedbed. (3-20-20)T

**07. Revegetation.** (3-20-20)T

**a.** The owner or operator shall select and establish plant species that can be expected to result in vegetation comparable to that growing on the affected lands prior to the oil and gas operations. Certified weed free seed should be used in revegetation. The owner or operator may use available technical data and results of field tests for selecting seeding practices and soil amendments that will result in viable revegetation. (3-20-20)T

**b.** The disturbed areas shall be reseeded in the first favorable season following rig demobilization, site regrading, and topsoil replacement. (3-20-20)T

**c.** Unless otherwise specified in the approved permit, the success of revegetation efforts shall be measured against the existing vegetation on site prior to the oil and gas operations, or against an adjacent reference area supporting similar types of vegetation. Reseeding or replanting is required until the following cover standards are met: (3-20-20)T

**i.** The ground cover of living plants on the revegetated area should be comparable to the ground cover of living plants on an adjacent reference area for two (2) full growing seasons after cessation of soil amendment or irrigation, if used; (3-20-20)T

**ii.** Ground cover shall be considered comparable if the planted area has at least seventy percent (70%) of the pre-disturbance, or adjacent reference area, ground cover; (3-20-20)T

**iii.** For locations with an average annual precipitation of more than twenty-six (26) inches, the Department, in approving a drilling permit or a pit, may set a minimum standard for success of revegetation as follows: Vegetative cover of seventy percent (70%) for two (2) full growing seasons in areas planted to herbaceous species only; or fifty percent (50%) vegetative cover for two (2) full growing seasons and six hundred (600) woody plants per acre in areas planted to a mixture of herbaceous and woody species; (3-20-20)T

**iv.** As used in this section, “herbaceous species” means grasses, legumes, and other forbs; “woody plants” means woody shrubs, trees, and vines; and “ground cover” means the area of the ground surface covered by the combined aerial parts of vegetation and the litter that is produced naturally on-site, expressed as a percentage of the total area measured. Rock surface areas will be excluded from this calculation; and (3-20-20)T

**v.** In all cases, vegetative cover shall be established to the extent necessary to control erosion. (3-20-20)T

**d.** Introduced species may be planted if they are known to be comparable to previous vegetation, or if known to be of equal or superior use for the approved post-reclamation land use, or, if necessary, to achieve a quick,

temporary cover for soil stabilization purposes. Species classified as poisonous or noxious weed species shall not be used in revegetation. (3-20-20)T

**e.** By mutual agreement of the Department, the surface owner, and the owner or operator, a site may be converted to a different, more desirable or more economically suitable habitat. (3-20-20)T

**f.** Planting of grasses and forbs should be done in a manner which promotes rapid stabilization of the soil surface. Wherever terrain permits, grasses and forbs should be drilled or compacted into the ground using agricultural grass planting equipment or other seeders specifically designed for revegetation applications. Broadcast and hydroseeding may be used on areas where other methods are impractical or unavailable. (3-20-20)T

**g.** The owner or operator should plant shrubs or shrub seed, as required, where shrub communities existed prior to oil and gas operations. Shrub seed may be planted as a portion of a grass seed mix or planted as bare-root transplants after grass seeding. Where the surface owner desires a specific land use such as grazing or cropland, shrubs will not be required in the revegetation species mix. Shrub lands undergoing revegetation with shrubs shall be protected from erosion by vegetation, chemical binders, or other acceptable means during establishment of the shrubs. (3-20-20)T

**h.** Tree stocking of forestlands should meet the following criteria: (3-20-20)T

**i.** Trees that are adapted to the site should be planted in a density which can be expected over time to yield a timber stand comparable to pre-disturbance timber stands; (3-20-20)T

**ii.** Trees shall be established for two (2) full growing seasons after cessation of any soil amendments and irrigation before they are considered to be established; and (3-20-20)T

**iii.** Forestlands undergoing revegetation with trees should be protected from erosion by vegetation, chemical binders, or other acceptable means during seedling establishment. (3-20-20)T

**i.** Revegetation is not required on areas that the surface owner wishes to incorporate into an irrigated field and any roads which will be used for other oil and gas operations. (3-20-20)T

**j.** Mulch should be used on severe sites and may be required by the permit where slopes are steeper than three (3) horizontal feet to one (1) vertical foot (3H:1V) or the mean annual rainfall is less than twelve (12) inches. When used, straw, or hay mulch should be obtained from certified weed free sources. "Mulch" means vegetation residues or other suitable materials to aid in the stabilization of soil and soil moisture conservation which will provide a micro-climate more suitable for germination and growth on severe sites. Annual grains such as rye, oats, and wheat may be used as a substitute for mulch where they will provide adequate protection and will be replaced by permanent species within a reasonable length of time. (3-20-20)T

**08. Reclamation Under a Surface Use Agreement.** Notwithstanding the requirements of Subsections 510.03 through 510.07 of this rule, reclamation may be superseded by the conditions of a surface use agreement as long as the site is left in a stable, non-eroding condition that will not impact fresh waters. (3-20-20)T

**511. -- 999. (RESERVED)**

# IDAPA 21 – IDAHO DIVISION OF VETERANS SERVICES

## DOCKET NO. 21-0000-2000F (FEE RULE)

### NOTICE OF OMNIBUS RULEMAKING – ADOPTION OF TEMPORARY RULE

**EFFECTIVE DATE:** The effective date of the temporary rules being adopted through this omnibus rulemaking is the adjournment date of the second regular session of the 65th Idaho State Legislature - March 20, 2020.

**AUTHORITY:** In compliance with Sections 67-5226, Idaho Code, notice is hereby given this agency has adopted temporary rules. The action is authorized pursuant to Sections 65-202; 65-204; and 66-907, Idaho Code.

**DESCRIPTIVE SUMMARY:** The following is the required finding and concise statement of its supporting reasons for adopting temporary rules:

This temporary rulemaking adopts the following chapters under IDAPA 21, rules of the Idaho Division of Veterans Services:

#### **IDAPA 21**

- 21.01.01, *Rules Governing Admission, Residency, and Maintenance Charges in Idaho State Veterans Homes and Division of Veterans Services Administrative Procedure*
- 21.01.04, *Rules Governing the Idaho Veterans Cemetery*

**TEMPORARY RULE JUSTIFICATION:** Pursuant to Sections 67-5226(1) and 67-5226(2), Idaho Code, the Governor has found that temporary adoption of the rule is appropriate for the following reasons:

These temporary rules are necessary to protect the public health, safety, and welfare of the citizens of Idaho and confer a benefit on its citizens. These temporary rules implement the duly enacted laws of the state of Idaho, provide citizens with the detailed rules and standards for complying with those laws, and assist in the orderly execution and enforcement of those laws. The expiration of these rules without due consideration and processes would undermine the public health, safety, and welfare of the citizens of Idaho and deprive them of the benefit intended by these rules.

**FEE SUMMARY:** Pursuant to Section 67-5226(2), the Governor has found that the fees or charges being imposed or increased is justified and necessary to avoid immediate danger and the fees are described herein:

The fees or charges, authorized in Sections 66-907 and 65-202(8), Idaho Code, are part of the agency's 2021 budget that relies upon the existence of these fees or charges to meet the state's obligations and provide necessary state services. Failing to reauthorize these temporary rules would create immediate danger to the state budget, immediate danger to necessary state functions and services, and immediate danger of a violation of Idaho's constitutional requirement that it balance its budget.

The following is a specific description of the fees or charges:

- IDAPA 21.01.01.915 – Maintenance Charges
- IDAPA 21.01.01.916.01 – Monthly Charges and Allowances Nursing Care
- IDAPA 21.01.01.916.02 – Monthly Charges and Allowances Residential and Domiciliary Care
- IDAPA 21.01.04.024 – Fees For Interment, Disinterment, and Reinterment
- 

**ASSISTANCE ON TECHNICAL QUESTIONS:** For assistance on technical questions concerning the temporary rule, contact Kevin Wallior 208-780-1308.

DATED this February 21, 2020.

Kevin Wallior  
Management Assistant  
Idaho Division of Veterans Services  
351 Collins Road, Boise, ID 83702  
Ph: 208-780-1308  
Fax: 208-780-1301

## IDAPA 21 – IDAHO DIVISION OF VETERANS SERVICES

### 21.01.01 – RULES GOVERNING ADMISSION, RESIDENCY, AND MAINTENANCE CHARGES IN IDAHO STATE VETERANS HOMES AND DIVISION OF VETERANS SERVICES ADMINISTRATIVE PROCEDURE

#### 000. LEGAL AUTHORITY.

The Administrator of the Division of Veterans Services with the advice of the Veterans Affairs Commission is authorized by the Idaho Legislature to establish rules governing requirements for admission to Idaho State Veterans Homes and to establish rules governing charges for residency, pursuant to Sections 65-202, 65-204 and 66-907, Idaho Code. (3-20-20)T

#### 001. TITLE AND SCOPE.

**01. Title.** These rules are titled IDAPA 21.01.01, “Rules Governing Admission, Residency, and Maintenance Charges in Idaho State Veterans Homes and Division of Veterans Services Administrative Procedure.” (3-20-20)T

**02. Scope.** These rules contain provisions for determining eligibility for admission and for establishing charges for residency in Idaho State Veterans Homes, together with rules of administrative procedure before the Idaho Veterans Affairs Commission. (3-20-20)T

#### 002. POLICY.

Through the facilities and services available at Idaho State Veterans Homes, the Division of Veterans Services will provide necessary care for honorably discharged eligible veterans. No applicant will be denied admission on the basis of sex, race, color, age, political or religious opinion or affiliation, national origin, or lack of income, nor will any care or other benefit at a Home be provided in a manner, place, or quality different than that provided for other residents with comparable disabilities and circumstances. However, if residents are financially able to do so, they must contribute to the cost of their care, with allowances made for retention of funds for their personal needs. (3-20-20)T

#### 003. INCORPORATION BY REFERENCE.

**01. Incorporated Documents.** These rules incorporate by reference: (3-20-20)T

**a.** 5 U.S.C. Section 2108(1) dated October 7, 2015. (3-20-20)T

**b.** 38 CFR Part 51, Subpart A, B, C, D, and E dated December 28, 2018. (3-20-20)T

**02. Document Availability.** Copies are available from the Superintendent of Documents, U.S. Government Printing Office, Washington, D.C. 20402-0001. (3-20-20)T

#### 004. -- 009. (RESERVED)

#### 010. DEFINITIONS.

For the purposes of the rules contained in this Chapter, the following terms are used as defined: (3-20-20)T

**01. Applicant.** A person who has expressed interest in applying for residency in an Idaho State Veterans Home. (3-20-20)T

**02. Asset.** Real or personal property that is owned in whole or in part by an applicant or resident, including stocks, bonds, goods, rights of action, evidences of debt, and cash or money that is not income. Insurance payments or monetary compensation for loss of or damage to an asset is an asset. Income not expended in the calendar month received is an asset beginning on the first day of the next calendar month. (3-20-20)T

**03. Bona Fide Resident.** A person who maintains a principal or primary home or place of abode in the state of Idaho coupled with the present intent to remain at that home or abode and return to it after any period of absence pursuant to Section 66-901, Idaho Code. (3-20-20)T

**04. Commission.** The Idaho Veterans Affairs Commission. (3-20-20)T

**05. Division.** Division of Veterans Services in the Idaho Department of Self Governing Agencies.

- (3-20-20)T
- 06. Division Administrator.** The Administrator of the Division of Veterans Services in the Department of Self Governing Agencies, or his designee. The chief officer of the Division of Veterans Services. (3-20-20)T
- 07. Home Administrator.** Administrator of an Idaho State Veterans Home. The chief officer of each respective Veterans Home. (3-20-20)T
- 08. Home.** An Idaho State Veterans Home. (3-20-20)T
- 09. Idaho State Veterans Home.** Pursuant to Section 66-901, Idaho Code, a Home for eligible veterans. (3-20-20)T
- 10. Income.** Money received from any source including wages, tips, commissions, private pension and retirement payments, social security benefits, unemployment compensation, veterans assistance benefits, and gifts. (3-20-20)T
- 11. Legal Dependents.** The mother, father, spouse, or minor children of an applicant or a resident who, by reason of insufficient financial resources, or non-minor children who because of disease, handicap or disability, must have financial support from the applicant or resident in order to maintain themselves. (3-20-20)T
- 12. Liquid Assets.** Those assets which are cash or can be liquidated for cash within a reasonable period of time including, but not limited to, money market certificates, certificates of deposit, stocks and bonds, and some tax shelter investments. (3-20-20)T
- 13. Maintenance Charge.** A charge made for care and residence at an Idaho State Veterans Home, based upon the current established rate. (3-20-20)T
- 14. Net Income.** That income used to compute charges after allowable deductions have been made. (3-20-20)T
- 15. Resident.** A person who is a resident of an Idaho State Veterans Home. (3-20-20)T
- 16. Spouse.** The husband or wife, under a marriage recognized by Title 32, Idaho Code, of a veteran or the widow or widower of a veteran under a marriage recognized by Title 32, Idaho Code. (3-20-20)T
- 17. VA.** United States Department of Veterans Affairs. (3-20-20)T
- 18. Veteran.** Has the meaning established in Section 65-203, Idaho Code. The separation or discharge considered under this definition means the conditions of the most recent separation or discharge from military service. (3-20-20)T

**011. -- 049. (RESERVED)**

**050. ADMINISTRATIVE POWERS.**

The Home Administrator has full authority in the management of a Home, subject to review by the Division Administrator and Commission. A Home Administrator can, in the execution of his duties, delegate certain responsibilities to his staff. When requested by the Division Administrator, the Home Administrator will attend regular and special meetings of the Commission. (3-20-20)T

**01. Representative Powers.** The Division Administrator is authorized to represent the Commission in all official transactions between the Homes and other departments of Idaho state government. (3-20-20)T

**02. Investigation Powers.** Upon receipt of an application for residency and for the duration of residency of any resident, the Division is authorized to conduct an investigation to determine the total value of the property and assets of the applicant/resident to determine his ability to pay maintenance charges established in this



Chapter pursuant to Section 66-907, Idaho Code. (3-20-20)T

**03. Inspection Powers.** Inspection of the rooms and facilities of a Home, as well as of the dress and appearance of all residents, can be conducted at any time by the Home Administrator. (3-20-20)T

**04. Emergency Powers.** In an emergency, the Home Administrator is authorized to use his judgment in matters not specifically covered by a statute, order, rule, or policy. (3-20-20)T

**051. -- 074. (RESERVED)**

**075. ADMINISTRATIVE DUTIES.**

The Home Administrator will enforce all orders and rules and implement all policies of the Division in the administration of a Home. (3-20-20)T

**01. Management of Records.** The Home Administrator must maintain accurate fiscal and resident records. (3-20-20)T

**a.** Nursing care records. Records relating to each nursing care resident of a Home will be kept in accordance with Idaho Department of Health and Welfare Rules, IDAPA 16.03.02, "Rules and Minimum Standards for Skilled Nursing and Intermediate Care Facilities in Idaho," and VA Rules 38 CFR Part 51; Subpart A, B, C, and D dated December 28, 2018. (3-20-20)T

**b.** Residential and domiciliary care records. Records relating to each residential care resident of a Home will be kept in accordance with VA Rules 38 CFR Part 51; Subpart A, B, C, and E dated December 28, 2018. (3-20-20)T

**02. Response to Complaints.** The Home Administrator will respond in writing to any written and signed complaint made by a resident pursuant to Section 300 of these rules. (3-20-20)T

**076. -- 099. (RESERVED)**

**100. ELIGIBILITY REQUIREMENTS.**

Applicants and residents must satisfy the following requirements: (3-20-20)T

**01. Veterans or Eligible Spouse.** (3-20-20)T

**a.** Nursing Care. Applicants for and residents of nursing care must be a veteran or the spouse of a veteran who is eligible for admission to a Home. The death of a veteran shall not disqualify a resident spouse if the veteran was eligible for admission to a Home at the time of death. (3-20-20)T

**b.** Residential Care and Domiciliary Care. Applicants for and residents of residential care and domiciliary care must be a veteran. A Home will not grant spouses admission for residential care or domiciliary care. (3-20-20)T

**02. Idaho Residency.** The applicant must be a bona fide resident of the state of Idaho at the time of admission to a Home. (3-20-20)T

**03. Incompetent Applicants.** Applicants and residents who are incompetent must provide copies of a legally sufficient guardianship or power of attorney. (3-20-20)T

**04. Necessity of Services.** Applicants and residents must meet the requirements for the level of care for which they apply or are receiving. At the request of the Home, residents must provide recertification of their need for services from a VA physician or a physician currently licensed by the Idaho Board of Medicine to practice medicine or surgery in the state of Idaho. (3-20-20)T

**a.** Nursing Care. To be eligible to receive nursing care in a Home, applicants must be referred by a VA physician or a physician currently licensed by the Idaho Board of Medicine to practice medicine or surgery in the

state of Idaho. (3-20-20)T

**b.** Residential and Domiciliary Care. Each applicant must submit to a physical examination performed by a licensed physician and meet the physical limitation requirements for residential care and domiciliary care. Applicants and residents must be unable to earn a living and have no adequate means of support due to wounds, old age, or physical or mental disabilities. However, each residential care and domiciliary care resident must ambulate independently or with the aid of a wheelchair, walker, or similar device and be capable of performing at the time of admission, and for the duration of his residency, all of the following with minimal assistance: (3-20-20)T

- i. Making his bed daily; (3-20-20)T
- ii. Maintaining his room in a neat and orderly manner at all times; (3-20-20)T
- iii. Keeping all clothing clean through proper laundering; (3-20-20)T
- iv. Observing cleanliness in person, dress and living habits and dressing himself; (3-20-20)T
- v. Bathing or showering frequently; (3-20-20)T
- vi. Shaving daily or keeping his mustache or beard neatly groomed; (3-20-20)T
- vii. Proceeding to and returning from the dining room and feeding himself; (3-20-20)T
- viii. Securing medical attention on an ambulatory basis and managing medications; (3-20-20)T
- ix. Maintaining voluntary control over body eliminations or control by use of an appropriate prosthesis; and (3-20-20)T
- x. Making rational decisions as to his desire to remain or leave the Home. (3-20-20)T

**05. Placement Restriction.** A Home shall not accept applicants or continue to extend care to residents for whom the facility does not have the capability or services to provide an appropriate level of care. (3-20-20)T

**06. Financial Statement.** Each applicant must file a signed, dated statement with the Home Administrator containing a report of income from all sources and a report of all liquid assets which will be used to determine the amount of the maintenance charge which is required in accordance with Section 66-907, Idaho Code, and these rules. (3-20-20)T

**07. Social Security Benefits.** If eligible for Social Security benefits, the applicants and residents and their spouses must apply for those benefits unless waived by the Home Administrator. (3-20-20)T

**08. Medicare Coverage.** If eligible for Medicare, the applicants and residents must elect to participate, unless participation is waived by the Home Administrator. (3-20-20)T

**09. Income Limitation.** (3-20-20)T

**a.** Nursing Care. None. (3-20-20)T

**b.** Residential and Domiciliary Care. An applicant whose total monthly net income, at the time of his application for residency, exceeds the current maximum annual rate of VA pension for a single veteran pursuant to Public Law 95588 divided by twelve (12) cannot be admitted unless granted a waiver by the Home Administrator. This waiver must include a statement from a VA Medical Center physician indicating the veteran is in “need of continuing medical care.” (3-20-20)T

**10. VA Pension -- Nursing Care.** Unless waived by the Home Administrator, a wartime veteran, as defined in 5 U.S.C. Section 2108, who is a nursing care applicant or resident must be eligible for, apply for, or be in receipt of a VA disability pension in accordance with Public Law 95588. Such waivers may be considered only when

the applicant or resident has signed a statement that he is able to defray the necessary expenses of the medical care for which he is applying or receiving and arrangements are made to secure medical services not provided by the VA. (3-20-20)T

**11. Agreements for Behavior and Care Needs.** The Homes may require that applicants or residents enter into agreements concerning the applicant or resident's behavior or care needs while residing in the Home. The resident's failure to perform these agreements is a basis for discharge from the Home. (3-20-20)T

**12. Limit on Admission of Spouses.** Unless waived in writing by the Division Administrator, a Home shall not accept spouses for admission if the Home's residency is at ninety-five percent (95%) or more of capacity. Homes shall not admit a spouse if the number of spouses residing in the home will exceed twenty-five percent (25%) of the residents of the Home following admission of the applicant. (3-20-20)T

**101. -- 149. (RESERVED)**

**150. APPLICATION PROCEDURE.**

**01. Submission of Application.** An application may be submitted to the administrative offices of a Home on a form from the Division. (3-20-20)T

**02. Application Processing.** Completed applications will be processed no later than three (3) working days from receipt. (3-20-20)T

**03. Waiting List.** An applicant who is approved for admission for whom a vacancy does not exist will be placed on a waiting list and accepted on a first come, first served basis dependent on the Home's ability to provide a level of care consistent with the needs of the applicant. The Home Administrator may award "priority status" to prospective Home residents resulting in their names being placed near the top of the Home waiting list, provided they have completed all preadmission requirements and meet one (1) or more of the following criteria: (3-20-20)T

**a.** Veterans who served during any war or conflict officially engaged in by the government of the United States. (3-20-20)T

**b.** Previous residents of Homes who have been discharged for therapeutic treatment or to live in a lesser level of care or in an independent setting and whose discharge plan indicates a readmission priority. (3-20-20)T

**c.** Current Home residents who demonstrate a need for a level of care provided by a Home and who would benefit from maintaining a stable environment. (3-20-20)T

**d.** Receive special consideration as per the request of the medical director because of his desire to provide a very specific continuum of care. (3-20-20)T

**04. Provision If Application Rejected.** An applicant whose application has been rejected and who feels he meets the eligibility requirements can request a hearing in accordance with the procedures specified in Section 982, et seq., of these rules. (3-20-20)T

**151. -- 199. (RESERVED)**

**200. CONDITIONS FOR ADMISSION.**

**01. Denial of Admission.** Admission may be denied to an otherwise eligible applicant for any reason for which an admitted resident could be involuntarily discharged. (3-20-20)T

**02. Assignment of Personal Property.** Prior to admission to a Home, an eligible applicant must agree that while he is a resident of a Home he will assign the following, under the conditions specified: (3-20-20)T

**a.** Pursuant to Section 66-906, Idaho Code, all personal property owned, money held, or assets to which he is entitled at the time of his death -- unless disposed of by will or rightfully claimed within five (5) years of

the death of the resident by an heir or person named in the resident's will -- must be assigned to the Division Administrator at the time of application for the sole use and benefit of a Home. (3-20-20)T

**b.** Upon discharge or voluntary departure from a Home, and after written notification is sent to the resident, all personal property owned or money deposited with the Home which is unclaimed by the former resident will be converted for the sole use and benefit of a Home as specified below: (3-20-20)T

**i.** Personal property unclaimed within thirty (30) days of departure or discharge will be made available to needy Home residents or disposed of at public auction or private sale and the proceeds deposited with the state; or (3-20-20)T

**ii.** Money deposited with the Home will be retained and deposited with the state; however, said money may be claimed by the former resident within five (5) years of departure or discharge. (3-20-20)T

**201. WEAPONS.**

Weapons including, but not limited to, firearms, ammunition, straight razors, and knives are not allowed. (3-20-20)T

**202. ACKNOWLEDGMENT OF CONDITIONS LEADING TO DISCHARGE.**

Upon admission to a Home, each resident will be advised in writing of the conditions under which immediate discharge will occur, as specified in Section 350 of these rules. Each resident must acknowledge receipt of this information by signature, and that acknowledgment will be a permanent part of each resident's file. (3-20-20)T

**203. -- 299. (RESERVED)**

**300. CONDUCT OF RESIDENTS.**

Each resident must comply with applicable rules in this Chapter and with any order or directive of the Home Administrator. All complaints made by the residents concerning food, quarters, ill treatment, neglect, abusive language, or other violations of any rule or standard applicable to the Home, or complaints against the operation of a Home may be made either verbally or in writing to the Home Administrator. (3-20-20)T

**01. No Operation of Motor Vehicles by Nursing Care Residents.** The operation or storage of privately owned motor vehicles by nursing care residents is prohibited on Home property. (3-20-20)T

**02. Operation of Motor Vehicles by Domiciliary and Residential Care Residents.** Each authorized domiciliary and residential care resident who drives a motor vehicle onto the grounds of a Home must adhere to the following: (3-20-20)T

**a.** Requirements: (3-20-20)T

**i.** Possess a valid driver's license; (3-20-20)T

**ii.** Have a current motor vehicle registration; (3-20-20)T

**iii.** Operator is insured against liability and property damage in accordance with Idaho law; and (3-20-20)T

**iv.** Park only in assigned spaces. (3-20-20)T

**b.** Prohibitions. Nonoperable motor vehicles and motor vehicle repairs are not permitted on the grounds of a Home. (3-20-20)T

**03. Housekeeping.** (3-20-20)T

**a.** Housekeeping services for nursing care residents shall be provided by the Home. (3-20-20)T

**b.** Each residential and domiciliary care resident must adhere to the following requirements (residential care residents may need minimal assistance): (3-20-20)T

- i. Making his bed daily; (3-20-20)T
- ii. Maintaining his room in a neat and orderly manner at all times; and (3-20-20)T
- iii. Assuring that all clothing is appropriately marked, stored and kept clean through proper laundering. (3-20-20)T
- c. All residents are prohibited from: (3-20-20)T
  - i. Washing clothes or other articles which present a health or safety hazard in resident rooms or bathrooms; (3-20-20)T
  - ii. Using electrical devices, including televisions, radios, recorders, and shavers, until they have been certified by Home maintenance staff as being safe for use; (3-20-20)T
  - iii. Entering the kitchen, laundry, shop or mechanical spaces without permission; and (3-20-20)T
  - iv. Interfering or tampering with the heating, refrigeration or air conditioning systems, televisions, lighting, appliances, plumbing, or mechanical equipment at the Home without authorization. (3-20-20)T
- 04. Personal Conduct.** Each resident must adhere to the following: (3-20-20)T
  - a. Requirements: (3-20-20)T
    - i. Observing cleanliness in person, dress and in living habits; (3-20-20)T
    - ii. Bathing or showering frequently; (3-20-20)T
    - iii. Observing the smoking policies of a Home; and (3-20-20)T
    - iv. Residential and domiciliary care residents must retire to a recreation area or utilize an individual bed light if desiring to read between 10 p.m. and 6:30 a.m. during which time all room overhead lights are turned off. (3-20-20)T
  - b. Prohibitions: (3-20-20)T
    - i. Creating a disturbance or using intoxicating beverages or nonprescribed controlled substances in the buildings or on the grounds (unless prescribed by a physician); (3-20-20)T
    - ii. Marking or writing on the walls of a building, or damaging the grounds or any other property; (3-20-20)T
    - iii. Using profanity or exhibiting vulgar behavior in the Home or in any other public place; (3-20-20)T
    - iv. Becoming involved in quarrels, persistent dissension or criticism of others; (3-20-20)T
    - v. Lending money to, or borrowing money from, another resident or an employee of the Home; (3-20-20)T
    - vi. Smoking in an unauthorized area; (3-20-20)T
    - vii. Taking food (other than fresh fruit for consumption within a reasonable time period), condiments, dishes or utensils from the dining room; (3-20-20)T
    - viii. Cooking or using heating devices in residents' rooms or other unauthorized areas; and (3-20-20)T

ix. Storing flammable or combustible material including, but not limited to, gasoline, butane, solvents, and acetone on Home grounds. (3-20-20)T

**301. -- 349. (RESERVED)**

**350. TRANSFER AND DISCHARGE OF RESIDENTS.**

A resident can be transferred or discharged, for a period to be determined by the Home Administrator, for the bases set forth in Section 350 of these rules. The Home Administrator will provide notice of transfer or discharge and the opportunity to appeal a transfer or discharge in accordance with Section 980 of these rules. (3-20-20)T

**01. Emergency Discharge or Transfer.** Upon determination by the Home Administrator that an emergency exists, a resident may be immediately discharged or transferred. (3-20-20)T

**02. General Discharge or Transfer.** If the Home Administrator determines that one (1) or more of the following is present or has occurred, the resident may be discharged or transferred from the Home: (3-20-20)T

**a.** Possession of a lethal weapon of any kind by the resident on Division property; possession of wine, beer, or liquor by the resident on Division property; or possession of a controlled substance or medication by the resident, unless prescribed by the resident's physician; (3-20-20)T

**b.** Excessive or habitual intoxication; (3-20-20)T

**c.** Willfully destroys or wrongfully appropriates state or another person's property; (3-20-20)T

**d.** Failure to comply with the rules of this Chapter or a written directive of the Home Administrator or the Division Administrator; (3-20-20)T

**e.** Financial conditions set forth in Section 950 of these rules are present; (3-20-20)T

**f.** Engages in a pattern of behavior that infringes upon the rights of another person; (3-20-20)T

**g.** Unauthorized absences from the Home in excess of those permitted by Section 352 of these rules; (3-20-20)T

**h.** Endangers the safety, wellbeing, or health of the resident or other persons or disrupts the peace of the home; (3-20-20)T

**i.** The resident is required by law to register as a sex offender. Should it be determined by the Home that it must provide resources in excess of those provided to other residents to ensure the safety of the resident or other persons; (3-20-20)T

**j.** The resident does not meet the requirements and limitations set forth in Section 100 of these rules. (3-20-20)T

**03. Discharge or Transfer During Absence.** A resident who is absent from the Home may be discharged or transferred due to one (1) or more of the following: (3-20-20)T

**a.** The Home will not have the capability or services to provide an appropriate level of care to the resident upon the resident's return to the Home; (3-20-20)T

**b.** The resident has not returned to the Home from an absence prior to the expiration of the bed hold period established by a third party payer paying more than half of the resident's maintenance charges; (3-20-20)T

**c.** The resident ceases to pay the resident's maintenance charges or a bed hold charge applicable to an absence. (3-20-20)T

**04. Voluntary Transfer or Discharge.** A resident may be transferred or discharged at any time upon

voluntary consent of the resident. (3-20-20)T

**351. (RESERVED)**

**352. UNAUTHORIZED ABSENCES -- RESIDENTIAL AND DOMICILIARY CARE.**

**01. Unauthorized Absences Prohibited.** For residential and domiciliary care residents, no more than three (3) unauthorized absences may be accumulated in a thirty (30) day period. If more than three (3) unauthorized absences are accumulated, the resident may be discharged for a period of thirty (30) days. (3-20-20)T

**02. Yearly Maximum.** The maximum number of unauthorized absences allowable in a one (1) year period is twelve (12). Any resident who exceeds twelve (12) unauthorized absences in one (1) year may be discharged for a period of up to one (1) year. (3-20-20)T

**03. Readmission Requirements.** Residents discharged for unauthorized absences must reapply for admission and are subject to the same restrictions and conditions as other applicants. (3-20-20)T

**353. -- 850. (RESERVED)**

**851. AVAILABLE SERVICES.**

The Division will make available the following services. (3-20-20)T

**01. Residential and Domiciliary Care.** The Division will make available the services listed below for residential and domiciliary care residents: (3-20-20)T

- a. Barber/Beauty Shop. (3-20-20)T
- b. Chaplain. (3-20-20)T
- c. Dietary. (3-20-20)T
- d. Laundry. (3-20-20)T
- e. Nursing (limited). (3-20-20)T
- f. Referral. (3-20-20)T
- g. Social Work. (3-20-20)T
- h. Therapeutic Recreation. (3-20-20)T
- i. Limited Transportation. (3-20-20)T

**02. Nursing Care.** In addition to the services listed in Subsection 851.01, the Division will make available the services listed below for nursing care residents: (3-20-20)T

- a. Dental Hygiene. (3-20-20)T
- b. Lab. (3-20-20)T
- c. Nursing (Skilled). (3-20-20)T
- d. Pharmaceutical. (3-20-20)T
- e. Physical Therapy. (3-20-20)T
- f. Physician. (3-20-20)T

- g. Speech Therapy. (3-20-20)T
- h. X-Ray. (3-20-20)T

**852. -- 879. (RESERVED)**

**880. FINANCIAL CONDITION OF APPLICANTS/RESIDENTS.**

Each applicant/resident or his legal representative must submit a signed and dated financial statement to the Home Administrator on which his income and liquid assets from all sources are reported. The statement must also indicate whether the applicant/resident is responsible for the support of any legal dependent who should be considered in fixing the amount of monthly charges. If changes occur in the applicant's/resident's income or liquid assets, it is the applicant's/resident's responsibility to submit an accurate financial statement immediately. (3-20-20)T

**01. Investigation of Financial Condition.** The Division is authorized to investigate the financial condition of applicants/residents to determine their ability to pay maintenance charges. An applicant/resident may need to provide a power of attorney or a release of information to the Home Administrator in order to assist in investigating his financial condition and to aid in securing any benefits for which he may be eligible. (3-20-20)T

**02. Retroactive Income.** In the event an applicant/resident is awarded retroactive income from any source, he is responsible to report this award to the Home Administrator and to pay his maintenance charge retroactive to the effective date of income. (3-20-20)T

**881. -- 914. (RESERVED)**

**915. MAINTENANCE CHARGES.**

Upon becoming a resident of a Home, each resident is liable for the payment of a maintenance charge as well as expenses for supplies, medication, equipment, and services (other than basic services for the assigned level of care) that are not provided or paid for by VA, Medicaid, Medicare, or other insurance unless otherwise determined by the Home Administrator. Residents living in a Home for any part of a month must pay for each day, based on the actual number of days in the month, at that fraction of their total charge. Refusal or failure to pay the established maintenance charge or related expenses is cause for discharge from the Home. (3-20-20)T

**01. Nursing Care Charges.** Charges shall be computed, based on payment source to include VA, Medicaid, Medicare, or full cost of care. (3-20-20)T

**02. Residential and Domiciliary Care Charges.** Charges will be computed, based on the following factors: (3-20-20)T

- a. If the resident has an income, those items used to compute the charge will include: (3-20-20)T
  - i. Social Security benefits; (3-20-20)T
  - ii. Retirement benefits; (3-20-20)T
  - iii. Income from annuities; (3-20-20)T
  - iv. Insurance benefits; (3-20-20)T
  - v. Rental from property; (3-20-20)T
  - vi. Farm income; (3-20-20)T
  - vii. VA pensions or compensations; (3-20-20)T
  - viii. Tax refunds; and (3-20-20)T



- ix. Income from any and all other sources. (3-20-20)T
- b.** If the resident is single, incompetent, and has liquid assets in excess of one thousand five hundred dollars (\$1,500), he will be assessed the current maximum charge until those assets are reduced to less than one thousand five hundred dollars (\$1,500). (3-20-20)T
- c.** If the resident is single, competent, and has liquid assets in excess of fifteen hundred dollars (\$1,500), he will be assessed the current maximum charge until those assets are reduced to less than fifteen hundred dollars (\$1,500). (3-20-20)T
- d.** Joint income will be used in computing charges for married persons. If the resident has dependents who rely upon him for financial support, the amount of liquid assets will not be drawn upon after they have declined to a level of five thousand dollars (\$5,000). (3-20-20)T
- e.** Residential Care. After allowable deductions, a resident will be assessed a fee of seventy-five percent (75%) of the remaining portion of his net monthly income up to the maximum charge. The maximum monthly maintenance charge shall be seventy-five percent (75%) of the current maximum annual rate of VA pension for a single veteran pursuant to Public Law 95 588 divided by twelve (12). (3-20-20)T
- f.** Domiciliary Care. After allowable deductions, a resident will be assessed a fee of sixty percent (60%) of the remaining portion of his net monthly income up to the maximum charge. The maximum monthly maintenance charge shall be sixty percent (60%) of the current maximum annual rate of VA pension for a single veteran pursuant to Public Law 95 588 divided by twelve (12). (3-20-20)T
- 03. Exclusions from Income or Payment for Residential and Domiciliary Care.** The only exclusions in computing monthly charges will be: (3-20-20)T
- a.** Those funds which a resident receives from the sale of hobby/craft items constructed and sold as part of a Home occupational therapy program; or (3-20-20)T
- b.** Those unusual expenses specified below, which are incurred after the resident's admission to a Home and are approved by the Home Administrator, up to a maximum monthly allowance which is established pursuant to Section 916 of these rules: (3-20-20)T
- i. Prosthetic, orthopedic, and paraplegic appliances; (3-20-20)T
- ii. Sensory aids; (3-20-20)T
- iii. Wheelchairs; (3-20-20)T
- iv. Therapy services; (3-20-20)T
- v. Hospital, medical, surgical expenses and bills for prescription drugs incurred and paid by the individual in the current month and documented by a paid receipt. (3-20-20)T
- c.** Reasonable medical insurance premiums, as paid, with documentation of payment. Other insurance premiums are excluded from consideration; or (3-20-20)T
- d.** An allowance established pursuant to Section 916 of these rules for retention by a resident for personal needs; (3-20-20)T
- e.** That amount necessary for a resident of a Home to contribute to the support of a legal dependent where proof of actual payment is documented. A monthly allowance will be established for a spouse or additional dependents pursuant to Section 916 of these rules. (These allowances take into consideration housing and utility costs.) (3-20-20)T
- 04. Income Eligibility Limits.** (3-20-20)T

a. Nursing Care. None. (3-20-20)T

b. Residential and Domiciliary Care. A resident's total monthly net income, from all sources, may not exceed the current maximum annual rate of VA pension for a single veteran pursuant to Public Law 95-588 divided by twelve (12) unless waived by the Home Administrator in accordance with Subsection 100.08 of these rules. (3-20-20)T

c. While in residence at a Home, a domiciliary resident may seek outside employment and receive income so that his total monthly net income from all sources will exceed the current maximum annual rate of VA pension for a single veteran pursuant to Public Law 95-588 divided by twelve (12) for a one-month transitional period. At the end of this one-month transitional period, the resident will be discharged. (3-20-20)T

**05. Continued Eligibility.** (3-20-20)T

a. Nursing Care. A resident may continue to be eligible for residency in a Home, regardless of income changes, if the conditions defined in Subsection 100.09 of these rules continue to be met. (3-20-20)T

b. Residential and Domiciliary Care. If a resident's net monthly income exceeds the income eligibility limit after admission to the Home, the resident may appeal to the Home Administrator for a waiver of the income eligibility limit which may be granted for good cause. Consideration for good cause must include "need for continuing medical care" as documented by a VA Medical Center physician. (3-20-20)T

**06. Payment Schedule.** Maintenance charges are due the first of each month and must be paid in full by the resident or guardian on or before the tenth day of the month. Payments may be made either by cash or by check, and a receipt will be issued. (3-20-20)T

**07. Security Deposit.** A deposit of one hundred dollars (\$100) will be required by domiciliary and residential care residents upon admission to a Home, unless waived by the Home Administrator. This deposit will be held until the resident leaves. Any debts or liabilities on behalf of the resident will be offset against this deposit at that time. After payment of any debts or liabilities, the remaining balance of the deposit will be returned to the outgoing resident. (3-20-20)T

**08. Leave of Absence or Hospitalization.** Residents receiving Medicaid, Medicare, or VA per diem will be charged for leave of absence or hospitalization in accordance with Medicaid, Medicare, and VA requirements. The Home will not reduce charges for leave of absence or hospitalization of residents not qualifying for Medicaid, Medicare, or VA payment for such absence and each day will count as if the resident were present at a Home. Unless waived by the Home Administrator or prohibited by law, the Home will charge residents receiving Medicaid, Medicare, or VA per diem the current VA per diem rate for each absent day of a leave of absence or hospitalization in excess of the period eligible for payment by Medicaid, Medicare, or the VA. (3-20-20)T

**09. Medicaid Eligibility.** All nursing care residents, including re-admitted residents must either apply for or become eligible for Medicaid benefits, or must pay the maximum monthly charge as it may be established from time to time. Eligibility for Medicaid benefits is determined entirely by the Idaho Department of Health and Welfare and its agents. Residents who cannot, or choose not to, qualify for Medicaid are required to pay for services in full from other than Medicaid funds. Care and services for those residents who are Medicaid eligible will be billed to and paid by Medicaid. Residents eligible for Medicaid will be assessed a fee equal to the resident's liability as determined by Medicaid. (3-20-20)T

**916. MONTHLY CHARGES AND ALLOWANCES.**

**01. Nursing Care.** Pursuant to Section 66-907, Idaho Code, maximum monthly charges are established by the Division Administrator with the advice of the Commission. A schedule of charges will be available in the business office of each Home. Charges will be reviewed from time to time by the Division Administrator and the Commission. (3-20-20)T

a. Changes to Charges. Members of the public may comment on proposed changes at meetings of the

Commission when changes are considered. (3-20-20)T

**b.** Notification and Posting. When changes are made to charges, residents or their families or sponsors will receive written notification and changes will be posted in the business office of each Home a minimum of thirty (30) days prior to the effective date of the change. (3-20-20)T

**02. Residential and Domiciliary Care.** Pursuant to Section 66-907, Idaho Code, maximum monthly charges and allowances are established by the Division Administrator with the advice of the Commission. A schedule of charges and allowances will be available in the business office of the Homes. Allowances will be reviewed from time to time by the Division Administrator and the Commission. (3-20-20)T

**a.** Changes to Charges and Allowances. Pursuant to Paragraphs 915.02.e. and 915.02.f. of these rules, monthly charges for residential and domiciliary care will be adjusted automatically when a change is made to the current maximum annual rate of VA pension for a single veteran pursuant to Public Law 95588 divided by twelve (12). Relative to monthly allowances, members of the public may comment on proposed changes at meetings of the Commission when changes are considered. (3-20-20)T

**b.** Notification and Posting of Changes to Allowances. When changes are made to allowances, residents or their families or sponsors will receive written notification, and changes will be posted in the business office of the Veterans Homes directly following notification pursuant to Public Law 95-588. (3-20-20)T

**917. -- 949. (RESERVED)**

**950. FINANCIAL GROUNDS FOR REJECTION OR DISCHARGE.**

The following circumstances may be considered as grounds for rejection of an application for residency or for revocation of residency and subsequent discharge. (When an application is rejected or a resident discharged, the applicant/resident will be given notification of intended application rejection or discharge, in accordance with the provisions in Section 982 of these rules.) (3-20-20)T

**01. Disposal of Assets.** If the Home Administrator determines that an applicant/resident has disposed of assets following or within sixty (60) months preceding initial application for residency, which would have the effect of reducing his maintenance charge, such action can lead to rejection of the application or discharge from a Home. (3-20-20)T

**02. Failure to Pay Maintenance Charge.** Refusal or failure to pay the established maintenance charge can be cause for discharge from a Home. If the resident is so discharged, or leaves a Home voluntarily, the resident will not be eligible for readmission to a Home until all indebtedness to the Home is paid in full, or acceptable arrangements have been made with the Home Administrator for repayment. (3-20-20)T

**03. Failure to Pay for Services.** (3-20-20)T

**a.** Residents who are excluded from receiving free services from a VA Medical Center may elect to purchase such services through a sharing agreement or contract between a Home and a VA Medical Center or an outside provider when such sharing agreement or contract exists. In those cases where sharing agreement or contract costs are borne by a Home, the resident must reimburse the Home for the costs of services provided. (3-20-20)T

**b.** Failure to reimburse a Home or a service provider within ten (10) days after receipt of a bill for services provided under a sharing agreement or contract may result in a resident's discharge from the Home. (3-20-20)T

**951. -- 979. (RESERVED)**

**980. NOTICE OF RESIDENT TRANSFER OR DISCHARGE AND NOTICE OF DENIAL OF AN APPLICATION FOR RESIDENCY.**

The Home Administrator or his designee must notify the applicant or resident of any action to be taken regarding rejection of an application or involuntary transfer or discharge from a Home. (3-20-20)T

- 01. Form of Notice.** (3-20-20)T
- a.** The notice of denial of application may be made orally. (3-20-20)T
  - b.** The notice of transfer or discharge must be in writing. (3-20-20)T
- 02. Content of Notice of Transfer or Discharge.** The notice must state the following: (3-20-20)T
- a.** The reason for the impending action and a reference to the pertinent rules under which the action is being brought or decision has been made; (3-20-20)T
  - b.** The effective date of the action; (3-20-20)T
  - c.** The location to which the resident is transferred or discharge, which is established for Nursing Care transfers and discharges only; (3-20-20)T
  - d.** The applicant's or resident's right to request a hearing according to the provisions in Section 982 of these rules; and (3-20-20)T
  - e.** The procedure for requesting a hearing, as provided in Subsection 982.03 of these rules. (3-20-20)T
  - f.** The name, address, and telephone number of the State long term care ombudsman; (3-20-20)T
  - g.** The name, address, and telephone number of the State Disability Rights agency responsible for the protection and advocacy for those residents with developmental disabilities or mental illness. (3-20-20)T
- 03. Notification Deadlines for Domiciliary Care.** The following notification deadlines are established for Domiciliary Care only: (3-20-20)T
- a.** Discharge notices must be sent to the resident three (3) days prior to the intended effective date of the action, except under the conditions noted in Subsections 350.01, 350.03 and 350.04 of these rules. (3-20-20)T
  - b.** Notification of findings of ineligibility for residency will be mailed to the applicant within three (3) working days after receipt of the completed application citing the reasons for rejection. (3-20-20)T
- 04. Notification Deadlines for Residential Care.** The following notification deadlines are established for Residential Care only: (3-20-20)T
- a.** Discharge notices must be sent to the resident fifteen (15) days prior to the intended effective date of the action, except under the conditions noted in Subsections 350.01, 350.03 and 350.04 of these rules. (3-20-20)T
  - b.** Notification of findings of ineligibility for residency will be mailed to the applicant within three (3) working days after receipt of the completed application citing the reasons for rejection. (3-20-20)T
- 05. Notification Deadlines for Nursing Care.** The following notification deadlines are established for Nursing Care only: (3-20-20)T
- a.** Notices of general discharge or transfer pursuant to Subsection 350.02 of these rules must be sent to the resident thirty (30) days prior to the intended effective date of the action. (3-20-20)T
  - b.** Notices of emergency discharge or transfer pursuant to Subsection 350.01 of these rules must be sent to the resident as soon as practical. (3-20-20)T
  - c.** Notices of discharge or transfer during absence pursuant to Subsection 350.03 of these rules must be sent to the resident within three (3) working days of the Home's determination to transfer. (3-20-20)T

d. Notice of discharge for unauthorized absences pursuant to Paragraph 350.02.g. of these rules must be sent to the resident within three (3) days of the last unauthorized absence establishing a basis for discharge. (3-20-20)T

e. The Home does not need to provide notice of voluntary transfer or discharge pursuant to Subsection 350.04 of these rules. (3-20-20)T

f. Notification of the denial of an application for residency will be mailed to the applicant within three (3) working days after receipt of the completed application citing the reasons for rejection. (3-20-20)T

**981. APPEAL PROCEDURE.**

Upon notification to a resident of transfer or discharge from a Home by the Home Administrator, the resident may request a hearing in accordance with the provisions in Section 982, "Provisions for Contested Cases," of these rules. Any additional violation of Home rules by a resident while on notice of transfer or discharge will be treated independent of any pending appeal. (3-20-20)T

**982. PROVISIONS FOR CONTESTED CASES.**

**01. Inapplicability of Idaho Rules of Administrative Procedure of the Attorney General.** All contested cases shall be governed by the provisions of these rules. The Commission and Division Administrator find that the provisions of IDAPA 04.11.01, et seq., "Idaho Rules of Administrative Procedure of the Attorney General," are inapplicable and inappropriate for contested cases before the Commission, because of the specific and unique requirements of federal and state law regarding notices, hearing processes, procedural requirements, time lines, and other provisions requiring the Division to adopt its own procedures pursuant to Section 67-5206(5)(b), Idaho Code, and hereby affirmatively promulgate and adopt alternative procedures and elect not to be governed by any of the provisions of IDAPA 04.11.01, et seq., "Idaho Rules of Administrative Procedure of the Attorney General." (3-20-20)T

**02. Hearing Rights.** Residents and applicants have the following rights to a hearing: (3-20-20)T

a. If a resident of a Home is notified of transfer or discharge, the resident will be afforded an opportunity for a hearing. A resident of a Home must attempt to resolve the bases stated on the notice of action through verbal discussions with the Home Administrator or his designee prior to submission of a written request for a hearing. A resident will not be afforded an opportunity for a hearing based upon a voluntary transfer or discharge under Subsection 350.04 of these rules. (3-20-20)T

b. If an application for residency in a Home is rejected, the applicant may request a hearing. (3-20-20)T

**03. Requesting a Hearing for Nursing Care.** A request for a hearing from a nursing care resident for residency in a Home must be submitted to the Idaho Department of Health and Welfare, Fair Hearing Office, P.O. Box 83720, Boise, Idaho 83720. Requests for appeal should be received by the Idaho Department of Health and Welfare before thirty (30) days have passed in order to stop the discharge before it occurs. (3-20-20)T

**04. Requesting a Hearing for Residential and Domiciliary Care.** (3-20-20)T

a. A request for a hearing from a resident for residential and domiciliary care residency in a Home must be submitted through the Home Administrator to the Division Administrator for possible resolution or the scheduling of a hearing. A resident's request must contain a description of what effort he has taken to satisfy the requirements of Paragraph 982.02.a. of these rules. (3-20-20)T

b. A request for a hearing must be in writing and signed by the applicant/resident. (3-20-20)T

c. A request for a hearing must be submitted within three (3) days of receipt of the written notice of action or denial. (3-20-20)T

d. Pending a hearing, benefits will be continued or held in abeyance as follows: (3-20-20)T

i. Benefits for domiciliary care, residential care, and nursing care residents will not be continued when the transfer or discharge is an emergency discharge under Subsection 350.01 of these rules or a discharge for unauthorized absences under Paragraph 350.02.g. of these rules. If the hearing request is made before the effective date of action and within three (3) days of receipt of the notice, no action will be taken by the Home Administrator on a general discharge under Subsection 350.02 of these rules, except Paragraph 350.02.g., or a transfer under Subsection 350.03 of these rules pending receipt of the final order. (3-20-20)T

e. The Division Administrator will not accept a request for a hearing from a voluntary transfer or discharge pursuant to Subsection 350.04 of these rules. (3-20-20)T

**983. PREHEARING PROVISIONS FOR RESIDENTIAL AND DOMICILIARY CARE.**

The following general provisions are applicable to those phases of all appeals which occur before the hearing is conducted unless precluded by statute or rule. (3-20-20)T

**01. Notice of Hearing.** Upon the receipt of a timely request for a hearing, the hearing shall be arranged by the Division Administrator and a notice sent to all parties that includes: (3-20-20)T

a. A statement of the time, place and nature of the hearing; (3-20-20)T

b. A statement of the legal authority under which the hearing is to be held; (3-20-20)T

c. A reference to the particular sections of any statutes and rules involved; (3-20-20)T

d. A statement of the issues involved; (3-20-20)T

e. A statement that all documents to be relied upon by the hearing officer to make its order or notice of decision, or otherwise related to the issues involved in the hearing and relied upon by any party, are to be filed with the Division Administrator and that each party must serve its own documents unless otherwise stated by law; (3-20-20)T

f. A statement that all parties may be represented by counsel; and (3-20-20)T

g. A statement concerning advance requests for hearing transcripts pursuant to Subsection 983.08 of these rules. (3-20-20)T

h. The assignment of a hearing officer for the hearing. The Division Administrator may designate the Commission as a hearing officer. (3-20-20)T

**02. Prehearing Conference.** The Division Administrator or hearing officer may, upon written or other sufficient notice to all interested parties, hold a prehearing conference for the following purposes: (3-20-20)T

a. To formulate or simplify the issues; (3-20-20)T

b. To obtain admissions or stipulations of fact and of documents; (3-20-20)T

c. To arrange for exchange of proposed exhibits or prepared expert testimony; (3-20-20)T

d. To limit the number of witnesses; (3-20-20)T

e. To determine the procedure at the hearing; and (3-20-20)T

f. To determine any other matters which may expedite the orderly conduct and disposition of the proceeding. (3-20-20)T

**03. Disposition of Case Without a Hearing.** Unless precluded by law, disposition without a hearing may be made of any contested case by stipulation, agreed settlement, consent order, motions to dismiss, summary

judgment, or default. (3-20-20)T

**04. Withdrawal of Appeal.** The initiating party at any time may withdraw from any contested case proceeding upon serving written notice of withdrawal to the Division Administrator. (3-20-20)T

**05. Withdrawal of Attorney or Representative.** Any attorney or other person representing a party in a contested case proceeding who wants to withdraw from such proceeding must immediately notify, in writing, the Division Administrator, and all involved parties. (3-20-20)T

**06. Intervention.** Persons, other than the original parties to the proceeding, who are directly and substantially affected by the proceeding, may intervene if they first secure an order from the Division Administrator granting leave to intervene. (3-20-20)T

**a. Granting of Leave to Intervene.** The granting of leave to intervene or to otherwise appear in any matter or proceeding shall not be construed to be a finding or determination that such party will or may be a party aggrieved by any ruling, order or decision of the agency for purposes of judicial review or appeal. (3-20-20)T

**b. Form and Content of Petitions.** Petitions for leave to intervene must be in writing and must clearly: (3-20-20)T

i. Identify the proceeding in which it is sought to intervene, setting forth the name and address of the intervenor; (3-20-20)T

ii. Make a clear and concise statement of the direct and substantial interest of the intervenor in such proceeding and the relationship of the intervenor to the other parties; (3-20-20)T

iii. State the manner in which such intervenor will be affected by such proceeding, outlining the matters and things relied upon by such intervenor as a basis for his request to intervene in such cause; (3-20-20)T

iv. If affirmative relief is sought, the petition must contain a clear and concise statement of relief sought and the basis thereof; and (3-20-20)T

v. A statement as to the nature and quantity of evidence the intervenor will present if such petition is granted. (3-20-20)T

**c. Filing of Petitions.** All petitions must be filed with the Division Administrator. Petitions to intervene and proof of service thereof on all other parties of record must be filed within seven (7) days after receiving notice of the proceeding, or if no notice is received, not less than fourteen (14) days prior to the date set for hearing and, if filed thereafter, must state a substantial reason for such delay; otherwise the petition will not be considered. (3-20-20)T

**07. Hearing Record.** The hearing officer or the Division Administrator will arrange for a record to be made of the hearing. The record must be a verbatim record and it will be recorded by a recording device, unless a party requests a stenographic recording by a certified court reporter, in writing, at least seven (7) days prior to the date of hearing. The record will be transcribed at the expense of the party requesting a transcription, and prepayment or guarantee of payment may be required. Once a transcription is requested, any party may obtain a copy at the party's own expense. The recorded proceedings will be provided to the Division Administrator for inclusion into the record. The Division will maintain an official record of each contested case for a period of not less than six (6) months after the expiration of the last date for judicial review, unless otherwise provided by law. The record will include all notices of proceedings, pleadings, motions, briefs, petitions and intermediate rulings, evidence received or considered, any oral or written statements allowed by the hearing officer or the Division Administrator, statement of matters officially noticed, offers of proof and objections and rulings thereon, the recording of the proceedings or any transcript of all or part of the proceedings, staff memoranda or data submitted to the hearing officer or the Division Administrator in connection with the proceeding, and any recommended order, preliminary order, final order or order on reconsideration. (3-20-20)T

**08. Subpoenas.** Where authorized by law, the hearing officer may compel the attendance of specific

persons and the production of specific documents, materials, or objects at any hearing by subpoena issued by the Division Administrator. (3-20-20)T

**09. Stipulations.** The parties to a contested case proceeding may stipulate as to any fact at issue, either by written stipulation or by oral statement shown upon the record. Any such stipulation is binding upon all parties so stipulating and may be considered by the hearing officer and the Division Administrator. The hearing officer and the Division Administrator may require proof by evidence of any facts stipulated to, notwithstanding the stipulation of the parties. (3-20-20)T

**10. Rules of Civil Procedure.** As contested case proceedings and hearings are informal, the Idaho Rules of Civil Procedure do not apply. The hearing officer shall provide the procedure at the hearing, as required by the provisions of Section 67-5242(3), Idaho Code. (3-20-20)T

**11. Discovery.** Prehearing discovery shall be strictly limited to obtaining the names of witnesses and copies of documents the opposing party intends to offer or present at the hearing. The hearing officer may order disclosure of this information if a party refuses to comply after receiving a written request. (3-20-20)T

**12. Briefing Schedule.** The hearing officer may require briefs and written memoranda to be filed by the parties, and may establish a reasonable briefing schedule. (3-20-20)T

**13. Informal Disposition.** Unless otherwise prohibited by statute or rule, the hearing officer may decline to initiate a contested case. Informal disposition may be made of any contested case by negotiation, stipulation, agreed settlement or consent order, which informal settlement is encouraged. The parties may stipulate as to the facts, reserving their right to appeal to a court of competent jurisdiction on issues of law. The hearing officer may request such additional information as may be necessary to decide whether to initiate or to decide a contested case. If the hearing officer declines to initiate or decide a contested case, a brief statement of the reasons for that decision will be furnished to all persons or parties involved. This disposition of a contested case by informal disposition is a final agency action pursuant to Section 67-5241, Idaho Code. (3-20-20)T

**984. HEARING PROVISIONS FOR RESIDENTIAL AND DOMICILIARY CARE.**

The following general provisions are applicable to those phases of all hearings, unless precluded by statute or rule. (3-20-20)T

**01. Computation of Time.** In computing any period of time relating to a hearing, the first day of the period is not to be included. The last day of the period is to be included unless it is a Saturday, Sunday or legal holiday, in which case the period runs until 5 p.m. of the next working day, unless otherwise provided by law. (3-20-20)T

**02. Service of Documents.** Documents concerning hearings must be served as follows: (3-20-20)T

**a.** All pleadings, briefs and subsequent papers must be served upon every party of record concurrently with the filing with the Division Administrator. (3-20-20)T

**b.** All notices and orders required to be served, other than the initial complaint or petition, must be served in person or by first-class mail. (3-20-20)T

**c.** The initial complaint or petition must be served in person or by certified mail. (3-20-20)T

**c.** The initial hearing request must be served in person or by certified mail. (3-20-20)T

**d.** Service by first-class or certified mail will be deemed complete when the document, properly addressed and stamped, is deposited in the United States mail. The postmark will be the determinant date for all time lines. (3-20-20)T

**e.** Proof of service must accompany all documents when they are filed with the Division Administrator. (3-20-20)T



**03. Hearing Officer Authority.** In the context of each proceeding and unless precluded by law, the hearing officer has the discretion, power and authority to: (3-20-20)T

- a. Determine the order of presentation; (3-20-20)T
- b. Grant or deny petitions for reconsideration; (3-20-20)T
- c. Determine the need, if any, for consolidation; (3-20-20)T
- d. Rule on all evidentiary questions; (3-20-20)T
- e. Rule on motions and objections and dispose of procedural requests; (3-20-20)T
- f. Determine the need for prehearing conferences, recesses, adjournments, hearings on motions and postponements; (3-20-20)T
- g. Administer oaths and affirmations; (3-20-20)T
- h. Examine witnesses; (3-20-20)T
- i. Issue subpoenas or request orders in the form of subpoenas as provided by law; (3-20-20)T
- j. Prescribe general rules of hearing decorum and conduct; (3-20-20)T
- k. Regulate the course of the proceeding; (3-20-20)T
- l. Formulate a reasoned statement in support of the decision. Findings of fact should be set forth in statutory language and be accompanied by a concise and explicit statement of the underlying facts of record supporting the findings. (3-20-20)T
- m. Perform any functions including those set forth in Sections 67-5241 through 67-5251, Idaho Code; and (3-20-20)T
- n. All other functions specifically authorized by statute or rule. (3-20-20)T
- o. The hearing officer shall not have the jurisdiction or authority to invalidate any federal or state statute, rule, or regulation. (3-20-20)T

**04. Ex Parte Consultations.** Ex parte communications between the hearing officer and any party to a contested case proceeding are precluded pursuant to Section 67-5253, Idaho Code. (3-20-20)T

**05. Representation by Counsel.** Any party in a contested case proceeding may be represented by counsel, at the party's own expense. (3-20-20)T

**06. Open Hearings.** All hearings may be open to the public, unless precluded by law. When the Commission is acting as a hearing officer, hearings will be held during regular meetings of the Commission unless otherwise scheduled by the Commission and will be arranged by the Division Administrator. (3-20-20)T

**07. Testimony Under Oath.** All testimony to be considered, with the exception of matters officially noticed or entered by stipulation, must be given under oath, as administered by the hearing officer or other authority authorized to administer oaths. (3-20-20)T

**08. Appearance and Representation.** Any party to a proceeding may appear and be heard in person or may authorize an attorney to represent the party at the party's own expense. Unless otherwise prohibited by law and with the prior approval of the hearing officer, a party may be assisted, but not represented, by a friend or relative. When a party chooses to appear in person and does not speak or understand the English language, an interpreter shall be allowed to interpret under oath. The interpreter is not allowed to act as a representative of the party and shall act at

the party's own expense. (3-20-20)T

**09. Default.** If a party fails to appear at a scheduled hearing or at any stage of a contested case without good cause and reasonable notice to the hearing officer and to all other parties, the hearing officer may enter a notice of proposed default order against the nonappearing party. A default order may be altered or set aside upon petition filed within seven (7) days of service of the order showing sufficient good cause stating the grounds relied on, and providing reasonable notice to all parties. (3-20-20)T

**10. Order of Presentation and Burden of Proof.** At any contested case hearing, the party having the burden of proof shall be the first to present testimony unless the hearing officer determines otherwise. Unless otherwise determined, in advance, by the hearing officer, the burden of proof shall be preponderance of the evidence. (3-20-20)T

**11. Evidence.** Pursuant to Section 67-5251, Idaho Code, the hearing shall be informal and technical rules of evidence do not apply, except that irrelevant, immaterial, incompetent, duly repetitious evidence, or evidence excludable on constitutional or statutory grounds protected by the rules of privilege recognized by law may be excluded. Hearsay evidence may be received if it is relevant to or corroborates competent evidence, but shall not be the sole basis for any finding of fact. Any part of the evidence may be received in written form if doing so will expedite the hearing without substantially prejudicing the interest of any party. Documentary evidence may be received in the form of copies or excerpts if the original is not readily available. (3-20-20)T

**12. Testimony by Telephone or Other Electronic Means.** With the prior approval of the hearing officer, witnesses may testify by telephone or other electronic means, provided the examination and responses are audible to all parties. (3-20-20)T

**13. Official Notice.** (3-20-20)T

**a. Discretionary Notice.** Notice may be taken of judicially cognizable facts by the hearing officer on its own motion or on motion of a party. In addition, notice may be taken of generally recognized technical or scientific facts within the hearing officer's specialized knowledge. Parties shall be notified either before or during the hearing, or by reference in preliminary reports or otherwise, of the material noticed including any staff memoranda or data, and the parties shall be afforded an opportunity to contest the material so noticed. The hearing officer's experience, technical competence, and specialized knowledge may be utilized in the evaluation of the evidence. (3-20-20)T

**b. Mandatory Notice.** For all hearings, the hearing officer must take official notice of the following materials on its own motion or on the motion of any party. Objections going to such notice must become a part of the record. For the purposes of the hearing, it is established as true without proof that the following are admissible, valid and enforceable: (3-20-20)T

- i. Rules of the Division and other state agencies; (3-20-20)T
- ii. Federal regulations; (3-20-20)T
- iii. The constitution and statutes of the United States and Idaho; (3-20-20)T
- iv. Public records; and (3-20-20)T
- v. Such other materials that a court of law must judicially notice. (3-20-20)T

**14. Hearing Officer Decision.** The hearing officer will issue a written order as provided in Section 67-5243, Idaho Code. (3-20-20)T

**a.** Recommended orders will contain a statement of the schedule for review of that order by the Division Administrator. (3-20-20)T

**b.** Preliminary orders will include notice of the right to seek a review of the order by the Division

Administrator and a statement that the order will become final without a request for such review. A request for review shall be filed no later than fourteen (14) days following the issuance of the preliminary order, unless a request for reconsideration by the hearing officer is filed prior to the expiration of such fourteen (14) day period. If a petition for reconsideration is made, a request shall be filed within fourteen (14) days of the hearing officer's order disposing of the petition or the deemed denial of the petition pursuant to Section 67-5243, Idaho Code. (3-20-20)T

**c.** A party may file a motion for reconsideration with the hearing officer no later than fourteen (14) days following the issuance of the preliminary order or the recommended order. (3-20-20)T

**15. Contents of the Record.** Pursuant to Section 67-5249(2), Idaho Code, the record in a contested case proceeding will be kept by the Division Administrator, on behalf of the hearing officer, and must include the following: (3-20-20)T

- a.** All notices, pleadings, motions and rulings; (3-20-20)T
- b.** All evidence received or considered; (3-20-20)T
- c.** A statement of all matters officially noticed; (3-20-20)T
- d.** A record of testimony and offers of proof, objections and rulings thereon; (3-20-20)T
- e.** A record of proposed findings and exceptions; (3-20-20)T
- f.** Any decision, opinion, or report by the Commission; (3-20-20)T
- g.** All staff memoranda or data submitted to the Commission in connection with consideration of the case; (3-20-20)T
- h.** All briefs or memoranda submitted by any party; and (3-20-20)T
- i.** Any recommended order, preliminary order, final order, or order on reconsideration. (3-20-20)T

**16. Review by the Division Administrator and Issuance of the Final Order.** Following the issuance of an order by the hearing officer, the Division Administrator will: (3-20-20)T

- a.** Review recommended orders as provided in Section 67-5244, Idaho Code; (3-20-20)T
- b.** Review preliminary orders upon the appeal of a party or upon the Division Administrator's own motion as provided in Section 67-5245, Idaho Code; and (3-20-20)T
- c.** Issue a final order as provided in Section 67-5246, Idaho Code. (3-20-20)T

**17. Judicial Review.** In accordance with Section 67-5271, Idaho Code, a party which has exhausted all administrative remedies available within the Division may seek judicial review. Proceedings for judicial review shall be instituted in accordance with Sections 67-5270 and 67-5273, Idaho Code. (3-20-20)T

**985. POST HEARING PROVISIONS FOR RESIDENTIAL AND DOMICILIARY CARE.**

The following provisions are applicable to those phases of all contested case proceedings which occur after the hearing has been conducted: (3-20-20)T

**01. Service of Decisions and Orders.** Decisions and orders are deemed to have been served when copies thereof are mailed to all parties of record or their attorneys by the Division Administrator. (3-20-20)T

**02. No Motions for Reconsideration.** Unless otherwise provided by law or these rules, motions for reconsideration shall not be permitted. (3-20-20)T

**03. Public Inspection.** All final decisions and orders of the Commission must be maintained by the

Division Administrator and made available for public inspection after service on the parties. (3-20-20)T

**04. Effect of Petition for Judicial Review.** The filing of a petition for judicial review shall not stay compliance with the decision and order or suspend the effectiveness of the decision and order, unless otherwise ordered or mandated by law. (3-20-20)T

**986. -- 999. (RESERVED)**

## 21.01.04 – RULES GOVERNING THE IDAHO STATE VETERANS CEMETERY

### 000. LEGAL AUTHORITY.

The Idaho Legislature has given the Administrator of the Division of Veterans Services the authority to promulgate rules governing the Idaho State Veterans Cemetery pursuant to Section 65-202, Idaho Code. (3-20-20)T

### 001. TITLE AND SCOPE.

**01. Title.** These rules are titled IDAPA 21.01.04, “Rules Governing the Idaho State Veterans Cemetery.” (3-20-20)T

**02. Scope.** These rules contain the provisions for eligibility for interment at the Idaho State Veterans Cemetery and the provisions for operation and maintenance of the Idaho State Veterans Cemetery. (3-20-20)T

### 002. INCORPORATION BY REFERENCE.

**01. Incorporated Documents.** These rules incorporate by reference the following: (3-20-20)T

**a.** The full text of 38 CFR 38.620, dated July 1, 2001. (3-20-20)T

**b.** 38 U.S.C.A. Section 2402, (2004 and Supp. 2004). (3-20-20)T

**c.** 38 CFR 39.5(d), dated July 1, 2008. (3-20-20)T

**02. Document Availability.** Copies are available from the Superintendent of Documents, U.S. Government Printing Office, Washington, D.C. 20402-0001. (3-20-20)T

### 003. -- 009. (RESERVED)

### 010. DEFINITIONS.

**01. Administrator.** The Administrator of the Idaho Division of Veterans Services or his designee. (3-20-20)T

**02. Applicant.** The individual requesting interment, disinterment or reinterment of a qualified person. (3-20-20)T

**03. Armed Forces Member.** A member or former member of the armed forces of the United States, the reserve component of the armed forces of the United States, the reserve officers training corps of the United States, or the armed forces of an ally of the United States who is eligible for burial in national cemeteries pursuant to 38 CFR 38.620 and 38 U.S.C. Section 2402. (3-20-20)T

**04. Cemetery.** The Idaho State Veterans Cemetery authorized pursuant to Section 65-108, Idaho Code. (3-20-20)T

**05. Committal Service.** A gathering of one (1) or more individuals prior to interment or reinterment. (3-20-20)T

**06. Cremains.** Cremated human remains. (3-20-20)T

**07. Designated Interpretive Trail.** A public recreational trail designated by a sign or marker. (3-20-20)T

**08. Disinterment.** The removal of human remains from their place of interment. (3-20-20)T

**09. Division.** The Idaho Division of Veterans Services. (3-20-20)T

**10. Interment.** The disposition of human remains by burial or the placement of cremains in a grave plot or in any location designated by the Administrator for use as a permanent location of cremains. (3-20-20)T

**11. Qualified Person.** A person who satisfies the requirements for eligibility for interment in national cemeteries found at 38 CFR 38.620 and 38 U.S.C. Section 2402 and is not prohibited from being interred by 38 CFR 39.10(b). (3-20-20)T

**12. Reinterment.** The interment of previously interred human remains. (3-20-20)T

**13. Unremarried Spouse.** An individual who is the surviving spouse of a deceased armed forces member and who has not remarried. (3-20-20)T

**14. USDVA.** The United States Department of Veterans Affairs. (3-20-20)T

**011. -- 019. (RESERVED)**

**020. ELIGIBILITY FOR INTERMENT.**

**01. Eligibility.** A qualified person is eligible for interment at the cemetery. An individual who is a qualified person based upon a relationship to an armed forces member is eligible for interment at the cemetery if the armed forces member is pre-registered for interment at the cemetery or is interred at the cemetery. (3-20-20)T

**02. Requirements.** (3-20-20)T

**a. Proof of Qualification as an Armed Forces Member.** The following documents may be submitted as proof that an individual is a qualified person: (3-20-20)T

**i.** A valid discharge from the armed forces of the United States in the name of the individual indicating that the character of discharge was other than dishonorable; or (3-20-20)T

**ii.** A copy of a Reserve Retirement Eligibility Benefits Letter in the name of the individual; or (3-20-20)T

**iii.** A valid certificate of naturalization or a valid United States passport in the name of the individual and a valid discharge in the name of the individual from the armed forces of an ally of the United States in a war during which the individual served indicating that the character of discharge was other than dishonorable; or (3-20-20)T

**iv.** Any other evidence satisfactory to the Administrator. (3-20-20)T

**b. Proof of Qualification for Relatives of an Armed Forces Member.** The following documents may be submitted as proof that an individual is a qualified person: (3-20-20)T

**i.** One (1) of the items listed in Subparagraphs 020.02.a.i. through 020.02.a.iii. of these rules for a parent of the individual, a valid birth or adoption record identifying such parent, and proof of the individual's birth date; or (3-20-20)T

**ii.** One (1) of the items listed in Subparagraphs 020.02.a.i. through 020.02.a.iii. of these rules for the spouse of the individual, a valid record of marriage between the individual and the armed forces member, and a certification that the individual was an unremarried spouse at the time of death, if the armed forces member predeceased the individual; or (3-20-20)T

**iii.** Any other evidence satisfactory to the Administrator. (3-20-20)T

**03. Burden of Proof.** The burden of proof in establishing eligibility for interment or reinterment in the cemetery shall be upon the applicant. (3-20-20)T

**021. APPLICATION FOR INTERMENT.**

**01. Who May Apply.** A qualified person seeking to pre-register for interment or their legal representative, the Administrator of a qualified person's estate, the personal representative of a deceased qualified person, or a relative of a deceased qualified person may apply for interment. If the qualified person was married at the time of death, that person's spouse must consent to the application. If no relative or legal representative of a qualified

person is available to apply on the behalf of a deceased qualified person, a veteran's organization or the Administrator may apply for interment. (3-20-20)T

**02. Pre-Registration for Interment.** A qualified person or the legal representative of a qualified person may pre-register for interment by submitting proof of eligibility and completing an application form prescribed by the Administrator. If the individual seeking to be pre-registered for interment is a qualified person based upon a relationship to an armed forces member, the armed forces member must be pre-registered for interment or interred at the cemetery. If a qualified person is eligible based upon marriage to an armed forces member, the Administrator must receive proof that the qualified person was an unremarried spouse at the time of death prior to interment. (3-20-20)T

**03. Application Following Death.** An applicant may submit an application for interment following the death of a qualified person by submitting proof of eligibility and completing an application form prescribed by the Administrator. (3-20-20)T

**022. INTERMENT AND REINTERMENT.**

**01. Remains.** Remains shall be delivered to the cemetery in a casket or, if cremated, in a recoverable container. The container for cremains designated by the applicant for interment in a location other than a grave plot shall not exceed nine (9) inches in width, thirteen (13) inches in height, and nine (9) inches in depth. (3-20-20)T

**02. Committal Services.** The cemetery shall provide a designated location for committal services. Graveside committal services shall not be held in the cemetery. The cemetery shall not provide facilities for viewing of remains. The arrangements for and any expenses associated with committal services shall be the responsibility of the applicant. The Administrator may assist the applicant in applying for military honors. (3-20-20)T

**023. DISINTERMENT AND REINTERMENT.**

**01. Disinterment.** The Administrator may approve an application for disinterment where the applicant for interment, the surviving unremarried spouse, if any, and the children of the interred person, or the legal representatives of any of the foregoing persons, complete and sign an application form prescribed by the Administrator and submit proof of applicable governmental approval of the disinterment, transporting, and reinterment of the remains. The Administrator shall approve an application for disinterment accompanied by the order of a court of competent jurisdiction. (3-20-20)T

**02. Reinterment.** (3-20-20)T

**a. Who May Be Reinterred.** The Administrator may approve an application for reinterment of remains in the cemetery where the remains are of a qualified person and the applicant for interment desires that the remains be interred with remains interred in the cemetery or with the remains of a qualified person pre-registered for interment in the cemetery. (3-20-20)T

**b. Application and Proof of Eligibility.** The applicant for reinterment shall complete an application form prescribed by the Administrator and submit proof of the eligibility of the qualified person and proof of applicable governmental approval of the disinterment, transporting, and reinterment of the remains. If the application seeks reinterment of the remains of a qualified person, the applicant shall identify the qualified person with whom the reinterred remains will be interred. (3-20-20)T

**024. FEES FOR INTERMENT, DISINTERMENT, AND REINTERMENT.**

The Administrator shall charge the following fees: (3-20-20)T

**01. Interment.** (3-20-20)T

**a.** A fee equal to the then current USDVA reimbursement for opening and closing an interment site containing a pre-placed crypt. The Administrator will accept, as full payment the amount of reimbursement by the USDVA to the Division for opening and closing an interment site containing a pre-placed crypt for a qualified veteran. (3-20-20)T

**b.** In addition to the fee charged under Paragraph 024.01.a. of this rule, the Administrator shall charge a fee of five hundred dollars (\$500) for preparation of an interment site not containing a pre-placed crypt. (3-20-20)T

**02. Disinterment.** A fee equal to the then current USDVA reimbursement for opening and closing an interment site. The expenses of removal, transportation and reinterment of remains, and the expenses of removal, transportation and reinstallation of the grave marker, if any, shall be paid by the applicant for disinterment. (3-20-20)T

**03. Reinterment.** A fee equal to the then current USDVA reimbursement for opening and closing an interment site for reinterment. The expenses of reinterment of remains and reinstallation of the grave marker, if any, shall be paid by the applicant for reinterment. (3-20-20)T

**025. -- 029. (RESERVED)**

**030. CEMETERY USE.**

**01. Public Use.** The cemetery will be open to public access from 8 a.m. to sunset daily. The Administrator may close the cemetery at 6 p.m. when a public fireworks display is planned. (3-20-20)T

**02. Interment Schedule.** Cemetery staff will schedule interments to ensure that cemetery staff complete their duties between the hours of 8 a.m. and 5 p.m. Cemetery staff will not schedule interments on Saturdays, Sundays and legal holidays without the prior approval of the Administrator. (3-20-20)T

**031. -- 039. (RESERVED)**

**040. MEMORIALS AND DONATIONS.**

**01. Flowers and Grave Decorations.** The Administrator will post the requirements for natural and artificial flowers and other grave decorations in the cemetery. Cemetery personnel may remove and discard grave decorations that fail to comply with the posted requirements or that are faded, wilted, tattered or worn. (3-20-20)T

**02. Plaques, Statues, and Other Memorials.** The Administrator may approve plaques, statues, and other memorials to commemorate events, units, individuals, groups, and organizations. Persons wishing to install such memorials shall submit an application on a form prescribed by the Administrator. The cost of all such memorials shall be the responsibility of the applicant. Memorials approved by the Administrator shall be donations to the cemetery. (3-20-20)T

**03. Grave Markers.** All grave markers in the cemetery shall be markers issued by the USDVA. Upright granite markers shall be used to mark graves. Flush granite markers shall be used to mark interments in an area reserved for the interment of cremains in the soil. Granite niche markers shall be used to mark the interment of cremains in a structure reserved for the interment of cremains. The Administrator may assist the applicant in completing all forms for ordering a grave marker required by the USDVA. (3-20-20)T

**04. Donations and Gifts.** The Administrator may accept gifts and donations to the Veterans Cemetery Maintenance Fund established pursuant to Section 65-107, Idaho Code. (3-20-20)T

**041. -- 049. (RESERVED)**

**050. PUBLIC BEHAVIOR IN THE CEMETERY.**

**01. Littering.** Littering is prohibited in the cemetery. (3-20-20)T

**02. Preservation of Cemetery Property.** The destruction, injury, defacement, removal or disturbance in or of any building, sign, equipment, monument, statute, marker or any other structures, or of any tree, flower, or other vegetation, or of any artifact or any other property in the cemetery is prohibited unless authorized by the Administrator. (3-20-20)T



**03. Recreation and Entertainment.** The cemetery shall not be used for any form of sports, entertainment or recreation, other than use limited solely to designated interpretive trails. The Administrator may limit access to designated interpretive trails to one (1) or more routes designated by a marker or sign. The cemetery shall not be used as a picnic ground. (3-20-20)T

**04. Public Ceremonies and Gatherings.** Except for committal services, any individual or group organizing a ceremony or gathering in the cemetery must first obtain the prior written approval of the Administrator. The cemetery shall not be used for partisan activities. Parties receiving authority to hold a ceremony or public gathering shall comply with all restrictions placed upon the ceremony or public gathering by the Administrator. (3-20-20)T

**05. Animals.** Leashed animals are allowed in the cemetery only on designated interpretive trails and marked designated interpretive trail access areas. Animal owners shall observe posted requirements for gaining access to designated interpretive trails, the use and behavior of animals, and the disposal of animal waste. (3-20-20)T

**06. Motor Vehicles.** Except as authorized by the Administrator: (3-20-20)T

**a.** Motor vehicles shall remain on authorized, established roadways or parking areas; (3-20-20)T

**b.** Motor vehicles are prohibited on interpretive trails; (3-20-20)T

**c.** Motor vehicle drivers shall observe posted traffic, directional, parking, and speed signs and all applicable state and local laws governing traffic on public roads; and (3-20-20)T

**d.** Overnight parking is prohibited in the cemetery. (3-20-20)T

**07. Alcohol.** No alcoholic beverages can be consumed in the cemetery. (3-20-20)T

**08. Photographs.** No commercial video or commercial still photographs can be taken in the cemetery without the prior written approval of the Administrator. (3-20-20)T

**051. -- 999. (RESERVED)**

## IDAPA 22 – BOARD OF MEDICINE

### DOCKET NO. 22-0000-2000F (FEE RULE)

#### NOTICE OF OMNIBUS RULEMAKING – ADOPTION OF TEMPORARY RULE

**EFFECTIVE DATE:** The effective date of the temporary rules being adopted through this omnibus rulemaking is the adjournment date of the second regular session of the 65th Idaho State Legislature - March 20, 2020.

**AUTHORITY:** In compliance with Sections 67-5226, Idaho Code, notice is hereby given this agency has adopted temporary rules. The action is authorized pursuant to Sections 54-1806(2), 54-1806(4), 54-1806(11), 54-1806A, 52-1807, 54-1812, 54-1813, 54-1814 and 54-1841, Idaho Code.

**DESCRIPTIVE SUMMARY:** The following is the required finding and concise statement of its supporting reasons for adopting temporary rules:

This temporary rulemaking adopts the following chapters under IDAPA 22:

#### **IDAPA 22**

- 22.01.01, *Rules of the Board of Medicine for the Licensure to Practice Medicine and Osteopathic Medicine in Idaho*
- 22.01.03, *Rules for the Licensure of Physician Assistants*
- 22.01.07, *Rules for the Licensure of Naturopathic Medical Doctors*
- 22.01.10, *Rules for the Licensure of Athletic Trainers to Practice in Idaho*
- 22.01.11, *Rules for Licensure of Respiratory Therapists and Permitting of Polysomnographers in Idaho*
- 22.01.13, *Rules for the Licensure of Dietitians*

**TEMPORARY RULE JUSTIFICATION:** Pursuant to Sections 67-5226(1) and 67-5226(2), Idaho Code, the Governor has found that temporary adoption of these rules is appropriate for the following reasons:

These temporary rules are necessary to protect the public health, safety, and welfare of the citizens of Idaho and confer a benefit on its citizens. These temporary rules implement the duly enacted laws of the state of Idaho, provide citizens with the detailed rules and standards for complying with those laws, and assist in the orderly execution and enforcement of those laws. The expiration of these rules without due consideration and processes would undermine the public health, safety, and welfare of the citizens of Idaho and deprive them of the benefit intended by these rules.

**FEE SUMMARY:** Pursuant to Section 67-5226(2), the Governor has found that the fees or charges being imposed or increased is justified and necessary to avoid immediate danger and the fees are described herein:

The fees or charges, authorized in Sections 54-1808, 54-3509, 54-3907, 54-4311, 54-5105, Idaho Code, are part of the agency's 2021 budget that relies upon the existence of these fees or charges to meet the state's obligations and provide necessary state services. Failing to reauthorize these temporary rules would create immediate danger to the state budget, immediate danger to necessary state functions and services, and immediate danger of a violation of Idaho's constitutional requirement that it balance its budget.

The following is a specific description of the fees or charges: The fees included in each rule chapter relate to licensure and renewal of licensure for each profession described in each rule chapter.

**ASSISTANCE ON TECHNICAL QUESTIONS:** For assistance on technical questions concerning the temporary rule, contact Anne Lawler, (208) 327-7000.

Dated this 14th day of February, 2020.

Anne K. Lawler, JD, RN, Executive Director  
Phone: (208) 327-7000 / Fax: (208) 327-7005  
E-mail: [anne.lawler@bom.idaho.gov](mailto:anne.lawler@bom.idaho.gov)

Idaho State Board of Medicine  
345 W. Bobwhite Court, Suite 150  
Boise, Idaho 83706

## IDAPA 22 – BOARD OF MEDICINE

### 22.01.01 – RULES OF THE BOARD OF MEDICINE FOR THE LICENSURE TO PRACTICE MEDICINE AND OSTEOPATHIC MEDICINE IN IDAHO

#### 000. LEGAL AUTHORITY.

Pursuant to Sections 54-1806(2), 54-1806(4), 54-1806(11), 54-1806A, 52-1807, 54-1812, 54-1813, 54-1814 and 54-1841, Idaho Code, the Idaho State Board of Medicine is authorized to promulgate rules to govern the practice of Medicine in Idaho. (3-20-20)T

#### 001. TITLE AND SCOPE.

These rules are titled IDAPA 22.01.01, “Rules of the Board of Medicine for the Licensure to Practice Medicine and Osteopathic Medicine in Idaho.” (3-20-20)T

#### 002. -- 009. (RESERVED)

#### 010. DEFINITIONS.

**01. Acceptable International School of Medicine.** An international medical school located outside the United States or Canada that meets the standards for medical educational facilities set forth in Subsection 051.02, is accredited by the Educational Commission for Foreign Medical Graduates (ECFMG) and provides the scope and content of the education and coursework that are equivalent to acceptable schools of medicine located within the United States or Canada. (3-20-20)T

**02. Educational Commission for Foreign Medical Graduates (ECFMG).** A nationally recognized non-profit organization that certifies international medical graduates who seek to enter United States residency and fellowship programs. (3-20-20)T

**03. Federation of State Medical Boards of the United States (FSMB).** A nationally recognized non-profit organization representing the seventy (70) medical and osteopathic boards of the United States and its territories. (3-20-20)T

**04. Medical Practice Act.** Title 54, Chapter 18, Idaho Code. (3-20-20)T

#### 011. ABBREVIATIONS.

**01. AAMC.** Association of American Medical Colleges. (3-20-20)T

**02. ACGME.** Accreditation Council for Graduate Medical Education. (3-20-20)T

**03. AMA.** American Medical Association. (3-20-20)T

**04. AOA.** American Osteopathic Association. (3-20-20)T

**05. CACMS.** Committee on Accreditation of Canadian Medical Schools. (3-20-20)T

**06. COCA.** Commission on Osteopathic College Accreditation. (3-20-20)T

**07. ECFMG.** Educational Commission for Foreign Medical Graduates. (3-20-20)T

**08. FAIMER.** Foundation for Advancement of International Medical Education. (3-20-20)T

**09. FSMB.** Federation of State Medical Boards. (3-20-20)T

**10. LCME.** Liaison Committee on Medical Education. (3-20-20)T

**11. USMLE.** United States Medical Licensing Exam. (3-20-20)T

**12. WFME.** World Federation for Medical Education. (3-20-20)T

#### 012. -- 049. (RESERVED)

**050. GENERAL QUALIFICATIONS FOR LICENSURE AND RENEWAL.**

Requirements for licensure and renewal are found in Title 54, Chapter 18, Idaho Code, IDAPA 22.01.05, and on Board approved forms. (3-20-20)T

**01. Special Purpose Examination.** Upon inquiry, if further examination is required, the Board may require passage of the Special Purpose Examination (SPEX) administered by the FSMB, a post licensure assessment conducted by the FSMB, or an evaluation by an independent agency accepted by the Board to evaluate physician competence. (3-20-20)T

**02. Additional Circumstances.** The Board may require further inquiry when in its judgment the need is apparent, including, but not limited to, the following circumstances: (3-20-20)T

i. Graduate of an international medical school located outside the United States and Canada and not accredited by the LCME; (3-20-20)T

ii. Applicant whose background investigation reveals evidence of impairment, competency deficit, or disciplinary action by any licensing or regulatory agency; (3-20-20)T

iii. An applicant has not been in active medical practice for a period exceeding one (1) year, or when practice has been significantly interrupted; (3-20-20)T

iv. An applicant has not written a recognized examination intended to determine ability to practice medicine within a period of five (5) years preceding application; (3-20-20)T

v. An applicant whose initial licensure was issued on the basis of an examination not recognized by the Board; or (3-20-20)T

vi. When there is any reason whatsoever to question the identity of the applicant. (3-20-20)T

**03. Board Determinations.** Recommendations of the assessment and or evaluation acceptable to the Board related to the ability of the applicant to practice medicine and surgery will be considered by the Board in its decision whether to issue a license and the Board may limit, condition, or restrict a license based on the Board's determination and the recommendation of the assessment or evaluation. (3-20-20)T

**051. LICENSURE FOR GRADUATES OF INTERNATIONAL MEDICAL SCHOOLS LOCATED OUTSIDE OF THE UNITED STATES AND CANADA.**

**01. International Medical Graduate.** In addition to meeting the requirements of Section 050, graduates of international medical schools located outside of the United States and Canada must submit to the Board: (3-20-20)T

**a.** Original certificate from the ECFMG or original documentation that the applicant has passed the examination either administered or recognized by the ECFMG and passed an examination acceptable to the Board that demonstrates qualification for licensure or successfully completed the United States Medical Licensing Exam (USMLE); (3-20-20)T

**b.** Original documentation directly from the international medical school that establishes to the satisfaction of the Board that the international medical school meets the standards for medical educational facilities set forth in Subsection 051.02; (3-20-20)T

**c.** Original documentation directly from the international medical school that it has not been disapproved or has its authorization, accreditation, certification or approval denied or removed by any state, country or territorial jurisdiction and that to its knowledge no state of the United States or any country or territorial jurisdiction has refused to license its graduates on the grounds that the school fails to meet reasonable standards for medical education facilities; (3-20-20)T

**d.** A transcript from the international medical school showing successful completion of all the courses taken and grades received and original documentation of successful completion of all clinical coursework; and (3-20-20)T

**e.** Original documentation of successful completion of three (3) years of progressive postgraduate training at one (1) training program accredited for internship, residency, or fellowship training by the ACGME, AOA or the Royal College of Physicians and Surgeons of Canada or its successor organization, provided however, a resident who is attending an Idaho based residency program may be licensed after successful completion of two (2) years of progressive post graduate training, if the following conditions are met: (3-20-20)T

**i.** The resident must have the written approval of the residency program director; (3-20-20)T

**ii.** The resident must have a signed written contract with the Idaho residency program to complete the entire residency program; (3-20-20)T

**iii.** The resident must remain in good standing at the Idaho-based residency program; (3-20-20)T

**iv.** The residency program must notify the Board within thirty (30) days if there is a change in circumstances or affiliation with the program (for example, if the resident resigns or does not demonstrate continued satisfactory clinical progress); and (3-20-20)T

**v.** The Idaho residency program and the Idaho Board have prescreened the applicant to ensure that the applicant has received an MD or DO degree from an approved school that is eligible for Idaho licensure after graduation. (3-20-20)T

**02. International Medical School Requirements.** An international medical school must be listed in the World Directory of Medical Schools, a joint venture of World Federation for Medical Education (WFME) and the Foundation for Advancement of International Medical Education and Research (FAIMER). (3-20-20)T

**052. GRADUATES OF UNAPPROVED INTERNATIONAL MEDICAL SCHOOLS LOCATED OUTSIDE OF THE UNITED STATES OR CANADA.**

In addition to meeting the requirements of Section 050 of these rules, graduates of unapproved international medical schools located outside the United States or Canada that do not meet the requirements of Section 051.02 of these rules, shall submit to the Board an original certificate or document of three (3) of the four (4) following requirements: (3-20-20)T

**01. Valid ECFMG Certificate.** Hold a valid certificate issued by ECFMG. (3-20-20)T

**02. Three Years of Completed Post Graduate Training.** Successful completion of three (3) years of progressive post graduate training at one (1) training program accredited for internship, residency or fellowship training in an ACGME or AOA or Royal College of Physicians and Surgeons of Canada or its successor organization's approved program. (3-20-20)T

**03. Board Certification.** Hold current board certification by a specialty board approved by the American Board of Medical Specialties or the AOA. (3-20-20)T

**04. Five Years Unrestricted Practice.** Evidence of five (5) years of unrestricted practice as a licensee of any United States or Canadian jurisdiction. (3-20-20)T

**053. -- 078. (RESERVED)**

**079. CONTINUING MEDICAL EDUCATION (CME) REQUIRED.**

**01. Purpose.** The purpose of practice relevant CME is to enhance competence, performance, understanding of current standards of care, and patient outcomes. (3-20-20)T

**02. Renewal.** Each person licensed to practice medicine and surgery or osteopathic medicine or

surgery in Idaho shall complete no less than forty (40) hours of practice relevant, Category 1, CME every two (2) years. (3-20-20)T

**03. Verification of Compliance.** Licensees will, at license renewal, provide an attestation to the Board indicating compliance. The Board, in its discretion, may require such additional evidence as is necessary to verify compliance. (3-20-20)T

**04. Alternate Compliance.** The Board may accept certification or recertification by a member of the American Board of Medical Specialties, the American Osteopathic Association, or the Royal College of Physicians and Surgeons of Canada or its successor organization in lieu of compliance with continuing education requirements during the cycle in which the certification or recertification is granted. The Board may also grant an exemption for full time participation in a residency or fellowship training at a professionally accredited institution. (3-20-20)T

**05. Penalties for Noncompliance.** The Board may condition, limit, suspend, or refuse to renew the license of any person whom the Board determines has failed to comply with the continuing education requirements of this chapter. (3-20-20)T

**080. PHYSICIAN PANELIST FOR PRELITIGATION CONSIDERATION OF MEDICAL MALPRACTICE CLAIMS.**

**01. Purpose.** The purpose of serving as a physician panelist for prelitigation consideration of medical malpractice claims against physicians and surgeons practicing in the state of Idaho or against licensed acute care general hospitals operating in the state of Idaho is to: (3-20-20)T

**a.** Cooperate in the prelitigation consideration of personal injury and wrongful death claims for damages arising out of the provision of or alleged failure to provide hospital or medical care in Idaho; and (3-20-20)T

**b.** Accept and hear complaints of such negligence and damages, made by or on behalf of any patient who is an alleged victim of such negligence. (3-20-20)T

**02. Eligibility.** A physician licensed to practice medicine and surgery or osteopathic medicine or surgery in Idaho must be available to serve in any two (2) year period, or a longer period not to exceed five (5) years, as determined by the panel chairman, as a physician panelist for prelitigation consideration of a medical malpractice claim. (3-20-20)T

**03. Excusing Physicians from Serving.** A physician panelist so selected must serve unless he had served on a prelitigation panel during any previous two (2) year period, or a longer period not to exceed five (5) years, as determined by the panel chairman or for good cause shown, is excused by the panel chairman. To show good cause for relief from serving, the selected physician panelist must present an affidavit to the panel chairman which shall set out the facts showing that service would constitute an unreasonable burden or undue hardship. The panel chairman has the sole authority to excuse a selected physician from serving on a prelitigation panel. (3-20-20)T

**04. Penalties for Noncompliance.** The Board may condition, limit, suspend, or refuse to renew the license of any physician whom the Board determines has failed to serve as a physician panelist for the prelitigation consideration of a medical malpractice claim. (3-20-20)T

**081. -- 099. (RESERVED)**

**100. FEES -- TABLE.**

**01. Fees -- Table.** Nonrefundable fees are as follows:

<b>Fees -- Table (Non-Refundable)</b>	
Licensure Fee	- Not more than \$600

<b>Fees -- Table (Non-Refundable)</b>		
Temporary License	-	Not more than \$300
Reinstatement License Fee plus total of renewal fees not paid by applicant	-	Not more than \$300
Inactive License Renewal Fee	-	Not more than \$100
Renewal of License to Practice Medicine Fee	-	Not more than \$300
Duplicate Wallet License	-	Not more than \$20
Duplicate Wall Certificate	-	Not more than \$50
Volunteer License Application Fee	-	\$0
Volunteer License Renewal Fee	-	\$0

(3-20-20)T

**02. Administrative Fees for Services.** Administrative fees for services shall be billed on the basis of time and cost. (3-20-20)T

**101. -- 150. (RESERVED)**

**151. DEFINITIONS RELATING TO SUPERVISING AND DIRECTING PHYSICIANS.**

**01. Alternate Directing Physician.** A designated Idaho licensed physician, registered with the Board pursuant to this chapter and Title 54, Chapter 39, Idaho Code, who oversees the practice of athletic training and is responsible for the athletic training services provided by the athletic trainer in the temporary absence of the directing physician. (3-20-20)T

**02. Alternate Supervising Physician for Interns and Residents.** A physician licensed to practice medicine or licensed to practice osteopathic medicine in Idaho who has been designated by the supervising physician and approved by and registered by the Board to supervise the intern or resident in the temporary absence of the supervising physician. (3-20-20)T

**03. Alternate Supervising Physician of Medical Personnel.** An Idaho licensed physician who is registered with the Board pursuant to this chapter, who supervises and has full responsibility for cosmetic treatments using prescriptive medical/cosmetic devices and/or products provided by medical personnel in the temporary absence of the supervising physician. (3-20-20)T

**04. Athletic Trainer.** A person who has met the qualifications for licensure as set forth in Title 54, Chapter 39, Idaho Code, is licensed under that chapter, and carries out the practice of athletic training under the direction of a designated Idaho licensed physician, registered with the Board. (3-20-20)T

**05. Directing Physician.** A designated Idaho licensed physician, registered with the Board pursuant to this chapter and Title 54, Chapter 39, Idaho Code, who oversees the practice of athletic training and is responsible for the athletic training services provided by the athletic trainer. This chapter does not authorize the practice of medicine or any of its branches by a person not so licensed by the Board. (3-20-20)T

**06. Medical Personnel.** An individual who provides cosmetic treatments using prescriptive medical/cosmetic devices and products that are exclusively non-incisive or non-ablative under the direction and supervision of a supervising physician registered with the Board, pursuant to the applicable Idaho statutes and the applicable rules promulgated by the Board. (3-20-20)T

**07. Supervising Physician of Interns or Residents.** Any person approved by and registered with the Board who is licensed to practice medicine and surgery or osteopathic medicine and surgery in Idaho, who signs the application for registration of an intern or resident, and who is responsible for the direction and supervision of their

activities. (3-20-20)T

**08. Supervising Physician of Medical Personnel.** An Idaho licensed physician who is registered with the Board pursuant to this chapter, who supervises and has full responsibility for cosmetic treatments using prescriptive medical/cosmetic devices and products provided by medical personnel. (3-20-20)T

**152. – 160. (RESERVED)**

**161. DUTIES OF DIRECTING PHYSICIANS.**

**01. Responsibilities.** The directing physician accepts full responsibility for the acts and athletic training services provided by the athletic trainer and oversees the practice of athletic training of the athletic trainer, and for the supervision of such acts which include, but are not limited to: (3-20-20)T

**a.** An on-site visit at least semiannually to personally observe the quality of athletic training services provided; and (3-20-20)T

**b.** Recording of a periodic review of a representative sample of the records, including, but not limited to, records made from the past six (6) months of the review to evaluate the athletic training services that were provided. (3-20-20)T

**02. Scope of Practice.** The directing physician must ensure the scope of practice of the athletic trainer, as set forth in IDAPA 22.01.10, “Rules for the Licensure of Athletic Trainers to Practice in Idaho,” and Section 54-3903, Idaho Code, will be limited to and consistent with the scope of practice of the directing physician and exclude any independent practice of athletic training by an athletic trainer. (3-20-20)T

**03. Directing Responsibility.** The responsibilities and duties of a directing physician may not be transferred to a business entity, professional corporation, or partnership, nor may they be assigned to another physician without prior notification and Board approval. (3-20-20)T

**04. Available Supervision.** The directing physician will oversee the activities of the athletic trainer and must be available either in person or by telephone to supervise, direct, and counsel the athletic trainer. The scope and nature of the direction of the athletic trainer will be outlined in an athletic training service plan or protocol, as set forth in IDAPA 22.01.10, “Rules for the Licensure of Athletic Trainers to Practice in Idaho,” Section 012. (3-20-20)T

**05. Disclosure.** It is the responsibility of each directing physician to ensure that each athlete who receives athletic training services is aware of the fact that said person is not a licensed physician. This disclosure requirement can be fulfilled by the use of name tags, correspondence, oral statements, office signs, or such other procedures that under the involved circumstances adequately advise the athlete of the education and training of the person rendering athletic training services. (3-20-20)T

**162. DUTIES OF SUPERVISING PHYSICIANS.**

**01. Responsibilities.** The supervising physician accepts full responsibility for the medical acts of and patient services provided by physician assistants and graduate physician assistants and for the supervision of such acts which shall include, but are not limited to: (3-20-20)T

**a.** An on-site visit at least monthly to personally observe the quality of care provided; (3-20-20)T

**b.** A periodic review of a representative sample of medical records to evaluate the medical services that are provided. When applicable, this review will also include an evaluation of adherence to the delegation of services agreement between the physician and physician assistant or graduate physician assistant; and (3-20-20)T

**c.** Regularly scheduled conferences between the supervising physician and such licensees. (3-20-20)T

**02. Pre-Signed Prescriptions.** The supervising physician will not utilize or authorize the physician assistant to use any pre-signed prescriptions. (3-20-20)T



**03. Supervisory Responsibility.** A supervising physician or alternate supervising physician may not supervise more than four (4) physician assistants or graduate physician assistants contemporaneously. The Board, however, may authorize a supervising physician or alternate supervising physician to supervise a total of six (6) such licensees contemporaneously if necessary to provide adequate medical care and upon prior petition documenting adequate safeguards to protect the public health and safety. The responsibilities and duties of a supervising physician may not be transferred to a business entity, professional corporation, or partnership, nor may they be assigned to another physician without prior notification and Board approval. (3-20-20)T

**04. Available Supervision.** The supervising physician will oversee the activities of the physician assistant or graduate physician assistant, and must always be available either in person or by telephone to supervise, direct, and counsel such licensees. The scope and nature of the supervision of the physician assistant and graduate physician assistant must be outlined in a delegation of services agreement, as set forth in IDAPA 22.01.03, “Rules for the Licensure of Physician Assistants,” Subsection 030.04. (3-20-20)T

**05. Disclosure.** It is the responsibility of each supervising physician to ensure that each patient who receives the services of a physician assistant or graduate physician assistant is aware of the fact that said person is not a licensed physician. This disclosure requirement can be fulfilled by the use of nametags, correspondence, oral statements, office signs, or such other procedures that under the involved circumstances adequately advise the patient of the education and training of the person rendering medical services. (3-20-20)T

**163. DUTIES OF SUPERVISING PHYSICIANS OF INTERNS AND RESIDENTS.**

**01. Responsibilities.** The supervising physician is responsible for the direction and supervision of the medical acts and patient services provided by an intern or resident. The direction and supervision of such activities include, but are not limited to: (3-20-20)T

- a. An on-site visit at least monthly to personally observe the quality of care provided; (3-20-20)T
- b. Recording of a periodic review of a representative sample of medical records to evaluate the medical services that are provided; and (3-20-20)T
- c. Regularly scheduled conferences between the supervising physician and the intern or resident. (3-20-20)T

**02. Available Supervision.** The supervising physician will oversee the activities of the intern or resident, and must always be available either in person or by telephone to supervise, direct and counsel the intern or resident. (3-20-20)T

**03. Disclosure.** It is the responsibility of each supervising physician to ensure that each patient who receives the services of an intern or resident is aware of the fact that said person is not a licensed physician. This disclosure requirement can be fulfilled by the use of nametags, correspondence, oral statements, office signs, or such other procedures that under the involved circumstances adequately advise the patient of the education and training of the person rendering medical services. (3-20-20)T

**164. SUPERVISING PHYSICIANS OF MEDICAL PERSONNEL.**

Prescriptive medical/cosmetic devices and products penetrate and alter human tissue and can result in complications such as visual impairment, blindness, inflammation, burns, scarring, hypopigmentation, and hyperpigmentation. Cosmetic treatments using such prescriptive medical/cosmetic devices and products is the practice of medicine as defined in Section 54-1803(1), Idaho Code. This chapter does not authorize the practice of medicine or any of its branches by a person not so licensed by the Board. (3-20-20)T

**01. Definitions.** (3-20-20)T

- a. Ablative. Ablative is the separation, eradication, removal, or destruction of human tissue. (3-20-20)T

- b.** Incisive. Incisive is the power and quality of cutting of human tissue. (3-20-20)T
- c.** Cosmetic Treatment. An aesthetic treatment prescribed by a physician for a patient that uses prescriptive medical/cosmetic devices and products to alter human tissue. (3-20-20)T
- d.** Prescriptive Medical/Cosmetic Device. A federal food and drug administration approved prescriptive device that uses waveform energy including, but not limited to, intense pulsed light or lasers, to cosmetically alter human tissue. (3-20-20)T
- e.** Prescriptive Medical/Cosmetic Product. A federal food and drug administration approved prescriptive product whose primary intended use of the product is achieved through chemical action and cosmetically alters human tissue including, but not limited to, filler substances such as collagen or fat; lipo transfer; muscle immobilizers or sclerosing agents. (3-20-20)T

**02. Duties and Responsibilities of Supervising Physicians.** The supervising physician accepts full responsibility for cosmetic treatments provided by medical personnel using prescriptive medical/cosmetic devices and products and for the supervision of such treatments. The supervising physician must be trained in the safety and use of prescriptive medical/cosmetic devices and products. (3-20-20)T

**a.** Patient Record. The supervising physician must document an adequate legible patient record of his evaluation and assessment of the patient prior to the initial cosmetic treatment. An adequate patient record must contain, at minimum, subjective information, an evaluation and report of objective findings, assessment or diagnosis, and the plan of care including, but not limited to, a prescription for prescriptive medical/cosmetic devices and products. (3-20-20)T

**b.** Supervisory Responsibility. A supervising physician or alternate supervising physician of medical personnel may not supervise more than three (3) such medical personnel contemporaneously. The Board, however, may authorize a supervising physician or alternate supervising physician to supervise a total of six (6) such medical personnel contemporaneously if necessary to provide adequate cosmetic treatments and upon prior petition documenting adequate safeguards to protect the public health and safety. The responsibilities and duties of a supervising physician may not be transferred to a business entity, professional corporation or partnership, nor may they be assigned to another physician without prior notification and Board approval. (3-20-20)T

**c.** Available Supervision. The supervising physician will be on-site or immediately available to respond promptly to any questions or problems that may occur while a cosmetic treatment is being performed by medical personnel using prescriptive medical/cosmetic devices and products. Such supervision includes, but is not limited to: (3-20-20)T

**i.** Periodic review of the medical records to evaluate the prescribed cosmetic treatments that are provided by such medical personnel including any adverse outcomes or changes in the treatment protocol; and (3-20-20)T

**ii.** Regularly scheduled conferences between the supervising physician and such medical personnel. (3-20-20)T

**d.** Scope of Cosmetic Treatments. Medical personnel providing cosmetic treatments are limited to using prescriptive medical/cosmetic devices and products that are exclusively non-incisive and non-ablative. The supervising physician will ensure cosmetic treatments using prescriptive medical/cosmetic devices and products provided by medical personnel are limited to and consistent with the scope of practice of the supervising physician. The supervising physician will ensure medical personnel do not independently provide cosmetic treatments using prescriptive medical/cosmetic devices and products. (3-20-20)T

**i.** The supervising physician will ensure that, with respect to each procedure performed, the medical personnel possess the proper training in cutaneous medicine, the indications for the prescribed treatment, and the pre- and post-procedure care involved; and (3-20-20)T

**ii.** The supervising physician will prepare a written protocol for medical personnel to follow when

using prescriptive medical/cosmetic devices and products. The supervising physician is responsible for ensuring that the medical personnel use prescriptive medical/cosmetic devices and products only in accordance with the written protocol and do not exercise independent judgment when using prescriptive medical/cosmetic devices and products.

(3-20-20)T

**e.** Training Requirements. Medical personnel who provide cosmetic treatments using prescriptive medical/cosmetic devices and products must have training and be certified by their supervising physicians on each device or product they will use. The training on each device or product includes the following:

(3-20-20)T

i. Physics and safety of the prescriptive medical/cosmetic devices and products;

(3-20-20)T

ii. Basic principle of the planned procedure and treatment;

(3-20-20)T

iii. Clinical application of the prescriptive medical/cosmetic devices and products including, but not limited to, wavelengths to be used with intense pulsed light/lasers;

(3-20-20)T

iv. Indications and contraindications for the use of the prescriptive medical/cosmetic devices and products;

(3-20-20)T

v. Pre-procedure and post-procedure care;

(3-20-20)T

vi. Recognition and acute management of complications that may result from the procedure or treatment; and

(3-20-20)T

vii. Infectious disease control procedures required for each treatment.

(3-20-20)T

viii. The supervising physician will assure compliance with the training and reporting requirements of this rule.

(3-20-20)T

ix. The supervising physician will submit verification of training upon the Medical Personnel Supervising Physician Registration form provided by the Board, to the Board for approval prior to the provision of cosmetic treatments using prescriptive medical/cosmetic devices and products by medical personnel. The Board may require the supervising physician to provide additional written information, which may include his affidavit attesting to the medical personnel's qualifications and clinical abilities to perform cosmetic treatments using prescriptive medical/cosmetic devices and products. The Medical Personnel Supervising Physician Registration Form will be sent to the Board and maintained on file at each practice location and at the address of record of the supervising physician. The Board may require such changes as needed to achieve compliance with this chapter and Title 54, Chapter 18, Idaho Code, and to safeguard the public.

(3-20-20)T

**f.** Disclosure. It is the responsibility of each supervising physician to ensure that every patient receiving a cosmetic treatment using prescriptive medical/cosmetic devices and products by such medical personnel is aware of the fact that such medical personnel are not licensed physicians. This disclosure requirement can be fulfilled by the use of name tags, correspondence, oral statements, office signs, or such other procedures that under the involved circumstances adequately advise the patient of the education and training of the medical personnel rendering such cosmetic treatments.

(3-20-20)T

**g.** Patient Complaints. The supervising physician will report to the Board of Medicine all patient complaints received against medical personnel that relate to the quality and nature of cosmetic treatments rendered.

(3-20-20)T

**h.** Duties and Responsibilities Nontransferable. The responsibilities and duties of a supervising physician may not be transferred to a business entity, professional corporation, or partnership, nor may they be assigned to another physician or person.

(3-20-20)T

**165. -- 200. (RESERVED)**

**201. REGISTRATION BY SUPERVISING AND DIRECTING PHYSICIANS.**

**01. Registration and Renewal.** Each supervising, directing, and alternate physician must register with the Board and such registration will be renewed annually. (3-20-20)T

**02. Notification.** The supervising and directing physician must notify the Board of any change in the status of any physician assistant, graduate physician assistant, athletic trainer, or medical personnel for whom he is responsible, including, but not limited to, changes in location, duties, responsibilities, or supervision, or termination of employment within thirty (30) days of such event. (3-20-20)T

**202. -- 239. (RESERVED)**

**240. FEES - TABLE.**

Nonrefundable fees are as follows:

<b>Fees -- Table (Non-Refundable)</b>	
Supervising Physician Registration Fee	- Not more than \$50
Annual Renewal of Supervising Physician Registration Fee	- Not more than \$25
Directing Physician Registration Fee	- Not more than \$50
Annual Renewal of Directing Physician Registration Fee	- Not more than \$25
Alternate supervising physicians and alternate directing physicians are not required to pay an annual fee.	

(3-20-20)T

**241. (RESERVED)**

**242. DEFINITIONS RELATED TO INTERNS AND RESIDENTS.**

**01. Acceptable Training Program.** A medical training program or course of medical study that has been approved by the Liaison Committee for Medical Education (LCME), Council on Medical Education or Commission on Osteopathic College Accreditation (COCA) of the American Osteopathic Association (AOA). (3-20-20)T

**02. Acceptable Post Graduate Training Program.** A post graduate medical training program or course of medical study that has been approved by the Accreditation Council for Graduate Medical Education (ACGME) or American Osteopathic Association (AOA). (3-20-20)T

**243. RESIDENT AND INTERN REGISTRATION.**

**01. Registration Certificate.** Upon approval of the registration application, the Board may issue a registration certificate that sets forth the period during which the registrant may engage in activities that may involve the practice of medicine. Each registration will be issued for a period of not less than one (1) year and will set forth its expiration date on the face of the certificate. Each registration will identify the supervising physician. Each registrant will notify the Board in writing of any change of the supervising physician or the program or course of study fourteen (14) days prior to any such change. If the Board deems the intern or resident qualified, and if the course study requires, the Board may additionally certify on the registration certificate that the intern or resident is qualified to write prescriptions for Class III through Class V scheduled medications. (3-20-20)T

**02. Termination of Registration.** The registration of an intern or resident may be terminated, suspended, or made conditional by the Board on the grounds set forth in Section 54-1814, Idaho Code, and under the procedures set forth in Section 54-1806A, Idaho Code. (3-20-20)T

**03. Annual Renewal of Registration.** Each registration must be renewed annually prior to its expiration date. Any registration not renewed by its expiration date will be canceled. (3-20-20)T

**04. Notification of Change.** Each registrant must notify the Board in writing of any adverse action or termination, whatever the outcome, from any post graduate training program and any name changes within fourteen (14) days of such event. (3-20-20)T

**05. Disclosure.** It is the responsibility of each registrant to ensure that every patient is aware of the fact that such intern and resident is currently enrolled in a post graduate training program and under the supervision of a licensed physician. This disclosure requirement can be fulfilled by the use of name tags, correspondence, oral statements, or such other procedures that under the circumstances adequately advise the patient of the education and training of the intern and resident. (3-20-20)T

**244. FEES - TABLE.**  
Nonrefundable fees are as follows:

<b>Fees -- Table</b>	
Resident and Intern Registration Fee	- Not more than \$25
Registration Annual Renewal Fee	- Not more than \$25

(3-20-20)T

**245. -- 999. (RESERVED)**

## 22.01.03 – RULES FOR THE LICENSURE OF PHYSICIAN ASSISTANTS

### 000. LEGAL AUTHORITY.

Pursuant to Section 54-1806(2), Idaho Code, the Idaho State Board of Medicine is authorized to promulgate rules to govern activities of persons licensed under these rules to practice as physician assistants and graduate physician assistants under the supervision of persons licensed to practice medicine or osteopathic medicine in Idaho.

(3-20-20)T

### 001. TITLE AND SCOPE.

01. **Title.** These rules are titled IDAPA 22.01.03, “Rules for the Licensure of Physician Assistants.”

(3-20-20)T

02. **Scope.** Pursuant to Idaho Code, Section 54-1807A(1), physician assistants and graduate physician assistants must be licensed with the Board prior to commencement of activities.

(3-20-20)T

### 002. -- 009. (RESERVED)

### 010. DEFINITIONS.

01. **Approved Program.** A course of study for the education and training of physician assistants that is accredited by the Accreditation Review Commission on Education for Physician Assistants (ARC-PA) or predecessor agency or equivalent agency recognized by the Board as recommended by the Committee.

(3-20-20)T

02. **Delegation of Services (DOS) Agreement.** An agreement on a Board-approved form signed and dated by the licensed physician assistant or graduate physician assistant and supervising and alternate supervising physician that defines the working relationship and delegation of duties between the supervising physician and the licensee as specified by Board rule.

(3-20-20)T

03. **Supervision.** The direction and oversight of the activities of and patient services provided by a physician assistant or graduate physician assistant by a supervising physician or alternate supervising physician who accepts full medical responsibility with respect thereto. The constant physical presence of the supervising or alternate supervising physician is not required as long as the supervisor and such licensee are or can be easily in contact with one another by radio, telephone, or other telecommunication device. The scope and nature of the supervision will be outlined in a delegation of services agreement, as defined in Subsection 030.04 of these rules.

(3-20-20)T

### 011. -- 019. (RESERVED)

### 020. REQUIREMENTS FOR LICENSURE.

Requirements for licensure and renewal are found in Title 54, Chapter 18, Idaho Code, IDAPA 22.01.05, and on Board-approved forms.

(3-20-20)T

### 021. -- 027. (RESERVED)

### 028. SCOPE OF PRACTICE.

01. **Scope.** The scope of practice of physician assistants and graduate physician assistants is generally defined in the delegation of services and may include a broad range of diagnostic, therapeutic and health promotion and disease prevention services.

(3-20-20)T

a. The scope of practice includes only those duties and responsibilities delegated to the licensee by their supervising and alternate supervising physician and in accordance with the delegation of services agreement and consistent with the expertise and regular scope of practice of the supervising and alternate supervising physician.

(3-20-20)T

b. The scope of practice may include prescribing, administering, and dispensing of medical devices and drugs, including the administration of a local anesthetic injected subcutaneously, digital blocks, or the application of topical anesthetics, while working under the supervision of a licensed medical physician.

(3-20-20)T

c. Physician assistants and graduate physician assistants are agents of their supervising and alternate supervising physician in the performance of all practice-related activities and patient services.

(3-20-20)T

d. A supervising physician or alternate supervising physician will each supervise no more than a total

of four (4) physician assistants or graduate physician assistants contemporaneously. (3-20-20)T

e. The Board, however, may authorize a supervising physician to supervise a total of six (6) such licensees contemporaneously if necessary to provide adequate medical care and upon prior petition documenting adequate safeguards to protect the public health and safety. (3-20-20)T

**029. CONTINUING EDUCATION REQUIREMENTS.**

Requirements for Renewal. Prior to renewal of each license as set forth by the expiration date on the face of the certificate, physician assistants shall attest to maintenance of certification by the National Commission on Certification of Physician Assistants or similar certifying agency approved by the Board, which certification requires a minimum of one hundred (100) hours of continuing medical education over a two-year (2) period. (3-20-20)T

**030. PRACTICE STANDARDS.**

**01. Identification.** The physician assistant or graduate physician assistant will at all times when on duty wear a placard or plate so identifying himself. (3-20-20)T

**02. Advertise.** No physician assistant or graduate physician assistant may advertise or represent himself either directly or indirectly, as a physician. (3-20-20)T

**03. Supervising Physician.** Each licensed physician assistant and graduate physician assistant will have a Board-approved supervising physician prior to practice. (3-20-20)T

**04. Delegation of Services Agreement.** Each licensed physician assistant and graduate physician assistant must maintain a current, completed copy of a Delegation of Services (DOS) Agreement between the licensee and each of his supervising and alternate supervising physicians. This agreement must be sent to the Board and be maintained on file at each practice location and at the address of record of the supervising and alternate supervising physician. (3-20-20)T

**05. Notification of Change or Addition of Supervising or Alternate Supervising Physician.** A physician assistant or graduate physician assistant must notify the Board when adding, changing, or deleting a supervising physician or alternate supervising physician. (3-20-20)T

**031. PARTICIPATION IN DISASTER AND EMERGENCY CARE.**

A physician assistant or graduate physician assistant licensed in this state or licensed or authorized to practice in any other state of the United States or currently credentialed to practice by a federal employer who is responding to a need for patient services created by an emergency or a state or local disaster (not to be defined as an emergency situation which occurs in the place of one's employment) may render such patient services that they are able to provide without supervision as it is defined in this chapter, or with such supervision as is available. Any physician who supervises a physician assistant or graduate physician assistant providing patient services in response to such an emergency or state or local disaster will not be required to meet the requirements set forth in this chapter for a supervising physician. (3-20-20)T

**032. -- 035. (RESERVED)**

**036. GRADUATE PHYSICIAN ASSISTANT.**

**01. Licensure Prior to Certification Examination -- Board Consideration.** Any person who has graduated from an approved physician assistant training program and meets all Idaho requirements, including achieving a college baccalaureate degree, but has not yet taken and passed the certification examination, may be considered by the Board for licensure as a graduate physician assistant for six (6) months when an application for licensure as a graduate physician assistant has been submitted to the Board on forms supplied by the Board and payment of the prescribed fee, provided: (3-20-20)T

a. The applicant will submit to the Board, within ten (10) business days of receipt, a copy of acknowledgment of sitting for the national certification examination. The applicant will submit to the Board, within ten (10) business days of receipt, a copy of the national certification examination results. (3-20-20)T

**b.** After the graduate physician assistant has passed the certification examination, the Board will receive verification of national certification directly from the certifying entity. Once the verification is received by the Board, the graduate physician assistant’s license will be converted to a permanent license and he may apply for prescribing authority pursuant to Section 042 of these rules. (3-20-20)T

**c.** The applicant who has failed the certification examination one (1) time, may petition the Board for a one-time extension of his graduate physician assistant license for an additional six (6) months. (3-20-20)T

**d.** If the graduate physician assistant fails to pass the certifying examination on two (2) separate occasions, the graduate physician assistant’s license will automatically be canceled upon receipt of the second failing certification examination score. (3-20-20)T

**e.** The graduate physician assistant applicant will agree to execute an authorization for the release of information, attached to his application as Exhibit A, authorizing the Board or its designated agents, having information relevant to the application, including but not limited to the status of the certification examination, to release such information, as necessary, to his supervising physician. (3-20-20)T

**02. Licensure Prior to College Baccalaureate Degree -- Board Consideration.** Licensure as a graduate physician assistant may also be considered upon application made to the Board on forms supplied by the Board and payment of the prescribed fee when all application requirements have been met as set forth in Section 020 of these rules, except receipt of documentation of a college baccalaureate degree, provided: (3-20-20)T

**a.** A college baccalaureate degree from a nationally accredited school with a curriculum approved by the United States Secretary of Education, the Council for Higher Education Accreditation, or both, or from a school accredited by another such agency approved by the Board shall be completed within five (5) years of initial licensure in Idaho; (3-20-20)T

**03. No Prescribing Authority.** Graduate physician assistants shall not be entitled to issue any written or oral prescriptions unless granted an exemption by the Board. Application for an exemption must be in writing and accompany documentation of a minimum of five (5) years of recent practice as a physician assistant in another state. (3-20-20)T

**04. Weekly Record Review.** Graduate physician assistants must have a weekly record review by their supervising physician, unless subject to an exemption as granted in Subsection 036.03. (3-20-20)T

**037. -- 041. (RESERVED)**

**042. PRESCRIPTION WRITING.** Approval and Authorization Required. A physician assistant may issue written or oral prescriptions for legend drugs and controlled drugs, Schedule II through V only in accordance with the current delegation of services agreement and applicable federal and state law, and any prescriptive practice will be consistent with the regular prescriptive practice of the supervising or alternate supervising physician. (3-20-20)T

**043. -- 050. (RESERVED)**

**051. FEES - TABLE.**  
Nonrefundable fees are as follows:

<b>Fees -- Table (Non-Refundable)</b>	
Licensure Fee - Physician Assistant & Graduate Physician Assistant	- Not more than \$250
Annual License Renewal Fee	- Not more than \$150
Reinstatement Fee	- \$50 plus past renewal fees
Reinstatement Fee for Graduate Physician Assistant	- Not more than \$100



<b>Fees -- Table (Non-Refundable)</b>	
Inactive License Fee	- Not more than \$150
Annual Renewal of Inactive License Fee	- Not more than \$100
Inactive Conversion Fee	- Not more than \$150

(3-20-20)T

**052. -- 999. (RESERVED)**

## 22.01.07 – RULES FOR THE LICENSURE OF NATUROPATHIC MEDICAL DOCTORS

### 000. LEGAL AUTHORITY.

Pursuant to Section 54-5104(2), Idaho Code, the Idaho State Board of Medicine is authorized to promulgate rules to implement provisions of the Naturopathic Medicine Act. (3-20-20)T

### 001. TITLE AND SCOPE.

These rules are titled IDAPA 22.01.07, “Rules for the Licensure of Naturopathic Medical Doctors,” and governs the licensure, scope of practice, and discipline of the Naturopathic Medical Doctors. (3-20-20)T

### 002. – 009. (RESERVED)

### 010. DEFINITIONS.

**01. Council on Naturopathic Medical Education (CNME).** The accrediting organization that is recognized by the United States Department of Education as the accrediting agency for education programs that prepare naturopathic medical doctors. (3-20-20)T

**02. North American Board of Naturopathic Examiners (NABNE).** The independent, nonprofit organization that qualifies applicants to take the Naturopathic Physicians Licensing Exam and submits those results to the regulatory authority. (3-20-20)T

**03. Naturopathic Physicians Licensing Exam (NPLEX).** The board examination for naturopathic medical doctors. (3-20-20)T

**04. Naturopathic Medical Doctor.** A person who meets the definition in Section 54-5101(5), Idaho Code. Licensed naturopathic physician, physician of naturopathic medicine, naturopathic medical doctor and NMD are interchangeable terms. (3-20-20)T

**05. Primary Care.** Comprehensive first contact and/or continuing care for persons with any sign, symptom, or health concern not limited by problem of origin, organ system, or diagnosis. It includes health promotion, disease prevention, health maintenance, counseling, patient education, diagnosis and treatment of acute and chronic illness. It includes collaborating with other health professionals and utilizing consultation or referral as appropriate. (3-20-20)T

### 011. – 019. (RESERVED)

### 020. GENERAL QUALIFICATIONS FOR LICENSURE.

Requirements for licensure and renewal are found in Title 54, Chapter 51, Idaho Code, IDAPA 22.01.05, “General Provisions of the Board of Medicine,” and on Board-approved forms. (3-20-20)T

### 021. APPLICATION FOR LICENSURE.

**01. Application.** Each applicant for licensure will submit a completed written application to the Board on forms prescribed by the Board, together with the nonrefundable application fee. (3-20-20)T

**02. Licensing Examinations.** Each applicant must provide certification of passing the following four (4) NPLEX exams: (3-20-20)T

a. Part I Biomedical Science; (3-20-20)T

b. Part II Core Clinical Science; (3-20-20)T

c. Part II Clinical Elective Minor Surgery; and (3-20-20)T

d. Part II Clinical Elective Pharmacology. (3-20-20)T

### 022. AUTHORITY TO PRESCRIBE, DISPENSE, ADMINISTER, AND ORDER.

Naturopathic medical doctors are allowed to prescribe, dispense, administer, and order the following: (3-20-20)T

**01. Laboratory and Diagnostic Procedures.** Naturopathic medical doctors licensed under this chapter may perform and order physical examinations, laboratory tests, imaging, and other diagnostic tests consistent with primary care. (3-20-20)T

**a.** All examinations, laboratory, and imaging tests not consistent with primary care must be referred to an appropriately licensed health care professional for treatment and interpretation. (3-20-20)T

**b.** Any test result or lesion suspicious of malignancy must be referred to the appropriate physician licensed pursuant to Chapter 18, Title 54 Idaho Code. (3-20-20)T

**02 Naturopathic Formulary.** The formulary for naturopathic medical doctors licensed under this chapter consists of non-controlled legend medications (excluding testosterone) deemed appropriate for the primary health care of patients within the scope of practice and training of each naturopathic medical doctor. Prescribing pursuant to the Naturopathic Formulary shall be according to the standard of health care provided by other qualified naturopathic medical doctors in the same community or similar communities, taking into account their training, experience and the degree of expertise to which they hold themselves out to the public. (3-20-20)T

**03. Formulary Exclusions.** The naturopathic formulary does not include: (3-20-20)T

**a.** Scheduled, controlled drugs, except for testosterone used in physiologic doses with regular lab assessment for hormone replacement therapy, gender dysphoria, or hypogonadism; (3-20-20)T

**b.** General anesthetics; (3-20-20)T

**c.** Blood derivatives except for platelet rich plasma; or (3-20-20)T

**d.** Systemic antineoplastic agents, except for the following antineoplastic agents used orally or topically for non-cancer purposes: (3-20-20)T

i. Fluorouracil (5FU); (3-20-20)T

ii. Anastrozole; and (3-20-20)T

iii. Letrozole. (3-20-20)T

**023. – 031. (RESERVED)**

**032. GROUNDS FOR DISCIPLINE OR DENIAL OF A LICENSE.**

In addition to statutory grounds for discipline set forth in Section 54-5109, Idaho Code, every person licensed as a naturopathic medical doctor is subject to discipline by the Board under the following grounds: (3-20-20)T

**01. Ability to Practice.** Demonstrating a manifest incapacity to carry out the functions of the licensee's ability to practice naturopathic medicine or deemed unfit by the Board to practice naturopathic medicine; (3-20-20)T

**02. Controlled Substance or Alcohol Abuse.** Using any controlled substance or alcohol in a manner which has or may have a direct and adverse bearing on the licensee's ability to practice naturopathic medicine with reasonable skill and safety; (3-20-20)T

**03. Education or Experience.** Misrepresenting educational or experience attainments; (3-20-20)T

**04. Medical Records.** Failing to maintain adequate naturopathic medical records. Adequate naturopathic medical records mean legible records that contain subjective information, an evaluation or report of objective findings, assessment or diagnosis, and the plan of care; (3-20-20)T

**05. Untrained Practice.** Practicing in an area of naturopathic medicine for which the licensee is not trained; (3-20-20)T

**06. Sexual Misconduct.** Committing any act of sexual contact, misconduct, exploitation, or intercourse with a patient or former patient or related to the licensee's practice of naturopathic medicine; (3-20-20)T

- a. Consent of the patient shall not be a defense. (3-20-20)T
  - b. Subsection 032.06 does not apply to sexual contact between a naturopathic medical doctor and the naturopathic medical doctor’s spouse or a person in a domestic relationship who is also a patient. (3-20-20)T
  - c. A former patient includes a patient for whom the naturopathic medical doctor has provided naturopathic medical services within the last twelve (12) months. Sexual or romantic relationships with former patients beyond that period of time may also be a violation if the naturopathic medical doctor uses or exploits the trust, knowledge, emotions, or influence derived from the prior professional relationship with the patient. (3-20-20)T
- 07. Failure to Report.** Failing to report to the Board any known act or omission of a licensee, applicant, or any other person, that violates any of the rules promulgated by the Board under the authority of the act; (3-20-20)T
- 08. Interfering with or Influencing Disciplinary Outcome.** Interfering with an investigation or disciplinary proceeding by willful misrepresentation of facts or by use of threats or harassment against any patient, Board or naturopathic medical board, Board staff, hearing officer, or witness in an attempt to influence the outcome of a disciplinary proceeding, investigation or other legal action; (3-20-20)T
- 09. Failure to Obey Laws and Rules.** Failing to obey federal and local laws and rules governing the practice of naturopathic medicine. (3-20-20)T

**033. CONTINUING MEDICAL EDUCATION (CME) REQUIREMENTS.**

- 01. Renewal.** Every two (2) years, a total of forty-eight (48) hours (twenty (20) of which is pharmacology) of Board-approved CME is required as part of the naturopathic medical doctor’s license renewal. (3-20-20)T
- 02. Verification of Compliance.** Licensees must, at license renewal, provide a signed statement to the Board indicating compliance. The Board, in its discretion, may require such additional evidence as it deems necessary to verify compliance. (3-20-20)T

**034. – 040. (RESERVED)**

**041. FEES.**  
Nonrefundable fees are shown in the following table:

<b>Fees -- Table (Non-Refundable)</b>	
Licensure Fee	Not more than \$600
Annual License Renewal Fee	Not more than \$300
Reinstatement Fee	Not more than \$200
Inactive License Renewal Fee	Not more than \$100
Duplicate Wallet License Fee	Not more than \$20
Duplicate Wall Certificate Fee	Not more than \$50

(3-20-20)T

**042. – 999. (RESERVED)**

## 22.01.10 – RULES FOR THE LICENSURE OF ATHLETIC TRAINERS TO PRACTICE IN IDAHO

### 000. LEGAL AUTHORITY.

Pursuant to Section 54-3914(2), Idaho Code, the Idaho State Board of Medicine is authorized to promulgate rules to govern the practice of athletic trainers. (3-20-20)T

### 001. TITLE AND SCOPE.

**01. Title.** These rules are titled IDAPA 22.01.10, “Rules for the Licensure of Athletic Trainers to Practice in Idaho.” (3-20-20)T

**02. Scope.** Pursuant to this chapter and Idaho Code, Section 54-3904, athletic trainers must be licensed with the Board prior to commencement of activities related to athletic training. (3-20-20)T

### 002. -- 009. (RESERVED)

### 010. DEFINITIONS.

**01. Actively Engaged.** A person who is employed in Idaho on a remuneration basis by an educational or health care institution, professional, amateur, or recreational sports club, or other bona fide athletic organization and is involved in athletic training as a responsibility of his employment. (3-20-20)T

**02. Association.** The Idaho Athletic Trainers’ Association. (3-20-20)T

**03. Athletic Training Service Plan or Protocol.** A written document, made upon a form provided by the Board, mutually agreed upon, signed and dated by the athletic trainer and directing physician that defines the athletic training services to be provided by the athletic trainer. The Board may review athletic training service plans or protocols, job descriptions, policy statements, or other documents that define the responsibilities of the athletic trainer in the practice setting, and may require such changes as needed to achieve compliance with this chapter and Title 54, Chapter 39, Idaho Code, and to safeguard the public. The Board of Chiropractic Physicians may review those athletic training service plans or protocols or other documents that define the responsibilities of the athletic trainer for those athletic trainers whose directing physicians are chiropractic physicians. (3-20-20)T

### 011. SCOPE OF PRACTICE.

**01. Referral by Directing Physician.** An athletic injury not incurred in association with an educational institution, professional, amateur, or recreational sports club or organization must be referred by a directing physician, but only after such directing physician has first evaluated the athlete. An athletic trainer treating or evaluating an athlete with an athletic injury incurred in association with an amateur or recreational sports club or organization will especially consider the need for a directing physician to subsequently evaluate the athlete and refer for further athletic training services. (3-20-20)T

**02. Limitations of Scope of Practice.** The scope of practice of the athletic trainer, as set forth in this chapter and Section 54-3903, Idaho Code, shall be limited to and consistent with the scope of practice of his directing physician. (3-20-20)T

**03. Identification.** The athletic trainer will at all times when on duty identify himself as an athletic trainer. (3-20-20)T

### 012. ATHLETIC TRAINING SERVICE PLAN OR PROTOCOL.

Each licensed athletic trainer providing athletic training services will create, upon a form provided by the Board, an athletic training service plan or protocol with his directing physician. This athletic training service plan or protocol must be reviewed and updated on an annual basis. Each licensed athletic trainer must notify the Board within thirty (30) days of any change in the status of his directing physician. This plan or protocol will not be sent to the Board, but must be maintained on file at each location in which the athletic trainer is practicing. The Board may review athletic training service plans or protocols, job descriptions, policy statements, or other documents that define the responsibilities of the athletic trainer in the practice setting, and may require such changes as needed to achieve compliance with this chapter, Title 54, Chapter 39, Idaho Code, and to safeguard the public. This plan or protocol will be made immediately available to the Board upon request. This plan or protocol will be made immediately available to the Board of Chiropractic Physicians upon request for those athletic trainers whose directing physicians are chiropractic physicians. This plan or protocol will include: (3-20-20)T

**01. Listing of Services and Activities.** A listing of the athletic training services to be provided and

specific activities to be performed by the athletic trainer. (3-20-20)T

**02. Locations and Facilities.** The specific locations and facilities in which the athletic trainer will function; and (3-20-20)T

**03. Methods to be Used.** The methods to be used to ensure responsible direction and control of the activities of the athletic trainer, which will provide for the: (3-20-20)T

a. Recording of an on-site visit by the directing physician at least semiannually or every semester; (3-20-20)T

b. Availability of the directing physician to the athletic trainer in person or by telephone and procedures for providing direction for the athletic trainer in emergency situations; and (3-20-20)T

c. Procedures for addressing situations outside the scope of practice of the athletic trainer. (3-20-20)T

**013. -- 019. (RESERVED)**

**020. GENERAL QUALIFICATIONS FOR LICENSURE AND RENEWAL.**

Requirements for licensure and renewal are found in Title 54, Chapter 39, Idaho Code, IDAPA 22.01.05, and on Board-approved forms. (3-20-20)T

**021. -- 029. (RESERVED)**

**030. APPLICATION FOR LICENSURE.**

**01. Application for Provisional Licensure.** (3-20-20)T

a. The Board, based upon the recommendation of the Board of Athletic Trainers, may issue provisional licensure to applicants who have successfully completed a bachelor's or advanced degree from an accredited four (4) year college or university, and met the minimum athletic training curriculum requirement established by the Board as recommended by the Board of Athletic Trainers and who have met all the other requirements set forth by Section 020 of these rules but who have not yet passed the examination conducted by the National Athletic Trainers' Association Board of Certification or a nationally recognized credentialing agency, approved by the Board as recommended by the Board of Athletic Trainers. (3-20-20)T

b. Each applicant for provisional licensure will submit a completed written application to the Board on forms prescribed by the Board, together with the application fee. The application shall be verified, under oath, and include an affidavit signed by an Idaho licensed athletic trainer affirming and attesting to supervise and be responsible for the athletic training services of the provisionally licensed athletic trainer and to review and countersign all records and documentation of services performed by the provisionally licensed athletic trainer. (3-20-20)T

ii. Supervision. A provisionally licensed graduate athletic trainer must be in direct association with his directing physician and Idaho licensed athletic trainer who will supervise and be available to render direction in person and on the premises where the athletic training services are being provided. The directing physician and the supervising athletic trainer is responsible for the athletic training services provided by the provisionally licensed graduate athletic trainer. The extent of communication between the directing physician and supervising athletic trainer and the provisionally licensed athletic trainer is determined by the competency of the provisionally licensed athletic trainer and the practice setting and the type of athletic training services being rendered. (3-20-20)T

c. Scope of Practice. The scope of practice of the provisionally licensed athletic trainer, as set forth in this chapter and Section 54-3903, Idaho Code, is limited to and consistent with the scope of practice of his directing physician and supervising athletic trainer and conform with the established athletic training service plan or protocol. (3-20-20)T

d. Expiration of Provisional License. All provisional licenses for athletic trainers will expire upon

meeting the minimum athletic training curriculum requirement established by the Board as recommended by the Board of Athletic Trainers and meeting all the other requirements set forth by Section 020 of these rules, including passing the certification examination conducted by the National Athletic Trainers' Association Board of Certification or a nationally recognized credentialing agency, approved by the Board as recommended by the Board of Athletic Trainers. (3-20-20)T

**031. -- 051. (RESERVED)**

**052. DENIAL OR REFUSAL TO RENEW LICENSURE OR SUSPENSION OR REVOCATION OF LICENSURE.**

**01. Application or Renewal Denial.** A new or renewal application for licensure may be denied by the Board and shall be considered a contested case. Every person licensed pursuant to Title 54, Chapter 39, Idaho Code and these rules is subject to discipline pursuant to the procedures and powers established by and set forth in Section 54-3911, Idaho Code, and the Idaho Administrative Procedure Act. (3-20-20)T

**02. Petitions for Reconsideration of Denial.** All petitions for reconsideration of a denial of a license application or reinstatement application shall be made to the Board within one (1) year from the date of the denial. (3-20-20)T

**053. -- 060. (RESERVED)**

**061. FEES -- TABLE.**

Nonrefundable fees are as follows:

<b>Fees -- Table (Non-Refundable)</b>	
Athletic Trainer Licensure Fee	- Not more than \$240
Athletic Trainer Annual Renewal Fee	- Not more than \$160
Directing Physician Registration Fee	- Not more than \$50
Annual Renewal of Directing Physician Registration Fee	- Not more than \$25
Alternate Directing Physician Registration/Renewal Fee	- \$0
Provisional Licensure Fee	- Not more than \$80
Annual Renewal of Provisional License Fee	- Not more than \$40
Inactive License Renewal Fee	- Not more than \$80
Reinstatement Fee	- Not more than \$50 plus unpaid renewal fees

(3-20-20)T

**062. -- 999. (RESERVED)**

**22.01.11 – RULES FOR LICENSURE OF RESPIRATORY THERAPISTS AND  
PERMITTING OF POLYSOMNOGRAPHERS IN IDAHO**

**000. LEGAL AUTHORITY.**

Pursuant to Sections 54-4304A, 54-4305, 54-4309, 54-4310, 54-4311, 54-4312 and 54-4316, Idaho Code, the Idaho State Board of Medicine is authorized to promulgate rules governing the practice of respiratory care and polysomnography related respiratory care. (3-20-20)T

**001. TITLE AND SCOPE.**

**01. Title.** These rules are titled IDAPA 22.01.11, “Rules for Licensure of Respiratory Therapists and Permitting of Polysomnographers in Idaho.” (3-20-20)T

**02. Scope.** Pursuant to Sections 54-4304 and 54-4304A, Idaho Code, and this chapter, respiratory therapists must be licensed and polysomnographers issued a permit by the Board prior to commencement of practice and related activities. (3-20-20)T

**002. -- 009. (RESERVED)**

**010. DEFINITIONS.**

**01. Board of Registered Polysomnographic Technologists.** A nationally recognized private testing, examining and credentialing body for the polysomnography related respiratory care profession. (3-20-20)T

**02. Comprehensive Registry Exam.** The comprehensive registry examination administered by the Board of Registered Polysomnographic Technologists, or administered by an equivalent board, recognized by the Board, the successful completion of which entitles a person to the professional designation of Registered Polysomnographic Technologist (RPSGT). (3-20-20)T

**03. Conditional Permit.** A time-restricted permit issued by the Board. (3-20-20)T

**04. Medical Practice Act.** Title 54, Chapter 18, Idaho Code. (3-20-20)T

**05. Written Registry and Clinical Simulation Examinations.** The certification examinations administered by the National Board of Respiratory Care, Inc., or certification examinations administered by an equivalent board, recognized by the Board, the successful completion of which entitles a person the professional designation of “Registered Respiratory Therapist” (RRT). (3-20-20)T

**011. APPLICATION TO BOTH PERMITS AND LICENSES.**

The provisions of this chapter governing procedures for suspension and revocation of licenses, payment and assessment of fees and governing misrepresentation, penalties and severability and other administrative procedures shall apply equally to permits for the practice of polysomnography related respiratory care services as to licenses for the practice of respiratory care. (3-20-20)T

**012. -- 030. (RESERVED)**

**031. GENERAL QUALIFICATIONS FOR LICENSURE AND RENEWAL.**

Requirements for licensure and renewal are found in Title 54, Chapter 43, Idaho Code, IDAPA 22.01.05, and on Board-approved forms. (3-20-20)T

**01. Application for Respiratory Care and Polysomnography Related Respiratory Care Practitioner.** (3-20-20)T

**a.** The Board may issue a dual license/permit to an applicant who meets the requirements set forth in this chapter and Sections 54-4306 and 54-4304A(2) and (3), Idaho Code. A dual license/permit shall authorize the holder to perform respiratory care and polysomnography related respiratory care in this state. (3-20-20)T

**b.** Application for a dual license/permit shall be made to the Board on a form prescribed by the Board, together with the application fee. (3-20-20)T

**c.** Such dual license/permit shall expire on the expiration date printed on the face of the certificate unless renewed. (3-20-20)T



**032. CONTINUING EDUCATION.**

**01. Evidence of Completion.** Prior to renewal each applicant for renewal, reinstatement or reapplication, shall submit evidence of successfully completing no less than twelve (12) clock hours per year of continuing education acceptable to the Board. Continuing education must be germane to the practice or performance of respiratory care. Appropriate continuing professional education activities include but are not limited to, the following: (3-20-20)T

- a. Attending or presenting at conferences, seminars or inservice programs. (3-20-20)T
- b. Formal course work in Respiratory Therapy related subjects. (3-20-20)T

**02. Polysomnographer Continuing Education.** Each individual applicant for renewal of an active permit shall, on or before the expiration date of the permit, submit satisfactory proof to the Licensure Board of successful completion of not less than twelve (12) hours of approved continuing education pertaining to the provision of polysomnographic-related respiratory care per year in addition to any other requirements for renewal as adopted by the Board. The Board, as recommended by the Licensure Board, may substitute all or a portion of the coursework required in Section 032 when an applicant for renewal shows evidence of passing an approved challenge exam or of completing equivalent education as determined by the Board, as recommended by the Licensure Board, to be in full compliance with the education requirements of this chapter. (3-20-20)T

**033. SUPERVISION OF RESPIRATORY CARE.**

The practice or provision of respiratory care by persons holding a student or consulting and training exemption, or temporary permit shall be in direct association with a respiratory care practitioner or licensed physician who shall be responsible for the activities of the person being supervised and shall review and countersign all patient documentation performed by the person being supervised. The supervising respiratory care practitioner or licensed physician need not be physically present or on the premises at all times but must be available for telephonic consultation. The extent of communication between the supervising or consulting respiratory care practitioner or licensed physician and the person being supervised shall be determined by the competency of the person, the treatment setting, and the diagnostic category of the client. (3-20-20)T

**034. DENIAL OR REFUSAL TO RENEW LICENSE OR PERMIT OR SUSPENSION OR REVOCATION OF LICENSE OR PERMIT.**

Discipline. A new or renewal application may be denied, and every person licensed or issued a permit pursuant to Title 54, Chapter 43, Idaho Code and these rules is subject to discipline, pursuant to the procedures and powers established by and set forth in Section 54-4312, Idaho Code and the Administrative Procedures Act. (3-20-20)T

**035. -- 045. (RESERVED)**

**046. FEES -- TABLE.**

**01. Fees -- Table.** Nonrefundable fees for Respiratory Care Practitioners are as follows:

<b>Fees -- Table (Non-Refundable)</b>	
Respiratory Care Practitioner Initial Licensure Fee	- Not more than \$180
Respiratory Care Practitioner Reinstatement Fee	- \$50 plus unpaid renewal fees
Annual Renewal Fee for Inactive License	- Not more than \$100
Inactive Conversion Fee	- Not more than \$100
Annual Renewal Fee	- Not more than \$140
Temporary Permit Fee	- Not more than \$180

(3-20-20)T

**02. Fees – Table.** Nonrefundable Permit Fees for Polysomnography Related Respiratory Care

Practitioners.

<b>Fees -- Table (Non-Refundable)</b>	
Initial Permit Fee – Registered Polysomnographic Technologist	- Not more than \$180
Initial Permit Fee -Polysomnographic Trainee	- Not more than \$100
Reinstatement Fee – Registered Polysomnographic Technologist	- \$50 plus unpaid renewal fees
Annual Renewal Fee – Registered Polysomnographic Technologist	- Not more than \$140
Annual Renewal Fee – Polysomnographic Trainee	- Not more than \$70
Temporary Permit Fee – Registered Polysomnographic Technologist	- Not more than \$180
Temporary Permit Fee – Polysomnographic Trainee	- Not more than \$90
Conditional Permit Fee – Registered Polysomnographic Technologist	- Not more than \$180
Conditional Permit Fee – Polysomnographic Trainee	- Not more than \$90
Annual Renewal Fee for Inactive License—Polysomnographic Technologist	- Not more than \$100
Inactive Conversion Fee	- Not more than \$100 plus unpaid active licensure fees for the time inactive

(3-20-20)T

**03. Fees - Table.** Nonrefundable Dual Licensure/Permit Fees for Practitioners of Respiratory and Polysomnography Related Respiratory Care. (3-20-20)T

**a.** Initial Licensure/Permit Fee. A person holding a current license or permit, if qualified, may apply for and obtain a dual license/permit without paying an additional fee.

<b>Fees -- Table (Non-Refundable)</b>	
Dual Licensure/Permit Fee	- Not more than \$180
A person holding a current license or permit, if qualified, may apply for and obtain a dual license/permit without paying an additional fee.	
Reinstatement Fee	- \$50 plus unpaid renewal fees
Annual Renewal Fee	- Not more than \$140
Renewal is required upon the expiration of either the permit or the license, whichever expires first if the two (2) initially were not obtained at the same time.	

(3-20-20)T

**047. -- 999. (RESERVED)**

**22.01.13 – RULES FOR THE LICENSURE OF DIETITIANS**

**000. LEGAL AUTHORITY.**

Pursuant to Section 54-3505(2), Idaho Code, the Idaho State Board of Medicine is authorized to promulgate rules to implement provisions of the Dietitians Act. (3-20-20)T

**001. TITLE AND SCOPE.**

These rules are titled IDAPA 22.01.13, “Rules for the Licensure of Dietitians.” (3-20-20)T

**002. -- 019. (RESERVED)**

**020. GENERAL QUALIFICATIONS FOR LICENSURE AND RENEWAL.**

Requirements for licensure and renewal are found in Title 54, Chapter 35, Idaho Code, IDAPA 22.01.05, and on Board-approved forms. (3-20-20)T

**021. PROVISIONAL LICENSURE.**

**01. Provisional License.** The Board may issue a provisional license to a person who has successfully completed the academic requirements of an education program in dietetics approved by the licensure board and has successfully completed a dietetic internship or preprofessional practice program, coordinated program or such other equivalent experience as may be approved by the board and who has met all the other requirements set forth by Section 020 of this rule but who has not yet passed the examination conducted by the Commission on Dietetic Registration. (3-20-20)T

**02. Provisional License Dietitian/Monitor Affidavit.** The provisionally licensed dietitian must obtain an affidavit signed by an Idaho licensed dietitian affirming and attesting that they will be responsible for the activities of the provisionally licensed dietitian and will review and countersign all patient documentation signed by the provisionally licensed dietitian. The supervising monitor need not be physically present or on the premises at all times but must be available for telephonic consultation. The extent of communication between the monitor and the provisionally licensed dietitian will be determined by the competency of the individual, the treatment setting, and the diagnostic category of the patients. (3-20-20)T

**03. Provisional Licensure Expiration.** Provisional licenses will become full active licenses upon the date of receipt of a copy of registration by the Commission on Dietetic Registration. All provisional licenses will expire on the last day of the current renewal cycle. (3-20-20)T

**022. -- 031. (RESERVED)**

**032. DENIAL OR REFUSAL TO RENEW, SUSPENSION OR REVOCATION OF LICENSE.**

**01. Disciplinary Authority.** A new or renewal application may be denied or a license may be suspended or revoked by the Board, and every person licensed pursuant to Title 54, Chapter 35, Idaho Code and these rules is subject to disciplinary actions or probationary conditions pursuant to the procedures and powers established by and set forth in Section 54-3505, Idaho Code, and the Idaho Administrative Procedure Act. (3-20-20)T

**033. -- 040. (RESERVED)**

**041. FEES -- TABLE.**

Nonrefundable fees are as follows:

<b>Fees -- Table (Non-Refundable)</b>	
Initial Licensure Fee	- Not more than \$150
Annual Renewal Fee	- Not more than \$100
Reinstatement Fee	- \$50 plus unpaid renewal fees
Inactive Conversion Fee	- Not more than \$50

(3-20-20)T

**042. -- 999. (RESERVED)**

## IDAPA 23 – BOARD OF NURSING

### DOCKET NO. 23-0101-2000F (FEE RULE)

#### NOTICE OF OMNIBUS RULEMAKING – ADOPTION OF TEMPORARY RULE

**EFFECTIVE DATE:** The effective date of the temporary rule being adopted through this omnibus rulemaking is the adjournment date of the second regular session of the 65th Idaho State Legislature - March 20, 2020.

**AUTHORITY:** In compliance with Sections 67-5226, Idaho Code, notice is hereby given this agency has adopted temporary rules. The action is authorized pursuant to Section 54-1404(13), Idaho Code.

**DESCRIPTIVE SUMMARY:** The following is the required finding and concise statement of its supporting reasons for adopting temporary rules:

This temporary rulemaking adopts the following chapter under IDAPA 23:

**IDAPA 23**

- 23.01.01, *Rules of the State of Idaho Board of Nursing*

**TEMPORARY RULES JUSTIFICATION:** Pursuant to Sections 67-5226(1) and 67-5226(2), Idaho Code, the Governor has found that temporary adoption of this rule is appropriate for the following reasons:

These temporary rules are necessary to protect the public health, safety, and welfare of the citizens of Idaho and confer a benefit on its citizens. These temporary rules implement the duly enacted laws of the state of Idaho, provide citizens with the detailed rules and standards for complying with those laws, and assist in the orderly execution and enforcement of those laws. The expiration of these rules without due consideration and processes would undermine the public health, safety, and welfare of the citizens of Idaho and deprive them of the benefit intended by these rules.

**FEE SUMMARY:** Pursuant to Section 67-5226(2), the Governor has found that the fees or charges being imposed are justified and necessary to avoid immediate danger and the fees/charges are described herein:

The fees or charges, authorized in Section 54-1404(8), Idaho Code, are part of the agency's 2021 budget that relies upon the existence of these fees or charges to meet the agency's obligations and provide necessary services. Failing to reauthorize these temporary rules would create immediate danger to the agency's budget, and immediate danger to necessary agency functions and services.

The following is a specific description of the fees or charges:

<b>23.01.01.900 - Initial Licensure, Renewal &amp; Reinstatement Fees</b>				
	<b>Registered Nurse</b>	<b>Practical Nurse</b>	<b>Advanced Practice Nurse</b>	<b>Medication Assistant - Certified</b>
Temporary License Fee	\$25	\$25	\$25	
Initial Application Fee			\$90	
License by Exam Fee	\$90	\$75	\$90	
License by Endorsement	\$110	\$110		
License Renewal	\$90	\$90	\$90	\$35
Expiration Date	Aug 31-odd years	Aug 31-even years	Aug 31-odd years	Aug 31-even years

<b>23.01.01.901 - Other Fees</b>	
Records Verification Fee	\$35
Return Check Fee	\$25

<b>23.01.01.903 - Education Program Fees</b>	
Evaluation of Nursing Education Programs	\$250
Evaluation of Courses of Instruction	\$500

<b>23.01.01.999 - Administrative Fine</b>	
Fine Assessment	\$100

**ASSISTANCE ON TECHNICAL QUESTIONS:** For assistance on technical questions concerning the temporary rule, contact Russell Barron, Executive Director at (208) 577-2482.

Dated this 18th day of February, 2020.

Russell Barron, Executive Director  
Idaho Board of Nursing  
280 N. 8th St. (8th & Bannock), Ste. 210  
P. O. Box 83720  
Boise, ID 83720-0061  
Phone: (208) 577-2479  
Fax: (208) 334-3262

# IDAPA 23 – BOARD OF NURSING

## 23.01.01 – RULES OF THE IDAHO BOARD OF NURSING

### 000. LEGAL AUTHORITY.

This chapter is adopted in accordance with Section 54-1404(13), Idaho Code. (3-20-20)T

### 001. TITLE AND SCOPE.

01. **Title.** These rules are titled IDAPA 23.01.01, “Rules of the Idaho Board of Nursing.” (3-20-20)T

02. **Scope.** These rules include, but are not limited to the minimum standards of nursing practice, licensure, educational programs and discipline. (3-20-20)T

### 002. FILING OF DOCUMENTS.

All written communications and documents that are intended to be part of an official record for decision in a rulemaking or contested case must be filed with the executive director of the Board. One (1) original is sufficient for submission to the hearing officer, with one (1) copy for the Board and one (1) copy submitted to the opposing party. Whenever documents are filed by facsimile transmission (FAX), originals are to be deposited in the mail the same day or hand delivered the following business day to the hearing officer or the Board, and opposing parties. (3-20-20)T

### 003. CHANGES IN NAME AND ADDRESS – ADDRESS FOR NOTIFICATION PURPOSES.

01. **Change of Name.** Whenever a change of licensee name or address occurs, the Board is to be immediately notified of the change. Documentation confirming the change of name will be provided to the Board on request. (3-20-20)T

02. **Address for Notification Purposes.** (3-20-20)T

a. The most recent mailing or electronic address on record with the Board is utilized for purposes of all written communication with the licensee. (3-20-20)T

b. In a contested case proceeding, the service of process of Board documents (including notices, summonses, complaints, subpoenas and orders) is made by: (3-20-20)T

i. Personal service; (3-20-20)T

ii. Mailing to the licensee’s mailing address on record; or (3-20-20)T

iii. E-mailing to the licensee’s electronic address on record, if authorized. Service on an electronic address is authorized when the licensee has already appeared in the proceeding or has agreed in writing to service by e-mail. (3-20-20)T

### 004. -- 009. (RESERVED)

### 010. DEFINITIONS.

The definitions set forth in Section 54-1402, Idaho Code, are applicable to these rules. In addition, unless the context clearly denotes or requires otherwise, for purposes of these rules, the below terms have the following meanings: (3-20-20)T

01. **Abandonment.** The termination of a nurse/patient relationship without first making appropriate arrangements for continuation of required nursing care. The nurse/patient relationship begins when responsibility for nursing care of a patient is accepted by the nurse. Refusal to accept an employment assignment or refusal to accept or begin a nurse/patient relationship is not abandonment. Reasonable notification, or a timely request for alternative care for a patient, directed to a qualified provider or to a staff supervisor, prior to leaving the assignment, constitutes termination of the nurse/patient relationship. (3-20-20)T

02. **Accreditation.** The official authorization or status granted by a recognized accrediting entity or agency other than a state board of nursing. (3-20-20)T

- 03. Administration of Medications.** The process whereby a prescribed medication is given to a patient by one (1) of several routes. Administration of medication is a complex nursing responsibility which requires a knowledge of anatomy, physiology, pathophysiology, and pharmacology. Only persons authorized under Board statutes and these rules may administer medications and treatments as prescribed by health care providers authorized to prescribe medications. (3-20-20)T
- 04. Approval.** The process by which the Board evaluates and grants official recognition to education programs that meet standards established by the Board. (3-20-20)T
- 05. Assist.** To aid or help in the accomplishment of a prescribed set of actions. (3-20-20)T
- 06. Assistance With Medications.** The process whereby a non-licensed care provider is delegated tasks by a licensed nurse to aid a patient who cannot independently self-administer medications. (3-20-20)T
- 07. Board Staff.** The executive director and other such personnel as are needed to implement the Nursing Practice Act and these rules. (3-20-20)T
- 08. Charge Nurse.** A licensed nurse who bears primary responsibility for assessing, planning, prioritizing and evaluating care for the patients on a unit, as well as the overall supervision of the licensed and unlicensed staff delivering the nursing care. (3-20-20)T
- 09. Clinical Preceptor.** A licensed registered nurse, or other qualified individual as defined in these rules, who acts to facilitate student training in a manner prescribed by a written agreement between the preceptor's employer and an educational institution. (3-20-20)T
- 10. Competence.** Safely performing those functions within the role of the licensee in a manner that demonstrates essential knowledge, judgment and skills. (3-20-20)T
- 11. Curriculum.** The systematic arrangement of learning experiences including didactic courses, practical experiences, and other activities needed to meet the requirements of the nursing program and of the certificate or degree conferred by the parent institution. (3-20-20)T
- 12. Delegation.** The process by which a licensed nurse assigns tasks to be performed by others. (3-20-20)T
- 13. Disability.** Any physical, mental, or emotional condition that interferes with the ability to safely and competently practice. (3-20-20)T
- 14. Emeritus License.** A license issued to a nurse retiring from active practice for any length of time. (3-20-20)T
- 15. Licensing Examination.** A licensing examination acceptable to the Board. (3-20-20)T
- 16. License in Good Standing.** A license not subject to current disciplinary action, restriction, probation or investigation in any jurisdiction. (3-20-20)T
- 17. Nursing Assessment.** The systematic collection of data related to the patient's health needs. (3-20-20)T
- 18. Nursing Diagnosis.** The clinical judgment or conclusion regarding patient/client/family/community response to actual or potential health problems made as a result of the nursing assessment. (3-20-20)T
- 19. Nursing Intervention.** An action deliberately selected and performed to support the plan of care. (3-20-20)T
- 20. Nursing Jurisdiction.** Unless the context clearly denotes a different meaning, when used in these rules, the term nursing jurisdiction means any or all of the fifty (50) states, U.S. territories or commonwealths, as the

case may be. (3-20-20)T

**21. Nursing Service Administrator.** A licensed registered nurse who has administrative responsibility for the nursing services provided in a health care setting. (3-20-20)T

**22. Organized Program of Study.** A written plan of instruction to include course objectives and content, teaching strategies, provisions for supervised clinical practice, evaluation methods, length and hours of course, and faculty qualifications. (3-20-20)T

**23. Patient.** An individual or a group of individuals who are the beneficiaries of nursing services in any setting and may include client, resident, family, community. (3-20-20)T

**24. Patient Education.** The act of teaching patients and their families, for the purpose of improving or maintaining an individual's health status. (3-20-20)T

**25. Plan of Care.** The goal-oriented strategy developed to assist individuals or groups to achieve optimal health potential. (3-20-20)T

**26. Practice Standards.** General guidelines that identify roles and responsibilities for a particular category of licensure and, used in conjunction with the decision-making model, define a nurse's relationship with other care providers. (3-20-20)T

**27. Probation.** A period of time set forth in an order in which certain restrictions, conditions or limitations are imposed on a licensee. (3-20-20)T

**28. Protocols.** Written standards that define or specify performance expectations, objectives, and criteria. (3-20-20)T

**29. Restricted License.** A nursing license subject to specific restrictions, terms, and conditions. (3-20-20)T

**30. Revocation.** Termination of the authorization to practice. (3-20-20)T

**31. Scope of Practice.** The extent of treatment, activity, influence, or range of actions permitted or authorized for licensed nurses based on the nurse's education, preparation, and experience. (3-20-20)T

**32. Supervision.** Designating or prescribing a course of action, or giving procedural guidance, direction, and periodic evaluation. Direct supervision requires the supervisor to be physically present and immediately accessible to designate or prescribe a course of action or to give procedural guidance, direction, and periodic evaluation. (3-20-20)T

**33. Suspension.** An order temporarily withdrawing a nurse's right to practice nursing. (3-20-20)T

**34. Technician/Technologist.** These individuals are not credentialed by regulatory bodies in Idaho and may include, but are not limited to: surgical, dialysis and radiology technicians/technologists, monitor technicians and medical assistants. (3-20-20)T

**35. Unlicensed Assistive Personnel (UAP).** This term is used to designate unlicensed personnel employed to perform nursing care services under the direction and supervision of licensed nurses. The term also includes licensed or credentialed health care workers whose job responsibilities extend to health care services beyond their usual and customary roles and which activities are provided under the direction and supervision of licensed nurses. UAPs are prohibited from performing any licensed nurse functions that are specifically defined in Section 54-1402, Idaho Code. UAPs may not be delegated procedures involving acts that require nursing assessment or diagnosis, establishment of a plan of care or teaching, the exercise of nursing judgment, or procedures requiring specialized nursing knowledge, skills or techniques. (3-20-20)T

**36. Universal Precautions.** The recommendations published by the Center for Disease Control,



Atlanta, Georgia, for preventing transmission of infectious disease. (3-20-20)T

**011. -- 039. (RESERVED)**

**040. TEMPORARY LICENSE.**

A temporary license is a nonrenewable license. (3-20-20)T

**01. Issued at Discretion of Board.** Temporary licenses are issued, and may be extended, at the discretion of the Board. (3-20-20)T

**02. Temporary Licensure by Interstate Endorsement.** A temporary license may be issued to an applicant for interstate endorsement on proof of current licensure in good standing in another nursing jurisdiction, satisfactory documentation of employment within the three (3) years immediately preceding application, and compliance with the requirements of Section 240 of these rules. (3-20-20)T

**03. Temporary Licensure by Examination.** A temporary license to practice nursing until notification of examination results and completion of criminal background check may be issued to an applicant for Idaho licensure following graduation from a nursing education program recognized by the professional licensing board for another nursing jurisdiction, and compliance with Section 221 of these rules. (3-20-20)T

**a.** The practice of nursing by new graduates holding temporary licensure is limited as follows: (3-20-20)T

**i.** Direct supervision by a licensed registered nurse is provided. (3-20-20)T

**ii.** Precluded from acting as charge nurse. (3-20-20)T

**b.** Temporary licenses issued to examination candidates are issued for a period not to exceed three (3) months. (3-20-20)T

**04. Unsuccessful Examination Candidates.** (3-20-20)T

**a.** An applicant who fails to pass the licensing examination is not eligible for further temporary licensure. (3-20-20)T

**b.** In the event that such applicant subsequently passes the licensing examination after twelve (12) months or more have elapsed following completion of the educational program, a temporary license with conditions may be issued until verification of clinical competence is received. (3-20-20)T

**05. Applicants Not in Active Practice.** A temporary license with specific terms and conditions may be issued to a person who has not actively engaged in the practice of nursing in any nursing jurisdiction for more than three (3) years immediately prior to the application for licensure or to an applicant whose completed application indicates the need for confirmation of the applicant's ability to practice safe nursing. (3-20-20)T

**06. Applicants from Other Countries.** Upon final evaluation of the completed application, the Board may, at its discretion, issue a temporary license to a graduate from a nursing education program outside of a nursing jurisdiction, pending notification of results of the licensing examination. (3-20-20)T

**07. Fee.** The applicant pays the temporary license fee, as prescribed in of these rules. (3-20-20)T

**041. -- 059. (RESERVED)**

**060. LPN, RN, AND APRN LICENSE RENEWAL.**

All licenses are renewed as prescribed in Section 54-1411, Idaho Code. (3-20-20)T

**01. Renewal Applications.** Renewal applications may be obtained by contacting the Board. (3-20-20)T

**02. Final Date to Renew.** The original completed renewal application and renewal fee as prescribed in Section 900 of these rules, are submitted to the Board and post-marked or electronically dated not later than August 31 of the appropriate renewal year. (3-20-20)T

**03. Date License Lapsed.** Licenses not renewed prior to September 1 of the appropriate year are lapsed and therefore invalid. (3-20-20)T

**061. CONTINUED COMPETENCE REQUIREMENTS FOR RENEWAL OF AN ACTIVE LICENSE.**

**01. Learning Activities.** In order to renew an LPN or RN license, a licensee shall complete or comply with at least two (2) of any of the learning activities listed below in Paragraphs 061.01.a., b., or c. within the two-year (2) renewal period: (3-20-20)T

- a. Practice:** (3-20-20)T
  - i. Current nursing specialty certification as defined in Section 402 of these rules; or (3-20-20)T
  - ii. One hundred (100) hours of practice or simulation practice, paid or unpaid, in which the nurse applies knowledge or clinical judgment in a way that influences patients, families, nurses, or organizations; (3-20-20)T
- b. Education, Continuing Education, E-learning, and In-service:** (3-20-20)T
  - i. Fifteen (15) contact hours of continuing education, e-learning, academic courses, nursing-related in-service offered by an accredited educational institution, healthcare institution, or organization (a contact hour equals not less than fifty (50) minutes); or (3-20-20)T
  - ii. Completion of a minimum of one (1) semester credit hour of post-licensure academic education relevant to nursing practice, offered by a college or university accredited by an organization recognized by the U.S. Department of Education; or (3-20-20)T
  - iii. Completion of a Board-recognized refresher course in nursing or nurse residency program; or (3-20-20)T
  - iv. Participation in or presentation of a workshop, seminar, conference, or course relevant to the practice of nursing and approved by an organization recognized by the Board to include, but not limited to: (3-20-20)T
    - (1) A nationally recognized nursing organization; (3-20-20)T
    - (2) An accredited academic institution; (3-20-20)T
    - (3) A provider of continuing education recognized by another board of nursing; (3-20-20)T
    - (4) A provider of continuing education recognized by a regulatory board of another discipline; or (3-20-20)T
    - (5) A program that meets criteria established by the Board; (3-20-20)T
- c. Professional Engagement:** (3-20-20)T
  - i. Acknowledged contributor to a published nursing-related article or manuscript; or (3-20-20)T
  - ii. Teaching or developing a nursing-related course of instruction; or (3-20-20)T
  - iii. Participation in related professional activities including, but not limited to, research, published professional materials, nursing-related volunteer work, teaching (if not licensee's primary employment), peer

reviewing, precepting, professional auditing, and service on nursing or healthcare related boards, organizations, associations or committees. (3-20-20)T

**02. APRN Continued Competence Requirements.** Registered nurses who also hold an active license as an APRN shall only meet the requirements of Section 300 of these rules. (3-20-20)T

**03. First Renewal Exemption.** A licensee is exempt from the continued competence requirement for the first renewal following initial licensure by examination. (3-20-20)T

**04. Extension.** The Board may grant an extension for good cause for up to one (1) year for the completion of continuing competence requirements. Such extension shall not relieve the licensee of the continuing competence requirements. (3-20-20)T

**05. Beyond the Control of Licensee Exemption.** The Board may, in the exercise of its sound discretion, grant an exemption for all or part of the continuing competence requirements due to circumstances beyond the control of the licensee. (3-20-20)T

**06. Disciplinary Proceeding.** Continued competence activities or courses required by Board order in a disciplinary proceeding shall not be counted as meeting the requirements for licensure renewal. (3-20-20)T

**07. Compliance Effective Dates.** Compliance with the continuing competence requirements of Sections 061 and 062 will be necessary to renew an LPN license beginning with 2018 renewals and an RN license beginning with 2019 renewals. (3-20-20)T

**062. DOCUMENTING COMPLIANCE WITH CONTINUED COMPETENCE REQUIREMENTS.**

**01. Retention of Original Documentation.** All licensees are to maintain original documentation of completion for a period of two (2) years following renewal and to provide such documentation within thirty (30) days of a request from the Board for proof of compliance. (3-20-20)T

**02. Documentation of Compliance.** Documentation of compliance consists of the following: (3-20-20)T

**a.** Evidence of national certification includes a copy of a certificate that includes the name of licensee, name of certifying body, date of certification, and date of certification expiration. Certification will be initially attained during the licensure period, have been in effect during the entire licensure period, or have been recertified during the licensure period. (3-20-20)T

**b.** Evidence of post-licensure academic education includes a copy of the transcript with the name of the licensee, name of educational institution, date(s) of attendance, name of course, and number of credit hours received. (3-20-20)T

**c.** Evidence of completion of a Board-recognized refresher course includes certificate or written correspondence from the provider with the name of the licensee, name of provider, and verification of successful completion of the course. (3-20-20)T

**d.** Evidence of completion of research or a nursing project includes an abstract or summary, the name of the licensee, role of the licensee as principal or contributing investigator, date of completion, statement of the problem, research or project objectives, methods used, and summary of findings. (3-20-20)T

**e.** Evidence of contributing to a published nursing-related article, manuscript, paper, book, or book chapter includes a copy of the publication to include the name of the licensee and publication date. (3-20-20)T

**f.** Evidence of teaching a course for college credit includes documentation of the course offering indicating instructor, course title, course syllabus, and the number of credit hours. Teaching a particular course may only be used once to satisfy the continued competence requirement unless the course offering and syllabus has changed in a material or significant fashion. (3-20-20)T

**g.** Evidence of teaching a course for continuing education credit includes a written attestation from the director of the program or authorizing entity including the date(s) of the course and the number of hours awarded. (3-20-20)T

**h.** Evidence of hours of continuing learning activities or courses includes the name of the licensee, title of activity, name of provider, number of hours, and date of activity. (3-20-20)T

**i.** Evidence of one hundred (100) hours of practice in nursing includes the name of the licensee and documentation satisfactory to the Board of the number of hours worked during review period validated by the employer/recipient agency. If self-employed, hours worked may be validated through other methods such as tax records or other business records. If practice is of a volunteer or gratuitous nature, hours worked may be validated by the recipient agency. (3-20-20)T

**063. REINSTATEMENT (NON-DISCIPLINE).**

A person whose license has lapsed for failure to pay the renewal fee by the specified date may apply for reinstatement by submitting the items set out in Section 54-1411(3), Idaho Code and a current fingerprint-based criminal history check as set forth in Section 54-1401(3), Idaho Code, as well as paying the fees prescribed in these rules. (3-20-20)T

**064. REINSTATEMENT AFTER DISCIPLINE.**

**01. Submission of Application Materials.** A person whose license has been subject to disciplinary action by the Board may apply for reinstatement of the license to active and unrestricted status by: (3-20-20)T

**a.** Submitting the items set out in Section 54-1411(3), Idaho Code; (3-20-20)T

**b.** Submitting a current fingerprint-based criminal history check as set forth in Section 54-1401(3), Idaho Code; (3-20-20)T

**c.** Paying the fees prescribed in these rules; and (3-20-20)T

**d.** Documenting compliance with any term and restrictions set forth in any order as a condition of reinstatement. (3-20-20)T

**02. Appearance Before Board.** Applicants for reinstatement may be called to appear before the Board. (3-20-20)T

**03. Application for Reinstatement After Revocation.** Unless otherwise provided in the order of revocation, applicants for reinstatement of revoked licenses are precluded from applying for reinstatement for a period of two (2) years after entry of the order. (3-20-20)T

**065. -- 075. (RESERVED)**

**076. PERSONS EXEMPTED BY BOARD.**

Licensure to practice nursing is not necessary, nor is the practice of nursing prohibited for persons exempted by the Board including: (3-20-20)T

**01. Technicians and Technologists.** Technicians and technologists who comply with Section 491 of these rules. (3-20-20)T

**02. Non-Resident Nurses.** Non-resident nurses currently licensed in good standing in another nursing jurisdiction, who are in Idaho on a temporary basis because of enrollment in or presentation of a short term course of instruction recognized or approved by the Board and who are performing functions incident to formal instruction. (3-20-20)T

**03. Family Members and Others.** (3-20-20)T

**a.** Family members providing care to a person to whom they are related by blood, marriage, adoption, legal guardianship or licensed foster care. (3-20-20)T

**b.** Non-family members who provide gratuitous care to a person on a temporary basis in order to give respite to family members who regularly provide care to that person. (3-20-20)T

**c.** Live-in domestics, housekeepers and companions provided they do not represent themselves as, nor receive compensation as, licensed nurses or other nursing care providers and so long as any health care provided is incidental to the services for which they are employed. (3-20-20)T

**04. Nurse Apprentice.** A nurse apprentice is a nursing student or recent graduate who is employed for remuneration in a non-licensed capacity outside the student role by a Board approved health care agency. (3-20-20)T

**a.** Applicants for nurse apprentice must: (3-20-20)T

i. Be enrolled in an accredited/approved nursing education program that is substantially equivalent to Idaho's approved programs for practical/registered nursing. (3-20-20)T

ii. Be in good academic standing at the time of application and notify the Board of any change in academic standing. (3-20-20)T

iii. Meet the employing agency's health care skills validation requirements. (3-20-20)T

iv. Satisfactorily complete a basic nursing fundamentals course. (3-20-20)T

v. Use obvious designations that identify the applicant as a nurse apprentice. (3-20-20)T

**b.** A completed application for nurse apprentice consists of: (3-20-20)T

i. Completed application form provided by the Board, to include a fee of ten dollars (\$10); and (3-20-20)T

ii. Verification of satisfactory completion of a basic nursing fundamentals course; and (3-20-20)T

iii. Validation of successful demonstration of skills from a nursing education program; and (3-20-20)T

iv. Verification of good academic standing. (3-20-20)T

**c.** An individual whose application is approved will be issued a letter identifying the individual as a nurse apprentice for a designated time period to extend not more than three (3) months after successful completion of the nursing education program. (3-20-20)T

**d.** A nurse apprentice may, under licensed registered nurse supervision, perform all functions approved by the Board for unlicensed assistive personnel as set forth in Section 490 of these rules. (3-20-20)T

**05. Employer Application.** (3-20-20)T

**a.** Health care agencies wishing to employ nurse apprentices are to complete an application form provided by the Board that consists of: (3-20-20)T

i. Job descriptions for apprentice; (3-20-20)T

ii. A written plan for orientation and skill validation; (3-20-20)T

iii. The name of the licensed registered nurse who is accountable and responsible for the coordination or management of the nurse apprentice program; (3-20-20)T

- iv. Assurance that a licensed registered nurse is readily available when nurse apprentice is working; (3-20-20)T
- v. A written procedure for the nurse apprentice who is asked to perform a task that could jeopardize a patient and who declines to perform the task; and (3-20-20)T
- vi. A fee of one hundred dollars (\$100). (3-20-20)T
- b.** Following application review, the Board may grant approval to a health care agency to employ nurse apprentices for a period of up to one (1) year. (3-20-20)T
- c.** To ensure continuing compliance with Board requirements, each approved agency submits an annual report to the Board on forms provided by the Board. Based on its findings, the Board may grant continuing approval annually for an additional one (1) year period. (3-20-20)T
- d.** At any time, if the employing agency fails to inform the Board of changes in conditions upon which approval was based or otherwise fails to comply with established requirements, the Board may notify the agency of withdrawal of approval. (3-20-20)T

**077. -- 089. (RESERVED)**

**090. REAPPLICATION FOR A LICENSE AFTER PREVIOUS DENIAL.**

- 01. Request for Review.** Review of a denied application may be requested by submitting a written statement and documentation that includes evidence, satisfactory to the Board, of rehabilitation, or elimination or cure of the conditions for denial. (3-20-20)T
- 02. Reapplication Files.** Reapplication files remain open and active for a period of twelve (12) months from date of receipt. After twelve (12) months, the file is closed and any subsequent reapplication will require submission of a new application form and payment of the applicable fees. (3-20-20)T

**091. -- 099. (RESERVED)**

**100. GROUNDS FOR DISCIPLINE.**

- 01. False Statement.** A false, fraudulent or forged statement or misrepresentation in procuring a license to practice nursing means, but need not be limited to: (3-20-20)T
  - a.** Procuring or attempting to procure a license to practice nursing by filing forged or altered documents or credentials; or (3-20-20)T
  - b.** Falsifying, misrepresenting facts or failing to verify and accurately report any and all facts submitted on any application for licensure, examination, relicensure, or reinstatement of licensure by making timely and appropriate inquiry of all jurisdictions in which licensee has made application for, or obtained, licensure or certification or engaged in the practice of nursing; or (3-20-20)T
  - c.** Impersonating any applicant or acting as proxy for the applicant in any examination for nurse licensure. (3-20-20)T
- 02. Conviction of a Felony.** Conviction of, or entry of a withheld judgment or a plea of nolo contendere to, conduct constituting a felony. (3-20-20)T
- 03. False or Assumed Name.** Practicing nursing under a false or assumed name means, but need not be limited to, carrying out licensed nursing functions while using other than the individual's given or legal name. (3-20-20)T
- 04. Offense Involving Moral Turpitude.** An offense involving moral turpitude means, but need not be

limited to, an act of baseness, vileness, or depravity in the private and social duties that a man owes to his fellow man, or to society in general, contrary to the accepted and customary rule of right and duty between man and man.

(3-20-20)T

**05. Gross Negligence or Recklessness.** Gross negligence or recklessness in performing nursing functions means, but need not be limited to, a substantial departure from established and customary standards of care which, under similar circumstances, would have been exercised by a licensed peer; an act or an omission where there is a legal duty to act or to refrain from acting that a reasonable and prudent practitioner of nursing under same or similar facts and circumstances would have done, would have refrained from doing or would have done in a different manner and which did or could have resulted in harm or injury to a patient/client. An exercise of so slight a degree of care as to justify the belief that there was a conscious or overt disregard or indifference for the health, safety, well-being, or welfare of the public shall be considered a substantial departure from the accepted standard of care.

(3-20-20)T

**06. Habitual Use of Alcohol or Drugs.** Habitual use of alcoholic beverages or drugs means, but need not be limited to, the use of such substances to the extent that the nurse's judgment, skills, or abilities to provide safe and competent nursing care are impaired; or that the individual is unable to care for himself or his property or his family members because of such use; or it is determined by a qualified person that the individual is in need of medical or psychiatric care, treatment or rehabilitation or counseling because of drug or alcohol use.

(3-20-20)T

**07. Physical or Mental Unfitness.** Physical or mental unfitness to practice nursing means, but need not be limited to, a court order adjudging that a licensee is mentally incompetent, or an evaluation by a qualified professional person indicating that the licensee is mentally or physically incapable of engaging in registered or practical nursing in a manner consistent with sound patient care; or uncorrected physical defect that precludes the safe performance of nursing functions.

(3-20-20)T

**08. Violations of Standards of Conduct.** Violations of standards of conduct and practice adopted by the Board means, but need not be limited to, any violation of those standards of conduct described in Section 101 of these rules.

(3-20-20)T

**09. Conduct to Deceive, Defraud or Endanger.** Conduct of a character likely to deceive, defraud, or endanger patients or the public includes, but need not be limited to:

(3-20-20)T

**a.** Violating the standards of conduct and practice adopted by the Board.

(3-20-20)T

**b.** Being convicted of any crime or act substantially related to nursing practice and including, but not limited to, sex crimes, drug violations, acts of violence and child or adult abuse.

(3-20-20)T

**10. Action Against a License.** Action against a license means entry of any order restricting, limiting, revoking or suspending or otherwise disciplining a license or privilege to practice nursing by any jurisdiction. A certified copy of an order entered in any jurisdiction is prima facie evidence of the matters contained therein.

(3-20-20)T

**11. Failure to Make Timely and Appropriate Inquiry.** Failing to make timely and appropriate inquiry verifying licensure status in all jurisdictions in which the applicant has ever applied for licensure, certification or privilege to practice, including those jurisdictions in which the applicant is currently or was ever licensed, or in which applicant has practiced, prior to filing any application, verification or other statement regarding licensure status with the Board.

(3-20-20)T

**12. Failure to Cooperate With Authorities.** Failure to cooperate with authorities in the investigation of any alleged misconduct or interfering with a Board investigation by willful misrepresentation of facts, failure to provide information on request of the Board, or the use of threats or harassment against any patient or witness to prevent them from providing evidence.

(3-20-20)T

**13. Patterns of Poor Practice.** Repeatedly engaging in conduct that departs from the customary standards of care.

(3-20-20)T

**101. STANDARDS OF CONDUCT.**

**01. Violations.** Any violation of these Standards of Conduct is grounds for disciplinary action in accordance with Section 54-1413(1), Idaho Code, of the Idaho Nursing Practice Act and Section 090 or 100 of these rules. (3-20-20)T

**02. Classification.** For purposes of convenience, the standards of conduct are grouped generally into one (1) of three (3) categories: license, practice, and professional responsibility. The fact that any particular standard is so classified in any particular category is not relevant for any purpose other than ease of use. (3-20-20)T

**03. License.** (3-20-20)T

**a. Period of Practice.** The nurse can practice registered or practical nursing in Idaho only with a current Idaho license or during the period of valid temporary licensure or as otherwise allowed by law. (3-20-20)T

**b. Aiding in Violation of Law.** The nurse shall not aid, abet, or assist any other person to violate or circumvent laws or rules pertaining to the conduct and practice of nursing. (3-20-20)T

**c. Reporting Grossly Negligent or Reckless Practice.** The nurse shall report to the Board any licensed nurse who is grossly negligent or reckless in performing nursing functions or who otherwise violates the Nursing Practice Act or the Board rules. (3-20-20)T

**d. Unlawful Use of License.** The nurse shall not permit their license to be used by another person for any purpose or permit unlicensed persons under their jurisdiction or supervision to indicate in any way that they are licensed to perform functions restricted to licensed persons. (3-20-20)T

**e. Impairment of Ability.** The nurse shall not practice nursing while the ability to practice is impaired by alcohol or drugs or physical, mental or emotional disability. (3-20-20)T

**04. Practice.** The nurse shall have knowledge of the statutes and rules governing nursing and function within the defined legal scope of nursing practice, not assume any duty or responsibility within the practice of nursing without adequate training or where competency has not been maintained, and: (3-20-20)T

**a. Delegate activities only to persons who are competent and qualified to undertake and perform the delegated activities and will not delegate to non-licensed persons functions that are to be performed only by licensed nurses. The nurse delegating functions is to supervise the persons to whom the functions have been assigned or delegated.** (3-20-20)T

**b. Act to safeguard the patient from the incompetent practice, verbal or physical abusive acts or illegal practice of any person.** (3-20-20)T

**c. Not obtain, possess, furnish or administer prescription drugs to any person, including self, except as directed by a person authorized by law to prescribe drugs.** (3-20-20)T

**d. Not abandon patients in need of nursing care in a negligent or wanton manner. The nurse will leave a nursing assignment only after properly reporting and notifying appropriate personnel and will transfer responsibilities to appropriate personnel or care giver when continued care is necessitated by the patient's condition.** (3-20-20)T

**e. Respect the patient's privacy.** (3-20-20)T

**f. Not disseminate information about the patient to individuals not entitled to such information except where such information is mandated by law or for the protection of the patient.** (3-20-20)T

**g. Observe the condition and signs and symptoms of a patient, record the information, and report to appropriate persons any significant changes.** (3-20-20)T



**h.** Function as a member of the health team and shall collaborate with other health team members as necessary to meet the patient's health needs. (3-20-20)T

**i.** Adhere to universal precautions and carry out principles of asepsis and infection control and not place the patient, the patient's family or the nurse's coworkers at risk for the transmission of infectious diseases. (3-20-20)T

**05. Professional Responsibility.** (3-20-20)T

**a.** Disclosing Contents of Licensing Examination. The nurse is not to disclose contents of any licensing examination, or solicit, accept, or compile information regarding the contents of any examination before, during, or after its administration. (3-20-20)T

**b.** Considerations in Providing Care. In providing nursing care, the nurse will respect and consider the individual's human dignity, health problems, personal attributes, national origin, and handicaps and not discriminate on the basis of age, sex, race, religion, economic or social status or sexual preferences. (3-20-20)T

**c.** Responsibility and Accountability Assumed. The nurse is responsible and accountable for their nursing judgments, actions and competence. (3-20-20)T

**d.** Witnessing Wastage of Controlled Substances Medication. Controlled substances may not be wasted without witnesses. The nurse cannot sign any record as a witness attesting to the wastage of controlled substance medications unless the wastage was personally witnessed. The nurse cannot solicit the signatures on any record of a person as a witness to the wastage of a controlled substance when that person did not witness the wastage. The nurse will solicit signatures of individuals who witnessed the wastage in a timely manner. (3-20-20)T

**e.** Record-keeping. The nurse shall make or keep accurate, intelligible entries into records mandated by law, employment or customary practice of nursing, and will not falsify, destroy, alter or knowingly make incorrect or unintelligible entries into patients' records or employer or employee records. (3-20-20)T

**f.** Diverting or Soliciting. The nurse will respect the property of the patient and employer and not take or divert equipment, materials, property, or drugs without prior consent or authorization, nor solicit or borrow money, materials or property from patients. (3-20-20)T

**g.** Exploit, Solicit, or Receive Fees. The nurse shall not exploit the patient or the patient's family for personal or financial gain or offer, give, solicit, or receive any fee or other consideration for the referral of a patient or client. (3-20-20)T

**h.** Professionalism. The nurse must not abuse the patient's trust, will respect the dignity of the profession and maintain appropriate professional boundaries with respect to patients, the patients' families, and the nurse's coworkers. The nurse is not to engage in sexual misconduct or violent, threatening or abusive behavior towards patients, patients' families or the nurse's coworkers. The nurse will be aware of the potential imbalance of power in professional relationships with patients, based on their need for care, assistance, guidance, and support, and ensure that all aspects of that relationship focus exclusively upon the needs of the patient. (3-20-20)T

**i.** For purposes of this rule and Section 54-1413, Idaho Code, sexual misconduct violations include, but are not limited to: (3-20-20)T

(1) Engaging in or soliciting any type of sexual conduct with a patient; (3-20-20)T

(2) Using the nurse-patient relationship, trust and confidence of the patient derived from the nurse-patient relationship, or any information obtained as a result of the nurse-patient relationship, to solicit, suggest or discuss dating or a romantic or sexual relationship with a patient; (3-20-20)T

(3) Using confidential information obtained during the course of the nurse-patient relationship to solicit, suggest or discuss dating or a romantic relationship, or engage in sexual conduct with a patient, former patient, colleague, or member of the public; and (3-20-20)T

(4) Engaging in or attempting to engage in sexual exploitation or criminal sexual misconduct directed at patients, former patients, colleagues, or members of the public, whether within or outside the workplace. (3-20-20)T

ii. For purposes of this rule: (3-20-20)T

(1) Consent of a patient is not a defense. In the case of sexual exploitation or criminal sexual misconduct, consent of the victim is not a defense. (3-20-20)T

(2) A patient ceases to be a patient thirty (30) days after receiving the final nursing services, or final reasonably anticipated nursing services from a nurse, unless the patient is determined by the Board to be particularly vulnerable by his minority; known mental, emotional, or physical disability; known alcohol or drug dependency; or other circumstance. A patient deemed particularly vulnerable ceases to be a patient one (1) year after receiving the final nursing services, or final reasonably anticipated nursing services from a nurse. (3-20-20)T

(3) It is not a violation of this rule for a nurse to continue a sexual relationship with a spouse or individual of majority if a consensual sexual relationship existed prior to the establishment of the nurse-patient relationship. (3-20-20)T

iii. The following definitions apply to this rule: (3-20-20)T

(1) “Sexual conduct” means any behavior that might reasonably be interpreted as being designed or intended to arouse or gratify the sexual desires of an individual. This includes, but is not limited to, physical touching of breasts, buttocks or sexual organs, creation or use of pornographic images, discussion about sexual topics unrelated to the patient’s care, intentional exposure of genitals, and not allowing a patient privacy, except as may be medically necessary. (3-20-20)T

(2) “Sexual exploitation” means any actual or attempted abuse of a position of vulnerability, differential power, or trust, for sexual purposes, including, but not limited to, profiting monetarily, socially or politically from the sexual conduct of another, or withholding or threatening to withhold care, medication, food or other services to coerce sexual conduct. (3-20-20)T

(3) “Criminal sexual misconduct” means any sexual conduct that, if proven, would constitute a felony or misdemeanor under state or federal law. (3-20-20)T

**102. -- 131. (RESERVED)**

**132. RESTRICTED LICENSES.**

Restricted licenses may be issued to qualified individuals in four (4) categories: post-discipline, non-practicing status, restricted status, and substance use and mental health disorders. Failure to comply with the terms and conditions of a restricted license will be cause for summary suspension. (3-20-20)T

**01. Following Disciplinary Action.** (3-20-20)T

**a.** After evaluation of an application for licensure reinstatement, the Board may issue a restricted license to a nurse whose license has been revoked. (3-20-20)T

**b.** The Board will specify the conditions of issuance of the restricted license in writing. The conditions may be stated on the license. (3-20-20)T

**02. Non-Practicing Status.** (3-20-20)T

**a.** Individuals who are prevented from engaging in the active practice of nursing may be issued a restricted license. (3-20-20)T

**b.** Non-practicing status does not entitle the licensee to engage in the active practice of nursing. The

status will be noted on the license. (3-20-20)T

c. The non-practicing restriction may be removed by the Board following receipt and evaluation of evidence satisfactory to the Board confirming that the licensee's physical or mental health status no longer prevents the individual from engaging in the active practice of nursing. (3-20-20)T

**03. Restricted Status.** (3-20-20)T

a. Individuals whose disabilities restrict or inhibit their ability to provide a full range of nursing services may be issued a restricted license. (3-20-20)T

b. The conditions may include, but are not limited to: (3-20-20)T

i. Notifying the Board of changes in employment status. (3-20-20)T

ii. Submission of regular reports by the employer or by such other entities or individuals as the Board may desire. (3-20-20)T

iii. Meeting with Board representatives. (3-20-20)T

iv. Specific parameters of practice, excluding the performance of specific nursing functions. (3-20-20)T

d. The conditions of restricted practice may be removed by the Board following receipt and evaluation of satisfactory evidence confirming that the health status of the licensee no longer restricts or inhibits the person's ability to provide a full range of nursing services. (3-20-20)T

**04. Disability Due to Substance Use Disorder or Mental Health Disorder.** (3-20-20)T

a. Individuals whose practice is or may be impaired due to substance use disorder or to mental health disorder may qualify for issuance of a restricted license as an alternative to discipline. (3-20-20)T

b. The executive director may restrict the license of an individual who has a substance use disorder or mental health disorder for a period not to exceed five (5) years and who: (3-20-20)T

i. Holds a current license to practice in Idaho as a registered nurse, advanced practice registered nurse, or licensed practical nurse, or is otherwise eligible, and is in the process of applying for licensure; (3-20-20)T

ii. Has a demonstrated or diagnosed substance use disorder or mental health disorder such that ability to safely practice is, or may be, impaired; (3-20-20)T

iii. Sign a written statement admitting to all facts that may constitute grounds for disciplinary action or demonstrate impairment of the safe practice of nursing, and waiving the right to a hearing and all other rights to due process in a contested case under the Idaho Administrative Procedures Act and the Nursing Practice Act; and (3-20-20)T

iv. Submit reliable evidence, satisfactory to the executive director, that they are competent to safely practice nursing before being authorized to return to active practice. (3-20-20)T

c. If ordered, the applicant must satisfactorily complete a treatment program accepted by the Board. (3-20-20)T

d. The applicant agrees to participation in the Board's monitoring program. (3-20-20)T

e. Admission to the Program for Recovering Nurses or issuance of a restricted license, or both, may be denied for any reason including, but not limited to the following: (3-20-20)T

- i. The applicant diverted controlled substances for other than self-administration; or (3-20-20)T
  - ii. The applicant creates too great a safety risk; or (3-20-20)T
  - iii. The applicant has been terminated from this, or any other, alternative program for non-compliance. (3-20-20)T
  - f. Upon satisfactory compliance with all of the terms of the restricted license, and provided that the licensee demonstrates that they are qualified and competent to practice nursing, the executive director will lift the restriction imposed. (3-20-20)T
- 05. Compliance Required.** Restricted licensure is conditioned upon the individual's prompt and faithful compliance with terms and conditions, which may include: (3-20-20)T
- a. Satisfactory progress in any ordered continuing treatment or rehabilitation program. (3-20-20)T
  - b. Regular and prompt notification to the Board of changes in name and address of self or any employer. (3-20-20)T
  - c. Obtaining of performance evaluations prepared by the employer to be submitted at specified intervals and at any time upon request. (3-20-20)T
  - d. Continuing participation in, and compliance with all recommendations and requirements of, the approved treatment or rehabilitation program, and obtaining of reports of progress submitted by the person directing the treatment or rehabilitation program at specified intervals and at any time upon request. (3-20-20)T
  - e. Submission of self-evaluations and personal progress reports at specified intervals and at any time upon request. (3-20-20)T
  - f. Submission of reports of supervised random alcohol/drug screens at specified intervals and at any time upon request. Participant is responsible for reporting as directed, submitting a sufficient quantity of sample to be tested, and payment for the screening. (3-20-20)T
  - g. Meeting with the Board's professional staff or advisory committee at any time upon request. (3-20-20)T
  - h. Working only in approved practice settings. (3-20-20)T
  - i. Authorization by licensee of the release of applicable records pertaining to assessment, diagnostic evaluation, treatment recommendations, treatment and progress, performance evaluations, counseling, random chemical screens, and after-care at periodic intervals as requested. (3-20-20)T
  - j. Compliance with all laws pertaining to nursing practice, all nursing standards, and all standards, policies and procedures of licensee's employer relating to any of the admitted misconduct or facts as set out in the written statement signed by licensee, or relating to the providing of safe, competent nursing service. (3-20-20)T
  - k. Compliance with other specific terms and conditions as may be directed by the executive director. (3-20-20)T
- 06. Summary Suspension - Lack of Compliance.** (3-20-20)T
- a. Any failure to comply with the terms and conditions of a restricted license is deemed to be an immediate threat to the health, safety, and welfare of the public and the executive director will, upon receiving evidence of any such failure, summarily suspend the restricted license. (3-20-20)T
  - i. Summary suspension of a restricted license may occur if, during participation in the program, information is received which, after investigation, indicates the individual may have violated a provision of the law or

Board rules governing the practice of nursing. (3-20-20)T

**b.** An individual whose restricted license has been summarily suspended by the executive director may request a hearing regarding the suspension by certified letter addressed to the Board. If the individual fails to request a hearing within twenty (20) days after service of the notice of suspension by the executive director, the right to a hearing is waived. If a hearing is timely requested, after the hearing the Board will enter an order affirming or rejecting summary suspension of the restricted license and enter such further orders revoking, suspending, or otherwise disciplining the nursing license as may be necessary. The above provisions do not limit or restrict the right of Board staff to bring any summary suspension order before the Board for further proceedings, even if the licensee has not requested a hearing. (3-20-20)T

**c.** The Board may, for good cause, stay any order of the executive director or may modify the terms and conditions of a restricted license as deemed appropriate to regulate, monitor or supervise the practice of any licensee. (3-20-20)T

**133. ADVISORY COMMITTEE.**

The Board will appoint a committee of at least six (6) persons to provide guidance to the Board on matters relating to nurses whose practice is, or may be, impaired due to substance use disorder or mental health disorder, and advise the Board on the direction of the program. Committee members include a member of the Board who serves as the chairperson and other members as established by the Board, but will include persons who are knowledgeable about mental health and substance use disorders. (3-20-20)T

**134. EMERGENCY ACTION.**

If the Board finds that public health, safety, or welfare requires emergency action and incorporates a finding to that effect in its order, summary suspension of a license may be ordered pending proceedings for revocation or other action. Such proceedings will be promptly instituted and determined as authorized in Title 67, Chapter 52, Idaho Code. (3-20-20)T

**135. -- 164. (RESERVED)**

**165. PETITION FOR REHEARING OR RECONSIDERATION.**

**01. Petition for Rehearing or Reconsideration.** An individual may petition for reconsideration of any final order or rehearing based upon the following grounds: (3-20-20)T

- a.** Newly discovered or newly available evidence relevant to the issue; or (3-20-20)T
- b.** Error in the proceeding or Board decision that would be grounds for reversal or judicial review of the order; or (3-20-20)T
- c.** Need for further consideration of the issues and the evidence in the public interest; or (3-20-20)T
- d.** A showing that issues not considered ought to be examined in order to properly dispose of the matter. (3-20-20)T

**02. Administrative Procedure.** The Administrative Procedures Act, Title 67, Chapter 52, Idaho Code, shall govern proceedings on petitions for reconsideration. (3-20-20)T

**166. -- 219. (RESERVED)**

**220. QUALIFICATIONS FOR LICENSURE BY EXAMINATION.**

**01. In-State.** Individuals who have successfully completed all requirements for graduation from an Idaho nursing education program approved by the Board will be eligible to make application to the Board to take the licensing examination. (3-20-20)T

**02. Out-of-State.** Individuals who hold a certificate of completion from a nursing education program having board of nursing approval in another nursing jurisdiction will be eligible to make application to the Board to

take the licensing examination, providing they meet substantially the same basic educational requirements as graduates of Idaho nursing education programs at the time of application. (3-20-20)T

**03. Practical Nurse Equivalency Requirement.** An applicant for practical nurse licensure by examination who has not completed an approved practical nurse program, must provide satisfactory evidence (such as official transcripts) of successful completion of nursing and related courses at an approved school preparing persons for licensure as registered nurses to include a course in personal and vocational relationships of the practical nurse. Related courses are to be equivalent to those same courses included in a practical nursing program approved by the Board. (3-20-20)T

**04. Time Limit for Writing Examinations.** Graduates who do not take the examination within twelve (12) months following completion of the nursing education program must follow specific remedial measures as prescribed by the Board. (3-20-20)T

**221. EXAMINATION APPLICATION.**

A completed application for licensure by examination consists of a completed board approved application, all applicable fees and any additional required documentation. (3-20-20)T

**222. EXAMINATION AND RE-EXAMINATION.**

**01. Applicants for Registered or Practical Nurse Licensure.** Applicants will successfully pass the National Council Licensure Examination (NCLEX) for registered nurse licensure or for practical nurse licensure, as applied for and approved. In lieu of the NCLEX, the Board may accept documentation that the applicant has taken and successfully passed the State Board Test Pool examination. (3-20-20)T

**223. -- 239. (RESERVED)**

**240. QUALIFICATIONS FOR LICENSURE BY ENDORSEMENT.**

An applicant for Idaho licensure by interstate endorsement must: (3-20-20)T

**01. Graduation.** Be a graduate of a state approved/accredited practical or registered nursing education program that is substantially equivalent to Idaho's board-approved practical or registered nursing education program. Applicants for practical nurse licensure may also qualify under the provisions of Section 241 of these rules. (3-20-20)T

**02. Licensing Examination.** Have taken the same licensing examination as that administered in Idaho and achieved scores established as passing for that examination by the Board. (3-20-20)T

**03. Minimum Requirements.** In lieu of the requirements in Subsections 240.01 and 240.02 of this rule, have qualifications that are substantially equivalent to Idaho's minimum requirements. (3-20-20)T

**04. Current Practice Experience.** Have actively practiced nursing at least eighty (80) hours within the preceding three (3) years. (3-20-20)T

**05. License from Another Nursing Jurisdiction.** Hold a license in good standing from another nursing jurisdiction. The license of any applicant subject to official investigation or disciplinary proceedings is not considered in good standing. (3-20-20)T

**241. LICENSURE BY EQUIVALENCY AND ENDORSEMENT LICENSURE.**

**01. Application by Equivalency.** An applicant for practical nurse licensure by interstate endorsement based on equivalency must meet the following requirements: (3-20-20)T

- a. Have successfully taken the same licensing examination as that administered in Idaho; and (3-20-20)T
- b. Hold a license in another nursing jurisdiction based on successful completion of nursing and related

courses at an approved school preparing persons for licensure as registered nurses to include a course in personal and vocational relationships of the practical nurse (or equivalent experience) and additional courses equivalent to those same courses included in a practical nursing program approved by the Board, and provide evidence thereof.

(3-20-20)T

**02. Applicants Licensed in Another Nursing Jurisdiction.** Graduates of schools of nursing located outside the United States, its territories or commonwealths who are licensed in a nursing jurisdiction and who meet the requirements of Subsections 240.02 through 240.05 of these rules may be processed as applicants for licensure by endorsement from another state.

(3-20-20)T

**03. Application for Licensure by Endorsement.** A completed application for licensure by interstate endorsement consists of a completed board approved application, all applicable fees and any additional required documentation.

(3-20-20)T

**242. -- 259. (RESERVED)**

**260. QUALIFICATIONS FOR LICENSURE OF GRADUATES OF SCHOOLS OF NURSING LOCATED OUTSIDE THE UNITED STATES, ITS TERRITORIES, OR COMMONWEALTHS.**

A graduate from a nursing education program outside of the United States, its territories or commonwealths must:

(3-20-20)T

**01. Qualifications.** Demonstrate nursing knowledge and English proficiency skills in reading, writing, speaking and listening.

(3-20-20)T

**02. Education Credentials.** Have education qualifications that are substantially equivalent to Idaho's minimum requirements at the time of application.

(3-20-20)T

**03. License.** Hold a license or other indication of authorization to practice in good standing, issued by a government entity or agency from a country outside the United States, its territories or commonwealths.

(3-20-20)T

**04. Examination/Re-Examination.** Take and achieve a passing score on the licensing examination required in Subsection 222.01 of these rules.

(3-20-20)T

**261. APPLICATION FOR LICENSURE OF GRADUATES OF SCHOOLS OF NURSING LOCATED OUTSIDE THE UNITED STATES, ITS TERRITORIES, OR COMMONWEALTHS.**

A completed application for licensure by a graduate of a nursing education program outside of the United States, its territories or commonwealths consists of a completed board approved application, all applicable fees and any additional required documentation.

(3-20-20)T

**262. -- 270. (RESERVED)**

**271. DEFINITIONS RELATED TO ADVANCED PRACTICE REGISTERED NURSING.**

**01. Accountability.** Means being answerable for one's own actions.

(3-20-20)T

**02. Advanced Practice Registered Nurse.** Means a registered nurse licensed in this state who has gained additional specialized knowledge, skills and experience through a graduate or post-graduate program of study as defined herein and is authorized to perform advanced nursing practice, which may include acts of diagnosis and treatment, and the prescribing, administering and dispensing of therapeutic pharmacologic and non-pharmacologic agents, as defined herein. Advanced practice registered nurses includes nurses licensed in the roles of certified nurse-midwife, clinical nurse specialist, certified nurse practitioner, and certified registered nurse anesthetist. Advanced practice registered nurses, when functioning within the recognized scope of practice, assume primary responsibility for the care of their patients in diverse settings. This practice incorporates the use of professional judgment in the assessment and management of wellness and conditions appropriate to the advanced practice registered nurse's role, population focus and area of specialization.

(3-20-20)T

**03. Authorized Advanced Practice Registered Nurse.** Means an advanced practice registered nurse

authorized by the Board to prescribe and dispense pharmacologic and non-pharmacologic agents pursuant to Section 315 of these rules. (3-20-20)T

**04. Certification.** Means recognition of the applicant's advanced knowledge, skills and abilities in a defined area of nursing practice by a national organization recognized by the Board. The certification process measures the theoretical and clinical content denoted in the advanced scope of practice, and is developed in accordance with generally accepted standards of validation and reliability. (3-20-20)T

**05. Certified Nurse-Midwife.** Means a licensed registered nurse who has graduated from a nationally accredited graduate or post-graduate nurse-midwifery program, and has current certification as a nurse-midwife from a national organization recognized by the Board. (3-20-20)T

**06. Certified Nurse Practitioner.** Means a licensed registered nurse who has graduated from a nationally accredited graduate or post-graduate nurse practitioner program and has current certification as a nurse practitioner from a national organization recognized by the Board. (3-20-20)T

**07. Certified Registered Nurse Anesthetist.** Means a licensed registered nurse who has graduated from a nationally accredited graduate or post-graduate nurse anesthesia program and has current certification as a nurse anesthetist from a national organization recognized by the Board. (3-20-20)T

**08. Clinical Nurse Specialist.** Means a licensed registered nurse who has graduated from a nationally accredited graduate or post-graduate clinical nurse specialist program and has current certification as a clinical nurse specialist from a national organization recognized by the Board. (3-20-20)T

**09. Collaboration.** Means the cooperative working relationship with another health care provider, each contributing their respective expertise in the provision of patient care, and such collaborative practice includes the discussion of patient treatment and cooperation in the management and delivery of health care. (3-20-20)T

**10. Consultation.** Means conferring with another health care provider for the purpose of obtaining information or advice. (3-20-20)T

**11. Diagnosis.** Means identification of actual or potential health problems and the need for intervention based on analysis of data collected. Diagnosis depends upon the synthesis of information obtained through interview, physical exam, diagnostic tests or other investigations. (3-20-20)T

**12. Intervention.** Means measures to promote health, protect against disease, treat illness in its earliest stages, manage acute and chronic illness, and treat disability. Interventions may include, but are not limited to ordering diagnostic studies, performing direct nursing care, prescribing pharmacologic or non-pharmacologic or other therapies and consultation with or referral to other health care providers. (3-20-20)T

**13. Peer Review Process.** The systematic process by which a qualified peer assesses, monitors, and makes judgments about the quality of care provided to patients measured against established practice standards. Peer review: (3-20-20)T

**a.** Measures on-going practice competency of the advance practice registered nurse (APRN); (3-20-20)T

**b.** Is performed by a licensed APRN, physician, physician assistant, or other professional certified by a recognized credentialing organization; and (3-20-20)T

**c.** Focuses on a mutual desire for quality of care and professional growth incorporating attitudes of mutual trust and motivation. (3-20-20)T

**14. Population Focus.** Means the section of the population which the APRN has targeted to practice within. The categories of population foci are: (3-20-20)T

**a.** Family/individual across the lifespan; (3-20-20)T



- b. Adult-gerontology; (3-20-20)T
- c. Women's health/gender-related; (3-20-20)T
- d. Neonatal; (3-20-20)T
- e. Pediatrics; and (3-20-20)T
- f. Psychiatric-mental health. (3-20-20)T

**15. Prescriptive and Dispensing Authorization.** Means the legal permission to prescribe, deliver, distribute and dispense pharmacologic and non-pharmacologic agents to a client in compliance with Board rules and applicable federal and state laws. Pharmacologic agents include legend and Schedule II through V controlled substances. (3-20-20)T

**16. Referral.** Means directing a client to a physician or other health professional or resource. (3-20-20)T

**17. Scope of Practice of Advanced Practice Registered Nurse.** Means those activities that the advanced practice registered nurse may perform. Those activities are defined by the Board according to the advanced practice registered nurse's education, preparation, experience and the parameters set forth by the advanced practice registered nurse's recognized, national certifying organization. (3-20-20)T

**18. Specialization.** Means a more focused area of preparation and practice than that of the APRN role/population foci that is built on established criteria for recognition as a nursing specialty to include, but not limited to, specific patient populations (e.g., elder care, care of post-menopausal women), and specific health care needs (e.g., palliative care, pain management, nephrology). (3-20-20)T

**272. -- 279. (RESERVED)**

**280. STANDARDS OF PRACTICE FOR ADVANCED PRACTICE REGISTERED NURSING.**

**01. Purpose.** (3-20-20)T

- a. To establish standards essential for safe practice by the advanced practice registered nurse; and (3-20-20)T
- b. To serve as a guide for evaluation of advanced practice registered nursing to determine if it is safe and effective. (3-20-20)T

**02. Core Standards for All Roles of Advanced Practice Registered Nursing.** The advanced practice registered nurse is a licensed independent practitioner who shall practice consistent with the definition of advanced practice registered nursing, recognized national standards and the standards set forth in these rules. (3-20-20)T

**a.** The advanced practice registered nurse shall provide client services for which the advanced practice registered nurse is educationally prepared and for which competence has been achieved and maintained. (3-20-20)T

**b.** The advanced practice registered nurse shall recognize their limits of knowledge and experience and consult and collaborate with and refer to other health care professionals as appropriate. (3-20-20)T

**c.** The advanced practice registered nurse shall evaluate and apply current evidence-based research findings relevant to the advanced nursing practice role. (3-20-20)T

**d.** The advanced practice registered nurse shall assume responsibility and accountability for health promotion and maintenance as well as the assessment, diagnosis and management of client conditions to include the

use of pharmacologic and non-pharmacologic interventions and the prescribing and dispensing of pharmacologic and non-pharmacologic agents. (3-20-20)T

**e.** The advanced practice registered nurse shall use advanced practice knowledge and skills in teaching and guiding clients and other health care team members. (3-20-20)T

**f.** The advanced practice registered nurse shall have knowledge of the statutes and rules governing advanced nursing practice, and practice within the established standards for the advanced nursing practice role and population focus. (3-20-20)T

**g.** The advanced practice registered nurse shall practice consistent with Subsections 400.01 and 400.02 of these rules. (3-20-20)T

**03. Certified Nurse-Midwife.** In addition to the core standards, the advanced practice registered nurse in the role of certified nurse midwife provides the full range of primary health care services to women throughout the lifespan, including gynecologic care, family planning services, preconception care, prenatal and postpartum care, childbirth, care of the newborn and reproductive health care treatment of the male partners of female clients. (3-20-20)T

**04. Clinical Nurse Specialist.** In addition to core standards, the advanced practice registered nurse in the role of clinical nurse specialist provides services to patients, care providers and health care delivery systems including, but not limited to, direct care, expert consultation, care coordination, monitoring for quality indicators and facilitating communication between patients, their families, members of the health care team and components of the health care delivery system. (3-20-20)T

**05. Certified Nurse Practitioner.** In addition to core standards, the advanced practice registered nurse in the role of certified nurse practitioner provides initial and ongoing comprehensive primary care services to clients including, but not limited to, diagnosis and management of acute and chronic disease, and health promotion, disease prevention, health education counseling, and identification and management of the effects of illness on clients and their families. (3-20-20)T

**06. Certified Registered Nurse Anesthetist.** In addition to core standards, the advanced practice registered nurse in the role of certified registered nurse anesthetist provides the full spectrum of anesthesia care and anesthesia-related care and services to individuals across the lifespan whose health status may range across the wellness-illness continuum to include healthy persons; persons with immediate, severe or life-threatening illness or injury; and persons with sustained or chronic health conditions. (3-20-20)T

**07. Documentation of Specialization.** Unless exempted under Section 305 of these rules, the advanced practice registered nurse must document competency within their specialty area of practice based upon education, experience and national certification in the role and population focus. (3-20-20)T

**281. -- 284. (RESERVED)**

**285. QUALIFICATIONS FOR ADVANCED PRACTICE REGISTERED NURSE.** To qualify as an advanced practice registered nurse, an applicant shall provide evidence of: (3-20-20)T

**01. Current Licensure.** Current licensure to practice as a registered nurse in Idaho; (3-20-20)T

**02. Completion of Advanced Practice Registered Nurse Program.** Successful completion of a graduate or post-graduate advanced practice registered nurse program which is accredited by a national organization recognized by the Board; and (3-20-20)T

**03. National Certification.** Current national certification by an organization recognized by the Board for the specified APRN role. (3-20-20)T

**286. -- 289. (RESERVED)**

**290. APPLICATION FOR LICENSURE -- ADVANCED PRACTICE REGISTERED NURSE.**

A completed application for licensure as an advanced practice registered nurse requesting licensure to practice as a certified nurse-midwife, clinical nurse specialist, certified nurse practitioner or certified registered nurse anesthetist consists of a completed board-approved application, all applicable fees and any additional required documentation. (3-20-20)T

**291. -- 294. (RESERVED)**

**295. TEMPORARY LICENSURE -- ADVANCED PRACTICE REGISTERED NURSE.**

A temporary license to engage in advanced practice registered nursing may be issued to the following: (3-20-20)T

**01. Applicants Awaiting Initial Certification Examination Results.** An otherwise qualified applicant who is eligible to take the first available certification examination following completion of an approved advanced practice registered nurse education program. Verification of registration to write a Board-recognized national certification examination must be received from the national certifying organization. (3-20-20)T

**a.** Temporary licensure to practice shall be deemed to expire upon failure of the certification examination. An applicant who fails the national certification exam shall not engage in advanced practice registered nursing until such time as all requirements are met. (3-20-20)T

**b.** An applicant who is granted a temporary license to practice as an advanced practice registered nurse must submit notarized results of the certification examination within ten (10) days of receipt. Failure to submit required documentation shall result in the immediate expiration of the temporary license. (3-20-20)T

**c.** The temporary license of an applicant who does not write the examination on the date scheduled shall immediately expire and the applicant shall not engage in advanced practice registered nursing until such time as all requirements are met. (3-20-20)T

**02. Applicants Whose Certification Has Lapsed.** A licensed registered nurse applying for re-entry into advanced registered nursing practice, who is required by the national certifying organization to meet certain specified practice requirements under supervision. The length of and conditions for temporary licensure shall be determined by the Board. (3-20-20)T

**03. Applicants Holding a Temporary Registered Nursing License.** An advanced practice registered nurse currently authorized to practice advanced practice registered nursing in another nursing jurisdiction upon issuance of a temporary license to practice as a registered nurse, and upon evidence of current certification as an advanced practice registered nurse from a Board-recognized national certifying organization. (3-20-20)T

**04. Applicants Without Required Practice Hours.** An advanced practice registered nurse who has not practiced the minimum required period of time during the renewal period may be issued a temporary license in order to acquire the required number of hours and demonstrate ability to safely practice. (3-20-20)T

**05. Application Processing.** An APRN whose application has been received but is not yet complete may be issued a temporary license. (3-20-20)T

**06. Term of Temporary License.** A temporary license expires at the conclusion of the term for which it is issued, or the issuance of a renewable license, whichever occurs earlier. (3-20-20)T

**296. -- 299. (RESERVED)**

**300. RENEWAL OF ADVANCED PRACTICE REGISTERED NURSE LICENSE.**

The advanced practice registered nurse license may be renewed every two (2) years as specified in Section 54-1411, Idaho Code, provided that the advanced practice registered nurse: (3-20-20)T

**01. Current Registered Nurse License.** Maintains a current registered nurse license or privilege to practice in Idaho. (3-20-20)T

**02. Evidence of Certification.** Submits evidence of current APRN certification by a national organization recognized by the Board. (3-20-20)T

**03. Evidence of Continuing Education.** Provides documentation of thirty (30) contact hours of continuing education during the renewal period, which shall include ten (10) contact hours in pharmacology if the nurse has prescriptive authority. Continuing education completed may be that required for renewal of national certification if documentation is submitted confirming the certifying organization's requirement is for at least thirty (30) contact hours. (3-20-20)T

**04. Hours of Practice.** Attests, on forms provided by the Board, to a minimum of two hundred (200) hours of advanced registered nursing practice within the preceding two (2) year period. (3-20-20)T

**05. Peer Review Process.** Provides evidence, satisfactory to the Board, of participation in a peer review process acceptable to the Board. (3-20-20)T

**06. Exemption From Requirements.** Nurse practitioners not certified by a national organization recognized by the Board and approved prior to July 1, 1998 shall be exempt from the requirement set forth in Subsection 300.02 of these rules. (3-20-20)T

**301. REINSTATEMENT OF ADVANCED PRACTICE REGISTERED NURSE LICENSE.**

An advanced practice registered nurse license may be reinstated as specified in Section 54-1411, Idaho Code, provided that the applicant: (3-20-20)T

**01. Current Registered Nurse License.** Maintains a current registered nurse license or privilege to practice in Idaho. (3-20-20)T

**02. Evidence of Certification.** Submits evidence of current APRN certification by a national organization recognized by the Board. (3-20-20)T

**03. Fee.** Pays the fee specified in Section 900 of these rules. (3-20-20)T

**302. -- 304. (RESERVED)**

**305. PERSONS EXEMPTED FROM ADVANCED PRACTICE REGISTERED NURSING LICENSE REQUIREMENTS.**

**01. Students.** Nothing in these rules prohibits a registered nurse who holds a current license, or privilege, to practice in Idaho and who is enrolled as a matriculated student in a nationally accredited educational program for advanced practice registered nursing from practicing as an advanced practice registered nurse when such practice is an integral part of the advanced practice registered nurse curriculum. (3-20-20)T

**02. Certified Nurse Practitioners Licensed Prior to July 1, 1998.** A certified nurse practitioner authorized to practice prior to July 1, 1998 may satisfy the requirement of Section 280.07 of these rules by documenting competency within their specialty area of practice based upon education, experience and national certification in that specialty or education, experience and approval by the Board. (3-20-20)T

**03. Advanced Practice Registered Nurses Educated Prior to January 1, 2016.** (3-20-20)T

**a.** An applicant for APRN licensure who completed a nationally accredited undergraduate or certificate APRN program prior to January 1, 2016, does not need to meet the APRN graduate or post-graduate educational requirements for initial licensure contained within Section 285 of these rules. (3-20-20)T

**b.** A person applying for APRN licensure in Idaho who: holds an existing APRN license issued by any nursing jurisdiction, completed their formal APRN education prior to January 1, 2016, and who meets all of the requirements for initial licensure contained within Sections 285 and 286 of these rules except for the APRN graduate or post-graduate educational requirement, may be issued an APRN license by endorsement if at the time the person received their APRN license in the other jurisdiction they would have been eligible for licensure as an APRN in

Idaho. (3-20-20)T

**306. DISCIPLINARY ENFORCEMENT.**

The Board may revoke, suspend or otherwise discipline the advanced practice registered nurse license of a licensee who fails to comply with current recognized scope and standards of practice, who fails to maintain national certification or competency requirements, or who violates the provisions of the Nursing Practice Act or rules of the Board. (3-20-20)T

**307. -- 314. (RESERVED)**

**315. PRESCRIPTIVE AND DISPENSING AUTHORIZATION FOR ADVANCED PRACTICE REGISTERED NURSES.**

**01. Initial Authorization.** An application for the authority to prescribe and dispense pharmacologic and non-pharmacologic agents may be made as part of initial licensure application or by separate application at a later date. Advanced practice registered nurses who complete their APRN graduate or post-graduate educational program after December 31, 2015, will automatically be granted prescriptive and dispensing authority with the issuance of their Idaho license. (3-20-20)T

**a.** An advanced practice registered nurse who applies for authorization to prescribe pharmacologic and non-pharmacologic agents within the scope of practice for the advanced practice role, shall: (3-20-20)T

**i.** Provide evidence of completion of thirty (30) contact hours of post-basic education in pharmacotherapeutics obtained as part of study within a formal educational program or continuing education program, related to advanced nursing practice; and (3-20-20)T

**ii.** Submit a completed, notarized application form provided by the Board. (3-20-20)T

**b.** Exceptions to the pharmacotherapeutic education may be approved by the Board. (3-20-20)T

**c.** Prescriptions written by authorized advanced practice registered nurses shall contain all the minimum information required by Idaho Board of Pharmacy statute and administrative rules and applicable federal law as well as the printed name and signature of the nurse prescriber, and the abbreviation for the applicable role of the advanced practice nurse (i.e. "CNP," "CNM," "CNS," or CRNA"). If the prescription is for a controlled substance, it shall also include the DEA registration number and address of the prescriber. (3-20-20)T

**02. Temporary Authorization.** The Board may grant temporary prescriptive authority to an applicant who holds a temporary advanced practice registered nurse license and who meets the requirements for initial authorization pursuant to Subsection 315.01 of these rules. (3-20-20)T

**03. Expiration of Temporary Prescriptive Authorization.** Temporary prescriptive authorization automatically expires on the expiration, revocation, suspension, placement on probation, or denial of any advanced practice registered nurse license. (3-20-20)T

**04. Prescribing and Dispensing Authorization.** All authorized advanced practice registered nurses may prescribe and dispense pharmacologic and non-pharmacologic agents pursuant to applicable state and federal laws. (3-20-20)T

**05. Valid Advanced Practice Registered Nurse/Patient Relationships.** (3-20-20)T

**a.** An advanced practice registered nurse shall not dispense pharmacologic agents except in the course of his professional practice and when a bona fide advanced practice registered nurse/patient relationship has been established. A valid relationship will exist when the advanced practice registered nurse has obtained sufficient knowledge of the patient's medical condition through examination and has assumed responsibility for the health care of the patient. (3-20-20)T

**b.** A valid advanced practice registered nurse/patient relationship is not required when dispensing or

prescribing medications under the circumstances set forth at Section 54-1733(4), Idaho Code. (3-20-20)T

**316. GROUNDS FOR DISCIPLINE OF AN ADVANCED PRACTICE REGISTERED NURSE LICENSE.**

In addition to the grounds set forth in Section 54-1413, Idaho Code, and Section 100 of these rules, an advanced practice registered nursing license may be suspended, revoked, placed upon probation, or other disciplinary sanctions imposed by the Board on the following grounds: (3-20-20)T

**01. Prescribing or Dispensing Controlled Substances.** Prescribing, dispensing, or selling any drug classified as a controlled substance to a family member or to himself. For purposes of Section 316 of these rules, “family member” is defined as the licensee’s spouse, child (biological, adopted, or foster), parent, sibling, grandparent, grandchild, or the same relation by marriage. (3-20-20)T

**02. Violating Governing Law.** Violating any state or federal law relating to controlled substances. (3-20-20)T

**03. Outside Scope of Practice.** Prescribing or dispensing outside the scope of the advanced practice registered nurse’s practice. (3-20-20)T

**04. Other Than Therapeutic Purposes.** Prescribing or dispensing for other than therapeutic purposes. (3-20-20)T

**317. -- 319. (RESERVED)**

**320. RECOGNITION OF NATIONAL CERTIFYING ORGANIZATIONS FOR ADVANCED PRACTICE REGISTERED NURSING.**

The Board recognizes advanced practice registered nurse certification organizations that meet criteria as defined by the National Council of State Boards of Nursing. (3-20-20)T

**321. -- 389. (RESERVED)**

**390. USE OF TITLES, ABBREVIATIONS, AND DESIGNATIONS FOR THE PRACTICE OF NURSING.**

**01. Title for Graduates.** A new graduate issued a temporary license pursuant to Section 040 of these rules can use the title graduate nurse, abbreviated GN, or graduate practical nurse, abbreviated GPN, or graduate nurse midwife, abbreviated GNM, or graduate clinical nurse specialist, abbreviated GCNS, or graduate nurse practitioner, abbreviated GNP, or graduate nurse anesthetist, abbreviated GNA, whichever is appropriate, until the renewable license is issued. (3-20-20)T

**02. Titles for Advanced Practice Registered Nurses.** Individuals who have successfully met all requirements for licensure as an advanced practice registered nurse have the right to use the title corresponding to the role of advanced nursing practice for which the individual is licensed. (3-20-20)T

**a.** Individuals who have successfully met all requirements for licensure as a certified nurse-midwife have the right to use the title certified nurse-midwife, abbreviated APRN, CNM. (3-20-20)T

**b.** Title of Clinical Nurse Specialist. Individuals who have successfully met all requirements for licensure as a clinical nurse specialist have the right to use the title clinical nurse specialist, abbreviated APRN, CNS. (3-20-20)T

**c.** Individuals who have successfully met all requirements for licensure as a certified nurse practitioner have the right to use the title certified nurse practitioner, abbreviated APRN, CNP. (3-20-20)T

**d.** Individuals who have successfully met all requirements for licensure as a certified registered nurse anesthetist have the right to use the title certified registered nurse anesthetist, abbreviated APRN, CRNA. (3-20-20)T

**03. Registered Nurse Title.** Individuals who have successfully met all requirements for licensure as registered nurse have the right to use the title Registered Nurse, abbreviated RN. (3-20-20)T

**04. Licensed Practical Nurse Title.** Individuals who have successfully met all requirements for licensure as a practical nurse have the right to use the title Licensed Practical Nurse, abbreviated LPN. (3-20-20)T

**391. -- 399. (RESERVED)**

**400. DECISION-MAKING MODEL.**

The decision-making model is the process by which a licensed nurse evaluates whether a particular act is within the legal scope of that nurse's practice and determines whether to delegate the performance of a particular nursing task in a given setting. This model applies to all licensure categories permitting active practice, regardless of practice setting. (3-20-20)T

**01. Determining Scope of Practice.** To evaluate whether a specific act is within the legal scope of nursing practice, a licensed nurse shall determine whether: (3-20-20)T

**a.** The act is expressly prohibited by the Nursing Practice Act, or the act is limited to the scope of practice of advanced practice registered nurses or to licensed registered nurses, or the act is prohibited by other laws; (3-20-20)T

**b.** The act was taught as a part of the nurse's educational institution's required curriculum and the nurse possesses current clinical skills; (3-20-20)T

**c.** The act does not exceed any existing policies and procedures established by the nurse's employer; (3-20-20)T

**d.** The act is consistent with standards of practice published by a national specialty nursing organization or supported by recognized nursing literature or reputable published research and the nurse can document successful completion of additional education through an organized program of study including supervised clinical practice or equivalent demonstrated competency; (3-20-20)T

**e.** The employment setting/agency has established policies and procedures or job descriptions authorizing performance of the act; and (3-20-20)T

**f.** Performance of the act is within the accepted standard of care that would be provided in a similar situation by a reasonable and prudent nurse with similar education and experience and the nurse is prepared to accept the consequences of the act. (3-20-20)T

**02. Deciding to Delegate.** When delegating nursing care, the licensed nurse retains accountability for the delegated acts and the consequences of delegation. Before delegating any task the nurse shall: (3-20-20)T

**a.** Determine that the acts to be delegated are not expressly prohibited by the Nursing Practice Act or Board rules and that the activities are consistent with job descriptions or policies of the practice setting; (3-20-20)T

**b.** Assess the client's status and health care needs prior to delegation, taking into consideration the complexity of assessments, monitoring required and the degree of physiological or psychological instability; (3-20-20)T

**c.** Exercise professional judgment to determine the safety of the delegated activities, to whom the acts may be delegated, and the potential for harm; (3-20-20)T

**d.** Consider the nature of the act, the complexity of the care needed, the degree of critical thinking required and the predictability of the outcome of the act to be performed; (3-20-20)T

**e.** Consider the impact of timeliness of care, continuity of care, and the level of interaction required with the patient and family; (3-20-20)T

f. Consider the type of technology employed in providing care and the knowledge and skills required to effectively use the technology, including relevant infection control and safety issues; (3-20-20)T

g. Determine that the person to whom the act is being delegated has documented education or training to perform the activity and is currently competent to perform the act; and (3-20-20)T

h. Provide appropriate instruction for performance of the act. (3-20-20)T

**03. Delegating to UAPs.** (3-20-20)T

a. The nursing care tasks that may be delegated to UAPs shall be stated in writing in the practice setting. Decisions concerning delegation will be determined in accordance with the provisions of Section 400 of these rules. UAPs may complement the licensed nurse in the performance of nursing functions, but cannot substitute for the licensed nurse; UAPs cannot redelegate a delegated act. (3-20-20)T

b. Where permitted by law, after completion of a Board-approved training program, UAPs in care settings may assist patients who cannot independently self-administer medications, provided that a plan of care has been developed by a licensed registered nurse, and the act has been delegated by a licensed nurse. Assistance with medication may include: breaking a scored tablet, crushing a tablet, instilling eye, ear or nose drops, giving medication through a pre-mixed nebulizer inhaler or gastric (non-nasogastric) tube, assisting with oral or topical medications and insertion of suppositories. (3-20-20)T

**04. Monitoring Delegation.** Subsequent to delegation, the licensed nurse shall: (3-20-20)T

a. Evaluate the patient's response and the outcome of the delegated act, and take such further action as necessary; and (3-20-20)T

b. Determine the degree of supervision required and evaluate whether the activity is completed in a manner that meets acceptable outcomes. The degree of supervision shall be based upon the health status and stability of the patient, the complexity of the care and the knowledge and competence of the individual to whom the activity is delegated. (3-20-20)T

**401. LICENSED REGISTERED NURSE (RN).**

In addition to providing hands-on nursing care, licensed registered nurses work and serve in a broad range of capacities including, but not limited to, regulation, delegation, management, administration, teaching, and case management. Licensed registered nurses, also referred to as registered nurses or as "RNs," are expected to exercise competency in judgment, decision making, implementation of nursing interventions, delegation of functions or responsibilities, and administration of medications and treatments prescribed by legally authorized persons. (3-20-20)T

**01. Standards of Practice.** A licensed registered nurse adheres to the decision-making model set forth in Section 400 of these rules. (3-20-20)T

**02. Functions.** A partial listing of tasks within the licensed registered nurse's function follows. This listing is for illustrative purposes only, it is not exclusive. The licensed registered nurse: (3-20-20)T

a. Assesses the health status of individuals and groups; (3-20-20)T

b. Utilizes data obtained by assessment to identify and document nursing diagnoses which serve as a basis for the plan of nursing care; (3-20-20)T

c. Collaborates with the patient, family, and health team members; (3-20-20)T

d. Develops and documents a plan for nursing intervention based on assessment, analysis of data, identified nursing diagnoses and patient outcomes; (3-20-20)T



- e. Is accountable and responsible for implementation of planned and prescribed nursing care; (3-20-20)T
  - f. Maintains safe and effective nursing care by: (3-20-20)T
  - i. Maintaining a safe environment; (3-20-20)T
  - ii. Evaluating patient status and instituting appropriate therapy or procedures which might be required in emergency situations to stabilize the patient's condition or prevent serious complications in accordance with standard procedures established by the policy-making body in the health care setting, including but not limited to administration of intravenous drugs and starting intravenous therapy based on protocols if the patient has been assessed and determined to be in peril; (3-20-20)T
  - iii. Acting as a patient's advocate; (3-20-20)T
  - iv. Applying principles of asepsis and infection control and universal standards when providing nursing care; (3-20-20)T
  - v. Implementing orders for medications and treatments issued by an authorized prescriber; and (3-20-20)T
  - vi. Providing information and making recommendations to patients and others in accordance with employer policies; (3-20-20)T
  - g. Utilizes identified goals and outcomes to evaluate responses to interventions; (3-20-20)T
  - h. Collaborates with other health professionals by: (3-20-20)T
  - i. Communicating significant changes in a patient's status or responses to appropriate health team professionals; (3-20-20)T
  - ii. Coordinating the plan of care with other health team professionals; and (3-20-20)T
  - iii. Consulting with nurses and other health team members as necessary; (3-20-20)T
  - i. Teaches the theory and practice of nursing; and (3-20-20)T
  - j. Facilitates, mentors and guides the practice of nursing formally and informally in practice settings. (3-20-20)T
  - k. Engages in other interfaces with healthcare providers and other workers in settings where there is not a structured nursing organization and in settings where health care plays a secondary role, where the nurse needs to identify the nursing role and responsibility for the particular type of interface, for example, teaching, supervising, consulting, advising, etc. (3-20-20)T
- 03. Chief Executive Role.** A licensed registered nurse functioning in a chief executive role is accountable and responsible for: (3-20-20)T
- a. Prescribing, directing and evaluating the quality of nursing services including, but not limited to, staff development and quality improvement; (3-20-20)T
  - b. Assuring that organizational policies and procedures, job descriptions and standards of nursing practice conform to the Nursing Practice Act and nursing practice rules; (3-20-20)T
  - c. Assuring that the knowledge, skills and abilities of nursing care staff are assessed and that nursing care activities do not exceed the legally defined boundaries of practice; and (3-20-20)T

d. Assuring that documentation of all aspects of the nursing organization is maintained. (3-20-20)T

**04. Management Role.** A licensed registered nurse functioning in a management role is accountable and responsible for: (3-20-20)T

a. The quality and quantity of nursing care provided by nursing personnel under their supervision; (3-20-20)T

and b. Managing and coordinating nursing care in accordance with established guidelines for delegation; (3-20-20)T

c. Providing leadership in formulating, interpreting, implementing, and evaluating the objectives and policies of nursing practice. (3-20-20)T

**402. LICENSED REGISTERED NURSE FUNCTIONING IN SPECIALTY AREAS.**

**01. Extended Functions.** A licensed registered nurse may carry out functions beyond the basic educational preparation described in Sections 600 through 681 of these rules under certain conditions. (3-20-20)T

**02. Conditions for Licensed Registered Nurses Functioning in Specialty Practice Areas.** A licensed registered nurse may carry out functions defined within parameters of a nursing specialty that meets criteria approved by the American Board of Nursing Specialties (ABNS) or the National Commission for Certifying Agencies (NCCA) of the National Organization for Competency Assurance (NOCA) when the nurse: (3-20-20)T

a. Can document successful completion of additional education through an organized program of study including supervised clinical experience or equivalent demonstrated competence consistent with provisions of Section 400 of these rules; and (3-20-20)T

b. Conforms to recognized nursing specialty practice parameters, characters, and standards for practice of the specialty. (3-20-20)T

**403. -- 459. (RESERVED)**

**460. LICENSED PRACTICAL NURSE (LPN).**

Licensed practical nurses function in dependent roles. Licensed practical nurses, also referred to as LPNs, provide nursing care at the delegation of a licensed registered nurse, licensed physician, or licensed dentist pursuant to rules established by the Board. The stability of the patient's environment, the patient's clinical state, and the predictability of the outcome determine the degree of direction and supervision that must be provided to the licensed practical nurse. (3-20-20)T

**01. Standards.** The licensed practical nurse shall be personally accountable and responsible for all actions taken in carrying out nursing activities and adheres to the decision-making model set forth in Section 400 of these rules. (3-20-20)T

**02. Functions.** A partial listing of some of the functions that are included within the legal definition of licensed practical nurse, Section 54-1402(3), Idaho Code, (Nursing Practice Act) follows. This list is for example only, it is not complete. The licensed practical nurse: (3-20-20)T

a. Contributes to the assessment of health status by collecting, reporting and recording objective and subjective data; (3-20-20)T

b. Participates in the development and modification of the plan of care; (3-20-20)T

c. Implements aspects of the plan of care; (3-20-20)T

d. Maintains safe and effective nursing care; (3-20-20)T

e. Participates in the evaluation of responses to interventions; (3-20-20)T

- f. Fulfills charge nurse responsibilities in health care facilities as allowed by state and federal law; (3-20-20)T
- g. Delegates to others as allowed by application of the decision-making model; and (3-20-20)T
- h. Accepts delegated assignments only as allowed by application of the decision-making model. (3-20-20)T
- i. Engages in other interfaces with healthcare providers and other workers in settings where there is not a structured nursing organization and in settings where health care plays a secondary role, where the nurse needs to identify the nursing role and responsibility for the particular type of interface, for example, teaching, supervising, consulting, advising, etc. (3-20-20)T

**461. -- 490. (RESERVED)**

**491. TECHNICIANS/TECHNOLOGISTS.**

**01. Functions.** Technicians/technologists may perform limited nursing functions within the ordinary, customary, and usual roles in their fields and are exempted from licensure by the Board under Section 54-1412, Idaho Code, provided they are: (3-20-20)T

- a. Enrolled in or have completed a formal training program acceptable to the Board; or (3-20-20)T
- b. Registered with or certified by a national organization acceptable to the Board. (3-20-20)T

**02. Supervision.** Technicians/technologists providing basic nursing care services on an organized nursing unit in an institutional setting must function under the supervision of a licensed registered nurse. (3-20-20)T

**492. -- 599. (RESERVED)**

**600. NURSING EDUCATION FOR REGISTERED AND PRACTICAL NURSES.**

**601. PURPOSE OF APPROVAL.**

To assure safe practice of nursing by establishing standards, criteria, and curriculum requirements for education programs preparing persons for the practice of nursing, and for enhancing the knowledge and skills of those in practice. (3-20-20)T

**01. Preparation of Graduates.** To ensure that graduates of nursing education programs are prepared for safe and effective nursing practice. (3-20-20)T

**02. Guide for Development.** To serve as a guide for the development of new nursing education programs. (3-20-20)T

**03. Continued Improvement.** To foster the continued improvement of established nursing education programs. (3-20-20)T

**04. Evaluation Criteria.** To provide criteria for the evaluation of new and established nursing education programs. (3-20-20)T

**05. Eligibility for Licensing Examination.** To assure eligibility for admission to the licensing examination for nurses, and to facilitate interstate endorsement of graduates of Board-approved nursing education programs. (3-20-20)T

**602. APPROVAL OF A NEW EDUCATIONAL PROGRAM.**

- 01. Educational Programs.** (3-20-20)T

- a.** Any university, college, or other institution wishing to establish a nursing education program must make application to the Board on forms supplied by the Board. The following information is to be included with the initial application: (3-20-20)T
- i. Purpose for establishing the nursing education program; (3-20-20)T
  - ii. Community needs and studies made, as basis for establishing a nursing education program; (3-20-20)T
  - iii. Type of program; (3-20-20)T
  - iv. Accreditation status, relationship of educational program to parent institution; (3-20-20)T
  - v. Financial provision for the educational program; (3-20-20)T
  - vi. Potential student enrollment; (3-20-20)T
  - vii. Provision for qualified faculty; (3-20-20)T
  - viii. Proposed clinical facilities and other physical facilities; and (3-20-20)T
  - ix. Proposed time schedule for initiating the program. (3-20-20)T
- b.** A representative of the Board will visit the educational and clinical facilities and then submit a written report to the Board. (3-20-20)T
- c.** Representatives of the parent institution must meet with the Board to review the application within ninety (90) days of the conduct of the initial survey visit. (3-20-20)T
- d.** Following the Board's review, the parent institution will be notified of the Board's decision within thirty (30) days of the review. (3-20-20)T
- e.** Following the appointment of a qualified nurse administrator, a minimum period of twelve (12) months is necessary for planning to be completed before the first class of students is admitted to the program. (3-20-20)T
- f.** Provisional approval may be applied for when the following conditions have been met: (3-20-20)T
- i. A qualified nurse administrator has been appointed; (3-20-20)T
  - ii. There are sufficient qualified faculty to initiate the program; (3-20-20)T
  - iii. The curriculum and plans for its implementation have been developed, including tentative clinical affiliation agreements; and (3-20-20)T
  - iv. Program policies have been developed. (3-20-20)T
- g.** Provisional approval must be granted before the first students are admitted to the nursing program. (3-20-20)T
- h.** Students can be admitted to the nursing program once provisional approval is granted. (3-20-20)T
- i. A representative of the Board will make a follow-up survey visit to the educational program and submit a written report to the Board. (3-20-20)T
  - ii. Following the Board's review, the parent institution will be notified of the Board's decision within

thirty (30) days. (3-20-20)T

iii. Following its review, the Board may grant: full approval, if all conditions have been met; or conditional approval, if all standards have not been met, with such conditions and requirements as the Board may designate to insure compliance with standards within the designated time period; or denial of approval, if standards have not been met. (3-20-20)T

i. Full approval will be applied for and granted within a three (3) year period following eligibility. (3-20-20)T

**603. CONTINUANCE OF FULL APPROVAL OF EDUCATIONAL PROGRAM.**

**01. Continuing Full Approval.** (3-20-20)T

a. A certificate of continuing full approval will be granted for up to eight (8) years to nursing education programs that consistently meet the Board's standards, as evidenced by: (3-20-20)T

i. Information included in the annual report to the Board; (3-20-20)T

ii. Information obtained by a Board representative through consultation visits; and (3-20-20)T

iii. Acceptable performance on the licensing examination for each program shall be a pass rate of eighty percent (80%) for its first-time writers in any given calendar year. A program whose pass rate falls below eighty percent (80%) for first-time writers in any two (2) consecutive calendar years shall: (3-20-20)T

(1) Present to the Board a plan for identifying possible contributing factors and for correcting any identified deficiencies; and (3-20-20)T

(2) Submit periodic progress reports on a schedule determined by the Board. (3-20-20)T

b. To ensure continuing compliance with the Board's standards, each approved nursing education program will submit an annual report to the Board. Based on its findings the Board may: (3-20-20)T

i. Request additional information from the nursing education program. (3-20-20)T

ii. Conduct an on-site review of the nursing education program. (3-20-20)T

iii. Request a full survey of the nursing education program. (3-20-20)T

c. Written reports of the survey will be submitted to the Board for review and acceptance. Copies of the report and recommendations will then be sent to the educational institution within thirty (30) days of the review. (3-20-20)T

d. Nursing education programs that do not meet the standards of the Board may be placed on conditional approval status, with such conditions and requirements as the Board may designate to ensure compliance with standards within a reasonable time period. (3-20-20)T

e. At the end of the period of conditional approval, full approval may be restored if the required conditions have been met, or approval may be withdrawn if the required conditions have not been met. Upon petition and written documentation by the nursing education program of extenuating circumstances, the Board may consider extending the period of conditional approval. The school must submit documentation within ten (10) days of notification of withdrawal of full approval. (3-20-20)T

f. Following notification of the Board's decision to place a program on conditional approval or to withdraw program approval, the educational program will have ten (10) days in which to request a hearing. Upon receipt of a request for hearing, the Board's action will be stayed until the matter is heard. Hearings shall be conducted in the same manner as disciplinary hearings, in accordance with Title 67, Chapter 52, Idaho Code.

(3-20-20)T

**604. DISCONTINUANCE OF AN EDUCATIONAL PROGRAM.**

When an educational institution plans to discontinue its education program, the following procedure must be used:  
(3-20-20)T

and **01. Notify in Writing.** Notify the Board in writing at least one (1) academic year prior to the closure;  
(3-20-20)T

**02. Follow Plan.** Follow institutional plan for program closure including: (3-20-20)T

**a.** Maintenance of program standards until last class has graduated; and (3-20-20)T

**b.** Provision for disposition of student records. (3-20-20)T

**605. -- 629. (RESERVED)**

**630. PHILOSOPHY AND OBJECTIVES OF EDUCATIONAL PROGRAM.**

The nursing education program shall have statements of philosophy and objectives that are consistent with those of the parent institution and with the law governing the practice of nursing. (3-20-20)T

**631. ADMINISTRATION OF EDUCATIONAL PROGRAM.**

**01. Administration of Educational Programs.** (3-20-20)T

**a.** The educational program in nursing shall be an integral part of an accredited institution of higher learning. (3-20-20)T

**b.** There shall be an institutional organizational design that demonstrates the relationship of the program to the administration and to comparable programs within the institution, and that clearly delineates the lines of authority, responsibility, and channels of communication. The program faculty are given the opportunity to participate in the governance of the program and the institution. (3-20-20)T

**i.** Qualifications, rights, and responsibilities of faculty are addressed in written personnel policies which are consistent with those of the parent institution as well as those of other programs within the institution. (3-20-20)T

**ii.** Faculty workloads shall be consistent with responsibilities identified in Section 644 of these rules. (3-20-20)T

**c.** The program must have an organizational design with clearly defined authority, responsibility, and channels of communication that assures both faculty and student involvement. (3-20-20)T

**d.** Administrative responsibility and control shall be delegated to the nursing education administrator by the parent institution. (3-20-20)T

**e.** The program must have a written purpose that is consistent with the mission of the institution. The program must have written policies that are congruent with the institution's policies and are periodically reviewed. (3-20-20)T

**632. FINANCIAL SUPPORT OF EDUCATIONAL PROGRAM FOR PRACTICAL NURSE, REGISTERED NURSE, AND ADVANCED PRACTICE REGISTERED NURSE.**

There must be evidence of financial support and resources adequate to achieve the purpose of the program. Resources include: facilities, equipment, supplies, and qualified administrative, instructional, and support personnel and services. (3-20-20)T

**633. RECORDS OF EDUCATIONAL PROGRAM.**

The nursing education program structure shall provide for pre-admission and current records for each student while enrolled. Final records for each student shall be maintained on a permanent basis in accordance with the policies of the parent institution. (3-20-20)T

**634. -- 639. (RESERVED)**

**640. FACULTY QUALIFICATIONS.**

**01. Practical Nurse Program Faculty Qualifications.** Nursing faculty who have primary responsibility for planning, implementing, and evaluating curriculum in a program leading to licensure as a practical nurse shall have: (3-20-20)T

- a. A current, unencumbered license to practice as a registered nurse in this state; (3-20-20)T
- b. A minimum of a baccalaureate degree with a major in nursing; and (3-20-20)T
- c. Evidence of nursing practice experience. (3-20-20)T

**02. Registered Nurse Program Faculty Qualifications.** There shall be sufficient faculty to achieve the purpose of the program. (3-20-20)T

**a.** Nursing faculty who have primary responsibility for planning, implementing, and evaluating curriculum in a program leading to licensure as a registered nurse shall have: (3-20-20)T

- i. A current, unencumbered license to practice as a registered nurse in this state; (3-20-20)T
- ii. A minimum of a master's degree with a major in nursing; and (3-20-20)T
- iii. Evidence of nursing practice experience. (3-20-20)T

**b.** Additional support faculty necessary to accomplish program objectives shall have: (3-20-20)T

- i. A current, unencumbered license to practice as a registered nurse in this state; (3-20-20)T
- ii. A minimum of a baccalaureate degree with a major in nursing; and (3-20-20)T
- iii. A plan approved by the Board for accomplishment of the master's of nursing within three (3) years of appointment to the faculty position. (3-20-20)T

**03. Advanced Practice Registered Nurse Program Faculty Qualifications.** There shall be sufficient faculty to achieve the purpose of the program. Faculty who have primary responsibility for planning, implementing and evaluating curriculum in a program preparing individuals to license as an advanced practice registered nurse shall have: (3-20-20)T

- a. A current, unencumbered license to practice as a registered nurse in this state; and (3-20-20)T
- b. A graduate degree or post-graduate degree in nursing; (3-20-20)T
- c. An advanced practice registered nurse license and national certification if responsible for courses in a specific advanced practice registered nurse role and population; and (3-20-20)T
- d. Evidence of advanced registered nursing practice experience. (3-20-20)T

**04. Non-clinical Nursing Courses Faculty Qualifications.** Interprofessional faculty teaching non-clinical nursing course shall have advanced preparation appropriate for the content being taught. (3-20-20)T

**05. Clinical Preceptors in Registered Nurse, Practical Nurse, and Advanced Practice Registered**

**Nurse Programs.** Clinical preceptors may be used to enhance clinical learning experiences. (3-20-20)T

**a.** Clinical preceptors in registered and practical nurse programs shall be licensed for nursing practice at or above the license role for which the student is preparing. (3-20-20)T

**b.** Clinical preceptors in advanced practice registered nurse programs shall be licensed to practice as an advanced practice registered nurse (APRN), a physician (MD or DO), or a physician assistant (PA) in an area of practice relevant to the educational course objectives. (3-20-20)T

**c.** Student-Preceptor ratio shall be appropriate to accomplishment of learning objectives; to provide for patient safety; and to the complexity of the clinical situation. (3-20-20)T

**d.** Criteria for selecting preceptors shall be in writing. (3-20-20)T

**e.** Functions and responsibilities of the preceptor shall be clearly delineated in a written agreement between the agency, the preceptor, and the educational program. (3-20-20)T

**f.** The faculty shall be responsible to: (3-20-20)T

**i.** Make arrangements with agency personnel in advance of the clinical experience, providing information such as numbers of students to be in the agency at a time, dates and times scheduled for clinical experience, faculty supervision to be provided, and arrange for formal orientation of preceptors. (3-20-20)T

**ii.** Inform agency personnel of faculty-defined objectives and serve as a guide for selecting students' learning experiences and making assignments. (3-20-20)T

**iii.** Monitor students' assignments, make periodic site visits to the agency, evaluate students' performance on a regular basis with input from the student and from the preceptor, and be available by telecommunication during students' scheduled clinical time. (3-20-20)T

**g.** Provide direct supervision, by either a qualified faculty person or an experienced registered nurse employee of the agency, during initial home visits and whenever the student is implementing a nursing skill for the first time or a nursing skill with which the student has had limited experience. (3-20-20)T

**07. Continued Study.** The parent institution will support and make provisions for continued professional development of the faculty. (3-20-20)T

**641. FACULTY.**

**01. Numbers Needed.** There shall be sufficient faculty with educational preparation and nursing expertise to meet the objectives and purposes of the nursing education program. (3-20-20)T

**a.** Number of faculty shall be sufficient to design and implement the curriculum necessary to prepare students to function in a rapidly changing healthcare environment. (3-20-20)T

**b.** Number of faculty in the clinical setting shall be sufficient in number to assure patient safety and meet student learning needs. (3-20-20)T

**02. Faculty-Student Ratio.** There shall be no more than ten (10) students for every faculty person in the clinical agencies. Deviations may be presented for approval with the program's annual report to the Board with written justification assuring client safety and supporting accomplishment of program objectives. (3-20-20)T

**642. (RESERVED)**

**643. ADMINISTRATOR RESPONSIBILITIES AND QUALIFICATIONS.**

**01. Administrator Responsibilities.** The administrator provides the leadership and is accountable for the administration, planning, implementation, and evaluation of the program. The administrator's responsibilities



include, but are not limited to: (3-20-20)T

- a. Development and maintenance of an environment conducive to the teaching and learning processes; (3-20-20)T
- b. Liaison with and maintenance of the relationship with administrative and other units within the institution; (3-20-20)T
- c. Leadership within the faculty for the development and implementation of the curriculum; (3-20-20)T
- d. Preparation and administration of the program budget; (3-20-20)T
- e. Facilitation of faculty recruitment, development, performance review, promotion, and retention; (3-20-20)T
- f. Liaison with and maintenance of the relationship with the Board; and (3-20-20)T
- g. Facilitation of cooperative agreements with practice sites. (3-20-20)T

**02. Administrator Qualifications.** The administrator of the program shall be a licensed registered nurse, with a current unencumbered license to practice in this state, and with the additional education and experience necessary to direct the program. (3-20-20)T

**a.** Practical Nurse Administrator. The administrator in a program preparing for practical nurse licensure shall: (3-20-20)T

- i. Hold a minimum of a graduate degree with a major in nursing; and (3-20-20)T
- ii. Have evidence of experience in education, administration, and practice sufficient to administer the program. (3-20-20)T

**b.** Registered Nurse Administrator. The administrator in a program preparing for registered nurse licensure shall: (3-20-20)T

- i. Hold a minimum of a graduate degree with a major in nursing and meet institutional requirements; and (3-20-20)T
- ii. Have evidence of experience in education, administration, and practice sufficient to administer the program. (3-20-20)T

**c.** Advanced Practice Registered Nurse Administrator. The administrator in a program preparing for advanced practice registered nursing shall: (3-20-20)T

- i. Hold a graduate and post-graduate degree, one (1) of which is in nursing; and (3-20-20)T
- ii. Have evidence of experience in education, administration, and practice sufficient to administer the program. (3-20-20)T

**03. Numbers of Administrators Needed.** There shall be at least one (1) qualified nursing administrator for each nursing education department or division. In institutions that offer nursing education programs for more than one (1) level of preparation and where the scope of administrative responsibility so requires, there shall be an individual administrator for each nursing education program. (3-20-20)T

**644. FACULTY RESPONSIBILITIES.**

**01. Faculty Responsibilities.** Nursing faculty responsibilities include, but are not limited to the

- following: (3-20-20)T
- a. Assess, plan, implement, evaluate, and modify the program based on sociological and environmental indicators; (3-20-20)T
  - b. Design, implement, evaluate, and update the curriculum using a written plan; (3-20-20)T
  - c. Develop, implement, evaluate, and update policies for student admission, progression, retention, and graduation in keeping with the policies of the school; (3-20-20)T
  - d. Participate in academic advisement and guidance of students; (3-20-20)T
  - e. Provide theoretical instruction and practice experiences; (3-20-20)T
  - f. Select, monitor, and evaluate preceptors and the student learning experiences; (3-20-20)T
  - g. Evaluate student achievement of curricular outcomes related to nursing knowledge and practice; (3-20-20)T
  - h. Evaluate teaching effectiveness; (3-20-20)T
  - i. Participate in activities that facilitate maintaining the faculty members' own nursing competence and professional expertise in the area of teaching responsibility, including instructional methodology; (3-20-20)T
  - j. Participate in other scholarly activities, including research, consistent with institutional and professional requirements; and (3-20-20)T
  - k. Participate in the organization of the program and institution. (3-20-20)T

**645. -- 659. (RESERVED)**

**660. STUDENTS, EDUCATIONAL PROGRAM.**

- 01. Student Policies.** Student policies should facilitate mobility and articulation and be consistent with the educational standards of the parent institution. Student policies in relation to the following must be in writing and available: (3-20-20)T
- a. Admission, readmission, progression, retention, graduation, dismissal, and withdrawal; (3-20-20)T
  - b. Physical, mental health, and legal standards required by affiliate agencies and the law governing the practice of nursing; (3-20-20)T
  - c. Student responsibilities; (3-20-20)T
  - d. Student rights and grievance procedures; and (3-20-20)T
  - e. Student opportunity to participate in program governance and evaluation. (3-20-20)T

**661. -- 679. (RESERVED)**

**680. CURRICULUM, EDUCATIONAL PROGRAM.**

- 01. Student Competence.** (3-20-20)T
- a. Students enrolled in a practical nursing program shall be provided the opportunity to acquire and demonstrate the knowledge, skills, and abilities for safe and effective nursing practice. The graduate from a practical nurse program is responsible and accountable to practice according to the standards of practice for the licensed

practical nurse as defined in Section 460 of these rules. (3-20-20)T

**b.** Students enrolled in a registered nurse program shall be provided the opportunity to acquire and demonstrate the knowledge, skills, and abilities for safe and effective nursing practice. The graduate from a registered nurse program is responsible and accountable to practice according to the standards of practice for the registered nurse as defined in Section 401 of these rules. (3-20-20)T

**c.** Students enrolled in advanced practice registered nursing education shall be provided the opportunity to acquire and demonstrate the knowledge, skills, and abilities for safe and effective advanced nursing practice. The graduate from an advanced practice registered nursing program is responsible and accountable to practice according to the standards for the advanced practice nursing role for which the nurse is prepared as defined in Section 280 of these rules. (3-20-20)T

**02. Program Evaluation.** The program shall have a plan for total program evaluation that includes, but is not limited to the following: organization and administration, faculty, students, curriculum, and performance of graduates. Implementation of the plan and use of findings for relevant decision making must be evident. (3-20-20)T

**681. CURRICULUM REQUIREMENTS FOR NURSING EDUCATION PROGRAMS.**

**01. General Curriculum.** For licensed practical nurses, registered nurses, and advanced practice registered nurses the general curriculum is as follows: (3-20-20)T

- a.** Be planned, implemented, and evaluated by the faculty with provisions for student input; (3-20-20)T
- b.** Reflect the mission and purpose of the nursing education program; (3-20-20)T
- c.** Be organized logically and sequenced appropriately; (3-20-20)T
- d.** Facilitate articulation for horizontal and vertical mobility; (3-20-20)T
- e.** Have a syllabus for each nursing course; (3-20-20)T
- f.** Have written, measurable terminal outcomes that reflect the role of the graduate; and (3-20-20)T
- g.** Be responsive to changing healthcare environment. (3-20-20)T

**02. Curriculum Changes.** Major curriculum changes, as defined in Section 700 of these rules, will be submitted to the Board for approval prior to implementation. (3-20-20)T

**03. Practice Sites.** The program will have sufficient correlated practice experiences to assure development of nursing competencies. (3-20-20)T

**04. Practical Nurse Curriculum.** The curriculum includes: (3-20-20)T

- a.** Nursing didactic content and practice experience that establish the knowledge base for demonstrating beginning competency; and (3-20-20)T
- b.** Integrated, combined or separate coursework from the following academic disciplines and meets requirements for the credential with a major in practical nursing: (3-20-20)T
  - i.** Communication and information systems concepts; (3-20-20)T
  - ii.** Behavioral and social science concepts that serve as a framework for understanding growth and development throughout the life cycle, human behavior, interpersonal relationships, and cultural diversity; (3-20-20)T

iii. Physical and biological sciences concepts that help the students gain an understanding of the principles of scientific theory and computation; (3-20-20)T

iv. Nursing concepts that provide the basis for understanding the principles of nursing care and appropriate and sufficient correlated nursing practice experiences to assure development of competencies as a member of the interdisciplinary team; (3-20-20)T

v. Concepts regarding legal, managerial, economic, and ethical issues related to responsibilities of the practical nurse; and (3-20-20)T

vi. Courses to meet the school's general education requirements for the credential awarded. (3-20-20)T

**05. Registered Nurse Curriculum.** The curriculum includes: (3-20-20)T

**a.** Nursing didactic content and practice experience that establish the knowledge base for demonstrating beginning competency related to: (3-20-20)T

i. Nursing practice; (3-20-20)T

ii. Systems thinking and interdisciplinary team function; and (3-20-20)T

iii. The promotion and restoration of optimal patient health throughout the lifespan in a variety of primary, secondary and tertiary settings focusing on individuals, groups, and communities. (3-20-20)T

**b.** Integrated, combined or separate coursework from the following academic disciplines and meets requirements for a degree with a major in nursing: (3-20-20)T

i. Concepts in written and oral communication, values clarification, scientific inquiry, computation, and informatics; (3-20-20)T

ii. Behavioral and social sciences concepts that serve as a framework for the understanding of growth and development throughout the life cycle, human behavior, interpersonal relationships, cultural diversity, and economics related to the social context of healthcare; (3-20-20)T

iii. Physical and biological sciences concepts that help the student gain an understanding of the principles of scientific theory; (3-20-20)T

iv. Arts and humanities concepts that develop the aesthetic, ethical, and intellectual capabilities of the student; (3-20-20)T

v. Concepts regarding research, nursing theory, legal and ethical issues, trends in nursing, principles of education and learning, and professional responsibilities; (3-20-20)T

vi. Experiences that promote the development of leadership and management skills, interdisciplinary and professional socialization; and (3-20-20)T

vii. Courses to meet the school's general education requirements for the academic degree. (3-20-20)T

**06. Advanced Practice Registered Nursing Program Curriculum.** The curriculum includes: (3-20-20)T

**a.** Content necessary to prepare the graduate for practice consistent with defined standards for advanced nursing practice; and (3-20-20)T

**b.** Content from nursing and related academic disciplines and meet requirements for a graduate degree with a major in nursing: (3-20-20)T

- i. Advanced theory and research in nursing, biological and behavioral sciences, interdisciplinary education, cultural diversity, economics and informatics sufficient to practice as a graduate prepared registered nurse; (3-20-20)T
- ii. Legal, ethical, and professional responsibilities of a graduate prepared registered nurse; (3-20-20)T
- iii. Didactic content and supervised practice experience relevant to the nursing focus of the graduate specialty; and (3-20-20)T
- iv. Courses to meet the school's requirements for the graduate degree. (3-20-20)T

**682. -- 699. (RESERVED)**

**700. CURRICULUM CHANGE, EDUCATIONAL PROGRAM.**

Any proposed curriculum revision that involves major changes in the philosophy and objectives, significant course content changes, or changes in the length of the program, shall be submitted to and approved by the Board prior to implementation. Minor curriculum changes such as redistribution of nursing course content or slight increase or decrease in the number of theory and clinical hours must be reported to the Board in the Annual Report, but do not require Board approval. Curriculum revision that alters existing articulation agreements must be approved by the State Board of Education prior to implementation. (3-20-20)T

**701. -- 729. (RESERVED)**

**730. PRACTICE SITES.**

The program must have sufficient practice experiences to assure development of nursing competencies. (3-20-20)T

**01. Approval by Other Agencies.** Cooperating agencies shall be approved by the recognized accreditation, evaluation or licensing body as appropriate. (3-20-20)T

**02. Evaluation by Faculty.** Agencies used to provide practice experiences must be evaluated periodically by faculty. (3-20-20)T

**03. Sufficient Experiences.** There must be sufficient practice experiences to assure the development of nursing competencies consistent with the level of preparation. (3-20-20)T

**04. Written Agreements.** There must be written agreements with cooperating agencies that are reviewed and revised periodically. (3-20-20)T

**05. Faculty Supervision.** Sufficient faculty must be employed to supervise student practice experiences. An appropriate student to faculty ratio must be maintained to provide for safety and protection of patients, students, and faculty members. (3-20-20)T

**06. Planned Communication.** Means shall be provided for ongoing and periodic planned communication between faculty and agency administrative personnel and between faculties of all educational programs using the agency; the responsibility for coordination shall be specifically identified. (3-20-20)T

**731. -- 899. (RESERVED)**

**900. INITIAL LICENSE, RENEWAL AND REINSTATEMENT FEES.**

**01. Assessed Fees.** Fees will be assessed for renewal of licensure or for reinstatement of a lapsed, disciplined, limited, or emeritus license. Any person submitting the renewal application and fee post-marked or electronically dated later than August 31 shall be considered delinquent and the license lapsed and therefore invalid:

<b>23.01.01.900 - Initial Licensure, Renewal &amp; Reinstatement Fees</b>				
	<b>Registered Nurse</b>	<b>Practical Nurse</b>	<b>Advanced Practice Nurse</b>	<b>Medication Assistant - Certified</b>
Temporary License Fee	\$25	\$25	\$25	
Initial Application Fee			\$90	
License by Exam Fee	\$90	\$75	\$90	
License by Endorsement	\$110	\$110		
License Renewal	\$90	\$90	\$90	\$35
Expiration Date	Aug 31-odd years	Aug 31-even years	Aug 31-odd years	Aug 31-even years

(3-20-20)T

**02. Reinstatement Fee.** Nurses requesting reinstatement of a lapsed, disciplined, or restricted license, or reinstatement of an emeritus license to active status, will be assessed the records verification and renewal fees.

(3-20-20)T

**901. OTHER FEES.**

Fees will be assessed for licensure of registered and practical nurses by examination and endorsement, and for temporary licenses and verification of licensure to another state.

Records Verification Fee	\$35
Return Check Fee	\$25

(3-20-20)T

**902. (RESERVED)**

**903. EDUCATION PROGRAM FEES.**

**01. Evaluation of Nursing Education Programs.** A fee not to exceed two hundred fifty dollars (\$250) per day will be assessed for survey and evaluation of nursing education programs which will be due at the time the evaluation is requested.

(3-20-20)T

**02. Evaluation of Courses of Instruction.** A fee not to exceed five hundred dollars (\$500) will be assessed for approval of courses of instruction related to nursing that are offered by commercial establishments. This fee will be due at the time the evaluation is requested.

(3-20-20)T

**904. NO REFUNDS.**

Fees are not refundable either in whole or in part.

(3-20-20)T

**905. ONLY ONE LICENSE - EXCEPTION.**

A licensee may hold only one (1) active renewable license to practice nursing at any time except that licensed advanced practice registered nurses must also be licensed to practice as licensed registered nurses.

(3-20-20)T

**906. -- 998. (RESERVED)**

**999. ADMINISTRATIVE FINE.**

An administrative fine not to exceed one hundred dollars (\$100) for each separate offense of practicing nursing without current licensure may be assessed as a condition of reinstatement of a license, or the issuance of a temporary or renewable license.

(3-20-20)T

**IDAPA 24 – DIVISION OF OCCUPATIONAL AND PROFESSIONAL LICENSES**

**24.01.01 – RULES OF THE BOARD OF ARCHITECTURAL EXAMINERS**

**DOCKET NO. 24-0101-2000F (FEE RULE)**

**NOTICE OF OMNIBUS RULEMAKING – ADOPTION OF TEMPORARY RULE**

**EFFECTIVE DATE:** The effective date of the temporary rule being adopted through this omnibus rulemaking is the adjournment date of the second regular session of the 65th Idaho State Legislature - March 20, 2020.

**AUTHORITY:** In compliance with Sections 67-5226, Idaho Code, notice is hereby given this agency has adopted a temporary rule. The action is authorized pursuant to Section 54-308, Idaho Code.

**DESCRIPTIVE SUMMARY:** The following is the required finding and concise statement of its supporting reasons for adopting a temporary rule:

This temporary rulemaking adopts the following chapter under IDAPA 24:

**IDAPA 24.01**

- 24.01.01, *Rules of the Board of Architectural Examiners.*

**TEMPORARY RULE JUSTIFICATION:** Pursuant to Sections 67-5226(1) and 67-5226(2), Idaho Code, the Governor has found that temporary adoption of the rule is appropriate for the following reasons:

These temporary rules are necessary to protect the public health, safety, and welfare of the citizens of Idaho and confer a benefit on its citizens. These temporary rules implement the duly enacted laws of the state of Idaho, provide citizens with the detailed rules and standards for complying with those laws, and assist in the orderly execution and enforcement of those laws. The expiration of these rules without due consideration and processes would undermine the public health, safety, and welfare of the citizens of Idaho and deprive them of the benefit intended by these rules. These rules establish and govern the standards necessary for architectural practice. Allowing these rules to expire would harm industry, and the public health, safety and welfare because the Board could not renew current licenses and admit new licensees.

**FEE SUMMARY:** Pursuant to Section 67-5226(2), the Governor has found that the fees or charges being imposed or increased is justified and necessary to avoid immediate danger and the fees are described herein:

The fees or charges, authorized in Section 54-313, Idaho Code, are part of the agency’s 2021 budget that relies upon the existence of these fees or charges to meet the state’s obligations and provide necessary state services. Failing to reauthorize these temporary rules would create immediate danger to the state budget, immediate danger to necessary state functions and services, and immediate danger of a violation of Idaho’s constitutional requirement that it balance its budget.

The following is a specific description of the fees or charges:

<b>FEE TYPE</b>	<b>AMOUNT (Not to Exceed)</b>
Examination	Established by NCARB
Application	\$25
Annual renewal	\$50
Endorsement license	\$50
Temporary license	\$50
Reinstatement	As provided in Section 67-2614, Idaho Code

**ASSISTANCE ON TECHNICAL QUESTIONS:** For assistance on technical questions concerning the temporary rule, contact Rob McQuade at (208) 334-3233.

DATED this February 21, 2020.

Kelley Packer  
Division Administrator  
Division of Occupational and Professional Licenses  
700 W. State Street  
P.O. Box 83720  
Boise, ID 83720  
Phone: (208) 334-3233  
Fax: (208) 334-3945



# IDAPA 24 – DIVISION OF OCCUPATIONAL AND PROFESSIONAL LICENSES

## 24.01.01 – RULES OF THE BOARD OF ARCHITECTURAL EXAMINERS

### 000. LEGAL AUTHORITY.

These rules are hereby prescribed and established pursuant to the authority vested in the Board of Architectural Examiners by the provisions of Section 54-308, Idaho Code. (3-20-20)T

### 001. TITLE AND SCOPE.

These rules are titled IDAPA 24.01.01, “Rules of the Board of Architectural Examiners.” (3-20-20)T

### 002. INCORPORATION BY REFERENCE.

The document titled NCARB Rules of Conduct as published by the National Council of Architectural Registration Boards, dated July 2014, is hereby incorporated by reference. All documents incorporated by reference can be obtained at the office of the Division and on the Board website. (3-20-20)T

### 003. -- 009. (RESERVED)

### 010. DEFINITIONS.

01. **AXP.** Architectural Experience Program. (3-20-20)T

02. **Direct Supervision.** Direct supervision of an unlicensed individual in the practice of architecture means the exercise of management, control, authority, responsibility, oversight and guidance over the unlicensed individuals work, activities and conduct. (3-20-20)T

03. **NAAB.** National Architectural Accrediting Board. (3-20-20)T

04. **NCARB.** National Council of Architectural Registration Board. (3-20-20)T

### 011. -- 099. (RESERVED)

### 100. ORGANIZATION.

01. **Organization of the Board.** At the first meeting of each calendar year, the Board shall organize and elect from its members a Chairman and Vice Chairman, who shall assume the duties of their respective offices immediately upon such selection. (3-20-20)T

02. **Board Members and Duties.** (3-20-20)T

a. **Chairman.** The Chairman shall be a voting member of the Board, and when present preside at all meetings, appoint with the consent of the Board, all committees, and shall otherwise perform all duties pertaining to the office of Chairman. The Chairman shall be an ex-officio member of all committees. (3-20-20)T

b. **Vice Chairman.** The Vice Chairman shall, in the absence or incapacity of the Chairman exercise the duties and possess all the powers of the Chairman. (3-20-20)T

### 101. -- 149. (RESERVED)

### 150. PROCEDURES AND DUTIES.

01. **Meetings.** The Board shall meet at least four (4) times annually at such times and places as designated by the Board or the Chairman of the Board. Special meetings may be held at the call of the Chairman or at the request of two (2) Board members, and all members shall be notified in writing, thereof. (3-20-20)T

02. **Voting.** Any motion before the Board shall fail on a tie vote. (3-20-20)T

### 151. -- 174. (RESERVED)

### 175. APPLICANT PAST CRIME REVIEW.

**01. Review Authority.** In reviewing an Applicant for licensure who has been convicted of a felony or misdemeanor as set forth in section 54-314(1)(d) Idaho Code, the Board may utilize the follow process and factors to determine the applicant's suitability for licensure: (3-20-20)T

**02. Exemption Review.** The exemption review shall consist of a review of any documents relating to the crime and any supplemental information provided by the applicant bearing upon his suitability for registration. The Board may, at its discretion, grant an interview of the applicant. (3-20-20)T

- a.** During the review, the Board shall consider the following factors or evidence: (3-20-20)T
  - i. The severity or nature of the crime; (3-20-20)T
  - ii. The period of time that has passed since the crime under review; (3-20-20)T
  - iii. The number or pattern of crimes or other similar incidents; (3-20-20)T
  - iv. The circumstances surrounding the crime that would help determine the risk of repetition; (3-20-20)T
  - v. The relationship of the crime to the practice of architecture; and (3-20-20)T
  - vi. The applicant's activities since the crime under review, such as employment, education, participation in treatment, payment of restitution, or any other factors which may be evidence of current rehabilitation. (3-20-20)T
- b.** The applicant shall bear the burden of establishing their current suitability for licensure. (3-20-20)T

**176. -- 199. (RESERVED)**

**200. FEES FOR EXAMINATIONS AND LICENSURE.**  
 No refund of fees shall be made.

FEE TYPE	AMOUNT (Not to Exceed)
Examination	Established by NCARB
Application	\$25.00
Annual renewal	\$50.00
Endorsement license	\$50.00
Temporary license	\$50.00
Reinstatement	As provided in Section 67-2614, Idaho Code

(3-20-20)T

**201. -- 249. (RESERVED)**

**250. QUALIFICATIONS OF APPLICANTS FOR EXAMINATION.**

**01. Accredited Degree Applicants.** All applicants for the Architectural Registration Examination (ARE) shall possess a professional degree in architecture from a program that is accredited by the National Architectural Accrediting Board (NAAB) or that is approved by the Board. All applicants for the ARE must have started or completed the Architectural Experience Program (AXP) requirements. (3-20-20)T

**02. Experience in Lieu of Degree Applicants.** The Board may allow an applicant without an architecture degree to sit for the architecture examination upon determining that such applicant has attained the knowledge and skill approximating that attained by graduation from an accredited architecture curriculum including the submission of a record of eight (8) years or more of experience in architecture work of a character deemed satisfactory by the Board. Said experience may include that necessary for completion of the AXP. Two (2) years of eight (8) or more years of experience may be accepted if determined that such experience is directly related to architecture under the direct supervision of a registered engineer (practicing as a structural, civil, mechanical or electrical engineer in the field of building construction) or a registered landscape architect. At least six (6) years of such experience must be obtained while working under the direct supervision of a licensed architect. A person is qualified for the examination once they have met the experience requirement and started the AXP. (3-20-20)T

**251. – 299. (RESERVED)**

**300. APPLICATION.**

**01. Licensure by Examination.** (3-20-20)T

**a.** Application for licensure by examination shall be made on the uniform application form adopted by the Board. (3-20-20)T

**b.** Applicants shall furnish all information required by the uniform application form and shall include the following: (3-20-20)T

**i.** If applying based upon an accredited degree: Furnish certification of graduation and a certified transcript of all subjects and grades received for all college courses taken. (3-20-20)T

**ii.** If applying based upon experience in lieu of an accredited degree: Furnish statement or statements, of all actual architectural or other applicable experience signed by the person under whose supervision the work was performed, giving kind and type of work done, together with dates of employment. (3-20-20)T

**c.** Application shall not be reviewed by the Board until all required information is furnished and the required fee is paid. (3-20-20)T

**d.** Applications received less than seven (7) days prior to a Board meeting may be held over to the next meeting. (3-20-20)T

**02. Licensure by Endorsement -- Blue Cover.** General requirements. Application shall be accompanied by a current blue cover dossier compiled by the NCARB certifying that the applicant has satisfactorily passed the standard NCARB examinations, or NCARB authorized equivalent and shall include letters, transcripts, and other documents substantiating all statements relative to education and experience made in said application as required by the Board. (3-20-20)T

**03. Licensure by Endorsement -- Equivalency.** (3-20-20)T

**a.** Applicants for licensure by endorsement must submit a complete application, verified under oath, to the Board at its official address. The application must be on the forms approved by the Board and submitted together with the appropriate fee(s) and supporting documentation. (3-20-20)T

**b.** Applicants shall provide proof of holding a current and valid license issued by another state, a licensing authority recognized by the Board. (3-20-20)T

**c.** Applicants shall provide proof of satisfactorily passing the NCARB examinations or NCARB authorized equivalent examination, as determined by the Board. (3-20-20)T

**301. -- 349. (RESERVED)**

**350. REGISTRATION EXAMINATION.**

The Board, having found that the content and methodology of the ARE prepared by NCARB is the most practicable and effective examination to test an applicant's qualifications for registration, adopts the ARE as the single, written and/or electronic examination for registration of architects in this state, and further adopts the following rules with respect thereto: (3-20-20)T

**01. When Taken.** The Board will cause the ARE, prepared by NCARB, to be administered to all applicants eligible, in accordance with the requirements of the Board, by their training and education to be examined for registration on dates scheduled by the NCARB. The Board shall cause repeat divisions of the ARE to be administered to qualified candidates on such dates as are scheduled by the NCARB. The ARE examination is a multiple part examination prepared by NCARB. Content of the examination in all of its sections is available from the Board or NCARB. (3-20-20)T

**02. Grading.** The ARE shall be graded in accordance with the methods and procedures recommended by the NCARB. To achieve a passing grade on the ARE, an applicant must receive a passing grade in each division. Grades from the individual division may not be averaged. Applicants will have unlimited opportunities to retake division which they fail except as set forth in these rules. The Board shall accept passing grades of computer administered divisions of the ARE as satisfying the requirements for said division(s) when such examinations are administered as prescribed by the NCARB. (3-20-20)T

**03. Passing (ARE).** To pass the ARE, an applicant must achieve a passing grade on each division. Subject to certain conditions, a passing grade for any division of the ARE shall be valid for five (5) years, after which time the division must be retaken unless all divisions have been passed. The Board may allow a reasonable extension of such period in circumstances where completion of all divisions is prevented by a medical condition, active duty in military service, or other like causes. Approval to take the ARE will terminate unless the applicant has passed or failed a division of the ARE within a period of five (5) years. Any applicant whose approval has so terminated must reapply for approval to take the ARE. (3-20-20)T

**351. -- 374. (RESERVED)**

**375. ARCHITECTURAL INTERN.**

An individual may represent themselves as an architectural intern only under the following conditions: (3-20-20)T

**01. Supervision.** Each architectural intern shall be employed by and work under the direct supervision of an Idaho licensed architect. (3-20-20)T

**02. AXP Enrollment.** Each architectural intern shall be enrolled in NCARB's AXP and shall maintain a record in good standing. (3-20-20)T

**03. Record.** Each architectural intern shall possess either: (3-20-20)T

**a.** A record with the NCARB establishing that AXP training has been started; or (3-20-20)T

**b.** A record establishing completion of all AXP training regulations as specified by NCARB. (3-20-20)T

**04. Prohibitions.** An architectural intern shall not sign or seal any architectural plan, specification, or other document. An architectural intern shall not engage in the practice of architecture except under the direct supervision of an Idaho licensed architect. (3-20-20)T

**376. -- 399. (RESERVED)**

**400. FIRM NAME.**

**01. Firm Names.** Firm names incorporating the use of names of unlicensed individuals are considered in violation of Section 54-315, Idaho Code. A firm may continue to utilize the name of a retired or deceased formerly licensed architect so long as their unlicensed status is clearly disclosed. (3-20-20)T

**401. -- 409. (RESERVED)**

**410. USE OF AN ARCHITECT'S SEAL.**

An architect's seal may be placed on all technical submissions prepared personally by the architect or prepared under the architect's responsible control or as otherwise allowed under the provisions of Section 54-304, Idaho Code. Nothing in this rule shall limit an architect's responsibility to the owner for the work of other licensed professionals to the extent established by contract between the owner and architect. (3-20-20)T

**411. -- 449. (RESERVED)**

**450. CONTINUING EDUCATION.**

In order to protect the public health and safety and promote the public welfare, the Board has adopted the following rules for continuing education. (3-20-20)T

**01. Continuing Education Requirement.** Each Idaho licensed architect must successfully complete a minimum of twelve (12) hours of continuing education in architectural health, safety and welfare in the calendar year prior to license renewal. (3-20-20)T

**a.** Each licensee will submit to the Board their annual renewal application form and required fees, and will certify that they have complied with annual CE requirements for the previous calendar year. Each licensee will provide to the Board together with their application for reinstatement of an expired license form and required fees, proof of compliance with annual CE requirements for each year that their license was expired. A license that has been canceled for failure to renew may be reinstated in accordance with Section 67-2614, Idaho Code. (3-20-20)T

**b.** A licensee shall be considered to have satisfied their CE requirements for the first renewal of their initial license. Licensees who have failed to meet the annual continuing education requirement may petition the Board for additional time to complete their continuing education requirements. (3-20-20)T

**c.** A licensee may carryover a maximum of six (6) hours of continuing education to meet the next year's continuing education requirement. (3-20-20)T

**d.** One (1) continuing education hour shall be equal to one (1) learning unit, as determined by the American Institute of Architects, or one (1) clock hour of education, as determined by the Board. (3-20-20)T

**02. Architectural Health, Safety and Welfare Requirement.** To qualify for continuing education, a course must involve architectural health, safety and welfare, which generally relates to the structural integrity or unimpairedness of a building or building sites and be germane to the practice of architecture. Courses may include the following subject areas: (3-20-20)T

**a.** Legal, which includes laws, codes, zoning, regulations, standards, life safety, accessibility, ethics, insurance to protect owners and public. (3-20-20)T

**b.** Building systems, which includes structural, mechanical, electrical, plumbing, communications, security, and fire protection. (3-20-20)T

**c.** Environmental, which includes energy efficiency, sustainability, natural resources, natural hazards, hazardous materials, weatherproofing, and insulation. (3-20-20)T

**d.** Occupant comfort, which includes air quality, lighting, acoustics, ergonomics. (3-20-20)T

**e.** Materials and methods, which includes construction systems, products, finishes, furnishings, and equipment. (3-20-20)T

**f.** Preservation, which includes historical, reuse, and adaptation. (3-20-20)T

**g.** Pre-Design, which includes land use analysis, programming, site selection, site and soils analysis, and surveying. (3-20-20)T

**h.** Design, which includes urban planning, master planning, building design, site design, interiors, safety and security measures. (3-20-20)T

**i.** Construction documents, which includes drawings, specifications, and delivery methods. (3-20-20)T

**j.** Construction contract administration, which includes contracts, bidding, contract negotiations. (3-20-20)T

**03. Approved Credit.** Continuing education courses must be in the subject of architectural health, safety and welfare and be presented by: (3-20-20)T

**a.** Providers approved by the National Architectural Accreditation Board (NAAB) schools of architecture; or (3-20-20)T

**b.** Providers approved by the National Council of Architectural Registration Board (NCARB); or (3-20-20)T

**c.** Providers approved by the American Institute of Architects (AIA); or (3-20-20)T

**d.** Providers as otherwise approved by the Board. All requests for approval or pre-approval of continuing education credits must be made to the Board in writing and must be accompanied by a statement that includes the name of the instructor or instructors, his or her qualifications, the date, time and location of the course, the specific agenda for the course, the number of continuing education hours requested, and a statement of how the course is believed to be in the nature of architectural health, safety and welfare. (3-20-20)T

**04. Verification of Attendance.** It shall be necessary for each licensee to maintain verification of attendance by securing authorized signatures or other documentation from the course instructors or sponsoring institution substantiating any and all hours attended by the licensee. This verification shall be maintained by the licensee for a period of five (5) years and provided to the Board upon request of the Board or its agent. (3-20-20)T

**05. Failure to Fulfill the Continuing Education Requirements.** The license will not be renewed for those licensees who fail to certify or otherwise provide acceptable documentation of meeting the CE requirements. Licensees who make a false attestation regarding compliance with the CE requirements shall be subject to disciplinary action by the Board. (3-20-20)T

**06. Exemptions.** A licensed architect shall be deemed to have complied with the CE requirements if the licensee attests in the required affidavit that for not less than ten (10) months of the preceding one (1) year period of licensure, the architect has met one (1) of the following criteria: (3-20-20)T

**a.** Meets the military exemption set forth in Section 67-2602A, Idaho Code. (3-20-20)T

**b.** Is a government employee working as an architect and assigned to duty outside the United States. (3-20-20)T

**c.** Special Exemption. The Board shall have authority to make exceptions for reasons of individual hardship, including health (certified by a medical doctor) or other good cause. The architect must provide any information requested by the Board to assist in substantiating hardship cases. This exemption is granted at the sole discretion of the Board. (3-20-20)T

**451. -- 749. (RESERVED)**

**750. CODE OF ETHICS.**

**01. Rules of Conduct.** The NCARB Rules of Conduct are hereby adopted as the Code of Ethics for all Idaho licensed architects. (3-20-20)T

**751. -- 999. (RESERVED)**

# IDAPA 24 – DIVISION OF OCCUPATIONAL AND PROFESSIONAL LICENSES

## 24.02.01 – RULES OF THE STATE ATHLETIC COMMISSION

### DOCKET NO. 24-0201-2000F (FEE RULE)

#### NOTICE OF OMNIBUS RULEMAKING – ADOPTION OF TEMPORARY RULE

**EFFECTIVE DATE:** The effective date of the temporary rule being adopted through this omnibus rulemaking is the adjournment date of the second regular session of the 65th Idaho State Legislature - March 20, 2020.

**AUTHORITY:** In compliance with Sections 67-5226, Idaho Code, notice is hereby given this agency has adopted a temporary rule. The action is authorized pursuant to Section 54-406, Idaho Code.

**DESCRIPTIVE SUMMARY:** The following is the required finding and concise statement of its supporting reasons for adopting a temporary rule:

This temporary rulemaking adopts the following chapter under IDAPA 24:

#### **IDAPA 24.02**

- 24.02.01, *Rules of the State Athletic Commission.*

**TEMPORARY RULE JUSTIFICATION:** Pursuant to Sections 67-5226(1) and 67-5226(2), Idaho Code, the Governor has found that temporary adoption of the rule is appropriate for the following reasons:

These temporary rules are necessary to protect the public health, safety, and welfare of the citizens of Idaho and confer a benefit on its citizens. These temporary rules implement the duly enacted laws of the state of Idaho, provide citizens with the detailed rules and standards for complying with those laws, and assist in the orderly execution and enforcement of those laws. The expiration of these rules without due consideration and processes would undermine the public health, safety, and welfare of the citizens of Idaho and deprive them of the benefit intended by these rules. These rules establish and govern the standards and practices of the Idaho Athletic Commission, which oversees boxing, mixed martial arts, and wrestling contests. Allowing these rules to expire would deny the Commission the ability to sanction permits and admit licensees; and elimination of the standards that protect combatants in sanctioned contests would harm the health, safety, and welfare of combatants.

**FEE SUMMARY:** Pursuant to Section 67-5226(2), the Governor has found that the fees or charges being imposed or increased are justified and necessary to avoid immediate danger and the fees are described herein:

The fees or charges, authorized in Sections 54-406, 54-410, and 54-416, Idaho Code, are part of the agency's 2021 budget that relies upon the existence of these fees or charges to meet the state's obligations and provide necessary state services. Failing to reauthorize these temporary rules would create immediate danger to the state budget, immediate danger to necessary state functions and services, and immediate danger of a violation of Idaho's constitutional requirement that it balance its budget.

The following is a specific description of the fees or charges:

<b>FEE TYPE</b>	<b>AMOUNT (Not to Exceed)</b>	<b>RENEWAL (Not to Exceed)</b>
Combatant	\$150	\$150
Non-combatant	\$150	\$150
Matchmaker	\$250	\$250
Promoter	\$1,000	\$750
Sanction Permit	\$200	\$250
Ring Official	\$150	\$150

**ASSISTANCE ON TECHNICAL QUESTIONS:** For assistance on technical questions concerning the temporary rule, contact Rob McQuade at (208) 334-3233.

DATED this February 21, 2020.

Kelley Packer  
Division Administrator  
Division of Occupational and Professional Licenses  
700 W. State Street  
P.O. Box 83720  
Boise, ID 83720  
Phone: (208) 334-3233  
Fax: (208) 334-3945



## 24.02.01 – RULES OF THE STATE ATHLETIC COMMISSION

### 000. LEGAL AUTHORITY.

Rulemaking authority is vested in the Athletic Commission in Title 54, Chapter 4, Idaho Code. (3-20-20)T

### 001. TITLE AND SCOPE.

These rules are to be known and cited at IDAPA 24.02.01, “Rules of the State Athletic Commission.” These rules are intended to provide clarification on the methods and restrictions of unarmed combat in Idaho. (3-20-20)T

### 002. -- 009. (RESERVED)

### 010. DEFINITIONS.

**01. Champion.** A person who has been formally acknowledged supreme in a branch of athletics or game of skill and who is ready to contend with any qualified challenger. (3-20-20)T

**02. Combatant.** Any boxer, kickboxer, martial artist, or wrestler who takes part as a competitor in an event. A “combatant” sometimes is referred to as a “contestant” in these rules. (3-20-20)T

**03. Event.** A program of one (1) or more unarmed combat contests or exhibitions. (3-20-20)T

**a.** An “amateur event” is an event in which the only combatants are amateur combatants. (3-20-20)T

**b.** A “professional event” is an event in which the only combatants are professional combatants. (3-20-20)T

**c.** A “pro-am” is an event in which combatants include professional combatants and amateur combatants. Professional combatants may not compete against amateur combatants in “pro-am” events. (3-20-20)T

**04. Main Event.** The headline or marquee contest or exhibition scheduled to occur at an event. (3-20-20)T

**05. Mixed Martial Arts (MMA).** A full contact sport that allows a wide variety of unarmed combat techniques from a mixture of martial arts traditions to be used in competitions. (3-20-20)T

**06. Stub.** That part of the ticket retained by a person entering the arena in which an event is held after the ticket has been collected. (3-20-20)T

**07. Ticket.** That document issued by the promoter allowing a person’s entrance and attendance at an event and may include that part of the ticket retained by the promoter documenting a person’s entrance to an event. (3-20-20)T

### 011. -- 099. (RESERVED)

### 100. LICENSING.

**01. Application for License.** Applicants will submit a complete, Commission-approved, application verified under oath, including the fee and any necessary supporting documentation to the Division for each of the following licenses: (3-20-20)T

**a.** Combatant; (3-20-20)T

**b.** Promoter; (3-20-20)T

**c.** Matchmaker; (3-20-20)T

**d.** Manager; (3-20-20)T

**e.** Second, including a trainer; (3-20-20)T

**f.** Ring Official; or (3-20-20)T

**g.** Sanctioning permit for an event. (3-20-20)T

**101. AGE AND PHYSICAL CONDITION.**

**01. Age of Combatant.** The Commission will review all complete applications for a combatant license so that the applicant's experience and fitness may be considered before a license is issued, if the applicant has: (3-20-20)T

- a. Not reached eighteen (18) years of age; or (3-20-20)T
- b. Reached thirty-six (36) years of age. (3-20-20)T

**02. Poor Vision.** The Commission will not issue a license to engage in unarmed combat to any applicant who is found to be blind in one (1) eye or whose vision in one (1) eye is so poor that a physician recommends that no license be granted. Exceptions will not be made due to exemplary vision in the good eye. (3-20-20)T

**03. Cerebral Hemorrhage.** The Commission will not issue a license to engage in unarmed combat to any person who has suffered a cerebral hemorrhage. (3-20-20)T

**04. Serious Head Injuries.** The Commission will review the application of any person who has suffered a serious head injury before a license is issued to that person. (3-20-20)T

**102. ABILITY OF COMBATANT.**

**01. Satisfy Commission.** Before a combatant license is issued by the Commission to any person, the Commission must be satisfied of the person's ability to compete. (3-20-20)T

**02. Questioned Ability.** If a combatant's ability to perform is questioned for any reason, the Commission may hold a hearing to determine: (3-20-20)T

- a. Whether the person's license should be revoked; or (3-20-20)T
- b. Whether he should be granted a license. (3-20-20)T

**103. PHYSICAL EXAMINATION OF COMBATANT.**

**01. Examination by Physician.** Any combatant who has applied for a license or a renewal of his license must be examined by a physician. The physician will establish the combatant's physical and mental fitness for competition. (3-20-20)T

**02. Additional Examination.** Any combatant licensed by the Commission who participates in a contest outside of the state of Idaho may need to take this examination again before being allowed to compete in Idaho. (3-20-20)T

**03. Drug Abuse.** The Commission will not issue a license to an athlete who has a recent history of drug abuse, without proof of participation in a recognized drug rehabilitation program and/or submission to urinalysis. (3-20-20)T

**04. Blood Testing.** The Commission will not issue a license to an athlete, or allow an athlete to compete in an event, if the athlete, within the six (6) months immediately preceding the application for licensure or the event at which the licensee wishes to compete, has tested positive for the HIV virus, Hepatitis B Surface Antigen and Hepatitis C Antibody, or illegal drugs or other substances. Accordingly, upon application for a license, the athlete will submit with the application a blood test report from a blood test conducted within the six (6) months preceding the application date. The blood test must have tested the athlete for HIV virus, Hepatitis B Surface Antigen, Hepatitis C Antibody, and illegal drugs and substances. Additionally, each combatant who is to compete in an event will, at the start of the event, provide the Commission with a blood test report from a blood test conducted within the six (6) months immediately preceding the event. Additional blood tests may be requested by the Commission in its

discretion. (3-20-20)T

**104. FEES.**

<b>FEE TYPE</b>	<b>AMOUNT (Not to Exceed)</b>	<b>RENEWAL (Not to Exceed)</b>
Combatant	\$150.00	\$150.00
Non-combatant	\$150.00	\$150.00
Matchmaker	\$250.00	\$250.00
Promoter	\$1,000.00	\$750.00
Sanction permit	\$200.00	\$250.00
Ring official	\$150.00	\$150.00

(3-20-20)T

**105. HONORING ACTIONS OF REGULATORY AGENCIES IN OTHER JURISDICTIONS.**

The Commission may honor the following actions of agencies in other jurisdictions which regulate boxing, wrestling, martial arts, or combination thereof: (3-20-20)T

**01. Suspension.** A suspension of a combatant ordered for: (3-20-20)T

**a.** Medical safety; (3-20-20)T

**b.** A violation of a law or rule governing boxing, wrestling, martial arts, or combination thereof which also exists in this state; or (3-20-20)T

**c.** Any other conduct which discredits boxing, wrestling, martial arts, or combination thereof as determined by the Commission. (3-20-20)T

**106. TIME BETWEEN CONTESTS.**

In no case may a combatant (excluding wrestlers) participate in more than one (1) contest or exhibition in any twenty-four (24) hour period. Without the special permission of the Commission, a combatant may not compete in this state unless: (3-20-20)T

**01. Four Days.** Four (4) days have elapsed since the combatant's last contest if the contest lasted not more than four (4) rounds. (3-20-20)T

**02. Seven Days.** Seven (7) days have elapsed since the combatant's last contest if the contest lasted five (5) or six (6) rounds. (3-20-20)T

**03. Fourteen Days.** Fourteen (14) days have elapsed since the combatant's last contest if the contest lasted seven (7) or eight (8) rounds. (3-20-20)T

**04. Twenty-One Days.** Twenty-one (21) days have elapsed since the combatant's last contest if the contest lasted nine (9) or ten (10) rounds. (3-20-20)T

**05. Forty-Five Days.** Forty-five (45) days have elapsed since the combatant's last contest if the contest lasted eleven (11) or twelve (12) rounds. (3-20-20)T

**107. FEMALE COMBATANTS.**

**01. Qualifications.** Only female combatants qualified to perform as a combatant may enter a contest. (3-20-20)T

- 02. Limitation.** A female combatant will not engage in a contest with a male combatant. (3-20-20)T
- 03. General Requirements.** In addition to meeting such requirements of this chapter as are applicable to combatants generally, a female applicant will: (3-20-20)T
- a.** Submit to pregnancy test within fourteen (14) days of the contest. (3-20-20)T
  - b.** Use a mouthpiece specially designed for her mouth; (3-20-20)T
  - c.** Wear ten (10) ounce gloves in a boxing contest; and (3-20-20)T
  - d.** Have her hair secured in a manner that does not interfere with the vision or safety of either combatant; (3-20-20)T
- 04. Addendum Requirement.** A female combatant will, in addition to signing the contract, sign an addendum certifying that the combatant is not pregnant and that the contest will not take place during a menstrual period. (3-20-20)T
- 05. Limitation on Contest.** A contest between female combatants is limited to ten (10) rounds of two (2) minutes duration. (3-20-20)T
- 06. Separate Dressing Rooms.** The promoters of a contest between female combatants will provide them with adequate separate dressing rooms. (3-20-20)T
- 108. REQUIREMENTS FOR LICENSE AS A PROMOTER.**
- 01. Requirements.** Any person applying for a license as a promoter may need to appear before the Commission and be prepared to prove his: (3-20-20)T
- a.** Integrity; (3-20-20)T
  - b.** Financial stability; and (3-20-20)T
  - c.** Knowledge of the responsibilities involved in the promotion of relevant combative programs. (3-20-20)T
- 02. Provide Waivers.** The applicant, or Commission approved designee, will provide all waivers necessary to the conduct of the Commission's investigation of the applicant's suitability. (3-20-20)T
- 109. AMATEUR ATHLETIC SANCTIONING ORGANIZATIONS.**  
The Commission may approve an entity as an officially recognized amateur athletic sanctioning organization that may sanction amateur events. The Commission is the final authority on whether an entity may be an amateur athletic sanctioning organization. (3-20-20)T
- 01. Application for Approval.** In order to be considered for approval as an officially recognized, amateur athletic sanctioning organization under Section 54-406(3)(b)(iii), Idaho Code, an entity will: (3-20-20)T
- a.** Meet the Criteria for Eligibility set forth in Subsection 109.02 of these rules; (3-20-20)T
  - b.** Submit to the Division a completed application form, supplied by the Commission, on which the person signing the application verifies under oath that he is an officer or other person authorized to sign on behalf of the entity, that the information on the application and submitted with the application is true and correct, and that the entity meets the Criteria for Eligibility set forth in Subsection 109.02 of these rules; (3-20-20)T
  - c.** Pay the appropriate fees, which are: (3-20-20)T
    - i.** Initial application processing fee: Two hundred fifty dollars (\$250); and (3-20-20)T

- ii. Initial approval fee: Five hundred dollars (\$500). (3-20-20)T
  - d. Provide the Division with such documentation as the Division may request in the course of reviewing the application, and including, without limitation, a list of the entity's officers and persons claiming an ownership interest in the entity, any requested bylaws, constitution, medical forms, contracts, rules, policies, and procedures used by the entity; and (3-20-20)T
  - e. If requested, appear before the Commission to answer, to the Commission's satisfaction, any questions the Commission may have about the entity or the application, including, without limitation, any questions regarding whether the entity meets the Criteria for Eligibility set forth in Subsection 109.02 of these rules; (3-20-20)T
- 02. Criteria for Eligibility.** An entity is eligible for approval as an amateur athletic sanctioning organization if it demonstrates, to the Commission's satisfaction, that it meets the Commission's eligibility criteria. An approved entity's failure to consistently meet these criteria may result in Commission action to suspend or revoke the entity's approved status. The eligibility criteria to be met are: (3-20-20)T
- a. The entity is incorporated or otherwise legally recognized under the law of its domicile;(3-20-20)T
  - b. The entity, if not incorporated or otherwise domiciled in Idaho, is authorized to transact business in Idaho; (3-20-20)T
  - c. The entity and its predecessor entity, if any, have never had an application for approval as an amateur sanctioning authority, organization, or similar body denied or disapproved, or an approval as an amateur sanctioning authority, organization, or similar body suspended, revoked, or restricted in any way, by any state, territory, country, or subdivision thereof. (3-20-20)T
  - d. No officer or person having an ownership interest in the entity has had a license, of the types issued by the Commission, suspended, revoked, or disciplined in any way by any state, territory, country, or subdivision thereof. (3-20-20)T
  - e. All sanctioned events will be conducted in accordance with the sanctioning bodies' rules as approved by the Commission. The entity must adopt and consistently enforce rules that: (3-20-20)T
    - i. Ensure that contests and exhibitions do not unreasonably endanger the health of combatants or other participants; (3-20-20)T
    - ii. Provide for the medical safety and care of participants in events; (3-20-20)T
    - iii. Exclude the medically unfit from the contests and exhibitions; (3-20-20)T
    - iv. Require the presence of an ambulance and EMT's on site at all times, and the attendance of an Idaho-licensed medical doctor or osteopathic physician at ringside. (3-20-20)T
    - v. Require the event promoter to obtain health insurance sufficient to cover the medical, surgical, and hospital care of all event participants, other than the promoter, for injuries sustained while participating in the event. The insurance obtained must meet the requirements specified in Section 299 of these rules. (3-20-20)T
    - vi. Require drug testing and blood testing consistent with the Commission's rules for events regulated by the Commission. The entity will submit the results of such testing to the Commission within forty-eight (48) hours after the event sanctioned by the entity ends. (3-20-20)T
    - vii. Restrict the types of blows that can be delivered; (3-20-20)T
    - viii. Exclude professional combatants from its contests and exhibitions, and not allow combatants to receive any type of purse payment or compensation except as approved by the Commission; (3-20-20)T

- ix. Limit the time and frequency of contests and exhibitions, including, without limitation, the times specified in Section 54-407, Idaho Code; (3-20-20)T
- x. Require that the entity oversee weigh-ins, the hand wrapping, the glove placement after inspecting the gloves as required by the entity's rules as approved by the Commission; (3-20-20)T
- xi. Require that the entity inspect and approve the contest area before the contest starts; (3-20-20)T
- xii. Require prompt investigation and resolution of complaints for participants, interested persons, and the Commission; (3-20-20)T
- xiii. Have a system of review to ensure the entity fairly applies its rules, policies, and procedures; (3-20-20)T
- xiv. Require the identification of the entity on all advertisements, programs, or handbills issued, used, or distributed in Idaho; (3-20-20)T
- xv. Require cooperation with the Commission, including without limitation, at least thirty (30) days advance notification to the Commission of sanctioned events to occur in Idaho, and admission of Commission representatives and agents without charge to any sanctioned event, and to any portion of the event. (3-20-20)T
- xvi. Require that event participants, and the entity, report to the Commission any violations of the entity's rules arising out of a sanctioned event; (3-20-20)T
- xvii. Require all participants, officials, and the entity to appear at reasonable times before the Commission and truthfully answer any lawful inquiry of the Commission; (3-20-20)T
- xviii. Ensure that all ring officials, including, without limitation, all timekeepers, judges, referees, and gloves, and all promoters who ask an entity to sanction an event, are licensed by the Commission; (3-20-20)T
- xix. Set an appropriate fee schedule for ring officials. (3-20-20)T
- xx. Require the event promoter to obtain a bond or other form of financial security, payable to the State of Idaho, and otherwise consistent with Section 300 of these rules. (3-20-20)T
- xxi. Require the event promoter to obtain liability insurance for the event, which insurance must adequately cover the promoter, venue, entity, and the Commission. (3-20-20)T
- xxii. Otherwise require sufficient health and safety standards before, during and after contests and exhibitions to ensure the health, safety, and well-being of any participating amateur combatants. The entity's health and safety standards must be no less stringent than the Commission's health and safety standards for contests and exhibitions for which the Commission may issue a sanctioning permit under Title 54, Chapter 4, Idaho Code. Sections 731 through 799 of these rules establish the minimum safety requirements for MMA events in Idaho. The entity's health and safety standards for sanctioned MMA events must, at a minimum, comport with the Section 731 through 799 requirements. (3-20-20)T
- f. For each event to be sanctioned by the entity, the entity will ensure that true and correct copies of the following documents are presented to the Division at least thirty (30) days before the event: (3-20-20)T
- i. The event promoter's bond or other form of financial security as referenced in Subparagraph 109.02.e.xx. of these rules. (3-20-20)T
- ii. The health insurance certificate for health insurance obtained by the promoter as referenced in Subparagraph 109.02.e.v. The deductible amount, claims submission instructions, and insurer contact information must also be provided. (3-20-20)T

iii. The liability insurance certificate for liability insurance obtained by the promoter as referenced in Subparagraph 109.02.e.xxii. of these rules. (3-20-20)T

g. The entity does not sanction events where: (3-20-20)T

i. Financial ties exist between the promoter and the entity, including, without limitation, when anyone serves as an officer, principal, or manager in both the entity and promotion company, or have an ownership interest in both the entity and the promotion company: (3-20-20)T

ii. Any ring official, employee, or agent that works for both the promoter and the entity. (3-20-20)T

iii. The entity or any of its officers, principals, managers, owners, or employees manages or trains any of the combatants. (3-20-20)T

**03. Violations.** The Commission may suspend or revoke its approval of an amateur athletic sanctioning organization if the approved entity or its officers, owners, or agents engage in any conduct that violates or is inconsistent with any of the requirements of this Section or reflects serious discredit on the sport of boxing, or uses dishonest methods to affect the outcome of any contest. (3-20-20)T

**04. Annual Review of Approval.** An entity's approval to be an amateur athletic sanctioning organization automatically expires one (1) year after issuance. If the entity wishes to remain as an approved amateur sanctioning organization, the entity will submit a timely and complete review application on forms approved by the Commission, along with the appropriate fees. To be timely, a review application and any supporting documentation must be received by the at least thirty (30) days before the automatic expiration date. After receiving a timely review application, the Commission will evaluate the application using the process and criteria set forth in Subsections 109.01 and 109.02. If the Commission is satisfied that the applicant has satisfied all requirements, then the Commission will renew the applicant's approval for another year term. The fees to be paid are: (3-20-20)T

a. Annual application processing fee: Two hundred fifty dollars (\$250); and (3-20-20)T

b. Annual approval fee: Five hundred dollars (\$500). (3-20-20)T

**110. MANAGER ACTING AS SECOND.**  
A manager licensed by the Commission may act as a second without having a second's license. (3-20-20)T

**111. REQUIREMENTS FOR LICENSE AS RING OFFICIAL.**

**01. Qualifications.** To qualify for a license as a ring official of contests, an applicant will: (3-20-20)T

a. Be at least twenty-one (21) years of age. The Commission may, for good cause shown, lower the minimum age limit for a particular applicant to eighteen (18) years of age; (3-20-20)T

b. Have no record of conviction of a felony or other crime involving moral turpitude unless approved by the commission; (3-20-20)T

c. Have had at least one (1) year experience in either amateur or professional contest as a ring official; (3-20-20)T

d. Submit verifications from three (3) persons of his proficiency as a ring official; and (3-20-20)T

e. Provide proof that the applicant meets the other requirements of the commission law and rules. (3-20-20)T

**02. Equivalent Qualifications.** In lieu of the above qualifications, the Commission may accept satisfactory evidence of equivalent qualifications possessed by an applicant who: (3-20-20)T

a. Is currently licensed in another state or country; or (3-20-20)T

b. Formerly held an Idaho license which lapsed in good standing. (3-20-20)T

**03. Other Functions.** A person holding a current Idaho license or who formerly held an Idaho license which lapsed in good standing may be licensed by the Commission without examination or internship to perform an officiating function other than that for which he is or was licensed if the Commission determines that he is qualified to perform that function. (3-20-20)T

**04. Ring Officials Determination.** The Commission will determine when additional ring officials are needed and when licensing examinations for ring officials will be conducted. (3-20-20)T

**05. Validity of Licenses.** Each license issued by the commission is annually renewable in accordance with Section 67-2614, Idaho Code. The renewal of a license is not automatic. The applicant's past performance and abilities may be considered in evaluating an application for renewal. (3-20-20)T

**112. (RESERVED)**

**113. APPLICANTS, LICENSEES, AND OFFICIALS.**

The Commission may direct any ring official, any person licensed by the Commission and any applicant for a license to submit to the Commission any forms, records, and statements at the times and manner as directed. (3-20-20)T

**114. GROUNDS FOR DENIAL OR REVOCATION OF LICENSE.**

The Commission may deny an application or suspend or revoke a license or take such other disciplinary action deemed appropriate if it finds that the applicant or licensee or any partner, officer, director, stockholder, or employee of the applicant or licensee has: (3-20-20)T

**01. Subject to Discipline.** Performed any act which constitutes a violation of the laws or rules of the commission. (3-20-20)T

**02. Specific Conduct.** (3-20-20)T

a. Has been convicted of a felony; (3-20-20)T

b. Engages in illegal bookmaking; (3-20-20)T

c. Engages in any illegal gambling activity; (3-20-20)T

d. Engages in any fraud or misrepresentation in the application process; (3-20-20)T

e. Has a recent history of drug abuse or fails a drug test or refuses to submit to a drug test; (3-20-20)T

f. Is under suspension from any other commission; or (3-20-20)T

g. Is engaged in any activity or practice which is detrimental to the best interests of a contest regulated by the commission. (3-20-20)T

**115. -- 199. (RESERVED)**

**200. CONTRACT BETWEEN MANAGER AND COMBATANT.**

**01. Contractual Obligations.** The Commission may refuse to honor a contract between a manager and combatant unless it complies with the requirements Section 200 of this rule. A contract between a manager and a combatant will be for a term of not more than four (4) years. Such a contract may contain an option which permits the manager, at the expiration of the initial term, to renew the contract for an additional period of not more than two (2) years. (3-20-20)T

**02. After Contract Services.** A manager may not contract to receive the services of a combatant under



his management for a match which is scheduled to take place after the expiration of the contract. (3-20-20)T

**03. Options.** A contract between a combatant and a manager may provide for voluntary binding arbitration of disputes by the Commission. If so agreed, the arbitration will be conducted by a member of the Commission mutually agreed upon by the two (2) parties or, if there is no agreement, by a member of the Commission appointed by the chairman. The arbitration will be conducted pursuant to generally accepted arbitration standards. (3-20-20)T

**04. Contract Approval.** The Commission may approve a contract entered into in another jurisdiction by a person who is not a resident of Idaho if the terms of the contract comply with the requirements of this section. If the terms of the contract exceed the limitations contained in this section, the Commission may honor the contract to the extent of those limitations. (3-20-20)T

**05. Manager Limitations.** A manager may not negotiate or sign for matches for a combatant who is not under contract to him. Any combatant who does not have a contract with a licensed manager must sign for his own contest and sign the receipt for his own purse. A manager or managers may not participate separately or collectively in more than thirty-three and one-third percent (33 1/3%) of the combatant's earnings in the ring. (3-20-20)T

**06. Manager Responsibilities.** If a manager signs only for a combatant's appearance at a contest, a copy of the manager's authorization to negotiate and sign for the combatant must accompany the contract which he concluded with the promoter. If the manager does not send a copy of his authorization, the Commission may deny any application received from the combatant or manager pending a hearing before the Commission. (3-20-20)T

**201. MANAGER'S ADVANCES -- ACCOUNTING.**

Any manager who advances or lends any money to any combatant or incurs indebtedness on behalf of a combatant will furnish an accounting in writing to the combatant every ninety (90) days. The accounting will be verified by the manager and set forth each item of indebtedness owed by the combatant, the date that the indebtedness occurred, the purpose of the indebtedness, and the name of the person to whom the debt is owed. (3-20-20)T

**202. CONTRACT BETWEEN PROMOTER AND COMBATANT.**

**01. Gate Receipts.** A promoter may not deduct any amount from the gate receipts, other than for any federal taxes and the fees prescribed herein until all combatants who are to be paid a percentage of the receipts have been paid, unless the amount to be paid to the combatant is specified in the contract. (3-20-20)T

**02. Contract Prohibitions.** (3-20-20)T

**a.** A contract which provides that a combatant fight exclusively for or at the option of one (1) promoter is prohibited. (3-20-20)T

**b.** A contract which provides that a combatant is to pay for the services of an opponent is prohibited. (3-20-20)T

**203. FILING CERTAIN CONTRACTS WITH COMMISSION.**

**01. Main and Semi-Main Events.** A contract between a promoter and a combatant for the main and semi-main events of a program will be filed with the Commission at least seven (7) working days before the event unless the Commission gives special approval for filing the contract closer to the time of weighing in. (3-20-20)T

**02. Other Combatants.** Contracts for all combatants who will be contending in the program will be filed before the scheduled time for weighing in. (3-20-20)T

**03. Disciplinary Action.** A promoter or matchmaker who fails to file a contract for any participant whose name is released to the news media is subject to disciplinary action. (3-20-20)T

**04. Media Contracts.** Any contract by the promoter for the sale, lease or other use of rights to

broadcast, televise including a right to make a closed-circuit telecast, or take motion pictures of a contest will be filed with the Commission at least five (5) working days before the event unless the promoter obtains special approval from the Commission for filing the contract at a time closer to the event. (3-20-20)T

**204. PERCENTAGE OF GATE RECEIPTS TO COMBATANT.**

Each combatant working on a percentage basis, will be paid on the basis of the net receipts of each exhibition after state and federal taxes, ring expenses and the price of complimentary tickets upon which a price is specified, have been deducted. (3-20-20)T

**205. PROMOTER'S ADVANCES TO COMBATANT OR MANAGER OR OCCURRENCE OF DEBT ON HIS BEHALF.**

**01. Restrictions.** A promoter licensed by the Commission will not directly or indirectly make any loan or advance to any combatant or manager except as provided in this rule. (3-20-20)T

**02. Any Indebtedness Restricted.** A promoter will not, directly or indirectly, create any indebtedness which becomes the obligation of a combatant or manager unless the promoter has the express written permission of the Commission for that action. (3-20-20)T

**206. FAILURE OF COMBATANT TO APPEAR.**

Any combatant who fails to appear in an event in which the combatant signed a contract to appear, without a written excuse determined to be valid by the Commission or a certificate from a physician designated by the Commission in advance in case of physical disability is subject to disciplinary action. Any combatant who files a certificate from a physician designated by the Commission stating that he is unable to fulfill a contract because of physical disability shall, on being restored to the eligible list, fulfill his contract with the same opponent or a suitable substitute specified in the contract within a reasonable time, that period to be set by the Commission, unless the combatant is released from the contract by mutual agreement. (3-20-20)T

**207. PAYMENT OF COMBATANT.**

**01. Payment in Full.** Every combatant will be paid in full according to the combatant's contract, and no part of the combatant's remuneration may be withheld except by order of the Commission, nor may any part of the combatant's remuneration be returned through arrangement with the combatant's manager to any matchmaker or promoter, except as otherwise provided in this section. (3-20-20)T

**02. Prior Written Commitments.** With the prior written permission of a member of the Commission, a promoter may withhold from the purse of a combatant money advanced to the combatant for transportation and maintenance in preparation for a contest, if their agreement so provides. (3-20-20)T

**03. Manager's Share.** A manager's share of the purse may be deducted and paid directly to the manager if the contract so specifies. (3-20-20)T

**04. Pending Action.** If arbitration of a contract entered into by a manager and combatant is pending before the Commission or if the contract is in litigation in a court of competent jurisdiction, the Commission may: (3-20-20)T

**a.** Withhold the amount in dispute in the Commission's trust fund until resolution of the dispute; or (3-20-20)T

**b.** Pay the disputed amount to the clerk of the court in which the litigation is pending. (3-20-20)T

**05. Prior Approval of Commission.** Neither a combatant nor his manager may assign his share of the purse, or any portion thereof, without the approval of the Commission. If a combatant or manager wants to assign his share of the purse, he must file a written request with the Commission at least seven (7) working days before the contest. (3-20-20)T

**208. PAYMENT OF PURSE.**

- 01. Payment Made.** All payment of purses will be made: (3-20-20)T
- a.** Immediately after the contest or exhibition; or (3-20-20)T
  - b.** If the combatant is to receive a percentage of the net receipts, immediately after that percentage is determined by a person designated by the Commission, unless otherwise ordered by the Commission. (3-20-20)T
- 02. Signatures.** Immediately after the contest or exhibition, the person designated by the Commission will release the checks or cash to the entitled persons and will obtain their signatures on a list in which they acknowledge the payment. (3-20-20)T
- 03. Reconciliation.** The promoter may withhold an amount of not more than ten percent (10%) of the purse for payment of expenses incurred by the combatant. A reconciliation of those expenses and payment of the undistributed portion of the purse will be made to the Commission on the Commission's form within seven (7) working days after the contest. The reconciliation must bear written approval of the combatant before it is submitted. If good cause is shown, the chairman of the Commission may grant an extension of the date for reconciliation for a period not to exceed thirty (30) days after the contest. (3-20-20)T
- 04. Alternative Payment.** The Commission may permit a form of payment other than those specified in this section. A promoter who wishes to pay the purse by an alternative method of payment will: (3-20-20)T
- a.** Submit a written request to the Commission at least thirty (30) days before the contest. (3-20-20)T
  - b.** Describe in detail the alternative method of payment contemplated. (3-20-20)T
  - c.** Show good cause for a waiver of the provisions as outlined in Section 208 of this rule. (3-20-20)T
  - d.** Comply with all requirements of the Commission regarding the production of relevant information. (3-20-20)T
  - e.** Follow precisely the procedural directives of the Commission if the request is granted. (3-20-20)T
- 05. Non-Payment of Amateurs.** Consistent with Section 54-402, Idaho Code, a promoter may not compensate any amateur for participating in or being associated in any way with the promoter's event. This ban absolutely bars a promoter from paying an amateur to sell tickets or merchandise or provide services related to an event. (3-20-20)T

**209. RETAINING PORTION OF PURSE PENDING DETERMINATION OF WHETHER PENALTY WILL BE CHARGED.**

At any time before the award of a purse to a contestant, a Commissioner may specify any amount not to exceed twenty-five thousand dollars (\$25,000) to be retained from the contestant's purse and transferred from the promoter to the Commission. The money will not be given to the contestant until the Commission determines that no penalty in lieu of revoking the contestant's license will be charged for any action or condition of the contestant. Any amount so specified is not a limitation upon the amount of a penalty which may be charged. (3-20-20)T

**210. -- 298. (RESERVED)**

**299. HEALTH INSURANCE.**

An event promoter will obtain health insurance sufficient to cover the medical, surgical, and hospital care of all event participants, other than the promoter, for injuries sustained while participating in the event. The insurance shall provide primary coverage for each such participant, and the minimum amount coverage per participant will be ten thousand dollars (\$10,000). The participant may not be required to pay a deductible associated with care provided under this insurance. If a participant pays for the medical, surgical or hospital care, the insurance proceeds must be paid to the participant or the participant's beneficiaries for reimbursement for the payment. (3-20-20)T

**300. SURETY BOND OR OTHER SECURITY.**

**01. Requirement.** Every promoter who applies for a sanctioning permit shall furnish a surety bond or other form of financial security to the Commission consistent with Section 54-408, Idaho Code. The bond or other form of financial security will be in an amount deemed by the Commission to be adequate to guarantee payment of all taxes, fees, fines, and other moneys due and payable under Title 54, Chapter 4, Idaho Code and the Commission's rules, including reimbursement to the purchasers of tickets for the event. (3-20-20)T

**02. Various Locations.** The promoter may apply one (1) bond or other form of financial security to multiple locations if only one (1) of the covered locations is scheduled for an event on any given calendar date. (3-20-20)T

**03. Total Sum.** Each bond or other form of financial security must be conditioned for the payment to the Commission of a sum equivalent to the total sale of tickets: (3-20-20)T

**a.** If the main event is not held on the date advertised, unless the event is subsequently held on a date fixed by the Commission; and (3-20-20)T

**b.** If the main event is neither held on the original date advertised nor on a subsequent date fixed by the Commission. (3-20-20)T

**04. Sum Due.** The sum is due within fifteen (15) days after default, to ensure reimbursement to the purchasers of tickets for the event, if the reimbursement of ticket holders is ordered by the Commission. (3-20-20)T

### **301. APPROVAL OF EVENTS.**

**01. Prior Approval.** No contest will be held without the prior approval of the Commission. A promoter will submit a completed application on a form provided by the Division for a sanctioning permit to hold an event on a specific date, and a permit be issued by the commission before the event may be announced or advertised. (3-20-20)T

**02. Deadline.** A complete application for a sanctioning permit together with application fees, applicable bond amount, proof of insurance, and information regarding the combatants named in the main and semi-main contest must be received by the commission no less than thirty (30) days prior to the date requested for the event named in the application. Combatants named in contests may be changed at the discretion of the commission. (3-20-20)T

**03. Cancellation.** The failure of the promoter to notify the Commission of a cancellation at least seven (7) calendar days before the date for the program will result in the forfeiture of all fees and will be grounds for disciplinary action. (3-20-20)T

### **302. (RESERVED)**

### **303. PROGRAM FOR CHARITY.**

**01. Application.** A person who wishes to present a program or event under the jurisdiction of the commission for charitable purposes will submit to the Commission a sanction application to present the program. The application will contain the name of the charity, charitable fund or organization which is to benefit from the program and the amount or percentage of the receipts of the program which is to be paid to the charity. (3-20-20)T

**02. Certified, Itemized Statement.** Within seventy-two (72) hours after such a program is held, the promoter will furnish to the Commission a certified itemized statement of the receipts and expenditures in connection with the program and the net amount paid to the charitable fund or organization. If the promoter fails to file the statement within the prescribed time, the Commission: (3-20-20)T

**a.** May suspend or revoke the promoter's license. (3-20-20)T

**b.** Shall not thereafter issue a permit to the promoter for the holding of any program for charitable

purposes. (3-20-20)T

**304. ARRANGEMENT OF CONTEST FOR PROMOTER.**

A contest may not be arranged on behalf of any promoter except by a licensed matchmaker. (3-20-20)T

**305. – 306. (RESERVED)**

**307. CERTAIN PERSONS RETAINED MUST HAVE LICENSES.**

No person will be retained for any of the following positions unless currently licensed by the Commission: (3-20-20)T

**01. Second.** (3-20-20)T

**02. Combatant.** (3-20-20)T

**03. Matchmaker.** (3-20-20)T

**04. Ring Official.** (3-20-20)T

**308. OFFICIALS OF EVENTS.**

**01. Officials Described.** The officials of events are the referee, judges, timekeeper, physician, and the Commission's agents. (3-20-20)T

**02. Commission Involvement.** The Commission will approve and assign all the officials. The promoter may select the announcer, subject to the Commission's approval. (3-20-20)T

**309. REFEREES.**

**01. Selection.** The Commission will select the referee for the main event in championship events and for events that the Commission considers to be special events. The Commission will set the fee and reasonable expenses that the referee is entitled to receive for an event. (3-20-20)T

**02. Protests.** If any licensee of the Commission protests the assignment of a referee, the protesting licensee will be given a hearing by the Commission if time permits. If time does not permit, the matter will be heard by two (2) Commissioners in order to make such disposition of the protest as the facts may justify. Protests not made in a timely manner may be summarily rejected. (3-20-20)T

**03. Physical Examination.** Each referee licensed by the Commission will annually undergo a complete physical examination, including an eye examination conducted by an optometrist or ophthalmologist. At the request of the Commission, the licensee will produce all records of the examination. (3-20-20)T

**310. JUDGES.**

**01. Selection.** The Commission will select the judges for the main event in championship events and for any other events which the Commission considers to be special events. (3-20-20)T

**02. Protests.** If any licensee of the Commission protests the assignment of a judge, the protesting licensee will be given a hearing by the Commission if time permits. If time does not permit, the matter will be heard by two (2) Commissioners in order to make such disposition of the protest as the facts may justify. Protests not made in a timely manner may be summarily rejected. (3-20-20)T

**03. Fees.** The Commission will set the fee and reasonable expenses which the judges are entitled to receive for an event. (3-20-20)T

**04. Station of Judges.** Judges will be stationed ringside at places designated by the Commission. (3-20-20)T

**05. Physical Examination.** Each judge licensed by the Commission may be required to submit to or provide proof of a complete physical examination, including an eye examination. (3-20-20)T

**311. ADMISSION OF LICENSEES AND AGENTS TO EVENTS.**

The promoter of any event under the jurisdiction of the commission will admit the following to said event without a ticket: (3-20-20)T

**01. Participants.** Any individual who is licensed by the Commission and who has been authorized by the commission to participate in said event upon such individual's presentation of a current and valid license issued by the commission. (3-20-20)T

**02. Commissioner or Agent.** The Athletic Commissioner, any Deputy Commissioner, and any agent of the Division upon presentation of valid identification that identifies the holder as a member of the commission or an agent of the Division. (3-20-20)T

**312. PAYMENT OF FEE TO OFFICIAL DESIGNATED BY COMMISSION.**

A promoter will pay the fee and reasonable expenses set by the Commission to any person whom the Commission directs to officiate in an event promoted by that promoter. (3-20-20)T

**313. POSTPONEMENT OF PROGRAM.**

**01. Prior Approval.** A promoter may not postpone a sanctioned event unless the postponement is approved by the Commission. (3-20-20)T

**02. No Fault Postponement.** If a postponement of a sanctioned event becomes necessary through no fault of the promoter, the Commission will grant an extension of the contracts and set a new date. (3-20-20)T

**03. Limitations on Postponement.** A small advance sale is not a legitimate reason for postponement. Indoor boxing and wrestling programs may not be called off or canceled on account of storms or for any other reason not expressed in this chapter except as approved by the Commission. (3-20-20)T

**04. Advance Notice.** A promoter may not call off a sanctioned event without one (1) week prior written approval of the Commission. (3-20-20)T

**314. MAIN AND SEMI-MAIN EVENTS.**

This section applies to the main and semi-main events. (3-20-20)T

**01. Notice.** The promoter must request Commission approval of any change in an announced or advertised program for the main and semi-main events at least one (1) week before the event. Notice of any change or substitution must also be conspicuously posted at the box office of the premises where the program is to be held and announced from the ring before the opening contest. (3-20-20)T

**02. Refunds.** If such change occurs and any patron desires a refund of the ticket price, the promoter will provide a refund upon presentation of the ticket or the ticket stub at the box office before the event is scheduled to begin. The box office must remain open a reasonable length of time to redeem such tickets. (3-20-20)T

**03. Substitutions.** A combatant may not substitute for another combatant in a contest which is the main and semi-main events unless the Commission approves the substitution. (3-20-20)T

**315. CONTAINERS.**

All drinks at an event will be dispensed in paper or plastic cups. (3-20-20)T

**316. -- 399. (RESERVED)**

**400. ADMISSION FEE AT QUARTERS WHERE COMBATANT TRAINS.**

**01. Fee.** An admission fee may not be charged to enter the quarters where a combatant is training unless the Commission has authorized the charging of admission. Where such an admission fee is charged, the Commission will consider the charge to be for the privilege of seeing an exhibition. (3-20-20)T

**02. State Fee.** The state fee on those gross receipts, exclusive of any federal taxes paid thereon, will be sent to the Commission with the report. (3-20-20)T

**401. APPROVAL OF FACILITIES BY COMMISSION BEFORE TICKETS MAY BE SOLD.**  
The sale of tickets for any proposed contest or exhibition is prohibited until: (3-20-20)T

**01. Approval.** Plans and statements showing the seating arrangements, the location of tickets of each price, and other aspects of the physical layout of the ring and apron have been approved by the Commission; and (3-20-20)T

**02. Other Considerations.** The aisle spacing, exit facilities, and the location of appliances to extinguish fires have been approved by the appropriate county or municipal authority. (3-20-20)T

**402. TICKETS LIMITED TO SEATING CAPACITY OF ARENA.**  
The sale of tickets for an event may not exceed the seating capacity of an indoor arena and no ticket may be issued for standing room. A person may not be sold the right of admission without a ticket. (3-20-20)T

**403. TICKETS.**

**01. Inventory.** The ticket outlet shall report to the Commission an inventory, which he affirms under oath to be correct, of all the tickets issued. (3-20-20)T

**02. Notification.** The promoter will notify the ticket outlet of the requirements of this section. (3-20-20)T

**404. CONTENTS OF TICKETS.**

**01. General.** Every ticket will have the price, name of the promoter, and date of the program plainly on it. (3-20-20)T

**02. Changes.** Requests for changes in ticket prices or dates of programs will be made in writing to the Commission for approval. (3-20-20)T

**03. License to Sell.** Tickets may not be sold by any person except through an agency holding a license to sell the tickets unless the sale is first approved by the Commission. (3-20-20)T

**405. COMPLIMENTARY TICKETS.**

**01. Limitation.** A promoter may not issue complimentary tickets for more than two percent (2%) of the seats in the house without the Commission's written authorization. The Commission does not consider complimentary tickets which it authorizes under this section to constitute part of the total gross receipts from admission fees for the purposes of calculating the Commission taxes. (3-20-20)T

**02. More Than Two Percent Issued.** If complimentary tickets are issued for more than two percent (2%) of the tickets sold: (3-20-20)T

**a.** Each combatant who is working on a percentage will be paid his percentage of the normal price of all complimentary tickets in excess of two percent (2%) of the tickets sold unless the contract between him and the promoter provides otherwise and stipulates the number of complimentary tickets which will be issued; and (3-20-20)T

**b.** If a service charge is made for complimentary tickets, the combatant is entitled to be paid his percentage of that service charge, less any deduction for federal taxes and fees. (3-20-20)T

**406. PROVISIONS OF TICKETS WITHOUT CHARGE OR AT REDUCED RATES.**

**01. Without Charge.** Each promoter will provide tickets without charge to holders of lifetime passes issued by the Commission. (3-20-20)T

**02. No Fees.** Persons who receive tickets pursuant to this section are not liable for the payment of any fees for those tickets. (3-20-20)T

**03. Optional Charges.** Each promoter may provide tickets without charge or at a reduced rate to: (3-20-20)T

**a.** Any of his employees, and if the promoter is a corporation, to a director or officer, who is regularly employed or engaged in promoting such programs, whether or not his duties require him to be admitted to the particular program and whether or not he is on duty at the time of that program; (3-20-20)T

**b.** A journalist who is performing his duties as such; and (3-20-20)T

**c.** A fireman or police officer who is performing his duties as such. (3-20-20)T

**04. Duties Required.** Each promoter will perform the following duties in relation to the issuance of complimentary tickets issued: (3-20-20)T

**a.** Each ticket issued to a journalist will be clearly marked "PRESS." No more tickets may be issued to journalists than will permit comfortable seating in the press area. (3-20-20)T

**b.** The promoter may allocate seats for the media, subject to the commission's final approval of the allocation. Seating at the press tables or in the press area will be limited to journalists who are actually covering the contest and to other persons designated by the Commission. (3-20-20)T

**c.** A list of passes issued to journalists must be submitted to the Commission. (3-20-20)T

**d.** Only one (1) complimentary ticket may be issued to any one (1) manager, second, combatant, or other person licensed by the Commission. (3-20-20)T

**e.** The Commission will approve in advance any credential issued by the promoter which allows an admission to the event without a ticket. Requests for the issuance of such credentials must be made at least five (5) hours before the first contest on the program. (3-20-20)T

**05. Admission Criteria.** Admission of any person who does not hold a ticket or who is not specifically exempted pursuant to this section is grounds for suspension or revocation of the promoter's license or the assessment of a penalty. (3-20-20)T

**06. Fees.** The Commission will collect all fees and taxes due on any ticket which is not specifically exempt pursuant to this section, and for any person who is admitted without a ticket in violation of this section. (3-20-20)T

**407. SPECULATION IN TICKETS PROHIBITED.**

**01. Prevent Speculation.** A promoter who holds programs or events under the jurisdiction of the commission shall exercise extraordinary caution to prevent speculation in tickets. (3-20-20)T

**02. No Other Price.** The promoter may not sell any tickets for a price other than the price printed thereon. (3-20-20)T

**a.** The promoter may not, without the Commission's written permission, change the price of tickets at any time after they have been placed on sale or sell them at any time during the program for a different price than



tickets for the same seats were offered or sold before the program commenced. (3-20-20)T

**b.** Any ticket sold for other than the price printed on the ticket will be over stamped with the actual price charged. The over stamp must be placed on the printed face of the ticket as well as the stub retained by the holder of the ticket. (3-20-20)T

**03. Exchange.** A person may only exchange tickets at the box office. A ticket may not be redeemed after the show has taken place. Tickets that have not sold will be returned to the box office not later than one (1) hour before the show is scheduled to begin. (3-20-20)T

**04. Removal and Possession of Stub.** A holder of a ticket for a program or event will not be allowed: (3-20-20)T

**a.** To pass through the gate of the premises where the program is being held unless his ticket is separated from the stub; or (3-20-20)T

**b.** To occupy a seat unless in possession of the stub. (3-20-20)T

**05. Tickets for Readmission.** A promoter may not issue a ticket to any person for the purpose of readmission due to leaving the arena and later reentering the arena, unless the promoter has obtained the commission's written permission for such an issuance. (3-20-20)T

**408. – 414. (RESERVED)**

**415. TICKETS: REMOVAL AND RETENTION AFTER MATCH; DESTRUCTION.**

**01. Removal.** All tickets and stubs sold or unsold, other than unsold reel tickets, used for any program or event may be removed to the office of the Division by the Commission after the Commission has completed the computation of gate receipts and tax due thereon. (3-20-20)T

**02. Destruction.** After the tickets and stubs have been held for at least fifteen (15) days by the Commission, the Commission will destroy them. If the tickets are not taken by the Commission, they must be retained by the promoters for at least six (6) months. Those tickets may be destroyed after they have been held for at least thirty (30) days and written permission has been granted by the Commission for the destruction of such tickets. Tickets need to be kept in separate packages for each show so that an audit can be made at any time by the Commission. (3-20-20)T

**416. -- 499. (RESERVED)**

**500. SANITATION.**

**01. Sanitary Conditions.** Each promoter is responsible for and must correct any violation of the regulations of the Commission or the public health district regarding the sanitary condition of dressing rooms, showers, water bottles, towels or other equipment. (3-20-20)T

**02. Reporting.** Physicians and the Commission or its agents will make a particular examination before or during each program or event to discover any violation of such regulations, and any such violation will be reported to the Commission immediately. (3-20-20)T

**501. REQUIRED NUMBER OF AMBULANCES; NOTICE TO AMBULANCE SERVICE AND HOSPITAL.**

**01. Required Number of Ambulances.** The following number of ambulances must be present at the site of any program or event under the jurisdiction of the commission: (3-20-20)T

**a.** Where the anticipated attendance is four thousand (4,000) persons or more but less than eight thousand (8,000) persons, one (1) ambulance. (3-20-20)T

- b. Where the anticipated attendance is eight thousand (8,000) persons or more, two (2) ambulances. (3-20-20)T

**02. Promoter Requirements.** Each promoter of a program or event will, without regard to the size of the anticipated attendance: (3-20-20)T

a. Give notice of the time, date and site of the program to the ambulance service or emergency medical service which is located nearest to the site of the program and ascertain from the service the length of time for one (1) of its ambulances to reach the site. (3-20-20)T

- b. Give such a notice to the nearest hospital and the persons in charge of its emergency room. (3-20-20)T

c. Before the start of the program or event, certify to a member of the Commission that the requirements of this section have been met. (3-20-20)T

**502. DRESSING ROOMS -- ONLY AUTHORIZED PERSONS ARE ALLOWED TO ENTER.**

**01. Authorized Persons to Enter.** On the day of a contest only the following people are allowed in the dressing room of a combatant; (3-20-20)T

- a. The combatant's manager; (3-20-20)T  
b. The combatant's seconds; (3-20-20)T  
c. Any authorized agent of the promoter; and (3-20-20)T  
d. Members of the Commission or its agent. (3-20-20)T

**02. Other Persons.** The promoter will furnish a doorman or doormen at the entrance to the dressing rooms to enforce this section. (3-20-20)T

**503. BOXING GLOVES.**

The gloves used in a boxing contest must meet the following requirements: (3-20-20)T

**01. General.** The gloves will be examined by the Commission and the referee. If padding in any of the gloves is found to be misplaced or lumpy or if any of the gloves are found to be imperfect, they must be changed before the contest starts. No breaking, roughing or twisting of gloves is permitted. (3-20-20)T

**02. Glove Specifications.** The gloves for every main event will be new, of the same brand for both combatants, furnished by the promoter, and of the size specified by the Commission. (3-20-20)T

**03. Sanitary.** If gloves to be used in preliminary contests have been used before, they will be whole, clean and in sanitary condition. The gloves are subject to inspection by the referee or the Commission. If found to be unfit, they will be immediately discarded and replaced with gloves meeting the requirements of this section. (3-20-20)T

**04. Extra Set.** Each promoter will have an extra set of gloves of the appropriate weight available at the glove table to be used in case gloves are broken or otherwise damaged during the course of a contest. (3-20-20)T

**05. Weight of Gloves.** Each combatant will wear gloves that are not less than eight (8) ounces and not more than ten (10) ounces in weight except that the Commission will set the weight of gloves to be used in a championship fight. Eight (8) ounce gloves will be used for all weight classes through welterweight (one hundred forty-seven (147) lbs). Super welterweight (above one hundred forty-seven (147) lbs) and above must use ten (10) ounce gloves. (3-20-20)T

**06. Distal Portion.** All gloves will have the distal portion of the thumb attached to the body of the glove so as to minimize the possibility of injury to an opponent's eye. (3-20-20)T

**504. BANDAGING OF COMBATANT'S HANDS.**

**01. General.** Bandages may not exceed one (1) winding of surgeon's adhesive tape, not over one and one-half (1 1/2) inches wide, placed directly on the hand to protect the part of the hand near the wrists. The tape may cross the back of the hand twice but may not extend within three-fourths (3/4) inch of the knuckles when the hand is clenched to make a fist. (3-20-20)T

**02. Additional Requirements.** Each combatant will use soft surgical bandage not over two (2) inches wide, held in place by not more than six (6) feet of surgeon's adhesive tape for each hand. Up to one (1) fifteen (15) yard roll of bandage may be used to complete the wrappings for each hand. Strips of tape may be used between the fingers to hold down the bandages. (3-20-20)T

**03. Witnesses.** Bandages must be adjusted in the dressing room in the presence of the Commission and both combatants. Either combatant may waive his privilege of witnessing the bandaging of the opponent's hands. (3-20-20)T

**505. EQUIPMENT OF THE CHIEF SECOND.**

**01. Equipment.** The chief second will equip himself with: (3-20-20)T

**a.** A clear plastic water bottle; (3-20-20)T

**b.** A bucket containing ice; (3-20-20)T

**c.** A solution of a kind approved by the Commission for stopping hemorrhaging; (3-20-20)T

**d.** Adhesive tape; (3-20-20)T

**e.** Gauze; (3-20-20)T

**f.** Scissors; and (3-20-20)T

**g.** One (1) extra mouthpiece. (3-20-20)T

**02. Ammonia.** No ammonia may be used in the ring. (3-20-20)T

**03. Ring Physician.** The ring physician or the Commission may at any time inspect the contents of the chief second's first-aid kit. (3-20-20)T

**506. BOXING RING.**

A boxing ring will meet the following requirements: (3-20-20)T

**01. Ring Dimensions.** The ring will be not less than sixteen (16) feet square not more than twenty-four (24) feet square within the ropes. The ring floor will extend at least eighteen (18) inches beyond the ropes. The ring floor will be padded with ensolite or another similar closed-cell foam. Padding will extend beyond the ring ropes and over the edge of the platform, with a top covering of canvas, duck or similar material tightly stretched and laced to the ring platform. Material that tends to gather in lumps or ridges must not be used. (3-20-20)T

**02. Ring Platform.** The ring platform will not be more than four (4) feet above the floor of the building, and will be provided with suitable steps for use of contestants. Ring posts will be of metal, not more than three (3) inches in diameter, extending from the floor of the building to a height of fifty-eight (58) inches above the ring floor. Rings posts will be at least eighteen (18) inches away from the ropes. (3-20-20)T

**03. Ropes.** There will be four (4) padded ring ropes, not less than one (1) inch in diameter and wrapped

in soft material. The lower rope will be eighteen (18) inches above the ring floor and offset four (4) inches to the outside of the ring from the ropes above. (3-20-20)T

**507. BELL OR GONG.**

There will be a bell or gong at the ring no higher than the floor level of the ring. The bell or gong will produce a clear tone easily heard by the contestants. (3-20-20)T

**508. EQUIPMENT OF A TIMEKEEPER.**

Every timekeeper will have the equipment prescribed by the Commission and will carry out the duties directed by the Commission. (3-20-20)T

**509. -- 599. (RESERVED)**

**600. WEIGHTS AND CLASSES OF COMBATANTS.**

- 01. Classes and Weights.** The classes and weights for each class are shown in the following schedule: (3-20-20)T
- a.** Strawweight -- up to one hundred five (105) pounds. (3-20-20)T
  - b.** Light-Flyweight -- over one hundred five (105) to one hundred eight (108) pounds. (3-20-20)T
  - c.** Flyweight -- over one hundred eight (108) to one hundred twelve (112) pounds. (3-20-20)T
  - d.** Super Flyweight -- over one hundred twelve (112) to one hundred fifteen (115) pounds. (3-20-20)T
  - e.** Bantamweight -- over one hundred fifteen (115) to one hundred eighteen (118) pounds. (3-20-20)T
  - f.** Super Bantamweight -- over one hundred eighteen (118) to one hundred twenty-two (122) pounds. (3-20-20)T
  - g.** Featherweight -- over one hundred twenty-two (122) to one hundred twenty-six (126) pounds. (3-20-20)T
  - h.** Super Featherweight -- over one hundred twenty-six (126) to one hundred thirty (130) pounds. (3-20-20)T
  - i.** Lightweight -- over one hundred thirty (130) to one hundred thirty-five (135) pounds. (3-20-20)T
  - j.** Super Lightweight -- over one hundred thirty-five (135) to one hundred forty (140) pounds. (3-20-20)T
  - k.** Welterweight -- over one hundred forty (140) to one hundred forty-seven (147) pounds. (3-20-20)T
  - l.** Super Welterweight -- over one hundred forty-seven (147) to one hundred fifty-four (154) pounds. (3-20-20)T
  - m.** Middleweight -- over one hundred fifty-four (154) to one hundred sixty (160) pounds. (3-20-20)T
  - n.** Super Middleweight -- over one hundred sixty (160) to one hundred sixty-eight (168) pounds. (3-20-20)T
  - o.** Light-Heavyweight -- over one hundred sixty-eight (168) to one hundred seventy-five (175) pounds. (3-20-20)T
  - p.** Cruiserweight -- over one hundred seventy-five (175) to one hundred ninety-five (195) pounds. (3-20-20)T

- q.** Heavyweight -- all over one hundred ninety-five (195) pounds. (3-20-20)T
- 02. Exceeding Weight Allowances.** No contest may be scheduled and no combatant may engage in a boxing contest without the approval of the Commission if the difference in weight between combatants exceeds the allowance shown in the following schedule: (3-20-20)T
- a.** Up to one hundred eighteen (118) pounds -- not more than three (3) pounds. (3-20-20)T
- b.** One hundred eighteen (118) to one hundred twenty-six (126) pounds -- not more than five (5) pounds. (3-20-20)T
- c.** One hundred twenty-six (126) to one hundred thirty-five (135) pounds -- not more than seven (7) pounds. (3-20-20)T
- d.** One hundred thirty-five (135) to one hundred forty-seven (147) pounds -- not more than nine (9) pounds. (3-20-20)T
- e.** One hundred forty-seven (147) to one hundred sixty (160) pounds -- not more than eleven (11) pounds. (3-20-20)T
- f.** One hundred sixty (160) to one hundred seventy-five (175) -- not more than twelve (12) pounds. (3-20-20)T
- g.** One hundred seventy-five (175) to one hundred ninety-five (195) pounds -- not more than twenty (20) pounds. (3-20-20)T
- h.** One hundred ninety-five (195) pounds and over -- no limit. (3-20-20)T
- 03. Weigh-Ins on Day of Contest.** If a weigh-in is scheduled on the day of the contest, weight loss in excess of two (2) pounds after the time of the weigh-in is not permitted. (3-20-20)T
- 601. CHAMPIONS.**
- 01. General.** This section applies to a boxer who has been declared the champion of his class. (3-20-20)T
- 02. Title Not at Stake.** A champion may engage in a contest in which his title is not at stake if the Commission consents to the contest. (3-20-20)T
- 03. Title at Stake.** The title of a champion is at stake if at the official weigh-in his opponent shows and is determined to be within the maximum weight limit of the class. Contests for the championship of the state will be held at twelve (12) rounds. If a champion in a match which has been approved by the Commission for the championship of the state has, within two (2) hours after the scheduled time for the weigh-in, failed to make the specified weight, his title must be declared vacant. (3-20-20)T
- 04. Fighting a Boxer from Heavier Class.** The Commission may permit a champion to fight a boxer belonging to a heavier class, but no restriction of minimum weight may be placed on the opponent to prevent his weighing in as a contender for the title. The difference in weight between the combatants may not exceed twenty (20) pounds unless both weigh over one hundred ninety-five (195) pounds. (3-20-20)T
- 05. Commission Names Champions.** The Commission may name professional boxing champions of the state each year in each weight class. A championship may be lost by default, forfeit or inability to make the weight, but a championship may only be won in a contest. (3-20-20)T
- 06. Defending a Title.** The titles of champions of the state will be defended at least once every six (6) months. If a boxer does not defend his title within this period, his title is automatically vacated. (3-20-20)T

**07. Presentation of Championship Belt to Commission Before Title Contest.** Every boxer who holds a belt for winning the championship of the state will present the belt to the Commission when the title is being defended. Any donor of a championship belt will be approved by the Commission. (3-20-20)T

**602. WEIGH-IN, EXAMINATION OF COMBATANT MAY BE ORDERED BY THE COMMISSION.** Any combatant who has signed a contract to box on a promoter's program is subject to an order by the Commission to appear at any time to be weighed or examined by any physician designated by the Commission. (3-20-20)T

**603. ADVANCE APPEARANCE OF COMBATANT SCHEDULED TO FIGHT IN MAIN EVENT.**

**01. When to Appear.** Each combatant who is scheduled to fight in a main event, except a combatant in a regularly scheduled weekly contest, must be present in any place specified by the promoter at least three (3) days before the scheduled day of the contest for the purpose of training, publicity, and whatever other purpose the promoter may desire, unless the combatant has the Commission's express written approval to be absent. (3-20-20)T

**02. Expenses.** Unless otherwise provided for in the contract, the combatant's expenses for this purpose will be borne by the promoter. If a boxer fails to comply with this requirement, the promoter, subject to approval of the Commission, may deduct ten percent (10%) of the offending combatant's purse. (3-20-20)T

**604. WEIGHING IN OF COMBATANTS.**

**01. Attendees and Scales Used at Weigh-In.** Each combatant will be weighed in the presence of the public, the other combatant, the Commission and an official representing the promoter, on scales approved by the Commission at any place designated by the Commission. (3-20-20)T

**02. Attire.** The combatant will have all weights stripped from his body before he is weighed in, but he may wear shorts. (3-20-20)T

**03. Attendance by Media.** Representatives of newspapers and the electronic news media who provide official identification as such will be admitted to each official weighing in of a combatant. (3-20-20)T

**04. Security.** The owner or operator of the premises in which the weighing in is held will provide adequate security for the combatant and other persons who are present. (3-20-20)T

**605. FORFEITURE FOR FAILURE TO MAKE WEIGHT.**

**01. Failure to Make Weight.** Any combatant who fails to make the weight agreed upon in his contract forfeits: (3-20-20)T

**a.** Ten percent (10%) of his purse if no lesser amount is set by the Commission; or (3-20-20)T

**b.** A lesser amount set by the Commission, unless the weight difference is one (1) pound or less. (3-20-20)T

**02. Dividing Forfeit.** A forfeit will be divided equally between the other combatant and the Commission. (3-20-20)T

**03. Exception.** Except as otherwise provided, if, during the two (2) hours following the time of the weigh-in, a combatant is able to make the weight or weighs less than one (1) pound outside the agreed limits, no forfeit may be imposed or fine assessed upon him. (3-20-20)T

**606. PHYSICAL AND EYE EXAMINATION OF COMBATANTS.**

A physician designated by the Commission must give each combatant a thorough physical and eye examination within thirty-six (36) hours, but not less than two (2) hours, before the contest or exhibition in which the combatant will participate. (3-20-20)T

**607. PHYSICIAN -- SUITABLE PLACE TO EXAMINE CONTESTANT; FEE; EMERGENCY TREATMENT.**

- 01. Suitable Examination Place.** The promoter will provide the physician designated by the Commission a suitable place to examine each contestant. (3-20-20)T
- 02. Fees.** The physician is entitled to receive a fee for his services at a bout. (3-20-20)T
- 03. Emergency Treatment.** The physician will give any injured contestant temporary or emergency treatment in the arena or dressing room and no additional fee may be charged. (3-20-20)T

**608. PHYSICIAN'S DETERMINATION OF FITNESS OF COMBATANTS AND REFEREE; CERTIFICATION; REPORT.**

- 01. Determination of Physician.** The physician who examines any combatant or referee who has contracted to participate in an event will determine that a combatant or referee will not participate in the event and must immediately report such finding to the promoter and the Commission if: (3-20-20)T
- a.** The combatant is unfit for competition; or (3-20-20)T
- b.** The referee is unfit for officiating. (3-20-20)T
- 02. Written Certification.** If the examining physician finds that the combatants and referees are in good physical condition, the physician will, one (1) hour before the start of the event, give written certification of those findings to the Commission. (3-20-20)T
- 03. Physician's Written Report.** Within twenty-four (24) hours after the event ends, the physician will mail or deliver to the Commission his written report on every licensee he examined. The report will be on a form furnished by the Commission. (3-20-20)T

**609. COMBATANT'S REPORT OF OWN ILLNESS OR INJURY; EXAMINATION; FEE.**

- 01. Combatant's Report of Non-Participation to Commission.** When a licensed combatant is unable to take part in a contest for which he is under contract because of injury or illness, he will immediately report the fact to the Commission and submit to an examination by a physician designated by the Commission. (3-20-20)T
- 02. Payment of Fees to Physician.** The fee for the physician's examination will be paid by the promoter if he has requested the examination, otherwise the fee will be paid by the combatant. (3-20-20)T

**610. SUSPENSION OF LICENSEE FOR MEDICAL REASON.**

- 01. Not Fit for Competition or Officiating.** Any licensee who is determined to be unfit to compete or officiate will be suspended until it is shown that he is fit for further competition or officiating. (3-20-20)T
- 02. Medical Suspension -- Thirty Days.** Any boxer suspended for thirty (30) days for his medical protection will take the same examination upon the expiration of his suspension as is required annually, unless the Commission directs him to submit to further tests of his physical condition. The physician may require any other procedures during the examination, including an electroencephalogram if indicated. (3-20-20)T

**611. -- 699. (RESERVED)**

**700. COMBATANTS MUST REPORT.**

Each combatant will report to the Commission in the dressing rooms at least one (1) hour before his scheduled time of the first match. (3-20-20)T

**701. BOXER'S COSTUME AND EQUIPMENT.**

**01. Costume.** Each combatant on a program will provide himself with the ring costume selected and approved by the Commission. (3-20-20)T

**02. Fit.** The trunks must be loose fitting and made of a lightweight cloth similar to an athlete's "running pants." The belt of the trunks must not extend above the waist line. (3-20-20)T

**03. Other Equipment.** Each combatant will wear: (3-20-20)T

**a.** A mouthpiece which has been individually fitted; and (3-20-20)T

**b.** An abdominal cup which will protect him against injury from a foul blow. (3-20-20)T

**702. COMBATANT'S PHYSICAL APPEARANCE.**

**01. Grease or Foreign Substances.** The excessive use of grease or any other foreign substance may not be used on the face of a combatant. The referees or the Commission will cause any excessive grease or foreign substance to be removed. (3-20-20)T

**02. Hair.** The Commission will determine whether head or facial hair presents any hazard to the safety of the combatant or his opponent or will interfere with the supervision and conduct of the contest. (3-20-20)T

**703. PROCEDURE FOR USE OF SCORECARDS.**

**01. Scorecards.** The Commission will, before the start of the contest, give scorecards to each judge. (3-20-20)T

**02. Scoring by Judges.** The judges will score each round of the contest on an individual scorecard and sign it. The referee will pick up the scorecard from each judge and turn in the scorecards at the Commission's desk before the start of each round. (3-20-20)T

**03. Presentation of Scorecards to Press After Contest.** The Commission may show the scorecards to accredited representatives of the press after the completion of the contest. (3-20-20)T

**04. Delivery of Scorecards to Commission.** The Commission will mail or deliver the scorecards together with required reports regarding the contest to the Division. (3-20-20)T

**05. Report of Each Contest.** Reports of each contest will be kept on file in the office of the Division. (3-20-20)T

**704. METHOD OF JUDGING.**

**01. Scoring by Judges.** Each judge will score every contest and determine the winner through the use of the following system: (3-20-20)T

**a.** The better combatant of a round receives ten (10) points and his opponent proportionately less. (3-20-20)T

**b.** If the round is even, each combatant receives ten (10) points. (3-20-20)T

**c.** No fraction of points may be given. (3-20-20)T

**d.** Points for each round will be awarded immediately after the end of the round. (3-20-20)T

**02. Majority Opinion.** After the end of the contest the announcer will pick up the scores of the judges from the Commission's desk. The majority opinion is conclusive and if there is no majority the decision is a draw. (3-20-20)T



**03. Announcing a Winner.** When the Commission has checked the scores, the announcer will be informed of the decision, and the announcer will inform the audience of the decision over the available public address system. (3-20-20)T

**705. INTRODUCTION FROM RING.**

Only a combatant or person officially identified with the contest may be introduced from the ring at an event, except with specific authority to do so from the Commission. (3-20-20)T

**706. REFEREE'S INSTRUCTIONS TO COMBATANTS.**

The referee will, before starting a contest, ascertain from each combatant the name of his chief second, who will be responsible for the conduct of the assistant seconds during the progress of the contest. The referee will call combatants together before each contest for final instructions, at which time each combatant will be accompanied by his chief second only. (3-20-20)T

**707. LIMITATIONS ON SECONDS.**

**01. Number of Seconds.** No contestant will have more than three (3) seconds except that in a contest for a world title the Commission may authorize four (4) seconds. (3-20-20)T

**02. Excessive Use of Water.** Any excessive or undue spraying or throwing of water on any boxer by a second between rounds is prohibited. (3-20-20)T

**708. CONTINUOUS PRESENCE OF PHYSICIAN AT RINGSIDE.**

**01. Presence of Physician at Ringside.** The physician designated by the Commission will sit at the immediate ringside at every event. A contest may not proceed unless the physician is in his seat at ringside. The physician must not leave until released by the Commission. He will be prepared to assist if any serious emergency arises and will render temporary or emergency treatments for cuts and minor injuries sustained by the combatants. (3-20-20)T

**02. Injury to Boxer During Round.** When a combatant appears to have been injured during the course of a round, his manager or second cannot attempt to render aid to him before the physician has had an opportunity to examine him. (3-20-20)T

**709. WARNING BEFORE START OF ROUND.**

Ten (10) seconds before the beginning of each round the timekeeper will give warning to the seconds of the combatants by blowing a whistle. (3-20-20)T

**710. DURATION OF ROUND.**

A round of boxing is three (3) minutes in duration. (3-20-20)T

**711. PERSONS ALLOWED IN RING.**

No persons other than the contestants and the referee may be in the ring during the progress of a round. (3-20-20)T

**712. FAIR BLOWS AND FOULS.**

**01. Fair Blow.** A fair blow is one delivered with the padded knuckle part of the glove on the front or side of the head or the front or side of the body above the belt. (3-20-20)T

**02. Fouls.** The following acts constitute fouls in boxing: (3-20-20)T

**a.** Hitting below the belt. (3-20-20)T

**b.** Hitting an opponent who is down or is getting up after being down. (3-20-20)T

**c.** Holding an opponent with one hand and hitting with the other. (3-20-20)T

- d. Holding or deliberately maintaining a clinch. (3-20-20)T
- e. Wrestling or kicking. (3-20-20)T
- f. Butting with the head or shoulder or using the knee. (3-20-20)T
- g. Hitting with the open glove, the butt of the hand, the wrist or the elbow, and all backhand blows. (3-20-20)T
- h. Purposely going down without being hit. (3-20-20)T
- i. Striking deliberately at that part of the body over the kidneys. (3-20-20)T
- j. Deliberately using the rabbit punch. (3-20-20)T
- k. Jabbing the opponent's eyes with the thumb of the glove. (3-20-20)T
- l. Using abusive language in the ring. (3-20-20)T
- m. Engaging in any unsportsman like trick or action which causes injury to an opponent. (3-20-20)T
- n. Hitting on the break. (3-20-20)T
- o. Hitting after the bell has sounded the end of the round. (3-20-20)T
- p. Hitting an opponent whose head is between and outside of the ropes. (3-20-20)T
- q. Pushing an opponent about the ring or into the ropes. (3-20-20)T

**713. UNFAIR PRACTICES; DUTIES OF REFEREES.**

**01. Enforcing the Rules.** A referee is responsible for enforcing the rules of the contest. He cannot permit unfair practices that may cause injury to a combatant. (3-20-20)T

**02. Warnings.** The referees will warn the combatants whenever they are committing fouls. (3-20-20)T

**03. Deducting Points.** If a combatant persists in committing fouls after he has been warned, the referee will deduct points from him or disqualify him. (3-20-20)T

**714. FOULS: DEDUCTION FOR POINTS; EFFECT OF CLAIMING LOW BLOW BY OPPONENT.**

**01. Deducting Points Because of Fouls.** If a contestant repeatedly fouls his opponent during a contest or commits any other infraction, the referee may penalize him by deducting a point from his score, whether or not the foul or infraction was intentional. (3-20-20)T

**02. Notification of Point Deduction.** When the referee determines that it is necessary to deduct a point because of a foul or infraction, he will inform the offender, the scoring table and the judges of the penalty to be assessed. (3-20-20)T

**03. Deduction of Points in Round Foul Occurs.** Any point or points to be deducted for any foul or infraction are deducted in the round in which the foul or infraction occurred, and may not be deducted from the score of any subsequent round. (3-20-20)T

**04. Contestant Claiming Low Blow.** A contestant may not be declared the winner of a contest on the basis of his claim that his opponent committed a foul by hitting him below the belt. If a contestant falls to the floor of the ring or otherwise indicates that he is unwilling to continue because of a claim of a blow to be a technical knockout in favor of the contestant who is willing to continue. (3-20-20)T

**715. FOULS: DISQUALIFICATION OF COMBATANT AND WITHHOLDING OF PURSE.**

Any combatant guilty of a foul in a contest may be disqualified by the referee and the participant's purse ordered withheld by the Commission. Disposition of the purse and the penalty to be imposed upon the combatant will be determined by the Commission. (3-20-20)T

**716. ACCIDENTAL FOULING.**

**01. Accidental Foul.** If a contest is stopped because of an accidental foul, the referee will determine whether the combatant who has been fouled can continue or not. If the combatant's chance of winning has not been seriously jeopardized as a result of a foul, the referee may order the contest continued after a reasonable interval. Before the contest begins again, the referee must inform the Commission of his determination that the foul was accidental. (3-20-20)T

**02. Contest Stopped Due to Accidental Foul.** If the referee determines that the contest may not continue because of an injury suffered as the result of an accidental foul, the bout will be declared a draw if the foul occurs during one-half (1/2) of the total scheduled rounds. (3-20-20)T

**03. Contest Stopped by Referee.** If an injury inflicted by an accidental foul later becomes aggravated by fair blows and the referee orders the contest stopped because of the injury, the outcome is determined by scoring the completed rounds and the round during which the referee stops the contest. (3-20-20)T

**717. STOPPING OF CONTEST: INJURY TO COMBATANT.**

The referee, in consultation with the ring physician designated by the Commission, will determine whether a contest should be stopped because of an injury to a combatant. (3-20-20)T

**718. STOPPING OF CONTEST: ONE-SIDED CONTEST; RISK OF INJURY; EXAMINATION BY PHYSICIAN.**

**01. One-Sided Contested.** The referee may stop a contest at any stage if he considers it too one-sided or if either combatant is in such a condition that to continue might subject him to serious injury. (3-20-20)T

**02. Risk of Injury and Examination by Physician.** If a combatant sustains any injury which the referee believes may incapacitate him, the referee will call the physician into the ring to examine the combatant. The physician will give his opinion to the referee before the referee renders his decision in the matter. (3-20-20)T

**719. STOPPING THE CONTEST: COMBATANT NOT HONESTLY COMPETING.**

If the referee decides that a combatant is not honestly competing, he may stop the contest before its scheduled completion, disqualify the combatant and recommend the purse of that combatant be held pending investigation by the Commission. The announcer will then inform the audience that no decision has been rendered. (3-20-20)T

**720. FAILURE OF COMBATANT TO RESUME.**

A combatant may not leave the ring during any one (1) minute rest period between rounds. If any combatant fails or refuses to resume the contest when the bell sounds signaling the commencement of the next round, the referee will award a decision of technical knockout to his opponent as of the round which has last been finished, unless the circumstances indicate to the referee the need for investigation or punitive action, in which event the referee will not give a decision and will recommend the purse or purses of either or both combatants to be withheld. (3-20-20)T

**721. GLOVES TO BE WIPED BY REFEREE AFTER BOXER FALLS.**

Before a boxer may resume boxing after having been knocked or having fallen or slipped to the floor of the ring, the referee shall wipe any accumulated resin from the boxer's gloves with a damp towel or the referee's shirt. (3-20-20)T

**722. KNOCKDOWN OF COMBATANT; PROCEDURE FOR COUNTING.**

**01. Knockdown.** When a combatant is knocked down, the referee will order the opponent to retire to the farthest neutral corner of the ring, pointing to the corner, and immediately begin the count over the combatant who is down. The referee will audibly announce the passing of the seconds, accompanying the count with motions of

his arm, the downward motion indication the end of each second. (3-20-20)T

**02. Timekeeper.** The timekeeper, by effective signaling, will give the referee the correct one (1) second interval for his count. The referee's count is the official count. Once the referee picks up the count from the timekeeper, the timekeeper will cease counting. No combatant who is knocked down may be allowed to resume boxing until the referee has finished counting to eight (8). The combatant may take the count either on the floor or standing. (3-20-20)T

**03. Failure of Opponent to Stay in Farthest Neutral Corner.** If the opponent fails to stay in the farthest neutral corner, the referee will cease counting until he has returned to his corner and will then go on with the count from the point at which it was interrupted. If the combatant who is down arises during the count, the referee may step between the combatants long enough to assure himself that the combatant just arisen is in condition to continue. If so assured, he will, without loss of time, order both combatants to go on with the contest. During the intervention by the referee the striking of a blow by either combatant may be ruled a foul. (3-20-20)T

**04. Knock-Out.** When a combatant is knocked out, the referee will perform a full ten (10) second count unless, in the judgment of the referee, the safety for the combatant would be jeopardized by such a count. If the combatant who is knocked down is still down when the referee calls the count of ten (10), the referee will wave both arms to indicate that he had been knocked out and will raise the hand of the opponent as the winner. (3-20-20)T

**05. Both Combatants Down.** If both combatants go down at the same time, the count will be continued as long as one (1) is still down. If both combatants remain down until the count of ten (10), the contest is stopped and the decision is a technical draw. (3-20-20)T

**06. Combatants Down -- Referee Counting.** If a combatant is down as a result of a legal blow at or near the end of a round, the ring official will continue the count. The combatant cannot be saved by the bell. (3-20-20)T

**07. Knockdown After Bell Has Sounded.** If a legal blow struck in the final seconds of a round causes a combatant to go down after the bell has sounded, that knockdown will be regarded as having occurred during the round just ended and the appropriate count will continue into the rest period following the bell. (3-20-20)T

**08. Three Knockdowns in Same Round.** There is no three (3) knockdown limit. (3-20-20)T

**723. RESUMING COUNT ON BOXER.**

If a knockdown occurs before the normal termination of a round and the boxer who is down stands up before the count of ten (10) is reached and then falls down immediately without being struck, the referee will resume the count where it was left off. (3-20-20)T

**724. ADJUDICATION OF TECHNICAL KNOCKOUT.**

**01. Contest Termination.** It must be adjudged a technical knockout to the credit of the winner if a contest is terminated because a combatant is: (3-20-20)T

a. Unable to continue; (3-20-20)T

b. Not honestly competing; (3-20-20)T

c. Injured; or (3-20-20)T

d. Disqualified. (3-20-20)T

**02. Win by Other Than Full Count.** A contest which is won by other than a full count of ten (10) or the scoring of the judges will be adjudged a technical knockout to the credit of the winner. (3-20-20)T

**725. PROCEDURE WHEN COMBATANT IS KNOCKED OUT; PERIOD BEFORE HIS NEXT CONTEST; EXAMINATION IN CASE OF HEAD INJURY.**

**01. Combatant Who Has Been Knocked Out.** A combatant who has been knocked out will be kept in a prone position until he has recovered. Except for the referee or chief second who may remove his mouthpiece, no one may touch him until the ring physician enters the ring, attends him and issues any instructions to his handlers. (3-20-20)T

**02. Decision of Technical Knockout Rendered by Referee.** If the referee has rendered a decision of technical knockout against a combatant, the participant will be placed on the ill and unavailable list for a period designated by the Commission after consulting the Commission's physician, but that period will not be less than fifteen (15) days. The combatant may not engage in any contact boxing during this period without the approval of the Commission. (3-20-20)T

**03. Knockout from Blow to Head.** If a combatant has been knocked out by a blow to the head, he will be placed on the ill and unavailable list for at least thirty (30) days. Before he is reinstated, he must satisfactorily pass an examination performed with a computerized tomographic scanning device or an electroencephalogram, or both, if the Commission or its physician finds that such an examination is necessary to determine his condition. (3-20-20)T

**04. Head Injury.** Whenever it appears that a combatant may have suffered a head injury, he will undergo such an examination if directed to do so by the Commission or its physician. (3-20-20)T

**726. WHEN COMBATANT FALLS FROM RING DURING ROUND.**

**01. Combatant Knocked or Falls from Ring Platform.** A combatant who has been knocked or has fallen through the ropes and over the edge of the ring platform during the contest may be helped back by anyone except his seconds or manager, and the referee may allow a reasonable amount of time for the combatant to return to the ring. If the combatant is on the ring platform outside the ropes, he must enter the ring immediately where he may resume the contest or take a count. The referee will start the count as soon as the combatant who had fallen is back in the ring. (3-20-20)T

**02. Stalling Outside Ropes.** If the combatant stalls for time outside the ropes, the referee will start the count without waiting for him to reenter the ring. (3-20-20)T

**03. Combatant to Neutral Corner.** When one (1) combatant has fallen through the ropes, the other combatant will retire to the farthest corner and stay there until ordered to continue the contest by the referee. (3-20-20)T

**04. Penalty.** A combatant who deliberately wrestles or throws an opponent from the ring, or who hits when he is partly out of the ring and is prevented by the ropes from assuming a position of defense, may be penalized. (3-20-20)T

**727. WHEN A BOXER SHALL BE DEEMED DOWN.**

**01. Feet Off Floor.** A boxer is deemed to be down when any part of his body other than his feet is on the floor. (3-20-20)T

**02. Hanging over Ropes.** A boxer is deemed to be down when he is hanging over the ropes without the ability to protect himself and he cannot fall to the floor. A referee may count a contestant out if he is on the floor or is being held up by the ropes. (3-20-20)T

**728. ANNOUNCEMENT OF WINNER OF BOUT.**

At the termination of each boxing bout the announcer will announce the winner and the referee will raise the winner's hand. (3-20-20)T

**729. CHANGE OF DECISION IN CONTEST.**

The Commission will not change a decision rendered at the end of any contest unless: (3-20-20)T

**01. Collusion.** The Commission determines that there was collusion affecting the result of the contest;

(3-20-20)T

**02. Error in Scoring.** The compilation of scorecards of the judges discloses an error which shows that the decision was given to the wrong combatant; or (3-20-20)T

**03. Error in Interpretation of Rules.** As a result of an error in interpreting a provision of this chapter, the referee has rendered an incorrect decision. (3-20-20)T

**04. Failure of Drug Test.** The Commission determines that there was a violation of Section 900. (3-20-20)T

**730. PHYSICIAN'S REPORT TO COMMISSION AFTER CONTEST.**

On the report which the physician designated by the Commission files after a contest, he shall list each case in which the boxer or wrestler: (3-20-20)T

**01. Injury.** Was injured during the contest; or (3-20-20)T

**02. Applies for Medical Aid.** Has applied for medical aid after the contest. (3-20-20)T

**731. MARTIAL ARTS AND MIXED MARTIAL ARTS (MMA).**

**01. Regulation of Marital Arts and MMA.** Except to the extent set forth under Rules 731-799, all requirements and the limitations relating to combatants and licenses (as set forth within Title 54, Chapter 4, Idaho Code, and in the remaining rules of the Commission) will apply to all martial arts and MMA contests and exhibitions. Notwithstanding the foregoing, at its sole discretion, the Commission may (by specific reference in the sanctioning permit) allow the use of other requirements and limitations during a particular martial arts contest or exhibition. (3-20-20)T

**02. Practices, Belt Promotions, and Non-Contact Demonstrations.** Martial arts practices, belt promotion testing and demonstrations (as used herein the term demonstrations means displays that do not involve combative contact between combatants or between participants) conducted by martial arts schools are not considered to be boxing. Such practices, testing, and demonstrations are exempt from the licensing requirements of Title 54, Chapter 4, Idaho Code, and persons do not need a license to participate in such practices, testing, and demonstrations. (3-20-20)T

**03. Licensing Exemption.** Martial arts schools that meet the conditions set forth within Section 54-406(3)(b), Idaho Code, may apply to the Commission for exemption from licensing and sanctioning permit requirements relating to exhibitions and contests. (3-20-20)T

**04. Use of Official Rules for Art.** Martial arts contests and exhibitions will be conducted pursuant to the official rules of the particular art. The sponsoring organization or promoter must file a copy of the official rules with the Commission before the Commission will issue a sanctioning permit for the contest or exhibition. (3-20-20)T

**05. Boxing Gloves.** The requirement set forth in Section 54-414, Idaho Code, of wearing boxing gloves applies to kickboxing but will not apply to any other form of martial art unless the use of boxing gloves is required by the official rules of that particular art. Any gloves utilized must be in good condition as approved by the commission. For the main and semi main events, gloves will be in new condition and of the same brand for combatants. (3-20-20)T

**732. MMA EQUIPMENT.**

The Commission is the final authority in all equipment matters. The following is a list of required equipment for MMA contests: (3-20-20)T

**01. Commission Approved Mouthpiece.** All combatants will wear a mouthpiece during the contest. It is strongly recommended that all combatants have two (2) form fitted mouthpieces available for use in each contest. (3-20-20)T

**a.** To Begin the Round. The round cannot begin if the mouthpiece is not inside the combatant's mouth and set in place. (3-20-20)T

**b.** During the Contest. The mouthpiece will be inside the combatant's mouth and properly set at all times during the contest. (3-20-20)T

**c.** Dislodged Mouthpiece. If the mouthpiece is dislodged during the contest, the referee will wait until the first opportune moment, without interfering with the action, call time out, and have the mouthpiece replaced. (3-20-20)T

**d.** Violations. At the discretion of the referee, points may be deducted or a disqualification rendered in the following situations: (3-20-20)T

i. When the mouthpiece is not being properly kept inside of the combatant's mouth; (3-20-20)T

ii. When the mouthpiece is purposely spit out; or (3-20-20)T

iii. When the corner fails to have the combatant resume competition with the mouthpiece in place or delays in replacing the mouthpiece after it becomes dislodged. (3-20-20)T

**02. Commission Approved MMA Gloves.** (3-20-20)T

**a.** General. The gloves will be examined by the Commission and the referee. If padding in the gloves is found to be misplaced or lumpy, or if any gloves are found to be imperfect, they must be changed before the contest starts. No breaking, roughing or twisting of gloves is permitted. (3-20-20)T

**b.** Weight: Each combatant will wear gloves that are not less than four (4) ounces in weight; (3-20-20)T

**c.** Specifications. Each combatant will wear open finger gloves that have no padding in the palm or fingertip area and that are appropriate in weight for the combatant's hand size. Under no circumstances will a combatant be allowed to wear bag gloves or any other gloves with metal or plastic inserts. (3-20-20)T

**03. Commission Approved Attire.** (3-20-20)T

**a.** Each combatant will wear a foul-proof groin protector. (3-20-20)T

**b.** Each female combatant will wear Commission-approved form fitting breast support protection. Supports may not have brace, metal or hard material of any kind. (3-20-20)T

**c.** For male combatants, no body shirts or pants are allowed. Female combatants will wear fighting shorts and rash guard. (3-20-20)T

**d.** Combatant may only use soft materials to tie hair. (3-20-20)T

**04. Prohibited Equipment and Attire.** (3-20-20)T

**a.** The following equipment and attire are prohibited: (3-20-20)T

i. Shoes; (3-20-20)T

ii. Facial hair, if determined by the Commission to pose a health, safety or sanitary issue; (3-20-20)T

iii. Tar material on any part of the body; (3-20-20)T

iv. Henna-type tattoos; (3-20-20)T

- v. Piercing accessories; and (3-20-20)T
- vi. Makeup of any kind. (3-20-20)T
- b. Masks, costumes, and props must be approved by the Commission prior to usage. (3-20-20)T
- c. Fingernails and toenails must be cut and trimmed prior to a contest. (3-20-20)T

**733. FAIR TECHNIQUES AND FOULS IN MMA EVENTS.**

**01. Fair Techniques.** Fair MMA techniques include the use of striking and grappling techniques, either while standing or on the ground, subject to techniques designated by the rules as fouls. (3-20-20)T

**02. Fouls.** The following actions will constitute fouls during any MMA event: (3-20-20)T

**a.** Head-butting or striking with the head in any manner. Any use of the head as a striking instrument whether head to head, head to body or otherwise is illegal. (3-20-20)T

**b.** Eye-gouging by means of fingers, chin, or elbow. Legal strikes or punches that contact the combatant's eye socket are not eye gouging and will be considered legal attacks. (3-20-20)T

**c.** A combatant must recognize that a referee may not be able to physically observe some actions and must make the referee aware if they are being bitten during an exhibition of unarmed combat. (3-20-20)T

**d.** Hair Pulling. A combatant may not grab hold of an opponent's hair in order to control the opponent in any way. (3-20-20)T

**e.** Fishhooking, meaning using the fingers to attack an opponent's mouth, nose, or ears, or stretching the skin to that area. Fishhooking generally is the placing of fingers into the mouth of an opponent and pulling the hands in opposite directions while holding onto the skin of the opponent. (3-20-20)T

**f.** Groin attacks, including striking, grabbing, pinching or twisting the groin area. (3-20-20)T

**g.** Smothering an opponent by cupping a hand over an opponent's mouth and nose. (3-20-20)T

**h.** Elbows thrown from a vertical angle. Elbows thrown from any other angle are legal, except that strikes with the elbow point from any angle are illegal during a contest or exhibition in which an amateur combatant participates. (3-20-20)T

**i.** Knee strikes of any kind to an amateur combatant's head. Further, when any combatant goes to the ground, only knees to the body are allowed. (3-20-20)T

**j.** Strikes to the back of the head. The back of the head is considered from the crown of the head down the centerline of the skull into the spine, with a one (1) inch variance to each side, similar to a mohawk haircut. Strikes that are thrown to areas behind the ears but not within the mohawk limitation are legal strikes. (3-20-20)T

**k.** Hand Chokes. A combatant may not attack an opponent with a choke utilizing only his hand or hands in an attempt to submit an opponent. A common phrase for this type of choke is the "C clamp" choke wherein the thumb is placed on one side of an opponent's neck with the fingers on the opposite side. (3-20-20)T

**l.** Placing one's fingers into an open laceration on an opponent in an attempt to enlarge the cut. A combatant may not place his fingers into an opponent's nose, ears, mouth, or any body cavity. (3-20-20)T

**m.** Small Joint Manipulation. Fingers and toes are small joints. Wrists, ankles, knees, shoulders and elbows are all large joints. (3-20-20)T

**n.** Spine Attacks. Illegal spine attacks include, without limitation, locks, such as the "Twister," and



- strikes to the spine. (3-20-20)T
- o.** Throat strikes of any kind including, without limitation, grabbing the trachea. (3-20-20)T

    - i.** No directed throat strikes are allowed. A directed attack would include a combatant pulling an opponent's head in a way to open the neck area for a striking attack. Directed throat attacks are not punches that connect during an exchange from the standing position while combatants are engaged in combat. (3-20-20)T
    - ii.** A combatant may not gouge his fingers or thumb into an opponent's neck or trachea in an attempt to submit the opponent. (3-20-20)T
    - iii.** All arm chokes such as the "rear naked," "guillotine" and "bar arm" are legal. (3-20-20)T
  - p.** Skin Clawing. Any attack that targets the combatant's skin by clawing at the skin or attempting to pull or twist the skin to apply pain. (3-20-20)T
  - q.** Kicking the head or groin of a grounded opponent. A grounded opponent is any combatant who has more than just the soles of the feet on the ground. If the referee determines that a combatant would be a grounded combatant, but not solely because the ring ropes or cage fence has held the combatant up from the ground, the referee can instruct the combatants that the combatant held up solely by the cage or ropes is being treated as a grounded combatant. A combatant can be kicked to the body when he is on the ground with any type of legal kick, but may not be kicked in the head or groin. (3-20-20)T
  - r.** Stomping, meaning any type of striking action with the feet wherein the combatant lifts his leg, bending it at the knee, and initiates a striking action with the bottom of the foot or heel. This includes stomping the feet while both combatants are standing. Axe kicks are not stomps. (3-20-20)T
  - s.** Pile-driving an opponent into the mat. (3-20-20)T

    - i.** A pile driver is considered to be any throw wherein a combatant controls an opponent's body by placing the opponent's feet straight up in the air and the head straight down and then forcibly driving the opponent's head into the canvas or flooring material. (3-20-20)T
    - ii.** It should be noted that if a combatant is placed into a submission hold by his opponent and the combatant is capable of elevating his opponent, the combatant may bring his opponent down in any manner because he is not in control of his opponent's body. The combatant who is attempting the submission can either adjust his position or let go of the hold before being slammed to the canvas. It is crucial that referees are properly advised and trained on this and that the combatants fully understand this at the rules meeting. (3-20-20)T
  - t.** Purposely throwing an opponent out of the ring or caged area. A combatant will not intentionally or purposely throw an opponent out of the ring or cage. (3-20-20)T
  - u.** Holding the shorts or gloves of an opponent. A combatant may not control an opponent's movement by holding onto the opponent's shorts or gloves. A combatant may hold onto or grab an opponent's hand as long as the combatant is not controlling the opponent's hand by using only the material of the glove but is actually gripping the hand. It is legal for a combatant to hold onto his own gloves or shorts. (3-20-20)T
  - v.** Engaging in any unsportsmanlike conduct is not allowed. Any type of behavior or conduct observed or heard by the referee that can be considered detrimental or disrespectful towards an opponent or the sport of MMA. This includes, but is not limited to, spitting at an opponent, using abusive language or abusive gestures, etc. (3-20-20)T
  - w.** Holding the ropes or the fence. (3-20-20)T

    - i.** A combatant may put his hands on the fence and push off at any time. A combatant may place his feet onto the cage and have his toes go through the fencing material at any time. If a combatant's fingers go through the cage and he grabs hold of the fence and starts to control either his body position or his opponent's body position,

it is an illegal action. A combatant may not grab the ropes or wrap his arms over the ring ropes at any time. (3-20-20)T

ii. If a combatant is caught holding the fence, cage or ring rope material the referee will issue a one-point (1) deduction from the offending combatant's scorecard. (3-20-20)T

iii. If a point deduction for holding the fence occurs, and the fouling combatant ends up in a superior position due to the foul, the combatants will be re-started, standing in a neutral position. (3-20-20)T

x. Attacking an opponent on or during the break. A combatant will not engage an opponent in any manner during a time-out or break of action in competition. (3-20-20)T

y. Engaging an opponent in any manner while the opponent is under the referee's care or handling. (3-20-20)T

z. Failing to follow the referee's instructions. Any deviation or non-compliance may result in the combatant's disqualification. (3-20-20)T

aa. Timidity, meaning any action by a combatant that is used to avoid contact with his opponent or to run away from the action of the fight. Timidity, includes, without limitation, intentionally avoiding contact with an opponent or consistently dropping the mouthpiece or faking an injury. The referee may also call timidity on a combatant for attempting to receive time by falsely claiming a foul or injury, for purposely dropping or spitting out his mouthpiece, or for committing any other action designed to stall the contest. (3-20-20)T

bb. Interference by the corner, meaning any action or activity by a corner aimed at disrupting the contest or causing an unfair advantage to a combatant. Corners are not allowed to distract the referee or influence the actions of the referee in any manner. (3-20-20)T

**03. Time Considerations for Fouls. (3-20-20)T**

a. A combatant who has been struck with a low blow is allowed up to five (5) minutes to recover from the foul and can continue on in the contest if allowed to by the ringside physician. (3-20-20)T

i. If the combatant states that they can continue on before the five (5) minute time allotment has expired, then as soon as is practical the referee will restart the contest. (3-20-20)T

ii. If the combatant goes over the five (5) minute time allotment, the contest cannot be restarted and is stopped. The outcome is determined by the round and time in which the contest was stopped. (3-20-20)T

b. If a combatant is fouled by a blow that the referee deems illegal, the referee will stop the action and call for time. The referee will take the injured combatant to the ringside physician and have the ringside physician examine the combatant to determine the combatant's ability to continue on in the contest. The ringside physician has up to five (5) minutes to make his determination. If the ringside physician determines that the combatant can continue on in the contest, then as soon as is practical the referee will restart the contest. Unlike the low blow foul, the combatant does not have the five (5) minute time allotment to use at his discretion. (3-20-20)T

c. If the referee stops the contest and employs the use of the ringside physician, the ringside physician's examination cannot exceed five (5) minutes. If five (5) minutes is exceeded, the contest cannot be restarted and is stopped. (3-20-20)T

d. If the ringside physician deems a combatant unfit to continue, the referee must immediately stop the contest. If the combatant is deemed unfit to continue by the ringside physician and part of the five (5) minute foul time is remaining, the combatant cannot use the remaining time. This will be enforced for all listed fouls, with the exception of a low blow foul. (3-20-20)T

**04. Intentional Fouling. (3-20-20)T**

**a.** When a contest is interrupted due to an injury caused by an intentional foul, the referee, in consultation with the ringside physician, will determine whether the intentionally fouled combatant can continue or not. If it is determined that the intentionally fouled combatant's chance of winning has not been seriously jeopardized as a result of the foul, the referee may order the contest continued after a reasonable interval. A combatant who is fouled with a low blow has up to five (5) minutes to recover. (3-20-20)T

**b.** If the referee, in consultation with the ringside physician, determines at any time during the contest that the intentionally fouled combatant's chance of winning has been seriously jeopardized or the combatant is unable to continue the contest as a result of the foul, or by any aggravation to an injury caused by the foul, the intentionally fouled combatant wins by "technical decision." (3-20-20)T

**05. Accidental Fouling.** (3-20-20)T

**a.** When a contest is interrupted due to an injury caused by an accidental foul, the referee, in consultation with the ringside physician, will determine whether the combatant who has been fouled can continue or not. If it is determined that a combatant has been accidentally fouled and the combatant's chance of winning has not been seriously jeopardized as a result of a foul, the referee may order the contest continued after a reasonable interval. A combatant who is fouled with a low blow has up to five (5) minutes to recover. (3-20-20)T

**b.** If the referee or the ringside physician, or both, determine that the contest may not continue because of an injury suffered as the result of an accidental foul or because of an injury inflicted by an accidental foul which later becomes aggravated by fair blows, and if less than two (2) rounds have been completed in the contest, then a "no contest" will be entered. If two (2) or more rounds have been completed in the contest, then the combatant who is ahead on the scorecards wins by "Technical Decision." (3-20-20)T

**06. Fouls or Unsportsmanlike Conduct During the One Minute Rest Period in MMA Contest.** (3-20-20)T

**a.** If a combatant fouls or acts in an unsportsmanlike manner during the one (1) minute rest period, the referee will deduct points from the offending combatant based on the severity of the offense. (3-20-20)T

**b.** The Chief Second is responsible for all corner activities. Any illegal activity may cause the Chief Second to be immediately removed from the corner from the entire contest. (3-20-20)T

**07. Concussive Head Impact Fouls in MMA Contest.** Before allowing a contest to continue, the referee should consult with the ringside physician in all cases involving concussive head fouls. The referee, in conjunction with the ringside physician, will determine the length of time needed to evaluate the affected combatant's suitability to continue. (3-20-20)T

**a.** If the referee determines that a foul to the head was intentional, he must follow the Intentional Foul rule. The referee will consider that allowing the contest to continue may subject the combatant to a severe injury. (3-20-20)T

**i.** If the affected combatant is not badly injured and his chance of winning has not been seriously jeopardized because of the foul, the contest may be allowed to continue. If the contest is allowed to continue, the offending combatant will be issued an official warning and have one (1) point deducted from his score in the round. (3-20-20)T

**ii.** If the referee determines that the affected combatant cannot continue, the offending combatant will lose by "Disqualification." (3-20-20)T

**b.** If the referee determines that a foul to the head was accidental, he will follow the Accidental Foul rule. The referee must consider that allowing the contest to continue may subject a combatant to a severe injury. (3-20-20)T

**i.** If the affected combatant is not badly injured and his chance of winning has not been seriously jeopardized because of the foul, the contest may be allowed to continue. (3-20-20)T

- ii. If the contest cannot continue the Technical Decision rule will be applied. (3-20-20)T
- 08. Low Blow in MMA Contest.** (3-20-20)T
  - a. If the referee determines that the low blow foul was intentional, he will follow the Intentional Foul rule. (3-20-20)T
    - i. If the offended combatant is not badly injured and their chance of winning has not been seriously jeopardized because of the foul, the Five (5) Minute rule may be applied. (3-20-20)T
    - ii. If the referee determines that the athlete cannot continue, the offending combatant will lose by “Disqualification.” (3-20-20)T
  - b. When a combatant is hit with an accidental low blow and claims injury, the referee, at his discretion, may apply the Five (5) Minute rule. If the injured combatant cannot resume fighting before the recovery period ends, the injured combatant will lose the contest by “No Contest.” (3-20-20)T
  - c. The Five (5) Minute Rule is only applicable to low blow fouls. (3-20-20)T
- 09. Disqualification.** A combatant will lose by “Disqualification” when he: (3-20-20)T
  - a. Intentionally fouls and causes harm to his opponent; (3-20-20)T
  - b. Continually refuses to follow the rules; or (3-20-20)T
  - c. Continually disobeys the referee. (3-20-20)T
- 10. Referee Action on Fouls in MMA Contest.** (3-20-20)T
  - a. The referee will inform the Commission Representative as soon as possible of the following: (3-20-20)T
    - i. The type of foul; (3-20-20)T
    - ii. If the foul was accidental or intentional; (3-20-20)T
    - iii. If points will be deducted from the offending combatant; (3-20-20)T
    - iv. If the offending combatant will be disqualified; (3-20-20)T
    - v. If the Five (5) Minute rule will or will not be applied; (3-20-20)T
    - vi. If the contest will be delayed to evaluate a combatant; or (3-20-20)T
    - vii. If the contest will or will not continue. (3-20-20)T
  - b. The referee will declare whether a blow is legal or a foul. If declared a foul, he will declare if it was Accidental or Intentional. Point deductions for fouls will be done at the time of the infraction. If an intentional foul causes injury and the injury is severe enough to immediately terminate the bout, the combatant causing the injury loses by “Disqualification.” (3-20-20)T
  - c. Point deductions for an intentional foul is mandatory. If an intentional foul causes an injury and the fouled combatant can continue, the referee at his discretion will deduct points from the offending combatant. (3-20-20)T

**734. SUSPENSION OF MMA CONTEST FOR UNFORESEEN REASONS.**

**01. Unforeseen Reasons.** If a contest has to be suspended for any reason other than the actions of the combatants, the referee will have the clock stopped and attend to the issue. The referee, Commission or Commission’s representative will decide the length of time allotted to address the issue. All reasonable efforts are made to resume the contest as soon as possible. It is expected that the responsible party or parties make a true effort to resolve the issue. (3-20-20)T

**02. Suspicious Circumstances.** If the contest is unexpectedly stopped under suspicious circumstances, all or part of the following actions may take place: (3-20-20)T

- a.** If a combatant or his corner is involved, the offending combatant may be disqualified. (3-20-20)T
- b.** The combatant may be subject to investigation and discipline in the event of a violation of these rules. (3-20-20)T
- c.** In certain circumstances the matter may be referred to the appropriate law enforcement agency or the courts, or both. (3-20-20)T

**735. STANDING EIGHT COUNT IN MMA CONTEST.**

No standing eight (8) count is permitted under any circumstances. Referee’s are responsible for combatant safety and will stop a contest when a combatant is unable to intelligently defend himself, or is unresponsive, timid, or mismatched in competition, or when the referee feels the combatant’s safety is jeopardized. (3-20-20)T

**736. WEIGHT CATEGORIES - MIXED MARTIAL ARTS.**

Commissions may use their discretion to approve certain matches out-of-weight class contests. The following comprises the full list of usable weight categories in any MMA contest.

<b>MEN’S DIVISIONS:</b>	
Featherweight	Up to 135 lbs.
Lightweight	135.1 to 155 lbs.
Welterweight	155.1 to 170 lbs.
Middleweight	170.1 to 185 lbs.
Light Heavyweight	185.1 to 205 lbs.
Heavyweight	205.1 to 265 lbs.
Super Heavyweight	265.1 lbs. and above

<b>WOMEN’S DIVISIONS:</b>	
Flyweight	95 lbs. and below
Featherweight	95.1 to 115 lbs.
Lightweight	115.1 to 125 lbs.
Welterweight	125.1 to 135 lbs.
Middleweight	135.1 to 145 lbs.
Light Heavyweight	145.1 to 155 lbs.
Cruiserweight	155.1 to 165 lbs.
Heavyweight	165.1 to 185 lbs.
Super Heavyweight	185.1 and above

(3-20-20)T

**737. MMA EVENT ROUNDS.**

**01. Length of Rounds.** Rounds for contests or exhibitions in which amateur combatants participate are three (3) minutes long. Rounds for contests or exhibitions in which professional combatants participate are five (5) minutes long. (3-20-20)T

**02. Number of Rounds.** Non-title contests consists of three (3) rounds. Title contests consist of five (5) rounds. (3-20-20)T

**738. METHODS OF WINNING MMA CONTEST.**

**01. Knockout (KO).** A knockout is declared when a combatant is unable to intelligently defend himself following a strike. (3-20-20)T

**02. Technical Knockout (TKO).** A technical knockout is declared when the licensed ringside physician or referee decides the combatant cannot continue due to a cut or other injury. (3-20-20)T

**03. Submission.** When a combatant submits by tapping out on the opponent or the mat as a result from a choke, lock, or any other legal technique or strike. A combatant may call out defeat when unable to tap out. (3-20-20)T

**04. Referee Stoppage.** The referee may stop the contest if a combatant can no longer defend himself or cannot or will not tap out, or for any other reason to preserve the health and safety of the combatants. (3-20-20)T

**05. Decision.** When the contest ends after the specified time period and there is no winner, or ends due to a foul or fouls that cause injury, or ends due to unforeseen circumstance, it will be scored by the three (3) judges. (3-20-20)T

**a.** Decisions made via a scorecard in MMA contest will be: (3-20-20)T

i. A “Unanimous Decision” in which all three (3) judges agree on winner. (3-20-20)T

ii. A “Split Decision” in which two (2) judges agree on one (1) combatant and one (1) judge scores for the other combatant. (3-20-20)T

iii. A “Majority Decision” in which two (2) judges agree on one (1) combatant and one (1) judge scores a draw. (3-20-20)T

**b.** A “Draw” may be: (3-20-20)T

i. A “Unanimous” decision in which all three (3) judges score the contest a draw; (3-20-20)T

ii. A “Majority” decision in which two (2) judges score the contest a draw and one (1) judge scores for a combatant; or (3-20-20)T

iii. A “Split” decision in which one (1) judge scores for a combatant, one (1) judge scores for the other combatant and one (1) judge scores the contest a draw. (3-20-20)T

**c.** Other scorecard decisions are: (3-20-20)T

i. Technical Decision; (3-20-20)T

ii. Technical Draw; or (3-20-20)T

iii. No Contest. (3-20-20)T

d. A “Disqualification” can result from fouling or unsportsmanlike conduct as determined by the referee. (3-20-20)T

**06. Inability of Opponent to Continue or Throws in Towel.** If the opponent is unable or unwilling to continue the contest or the combatant’s corner decides that the combatant is unable to continue and indicates this by throwing the towel into the ring or cage, a TKO will result against this combatant. (3-20-20)T

**739. MMA CONTEST SCORING.**

**01. 10 Point Must System.** All contests will be evaluated and scored by three (3) judges. In exigent circumstances, or at the discretion of the Commission, a referee may be allowed to judge a contest. The 10 Point Must System will be the standard system of scoring a contest. In the event that a contest ends by technical decision, the judges will score the partial round. (3-20-20)T

**02. Method of Judging.** (3-20-20)T

a. Scoring by Judges. Each judge will score every contest and will determine the winner using the following scoring system: (3-20-20)T

i. The better combatant of a round receives ten (10) points and his opponent proportionately fewer points. (3-20-20)T

ii. If the round is even, each combatant receives ten (10) points. (3-20-20)T

iii. No point fractions may be given. (3-20-20)T

iv. Points for each round are awarded immediately after the end of the round. (3-20-20)T

b. Majority Opinion. After the end of the contest the announcer will pick up the scores of the judges from the Commission’s desk. The majority opinion is conclusive. If there is no majority decision, the contest is declared a technical draw. (3-20-20)T

c. Announcing a Winner. When the Commission has checked the scores, the announcer will be informed of the decision, and the announcer will inform the audience of the decision over the available public address system. (3-20-20)T

**03. Primary Scoring Considerations.** The following are primary scoring considerations for scoring an amateur MMA competition: (3-20-20)T

a. Legal striking. Clean, effective strikes in the legal scoring zone - number and quality of legal scoring blows; (3-20-20)T

b. Legal takedowns, throws or knockdowns; (3-20-20)T

c. Near completed submission; (3-20-20)T

d. Overall control and dominance; and (3-20-20)T

e. Damage. (3-20-20)T

**740. COMBATANT DOWN AFTER THE SOUND OF THE BELL.**

**01. End of Round.** The round ends when the bell sounds to end the round. (3-20-20)T

**02. Combatant Down After Round Has Ended.** If during the round legal blows negatively affect a combatant and the combatant goes down after the bell has sounded ending the round, the referee will consider the

round ended and the one-minute rest period started. The referee may then allow the combatant's corner to assist the downed combatant or he may summon the ringside physician to evaluate the combatant, or both. (3-20-20)T

**741. BLOWS AT OR AFTER THE BELL IN MMA CONTEST.**

**01. Legal Blow.** A blow that strikes a combatant concurrent with the sounding of the bell is deemed to be a legal blow. (3-20-20)T

**02. Illegal Blow.** A blow that strikes a combatant after the sounding of the bell is deemed to be a foul. The referee will determine if it was accidental or intentional foul. (3-20-20)T

**742. TERMINATION OF A CONTEST DUE TO A FAIR BLOW IN MMA CONTEST.**

If an athlete sustains an injury from a fair blow and the injury is severe enough to immediately terminate the contest, the injured combatant will lose by "Technical Knockout (TKO)". (3-20-20)T

**743. COMBAT PLATFORMS (RING/CAGE).**

All MMA contests will take place in either a cage or a ring that has been approved by the Commission. The cage or ring will be subject to inspection prior to each contest by the Commission, a Commission representative, or a referee. (3-20-20)T

**744. -- 799. (RESERVED)**

**800. WRESTLING: SPECIAL LICENSE IS REQUIRED FOR A CONTEST.**

Unless a special license has been obtained, all professional wrestling programs under the supervision and authority of the Commission are only exhibitions and not contests, and those exhibitions cannot be advertised or announced as contests. (3-20-20)T

**801. WRESTLING: DISQUALIFICATION FOR DANGEROUS TACTICS.**

**01. Restrictions.** The referee will not permit physically dangerous conduct or tactics by any wrestler. Any wrestler who fails to discontinue those tactics, after being warned by the referee, will be disqualified and have his purse held up and paid to the Commission. (3-20-20)T

**02. Professionalism.** A referee cannot participate in an exhibition to the extent that the Commission or the referee is made to look ridiculous. (3-20-20)T

**802. LICENSEE'S DUTIES AT WRESTLING EXHIBITION.**

**01. Conduct.** The referee, promoter and his agents, attaches and employees, and participants in any wrestling exhibition will maintain peace, order and decency in the conduct of the exhibition. (3-20-20)T

**02. No Abusive Behavior.** A person who is involved in such exhibition will not abuse the referee or an official of the Commission. (3-20-20)T

**03. Decision and Appeal.** The Commission will hear any complaint about a referee or an official. (3-20-20)T

**803. WRESTLERS -- PHYSICAL EXAMINATION.**

Any person applying for or renewing a license as a wrestler will first be examined by a physician approved by the Commission to establish physical and mental fitness. A wrestler will be furnished a list of approved examining physicians by the Commission. The Commission may order the examination of any wrestler for the purpose of determining whether the wrestler is fit and qualified to engage in further exhibitions. (3-20-20)T

**804. -- 899. (RESERVED)**

**900. ADMINISTRATION OR USE OF ALCOHOL, DRUGS, STIMULANTS.**



**01. Prohibitions.** The administration of or use of any of the following, in any part of the body either before or during an event, to or by any combatant is prohibited: (3-20-20)T

- a. Alcohol; (3-20-20)T
- b. Drugs; (3-20-20)T
- c. Injection; or (3-20-20)T
- d. Stimulant. (3-20-20)T

**02. Urinalysis.** A combatant will submit to a urinalysis of chemical test before or after a contest if the Commission directs him to do so. (3-20-20)T

**03. Suspension.** No combatant will be allowed to box if his urinalysis testing reveals the presence of illegal substance(s). (3-20-20)T

**04. Procedure for Testing for Illegal Substance(s).** (3-20-20)T

a. The Commission reserves the right to conduct random drug testing. A combatant with a recent history of drug abuse may be specifically required to test. Both combatants in the title contest will be tested by urine specimen or blood test at the discretion of the commission. (3-20-20)T

b. The combatant to be tested shall go directly to the dressing room after the end of the fight. Only water may be consumed until the test sample has been taken. The Commission's approved physician or agent will give each combatant the specimen container and observe the combatant give the specimen into the container. The container will be sealed and labeled by the physician or agent. The Chain of Custody Form is signed by the combatant, or manager, and the physician or agent will also sign and date the form. The physician or agent will transport the sample to the testing laboratory as selected by the Commission. Any other person taking custody of the sample will sign and date The Chain of Custody Form. After completion of the test, the Chain of Custody Form will be returned to the Commission with the test results. (3-20-20)T

**05. Subject to Disciplinary Action.** A licensee who violates any provision of this Section is subject to disciplinary action by the Commission. (3-20-20)T

**901. PREPARATIONS TO STOP HEMORRHAGING.**

The Commission will periodically review the preparations available to stop hemorrhaging. Only the preparations which are approved by the Commission may be used to stop hemorrhaging on the ring. Avetine and Thrombin are the only Commission approved preparations to stop hemorrhaging. (3-20-20)T

**902. COMBATANT NOT TO HAVE PROMOTER OR CERTAIN OTHERS ACT AS MANAGER OR HOLD FINANCIAL INTEREST.**

A combatant may not have a promoter or any of its members, stockholders, officials, matchmakers or assistant matchmakers: (3-20-20)T

**01. Manager.** Act directly or indirectly as manager; or (3-20-20)T

**02. Financial Interest.** Hold any financial interest in the management of the combatant's earnings. (3-20-20)T

**903. REPORT TO COMMISSION OF SOLICITATION TO CONDUCT CONTEST FRAUDULENTLY.**

When any person who is licensed by the Commission is approached with a request or suggestion that a contest not be conducted honestly, that person must immediately report that matter to the Commission. Failure to do so is a ground for disciplinary action. (3-20-20)T

**904. SUSPENSION OF A LICENSE -- DEBTS IN CONNECTION WITH TRAINING.**

Any boxer, wrestler or manager may have his license suspended by the Commission if he fails to pay any legitimate

debt which he contracted in connection with training and use of a gymnasium. (3-20-20)T

**905. GROUNDS FOR DISCIPLINARY ACTION.**

Any person who is licensed by the Commission may have his license suspended or revoked, or be fined or otherwise disciplined by the Commission for any of the following: (3-20-20)T

- 01. Violation of Laws.** Having violated the laws of Idaho, except for minor traffic violations. (3-20-20)T
- 02. Violation of Rules.** Having violated any provisions of this chapter. (3-20-20)T
- 03. Valid Orders of Commission.** Failed or refused to comply with a valid order of the Commission. (3-20-20)T
- 04. Good Conduct.** Conduct at any time or place in a manner which is deemed by the Commission to reflect discredit to boxing or wrestling. (3-20-20)T

**906. (RESERVED)**

**907. LICENSEES PROHIBITED FROM DEALING WITH PERSONS WHOSE LICENSES ARE SUSPENDED OR REVOKED.**

A person who is licensed by the Commission will not have any dealings related to boxing or wrestling with any person whose license had been suspended or revoked by the Commission. (3-20-20)T

**908. SUSPENSION AND REVOCATION OF LICENSES.**

**01. Comply with Suspensions.** Every promoter and matchmaker will take notice of the bulletins of suspension sent out by the Commission and will not permit any person under suspension to take any part as a participant or in arranging or conducting matches or exhibitions during the period of suspension. (3-20-20)T

**02. Additional.** Every person whose license has been suspended or revoked by the Commission will refrain from participating in or matchmaking or holding contests during the period of suspension or after the revocation. (3-20-20)T

**03. Specific Actions.** Any person whose license has been suspended or revoked is barred from: (3-20-20)T

- a.** The dressing rooms at the premises where any program of boxing is being held; (3-20-20)T
- b.** Occupying any seat within six (6) rows of the ring platform; (3-20-20)T
- c.** Approaching within six (6) rows of seats from the ring platform; and (3-20-20)T
- d.** Communicating in the arena or near the dressing rooms with any of the principals in the contests, their managers, their seconds, of the referee, whether directly or by a messenger, during any program. (3-20-20)T
- e.** Any person who violates a provision of Subsection 908.03 of this rule may be ejected from the arena or building where the program is being held, and the price paid for admission refunded upon presentation of the ticket stub at the box office. Thereafter, he is barred entirely from all premises used for contests or exhibitions while the programs are being held. (3-20-20)T

**04. Dishonest Methods.** If a license issued by the Commission has been suspended because the holder used dishonest methods to affect the outcome of any contest or because of any conduct reflecting serious discredit upon the sport of boxing, the Commission will not reinstate the license for six (6) months in the case of first offense. In the case of a second offense, the holder's license will be revoked. (3-20-20)T

**05. Temporary Suspension.** Any manager who is under temporary suspension is considered to have

forfeited all rights in this state under the terms of any contract with a combatant licensed by the Commission. Any attempt by a suspended manager to exercise those contract rights will result in a permanent suspension of his license. The license of any combatant, matchmaker, or promoter who continues to engage in any contractual relations with a manager whose license has been suspended by the Commission may be indefinitely suspended. (3-20-20)T

**06. Continuation.** A combatant whose manager has been suspended may continue to compete independently during the term of that suspension, signing contracts for matches. Payment of a combatant's earnings may not be made by any promoter to a manager who is under suspension, or to a suspended manager's agent, but will be paid in full to the combatant. (3-20-20)T

**07. Cancellation of Contract Rights.** Revocation of a manager's license automatically cancels all contract rights in this state under any contracts with combatants made under the authority of the Commission. If such a revocation occurs, a combatant may operate independently and make contracts for matches or enter into contracts with other managers licensed by the Commission. (3-20-20)T

**909. PENALTIES FOR CERTAIN VIOLATIONS; REVIEW BY COMMISSION.**

**01. Penalties General.** Except as otherwise provided in this chapter, the Commission may charge a penalty not to exceed twenty-five thousand dollars (\$25,000) for: (3-20-20)T

**a.** Any violation of the provisions of these rules (IDAPA 24.02.01, "Rules of the Athletic Commission"); or (3-20-20)T

**b.** Being late or failing to appear for a weigh-in or contest. (3-20-20)T

**02. Later Review.** Any disciplinary action taken pursuant to Subsection 909.01 of these rules will be reviewed at a later date by the Commission. (3-20-20)T

**910. -- 999. (RESERVED)**

# **IDAPA 24 – DIVISION OF OCCUPATIONAL AND PROFESSIONAL LICENSES**

## **24.03.01 – RULES OF THE STATE BOARD OF CHIROPRACTIC PHYSICIANS**

### **DOCKET NO. 24-0301-2000F (FEE RULE)**

#### **NOTICE OF OMNIBUS RULEMAKING – ADOPTION OF TEMPORARY RULE**

**EFFECTIVE DATE:** The effective date of the temporary rule being adopted through this omnibus rulemaking is the adjournment date of the second regular session of the 65th Idaho State Legislature - March 20, 2020.

**AUTHORITY:** In compliance with Sections 67-5226, Idaho Code, notice is hereby given this agency has adopted a temporary rule. The action is authorized pursuant to Section 54-707, Idaho Code.

**DESCRIPTIVE SUMMARY:** The following is the required finding and concise statement of its supporting reasons for adopting a temporary rule:

This temporary rulemaking adopts the following chapter under IDAPA 24:

#### **IDAPA 24.03**

- 24.03.01, *Rules of the State Board of Chiropractic Physicians.*

**TEMPORARY RULE JUSTIFICATION:** Pursuant to Sections 67-5226(1) and 67-5226(2), Idaho Code, the Governor has found that temporary adoption of the rule is appropriate for the following reasons:

These temporary rules are necessary to protect the public health, safety, and welfare of the citizens of Idaho and confer a benefit on its citizens. These temporary rules implement the duly enacted laws of the state of Idaho, provide citizens with the detailed rules and standards for complying with those laws, and assist in the orderly execution and enforcement of those laws. The expiration of these rules without due consideration and processes would undermine the public health, safety, and welfare of the citizens of Idaho and deprive them of the benefit intended by these rules. These rules govern the qualifications for chiropractors as well as regulate the practice of chiropractic physicians. Allowing these rules to expire would harm licensees and consumers who seek treatment from chiropractic physicians.

**FEE SUMMARY:** Pursuant to Section 67-5226(2), the Governor has found that the fees or charges being imposed or increased are justified and necessary to avoid immediate danger and the fees are described herein:

The fees or charges, authorized in Section 54-707A, Idaho Code, are part of the agency's 2021 budget that relies upon the existence of these fees or charges to meet the state's obligations and provide necessary state services. Failing to reauthorize these temporary rules would create immediate danger to the state budget, immediate danger to necessary state functions and services, and immediate danger of a violation of Idaho's constitutional requirement that it balance its budget.

The following is a specific description of the fees or charges:

<b>Fee Type</b>	<b>Amount (Not to Exceed)</b>
Application	\$200
Original License	\$200
Annual Renewal	\$200
Inactive License	\$150
Reinstatement of Expired License	\$35
Reinstatement of Inactive License	\$150
Temporary Permit	\$150

<b>Fee Type</b>	<b>Amount (Not to Exceed)</b>
Intern Permit	\$150
Application for Clinical Nutrition Certification	\$175
Clinical Nutrition Certification Renewal	\$175

ASSISTANCE ON TECHNICAL QUESTIONS: For assistance on technical questions concerning the temporary rule, contact Rob McQuade at (208) 334-3233.

DATED this February 21, 2020.

Kelley Packer  
Division Administrator  
Division of Occupational and Professional Licenses  
700 W. State Street  
P.O. Box 83720  
Boise, ID 83720  
Phone: (208) 334-3233  
Fax: (208) 334-3945

## 24.03.01 – RULES OF THE STATE BOARD OF CHIROPRACTIC PHYSICIANS

### 000. LEGAL AUTHORITY.

These rules are hereby prescribed and established pursuant to the authority vested in the State Board of Chiropractic Physicians by the provisions of Section 54-707, Idaho Code. (3-20-20)T

### 001. TITLE AND SCOPE.

These rules are titled IDAPA 24.03.01, “Rules of the State Board of Chiropractic Physicians.” (3-20-20)T

### 002. -- 009. (RESERVED)

### 010. DEFINITION.

**01. Chiropractic Assistant.** A chiropractic assistant is an individual functioning in a dependent relationship with a supervising chiropractic physician in the performance of any chiropractic practice. (3-20-20)T

**02. Chiropractic Intern.** A chiropractic intern is defined as any individual who is presently enrolled in a school of chiropractic and is qualified to practice as an intern as established by the approved chiropractic college that the individual attends and who will function in a dependent relationship with a supervising chiropractic physician in the performance of chiropractic practice. (3-20-20)T

**03. Direct Personal Supervision.** Direct Personal Supervision means that the licensed chiropractic physician is physically present in the clinic, is monitoring the activities of the supervisee, and is available to intervene, if necessary. (3-20-20)T

**04. Inactive Retired.** The status of a licensee who is over sixty-five (65) years of age, has paid the inactive retired fee and is permanently retired from the practice of chiropractic. The holder of an inactive retired license may not practice chiropractic in Idaho. (3-20-20)T

### 011. -- 099. (RESERVED)

### 100. APPLICATIONS.

**01. Qualifications.** (3-20-20)T

**a.** New applicants will meet the following requirements: (3-20-20)T

**i.** National Boards Parts I, II, III, and IV; (3-20-20)T

**ii.** Graduation from a Council on Chiropractic Education (CCE) approved college or university; and (3-20-20)T

**iii.** Applicants will be required to sign an affidavit swearing under oath that they have fully reviewed and understand and will abide by the Chiropractic Act, Title 54, Chapter 7, Idaho Code, and the Board’s Rules, IDAPA 24, Title 03, Chapter 01, “Rules of the State Board of Chiropractic Physicians.” (3-20-20)T

**b.** Endorsement applicants will meet the following requirements: (3-20-20)T

**i.** Successful passage of the National Boards Parts which were in effect at the time of graduation from chiropractic college and physiotherapy; (3-20-20)T

**ii.** If licensed prior to January, 1980, CCE approved college or university not required. If licensed after January, 1980, applicant must have graduated from a CCE approved college or university; (3-20-20)T

**iii.** Five (5) years of consecutive practice without discipline immediately prior to application and holds a current, valid license to practice in a state, territory, or district of the United States or Canada; (3-20-20)T

**iv.** Applicants must demonstrate that they possess the requisite qualifications to provide the same standard of chiropractic care as provided by physicians in this state. The Board may, in its sole discretion, require further examination to establish such qualifications, such as passage of the National Board Special Purposes Examination for Chiropractors (SPEC); and (3-20-20)T

**v.** Applicants will be required to sign an affidavit swearing under oath that they have fully reviewed

and understand and will abide by the Chiropractic Act, Title 54, Chapter 7, Idaho Code, and the Board's Rules, IDAPA 24, Title 03, Chapter 01, "Rules of the State Board of Chiropractic Physicians." (3-20-20)T

**101. -- 149. (RESERVED)**

**150. FEES.**

All fees are non-refundable.

<b>Fee Type</b>	<b>Amount (Not to Exceed)</b>
Application	\$200
Original license	\$200
Annual renewal	\$200
Inactive license	\$150
Reinstatement of expired license	\$35
Reinstatement of inactive license	\$150
Temporary permit	\$150
Intern permit	\$150
Application for clinical nutrition certification	\$175
Clinical nutrition certification renewal	\$175

(3-20-20)T

**151. -- 199. (RESERVED)**

**200. EXAMINATIONS.**

It shall be the applicant's duty to take and successfully pass the National Board Examinations administered by the National Board of Chiropractic Examiners as specified in these rules. (3-20-20)T

**201. -- 299. (RESERVED)**

**300. INACTIVE LICENSE.**

A licensee holding a current active license in this state who is not practicing chiropractic in this state may be issued an inactive license in accordance with Section 54-708(2), Idaho Code, as follows: (3-20-20)T

**01. Inactive Status.** Each application for an Inactive status license must be accompanied by: (3-20-20)T

**a.** The established fee; and (3-20-20)T

**b.** A written application to change a current active license to an inactive license. (3-20-20)T

**c.** An inactive license shall be issued for one (1) year. (3-20-20)T

**02. Inactive License Status Renewal.** (3-20-20)T

**a.** An inactive license must be renewed annually by submitting the established fee and renewal application. Inactive licenses not renewed will be canceled. (3-20-20)T

**b.** All continuing education requirements will be waived for any year or portion thereof that a licensee maintains an inactive license and is not actively practicing or supervising in Idaho. (3-20-20)T

**03. Return to Active Status of License Inactive for Five (5) or Fewer Years.** An inactive license

holder whose license has been inactive for five (5) or fewer years may convert from inactive to active license status by: (3-20-20)T

- a. Making written application to the Board on a form prescribed by the Board; (3-20-20)T
- b. Providing documentation to the Board showing successful completion within the previous twelve (12) months of the continuing education requirements for renewal of an active license; and (3-20-20)T
- c. Paying a fee equivalent to the difference between the current inactive fee and the active renewal fee. (3-20-20)T

**04. Return to Active Status of License Inactive for More Than Five (5) Years.** An inactive license holder whose license has been inactive for more than five (5) years may convert from inactive to active license status by: (3-20-20)T

- a. Making written application to the Board on a form prescribed by the Board. (3-20-20)T
- b. Providing an account to the Board for that period of time during which the license was inactive and fulfilling requirements that demonstrate competency to resume practice. Those requirements may include, but are not limited to, education, supervised practice, and examination as determined by the Board. The Board may consider practice in another jurisdiction in determining competency. (3-20-20)T
- c. Paying a fee equivalent to the difference between the current inactive fee and the active renewal fee. (3-20-20)T

**05. Clinical Nutrition Certificate Expires.** If a licensee holds a clinical nutrition certificate and places their license on inactive status, the clinical nutrition certificate is immediately canceled as though the license was not timely renewed as provided in Section 703 of these rules. (3-20-20)T

**06. Reissuance of Clinical Nutrition Certificate.** An inactive license holder who held a clinical nutrition certificate at the time their license was placed on inactive status who returns to active license status pursuant to this rule may be reissued a clinical nutrition certificate by showing proof of compliance with the provisions of Sections 704, 705, and 706 that apply to their situation. (3-20-20)T

**301. -- 349. (RESERVED)**

**350. CONTINUING EDUCATION.** All licensees must comply with the following continuing education requirements: (3-20-20)T

**01. Requirement.** Applicants for renewal shall be required to complete a minimum of eighteen (18) hours of continuing education within the preceding twelve (12) months, as approved by the Board. (3-20-20)T

- a. Continuing education credit will only be given for actual time in attendance or for the time spent participating in the educational activity. (3-20-20)T
- b. The educational setting may include a classroom, conference/seminar, on-line, or a virtual classroom. (3-20-20)T
- c. If the licensee completes two (2) or more courses having substantially the same content during any one (1) renewal period, the licensee only will receive continuing education credit for one (1) of the courses. (3-20-20)T

**02. Documentation.** Each licensee shall maintain documentation verifying continuing education attendance and curriculum for a period of five (5) years from the date of completion. This documentation will be subject to audit by the Board. (3-20-20)T

- a. Documented evidence of meeting the continuing education requirement shall be in the form of a



certificate or letter from the sponsoring entity that includes verification of attendance by the licensee, the title of the activity, the subject material covered, the dates and number of hours credited, and the presenter's full name and professional credentials. (3-20-20)T

**b.** A licensee must submit the verification documentation to the Board if requested by the Board. In the event a licensee fails to provide the Board with acceptable documentation of the hours attested to on the renewal application, the licensee may be subject to disciplinary action. (3-20-20)T

**03. Waiver.** The Board may waive the requirements of this rule for reasons of individual hardship including health or other good cause. The licensee should request the waiver in advance of renewal and must provide any information requested by the Board to assist in substantiating hardship cases. This waiver is granted at the sole discretion of the Board. (3-20-20)T

**04. Carryover of Continuing Education Hours.** Continuing education hours not claimed in the current renewal year may be claimed in the next renewal year. Hours may be carried forward from the immediately preceding year, and may not be carried forward more than one renewal year. (3-20-20)T

**05. Exemption.** A licensee is exempt from the continuing education requirements under this section for the period between the initial issuance or the original license and the first expiration date of that license. (3-20-20)T

**06. Continuing Education Activities.** The following educational activities qualify for continuing education: (3-20-20)T

**a.** Post-graduate education courses, germane to chiropractic practice as approved by the Board. (3-20-20)T

**b.** Attendance at Board meetings. (3-20-20)T

**351. APPROVAL OF CONTINUING EDUCATION COURSES.**

**01. Approved Continuing Education Courses.** Approved continuing education courses shall be those courses, programs, and activities that are germane to the practice of chiropractic, as defined in Sections 54-704(1) and (2), Idaho Code, and meet the general requirements and content requirements of these rules, and are approved, sponsored, or provided by the following entities or organizations, or otherwise approved by the Board: (3-20-20)T

**a.** Council of Chiropractic Education (CCE) approved chiropractic college or university, a college or university accredited by a nationally recognized accrediting agency as recognized by the United States Secretary of Education or an educational program approved by the Board; (3-20-20)T

**b.** Providers of Approved Continuing Education (PACE); (3-20-20)T

**c.** National and state chiropractic associations; and (3-20-20)T

**d.** Provider Course Approval. Other courses that may be approved by the Board based upon documentation submitted by a continuing education provider. Requests for approval of courses made by the provider must be submitted on a form approved by the Board that includes: (3-20-20)T

**i.** The nature and subject of the course and how it is germane to the practice of chiropractic; (3-20-20)T

**ii.** The name of the instructor(s) and their qualifications; (3-20-20)T

**iii.** The date, time, and location of the course; (3-20-20)T

**iv.** The specific agenda for the course; (3-20-20)T

- v. The number of continuing education hours requested; (3-20-20)T
- vi. The procedures for verification of attendance; and (3-20-20)T
- vii. Other information as may be requested by the Board. (3-20-20)T
- viii. Upon review of all information requested, the Board may deny any request for a course that does not meet the requirements of Idaho law or rule. Board approval of a course shall be granted for a period not to exceed two (2) years or until the course materials or instructors are changed, whichever may occur first. (3-20-20)T

**02. Licensee Course Approval.** Other courses that may be approved by the Board based upon documentation submitted by the licensee. All requests for approval must be made to the Board in writing and include the nature and subject of the course and its relevancy to the practice of chiropractic, name of instructor(s) and their qualifications, date, time and location of the course, and procedures for verification of attendance. (3-20-20)T

**352. -- 399. (RESERVED)**

**400. APPROVED SCHOOLS OF CHIROPRACTIC.**

**01. Requirement for Approval. (3-20-20)T**

**a.** The Board will consider a school, college, or university in good standing only if such school, college, or university conforms to the requirements of “recognized candidate for accreditation,” or “accredited” of the Council of Chiropractic Education or any foreign country college which meets equivalent standards as determined by the Board and teaches accredited courses in all the subjects set forth in Section 54-709(1)(b), Idaho Code. (3-20-20)T

**b.** Regardless of the Council on Chiropractic Education status, the Board may make additional requirements for approval as a reputable school, college or university of Chiropractic. (3-20-20)T

**02. New Schools.** Those graduates of new schools of chiropractic will only be accepted for licensure application provided the school reaches “recognized candidate for accreditation” status with the Council on Chiropractic Education within one year following the first graduating class. (3-20-20)T

**401. -- 449. (RESERVED)**

**450. ADVERTISEMENTS.**

**01. Prohibited Advertising.** No chiropractor shall disseminate or cause the dissemination of any advertisement or advertising which is any way fraudulent, false, deceptive or misleading. Any advertisement or advertising shall be deemed by the board to be fraudulent, false, deceptive, or misleading if it: (3-20-20)T

**a.** Is likely to deceive, defraud, or harm the public; or (3-20-20)T

**b.** Uses false or misleading statement(s) regarding a chiropractor’s skill or the efficacy or value of the chiropractic medicine, treatment, or remedy prescribed by a chiropractor or at a chiropractor’s direction in the treatment of any disease or other condition of the body or mind. (3-20-20)T

**451. -- 549. (RESERVED)**

**550. CHIROPRACTIC ASSISTANTS.**

**01. Chiropractic Physician Responsible and Liable.** The chiropractic physician shall be responsible and liable for: (3-20-20)T

**a.** Direct personal supervision; (3-20-20)T

**b.** Any acts of the assistant in the performance of chiropractic practice; (3-20-20)T

c. Proper training and capabilities of the chiropractic assistant before authorization is given to perform any chiropractic practice. (3-20-20)T

**02. Chiropractic Assistant Limitations.** A chiropractic assistant shall not: (3-20-20)T

a. Manipulate articulations; (3-20-20)T

b. Provide diagnostic results or interpretations to the patient; (3-20-20)T

c. Provide treatment advice to any patient without instructions from the supervising Chiropractic Physician. (3-20-20)T

**551. CHIROPRACTIC INTERN.**

**01. Chiropractic Physician Responsible and Liable.** The chiropractic physician shall be responsible and liable for: (3-20-20)T

a. Direct personal supervision of the intern; (3-20-20)T

b. Any acts of the intern in the performance of chiropractic practice; (3-20-20)T

c. Determining that the intern possesses sufficient training and capabilities before authorization is given to perform any chiropractic practice. (3-20-20)T

**02. Chiropractic Intern Limitations.** A chiropractic intern shall not: (3-20-20)T

a. Perform any chiropractic practice independently, but must perform all such practice under the direct personal supervision of a licensed Chiropractic Physician; (3-20-20)T

b. Provide diagnostic results or interpretations to the patient prior to consultation with the supervising Chiropractic Physician; (3-20-20)T

c. Provide treatment advice to any patient without instructions from the supervising Chiropractic Physician. (3-20-20)T

**552. TEMPORARY PRACTICE PERMITS.**

When an original application for license or internship is accepted by the board as being fully completed, in accordance with the requirements of the Idaho Chiropractic Physician Law and these Rules, a temporary permit to practice may be issued. (3-20-20)T

**01. Supervision Required.** A permit holder may work only when under the direct personal supervision of a chiropractic physician currently licensed in Idaho. The name, address and signature of the supervising chiropractic physician shall appear on the application. (3-20-20)T

**02. Only One Permit May Be Issued.** Only one (1) permit may be issued under any circumstances to any individual. (3-20-20)T

**03. Validity of Temporary Permits.** Temporary permit to practice will be valid for a period not to exceed twelve (12) months and only: (3-20-20)T

a. In the case of an applicant for Idaho licensure, until the results of the next scheduled examination have been released. No work permit will be issued to an applicant who has previously failed an examination for licensure in this or any other state, territory, possession, or country more than once. Failure to sit for the next scheduled examination will invalidate the work permit and no further permits will be issued. (3-20-20)T

b. In the case of an intern, until the scheduled date of graduation from an approved school of

chiropractic. Upon original application for licensure in Idaho, the intern permit may be extended by the board until the results of the next scheduled examination have been released. No work permit will be issued to an applicant who has previously failed an examination for licensure in this or any other state, territory, possession, or country more than once. Failure to sit for the next scheduled examination will invalidate the work permit and no further permits will be issued. (3-20-20)T

**553. -- 604. (RESERVED)**

**605. CODE OF ETHICS.**

Chiropractic physicians are responsible for maintaining and promoting ethical practice in accordance with the ethical principles set forth in Appendix A in these rules. (3-20-20)T

**606. -- 699. (RESERVED)**

**700. CLINICAL NUTRITION CERTIFICATION AND PRACTICE.**

**01. Non-Certified Clinical Nutritional Practice.** Clinical nutritional methods as referenced in Section 54-704(1), Idaho Code, include, but are not limited to, the clinical use, administration, recommendation, compounding, prescribing, selling, and distributing non-prescription vitamins, minerals, botanical medicine, herbals, homeopathic, phytonutrients, antioxidants, enzymes and glandular extracts, and durable and non-durable medical goods and devices. Nothing herein shall allow any deviation from Section 54-704(3), Idaho Code. (3-20-20)T

**02. Certified Clinical Nutritional Practice.** The Board may issue clinical nutrition certification to a chiropractic physician licensed by the Board who successfully completes the minimum education and complies with requirements in Chapter 7, Title 54, Idaho Code governing clinical nutrition certification and the requirements of Sections 700 through 706. (3-20-20)T

**701. (RESERVED)**

**702. REQUIREMENTS FOR CLINICAL NUTRITION CERTIFICATION.**

The Board may grant clinical nutrition certification to a licensee who completes an application, pays the applicable fees and meets the following requirements: (3-20-20)T

**01. General.** (3-20-20)T

**a.** Hold and maintain a current, active, unrestricted license as a chiropractic physician issued by the Board. (3-20-20)T

**b.** Not have been on probation or otherwise disciplined by the Board or by any other licensing board or regulatory entity; provided the applicant may make written request to the Board for an exemption review to determine the applicant's suitability for certification, which the Board shall determine in accordance with the following: (3-20-20)T

**i.** The exemption review shall consist of a review of any documents relating to the probation or discipline and any supplemental information provided by the applicant bearing upon the applicant's suitability for certification. The Board may, at its discretion, grant an interview of the applicant. During the review, the Board shall consider the following factors or evidence: (3-20-20)T

(1) The severity or nature of the violation(s) resulting in probation or discipline; (3-20-20)T

(2) The period of time that has passed since the violation(s) under review; (3-20-20)T

(3) The number or pattern of violations or other similar incidents; (3-20-20)T

(4) The circumstances surrounding the violation(s) that would help determine the risk of repetition; (3-20-20)T

(5) The relationship of the violation(s) to the practice of chiropractic or any health care profession, including but not limited to, whether the violation(s) related to clinical practice, involved patient care, a violation of any state or federal law, rule or regulation relating to controlled substances or to a drug, substance or product identified in Section 54-704(3)(b), Idaho Code; (3-20-20)T

(6) The applicant's activities since the violation(s) under review, such as employment, education, participation in treatment, payment of restitution, or any other factors that may be evidence of current rehabilitation; and (3-20-20)T

(7) Any other mitigating or aggravating circumstances. (3-20-20)T

ii. The applicant shall bear the burden of establishing current suitability for certification. (3-20-20)T

c. Successfully complete the requirements of Section 54-717, Idaho Code, and Section 702. (3-20-20)T

d. Written verification of current health care provider cardiopulmonary resuscitation (CPR) certification. Health care provider CPR certification must be from a course that includes a hands-on skill component as provided by the American Heart Association, American Red Cross, American Health and Safety Institute or similar provider approved by the Board. Written verification of current basic life support (BLS) certification. All chiropractic physicians holding clinical nutrition certification must maintain current health care provider CPR and BLS certification as provided in this Section. (3-20-20)T

e. Certify that the chiropractic physician has BLS equipment on the premises where clinical nutrition treatment is being performed. BLS equipment shall include at a minimum: (3-20-20)T

i. Rescue breathing equipment. (3-20-20)T

ii. Oxygen. (3-20-20)T

iii. Epinephrine. (3-20-20)T

f. Certify that the chiropractic physician possesses and will provide to patients informed consent documentation that explains the benefits and potential risks of the specific course of intravenous or injectable nutrition therapy that is being proposed and that the physician will in advance obtain from the patient written voluntary permission to perform the proposed therapy in accordance with Section 54-717(7), Idaho Code. (3-20-20)T

g. Payment of all fines, costs, fees or other amounts that are due and owing to the Board or in compliance with a payment arrangement with the Board is required to be eligible for clinical nutrition certification pursuant to Sections 700 through 706. (3-20-20)T

**02. Didactic Education Requirement.** Provide a certificate or other evidence acceptable to the Board of successful completion of a minimum of seven (7) credits (seventy-seven (77) hours) of didactic human nutrition, nutrition biochemistry, and nutritional pharmacology courses. The certificate or other evidence of successful completion must be provided directly to the Board by the educational institution. (3-20-20)T

a. Chiropractic physicians licensed by the Board who apply for clinical nutrition certification may be determined to have satisfied the didactic education requirements only if they present a certificate or other evidence acceptable to the Board pursuant to this Section demonstrating they commenced obtaining the didactic education required by this Section no earlier than three (3) years prior to applying for clinical nutrition certification and thereafter successfully completed the requirements. (3-20-20)T

**03. Practicum Requirement.** Provide a certificate or other evidence acceptable to the Board of successful completion of a minimum of twenty-four (24) hours of practicum in intravenous and injectable nutrient therapy, which must include: sterile needle practices, phlebotomy, proper injection techniques, intravenous therapy techniques, intramuscular injection techniques, safety practices, and use and expected outcomes utilizing micronutrients, response to adverse effects, lab testing, and blood chemistry interpretation. (3-20-20)T

**a.** After July 1, 2019, the practicum of any applicant for clinical nutrition certification required by this Section must not have commenced more than two (2) years prior to the date of application for clinical nutrition certification and be successfully completed thereafter. (3-20-20)T

**04. Accredited Institution and Program Requirement.** The courses and practicum required by Subsections 702.02 and 702.03 must be taken from an accredited chiropractic college or other accredited institution of higher education. In addition the courses and practicum must be from an accredited program at the college or institution or be a program approved by the Board. (3-20-20)T

**a.** For purposes of this Section “accredited” means accredited by an accrediting agency recognized by the United States Department of Education. (3-20-20)T

**b.** For purposes of this Section “approved by the Board” means a program that is a “recognized candidate for accreditation,” has “initial accreditation” status or “preaccreditation” status by an accrediting body recognized by the United States Department of Education, or is substantially equivalent to a program having that status. (3-20-20)T

**c.** An applicant for clinical nutrition certification shall bear the burden to demonstrate their education and training in clinical nutrition meets the requirements of this Section, including both the accredited institution and accredited program requirements. (3-20-20)T

**05. Audit of Compliance with Clinical Nutrition Certification and Recertification Requirements.** The Board may conduct audits to confirm that licensees meet the requirements to maintain clinical nutrition certification and recertification. In the event a licensee audited by the Board fails to provide documentation or other evidence acceptable to the Board of meeting the clinical nutrition certification or recertification requirements as verified to the Board as part of their annual license renewal or the recertification process the matter will be referred to Division’s investigative unit for investigation and potential disciplinary proceedings by the Board. (3-20-20)T

**06. Requirement to Maintain Supporting Documentation.** A licensee need not submit documentation to the Board with a chiropractic license renewal application verifying qualifications for annual issuance of clinical nutrition certification pursuant to Section 703, or verifying qualifications to recertify clinical nutrition certification pursuant to Section 706. However, a licensee must maintain documentation for a period of five (5) years verifying the licensee has satisfied the requirements. A licensee must submit the documentation to the Board if the annual reissuance or the recertification is audited. All documentation must include the licensee’s name, and as applicable, the date the course or other required activity commenced and was completed, provider name, course title and description, length of the course/activity, and other information required by the Board. (3-20-20)T

**703. ANNUAL ISSUANCE OF CLINICAL NUTRITION CERTIFICATION WITH LICENSE RENEWAL.**

**01. Expiration Date.** Chiropractic physicians’ clinical nutrition certification expires on the expiration date of their chiropractic license and must be issued annually with the renewal of their license pursuant to Section 250. The Board shall waive the clinical nutrition certification fee in conjunction with the first timely renewal of the chiropractic license after initial clinical nutrition certification. (3-20-20)T

**02. Issuance.** Clinical nutrition certification shall be issued annually by timely submission of a chiropractic license renewal application, payment of the chiropractic license renewal fee, the clinical nutrition certification fee, any amounts owing pursuant to Subsection 702.01.g., and verifying to the Board that the licensee is in compliance with the requirements for clinical nutrition certification as provided in the Board’s laws and rules. (3-20-20)T

**03. Failure to Comply with Issuance Requirements.** (3-20-20)T

**a.** If a licensee with clinical nutrition certification fails to verify meeting clinical nutrition certification annual issuance requirements when renewing their chiropractic physician license the clinical nutrition certification is canceled and the chiropractic physician license will be renewed without clinical nutrition certification. (3-20-20)T

b. If a licensee with clinical nutrition certification fails to timely renew their chiropractic physician license their clinical nutrition certification is canceled. (3-20-20)T

c. Clinical nutrition certification canceled pursuant to this Section may be reissued within three (3) years in accordance with Section 704. (3-20-20)T

**704. REISSUANCE OF CANCELLED CLINICAL NUTRITION CERTIFICATION.**

**01. Reissuance.** Clinical nutrition certification canceled pursuant to Subsection 703.03 may be reissued within three (3) years of cancellation as follows: (3-20-20)T

a. Submission of a reissuance application and payment of the current clinical nutrition certification fee. (3-20-20)T

b. Submission of any other documents required by the Board for reissuance including but not limited to: (3-20-20)T

i. Documentation of holding current licensure as a chiropractic physician from the Board meeting the requirements of Section 702. (3-20-20)T

ii. Documentation of compliance with clinical recertification requirements in accordance with Section 706. (3-20-20)T

iii. Documentation of current health care provider CPR and BLS certification and certification that the chiropractic physician has BLS equipment on the premises where clinical nutrition treatment is performed and that informed consent and voluntary permission to perform the proposed therapy are being used in accordance with Section 702. (3-20-20)T

**705. CLINICAL NUTRITION CERTIFICATION CANCELLED FOR OVER THREE (3) YEARS.**

Clinical nutrition certification canceled for a period of more than three (3) years may not be reissued. The chiropractic physician so affected shall be required to make application to the Board in compliance with Section 701 and Section 702 and pay the application and other fees for new clinical nutrition certification. The applicant shall be reviewed by the Board and considered as follows: (3-20-20)T

**01. Current Competency and Training.** The chiropractic physician shall fulfill requirements as determined by the Board that demonstrate the chiropractic physician's competency to regain clinical nutrition certification in this state. Such requirements may include, but are not limited to, education, supervised practice, and examination, including some or all education, training and other requirements for original clinical nutrition certification as set forth in Section 54-717, Idaho Code, and Section 702. (3-20-20)T

**02. New Clinical Nutrition Certification.** Chiropractic Physicians who fulfill the conditions and requirements of this Section may be granted a new clinical nutrition certification. (3-20-20)T

**706. CLINICAL NUTRITION RECERTIFICATION REQUIREMENT.**

**01. Recertification in Clinical Nutrition Every Three (3) Years.** After Initial certification in clinical nutrition, chiropractic physicians must recertify in clinical nutrition every three (3) years in order to maintain clinical nutrition certification. (3-20-20)T

**02. Annual Verification of Meeting Requirements.** In order to maintain clinical nutrition certification pursuant to Section 54-717, Idaho Code, and Section 700, chiropractic physicians having clinical nutrition certification must annually verify, along with their chiropractic license renewal, pursuant to Subsection 706.01 by attesting to the Board they are in compliance with the requirements to recertify in clinical nutrition the following: (3-20-20)T

a. Completion within the three (3) years prior to required recertification of a twelve (12) hour in

person face to face classroom course from an institution and program meeting Section 702.04 accreditation requirements. The course must include both didactic education and practical review and practice of contemporary developments and best practices to maintain core competency in the practice of clinical nutrition as set forth in Section 54-716, Idaho Code, and Section 54-717, Idaho Code. (3-20-20)T

**b.** Current licensure as a chiropractic physician issued by the Board meeting the requirements of Section 702. (3-20-20)T

**c.** Current health care provider CPR and BLS certification and that BLS equipment is maintained on the premises where clinical nutrition treatment is performed pursuant to Section 702. (3-20-20)T

**d.** They possess and will provide to patients informed consent documentation that explains the benefits and potential risks of the specific course of intravenous or injectable nutrition therapy that is being proposed and that the physician will in advance obtain from the patient written voluntary permission to perform the proposed therapy in accordance with Section 54-717(7), Idaho Code. (3-20-20)T

**03. Recertification is in Addition to Required Annual Continuing Education.** The twelve (12) hour recertification course requirement is in addition to the annual eighteen (18) hours of continuing education required under Subsection 300.01. (3-20-20)T

**04. Failure to Timely Recertify in Clinical Nutrition.** Clinical nutrition certification not timely recertified in accordance with Section 706 shall expire and be canceled. Clinical nutrition certification canceled for failure to recertify may be reissued within three (3) years in accordance with Section 704. (3-20-20)T

**707. OBTAINING AND INDEPENDENTLY ADMINISTERING CLINICAL NUTRITION PRESCRIPTION DRUG PRODUCTS.**

A chiropractic physician with clinical nutrition certification as defined by Sections 54-704(4), 54-716 and 54-717, Idaho Code, may obtain and independently administer prescription drug products in the practice of chiropractic subject to the conditions below. (3-20-20)T

**01. Current Certification in Clinical Nutrition Required.** Only chiropractic physicians who hold current certification in clinical nutrition by the Board may obtain and independently administer prescription drug products during chiropractic practice. (3-20-20)T

**02. Obtain Prescription Drugs Products from the Formulary.** A chiropractic physician with clinical nutrition certification may not obtain a prescription drug product that is not listed in the chiropractic clinical nutrition formulary. (3-20-20)T

**03. Only Administer Prescription Drug Products from the Formulary.** Chiropractic physicians with clinical nutrition certification may only administer those prescription drug products listed in the chiropractic clinical nutrition formulary. (3-20-20)T

**a.** Chiropractic physicians with clinical nutrition certification shall not prescribe, dispense, distribute, or direct to a patient the use of a prescription drug product. (3-20-20)T

**04. Routes of Administration and Dosing of Prescription Drug Products.** Prescription drug products listed in the chiropractic clinical nutrition formulary may be administered through oral, topical, intravenous, intramuscular or subcutaneous routes by a chiropractic physician with clinical nutrition certification. The route of administration and dosing shall be in accordance with the product's labeling as approved by the federal food and drug administration or with the manufacturer's instructions. (3-20-20)T

**05. Practice Limited to Chiropractic Physicians with Clinical Nutrition Certification.** Chiropractic interns, chiropractic assistants, holders of chiropractic temporary practice permits and others working under the authority or direction of a chiropractic physician may not perform any practice or function requiring clinical nutrition certification. (3-20-20)T

**06. Sale, Transfer, or Other Distribution of Prescription Drugs Prohibited.** Chiropractic



physicians with clinical nutrition certification may obtain and administer prescription drug products to a patient only in accordance with this Section 707. Chiropractic physicians may not prescribe, sell, transfer, dispense, or otherwise distribute prescription drug products to any person or entity. Prescription drug products not administered to a patient shall be handled in accordance with Subsections 708.05, 708.06, and 708.07. (3-20-20)T

**708. CLINICAL NUTRITION FORMULARY.**

Chiropractic physicians certified in clinical nutrition may obtain and independently administer, during chiropractic practice, only the prescription drug products listed in this chiropractic clinical nutrition formulary and subject to the provisions hereof. (3-20-20)T

**01. Chiropractic Clinical Nutrition Prescription Drug Formulary.** Prescription drug products that may be used by chiropractic physicians with clinical nutrition certification are limited to the following: (3-20-20)T

- a.** Vitamins: vitamin A, all B vitamins and vitamin C; (3-20-20)T
- b.** Minerals: ammonium molybdate, calcium, chromium, copper, iodine, magnesium, manganese, potassium, selenium, sodium, and zinc; (3-20-20)T
- c.** Fluids: dextrose, lactated ringers, plasma lyte, saline, and sterile water; (3-20-20)T
- d.** Epinephrine; and (3-20-20)T
- e.** Oxygen for use during an emergency or allergic reaction. (3-20-20)T

**02. Sources of Clinical Nutrition Prescription Drug Products.** Prescription drug products listed in the chiropractic clinical nutrition formulary shall be obtained only by a chiropractic physician with clinical nutrition certification and only from a source licensed under Chapter 17, Title 54, Idaho Code, that is a wholesale distributor, a manufacturer, a pharmacy, or an outsourcing facility and from no other source. (3-20-20)T

**03. No Compounding of Prescription Drug Products.** No vitamin or mineral may be compounded, as defined in Section 54-1705, Idaho Code, by a chiropractic physician. A compounded drug product containing two (2) or more of the vitamins or minerals approved in the chiropractic clinical nutrition formulary shall be obtained for office use by a chiropractic physician with clinical nutrition certification only from an outsourcing facility licensed under Chapter 17, Title 54, Idaho Code and from no other source. A chiropractic physician may not obtain or use in chiropractic practice a compounded drug product containing a prescription drug product that is not included in the chiropractic clinical nutrition formulary. (3-20-20)T

**04. Limitations on Possession of Prescription Drug Products.** Possession of prescription drug products without a valid prescription drug order by chiropractic physicians licensed pursuant to Chapter 7, Title 54, Idaho Code, and certified pursuant to Sections 54-708, and 54-717, Idaho Code, or their agents or employees shall be limited to: (3-20-20)T

- a.** Only those prescription drug products listed in Sections 54-716, Idaho Code, and in the chiropractic clinical nutrition formulary; (3-20-20)T
- b.** Only those quantities reasonably required for use in the usual and lawful course of the chiropractic physician's clinical nutrition practice based on the patient panel size and history of orders. (3-20-20)T

**05. Prescription Drug Product Storage.** Clinical nutrition prescription drugs must be stored in accordance with United States Pharmacopeia-National Formulary requirements in an area maintained and secured appropriately to safeguard product integrity and protect against product theft or diversion. (3-20-20)T

**06. Expired, Deteriorated, Adulterated, Damaged, or Contaminated Prescription Drug Products.** Expired, deteriorated, adulterated, damaged, or contaminated prescription drug products must be removed from stock and isolated for return, reclamation or destruction. (3-20-20)T

**07. Compliance with Federal and State Requirements.** In addition to the requirements of the Idaho

Chiropractic Practice Act and rules of the Board, chiropractic physicians shall comply with all federal and state laws, rules and policies governing possession, storage, record keeping, use, and disposal of prescription drug products. (3-20-20)T

**709. MEDICAL WASTE.**

Chiropractic physicians certified in clinical nutrition must dispose of medical waste during the practice of chiropractic clinical nutrition according to the following protocol: (3-20-20)T

**01. Containers for Non-Sharp, Medical Waste.** Medical waste, except for sharps, must be placed in disposable containers/bags that are impervious to moisture and strong enough to preclude ripping, tearing, or bursting under normal conditions of use. The bags must be securely tied so as to prevent leakage or expulsion of solid or liquid waste during storage, handling, or transport. The containment system must have a tight-fitting cover and be kept clean and in good repair. All bags used for containment of medical waste must be clearly identified by label or color, or both. (3-20-20)T

**02. Containers for Sharps.** Sharps must be placed in impervious, rigid, puncture-resistant containers immediately after use. After use, needles must not be bent, clipped or broken by hand. Rigid containers of discarded sharps must either be labeled or colored like the disposable bags used for other medical waste, or placed in such labeled or colored bags and disposed of according to container guidelines. (3-20-20)T

**710. -- 999. (RESERVED)**

**Appendix A – Chiropractic Physicians Code of Ethics**

**PREAMBLE**

This code of ethics set forth principles for the ethical practice of chiropractic. All chiropractic physicians are responsible for maintaining and promoting ethical practice and otherwise complying with the terms of this code of ethics. To this end, the chiropractic physician shall act in the best interest of the patient. This code of ethics shall be binding on all chiropractic physicians.

**1. Duty to Report**

A. Duty to Report. It shall be the duty of every licensee to notify the Board through the Division of Occupational and Professional Licenses of any violation of the Chiropractic Act or Board Rules, if the licensee has personal knowledge of the conduct.

B. Reporting of Certain Judgments to Board. If a judgment is entered against a licensee in any court, or a settlement is reached on a claim involving malpractice exceeding fifty thousand dollars (\$50,000), a licensee shall report that fact to the Board within thirty (30) days. The licensee may satisfy the provision of this subsection if he/she provides the Board with a copy of the judgment or settlement.

If a licensee is convicted of a felony or a crime involving dishonesty, theft, violence, habitual use of drugs or alcohol, or sexual misconduct, he/she shall report that fact to the board within thirty (30) days following the conviction.

**2. Advertising of Research Projects**

Advertisement of Affiliation with Research Projects. If a licensee advertises any affiliation with a research project, he must make a written statement of the objectives, cost and budget of the project, and the person conducting the research. Such statements are to be made available at the request of the Board, to scientific organizations, and to the general public. The advertisement must indicate that it is supported by clinical research. Any willful failure to comply with these requirements will be deemed false and deceptive advertising under rule 450. Licensee must comply with all state and federal laws and regulations governing research projects on humans, and shall obtain "Institutional Review Board" (IRB) approval as established and set forth in the U.S. Code of Federal Regulations, Title 45, Part 46, Subpart A (45 CFR 46.101-46-505).

### **3. Sexual Misconduct**

The doctor-patient relationship requires the chiropractic physician to exercise utmost care that he or she will do nothing to exploit the trust and dependency of the patient. Sexual misconduct is a form of behavior that adversely affects the public welfare and harms patients individually and collectively. Sexual misconduct exploits the doctor-patient relationship and is a violation of the public trust. This section of the Code of Ethics shall not apply between a chiropractor and their spouse.

For the purposes of this subsection, sexual misconduct is divided into sub-categories based upon the severity of the conduct:

A. Sexual Impropriety. Any behavior such as gestures, expressions, and statements which are sexually suggestive or demeaning to a patient, or which demonstrate a lack of respect for a patient's privacy.

B. Sexual Violation. Physician-patient contact of a sexual nature, whether initiated by the physician or the patient.

C. A chiropractic physician shall wait at least one (1) year ("waiting period") following the termination of a professional doctor-patient relationship, before beginning any type of sexual relationship with a former patient.

### **4. Prepaid Funds**

A chiropractic physician shall promptly refund any unearned fees within thirty (30) days upon request and cancellation of the prepaid contract. A full accounting of the patient account shall be provided to the patient at the time of the refund or upon request.

# IDAPA 24 – DIVISION OF OCCUPATIONAL AND PROFESSIONAL LICENSES

## 24.04.01 – RULES OF PROCEDURE OF THE BOARD OF REGISTRATION FOR PROFESSIONAL GEOLOGISTS

DOCKET NO. 24-0401-2000F (FEE RULE)

### NOTICE OF OMNIBUS RULEMAKING – ADOPTION OF TEMPORARY RULE

**EFFECTIVE DATE:** The effective date of the temporary rule being adopted through this omnibus rulemaking is the adjournment date of the second regular session of the 65th Idaho State Legislature - March 20, 2020.

**AUTHORITY:** In compliance with Sections 67-5226, Idaho Code, notice is hereby given this agency has adopted a temporary rule. The action is authorized pursuant to Section 54-2808, Idaho Code.

**DESCRIPTIVE SUMMARY:** The following is the required finding and concise statement of its supporting reasons for adopting a temporary rule:

This temporary rulemaking adopts the following chapter under IDAPA 24:

#### **IDAPA 24.04**

- 24.04.01, *Rules of Procedure of the Board of Registration of Professional Geologists.*

**TEMPORARY RULE JUSTIFICATION:** Pursuant to Sections 67-5226(1) and 67-5226(2), Idaho Code, the Governor has found that temporary adoption of the rule is appropriate for the following reasons:

These temporary rules are necessary to protect the public health, safety, and welfare of the citizens of Idaho and confer a benefit on its citizens. These temporary rules implement the duly enacted laws of the state of Idaho, provide citizens with the detailed rules and standards for complying with those laws, and assist in the orderly execution and enforcement of those laws. The expiration of these rules without due consideration and processes would undermine the public health, safety, and welfare of the citizens of Idaho and deprive them of the benefit intended by these rules. These rules govern the qualifications for registered geologists who protect the public health, safety and welfare by providing reasoned input in minimizing potential danger from geologic hazards during construction projects; alerting the public to potential danger in areas of seismic risk; defining impacts of human activities and natural occurrences on aquifers, recharge areas, and other water resources; and outlining steps in geohazard mitigation for features such as: fault zones, landslides, and unstable foundation areas. Not reauthorizing these rules would hinder the Board's ability to admit new applicants, to renew current licenses, and would affect registered geologists' ability to affix their stamp.

**FEE SUMMARY:** Pursuant to Section 67-5226(2), the Governor has found that the fees or charges being imposed or increased are justified and necessary to avoid immediate danger and the fees are described herein:

The fees or charges, authorized in Sections 54-2813, 54-2814, and 54-2816, Idaho Code, are part of the agency's 2021 budget that relies upon the existence of these fees or charges to meet the state's obligations and provide necessary state services. Failing to reauthorize these temporary rules would create immediate danger to the state budget, immediate danger to necessary state functions and services, and immediate danger of a violation of Idaho's constitutional requirement that it balance its budget.

The following is a specific description of the fees or charges:

FEE TYPE	AMOUNT (Not to Exceed)
Application	\$100
Initial Certificate	\$20
Annual Renewal	\$60

<b>FEE TYPE</b>	<b>AMOUNT (Not to Exceed)</b>
Annual Renewal for Registrants Seventy (70) Years of Age or Older	One-half (1/2) of the current renewal fee
Reinstatement	Is as provided in Section 67-2614, Idaho Code
Duplicate Certificate	\$20
Examination	Set by ASBOG

**ASSISTANCE ON TECHNICAL QUESTIONS:** For assistance on technical questions concerning the temporary rule, contact Rob McQuade at (208) 334-3233.

DATED this February 21, 2020.

Kelley Packer  
Division Administrator  
Division of Occupational and Professional Licenses  
700 W. State Street  
P.O. Box 83720  
Boise, ID 83720  
Phone: (208) 334-3233  
Fax: (208) 334-3945

## 24.04.01 – RULES OF THE BOARD OF REGISTRATION FOR PROFESSIONAL GEOLOGISTS

### 000. LEGAL AUTHORITY.

These rules are hereby prescribed and established pursuant to the authority vested in the Board of Registration For Professional Geologists by the provisions of Section 54-2808, Idaho Code. (3-20-20)T

### 001. TITLE AND SCOPE.

These rules are titled IDAPA 24.04.01, “Rules of the Board of Registration for Professional Geologists.” These rules establish procedures for the organization and operation of the Board. (3-20-20)T

### 002. -- 009. (RESERVED)

### 010. DEFINITIONS.

For the purposes of these rules, the following definitions apply: (3-20-20)T

**01. Geologist-in-Training.** The interim designation given to any person who has met the academic requirements and successfully passed the fundamentals of geology portion of the professional examination but has not yet completed the requisite years of experience and passed the practices of geology examination. (3-20-20)T

**02. Registrant.** Any person currently registered as a professional geologist. (3-20-20)T

**03. Responsible Position.** A position wherein a person, having independent control, direction, or supervision of a geological project, investigates and interprets geologic features. (3-20-20)T

**04. Responsible Charge.** Means the control and direction of geology work, requiring initiative, professional skill, independent judgment, and professional knowledge of the content of relevant documents during their preparation. (3-20-20)T

### 011. -- 099. (RESERVED)

### 100. GENERAL PROVISIONS.

**01. Filing of Documents.** All correspondence, including remittances and renewal fees, shall be directed to the office of the Board. (3-20-20)T

**02. Meetings.** The Board shall meet at least once each year at the call of the chairman; the Board shall elect a chairman and vice-chairman at such annual meeting. In addition to an annual meeting, the chairman may call special meetings from time to time when, it is deemed necessary, or upon the written request of any three (3) members of the Board. (3-20-20)T

**03. Officers.** The vice-chairman shall, in the absence or incapacity of the chairman, exercise the duties and possess all the powers of the chairman. (3-20-20)T

**04. Committees.** The chairman may appoint committees as necessary, to perform special duties and shall present reports to the Board at the time specified or at the earliest regular or special meeting of the Board. (3-20-20)T

**05. Certificates.** Certificates of registration shall be issued to each Registrant on forms adopted by the Board. Certificates shall be displayed by Registrants in their place of business (3-20-20)T

**06. Seals.** The Board has adopted a seal for use by each Registrant. The seal may be a rubber stamp, crimp, or electronically generated image. Whenever the seal is applied, the Registrant’s signature and date shall also be included. If the signature is handwritten, it shall be adjacent to or across the seal. No further words or wording are required. A facsimile signature generated by any method will not be acceptable unless accompanied by a digital signature. (See “Appendix A” at end of this Chapter.) (3-20-20)T

**a.** The seal, signature, and date shall be placed on all final specifications, reports, information, and calculations, whenever presented. Any such document that is not final and does not contain a seal, signature, and date shall be clearly marked as “Preliminary,” “Draft,” “Not for Construction,” or with similar words to distinguish the document from a final document. (3-20-20)T

**b.** The seal, signature, and date shall be placed on all original documents. The application of the Registrant’s seal, signature, and date shall constitute certification that the work thereon was done by the Registrant or

under the Registrant’s supervision. Each plan or drawing sheet shall be sealed and signed by the Registrant or Registrants responsible for each sheet. In the case of a business entity, each plan or drawing sheet shall be sealed and signed by the Registrant or Registrants involved. The supervising professional geologist shall sign and seal the title or first sheet. Copies of electronically produced documents, listed in Paragraph 100.06.b. of these rules, distributed for informational uses such as for bidding purposes or working copies, may be issued with the Registrant’s seal and a notice that the original document is on file with the Registrant’s signature and date. The words “Original Signed By:” and “Date Original Signed:” shall be placed adjacent to or across the seal on the electronic original. The storage location of the original document shall also be provided. Only the title page of reports, specifications, and like documents need bear the seal, signature, and date of the Registrant. (3-20-20)T

**c.** The seal and signature shall be used by the Registrant only when the work being stamped was under the Registrant’s responsible charge. Upon sealing, the Registrant takes full professional responsibility for that work. After-the-fact ratification by the sealing of documents relating to work that was not performed by the Registrant but by an unregistered subordinate or other unregistered individual and without thorough technical review throughout the project by the sealing Registrant is prohibited. (3-20-20)T

**d.** In the event a Registrant in responsible charge of a project leaves employment, is transferred, is promoted, becomes incapacitated, dies, or is otherwise not available to seal, sign, and date final documents, the duty of responsible charge for the project shall be accomplished by successor Registrant by becoming familiar with and reviewing, in detail, and retaining the project documents to date. Subsequent work on the project must clearly and accurately reflect the successor Registrant’s responsible charge. The successor Registrant shall seal, sign, and date all work product in conformance with Section 54-2815, Idaho Code. (3-20-20)T

**07. Address Change.** Each Applicant and Registrant shall notify the Board within sixty (60) days of any and all changes of address, giving both old and new address. (3-20-20)T

**101. -- 149. (RESERVED)**

**150. FEES.**

The fees for registration under the Act shall be the following:

FEE TYPE	AMOUNT (Not to Exceed)
Application	\$100
Initial Certificate	\$20
Annual Renewal	\$60
Annual Renewal for Registrants Seventy (70) Years of Age or Older	One-half (1/2) of the current renewal fee
Reinstatement	Is as provided in Section 67-2614, Idaho Code
Duplicate Certificate	\$20
Examination	Set by ASBOG

(3-20-20)T

**151. -- 199. (RESERVED)**

**200. APPLICATION PROCEDURES.**

**01. Applications.** Applications for registration shall be: (3-20-20)T

**a.** On forms prescribed by the Board and accompanied by official transcripts, reference statements, and a signed code of ethics (See “Appendix B” at end of this Chapter); (3-20-20)T

b. Received by the Board, if for registration by examination, not less than ninety (90) days prior to the date of examination; (3-20-20)T

c. Subscribed and certified to by the Applicant under penalty of perjury as provided for by state law; and (3-20-20)T

d. Incomplete applications will not be accepted by the Board and will be returned to the Applicant with a statement of the reason for return. (3-20-20)T

**02. Appeal.** Upon notification by the Board that the Application has been denied or rejected, the Applicant, within thirty (30) days of receipt of such notice, may petition the Board for a hearing, under the provisions of Title 67, Chapter 52, Idaho Code. (3-20-20)T

**03. Dates.** The date of application shall be the date it is delivered in person to the Board office or, if mailed, the date shown by post office cancellation mark. Qualifying education and experience of the Applicant, for examination and registration, shall be computed from the date of application as described above. (3-20-20)T

**04. References.** Statements from personal references in Responsible Positions concerning the Applicant's technical ability and personal character, shall be received, as prescribed by the Act, prior to any action by the Board to approve an Application. Each statement must reflect in a positive way the technical and ethical merits of the Applicant. Applicants for the Fundamentals of Geology examination may fulfill this requirement with reference statements from geologists in Responsible Positions familiar with the ability and character of the Applicant as demonstrated in an academic setting. (3-20-20)T

**05. Lack of Activity.** If an applicant fails to respond to a Board request or an application has lacked activity for twelve (12) consecutive months, the application on file with the Board will be deemed denied and will be terminated upon a thirty (30) day written notice, unless good cause is demonstrated to the Board. (3-20-20)T

**201. -- 299. (RESERVED)**

**300. EXAMINATIONS.**

Except as otherwise provided in statute, every Applicant for registration as a professional geologist shall take and pass the complete professional examination for registration as a professional geologist. (3-20-20)T

**01. Fundamentals of Geology.** The written examination is the Fundamentals of Geology examination provided by ASBOG. To be eligible to take the Fundamentals of Geology examination, an Applicant must have completed thirty (30) semester units or equivalent quarter units in courses in geological science leading to a degree in the geological sciences of which at least twenty-four (24) units are in third or fourth year, and/or graduate courses. Applicants who can satisfy to the Board that they will have completed the required coursework and number of units and will be graduating at the end of the spring, summer or fall terms of any given year, may be eligible for examination immediately preceding the date of graduation. (3-20-20)T

**02. Practice of Geology.** The written examination is the Practice of Geology examination provided by ASBOG. To be eligible to take the Practice of Geology examination an Applicant must have satisfied the education requirements as set forth in Section 54-2812, Idaho Code. (3-20-20)T

**03. Authorization.** (3-20-20)T

a. The Board shall notify each Applicant in writing of the acceptance or rejection of his Application and, if rejected, the reason for the rejection. (3-20-20)T

b. Not less than ninety (90) days prior to the examination date, the Applicant shall give written notice to the Board of his intent to take the examination and shall submit all applicable testing fees in full. (3-20-20)T

c. Not less than thirty (30) days prior to the examination date, the Board shall give written notice to each Applicant that has previously given written notice and has paid his examination fees, of the date, time, and



location(s) of the examination. (3-20-20)T

**04. Reexamination.** An Applicant failing their first examination may apply for reexamination without filing a new Application and shall be entitled to such reexamination on payment of the reexamination fee. Provided, however, that it shall be unlawful for an Applicant failing any examination to practice professional geology under the appropriate provisions of the Act. (3-20-20)T

**05. Time and Place.** The Board shall make all arrangements necessary to provide sufficient help to conduct examinations and to provide adequate facilities at such locations throughout the state as may be required to accommodate the number of Applicants to be examined upon the dates prescribed by ASBOG. (3-20-20)T

**06. Scores.** An Applicant for registration by examination must successfully pass both the Fundamentals of Geology examination and the Practice of Geology examination. (3-20-20)T

**a.** Every Applicant receiving a scaled score of seventy (70) or more, as determined by ASBOG, on the Fundamentals of Geology examination shall be deemed to have passed the examination, is thereby eligible to receive certification as a Geologist-in-Training. (3-20-20)T

**b.** Every Applicant receiving a scaled score of seventy (70) or more, as determined by ASBOG, on the Practice of Geology examination shall be deemed to have passed such examination and will be registered as a professional geologist. (3-20-20)T

**c.** Every Applicant receiving a scaled score of less than seventy (70), as determined by ASBOG, on either the Fundamentals of Geology examination or the Practice of Geology examination, shall be deemed to have failed such examination. Every Applicant having failed shall have his Application denied without prejudice, but shall be allowed to retake the failed examination in accordance with Subsection 300.04 of these rules. (3-20-20)T

**07. Re-Score or Review of Examination.** (3-20-20)T

**a.** An Applicant who fails to obtain a passing grade in any portion of the written examination may request a rescore or review of his examination papers at such times, locations, and under such circumstances as may be designated by the Board, ASBOG, or both. (3-20-20)T

**b.** When a review is requested and authorized, at the time of review, no one other than the examinee or his attorney and a representative of the Board shall have access to such examination papers. (3-20-20)T

**301. -- 399. (RESERVED)**

**400. GEOLOGIST IN TRAINING.**

An Applicant who has passed the Fundamentals of Geology examination and satisfied the education requirements set forth in Subsection 300.01 of these rules, will receive a certificate of completion designating the Applicant as a Geologist-in-Training. (3-20-20)T

**01. Supervised Practice.** The possession of a Geologist-in-Training certificate by an Applicant does not entitle the Applicant to practice professional geology without supervision. (3-20-20)T

**02. Limitation.** Designation as a Geologist in Training is limited to a period not to exceed ten (10) years. If after ten (10) years the Geologist-in-Training has not met all requirements for registration as a professional geologist, the Geologist-in-Training certification is withdrawn and the Applicant must re-apply for registration. (3-20-20)T

**401. -- 999. (RESERVED)**

**APPENDIX A -- AS REFERENCED IN SECTION 24.04.01.100.06.b.**

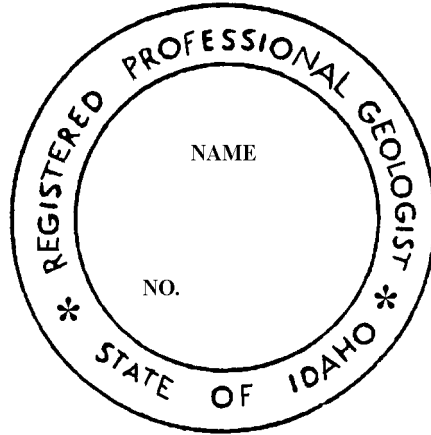

SEAL OF REGISTERED PROFESSIONAL GEOLOGIST  
Diameter of Outer Ring: 1 1/2 Inches  
Diameter of Inner Ring: 1 Inch

**APPENDIX B -- AS REFERENCED IN SUBSECTION 24.04.01.200.01.a.**

**STATE OF IDAHO  
BOARD OF REGISTRATION  
FOR PROFESSIONAL GEOLOGISTS  
CODE OF ETHICS**

Geology is a profession, and the privilege of professional practice requires morality and responsibility, as well as professional knowledge, on the part of each practitioner. Each registered professional geologist shall be guided by the highest standards of business ethics, personal honor and professional conduct.

With regard for the geologic profession and recognizing in the Code of Ethics a set of dynamic principles to guide his services to his fellow men, and with full knowledge of the responsibility of geologists to safeguard health, safety, and public welfare, a registered geologist:

1. Brings credit, honor and dignity to the geologic profession in his dealings with clients, other geologists, and the public.
2. Acts for his clients as a faithful agent or trustee and accepts remuneration only in accordance with his stated charges for services rendered.
3. Exchanges non-confidential geologic information with other geologists, students, and the public; encourages the public understanding of geology, and ensures proper credit for geologic work.
4. Does not reveal nor seek the revelation of geologic work performed for a paying client.
5. Does not advertise or solicit geologic work assignments in a fraudulent, misleading or deceptive manner.

6. Promptly reports to the Board unethical conduct on the part of any geologist.
7. Undertakes professional service or renders expert opinion only when qualified in the specific technical areas involved.
8. Functions without prejudice with respect to gender, religion, national or ethnic origin, age, sexual preference, or physical or mental disability.

Acknowledged and subscribed to:

Signature of Applicant

Adopted by the Board September 11, 1971  
Amended March 17, 2007.

Sign and return this form with your completed application forms.

## **IDAPA 24 – DIVISION OF OCCUPATIONAL AND PROFESSIONAL LICENSES**

### **24.05.01 – RULES OF THE BOARD OF DRINKING WATER AND WASTEWATER PROFESSIONALS**

#### **DOCKET NO. 24-0501-2000F (FEE RULE)**

#### **NOTICE OF OMNIBUS RULEMAKING – ADOPTION OF TEMPORARY RULE**

**EFFECTIVE DATE:** The effective date of the temporary rule being adopted through this omnibus rulemaking is the adjournment date of the second regular session of the 65th Idaho State Legislature - March 20, 2020.

**AUTHORITY:** In compliance with Sections 67-5226, Idaho Code, notice is hereby given this agency has adopted a temporary rule. The action is authorized pursuant to Section 54-2406, Idaho Code.

**DESCRIPTIVE SUMMARY:** The following is the required finding and concise statement of its supporting reasons for adopting a temporary rule:

This temporary rulemaking adopts the following chapter under IDAPA 24:

#### **IDAPA 24.05**

- 24.05.01, *Rules of the Board of Drinking Water and Wastewater Professionals.*

**TEMPORARY RULE JUSTIFICATION:** Pursuant to Sections 67-5226(1) and 67-5226(2), Idaho Code, the Governor has found that temporary adoption of the rule is appropriate for the following reasons:

These temporary rules are necessary to protect the public health, safety, and welfare of the citizens of Idaho and confer a benefit on its citizens. These temporary rules implement the duly enacted laws of the state of Idaho, provide citizens with the detailed rules and standards for complying with those laws, and assist in the orderly execution and enforcement of those laws. The expiration of these rules without due consideration and processes would undermine the public health, safety, and welfare of the citizens of Idaho and deprive them of the benefit intended by these rules. These rules govern the qualifications for individuals who maintain Idaho's public drinking water and public wastewater systems. Allowing these rules to expire would harm the licensees, the localities who operate public drinking water and public wastewater systems, the environment, and the public health.

**FEE SUMMARY:** Pursuant to Section 67-5226(2), the Governor has found that the fees or charges being imposed or increased are justified and necessary to avoid immediate danger and the fees are described herein:

The fees or charges, authorized in Section 54-2407, Idaho Code, are part of the agency's 2021 budget that relies upon the existence of these fees or charges to meet the state's obligations and provide necessary state services. Failing to reauthorize these temporary rules would create immediate danger to the state budget, immediate danger to necessary state functions and services, and immediate danger of a violation of Idaho's constitutional requirement that it balance its budget.

The following is a specific description of the fees or charges:

<b>FEE TYPE</b>	<b>AMOUNT (Not to Exceed)</b>
Application	\$25
Examination	Amount set by examination provider
Endorsement	\$30
Original License	\$30
Annual renewal	\$30
Reinstatement	As provided in Section 67-2614, Idaho Code

**ASSISTANCE ON TECHNICAL QUESTIONS:** For assistance on technical questions concerning the temporary rule, contact Rob McQuade at (208) 334-3233.

DATED this February 21, 2020.

Kelley Packer  
Division Administrator  
Division of Occupational and Professional Licenses  
700 W. State Street  
P.O. Box 83720  
Boise, ID 83720  
Phone: (208) 334-3233  
Fax: (208) 334-3945

## 24.05.01 – RULES OF THE BOARD OF DRINKING WATER AND WASTEWATER PROFESSIONALS

### 000. LEGAL AUTHORITY.

These rules are hereby prescribed and established pursuant to the authority vested in the Board of Drinking Water and Wastewater Professionals by the provisions of Section 54-2406, Idaho Code. (3-20-20)T

### 001. TITLE AND SCOPE.

These rules are titled IDAPA 24.05.01, “Rules of the Board of Drinking Water and Wastewater Professionals.” (3-20-20)T

### 002. -- 009. (RESERVED)

### 010. DEFINITIONS.

**01. Class I Restricted License.** Class I restricted license means a water or wastewater license associated with a specific class I system. A restricted license is available for water distribution or treatment or for wastewater collection or treatment. A restricted license is not transferable and does not qualify for endorsement. (3-20-20)T

**02. DEQ.** The Idaho Department of Environmental Quality. (3-20-20)T

**03. Direct Supervision.** Supervision in a way that will ensure the proper operation and maintenance of the public drinking water or public wastewater system. Supervision shall include, but not be limited to, providing written, hands-on, or oral instruction as well as verification that the instructions are being completed. The supervisor has an active on-site or on-call presence at the specific facility. (3-20-20)T

**04. Endorsement.** Endorsement (often referred to as “reciprocity”) is that process by which a person licensed in another jurisdiction may apply for a license in Idaho. (3-20-20)T

**05. EPA.** The United States Environmental Protection Agency. (3-20-20)T

**06. Experience.** One (1) year of experience is based upon a minimum of one thousand six hundred hours (1,600) worked. (3-20-20)T

**07. On-Site Operating Experience.** On-site operating experience means experience obtained while physically present at the location of the system. (3-20-20)T

**08. Operating Personnel.** Operating personnel means any person who is employed, retained, or appointed to conduct the tasks associated with the day-to-day operation and maintenance of a public drinking water system or a public wastewater system. Operating personnel shall include every person making system control or system integrity decisions about water quantity or water quality that may affect public health. (3-20-20)T

**09. Person.** A human being, municipality, or other governmental or political subdivision or other public agency, or public or private corporation, any partnership, firm, association, or other organization, any receiver, trustee, assignee, agent or other legal representative of the foregoing or other legal entity. (3-20-20)T

**10. Responsible Charge Operator.** An operator of a public drinking water system or wastewater system, designated by the system owner, who holds a valid license at a class equal to or greater than the drinking water system or wastewater classification, who is in responsible charge of the public drinking water system or the wastewater system. (3-20-20)T

**11. Substitute or Back-Up Responsible Charge Operator.** An operator of a public drinking water or wastewater system who holds a valid license at a class equal to or greater than the drinking water or wastewater system classification, designated by the system owner to replace and to perform the duties of the responsible charge operator when the responsible charge operator is not available or accessible. (3-20-20)T

**12. Very Small Public Drinking Water System.** A community or non-transient non-community public water system that serves five hundred (500) persons or less and has no treatment other than disinfection or has only treatment which does not require any chemical treatment, process adjustment, backwashing or media regeneration by an operator (e.g. calcium carbonate filters, granular activated carbon filters, cartridge filters, ion exchangers). (3-20-20)T

**13. Very Small Wastewater System.** A public wastewater system that serves five hundred (500)

connections or less and includes a collection system with a system size of six (6) points or less on the Department of Environmental Quality (DEQ) system classification rating form and is limited to only one (1) of the following wastewater treatment processes: (3-20-20)T

- a. Aerated lagoons: (3-20-20)T
- b. Non-aerated lagoon(s); (3-20-20)T
- c. Primary treatment; or (3-20-20)T
- d. Primary treatment discharging to a large soil absorption system (LSAS). (3-20-20)T

**011. -- 099. (RESERVED)**

**100. ORGANIZATION.**

**01. Meetings.** The Board shall meet at least two (2) times annually at such times and places as designated by the Board or the Chairman of the Board. A minimum of four Board members shall constitute a quorum and shall be required to be present in order to hold a meeting of the Board. A majority vote of the Board members present at a meeting shall be considered the action of the Board as a whole. The Chairman may vote only in the event of a tie vote. (3-20-20)T

**02. Organization of the Board.** At the first meeting of each fiscal year, the Board shall elect from its members a Chairman, who shall assume the duty of the office immediately upon such selection. (3-20-20)T

**101. -- 149. (RESERVED)**

**150. APPLICATION.**

Each applicant for licensure shall submit a complete application together with the required fees. The applicant must provide or facilitate the provision of any supplemental third party documents that may be required. The Board shall not review an application until all required information is furnished and the required fees paid. (3-20-20)T

**01. Licensure by Examination.** An application shall be made on the uniform application form adopted by the Board and furnished to the applicant by the Division. All applications shall include: (3-20-20)T

- a. Documentation of having met the appropriate educational requirement; (3-20-20)T
- b. Documentation of all actual applicable experience giving kind and type of work done, together with dates of employment, and verification by affidavit of the most current applicable experience, signed by the person under whose supervision the work was performed. (3-20-20)T

**02. Licensure by Endorsement.** An application shall be made on the uniform application form adopted by the Board and furnished to the applicant by the Division. All applications shall include: (3-20-20)T

- a. Official documentation of licensure sent to the Division directly from each regulatory authority from which the applicant has obtained licensure. Such documentation shall note name, address, current status, date originally issued, expiration date, and any disciplinary action imposed; (3-20-20)T
- b. A copy of the current regulations governing licensure in each jurisdiction from which the applicant obtained licensure. (3-20-20)T

**03. Application Required.** Applicants seeking licensure in any type or classification of licensure shall submit a separate application for each type and classification of licensure being sought. Applicants holding a current type and classification of license and who are seeking a classification upgrade within the same license type and category shall not be required to submit an original license fee with their application. (3-20-20)T

**04. Lack of Activity.** Applications on file with the Board where an applicant has failed to respond to a

Board request or where the applications have lacked activity for twelve (12) consecutive months shall be deemed denied and shall be terminated upon thirty (30) days written notice unless good cause is established to the Board.  
(3-20-20)T

**151. -- 174. (RESERVED)**

**175. LICENSE TYPES AND CLASSIFICATIONS.**

The Board shall issue each of the following licenses under the provisions of Chapter 24, Title 54, Idaho Code.

- 01. Drinking Water Distribution Operator.** (3-20-20)T
  - a. Class Operator-In-Training. (3-20-20)T
  - b. Class I Restricted. (3-20-20)T
  - c. Class I. (3-20-20)T
  - d. Class II. (3-20-20)T
  - e. Class III. (3-20-20)T
  - f. Class IV. (3-20-20)T
- 02. Drinking Water Treatment Operator.** (3-20-20)T
  - a. Class Operator-In-Training. (3-20-20)T
  - b. Class I Restricted. (3-20-20)T
  - c. Class I. (3-20-20)T
  - d. Class II. (3-20-20)T
  - e. Class III. (3-20-20)T
  - f. Class IV. (3-20-20)T
- 03. Wastewater Treatment Operator.** (3-20-20)T
  - a. Class Operator-In-Training. (3-20-20)T
  - b. Lagoon. (3-20-20)T
  - c. Class I Restricted. (3-20-20)T
  - d. Class I. (3-20-20)T
  - e. Class II. (3-20-20)T
  - f. Class III. (3-20-20)T
  - g. Class IV. (3-20-20)T
  - h. Land Application. (3-20-20)T
- 04. Wastewater Collection Operator.** (3-20-20)T



- a. Class Operator-In-Training. (3-20-20)T
- b. Class I Restricted. (3-20-20)T
- c. Class I. (3-20-20)T
- d. Class II. (3-20-20)T
- e. Class III. (3-20-20)T
- f. Class IV. (3-20-20)T
- 05. Wastewater Laboratory Analyst. (3-20-20)T**
  - a. Class I. (3-20-20)T
  - b. Class II. (3-20-20)T
  - c. Class III. (3-20-20)T
  - d. Class IV. (3-20-20)T
- 06. Backflow Assembly Tester. (3-20-20)T**
- 07. Drinking Water Very Small System Operator. (3-20-20)T**
- 08. Wastewater Very Small System Operator. (3-20-20)T**

**176. -- 199. (RESERVED)**

**200. FEES FOR EXAMINATION AND LICENSURE.**  
 Application and examination fees are non-refundable.

FEE TYPE	AMOUNT (Not to Exceed)
Application	\$25
Examination	Amount set by examination provider
Endorsement	\$30
Original License	\$30
Annual renewal	\$30
Reinstatement	As provided in Section 67-2614, Idaho Code

(3-20-20)T

**201. -- 249. (RESERVED)**

**250. LICENSE REQUIRED -- SCOPE OF PRACTICE.**

All water and wastewater operating personnel, including those in responsible charge and those in substitute responsible charge, of public water systems and public wastewater systems, and all backflow assembly testers, shall be licensed under the provisions of these rules and Chapter 24, Title 54, Idaho Code. (3-20-20)T

- 01. Drinking Water Operator Scope.** Operating personnel shall only act in accordance with the

nature and extent of their license. Those in responsible charge or substitute responsible charge of a public water system must hold a valid license equal to or greater than the classification of the public water system where the responsible charge or substitute responsible charge operator is in responsible charge. The types of water systems are distribution and treatment. (3-20-20)T

**02. Wastewater Operator Scope.** Operating personnel shall only act in accordance with the nature and extent of their license. Those in responsible charge or substitute responsible charge of a public wastewater system shall hold a valid license equal to or greater than the classification of the public wastewater system where the responsible charge or substitute responsible charge operator is in responsible charge. The types of wastewater systems are collection, laboratory analyst, and treatment. (3-20-20)T

**03. Backflow Assembly Tester.** Individuals licensed as backflow assembly testers may inspect and test backflow prevention assemblies as defined in Title 54, Chapter 24, Idaho Code. (3-20-20)T

**04. Operator-in-Training.** Operators-in-training shall practice only under the direct supervision of a licensed operator of a type, category, and classification higher than operator-in-training. No operator-in-training shall accept or perform the designated responsible charge duties at any system. (3-20-20)T

**251. -- 299. (RESERVED)**

**300. GENERAL REQUIREMENTS FOR LICENSE.**

Applicants shall submit an application together with the required fees and such documentation as is required. (3-20-20)T

**01. Examination Requirement.** Applicants must pass a written examination for each individual classification in each type of licensure with a minimum score of seventy percent (70%). (3-20-20)T

**a.** The examination will reflect different levels of knowledge, ability and judgment required for the established license type and class. The Board will administer examinations at such times and places as the Board may determine. (3-20-20)T

**b.** The examination for all types and classes of licensure shall be validated and provided by the Association of Boards of Certification (ABC). The American Backflow Prevention Association (ABPA) backflow assembly tester examination is also approved for backflow assembly tester licensure. (3-20-20)T

**c.** Applicants who fail an examination must make application to retake the same type and class examination and pay the required examination fees prior to retaking the examination. (3-20-20)T

**d.** Applicants must take and pass the examination within one (1) year of application approval. After one (1) year a new application and applicable fees must be submitted. (3-20-20)T

**02. Education Requirements.** Documentation must be provided showing proof of education required for the type and level of license being sought. (3-20-20)T

**03. Experience Requirement.** Only actual verified on-site operating experience at a treatment, distribution or collection system will be acceptable except as may be allowed by substitution as set forth in these rules. Experience as a laboratory analyst can be counted as wastewater operating experience for up to one-half (1/2) of the wastewater operating experience requirement but cannot be counted as responsible charge experience. Experience as a wastewater operator can be counted as laboratory analyst experience for up to one-half (1/2) of the laboratory analyst experience. Applicants shall not receive more than one (1) year of experience for hours worked in excess of one thousand six hundred (1,600) hours in a calendar year unless specifically approved by the Board based upon documentation submitted by the Applicant. (3-20-20)T

**04. Apprenticeship Program.** The Board may approve Apprenticeship Programs that are designed to provide either experience or experience and education for individuals seeking licensure in Idaho as an Operator-In-Training, or a Class I, II or III Water or Wastewater Operator. A basic Apprenticeship Program is designed to provide hands on experience and education related to the operation of Class I and II facilities. An advanced Apprenticeship

Program is designed to provide hands on experience and education related to Class III facilities. All approved Apprenticeship Programs shall be registered with the U.S. Department of Labor, Office of Apprenticeship, meet the Standards of Apprenticeship developed by the U.S. Department of Labor and meet the intent of these rules regarding the education and experience necessary for Operator-In-Training, Class I, II and III licensure. Sponsors of Apprenticeship Programs shall seek Board approval by application along with all supporting documentation necessary to establish the program meets the intent of these rules regarding education and experience. The Board may revoke the approval of any program that fails to comply with the Board's rules. (3-20-20)T

**301. -- 309. (RESERVED)**

**310. REQUIREMENTS FOR OPERATOR-IN-TRAINING LICENSE.**

Each applicant for an Operator-In-Training License must meet the following requirements: (3-20-20)T

**01. Education.** Possess a high school diploma or GED; and (3-20-20)T

**02. Examination.** Pass the relevant Class I examination or be enrolled in an Apprenticeship Program approved by the Board. (3-20-20)T

**311. -- 314. (RESERVED)**

**315. REQUIREMENTS FOR A VERY SMALL WATER SYSTEM LICENSE.**

To qualify for a Very Small Water System license an operator must meet the following requirements: (3-20-20)T

**01. Education.** Possess a high school diploma or GED and; (3-20-20)T

**02. Experience.** Document eighty-eight (88) hours of acceptable on-site operating experience at a water system; and (3-20-20)T

**a.** Complete an approved six-hour water treatment course or an approved six-hour chlorination course or a combination of said approved courses equaling six (6) hours; and (3-20-20)T

**b.** Complete an approved six-hour water distribution course; and (3-20-20)T

**03. Examination.** Pass the relevant very small water system examination. (3-20-20)T

**316. -- 319. (RESERVED)**

**320. REQUIREMENTS FOR A VERY SMALL WASTEWATER SYSTEM LICENSE.**

To qualify for a Very Small Wastewater System license, an operator must meet the following requirements: (3-20-20)T

**01. Education.** Possess a high school diploma or GED; and (3-20-20)T

**02. Experience.** Document fifty (50) hours of acceptable on-site operating experience at a wastewater collection system; and (3-20-20)T

**a.** Fifty (50) hours of acceptable relevant on-site operating experience at a wastewater treatment system or lagoon; and (3-20-20)T

**b.** Complete an approved six-hour pumps and motors course or an approved six-hour collection course or a combination of said approved courses equaling six (6) hours; and (3-20-20)T

**c.** Complete an approved six-hour lagoon operation and maintenance course; or an approved six-hour large soil absorption system course or an approved six-hour wastewater treatment course or a combination of said approved courses equaling six (6) hours; and (3-20-20)T

**03. Examination.** Pass the relevant lagoon examination. (3-20-20)T

**321. -- 324. (RESERVED)**

**325. REQUIREMENTS FOR CLASS I RESTRICTED WATER OR WASTEWATER LICENSE.**

To qualify for a Class I Restricted water or wastewater license an operator must meet the following requirements: (3-20-20)T

- 01. Education.** Possess a high school diploma or GED; and (3-20-20)T
- 02. Experience.** Document two hundred sixty (260) hours of acceptable relevant on-site operating experience during twelve (12) consecutive months with the system and complete sixteen (16) hours of continuing education relevant to the license; and (3-20-20)T
- 03. Examination.** Pass the relevant Class I examination. (3-20-20)T
- 04. Restricted License Upgrade.** Upon obtaining one thousand six hundred (1,600) hours of supervised on-site operating experience for each license, the operator shall be eligible to apply for an unrestricted Class I license. There is no limit on the amount of time needed to obtain the necessary experience to qualify for the unrestricted license. A restricted license is limited to a specific system. (3-20-20)T

**326. -- 327. (RESERVED)**

**328. REQUIREMENTS FOR A CLASS I OPERATOR LICENSE.**

To qualify for a Class I operator license an applicant must meet the following requirements: (3-20-20)T

- 01. Education.** Possess a high school diploma or GED; and (3-20-20)T
- 02. Experience.** Document one (1) year of acceptable relevant on-site operating experience at a Class I or higher system or successfully complete one (1) year of an Approved Apprenticeship Program; and (3-20-20)T
- 03. Examination.** Pass the relevant Class I examination. (3-20-20)T

**329. (RESERVED)**

**330. REQUIREMENTS FOR A CLASS II OPERATOR LICENSE.**

To qualify for a Class II license an applicant must meet the following requirements: (3-20-20)T

- 01. Education.** Possess a high school diploma or GED; and (3-20-20)T
- 02. Experience.** Document three (3) years of acceptable relevant on-site operating experience at a Class I or higher system or successfully complete an Approved Apprenticeship Program; and (3-20-20)T
- 03. Examination.** Pass the relevant Class II examination. (3-20-20)T

**331. -- 334. (RESERVED)**

**335. REQUIREMENTS FOR A CLASS III OPERATOR LICENSE.**

To qualify for a Class III license an applicant must meet the following requirements: (3-20-20)T

- 01. Education.** Possess a high school diploma or GED and two (2) years of post-high school education in the environmental control field, engineering or related science; and (3-20-20)T
- 02. Experience.** Document four (4) years of acceptable relevant on-site operating experience, including two (2) years of responsible charge of a major segment of a system in the same or next lower class, of a Class I or higher system for collection or distribution or Class II or higher system for treatment or successful completion of an Approved Apprenticeship Program; and (3-20-20)T

- 03. Examination.** Pass the relevant Class III examination. (3-20-20)T
- 336. -- 339. (RESERVED)**
- 340. REQUIREMENTS FOR A CLASS IV OPERATOR LICENSE.**  
To qualify for a Class IV license an applicant must meet the following requirements; (3-20-20)T
- 01. Education.** Possess a high school diploma or GED and four (4) years of post-high school education in the environmental control field, engineering or related science; and (3-20-20)T
- 02. Experience.** Document four (4) years of acceptable relevant on-site operating experience, including two (2) years of responsible charge of a major segment of a system in the same or next lower class, at a Class I or higher system for collection or distribution or Class III or higher system for treatment; and (3-20-20)T
- 03. Examination.** Pass the relevant Class IV examination. (3-20-20)T
- 341. -- 344. (RESERVED)**
- 345. REQUIREMENTS FOR A LAGOON OPERATOR LICENSE.**  
To qualify for a lagoon license, an operator must meet the following requirements; (3-20-20)T
- 01. Education.** Possess a high school diploma or GED; and (3-20-20)T
- 02. Experience.** Document twelve (12) consecutive months of acceptable on-site operating experience at a Lagoon system; and (3-20-20)T
- 03. Examination.** Pass the relevant Lagoon examination. (3-20-20)T
- 346. -- 349. (RESERVED)**
- 350. REQUIREMENTS FOR A WASTEWATER LAND APPLICATION LICENSE.**  
To qualify for a Wastewater Land Application license, an operator must meet the following requirements: (3-20-20)T
- 01. Education.** Possess a high school diploma or GED; and (3-20-20)T
- 02. Experience.** Document a minimum six (6) months of on-site operating experience at a wastewater land application system; and (3-20-20)T
- 03. Examination.** Pass the relevant Wastewater Land Application examination; and (3-20-20)T
- 04. Other.** Possess a wastewater Class I or higher operation license. The wastewater land application operator that is a responsible charge or substitute responsible charge operator must be licensed at the type and class equal to or greater than the classification of the wastewater system. (3-20-20)T
- 351. -- 354. (RESERVED)**
- 355. REQUIREMENTS FOR A BACKFLOW ASSEMBLY TESTER LICENSE.**  
To qualify for a backflow assembly tester license, an applicant must meet the following requirements: (3-20-20)T
- 01. Education.** Possess a high school diploma or GED, and (3-20-20)T
- 02. Experience.** Document successful completion of a Board-approved backflow assembly tester training program in compliance with the Cross Connection Control Accepted Procedure and Practice Manual and consisting of theory instruction, practical instruction, and a practical examination in compliance with the USC Test procedures; and (3-20-20)T
- 03. Examination.** Pass the relevant Backflow Assembly Tester examination. (3-20-20)T

**356. -- 359. (RESERVED)**

**360. REQUIREMENTS FOR WASTEWATER LABORATORY ANALYST LICENSE.**

To qualify for a wastewater laboratory analyst license, an applicant must meet the following requirements for the relevant class: (3-20-20)T

- 01. Class I.** (3-20-20)T
  - a.** Possess a high school diploma or GED; and (3-20-20)T
  - b.** Document one (1) year of acceptable lab experience at a class I or higher system; and (3-20-20)T
  - c.** Pass the relevant class I laboratory analyst examination. (3-20-20)T
- 02. Class II.** (3-20-20)T
  - a.** Possess a high school diploma or GED; and (3-20-20)T
  - b.** Document three (3) years of acceptable lab experience at a class I or higher system; and (3-20-20)T
  - c.** Pass the relevant class II laboratory analyst examination. (3-20-20)T
- 03. Class III.** (3-20-20)T
  - a.** Possess a high school diploma or GED and two (2) years of post-high school education in the environmental control field, engineering or related science; and (3-20-20)T
  - b.** Document four (4) years of acceptable lab experience at a class II or higher system; and (3-20-20)T
  - c.** Pass the relevant class III laboratory analyst examination. (3-20-20)T
- 04. Class IV.** (3-20-20)T
  - a.** Possess a high school diploma or GED and four (4) years of post-high school education in the environmental control field, engineering or related science; and (3-20-20)T
  - b.** Document four (4) years of acceptable lab experience at a class III or higher system; and (3-20-20)T
  - c.** Pass the relevant class IV laboratory analyst examination. (3-20-20)T

**361. -- 374. (RESERVED)**

**375. SUBSTITUTIONS.**

- 01. Substituting Education for Experience.** Applicants may substitute approved education for operating and responsible charge experience as specified below. (3-20-20)T
  - a.** No substitution for on-site operating experience shall be permitted for licensure as a very small system operator or a Class I operator. (3-20-20)T
  - b.** For Classes II, III and IV, substitution shall only be allowed for the required experience when fifty percent (50%) of all stated experience (both on-site operating and responsible charge) has been met by actual on-site operating experience. (3-20-20)T
  - c.** For Class II, a maximum of one and one-half (1½) years of post-high school education in the

environmental control field, engineering or related science may be substituted for one and one-half (1½) years of operating experience. (3-20-20)T

**d.** For Class III and IV, a maximum of two (2) years of post-high school education in the environmental control field, engineering or related science may be substituted for two (2) years of on-site operating experience; however the applicant for Class III must still have one (1) year of responsible charge experience and the applicant for Class IV must have two (2) years of responsible charge experience. (3-20-20)T

**e.** Education substituted for on-site operating experience may not be also credited toward the education requirement. (3-20-20)T

**f.** One (1) year of post-high school education may be substituted for one (1) year experience up to a maximum of fifty percent (50%) of the required on-site operating or responsible charge experience. (3-20-20)T

**02. Substituting Experience for Education.** Where applicable, approved on-site operating and responsible charge experience may be substituted for education as specified below: (3-20-20)T

**a.** One (1) year of on-site operating experience may be substituted for two (2) years of grade school or one (1) year of high school with no limitation. (3-20-20)T

**b.** For Class III and IV, additional responsible charge experience (that exceeding the two-year class requirements) may be substituted for post-high school education on a one (1) for one (1) basis: one (1) year additional responsible charge equal one (1) year post-high school education. (3-20-20)T

**03. Substituting Experience for Experience.** Related experience may be substituted for experience up to one-half (½) of the operating experience requirement for Class II, III and IV. Experience that may be substituted includes, but is not limited to, the following: (3-20-20)T

**a.** Experience as an environmental or operations consultant; (3-20-20)T

**b.** Experience in an environmental or engineering branch of federal, state, county, or local government; (3-20-20)T

**c.** Experience as a wastewater collection system operator; (3-20-20)T

**d.** Experience as a wastewater treatment plant operator; (3-20-20)T

**e.** Experience as a water distribution system operator and/or manager; (3-20-20)T

**f.** One (1) year of post-high school education may be substituted for one (1) year experience up to a maximum of fifty percent (50%) of the required operating or responsible charge experience. (3-20-20)T

**g.** Experience in waste treatment operation and maintenance. (3-20-20)T

**h.** Experience as a laboratory analyst can be counted as wastewater operating experience for up to one-half (1/2) of the wastewater operating experience requirement but cannot be counted as responsible charge experience. (3-20-20)T

**i.** Experience as a wastewater operator can be counted as laboratory analyst experience for up to one-half (1/2) of the laboratory analyst experience requirement. (3-20-20)T

**04. Equivalency Policy.** Substitutions for education or experience requirements needed to meet minimum requirements for license will be evaluated upon the following equivalency policies: (3-20-20)T

**a.** High School - High School diploma equals GED or equivalent as approved by the Board equals four (4) years. (3-20-20)T

**b.** College - Thirty (30) credits equal one (1) year (limited to curricula in environmental engineering, environmental sciences, water/wastewater technology, and/or related fields as determined by the Board). (3-20-20)T

**c.** Continuing Education Units (CEU) for operator training courses, seminars, related college courses, and other training activities. Ten (10) classroom hours equal one (1) CEU; forty-five (45) CEUs equal one (1) year of college. (3-20-20)T

**376. -- 399. (RESERVED)**

**400. ENDORSEMENT.**

The board may waive the examination requirements and issue the appropriate license for applicants holding licenses issued by other States that have equivalent license requirements and who otherwise meet the requirements set forth in Subsections 150.02, 150.03, and 150.04. (3-20-20)T

**401. -- 449. (RESERVED)**

**450. WASTEWATER GRANDPARENT PROVISION.**

The board issued grandparent licenses to wastewater operators who provided documentation satisfactory to the board of being in responsible charge of an existing public wastewater system on or before April 15, 2006. (3-20-20)T

**01. Grandparent License.** A grandparent license allowed the licensee to operate in responsible charge of the specific facility identified in the original application. The license is site specific and non-transferable and does not grant authority for the holder to practice at any other system in any capacity as an operator. (3-20-20)T

**02. License Requirements.** A grandparent licensed wastewater operator is required to meet all other requirements including the continuing education and renewal requirements. (3-20-20)T

**03. Wastewater System Classification Limitations.** The grandparent license shall become invalid any time the classification of the wastewater system changes to a higher classification. (3-20-20)T

**451. -- 499. (RESERVED)**

**500. CONTINUING EDUCATION.**

In order to further protect the health, safety and welfare of Idaho's public, and to facilitate the continued competence of persons licensed under the drinking water and wastewater professionals licensing act, the Board has adopted the following rules for continuing education. (3-20-20)T

**01. Continuing Education Requirement.** Each licensee must successfully complete a minimum of six (6) hours (0.6 CEUs) of approved continuing education annually for license renewal, except that backflow assembly testers shall complete an eight (8) hour refresher course every two (2) years for license renewal. Continuing education must be earned in a subject matter relevant to the field in which the license is issued. A licensee holding one (1) or more drinking water license(s) shall be required to meet the annual continuing education requirement for only one license. A licensee holding one (1) or more wastewater license(s) shall be required to meet the annual continuing education requirement for only one license. A licensee holding both drinking water and wastewater class licenses must complete a minimum of six (6) hours annually for the drinking water license plus six (6) hours annually for the wastewater license. (3-20-20)T

**a.** Each licensee shall submit to the Board an annual license renewal application form, together with the required fees, certifying by signed affidavit that compliance with the CE requirements have been met. The Board may conduct such continuing education audits and require verification of attendance as deemed necessary to ensure compliance with the CE requirements. (3-20-20)T

**b.** A licensee shall be considered to have satisfied their CE requirements for the first renewal of their license. (3-20-20)T

**c.** A water or wastewater licensee may carryover a maximum of six (6) hours of continuing education to meet the next year's continuing education requirement. The same hours may not be carried forward more than one



(1) renewal cycle. (3-20-20)T

**d.** Continuing Education hours for approved operator training courses, seminars, related college courses, and other training activities may be converted to Continuing Education Units (CEU) as follows: Six (6) classroom hours = point six (0.6) CEU. (3-20-20)T

**02. Subject Material.** The subject material of the continuing education requirement shall be relevant to the license for which the continued education is required. “Relevant” shall be limited to material germane to the operation, maintenance and administration of drinking water and wastewater systems as referenced in Chapter 24, Title 54, Idaho Code, and includes those subjects identified in the “need to know” criteria published by the Associations of Boards of Certification. (3-20-20)T

**03. Course Approval.** All course providers must submit requests for approval of continuing education courses to the Board in writing no less than thirty (30) days prior to the course being offered, on a form approved by the Board that includes: (3-20-20)T

- a.** The name and qualifications of the instructor or instructors; (3-20-20)T
- b.** The date, time and location of the course; (3-20-20)T
- c.** The specific agenda for the course; (3-20-20)T
- d.** The type and number of continuing education credit hours requested; (3-20-20)T
- e.** A statement of how the course is believed to be relevant as defined; (3-20-20)T
- f.** Any certificate of approval from a governmental agency if the course has been previously approved for continuing education; (3-20-20)T
- g.** The training materials; (3-20-20)T
- h.** Other information as may be requested by the Board. (3-20-20)T
- i.** Upon review of all information requested, the Board may either approve or deny any request for a course. Board approval of a course shall be granted for a period not to exceed five (5) years or until the course materials or instructors are changed. (3-20-20)T

**04. Approved Courses.** Those continuing education courses which are relevant and approved by the states of Nevada, Oregon, Montana, Utah, Wyoming, and Washington are deemed approved by the Board. (3-20-20)T

**05. Verification of Attendance.** It shall be necessary for each licensee to maintain verification of attendance by securing authorized signatures or other documentation from the course instructors or sponsoring institution substantiating any and all hours attended by the licensee. This verification shall be maintained by the licensee and provided upon request of the Board or its agent. (3-20-20)T

**06. Distance Learning and Independent Study.** The Board may approve a course of study for continuing education credit that does not include the actual physical attendance of the licensee in a face-to-face setting with the course instructor. The licensee shall maintain documentation of the nature and details of the course and evidence that the licensee successfully completed the course, which shall be made available to the Board upon request. (3-20-20)T

**07. Failure to Fulfill the Continuing Education Requirements.** The license will not be renewed for those licensees who fail to certify or otherwise provide acceptable documentation of meeting the CE requirements. Licensees who make a false attestation regarding compliance with the CE requirements shall be subject to disciplinary action by the Board. (3-20-20)T

**08. Exemptions.** The Board may waive the continuing education requirement or extend the deadline up to ninety (90) days for any one or more of the following circumstances. The licensee must request the exemption and provide any information requested to assist the Board in making a determination. An exemption may be granted at the sole discretion of the Board. (3-20-20)T

**a.** The licensee is a resident of another jurisdiction recognized by the Board having a continuing professional education requirement for licensure renewal and has complied with the requirements of that state or district. (3-20-20)T

**b.** The licensee is a government employee working outside the continental United States. (3-20-20)T

**c.** The licensee documents individual hardship, including health (certified by a medical doctor) or other good cause. (3-20-20)T

**501. -- 599. (RESERVED)**

**600. RENEWAL OR REINSTATEMENT OF LICENSE.**

**01. Expiration Date.** All licenses expire and must be renewed annually on forms approved by the Board in accordance with Section 67-2614, Idaho Code. Licenses not so renewed will be cancelled in accordance with Section 67-2614, Idaho Code. (3-20-20)T

**02. Reinstatement.** Any license cancelled for failure to renew may be reinstated in accordance with Section 67-2614, Idaho Code, with the exception that the applicant shall submit proof of having completed the total number of required continuing education for each year the license or certificate was cancelled. (3-20-20)T

**03. Operator-in-Training License.** Applicants for the operator-in-training license shall, upon compliance with the requirements of Subsections 300.01 and 300.02, be issued a “one-time” non-renewable license for the purpose of gaining supervised experience as an operator-in-training (OIT). This license will be valid for three (3) years from the date of issue. (3-20-20)T

**04. Backflow Assembly Testers.** Backflow assembly testers shall complete a Board-approved eight (8) hour refresher course every two (2) years for license renewal. (3-20-20)T

**05. Wastewater Land Application License.** Wastewater land application licenses shall not be renewed unless the licensee also maintains a current wastewater treatment license. (3-20-20)T

**601. -- 649. (RESERVED)**

**650. BACKFLOW ASSEMBLY TESTER CODE OF ETHICS AND STANDARDS OF CONDUCT.**

All backflow assembly tester licensees shall comply with the Idaho Backflow Assembly Tester Code of Ethics and Standards of Conduct as approved by the Board and attached to these rules as Appendix A. (3-20-20)T

**651. -- 699. (RESERVED)**

**700. DISCIPLINE.**

**01. Civil Fine.** The Board may impose a civil fine not to exceed one thousand dollars (\$1,000) upon a licensee for each violation of Chapter 24, Title 54, Idaho Code. (3-20-20)T

**02. Costs and Fees.** The Board may order a licensee to pay the costs and fees incurred by the Board in the investigation or prosecution of the licensee for violation of Chapter 24, Title 54, Idaho Code. (3-20-20)T

**701. -- 799. (RESERVED)**

**800. STAKEHOLDER INVOLVEMENT.**

Ongoing drinking water stakeholder involvement shall be provided through the existing DEQ drinking water

advisory committee.

(3-20-20)T

**801. -- 999. (RESERVED)**

**APPENDIX A**

**IDAHO BACKFLOW ASSEMBLY TESTER CODE OF ETHICS AND STANDARDS OF CONDUCT**

The purpose of this rule is to protect public health by setting minimum requirements and standards for licensed Backflow Assembly Testers in Idaho who inspect and field test backflow assemblies, backflow prevention devices and air gaps that protect public water systems.

**1. Code of Ethics --** A licensed Backflow Assembly Tester shall:

- a.** At all times, act in accordance with his/her primary obligation to perform his/her duties with due care and diligence to protect the safety, health and welfare of the public;
- b.** Comply with the laws and rules governing Backflow Assembly Testers and all applicable state and federal laws and regulations relating to backflow assembly testing;
- c.** Perform only those duties consistent with and appropriate to his/her experience, training, skills, abilities, and licensure; and
- d.** Be objective and truthful in all professional reports, statements, or testimony and include all relevant and pertinent information in such reports, statements or testimony.

**2. Definitions:**

- a.** Backflow Prevention Assembly: an approved assembly such as a Double Check Valve Assembly (DCVA), a Pressure Vacuum Breaker Assembly (PVBA), a Reduced Pressure Backflow Assembly (RPBA), or a Spill-Resistant Pressure Vacuum Breaker Assembly (SVBA) used for the protection of the public water supply according to the provisions of IDAPA 58.01.08, "Idaho Rules for Public Drinking Water Systems," as administered by DEQ.
- b.** Backflow Prevention Device: an approved device such as an Atmospheric Vacuum Breaker (AVB), which does not contain valves or test ports, or a method, such as an air gap, that is utilized to prevent cross connections to a public water supply.
- c.** Calibration/Verification: the annual verification, calibration, or both of a backflow assembly field test kit by an instrument calibration laboratory/facility or by a person qualified to verify and calibrate a field test kit such as a manufacturer, dealer licensed to calibrate or verify field test kits, or calibration technician.
- d.** Customer: means the owner of the property or his/her authorized or appointed agent.
- e.** Field Test Kit: an instrument, either mechanical or electronic in design, and all related fittings, tools, equipment and appurtenances necessary to perform field verification tests on backflow prevention assemblies.

**3. Standards of Conduct**

- a.** Principle 1 -- A Backflow Assembly Tester shall act only within the scope of practice as set forth in the Board's laws and rules. A Backflow Assembly Tester must use due care and diligence in performing his/her duties.
- b.** Principle 2 -- When conducting inspections and field tests of backflow prevention assemblies, a Backflow Assembly Tester must use test procedures that comply with standard field test procedures.
- c.** Principle 3 -- The Backflow Assembly Tester shall observe or inspect existing installations of

backflow prevention assemblies to identify whether the assembly is properly installed and whether, in the opinion of the Backflow Assembly Tester, the assembly is adequate and appropriate for the degree of hazard posed to the Public Water System having jurisdiction over the assembly.

i. A Backflow Assembly Tester must report improperly installed assemblies to the customer and the Public Water System having jurisdiction over the backflow prevention assembly and also must note the discrepancy on the test report and submit the test report to the customer and the Public Water System having jurisdiction over the backflow prevention assembly.

ii. A Backflow Assembly Tester must note discrepancies regarding inadequate or inappropriate backflow prevention assemblies on the test report and submit the test report to the customer and the Public Water System having jurisdiction over the backflow prevention assembly.

d. Principle 4 -- A Backflow Assembly Tester shall use a properly working and calibrated field test kit that meets the requirements of the Pacific Northwest Section of the American Water Works Association Cross Connection Control Manual, Seventh Edition, November 2012. When requested by a Public Water System, a Backflow Assembly Tester shall submit the most recent calibration report that verifies the accuracy of the field kit. When requested by a Public Water System, a Backflow Assembly Tester shall submit proof of current licensure in Idaho as a Backflow Assembly Tester.

e. Principle 5 -- The Backflow Assembly Tester must competently use a field test kit, all tools, and other equipment and appurtenances necessary to inspect and field test backflow prevention assemblies, inspect air gaps and backflow prevention devices.

f. Principle 6 -- When a backflow prevention assembly passes a field test, the Backflow Assembly Tester shall submit within fifteen (15) business days of performing the field test a passing test report to the customer and the Public Water System having jurisdiction over the backflow prevention assembly.

g. Principle 7 -- When a backflow prevention assembly is defective or fails to pass the field test, the Backflow Assembly Tester shall submit immediately, if possible, but no later than within two (2) business days, a failing field test report to the customer and the Public Water System having jurisdiction over the backflow prevention assembly.

h. Principle 8 -- The Backflow Assembly Tester shall complete a test report for each backflow prevention assembly for which the Backflow Assembly Tester conducts a field test. A test report must be legible and contain all relevant and pertinent information pertaining to the field test including, at a minimum, the make, model, size, serial number, orientation, and test results for each test conducted.

i. A Backflow Assembly Tester shall record data and sign test reports only for backflow prevention assemblies for which the Backflow Assembly Tester has personally conducted the field test.

ii. A Backflow Assembly Tester shall not falsify the results of a backflow prevention assembly field test or inspection.

# IDAPA 24 – DIVISION OF OCCUPATIONAL AND PROFESSIONAL LICENSES

## 24.06.01 – RULES FOR THE LICENSURE OF OCCUPATIONAL THERAPISTS AND OCCUPATIONAL THERAPY ASSISTANTS

DOCKET NO. 24-0601-2000F (FEE RULE)

### NOTICE OF OMNIBUS RULEMAKING – ADOPTION OF TEMPORARY RULE

**EFFECTIVE DATE:** The effective date of the temporary rule being adopted through this omnibus rulemaking is the adjournment date of the second regular session of the 65th Idaho State Legislature - March 20, 2020.

**AUTHORITY:** In compliance with Sections 67-5226, Idaho Code, notice is hereby given this agency has adopted a temporary rule. The action is authorized pursuant to Section 54-3717, Idaho Code.

**DESCRIPTIVE SUMMARY:** The following is the required finding and concise statement of its supporting reasons for adopting a temporary rule:

This temporary rulemaking adopts the following chapter under IDAPA 24:

#### **IDAPA 24.06**

- 24.06.01, *Rules for the Licensure of Occupational Therapists and Occupational Therapy Assistants.*

**TEMPORARY RULE JUSTIFICATION:** Pursuant to Sections 67-5226(1) and 67-5226(2), Idaho Code, the Governor has found that temporary adoption of the rule is appropriate for the following reasons:

These temporary rules are necessary to protect the public health, safety, and welfare of the citizens of Idaho and confer a benefit on its citizens. These temporary rules implement the duly enacted laws of the state of Idaho, provide citizens with the detailed rules and standards for complying with those laws, and assist in the orderly execution and enforcement of those laws. The expiration of these rules without due consideration and processes would undermine the public health, safety, and welfare of the citizens of Idaho and deprive them of the benefit intended by these rules. The Occupational Therapy Licensure Board licenses individuals who meet a national education standards and qualifications to therapeutically use everyday life activities to help individuals or groups participate in roles and situations in home, school, the workplace, community, and other settings. These rules public health, safety, and welfare through ensuring those who work with vulnerable members of our society are ethical in their practice and possess and maintain the education and training to assess and treat people who need services in order to function in everyday life activities.

**FEE SUMMARY:** Pursuant to Section 67-5226(2), the Governor has found that the fees or charges being imposed or increased are justified and necessary to avoid immediate danger and the fees are described herein:

The fees or charges, authorized in Section 54-3712, Idaho Code, are part of the agency's 2021 budget that relies upon the existence of these fees or charges to meet the state's obligations and provide necessary state services. Failing to reauthorize these temporary rules would create immediate danger to the state budget, immediate danger to necessary state functions and services, and immediate danger of a violation of Idaho's constitutional requirement that it balance its budget.

The following is a specific description of the fees or charges:

FEE TYPE	AMOUNT (Not to Exceed)	RENEWAL FEE (Not to Exceed)
Initial Licensure for Occupational Therapists	\$80	\$40
Initial Licensure for Occupational Therapy Assistants	\$60	\$30
Limited Permit or Temporary License	\$25	

<b>FEE TYPE</b>	<b>AMOUNT (Not to Exceed)</b>	<b>RENEWAL FEE (Not to Exceed)</b>
Reinstatement Fee	As provided in Section 67-2614, Idaho Code	
Inactive License Renewal	\$20	
Inactive to Active License	The difference between the current inactive and active license renewal fees	

**ASSISTANCE ON TECHNICAL QUESTIONS:** For assistance on technical questions concerning the temporary rule, contact Rob McQuade at (208) 334-3233.

DATED this February 21, 2020.

Kelley Packer  
Division Administrator  
Division of Occupational and Professional Licenses  
700 W. State Street  
P.O. Box 83720  
Boise, ID 83720  
Phone: (208) 334-3233  
Fax: (208) 334-3945

## 24.06.01 – RULES FOR THE LICENSURE OF OCCUPATIONAL THERAPISTS AND OCCUPATIONAL THERAPY ASSISTANTS

### 000. LEGAL AUTHORITY.

Pursuant to Section 54-3717(2), Idaho Code, the Occupational Therapy Licensure Board of Idaho is authorized to promulgate rules that implement the provisions of Chapter 37, Title 54, Idaho Code. (3-20-20)T

### 001. TITLE AND SCOPE.

These rules are titled IDAPA 24.06.01, “Rules for the Licensure of Occupational Therapists and Occupational Therapy Assistants.” (3-20-20)T

### 002. -- 009. (RESERVED)

### 010. DEFINITIONS.

**01. Client-Related Tasks.** Client-related tasks are routine tasks during which the aide may interact with the client but does not act as a primary service provider of occupational therapy services. (3-20-20)T

**02. Direct Line-of-Sight Supervision.** Direct line-of-sight supervision requires the supervisor’s physical presence when services are being provided to clients by the individual under supervision. (3-20-20)T

**03. Direct Supervision.** Direct supervision requires daily, in-person contact by the supervisor at the site where services are provided to clients by the individual under supervision. (3-20-20)T

**04. Evaluation.** Evaluation is the process of obtaining and interpreting data necessary for treatment, which includes, but is not limited to, planning for and documenting the review, specific observation, interviewing, and administering data collection procedures, which include, but are not limited to, the use of standardized tests, performance checklists, and activities and tasks designed to evaluate specific performance abilities. (3-20-20)T

**05. General Supervision.** General Supervision requires in-person or synchronous interaction at least once per month by an occupational therapist and contact by other means as needed. Other means of contact include, but are not limited to, electronic communications such as email. (3-20-20)T

**06. Routine Supervision.** Routine Supervision requires in-person or synchronous interaction at least once every two (2) weeks by an occupational therapist and contact by other means as needed. Other means of contact include, but are not limited to, electronic communications such as email. (3-20-20)T

### 011. SUPERVISION.

An occupational therapist shall supervise and be responsible for the patient care given by occupational therapy assistants, limited permit holders, aides, and students. An occupational therapist’s or occupational therapy assistant’s failure to provide appropriate supervision in accordance with these rules is grounds for discipline. (3-20-20)T

**01. Occupational Therapy Assistants.** Occupational therapy assistants must be supervised by an occupational therapist. General Supervision must be provided at a minimum. (3-20-20)T

**02. Limited Permit Holders.** Limited permit holders must be supervised by an occupational therapist or occupational therapy assistant. Direct supervision must be provided at a minimum. The occupational therapist is responsible for the overall use and actions of the limited permit holder. (3-20-20)T

**03. Occupational Therapy Aides.** Occupational therapy aides do not provide skilled occupational therapy services. An aide must be trained by an occupational therapist or an occupational therapy assistant to perform specifically delegated tasks. The occupational therapist is responsible for the overall use and actions of the aide. The occupational therapist must oversee the development, documentation, and implementation of a plan to supervise and routinely assess the ability of the occupational therapy aide to carry out non-client related and client-related tasks. The occupational therapy assistant may contribute to the development and documentation of this plan. (3-20-20)T

**a.** The following factors must be present when an occupational therapist or occupational therapy assistant assigns a selected client-related task to the aide: (3-20-20)T

i. The outcome of the assigned task is predictable; (3-20-20)T

ii. The situation of the client and the environment is stable and will not require that judgment, interpretations, or adaptations be made by the aide; (3-20-20)T

- iii. The client has demonstrated some previous performance ability in executing the task; and (3-20-20)T
  - iv. The task routine and process have been clearly established. (3-20-20)T
  - b.** Before assigning client-related and non-client related tasks to an aide, the occupational therapist or occupational therapy assistant must ensure that the aide is able to competently perform the task. (3-20-20)T
  - c.** The occupational therapist or occupational therapy assistant must train the aide to perform client-related and non-client related tasks at least once per month. (3-20-20)T
  - d.** An aide must perform client-related tasks under the direct line-of-sight supervision of an occupational therapist or occupational therapy assistant. (3-20-20)T
  - e.** Occupational therapists and occupational therapy assistants must document all training and supervision of an aide. (3-20-20)T
- 04. Students.** Students must be under the direct on-site supervision of an occupational therapist or occupational therapy assistant who is appropriately supervised by an occupational therapist. The occupational therapist is responsible for the overall use and actions of the student. (3-20-20)T
- 05. Supervision Requirements.** Supervision is the direction and review of service delivery, treatment plans, and treatment outcomes. Unless otherwise specified in this rule, General Supervision is the minimum level of supervision that must be provided. Methods of supervision may include, but are not limited to, Direct Line-of-Sight Supervision, Direct Supervision, Routine Supervision, or General Supervision, as needed to ensure the safe and effective delivery of occupational therapy. (3-20-20)T
- a.** An occupational therapist and an occupational therapy assistant must ensure the delivery of services by the individual being supervised is appropriate for client care and safety and must evaluate: (3-20-20)T
    - i. The complexity of client needs; (3-20-20)T
    - ii. The number and diversity of clients; (3-20-20)T
    - iii. The skills of the occupational therapist assistant, aide, or limited permit holder; (3-20-20)T
    - iv. The type of practice setting; (3-20-20)T
    - v. The requirements of the practice setting; and (3-20-20)T
    - vi. Other regulatory requirements applicable to the practice setting or delivery of services. (3-20-20)T
  - b.** Supervision must be documented in a manner appropriate to the supervised position and the setting. The documentation must be kept as required by Section 013 of these rules. (3-20-20)T
  - c.** Supervision must include consultation at appropriate intervals regarding evaluation, intervention, progress, reevaluation and discharge planning for each patient. Consultation must be documented and signed by the supervisor and supervisee. (3-20-20)T

**012. DEEP THERMAL, ELECTROTHERAPEUTIC, MECHANICAL PHYSICAL AGENT MODALITIES, AND WOUND CARE.**

**01. Qualifications.** Except as provided in Subsection 012.02 of these rules, a person may not utilize occupational therapy techniques involving deep thermal, electrotherapeutic, or mechanical physical agent modalities or perform wound care management unless the person is licensed by the Board as an occupational therapist and certified by the Hand Therapy Commission. In lieu of being certified by the Hand Therapy Commission, the person



must have obtained education and training as follows. (3-20-20)T

**a.** If the person utilizes techniques involving deep thermal, electrotherapeutic, or mechanical physical agent modalities, the person must have successfully completed thirty (30) contact hours in the application of deep thermal, electrotherapeutic modalities, and mechanical physical agent modalities, along with forty (40) hours of supervised, on-the-job or clinical internship or affiliation training pertaining to such modalities. (3-20-20)T

**b.** If the person manages wound care, the person must have successfully completed fifteen (15) contact hours in wound care management, along with forty (40) hours of supervised, on-the-job or clinical internship or affiliation training pertaining to wound care management. (3-20-20)T

**c.** If the person utilizes both deep thermal, electrotherapeutic, or mechanical physical agent modalities and manages wound care, the forty (40) hours of supervised components may be obtained concurrently. (3-20-20)T

**02. Obtaining Education and Supervised Training.** A student occupational therapist, graduate occupational therapist, and an occupational therapist may utilize deep thermal, electrotherapeutic, or mechanical physical agent modalities or manage wound care while working towards obtaining the education and supervised training described in Section 012 of these rules. The supervisor must provide at least direct supervision to the student occupational therapist, and at least routine supervision to the graduate occupational therapist or occupational therapist. An occupational therapy assistant may apply deep thermal, electrotherapeutic, or mechanical physical agent modalities under routine supervision if the occupational therapy assistant has obtained the education and training described in this section. Otherwise, the occupational therapy assistant must work under direct line-of-sight supervision while applying such modalities. (3-20-20)T

**03. Supervised Training by Qualified Individual.** The supervised training described in Section 012 of these rules must be provided by an occupational therapist who is qualified pursuant to Subsection 012.01, or by another type of licensed health care practitioner whose education, training, and scope of practice enable the practitioner to competently supervise the person as to the modalities utilized and wound care management provided. (3-20-20)T

**013. RECORD KEEPING.**

Occupational therapists and occupational therapy assistants must maintain adequate records that are consistent with the standard business practices of the setting in which the licensee is providing occupational therapy or supervision and that show necessary client care, supervision provided by the licensee, and compliance with regulatory requirements applicable to the setting. (3-20-20)T

**014. -- 019. (RESERVED)**

**020. GENERAL QUALIFICATIONS FOR LICENSURE.**

**01. Applicant.** The Board may refuse licensure if it finds the applicant has engaged in conduct prohibited by Section 54-3718, Idaho Code; provided, the Board shall take into consideration the rehabilitation of the applicant and other mitigating circumstances. (3-20-20)T

**02. Education.** Each applicant shall provide evidence of successful completion of the academic requirements of an educational program in occupational therapy that is accredited by the American Occupational Therapy Association's Accreditation Council for Occupational Therapy Education (ACOTE), or by a predecessor or successor organization recognized by the United States Secretary of Education, the Council for Higher Education Accreditation, or both. (3-20-20)T

**03. Examination.** Each applicant shall either pass an examination required by the Board or shall be entitled to apply for licensure by endorsement or limited permit. (3-20-20)T

**a.** The written examination shall be the examination conducted by the National Board for Certification in Occupational Therapy, Inc. (NBCOT) and the passing score shall be the passing score established by the NBCOT. (3-20-20)T

b. An applicant for licensure by examination who fails to pass the examination on two (2) attempts must submit a new application. (3-20-20)T

**021. APPLICATION FOR LICENSURE.**

**01. Licensure by Endorsement.** An applicant may be eligible for licensure without examination if he or she meets all of the other qualifications prescribed in Section 54-3709, Idaho Code, and also holds a current valid license or registration from some other state, territory or district of the United States, or certified by the National Board for Certification in Occupational Therapy providing they meet Idaho standards and are equivalent to the requirements for licensure pursuant to these rules. (3-20-20)T

**02. Limited Permit.** The Board may issue a Limited Permit to a graduate occupational therapist or graduate occupational therapy assistant who meets the requirements set forth by Sections 54-3706(1) and 54-3706(2), Idaho Code, who has not yet passed the examination as required in Paragraph 020.04.a. of these rules. (3-20-20)T

a. A Limited Permit shall only allow a person to practice occupational therapy in association with and under the supervision of a licensed occupational therapist. (3-20-20)T

b. A Limited Permit shall be valid six (6) months from the date of issue. (3-20-20)T

c. A Limited Permit may be extended by the Board for good cause. (3-20-20)T

**04. Temporary License.** The Board may issue a temporary license to a person applying for licensure as an occupational therapist or an occupational therapy assistant if the person is currently licensed and in good standing to practice in another jurisdiction and meets that jurisdiction's requirements for licensure by endorsement. (3-20-20)T

a. A temporary license shall automatically expire once the Board has processed the person's application for licensure and issued or denied the applied-for license, or in six (6) months after the date on which the Board issued the temporary license, whichever is sooner. (3-20-20)T

**05. Personal Interview.** The Board may, at its discretion, require the applicant to appear for a personal interview. (3-20-20)T

**022. WRITTEN STATEMENT OF SUITABILITY FOR LICENSURE.**

An applicant who, or whose license, has a criminal conviction, finding of guilt, withheld judgment, or suspended sentence for any crime under any municipal, state, or federal law other than minor traffic offenses, or has been subject to discipline by any state professional regulatory agency or professional organization must submit with the application a written statement and any supplemental information establishing the applicant's current suitability for licensure. (3-20-20)T

**01. Consideration of Factors and Evidence.** The Board shall consider the following factors or evidence: (3-20-20)T

a. The severity or nature of the crime or discipline; (3-20-20)T

b. The period of time that has passed since the crime or discipline under review; (3-20-20)T

c. The number or pattern of crimes or discipline or other similar incidents; (3-20-20)T

d. The circumstances surrounding the crime or discipline that would help determine the risk of repetition; (3-20-20)T

e. The relationship of the crime or discipline to the practice of occupational therapy; (3-20-20)T

f. The applicant's activities since the crime or discipline under review, such as employment, education, participation in treatment, payment of restitution, or any other factors that may be evidence of current

rehabilitation; and (3-20-20)T

**g.** Any other information regarding rehabilitation or mitigating circumstances. (3-20-20)T

**02.** **Interview.** The Board may, at its discretion, grant an interview of the applicant. (3-20-20)T

**03.** **Applicant Bears the Burden.** The applicant shall bear the burden of establishing the applicant's current suitability for licensure. (3-20-20)T

**023. -- 024. (RESERVED)**

**025. CONTINUING EDUCATION.**

In order to protect public health and safety and promote the public welfare, the Board has adopted the following continuing education requirement of all licensees: (3-20-20)T

**01. Requirement.** Each licensee shall successfully complete, in the twelve (12) months preceding license renewal, a minimum of ten (10) contact hours of continuing education, as approved by the Board. (3-20-20)T

**a.** One (1) contact hour is equivalent to one (1) clock hour for the purpose of obtaining continuing education. (3-20-20)T

**b.** The Board shall waive the continuing education requirement for the first license renewal after initial licensure. (3-20-20)T

**02. Attestation.** The licensee must attest, as part of the annual license renewal process, that the licensee is in compliance with the continuing education requirement. (3-20-20)T

**03. Courses and Activities.** At least five (5) contact hours must directly relate to the delivery of occupational therapy services. The remaining contact hours must be germane to the practice of occupational therapy and relate to other areas of a licensee's practice. A licensee may take online or home study courses or self-competency assessments, as long as a course completion certificate is provided. (3-20-20)T

**a.** The delivery of occupational therapy services may include: models, theories or frameworks that relate to client care in preventing or minimizing impairment, enabling function within the person/environment or community context. (3-20-20)T

**b.** Other areas may include, but are not limited to, occupation based theory assessment/interview techniques, intervention strategies, and community/environment as related to the licensee's practice. (3-20-20)T

**c.** Continuing education acceptable to the Board includes, but is not limited to, programs or activities sponsored by the American Occupational Therapy Association (AOTA), the Idaho Occupational Therapy Association (IOTA), or National Board for Certification in Occupational Therapy (NBCOT); post-professional coursework completed through any approved or accredited educational institution; or otherwise meet all of the following criteria: (3-20-20)T

**i.** The program or activity contributes directly to professional knowledge, skill, and ability; (3-20-20)T

**ii.** The program or activity relates directly to the practice of occupational therapy; and (3-20-20)T

**iii.** The program or activity must be objectively measurable in terms of the hours involved. (3-20-20)T

**04. Carry Over and Duplication.** A maximum of ten (10) continuing education hours may be carried forward from the immediately preceding year, and may not be carried forward more than one renewal year. If the licensee completes two (2) or more courses having substantially the same content during any one (1) renewal period, the licensee only will receive continuing education credit for one (1) of the courses. (3-20-20)T

**05. Documentation.** A licensee need not submit documentation of continuing education when the licensee renews a license. However, a licensee must maintain documentation verifying that the licensee has completed the continuing education requirement for a period of four (4) years from the date of completion. A licensee must submit the verification documentation to the Board if the licensee is audited by the Board. A percentage of occupational therapists and certified occupational therapy assistants will be audited every year. Documentation for all activities must include licensee's name, date of activity or when course was completed, provider name, course title, description of course/activity, and number of contact hours. (3-20-20)T

**a.** Continuing education course work. The required documentation for this activity is a certificate or documentation of attendance. (3-20-20)T

**b.** In-service training. The required documentation for this activity is a certificate or documentation of attendance. (3-20-20)T

**c.** Professional conference or workshop. The required documentation for this activity is a certificate or documentation of attendance. (3-20-20)T

**d.** Course work offered by an accredited college or university, provided that the course work is taken after the licensee has obtained a degree in occupational therapy, and the course work provides skills and knowledge beyond entry-level skills or knowledge. The required documentation for this activity is a transcript. (3-20-20)T

**e.** Publications. The required documentation for this activity is a copy of the publication. (3-20-20)T

**f.** Presentations. The required documentation for this activity is a copy of the presentation or program listing. Any particular presentation may be reported only once per reporting period. (3-20-20)T

**g.** Interactive online courses and evidence-based competency assessments. The required documentation for this activity is a certificate or documentation of completion. (3-20-20)T

**h.** Development of instructional materials incorporating alternative media such as video, audio and/or software programs to advance professional skills of others. The required documentation for this activity is a program description. The media/software materials must be available if requested during audit process. (3-20-20)T

**i.** Professional manuscript review. The required documentation for this activity is a letter from the publishing organization verifying review of manuscript. A maximum of five (5) hours is allowed per renewal period for this category. (3-20-20)T

**j.** Guest lecturer for occupational therapy related academic course work (academia not primary role). The required documentation for this activity is a letter or other documentation from instructor. (3-20-20)T

**k.** Serving on a professional board, committee, disciplinary panel, or association. The required documentation for this activity is a letter or other documentation from the organization. A maximum of five (5) hours is allowed per renewal period for this category. (3-20-20)T

**l.** Level II fieldwork direct supervision of an occupational therapy student or occupational therapy assistant student by site designated supervisor(s). The required documentation for this activity is the name of student(s), letter of verification from school, and dates of fieldwork. (3-20-20)T

**06. Exemptions.** A licensee may request an exemption from the continuing education requirement for a particular renewal period for reasonable cause. The licensee must provide any information requested by the Board to assist in substantiating the licensee's need for a claimed exemption: (3-20-20)T

**026. -- 029. (RESERVED)**

**030. INACTIVE STATUS.**

**01. Request for Inactive Status.** Occupational Therapists and Occupational Therapy Assistants requesting an inactive status during the renewal of their active license must submit a written request and pay the established fee. (3-20-20)T

**02. Inactive License Status.** (3-20-20)T

**a.** Licensees may not practice in Idaho while on inactive status. (3-20-20)T

**b.** All continuing education requirements will be waived for any year or portion thereof that a licensee maintains an inactive license and is not actively practicing or supervising in Idaho, subject to Subsection 030.03 of these rules. (3-20-20)T

**03. Reinstatement to Full Licensure from Inactive Status.** (3-20-20)T

**a.** Return to Active Status of License - Inactive for Five (5) or Fewer Years. An inactive license holder whose license has been inactive for five (5) or fewer years may convert from inactive to active license status by: (3-20-20)T

**i.** Providing documentation to the Board showing successful completion within the previous twelve (12) months of the continuing education requirements for renewal of an active license; and (3-20-20)T

**ii.** Paying a fee equivalent to the difference between the current inactive fee and the active renewal fee. (3-20-20)T

**b.** Return to Active Status of License - Inactive for Greater than Five (5) Years. An inactive license holder whose license has been inactive for greater than five (5) years may convert from inactive to active license status by: (3-20-20)T

**i.** Providing documentation to the Board showing successful completion within the previous twelve (12) months of the continuing education requirements for renewal of an active license; and (3-20-20)T

**ii.** Providing proof that the licensee has actively engaged in the practice of occupational therapy in another state or territory of the United States for at least three (3) of the immediately preceding five (5) years, or provide proof that the licensee is competent to practice in Idaho. (3-20-20)T

**iii.** The Board may consider the following factors when determining proof of competency: (3-20-20)T

(1) Number of years of practice prior to transfer from active status; (3-20-20)T

(2) Employment in a field similar to occupational therapy; and (3-20-20)T

(3) Any other factors the Board deems appropriate. (3-20-20)T

**031. (RESERVED)**

**032. DENIAL OR REFUSAL TO RENEW, SUSPENSION OR REVOCATION OF LICENSE.**

**01. Disciplinary Authority.** A new application may be denied or renewal refused, and every person licensed pursuant to Title 54, Chapter 37, Idaho Code and these rules is subject to discipline, pursuant to the procedures and powers established by and set forth in Section 54-3718, Idaho Code, IDAPA 04.11.01, "Idaho Rules of Administrative Procedure of the Attorney General," and the Administrative Procedure Act, Title 67, Chapter 52, Idaho Code. (3-20-20)T

**02. Grounds for Discipline.** In addition to the grounds set forth in Section 54-3718, Idaho Code, applicants may be denied or refused licensure and licensees are subject to discipline upon the following grounds, including but not limited to: (3-20-20)T

- a. Obtaining a license by means of fraud, misrepresentation, or concealment of material facts; (3-20-20)T
- b. Being guilty of unprofessional conduct or violating the Code of Ethics in Appendix A, incorporated herein by reference governing said licensees, including the provision of health care which fails to meet the standard of health care provided by other qualified licensees in the same community or similar communities, taking into account the licensee’s training, experience and the degree of expertise to which he holds himself out to the public; (3-20-20)T
- c. The unauthorized practice of medicine; (3-20-20)T
- d. Failure to properly supervise persons as required in these rules. (3-20-20)T

**03. Penalties.** In addition to any other disciplinary sanctions the Board may impose against a licensee, the Board may impose a fine of up to one thousand dollars (\$1,000) per violation, or in such greater amount as the Board may deem necessary to deprive the licensee of any economic advantage gained by the licensee through the conduct that resulted in discipline and that reimburses the Board for costs of the investigation and disciplinary proceedings. (3-20-20)T

**033. -- 040. (RESERVED)**

**041. FEES.**

FEE TYPE	AMOUNT (Not to Exceed)	RENEWAL FEE (Not to Exceed)
Initial Licensure for Occupational Therapists	\$80	\$40
Initial Licensure for Occupational Therapy Assistants	\$60	\$30
Limited Permit or Temporary License	\$25	
Reinstatement Fee	As provided in Section 67-2614, Idaho Code.	
Inactive License Renewal	\$20	
Inactive to Active License	The difference between the current inactive and active license renewal fees	

(3-20-20)T

**042. STANDARDS OF PRACTICE FOR TELEHEALTH**

**01. Determining Type of Evaluation.** In making the determination whether an in-person evaluation or intervention are necessary, an occupational therapist shall consider at a minimum: (3-20-20)T

- a. The complexity of the client's condition; (3-20-20)T
- b. His or her own knowledge, skills and abilities; (3-20-20)T
- c. The client's context and environment; (3-20-20)T
- d. The nature and complexity of the intervention; (3-20-20)T
- e. The pragmatic requirements of the practice setting; and (3-20-20)T

f. The capacity and quality of the technological interface. (3-20-20)T

**02. Supervision of Occupational Therapy Assistant.** Supervision of Occupational Therapy Assistant under 24.06.01.011 for routine and general supervision, can be done through telehealth, but cannot be done when direct or direct line-of-sight is determined by the supervising occupational therapist. The same considerations in (1)(a) through (f) must be considered in determining whether telehealth should be used. (3-20-20)T

**043. -- 999. (RESERVED)**

**APPENDIX A**  
**OCCUPATIONAL THERAPY CODE OF ETHICS**  
**PREAMBLE**

All Occupational Therapists, Occupational Therapy Assistants, and Limited Permit Holders (collectively, “occupational therapy personnel”) are responsible for maintaining and promoting the ethical practice of occupational therapy. Occupational therapy personnel shall act in the best interest of the patient/client at every level of practice. This Code of Ethics, modeled in principle and the spirit of the Code of Ethics of the American Occupational Therapy Association, sets forth principals for the ethical practice of occupational therapy for occupational therapy personnel. This Code of Ethics shall be binding on all occupational therapy personnel.

**Principle 1.**

Occupational therapy personnel shall demonstrate, a concern for the well-being of the recipients of their services. (beneficence).

**Principle 2.**

Occupational therapy personnel shall take reasonable precautions to avoid imposing or inflicting harm upon the recipient of services or to his or her property. (nonmaleficence)

**Principle 3.**

Occupational therapy personnel shall respect the recipient and/or their surrogate(s) as well as the recipient's rights. (autonomy, privacy, confidentiality)

**Principle 4.**

Occupational therapy personnel shall achieve and continually maintain high standards of competence. (duties)

**Principle 5.**

Occupational therapy personnel shall comply with laws and policies guiding the profession of occupational therapy. (justice)

**Principle 6.**

Occupational therapy personnel shall provide accurate information about occupational therapy services. (veracity)

**Principle 7.**

Occupational therapy personnel shall treat colleagues and other professionals with fairness, discretion, and integrity. (fidelity)

**IDAPA 24 – DIVISION OF OCCUPATIONAL AND PROFESSIONAL LICENSES**

**24.07.01 – RULES OF THE IDAHO STATE BOARD OF LANDSCAPE ARCHITECTS**

**DOCKET NO. 24-0701-2000F (FEE RULE)**

**NOTICE OF OMNIBUS RULEMAKING – ADOPTION OF TEMPORARY RULE**

**EFFECTIVE DATE:** The effective date of the temporary rule being adopted through this omnibus rulemaking is the adjournment date of the second regular session of the 65th Idaho State Legislature - March 20, 2020.

**AUTHORITY:** In compliance with Sections 67-5226, Idaho Code, notice is hereby given this agency has adopted a temporary rule. The action is authorized pursuant to Section 54-3003, Idaho Code.

**DESCRIPTIVE SUMMARY:** The following is the required finding and concise statement of its supporting reasons for adopting a temporary rule:

This temporary rulemaking adopts the following chapter under IDAPA 24:

**IDAPA 24.07**

- 24.07.01, *Rules of the Idaho State Board of Landscape Architects.*

**TEMPORARY RULE JUSTIFICATION:** Pursuant to Sections 67-5226(1) and 67-5226(2), Idaho Code, the Governor has found that temporary adoption of the rule is appropriate for the following reasons:

These temporary rules are necessary to protect the public health, safety, and welfare of the citizens of Idaho and confer a benefit on its citizens. These temporary rules implement the duly enacted laws of the state of Idaho, provide citizens with the detailed rules and standards for complying with those laws, and assist in the orderly execution and enforcement of those laws. The expiration of these rules without due consideration and processes would undermine the public health, safety, and welfare of the citizens of Idaho and deprive them of the benefit intended by these rules. These rules govern the qualifications to practice landscape architecture and ensure that an individual has demonstrated the knowledge, skills, and abilities to practice landscape architecture without endangering the health, safety or welfare of the public.

**FEE SUMMARY:** Pursuant to Section 67-5226(2), the Governor has found that the fees or charges being imposed or increased are justified and necessary to avoid immediate danger and the fees are described herein:

The fees or charges, authorized in Section 54-3003, Idaho Code, are part of the agency’s 2021 budget that relies upon the existence of these fees or charges to meet the state’s obligations and provide necessary state services. Failing to reauthorize these temporary rules would create immediate danger to the state budget, immediate danger to necessary state functions and services, and immediate danger of a violation of Idaho’s constitutional requirement that it balance its budget.

The following is a specific description of the fees or charges:

<b>FEE TYPE</b>	<b>AMOUNT (Not to Exceed)</b>
Application	\$75
Landscape Architect-in-training Application	\$25
Examination	As established by CLARB
Original License and Annual Renewal	\$125
Reinstatement	As provided in Section 67-2614, Idaho Code



**ASSISTANCE ON TECHNICAL QUESTIONS:** For assistance on technical questions concerning the temporary rule, contact Rob McQuade at (208) 334-3233.

DATED this February 21, 2020.

Kelley Packer  
Division Administrator  
Division of Occupational and Professional Licenses  
700 W. State Street  
P.O. Box 83720  
Boise, ID 83720  
Phone: (208) 334-3233  
Fax: (208) 334-3945

## 24.07.01 – RULES OF THE IDAHO STATE BOARD OF LANDSCAPE ARCHITECTS

### 000. LEGAL AUTHORITY (RULE 0).

In accordance with Section 54-3003, Idaho Code, the Idaho State Board of Landscape Architects promulgates these rules which implement the provisions of Chapter 30, Title 54, Idaho Code. (3-20-20)T

### 001. TITLE AND SCOPE (RULE 1).

These rules are titled IDAPA 24.07.01, “Rules of the Idaho State Board of Landscape Architects.” (3-20-20)T

### 002. INCORPORATION BY REFERENCE (RULE 4).

The document titled the Council of Landscape Architectural Registration Boards (CLARB) Model Rules of Professional Conduct as amended February 2007, referenced in Subsection 425, is herein incorporated by reference. (3-20-20)T

### 003. ADDRESS OF IDAHO BOARD OF LANDSCAPE ARCHITECTS (RULE 5).

The office of the Board of Landscape Architects is located within the Division of Occupational and Professional Licenses, 700 W. State Street, Boise, Idaho 83702. The Division is open between the hours of 8:00 a.m. and 5:00 p.m. each day except Saturdays, Sundays and holidays. The phone number of the Board is (208) 334-3233. The Board's fax number is (208) 334-3945. The Board's e-mail address is [lar@ibol.idaho.gov](mailto:lar@ibol.idaho.gov). The Board's official website is <http://www.ibol.idaho.gov>. (3-20-20)T

### 004. -- 100. (RESERVED)

### 101. APPROVED EDUCATION (RULE 101).

An approved college or school of landscape architecture shall have a landscape architecture program accredited by the Landscape Architectural Accreditation Board (LAAB), or shall substantially meet the accrediting standards of the LAAB as may be determined by the Board. (3-20-20)T

### 102. PRACTICAL EXPERIENCE IN LIEU OF EDUCATION (RULE 102).

An applicant shall document at least eight (8) years of actual practical experience in landscape architecture in lieu of graduation from an approved college or school of landscape architecture. Such experience shall establish the applicant's education in those subjects and areas contained in the curriculum of an approved college or school of landscape architecture. No less than fifty percent (50%) of such practical experience shall be under the supervision of a licensed landscape architect. (3-20-20)T

### 103. -- 199. (RESERVED)

### 200. APPLICATION (RULE 200).

Each applicant for licensure shall submit a complete application together with the required fees to the Board. An application shall be made on the uniform application form adopted by the Board and furnished to the applicant by the Division. An application shall not be reviewed by the Board until all required information is furnished and the required fees paid. (3-20-20)T

### 201. APPLICATION FORM (RULE 201).

**01. Reference Requirements.** Applicants are required to furnish the Board with four (4) references. Two (2) of the references must be from currently licensed Landscape Architects. The remaining two (2) may be licensed landscape architects, licensed engineers, licensed architects, or any combination thereof. All references must be from competent individuals who are well acquainted with the applicant's character and professional ability. (3-20-20)T

**02. Materials Submitted to Board.** All required applications, statements, fees and other documentation must be submitted to the Board in care of the Division of Occupational and Professional Licenses, and shall include: (3-20-20)T

a. Documentation of being at least eighteen (18) years of age at the time of application; and (3-20-20)T

b. Either certification of graduation from an approved college or school of landscape architecture; or (3-20-20)T

c. Documentation of all actual landscape architectural or other applicable experience signed by the person under whose supervision the work was performed, giving kind and type of work done, together with dates of

employment; and (3-20-20)T

**d.** Proof of successful passage of an examination approved by the Board. (3-20-20)T

**03. Deadlines.** To be considered by the Board, completed applications must be received by the Division prior to the next scheduled meeting of the Board. (3-20-20)T

**04. Inactive Applications.** Applications on file with the Board where an applicant has failed to respond to a Board request or where the applications have lacked activity for twelve (12) consecutive months shall be deemed denied and shall be terminated upon thirty (30) days written notice unless good cause is established to the Board. (3-20-20)T

**202. -- 249. (RESERVED)**

**250. LANDSCAPE ARCHITECT-IN-TRAINING (RULE 250).**

An individual may represent themselves as a landscape architect-in-training only under the following conditions: (3-20-20)T

**01. Qualifications.** Any person who is at least eighteen (18) years of age and has graduated from an approved college or school of landscape architecture, or who documents at least eight (8) years of actual practical experience in landscape architecture approved by the Board. (3-20-20)T

**02. Supervision.** Each landscape architect-in-training shall be employed by and work under the direct supervision of an Idaho licensed landscape architect. Any change in supervision shall require a new application and registration. (3-20-20)T

**03. Prohibitions.** A landscape architect-in-training shall not sign or seal any plan, specification, or other document, and shall not engage in the practice of landscape architecture except under the direct supervision of an Idaho licensed landscape architect. (3-20-20)T

**04. Registration.** Each landscape architect-in-training shall register with the Board on forms provided by the Division of Occupational and Professional Licenses that shall include the application fee and the names and addresses of their employer, and supervisor. (3-20-20)T

**05. Termination.** A registration for a landscape architect-in-training shall not exceed a total of six (6) years. (3-20-20)T

**251. -- 299. (RESERVED)**

**300. EXAMINATIONS (RULE 300).**

The examination prepared by the Council of Landscape Architectural Registration Boards is an approved examination. The Board may approve other examinations it deems appropriate. (3-20-20)T

**01. Minimum Passing Score.** The minimum passing score for each section of the examination shall be the score as determined by the examination provider. (3-20-20)T

**02. Failing a Section of Exam.** An applicant failing any section of the examination will be required to retake only that section failed. (3-20-20)T

**301. (RESERVED)**

**302. ENDORSEMENT (RULE 302).**

The Board may approve the registration and licensure of an applicant who holds a current license in another state and who has successfully passed the Landscape Architect Registration Examination as required by Section 300 or holds a current Council of Landscape Architectural Registration Boards certificate. (3-20-20)T

**303. -- 399. (RESERVED)**

**400. FEES (RULE 400).**  
Fees are not refundable.

<b>FEE</b>	<b>AMOUNT (Not to Exceed)</b>
Application	\$75
Landscape Architect-in-training Application	\$25
Examination	As established by CLARB
Original License and Annual Renewal	\$125
Reinstatement	As provided in Section 67-2614, Idaho Code

(3-20-20)T

**401. -- 424. (RESERVED)**

**425. RULES OF PROFESSIONAL RESPONSIBILITY (RULE 425).**

**01. Rules of Professional Responsibility.** Pursuant to Section 004 of these rules, the CLARB model rules of professional conduct, as incorporated, are the Rules of Professional Responsibility for all Idaho licensed landscape architects. (3-20-20)T

**02. Violation of the Rules of Professional Responsibility.** The Board will take action against a licensee under Section 54-3004(5), Idaho Code, who is found in violation of the Rules of Professional Responsibility. (3-20-20)T

**426. -- 449. (RESERVED)**

**450. DISCIPLINE (RULE 450).**

**01. Civil Fine.** The Board may impose a civil fine not to exceed one thousand dollars (\$1,000) upon a licensed landscape architect for each violation of Section 54-3004, Idaho Code. (3-20-20)T

**02. Costs and Fees.** The Board may order a licensed landscape architect to pay the costs and fees incurred by the Board in the investigation or prosecution of the licensee for violation of Section 54-3004, Idaho Code. (3-20-20)T

**451. -- 499. (RESERVED)**

**500. MEETINGS (RULE 500).**

Board meetings will be held at least twice yearly and at such other times as the Board deems necessary. (3-20-20)T

**501. -- 999. (RESERVED)**

# IDAPA 24 – DIVISION OF OCCUPATIONAL AND PROFESSIONAL LICENSES

## 24.08.01 – RULES OF THE STATE BOARD OF MORTICIANS

### DOCKET NO. 24-0801-2000F (FEE RULE)

#### NOTICE OF OMNIBUS RULEMAKING – ADOPTION OF TEMPORARY RULE

**EFFECTIVE DATE:** The effective date of the temporary rule being adopted through this omnibus rulemaking is the adjournment date of the second regular session of the 65th Idaho State Legislature - March 20, 2020.

**AUTHORITY:** In compliance with Sections 67-5226, Idaho Code, notice is hereby given this agency has adopted a temporary rule. The action is authorized pursuant to Sections 54-1106 and 54-1107, Idaho Code.

**DESCRIPTIVE SUMMARY:** The following is the required finding and concise statement of its supporting reasons for adopting a temporary rule:

This temporary rule adopts the following chapter under IDAPA 24:

#### **IDAPA 24.08**

- 24.08.01, *Rules of the State Board of Morticians.*

**TEMPORARY RULE JUSTIFICATION:** Pursuant to Sections 67-5226(1) and 67-5226(2), Idaho Code, the Governor has found that temporary adoption of the rule is appropriate for the following reasons:

These temporary rules are necessary to protect the public health, safety, and welfare of the citizens of Idaho and confer a benefit on its citizens. These temporary rules implement the duly enacted laws of the state of Idaho, provide citizens with the detailed rules and standards for complying with those laws, and assist in the orderly execution and enforcement of those laws. The expiration of these rules without due consideration and processes would undermine the public health, safety, and welfare of the citizens of Idaho and deprive them of the benefit intended by these rules. The State Board of Morticians is charged with the duty to regulate, license, and supervise funeral homes, crematories, Morticians, and Funeral Directors in the State of Idaho. The Board's primary responsibility is to protect public health, safety, and welfare through licensure and enforcement of Idaho law. Failure to renew these rules would harm public health and safety through eliminating requirements of licensees and licensed facilities to safely, compassionately, and ethically prepare and make final disposition of the deceased.

**FEE SUMMARY:** Pursuant to Section 67-5226(2), the Governor has found that the fees or charges being imposed or increased are justified and necessary to avoid immediate danger and the fees are described herein:

The fees or charges, authorized in Section 54-1115, Idaho Code, are part of the agency's 2021 budget that relies upon the existence of these fees or charges to meet the state's obligations and provide necessary state services. Failing to reauthorize these temporary rules would create immediate danger to the state budget, immediate danger to necessary state functions and services, and immediate danger of a violation of Idaho's constitutional requirement that it balance its budget.

The following is a specific description of the fees or charges:

<b>FEE TYPE</b>	<b>AMOUNT (Not to Exceed)</b>
Funeral Director	\$85
Funeral Establishment	\$125
Crematory Establishment	\$200
Mortician	\$85
Inactive License	\$40

<b>FEE TYPE</b>	<b>AMOUNT (Not to Exceed)</b>
Resident Trainee	\$50
Application Fee	\$100
Certificate of Authority	\$50

**ASSISTANCE ON TECHNICAL QUESTIONS:** For assistance on technical questions concerning the temporary rule, contact Rob McQuade at (208) 334-3233.

DATED this February 21, 2020.

Kelley Packer  
Division Administrator  
Division of Occupational and Professional Licenses  
700 W. State Street  
P.O. Box 83720  
Boise, ID 83720  
Phone: (208) 334-3233  
Fax: (208) 334-3945

## 24.08.01 – RULES OF THE STATE BOARD OF MORTICIANS

### 000. LEGAL AUTHORITY.

The following rules have been adopted by the Idaho State Board of Morticians and the Chief, Division of Occupational and Professional Licenses in accordance with the provisions of Section 54-1106 and 54-1107, Idaho Code. (3-20-20)T

### 001. TITLE AND SCOPE.

These rules are titled IDAPA 24.08.01, “Rules of the State Board of Morticians.” (3-20-20)T

### 002. -- 099. (RESERVED)

### 100. MEETINGS.

The board shall hold meetings no less than annually at such times and places as determined by the board. The annual election of chairman will be held during the first meeting of each fiscal year. The chairman of the board shall preside at all meetings, appoint all committees, and perform all the functions incidental to the office of chairman. (3-20-20)T

### 101. -- 149. (RESERVED)

### 150. TIME OF EXAMINATIONS.

Examinations will be held no less than semi-annually at such times or places as the Board may determine. (3-20-20)T

### 151. -- 199. (RESERVED)

### 200. APPLICATION.

Application must be postmarked sixty (60) days prior to the date of examination. (3-20-20)T

**01. Lack of Activity.** If an applicant fails to respond to a Board request or an application has lacked activity for twelve (12) consecutive months, the application on file with the Board will be deemed denied and will be terminated upon a thirty (30) day written notice, unless good cause is demonstrated to the Board. (3-20-20)T

### 201. -- 249. (RESERVED)

### 250. RESIDENT TRAINEE.

A Resident Trainee is a person who is licensed to train, under the direct and immediate supervision of a sponsoring mortician, to become a licensed mortician or funeral director. (3-20-20)T

#### **01. Training Requirements.** (3-20-20)T

**a.** Training requires the Resident Trainee’s diligent attention to the subject matter in the course of regular and full-time paid employment. Full-time employment requires that the Resident Trainee be employed for at least thirty-six (36) hours per week for fifty (50) weeks per year within the mortuary where the Resident Trainee’s sponsoring mortician is the practicing, resident mortician. (3-20-20)T

**i.** At least three-fourths (3/4) of the Resident Trainee’s training must consist of the sponsoring mortician instructing and demonstrating practices and procedures to increase the Resident Trainee’s knowledge of the service performed by a mortician or a funeral director as defined in Chapter 11, Title 54, Idaho Code. (3-20-20)T

**ii.** For the balance of the required hours, the sponsoring mortician, or his licensed appointee, must be immediately available to consult with the Resident Trainee. (3-20-20)T

**b.** All training must occur within Idaho. (3-20-20)T

**c.** A Resident Trainee shall not sign a death certificate. (3-20-20)T

#### **02. Sponsoring Mortician.** A sponsoring mortician must: (3-20-20)T

**a.** Be an Idaho-licensed mortician who practices as a full-time resident mortician in Idaho. (3-20-20)T

**b.** Not serve as the sponsoring mortician for more than two (2) “Resident Trainees at any given time.” (3-20-20)T

**c.** Supervise and instruct the Resident Trainee, and provide demonstrations for and consultations to the Resident Trainee, as described in Subsection 250.01, of this rule. (3-20-20)T

**d.** Complete and co-sign, with the Resident Trainee, quarterly and final reports. These reports must be completed on forms approved by the Board and document the information described in Subparagraphs 250.04.c. and 250.04.d., of this rule. The sponsoring mortician must promptly submit a report after the period of time covered by the report ends. For example, the sponsoring mortician must promptly submit the first quarter report after the first quarter ends, the second quarter report after the second quarter ends, etc. (3-20-20)T

**e.** Promptly notify the Board in writing if a Resident Trainee's training is terminated, including termination due to interruption as specified in Subsection 250.05, of this rule and submit a final report documenting training up to the termination date. (3-20-20)T

**03. Eligibility to Be Licensed.** A person may not be licensed as a "Resident Trainee" if the person has practiced as a Resident Trainee or apprentice for a total cumulative period of more than three (3) years in Idaho, unless approved by the Board for good cause. For purposes of accounting for total cumulative training as a Resident Trainee, the sponsoring mortician must notify the Division at the beginning and termination of the training period. When a Resident Trainee completes training, the Resident Trainee must complete the remaining qualifications for licensure as a mortician or funeral director within the following three (3) years or show good reason for further delay. (3-20-20)T

**04. Resident Trainee Applicants to Qualify.** (3-20-20)T

**a.** An applicant for a Resident Trainee license must apply on Board-approved forms and pay the appropriate fee. The applicant must: (3-20-20)T

i. Be at least eighteen (18) years of age; (3-20-20)T

ii. Be of good moral character; (3-20-20)T

iii. Have graduated from an accredited high school or have received an equivalent education as determined by the standards set and established by the state board of education; (3-20-20)T

iv. Identify the sponsoring mortician and the funeral establishment in which the applicant will train. The applicant must promptly notify the Board in writing if this information changes during the training period. (3-20-20)T

**b.** The effective date of the resident training shall be determined by the board at its next meeting. In no case shall it be prior to the date the application, together with the required fees, are received in the office of the Division. (3-20-20)T

**c.** Resident Trainees pursuing a mortician license must complete and co-sign, with the sponsoring mortician, quarterly and final reports documenting that the applicant has assisted in embalming at least twenty-five (25) dead human bodies and assisted in making at least twenty-five (25) funeral arrangements and in conducting at least twenty-five (25) funerals under supervision. (3-20-20)T

**d.** Resident Trainees pursuing a funeral director license must complete and co-sign, with the sponsoring mortician, quarterly and final reports documenting that the applicant has assisted in making at least twenty-five (25) funeral arrangements and in conducting at least twenty-five (25) funerals under supervision. (3-20-20)T

**05. Interruption in Training.** An interruption in training of sixty (60) days or more constitutes termination of training. (3-20-20)T

**251. -- 299. (RESERVED)**

**300. APPLICATIONS AND EXAMINATION.**



In order to be admitted to the examination, the applicant must submit a completed application on forms provided by the Division and provide all requested documentation including proof of having completed the training period as prescribed by law and these rules, and meet the specific requirements for license as set forth in Section 54-1109 of the Idaho Code as follows: (3-20-20)T

**01. Age.** Applicant must have attained the age of twenty-one (21) years by the time of examination. (3-20-20)T

**02. Moral Character.** Must be of good moral character. (3-20-20)T

**03. Mortician Educational Requirements.** Applicants for a mortician license must have completed and received credit for at least sixty (60) semester hours or ninety (90) quarter hours instruction in a duly accredited college or university and has obtained at least a C grade average for all courses of instruction; provided, however, at least three-fourths (3/4) of all such credits must be for courses in fields of liberal arts, business or science directly relating to the knowledge required to successfully compete in the field of mortuary science. In questionable cases the decision of the board shall be final. These requirements shall be in addition to and not considered a part of the completion of and graduation from a mortuary college accredited by the American Board of Funeral Service Education that includes an embalming course of study. (3-20-20)T

**04. Funeral Director Educational Requirements.** Applicants for a funeral director license must have completed and received at least sixty (60) semester hours' or ninety (90) quarter-hours' instruction from a duly accredited college or university and has obtained at least a C grade average for all courses of instruction; provided, however, at least three-fourths (3/4) of all such credits must be for courses in the fields of liberal arts, business or science as defined and specified by the board. These requirements shall be in addition to completion of at least fifteen (15) semester credit hours or the equivalent from a mortuary college accredited by the American board of funeral service education, inc., or such credits as are otherwise approved by the board, with course of study to include business law, psychology, sociology, funeral service counseling, funeral service management and other classes that relate to conducting funeral business. (3-20-20)T

**05. Completion of One Year as a Resident Trainee.** Must have served one (1) year as required by statute as a Resident Trainee and receive certification from a sponsoring mortician in Idaho. (3-20-20)T

**a.** An applicant pursuing licensure as a mortician must document on Board-approved forms that the applicant has assisted in embalming at least twenty-five (25) dead human bodies and assisted in making at least twenty-five (25) funeral arrangements and in conducting at least twenty-five (25) funerals under the supervision of a sponsoring mortician. (3-20-20)T

**b.** An applicant pursuing licensure as a funeral director must document on Board-approved forms that the applicant has assisted in making at least twenty-five (25) funeral arrangements and in conducting twenty-five (25) funerals under the supervision of a sponsoring mortician. (3-20-20)T

**301. -- 324. (RESERVED)**

**325. APPROVED EXAMINATION.** Applicants for licensure shall successfully pass the examinations set forth below. (3-20-20)T

**01. Mortician Examination.** The Mortician examination shall consist of: (3-20-20)T

**a.** All sections of the International Conference of Funeral Service Examining Board's National Board Examination; and (3-20-20)T

**b.** The examination of the laws and rules of the state of Idaho relating to the care, disinfection, preservation, burial, transportation, or other final disposition of human remains; and (3-20-20)T

**c.** The examination of the rules of the Department of Health and Welfare relating to infectious diseases and quarantine. (3-20-20)T

- 02. Funeral Director.** The funeral director examination shall consist of: (3-20-20)T
- a.** The Arts section of the State Based Examination conducted by the International Conference of Funeral Service Examination Board; and (3-20-20)T
- b.** The examination of the laws and rules of the state of Idaho relating to the care, disinfection, preservation, burial, transportation, or other final disposition of human remains; and (3-20-20)T
- c.** The examination of the rules of the Idaho Department of Health and Welfare relating to infectious diseases and quarantine. (3-20-20)T
- 03. Grading.** The required average grade to pass the examination is seventy-five percent (75%). Provided further, that where the applicant has a score of less than seventy percent (70%) in one (1) or more subjects, such applicant shall not be passed, notwithstanding that his average mark may be higher than seventy-five percent (75%), however, should the applicant apply for reexamination he may, by board approval, be required to retake only that portion of the examination which he failed in previous examination. (3-20-20)T
- 326. -- 349. (RESERVED)**
- 350. ENDORSEMENT.**  
Refer to Section 54-1109(3) and (4), Idaho Code. (3-20-20)T
- 351. -- 379. (RESERVED)**
- 380. INACTIVE LICENSE.**
- 01. Request for Inactive License.** Persons holding an unrestricted mortician or funeral director license in this state may apply for inactive status by making written application to the Board on a form prescribed by the Board and paying the established fee. (3-20-20)T
- 02. Inactive License Status.** (3-20-20)T
- a.** Inactive license renewal notices and licenses will be marked “inactive”. (3-20-20)T
- b.** Inactive license holders may not practice in Idaho while on inactive status. (3-20-20)T
- c.** If a licensee holds a certificate of authority and places their license on inactive status, their certificate of authority expires as of the date their license becomes inactive. (3-20-20)T
- d.** All continuing education requirements will be waived for any year or portion thereof that a licensee maintains an inactive license and is not actively practicing or supervising in Idaho. (3-20-20)T
- 03. Return to Active License Status.** An inactive license holder may convert from inactive to active license status by: (3-20-20)T
- a.** Making written application to the Board on a form prescribed by the Board; (3-20-20)T
- b.** Providing documentation to the Board showing successful completion within the previous twelve (12) months of the continuing education requirements for renewal of an active license; and (3-20-20)T
- c.** Paying a fee equivalent to the difference between the current inactive fee and the active renewal fee. (3-20-20)T
- d.** An inactive licensee who held a certificate of authority at the time their license became inactive who returns to active license status pursuant to this rule may be reissued a certificate of authority by paying the renewal fee for the certificate of authority. (3-20-20)T

**381. -- 399. (RESERVED)**

**400. EXPIRATION OF LICENSE.**

All licenses shall expire each year and will be cancelled if not renewed by payment of the required fee before the birthdate of the license holder. There will be no grace period. (3-20-20)T

**401. -- 409. (RESERVED)**

**410. CONTINUING EDUCATION.**

In order to protect the public health and safety and promote the public welfare, the Board has adopted the following rules for continuing education. (3-20-20)T

**01. Continuing Education (CE) Requirement.** Each Idaho licensed mortician and funeral director must successfully complete a minimum of eight (8) hours of continuing education annually for license renewal. (3-20-20)T

**a.** Each licensee must certify on their renewal application form that compliance with the annual CE requirements has been met during the previous twelve (12) months. The Board may conduct such continuing education audits and require verification of attendance as deemed necessary to ensure compliance with the CE requirements. (3-20-20)T

**b.** A licensee is considered to have satisfied the CE requirements for the first renewal of the initial license. (3-20-20)T

**c.** After July 1, 2011, and prior to reinstatement of a license lapsed, canceled, or otherwise non-renewed for less than five (5) years, the applicant must provide proof of attendance of eight (8) hours of continuing education for the previous twelve (12) months. A license that has lapsed, been canceled, or otherwise not renewed for more than five (5) years may be reinstated in accordance with Section 67-2614, Idaho Code. (3-20-20)T

**02. Credit.** Continuing education credit will only be given for actual time in attendance or for the time spent participating in the educational activity. One (1) hour of continuing education is equal to sixty (60) minutes. Courses taken by correspondence or by computer on-line may be approved for continuing education if the courses require an exam or other proof of successful completion. Only four (4) hours of the required continuing education may be from correspondence, computer on-line, or self-study in each renewal period. The remaining hours must be in an interactive setting that provides the opportunity for participants to communicate directly with the instructor. Each licensee must maintain proof of attendance or successful completion documentation of all continuing education courses for a period of three (3) years. (3-20-20)T

**a.** A licensee may carryover a maximum of eight (8) hours of continuing education to meet the next year's continuing education requirement. Only four (4) hours may be carried over from correspondence, computer on-line, or self-study. (3-20-20)T

**03. Providers/Sponsors/Subjects of Continuing Education.** The continuing education must be provided by a college or university, a national or state association, trade group, or other person or entity approved by the Board and must be germane to the license held. Continuing education may include, but shall not be limited to, the following subject areas: (3-20-20)T

**a.** Public Health and Technical. This includes, but is not limited to, embalming, restorative art, after care, organ procurement, sanitation, and infection control. (3-20-20)T

**b.** Business Management. This includes, but is not limited to, computer application, marketing, personnel management, accounting, or comparable subjects. (3-20-20)T

**c.** Social Science. This includes, but is not limited to, communication skills (both written and oral), sociological factors, counseling, grief psychology, funeral customs, or comparable subjects. (3-20-20)T

**d.** Legal, Ethical, Regulatory. This includes, but is not limited to, OSHA (Occupational Safety and

Health Association), FTC (Federal Trade Commission), ethical issues, legal interpretations, or comparable subjects. (3-20-20)T

**04. Verification of Attendance.** Each licensee must maintain verification of attendance by securing authorized signatures or other documentation from the course instructors or sponsoring institution substantiating any and all hours attended by the licensee. (3-20-20)T

**05. Failure to Fulfill the Continuing Education Requirements.** The license will not be renewed for a licensee who fails to certify compliance with CE requirements. A licensee who makes a false attestation regarding compliance with the CE requirements is subject to disciplinary action by the Board. (3-20-20)T

**06. Special Exemption.** The Board has authority to make exceptions for reasons of individual hardship, including health, when certified by a medical doctor, or other good cause. Each licensee must provide any information requested by the Board to assist in substantiating hardship cases. This exemption is granted at the sole discretion of the Board. Request for special exemption must be made prior to licensure renewal. (3-20-20)T

**411. -- 424. (RESERVED)**

**425. MAINTENANCE OF PRE-NEED TRUST ACCOUNT FEES.** Maintenance of pre-need trust accounts fee. Pursuant to Section 54-1134 D, Idaho Code, a fee not to exceed ten percent (10%) of the annual earned interest income may be charged for maintenance of pre-need trust accounts. (3-20-20)T

**426. -- 449. (RESERVED)**

**450. FUNERAL ESTABLISHMENT AND CREMATORY ESTABLISHMENT.** All applicants for establishment license shall submit a completed application on a form approved by the Board. All newly licensed establishments and all branch or satellite facilities must meet the same requirements for licensure. A walk-through inspection of the establishment must be arranged and completed within six (6) months of the Board's review of the application or the application will be deemed denied and will be terminated upon a thirty (30) day written notice, unless good cause is demonstrated to the Board. (3-20-20)T

**01. Contents of Application.** Each applicant for a license to operate a funeral establishment or crematory establishment in Idaho shall document the following: (3-20-20)T

- a.** Name and address of owner whether individual or entity; and (3-20-20)T
- b.** Notarized signature of applicant or authorized agent; and (3-20-20)T
- c.** Name and license number of responsible licensee; and (3-20-20)T
- d.** Other such information as the board may require. (3-20-20)T

**02. Change in Ownership or Location.** Any change in the ownership or location of a funeral establishment shall constitute a new funeral establishment for the purposes of licensure. (3-20-20)T

**03. Funeral Establishment.** All funeral establishments shall be required to provide each of the following: (3-20-20)T

- a.** An operating room and necessary equipment for embalming; (3-20-20)T
- b.** A selection room for caskets and merchandise which may include video, catalogs, and electronic depiction of caskets and merchandise; (3-20-20)T
- c.** A chapel where funeral or other religious ceremonies may be held; and (3-20-20)T
- d.** A room for viewing and visitation. (3-20-20)T

**04. Funeral Firm.** Every funeral firm in the state of Idaho and/or licensee thereof shall give or cause to be given to the person or persons making funeral arrangements or arranging for the disposition of the dead human body at the time of said arrangements and prior to rendering that service or providing that merchandise, a written statement showing to the extent then known the following: (3-20-20)T

- a.** The price of the service that the person or persons have selected and what is included therein. (3-20-20)T
- b.** The prices of each of the supplementary items of service and/or merchandise requested. (3-20-20)T
- c.** The amount involved for each of the items for which the firm will advance monies as an accommodation for the family. (3-20-20)T
- d.** The method of payment. (3-20-20)T
- e.** If the quoted price includes a basic component of a funeral or a part thereof which is not desired, then a credit thereof should be granted. (3-20-20)T

**05. Crematory Establishment.** All crematory establishments shall be required to provide each of the following: (3-20-20)T

**a.** Detailed information regarding each retort, specifically documenting that each retort and accompanying equipment is listed by an approved testing agency as listed in the Uniform Fire Code or in the case of alkaline hydrolysis, a pressurized vessel heated to one hundred fifty degrees Celsius (150° C) (three hundred two degrees Fahrenheit (302° F)) for a minimum recommended period of thirty (30) minutes, thereby meeting or exceeding the United States Center for Disease Control (CDC) requirements for the complete destruction of human pathogens; and (3-20-20)T

**b.** One (1) set of blueprints for the proposed new construction or remodeling where the retort is to be located. The blueprints must be approved by the local building department as being in compliance with applicable building codes and ordinances. (3-20-20)T

**451. (RESERVED)**

**452. MINIMUM STANDARDS.**

**01. Reasonable Sanitation and Safety Required.** In the interest of the protection of the public welfare, no license will be issued on an application to operate a funeral establishment or crematory unless it is apparent that the establishment or crematory can and will be operated in a reasonably sanitary and safe manner and that all pertinent federal, state, and local permits have been obtained when operating an alkaline hydrolysis retort. (3-20-20)T

**02. Reduction of Cremated Remains.** No crematory will be licensed or operated unless it is capable of reducing human remains to cremains containing not more than five percent (5%) of the weight of the body immediately after death. (3-20-20)T

**03. Delay Before Cremation.** No dead human body, regardless of cause of death, is to be cremated, nor is actual cremation of such a body to be commenced, unless the county coroner in the county in which the death occurred gives his written authorization to cremate the body. (3-20-20)T

**04. Embalming.** If a dead human body is to be held longer than twenty-four (24) hours prior to burial, cremation, or other disposition, the body must be either embalmed or refrigerated at thirty-six degrees Fahrenheit (36F) or less until buried, cremated, or otherwise disposed of. (3-20-20)T

**05. Casket Not Necessary.** It is not necessary for the body to be in a casket for cremation to take place. (3-20-20)T

- a. This is not to be construed to mean that the crematory must cremate without a casket; and (3-20-20)T
- b. It will not prevent the operators from developing their own internal requirements for aesthetic or sanitary reasons. (3-20-20)T

**453. RECEIPT FOR BODIES TO BE CREMATED.**

The following must be performed by the operator of a crematory upon receipt of a human body for cremation: (3-20-20)T

- 01. Provide a Receipt.** A receipt must be delivered to the licensed mortician or funeral director, his agent, or another person who delivers such body to the crematory. (3-20-20)T
- 02. Contents of Receipt.** The receipt must show: (3-20-20)T
  - a. The name of the decedent whose body was received; and (3-20-20)T
  - b. The date on which that body was received; and (3-20-20)T
  - c. The place where that body was received; and (3-20-20)T
  - d. The name and address of the funeral establishment from whom that body was received; and (3-20-20)T
  - e. The name and address of the person, or the names and addresses of the persons, if more than one (1), who actually delivers the body. (3-20-20)T

**454. RECORDS OF BODIES.**

- 01. Content of Record.** Each funeral establishment and crematory must maintain a record of each burial, cremation, or other disposition of human remains, disclosing: (3-20-20)T
  - a. The name of the decedent; and (3-20-20)T
  - b. The name and address of the person, or names and addresses of the persons if more than one (1), authorizing the burial, cremation, or other disposition of that body; and (3-20-20)T
  - c. A statement as to whether or not the body was embalmed; and (3-20-20)T
  - d. The date of the burial, cremation, or other disposition of that body; and (3-20-20)T
  - e. The subsequent disposal of any cremated remains. (3-20-20)T

**455. RESPONSIBILITY, INSPECTION, AND CONFIDENTIALITY OF RECORDS.**

- 01. Responsibility for Record.** Records regarding the burial, cremation, and other disposition of human bodies must be made as soon as reasonably possible after the burial, cremation, or other disposition and must be dated and signed by the licensed mortician or funeral director who supervised or was otherwise directly responsible for the burial, cremation, or other disposition. (3-20-20)T
- 02. Inspection of Records.** Records regarding the receipt, burial, cremation, and other disposition of human bodies must be maintained at the funeral establishment and crematory and be open for inspection at any reasonable time by the Board or its designated representatives. (3-20-20)T
- 03. Confidentiality of Records.** Any disclosure of information obtained by the Board in connection with licensure activities and records of funerals or cremations must comply with Idaho Public Records Act, Title 74,

Chapter 1, Idaho Code.

(3-20-20)T

**456. -- 499. (RESERVED)**

**500. FEES.**

<b>FEE TYPE</b>	<b>AMOUNT (Not to Exceed)</b>
Funeral Director	\$85
Funeral Establishment	\$125
Crematory Establishment	\$200
Mortician	\$85
Inactive License	\$40
Resident Trainee	\$50
Application Fee	\$100
Certificate of Authority	\$50

(3-20-20)T

**501. DISCIPLINE.**

**01. Civil Fine.** The Board may impose a civil fine not to exceed one thousand dollars (\$1,000) upon a licensee for each violation of Section 54-1116, Idaho Code. (3-20-20)T

**02. Costs and Fees.** The Board may order a licensee to pay the costs and fees incurred by the Board in the investigation or prosecution of the licensee if found in violation of Section 54-1116, Idaho Code. (3-20-20)T

**502. -- 999. (RESERVED)**

**IDAPA 24 – DIVISION OF OCCUPATIONAL AND PROFESSIONAL LICENSES**

**24.09.01 – RULES OF THE BOARD OF EXAMINERS OF NURSING HOME ADMINISTRATORS**

**DOCKET NO. 24-0901-2000F (FEE RULE)**

**NOTICE OF OMNIBUS RULEMAKING – ADOPTION OF TEMPORARY RULE**

**EFFECTIVE DATE:** The effective date of the temporary rule being adopted through this omnibus rulemaking is the adjournment date of the second regular session of the 65th Idaho State Legislature - March 20, 2020.

**AUTHORITY:** In compliance with Sections 67-5226, Idaho Code, notice is hereby given this agency has adopted a temporary rule. The action is authorized pursuant to Section 54-1604, Idaho Code.

**DESCRIPTIVE SUMMARY:** The following is the required finding and concise statement of its supporting reasons for adopting a temporary rule:

This temporary rulemaking adopts the following chapters under IDAPA 24:

**IDAPA 24.09**

- 24.09.01, *Rules of the Board of Examiners of Nursing Home Administrators.*

**TEMPORARY RULE JUSTIFICATION:** Pursuant to Sections 67-5226(1) and 67-5226(2), Idaho Code, the Governor has found that temporary adoption of the rule is appropriate for the following reasons:

These temporary rules are necessary to protect the public health, safety, and welfare of the citizens of Idaho and confer a benefit on its citizens. These temporary rules implement the duly enacted laws of the state of Idaho, provide citizens with the detailed rules and standards for complying with those laws, and assist in the orderly execution and enforcement of those laws. The expiration of these rules without due consideration and processes would undermine the public health, safety, and welfare of the citizens of Idaho and deprive them of the benefit intended by these rules. These rules govern the qualifications for nursing home administrators, which ensures the integrity and competence of a profession charged with maintaining the quality of care for vulnerable citizens. Allowing these rules to expire would harm the health, safety, and welfare of residents of nursing homes, as well as current and prospective licensees.

**FEE SUMMARY:** Pursuant to Section 67-5226(2), the Governor has found that the fees or charges being imposed or increased are justified and necessary to avoid immediate danger and the fees are described herein:

The fees or charges, authorized in Section 54-1604, Idaho Code, are part of the agency’s 2021 budget that relies upon the existence of these fees or charges to meet the state’s obligations and provide necessary state services. Failing to reauthorize these temporary rules would create immediate danger to the state budget, immediate danger to necessary state functions and services, and immediate danger of a violation of Idaho’s constitutional requirement that it balance its budget.

The following is a specific description of the fees or charges:

<b>FEE</b>	<b>AMOUNT (Not to Exceed)</b>
Original Application	\$200
Original License	\$200
Annual Renewal	\$200
Endorsement Application	\$200
Temporary Permit	\$100
Administrator-in-training	\$100
License Reinstatement	\$100



**ASSISTANCE ON TECHNICAL QUESTIONS:** For assistance on technical questions concerning the temporary rule, contact Rob McQuade at (208) 334-3233.

DATED this February 21, 2020.

Kelley Packer  
Division Administrator  
Division of Occupational and Professional Licenses  
700 W. State Street  
P.O. Box 83720  
Boise, ID 83720  
Phone: (208) 334-3233  
Fax: (208) 334-3945

## 24.09.01 – RULES OF THE BOARD OF EXAMINERS OF NURSING HOME ADMINISTRATORS

### 000. LEGAL AUTHORITY.

These rules are hereby prescribed and established pursuant to the authority vested in the Board of Examiners of Nursing Home Administrators by the provisions of Section 54-1604, Idaho Code. (3-20-20)T

### 001. TITLE AND SCOPE.

These rules are titled IDAPA 24.09.01, “Rules of the Board of Examiners of Nursing Home Administrators.” (3-20-20)T

### 002. ADDRESS OF THE BOARD OF EXAMINERS OF NURSING HOME ADMINISTRATORS.

The office of the Board of Examiners of Nursing Home Administrators is located within the Division of Occupational and Professional Licenses, 700 W. State Street, Boise, Idaho 83702. The Division is open between the hours of 8:00 a.m. and 5:00 p.m. each day except Saturdays, Sundays and holidays. The telephone number of the Board is (208) 334-3233. The Board's fax number is (208) 334-3945. The Board's e-mail address is [nha@ibol.idaho.gov](mailto:nha@ibol.idaho.gov). The Board's official website is <http://www.ibol.idaho.gov>. (3-20-20)T

### 003. -- 099. (RESERVED)

## 100. EXAMINATION FOR LICENSURE.

**01. Examination Fee.** The examination fee for the national examination shall be in the amount as determined by the National Association of Long Term Care Administration Boards and shall be paid to the entity administering said examination. The examination fee is in addition to the license fee provided for in Section 54-1604, sub-paragraph (g), Idaho Code. (3-20-20)T

**02. Good Moral Character.** An applicant who has a criminal conviction, finding of guilt, withheld judgment, or suspended sentence for any felony or any crime related to an applicant’s fitness for licensure, or whose license has been subject to discipline by any state professional regulatory agency or professional organization must submit with the application a written statement and any supplemental information establishing the applicant’s current suitability for licensure. (3-20-20)T

- a. Consideration of Factors and Evidence.** The Board shall consider the following factors or evidence: (3-20-20)T
- i. The severity or nature of the crime or discipline; (3-20-20)T
  - ii. The period of time that has passed since the crime or discipline under review; (3-20-20)T
  - iii. The number or pattern of crimes or discipline or other similar incidents; (3-20-20)T
  - iv. The circumstances surrounding the crime or discipline that would help determine the risk of repetition; (3-20-20)T
  - v. The relationship of the crime or discipline to the practice; (3-20-20)T
  - vi. The applicant's activities since the crime or discipline under review, such as employment, education, participation in treatment, payment of restitution, or any other factors that may be evidence of current rehabilitation; and (3-20-20)T
  - vii. Any other information regarding rehabilitation or mitigating circumstances. (3-20-20)T
- b. Interview.** The Board may, at its discretion, grant an interview of the applicant. (3-20-20)T
- c. Applicant Bears the Burden.** The applicant shall bear the burden of establishing the applicant’s current suitability for licensure. (3-20-20)T

**03. Contents of Exam, Passing Scores.** An applicant must pass an examination issued by NAB, and an examination pertaining to Idaho law and rules governing nursing homes administered by the Board. The passing score of the Idaho Laws and Rules Examination shall be seventy-five percent (75%). (3-20-20)T

**04. Date and Location of Exam.** Examinations shall be held at the location and at the times determined by the entity administering the national examination. The state examination shall be a take-home examination and be returned to the Board. (3-20-20)T

**101. -- 199. (RESERVED)**

**200. CONTINUING EDUCATION REQUIREMENTS.**

**01. Educational Requirements.** In order to qualify as continuing education, a seminar or course of study must be relevant to nursing home administration as determined by the Board and sponsored by accredited universities or colleges, State or National health related associations, and/or approved by NCERS (National Continuing Education Review Service). (3-20-20)T

**02. Renewal of License.** Applicants for renewal of license shall be required to complete a minimum of twenty (20) clock hours of approved courses within the preceding twelve-month (12) period. Licensees shall not be required to comply with this requirement during the first year in which they become licensed under this chapter. (3-20-20)T

**03. Carryover of Continuing Education Hours.** Continuing education hours not claimed in the current renewal year may be claimed in the next renewal year. A maximum of twenty (20) hours may be carried forward from the immediately preceding year, and may not be carried forward more than one (1) renewal year. (3-20-20)T

**04. Waiver.** The Board may waive the requirements of this rule for reasons of individual hardship including health or other good cause. The licensee should request the waiver in advance of renewal and must provide any information requested by the Board to assist in substantiating hardship cases. This waiver is granted at the sole discretion of the Board. (3-20-20)T

**201. -- 299. (RESERVED)**

**300. ENDORSEMENT.**

Each applicant for licensure by endorsement shall be required to document compliance with each of the following requirements. (3-20-20)T

**01. A Valid License.** Hold a valid and current nursing home administrator license issued in another state or jurisdiction with substantially equivalent licensing standards. (3-20-20)T

**02. Experience/Education.** (3-20-20)T

**a.** One thousand (1,000) hours of experience as an administrator in training in another state; or (3-20-20)T

**b.** A total of one thousand (1,000) hours of combined experience obtained in an administrator in training program and from practical experience as an administrator in another state; or (3-20-20)T

**c.** A master's degree in health administration related to long-term care from an accredited institution; or (3-20-20)T

**d.** A master's degree in health administration or business administration with a healthcare emphasis from an accredited institution and one (1) year management experience in long-term care. (3-20-20)T

**03. National Examination.** Has taken and successfully passed the NAB examination. (3-20-20)T

**04. State Examination.** Has taken and successfully completed the state of Idaho examination. (3-20-20)T

**05. Criminal History.** Applicant is subject to Section 100.02 of these rules. (3-20-20)T

**301. -- 399. (RESERVED)**

**400. NURSING HOME ADMINISTRATORS-IN-TRAINING.**

**01. Supervised Hour Requirements.** An individual must successfully complete one thousand (1,000) hours under the direct supervision of a licensed nursing home administrator in compliance with Section 54-1610, Idaho Code, and these rules in order to be eligible to take the examination. (3-20-20)T

**02. Trainees.** A trainee must work on a full time basis in any capacity in an Idaho licensed nursing home setting. Full time shall be at least a thirty-two (32) hour per week work schedule with consideration for normal leave taken. (3-20-20)T

**a.** Each trainee shall register with the Board as a Nursing Home Administrator-In-Training (AIT) by submitting an application provided by the Board together with the required fee. The effective date of each AIT program shall be the date the Board approves the application. (3-20-20)T

**b.** Reports for those trainees employed in a nursing home must be submitted to the Board after completion of each five hundred (500) hour increment and reflect that the preceptor of the trainee has instructed, assisted and given assignments as deemed necessary to fulfill the requirements of Subsection 400.03. (3-20-20)T

**03. Nursing Home Administrator-in-Training Requirements.** A Nursing Home Administrator-in-Training shall be required to train in all domains of nursing home administration including the following: (3-20-20)T

**a.** Customer care, support, and services. (3-20-20)T

**b.** Human resources. (3-20-20)T

**c.** Finance. (3-20-20)T

**d.** Environment. (3-20-20)T

**e.** Management and leadership. (3-20-20)T

**f.** Completion of a specialized course of study in nursing home long-term health care administration approved by NAB or otherwise approved by the Board. (3-20-20)T

**04. Facility Administrator.** The trainee must spend no less than thirty-two (32) hours a month with the preceptor in a training and/or observational situation in the five (5) domains of nursing home administration as outlined in Subsection 400.03. Time spent with the preceptor must be in addition to the full time work that the trainee must perform under Subsection 400.02, unless the Administrator-in-Training role is designated as a full time training position. Collectively, during the training period, reports must reflect particular emphasis on all five (5) domains of nursing home administration during the time spent in the nursing home. (3-20-20)T

**05. Preceptor Certification.** (3-20-20)T

**a.** A nursing home administrator who serves as a preceptor for a nursing home administrator-in-training must be certified by the Board of Examiners of Nursing Home Administrators. The Board will certify the Idaho licensed nursing home administrator to be a preceptor who: (3-20-20)T

**i.** Is currently practicing as a nursing home administrator and who has practiced a minimum of two (2) consecutive years as a nursing home administrator; and (3-20-20)T

**ii.** Who successfully completes a six (6) clock hour preceptor orientation course approved by the Board. (3-20-20)T

**b.** The orientation course will cover the philosophy, requirements and practical application of the nursing home administrator-in-training program and a review of the six (6) phases of nursing home administration as outlined in Subsection 400.03. (3-20-20)T

**c.** The preceptor must be re-certified by the Board every ten (10) years. (3-20-20)T

**401. -- 449. (RESERVED)**

**450. ADMINISTRATOR DESIGNEE QUALIFICATION.**

In order to practice as an administrator designee, an individual shall register with the Board as an Administrator Designee by submitting an application and providing documentation of each the following requirements. (3-20-20)T

- 01. Criminal History.** Applicant is subject to Section 100.02 of these rules. (3-20-20)T
- 02. Education.** Provide proof of either: (3-20-20)T
  - a.** A bachelors degree from an approved college or university, or (3-20-20)T
  - b.** Two (2) years of satisfactory practical experience in nursing home administration or a related health administration area for each year of the required education as set forth in Section 54-1605(3), Idaho Code; (3-20-20)T
- 04. Experience.** Provide proof of having one (1) year of management experience in a skilled nursing facility. Experience documented in Subsection 450.03.b. may also be used to meet this requirement. (3-20-20)T
- 05. Authorization.** Submit an agreement signed by an Idaho Licensed Nursing Home Administrator who will act as a consultant to assist the designee in administrating the facility. (3-20-20)T

**451. -- 499. (RESERVED)**

**500. PERMITS.**

- 01. Requirements for Issuance.** A temporary permit may be issued upon submission of an endorsement application evidencing a license in good standing in another state and payment of fees. The permit shall be valid until the Board acts upon their endorsement application. No more than one (1) temporary permit may be granted to any applicant for any reason. (3-20-20)T
- 02. Issuance of a Temporary Permit Does Not Obligate the Board.** Issuance of a temporary permit does not obligate the board to subsequently issue a license. Issuance of a subsequent license depends upon a successful application to the Board. (3-20-20)T

**501. -- 599. (RESERVED)**

**600. FEES.**

<b>FEE</b>	<b>AMOUNT (Not to Exceed)</b>
Original Application	\$200
Original License	\$200
Annual Renewal	\$200
Endorsement Application	\$200
Temporary Permit	\$100
Administrator-in-training	\$100
License Reinstatement	\$100

(3-20-20)T

**601. -- 999. (RESERVED)**

# IDAPA 24 – DIVISION OF OCCUPATIONAL AND PROFESSIONAL LICENSES

## 24.10.01 – RULES OF THE STATE BOARD OF OPTOMETRY

### DOCKET NO. 24-1001-2000F (FEE RULE)

#### NOTICE OF OMNIBUS RULEMAKING – ADOPTION OF TEMPORARY RULE

**EFFECTIVE DATE:** The effective date of the temporary rule being adopted through this omnibus rulemaking is the adjournment date of the second regular session of the 65th Idaho State Legislature - March 20, 2020.

**AUTHORITY:** In compliance with Sections 67-5226, Idaho Code, notice is hereby given this agency has adopted a temporary rule. The action is authorized pursuant to Sections 54-1509, Idaho Code.

**DESCRIPTIVE SUMMARY:** The following is the required finding and concise statement of its supporting reasons for adopting a temporary rule:

This temporary rulemaking adopts the following chapter under IDAPA 24:

**IDAPA 24.10**

- 24.10.01, *Rules of the State Board of Optometry.*

**TEMPORARY RULE JUSTIFICATION:** Pursuant to Sections 67-5226(1) and 67-5226(2), Idaho Code, the Governor has found that temporary adoption of the rule is appropriate for the following reasons:

These temporary rules are necessary to protect the public health, safety, and welfare of the citizens of Idaho and confer a benefit on its citizens. These temporary rules implement the duly enacted laws of the state of Idaho, provide citizens with the detailed rules and standards for complying with those laws, and assist in the orderly execution and enforcement of those laws. The expiration of these rules without due consideration and processes would undermine the public health, safety, and welfare of the citizens of Idaho and deprive them of the benefit intended by these rules. These rules govern the qualifications to practice optometry and maintain practice fitness. Allowing these rules to expire would reduce consumer choice, harm licensees, and impose a barrier to entry into the profession.

**FEE SUMMARY:** Pursuant to Section 67-5226(2), the Governor has found that the fees or charges being imposed or increased are justified and necessary to avoid immediate danger and the fees are described herein:

The fees or charges, authorized in Section 54-1506, Idaho Code, are part of the agency's 2021 budget that relies upon the existence of these fees or charges to meet the state's obligations and provide necessary state services. Failing to reauthorize these temporary rules would create immediate danger to the state budget, immediate danger to necessary state functions and services, and immediate danger of a violation of Idaho's constitutional requirement that it balance its budget.

The following is a specific description of the fees or charges:

FEE TYPE	AMOUNT (Not to Exceed)
License Application	\$100
Annual Fund	\$75
Annual Renewal	\$75
Certificate to Obtain and Use Pharmaceutical Agents	\$10
Reinstatement	As provided in Section 67-2614, Idaho Code

**ASSISTANCE ON TECHNICAL QUESTIONS:** For assistance on technical questions concerning the temporary rule, contact Rob McQuade at (208) 334-3233.

DATED this February 21, 2020.

Kelley Packer  
Division Administrator  
Division of Occupational and Professional Licenses  
700 W. State Street  
P.O. Box 83720  
Boise, ID 83720  
Phone: (208) 334-3233  
Fax: (208) 334-3945

## 24.10.01 – RULES OF THE STATE BOARD OF OPTOMETRY

### 000. LEGAL AUTHORITY.

These rules are hereby prescribed and established pursuant to the authority vested in the State Board of Optometry by the provisions of Section 54-1509, Idaho Code. (3-20-20)T

### 001. TITLE AND SCOPE.

These rules are titled IDAPA 24.10.01, “Rules of the State Board of Optometry.” (3-20-20)T

### 002. -- 009. (RESERVED)

### 010. DEFINITIONS.

**01. Low Vision.** Refer to Section 54-1501(5), Idaho Code, correcting defects may include low vision but is not limited to low vision rehabilitation. (3-20-20)T

**02. Opticianry.** The professional practice of filling prescriptions from a licensed optometrist or ophthalmologist for ophthalmic lenses, contact lenses, and any other ophthalmic device used to improve vision. Opticianry does not include prescriptive authority. (3-20-20)T

**03. Vision Therapy.** Any person who assesses, diagnoses, treats, or prescribes treatment for conditions of the visual system or manages a patient with vision therapy, visual training, visual rehabilitation, orthoptics or eye exercises or who hold him/herself out as being able to do so for the rehabilitation and/or treatment of physical, physiological, sensorimotor, neuromuscular or perceptual anomalies of the eyes or vision system or who prescribes or utilizes lenses, prisms, filters, occlusion or other devices for the enhancement, rehabilitation and/or treatment of the visual system or prevention of visual dysfunctions, except under the supervision and management of a licensed optometrist, is engaged in the practice of optometry. (3-20-20)T

### 011. -- 149. (RESERVED)

### 150. MEETING OF THE BOARD.

The Board shall meet at least annually and at other such times and places as designated by the Chairman or upon written request of any two members of the Board. All meetings shall be held in accordance with the Idaho Open Meeting Law, Chapter 23, Title 67, Idaho Code. (3-20-20)T

### 151. -- 174. (RESERVED)

### 175. METHOD OF APPLICATION – EXAMINATION OF APPLICANTS.

Applications for license shall be made on forms approved by the Board. (3-20-20)T

**01. Application.** The application must be accompanied by: (3-20-20)T

**a.** The required fee. (3-20-20)T

**b.** A complete transcript of credits from any college of optometry attended. (3-20-20)T

**c.** A photocopy of any diplomas granted by any college of optometry. (3-20-20)T

**d.** A copy of certified results establishing successful passage of the required examinations. (3-20-20)T

**02. Application Review.** Only fully completed applications accompanied by appropriate documents shall be reviewed for licensure. (3-20-20)T

**03. Exam Content.** The written and the practical portions of the Idaho examination shall be all parts of the National Board of Examiners in Optometry Examination (NBEOE) and the Board approved jurisprudence examination. A passing grade for the NBEOE shall be that established by the test provider. The passing grade for the jurisprudence examination shall be seventy-five percent (75%). A passing score on all examinations shall be necessary to qualify for a license to practice Optometry in Idaho. (3-20-20)T

### 176. -- 199. (RESERVED)

### 200. APPROVAL OF SCHOOLS OF OPTOMETRY.

The State Board of Optometry recognizes as reputable and in good standing the schools and colleges of optometry



which have met the standards set by the Accreditation Council on Optometric Education, or its successor agency, a list of which may be obtained from the secretary of the Board or from the office of the Division of Occupational and Professional Licenses in Boise. (3-20-20)T

**201. -- 224. (RESERVED)**

**225. APPROVAL OF PRELIMINARY EDUCATION.**

The State Board of Optometry recognizes the preliminary education prerequisites for entry into a school, college or university of optometry approved by the Council on Optometric Education of the American Optometric Association as adequate preliminary education prerequisites for licensing in Idaho. (3-20-20)T

**226. -- 249. (RESERVED)**

**250. LICENSES CANCELED FOR FAILURE TO RENEW.**

A license that has been canceled for failure to renew may be reinstated in accordance with Section 67-2614, Idaho Code. Any person whose license to practice optometry has been canceled for failure to renew for a period of more than five (5) years must apply for a new license in accordance with the requirements of Section 67-2614, Idaho Code. (3-20-20)T

**251. -- 274. (RESERVED)**

**275. ENDORSEMENT.**

**01. Endorsement.** Any person who presents to the Board of Optometry a certified copy of a certificate or license of registration which he holds in good standing in another state or a foreign country, which state or foreign country has similar requirements for licensing or registration as is provided for new applicants in Idaho (including therapeutic privileges), may apply to the Board for the issuance of a license to practice optometry in the state of Idaho. (3-20-20)T

**02. Conditions to be Granted a License.** The right to be granted a license to practice optometry in Idaho is also subject to the following conditions set out below: (3-20-20)T

**a.** The submission of a completed application meeting the requirements of Subsection 175.01 including the applicable fee. (3-20-20)T

**b.** That the license or certificate of registration of the applicant shall not have been suspended or revoked by any state or country or subject to any pending or unresolved licensure action in any state or country. That the applicant must not have committed any act which would constitute a violation of the Optometry Act or Board Rules. (3-20-20)T

**c.** For those licensed in another state the applicant must document to the Board for approval, the education, training, and examination for diagnostic and therapeutic privileges in the other state and return the state of Idaho law examination. (3-20-20)T

**d.** That the applicant has been engaged in the practice of optometry continuously for three (3) of the last four (4) years. (3-20-20)T

**276. -- 299. (RESERVED)**

**300. CONTINUING EDUCATION IN OPTOMETRY.**

**01. Hours Required, Advance Approval.** (3-20-20)T

**a.** Each optometrist licensed by the state of Idaho shall attend in each calendar year prior to license renewal, a minimum of twelve (12) full hours of approved optometric continuing education courses or meetings. (3-20-20)T

**b.** Approved optometric continuing education courses or meetings shall be those post-graduate optometric education courses or meetings approved in advance by the Board of Optometry or post-graduate study sessions or seminars at an accredited school or college of optometry. In addition, all Council on Optometric Practitioners Education (COPE) approved courses are approved for continuing education credit. If an optometrist attends or plans to attend a course of study or seminar which has not been approved in advance, he may petition the Board for approval of that educational course of study, setting forth a description of the course. The Board may, in its discretion, approve the course upon review of the material submitted either in advance or after completion of the course. (3-20-20)T

**02. Additional Hours Required to Use Therapeutic Pharmaceutical Agents.** (3-20-20)T

**a.** Each optometrist licensed by the state of Idaho to use therapeutic pharmaceutical agents shall attend in each calendar year prior to license renewal, a minimum of six (6) additional full hours of approved optometric courses or meetings. (3-20-20)T

**b.** This six (6) hours of continuing education must be in courses involving ocular pharmacology and/ or advanced ocular disease and are in addition to the twelve (12) hours of continuing education required under Subsection 300.01. (3-20-20)T

**03. Correspondence/Home Study Courses/Observation.** The Board allows credit for correspondence courses, individual home study and observation that is germane to the practice of optometry. No more than nine (9) hours of continuing education shall be permitted each year in correspondence courses or other continuing education obtained from "home study" courses or observation. (3-20-20)T

**04. Waiver of Requirements.** The Board of Optometry shall waive the continuing education requirement for the first license renewal after initial licensure. The Board of Optometry may, upon application, waive the requirements of this rule in cases involving illness, unusual circumstances interfering with the optometrist's ability to practice or inability to conform to the rules due to military duty. (3-20-20)T

**05. Renewal Application Form.** Each licensed Idaho optometrist will be furnished a license renewal application form by the State Board of Optometry on which each optometrist shall attest on their annual license renewal application that they have satisfied the continuing education requirements. False attestation of satisfaction of the continuing education requirements on a renewal application shall subject the licensee to disciplinary action. (3-20-20)T

**06. Audit.** The Board may conduct audits to confirm that the continuing education requirements have been met. In the event a licensee fails to provide the Board with acceptable documentation of the hours attested to on the renewal application, the license will not be renewed. (3-20-20)T

**07. Documentation of Attendance.** It shall be necessary for each licensed Idaho optometrist to provide documentation verifying attendance or completion of continuing education by securing authorized signatures, documentation, or electronic verification from the course instructors, providers, or sponsoring institution substantiating any hours attended by the licensee. This documentation must be maintained by the licensee and provided upon request by the Board or its agent. (3-20-20)T

**08. Excess Hours.** A licensee may carryover a maximum of six (6) hours of continuing education to meet the next year's continuing education requirement. Excess hours may be used only during the next renewal period and may not be carried forward more than one (1) year. (3-20-20)T

**301. -- 324. (RESERVED)**

**325. CODE OF ETHICS.**

**01. Patient's Visual Welfare.** The licensed optometrist shall keep the patient's visual welfare uppermost in his consideration at all times and promote the best methods of care for the visual needs of mankind. (3-20-20)T

**02. Confidentiality.** The optometrist shall preserve information concerning his patients in confidence and not release that information unless authorized by the patient or their lawful agent. An optometrist may, however, supply information of an otherwise confidential or privileged nature when lawfully subpoenaed to testify at a deposition or hearing in any proceeding before the Board of Optometry, or at any other time and place ordered by a court of law. (3-20-20)T

**03. Conduct of Practice.** The optometrist shall conduct his practice in a dignified and professional manner and in keeping with the mode of practice of a professional person entrusted with the care of the health of citizens of this state and shall abide by the rulings of the Board of Optometry. (3-20-20)T

**04. Unprofessional Conduct.** In order to define what constitutes unprofessional conduct, the board sets forth certain prohibited actions. In conducting his practice, an optometrist must not: (3-20-20)T

**a.** Practice optometry in any manner other than as a professional person in an individual capacity, or in partnership with or associate with other licensed health care professionals. An optometrist may be a stock holder in and practice as a member of a professional service corporation with other licensed health care professionals as authorized by Title 54, Chapter 15, Idaho Code, but the optometrist must list his individual name as well as any name selected for the professional service corporation on any letterheads, telephone directories, office or building directories, or other places where the general public might be advised of the fact that the individual is practicing optometry, as required by these rules. (3-20-20)T

**b.** Use either “Cappers” or “Steerers” or accept a split or divided fee for the purpose of obtaining patients or use solicitors or agents for the purpose of securing patients or conducting eye examinations or furnishing optometric services. (3-20-20)T

**c.** Allow his prescription files and records to be used by any unlicensed person, firm, or corporation not under the direct control of that optometrist for the practice of optometry. (3-20-20)T

**d.** Fail to perform services for which fees have been received. (3-20-20)T

**e.** File false reports of services performed or fees rendered. (3-20-20)T

**f.** Permit the use of his name or professional title by or in conjunction with any person not an optometrist, or any firm, company, corporation or military association which illegally practices or in any manner holds himself or itself out to the public as being entitled to practice the profession of optometry when not licensed to do so under the law of Idaho or which uses the title “Optometric Services” in such a manner in advertising as to convey to the public the impression that the individual or corporation is entitled to practice optometry or furnish optometric advice or services when not so authorized by law. (3-20-20)T

**326. -- 424. (RESERVED)**

**425. RULES DEFINING GROSS INCOMPETENCE.**

In order to protect the public, the Board of Optometry defines as “gross incompetence” any behavior or practice on the part of the licensed optometrist which demonstrates a lack of competence with respect to discharging professional obligations or duties which might result in injury or damage to a patient whether such injury or damage actually occurs or not and in particular, the Board defines as “gross incompetence” any of the following: (3-20-20)T

**01. Failure to Meet Prevailing Standards.** Failure to meet prevailing standards, or willful rendering of substandard care, either individually or as part of a third party reimbursement agreement or by other agreement. (3-20-20)T

**02. Failure to Meet Prevailing Standards in the Referral of Any Patient Who Is Suffering From Any Apparent or Suspected Pathological Condition.** A failure to meet prevailing standards in the referral of any patient who is suffering from any apparent or suspected pathological condition to a person competent and licensed to properly treat or diagnose the condition. (3-20-20)T

**03. Employment of Techniques or Methods of Practice.** Employment of techniques or methods of

practice in treating or prescribing for a patient when he does not have proper training in the technique or methods of practice. (3-20-20)T

**04. Failure to Advise Patient of Possible Danger When a Lens Not Meeting Impact Resistance Standards of F.D.A.** Failure to advise his patient of possible danger when a lens does not meet impact resistance standards of F.D.A. Regulation, 21 CFR 801.410, and is provided to the patient. (3-20-20)T

**05. Failure to Provide Follow-Up Care.** Failure to provide follow-up care according to prevailing standards. (3-20-20)T

**06. Displaying Gross Ignorance or Demonstrating Gross Inefficiency.** Displaying gross ignorance or demonstrating gross inefficiency in the care of a patient. (3-20-20)T

**07. Failure to Verify the Specifications of All Lenses.** Failure to verify the specifications of all lenses provided by him. (3-20-20)T

**08. Failing to Perform Tests and Record Findings.** In the course of an examination of a patient, failure to perform tests and record findings in a manner consistent with prevailing standards of optometric care. (3-20-20)T

**09. Using Pharmaceutical Agents.** Using pharmaceutical agents in the practice of optometry without having attended sufficient training programs or schools and acquiring the knowledge necessary to use the drugs in a competent manner. (3-20-20)T

**10. Illegal Prescription Sale, Administration, Distribution, or Use of Drugs.** Prescribing, selling, administering, distributing, giving, or using drugs legally classified. Prescribing, selling, administering, distributing, giving, or using drugs legally classified as a controlled substance or as an addictive or dangerous drug for other than accepted diagnostic or therapeutic purposes. (3-20-20)T

**11. Disciplinary Action or Sanctions.** Disciplinary action or sanctions taken by another state, jurisdiction, peer review body or a professional association or society against an optometrist for acts or conduct similar to acts or conduct which would constitute grounds for action as defined under "Rules of the Idaho Board of Optometry." (3-20-20)T

**12. Sanitary Office.** Failure to maintain sanitary office conditions, equipment, and use appropriate techniques and procedures. (3-20-20)T

**13. Failure to Release Prescription.** Failure to release either a spectacle or contact lens prescription as required by Federal law. (3-20-20)T

**14. Sufficient Training or Education.** Performing procedures without having successfully completed education, instruction or certification. (3-20-20)T

**426. -- 449. (RESERVED)**

**450. PRESCRIPTIONS FOR SPECTACLES AND CONTACT LENSES.**

Eyeglasses and contact lenses, including plano or cosmetic contact lenses, may only be dispensed upon a current prescription issued by an optometrist or medical physician. Every prescription written or issued by an optometrist practicing in Idaho shall contain at least the following information: (3-20-20)T

**01. Prescription for Spectacles.** Prescriptions for spectacles must contain the following: (3-20-20)T

**a.** Sphere, cylinder, axis, prism power and additional power, if applicable; and (3-20-20)T

**b.** The standard expiration date of the prescription must be at least one (1) year from date the prescription was originally issued. (3-20-20)T

**02. All Prescriptions for Rigid Contact Lenses.** All prescriptions for rigid contact lenses must contain at least the following information: (3-20-20)T

- a. Base curve; (3-20-20)T
- b. Lens manufacturer or “brand” name; (3-20-20)T
- c. Overall diameter; (3-20-20)T
- d. Lens material; (3-20-20)T
- e. Power; and (3-20-20)T

f. The standard expiration date of the prescription must be at least one (1) year from date the prescription was originally issued. A shorter prescription period may be allowed when based upon a documented medical condition. (3-20-20)T

**03. All Prescriptions for Soft Contact Lenses.** All prescriptions for soft contact lenses must contain at least the following information: (3-20-20)T

- a. Lens manufacturer or “brand” name; (3-20-20)T
- b. Series or base curve; (3-20-20)T
- c. Power; (3-20-20)T
- d. Diameter, if applicable; (3-20-20)T
- e. Color, if applicable; and (3-20-20)T

f. The standard expiration date of the prescription is one (1) year from date the prescription was originally issued. A shorter prescription period may be allowed when based upon a documented medical condition. (3-20-20)T

**04. Alteration of Prescriptions.** A person may not alter the specifications of an ophthalmic lens prescription without the prescribing doctor’s consent. (3-20-20)T

**05. Expired Contact Lens Prescription.** A person may not fill an expired contact lens prescription. (3-20-20)T

**06. Fitting and Dispensing Contact Lenses.** (3-20-20)T

a. Contact lenses may be fitted only by an optometrist, or licensed physician. (3-20-20)T

b. An ophthalmic dispenser may dispense contact lenses on a fully written contact lens prescription issued by an optometrist or licensed physician. (3-20-20)T

c. Notwithstanding Subsection 450.06.b., an optometrist, or licensed physician who issues a contact lens prescription remains professionally responsible to the patient. (3-20-20)T

**451. -- 474. (RESERVED)**

**475. PATIENTS RECORDS.**

**01. Optometrist Shall Keep a Complete Record of All Patients Examined.** Every optometrist practicing in the state of Idaho shall keep a complete record of all patients examined by him or for whom he has adapted optical accessories, including copies of prescriptions issued to the patient and copies of statements of charges

delivered or provided to the patient. All such records shall be maintained in an orderly and accessible manner and place and shall be maintained for at least five (5) years following the optometrist's last professional contact with the patient. Failure to maintain such records is deemed to be unprofessional conduct and constitutes gross incompetence in the handling of the patient's affairs. (3-20-20)T

**02. Prescription Files.** The prescription files and all records pertaining to the practice of optometry shall be maintained as the sole property of the optometrist and not be distributed to any unlicensed person except as required by law or when lawfully subpoenaed in a criminal or civil proceeding in court, or subpoenaed for presentation at a deposition or hearing authorized by the Board of Optometry. (3-20-20)T

**03. Storage of Patient Records.** Storage of patient records must be in compliance with rules in accordance with Health Insurance Portability and Accountability Act (HIPAA) including that patient records must be stored in an area inaccessible to patients. (3-20-20)T

**476. -- 499. (RESERVED)**

**500. PRECEPTORSHIP PROGRAM.**

An optometrist may use a student of optometry in his office under his direct supervision for educational purposes. (3-20-20)T

**501. -- 524. (RESERVED)**

**525. GENERAL RULES.**

**01. Engaging as an Advisor or Staff Optometrist.** An optometrist may be engaged as an advisor for or be engaged as a staff optometrist for an administrator for: (3-20-20)T

- a.** Industrial plants where industrial vision programs are being, or have been instituted. (3-20-20)T
- b.** Health programs sponsored or funded by any agency or municipal county, state or federal government. (3-20-20)T
- c.** Research organizations or educational institutions. (3-20-20)T
- d.** Insurance companies. (3-20-20)T
- e.** Hospitals. (3-20-20)T
- f.** Ophthalmologists. (3-20-20)T
- g.** Corporations where the optometrist's full time is engaged by the corporation to care for the visual needs of the employees of such corporation and their families. (3-20-20)T

**02. Professional Responsibilities.** Provided, however, that in acting in the capacity of consultant, advisor, or staff optometrists, the optometrist shall at all times remain cognizant of his professional responsibilities and shall with demeanor, decorum and determination retain his right of independent professional judgment and title in all situations and circumstances and in a manner similar to that which he would exercise if he were engaged in practice in his own office. (3-20-20)T

**526. -- 574. (RESERVED)**

**575. FEES.**

<b>FEE TYPE</b>	<b>AMOUNT (Not to Exceed)</b>
License Application	\$100
Annual Fund	\$75
Annual Renewal	\$75
Certificate to obtain and use pharmaceutical agents	\$10
Reinstatement	As provided in Section 67-2614, Idaho Code

(3-20-20)T

**576. -- 599. (RESERVED)**

**600. BOARD CERTIFICATION OF OPTOMETRIST AUTHORIZED TO OBTAIN AND USE PHARMACEUTICAL AGENTS.**

**01. The Right to Obtain and Use Topically Applied Diagnostic Pharmaceutical Agents.** The right to obtain and use topically applied diagnostic pharmaceutical agents for use in diagnosis of another in the practice of optometry as defined by Section 54-1501, Idaho Code, is subject to the following conditions set out below:

(3-20-20)T

**a.** Optometrists who have obtained a certificate from the Board of Optometry authorizing them to obtain and use topically applied diagnostic pharmaceutical agents shall obtain, from pharmacists licensed by the state of Idaho, or from any other source, and use only those agents listed below:

(3-20-20)T

i. All medications for use in the diagnosis of conditions of the human eye and/or eyelid. (3-20-20)T

ii. All over-the-counter agents. (3-20-20)T

iii. Such other diagnostic pharmaceutical agents as may be approved by the Board of Optometry. (3-20-20)T

**b.** The Board of Optometry shall issue a certificate to obtain and use the diagnostic drugs specifically identified and listed in this rule to any optometrist licensed to practice in Idaho who complies with both the minimum educational requirements in the subject of general and ocular pharmacology and the minimum continuing educational requirements set out below:

(3-20-20)T

i. Each optometrist certified to obtain and use topically applied pharmaceutical agents shall have completed courses totaling fifty-five (55) hours of actual classroom instruction in general and ocular pharmacology and emergency medical care given by an institution approved by the Council on Post Secondary Accreditation of the U.S. Department of Education or an instructor accredited and employed by such institution and which have been approved by the Board of Optometry.

(3-20-20)T

ii. Each optometrist certified to obtain and use topically applied pharmaceutical agents shall also have completed a refresher course in cardiopulmonary resuscitation (CPR), emergency medical care provided by the Emergency Medical Services Bureau, or equivalent program either approved or provided by the Board of Optometry, within a two (2) year period preceding issuance of the certificate by the Board of Optometry.

(3-20-20)T

iii. In order to maintain the certificate issued by the Board, each certified optometrist must complete a refresher course in CPR described in Subsection 600.01.b.ii. above once during each two (2) year period following certification and shall list and describe the course attended and the dates of attendance upon a license renewal application form filed pursuant to Section 300.

(3-20-20)T

**c.** In order to implement this rule, the Board of Optometry may designate and approve courses of instruction given by those institutions or instructors described in Subsection 600.01.b.i. above which may be necessary to provide practicing optometrists who have received less than fifty-five (55) hours of actual classroom instruction in general and ocular pharmacology in optometry school with the opportunity to meet the requirements of this rule. (3-20-20)T

**02. The Right to Prescribe, Administer and Dispense Therapeutic Pharmaceutical Agents.** The right to prescribe, administer and dispense therapeutic pharmaceutical agents in the practice of optometry as defined by Section 54-1501, Idaho Code, is subject to the following conditions set out below: (3-20-20)T

**a.** Optometrists who have obtained a certificate from the Board of Optometry authorizing them to prescribe, administer and dispense therapeutic pharmaceutical agents shall obtain, from pharmacists licensed by the State of Idaho, or from any other source, and use only those agents listed below: (3-20-20)T

- i. All medications for use in the treatment of the human eye and/or eyelid. (3-20-20)T
- ii. All over-the-counter agents. (3-20-20)T
- iii. Such other therapeutic pharmaceutical agents as may be approved by the Board of Optometry. (3-20-20)T

**b.** The Board of Optometry shall issue a certificate to prescribe, administer and dispense the therapeutic medications to any optometrist licensed to practice in Idaho who complies with Subsection 600.01 and both the minimum educational and clinical experience requirements in the subject of ocular pharmacology and therapeutics and the minimum continuing educational requirements set out below: (3-20-20)T

i. Completion of a minimum of one hundred (100) hours of actual classroom and clinical instruction in ocular pharmacology and therapeutics courses given by an institution or organization approved by the Council on Post-Secondary Accreditation of the U.S. Department of Education, or an Instructor employed by such institution, which have been approved by the Board of Optometry. (3-20-20)T

ii. Successful passage of the "Treatment and Management of Ocular Diseases" section of the optometrist examination approved by the Association of Regulatory Boards of Optometry, Inc. (ARBO) or its equivalent as approved by the Board. (3-20-20)T

**601. -- 999. (RESERVED)**



# IDAPA 24 – DIVISION OF OCCUPATIONAL AND PROFESSIONAL LICENSES

## 24.11.01 – RULES OF THE STATE BOARD OF PODIATRY

### DOCKET NO. 24-1101-2000F (FEE RULE)

#### NOTICE OF OMNIBUS RULEMAKING – ADOPTION OF TEMPORARY RULE

**EFFECTIVE DATE:** The effective date of the temporary rules being adopted through this omnibus rulemaking is the adjournment date of the second regular session of the 65th Idaho State Legislature - March 20, 2020.

**AUTHORITY:** In compliance with Sections 67-5226, Idaho Code, notice is hereby given this agency has adopted a temporary rule. The action is authorized pursuant to Section 54-605, Idaho Code.

**DESCRIPTIVE SUMMARY:** The following is the required finding and concise statement of its supporting reasons for adopting a temporary rule:

This temporary rulemaking adopts the following chapter under IDAPA 24.11.01:

**IDAPA 24.11**

- 24.11.01, *Rules of the State Board of Podiatry.*

**TEMPORARY RULE JUSTIFICATION:** Pursuant to Sections 67-5226(1) and 67-5226(2), Idaho Code, the Governor has found that temporary adoption of the rule is appropriate for the following reasons:

These temporary rules are necessary to protect the public health, safety, and welfare of the citizens of Idaho and confer a benefit on its citizens. These temporary rules implement the duly enacted laws of the state of Idaho, provide citizens with the detailed rules and standards for complying with those laws, and assist in the orderly execution and enforcement of those laws. The expiration of these rules without due consideration and processes would undermine the public health, safety, and welfare of the citizens of Idaho and deprive them of the benefit intended by these rules. These rules govern the qualifications for the practice of podiatry and define the ethical standards of the profession in Idaho. Allowing these rules, including the ethical standards, to expire would harm the public health, safety, and welfare, harm licensees, and harm prospective licensees.

**FEE SUMMARY:** Pursuant to Section 67-5226(2), the Governor has found that the fees or charges being imposed or increased are justified and necessary to avoid immediate danger and the fees are described herein:

The fees or charges, authorized in Sections 54-605, and 54-606, Idaho Code, are part of the agency's 2021 budget that relies upon the existence of these fees or charges to meet the state's obligations and provide necessary state services. Failing to reauthorize these temporary rules would create immediate danger to the state budget, immediate danger to necessary state functions and services, and immediate danger of a violation of Idaho's constitutional requirement that it balance its budget.

The following is a specific description of the fees or charges:

Application	\$200
Original License	\$400
Written Examination	Set by National Examining Entity
Annual Renewal	\$500
Inactive License Annual Renewal	\$250

**ASSISTANCE ON TECHNICAL QUESTIONS:** For assistance on technical questions concerning the temporary rule, contact Rob McQuade at (208) 334-3233.

DATED this February 21, 2020.

Kelley Packer  
Division Administrator  
Division of Occupational and Professional Licenses  
700 W. State Street  
P.O. Box 83720  
Boise, ID 83720  
Phone: (208) 334-3233  
Fax: (208) 334-3945

## 24.11.01 – RULES OF THE STATE BOARD OF PODIATRY

### 000. LEGAL AUTHORITY.

These rules are hereby prescribed and established pursuant to the authority vested in the State Board of Podiatry, by the provisions of Section 54-605, Idaho Code. (3-20-20)T

### 001. TITLE AND SCOPE.

These rules are titled IDAPA 24.11.01, “Rules of the State Board of Podiatry.” (3-20-20)T

### 002. INCORPORATION BY REFERENCE.

The document titled American Podiatric Medical Association’s Code of Ethics as published by the American Podiatric Medical Association, dated March 2013 and referenced in Section 500, is herein incorporated by reference and is available for review at the Board’s office and on the Board’s web site at <http://www.ibol.idaho.gov>. (3-20-20)T

### 003. -- 009. (RESERVED)

### 010. DEFINITIONS AND STANDARDS.

01. **Licensure.** Licensure means a license to practice podiatry in Idaho. (3-20-20)T

02. **Reputable School.** A “reputable school” of podiatry is defined as an approved podiatry school located within the United States or Canada and designated as such by the Council on Podiatric Medical Education and the American Podiatric Medical Association. (3-20-20)T

### 011. -- 149. (RESERVED)

### 150. PRE-PROFESSIONAL EDUCATION.

All applicants must provide official documentation of credits granted for at least two (2) full years of general college study in a college or university of recognized standing. (3-20-20)T

### 151. PROFESSIONAL EDUCATION.

All applicants must possess evidence of graduation from four (4) full years of study in a reputable school of podiatry, as defined in Subsection 010.04 of these rules. (3-20-20)T

### 152. PODIATRIC RESIDENCY.

01. **Residency Required for Licensure.** A candidate may not apply for licensure until completion of an accredited podiatric residency as approved by the Council on Podiatric Medical Education of no less than twenty-four (24) months, a minimum of twelve (12) months of which must be surgical. (3-20-20)T

02. **Submission of Verification of Residency Curriculum.** Notwithstanding the provisions of Subsection 152.01, a candidate must provide directly from the residency program such official documentation of completion of the entire curriculum as the board may require. Any deviation of this requirement must be approved by the Board. (3-20-20)T

### 153. -- 199. (RESERVED)

### 200. CREDENTIALS TO BE FILED BY ALL APPLICANTS.

01. **Certified Copy of National Board Results.** A copy of the applicable National Board results that has been certified as true and correct by the examining entity. (3-20-20)T

02. **Educational Certificate Requirement.** Each applicant must provide official documentation of a collegiate education of not less than two (2) years in an accredited college or university giving instruction in letters and sciences. (3-20-20)T

03. **Diploma.** Certified photostatic copy of diploma granted by any college of podiatry and official certified transcripts indicating graduation from the program. (3-20-20)T

04. **Residency Certification Requirement.** All applications must include certification of completion of a residency as defined in Rule 152. (3-20-20)T

### 201. -- 299. (RESERVED)

**300. FEES.**

All fees are non-refundable; if a license is not issued, the license fee will be refunded.

<b>FEE TYPE</b>	<b>AMOUNT (Not to Exceed)</b>
Application	\$200
Original License	\$400
Written Examination	Set by National Examining Entity
Annual Renewal	\$500
Inactive License Annual Renewal	\$250

(3-20-20)T

**301. -- 399. (RESERVED)**

**400. LICENSURE BY EXAMINATION.**

**01. Examination of Applicants.** All applicants must successfully pass all parts of the American Podiatric Medical Licensing Examination developed and administered by the National Board of Podiatric Medical Examiners. (3-20-20)T

**02. Passing Grade.** A passing grade in all subjects examined is the grade established by the examination provider. (3-20-20)T

**401. LICENSURE BY ENDORSEMENT.**

Under Section 54-613, Idaho Code, applicants for licensure by endorsement may be granted a license upon the approval of the Board. Each applicant for licensure by endorsement must provide documentation for each of the following before licensure will be considered: (3-20-20)T

**01. Certification of License.** Certification of having maintained a current license or other authority to practice issued by a regulatory board of Podiatry in any state or territory. (3-20-20)T

**02. Credentials.** Credentials as required in Subsections 200.02 through 200.05. (3-20-20)T

**03. Examination.** Successful passage of a written licensure examination covering all those subjects noted in Section 54-606, Idaho Code. Official certification of examination must be received by the board directly from: (3-20-20)T

**a.** The applicant's state or territory of licensure; or (3-20-20)T

**b.** The national board of podiatric medical examiners. (3-20-20)T

**04. Residency.** Proof of completion of the residency requirement as set forth in Subsection 200.06 of this rule. However, if the applicant graduated from a college of podiatry prior to 1993, this requirement will be waived. (3-20-20)T

**05. Practical Experience.** Having practiced podiatry under licensure for three (3) of the last five (5) years immediately prior to the date of application. (3-20-20)T

**06. Continuing Education.** Having completed at least fifteen (15) hours of continuing education germane to the practice of podiatry during the twelve (12) months prior to the date of application. (3-20-20)T

**07. Disciplinary Action.** Has not been the subject of any disciplinary action including pending or

unresolved licensure actions within the last five (5) years immediately prior to application and has never had a license to practice podiatry revoked or suspended either voluntarily or involuntarily in any jurisdiction. (3-20-20)T

**402. TEMPORARY LICENSES.**

No temporary licenses will be granted for the practice of podiatry in Idaho. (3-20-20)T

**403. -- 409. (RESERVED)**

**410. ORIGINAL APPLICATION.**

The original application will be considered null and void after a period of two (2) years from date of original application if no license has been issued. (3-20-20)T

**411. -- 424. (RESERVED)**

**425. INACTIVE STATUS.**

**01. Request for Inactive Status.** Each person requesting an inactive status during the renewal of their active license must submit a written request and pay the inactive license fee. (3-20-20)T

**02. Inactive License Status.** (3-20-20)T

**a.** All continuing education requirements will be waived during the time that a licensee maintains an inactive license in Idaho. (3-20-20)T

**b.** When the licensee desires active status, the licensee must show acceptable fulfillment of continuing education requirements for the previous twelve (12) months and submit a fee equivalent to the difference between the inactive and active renewal fee. (3-20-20)T

**426. -- 449. (RESERVED)**

**450. SCOPE OF PRACTICE.**

**01. Competence.** Upon being granted a license to practice podiatry, a practitioner is authorized to provide only those services and treatments for which that practitioner has been trained and prepared to provide. Information contained within the application file and supplemental certified information of additional training and experience included in the credential file maintained by the practitioner is prima facie evidence of the practitioner's education and experience. It is the responsibility of the individual practitioner to ensure that the information in his credential file is accurate, complete and supplemented to support all procedures, applications and treatments employed by the practitioner. Practice beyond a practitioner's documented education and experience may violate the adopted code of ethics and be grounds for discipline by the board. (3-20-20)T

**02. Advanced Surgical Procedures.** Advanced surgical procedures must be performed in a licensed hospital or certified ambulatory surgical center accredited by the joint commission on accreditation of healthcare organizations or the accreditation association for ambulatory health care where a peer review system is in place. Advanced surgical procedures are defined as: (3-20-20)T

**a.** Ankle fractures - Open Reduction and Internal Fixation. (3-20-20)T

**b.** Ankle and rearfoot arthrodesis. (3-20-20)T

**c.** Nerve surgery of the leg. (3-20-20)T

**d.** Major tendon repair or transfer surgery - proximal to ankle. (3-20-20)T

**e.** Autogenous bone grafting. (3-20-20)T

**f.** External fixation of the rearfoot, ankle and leg. (3-20-20)T

**451. -- 499. (RESERVED)**

**500. STANDARDS OF THE ETHICAL PRACTICE OF PODIATRY.**

The standards for the ethical practice of podiatry is the American Podiatric Medical Association's Code of Ethics as referenced in Section 004 of these rules and are hereby adopted and apply to all practitioners of podiatry. (3-20-20)T

**501. -- 549. (RESERVED)**

**550. DISCIPLINE.**

**01. Civil Fine.** The Board may impose a civil fine not to exceed one thousand dollars (\$1,000) upon a licensed podiatrist for each violation of Sections 54-608 and 54-609, Idaho Code. (3-20-20)T

**02. Costs and Fees.** The Board may order a licensed podiatrist to pay the costs and fees incurred by the Board in the investigation or prosecution of the licensee for violation of Sections 54-608 and 54-609, Idaho Code. (3-20-20)T

**551. -- 699. (RESERVED)**

**700. CONTINUING EDUCATION.**

**01. Education Requirement for License Renewal.** Each podiatrist licensed by the state of Idaho must complete in each twelve-month period preceding the renewal of a license to practice podiatry in Idaho, a minimum of fifteen (15) full hours of podiatry continuing education. Continuing education includes lectures, conferences, seminars, moderator-guided panel discussions, clinical and practical workshops, internet based learning and home study. Education must be germane to the practice of podiatry; and (3-20-20)T

**a.** Approved by the Council on Podiatric Medical Education; or (3-20-20)T

**b.** Otherwise approved by the Board. (3-20-20)T

**02. Submission of License Renewal Application Form.** Each licensed Idaho podiatrist will be furnished a license renewal application form by the Division of Occupational and Professional Licenses on which each podiatrist will be required to certify by signed affidavit that compliance with the continuing education requirements has been met and must submit the renewal application together with the required fees to the Division. (3-20-20)T

**03. Verification of Completion.** A licensee must maintain verification of completion by securing authorized signatures or other documentation from the course instructors or sponsoring institution substantiating any and all hours completed by the licensee. This verification must be maintained by the licensee and provided to the Board upon the request of the Board or its agent. The Board will conduct random audits to monitor compliance. Failure to provide proof of meeting the continuing education upon request of the Board will be grounds for disciplinary action. (3-20-20)T

**04. Carryover of Continuing Education Hours.** Continuing education not claimed for credit in the current renewal year may be credited for the next renewal year. A maximum of fifteen (15) hours may be carried forward from the immediately preceding year. (3-20-20)T

**05. Special Exemption.** The Board has authority to make exceptions for reasons of individual hardship, including health, when certified by a medical doctor, or for other good cause. The licensee must provide any information requested by the Board to assist in substantiating hardship cases. This exemption is granted at the sole discretion of the Board. (3-20-20)T

**701. -- 999. (RESERVED)**

# IDAPA 24 – DIVISION OF OCCUPATIONAL AND PROFESSIONAL LICENSES

## 24.12.01 – RULES OF THE IDAHO STATE BOARD OF PSYCHOLOGIST EXAMINERS

### DOCKET NO. 24-1201-2000F (FEE RULE)

#### NOTICE OF OMNIBUS RULEMAKING – ADOPTION OF TEMPORARY RULE

**EFFECTIVE DATE:** The effective date of the temporary rules being adopted through this omnibus rulemaking is the adjournment date of the second regular session of the 65th Idaho State Legislature - March 20, 2020.

**AUTHORITY:** In compliance with Sections 67-5226, Idaho Code, notice is hereby given this agency has adopted a temporary rule. The action is authorized pursuant to Sections 54-2305, Idaho Code.

**DESCRIPTIVE SUMMARY:** The following is the required finding and concise statement of its supporting reasons for adopting a temporary rule:

This temporary rulemaking adopts the following chapter under IDAPA 24.12.01:

#### **IDAPA 24.12**

- 24.12.01, *Rules of the Idaho State Board of Psychologist Examiners.*

**TEMPORARY RULE JUSTIFICATION:** Pursuant to Sections 67-5226(1) and 67-5226(2), Idaho Code, the Governor has found that temporary adoption of the rule is appropriate for the following reasons:

These temporary rules are necessary to protect the public health, safety, and welfare of the citizens of Idaho and confer a benefit on its citizens. These temporary rules implement the duly enacted laws of the state of Idaho, provide citizens with the detailed rules and standards for complying with those laws, and assist in the orderly execution and enforcement of those laws. The expiration of these rules without due consideration and processes would undermine the public health, safety, and welfare of the citizens of Idaho and deprive them of the benefit intended by these rules. These rules govern the qualifications and ethical standards for psychologists in Idaho, as well as the necessary credentials and standards of practice for certified psychologists to exercise prescriptive authority. Allowing these rules to expire would deprive the Board of the ability to admit new psychologists to practice and renew current licenses, harming the public health, safety, and welfare.

**FEE SUMMARY:** Pursuant to Section 67-5226(2), the Governor has found that the fees or charges being imposed or increased are justified and necessary to avoid immediate danger and the fees are described herein:

The fees or charges, authorized in Sections 54-2307, 54-2312, 54-2312A, 54-2315, and 54-2318, Idaho Code, are part of the agency's 2021 budget that relies upon the existence of these fees or charges to meet the state's obligations and provide necessary state services. Failing to reauthorize these temporary rules would create immediate danger to the state budget, immediate danger to necessary state functions and services, and immediate danger of a violation of Idaho's constitutional requirement that it balance its budget.

The following is a specific description of the fees or charges:

FEE TYPE	AMOUNT (Not to Exceed)	RENEWAL (Not to Exceed)
Original Application for Licensure by Exam	\$150	
Inactive License Renewal	\$125	
Annual Renewal	\$250	
Original Application for Licensure by Endorsement/Senior Psychologist	\$250	
Original Application for Provisional Certification of Prescriptive Authority	\$250	\$250

<b>FEE TYPE</b>	<b>AMOUNT (Not to Exceed)</b>	<b>RENEWAL (Not to Exceed)</b>
Original Application for Certification of Prescriptive Authority	\$250	\$250
Original Application for Certification of Prescriptive Authority by Endorsement	\$250	
Application for Service Extender	\$100	\$100
Examination and Reexamination	The amount charged by the national examining entity plus a processing fee of \$25	
Reinstatement	As set forth in Section 67-2614, Idaho Code.	
Temporary License	\$50	

**ASSISTANCE ON TECHNICAL QUESTIONS:** For assistance on technical questions concerning the temporary rule, contact Rob McQuade at (208) 334-3233.

DATED this February 21, 2020.

Kelley Packer  
Division Administrator  
Division of Occupational and Professional Licenses  
700 W. State Street  
P.O. Box 83720  
Boise, ID 83720  
Phone: (208) 334-3233  
Fax: (208) 334-3945



## 24.12.01 – RULES OF THE IDAHO STATE BOARD OF PSYCHOLOGIST EXAMINERS

### 000. LEGAL AUTHORITY.

These rules are hereby prescribed and established pursuant to the authority vested in the Idaho State Board of Psychologist Examiners by the provisions of Section 54-2305, Idaho Code. (3-20-20)T

### 001. TITLE AND SCOPE.

These rules are titled IDAPA 24.12.01, “Rules of the Idaho State Board of Psychologist Examiners.” (3-20-20)T

### 002. INCORPORATION BY REFERENCE.

The document titled “Ethical Principles of Psychologists and Code of Conduct,” published by the American Psychological Association and dated June 1, 2003 with the 2010 amendments effective June 1, 2010, as referenced in Section 350, is herein incorporated by reference and is available from the Board’s office and on the Board web site. (3-20-20)T

### 003. -- 009. (RESERVED)

### 010. DEFINITIONS.

**01. Certificate of Professional Qualification.** A certificate of professional qualification means the certificate of professional qualification granted to a psychologist by the Association of State and Provincial Psychology Boards. (3-20-20)T

**02. Collaboration or Collaborative Relationship.** Collaboration or collaborative relationship means a cooperative working relationship between a prescribing psychologist and a licensed medical provider in the provision of patient care, including cooperation in the management and delivery of physical and mental health care, to ensure optimal patient care. (3-20-20)T

**03. Geriatric Patient.** A person sixty-five (65) years of age or older. (3-20-20)T

**04. Licensed Medical Provider.** A physician or physician assistant licensed pursuant to chapter 18, title 54, Idaho Code, or an advanced practice registered nurse licensed pursuant to chapter 14, title 54, Idaho Code. (3-20-20)T

**05. Mental, Nervous, Emotional, Behavioral, Substance Abuse, and Cognitive Disorders.** Disorders, illnesses, or diseases listed in either the most recent edition of the Diagnostic and Statistical Manual of Mental Disorders published by the American Psychiatric Association or those listed in the International Classification of Diseases published by the World Health Organization. (3-20-20)T

**06. Pediatric Patient.** A person seventeen (17) years of age or younger. (3-20-20)T

**07. Prescribing Psychologist.** A person who holds a license to practice psychology issued by the Board and who holds a Certification or Provisional Certification of Prescriptive Authority issued by the Board under Sections 54-2317, 54-2318, 54-2319, Idaho Code, and these rules. (3-20-20)T

**08. Supervising Physician.** A board-certified psychiatrist, neurologist, or other physician with specialized training and experience in the management of psychotropic medication and who is licensed under chapter 18, title 54, Idaho Code, or an equivalent licensing provision of the law of a state adjoining Idaho. (3-20-20)T

### 011. -- 099. (RESERVED)

### 100. APPLICATION.

**01. Filing an Application.** Applicants for licensure or certification or provisional certification of prescriptive authority must submit a complete application, verified under oath, to the Board at its official address. The application must be on the forms approved by the Board and submitted together with the appropriate fee(s) and supporting documentation. (3-20-20)T

**02. Supporting Documents.** The applicant must provide or facilitate the provision of any supporting third-party documents that may be required under the qualifications for the license being sought. (3-20-20)T

**a.** Any third-party documents, including letters of reference, must be received by the Board directly from the third party. (3-20-20)T

**b.** One (1) of the two (2) years of supervised experience as required by Section 2307(2)(a), Idaho Code, for initial licensure may be pre-doctoral. The second year must be post-doctoral work under appropriate supervision and must be verified by the appropriate supervisor. (3-20-20)T

**101. -- 149. (RESERVED)**

**150. FEES.**

All fees are non-refundable. The examination or reexamination fee are in addition to the application fee and must accompany the application.

<b>FEE TYPE</b>	<b>AMOUNT (Not to Exceed)</b>	<b>RENEWAL (Not to Exceed)</b>
Original Application for Licensure by Exam	\$150	
Inactive License Renewal	\$125	
Annual Renewal	\$250	
Original Application for Licensure by Endorsement/Senior Psychologist	\$250	
Original Application for Provisional Certification of Prescriptive Authority	\$250	\$250
Original Application for Certification of Prescriptive Authority	\$250	\$250
Original Application for Certification of Prescriptive Authority by Endorsement	\$250	
Application for Service Extender	\$100	\$100
Examination and Reexamination	The amount charged by the national examining entity plus a processing fee of \$25	
Reinstatement	As set forth in Section 67-2614, Idaho Code.	
Temporary License	\$50	

(3-20-20)T

**151. -- 199. (RESERVED)**

**200. EXAMINATIONS.**

**01. Written Exam Required.** The Board will require a written examination of applicants. The written examination will be the National Examination for Professional Practice In Psychology (EPPP). (3-20-20)T

**02. Passing Score.** The Board has determined that a passing score on the EPPP is a raw score of one hundred forty (140) or, for examinations after April 1, 2001, a scaled score of five hundred (500) for licensure. (3-20-20)T

**03. Time and Place of Exam.** The examination will be conducted at a time and place specified by the administrator of the national examination for professional practice in psychology (EPPP). (3-20-20)T

**04. Failure of Exam.** The first time the examination is failed the applicant may take it again the next

time it is given upon application and payment of fees. If the examination has been failed twice, the individual must wait at least one (1) year and petition the Board for approval to take the examination the third time. The petition must include evidence satisfactory to the Board that the applicant has taken additional study in the field of Psychology before approval will be granted. (3-20-20)T

**201. EXAMINATION FOR PROVISIONAL CERTIFICATION OF PRESCRIPTIVE AUTHORITY.**

The approved examination for provisional certification of prescriptive authority is the Psychopharmacology Examination for Psychologists (PEP). (3-20-20)T

**01. Passing Score.** A passing score will be determined by the Association of State and Provincial Psychology Boards (ASPPB). (3-20-20)T

**02. Date of Exam.** The passage of the exam may have occurred prior to the effective date of these rules. (3-20-20)T

**202. -- 249. (RESERVED)**

**250. ENDORSEMENT.**

**01. Eligibility for Endorsement.** An applicant who is in possession of a valid statutory license or statutory certificate from another state or Canada may apply for licensing under the endorsement section of this law. (3-20-20)T

**02. Requirements for Endorsement.** An applicant under the endorsement section must have: (3-20-20)T

**a.** A valid psychology license or certificate issued by the regulatory entity of another jurisdiction; and (3-20-20)T

**b.** A history of no disciplinary action in any jurisdiction; and (3-20-20)T

**c.** Meet one of the following qualifications: (3-20-20)T

**i.** A current certificate of professional qualification in Psychology as defined in these rules; or (3-20-20)T

**ii.** A registration with the National Register of Health Service Providers in Psychology; or (3-20-20)T

**iii.** A certification by American Board of Professional Psychology; or (3-20-20)T

**iv.** Graduated from an APA accredited program with a doctoral degree in psychology and two (2) years of supervised experience acceptable to the Board, one (1) year of which may include a pre-doctoral practicum or internship and one (1) year of which must be post-doctoral; (3-20-20)T

**d.** Or complete both of the following: (3-20-20)T

**i.** Graduated with a doctoral degree in psychology or a related field, provided experience and training are acceptable to the Board; and (3-20-20)T

**ii.** A record of practicing Psychology at the independent level for the five (5) years of the last seven (7) years immediately prior to application. (3-20-20)T

**251. ENDORSEMENT FOR CERTIFICATION OF PRESCRIPTIVE AUTHORITY.**

The Board may grant a provisional certification or certification of prescriptive authority by endorsement to an applicant who completes an application as set forth in Section 100 of these rules, pays the required fee, and meets the following requirements: (3-20-20)T

**01. Holds a Current License.** The applicant must be the holder of a current and unrestricted license to practice psychology in another state and in Idaho; (3-20-20)T

**02. Holds a Current Certificate of Prescriptive Authority.** (3-20-20)T

**a.** The applicant must be the holder of a current and unrestricted certification of prescriptive authority from another state that imposes substantially equivalent educational and training requirements as those contained in Sections 54-2317 and 54-2318, Idaho Code, and these rules; or (3-20-20)T

**b.** The applicant must have training from the United States department of defense demonstration project or other similar program developed and operated by any branch of the armed forces that imposes substantially equivalent educational and training requirements as those contained in Sections 54-2317 and 54-2318, Idaho Code, and these rules. (3-20-20)T

**03. Credit Toward Requirements.** In the event that an applicant has not met the requirements for certification of prescriptive authority, the Board may consider an applicant's experience in prescribing in another state as meeting a portion of the requirements necessary to qualify for provisional certification or certification of prescriptive authority in this state. In that event, the Board may require additional education, supervision, or both to satisfy the requirements to obtain a provisional certification or certification of prescriptive authority in this state. (3-20-20)T

**04. Advisory Panel.** The Advisory Panel, as established in Section 54-2320, Idaho Code, will review the education and training of an applicant seeking certification by endorsement and advise the Board as to its sufficiency to meet the requirements for provisional certification or certification of prescriptive authority under Chapter 23, Title 54, Idaho Code, and these rules. (3-20-20)T

**252. -- 274. (RESERVED)**

**275. INACTIVE STATUS.**

**01. Request for Inactive Status.** Persons requesting an inactive status during the renewal of their active license must submit a written request and pay the established fee. (3-20-20)T

**02. Inactive License Status.** (3-20-20)T

**a.** All continuing education requirements will be waived for any year or portion thereof that a licensee maintains an inactive license and is not actively practicing or supervising in Idaho. (3-20-20)T

**b.** When the licensees desire active status, they must show fulfillment of continuing education requirements within the previous twelve (12) months and submit a fee equivalent to the difference between the current inactive and active renewal fee. (3-20-20)T

**276. -- 299. (RESERVED)**

**300. TEMPORARY LICENSES.**

Persons not licensed in this state who desire to practice psychology under the provisions of this chapter for a period not to exceed thirty (30) days within a calendar year may do so if they hold a license in another state or province have had no disciplinary action, and pay the required fee. Persons authorized to practice under this section must hold a certification of prescriptive authority issued by the Idaho Board of Psychologist Examiners to issue a prescription. (3-20-20)T

**301. -- 349. (RESERVED)**

**350. CODE OF ETHICS.**

All licensees must have knowledge of the Ethical Principles of Psychologists and Code of Conduct, as published in the American Psychologist, as referenced in Section 004. (3-20-20)T

**351. -- 374. (RESERVED)**

**375. DISCIPLINE.**

The Board may impose a civil fine not to exceed one thousand dollars (\$1,000) upon a licensed psychologist for each violation of Section 54-2309, Idaho Code. (3-20-20)T

**376. -- 379. (RESERVED)**

**380. REHABILITATION COMPONENTS.**

In the event of a violation of Board laws or rules, the Board, in its discretion, may implement a plan of rehabilitation. Completion of the plan may lead to consideration of submission of an application for re-licensure, the removal of suspension, or the removal of supervision requirements. In the event the licensee has not met the Board's criteria for rehabilitation, the plan may be revised, expanded, or continued depending upon the progress of the rehabilitation program. The rehabilitation components listed in this Section should be considered illustrative, but not exhaustive, of the potential options available to the Board. In each instance, rehabilitation parameters will be tailored to the individual needs of the licensee. (3-20-20)T

**01. Options in Devising Rehabilitation Program.** The Board may follow one (1) or more options in devising a rehabilitation program: (3-20-20)T

**a.** The individual may be supervised in all or selected areas of activities related to his practice as a licensee by a licensed psychologist approved by the Board for a specified length of time. (3-20-20)T

**i.** The Board may specify the focus of the supervision. (3-20-20)T

**ii.** The Board may specify the number of hours per week required in a face-to-face supervisory contract. (3-20-20)T

**iii.** The Board may require the supervisor to provide periodic and timely reports to the Board concerning the progress of the supervisee. (3-20-20)T

**iv.** Any fees for supervision time will be the responsibility of the supervisee. (3-20-20)T

**02. Educational Programs.** The individual may be expected to successfully complete a variety of appropriate educational programs. Appropriate educational formats may include, but are not limited to, workshops, seminars, courses in regionally accredited universities, or organized pre- or post-doctoral internship settings. Workshops or seminars that are not held in a setting of academic review (approved continuing education) need prior approval of the Board. Any course of study must be approved by the Board prior to enrollment if it is to meet the criteria of a rehabilitation plan. (3-20-20)T

**03. Additional Requirements.** The Board may require of the individual: (3-20-20)T

**a.** Psychodiagnostic evaluations by a psychologist approved by the Board; (3-20-20)T

**b.** A physical examination that may include an alcohol and drug screen by a physician approved by the Board; (3-20-20)T

**c.** Psychotherapy on a regular basis from a psychologist approved by the Board; (3-20-20)T

**d.** Take or retake and pass the appropriate professional examination; or (3-20-20)T

**381. -- 399. (RESERVED)**

**400. RENEWAL OF LICENSE -- CONTINUING EDUCATION.**

Licenses may be renewed or reinstated by payment of the required fees and by submitting certification of having satisfied the continuing education requirement. (3-20-20)T

**401. CONTINUING EDUCATION REQUIREMENTS FOR RELICENSURE IN PSYCHOLOGY.**

**01. Number of Hours Required.** All licensed psychologists, in order to renew their license, must have accumulated twenty (20) hours per year of continuing education credits. All prescribing psychologists, in order to renew their provisional certification or certification of prescriptive authority, must have accumulated twenty (20) hours per year of continuing education credits in psychopharmacology or psychopharmacotherapy offered in accordance with Subsection 402.01 of these rules. Continuing education credits for a prescribing psychologist are in addition to the continuing education credits required to renew their psychologist license. (3-20-20)T

**a.** At the time of renewal of the psychologists' licenses and prescribing psychologists' certifications, they will certify that they are aware of the requirements for continuing education and that they have met those requirements for the preceding year. (3-20-20)T

**b.** At the time of reinstatement of a psychologist's license or a prescribing psychologist's certification or provisional certification, the psychologist must provide proof of meeting the requirements for continuing education for the preceding year. (3-20-20)T

**c.** A minimum of four (4) hours credit in ethics, standards of care, and/or review of laws pertaining to the practice of psychology is required every three (3) years. Areas covered may include practice, consultation, research, teaching, and/or supervision. These units may be used as part of the continuing education credit required. (3-20-20)T

**02. Professional Level of Continuing Education – Time Period Records Kept - Audit.** This continuing education experience must be at an appropriate level for professional training in psychology. The licensees have responsibility for demonstrating the relevance and adequacy of the educational experience they select. The licensees are also responsible for keeping an accurate record of their own personal continuing education hours for a period of five (5) years. A random audit may be conducted to insure compliance. (3-20-20)T

**03. Newly Licensed Individuals.** Newly licensed individuals will be considered to have satisfied the continuing education requirements for the remainder of the year in which their license is granted. (3-20-20)T

**04. Certificates of Satisfactory Attendance and Completion.** Certificates of satisfactory attendance and completion, participant lists, transcripts from universities, letters of certification on instructor's letterhead, and other reasonably convincing proof of the submitted activities may serve as documentation when persons audited are required to submit proof of continuing education. (3-20-20)T

**05. Licensees Who Do Not Fulfill the Continuing Education Requirements.** Licensees who do not fulfill the continuing education requirements may be subject to disciplinary action. (3-20-20)T

**06. Carryover of Continuing Education Hours.** Continuing education courses not claimed for CE credit in the current renewal year, may be credited for the next renewal year. A maximum of twenty (20) hours may be carried forward from the immediately preceding year for renewal of a psychologist license, and a maximum of twenty (20) hours may be carried forward from the immediately preceding year for renewal of a prescribing psychologist's certificate. (3-20-20)T

**07. Special Exemption.** The Board may make exceptions for reasons of individual hardship including health, when certified by a medical doctor, or other good cause. The licensee must provide any information requested by the Board to assist in substantiating hardship cases. This exemption is granted at the sole discretion of the Board. Request for special exemption must be made prior to licensure renewal. (3-20-20)T

**402. GUIDELINES FOR APPROVAL OF CONTINUING EDUCATION CREDITS.**

**01. Continuing Education Credit.** Continuing education credit will be given to formally organized workshops or classes with an attendance roster and preassigned continuing education credit offered in association with or under the auspices of: (3-20-20)T

**a.** Regionally accredited institutions of higher education. (3-20-20)T

- b. The American Psychological Association. (3-20-20)T
- c. A Regional Psychological Association. (3-20-20)T
- d. A State Psychological Association. (3-20-20)T
- e. For prescribing psychologists, in addition to the approved organizations above, workshops or classes may be classified as continuing medical education credit and offered in association with or under the auspices of: (3-20-20)T
  - i. The American Medical Association; (3-20-20)T
  - ii. A regional medical association; (3-20-20)T
  - iii. A state medical association; or (3-20-20)T
  - iv. Offered by sponsors accredited by the Accreditation Council for Continuing Medical Education (ACCME). (3-20-20)T
- f. Credit will be given for the number of credit hours preauthorized by the sponsoring agency with no upper limit on the number of hours. (3-20-20)T

**02. Credit for International, National and Regional Meetings of Psychological Organizations.** Six (6) hours of continuing education credit will be allowed for documented attendance at international, national and regional meetings of psychological organizations. (3-20-20)T

**03. Credit for Other Relevant Workshops, Classes or Training Experiences.** Other relevant workshops, classes or training experiences when not offered, approved, or provided by an entity in Subsection 402.01, may receive up to six (6) hours of credit per experience provided they are conducted by a licensed or reputable psychologist or other mental health professional. Each documented hour of training experience counts as one (1) hour of continuing education experience. (3-20-20)T

**04. Presentation of Papers.** Presentation of papers at international, national, regional or state psychological or other professional associations may be counted as equivalent to six (6) hours per event. Only actual presentation time may be counted; preparation time does not qualify for credit. The licensee must provide the Board with a letter from a sponsor, host organization, or professional colleague, copy of the program, and a summary of the evaluations from the event. (3-20-20)T

**05. Self-Study, Lectures or Public or Professional Publications and Presentations.** The Board also recognizes the value of self-study, lectures or public or professional publications and presentations (including for example, in the case of the university faculty, preparation of a new course). Therefore, the Board will allow credit for six (6) hours of individual study per year. (3-20-20)T

a. Self-Study. The reading of a publication may qualify for credit with proper documentation verifying completion. A licensee seeking credit for reading a publication must submit results from a test on the information contained within the publication. If a test is not available, the licensee must seek pre-approval of the Board. (3-20-20)T

b. Professional publications. Publication activities are limited to articles in professional journals, a chapter in an edited book, or a published book. The licensee must provide the Board with a copy of the cover page of the article or book in which the licensee has been published. For chapters of an edited book, licensees must submit a copy of the table of contents. (3-20-20)T

**06. Board Assessment of Continuing Education Activities.** The Board of Psychologist Examiners may avail itself of help and consultation from the American Psychological Association or the Idaho Psychological Association in assessing the appropriateness of continuing education activities. (3-20-20)T

**07. Electronic Continuing Education Courses. (3-20-20)T**

**a.** Non-interactive. A maximum of ten (10) on-line, non-interactive continuing education hours relevant to the practice of psychology may be counted during each reporting period. (3-20-20)T

**i.** Continuing education credit will be given to on-line education offered in association with or under the auspices of the organizations listed in Subsections 402.01.a. through 402.01.d. of these rules. (3-20-20)T

**ii.** The licensee must provide the Board with a copy of the certification, verified by the authorized signatures from the course instructors, providers, or sponsoring institution, substantiating any hours completed by the licensee. (3-20-20)T

**b.** Interactive. To qualify for credit, teleconferences must feature an interactive format. Interactive conferences are those that provide the opportunity for participants to communicate directly with the instructor or that have a facilitator present at the conference site. The licensee must provide the Board with a copy of the certificate, or a letter signed by course instructors, providers, or sponsoring institution, substantiating any hours attended by licensee. (3-20-20)T

**i.** When offered, approved, or provided by entities in Subsection 402.01, the number of hours that may be counted during each reporting period is not limited. (3-20-20)T

**ii.** When not offered, approved, or provided by an entity in Subsection 402.01, a maximum of six (6) hours may be counted during each reporting period. (3-20-20)T

**403. -- 449. (RESERVED)**

**450. GUIDELINES FOR USE OF SERVICE EXTENDERS TO LICENSED PSYCHOLOGISTS.**

The Board recognizes that licensed psychologists may choose to extend their services by using service extenders. The Board provides general rules to cover all service extenders as well as specific rules to cover service extenders with different levels of training and experience. (3-20-20)T

**01. General Provisions for Licensed Psychologists Extending Their Services Through Others. (3-20-20)T**

**a.** The licensed psychologist will have administrative control for a service extender. (3-20-20)T

**b.** The licensed psychologist exercising professional direction for a service extender must: (3-20-20)T

**i.** Prior to employing the service extender, formulate and provide to the Board a written supervisory plan for each service extender and obtain approval for the plan. The plan must include provisions for supervisory sessions and chart review. If the psychologist requires recordings to be made of psychological services delivered by the service extender, then the plan must also specify review and destruction of these recordings. The plan must also specify the hours per calendar week that the licensed psychologist will be at the same physical location as the person extending the services of the licensed psychologist. The plan must be accompanied by a completed application form and appropriate application fee. (3-20-20)T

**ii.** Establish and maintain a level of supervisory contact sufficient to be readily accountable in the event that professional, ethical, or legal issues are raised. For service extenders in Categories I and II, there will be a minimum of one (1) hour of face-to-face supervisory contact by the licensed psychologist with the service extender for each one (1) to twenty (20) hours of services provided by the service extender during any calendar week. At least one half (1/2) of this face-to-face supervisory contact will be conducted individually, and up to one half (1/2) of this face-to-face supervisory contact may be provided using a group format. A written record of this supervisory contact, including the type of activities conducted by the service extender, must be maintained by the licensed psychologist. Except under unusual circumstances, the supervisory contact will occur either during the week the services are extended or during the week following. In no case will services be extended more than two (2) weeks without supervisory contact between the service extender and the licensed psychologist. For service extenders in Category III,



there will be a minimum of one (1) hour of face-to-face supervisory contact by the licensed psychologist with the service extender during each calendar month that services are provided by the service extender. A written record of this supervisory contact, including the type of activities conducted by the service extender, must be maintained by the licensed psychologist. The licensed psychologist will also be available for consultation either face-to-face, by phone, or by other means of contact on any day that services are provided by the service extender. (3-20-20)T

iii. Provide the service extender a copy of the current Ethical Standards of the American Psychological Association, and obtain a written agreement from the service extender of his intention to abide by them. (3-20-20)T

c. Supervision of service extenders through electronic communications, including video conferencing, cannot replace face-to-face supervision. Psychologists will ensure that the service that they provide through the use of service extenders is provided according to all applicable laws and rules. (3-20-20)T

**02. Qualifications for Service Extenders. (3-20-20)T**

a. Category I: A service extender will be placed in Category I if: (3-20-20)T

i. The licensed psychologist wishing to employ the service extender verifies in writing to the satisfaction of the Board that the service extender holds a license in counseling, social work, or a related mental health profession issued by the state of Idaho to practice a specific profession, and that the issuance of that license requires the licensee hold a master's degree or its equivalent as determined by the Board; or (3-20-20)T

ii. The service extender meets the criteria for Category II specified below and the licensed psychologist wishing to employ the service extender verifies in writing to the satisfaction of the Board that the service extender has satisfactorily functioned as a service extender to one (1) or more licensed psychologist for at least twenty (20) hours per calendar week over a period totaling two hundred sixty (260) weeks. (3-20-20)T

b. Category II: A service extender will be placed in Category II if the licensed psychologist wishing to employ the service extender verifies in writing to the satisfaction of the Board that the service extender holds a master's degree or equivalent from a program in psychology, counseling, or human development as determined by the Board. (3-20-20)T

c. Category III: A service extender will be placed in Category III if the licensed psychologist wishing to employ the service extender verifies in writing to the satisfaction of the Board that the service extender holds a master's degree or equivalent from a program in psychology, counseling, or human development as determined by the Board, and the service extender will only provide psychometrician services. Such services are defined as administrating, scoring, and/or summarizing psychological or neuropsychological tests and test data that require specialized training. Interpretation of the testing data must be performed by the licensed psychologist. Service extenders in Category III will not be allowed to perform psychotherapy, intake assessments, or other services outside the scope of psychometric services defined above. The licensed psychologist wishing to employ the service extender must also verify in writing to the satisfaction of the Board that the service extender has been properly trained in all of the testing instruments that the service extender will administer at the start of employment and will continue to receive proper training in any new testing instruments utilized by the service extender over the course of employment. (3-20-20)T

**03. Conditions for Use of Service Extenders. (3-20-20)T**

a. All persons used to extend the services of a licensed psychologist must be under the direct and continuing administrative control and professional direction of a licensed psychologist. These service extenders may not use any title incorporating the word "psychologist" or any of its variants or derivatives, e.g. "psychological," "psychotherapist." (3-20-20)T

b. Work assignments must be commensurate with the skills of the service extender and procedures must be planned in consultation with the licensed psychologist under all circumstances. (3-20-20)T

c. Public announcement of fees and services, as well as contact with lay or professional public must be offered only in the name of the licensed psychologist whose services are being extended. However, persons

licensed to practice professions other than psychology may make note of their status in such announcements or contacts. (3-20-20)T

**d.** Setting and collecting of fees must remain the sole domain of the licensed psychologist; excepting that when a service extender is used to provide services of the licensed psychologist, third party payers must be informed of this occurrence in writing at the time of billing. Unless otherwise provided in these rules and regulations, licensed psychologists may neither claim nor imply to service recipients or to third party payers an ability to extend their services through any person who has not been approved as a service extender to that psychologist as specified in this section. (3-20-20)T

**e.** All service recipients must sign a written notice of the service extender's status as a service extender for the licensed psychologist. A copy of the signed written notice will be maintained on file with the licensed psychologist. (3-20-20)T

**f.** Within the first three (3) contacts, the licensed psychologist must have face-to-face contact with each service recipient. (3-20-20)T

**g.** A licensed psychologist must be available to both the service extender and the service recipient for emergency consultation. (3-20-20)T

**h.** Service Extenders must be housed in the same service delivery site as the licensed psychologist whose services they extend. Whatever other activities they may be qualified to perform, service extenders must limit themselves to acting as service extenders of the licensed psychologist when providing direct services so long as they are physically located in the offices of the licensed psychologist. (3-20-20)T

**i.** A service extender in Category I may deliver as much as, but not more than fifty percent (50%) of their service while the licensed psychologist is not physically present at the service delivery site. A service extender in Category II may deliver as much as, but not more than twenty-five percent (25%) of their service while the licensed psychologist is not physically present at the service delivery site. Service extenders in the Category III may deliver as much as, but not more than seventy-five percent (75%) of their service while the licensed psychologist is not physically present at the service delivery site. Service Extenders providing as many as, but no more than, three (3) hours of service extension per calendar week must be exempted from the on-site provisions of Section 450 of this rule. Without notification to the Board, short term exemption from this rule for atypical circumstances, such as irregular travel by the licensed psychologist, may occur for periods as long as, but no longer than three (3) calendar weeks. Longer exemptions may be granted at the discretion of the Board on written request by the licensed psychologist to the Board. (3-20-20)T

**j.** The licensed psychologist must employ no more than three (3) service extenders. (3-20-20)T

**k.** When a licensed psychologist terminates employment of a service extender, the licensed psychologist will notify the Board in writing within thirty (30) days. (3-20-20)T

**l.** At the time of license renewal the licensed psychologist must submit for each service extender the appropriate fee together with certification to the Board that they possess: (3-20-20)T

**i.** A written record of supervisory contact for the previous twelve (12) months; and (3-20-20)T

**ii.** The percentage of time during the previous twelve (12) months that the service extender extended services while the licensed psychologist was at the service delivery site; and (3-20-20)T

**iii.** An updated plan for the supervision of each of his service extenders. (3-20-20)T

**m.** Documentation of supervisory notes, hours of supervision, number of hours on-site while the service extender provided services, and plan of supervision must be maintained by the supervisor for not less than three (3) years for each service extender and submitted to the Board upon request. (3-20-20)T

**451. -- 499. (RESERVED)**

**500. EDUCATIONAL AND CREDENTIALING REQUIREMENTS FOR LICENSURE.**

Applicants who receive a doctoral degree from a program accredited by the American Psychological Association are considered to have met all criteria outlined in Section 500. (3-20-20)T

**01. Training in Professional Psychology.** Training in professional psychology is doctoral training offered in an institution of higher education accredited by: (3-20-20)T

- a. Middle States Commission on Higher Education. (3-20-20)T
- b. The New England Association of Schools and Colleges. (3-20-20)T
- c. Higher Learning Commission. (3-20-20)T
- d. The Northwest Commission on Colleges and Universities. (3-20-20)T
- e. The Southern Association of Colleges and Schools. (3-20-20)T
- f. The Western Association of Schools and Colleges. (3-20-20)T

**02. Training Program.** The training program must stand as a recognizable, coherent organizational entity within the institution. Programs that are accredited by the American Psychological Association or that meet the criteria for such accreditation are recognized as meeting the definition of a professional psychology program. (3-20-20)T

**03. Authority and Primary Responsibility.** There must be a clear authority and primary responsibility for the core and specialty areas by a designated leader who is a doctoral psychologist and is a member of the core faculty. (3-20-20)T

**04. Content of Program.** The program must be an integrated, organized sequence of study. (3-20-20)T

**05. There Must Be an Identifiable Training Faculty and a Psychologist Responsible for the Program.** There must be an identifiable training faculty on site of sufficient size and breadth to carry out the training responsibilities. A faculty psychologist must be responsible for the program. (3-20-20)T

**06. Program Must Have an Identifiable Body.** The program must have an identifiable body of students who are matriculated in that program for a degree. (3-20-20)T

**07. What the Program Must Include.** The program must include supervised practicum and pre-doctoral internship appropriate to the practice of psychology. Pre-doctoral internships must be completed at member sites of the Association of Psychology Postdoctoral and Internship Centers, or sites demonstrating an equivalent program. (3-20-20)T

**08. Curriculum.** The curriculum must encompass a minimum of three (3) academic years of full time graduate study at least one (1) year of which is spent in full-time physical residence at the degree granting educational institution. In addition to instruction in professional areas of competence, which include assessment and diagnosis, intervention, consultation, and supervision, the core program must require each student to demonstrate competence in specific substantive areas. Minimal competence is demonstrated by passing a three (3) credit semester graduate course (or a five (5) credit quarter graduate course) in each of the substantive areas listed below: (3-20-20)T

- a. Biological Bases of Behavior: Physiological psychology, comparative psychology, neuropsychology, sensation and perception, psychopharmacology. (3-20-20)T
- b. Cognitive-Affective Bases of Behavior: Learning, cognition, motivation, emotion. (3-20-20)T
- c. Social Bases of Behavior: Social psychology, group processes, organizational and systems theory. (3-20-20)T

- d. Individual Differences: Personality theory, human development, abnormal psychology. (3-20-20)T
- e. Scientific and Professional Standards and Ethics. (3-20-20)T
- f. Research Design and Methodology. (3-20-20)T
- g. Techniques of Data Analysis: statistics, multivariate statistics, factor analysis, multiple regression, non-parametric statistics. (3-20-20)T
- h. Psychological Measurement: psychometric principles, test theory, personality assessment, cognitive assessment. (3-20-20)T
- i. History and Systems of Psychology. (3-20-20)T
- j. Multiculturalism and Individual Diversity. (3-20-20)T

**501. -- 549. (RESERVED)**

**550. REQUIREMENTS FOR SUPERVISED PRACTICE.**

**01. Duration and Setting of Supervised Practice. (3-20-20)T**

a. A year of supervised experience is defined as a minimum of one thousand (1000) hours of supervised service provision acquired during not less than a twelve (12) month and no more than a thirty-six (36) calendar month period. The first year of supervised experience must be accredited only after acquiring the equivalent of one (1) year of full time graduate study. A second year must be obtained post-doctorally. (3-20-20)T

**02. Qualifications of Supervisors.** Supervising psychologists must be licensed and must have training in the specific area of practice in which they are offering supervision. (3-20-20)T

**03. Amount of Supervisory Contact.** One (1) hour per week of face-to-face individual contact per twenty (20) hours of applicable experience is a minimum. (3-20-20)T

**04. Evaluation and Accreditation of Supervised Practice.** The Board will require submission of information by the supervisor(s) that enable it to evaluate and credit the extent and quality of the candidate's supervised practice, on a form approved by the Board (3-20-20)T

**05. Unacceptable Supervision.** Supervised practice time during which the supervisor deems supervisee's performance to have been unacceptable will not be credited towards the required supervised practice hours. (3-20-20)T

**551. -- 600. (RESERVED)**

**601. TELEPSYCHOLOGY.**

This rule supplements Title 54, Chapter 57, Idaho Code, the Idaho Telehealth Access Act, the American Psychological Association Guidelines for the Practice of Telepsychology, and all other laws and rules applicable to the practice of telepsychology in this state. (3-20-20)T

**01. Definitions.** For purposes of telepsychology services, the following terms are defined as follows: (3-20-20)T

a. Emergency. Emergency means a situation in which there is an occurrence that poses an imminent threat of a life threatening condition or severe bodily harm. (3-20-20)T

b. Information Technology. Information technology means the production, storage, and communication of information using computers and microelectronics including but not limited to telephones, mobile

devices, interactive videoconferencing, email, chat, text, social media, and other Internet based services. (3-20-20)T

**c.** Telehealth Provider. Telehealth provider means a person who is licensed, required to be licensed, or, if located outside of Idaho, would be required to be licensed if located in Idaho by Title 54, Chapter 23, Idaho Code and who provides or offers to provide telepsychology services to persons who are located in or who reside in Idaho. (3-20-20)T

**d.** Telepsychology Services. Telepsychology services mean psychological services provided by a provider through the use of electronic communications, information technology, asynchronous store and forward transfer of information or synchronous interaction between the provider at a distant site and a service recipient at an originating site. Such services include, but are not limited to, assessing, testing, diagnosing, treating, educating, and consulting. (3-20-20)T

**02. General.** (3-20-20)T

**a.** When telepsychology services are contemplated, a telehealth provider will document individualized potential benefits and potential risks to the service recipient(s). (3-20-20)T

**b.** Before telepsychology services are provided, a telehealth provider will document an emergency plan in the service recipient's record. The plan will specify the procedure for dealing with emergencies that will in an effective and timely way, provide for the service recipient's welfare. (3-20-20)T

**c.** Except for psycho-educational purposes, the use of avatars for telepsychology services is prohibited. (3-20-20)T

**03. Initial Contact.** Telehealth providers will, upon initial contact with the service recipient except in an emergency, prior to providing telepsychology services, obtain the written, informed consent of the service recipient(s), consistent with accepted professional and legal requirements concerning: (3-20-20)T

**a.** The limitations and challenges of using information technology to provide telepsychology services; (3-20-20)T

**b.** The potential for breaches in confidentiality of information while delivering telepsychology services; (3-20-20)T

**c.** The risks of sudden and unpredictable disruption of telepsychology services and the alternative means by which communication may be re-established. (3-20-20)T

**04. Informed Consent.** Telehealth providers will, upon initial and subsequent contact with the service recipient: (3-20-20)T

**a.** Make reasonable efforts to verify the identity of the service recipient; (3-20-20)T

**b.** Provide to the service recipient alternative means of contacting the telehealth provider should communications be disrupted during the provision of services. (3-20-20)T

**c.** Discuss who, in addition to the provider and the service recipient, may have access to the content of telecommunications between the provider and service recipient; (3-20-20)T

**d.** Inform the service recipient of when and how the provider will respond to electronic messages; (3-20-20)T

**e.** Ensure that a written agreement has been executed with service recipient(s) concerning compensation, billing, and payment arrangements. (3-20-20)T

**05. Security and Confidentiality.** Telehealth providers must: (3-20-20)T

**a.** Use secure communications when providing telepsychology services and document consent for the use of non-secure communication means when they are necessary; (3-20-20)T

**b.** Document how electronic communications are stored and maintain confidentiality of communications with service recipients; (3-20-20)T

**c.** Ensure that unauthorized persons cannot recover or access confidential electronically-stored information when retained by the provider and after the data or equipment in which the data is stored has been discarded. (3-20-20)T

**d.** Inform service recipients how electronic communications may be sent to the provider and how the provider will store these communications. (3-20-20)T

**06. Assessment.** (3-20-20)T

**a.** When conducting psychological assessments using telepsychology services, telehealth providers must only use test and assessment procedures that are empirically supported for the patient population being evaluated. (3-20-20)T

**b.** Telehealth providers using telepsychology for assessment must ensure that the identity of service recipients remains secure, that test security is maintained, that test-taking conditions are conducive to quiet and private test administration, and that the parameters of the test(s) are not compromised. (3-20-20)T

**c.** Telehealth providers will explain to service recipients the potential limitations of conclusions and recommendations drawn from the results on online assessments and will document these limitations in the findings or report. Treatment will not be based solely upon the results of online assessments. (3-20-20)T

**07. Interjurisdictional Practice.** (3-20-20)T

**a.** Before delivering telepsychology services to recipients across state, territorial, and international boundaries, telehealth providers should familiarize themselves and ensure that they comply with all applicable laws. (3-20-20)T

**b.** Telehealth providers who are licensed to practice psychology pursuant to Title 54, Chapter 23, Idaho Code are under the jurisdiction of the Board when providing telepsychology services to Idaho residents located either within or outside of Idaho and to all recipients located within the state of Idaho. (3-20-20)T

**c.** Except when providing telepsychology services in response to an emergency, telehealth providers who are not licensed to practice psychology in this state, who do not hold a temporary license under Section 300, or who are not otherwise exempt by law, but who are nevertheless providing telepsychology services to recipients located in this state, are guilty of a misdemeanor crime under Chapter 23, Title 54, Idaho Code. (3-20-20)T

**602. -- 699. (RESERVED)**

**700. QUALIFICATIONS FOR PROVISIONAL CERTIFICATION OF PRESCRIPTIVE AUTHORITY.**

The Board may grant a provisional certification of prescriptive authority to an applicant who holds a current license to practice psychology in Idaho, who completes an application as set forth in Section 100 of these rules, pays the required fee, and who meets the following educational and training qualifications. (3-20-20)T

**01. Doctoral Degree.** The applicant must have been awarded a doctoral degree in psychology from an institution of higher education that meets the requirements in Section 54-2317(2), Idaho Code. (3-20-20)T

**02. Master's Degree.** The applicant must have been awarded a master's degree in clinical psychopharmacology from an accredited program that meets the requirements in Section 54-2317(3), Idaho Code. (3-20-20)T

**03. Clinical Experience.** An applicant must have successfully completed clinical experience as part of

the master’s clinical psychopharmacology program that includes a diverse population of patients. (3-20-20)T

**a.** Clinical experience must include a minimum of four hundred (400) hours consisting of direct patient contact and collaboration with licensed medical providers involving a minimum of one hundred (100) separate patients. (3-20-20)T

**b.** A diverse population of patients includes diversity in: (3-20-20)T

i. Gender; (3-20-20)T

ii. Different ages throughout the life cycle, including adults, children/adolescents, and geriatrics, as possible and appropriate; (3-20-20)T

iii. Range of disorders listed in the most recent diagnostic and statistical manual of mental disorders published by the American psychiatric association and acute and chronic disorders; (3-20-20)T

iv. Ethnicity; (3-20-20)T

v. Socio-cultural background; and (3-20-20)T

vi. In-patient and out-patient settings, as possible and appropriate. (3-20-20)T

**04. Examination.** An applicant must successfully pass the national examination in psychopharmacology, as approved by the Board under Section 201 of these rules. (3-20-20)T

**05. Supervision Agreement.** An applicant must submit to the Board a supervision agreement that identifies the supervising physician(s) who will directly supervise the applicant’s prescribing under a provisional certification of prescriptive authority. The documentation submitted to the Board must also identify: (3-20-20)T

**a.** For each supervising physician, the supervisor’s name, address, license number, state in which granted, licensure status, length of licensure, and area of specialization; (3-20-20)T

**b.** For each supervising physician, documentation of the physician’s board-certification as a psychiatrist or neurologist or of specialized training and experience in the management of psychotropic medication; (3-20-20)T

**c.** For an applicant seeking to prescribe for pediatric or geriatric patients, the supervising physician(s)’ specialized training and experience in treating the patient population for which the applicant seeks to prescribe; (3-20-20)T

**d.** Designate a primary supervising physician when more than one (1) supervising physician is identified. The primary supervising physician will be responsible for coordinating between the other supervising physician(s) to obtain written progress reports at least every six (6) months concerning how the provisional prescribing psychologist is performing in the domains for supervision. (3-20-20)T

**e.** The types of cases for which each supervisor will be responsible for supervising and in which the supervisor has specialized training and experience. (3-20-20)T

**f.** The number of provisional certification holders supervised by each supervising physician. A supervising physician may not concurrently supervise more than three (3) provisional certification holders unless otherwise approved by the Board; and (3-20-20)T

**g.** The name and nature of setting in which the applicant will practice; (3-20-20)T

**h.** Prior to a change in supervisors or a change in the supervision agreement, the supervisee must notify the Board and the change must be approved by the Board, or a designated member of the Board, prior to the commencement of supervision by a new supervisor or implementation of the change. (3-20-20)T

**701. SUPERVISED PRACTICE OF PROVISIONAL CERTIFICATION HOLDER.**

A holder of a provisional certification of prescriptive authority may only prescribe under the supervision of physician(s) approved by the Board. Prior to application for a certification of prescriptive authority, a provisional certification holder must complete two (2) years of satisfactory prescribing, which includes: (3-20-20)T

**01. Hours of Supervision.** A minimum of two thousand (2,000) hours acquired in not less than twenty-four (24) months and not more than forty-eight (48) months. (3-20-20)T

**a.** The two thousand (2,000) hours may consist of direct patient contact, supervision, case consultations, and collaboration with licensed health care providers for the purpose of evaluation and treatment of patients with medication(s) within the formulary set forth in Section 730 of these rules. (3-20-20)T

**b.** Supervised practice time during which the supervisor(s) deem(s) a supervisee's performance to have been unsatisfactory will not be credited towards the required supervised practice hours. A supervisor who believes the supervisee's practice is unsatisfactory should notify the supervisee and the primary supervisor as soon as possible and identify the basis for such conclusion including, but not limited to, specific domains or issues needing remediation. (3-20-20)T

**02. Number of Patients.** A minimum of fifty (50) separate patients who are seen for the purpose of evaluation and treatment with those medications that are within the formulary established in Section 730 of these rules. (3-20-20)T

**03. Amount of Supervisory Contact.** Supervision must occur on a one-to-one basis at a minimum of one (1) hour for each six (6) hours of clinical contact time with patients being seen for the purpose of evaluation and treatment with those medications that are within the formulary established in Section 730 of these rules. One-to-one supervision must be provided either face-to-face, telephonically, or by live video communication. (3-20-20)T

**04. Domains for Supervision.** Supervision must include assessment of the provisional certification holder with regard to each of the following domains: (3-20-20)T

- a.** Basic science; (3-20-20)T
- b.** Neurosciences; (3-20-20)T
- c.** Physical assessments and laboratory exams; (3-20-20)T
- d.** Clinical medicine and pathophysiology; (3-20-20)T
- e.** Clinical and research pharmacology and psychopharmacology; (3-20-20)T
- f.** Clinical pharmacotherapeutics; (3-20-20)T
- g.** Research; and (3-20-20)T
- h.** Professional, ethical, and legal issues. (3-20-20)T

**702. QUALIFICATIONS TO PRESCRIBE FOR PEDIATRIC OR GERIATRIC PATIENTS.**

A prescribing psychologist may not prescribe for pediatric or geriatric patients unless approved by the Board. The Board may only grant prescriptive authority for pediatric patients or geriatric patients to an applicant for certification of prescriptive authority who has completed one (1) year of satisfactory prescribing, as attested to by the supervising physician, for the patient population for which the prescribing psychologist seeks to prescribe. (3-20-20)T

**01. Credit Toward Certification.** The one (1) year of satisfactory prescribing for a pediatric or geriatric population may be counted as one (1) year of the two (2) years of satisfactory prescribing required to qualify for a certification of prescriptive authority. (3-20-20)T



**02. Hours of Supervision.** One (1) year of satisfactory prescribing includes a minimum of one thousand (1,000) hours acquired in not less than twelve (12) months and not more than twenty-four (24) months. (3-20-20)T

**a.** The one thousand (1,000) hours may consist of direct patient contact, supervision, case consultations, and collaboration with licensed medical providers for the purpose of evaluation and treatment of patients with medication(s) within the formulary set forth in Section 730 of these rules. A minimum of eight hundred (800) hours of the one thousand (1,000) hours must be directly related to the population for which the prescribing psychologist seeks to prescribe. (3-20-20)T

**b.** Supervised practice time during which the supervisor(s) deem(s) a supervisee's performance to have been unsatisfactory will not be credited towards the required supervised practice hours. A supervisor who believes the supervisee's practice is unsatisfactory should notify the supervisee and the primary supervisor as soon as possible and identify the basis for such conclusion including, but not limited to, specific domains or issues needing remediation. (3-20-20)T

**03. Number of Patients.** One (1) year of satisfactory prescribing includes a minimum of twenty-five (25) separate patients in the population for which the prescribing psychologist seeks to prescribe and who are seen for the purpose of evaluation and treatment with those medications that are within the formulary established in Section 730 of these rules. For a prescribing psychologist who seeks to prescribe for pediatric patients, a minimum of ten (10) separate patients must be twelve (12) years of age or younger and a minimum of ten (10) separate patients must be between thirteen (13) years of age and seventeen (17) years of age. (3-20-20)T

**04. Amount of Supervisory Contact.** Supervision must be obtained in accordance with Subsection 701.03 of these rules, and under a supervision agreement approved by the Board in accordance with Subsection 700.05 of these rules. (3-20-20)T

**05. Domains for Supervision.** Supervision must include assessment in each of the domains set forth in Subsection 701.04 of these rules. (3-20-20)T

**703. -- 709. (RESERVED)**

**710. QUALIFICATIONS FOR CERTIFICATION OF PRESCRIPTIVE AUTHORITY.**

The Board may grant a certification of prescriptive authority to an applicant who completes an application as set forth in Section 100 of these rules and who meets the following educational and training qualifications. (3-20-20)T

**01. Holds a License to Practice Psychology.** The applicant must hold a current license to practice psychology issued by the Board. (3-20-20)T

**02. Holds Provisional Certification.** The applicant must hold a provisional certification of prescriptive authority issued by the Board. (3-20-20)T

**03. Supervision.** The applicant must have successfully completed at least two (2) years of satisfactory prescribing under supervision that meets the requirements of Section 701 of these rules, as attested to by the supervising physician(s). (3-20-20)T

**711. -- 719. (RESERVED)**

**720. STANDARDS OF PRACTICE FOR PRESCRIPTIVE AUTHORITY.**

A prescribing psychologist who issues a prescription for medication to a patient must collaborate with the patient's licensed medical provider and follow standards of practice as set forth in these rules. (3-20-20)T

**01. Licensed Medical Provider.** A prescribing psychologist may only prescribe medication to a patient who has a licensed medical provider. If a patient does not have a licensed medical provider, the prescribing psychologist must refer the patient to a licensed medical provider prior to prescribing medication. (3-20-20)T

**a.** In the event a patient terminates the relationship with the patient's licensed medical provider, with

whom the prescribing psychologist has established a collaborative relationship, and the patient declines to secure a new licensed medical provider, the prescribing psychologist must advise the patient that the prescribing psychologist cannot continue to psychopharmacologically manage the patient. (3-20-20)T

**b.** The prescribing psychologist must document that the psychologist has made every reasonable effort to encourage the patient to maintain or establish a relationship with a licensed medical provider. (3-20-20)T

**c.** In those cases, in which an abrupt discontinuation of a psychopharmacologic medication could represent a health risk or result in adverse effects, the prescribing psychologist, with concurrence from the previously established licensed medical provider, may prescribe the medication in a manner that is customarily recognized as a discontinuation regimen until the medication has been completely discontinued. The prescribing psychologist must document the discontinuation regimen in the patient's medical records. (3-20-20)T

**02. Release of Information.** A prescribing psychologist must obtain a release of information from the patient or the patient's legal guardian authorizing the psychologist to contact the patient's licensed medical provider. If the patient or the patient's legal guardian refuses to sign a release of information for the patient's licensed medical provider, the prescribing psychologist must inform the patient or the patient's legal guardian that the psychologist cannot treat the patient pharmacologically without an ongoing collaborative relationship with the patient's licensed medical provider. The psychologist must refer the patient to another mental health care provider who is not required to maintain an ongoing collaborative relationship with a licensed medical provider. (3-20-20)T

**03. Initial Collaboration with Licensed Medical Provider.** Prior to prescribing medication, a prescribing psychologist must contact the patient's licensed medical provider as provided in these rules and receive the results of the licensed medical provider's assessment. (3-20-20)T

**a.** The prescribing psychologist must inform the licensed medical provider of: (3-20-20)T

**i.** The medication(s) the prescribing psychologist intends to prescribe for mental, nervous, emotional, behavioral, substance abuse, cognitive disorders; and (3-20-20)T

**ii.** Any laboratory tests that the prescribing psychologist ordered or reviewed. (3-20-20)T

**b.** The prescribing psychologist must discuss with the licensed medical provider the relevant indications and contraindications to the patient of prescribing the medication(s) that the prescribing psychologist intends to prescribe. (3-20-20)T

**c.** The prescribing psychologist must document the date and time of contacts with the licensed medical provider, a summary of what was discussed, and the outcome of the discussions or decisions reached. (3-20-20)T

**04. Ongoing Collaboration with Licensed Medical Provider.** After the initial collaborative relationship with the patient's licensed medical provider is established, the prescribing psychologist must maintain and document the collaborative relationship to ensure that relevant information is exchanged accurately and in a timely manner. At a minimum the prescribing psychologist must: (3-20-20)T

**a.** Contact the licensed medical provider for any changes in medication not previously discussed with the licensed medical provider. (3-20-20)T

**b.** Contact the licensed medical provider if and when the patient experiences adverse effects from medications prescribed by the psychologist that may be related to the patient's medical condition for which he or she is being treated by a health care practitioner. (3-20-20)T

**c.** Contact the licensed medical provider regarding results of laboratory tests related to the medical care of the patient that have been ordered by the psychologist in conjunction with psychopharmacological treatment. (3-20-20)T

**d.** Inform the licensed medical provider as soon as possible of any change in the patient's

psychological condition that may affect the medical treatment being provided by the licensed medical provider.

(3-20-20)T

**e.** Request that as part of the collaborative relationship, the licensed medical provider inform the prescribing psychologist of any new medical diagnosis or changes in the patient's medical condition that may affect the treatment being provided by the prescribing psychologist.

(3-20-20)T

**f.** Request that as part of the collaborative relationship, the licensed medical provider inform the prescribing psychologist of any psychotropic medications prescribed or discontinued by the licensed medical provider or other licensed medical provider, of which the licensed medical provider is aware, the dates of any subsequent changes in psychotropic medications prescribed by the licensed medical provider or other licensed medical provider, of which the licensed medical provider is aware, and the efforts to coordinate the mental health care of the patient as soon as possible.

(3-20-20)T

**05. Disagreement between Prescribing Psychologist and Licensed Medical Provider.** If the licensed medical provider and the prescribing psychologist do not agree about a particular psychopharmacological treatment strategy, the prescribing psychologist must document the reasons for recommending the psychopharmacological treatment strategy that is in disagreement and must inform the licensed medical provider of that recommendation. If the licensed medical provider believes the medication is contraindicated because of a patient's medical condition, the prescribing psychologist must defer to the judgment of the licensed medical provider and may not prescribe that psychopharmacological treatment strategy.

(3-20-20)T

**06. Prohibited Agreements with Licensed Medical Providers.** A prescribing psychologist is prohibited from employing a licensed medical provider or entering into an independent contractor or similar contractual or financial relationship with a licensed medical provider with whom the prescribing psychologist collaborates, unless approved by the Board. The Board may grant an exception to this requirement on a case-by-case basis where the prescribing psychologist shows that such relationship is structured so as to prohibit interference with the licensed medical provider's relationship with patients, the licensed medical provider's exercise of independent medical judgment, and satisfaction of the obligations and responsibilities in Chapter 23, Title 57, Idaho Code, and these rules.

(3-20-20)T

**07. Prescriptions.** All prescriptions issued by a prescribing psychologist must comply with all applicable federal and state laws, rules and regulations and these rules.

(3-20-20)T

**08. Emergencies.** If a prescribing psychologist determines that an emergency exists that may jeopardize the health or well being of the patient, the prescribing psychologist may, without prior consultation with the patient's licensed medical provider, prescribe psychotropic medications or modify an existing prescription for psychotropic medication previously written for that patient by that prescribing psychologist. The prescribing psychologist must consult with the licensed medical provider as soon as possible. The prescribing psychologist must document in the patient's psychological evaluation/treatment records the nature and extent of the emergency and the attempt(s) made to contact the licensed medical provider prior to prescribing or other reason why contact could not be made.

(3-20-20)T

**09. Disaster Areas.** If a prescribing psychologist is working in a declared emergency/disaster area, the on-site medical staff can serve as the evaluating licensed medical provider.

(3-20-20)T

**721. -- 729. (RESERVED)**

**730. FORMULARY.**

A prescribing psychologist may prescribe medications and controlled substances that are recognized in or customarily used in the diagnosis, treatment and management of individuals with mental, nervous, emotional, behavioral, substance abuse and cognitive disorders and that are relevant to the practice of psychology or other procedures directly related thereto under the following limitations.

(3-20-20)T

**01. Prohibited Medications and Controlled Substances.** A prescribing psychologist may not prescribe:

(3-20-20)T

**a.** Any medication or controlled substance designated or included as a Schedule I controlled substance; or (3-20-20)T

**b.** Any opioid. (3-20-20)T

**02. Disorders and Conditions.** A prescribing psychologist may not prescribe medication to treat a primary endocrine, cardiovascular, orthopedic, neurologic, gynecologic, obstetric, metabolic, hematologic, respiratory, renal, gastrointestinal, hepatic, dermatologic, oncologic, infectious, ophthalmologic, or rheumatologic illness or disorder. The provisions of this rule do not prohibit a prescribing psychologist from prescribing to treat a mental, nervous, emotional, behavioral, substance abuse or cognitive disorder that arises secondary to a primary physical illness, provided that the primary illness is being treated by a licensed medical provider and the prescribing psychologist collaborates with the patient's licensed medical provider, as provided in these rules. (3-20-20)T

**731. -- 999. (RESERVED)**

**IDAPA 24 – DIVISION OF OCCUPATIONAL AND PROFESSIONAL LICENSES**

**24.13.01 – RULES GOVERNING THE PHYSICAL THERAPY LICENSURE BOARD**

**DOCKET NO. 24-1301-2000F (FEE RULE)**

**NOTICE OF OMNIBUS RULEMAKING – ADOPTION OF TEMPORARY RULE**

**EFFECTIVE DATE:** The effective date of the temporary rules being adopted through this omnibus rulemaking is the adjournment date of the second regular session of the 65th Idaho State Legislature - March 20, 2020.

**AUTHORITY:** In compliance with Sections 67-5226, Idaho Code, notice is hereby given this agency has adopted a temporary rule. The action is authorized pursuant to Section 54-2206, Idaho Code.

**DESCRIPTIVE SUMMARY:** The following is the required finding and concise statement of its supporting reasons for adopting a temporary rule:

This temporary rulemaking adopts the following chapter under IDAPA 24.13.01:

**IDAPA 24.13**

- 24.13.01, *Rules Governing the Physical Therapy Licensure Board.*

**TEMPORARY RULE JUSTIFICATION:** Pursuant to Section 67-5226(1) and 67-5226(2), Idaho Code, the Governor has found that temporary adoption of the rule is appropriate for the following reasons:

These temporary rules are necessary to protect the public health, safety, and welfare of the citizens of Idaho and confer a benefit on its citizens. These temporary rules implement the duly enacted laws of the state of Idaho, provide citizens with the detailed rules and standards for complying with those laws, and assist in the orderly execution and enforcement of those laws. The expiration of these rules without due consideration and processes would undermine the public health, safety, and welfare of the citizens of Idaho and deprive them of the benefit intended by these rules. These rules govern the qualifications for physical therapists and physical therapist assistants and define the ethical standards to which licensees must adhere. Allowing these rules to expire would harm the public health, safety, and welfare since these rules help ensure the competence and appropriate conduct of physical therapists and physical therapist assistants.

**FEE SUMMARY:** Pursuant to Section 67-5226(2), the Governor has found that the fees or charges being imposed or increased are justified and necessary to avoid immediate danger and the fees are described herein:

The fees or charges, authorized in Section 54-2207, Idaho Code, are part of the agency’s 2021 budget that relies upon the existence of these fees or charges to meet the state’s obligations and provide necessary state services. Failing to reauthorize these temporary rules would create immediate danger to the state budget, immediate danger to necessary state functions and services, and immediate danger of a violation of Idaho’s constitutional requirement that it balance its budget.

The following is a specific description of the fees or charges:

Physical Therapist License	\$25	\$25
Physical Therapist Assistant License	\$20	\$20
Examination	Established by examination entity plus an administrative fee not to exceed \$20	
Reinstatement	As provided in Section 67-2614, Idaho Code	

		
Application	\$25	

**ASSISTANCE ON TECHNICAL QUESTIONS:** For assistance on technical questions concerning the temporary rule, contact Rob McQuade at (208) 334-3233.

DATED this February 21, 2020.

Kelley Packer  
Division Administrator  
Division of Occupational and Professional Licenses  
700 W. State Street  
P.O. Box 83720  
Boise, ID 83720  
Phone: (208) 334-3233  
Fax: (208) 334-3945

## 24.13.01 – RULES GOVERNING THE PHYSICAL THERAPY LICENSURE BOARD

### 000. LEGAL AUTHORITY (RULE 0).

These rules are hereby prescribed and established pursuant to the authority vested in the Physical Therapy Licensure Board by the provisions of Section 54-2206, Idaho Code. (3-20-20)T

### 001. TITLE AND SCOPE (RULE 1).

The rules are titled IDAPA 24.13.01, "Rules Governing the Physical Therapy Licensure Board." (3-20-20)T

### 002. -- 009. (RESERVED)

### 010. DEFINITIONS (RULE 10).

**01. Physical Therapist Assistant.** An individual who meets the requirements of Title 54, Chapter 22, Idaho Code, holds an active license, and who performs physical therapy procedures and related tasks that have been selected and delegated only by a supervising physical therapist. (3-20-20)T

**02. Supportive Personnel.** An individual, or individuals, who are neither a physical therapist or a physical therapist assistant, but who are employed by and/or trained under the direction of a licensed physical therapist to perform designated non-treatment patient related tasks and routine physical therapy tasks. (3-20-20)T

**03. Non-Treatment Patient Related Tasks.** Actions and procedures related to patient care that do not involve direct patient treatment or direct personal supervision, but do require a level of supervision not less than general supervision, including, but not limited to: treatment area preparation and clean-up, equipment set-up, heat and cold pack preparation, preparation of a patient for treatment by a physical therapist or physical therapist assistant, transportation of patients to and from treatment, and assistance to a physical therapist or physical therapist assistant when such assistance is requested by a physical therapist or physical therapist assistant when safety and effective treatment would so require. (3-20-20)T

**04. Routine Physical Therapy Tasks.** Actions and procedures within the scope of practice of physical therapy, which do not require the special skills or training of a physical therapist or physical therapist assistant, rendered directly to a patient by supportive personnel at the request of and under the direct personal supervision of a physical therapist or physical therapist assistant. (3-20-20)T

### 05. Testing. (3-20-20)T

**a.** Standard methods and techniques used in the practice of physical therapy to gather data about individuals including: (3-20-20)T

- i. Electrodiagnostic and electrophysiological measurements; (3-20-20)T
- ii. Assessment or evaluation of muscle strength, force, endurance and tone; (3-20-20)T
- iii. Reflexes; (3-20-20)T
- iv. Automatic reactions; (3-20-20)T
- v. Posture and body mechanics; (3-20-20)T
- vi. Movement skill and accuracy; (3-20-20)T
- vii. Joint range of motion and stability; (3-20-20)T
- viii. Sensation; (3-20-20)T
- ix. Perception; (3-20-20)T
- x. Peripheral nerve function integrity; (3-20-20)T
- xi. Locomotor skills; (3-20-20)T
- xii. Fit, function and comfort of prosthetic, orthotic, and other assistive devices; (3-20-20)T

- xiii. Limb volume, symmetry, length and circumference; (3-20-20)T
- xiv. Clinical evaluation of cardiac and respiratory status to include adequacy of pulses, noninvasive assessment of peripheral circulation, thoracic excursion, vital capacity, and breathing patterns; (3-20-20)T
- xv. Vital signs such as pulse, respiratory rate, and blood pressure; (3-20-20)T
- xvi. Activities of daily living; and the physical environment of the home and work place; and (3-20-20)T
- xvii. Pain patterns, localization and modifying factors; and (3-20-20)T
- xviii. Photosensitivity. (3-20-20)T
- b.** Specifically excluded are the ordering of electromyographic study, electrocardiography, thermography, invasive vascular study, selective injection tests, or complex cardiac or respiratory function studies without consultation and direction of a physician. (3-20-20)T
- 06. Functional Mobility Training.** Includes gait training, locomotion training, and posture training. (3-20-20)T
- 07. Manual Therapy.** Skilled hand movements to mobilize or manipulate soft tissues and joints for the purpose of: (3-20-20)T
  - a.** Modulating pain, increasing range of motion, reducing or eliminating soft tissue swelling, inflammation or restriction; (3-20-20)T
  - b.** Inducing relaxation; (3-20-20)T
  - c.** Improving contractile and non-contractile tissue extensibility; and (3-20-20)T
  - d.** Improving pulmonary function. (3-20-20)T
- 08. Dry Needling.** A skilled intervention performed by a physical therapist that uses a thin filiform needle to penetrate the skin and stimulate underlying neural, muscular, and connective tissues for the evaluation and management of neuromusculoskeletal conditions, pain and movement impairments. (3-20-20)T
- 09. Physical Agents or Modalities.** Thermal, acoustic, radiant, mechanical, or electrical energy used to produce physiologic changes in tissues. (3-20-20)T
- 10. General Supervision.** A physical therapist's availability at least by means of telecommunications, which does not require a physical therapist to be on the premises where physical therapy is being provided, for the direction of a physical therapist assistant. (3-20-20)T
- 11. Direct Supervision.** A physical therapist's or physical therapist assistant's physical presence and availability to render direction in person and on the premises where physical therapy is being provided. (3-20-20)T
- 12. Direct Personal Supervision.** A physical therapist's or physical therapist assistant's direct and continuous physical presence and availability to render direction, in person and on the premises where physical therapy is being provided. The physical therapist or physical therapist assistant must have direct contact with the patient during each session and assess patient response to delegated treatment. (3-20-20)T
- 13. Supervising Physical Therapist.** A licensed physical therapist who developed and recorded the initial plan of care and/or who has maintained regular treatment sessions with a patient. Such physical therapist's designation of another licensed physical therapist if the physical therapist who developed and recorded the initial plan of care or maintained regular treatment sessions is not available to provide direction at least by means of telecommunications. (3-20-20)T



**14. Nationally Accredited School.** A school or course of physical therapy or physical therapist assistant with a curriculum approved by: (3-20-20)T

**a.** The American Physical Therapy Association (APTA) from 1926 to 1936; or the APTA Accreditation Commission; or (3-20-20)T

**b.** The Council on Medical Education and Hospitals of the American Medical Association from 1936 to 1960; or (3-20-20)T

**c.** An accrediting agency recognized by the U.S. Department of Education, the Council on Postsecondary Accreditation, or a successor entity, or both. (3-20-20)T

**15. Examination.** The examination is the National Physical Therapy Examination (NPTE) administered by Federation of State Boards of Physical Therapy. The examination may also include a jurisprudence examination adopted by the Board. (3-20-20)T

**011. -- 015. (RESERVED)**

**016. SUPERVISION (RULE 16).**

A physical therapist shall supervise and be responsible for patient care given by physical therapist assistants, supportive personnel, physical therapy students, and physical therapist assistant students. (3-20-20)T

**01. Procedures and Interventions Performed Exclusively by Physical Therapist.** The following procedures and interventions shall be performed exclusively by a physical therapist: (3-20-20)T

**a.** Interpretation of a referral for physical therapy if a referral has been received. (3-20-20)T

**b.** Performance of the initial patient evaluation and problem identification including a diagnosis for physical therapy and a prognosis for physical therapy. (3-20-20)T

**c.** Development or modification of a treatment plan of care which is based on the initial evaluation and which includes long-term and short-term physical therapy treatment goals. (3-20-20)T

**d.** Assessment of the competence of physical therapist assistants, physical therapy students, physical therapist assistant students, and supportive personnel to perform assigned procedures, interventions and routine tasks. (3-20-20)T

**e.** Selection and delegation of appropriate portions of treatment procedures, interventions and routine physical therapy tasks to the physical therapist assistants, physical therapy students, physical therapist assistant students, and supportive personnel. (3-20-20)T

**f.** Performance of a re-evaluation when any change in a patient's condition occurs that is not consistent with the physical therapy treatment plan of care, patient's anticipated progress, and physical therapy treatment goals. (3-20-20)T

**g.** Performance and documentation of a discharge evaluation and summary of the physical therapy treatment plan. (3-20-20)T

**h.** Performance of dry needling. (3-20-20)T

**02. Supervision of Physical Therapist Assistants.** A physical therapist assistant must be supervised by a physical therapist by no less standard than general supervision. (3-20-20)T

**a.** A physical therapist assistant must not change a procedure or intervention unless such change of procedure or intervention has been included within the treatment plan of care as set forth by a physical therapist. (3-20-20)T

**b.** A physical therapist assistant may not continue to provide treatment as specified under a treatment plan of care if a patient's condition changes such that further treatment necessitates a change in the established treatment plan of care unless the physical therapist assistant has consulted with the supervising physical therapist prior to the patient's next appointment for physical therapy, and a re-evaluation is completed by the supervising physical therapist. (3-20-20)T

**c.** The supervising physical therapist must provide direct personal contact with the patient and assess the plan of care on or before every ten (10) visits or once a week if treatment is performed more than once per day but no less often than once every sixty (60) days. The supervising therapist's assessment must be documented in the patient record. (3-20-20)T

**d.** A physical therapist assistant may refuse to perform any procedure, intervention, or task delegated by a physical therapist when such procedure, intervention, or task is beyond the physical therapist assistant's skill level or scope of practice standards. (3-20-20)T

**e.** A physical therapist is not required to co-sign any treatment related documents prepared by a physical therapist assistant, unless required to do so in accordance with law, or by a third-party. (3-20-20)T

**03. Supervision of Supportive Personnel.** Any routine physical therapy tasks performed by supportive personnel requires direct personal supervision. (3-20-20)T

**04. Supervision of Physical Therapy and Physical Therapist Assistant Students.** Supervision of physical therapy students and physical therapist assistant students requires direct supervision. (3-20-20)T

**a.** A physical therapy student is only supervised by the direct supervision of a physical therapist. (3-20-20)T

**b.** A physical therapy student is required to sign all treatment notes with the designation "SPT" after their name, and all such signatures require the co-signature of the supervising physical therapist. (3-20-20)T

**c.** A physical therapist assistant student is required to sign all treatment notes with the designation "SPTA" after their name, and all such signatures require the co-signature of the supervising physical therapist or supervising physical therapist assistant. (3-20-20)T

**05. Supervision Ratios.** (3-20-20)T

**a.** At no time during the treatment of a patient or patients for physical therapy may the number of physical therapist assistants providing such treatment be more than twice in number of such supervising physical therapist(s) providing physical therapy treatment at any physical therapy practice or site. (3-20-20)T

**b.** At no time during the treatment of a patient or patients for physical therapy may the number of supportive personnel performing routine physical therapy tasks be more than twice in number of such supervising physical therapist(s) or supervising physical therapist assistant(s) providing physical therapy treatment at any physical therapy practice or site. (3-20-20)T

**c.** At no time during the treatment of a patient or patients for physical therapy may the number of physical therapy students performing delegated supervised physical therapy tasks be more than twice in number of such supervising physical therapist(s) providing physical therapy treatment at any physical therapy practice or site. (3-20-20)T

**d.** At no time during the treatment of a patient or patients for physical therapy may the number of physical therapist assistant students performing delegated supervised physical therapy tasks be more than twice in number of such supervising physical therapist(s) or supervising physical therapist assistant(s) providing physical therapy treatment at any physical therapy practice or site. (3-20-20)T

**e.** At no time during the treatment of a patient or patients for physical therapy shall the number of

physical therapist assistants, physical therapy students, physical therapist assistants students, and supportive personnel, or a combination thereof, performing delegated supervised physical therapy or routine physical therapy tasks be more than three (3) times in number of such physical therapist(s) providing physical therapy treatment at any physical therapy practice or site; nor may the number of physical therapist assistant students or supportive personnel, or a combination thereof, performing delegated and supervised physical therapy tasks or routine physical therapy tasks be more than twice in number of such physical therapist assistant(s) providing physical therapy treatment at any physical therapy practice or site. (3-20-20)T

**017. -- 099. (RESERVED)**

**100. MEETINGS AND ORGANIZATION (RULE 100).**

**01. Meetings.** The Board meets at least once annually at such time and place as designated by the Board or the Chairman of the Board. Special meetings may be held at the call of the Chairman or any two (2) members, and all members shall be notified in writing. (3-20-20)T

**02. Voting.** A quorum is three (3) Board members. A majority vote of Board members present is considered the action of the Board as a whole. Any motion before the Board fails on a tie vote. (3-20-20)T

**101. -- 149. (RESERVED)**

**150. APPLICATION (RULE 150).**

Each applicant must submit a completed written application on forms provided by the Board together with applicable fees. The application must be verified under oath and requires the following information: (3-20-20)T

**01. Education.** The educational background of the applicant; (3-20-20)T

**02. Evidence of Graduation.** Evidence of graduation from a nationally accredited school; (3-20-20)T

**03. Criminal Convictions.** The disclosure of any criminal conviction or charges against the applicant other than minor traffic offenses; (3-20-20)T

**04. Disciplinary Action.** The disclosure of any disciplinary action against the applicant by any professional regulatory agency; (3-20-20)T

**05. License or Registration Denial.** The disclosure of the denial of registration or licensure by any state or district regulatory body; (3-20-20)T

**06. References.** Two (2) references from individuals, other than relatives or individuals living with the applicant, who have at least two (2) years of personal knowledge of the applicant's character and ability to provide physical therapy; and (3-20-20)T

**07. Other Information.** Such other information as the Board deems necessary to identify and evaluate the applicant's credentials. (3-20-20)T

**08. Lack of Activity.** Applications on file with the Board where an applicant has failed to respond to a Board request or where the applications have lacked activity for twelve (12) consecutive months is deemed denied and will be terminated upon thirty (30) days written notice unless good cause is established to the Board. (3-20-20)T

**151. -- 174. (RESERVED)**

**175. REQUIREMENTS FOR LICENSURE (RULE 175).**

An individual shall be entitled to a license upon meeting the following requirements: (3-20-20)T

**01. Application.** Submission of a complete application establishing that the individual has met the qualifications as set forth in these rules. (3-20-20)T

**02. Examination.** Submission of proof that the individual has successfully passed the NPTE with a scaled score of at least six hundred (600) and the jurisprudence examination with a score of at least seventy-five percent (75%). Foreign educated individuals whose native language is not English must submit proof of successfully passing one (1) of the following English proficiency exams: (3-20-20)T

**a.** Test of English as a Foreign Language (TOEFL) with minimum passing scores of two hundred twenty (220) for computer test and five hundred sixty (560) for paper test; (3-20-20)T

**b.** Test of English as a Foreign Language - internet based test (TOEFL IBT) with minimum passing scores of twenty-four (24) in writing; twenty-six (26) in speaking, twenty-one (21) in reading, and eighteen (18) in listening; or (3-20-20)T

**c.** As otherwise approved by the Board. (3-20-20)T

**176. -- 179. (RESERVED)**

**180. REQUIREMENTS TO PRACTICE DRY NEEDLING (RULE 180).**

A physical therapist, with at least one (1) year of practice as a licensed physical therapist, may perform dry needling upon successful completion of education and training in dry needling that meets the following requirements: (3-20-20)T

**01. Length of Course.** The education and training consists of a minimum of twenty-seven (27) hours of in-person instruction of which no less than sixteen (16) hours must be hands-on application of dry needling techniques by the physical therapist; (3-20-20)T

**02. Safety Training.** The education and training includes instruction and training on indications/contraindications for dry needling, safe needling technique, and blood borne pathogens; (3-20-20)T

**03. Course Approval.** Each course is approved by the Federation of State Boards of Physical Therapy (FSBPT) or another nationally recognized accrediting body of physical therapy that is approved by the Board; and (3-20-20)T

**04. Proficiency Assessment.** Each course requires successful completion of an assessment of proficiency in dry needling, which includes a practical demonstration of the physical therapist's dry needling skills. (3-20-20)T

**05. Course Completion.** Completion of this education and training may have occurred prior to the effective date of these rules. (3-20-20)T

**181. PRACTICE OF DRY NEEDLING (RULE 181).**

A physical therapist who practices dry needling must maintain documentation of having satisfied the requirements of Section 180 of these rules and must obtain and maintain documentation of written informed consent from patients. (3-20-20)T

**01. Documentation of Training.** Upon request by the Board, a physical therapist must produce documentation of having satisfied the education and training requirements in Section 180 of these rules. (3-20-20)T

**02. Written Informed Consent.** Prior to performing dry needling on a patient, the physical therapist must provide the patient with information that includes a definition and description of the practice of dry needling and a description of the risks, benefits, and potential side effects of dry needling and obtain the patient's written consent to treatment, which documentation must be maintained as part of the patient record. (3-20-20)T

**182. -- 199. (RESERVED)**

**200. FEES (RULE 200).**

All fees are non-refundable.

FEE TYPE	AMOUNT (Not to Exceed)	RENEWAL (Not to Exceed)
Physical Therapist License	\$25	\$25
Physical Therapist Assistant License	\$20	\$20
Examination	Established by examination entity plus an administrative fee not to exceed \$20	
Reinstatement	As provided in Section 67-2614, Idaho Code	
Application	\$25	

(3-20-20)T

**201. -- 249. (RESERVED)**

**250. CONTINUING EDUCATION REQUIREMENT (RULE 250).**

**01. Renewal of License.** Every person holding a license issued by the Board must annually complete sixteen (16) contact hours of continuing education prior to license renewal. (3-20-20)T

**02. Reinstatement of License.** Any license cancelled for failure to renew may be reinstated in accordance with Section 67-2614, Idaho Code, with the exception that the applicant must submit proof of having met the following continuing education requirement: (3-20-20)T

- a.** For licenses expired for one (1) year or less, one (1) year of continuing education; (3-20-20)T
- b.** For licenses expired for more than one (1) year and up to two (2) years, two (2) years of continuing education; (3-20-20)T
- c.** For licenses expired for more than two (2) years, three (3) years of continuing education. (3-20-20)T

**03. Contact Hours.** The contact hours of continuing education must be obtained in areas of study germane to the practice for which the license is issued as approved by the board. (3-20-20)T

**04. Documentation of Attendance.** The applicant must provide documentation verifying attendance by securing authorized signatures or other documentation from the course instructors, providers, or sponsoring institution substantiating any hours attended by the licensee. This documentation must be maintained by the licensee and provided to the board upon request by the board or its agent. (3-20-20)T

**05. Excess Hours.** Continuing education hours accumulated during the twelve (12) months immediately preceding the license expiration date may be applied toward meeting the continuing education requirement for the next license renewal. Hours in excess of the required hours may be carried forward. Excess hours may be used only during the next renewal period and may not be carried forward more than one (1) time. (3-20-20)T

**06. Compliance Audit.** The board may conduct random continuing education audits of those persons required to obtain continuing education in order to renew a license and require that proof acceptable to the board of meeting the continuing education requirement be submitted to the Division. Failure to provide proof of meeting the continuing education upon request of the board are grounds for disciplinary action. (3-20-20)T

**07. Special Exemption.** The board has authority to make exceptions for reasons of individual

hardship, including health (certified by a medical doctor) or other good cause. The licensee must provide any information requested by the board to assist in substantiating hardship cases. This exemption is granted at the sole discretion of the board. (3-20-20)T

**08. Continuing Education Credit Hours.** Hours of continuing education credit may be obtained by attending and participating in a continuing education activity approved by the Board. (3-20-20)T

**a. General Criteria.** A continuing education activity which meets all of the following criteria is appropriate for continuing education credit: (3-20-20)T

i. Constitutes an organized program of learning which contributes directly to the professional competency of the licensee; (3-20-20)T

ii. Pertains to subject matters integrally related and germane to the practice of the profession; (3-20-20)T

iii. Conducted by individuals who have specialized education, training and experience to be considered qualified to present the subject matter of the program. The Board may request documentation of the qualifications of presenters; (3-20-20)T

iv. Application for Board approval is accompanied by a paper, manual or outline which describes the specific offering and includes the program schedule, goals and objectives; and (3-20-20)T

v. Provides proof of attendance to licensees in attendance including: Date, location, course title, presenter(s); Number of program contact hours (One (1) contact hour equals one (1) hour of continuing education credit.); and the official signature or verification of the program sponsor. (3-20-20)T

**b. Specific Criteria.** Continuing education hours of credit may be obtained by: (3-20-20)T

i. Presenting professional programs which meet the criteria listed in these rules. Two (2) hours of credit will be awarded for each hour of presentation by the licensee. A course schedule or brochure must be maintained for audit; (3-20-20)T

ii. Providing official transcripts indicating successful completion of academic courses which apply to the field of physical therapy in order to receive the following continuing education credits: (3-20-20)T

(1) One (1) academic semester hour = fifteen (15) continuing education hours of credit; (3-20-20)T

(2) One (1) academic trimester hour = twelve (12) continuing education hours of credit; (3-20-20)T

(3) One (1) academic quarter hour = ten (10) continuing education hours of credit. (3-20-20)T

iii. Attending workshops, conferences, symposiums or electronically transmitted, live interactive conferences which relate directly to the professional competency of the licensee; (3-20-20)T

iv. Authoring research or other activities that are published in a recognized professional publication. The licensee will receive five (5) hours of credit per page; (3-20-20)T

v. Viewing videotaped presentations if the following criteria are met: (3-20-20)T

(1) There is a sponsoring group or agency; (3-20-20)T

(2) There is a facilitator or program official present; (3-20-20)T

(3) The program official may not be the only attendee; and (3-20-20)T

(4) The program meets all the criteria specified in these rules; (3-20-20)T

- vi. Participating in home study courses that have a certificate of completion; (3-20-20)T
- vii. Participating in courses that have business-related topics: marketing, time management, government regulations, and other like topics; (3-20-20)T
- viii. Participating in courses that have personal skills topics: career burnout, communication skills, human relations, and other like topics; (3-20-20)T
- ix. Participating in courses that have general health topics: clinical research, CPR, child abuse reporting, and other like topics; (3-20-20)T
- x. Supervision of a physical therapist student or physical therapist assistant student in an accredited college program. The licensee will receive four (4) hours of credit per year; and (3-20-20)T
- xi. Completion and awarding of Board Certification or recertification by American Board of Physical Therapy Specialists (ABPTS). The licensee will receive sixteen (16) hours for the year the certification or recertification was received. (3-20-20)T

**09. Course Approval.** Courses of study relevant to physical therapy and sponsored or provided by the following entities or organizations are approved for continuing education credits: (3-20-20)T

- a. The American Physical Therapy Association (APTA) or any of its sections or local chapters; or (3-20-20)T
- b. The Federation of State Boards of Physical Therapy (FSBPT); or (3-20-20)T
- c. Commission on Accreditation in Physical Therapy Education (CAPTE); or (3-20-20)T
- d. National Athletic Trainers Association (NATA); or (3-20-20)T
- e. A College or University which is accredited or a candidate for accreditation by the Northwest Association of Secondary and Higher Schools or any similar accrediting body; or (3-20-20)T
- f. Otherwise approved by the Board. (3-20-20)T

**10. Submitting False Reports or Failure to Comply.** The Board may condition, limit, suspend, or refuse to renew the license of any individual whom the Board determines submitted a false report of continuing education or failed to comply with the continuing education requirements. (3-20-20)T

**11. Failure to Receive the Renewal Application.** Failure to receive the renewal application does not relieve the licensee of the responsibility of meeting the continuing education requirements and submitting the renewal application and renewal fee. (3-20-20)T

**251. -- 274. (RESERVED)**

**275. DISCIPLINARY PENALTY (RULE 275).**

**01. Disciplinary Procedures.** The disciplinary procedures of the Division are the disciplinary procedures of the Board. (3-20-20)T

**02. Civil Fine.** The Board may impose a civil fine not to exceed one thousand dollars (\$1,000) for each violation upon anyone licensed under Title 54, Chapter 22, Idaho Code who is found by the Board to be in violation of Section 54-2219, Idaho Code. (3-20-20)T

**03. Costs and Fees.** The Board may order anyone licensed under Title 54, Chapter 22, Idaho Code, who is found by the Board to be in violation of the provisions of Title 54, Chapter 22, Idaho Code, to pay the costs

and fees incurred by the Board in the investigation or prosecution of the licensee.

(3-20-20)T

**276. -- 299. (RESERVED)**

**300. CODE OF ETHICS (RULE 300).**

Physical therapists and physical therapist assistants are responsible for maintaining and promoting ethical practice in accordance with the ethical principles set forth in Appendix A and Appendix B to these rules. (3-20-20)T

**301. -- 999. (RESERVED)**

**Appendix A - Physical Therapist Code Of Ethics**

**Preamble**

This Code of Ethics of the American Physical Therapy Association sets forth principles for the ethical practice of physical therapy. All physical therapists are responsible for maintaining and promoting ethical practice. To this end, the physical therapist shall act in the best interest of the patient/client. This Code of Ethics shall be binding on all physical therapists.

**Principle 1**

A physical therapist shall respect the rights and dignity of all individuals and shall provide compassionate care.

**Principle 2**

A physical therapist shall act in a trustworthy manner toward patients/clients and in all other aspects of physical therapy practice.

**Principle 3**

A physical therapist shall comply with laws and regulations governing physical therapy and shall strive to effect changes that benefit patients/clients.

**Principle 4**

A physical therapist shall exercise sound professional judgment.

**Principle 5**

A physical therapist shall achieve and maintain professional competence.

**Principle 6**

A physical therapist shall maintain and promote high standards for physical therapy practice, education, and research.

**Principle 7**

A physical therapist shall seek only such remuneration as is deserved and reasonable for physical therapy services.

**Principle 8**

A physical therapist shall provide and make available accurate and relevant information to patients/clients about their care and to the public about physical therapy services.

**Principle 9**

A physical therapist shall protect the public and the profession from unethical, incompetent, and illegal acts.

**Principle 10**

A physical therapist shall endeavor to address the health needs of society.

**Principle 11**

A physical therapist shall respect the rights, knowledge, and skills of colleagues and other health care



professionals.

## **APPENDIX B - PHYSICAL THERAPIST ASSISTANT CODE OF ETHICS**

### **Preamble**

This document of the American Physical Therapy Association sets forth standards for the ethical conduct of the physical therapist assistant. All physical therapist assistants are responsible for maintaining high standards of conduct while assisting physical therapists. The physical therapist assistant shall act in the best interest of the patient/client. These standards of conduct shall be binding on all physical therapist assistants.

### **Standard 1**

A physical therapist assistant shall respect the rights and dignity of all individuals and shall provide compassionate care.

### **Standard 2**

A physical therapist assistant shall act in a trustworthy manner toward patients/clients.

### **Standard 3**

A physical therapist assistant shall provide selected physical therapy interventions only under the supervision and direction of a physical therapist.

### **Standard 4**

A physical therapy assistant shall comply with laws and regulations governing physical therapy.

### **Standard 5**

A physical therapist assistant shall achieve and maintain competence in the provision of selected physical therapy interventions.

### **Standard 6**

A physical therapist assistant shall make judgments that are commensurate with his or her educational and legal qualifications as a physical therapist assistant.

### **Standard 7**

A physical therapist assistant shall protect the public and the profession from unethical, incompetent, and illegal acts.

# IDAPA 24 – DIVISION OF OCCUPATIONAL AND PROFESSIONAL LICENSES

## 24.14.01 – RULES OF THE STATE BOARD OF SOCIAL WORK EXAMINERS

### DOCKET NO. 24-1401-2000F (FEE RULE)

#### NOTICE OF OMNIBUS RULEMAKING – ADOPTION OF TEMPORARY RULE

**EFFECTIVE DATE:** The effective date of the temporary rules being adopted through this omnibus rulemaking is the adjournment date of the second regular session of the 65th Idaho State Legislature - March 20, 2020.

**AUTHORITY:** In compliance with Sections 67-5226, Idaho Code, notice is hereby given this agency has adopted a temporary rule. The action is authorized pursuant to Section 54-3204, Idaho Code.

**DESCRIPTIVE SUMMARY:** The following is the required finding and concise statement of its supporting reasons for adopting a temporary rule:

This temporary rulemaking adopts the following chapter under IDAPA 24.14.01:

#### **IDAPA 24.14**

- 24.14.01, *Rules of the State Board of Social Work Examiners.*

**TEMPORARY RULE JUSTIFICATION:** Pursuant to Sections 67-5226(1) and 67-5226(2), Idaho Code, the Governor has found that temporary adoption of the rule is appropriate for the following reasons:

These temporary rules are necessary to protect the public health, safety, and welfare of the citizens of Idaho and confer a benefit on its citizens. These temporary rules implement the duly enacted laws of the state of Idaho, provide citizens with the detailed rules and standards for complying with those laws, and assist in the orderly execution and enforcement of those laws. The expiration of these rules without due consideration and processes would undermine the public health, safety, and welfare of the citizens of Idaho and deprive them of the benefit intended by these rules. These rules govern the qualifications for licensed professional social workers, as well as outline the ethical responsibilities and code of professional conduct licensees must adhere to. Allowing these rules and the requirements contained within them to lapse would harm the safety and welfare of citizens, licensees, and prospective licensees.

**FEE SUMMARY:** Pursuant to Section 67-5226(2), the Governor has found that the fees or charges being imposed or increased are justified and necessary to avoid immediate danger and the fees are described herein:

The fees or charges, authorized in Section 54-3209, Idaho Code, are part of the agency's 2021 budget that relies upon the existence of these fees or charges to meet the state's obligations and provide necessary state services. Failing to reauthorize these temporary rules would create immediate danger to the state budget, immediate danger to necessary state functions and services, and immediate danger of a violation of Idaho's constitutional requirement that it balance its budget.

The following is a specific description of the fees or charges:

<b>FEE TYPE</b>	<b>AMOUNT (Not to Exceed)</b>	<b>RENEWAL (Not to Exceed)</b>	<b>INACTIVE (Not to Exceed)</b>
Application	\$70		
Examination	Set by testing service		
Endorsement and license	\$90		
Licensed Clinical Social Worker	\$70	\$90	\$45
Licensed Masters Social Worker	\$70	\$80	\$40

<b>FEE TYPE</b>	<b>AMOUNT (Not to Exceed)</b>	<b>RENEWAL (Not to Exceed)</b>	<b>INACTIVE (Not to Exceed)</b>
Licensed Social Worker	\$70	\$80	\$40
Reinstatement	In accordance with Section 67-2614, Idaho Code		

**ASSISTANCE ON TECHNICAL QUESTIONS:** For assistance on technical questions concerning the temporary rule, contact Rob McQuade at (208) 334-3233.

DATED this February 21, 2020.

Kelley Packer  
Division Administrator  
Division of Occupational and Professional Licenses  
700 W. State Street  
P.O. Box 83720  
Boise, ID 83720  
Phone: (208) 334-3233  
Fax: (208) 334-3945

## 24.14.01 – RULES OF THE STATE BOARD OF SOCIAL WORK EXAMINERS

### 000. LEGAL AUTHORITY.

These rules are hereby prescribed and established pursuant to the authority vested in the State Board of Social Work Examiners by the provisions of Section 54-3204, Idaho Code. (3-20-20)T

### 001. TITLE AND SCOPE.

These rules are titled IDAPA 24.14.01, “Rules of the State Board of Social Work Examiners.” (3-20-20)T

### 002. -- 009. (RESERVED)

### 010. DEFINITIONS.

**01. Professionalism.** Behavior exhibited on the part of an applicant which is in conformity with the Social Work Code of Professional Conduct as defined in Section 450 of these rules and within the limits of state law. (3-20-20)T

**02. Psychotherapy.** Treatment methods using a specialized, formal interaction between a Clinical Social Worker and an individual, couple, family, or group in which a therapeutic relationship is established, maintained, or sustained to understand unconscious processes, intrapersonal, interpersonal, and psychosocial dynamics, and the diagnosis and treatment of mental, emotional, and behavioral disorders, conditions, and addictions. (3-20-20)T

**03. Relative.** For the purposes of these rules, a relative is a person’s spouse, parent, child, or sibling, regardless of whether the relation is by blood, through marriage, or by law. (3-20-20)T

**04. Supportive Counseling.** Supportive counseling by a social worker means a method used by social workers to assist individuals, couples, families, and groups in learning how to solve problems and make decisions about personal, health, social, educational, vocational, financial, and other interpersonal concerns. This help in the maintenance of adaptive patterns is done in the interview through reassurance, advice giving, information providing, and pointing out client strengths and resources. Supportive counseling does not seek to reach unconscious material. (3-20-20)T

### 011. -- 099. (RESERVED)

### 100. APPROVED COLLEGES AND UNIVERSITIES.

Any college, university, or school of social work that is accredited or is a candidate for accreditation by the Northwest Commission on Colleges and Universities or any similar accrediting body, and that offers a social work program that is accredited by the Council on Social Work Education (CSWE) or that is otherwise approved by the Board. The social work program must be a recognizable, coherent organizational entity within the institution. (3-20-20)T

### 101. -- 149. (RESERVED)

### 150. BOARD MEETINGS.

The Board must meet at least three (3) times each year. (3-20-20)T

### 151. -- 199. (RESERVED)

### 200. LICENSING QUALIFICATIONS AND DEFINITION OF TERMS.

All applicants for licensing under the Social Work Licensing Act must meet the minimum qualifications as set forth by this act. (3-20-20)T

**01. Educational Requirements.** Educational requirements must be verified by submission of official transcripts sent directly to the Board from the educational institution or from the repository of primary source credentialing information administered by the Association of Social Work Boards (ASWB). Applicants are responsible for arranging transmission of this information. (3-20-20)T

### 201. PRACTICE OF SOCIAL WORK.

**01. Baccalaureate Social Work.** The application of social work theory, knowledge, methods, and ethics to restore or enhance social or psychosocial functioning of individuals, couples, families, groups, organizations, and communities. Baccalaureate social work is a generalist practice that includes assessment, planning, intervention, evaluation, case management, information and referral, supportive counseling, supervision,

and consultation with clients. Baccalaureate social work also includes advocacy, education, community organization, and the development, implementation and administration of policies, programs, and activities. Bachelor level social workers are prohibited from performing psychotherapy. Baccalaureate social work can include independent practice, but not private practice. (3-20-20)T

**02. Master’s Social Work.** The application of social work theory, knowledge, methods and ethics, and the professional use of self to restore or enhance social, psychosocial or biopsychosocial functioning of individuals, couples, families, groups, organizations, and communities. Master’s social work requires the application of specialized knowledge and advanced practice skills in the areas of assessment, treatment planning, implementation and evaluation, case management, information and referral, supportive counseling, supervision and consultation with clients, advocacy, teaching, research, community organization, and the development, implementation, and administration of policies, programs, and activities. Master level social workers who do not hold clinical licensure may provide psychotherapy only under the supervision of a licensed clinical social worker, psychologist, or psychiatrist and in accordance with an approved supervision plan. Master’s social work can include independent practice, but not private practice. (3-20-20)T

**03. Clinical Social Work.** The practice of clinical social work is a specialty within the practice of master’s social work and requires the application of specialized clinical knowledge and advanced clinical skills in the areas of assessment, diagnosis, and treatment of mental, emotional, and behavioral disorders, conditions and addictions. Clinical social work is based on knowledge and theory of psychosocial development, behavior, psychopathology, motivation, interpersonal relationships, environmental stress, social systems, and cultural diversity, with particular attention to person-in-environment. It shares with all social work practice the goal of enhancement and maintenance of psychosocial functioning of individuals, families, and small groups. Clinical social work includes, but is not limited to, individual, couples, family and group psychotherapy, and includes independent and private practice. (3-20-20)T

**04. Employment of a Social Worker.** A social worker employed directly by a physician, psychologist or other social worker, or by a public or private agency, institution, hospital, nursing home, rehabilitation center, or any similar facility, is not to be considered within the definition of an independent practitioner. Furthermore, a social worker who contracts with an agency or institution that assumes full responsibility for and supervises the services provided to clients is not considered to be a private practitioner. (3-20-20)T

**202. -- 209. (RESERVED)**

**210. SUPERVISION.**

**01. Generally Applicable Supervision Requirements.** All supervised experience, as set forth in this section, must meet the following requirements: (3-20-20)T

**a.** Supervision must be consultative-teaching supervision which is directed toward enhancement and improvement of the individual’s social work values, knowledge, methods, and techniques. (3-20-20)T

**b.** A minimum of one hundred (100) hours of the required supervision must be face-to-face contact with the supervisor and must occur on a regular and on-going basis. Supervision may include a face-to-face setting provided by a secure live electronic connection. The secure live electronic connection must comply with any applicable state and federal laws, rules and regulations, including the health insurance portability and accountability act (HIPAA). (3-20-20)T

**i.** A supervisee may count in full all time in a supervisory session where the ratio of supervisor to supervisees does not exceed one (1) supervisor to two (2) social workers. All one hundred (100) hours may be earned in such a one (1) to two (2) setting. (3-20-20)T

**ii.** Group supervision may count for no more than fifty (50) hours of face-to-face contact. Group supervision may count only where the ratio of supervisor to supervisees does not exceed one (1) supervisor to six (6) supervisees, and the allowable countable time must be prorated by the following formula: total session minutes divided by total supervisees, multiplied by two (2) equals the maximum allowable countable time per supervisee for the session. i.e. a supervisee attending a one (1) hour group supervisory session consisting of six (6) supervisees must

be allowed twenty (20) minutes of group supervision credit (60 minutes/6 supervisees x 2 = 20 minutes). (3-20-20)T

**02. Pursuing Licensure As Independent Practitioners.** Requirements for supervision of baccalaureate or master's social workers pursuing licensure as independent practitioners. (3-20-20)T

**a.** Develop a plan for supervision that must be reviewed and approved by a designated Board member prior to commencement of supervision. (3-20-20)T

**b.** Complete a minimum of three thousand (3,000) hours of supervised social work experience. The hours must be accumulated in not less than two (2) years but in not more than five (5) years unless an extension is approved by the Board for good cause shown. (3-20-20)T

**c.** Supervision must be provided by a qualified and experienced licensed social worker with a current license in good standing and approved to pursue independent practice. (3-20-20)T

**i.** For a baccalaureate social worker the supervisor must hold a license at the baccalaureate, masters, or clinical level. (3-20-20)T

**ii.** For a masters social worker the supervisor must hold a license at the masters, or clinical level. (3-20-20)T

**iii.** Prior to a change in supervisors, the supervisee must notify the Board and the change must be approved by a designated member of the Board prior to the commencement of supervision by the new supervisor. (3-20-20)T

**iv.** The supervisee may not have more than two (2) supervisors at any given time. (3-20-20)T

**03. Pursuing Licensure As Clinical Social Worker.** Requirements for supervision of master's social workers pursuing licensure as clinical social worker. (3-20-20)T

**a.** Develop a plan for supervision that must be reviewed and approved by a designated Board member prior to commencement of supervision. (3-20-20)T

**b.** Complete a minimum of three thousand (3,000) hours of supervised social work experience focused on clinical social work. The hours must be accumulated in not less than two (2) years but in not more than five (5) years unless an extension is approved by the Board for good cause shown. The hours must also meet the following: (3-20-20)T

**i.** One thousand seven hundred fifty (1,750) hours of direct client contact involving treatment in clinical social work as defined; and (3-20-20)T

**ii.** One thousand two hundred fifty (1,250) hours involving assessment, diagnosis, and other clinical social work as defined. (3-20-20)T

**c.** Fifty percent (50%) of supervised experience must be provided by a licensed clinical social worker registered as a supervisor pursuant to Section 211 of these rules. The remaining fifty percent (50%) of supervision may be provided by one or more of the following: (3-20-20)T

**i.** A licensed clinical social worker who is registered as a supervisor pursuant to Section 211; (3-20-20)T

**ii.** A licensed clinical psychologist; (3-20-20)T

**iii.** A person licensed to practice medicine and surgery who practices in the area of psychiatry; (3-20-20)T

**iv.** A licensed clinical professional counselor registered as a supervisor by the Idaho Licensing Board

of Professional Counselors and Marriage and Family Therapists; or (3-20-20)T

v. A licensed marriage and family therapist registered as a supervisor by the Idaho Licensing Board of Professional Counselors and Marriage and Family Therapists. (3-20-20)T

d. Prior to a change in supervisors, the supervisee must notify the Board and the change must be approved by a designated member of the Board prior to the commencement of supervision by the new supervisor. (3-20-20)T

e. The supervisee may not have more than two (2) supervisors at any given time. (3-20-20)T

**04. Out-of-State Supervised Experience.** The Board may consider supervised experience obtained outside the state of Idaho submitted for Idaho licensure purposes as proscribed under Section 210.03 and consistent with that jurisdictions laws. Such experience, whether already obtained or planned to be obtained, must be included in the plan for supervision and reviewed and approved by a designated Board member. (3-20-20)T

a. Previous supervised experience must have been obtained within the five (5) year period preceding the submission of the plan for supervision and must have been obtained in compliance with the law and rules of the state in which the experience was obtained. (3-20-20)T

**211. SOCIAL WORK SUPERVISOR REGISTRATION.**

Idaho licensed social workers must be registered with the Board in order to provide postgraduate supervision for those individuals in Idaho pursuing licensure as a clinical social worker. (3-20-20)T

**01. Requirements for Registration.** (3-20-20)T

a. Document at least two-years' experience as a licensed clinical social worker. (3-20-20)T

b. Have not been the subject of any disciplinary action for five (5) years prior to application for registration. (3-20-20)T

c. Document fifteen (15) contact hours of education in clinical supervisor training within the past five (5) years, as approved by the Board, or if previously registered as a supervisor with the Board, document six (6) hours of education in advanced supervisor training as approved by the Board. (3-20-20)T

**02. Registration.** (3-20-20)T

a. Upon receipt of a completed application verifying compliance with the requirements for registration as a supervisor, the applicant must be registered as a supervisor. (3-20-20)T

b. A supervisor's registration must remain valid only so long as the individual's clinical social worker license remains current and in good standing. (3-20-20)T

**03. Renewal.** A supervisor's registration is valid for a term of five (5) years. To renew a supervisor registration, the registered supervisor must submit a renewal application and: (3-20-20)T

a. Hold an active Idaho clinical social worker license which has not been subject to discipline, the Board may, in its discretion, approve a supervisor who has been previously disciplined based on the nature of the discipline and the time elapsed; and (3-20-20)T

b. Document six (6) hours of continuing education in advanced supervisor training as approved by the Board and completed within the previous five (5) years. (3-20-20)T

**212. -- 224. (RESERVED)**

**225. INACTIVE STATUS.**

**01. Request for Inactive Status.** Each person requesting an inactive status must submit the required form and pay the inactive license fee. (3-20-20)T

**02. Inactive License Status.** (3-20-20)T

**a.** All continuing education requirements will be waived for any year or portion thereof that a licensee maintains an inactive license and is not actively practicing or supervising in Idaho (3-20-20)T

**b.** To return to active status, a licensee must complete one (1) year of continuing education requirements and submit a fee equivalent to the difference between the inactive and active renewal fee. (3-20-20)T

**03. Return to Active Status After Five (5) Years or More of Inactive Status.** Licensee must provide an account to the Board for that period of time during which the license was inactive and fulfilling requirements that demonstrate competency to resume practice. Those requirements may include, but are not limited to, education, supervised practice, and examination as determined by the Board. The Board may consider practice in another jurisdiction in determining competency. (3-20-20)T

**226. -- 299. (RESERVED)**

**300. FEES.**

All fees are non-refundable.

<b>FEE TYPE</b>	<b>AMOUNT (Not to Exceed)</b>	<b>RENEWAL (Not to Exceed)</b>	<b>INACTIVE (Not to Exceed)</b>
Application	\$70		
Examination	Set by testing service		
Endorsement and license	\$90		
Licensed Clinical Social Worker	\$70	\$90	\$45
Licensed Masters Social Worker	\$70	\$80	\$40
Licensed Social Worker	\$70	\$80	\$40
Reinstatement	In accordance with Section 67-2614, Idaho Code		

(3-20-20)T

**301. -- 349. (RESERVED)**

**350. EXAMINATIONS AND ENDORSEMENT.**

Applications for examination and endorsement may be reviewed and approved by a designated Board member upon determination that the applicant meets the qualifications. Approval to sit for examination does not obligate the Board to issue a license if it is later determined that the applicant does not meet the requirements for licensure. (3-20-20)T

**01. Exam.** The Board approves the uniform, nationally standardized examination of the Association of Social Work Boards (ASWB) as the Idaho licensure examination. (3-20-20)T

**a.** Bachelor level candidates are required to successfully pass the bachelor’s examination. (3-20-20)T

**b.** Masters level candidates are required to successfully pass the master’s examination. (3-20-20)T

**c.** Clinical level candidates are required to successfully pass the clinical examination. (3-20-20)T



**02. Graduation Date to Qualify for Exam.** Candidates for examination who can satisfy the Board that they will be graduating at the end of the spring, summer, or fall terms of any given year may qualify for examination immediately preceding the date of graduation. (3-20-20)T

**03. Endorsement.** The Board may grant a license to any person who submits an application and who: (3-20-20)T

**a.** Holds a current, active social work license, at the level for which a license is being sought, issued by the authorized regulatory entity in another state or country, the certification of which must be received directly by the Board from the issuing agency; and (3-20-20)T

**b.** Has not been disciplined within the last five (5) years, had a license revoked, suspended, restricted, or otherwise sanctioned by any regulatory entity and has never voluntarily surrendered a license; and (3-20-20)T

**c.** Has not been convicted, found guilty, or received a withheld judgment or suspended sentence for any crime that is inconsistent with the profession of social work. In reviewing the application, the Board may review the following factors or evidence: (3-20-20)T

i. The severity or nature of the crime; (3-20-20)T

ii. The period of time that has passed since the crime under review; (3-20-20)T

iii. The number or pattern of crimes or other similar incidents; (3-20-20)T

iv. The circumstances surrounding the crime that would help determine the risk of repetition; (3-20-20)T

v. The relationship of the crime to the practice of social work; and (3-20-20)T

vi. The applicant's activities since the crime under review, such as employment, education, participation in treatment, payment of restitution, or any other factors which may be evidence of current rehabilitation; and (3-20-20)T

**d.** Has successfully passed an examination, as referenced in Subsection 350.02, or an examination provided by the Professional Examination Service (PES) at the clinical social worker and social worker level or the Education Testing Service (ETS) examination; and (3-20-20)T

**e.** Has certified under oath to abide by the laws and rules governing the practice of social work in Idaho and the code of professional conduct. (3-20-20)T

**f.** The Board may waive the examination requirement in Subsection 350.05.d. for an applicant who was not required to pass such an examination at the time the applicant initially obtained a social work license, provided that the applicant meets all other requirements in this subsection and has actively practiced social work for five (5) of the last seven (7) years preceding application. (3-20-20)T

### **351. CONTINUING EDUCATION.**

**01. Continuing Education Requirements.** (3-20-20)T

**a.** Continuing education is required for renewal at all levels of social work licensure in Idaho. The Board may waive this requirement upon a showing of good cause. (3-20-20)T

**b.** Each licensee must complete a minimum of twenty (20) continuing education (CE) hours, including at least one (1) hour in professional ethics. (3-20-20)T

**c.** Compliance with the continuing education (CE) requirements for licensees must be reported

annually. A continuing education course taken in any renewal year, but not claimed for CE credit in that year, may be utilized for credit in the following renewal year. (3-20-20)T

**d.** Licensees will maintain documentation verifying CE attendance and curriculum for a period of four (4) years. This documentation will be subject to audit by the board. (3-20-20)T

**e.** Licensees are not required to comply with this requirement during the first year in which they become licensed under the social work act. (3-20-20)T

**f.** One (1) continuing education hour equals one (1) clock hour. (3-20-20)T

**g.** Courses that are part of the curriculum of a university, college or other educational institution are allotted CE credit at the rate of fifteen (15) CE hours for each semester hour or ten (10) CE hours for each quarter hour of school credit awarded. (3-20-20)T

**h.** Applications for reinstatement of a canceled license must include documented proof of meeting the continuing education requirements for the previous twelve (12) months. The requirement for professional ethics training continues during any period of cancellation. (3-20-20)T

**02. Categories of Continuing Education.** (3-20-20)T

**a.** Category I. Category I includes formally organized learning events, ideally involving face-to-face interaction with a teacher for the purpose of accomplishing specific learning objectives. Courses, workshops, conferences, practice oriented seminars, staff development and training activities coordinated and/or taught by approved and recognized educators also are included in this category. Because of our geographic location and sparse population, closed circuit T.V., video and audio tapes, internet based courses, and correspondence courses may be substituted for face-to-face contact if the course is interactive or requires an examination. (3-20-20)T

**b.** Category II. No more than ten (10) CE hours may be obtained from this category. Category II consists of a variety of self-directed professional study activities and growth experiences. Examples include making an initial presentation on professional issues or programs, teaching a course for the first time, presenting a lecture or conducting a workshop for the first time, editing or writing professional books or articles, and conducting professional research. (3-20-20)T

**c.** The subject matter of all approved continuing education must be germane to the practice of social work as defined in Section 54-3202, Idaho Code, and may include the specialties of Marriage and Family Therapy, Psychiatry, Psychiatric Nursing, or Psychology. (3-20-20)T

**03. Continuing Education Sources.** (3-20-20)T

**a.** Continuing education course providers must include: (3-20-20)T

**i.** Professional Associations. Continuing education hours may be obtained by participating in activities sponsored by or approved by professional associations including but not limited to the Idaho Chapter of the National Association of Social Workers, Idaho Society for Clinical Social Workers. The professional association must certify the number of clock hours of educational content in each sponsored or approved activity. (3-20-20)T

**ii.** Educational Institutions. Continuing education hours may be obtained by completing coursework not below your level of licensing or by participating in continuing education programs sponsored by or approved by educational institutions accredited by a regional body recognized by the Council on Post Secondary Accreditation. The educational institution must certify the number of clock hours of educational content in each sponsored or approved program. (3-20-20)T

**iii.** Government Agencies, Schools and Hospitals. Continuing education hours may be obtained by participating in in-service training, courses or workshops sponsored by federal, state, or local government agencies, public school systems and licensed hospitals. The provider must certify the number of clock hours of educational content in each approved activity. (3-20-20)T

iv. Private social service agencies and other entities. Continuing education hours may be obtained by participating in continuing education programs sponsored by agencies or entities who regularly provide social work services. The provider must certify the number of clock hours of educational content in each approved activity. (3-20-20)T

b. All continuing education hours must be relevant to the profession of social work at the individual's particular level of social work licensure. The presenter's level of education must be at the licensee's level or above. Continuing education for clinical licensees must be clinical in nature except that five (5) hours each year may be non-clinical but must be germane to the practice of social work. Final approval of acceptable programs rests with the Board. (3-20-20)T

**04. Documentation.** (3-20-20)T

a. Each licensee must maintain documentation verifying CE attendance and curriculum for a period of four (4) years from the date of completion. This documentation will be subject to audit by the Board. (3-20-20)T

b. Licensees must attest, on their annual license renewal application, that they have satisfied the continuing education requirements. False attestation of satisfaction of the continuing education requirements on a renewal application will subject the licensee to disciplinary action, including revocation. (3-20-20)T

c. Continuing education documents must be in the form of a certificate of attendance, a statement signed by the provider verifying participation in the activity, an official transcript, or other documentation such as a certificate or letter from the sponsoring entity that includes the title of the activity, the subject material covered, the dates and number of hours credited, and the presenter's full name and professional credentials, or other documentation as the Board may require. (3-20-20)T

**352. -- 399. (RESERVED)**

**400. UNPROFESSIONAL CONDUCT.**

"Unprofessional conduct" is further defined as any violation of the Social Work Code of Professional Conduct. (3-20-20)T

**401. -- 449. (RESERVED)**

**450. STATEMENT OF PUBLIC POLICY AND CODE OF PROFESSIONAL CONDUCT.**

The profession of social work is dedicated to serving people; the professional relationship between social workers and clients thus is governed by the highest moral and ethical values. The client is in a vulnerable role that extends beyond the time frame of actual services. In both social and professional interactions, this vulnerability is taken into consideration whether the person is currently or has been a client. Following is the Code of Professional Conduct: (3-20-20)T

**01. The Social Worker's Ethical Responsibility to Clients.** (3-20-20)T

a. For the purpose of this Code of Professional Conduct, a client is anyone for whom the social worker provides social work services directly or indirectly through consultations, staffings, or supervision with other professionals. (3-20-20)T

b. The social worker will not commit fraud nor misrepresent services performed. (3-20-20)T

c. The social worker will not solicit the clients of an agency for which they provide services for his private practice. (3-20-20)T

d. The social worker will not divide a fee or accept or give anything of value for receiving or making a referral. (3-20-20)T

e. The social worker will provide clients with accurate and complete information regarding the extent

and nature of the services available to them. (3-20-20)T

**f.** The social worker will terminate service to clients, and professional relationships with them, when such service and relationships are no longer required or in which a conflict of interest arises. (3-20-20)T

**g.** A social worker may not violate a position of trust by knowingly committing any act detrimental to a client. (3-20-20)T

**h.** A social worker may not exploit their professional relationships with clients (or former clients), supervisees, supervisors, students, employees, or research participants, sexually or otherwise. Social workers will not condone or engage in sexual harassment. Sexual harassment is defined as deliberate or repeated comments, gestures, or physical contacts of a sexual nature that are unwelcomed by the recipient. (3-20-20)T

**i.** A social worker may not engage in romantic or sexual acts with a client or with a person who has been a client within the past three (3) years, with a relative of a client, or with a person with whom the client maintains a close personal relationship when it has the potential to be harmful to the client. A social worker must not provide social work services to a person with whom he/she has had a romantic or sexual relationship. (3-20-20)T

**02. The Social Worker's Conduct and Comportment as a Social Worker.** (3-20-20)T

**a.** In providing services, a social worker may not discriminate on the basis of age, gender, race, color, religion, national origin, mental status, physical disability, social or economic status, political belief, or any other preference or personal characteristic, condition or status. (3-20-20)T

**b.** Social workers may not undertake any activity in which their personal problems are likely to lead to inadequate performance or harm to a client, colleague, student, or research participant. If engaged in such activity when they become aware of their personal problems, they must seek competent professional assistance to determine whether they should suspend, terminate, or limit the scope of their professional activities. (3-20-20)T

**c.** A social worker may not practice while impaired by medication, alcohol, drugs, or other chemicals. A social worker may not practice under a mental or physical condition that impairs the ability to practice safely. (3-20-20)T

**d.** A social worker may not repeatedly fail to keep scheduled appointments. (3-20-20)T

**e.** The social worker who anticipates the termination or interruption of service to clients must notify clients promptly and seek the transfer, referral, or continuation of services in relation to the clients' needs and preferences. (3-20-20)T

**f.** The social worker must attempt to make appropriate referrals as indicated by the client's need for services. (3-20-20)T

**g.** A social worker must obtain the client's or legal guardian's informed written consent when a client is to be involved in any research project. A social worker must explain the research, including any implications. (3-20-20)T

**h.** The social worker must obtain informed consent of clients before taping, recording, or permitting third party observation of their activities. (3-20-20)T

**i.** A social worker must safeguard information given by clients in providing client services. Except when required by law or judicial order, a social worker must obtain the client's informed written consent before releasing confidential information from the setting or facility except for compelling reasons defined as but not limited to: (3-20-20)T

**i.** Consultation with another professional on behalf of the client thought to be dangerous to self or others; (3-20-20)T

- ii. Duty to warn pursuant to Chapter 19, Title 6, Idaho Code; (3-20-20)T
- iii. Child abuse and sexual molestation pursuant to Chapter 16, Title 16, Idaho Code; and (3-20-20)T
- iv. Any other situation in accordance with statutory requirements. (3-20-20)T
- j.** A social worker must report any violation of the law or rules, including Code of Professional Conduct, by a person certified under Chapter 32, Title 54, Idaho Code. (3-20-20)T

**03. Competent Practice for Social Workers.** All social workers must practice in a competent manner consistent with their level of education, training and experience. (3-20-20)T

**a.** A social worker must only represent himself and practice within the boundaries of his education, training, licensure level, supervision, and other relevant professional experience. (3-20-20)T

**b.** A social worker must only practice within new areas or use new intervention techniques or approaches after engaging in appropriate study, training, consultation, or supervision. (3-20-20)T

**c.** A social worker must exercise careful judgment, when generally recognized standards do not exist with respect to an emerging area of practice, and take responsible steps to ensure the competence of his practice. (3-20-20)T

**04. The Advertising Rules for Social Workers.** No social worker may disseminate or cause the dissemination of any advertisement or advertising that is any way fraudulent, false, deceptive or misleading. Any advertisement or advertising is deemed by the board to be fraudulent, false, deceptive, or misleading if it: (3-20-20)T

**a.** Contains a misrepresentation of fact; or (3-20-20)T

**b.** Is misleading or deceptive because in its content or in the context in which it is presented it makes only a partial disclosure of relevant facts. More specifically, it is misleading and deceptive for a social worker to advertise free services or services for a specific charge when in fact the social worker is transmitting a higher charge for the advertised services to a third party payor for payment or charges the patient or a third party. It is misleading and deceptive for a social worker or a group of social workers to advertise a social work referral service or bureau unless the advertisement specifically names each of the individual social workers who are participating in the referral service or bureau. (3-20-20)T

**c.** Creates false or unjustified expectations of beneficial treatment or successful outcomes; or (3-20-20)T

**d.** Fails to identify conspicuously the social worker or social workers referred to in the advertising as a social worker or social workers; or (3-20-20)T

**e.** Contains any representation or claims, as to which the social worker, referred to in the advertising, fails to perform; or (3-20-20)T

**f.** Contains any representation which identifies the social worker practice being advertised by a name which does not include the terms “social worker,” “social work,” or some easily recognizable derivation thereof; or (3-20-20)T

**g.** Contains any representation that the practitioner has received any license or recognition by the state of Idaho or its authorized agents, which is superior to the license and recognition granted to any social worker who successfully meets the licensing requirements of Chapter 32, Title 54, Idaho Code; or (3-20-20)T

**h.** Appears in any classified directory, listing, or compendium under a heading, which when considered together with the advertisement, has the capacity or tendency to be deceptive or misleading with respect to the profession or professional status of the social worker; or (3-20-20)T

- i. Contains any other representation, statement, or claim which is misleading or deceptive. (3-20-20)T

**05. Dual Relationships.** A social worker may not engage in dual or multiple relationships with clients, with relatives of a client, or with individuals with whom clients maintain close personal relationships, in which a reasonable and prudent social worker would conclude after appropriate assessment that there is a risk of harm or exploitation to the client or of impairing a social worker's objectivity or professional judgment. A dual or multiple relationship is a relationship that occurs when a social worker interacts with a client in more than one capacity, whether it be before, during, or after the professional, social, or business relationship. Dual or multiple relationships can occur simultaneously or consecutively. After an appropriate assessment that the relationship does not create a risk of harm or exploitation to the client and will not impair a social worker's objectivity or professional judgment, the social worker must document in case records, prior to the interaction, when feasible, the rationale for such a relationship, the potential benefit to the client, and anticipated consequences for the client. (3-20-20)T

**06. Business Relationships.** A social worker may not purchase goods or services from a client or otherwise engage in a business relationship with a client except when: (3-20-20)T

- a. The client is providing necessary goods or services to the general public; (3-20-20)T
- b. A reasonable and prudent social worker would determine that it is not practical or reasonable to obtain the goods or services from another provider; and (3-20-20)T
- c. A reasonable and prudent social worker would determine that engaging in the business relationship will not be detrimental to the client or the professional relationship. (3-20-20)T

**07. Bartering.** Bartering is the acceptance of goods, services, or other nonmonetary remuneration from a client in return for a social worker's services. Social workers may not barter except when such arrangement is not exploitative and: (3-20-20)T

- a. Is initiated by the client and with the client's written informed consent; and (3-20-20)T
- b. Has an easily determined fair market value of the goods or services received. (3-20-20)T

**451. -- 474. (RESERVED)**

**475. DISCIPLINE.**

**01. Civil Fine.** The Board may impose a civil fine not to exceed one thousand dollars (\$1,000) upon a licensed social worker for each violation of Section 54-3211, Idaho Code. (3-20-20)T

**02. Costs and Fees.** The Board may order a licensed social worker to pay the costs and fees incurred by the Board in the investigation or prosecution of the licensee for violation of Section 54-3211, Idaho Code. (3-20-20)T

**476. -- 999. (RESERVED)**

## **IDAPA 24 – DIVISION OF OCCUPATIONAL AND PROFESSIONAL LICENSES**

### **24.15.01 – RULES OF THE IDAHO LICENSING BOARD OF PROFESSIONAL COUNSELORS AND MARRIAGE AND FAMILY THERAPISTS**

#### **DOCKET NO. 24-1501-2000F (FEE RULE)**

#### **NOTICE OF OMNIBUS RULEMAKING – ADOPTION OF TEMPORARY RULE**

**EFFECTIVE DATE:** The effective date of the temporary rules being adopted through this omnibus rulemaking is the adjournment date of the second regular session of the 65th Idaho State Legislature - March 20, 2020.

**AUTHORITY:** In compliance with Sections 67-5226, Idaho Code, notice is hereby given this agency has adopted a temporary rule. The action is authorized pursuant to Section 54-3404, Idaho Code.

**DESCRIPTIVE SUMMARY:** The following is the required finding and concise statement of its supporting reasons for adopting a temporary rule:

This temporary rulemaking adopts the following chapter under IDAPA 24.15.01:

#### **IDAPA 24.15**

- 24.15.01, *Rules of the Idaho Licensing Board of Professional Counselors and Marriage and Family Therapists.*

**TEMPORARY RULE JUSTIFICATION:** Pursuant to Sections 67-5226(1) and 67-5226(2), Idaho Code, the Governor has found that temporary adoption of the rule is appropriate for the following reasons:

These temporary rules are necessary to protect the public health, safety, and welfare of the citizens of Idaho and confer a benefit on its citizens. These temporary rules implement the duly enacted laws of the state of Idaho, provide citizens with the detailed rules and standards for complying with those laws, and assist in the orderly execution and enforcement of those laws. The expiration of these rules without due consideration and processes would undermine the public health, safety, and welfare of the citizens of Idaho and deprive them of the benefit intended by these rules. These rules govern the qualifications and ethical standards for professional counselors and marriage and family therapists. Allowing these rules to expire would harm public health, safety, and welfare through removing safeguards designed to protect against harm or damage to vulnerable children, adolescents, and adults.

**FEE SUMMARY:** Pursuant to Section 67-5226(2), the Governor has found that the fees or charges being imposed or increased are justified and necessary to avoid immediate danger and the fees are described herein:

The fees or charges, authorized in Section 54-3411, Idaho Code, are part of the agency's 2021 budget that relies upon the existence of these fees or charges to meet the state's obligations and provide necessary state services. Failing to reauthorize these temporary rules would create immediate danger to the state budget, immediate danger to necessary state functions and services, and immediate danger of a violation of Idaho's constitutional requirement that it balance its budget.

The following is a specific description of the fees or charges:

<b>LICENSE/PERMIT/REGISTRATION</b>	<b>INITIAL FEE (Not to Exceed)</b>	<b>ANNUAL RENEWAL FEE (Not to Exceed)</b>
Application	\$100	
License	\$100	\$120
Intern Registration	\$25	
Reinstatement Fee	As provided in Section 67-2614, Idaho Code	
Senior License		\$60

<b>LICENSE/PERMIT/REGISTRATION</b>	<b>INITIAL FEE (Not to Exceed)</b>	<b>ANNUAL RENEWAL FEE (Not to Exceed)</b>
Inactive License		\$60
Inactive to Active License Fee	The difference between the current inactive and active license renewal fees	

**ASSISTANCE ON TECHNICAL QUESTIONS:** For assistance on technical questions concerning the temporary rule, contact Rob McQuade at (208) 334-3233.

DATED this February 21, 2020.

Kelley Packer  
Division Administrator  
Division of Occupational and Professional Licenses  
700 W. State Street  
P.O. Box 83720  
Boise, ID 83720  
Phone: (208) 334-3233  
Fax: (208) 334-3945



**24.15.01 – RULES OF THE IDAHO LICENSING BOARD OF PROFESSIONAL  
COUNSELORS AND MARRIAGE AND FAMILY THERAPISTS**

**000. LEGAL AUTHORITY.**

These rules are hereby prescribed and established pursuant to the authority vested in the Idaho Licensing Board of Professional Counselors and Marriage and Family Therapists by the provisions of Section 54-3404, Idaho Code. (3-20-20)T

**001. TITLE AND SCOPE.**

These rules are titled IDAPA 24.15.01, “Rules of the Idaho Licensing Board of Professional Counselors and Marriage and Family Therapists.” (3-20-20)T

**002. – 003. (RESERVED)**

**004. INCORPORATION BY REFERENCE.**

**01. ACA Code of Ethics.** “ACA Code of Ethics,” as published by the American Counseling Association (ACA), effective 2014, is herein incorporated by reference and is available from the Board’s office and website. (3-20-20)T

**02. AAMFT Code of Ethics.** The document titled “AAMFT Code of Ethics,” as published by the American Association for Marriage and Family Therapy (AAMFT), effective January 1, 2015, is herein incorporated by reference and is available from the Board’s office and website. (3-20-20)T

**03. Guidelines.** The document titled “Approved Supervision Designation Handbook” that provides supervision guidelines for supervisors, as published by the American Association for Marriage and Family Therapy (AAMFT), dated October 2007, is herein incorporated by reference and is available from the Board’s office and website. (3-20-20)T

**005. -- 009. (RESERVED)**

**010. DEFINITIONS.**

**01. Accredited University or College.** An accredited university or college is a college or university accredited by a regional accrediting agency as identified by the U.S. Department of Education. (3-20-20)T

**02. Face-to-face Setting.** May include a secure live electronic face-to-face connection between the supervisor and supervisee. (3-20-20)T

**03. Licensed Mental Health Professional Supervisor.** A clinical professional counselor, marriage and family therapist, psychologist, clinical social worker, or psychiatrist, whose license in Idaho is active, current, and in good standing and who, when applicable, is registered as a supervisor with their respective licensing board. (3-20-20)T

**04. Practicum.** The term practicum includes a practicum, internship, or a combination, taken as part of the graduate level program. (3-20-20)T

**05. Supplemental Practicum Hours.** Supplemental practicum hours are hours of direct client contact that are supervised at a ratio of one (1) hour of supervision for every ten (10) hours of direct client contact by a registered supervisor for the profession for which the applicant is seeking licensure. (3-20-20)T

**011. -- 149. (RESERVED)**

**150. QUALIFICATIONS FOR PROFESSIONAL COUNSELOR LICENSURE.**

Licensure as a “professional counselor” is restricted to persons who have successfully completed the required examination and each of the following: (3-20-20)T

**01. Graduate Program.** Possess a master’s degree or higher, which includes an educational specialist degree, that is primarily counseling in nature, from an accredited university or college offering a graduate program in counseling, provided that the program is either: (3-20-20)T

- a. Approved by the Council for Accreditation of Counseling and Related Educational Programs; or (3-20-20)T

**b.** A counseling program of at least sixty (60) semester hours or ninety (90) quarter hours in length and that at a minimum includes successful completion of one (1) graduate level course unique to the eight (8) areas and an advanced counseling practicum as follows: (3-20-20)T

**i.** Human growth and development: Includes studies that provide a broad understanding of the nature and needs of individuals at all developmental levels. Emphasis is placed on psychological, sociological, and physiological approaches. Also included are areas such as human behavior (normal and abnormal), personality theory, and learning theory. (3-20-20)T

**ii.** Social and cultural foundations: Includes studies of change, ethnic groups, subcultures, changing roles of women, sexism, urban and rural societies, population patterns, cultural mores, use of leisure time, and differing life patterns. (3-20-20)T

**iii.** The helping relationship: Includes philosophic bases of the helping relationship: Consultation theory and/or an emphasis on the development of counselor and client (or consultee) self-awareness and self-understanding. (3-20-20)T

**iv.** Groups: Includes theory and types of groups, as well as descriptions of group practices, methods dynamics, and facilitative skills. It includes either a supervised practice and/or a group experience. (3-20-20)T

**v.** Life-style and career development: Includes areas such as vocational-choice theory, relationship between career choice and life-style, sources of occupational and educational information, approaches to career decision-making processes, and career-development exploration techniques. (3-20-20)T

**vi.** Appraisal of the individual: Includes the development of a framework for understanding the individual, including methods of data gathering and interpretation, individual and group testing, case-study approaches and the study of individual differences. Ethnic, cultural, and sex factors are also considered. (3-20-20)T

**vii.** Research and evaluation: Includes areas such as statistics, research design, and development of research and demonstration proposals. It also includes understanding legislation relating to the development of research, program development, and demonstration proposals, as well as the development and evaluation of program objectives. (3-20-20)T

**viii.** Professional orientation: Includes goals and objectives of professional counseling organizations, codes of ethics, legal consideration, standards of preparation, certification, and licensing and role of identity of counselors. (3-20-20)T

**ix.** Advanced counseling practicum: Complete at least two (2) semester courses of an advanced counseling practicum taken at the graduate school level, provided that the applicant completed a total of two hundred eighty hours (280) of direct client contact that is supervised at the ratio of at least one (1) hour of one-to-one supervision for every ten (10) hours of experience in the setting. An applicant may complete one (1) supplemental practicum hour for every hour in which the practicum was deficient and that meets the requirements of Subsection 230.02 of these rules. (3-20-20)T

**02. Supervised Experience Requirement.** One thousand (1,000) hours of supervised experience in counseling acceptable to the Board. (3-20-20)T

**a.** One thousand (1,000) hours is defined as one thousand (1,000) clock hours of experience working in a counseling setting, four hundred (400) hours of which must be direct client contact. Supervised experience in practicum taken at the graduate level may be utilized. The supervised experience includes a minimum of one (1) hour of face-to-face or one-to-one (1/1) or one-to-two (1/2) supervision with the supervisor for every twenty (20) hours of job/internship experience. (3-20-20)T

**b.** Supervision must be provided in compliance with the ACA Code of Ethics that was adopted by the Board at the time the supervision and provided by a counselor education faculty member at an accredited college or university, Professional Counselor, registered with the Board as a supervisor, or a licensed mental health professional

supervisor as defined in these rules. If the applicant's supervision was provided in another state, it must have been provided by a counseling professional licensed by that state, provided the requirements for licensure in that state are substantially equivalent to the requirements in Idaho. (3-20-20)T

**c.** Experience in counseling is defined as assisting individuals or groups, through the counseling relationship, to develop an understanding of personal problems, to define goals, and to plan action reflecting interests, abilities, aptitudes, and needs as related to personal-social concerns, educational progress, and occupations and careers. Counseling experience may include the use of appraisal instruments, referral activities, and research findings. (3-20-20)T

**d.** The Board considers the recommendation of the supervisor(s) when determining the acceptability of the applicant's supervised experience. (3-20-20)T

**151. -- 224. (RESERVED)**

**225. CLINICAL PROFESSIONAL COUNSELOR LICENSURE.**

Licensure as a "clinical professional counselor" is restricted to applicants who have successfully passed the required examination and have met the following: (3-20-20)T

**01. License.** Hold a "professional counselor" license in this state or a license or other authorization in another state that has substantially similar requirements to a licensed professional counselor in this state, provided the license or authorization is current and in good standing; and (3-20-20)T

**02. Experience.** Document two thousand (2,000) hours of direct client contact experience under supervision accumulated in no less than a two (2) year period after licensure or other authorization to practice in any state. (3-20-20)T

**a.** All applicants must provide verification of meeting at least one thousand (1,000) hours of supervised experience under the supervision of a licensed Clinical Professional Counselor registered as a supervisor with the Board. The remainder of the supervision may be provided by a licensed mental health professional supervisor as defined in these rules. If the applicant's supervision was provided in another state, it must have been provided by a counseling professional licensed by that state, provided the requirements for license and supervision are substantially equivalent to the requirements in Idaho. (3-20-20)T

**b.** One (1) hour of clinical supervision for every thirty (30) hours of direct client contact is required. Individual supervision is defined as one (1) hour of face-to-face, one-on-one (1:1) or one-to-two (1:2) supervision to every thirty (30) hours of direct client contact. Supervision must be provided in a face-to-face setting. (3-20-20)T

**c.** No more than one-half (1/2) of the required supervision hours may be group supervision. (3-20-20)T

**03. Recommendation of the Supervisor(s).** The Board considers the recommendation of the supervisor(s) when determining the acceptability of the applicant's supervised experience. (3-20-20)T

**226. -- 229. (RESERVED)**

**230. QUALIFICATIONS FOR ASSOCIATE MARRIAGE AND FAMILY THERAPIST.**

An applicant for associate marriage and family therapist licensure must pass the required examination and meet the following: (3-20-20)T

**01. Graduate Degree.** Possess a graduate degree as outlined in Subsection 238.01 of these rules or a master's degree or higher in marriage and family therapy or a related field from an accredited university or college, provided that the graduate program meets one of the following: (3-20-20)T

**a.** Accredited by the Commission on Accreditation for Marriage and Family Therapy Education (COAMFTE); or (3-20-20)T

**b.** Accredited by the Council for Accreditation of Counseling and Related Educational Programs-Marriage, Couple, and Family Counseling (CACREP-MCFC); or (3-20-20)T

**c.** The program includes, at a minimum, twenty-seven (27) semester credits or thirty-six (36) quarter credits of the graduate level coursework set forth in Subsection 238.01.b of these rules. (3-20-20)T

**02. Practicum.** Completion of a supervised practicum in no less than a twelve (12) month period as part of the graduate program. The practicum must consist of at least three hundred (300) hours of direct client contact, of which at least one hundred fifty (150) hours must be with couples, families and other systems, provided that the Board may grant a license to an applicant who completed a practicum with fewer than the required hours and completed one (1) supplemental practicum hour for every hour in which the practicum was deficient. Supplemental practicum hours must be completed as: (3-20-20)T

**a.** A Registered Intern under Section 245 of these rules; or (3-20-20)T

**b.** Supervised practice in another jurisdiction that is sufficient to be considered substantially similar to the supplemental practicum hour requirements of these rules; or (3-20-20)T

**c.** A combination of Paragraph 02.a. and 02.b. of this subsection. (3-20-20)T

**231. – 237. (RESERVED)**

**238. MARRIAGE AND FAMILY THERAPISTS.**

An applicant for marriage and family therapist licensure must pass the required examination and meet the following: (3-20-20)T

**01. Graduate Degree.** Possess a master’s degree or higher in marriage and family therapy or a related field from an accredited university or college provided that the program is either: (3-20-20)T

**a.** Accredited by the Commission on Accreditation for Marriage and Family Therapy Education (COAMFTE); or (3-20-20)T

**b.** A program of at least sixty (60) semester hours or ninety (90) quarter hours in length and that includes at a minimum: (3-20-20)T

**i.** Marriage and family studies – Nine (9) semester credit hours or twelve (12) quarter credit hours: includes theoretical foundations, history, philosophy, etiology and contemporary conceptual directions of marriage and family therapy or marriage and family counseling; family systems theories and other relevant theories and their application in working with a wide variety of family structures, including families in transition, nontraditional families and blended families, and a diverse range of presenting issues; and preventive approaches, including premarital counseling, parent skill training and relationship enhancement, for working with couples, families, individuals, subsystems and other systems; (3-20-20)T

**ii.** Marriage and family therapy – Nine (9) semester credit hours or twelve (12) quarter credit hours: includes the practice of marriage and family therapy related to theory, and a comprehensive survey and substantive understanding of the major models of marriage and family therapy or marriage and family counseling; and interviewing and assessment skills for working with couples, families, individuals, subsystems and other systems, and skills in the appropriate implementation of systematic interventions across a variety of presenting clinical issues including, but not limited to, socioeconomic disadvantage, abuse and addiction; (3-20-20)T

**iii.** Biopsychosocial health and development across the lifespan – Nine (9) semester credit hours or twelve (12) quarter credit hours: includes individual development and transitions across the life span; family, marital and couple life cycle development and family relationships, family of origin and intergenerational influences, cultural influences, ethnicity, race, socioeconomic status, religious beliefs, gender, sexual orientation, social and equity issues and disability; human sexual development, function and dysfunction, impacts on individuals, couples and families, and strategies for intervention and resolution; and issues of violence, abuse and substance use in a relational context, and strategies for intervention and resolution; (3-20-20)T

iv. Psychological and mental health competency – Six (6) semester credit hours or eight (8) quarter credit hours: includes psychopathology, including etiology, assessment, evaluation and treatment of mental disorders, use of the current diagnostic and statistical manual of mental disorders, differential diagnosis and multiaxial diagnosis; standard mental health diagnostic assessment methods and instruments, including standardized tests; and psychotropic medications and the role of referral to and cooperation with other mental health practitioners in treatment planning, and case management skills for working with individuals, couples, families, and other systems and relational groups; (3-20-20)T

v. Professional ethics and identity – Three (3) semester credit hours or four (4) quarter credit hours: includes professional identity, including professional socialization, professional organizations, training standards, credentialing bodies, licensure, certification, practice settings and collaboration with other disciplines; ethical and legal issues related to the practice of marriage and family therapy, legal responsibilities of marriage and family therapy and marriage and family counseling practice and research, business aspects, reimbursement, recordkeeping, family law, confidentiality issues and the relevant codes of ethics, including the code of ethics specified by the board; and the interface between therapist responsibility and the professional, social and political context of treatment; (3-20-20)T

vi. Research – Three (3) semester credit hours or four (4) quarter credit hours: includes research in marriage and family therapy or marriage and family counseling and its application to working with couples and families; and research methodology, quantitative and qualitative methods, statistics, data analysis, ethics and legal considerations of conducting research, and evaluation of research. (3-20-20)T

**02. Practicum.** Completed a supervised practicum, including any supplemental practicum hours, which meets the requirements of Subsection 230.02 of these rules. (3-20-20)T

**03. Supervised Marriage and Family Therapy Experience.** Completed at least three thousand (3,000) hours of graduate or post-graduate supervised experience in marriage and family therapy that meets the following requirements: (3-20-20)T

a. A minimum of two thousand (2,000) post-master’s direct client contact hours, over a period of not less than two (2) years, which must include a minimum of one thousand (1,000) direct client contact hours with couples, families, and other systems; and (3-20-20)T

b. A minimum of two hundred (200) hours of post-master’s supervision. (3-20-20)T

c. Other hours must support development as a marriage and family therapist, and may include: additional hours of supervision, additional practicum hours above the three hundred (300) hours required in Subsection 230.02 of these rules, writing clinical reports, writing case notes, case consultation, coordination of care, administering tests, and attending workshops, training sessions, and conferences. (3-20-20)T

d. A minimum of one hundred (100) hours post-master’s supervision must be obtained from a registered marriage and family therapist supervisor. The remaining one hundred (100) hours of supervision may also be obtained from a licensed mental health professional supervisor as defined in these rules who documents: (3-20-20)T

i. A minimum of five (5) years of experience providing marriage and family therapy; and (3-20-20)T

ii. Fifteen (15) contact hours of education in supervisor training; and (3-20-20)T

iii. Has not been the subject of any disciplinary action for five (5) years immediately prior to providing supervision. (3-20-20)T

e. No more than one hundred (100) hours of group supervision are allowed. Group supervision is defined as up to six (6) supervisees and one (1) supervisor; and (3-20-20)T

f. Individual supervision is defined as up to two (2) supervisees per supervisor; and (3-20-20)T

- g.** Supervision must employ observation of client contact such as the use of audio technologies or video technologies or co-therapy, or live supervision; and (3-20-20)T
- h.** A supervisor may not act as an applicant’s personal Professional Counselor/Therapist. (3-20-20)T
- i.** The Board considers the recommendation of the supervisor(s) when determining the acceptability of the applicant’s supervised experience. (3-20-20)T
- j.** Supervision obtained in another jurisdiction or from a supervisor in another jurisdiction must conform with the jurisdiction’s requirements provided they are substantially equivalent to Idaho’s requirements. (3-20-20)T

**239. SUPERVISOR REQUIREMENTS.**

Licenses in Idaho must be registered with the board to provide supervision for those individuals pursuing licensure in the state of Idaho as a counselor or marriage and family therapist. (3-20-20)T

**01. Requirements for Registration.** The board will register an applicant who: (3-20-20)T

**a.** Possesses two (2) years experience as a licensed counselor or marriage and family therapist, respective to the profession for which the applicant seeks registration as a supervisor, and document at least one thousand five hundred (1,500) hours of direct client contact as a counselor or two thousand (2,000) hours of direct client contact with couples, families, and other systems as a marriage and family therapist. (3-20-20)T

**b.** Documents fifteen (15) contact hours of education in supervisor training as approved by the Board. (3-20-20)T

**c.** Has not been subject to discipline for five (5) years prior to registration, provided that the Board may in its discretion approve a supervisor with disciplinary action for failing to complete continuing education requirements. (3-20-20)T

**02. Supervision.** (3-20-20)T

**a.** A registered supervisor must provide supervision in conformance with the guidelines for supervisors set forth in the ACA Code of Ethics for counselor supervisors or the American Association for Marriage and Family Therapists and the guidelines set forth in the AAMFT Code of Ethics for marriage and family therapist supervisors. (3-20-20)T

**b.** Unless the primary work role of an individual is as a clinical supervisor, a registered supervisor may not supervise more than six (6) supervisees concurrently. (3-20-20)T

**c.** Supervision must be provided in a face-to-face setting. (3-20-20)T

**d.** A registered supervisor must ensure that informed consent containing information about the roles of the supervisor and supervisee is obtained from clients of the supervisee. (3-20-20)T

**04. Renewal.** Subject to the conditions in Paragraph 239.04.c. of this rule, a supervisor’s registration is valid for a term of five (5) years, provided the supervisor’s license remains current, active, in good standing, and is not subject to discipline. To renew a supervisor registration, the licensee must submit to the Board a complete application for registration renewal prior to the expiration of the current registration and meet the following: (3-20-20)T

**a.** Document six (6) hours of continuing education in advanced supervisor training as approved by the Board and completed within the previous five (5) years. (3-20-20)T

**b.** For supervisors registered for less than five (5) years prior to July 1, 2016 must submit a complete application for registration renewal and meet the renewal requirements by July 1, 2020. (3-20-20)T

**240. EXAMINATION FOR LICENSURE.**

Applicants must have successfully completed the required written examination. (3-20-20)T

**01. Examination.** The required written examination is: (3-20-20)T

**a.** For counselor applicants, the National Counselor Examination prepared by the National Board of Certified Counselors (NBCC). (3-20-20)T

**b.** For clinical counselor applicants, the National Clinical Mental Health Counselor Examination (NCMHCE) prepared by the National Board of Certified Counselors (NBCC). (3-20-20)T

**c.** For associate marriage and family therapist and marriage and family therapist applicants, the National Marital and Family Therapy Examination as approved by the Association of Marital and Family Therapy Regulatory Boards (AMFTRB) or another recognized competency examination in marriage and family therapy that is approved by the Board. (3-20-20)T

**02. Time and Place.** The examination will be conducted at a time and place specified by the Board or the examining entity. (3-20-20)T

**03. Successful Passage.** Successful passage of the examination is defined as achievement of the passing score set by the preparer of the examination. Reexamination consists of the entire examination. (3-20-20)T

**241. Non-United States Educated Applicants.**

Applicants with a graduate degree from a country other than the United States may be required to submit a certification from a credential evaluation service that is a member of the National Association of Credential Evaluation Services (NACES) or approved by the Board. The service must certify that the graduate degree is equivalent to a graduate degree from the United States. All costs for the certification are the responsibility of the applicant. All information submitted to the Board must be submitted with an English translation. (3-20-20)T

**242. -- 244. (RESERVED)**

**245. REGISTERED INTERNS.**

The Board may issue a registration to allow an intern to engage in the practice of counseling or marriage and family therapy while completing either the supervised experience or supplemental practicum hours required for licensure. A registered intern may only practice under the direct supervision of a person registered as a supervisor with the Board or otherwise approved to provide supervision under this chapter. (3-20-20)T

**01. Requirements for Registration.** An applicant must meet the following requirements: (3-20-20)T

**a.** Possess a graduate degree in counseling, marriage and family therapy, or a closely related field from an accredited university or college. (3-20-20)T

**b.** Designate a supervisor who is registered with the board as a supervisor as set forth in these rules or who is otherwise approved to provide marriage and family therapy supervision as set forth in Section 238 of these rules. (3-20-20)T

**02. Supervision.** The designated supervisor is responsible to provide supervision and ensure that a Registered Intern is competent to practice such counseling or marriage and family therapy as may be provided. (3-20-20)T

**03. Designation of Intern Status.** Only a Registered Intern may use the title Registered Counselor Intern or Registered Marriage and Family Therapist Intern. Registered interns must explicitly state that they are interns in their documentation and advertising, such as business cards, informed consent forms, and other disclosures. (3-20-20)T

**04. Expiration.** An individual may not practice as an intern for more than four (4) years from the

original date of registration, unless good cause is demonstrated to the board. (3-20-20)T

**246. -- 249. (RESERVED)**

**250. FEES.**

**01. Application, License, and Registration Fee.** All fees are non refundable:

LICENSE/PERMIT/REGISTRATION	INITIAL FEE (Not to Exceed)	ANNUAL RENEWAL FEE (Not to Exceed)
Application	\$100	
License	\$100	\$120
Intern Registration	\$25	
Reinstatement Fee	As provided in Section 67-2614, Idaho Code	
Senior License		\$60
Inactive License		\$60
Inactive to Active License Fee	The difference between the current inactive and active license renewal fees	

(3-20-20)T

**02. Examination or Reexamination Fee.** The examination or reexamination fees are the fees set by the provider of the approved examination plus an administration fee of twenty-five dollars (\$25) for the Marriage and Family Therapy examination. (3-20-20)T

**251. -- 299. (RESERVED)**

**300. ENDORSEMENT.**

The Board may grant a license to an applicant who: (3-20-20)T

**01. Holds a Current License.** Holds a current active license, in the profession and at the level for which a license is being sought, issued by the authorized regulatory entity in another state or foreign country. The state or foreign country must have substantially similar requirements for licensing as is provided for new applicants in Idaho. The certification of licensure must be received by the Board from the issuing agency; and (3-20-20)T

**02. Has Documented Experience.** Has a documented record of at least five (5) years actual practice under licensure in the seven (7) years immediately prior to application in the profession for which a license is being sought, or can demonstrate hardship or extenuating circumstances that prohibited practice during a portion of the seven (7) year period as determined by the Board. (3-20-20)T

**301. -- 349. (RESERVED)**

**350. CODE OF ETHICS.**

The Board adopts the American Counseling Association (ACA) Code of Ethics and the American Association for Marriage and Family Therapy (AAMFT) Code of Ethics. All licensees must adhere to the appropriate Code of Ethics pertaining to their licensure. (3-20-20)T

**351. -- 359. (RESERVED)**

**360. INACTIVE STATUS.**



**01. Request for Inactive Status.** Each person requesting an inactive status must submit a written request and pay the established fee. (3-20-20)T

**02. Inactive License Status.** (3-20-20)T

**a.** All continuing education requirements will be waived for any year or portion thereof that a licensee maintains an inactive license. (3-20-20)T

**b.** When the licensee desires active status, the licensee must show acceptable fulfillment of continuing education requirements for the previous twelve (12) months and submit a fee equivalent to the difference between the inactive and active renewal fee, provided that a licensee whose license has been inactive five (5) years or more must provide an account to the Board for that period of time during which the license was inactive and fulfill requirements that demonstrate competency to resume practice. Those requirements may include, but are not limited to, education, supervised practice, and examination as determined by the Board. The Board may consider practice in another jurisdiction in determining competency. (3-20-20)T

**c.** Licensees may not practice or supervise counseling or marriage and family therapy in Idaho while on inactive status. (3-20-20)T

**361. -- 374. (RESERVED)**

**375. SENIOR STATUS.**

**01. Request for Senior Status.** Each person having attained the age of sixty-five (65) and requesting a senior status during the renewal of their active license must submit a written request and pay the established fee. (3-20-20)T

**02. Continuing Education.** Continuing education must be completed annually per Section 425 of this rule. (3-20-20)T

**376. -- 424. (RESERVED)**

**425. CONTINUING EDUCATION.**

All licensees must complete in each twenty-four-month period preceding the renewal of a license, forty (40) contact hours of continuing education. A contact hour is one (1) hour of actual participation in a continuing education activity, exclusive of breaks. (3-20-20)T

**01. Contact Hours.** The contact hours of continuing education must be obtained in areas of study germane to the practice for which the license is issued as approved by the Board. No less than six (6) contact hours for each renewal period must be in ethics, which must be specific to legal issues, law, or ethics. Therapeutic workshops, retreats and other self-help activities are not considered continuing education training unless specific parts of the experience are applicable to counseling or therapy practice. (3-20-20)T

**02. Documentation of Attendance.** Each licensee must maintain documentation verifying hours of attendance by securing authorized signatures or other documentation from the course instructors, providers, or sponsoring institution. This documentation is subject to audit and must be provided upon request by the Board or its agent. (3-20-20)T

**03. Approved Contact Hours, Limitations, and Required Documents.** (3-20-20)T

**a.** College or University Courses for Credit or Audit. There is no limit to the contact hours that a licensee may obtain in this category during each reporting period. However, all courses are subject to Board approval. For college or university courses, one (1) semester credit equals fifteen (15) contact hours; one (1) quarter credit equals ten (10) contact hours. The licensee must provide the Board with a copy of the licensee's transcript substantiating any hours attended by the licensee. (3-20-20)T

**b.** Seminars, Workshops, Conferences. There is no limit to the contact hours that a licensee may obtain in this category during each reporting period. Verifying documentation is a copy of the certificate, or letter signed by course instructors, providers, or sponsoring institution substantiating any hours attended by the licensee.

(3-20-20)T

**c.** Publications. A maximum of eight (8) contact hours may be counted in this category during each reporting period. Publication activities are limited to articles in journals, a chapter in an edited book, or a published book or professional publication. Verifying documentation is a copy of the cover page or the article or book in which the licensee has been published. For a chapter in an edited book the licensee must submit a copy of the table of contents.

(3-20-20)T

**d.** Presentations. A maximum of eight (8) contact hours may be counted in this category during each reporting period. Class, conference, or workshop presentations may be used for contact hour credit if the topic is germane to the field. A specific presentation given repeatedly can only be counted once. A particular presentation will qualify for contact hour credit one (1) time in a five (5) year period. Only actual presentation time may be counted; preparation time does not qualify for contact hour credit. Verifying documentation is a copy of the conference program or a letter from the sponsor, host organization, or professional colleague.

(3-20-20)T

**e.** Clinical Supervision and Case Consultation. A maximum of ten (10) contact hours of received supervision/consultation may be counted in this category during each reporting period. In order to qualify for contact hour credit, supervision/consultation must be received on a regular basis with a set agenda. No credit will be given for the licensee's supervision of others. Verifying documentation is a letter from the supervisor or consultant listing periods of supervision or consultation.

(3-20-20)T

**f.** Dissertation. A maximum of ten (10) contact hours may be counted in this category during each reporting period. Verifying documentation is a copy of the licensee's transcript and the title of the dissertation.

(3-20-20)T

**g.** Leadership. A maximum of eight (8) contact hours may be counted in this category during each reporting period. Verifying documentation is a letter from a professional colleague listing the position of leadership, periods of leadership, and the name of the organization under which the leadership took place. The following leadership positions qualify for continuing education credits:

(3-20-20)T

- i. Executive officer of a state or national counseling or therapy organization; (3-20-20)T
- ii. Editor or editorial board service of a professional counseling or therapy journal; (3-20-20)T
- iii. Member of a national ethics disciplinary review committee rendering licenses, certification, or professional membership; (3-20-20)T
- iv. Active member of a counseling or therapy working committee producing a substantial written product; (3-20-20)T
- v. Chair of a major counseling or therapy conference or convention; or (3-20-20)T
- vi. Other leadership positions with justifiable professional learning experiences. (3-20-20)T

**h.** Home Study and On-line Education. There is no limit to the contact hours that a licensee may obtain in this category during each reporting period. Home study or on-line courses qualify for contact hours, provided that the course is provided by a Board-approved continuing education provider or a course pre-approved by the Board. Verifying documentation is a copy of the certification that is verified by the authorized signatures from the course instructors, providers, or sponsoring institution and substantiates any hours completed by the licensee. A licensee seeking contact credit for reading a publication must submit results from a test on the information contained within the publication and administered by an independent third-party.

(3-20-20)T

**i.** Board Meetings. Continuing education credit may be granted for a maximum of four (4) hours each renewal period for time spent attending two (2) Board meetings.

(3-20-20)T

**04. Waiver.** The Board may waive continuing education requirements for reasons of individual hardship, including health (certified by a medical doctor) or other good cause. The licensee must request such waiver prior to renewal and provide any information requested by the Board to assist in substantiating hardship cases. This waiver is granted at the sole discretion of the Board. (3-20-20)T

**426. – 524. (RESERVED)**

**525. DOCUMENTATION OF INFORMED CONSENT.**

In accordance with Section 54-3410A, Idaho Code, all licensees and registered interns will document the process of obtaining the informed consent of clients at the beginning of treatment and at other times as appropriate. Licensees and interns must adhere to their respective Codes of Ethics and state law in obtaining informed consent and disclosing information to clients. The receipt of the disclosure must be acknowledged in writing by both the client and the licensee or intern, and such disclosure of information concerning their practice must include: (3-20-20)T

**01. Name, Business Address and Phone Number of Licensee or Intern.** If the licensee or intern is practicing under supervision, the statement must include the licensee or intern status as such and the designated qualified supervisor's name, business address and phone number; (3-20-20)T

**02. License Type and License Number, Credentials, and Certifications.** (3-20-20)T

**03. Education.** Education with the name(s) of the institution(s) attended and the specific degree(s) received; (3-20-20)T

**04. Theoretical Orientation and Approach.** Counseling or marriage and family therapy; (3-20-20)T

**05. Relationship.** Information about the nature of the clinical relationship; fee structure and billing arrangements; cancellation policy; (3-20-20)T

**06. The Extent and Limits of Confidentiality.** (3-20-20)T

**07. Written Statement.** A statement that sexual intimacy is never appropriate with a client and should be reported to the board. (3-20-20)T

**08. Client's Rights.** The client's rights to be a participant in treatment decisions, to seek a second opinion, to file a complaint without retaliation, and to refuse treatment. (3-20-20)T

**09. Board Information.** The name, address, and phone number of the Board with the information that the practice of licensees and interns is regulated by the Board. (3-20-20)T

**526. -- 999. (RESERVED)**

# IDAPA 24 – DIVISION OF OCCUPATIONAL AND PROFESSIONAL LICENSES

## 24.16.01 – RULES OF THE STATE BOARD OF DENTURITRY

### DOCKET NO. 24-1601-2000F (FEE RULE)

#### NOTICE OF OMNIBUS RULEMAKING – ADOPTION OF TEMPORARY RULE

**EFFECTIVE DATE:** The effective date of the temporary rules being adopted through this omnibus rulemaking is the adjournment date of the second regular session of the 65th Idaho State Legislature - March 20, 2020.

**AUTHORITY:** In compliance with Sections 67-5226, Idaho Code, notice is hereby given this agency has adopted a temporary rule. The action is authorized pursuant to Section 54-3309, Idaho Code.

**DESCRIPTIVE SUMMARY:** The following is the required finding and concise statement of its supporting reasons for adopting a temporary rule:

This temporary rulemaking adopts the following chapter under IDAPA 24.16.01:

**IDAPA 24.16**

- 24.16.01, *Rules of the State Board of Denturitry.*

**TEMPORARY RULE JUSTIFICATION:** Pursuant to Sections 67-5226(1) and 67-5226(2), Idaho Code, the Governor has found that temporary adoption of the rule is appropriate for the following reasons:

These temporary rules are necessary to protect the public health, safety, and welfare of the citizens of Idaho and confer a benefit on its citizens. These temporary rules implement the duly enacted laws of the state of Idaho, provide citizens with the detailed rules and standards for complying with those laws, and assist in the orderly execution and enforcement of those laws. The expiration of these rules without due consideration and processes would undermine the public health, safety, and welfare of the citizens of Idaho and deprive them of the benefit intended by these rules. These rules govern the qualifications and facility standards for the practice of denturitry. Allowing these rules to expire would deny the Board of its ability to ensure minimum qualifications for practice are met and facility standards are maintained.

**FEE SUMMARY:** Pursuant to Section 67-5226(2), the Governor has found that the fees or charges being imposed or increased are justified and necessary to avoid immediate danger and the fees are described herein:

The fees or charges, authorized in Section 54-3312, Idaho Code, are part of the agency's 2021 budget that relies upon the existence of these fees or charges to meet the state's obligations and provide necessary state services. Failing to reauthorize these temporary rules would create immediate danger to the state budget, immediate danger to necessary state functions and services, and immediate danger of a violation of Idaho's constitutional requirement that it balance its budget.

The following is a specific description of the fees or charges:

FEE TYPE	AMOUNT (Not to Exceed)
License Application and Examination	\$300
License Application and Re-examination	\$300
Intern Application and Permit	\$300
Initial License	\$300
Inactive License	\$50
Annual Renewal	\$750

**ASSISTANCE ON TECHNICAL QUESTIONS:** For assistance on technical questions concerning the temporary rule, contact Rob McQuade at (208) 334-3233.

DATED this February 21, 2020.

Kelley Packer  
Division Administrator  
Division of Occupational and Professional Licenses  
700 W. State Street  
P.O. Box 83720  
Boise, ID 83720  
Phone: (208) 334-3233  
Fax: (208) 334-3945

## 24.16.01 – RULES OF THE STATE BOARD OF DENTURITRY

### 000. LEGAL AUTHORITY.

In accordance with Section 54-3309, Idaho Code, the State Board of Denturitry has promulgated rules implementing the provisions of Chapter 33, Title 54, Idaho Code. (3-20-20)T

### 001. TITLE AND SCOPE.

These rules are titled IDAPA 24.16.01, “Rules of the State Board of Denturitry.” (3-20-20)T

### 002. -- 009. (RESERVED)

### 010. DEFINITIONS.

**01. Denturist Services.** For purposes of the unconditional ninety (90) day guarantee prescribed in Section 54-3320(c), Idaho Code, denturist services include any and all prosthetic dental appliances and materials and/or services related to the furnishing or supplying of such a denture, including preparatory work, construction, fitting, furnishing, supplying, altering, repairing or reproducing any prosthetic dental appliance or device. (3-20-20)T

**02. Denture Technician.** A person who is limited to making, constructing, altering, reproducing or repairing of a full upper or lower removable prosthetic denture, the repairing of a removable partial upper or lower prosthetic denture but is not allowed to make an impression or come in direct contact with a patient. (3-20-20)T

### 011. -- 149. (RESERVED)

### 150. EXAMINATIONS.

**01. Date of Licensure Examination.** The licensure examination will be held no less than two (2) times per year at such times and places as may be determined by the Board. (3-20-20)T

**02. Content.** Examinations include both a written theory examination and a practical demonstration of skills. (3-20-20)T

**03. Grading.** An applicant must obtain a score of seventy-five percent (75%) or better on each part of the examination in order to pass the examination. (3-20-20)T

**04. Re-Examination.** (3-20-20)T

**a.** Applicants who fail either part or all of the examination will be required to make application and pay the required fees prior to being eligible to retake the failed part of the examination. (3-20-20)T

**b.** Applicants failing either part or all of the examination on the first attempt will not be required to complete any additional instruction prior to being eligible to make application and retake the examination. (3-20-20)T

**c.** Applicants failing either part or all of the examination on a second attempt and all subsequent attempts are not eligible to make application and retake the examination within one (1) year of the date of the examination failure. The Board may recommend additional course work or clinical work for any applicant who has failed an examination two (2) or more times. (3-20-20)T

### 151. -- 199. (RESERVED)

### 200. APPLICATIONS.

**01. Application Filing Date.** Licensure applications must be received in the Division of Occupational and Professional Licenses at least seven (7) business days prior to the next scheduled meeting of the Board. Applications received after that date may be held over for the Board’s next meeting. (3-20-20)T

**02. Application Form for Licensure.** Applications for licensure must be made on forms approved by the Board and furnished by the Division of Occupational and Professional Licenses and must include all other documents necessary to establish the applicant meets the requirements for licensure except examination and is eligible to take the licensure examination. (3-20-20)T

**03. Application Must Be Complete.** All applications must be complete in every respect and

accompanied by the appropriate fees before being considered received by the Division of Occupational Professional Licenses. (3-20-20)T

**04. Authorization for Examination.** (3-20-20)T

**a.** After the Board evaluates the applicant’s qualifications to take the examination the applicant will be notified in writing of the approval or denial, and, if denied, the reason for the denial. (3-20-20)T

**b.** At the time the Board approves an applicant to take the examination the Board will set the date and location(s) of the next examination if it has not already been set. Approved applicants will be notified of the date and location(s) of the next examination. (3-20-20)T

**201. -- 249. (RESERVED)**

**250. FEES.**

FEE TYPE	AMOUNT (Not to Exceed)
License Application and Examination	\$300
License Application and Re-examination	\$300
Intern Application and Permit	\$300
Initial License	\$300
Inactive License	\$50
Annual Renewal	\$750

(3-20-20)T

**251. -- 299. (RESERVED)**

**300. INTERNSHIP.**

**01. Requirements and Conditions for Internship.** (3-20-20)T

**a.** To be eligible for internship the applicant must have completed: (3-20-20)T

**i.** The educational requirements set forth in Section 54-3310(b), Idaho Code; or (3-20-20)T

**ii.** Have dentistry experience of three (3) years within the five (5) years immediately preceding application. (3-20-20)T

**b.** Where an internship is established based on experience, the internship is valid only while the intern is actively pursuing completion of Idaho licensure requirements. (3-20-20)T

**c.** Application must be made on forms provided by the Division of Occupational and Professional Licenses and must: (3-20-20)T

**i.** Document the location of practice; (3-20-20)T

**ii.** Include the name and address of the supervising denturist or dentist; (3-20-20)T

**iii.** Include a sworn or affirmed statement by the supervising denturist or dentist; (3-20-20)T

**iv.** Include a sworn or affirmed statement by the supervisor accepting supervision of the intern;

- (3-20-20)T
- v. Include a sworn statement by applicant that he is knowledgeable of law and rules and will abide by all requirements of such law and rules; and (3-20-20)T
- vi. Include such other information necessary to establish applicant's qualifications for licensure as a denturist and establish compliance with pre-intern requirements. (3-20-20)T
- d. The supervising denturist or dentist must be present and directly observe any intern interaction with a patient. (3-20-20)T
- e. Two (2) years of internship under the supervision of a licensed denturist must be completed in not less than twenty-four (24) months and may not exceed thirty (30) months except as approved by the Board. (3-20-20)T
- 02. Internship Equivalency.** A person is considered to have the equivalent of two (2) years internship under a licensed denturist who has met and verifies one (1) of the following within the five (5) years immediately preceding application: (3-20-20)T
- a. Two (2) years internship as a denture lab technician under a licensed dentist; or (3-20-20)T
- b. Two (2) years in the military as a denture lab technician; or (3-20-20)T
- c. Three (3) years experience as a denturist under licensure in another state or Canada. (3-20-20)T
- 03. Internship Not to Exceed One Year.** Internship not to exceed one (1) year acquired through a formal training program in an acceptable school will be accepted toward the two (2) year required internship for licensure. (3-20-20)T
- 04. Training Requirements.** Each year of required internship consists of two thousand (2,000) clock hours of training and performance of the following minimum procedures for licensure. (3-20-20)T
- a. Procedures include all steps required in constructing a finished denture but are not limited to the following: (3-20-20)T
- i. Patient charting -- thirty-six (36) minimum. (3-20-20)T
- ii. Operatory sanitation -- thirty-six (36) minimum. (3-20-20)T
- iii. Oral examination -- thirty-six (36) minimum. (3-20-20)T
- iv. Impressions, preliminary and final (pour models, custom trays) -- thirty-six (36) minimum. (3-20-20)T
- v. Bite registrations -- twelve (12) minimum. (3-20-20)T
- vi. Articulations -- twelve (12) minimum. (3-20-20)T
- vii. Set ups -- twelve (12) minimum. (3-20-20)T
- viii. Try ins -- twelve (12) minimum. (3-20-20)T
- ix. Processing (wax up, flask-boil out, packing, grind-polish) -- thirty-six (36) minimum. (3-20-20)T
- x. Delivery-post adjustment -- thirty-six (36) minimum. (3-20-20)T
- b. Processed relines (one (1) plate = one (1) unit) -- twenty-four (24) units. (3-20-20)T



c. Tooth repairs -- forty-eight (48) minimum. (3-20-20)T

d. Broken or fractured plates or partials -- forty-eight (48) minimum. (3-20-20)T

**05. Reporting Requirements.** Interns must file reports, attested to by the supervisor, with the Board on forms provided by the Division of Occupational and Professional Licenses on a monthly basis and recapped at termination or completion of the training. (3-20-20)T

**06. Denture Clinic Requirements.** Denture clinic requirements for approved internship training: (3-20-20)T

a. There may not be more than one (1) internee per licensed denturist or dentist who is practicing at the clinic on a full time basis. (3-20-20)T

b. There must be a separate work station in the laboratory area for each intern with standard equipment, i.e. lathe, torch and storage space. The intern must provide necessary hand tools to perform the duties of the denture profession. Use of the operatory facilities and other equipment will be shared with the intern. (3-20-20)T

**07. Internship Supervisor Requirements.** (3-20-20)T

a. A supervisor must: (3-20-20)T

i. Be approved in advance by the Board for each internship. (3-20-20)T

ii. Not have been the subject of any disciplinary action by the Board, by the Idaho Board of Dentistry or by any other jurisdiction for five (5) years immediately prior to being approved as the supervisor. (3-20-20)T

b. A supervisor that is a denturist must: (3-20-20)T

i. Hold an Idaho denturist license that is current and in good standing and is renewed as provided in these rules; and (3-20-20)T

ii. Have actively practiced dentistry for at least three (3) of the five (5) years immediately prior to being approved as the supervisor. (3-20-20)T

c. A supervisor that is a dentist must: (3-20-20)T

i. Hold an Idaho dentist license that is current and in good standing and is renewed as provided in Chapter 9, Title 54, Idaho Code; and (3-20-20)T

ii. Have actively practiced general dentistry, or a dental specialty accepted by the Board, for at least three (3) of the five (5) years immediately prior to being approved as a supervisor. (3-20-20)T

d. Supervise only one (1) intern. A supervisor will not be approved to supervise more than one (1) intern at a time. (3-20-20)T

e. Termination of supervisor approval. Approval of the supervisor immediately terminates if the supervisor is disciplined or ceases to meet supervisor requirements. (3-20-20)T

**301. -- 314. (RESERVED)**

**315. INACTIVE LICENSURE STATUS.**

**01. Request License be Placed on Inactive Status.** A dentistry licensee may request the Board that his license be placed upon inactive status. (3-20-20)T

**02. License Fee for Inactive Status.** A licensee is required to submit an annual renewal fee of fifty dollars (\$50) in order to remain on inactive status. (3-20-20)T

**03. While on Inactive Status.** A licensee on inactive status may not provide or perform denturist services as defined in these rules. (3-20-20)T

**04. Reactivating Inactive License.** A licensee on inactive status may reactivate his license to active status by paying the renewal fee for an active license and providing proof they have completed and obtained such continuing education as required by Board rule of not less than twelve (12) hours for each year of inactive licensure. (3-20-20)T

**05. License Inactive over Five Years.** No license may remain on inactive status for more than five (5) years. (3-20-20)T

**316. -- 349. (RESERVED)**

**350. CONTINUING EDUCATION.**

The Board may accredit education programs for purposes of continuing education where the subject matter of the program is determined to be pertinent to the practice of dentistry. (3-20-20)T

**01. Subjects.** Subjects deemed pertinent to the practice of dentistry are those set forth in Section 54-3311(b), Idaho Code and may also include ethics courses. (3-20-20)T

**02. Request for Approval.** Requests for approval of continuing education programs must be made to the Board, in writing, and provide an outline of the program which the Board is being asked to approve. The request must also address the matters set forth in Subsection 350.05 below. Requests may accompany the annual renewal form or may be made to the Board in advance of the program for which approval is sought as indicated in Subsection 350.03, below. (3-20-20)T

**03. Requests for Pre-Approval.** Requests for pre-approval of continuing education programs must be made to the Board, in writing, and provide an outline of the program which the Board is being asked to approve. Requests for pre-approval must also address the matters set forth in Subsection 350.05 below. (3-20-20)T

**a.** Requests for pre-approval must be received by the Division of Occupational and Professional Licenses no less than eleven (11) working days prior to the date of the program. (3-20-20)T

**b.** Requests for pre-approval which are not denied within ten (10) working days from receipt by the Division will be deemed approved. (3-20-20)T

**c.** Only those continuing education programs sponsored by recognized educational institutions (such as accredited colleges or universities), state or national denturist boards or associations, will be eligible for pre-approval consideration by the Board. All other programs will be considered at the time of renewal. (3-20-20)T

**04. Credit for Continuing Education Attendance.** Continuing education credit will be given only for actual time in attendance by the licensee. No credit will be given for non-instructive time. Correspondence or Home Study courses are not eligible for continuing education credits. (3-20-20)T

**05. Requests for Approval of Programs.** All requests for approval or pre-approval of educational programs must be accompanied by a statement that includes the name of the instructor or instructors, the date and time and location of the course, the specific agenda for the course, and a statement by the licensee of how the course is believed to be pertinent to the practice of dentistry as specified in Section 54-3311(b), Idaho Code. (3-20-20)T

**351. -- 399. (RESERVED)**

**400. INSPECTIONS.**

**01. Who May Examine or Inspect.** The Board or its agents may examine and inspect the place of

business of any dentist at anytime during business hours or upon at least seventy-two (72) hours notice made by U.S. mail to the address of record of the dentist when the Board or its agents are unable to establish the regular business hours. (3-20-20)T

**02. Reason for Inspection.** Inspections are made to insure compliance with the Standards of Conduct and practice set forth in Section 450. Deficiencies are a violation of Section 450 and actionable against the dentist under Section 54-3314(c), Idaho Code. (3-20-20)T

**401. -- 449. (RESERVED)**

**450. STANDARDS OF CONDUCT AND PRACTICE.**

**01. Sanitation.** (3-20-20)T

**a.** There must be three (3) separate rooms; a reception room, and operatory room and a laboratory. (3-20-20)T

**b.** The operatory room must have hot and cold running water, basin with approved disposal system; disinfectant soap; single-use towels, a cuspidor with running water and a closed waste receptacle. (3-20-20)T

**c.** The laboratory room must have hot and cold running water, and basin with approved disposal system. (3-20-20)T

**d.** There must be a method of sterilization and disinfection evident and in use to insure the protection of the public. (3-20-20)T

**e.** All floors, walls, ceiling and benches must be kept in a sanitary condition at all times. (3-20-20)T

**f.** Every patient must have a separate and clean bib and a disposable cup. (3-20-20)T

**g.** The hands of every dentist must be washed in the presence of every patient with germicidal or antiseptic soap and water. Every dentist must wear disposable gloves. (3-20-20)T

**h.** Adequate and conveniently located toilet facilities with hot and cold running water, basin with approved disposal system, soap and single use towels will be provided within the building. (3-20-20)T

**i.** All dentist offices are open to inspection anytime during the business hours to inspection by the Board or its agents. (3-20-20)T

**02. Office Standards.** (3-20-20)T

**a.** Dentists must take care to use proper sterilization and sanitation techniques in all phases of their work. (3-20-20)T

**b.** A complete record of each patient must be kept. (3-20-20)T

**c.** All teeth and materials used must meet ADA standards. (3-20-20)T

**03. Advertisements.** (3-20-20)T

**a.** No dentist may disseminate or cause the dissemination of any advertisement or advertising that is any way fraudulent, false, deceptive or misleading. (3-20-20)T

**04. General Conditions.** (3-20-20)T

**a.** Conditions deemed by investigators to be a menace to the public health will be brought to the attention of the Board for consideration and immediate action. (3-20-20)T

**b.** These Standards of Conduct and Practice must be conspicuously posted in every licensed dentist's place of business. (3-20-20)T

**05. Patient Record.** A dentist must record, update and maintain documentation for each patient relevant to health history, clinical examinations and treatment, and financial data. Documentation must be written or computerized. Records must be maintained in compliance with any applicable state and federal laws, rules and regulations, including the health insurance portability and accountability act (HIPAA), P.L. 104-191 (1996), and the health information technology for economic and clinical health act (HITECH), P.L. 111-115 (2009). Such records must be accessible to other providers and to the patient in accordance with applicable laws, rules and regulations. Records must include, but are not limited to, the following: (3-20-20)T

- a.** Patient data, including name, address, date and description of examination; (3-20-20)T
- b.** Evidence of informed consent; (3-20-20)T
- c.** Date and description of treatment, services rendered, and any complications; (3-20-20)T
- d.** Health history as applicable; and (3-20-20)T
- e.** Any other information deemed appropriate to patient care. (3-20-20)T

**06. Record Retention.** Patient documentation, written or archived electronically by computer, must be retained for a minimum of seven (7) years and available upon request by the Board. (3-20-20)T

**451. -- 474. (RESERVED)**

**475. REGISTRATION STATEMENT.**

To enable the Board to examine or inspect the place of business of any licensed dentist as referred to in Section 54-3314(5)(b), Idaho Code, the filing of an annual statement is required of all licensed denturists. (3-20-20)T

**01. Statement.** must list the name and principal place of business of the dentist who is responsible for the practice of dentistry at that location. (3-20-20)T

**02. Other Business Locations.** Any other business locations maintained by the principal dentist and all denturists employed at the business. (3-20-20)T

**03. Date of Filing.** must be filed with the Board annually or within ten (10) days of any change in either location, identity of principal dentist or dentist employees. (3-20-20)T

**04. Failure to Timely File.** Failure to timely file or update this statement will constitute grounds for discipline pursuant to Section 54-3314(a), Idaho Code. (3-20-20)T

**476. GUARANTEE OF DENTURIST SERVICES.**

As prescribed in Section 54-3320(c), Idaho Code, unconditional guarantee of dentist services will require that the licensee refund, in full, any monies received in connection with the providing of dentist services, if demanded by the purchaser within ninety (90) days of delivery of the dentures, or the providing of services for which a fee is charged. (3-20-20)T

**01. Ninety Day Period.** The ninety (90) day period will be tolled for any period in which the dentist has taken possession or control of the dentures after original delivery. (3-20-20)T

**02. Written Contract.** By written contract signed by the purchaser, the dentist may specify the amount of the purchase price of the dentures, if any, that is nonrefundable should the consumer choose to cancel the purchase within the guarantee period. (3-20-20)T

**03. Nonrefundable Amount.** Under no circumstances will the nonrefundable amount exceed twenty-

five percent (25%) of the total purchase price of the dentures. (3-20-20)T

**04. Limitation.** There is no limitation on the consumer's right to cancel. (3-20-20)T

**05. Cancellation of Agreement.** If the licensee elects to cancel the agreement or refuses to provide adjustments or other appropriate services to the consumer, the consumer will be entitled to a complete refund. (3-20-20)T

**477. -- 479. (RESERVED)**

**480. DISCIPLINE.**

**01. Civil Fine.** The Board may impose a civil fine not to exceed one thousand dollars (\$1,000) upon a licensed dentist for each violation of Section 54-3314(a), Idaho Code. (3-20-20)T

**02. Costs and Fees.** The Board may order a licensed dentist to pay the costs and fees incurred by the Board in the investigation or prosecution of the licensee for violation of Section 54-3314(a), Idaho Code. (3-20-20)T

**481. -- 999. (RESERVED)**

# IDAPA 24 – DIVISION OF OCCUPATIONAL AND PROFESSIONAL LICENSES

## 24.17.01 – RULES OF THE STATE BOARD OF ACUPUNCTURE

### DOCKET NO. 24-1701-2000F (FEE RULE)

#### NOTICE OF OMNIBUS RULEMAKING – ADOPTION OF TEMPORARY RULE

**EFFECTIVE DATE:** The effective date of the temporary rule being adopted through this omnibus rulemaking is the adjournment date of the second regular session of the 65th Idaho State Legislature - March 20, 2020.

**AUTHORITY:** In compliance with Sections 67-5226, Idaho Code, notice is hereby given this agency has adopted a temporary rule. The action is authorized pursuant to Section 54-4705, Idaho Code.

**DESCRIPTIVE SUMMARY:** The following is the required finding and concise statement of its supporting reasons for adopting a temporary rule:

This temporary rulemaking adopts the following chapter under IDAPA 24.17.01:

**IDAPA 24.17**

- 24.17.01, *Rules of the State Board of Acupuncture.*

**TEMPORARY RULE JUSTIFICATION:** Pursuant to Section 67-5226(1) and 67-5226(2), Idaho Code, the Governor has found that temporary adoption of the rule is appropriate for the following reasons:

These temporary rules are necessary to protect the public health, safety, and welfare of the citizens of Idaho and confer a benefit on its citizens. These temporary rules implement the duly enacted laws of the state of Idaho, provide citizens with the detailed rules and standards for complying with those laws, and assist in the orderly execution and enforcement of those laws. The expiration of these rules without due consideration and processes would undermine the public health, safety, and welfare of the citizens of Idaho and deprive them of the benefit intended by these rules. These rules establish and govern the standards necessary for the practice of acupuncture and allowing the rules to expire would impede the Board’s ability to ensure that acupuncture services are provided by competent individuals.

**FEE SUMMARY:** Pursuant to Section 67-5226(2), the Governor has found that the fees or charges being imposed or increased is justified and necessary to avoid immediate danger and the fees are described herein:

The fees or charges, authorized in Section 54-4710(2), Idaho Code, are part of the agency’s 2021 budget that relies upon the existence of these fees or charges to meet the state’s obligations and provide necessary state services. Failing to reauthorize these temporary rules would create immediate danger to the state budget, immediate danger to necessary state functions and services, and immediate danger of a violation of Idaho’s constitutional requirement that it balance its budget.

The following is a specific description of the fees or charges:

License/Certification/Permit/Certification	Initial Fee (Not to Exceed)	Annual Renewal Fee (Not to Exceed)
Application	\$50	n/a
License	\$150	\$75
Certification	\$150	\$75
Acupuncture Trainee	\$150	\$50
Inactive License or Certification	n/a	\$50
Reinstatement	\$250	n/a

**ASSISTANCE ON TECHNICAL QUESTIONS:** For assistance on technical questions concerning the temporary rule, contact Rob McQuade at (208) 334-3233.

DATED this February 21, 2020.

Kelley Packer  
Division Administrator  
Division of Occupational and Professional Licenses  
700 W State Street  
P.O. Box 83720  
Boise, ID 83720  
Phone: (208) 334-3233  
Fax: (208) 334-3945

## 24.17.01 – RULES OF THE STATE BOARD OF ACUPUNCTURE

### 000. LEGAL AUTHORITY.

These rules are hereby prescribed and established pursuant to the authority vested in the State Board of Acupuncture by the provisions of Section 54-4705, Idaho Code. (3-20-20)T

### 001. TITLE AND SCOPE.

**01. Title.** These rules are titled IDAPA 24.17.01, “Rules of the State Board of Acupuncture.” (3-20-20)T

**02. Scope.** These rules review and establish the minimum requirements for licensure/certification of acupuncturists. (3-20-20)T

### 002. -- 009. (RESERVED)

### 010. DEFINITIONS.

**01. Accredited College or University.** An accredited college or university is a college or university accredited by an accrediting organization approved by the U.S. Department of Education. (3-20-20)T

**02. Approved Acupuncture Program.** A formal full-time acupuncture educational program that has met the standards of the Accreditation Commission for Acupuncture and Oriental Medicine or an equivalent educational body. An acupuncture program may be established as having satisfied this requirement by obtaining: (3-20-20)T

**a.** Accreditation; or (3-20-20)T

**b.** Candidacy for accreditation; or (3-20-20)T

**c.** An equivalent evaluation performed by a private, state government, or foreign government agency recognized for that purpose by the NCCAOM (National Certification Commission for Acupuncture and Oriental Medicine) Eligibility Committee. (3-20-20)T

**03. License.** Any license or certification issued to a qualified applicant pursuant to the laws and rules of the Board, permitting said applicant to practice acupuncture in the state of Idaho. (3-20-20)T

**04. Practitioner.** A person to whom a license, certification, or acupuncture trainee has been issued pursuant to Title 54, Chapter 47, Idaho Code. (3-20-20)T

### 011. -- 199. (RESERVED)

### 200. QUALIFICATIONS FOR LICENSURE OR CERTIFICATION.

**01. Requirements for Licensure.** Applicants for licensure must submit a complete application, required fee, and official certified documentation of either: (3-20-20)T

**a.** Certification from NCCAOM; or (3-20-20)T

**b.** Graduation from an approved formal full-time acupuncture program of at least one thousand seven hundred twenty-five (1,725) hours of entry-level acupuncture education which includes a minimum of one thousand (1000) hours of didactic course work and five hundred (500) clinical hours practice; and (3-20-20)T

**c.** Successful completion of an acupuncture internship, or other equivalent experience as approved by the Board; and (3-20-20)T

**d.** Receipt of a passing grade on an NCCAOM Acupuncture certification examination; or (3-20-20)T

**e.** Other demonstration of proficiency as uniformly required by the Board for other similarly qualified applicants for licensure; and (3-20-20)T

**f.** Successful completion of a Blood Borne Pathogen course and comprehensive examination that incorporates clean needle techniques and OSHA procedures and requirements. (3-20-20)T



**201. ACUPUNCTURE TRAINEE PERMIT.**

The Board may issue an acupuncture trainee permit to allow a person to engage in the practice of acupuncture while actively pursuing licensure or certification. The permit will expire one (1) year from date of issue. The permit may be extended in accordance with Section 54-4708, Idaho Code. The holder of an acupuncture trainee permit may only practice under the supervision of a person licensed or certified under this chapter who meets the requirements in Section 404 of these rules. An applicant for a permit must present evidence satisfactory to the Board of meeting the following requirements: (3-20-20)T

**01. Education.** An applicant must submit documentation of either: (3-20-20)T

**a.** Current enrollment in an Approved Acupuncture Program and actively pursuing completion of the program; or (3-20-20)T

**b.** Satisfaction of the requirement for certification as set forth in Section 54-4707, Idaho Code. (3-20-20)T

**02. Supervision.** Submission of a supervision plan specifying at a minimum the name of the supervisor and the setting and location where the permit holder will practice. A supervision plan may be approved by a designated Board member. (3-20-20)T

**202. -- 225. (RESERVED)**

**226. REQUEST FOR APPROVAL OF QUALIFICATION.**

**01. Course Review.** A person or entity may request approval of a course of study in acupuncture that will be offered to qualify applicants for a credential to practice acupuncture. The request must include a complete description of the required hours, scope and extent of academic and other training and clinical experience offered through the course along with appropriate supporting documentation and course materials. The request must also designate whether approval is sought for compliance with standards for certification. (3-20-20)T

**02. Individual Qualification.** An applicant may request approval of his individual qualification for licensure or certification in acupuncture. The request must include a complete description of the number of hours, scope and extent of academic and other training and clinical experience the individual has received along with available supporting documentation. The request must also designate whether qualification is sought for licensure or certification. A demonstration of proficiency or examination may be required as a part of the determination of the individual's qualification. (3-20-20)T

**227. -- 299. (RESERVED)**

**300. FEES.**

All fees are non-refundable:

<b>License/Certification/Permit/Certification</b>	<b>Initial Fee (Not to Exceed)</b>	<b>Annual Renewal Fee (Not to Exceed)</b>
Application	\$50	n/a
License	\$150	\$75
Certification	\$150	\$75
Acupuncture Trainee	\$150	\$50
Inactive License or Certification	n/a	\$50
Reinstatement	\$250	n/a

(3-20-20)T

**301. REINSTATEMENT OF LICENSE.**

The applicant must submit proof of having met the continuing education required of licensees by Section 305 through 307 of these rules as follows: (3-20-20)T

**01. Expired for One Year or Less.** For licenses or certificates expired for one (1) year or less, one (1) year of continuing education; (3-20-20)T

**02. Expired More than One Year.** For licenses or certificates expired for more than one (1) year, two (2) years of continuing education. (3-20-20)T

**302. INACTIVE STATUS.**

A currently licensed or certified practitioner may request in writing to have their license placed on inactive status and pay the inactive status fee. Such request must be made prior to the expiration date of the license. (3-20-20)T

**01. Waiving Continuing Education Requirements – Inactive Status.** All continuing education requirements will be waived for any year or portion thereof that a licensee maintains an inactive license. (3-20-20)T

**02. Return to Active Status.** (3-20-20)T

**a.** A licensee desiring to return to active status must complete the equivalent of one (1) year of continuing education for every year the license was inactive and submit a fee equivalent to the difference between the inactive fee and renewal fee. (3-20-20)T

**b.** For licenses inactive five (5) years or greater, the licensee shall complete forty-five (45) hours of continuing education and either provide proof that the licensee has actively engaged in the practice of acupuncture in another state or territory of the United States for at least three (3) of the immediately preceding five (5) years, or provide proof that the licensee is competent to practice acupuncture in Idaho. (3-20-20)T

**c.** The Board may consider the following factors when determining proof of competency: (3-20-20)T

i. Practice of acupuncture in another jurisdiction; (3-20-20)T

ii. Number of years of practice prior to transfer from active status; (3-20-20)T

iii. Completion of continuing education courses; (3-20-20)T

iv. Employment in a field similar to acupuncture; and (3-20-20)T

v. Any other factors the Board deems appropriate. (3-20-20)T

**303. -- 304. (RESERVED)**

**305. CONTINUING EDUCATION REQUIREMENTS.**

In order to further protect the public health and to facilitate the administration of the Acupuncture Act, the Board has adopted the following requirements: (3-20-20)T

**01. Requirement.** All practitioners are required to complete a minimum of fifteen (15) hours of continuing education within the preceding twelve (12) months. A minimum of ten (10) hours of continuing education must be from Category I topics, and a maximum of five (5) hours of continuing education may be from Category II topics, as set forth in Sections 306 and 307 of these rules. (3-20-20)T

**02. Verification of Attendance.** Each licensee must maintain verification of attendance by securing authorized signatures or other documentation from the course instructors or sponsoring institution substantiating any hours attended by the applicant. This verification must be maintained by the licensee for no less than four (4) years and provided to the Board upon the request of the Board or its agent. (3-20-20)T

**03. Distance Learning and Independent Study.** The Board may approve a course of study for continuing education credit that does not include the actual physical attendance of the applicant in a face-to-face setting with the course instructor. Distance Learning or Independent Study courses are eligible for continuing education credits if approved by NCCAOM or upon approval of the Board. (3-20-20)T

**04. Special Exemption.** The Board has authority to make exceptions for reasons of individual hardship. The licensee must provide any information requested by the Board to assist in substantiating hardship cases. This exemption is granted at the sole discretion of the Board. (3-20-20)T

**05. Carryover.** A continuing education course taken in a renewal year, but not claimed for continuing education credit in that year, may only be claimed for credit in the following renewal year. (3-20-20)T

**06. Credit for Teaching.** Licensees may earn continuing education credit by teaching Board-approved courses. A licensee will earn one (1) credit hour for every two (2) hours of teaching. Credit for teaching will not exceed five (5) hours of the total continuing education hours required for a renewal period and will be credited to the category of the topic taught. (3-20-20)T

**306. APPROVAL OF CONTINUING EDUCATION COURSES.**

Approved continuing education courses are those courses, programs, and activities that are approved or provided by the following entities or organizations, or otherwise approved by the Board: (3-20-20)T

**01. NCCAOM;** (3-20-20)T

**02. Accredited Schools.** Acupuncture and oriental medicine; and (3-20-20)T

**03. Other Courses May Be Approved by the Board.** Other courses may be approved based upon documentation submitted by the licensee or course provider. All requests for approval or pre-approval of educational programs must be made to the Board in writing, and must be accompanied by a statement that includes the name of the instructor or instructors, the date and time and location of the course, the specific agenda for the course, the number of continuing education credit hours requested, and a statement of how the course is believed to be pertinent to the practice of acupuncture. (3-20-20)T

**307. CONTENT OF CONTINUING EDUCATION COURSES.**

The content of a continuing education course must be germane to the practice of acupuncture as defined in Section 54-4702, Idaho Code, and: (3-20-20)T

**01. Category I.** Category I courses relate to the following topics: (3-20-20)T

**a.** Acupuncture and the practice of acupuncture as defined in Section 54-4702, Idaho Code including topics that directly concern the history and theory of acupuncture, oriental medicine diagnosis and treatment techniques, and techniques of adjunctive oriental medicine therapies; (3-20-20)T

**b.** The role of acupuncture in individual and public health, such as emergencies and disasters; or (3-20-20)T

**c.** Research and evidence-based medicine as related to acupuncture and Asian medicine; (3-20-20)T

**02. Category II.** Category II courses relate to the following topics: (3-20-20)T

**a.** Western biomedicine and biological sciences; (3-20-20)T

**b.** Scientific or clinical content with a direct bearing on the quality of patient care, community or public health, or preventive medicine; (3-20-20)T

**c.** Laws and ethics; (3-20-20)T

**d.** Enhancement of effective communication with other medical practitioners; (3-20-20)T

e. Behavioral sciences, patient counseling, and patient management and motivation when such courses are specifically oriented to the improvement of patient health; (3-20-20)T

f. Practice management unrelated to clinical matters and direct patient care, including, but not limited to, administrative record keeping, insurance billing and coding, and general business organization and management; or (3-20-20)T

g. Patient education including, but not limited to, patient education in East Asian therapeutic exercise techniques and Asian nutritional therapies. (3-20-20)T

**308. -- 400. (RESERVED)**

**401. RECORDS.**

A practitioner must keep accurate records of each patient the practitioner treats. The records must at a minimum include the name of the patient and the indication and nature of treatment given. Records must be kept on file for a minimum of five (5) years. A patient's records will be made available to the patient within thirty (30) days of a request. (3-20-20)T

**402. (RESERVED)**

**403. EMPLOYMENT OF UNLICENSED, NON-EXEMPT INDIVIDUALS.**

Individuals who do not have a license and are not exempt from licensure may not perform any insertion of acupuncture needles or use similar devices and therapies, including application of moxibustion. They may only support the practitioner's professional practice by performing office and ministerial acts related to acupuncture. The practitioner is responsible for the services provided by such employees. (3-20-20)T

**404. SUPERVISION OF TRAINEES.**

A licensed or certified acupuncturist providing supervision to trainees shall be responsible for the services provided by such individuals. Failure to adequately supervise such an individual may subject the supervisor to discipline. (3-20-20)T

**01. Qualifications of Supervisors.** Prior to providing supervision to a trainee, a supervisor must: (3-20-20)T

a. Have held a current acupuncture license or certification without restriction for a minimum of five (5) years. (3-20-20)T

b. Have not been the subject of any disciplinary action within the preceding five (5) years, provided that the Board may in its discretion approve a supervisor with disciplinary action for failing to complete continuing education requirements. (3-20-20)T

**02. Supervision.** For the first one hundred (100) hours of practice, the supervisor must provide supervision in person when the trainee is providing treatment. After the first one hundred (100) hours of practice, the supervisor may provide supervision by making themselves accessible to the trainee by telephone, or video conferencing, provided that the trainee has successfully completed the requirement in Paragraph 404.02.a. of this rule, and provided that the supervisor meets with the trainee in person on at least a monthly basis during which time the supervisor must review case studies and require the trainee to demonstrate acupuncture point location and needle placement technique. (3-20-20)T

a. Before providing treatment without in-person supervision, the trainee must successfully complete a Blood Borne Pathogen course and comprehensive examination that incorporates clean needle techniques and OSHA procedures and requirements. (3-20-20)T

b. The supervisor must provide the trainee with adequate training, which must include at a minimum charting, diagnosis, and treatment plans, and opportunities for the trainee to complete at least twenty-five (25) case studies. (3-20-20)T

c. The supervisor and trainee must keep adequate records of supervision, which shall include at a minimum, summary of case studies in progress or completed by the trainee under supervision, treatment plan for each patient, and the dates of supervision. (3-20-20)T

**03. Continuing Education.** A supervisor may annually count up to ten (10) hours of supervision of a trainee toward the Category I continuing education requirements. Supervision hours not claimed in the current renewal year may be claimed in the next renewal year. A maximum of ten (10) hours may be carried forward from the immediately preceding year, and may not be carried forward more than one renewal year. (3-20-20)T

**04. Completion of Supervision.** At the conclusion of supervision of a trainee, the supervisor must verify the hours of supervision, the type of supervision provided to the trainee, and the documentation of at least twenty-five (25) case studies by the trainee. (3-20-20)T

**05. Termination of Supervision or Change in Supervisor.** A supervisor may terminate supervision at any time by submitting written notice of termination to the Board. (3-20-20)T

**405. ADVERTISING.**

A practitioner shall not disseminate or cause the dissemination of any advertisement or advertising including offers, statements, or other representations, which is in any way fraudulent, false, deceptive, or misleading. (3-20-20)T

**406. – 524. (RESERVED)**

**525. DISPLAY OF LICENSE.**

The license shall be conspicuously displayed in the office of the Practitioner. (3-20-20)T

**526. -- 574. (RESERVED)**

**575. DISCIPLINE.**

**01. Civil Fine.** The Board may impose a civil fine not to exceed one thousand dollars (\$1,000) upon a licensee for each violation of Section 54-4711, Idaho Code. (3-20-20)T

**02. Costs and Fees.** The Board may order a licensee to pay the costs and fees incurred by the Board in the investigation or prosecution of the licensee for violation of Section 54-4711, Idaho Code. (3-20-20)T

**576. -- 999. (RESERVED)**

**IDAPA 24 – DIVISION OF OCCUPATIONAL AND PROFESSIONAL LICENSES**

**24.18.01 – RULES OF THE REAL ESTATE APPRAISER BOARD**

**DOCKET NO. 24-1801-2000F (FEE RULE)**

**NOTICE OF OMNIBUS RULEMAKING – ADOPTION OF TEMPORARY RULE**

**EFFECTIVE DATE:** The effective date of the temporary rules being adopted through this omnibus rulemaking is the adjournment date of the second regular session of the 65th Idaho State Legislature - March 20, 2020.

**AUTHORITY:** In compliance with Sections 67-5226, Idaho Code, notice is hereby given this agency has adopted a temporary rule. The action is authorized pursuant to Section 54-4106, Idaho Code.

**DESCRIPTIVE SUMMARY:** The following is the required finding and concise statement of its supporting reasons for adopting a temporary rule:

This temporary rulemaking adopts the following chapter under IDAPA 24.18.01:

**IDAPA 24.18**

24.18.01, *Rules of the Real Estate Appraiser Board.*

**TEMPORARY RULE JUSTIFICATION:** Pursuant to Sections 67-5226(1) and 67-5226(2), Idaho Code, the Governor has found that temporary adoption of the rule is appropriate for the following reasons:

These temporary rules are necessary to protect the public health, safety, and welfare of the citizens of Idaho and confer a benefit on its citizens. These temporary rules implement the duly enacted laws of the state of Idaho, provide citizens with the detailed rules and standards for complying with those laws, and assist in the orderly execution and enforcement of those laws. The expiration of these rules without due consideration and processes would undermine the public health, safety, and welfare of the citizens of Idaho and deprive them of the benefit intended by these rules. These rules govern the initial and ongoing licensure requirements for real estate appraisers and appraisal management companies in Idaho. These rules are required under federal law in order for Idaho licensed appraisers to conduct appraisals for federally related transactions. Allowing these rules to expire would put Idaho out of compliance with the federal requirements, which would harm licensees and the public.

**FEE SUMMARY:** Pursuant to Section 67-5226(2), the Governor has found that the fees or charges being imposed or increased are justified and necessary to avoid immediate danger and the fees are described herein:

The fees or charges, authorized in Sections 54-4113, 54-4124, and 54-4134, Idaho Code, are part of the agency’s 2021 budget that relies upon the existence of these fees or charges to meet the state’s obligations and provide necessary state services. Failing to reauthorize these temporary rules would create immediate danger to the state budget, immediate danger to necessary state functions and services, and immediate danger of a violation of Idaho’s constitutional requirement that it balance its budget.

The following is a specific description of the fees or charges:

<b>FEE TYPE</b>	<b>AMOUNT (Not to Exceed)</b>	<b>RENEWAL (Not to Exceed)</b>
Application	\$200	
License	\$100*	\$275*
AMC Registration	\$1,000**	\$900**
Reinstatement	As provided in Section 67-2614, Idaho Code	
Application for Reciprocity	\$200	

<b>FEE TYPE</b>	<b>AMOUNT (Not to Exceed)</b>	<b>RENEWAL (Not to Exceed)</b>
Original license via Reciprocity	\$100*	
Temporary Permit	\$75	
Trainee Registration	\$50	
Continuing Education Provider Application	\$100	
Examination and Reexamination	As charged by the provider	

**ASSISTANCE ON TECHNICAL QUESTIONS:** For assistance on technical questions concerning the temporary rule, contact Rob McQuade at (208) 334-3233.

DATED this February 21, 2020.

Kelley Packer  
Division Administrator  
Division of Occupational and Professional Licenses  
700 W. State Street  
P.O. Box 83720  
Boise, ID 83720  
Phone: (208) 334-3233  
Fax: (208) 334-3945

## 24.18.01 – RULES OF THE REAL ESTATE APPRAISER BOARD

### **000. LEGAL AUTHORITY.**

These rules are hereby prescribed and established pursuant to the authority vested in the Real Estate Appraiser Board by the provisions of Section 54-4106, Idaho Code. (3-20-20)T

### **001. TITLE AND SCOPE.**

These rules are titled IDAPA 24.18.01, “Rules of the Real Estate Appraiser Board.” (3-20-20)T

### **002. – 003. (RESERVED)**

### **004. INCORPORATION BY REFERENCE.**

The document titled “Uniform Standards of Professional Appraisal Practice (USPAP),” 2020-2021 Edition, excluding standards 7, 8, 9, and 10, published by the Appraisal Foundation and effective January 1, 2020, as referenced in Subsection 700, is herein incorporated by reference and is available for review at the Board’s office and may be purchased from the Appraisal Foundation, Distribution Center, P. O. Box 381, Annapolis Junction, MD 20701-0381. (3-20-20)T

### **005. -- 009. (RESERVED)**

### **010. DEFINITIONS.**

The definitions numbered one through fifteen (1-15), appearing at Section 54-4104, Idaho Code are incorporated herein by reference as if set forth in full. (3-20-20)T

**01. Accredited.** Accredited by the Commission on Colleges, a regional or national accreditation association, or by an accrediting agency that is recognized by the U.S. Secretary of Education. (3-20-20)T

**02. Advisory Committee.** A committee of state certified or licensed real estate appraisers appointed by the board to provide technical assistance relating to real estate appraisal standards and real estate appraiser experience, education and examination requirements that are appropriate for each classification of state certified or licensed real estate appraiser. (3-20-20)T

**03. Appraiser Qualifications Board.** Appraiser Qualifications Board of the Appraisal Foundation establishes the qualifications criteria for licensing, certification and recertification of appraisers. (3-20-20)T

**04. Appraisal Standards Board.** The Appraisal Standards Board of the Appraisal Foundation develops, publishes, interprets and amends the Uniform Standards of Professional Appraisal Practice (USPAP) on behalf of appraisers and users of appraisal services. (3-20-20)T

**05. Classroom Hour.** Fifty (50) minutes out of each sixty (60) minute hour in a setting which may include a classroom, conference/seminar, on-line or a virtual classroom. (3-20-20)T

**06. Field Real Estate Appraisal Experience.** Personal inspections of real property, assembly and analysis of relevant facts, and by the use of reason and the exercise of judgment, formation of objective opinions as to the market or other value of such properties or interests therein and preparation of written appraisal reports or other memoranda showing data, reasoning, and conclusion. Professional responsibility for the valuation function is essential. (3-20-20)T

**07. FIRREA.** Title XI, Financial Institutions Reform, Recovery and Enforcement Act of 1989, as amended, was designed to ensure that more reliable appraisals are rendered in connection with federally related transactions. (3-20-20)T

**08. Real Estate.** In addition to the previous definition in Section 54-4104(11), Idaho Code, will also mean an identified parcel or tract of land, including improvements, if any. (3-20-20)T

**09. Real Property.** In addition to the previous definition in Section 54-4104(11), Idaho Code, will also mean one or more defined interests, benefits, or rights inherent in the ownership of real estate. (3-20-20)T

**10. Residential Unit.** Real estate with a current highest and best use of a residential nature. A residential unit includes a kitchen and a bathroom. (3-20-20)T

**11. Uniform Standards of Professional Appraisal Practice or USPAP.** Those uniform standards adopted by the Appraisal Foundation’s Appraisal Standards Board. These standards may be altered, amended,



interpreted, supplemented, or repealed by the Appraisal Standards Board (ASB) from time to time. (3-20-20)T

**12. USPAP Course.** For the purposes of licensure and license renewal, any reference to the approved USPAP course means the National USPAP Course provided by Appraisal Qualifications Board Certified USPAP Instructors and Educational Providers. (3-20-20)T

**13. Appraisal Management Company or AMC.** Appraisal Management Company or AMC means a natural person or organization that meets the definition in Section 54-4122, Idaho Code, and is registered under the Idaho Appraisal Management Company Registration and Regulation Act. (3-20-20)T

**011. -- 099. (RESERVED)**

**100. ORGANIZATION AND MEETINGS.**

**01. Organization of Board.** At the first meeting of each year, the Board shall organize and elect from its members a Chairman and Vice Chairman who shall assume the duties of their respective offices immediately upon such selection. (3-20-20)T

**02. Meetings.** The Board meets at least four (4) times annually and at such other times as requested by the Board or its chairman. (3-20-20)T

**03. Quorum.** A quorum is three (3) board members. A majority vote of the quorum present is considered the action of the Board as a whole. (3-20-20)T

**101. -- 149. (RESERVED)**

**150. FEES.**

Fees are non-refundable and established in accordance with Sections 54-4113, 54-4124, and 54-4134, Idaho Code, as follows:

<b>FEE TYPE</b>	<b>AMOUNT (Not to Exceed)</b>	<b>RENEWAL (Not to Exceed)</b>
Application	\$200	
License	\$100*	\$275*
AMC Registration	\$1,000**	\$900**
Reinstatement	As provided in Section 67-2614, Idaho Code	
Application for Reciprocity	\$200	
Original license via Reciprocity	\$100*	
Temporary Permit	\$75	
Trainee Registration	\$50	
Continuing Education Provider Application	\$100	
Examination and Reexamination	As charged by the provider	

(3-20-20)T

**01. Fees Followed by One Asterisk (\*) Means.** Proposed fees for these categories marked with an asterisk (\*) include forty dollars (\$40) to be submitted by the state to the federal government. Title XI, Section 1109 of the FIRREA as amended requires each state to submit a roster listing of state licensed appraisers to the Appraisal

Subcommittee of the Federal Financial Institutions Examination Council “no less than annually.” The state is also required to collect from such individuals who perform appraisals in federally related transactions an annual registry fee of “not more than eighty-five dollars (\$85),” such fees to be transmitted by the state to the federal government on an annual basis. This fee is subject to change by the Appraisal Subcommittee. (3-20-20)T

**02. Fees Followed by Two Asterisks (\*\*)** Means. The fees for the categories marked with two (2) asterisks (\*\*) do not include additional fees assessed pursuant to Title XI, Section 1109 of the FIRREA, as amended, including, but not limited to, an AMC registry fee, such fees to be collected from AMCs by the state and transmitted to the federal government on an annual basis. (3-20-20)T

**151. -- 199. (RESERVED)**

**200. APPLICATION.**

**01. Appraiser License Application.** Any person desiring to apply for licensure must submit a completed application with required supporting documents and appropriate fees to the Division at its official address. After the qualifications have been reviewed, verified and approved by the Board, the applicant will receive the pre-approved examination card and must submit the appropriate fees to the examining entity. (3-20-20)T

**02. Eligibility for Examination.** The qualified applicant will be sent notification on how to register for the examination subsequent to the determination of eligibility based on documentation that the applicant has met the required education and experience requirements. (3-20-20)T

**03. Trainee Registration Application.** Any person desiring registration as a trainee must submit a completed application with required supporting documents and appropriate fees to the Division at its official address. (3-20-20)T

**04. AMC Registration Application.** Any person or organization desiring registration as an AMC must submit a completed application with required supporting documents and appropriate fees to the Division at its official address. (3-20-20)T

**201. -- 249. (RESERVED)**

**250. REQUIREMENTS FOR LICENSURE.**

All applicants for licensure in any real estate appraiser classification must comply with the following education, experience and examination requirements in addition to meeting those requirements set forth in Sections 275, 300, 350, and 400 below. (3-20-20)T

**01. Education.** Classroom hours will be credited only for courses with content that follows the Required Core Curriculum as outlined by the Appraisal Qualification Board. (3-20-20)T

**a.** Credit toward the classroom hour requirement may only be granted where the length of the educational offering is at least fifteen (15) hours, and the individual successfully completes a closed-book examination pertinent to the educational offering. In addition, distance education courses intended for use as qualifying education must include a written, closed-book final examination - proctored by an official approved by the college or university or by the sponsoring organization. The term “written” as used herein refers to an exam that might be written on paper or administered electronically on a computer workstation or other device. Oral exams are not acceptable. The testing must be in compliance with the examination requirements of this section. (3-20-20)T

**b.** Credit for the classroom hour requirement may be obtained from the following: (3-20-20)T

**i.** Colleges or Universities. (3-20-20)T

**ii.** Community or Junior Colleges. (3-20-20)T

**iii.** Courses approved by the Appraisal Qualifications Board. (3-20-20)T

- iv. State or Federal Agencies or Commissions. (3-20-20)T
- v. Other providers approved by the Board. (3-20-20)T
- c. Only those courses completed preceding the date of application will be accepted for meeting educational requirements. (3-20-20)T
- d. Course credits that are obtained from the course provider by challenge examination without attending the course will not be accepted. (3-20-20)T
- e. Credit toward education requirements may be obtained through completion of a degree in Real Estate from: (3-20-20)T
  - i. An accredited degree-granting college or university that has been approved by the Association to Advance Collegiate Schools of Business; or (3-20-20)T
  - ii. A regional or national accreditation agency that is recognized by the U.S. Secretary of Education and whose curriculum has been reviewed and approved by the Appraiser Qualifications Board. (3-20-20)T
- f. Applicants with a college degree from a foreign country may have their education evaluated for equivalency by one (1) of the following: (3-20-20)T
  - i. An accredited, degree-granting domestic college or university; (3-20-20)T
  - ii. The American Association of Collegiate Registrars and Admissions Officers (AACRAO); (3-20-20)T
  - iii. A foreign degree credential evaluation services company that is a member of the National Association of Credential Evaluation Services (NACES); or (3-20-20)T
  - iv. A foreign degree credential evaluation service company that provides equivalency evaluation reports accepted by an accredited degree-granting domestic college or university or by a state licensing board that issues credentials in another discipline. (3-20-20)T
- 02. Experience.** (3-20-20)T
  - a. The work product claimed for experience credit must be in conformity with USPAP. (3-20-20)T
  - b. All appraisal experience must be obtained as a registered trainee or as a licensed appraiser. At least five hundred (500) hours in no less than three (3) months must be obtained in Idaho pursuant to these rules. The Board will only consider experience from other jurisdictions with substantially equal requirements. (3-20-20)T
  - c. Only experience gained during the five (5) years immediately preceding application will be considered for evaluation. (3-20-20)T
  - d. Acceptable non field appraisal experience includes, but is not limited to the following: Fee and Staff appraisal analysis, ad valorem tax appraisal, condemnation appraisal, technical review appraisal, appraisal analysis, review appraisal, real estate counseling, highest and best use analysis, and feasibility analysis/study. (3-20-20)T
  - e. Each applicant applying for licensure must verify completion of the required experience via affidavit, under oath subject to penalty of perjury, and notarized on a form provided by the Board. (3-20-20)T
    - i. The Board requires submission of a log that details hours claimed for experience credit. The log must include the following: (3-20-20)T
      - (1) Type of property; (3-20-20)T

- (2) Address of the property; (3-20-20)T
  - (3) Report date; (3-20-20)T
  - (4) Description of work performed; (3-20-20)T
  - (5) Number of work hours; (3-20-20)T
  - (6) Complexity; (3-20-20)T
  - (7) Approaches to value; (3-20-20)T
  - (8) Appraised value; (3-20-20)T
  - (9) Scope of supervising appraiser's review; and (3-20-20)T
  - (10) Signature and license number of the supervising appraiser. (3-20-20)T
- ii. The Board reserves the right to contact an employer for confirmation of length and extent of experience claimed. This may require an employer to submit appraisal reports and/or an affidavit. (3-20-20)T
- iii. The Board may request submission of written reports or file memoranda that substantiate an applicant's claim for experience credit. (3-20-20)T
- f.** Ad valorem tax appraisers must demonstrate the use of techniques to value properties similar to those used by appraisers and effectively use the process as defined in Subsection 010.06, Field Real Estate Appraisal Experience in order to receive experience credit. (3-20-20)T
- 03. Examination.** Successful completion of an examination appropriate to the license classification being applied for and approved by the Board pursuant to the guidelines of the Appraisal Qualifications Board. (3-20-20)T
- 251. -- 274. (RESERVED)**
- 275. REGISTERED TRAINEE REAL ESTATE APPRAISER.**
- 01. Qualification.** Each applicant for registration as an appraiser trainee must meet the following requirements: (3-20-20)T
- a.** Education. Within the five-year period preceding application, all applicants for registration as a trainee must document completion of at least seventy-five (75) classroom hours of courses in subjects related to real estate appraisal as follows: (3-20-20)T
- i. Basic Appraisal Principles - not less than thirty (30) hours specifically including Real Property Concepts and Characteristics, Legal Considerations, Influences on Real Estate Values, Types of Value, Economic Principles, Overview of Real Estate Markets and Analysis, and Ethics and How They Apply in Appraisal Theory and Practice; and (3-20-20)T
  - ii. Basic Appraisal Procedures - not less than thirty (30) hours specifically including Overview of Approaches to Value, Valuation Procedures, Property Description, and Residential Applications; and (3-20-20)T
  - iii. National USPAP Course - not less than fifteen (15) hours. (3-20-20)T
- b.** Experience. All applicants for registration as a trainee must retain and identify at least one (1) qualified supervisor as required by law and rule. (3-20-20)T

**c.** Examination. Each trainee applicant shall document successful passage of examinations in each of the prerequisite courses required for registration as a trainee. (3-20-20)T

**d.** Prior to registration as an appraiser trainee, each trainee applicant must complete a trainee appraiser course that complies with the content requirements established by the Appraisal Qualifications Board. This course is in addition to the education requirements set forth in Section 275. (3-20-20)T

**02. Scope and Practice.** An Appraiser Trainee shall not be involved in the appraisal of any property that exceeds the lawful scope of practice of the supervising appraiser. The appraiser trainee shall be subject to USPAP. (3-20-20)T

**a.** Each appraiser trainee is permitted to have more than one (1) supervising appraiser provided a supervising appraiser is not registered to more than three (3) trainees at any one (1) time. (3-20-20)T

**b.** An appraisal log shall be maintained for each supervising appraiser by the appraiser trainee and shall include no less than the requirements outlined in Subsection 250.02.e.i. for each appraisal. (3-20-20)T

**c.** An appraiser trainee shall be entitled to obtain copies of all appraisal reports prepared by the trainee. (3-20-20)T

**03. Continuing Education.** Prior to the second renewal and for each continuing education cycle thereafter as provided in Section 275 of this rule, an appraiser trainee shall be required to obtain: (3-20-20)T

**a.** The equivalent of thirty (30) classroom hours of instruction in approved courses or seminars during the twenty-four (24) month period preceding the renewal. Once every twenty-four (24) months, registered appraiser trainees will be required to attend an approved seven-hour USPAP update course or the equivalent. The course must cover the most recent USPAP edition. (3-20-20)T

**b.** All continuing education shall be in compliance with Subsections 401.01 through 401.05. If the licensee completes two (2) or more courses having substantially the same content during any one (1) continuing education cycle, the licensee only will receive continuing education credit for one (1) of the courses. (3-20-20)T

**c.** Continuing education credit may also be granted for participation, other than as a student, in appraisal educational processes and programs. Examples of activities for which credit may be granted are teaching, program development, authorship of textbooks, or similar activities that are determined to be equivalent to obtaining continuing education. Credit for educational processes and programs continuing education shall not exceed one-half (1/2) of the total continuing education credits required for a renewal period. (3-20-20)T

**d.** The purpose of continuing education is to ensure that the appraiser trainee participates in a program that maintains and increases skill, knowledge and competence in real estate appraising. (3-20-20)T

**04. Renewal and Reinstatement.** An appraiser trainee shall renew their registration annually as set forth in Section 67-2614, Idaho Code, and may reinstate after expiration as provided in Section 67-2614, Idaho Code. Beginning July 1, 2017, an individual may only be registered as an appraiser trainee for a maximum period of five (5) years, unless approved by the Board for good cause. (3-20-20)T

**276. REGISTERED TRAINEE SUPERVISORS.**

**01. Registered Trainee Supervisor Requirements.** (3-20-20)T

**a.** A supervising appraiser shall: (3-20-20)T

**i.** Hold a current Idaho license as a Certified Residential Appraiser or as a Certified General Appraiser when supervising a trainee registered in Idaho. (3-20-20)T

**ii.** Have held a current and unrestricted license as a Certified Residential Appraiser or a Certified General Appraiser for at least three (3) years prior to providing supervision; and; (3-20-20)T

- iii. Submit evidence of completion of an approved four-hour (4) continuing education course regarding the role of a supervising appraiser. (3-20-20)T
  - iv. Not have been disciplined by the Board or any other state or jurisdiction within the previous four (4) years; and (3-20-20)T
  - v. Not supervise more than three (3) appraiser trainees at one time; and (3-20-20)T
  - vi. Be responsible for the training and direct supervision of the appraiser trainee; and (3-20-20)T
  - vii. Accept responsibility for all appraiser trainee appraisal reports by signing and certifying that the report is in compliance with USPAP; and (3-20-20)T
  - viii. Review and sign all appraiser trainee appraisal report(s); and (3-20-20)T
  - ix. Personally inspect each appraised property with the appraiser trainee until the supervising appraiser determines the appraiser trainee is competent in accordance with the Competency Provision of USPAP for the property type. (3-20-20)T
- b. An accurate, current and complete appraisal experience log shall be maintained jointly by the supervising appraiser and the appraiser trainee as outlined in Subsection 250.02.e.i. (3-20-20)T
  - c. A supervising appraiser may not continue to supervise if: (3-20-20)T
    - i. The appraiser ceases to meet supervisor requirements; or (3-20-20)T
    - ii. The appraiser is disciplined, unless the board grants a waiver and a waiver may be subject to conditions set by the board. (3-20-20)T

**277. -- 299. (RESERVED)**

**300. LICENSED RESIDENTIAL REAL ESTATE APPRAISER CLASSIFICATION APPRAISER QUALIFICATION CRITERIA.**

The state licensed residential real estate appraiser classification applies to the appraisal of residential real property consisting of one (1) to four (4) non-complex residential units having a transaction value less than one million dollars (\$1,000,000) and complex one (1) to four (4) residential units having a transaction value less than two hundred fifty thousand dollars (\$250,000). Applicants must meet the following education, experience and examination requirements in addition to complying with Section 250. Subsequent to being licensed, every licensee must annually meet the continuing education requirement. (3-20-20)T

- 01. Education.** As a prerequisite to taking the examination for licensure as an Idaho Licensed Residential Real Estate Appraiser, each applicant shall: (3-20-20)T
  - a. Document registration as an Appraiser Trainee; and (3-20-20)T
  - b. Document the successful completion of not less than seventy-five (75) classroom hours of courses in subjects related to real estate appraisal as follows: (3-20-20)T
    - i. Residential Market Analysis and Highest and Best Use – not less than fifteen (15) hours; and (3-20-20)T
    - ii. Residential Appraiser Site Valuation and Cost Approach – not less than fifteen (15) hours; and (3-20-20)T
    - iii. Residential Sales Comparison and Income Approaches – not less than thirty (30) hours specifically including: Valuation Principles and Procedures – Sales Comparison Approach; Valuation Principles and Procedures

– Income Approach; Finance and Cash Equivalency; Financial Calculator Introduction; Identification, Derivation and Measurement of Adjustments; Gross Rent Multipliers; Partial Interests; Reconciliation; and Case Studies; and (3-20-20)T

iv. Residential Report Writing and Case Studies – not less than fifteen (15) hours specifically including: Writing and Reasoning Skills; Common Writing Problems; Form Reports; Report Options and USPAP Compliance; Case Studies. (3-20-20)T

**02. Experience.** Prerequisite to sit for the examination: (3-20-20)T

a. Document one thousand (1,000) hours of supervised appraisal experience as a registered Appraiser Trainee in no less than six (6) months. Experience documentation in the form of reports or file memoranda should be available to support the claim for experience. (3-20-20)T

b. Of the required one thousand (1,000) hours, the applicant must accumulate a minimum of seven hundred-fifty (750) hours from field real estate appraisal experience. The balance of two hundred-fifty (250) hours may include non-field experience, refer to Subsection 250.02.d. (3-20-20)T

**03. Examination.** Successful completion of the Licensed Residential Appraiser examination approved by the Board pursuant to the guidelines of the Appraisal Qualifications Board. (3-20-20)T

**301. -- 349. (RESERVED)**

**350. CERTIFIED RESIDENTIAL REAL ESTATE APPRAISER CLASSIFICATION APPRAISER QUALIFICATION CRITERIA.**

The State Certified Residential Real Estate Appraiser classification applies to the appraisal of residential properties of four (4) or less units without regard to transaction value or complexity. Applicants must meet the following education, experience and examination requirements in addition to complying with Section 250. Subsequent to being certified every licensee must annually meet the continuing education requirement. (3-20-20)T

**01. Education.** As a prerequisite to taking the examination for licensure as an Idaho Certified Residential Real Estate Appraiser, each applicant shall: (3-20-20)T

a. Hold a Bachelor's degree in any field of study from an accredited degree-granting college or university, or meet one of the following options: (3-20-20)T

i. Possession of an Associate's degree in a field of study related to business administration, accounting, finance, economics or real estate; or (3-20-20)T

ii. Successful completion of thirty (30) semester hours of college-level courses that cover each of the following specific topic areas and hours: English composition (three (3) semester hours), microeconomics (three (3) semester hours), macroeconomics (three (3) semester hours), finance (three (3) semester hours), algebra, geometry or higher mathematics (three (3) semester hours), statistics (three (3) semester hours), computer science (three (3) semester hours), business or real estate law (three (3) semester hours), and two (2) elective courses in any of the topics listed above or in accounting, geography, agricultural economics, business management, or real estate (three (3) semester hours each); or (3-20-20)T

iii. Successful completion of at least thirty (30) semester hours of College Level Examination Program® (CLEP®) examinations from each of the following subject matter areas: college algebra (three (3) semester hours), college composition (six (6) semester hours), college composition modular (three (3) semester hours), college mathematics (six (6) semester hours), principles of macroeconomics (three (3) semester hours), principles of microeconomics (three (3) semester hours), introductory business law (three (3) semester hours), and information systems (three (3) semester hours), or (3-20-20)T

iv. Any combination of the above criteria (within Subsections 350.01.a.ii. and 350.01.a.iii. of these rules) that ensures coverage of all topics and hours identified in Subsection 350.01.a.ii. (3-20-20)T

**b.** As an alternative to the requirements in Subsection 350.01.a., above, individuals who have held a Licensed Residential credential for a minimum of five (5) years may qualify as meeting the requirements of Subsection 350.01.a., if it is established that there is no record of any adverse, final, and non-appealable disciplinary action affecting the Licensed Residential appraiser's legal eligibility to engage in appraisal practice within the five (5) years immediately preceding the date of application for a Certified Residential license. (3-20-20)T

**c.** Document registration as an Appraiser Trainee and completion of the education required for licensure as a Licensed Residential Real Estate Appraiser, or hold a current license as a Licensed Residential Real Estate Appraiser; and (3-20-20)T

**d.** Document the successful completion of not less than fifty (50) classroom hours of courses in subjects related to real estate appraisal as follows: (3-20-20)T

**i.** Statistics, Modeling and Finance: not less than fifteen (15) hours, specifically including Statistics; Valuation Models (AVM's and Mass Appraisal); and Real Estate Finance; and (3-20-20)T

**ii.** Advanced Residential Applications and Case Studies: not less than fifteen (15) hours, specifically including Complex Property, Ownership and Market Conditions; Deriving and Supporting Adjustments; Residential Market Analysis; and Advanced Case Studies; and (3-20-20)T

**iii.** Appraisal Subject Matter Electives: not less than twenty (20) hours, and may include hours over the minimum shown in Subsection 350.01.d. of these rules. (3-20-20)T

**02. Experience.** Experience is a prerequisite to sit for the licensure examination: (3-20-20)T

**a.** Document one thousand five hundred (1,500) hours of appraisal experience in no less than twelve (12) months (see Subsection 250.02). Experience documentation in the form of reports or file memoranda should be available to support the claim for experience. (3-20-20)T

**b.** One thousand two hundred (1,200) hours of the experience shall be from residential field appraisal experience. The balance of three hundred (300) hours may include non-field experience, refer to Subsection 250.02.d. (3-20-20)T

**c.** Examination. Successful completion of the Certified Residential Appraiser examination approved by the Board pursuant to the guidelines of the Appraisal Qualifications Board. (3-20-20)T

**351. -- 399. (RESERVED)**

**400. CERTIFIED GENERAL REAL ESTATE APPRAISER CLASSIFICATION APPRAISER QUALIFICATION CRITERIA.**

The State Certified General Real Estate Appraiser classification applies to the appraisal of all types of real property. Applicants must meet the following examination, education, and experience requirements in addition to complying with Section 250. Subsequent to being certified, an individual must meet the continuing education requirement. (3-20-20)T

**01. Education.** As a prerequisite to taking the examination for licensure as an Idaho Certified General Real Estate Appraiser, each applicant shall: (3-20-20)T

**a.** Hold a Bachelor's degree or higher from an accredited degree-granting college or university; and (3-20-20)T

**b.** Document registration as an Appraiser Trainee and document the successful completion of not less than two hundred twenty-five (225) classroom hours of courses in subjects related to real estate appraisal as follows: (3-20-20)T

**i.** Statistics, Modeling and Finance: not less than fifteen (15) hours, specifically including Statistics; Valuation Models (AVM's and Mass Appraisal), and Real Estate Finance; (3-20-20)T



- ii. General Appraiser Market Analysis and Highest and Best Use: not less than thirty (30) hours; (3-20-20)T
- iii. General Appraiser Sales Comparison Approach: not less than thirty (30) hours, specifically including Value Principles, Procedures, Identification and Measurement of Adjustments, Reconciliation, and Case Studies; (3-20-20)T
- iv. General Appraiser Site Valuation and Cost Approach: not less than thirty (30) hours; (3-20-20)T
- v. General Appraiser Income Approach: not less than sixty (60) hours, specifically including Overview, Compound Interest, Lease Analysis, Income Analysis, Vacancy and Collection Law, Estimating Operating Expenses and Reserves, Reconstructed Income and Expense Statement, Stabilized Net Operating Income Estimate, Direct Capitalization, Discounted Cash Flow, Yield Capitalization, Partial Interest, and Case Studies; (3-20-20)T
- vi. General Appraiser Report Writing and Case Studies: not less than thirty (30) hours, specifically including Writing and Reasoning Skills, Common Writing Problems, Report Options and USPAP Compliance, and Case Studies; and (3-20-20)T
- vii. Appraisal Subject Matter Electives: not less than thirty (30) hours, and may include hours over the minimum shown in Subsection 400.01.b. of these rules; or (3-20-20)T
- c. Document licensure as a Licensed Residential Real Estate Appraiser and the successful completion of not less than one hundred fifty (150) classroom hours of courses in subjects related to real estate appraisal as follows: (3-20-20)T
  - i. Statistics, Modeling and Finance: not less than fifteen (15) hours, specifically including Statistics; Valuation Models (AVM's and Mass Appraisal); and Real Estate Finance; and (3-20-20)T
  - ii. General Appraiser Market Analysis and Highest and Best Use: not less than fifteen (15) hours; and (3-20-20)T
  - iii. General Appraiser Sales Comparison Approach: not less than fifteen (15) hours, specifically including Value Principles, Procedures, Identification and Measurement of Adjustments, Reconciliation, and Case Studies; and (3-20-20)T
  - iv. General Appraiser Site Valuation and Cost Approach: not less than fifteen (15) hours; and (3-20-20)T
  - v. General Appraiser Income Approach: not less than forty-five (45) hours, specifically including Overview, Compound Interest, Lease Analysis, Income Analysis, Vacancy and Collection Law, Estimating Operating Expenses and Reserves, Reconstructed Income and Expense Statement, Stabilized Net Operating Income Estimate, Direct Capitalization, Discounted Cash Flow, Yield Capitalization, Partial Interest, and Case Studies; and (3-20-20)T
  - vi. General Appraiser Report Writing and Case Studies: not less than fifteen (15) hours, specifically including Writing and Reasoning Skills, Common Writing Problems, Report Options and USPAP Compliance, and Case Studies; and (3-20-20)T
  - vii. Appraisal Subject Matter Electives: not less than thirty (30) hours. and may include hours over the minimum shown in Subsection 400.01.c.; or (3-20-20)T
- d. Document licensure as a Certified Residential Real Estate Appraiser and the successful completion of not less than one hundred five (105) classroom hours of courses in subjects related to real estate appraisal as follows: (3-20-20)T
  - i. General Appraiser Market Analysis and Highest and Best Use: not less than fifteen (15) hours; and (3-20-20)T

ii. General Appraiser Sales Comparison Approach: not less than fifteen (15) hours, specifically including Value Principles, Procedures, Identification and Measurement of Adjustments, Reconciliation, and Case Studies; and (3-20-20)T

iii. General Appraiser Site Valuation and Cost Approach: not less than fifteen (15) hours; and (3-20-20)T

iv. General Appraiser Income Approach: not less than forty-five (45) hours, specifically including Overview, Compound Interest, Lease Analysis, Income Analysis, Vacancy and Collection Law, Estimating Operating Expenses and Reserves, Reconstructed Income and Expense Statement, Stabilized Net Operating Income Estimate, Direct Capitalization, Discounted Cash Flow, Yield Capitalization, Partial Interest, and Case Studies; and (3-20-20)T

v. General Appraiser Report Writing and Case Studies: not less than fifteen (15) hours, specifically including Writing and Reasoning Skills, Common Writing Problems, Report Options and USPAP Compliance, and Case Studies. (3-20-20)T

**02. Experience.** Experience is a prerequisite to sit for the licensure examination: (3-20-20)T

a. Document three thousand (3,000) hours of appraisal experience in no less than eighteen (18) months (See Subsection 250.02). Experience documentation in the form of reports or file memoranda should be available to support the claim for experience. (3-20-20)T

b. One thousand five hundred (1,500) hours of the experience must be non-residential appraisal experience. The balance of one thousand five hundred (1,500) hours may be solely residential experience or can include up to five hundred (500) hours of non-field experience as outlined in Subsection 250.02.d. (3-20-20)T

c. Examination. Successful completion of the Certified General Appraiser examination approved by the Board pursuant to the guidelines of the Appraisal Qualifications Board. (3-20-20)T

**401. CONTINUING EDUCATION.**

All certified/licensed appraisers must comply with the following continuing education requirements: (3-20-20)T

**01. Purpose of Continuing Education.** The purpose of continuing education is to ensure that the appraiser participates in a program that maintains and increases his skill, knowledge and competency in real estate appraising. (3-20-20)T

**02. Hours Required.** The equivalent of thirty (30) classroom hours of instruction in courses or seminars during the twenty-four (24) months prior to renewal is required. If the licensee completes two (2) or more courses having substantially the same content during any one (1) continuing education cycle, the licensee only will receive continuing education credit for one (1) of the courses. (3-20-20)T

a. If the educational offering is taken on-line or in a virtual classroom, the course must include successful completion of prescribed course mechanisms required to demonstrate knowledge of the subject matter. (3-20-20)T

b. Credit toward the classroom hour requirement may be granted only where the length of the educational offering is at least two (2) hours. (3-20-20)T

c. Credit for the classroom hour requirement may be obtained by accredited courses which have been approved by the Appraisal Qualifications Board and by courses approved by Real Estate Appraiser Boards of states with reciprocity with Idaho. All other courses must have approval of the Board, which shall require the continuing education provider to submit the educational course approval application and application fee as set forth in these rules along with the documentation including the instructors and their qualifications, course content, length of course, and its location. Courses shall be approved for a period of four (4) years. (3-20-20)T

d. Once every twenty-four (24) months, Idaho State Certified/Licensed Real Estate Appraisers and

registered trainees will be required to attend an approved seven (7) hour USPAP update course or the equivalent. The course must cover the most recent USPAP edition. (3-20-20)T

**03. Credit for Appraisal Educational Processes and Programs.** Continuing education credit may also be granted for participation, other than as a student, in appraisal educational processes and programs. Examples of activities for which credit may be granted are teaching, program development, authorship of textbooks, or similar activities which are determined to be equivalent to obtaining continuing education. Credit for educational processes and programs continuing education shall not exceed one-half (1/2) of the total continuing education credits required for a renewal period. (3-20-20)T

**04. Credit for Attending the Licensure Board Meetings.** Continuing education credit may be granted for a maximum of two (2) hours each continuing education cycle for time spent attending one (1) Board meeting. Members of the board shall not be entitled to continuing education credit for board service. (3-20-20)T

**05. Requirement When a Certificate/License Is Canceled.** For each year (less than five (5)) in which a license is lapsed, canceled, or otherwise non-renewed, fifteen (15) hours of continuing education must be documented, including a seven (7) hour USPAP update course, prior to reinstatement. The course must cover the most recent USPAP edition. (3-20-20)T

**402. -- 449. (RESERVED)**

**450. RECIPROCITY.**  
Applicant must comply with Section 54-4115, Idaho Code. (3-20-20)T

**01. Submit Statement Verifying Certification/Licensure.** Submit current notarized statement verifying certification/licensure in good standing in another state. (3-20-20)T

**451. -- 499. (RESERVED)**

**500. TEMPORARY PRACTICE.**

**01. Requirements for Issuance.** A permit to temporarily practice may be issued to individuals coming to Idaho who are certified/licensed in another state and are either transferring to Idaho or have a temporary assignment in Idaho. (3-20-20)T

**02. Proof of Current Certification or Licensure.** The applicant must be listed on the National Registry, maintained by the Appraisal Subcommittee, as current and in good standing and comply with Section 54-4115(3), Idaho Code, regarding irrevocable consent. (3-20-20)T

**03. Assignments and Length of Time Permit Will Be Issued.** Permit to temporarily practice will be issued on a per appraisal assignment basis for a period not to exceed six (6) months. A temporary permit may be extended one (1) time only. (3-20-20)T

**501. -- 524. (RESERVED)**

**525. DISCIPLINE.**

**01. Civil Fine.** The Board may impose a civil fine not to exceed one thousand dollars (\$1,000) upon a licensed or certified real estate appraiser for each violation of Section 54-4107(1), Idaho Code. (3-20-20)T

**02. Costs and Fees.** The Board may order a licensed or certified real estate appraiser to pay the costs and fees incurred by the Board in the investigation or prosecution of the licensee for violation of Section 54-4107(1), Idaho Code. (3-20-20)T

**526. -- 539. (RESERVED)**

**540. APPRAISALS IN LITIGATION.**

Licensed or certified appraisers providing opinions of value in litigation shall comply with USPAP Standard 1 including maintaining a work file in support of the opinion of value in litigation. (3-20-20)T

**541. -- 699. (RESERVED)**

**700. UNIFORM STANDARDS OF PROFESSIONAL APPRAISAL PRACTICE/CODE OF ETHICS.**

The Uniform Standards of Professional Practice, excluding standards 7, 8, 9, and 10, as published by the Appraisal Foundation and referenced in Section 004, are hereby adopted as the rules of conduct and code of ethics for all Real Estate Appraisers licensed under Title 54, Chapter 41, Idaho Code, and these rules. (3-20-20)T

**701. -- 999. (RESERVED)**

# IDAPA 24 – DIVISION OF OCCUPATIONAL AND PROFESSIONAL LICENSES

## 24.19.01 – RULES OF THE BOARD OF EXAMINERS OF RESIDENTIAL CARE FACILITY ADMINISTRATORS

### DOCKET NO. 24-1901-2000F (FEE RULE)

#### NOTICE OF OMNIBUS RULEMAKING – ADOPTION OF TEMPORARY RULE

**EFFECTIVE DATE:** The effective date of the temporary rules being adopted through this omnibus rulemaking is the adjournment date of the second regular session of the 65th Idaho State Legislature - March 20, 2020.

**AUTHORITY:** In compliance with Sections 67-5226, Idaho Code, notice is hereby given this agency has adopted a temporary rule. The action is authorized pursuant to Section 54-4205, Idaho Code.

**DESCRIPTIVE SUMMARY:** The following is the required finding and concise statement of its supporting reasons for adopting a temporary rule:

This temporary rulemaking adopts the following chapter under IDAPA 24.19.01:

#### **IDAPA 24.19**

- 24.19.01, *Rules of the Board of Examiners of Residential Care Facility Administrators.*

**TEMPORARY RULE JUSTIFICATION:** Pursuant to Sections 67-5226(1) and 67-5226(2), Idaho Code, the Governor has found that temporary adoption of the rule is appropriate for the following reasons:

These temporary rules are necessary to protect the public health, safety, and welfare of the citizens of Idaho and confer a benefit on its citizens. These temporary rules implement the duly enacted laws of the state of Idaho, provide citizens with the detailed rules and standards for complying with those laws, and assist in the orderly execution and enforcement of those laws. The expiration of these rules without due consideration and processes would undermine the public health, safety, and welfare of the citizens of Idaho and deprive them of the benefit intended by these rules. These rules govern the qualifications and code of ethics for individuals who run residential care facilities, which are home to residents with varying assistive needs. Allowing these rules to expire would harm the safety and welfare of the residents of residential care facilities, current licensees, and prospective licensees.

**FEE SUMMARY:** Pursuant to Section 67-5226(2), the Governor has found that the fees or charges being imposed or increased are justified and necessary to avoid immediate danger and the fees are described herein:

The fees or charges, authorized in Sections 54-4205, and 54-4206, Idaho Code, are part of the agency's 2021 budget that relies upon the existence of these fees or charges to meet the state's obligations and provide necessary state services. Failing to reauthorize these temporary rules would create immediate danger to the state budget, immediate danger to necessary state functions and services, and immediate danger of a violation of Idaho's constitutional requirement that it balance its budget.

The following is a specific description of the fees or charges:

<b>FEE TYPE</b>	<b>AMOUNT (Not to Exceed)</b>
Application	\$150
Annual Renewal	\$150
Provisional Permit	\$150
Reissuance of Lost License	\$10
Reinstatement	As provided in Section 67-2614, Idaho Code

**ASSISTANCE ON TECHNICAL QUESTIONS:** For assistance on technical questions concerning the temporary rule, contact Rob McQuade at (208) 334-3233.

DATED this February 21, 2020.

Kelley Packer  
Division Administrator  
Division of Occupational and Professional Licenses  
700 W. State Street  
P.O. Box 83720  
Boise, ID 83720  
Phone: (208) 334-3233  
Fax: (208) 334-3945

**24.19.01 – RULES OF THE BOARD OF EXAMINERS OF RESIDENTIAL  
CARE FACILITY ADMINISTRATORS**

**000. LEGAL AUTHORITY.**

These rules are hereby prescribed and established pursuant to the authority vested in the Board of Examiners of Residential Care Facility Administrators by the provisions of Section 54-4205, Idaho Code. (3-20-20)T

**001. TITLE AND SCOPE.**

These rules are titled IDAPA 24.19.01, “Rules of the Board of Examiners of Residential Care Facility Administrators.” (3-20-20)T

**002. – 003. (RESERVED)**

**004. INCORPORATION BY REFERENCE.**

The document titled “ACHCA Code of Ethics,” published by the American College of Health Care Administrators (ACHCA) as referenced in Section 650, is herein incorporated by reference and is available from the Board’s office and on the Board web site. (3-20-20)T

**005. -- 099. (RESERVED)**

**100. APPLICATIONS.**

Applications will be on forms approved by the Board. No application will be considered for any action unless accompanied by the appropriate fees and until the required supporting documentation is received by the Division. If an applicant fails to respond to a Board request or an application has lacked activity for twelve (12) consecutive months, the application on file with the Board will be deemed denied and will be terminated upon thirty (30) days written notice, unless good cause is established to the Board. (3-20-20)T

**101. -- 149. (RESERVED)**

**150. QUALIFICATIONS FOR ADMINISTRATOR LICENSE.**

Each applicant for an administrator’s license must submit proof, along with their application, that said individual is at least twenty-one (21) years of age and meets all the following qualifications for the issuance of a license: (3-20-20)T

**01. Good Moral Character.** The applicant must submit a criminal background check by an entity approved by the Board establishing that the applicant has not been convicted, pled guilty or nolo contendere or received a withheld judgment for a felony or any crime involving dishonesty or the health or safety of a person. (3-20-20)T

**02. Education and Experience.** The applicant must document one (1) of the combinations of education and experience in accordance with Section 54-4206, Idaho Code, and Subsection 400 of these rules. (3-20-20)T

**03. Coursework.** The applicant must document completion of a specialized course or program of study as set forth in Subsection 400 of these rules. (3-20-20)T

**04. Examination.** The applicant must submit proof of successful passage of a relevant examination as approved by the Board and defined in Subsection 300 of these rules. (3-20-20)T

**151. -- 159. (RESERVED)**

**160. NURSING HOME ADMINISTRATOR QUALIFICATIONS FOR LICENSE.**

Any applicant who holds a valid Idaho nursing home administrator license must meet the requirements provided in Section 54-4211(2), Idaho Code, and must take and pass the Board-approved residential care administrator examination. This requirement may be waived if the applicant submits evidence satisfactory to the Board that he has at least one (1) year of leadership or management experience working in a residential care facility or nursing home facility within the five (5) years preceding the application. (3-20-20)T

**161. -- 199. (RESERVED)**

**200. BOARD MEETINGS -- DATES -- PLACES.**

**01. Board Meeting Dates.** The Board meets at least semi-annually at such time and place as determined by the Board. (3-20-20)T

**02. Dates and Places May be Changed.** Dates and places of board meetings may be changed by the action of the majority of the Board and advance public notice given. (3-20-20)T

**201. -- 299. (RESERVED)**

**300. EXAMINATIONS.**

**01. Examination.** The Board approves the following examinations for licensure: (3-20-20)T

**a.** The Residential Care Facility Administrators examination developed and administered by the National Association of Boards of Examiners of Long Term Care Administrators (NAB) and an open book examination of law and rules governing residential care administrators in Idaho. The passing score for the NAB examination is determined by NAB. An applicant for examination is required to register with NAB and pay any required examination fees directly to NAB. The passing score for the open book examination is seventy-five percent (75%). (3-20-20)T

**b.** Other examinations as approved by the Board. (3-20-20)T

**301. -- 399. (RESERVED)**

**400. EDUCATIONAL AND TRAINING REQUIREMENTS.**

**01. Approved Course.** (3-20-20)T

**a.** The Certification Program for Residential Care Facility Administrators course, administered by the Idaho Health Care Association (IHCA)/Idaho Center for Assisted Living (ICAL), are approved courses of study to qualify for licensure. (3-20-20)T

**b.** Any Certification Program for Residential Care Facility Administrators provided by a state or national Residential Care Facility Administrator organization or a nationally or regionally accredited college or university must be an approved course of study to qualify for licensure. (3-20-20)T

**02. Approval of Other Courses.** Applicants may, in lieu of completion of the Certification Program for Residential Care Facility Administrators, submit official documentation of successful completion of relevant courses. These courses must be approved by the Board before equivalency will be given. (3-20-20)T

**401. CONTINUING EDUCATION.**

**01. Minimum Hours Required.** Applicants for annual renewal or reinstatement are required to complete a minimum of twelve (12) hours of continuing education courses within the preceding twelve-month (12) period. Basic First Aid, Cardio-Pulmonary Resuscitation, medication assistance, or fire safety courses will not be considered for continuing education credit. (3-20-20)T

**02. Course Approval.** Courses of study relevant to residential care facility administration and sponsored or provided by the following entities or organizations are approved for continuing education credits: (3-20-20)T

**a.** Accredited colleges or universities. (3-20-20)T

**b.** Federal, state or local government entities. (3-20-20)T

**c.** National or state associations. (3-20-20)T

**d.** Otherwise approved by the Board based upon documentation submitted by the licensee or course provider reviewing the nature and subject of the course and its relevancy to residential care administration, name of instructor(s) and their qualifications, date, time and location of the course and procedures for verification of



attendance. (3-20-20)T

**03. Credit.** Continuing education credit will only be given for actual time in attendance or for the time spent participating in the educational activity. One (1) hour of continuing education is equal to sixty (60) minutes. Courses taken by correspondence or by computer on-line may be approved for continuing education if the courses require an exam or other proof of successful completion. Each licensee must maintain proof of attendance or successful completion documentation of all continuing education courses for a period of three (3) years. (3-20-20)T

**04. Special Exemption.** The Board has authority to make exceptions for reasons of individual hardship, including health, when certified by a medical doctor, or other good cause. The licensee must provide any information requested by the Board to assist in substantiating hardship cases. This exemption is granted at the sole discretion of the Board. (3-20-20)T

**402. -- 449. (RESERVED)**

**450. SCOPE OF PRACTICE.**

A residential care facility administrator must possess the education, training, and experience necessary to insure that appropriate services and care are provided for each facility resident within any facility under the licensee's administration. Information contained within the application together with supporting documentation maintained by the licensee is prima facie evidence of the licensee's education and experience. It is the responsibility of the individual licensee to maintain adequate documentation of education and experience appropriate to the planning, organizing, directing and control of the operation of a residential care facility. (3-20-20)T

**451. -- 599. (RESERVED)**

**600. FEES.**

<b>FEE TYPE</b>	<b>AMOUNT (Not to Exceed)</b>
Application	\$150
Annual Renewal	\$150
Provisional Permit	\$150
Reissuance of Lost License	\$10
Reinstatement	As provided in Section 67-2614, Idaho Code

(3-20-20)T

**601. -- 649. (RESERVED)**

**650. DISCIPLINE.**

**01. Civil Fine.** The Board may impose a civil fine not to exceed one thousand dollars (\$1,000) upon a licensed residential care facility administrator for each violation of Section 54-4213(1), Idaho Code. (3-20-20)T

**02. Costs and Fees.** The Board may order a licensed residential care facility administrator to pay the costs and fees incurred by the Board in the investigation or prosecution of the licensee for violation of Section 54-4213(1), Idaho Code. (3-20-20)T

**03. Code of Ethics.** The Board has adopted (ACHCA) Code of Ethics. Violations of the code of ethics is considered grounds for disciplinary action. (3-20-20)T

**651. -- 999. (RESERVED)**

**IDAPA 24 – DIVISION OF OCCUPATIONAL AND PROFESSIONAL LICENSES**

**24.21.01 – RULES OF THE IDAHO STATE CONTRACTORS BOARD**

**DOCKET NO. 24-2101-2000F (FEE RULE)**

**NOTICE OF OMNIBUS RULEMAKING – ADOPTION OF TEMPORARY RULE**

**EFFECTIVE DATE:** The effective date of the temporary rules being adopted through this omnibus rulemaking is the adjournment date of the second regular session of the 65th Idaho State Legislature - March 20, 2020.

**AUTHORITY:** In compliance with Sections 67-5226, Idaho Code, notice is hereby given this agency has adopted a temporary rule. The action is authorized pursuant to Section 54-5206, Idaho Code.

**DESCRIPTIVE SUMMARY:** The following is the required finding and concise statement of its supporting reasons for adopting a temporary rule:

This temporary rulemaking adopts the following chapter under IDAPA 24.21.01:

**IDAPA 24.21**

- 24.21.01, *Rules of the Idaho State Contractors Board.*

**TEMPORARY RULE JUSTIFICATION:** Pursuant to Sections 67-5226(1) and 67-5226(2), Idaho Code, the Governor has found that temporary adoption of the rule is appropriate for the following reasons:

These temporary rules are necessary to protect the public health, safety, and welfare of the citizens of Idaho and confer a benefit on its citizens. These temporary rules implement the duly enacted laws of the state of Idaho, provide citizens with the detailed rules and standards for complying with those laws, and assist in the orderly execution and enforcement of those laws. The expiration of these rules without due consideration and processes would undermine the public health, safety, and welfare of the citizens of Idaho and deprive them of the benefit intended by these rules. These rules govern the process for registering as a contractor in Idaho. Allowing these rules to expire would harm the public safety and welfare because the Board would not have a framework to analyze applicants with felony convictions.

**FEE SUMMARY:** Pursuant to Section 67-5226(2), the Governor has found that the fees or charges being imposed or increased are justified and necessary to avoid immediate danger and the fees are described herein:

The fees or charges, authorized in Section 54-5207, Idaho Code, are part of the agency’s 2021 budget that relies upon the existence of these fees or charges to meet the state’s obligations and provide necessary state services. Failing to reauthorize these temporary rules would create immediate danger to the state budget, immediate danger to necessary state functions and services, and immediate danger of a violation of Idaho’s constitutional requirement that it balance its budget.

The following is a specific description of the fees or charges:

<b>FEE TYPE</b>	<b>AMOUNT (Not to Exceed)</b>
Application (includes original registration)	\$50
Reciprocal	\$50
Renewal	\$50
Reinstatement	\$35

**ASSISTANCE ON TECHNICAL QUESTIONS:** For assistance on technical questions concerning the temporary rule, contact Rob McQuade at (208) 334-3233.

DATED this February 21, 2020.

Kelley Packer  
Division Administrator  
Division of Occupational and Professional Licenses  
700 W. State Street  
P.O. Box 83720  
Boise, ID 83720  
Phone: (208) 334-3233  
Fax: (208) 334-3945

## 24.21.01 – RULES OF THE IDAHO STATE CONTRACTORS BOARD

### 000. LEGAL AUTHORITY.

These rules are hereby prescribed and established pursuant to the authority vested in the Idaho State Contractors Board by the provisions of Section 54-5206, Idaho Code. (3-20-20)T

### 001. TITLE AND SCOPE.

These rules are title IDAPA 24.21.01, “Rules of the Idaho State Contractors Board.” (3-20-20)T

### 002. -- 099. (RESERVED)

### 100. ORGANIZATION.

**01. Meetings.** The Board meets not less than once during each calendar quarter and at such times and places as designated by the Board or the Chairman of the Board. Special meetings may be held at the call of the Chairman, and all members will be notified in writing. (3-20-20)T

**a.** A minimum of three (3) Board members constitutes a quorum and is required for the transaction of business. A majority vote of the Board members present at a meeting is considered the action of the Board as a whole. (3-20-20)T

**02. Organization of the Board.** At the first meeting of each fiscal year, the Board elects from its members a Chairman, who assumes the duty of the office immediately upon such selection. (3-20-20)T

**a.** The Chairman, when present, presides at all meetings, appoints with the consent of the Board, all committees, and otherwise performs all duties pertaining to the office of Chairman. The Chairman will be an ex-officio member of all committees. (3-20-20)T

### 101. -- 149. (RESERVED)

### 150. APPLICATION.

Each applicant for registration must submit a complete application on applications forms approved by the board together with the required fee(s). The applicant must provide or facilitate the provision of any supplemental third party documents that may be required. Applications on file with the Board where an applicant has failed to respond to a Board request or where the applications have lacked activity for twelve (12) consecutive months are deemed denied and will be terminated upon thirty (30) days written notice unless good cause is established to the Board. (3-20-20)T

### 151. -- 164. (RESERVED)

### 165. ADDITIONAL QUALIFICATIONS FOR REGISTRATION.

Applicants for a registration must meet the following qualifications in addition to those set forth in Section 54-5210, Idaho Code and these rules. (3-20-20)T

**01. Felony Conviction.** Not have been convicted of any felony in a state or federal court; provided the applicant may make written request to the board for an exemption review to determine the applicant's suitability for registration, which the board determines in accordance with the following: (3-20-20)T

**02. Exemption Review.** The exemption review consists of a review of any documents relating to the felony and any supplemental information provided by the applicant bearing upon his suitability for registration. The board may, at its discretion, grant an interview of the applicant. (3-20-20)T

**a.** During the review, the board considers the following factors or evidence: (3-20-20)T

**i.** The severity or nature of the felony; (3-20-20)T

**ii.** The period of time that has passed since the felony under review; (3-20-20)T

**iii.** The number or pattern of felonies or other similar incidents; (3-20-20)T

**iv.** The circumstances surrounding the crime that would help determine the risk of repetition; (3-20-20)T

**v.** The relationship of the crime to the registered practice of construction; and (3-20-20)T

vi. The applicant's activities since the crime under review, such as employment, education, participation in treatment, payment of restitution, or any other factors which may be evidence of current rehabilitation. (3-20-20)T

b. The applicant bears the burden of establishing his current suitability for registration. (3-20-20)T

**03. Fraud in Application Process.** The registration application and supporting documents are free from any fraud or material misrepresentations. (3-20-20)T

**166. -- 174. (RESERVED)**

**175. FEES.**  
Fees are non-refundable:

<b>FEE TYPE</b>	<b>AMOUNT (Not to Exceed)</b>
Application (includes original registration)	\$50
Reciprocal	\$50
Renewal	\$50
Reinstatement	\$35

(3-20-20)T

**176. -- 999. (RESERVED)**

**IDAPA 24 – DIVISION OF OCCUPATIONAL AND PROFESSIONAL LICENSES**

**24.22.01 – RULES OF THE IDAHO STATE LIQUEFIED PETROLEUM GAS SAFETY BOARD**

**DOCKET NO. 24-2201-2000F (FEE RULE)**

**NOTICE OF OMNIBUS RULEMAKING – ADOPTION OF TEMPORARY RULE**

**EFFECTIVE DATE:** The effective date of the temporary rules being adopted through this omnibus rulemaking is the adjournment date of the second regular session of the 65th Idaho State Legislature - March 20, 2020.

**AUTHORITY:** In compliance with Sections 67-5226, Idaho Code, notice is hereby given this agency has adopted a temporary rule. The action is authorized pursuant to Section 54-5310, Idaho Code.

**DESCRIPTIVE SUMMARY:** The following is the required finding and concise statement of its supporting reasons for adopting a temporary rule:

This temporary rulemaking adopts the following chapter under IDAPA 24.22.01:

**IDAPA 24.22**

- 24.22.01, *Rules of the Idaho State Liquefied Petroleum Gas Safety Board.*

**TEMPORARY RULE JUSTIFICATION:** Pursuant to Sections 67-5226(1) and 67-5226(2), Idaho Code, the Governor has found that temporary adoption of the rule is appropriate for the following reasons:

These temporary rules are necessary to protect the public health, safety, and welfare of the citizens of Idaho and confer a benefit on its citizens. These temporary rules implement the duly enacted laws of the state of Idaho, provide citizens with the detailed rules and standards for complying with those laws, and assist in the orderly execution and enforcement of those laws. The expiration of these rules without due consideration and processes would undermine the public health, safety, and welfare of the citizens of Idaho and deprive them of the benefit intended by these rules. These rules govern the qualifications for facilities and individuals who engage in the selling, filling, refilling, transporting, delivering, or commercial handling of liquefied petroleum gas (LPG), or engage in the installation or maintenance of systems, equipment, pipes or containers for the use or storage of LPG. Allowing these rules and the standards set forth within them to expire would endanger public health, safety, and welfare.

**FEE SUMMARY:** Pursuant to Section 67-5226(2), the Governor has found that the fees or charges being imposed or increased are justified and necessary to avoid immediate danger and the fees are described herein:

The fees or charges, authorized in Sections 54-5313, and 54-5308 Idaho Code, are part of the agency’s 2021 budget that relies upon the existence of these fees or charges to meet the state’s obligations and provide necessary state services. Failing to reauthorize these temporary rules would create immediate danger to the state budget, immediate danger to necessary state functions and services, and immediate danger of a violation of Idaho’s constitutional requirement that it balance its budget.

The following is a specific description of the fees or charges:

<b>FEE TYPE</b>	<b>AMOUNT (Not to Exceed)</b>	<b>RENEWAL (Not to Exceed)</b>
Application	\$30	
Individual License	\$75	\$75
Endorsement	\$75	
Dealer-in-training	\$50	
Facility License	\$100	\$100
Bulk Storage Facility	\$400	\$400

<b>FEE TYPE</b>	<b>AMOUNT (Not to Exceed)</b>	<b>RENEWAL (Not to Exceed)</b>
Facility Re-inspection	\$125	

**ASSISTANCE ON TECHNICAL QUESTIONS:** For assistance on technical questions concerning the temporary rule, contact Rob McQuade at (208) 334-3233.

DATED this February 21, 2020.

Kelley Packer  
Division Administrator  
Division of Occupational and Professional Licenses  
700 W. State Street  
P.O. Box 83720  
Boise, ID 83720  
Phone: (208) 334-3233  
Fax: (208) 334-3945

**24.22.01 – RULES OF THE IDAHO STATE LIQUEFIED PETROLEUM GAS SAFETY BOARD**

**000. LEGAL AUTHORITY.**

In accordance with Section 54-5310, Idaho Code, the Idaho State Liquefied Petroleum Gas Safety Board has promulgated rules that implement the provisions of Chapter 53, Title 54, Idaho Code. (3-20-20)T

**001. TITLE AND SCOPE.**

These rules are titled IDAPA 24.22.01, “Rules of the Idaho State Liquefied Petroleum Gas Safety Board.”(3-20-20)T

**002. – 003. (RESERVED)**

**004. INCORPORATION BY REFERENCE.**

The document titled Liquefied Petroleum Gas Code, 2017 Edition, commonly known as NFPA 58, published by National Fire Protection Association (NFPA), is herein incorporated by reference and is available for public inspection at the Board’s office. Copies of the 2017 Liquefied Petroleum Gas Code are available for purchase from the National Fire Protection Association, 11 Tracy Drive, Avon, MA 02322. (3-20-20)T

**005. -- 099. (RESERVED)**

**100. ORGANIZATION.**

At the first meeting of each fiscal year, the Board elects from its members a Chairman, who assumes the duty of the office immediately upon such selection. (3-20-20)T

**101. -- 174. (RESERVED)**

**175. FEES.**

All fees are non-refundable:

FEE TYPE	AMOUNT (Not to Exceed)	RENEWAL (Not to Exceed)
Application	\$30	
Individual License	\$75	\$75
Endorsement	\$75	
Dealer-in-training	\$50	
Facility License	\$100	\$100
Bulk Storage Facility	\$400	\$400
Facility Reinspection	\$125	

(3-20-20)T

**176. – 224. (RESERVED)**

**225. APPROVED EDUCATION AND EXAMINATIONS.**

Each applicant must provide certified proof that they have successfully completed the following: (3-20-20)T

**01. Basic Education.** The Basic Certified Employee Training Program (CETP) provided by the National Propane Gas Association or the equivalent as determined by the Board within the thirty-six (36) months immediately preceding application. (3-20-20)T

**02. Licensure Examination.** Receipt of a passing grade on the Basic Certified Employee Training Program (CETP) examination provided by the National Propane Gas Association or the equivalent as determined by the Board within the thirty-six (36) months immediately preceding application. (3-20-20)T

**226. -- 249. (RESERVED)**

**250. PRACTICAL EXPERIENCE.**

**01. Supervised Practical Experience.** Each applicant must provide certified proof that the applicant



has successfully obtained at least one (1) year of practical experience in a Liquefied Petroleum Gas (LPG) facility while the applicant was under supervision of a licensed dealer. A person in the process of meeting the practical experience requirement must complete the education and examination requirements and apply for a dealer license within eighteen (18) months of beginning to obtain supervised experience. (3-20-20)T

**02. Dealer-in-Training License.** An individual may not begin obtaining supervised practical experience until the individual has applied for and obtained a dealer-in-training license from the board. Such license is issued on a non-renewable basis and is for the purpose of enabling the individual to gain the supervised practical experience that the person must obtain to become an LPG dealer. The dealer-in-training license is valid for eighteen (18) months from the date of issue. (3-20-20)T

**251. -- 349. (RESERVED)**

**350. FACILITY LICENSURE.**

**01. Facility Licensure and Operation Requirements.** (3-20-20)T

**a.** Application for a facility license must include a certificate of general liability insurance set forth in these rules and plans and specifications complying with local ordinances and zoning requirements. All applications must be submitted to the Board for approval and a license must be issued before a new facility may open for business; (3-20-20)T

**b.** Each facility application must clearly identify and designate a location adequate to allow the facilities safe operation and the selling, filling, refilling, or commercial handling or commercial storage of liquefied petroleum gas; (3-20-20)T

**c.** Each facility must meet all requirements of NFPA 58. (3-20-20)T

**02. Facility Changes in Ownership or Location.** (3-20-20)T

**a.** Whenever a change of ownership or location of a facility occurs, an original application must be submitted, the fee must be paid and compliance with all rules concerning a new facility documented, before a new license will be issued. FACILITY LICENSES ARE NOT TRANSFERABLE. (3-20-20)T

**b.** Deletion of an owner from multiple ownership does not constitute a change in ownership. (3-20-20)T

**c.** Addition of an owner to multiple ownership does constitute a change in ownership. (3-20-20)T

**d.** Whenever any facility ceases operation at the licensed location, the owner(s) must notify the Board in writing that the facility is out of business and the facility license must be submitted to the Division. A new facility license will not be issued for any location that is currently licensed as a facility at the time of application. (3-20-20)T

**351. -- 354. (RESERVED)**

**355. GENERAL LIABILITY INSURANCE REQUIREMENT.**

No facility license will be issued without a certificate showing proof of a current general liability insurance policy in the sum of not less than one million dollars (\$1,000,000) for an occurrence. The Board may conduct random audits of facility licenses and request documentation of a current general liability insurance policy. (3-20-20)T

**01. Original Facility License Application.** An application for facility license will not be considered complete without a certificate of general liability insurance showing a current policy. The policy must be kept in full force and effect. (3-20-20)T

**02. Renewal of Facility License.** All licenses being renewed must certify that the facility holds a current general liability insurance policy. (3-20-20)T

**356. -- 374. (RESERVED)**

**375. INSPECTION RULES.**

All facilities are subject to inspection by the Board or its agents at any time without notice to insure the safe operation of each facility and to insure continued compliance with the requirements of NFPA 58 and the Idaho laws and rules. The Board may adopt a form which establishes for the facility those material rules of NFPA 58 which will be inspected, and a level of compliance necessary for issuance or retention of a license or disciplinary action. The Board may further determine the time frame a facility may be granted in order to comply with NFPA 58, but still continue to operate, or pursue disciplinary action for a failure to comply. In the event of non-compliance necessitating re-inspection, the Board may assess a re-inspection fee. (3-20-20)T

**376. -- 399. (RESERVED)**

**400. ENDORSEMENT.**

Any person who holds a current, unsuspended, unrevoked or otherwise nonsanctioned license in another state or country that has licensing requirements substantially equivalent to or higher than those in Idaho may, submit the required application, supporting documentation, and required fee, for Board consideration. Those applicants who received their professional education or experience outside of the United States must provide such additional information concerning their professional education or experience as the Board may request. The Board may, in its discretion, require successful completion of additional course work or examination for any applicant under this provision. (3-20-20)T

**401. -- 449. (RESERVED)**

**450. DISCIPLINE.**

**01. Civil Fine.** The Board may impose a civil fine not to exceed one thousand dollars (\$1,000) upon a licensed LPG dealer or a licensed LPG facility for each violation of Section 54-5315, Idaho Code. (3-20-20)T

**02. Costs and Fees.** The Board may order a licensed LPG dealer or a licensed LPG facility to pay the costs and fees incurred by the Board in the investigation or prosecution of the licensee for violation of Section 54-5315, Idaho Code. (3-20-20)T

**451. -- 999. (RESERVED)**

# IDAPA 24 – DIVISION OF OCCUPATIONAL AND PROFESSIONAL LICENSES

## 24.23.01 – RULES OF THE SPEECH, HEARING AND COMMUNICATION SERVICES LICENSURE BOARD

### DOCKET NO. 24-2301-2000F (FEE RULE)

#### NOTICE OF OMNIBUS RULEMAKING – ADOPTION OF TEMPORARY RULE

**EFFECTIVE DATE:** The effective date of the temporary rules being adopted through this omnibus rulemaking is the adjournment date of the second regular session of the 65th Idaho State Legislature - March 20, 2020.

**AUTHORITY:** In compliance with Sections 67-5226, Idaho Code, notice is hereby given this agency has adopted a temporary rule. The action is authorized pursuant to Section 54-2910, Idaho Code.

**DESCRIPTIVE SUMMARY:** The following is the required finding and concise statement of its supporting reasons for adopting a temporary rule:

This temporary rulemaking adopts the following chapter under IDAPA 24.23.01:

#### **IDAPA 24.23**

- 24.23.01, *Rules of the Speech, Hearing, and Communications Services Licensure Board.*

**TEMPORARY RULE JUSTIFICATION:** Pursuant to Sections 67-5226(1) and 67-5226(2), Idaho Code, the Governor has found that temporary adoption of the rule is appropriate for the following reasons:

These temporary rules are necessary to protect the public health, safety, and welfare of the citizens of Idaho and confer a benefit on its citizens. These temporary rules implement the duly enacted laws of the state of Idaho, provide citizens with the detailed rules and standards for complying with those laws, and assist in the orderly execution and enforcement of those laws. The expiration of these rules without due consideration and processes would undermine the public health, safety, and welfare of the citizens of Idaho and deprive them of the benefit intended by these rules. These rules govern the qualifications for speech pathologists, audiologists, hearing aid dealers and fitters, and sign language interpreters, as well as the code of ethics for sign language interpreters. Allowing these rules to expire would harm the health, safety, and welfare of Idaho citizens with speech and hearing disorders.

**FEE SUMMARY:** Pursuant to Section 67-5226(2), the Governor has found that the fees or charges being imposed or increased are justified and necessary to avoid immediate danger and the fees are described herein:

The fees or charges, authorized in Sections 54-2912, 54-2913, 54-2914, 54-2915, 54-2916A, 54-2918, and 54-2921, Idaho Code, are part of the agency's 2021 budget that relies upon the existence of these fees or charges to meet the state's obligations and provide necessary state services. Failing to reauthorize these temporary rules would create immediate danger to the state budget, immediate danger to necessary state functions and services, and immediate danger of a violation of Idaho's constitutional requirement that it balance its budget.

The following is a specific description of the fees or charges:

LICENSE/PERMIT/REGISTRATION	INITIAL FEE (Not to Exceed)	ANNUAL RENEWAL FEE (Not to Exceed)
Application	\$30	
Original or Endorsement	\$70	\$100
Provisional Permit or Extension	\$100	
Registration Out-of-State Licensee	\$10	
Reinstatement fee	As provided in Section 67-2614, Idaho Code.	

<b>LICENSE/PERMIT/REGISTRATION</b>	<b>INITIAL FEE (Not to Exceed)</b>	<b>ANNUAL RENEWAL FEE (Not to Exceed)</b>
Inactive license		\$65
Inactive to active license fee	The difference between the current inactive and active license renewal fees	

**ASSISTANCE ON TECHNICAL QUESTIONS:** For assistance on technical questions concerning the temporary rule, contact Rob McQuade at (208) 334-3233.

DATED this February 21, 2020.

Kelley Packer  
Division Administrator  
Division of Occupational and Professional Licenses  
700 W. State Street  
P.O. Box 83720  
Boise, ID 83720  
Phone: (208) 334-3233  
Fax: (208) 334-3945

**24.23.01 – RULES OF THE SPEECH, HEARING, AND COMMUNICATION SERVICES LICENSURE BOARD**

**000. LEGAL AUTHORITY.**

These rules are hereby prescribed and established pursuant to the authority vested in the Speech, Hearing and Communication Services Licensure Board by the provisions of Section 54-2910, Idaho Code. (3-20-20)T

**001. TITLE AND SCOPE.**

These rules are titled IDAPA 24.23.01, “Rules of the Speech, Hearing, and Communication Services Licensure Board.” (3-20-20)T

**002. – 003. (RESERVED)**

**004. INCORPORATION BY REFERENCE.**

The document titled “National Association of the Deaf (NAD)-Registry of Interpreters for the Deaf, Inc. (RID) Code of Professional Conduct,” copyright 2005 by the Registry of Interpreters for the Deaf, is incorporated by reference into this rule and is available at the Board’s office and on the Board’s web site. (3-20-20)T

**005. -- 009. (RESERVED)**

**010. DEFINITIONS.**

**01. Audiology Support Personnel.** Unlicensed natural persons who work under the direction and supervision of an audiologist who is licensed in accordance with Title 54, Chapter 29, Idaho Code, and is engaged in the practice of audiology. (3-20-20)T

**02. Direct Client Contact.** Assessment, diagnosis, evaluation, screening, treatment, report writing, family or client consultation, counseling, or any combination of these activities. (3-20-20)T

**03. Dual Licensure.** The status of a person who holds more than one (1) license under Title 54, Chapter 29, Idaho Code. (3-20-20)T

**011. -- 174. (RESERVED)**

**175. FEES.**

All fees are non-refundable. Fees are established in accord with Title 54, Chapter 29, Idaho Code as follows: (3-20-20)T

**01. License, Permit, and Registration Fees.**

LICENSE/PERMIT/REGISTRATION	INITIAL FEE (Not to Exceed)	ANNUAL RENEWAL FEE (Not to Exceed)
Application	\$30	
Original or Endorsement	\$70	\$100
Provisional Permit or Extension	\$100	
Registration Out-of-State Licensee	\$10	
Reinstatement fee	As provided in Section 67-2614, Idaho Code.	
Inactive license		\$65
Inactive to active license fee	The difference between the current inactive and active license renewal fees	

(3-20-20)T

**02. Examination Fees.** The examination fee is that charged by the examination provider plus an administration fee of one hundred dollars (\$100) when the examination is administered by the Board. (3-20-20)T

**176. -- 204. (RESERVED)**

**205. INACTIVE STATUS.**

**01. Request for Inactive Status.** Each person requesting an inactive status of an active license must submit a written request and pay the established fee. (3-20-20)T

**02. Inactive License Status.** (3-20-20)T

**a.** All continuing education requirements will be waived for any year or portion thereof that a licensee maintains an inactive license. (3-20-20)T

**b.** When the licensee desires active status, the licensee must show acceptable fulfillment of ten (10) contact hours of continuing education during the previous twelve (12) months and submit a fee equivalent to the difference between the inactive and active renewal fee, provided that a licensee whose license has been inactive five (5) years or more must provide an account to the Board for that period of time during which the license was inactive and fulfill requirements that demonstrate competency to resume practice. Those requirements may include, but are not limited to, education, supervised practice, and examination as determined by the Board. The Board may consider practice in another jurisdiction in determining competency. (3-20-20)T

**c.** Licensees may not practice or supervise in Idaho as an Audiologist, Speech-Language Pathologist, Speech-Language Pathologist Aide, Speech-Language Pathologist Assistant, Hearing Aid Dealer and Fitter, or Sign Language Interpreter while on inactive status. (3-20-20)T

**206. -- 209. (RESERVED)**

**210. QUALIFICATIONS FOR AUDIOLOGIST LICENSURE.**

All applicants for licensure as an audiologist must comply with the following education, experience, and examination requirements: (3-20-20)T

**01. Graduate Program Requirement.** A master's or doctoral degree with emphasis in audiology or not less than seventy-five (75) semester credit hours of post-baccalaureate study that culminates in a doctoral degree from a nationally accredited school for audiology. (3-20-20)T

**02. Examination.** Pass the audiology examination given by PRAXIS within the last five (5) years or other examination as may be approved by the Board. (3-20-20)T

**03. Experience.** Successfully complete a supervised academic clinical practicum as part of a doctoral program that satisfies Subsection 210.01 of this rule or supervised postgraduate experience that is substantially equivalent to such a practicum. An applicant who has insufficient supervised experience as part of the doctoral program may obtain the necessary experience under a provisional permit as provided in these rules. (3-20-20)T

**211. SUPPORT PERSONNEL: AUDIOLOGY.**

**01. Supervising Audiologist – Responsibilities – Restrictions.** (3-20-20)T

**a.** The supervising licensed audiologist is responsible for everything audiology support personnel do or fail to do while performing their duties under the supervising audiologist's supervision. (3-20-20)T

**b.** Responsibilities of the supervising audiologist include, but are not limited to: (3-20-20)T

**i.** Training, assessing the competency, and evaluating the performance of audiology support personnel. (3-20-20)T

**ii.** Approving or disapproving all orders and directives concerning audiology tasks issued by administrators or other managers. (3-20-20)T

iii. Assigning audiology tasks to audiology support personnel and supervising the performance of those tasks. Assigned tasks must not exceed the knowledge and skills of audiology support personnel nor require the exercise of professional judgment, interpretation of test results, or the development or modification of treatment plans. (3-20-20)T

iv. Assessing the abilities of audiology support personnel to perform assigned audiology tasks. (3-20-20)T

v. Providing feedback to audiology support personnel to facilitate improved job performance. (3-20-20)T

c. The number of audiology support personnel that an audiologist may supervise at any one time must be consistent with the delivery of appropriate, quality service, and Title 54, Chapter 29, Idaho Code. (3-20-20)T

d. An audiologist must supervise audiology support personnel in the following manner: (3-20-20)T

i. A supervising audiologist must directly supervise audiology support personnel no less than one (1) time for every five (5) times that support personnel provide audiology services to a patient (twenty percent (20%)). Direct supervision requires in-view real-time observation and guidance while an assigned activity is performed. This requirement can be met when the supervisor is providing supervision from a distant site using two-way video and audio transmission. The supervising audiologist will document and retain a record of all direct supervision periods. (3-20-20)T

ii. When not providing direct supervision, the supervising audiologist must provide direction and supervision to audiology support personnel while support personnel are providing audiology services to a patient by making themselves accessible to the support personnel by telephone, video conferencing or in person. (3-20-20)T

**02. Audiology Support Personnel – Roles – Restrictions.** Audiology support personnel perform only tasks that are planned, delegated, and supervised by the supervising audiologist. Duties and responsibilities are assigned based on training, certification, available supervision, and specific work setting, provided that an audiologist may not allow audiology support personnel to perform the following: (3-20-20)T

a. Any task prohibited by state or federal law. (3-20-20)T

b. Interpreting observations or data into diagnostic statements of clinical management strategies or procedures. (3-20-20)T

c. Determining case selection. (3-20-20)T

d. Transmitting clinical information, either verbally or in writing, to anyone without the approval of the supervising audiologist. (3-20-20)T

e. Composing clinical reports except for progress notes to be reviewed by the audiologist and held in the client's records. (3-20-20)T

f. Referring a patient/client to other professionals or agencies. (3-20-20)T

g. Referring to self or using in connection with audiology support person's name, any title other than one determined by the supervising audiologist that is consistent with state and federal law. (3-20-20)T

h. Signing any formal documents (e.g. treatment plans, reimbursement forms, or reports). (3-20-20)T

i. Discharging a patient/client from services. (3-20-20)T

j. Removal of cerumen. (3-20-20)T

- 03. Audiology Support Personnel – Pre-Service and In-Service Instruction.** (3-20-20)T
- a.** The supervising audiologist is responsible for maintaining a written record of completed training activity. (3-20-20)T
- b.** Training will be conducted pre-service (before tasks are assigned) and in-service (after tasks are assigned). The quality and content of training is left to the discretion of the supervising audiologist. The following guidelines apply to both pre-service and in-service training. (3-20-20)T
- i.** Training should be well-defined and specific to assigned tasks. (3-20-20)T
- ii.** Supervising audiologists should ensure that the scope and intensity of training is sufficient to prepare audiology support personnel to successfully perform assigned tasks. (3-20-20)T
- iii.** Training should be competency-based and be provided through a variety of formal and informal instructional methods accompanied by written policies and procedures. (3-20-20)T
- iv.** Supervising audiologists should provide audiology support personnel with a written description of their roles and functions. Audiologists should provide personnel with ongoing training opportunities to ensure that audiology practices are current and skills are maintained. (3-20-20)T
- v.** Training should include the identification of and appropriate response to linguistic and cultural challenges which may affect the delivery of service. (3-20-20)T

**212. NEWBORN HEARING SCREENING TESTS.**

Performing newborn hearing screening tests on infants using automated equipment that produces a pass/fail response does not, by itself, constitute the practice of audiology or convert persons performing the tests into audiology support personnel. (3-20-20)T

**213. -- 219. (RESERVED)**

**220. QUALIFICATIONS FOR SPEECH-LANGUAGE PATHOLOGIST LICENSURE.**

All applicants for licensure as a speech-language pathologist must comply with the following education, experience, and examination requirements: (3-20-20)T

**01. Graduate Program Requirement.** A master's or doctoral degree from a nationally accredited school of speech-language pathology with a curriculum approved by the Board and includes a supervised academic clinical practicum. (3-20-20)T

**02. Examination.** Pass an examination in speech-language pathology given by PRAXIS or other examination as may be approved by the Board. (3-20-20)T

**03. Supervised Experience.** Satisfactorily complete the supervised postgraduate experience approved by the Board as follows: (3-20-20)T

**a.** One thousand two hundred sixty (1,260) hours of experience gained under the supervision of a licensed speech-language pathologist in no less than thirty-six (36) weeks of full-time (thirty-five (35) hours per week) experience or the equivalent part-time experience and in no more than forty-eight (48) months. (3-20-20)T

**b.** One thousand ten (1,010) hours of experience must be in direct client contact as defined in these rules. (3-20-20)T

**c.** A minimum of eighteen (18) hours of direct client contact must be observed on-site by the Board-approved supervisor and provided on a regular basis throughout the hours of experience. (3-20-20)T

**d.** The nature of the supervision and contact must allow for immediate feedback and can be conducted using audio/visual, in person, electronic means, or telephone. (3-20-20)T



**221. -- 229. (RESERVED)**

**230. QUALIFICATIONS FOR SPEECH-LANGUAGE PATHOLOGIST AIDE LICENSURE.**

All applicants for licensure as a speech-language pathologist aide must comply with the following education and examination requirements: (3-20-20)T

**01. Education Program Requirement.** A baccalaureate degree from a nationally accredited school of speech-language pathology with a curriculum approved by the Board. (3-20-20)T

**02. Examination.** Pass an examination in speech-language pathology aide as approved by the Board. (3-20-20)T

**03. Supervision.** A speech-language pathologist aide must work under the supervision of a speech-language pathologist. (3-20-20)T

**231. -- 239. (RESERVED)**

**240. QUALIFICATIONS FOR SPEECH-LANGUAGE PATHOLOGIST ASSISTANT LICENSURE.**

All applicants for licensure as a speech-language pathologist assistant must comply with the following education and examination requirements: (3-20-20)T

**01. Education Program Requirement.** An associate degree from a nationally accredited school of speech-language pathology with a curriculum approved by the Board. (3-20-20)T

**02. Examination.** Pass an examination in speech-language pathology assistant approved by the Board. (3-20-20)T

**03. Supervision.** A speech-language pathologist assistant must work under the supervision of a speech-language pathologist. (3-20-20)T

**241. -- 249. (RESERVED)**

**250. QUALIFICATIONS FOR HEARING AID DEALER AND FITTER LICENSURE.**

All applicants for licensure as a hearing aid dealer and fitter must comply with the following education, experience, and examination requirements: (3-20-20)T

**01. Education Requirement.** A high school diploma or successful passage of the General Educational Development diploma (GED). (3-20-20)T

**02. Examination.** Pass the national International Hearing Instrument Studies examination and the practical examination approved by the Board. An applicant who fails to obtain a satisfactory score as determined by the examination provider in either the written examination or a section of the practical examination, may retake only the portion of the examination failed in order to qualify for licensure. If the applicant again fails the examination the applicant must retake the entire examination until the examination is successfully passed to qualify for licensure. (3-20-20)T

**251. -- 259. (RESERVED)**

**260. QUALIFICATIONS FOR SIGN LANGUAGE INTERPRETER LICENSURE.**

The Board may grant a sign language interpreter license to an applicant who meets the following: (3-20-20)T

**01. Education.** Possess a high school diploma or the equivalent; (3-20-20)T

**02. Examination or Certification.** Pass one (1) written and one (1) practical or performance competency examination approved by the Board or hold a current certification approved by the Board. (3-20-20)T

**a.** Written examinations approved by the Board include, but are not limited to: The Educational Interpreter Performance Assessment (EIPA), any interpreting generalist written examination developed by the Registry of Interpreters for the Deaf (RID), the Center for Assessment of Sign Language Interpreters (CASLI), or any state government. (3-20-20)T

**b.** Practical or performance examinations approved by the Board include, but are not limited to: any practical or performance general interpreting examination recognized by the Registry of Interpreters for the Deaf (RID) or the Educational Interpreter Performance Assessment (EIPA) at score 4.0 or above. The practical or performance examination must have been passed within ten (10) years before the date of original application for licensure. (3-20-20)T

**c.** Certifications approved by the Board include, but are not limited to, those administered by: Registry of Interpreters for the Deaf (RID); National Association of the Deaf (NAD); Center for Assessment of Sign Language Interpreters (CASLI); Board for Evaluation of Interpreters (BEI) at basic level or above, or if certified before 2014, at intermediate level or above; Utah Interpreter Program (UIP) at professional or master level, or a Utah Certified: Deaf Interpreter (UC:DI). (3-20-20)T

**261. TELEPRACTICE OF SIGN LANGUAGE INTERPRETING.**

A person who performs sign language interpreting services through the use of electronic communications, information technology, asynchronous store and forward transfer, or synchronous interaction to persons located in Idaho are subject to the licensure, registration, or deaf interpreter requirements of Chapter 24, Title 54, Idaho Code, and these rules unless the person is located outside of Idaho and providing video relay services regulated by the Federal Communication Commission (FCC). (3-20-20)T

**262. -- 264. (RESERVED)**

**265. CODE OF ETHICS AND STANDARDS FOR SIGN LANGUAGE INTERPRETERS.**

All licensed sign language interpreters must follow the National Association of the Deaf (NAD)-Registry of Interpreters for the Deaf, Inc. (RID) code of professional conduct as incorporated by reference in Section 004 of these rules, and must practice competently and in a manner consistent with the licensee's training, skill, and experience. (3-20-20)T

**266. -- 269. (RESERVED)**

**270. REGISTRATION FOR OUT-OF-STATE LICENSEES.**

A person licensed or certified as sign language interpreter in another state, territory, or the District of Columbia may practice sign language interpreting in this state without a license issued by the board for a period not to exceed in the aggregate thirty (30) days in any calendar year provided that they fulfill the following requirements: (3-20-20)T

**01. Statement of Registration.** Before commencing such work, the person will file with the Board on a form approved by the board a statement of registration providing the person's name, residence, sign language interpreter license or certificate of registration number, and the name, address, and phone number of the issuing authority; (3-20-20)T

**02. Registration Fee.** Payment of one (1) registration fee for each calendar year in which they register; (3-20-20)T

**03. Statement of Time Engaged.** Within five (5) business days of completion of the work, the person will submit to the Board on a form approved by the Board a statement of the number of days in which the person engaged in that work within the state. (3-20-20)T

**271. -- 279. (RESERVED)**

**280. DEAF INTERPRETERS.**

**01. Letter of Endorsement.** Persons who are deaf or hard-of-hearing and are not sign language interpreters may perform sign language interpreting services in the role of a deaf interpreter if they file with the Board

two (2) written endorsement letters from sign language interpreters licensed by the Board. Each letter must, at a minimum, include: (3-20-20)T

- a. Date letter of endorsement was written; (3-20-20)T
- b. Full name, mailing address, and phone number of the deaf interpreter; (3-20-20)T
- c. Name, mailing address, and phone number of the sign language interpreter; and (3-20-20)T
- d. A statement endorsing the deaf interpreter to perform sign language interpreting services and an explanation as to why the sign language interpreter believes that the deaf interpreter has the skills and the knowledge to perform this role. (3-20-20)T

**02. Withdrawal of Endorsement.** A sign language interpreter who has endorsed a deaf interpreter may withdraw their endorsement at any time upon delivery of written notice to the deaf interpreter and the Board. (3-20-20)T

**281. -- 309. (RESERVED)**

**310. ENDORSEMENT.**

The Board may grant a license to any person who holds a current, active license, at the level for which a license is being sought, issued by the authorized regulatory entity in another state and has not engaged in conduct that would constitute grounds for discipline under Section 54-2918, Idaho Code, unless the applicant has demonstrated suitability for licensure as set forth in these rules. (3-20-20)T

**311. -- 319. (RESERVED)**

**320. WRITTEN STATEMENT OF SUITABILITY FOR LICENSURE.**

An applicant who or whose license has a conviction, finding of guilt, withheld judgment, or suspended sentence for a felony or has been subject to discipline in another state, territory, or country must submit with his application a written statement and any supplemental information establishing the applicant's current suitability for licensure. (3-20-20)T

**01. Consideration of Factors and Evidence.** The board may consider the following factors or evidence: (3-20-20)T

- a. The severity or nature of the crime or discipline; (3-20-20)T
- b. The period of time that has passed since the crime or discipline under review; (3-20-20)T
- c. The number or pattern of crimes or discipline or other similar incidents; (3-20-20)T
- d. The circumstances surrounding the crime or discipline that would help determine the risk of reoccurrence; (3-20-20)T
- e. The relationship of the crime or discipline to the practice of sign language interpreting; (3-20-20)T
- f. The applicant's activities since the crime or discipline under review, such as employment, education, participation in treatment, payment of restitution, or any other factors which may be evidence of current rehabilitation; and (3-20-20)T
- g. Any other information regarding rehabilitation or mitigating circumstances. (3-20-20)T

**02. Interview.** The Board may, at its discretion, grant an interview of the applicant. (3-20-20)T

**03. Applicant Bears the Burden.** The applicant bears the burden of establishing the applicant's current suitability for licensure. (3-20-20)T

**321. -- 399. (RESERVED)**

**400. CONTINUING EDUCATION.**

All licensees must complete the following continuing education requirements: (3-20-20)T

**01. Requirement.** For licensed sign language interpreters and up until January 1, 2021, for all other licensees, each licensee will successfully complete, in the twelve (12) months preceding each renewal of their license, a minimum of ten (10) contact hours of continuing education. (3-20-20)T

**a.** Effective January 1, 2021, for licensees other than sign language interpreters, each licensee will successfully complete, in the three (3) years prior to their license expiration date, a minimum of thirty (30) contact hours of continuing education. (3-20-20)T

**b.** A contact hour is a measurement of the licensee's participation in an area of study germane to the practice for which the license is issued as approved by the Board. One (1) contact hour requires one (1) hour of participation in a Board-approved continuing education program excluding meals and breaks. One (1) contact hour equals one (1) clock hour for purposes of obtaining continuing education credit. (3-20-20)T

**c.** For college or university courses that are approved by the Board for continuing education credit, one (1) semester credit hour equals fifteen (15) contact hours; one (1) quarter credit hour equals ten (10) contact hours. (3-20-20)T

**d.** For proctoring the hearing aid dealing and fitting examination administered by the Board, a licensee may claim three (3) contact hours per exam up to a total of six (6) contact hours during each year, provided that a licensee may not claim more than nine (9) contact hours during any three (3) year period. (3-20-20)T

**e.** Effective January 1, 2021, the Board will waive the continuing education requirement for the first three (3) license renewals after initial licensure for licensees other than sign language interpreters. For sign language interpreters and up until January 1, 2021, for all other licensees, the Board will waive the continuing education requirement for the first renewal after initial licensure. (3-20-20)T

**02. Documentation.** Each licensee must maintain documentation verifying hours of attendance by securing authorized signatures or other documentation from the course instructors, providers, or sponsoring institution. This documentation is subject to audit and must be provided upon request by the Board or its agent. (3-20-20)T

**03. Waiver.** The Board may waive continuing education requirements for reasons of individual hardship, including health, when certified by a medical doctor, or other good cause. The licensee must provide any information requested by the Board to assist in substantiating hardship cases. This waiver is granted at the sole discretion of the Board. (3-20-20)T

**04. Carryover of Continuing Education Hours.** Until January 1, 2021, continuing education hours not claimed in the current renewal year may be claimed in the next renewal year. A maximum of ten (10) hours may be carried forward from the immediately preceding year, and may not be carried forward more than one renewal year. (3-20-20)T

**401. -- 449. (RESERVED)**

**450. PROVISIONAL PERMITS.**

**01. Scope and Purpose.** The Board may issue a provisional permit to allow an applicant to engage in the supervised practice of a profession regulated by Title 54, Chapter 29, Idaho Code, while pursuing licensure for that profession. (3-20-20)T

**a.** A provisional permit holder for audiology or speech language may practice the respective profession while completing the supervised experience necessary for licensure set forth in Subsection 210.03 or

Subsection 220.03. (3-20-20)T

**b.** A provisional permit holder for sign language interpreting or hearing aid dealing and fitting may practice the respective profession while pursuing passage of examination(s) or certification necessary for licensure as set forth in Subsection 260.02. (3-20-20)T

**02. Supervisor.** A provisional permit holder may only practice under the supervision of a licensee(s) whose license is current, in good standing, has not had discipline in the last two (2) years, and who is not supervising more than one (1) other permit holder, and as set forth below: (3-20-20)T

**a.** A permit holder must be supervised by a licensee for the profession corresponding to the permit, except that a hearing aid dealer and fitter permit holder must be supervised by: (3-20-20)T

**i.** A hearing aid dealer and fitter who holds a current hearing instrument sciences (BC-HIS) from the National Board for Certification in Hearing Instrument Sciences or has three (3) years of active practice immediately preceding approval as a supervisor; or (3-20-20)T

**ii.** An audiologist with one (1) year of active practice immediately preceding approval as a supervisor. (3-20-20)T

**iii.** For an applicant who holds a current hearing instrument sciences (BC-HIS) from the National Board for Certification in Hearing Instrument Sciences, the Board may within its discretion approve a supervisor who is an audiologist with less than one (1) year of practice, is supervising more than one (1) other permit holder, or both. The Board's approval of such a supervisor may be rescinded in the event the permit holder fails a licensing examination or the permit holder failure to take the licensing examination within six (6) months after issuance of the permit. The Board may allow the supervisor to continue to supervise the permit holder upon adequate assurance that the supervision being provided is sufficient to ensure the safe and effective delivery of hearing aid dealing and fitting services and preparation for the examination. (3-20-20)T

**b.** A supervisor for a permit holder, except for sign language interpreter supervisor, must have an established business site in Idaho. A supervisor and permit holder for hearing aid dealing and fitting must work in the same facility. (3-20-20)T

**c.** A supervisor may terminate their supervision of a permit holder by a written notice to the Board and the permit holder by certified mail at least ten (10) calendar days prior to the termination. (3-20-20)T

**03. Supervision.** The supervisor is responsible for all practice and conduct of each permit holder under supervision. The supervisor and permit holder for hearing aid dealing and fitting must have adequate personal contact, which at a minimum includes: (3-20-20)T

**a.** Personal contact each work day to review any assignments, client contacts, and hearing aid fittings for the first sixty (60) days of practice. The nature of the supervision and contact must allow for immediate feedback and includes audio/visual, in person, or telephone contacts. (3-20-20)T

**b.** After the first sixty (60) days of practice, personal contact as described in Subsection 450.03.a. must be made no less than once in each calendar week throughout the remaining period of the permit. (3-20-20)T

**c.** In the event a permit holder fails the licensing examination two (2) consecutive times and is eligible to maintain a permit, the supervisor and permit holder must reinstate contact in person each work day as set forth in Subsection 450.03.a. (3-20-20)T

**04. Plan of Training and Quarterly Reports.** An applicant must submit a plan of training approved by the designated supervisor(s). Permit holders must submit quarterly reports signed by the supervisor(s) reflecting the progress on the plan(s) of training and any additional information required by this rule. (3-20-20)T

**a.** A plan of training for hearing aid dealing and fitting or a sign language interpreter must cover all sections of the license examination(s). (3-20-20)T

**b.** A plan of training and supervision for an audiology or speech language pathology permit holder must provide for adequate direct client contact activities which include assessment, diagnosis, evaluation, screening, treatment, and client management. (3-20-20)T

**c.** Quarterly reports must be on forms approved by the Board, attested to and signed by the permit holder and approved supervisor(s), and include: (3-20-20)T

**i.** A log of client and supervisor contacts; (3-20-20)T

**ii.** Supervisor’s statement of completed training assignments by the permit holder; (3-20-20)T

**iii.** For an audiology permit holder, documentation of all hearing aid sales or fittings made by the permit holder; (3-20-20)T

**iv.** For a sign language interpreter, certification of attendance for any workshop or training session that permit holder has attended; (3-20-20)T

**v.** For a hearing aid dealing and fitting permit holder, a copy of test results for all persons tested by the permit holder whether or not a sale occurred and a copy of each hearing aid order for all fittings including specifications of instruments ordered. (3-20-20)T

**d.** Quarterly reports are due on or before April 10th, July 10th, October 10th, and January 10th for the three (3) calendar month period preceding the month due. If the permit has not been in effect for the entire quarter, the report is due for that portion of the quarter in which the permit was in effect. If quarterly reports are not received by the specified due date, are inadequate, or document inadequate progress or incompetent practice the permit may be suspended or revoked upon notice and an opportunity to be heard. (3-20-20)T

**05. Change in Supervisor or Plan of Training.** A permit holder must notify the Board prior to changing supervisors or changing the plan of training, and the change must be approved by the Board, or a designated member of the Board, prior to the commencement of supervision by a new supervisor or implementation of the change. Any supervision obtained from a supervisor or under a plan of training prior to or without approval of the Board will only be accepted at the discretion of the Board. (3-20-20)T

**06. Cancellation of Permit.** A permit is cancelled upon any of the following: issuance of a license, expiration of the permit, or ten (10) business days after termination or disqualification of all supervision or supervisors if the permit holder has not applied for a change of supervisor. (3-20-20)T

**07. Expiration.** Following the approval of a permit holder’s original application, a provisional permit expires after: (3-20-20)T

**a.** Twenty-four (24) months for the practice of audiology or the practice of hearing aid dealing and fitting. (3-20-20)T

**b.** Forty-eight (48) months for the practice of speech language pathology. (3-20-20)T

**c.** Twelve (12) months for the practice of sign language interpreting, provided that the Board may at its discretion, and upon application of the permit holder and approval of the supervisor, extend the time period by an additional twelve (12) months. The permit holder may apply for an extension a maximum of two (2) times, such that no permit holder may practice under a permit for more than thirty-six (36) months after the approval of the original application. (3-20-20)T

**d.** The Board may extend the time period for reasons of individual hardship, including health when certified by a medical doctor, or other good cause that prevented the permit holder from completing the supervision within the stated time period. (3-20-20)T

**451. -- 499. (RESERVED)**

**500. HEARING EVALUATION.**

**01. Purpose of Rule.** The purpose of this rule is to define, “tests utilizing appropriate procedures,” as used in Section 54-2923(6), Idaho Code. This rule is intended to be consistent with and to complement FDA Rule 801.420 as it refers to hearing evaluations. (3-20-20)T

**02. Pre-Fitting Testing.** All prospective hearing aid consumers must be given calibrated pure-tone air and bone tests with masking when applicable. Speech tests must be given by appropriate equipment calibrated to current H.T.L. reference levels. (3-20-20)T

**03. Sound Field Testing.** Before the prospective consumer purchases a hearing aid or within six (6) weeks afterward, the licensee must conduct the testing necessary to document that the fitted instrument meets industry standards and provides benefit to the consumer. This testing must be accomplished using appropriate sound field testing so as to ensure repeatability. Verification of benefit may be accomplished using any one (1) of the following tests: (3-20-20)T

- a. Soundfield testing for speech discrimination in both the aided and unaided conditions; (3-20-20)T
- b. Soundfield testing using warble tones or narrowband noise to evaluate functional gain; or (3-20-20)T
- c. “Real ear” probe microphone measurements. (3-20-20)T

**04. Records.** A copy of all test data must be kept on file by the licensee for two (2) years after sale. (3-20-20)T

**05. Exemptions.** The testing requirements contained in Subsections 450.02 and 450.03 of this rule do not apply to consumers who cannot respond to acceptable audiological tests, for any reason. (3-20-20)T

**551. -- 599. (RESERVED)**

**600. WRITTEN CONTRACTS.**

**01. Contract Form.** Any person who practices the fitting and sale of hearing aids must enter into a written contract with the person to be supplied with the hearing aid, which is signed by the licensee and the consumer and contains the information required in Subsections 600.01.a. through g. The written contract must be given to the consumer at the time of the sale and must contain the following: (3-20-20)T

- a. License number; (3-20-20)T
- b. Business address; (3-20-20)T
- c. The specifications as to the make, model, and manufacture date of the hearing aid; (3-20-20)T
- d. Clearly state the full terms of the sale, including the exact portion of the purchase price, not to exceed twenty-five (25%) percent of the total purchase price of the hearing instrument and fitting expenses, that is nonrefundable; (3-20-20)T
- e. Provide the serial number of the hearing aid upon delivery; (3-20-20)T
- f. Be clearly marked as “used” or “reconditioned,” whichever is applicable, if the aid is not new; and (3-20-20)T
- g. In print size no smaller than ten (10) point type: (3-20-20)T
- i. The address of the Division of Occupational and Professional Licenses and the procedure for filing

complaints against anyone licensed to dispense hearing aids.

(3-20-20)T

ii. A nonwaivable statement that the contract is null and void and unenforceable if the hearing aid being purchased is not delivered to the consumer within thirty (30) days of the date the written contract is signed, and that in the event the hearing aid is not delivered to the consumer within thirty (30) days of the date the written contract is signed, the licensee shall promptly refund any and all moneys paid for the purchase of the hearing aid.

(3-20-20)T

**02. Cancellation and Refund.** The written contract must grant the consumer a nonwaivable thirty (30) day right to cancel the purchase and obtain a refund. The thirty (30) day right to cancel commences from either the date the contract is signed or the hearing aid is originally delivered to the consumer, whichever is later. The thirty (30) day period is tolled for any period in which the licensee has taken possession or control of the hearing aid after its original delivery.

(3-20-20)T

**03. Dealer Cancellation.** In the event that any licensee cancels, nullifies, or otherwise, of their own volition, refuses to honor any written contract, for any reason other than consumer cancellation as set forth in Subsection 500.02, that licensee must promptly refund any and all moneys paid for the purchase of the hearing aid, including any monies designated by the contract as nonrefundable in the event that the consumer had canceled the purchase.

(3-20-20)T

**601. -- 999. (RESERVED)**



**IDAPA 24 – DIVISION OF OCCUPATIONAL AND PROFESSIONAL LICENSES**

**24.24.01 – RULES OF THE GENETIC COUNSELORS LICENSING BOARD**

**DOCKET NO. 24-2401-2000F (FEE RULE)**

**NOTICE OF OMNIBUS RULEMAKING – ADOPTION OF TEMPORARY RULE**

**EFFECTIVE DATE:** The effective date of the temporary rules being adopted through this omnibus rulemaking is the adjournment date of the second regular session of the 65th Idaho State Legislature - March 20, 2020.

**AUTHORITY:** In compliance with Sections 67-5226, Idaho Code, notice is hereby given this agency has adopted a temporary rule. The action is authorized pursuant to Sections 54-5607, Idaho Code.

**DESCRIPTIVE SUMMARY:** The following is the required finding and concise statement of its supporting reasons for adopting a temporary rule:

This temporary rulemaking adopts the following chapter under IDAPA 24.24.01:

**IDAPA 24.24**

- 24.24.01, *Rules of the Genetic Counselors Licensing Board.*

**TEMPORARY RULE JUSTIFICATION:** Pursuant to Sections 67-5226(1) and 67-5226(2), Idaho Code, the Governor has found that temporary adoption of the rule is appropriate for the following reasons:

These temporary rules are necessary to protect the public health, safety, and welfare of the citizens of Idaho and confer a benefit on its citizens. These temporary rules implement the duly enacted laws of the state of Idaho, provide citizens with the detailed rules and standards for complying with those laws, and assist in the orderly execution and enforcement of those laws. The expiration of these rules without due consideration and processes would undermine the public health, safety, and welfare of the citizens of Idaho and deprive them of the benefit intended by these rules. These rules govern the qualifications, code of ethics, and standards of practice for genetic counselors. Allowing these rules to expire would harm the public health, safety, and welfare of those citizens who utilize genetic services.

**FEE SUMMARY:** Pursuant to Section 67-5226(2), the Governor has found that the fees or charges being imposed or increased are justified and necessary to avoid immediate danger and the fees are described herein:

The fees or charges, authorized in Section 54-5613, Idaho Code, are part of the agency’s 2021 budget that relies upon the existence of these fees or charges to meet the state’s obligations and provide necessary state services. Failing to reauthorize these temporary rules would create immediate danger to the state budget, immediate danger to necessary state functions and services, and immediate danger of a violation of Idaho’s constitutional requirement that it balance its budget.

The following is a specific description of the fees or charges:

<b>FEE TYPE</b>	<b>AMOUNT (Not to Exceed)</b>
Application	\$200
Original License	\$200
Annual Renewal	\$200
Provisional License	\$200
License by Endorsement	\$200
Examination	Determined by third-party examination administrator

<b>FEE TYPE</b>	<b>AMOUNT (Not to Exceed)</b>
Reinstatement	As provided in Section 67-2614, Idaho Code

**ASSISTANCE ON TECHNICAL QUESTIONS:** For assistance on technical questions concerning the temporary rule, contact Rob McQuade at (208) 334-3233.

DATED this February 21, 2020.

Kelley Packer  
Division Administrator  
Division of Occupational and Professional Licenses  
700 W. State Street  
P.O. Box 83720  
Boise, ID 83720  
Phone: (208) 334-3233  
Fax: (208) 334-3945

**24.24.01 – RULES OF THE GENETIC COUNSELORS LICENSING BOARD**

**000. LEGAL AUTHORITY.**

These rules are hereby prescribed and established pursuant to the authority vested in the Genetic Counselors Licensing Board by the provisions of Title 54, Chapter 56, Idaho Code. (3-20-20)T

**001. TITLE AND SCOPE.**

**01. Title.** The rules are titled IDAPA 24.24.01, “Rules of the Genetic Counselors Licensing Board.” (3-20-20)T

**02. Scope.** These rules implement the purposes and intent of Chapter 56, Title 54, Idaho Code, to regulate the profession of genetic counseling in the interest of the public health, safety, and welfare. (3-20-20)T

**002. INCORPORATION BY REFERENCE.**

The document titled “National Society of Genetic Counselors Code of Ethics,” adopted January 1992 and revised December 2004 and January 2006, is incorporated by reference into this rule and is available at the Board’s office and on the Board’s web site. (3-20-20)T

**005. -- 099. (RESERVED)**

**100. ORGANIZATION OF THE BOARD.**

At the first meeting of each fiscal year, the Board will elect from its members a Chairman, who will assume the duties of the office at the direction of the Board. (3-20-20)T

**101. -- 249. (RESERVED)**

**250. FEES.**

All fees are non-refundable except that, if a license fee is tendered but the Board does not issue a license, the respective license fee will be returned. Fees are established in accord with Section 54-5613, Idaho Code as follows:

<b>FEE TYPE</b>	<b>AMOUNT (Not to Exceed)</b>
Application	\$200
Original License	\$200
Annual Renewal	\$200
Provisional License	\$200
License by Endorsement	\$200
Examination	Determined by third-party examination administrator
Reinstatement	As provided in Section 67-2614, Idaho Code

(3-20-20)T

**251. -- 299. (RESERVED)**

**300. REQUIREMENTS FOR ORIGINAL LICENSURE.**

**01. General.** An applicant who in any state, territory or country has had a license revoked or suspended or has been otherwise disciplined by a Board, a government agency, or any other disciplinary body, or has been found guilty, convicted, received a withheld judgment or suspended sentence for a felony or a lesser crime conviction must submit with his application a written statement and any supplemental information establishing his current suitability for licensure. (3-20-20)T

**02. Consideration of Factors and Evidence.** The Board will consider the following factors or evidence: (3-20-20)T

**a.** The severity or nature of the crime or discipline; (3-20-20)T

**b.** The period of time that has passed since the crime or discipline under review; (3-20-20)T

- c. The number or pattern of crimes or discipline or other similar incidents; (3-20-20)T
- d. The circumstances surrounding the crime or discipline that would help determine the risk of repetition; (3-20-20)T
- e. The relationship of the crime or discipline to the practice of genetic counseling; (3-20-20)T
- f. The applicant's activities since the crime or discipline under review, such as employment, education, participation in treatment, payment of restitution, or any other factors which may be evidence of current rehabilitation; and (3-20-20)T
- g. Any other information regarding rehabilitation or mitigating circumstances. (3-20-20)T
- 03. Interview.** The Board may, at its discretion, grant an interview of the applicant. (3-20-20)T
- 04. Applicant Bears the Burden.** The applicant will bear the burden of establishing his current suitability for licensure. (3-20-20)T
- 05. Education.** An applicant must hold a master's degree or higher in genetics from an American Board of Genetic Counseling (ABGC), American Board of Medical Genetics (ABMG), Accreditation Council for Genetic Counseling (ACGC), or National Society of Genetic Counselors (NSGC) accredited program or master's degree or higher in a related field of study as approved by the Board. (3-20-20)T
- 06. Examination.** An applicant must pass an ABGC or ABMG administered genetic counselor certification exam. The passage of the exam may have occurred prior to the effective date of these rules. (3-20-20)T
- 07. Certification.** An applicant must provide proof of current certification from the ABGC or ABMG. (3-20-20)T

**301. -- 309. (RESERVED)**

**310. REQUIREMENTS FOR LICENSURE BY ENDORSEMENT.**

The Board may grant a license to an applicant for licensure by endorsement who meets the following requirements: (3-20-20)T

- 01. General.** Meets the requirements prescribed in Subsection 300.01 of these rules; and (3-20-20)T
- 02. Holds a Current License.** The applicant must be the holder of a current active license in the profession and at the level for which a license is being sought, issued by the authorized regulatory entity of another state, territory, or jurisdiction. The state, territory, or jurisdiction must have licensing requirements substantially equivalent to or higher than those required for new applicants in Idaho. The certification of licensure must be received by the Board from the issuing agency. (3-20-20)T

**311. REQUIREMENTS FOR PROVISIONAL LICENSE.**

The Board may issue a provisional license to allow a person who has been granted active candidate status to engage in the practice of genetic counseling. The holder of a provisional license may only practice under the general supervision of a person fully licensed under this chapter or a physician licensed in this state. (3-20-20)T

- 01. General.** Meets the requirements prescribed in Subsection 300.01 of these rules; and (3-20-20)T
- 02. Supervision.** While the provisional licensee is providing genetic counseling services, the licensee's supervisor need not be physically present; however, the supervisor must be readily accessible to the provisional licensee by telephone or by electronic means for consultation and assistance. (3-20-20)T

**312. INACTIVE STATUS.**

**01. Request for Inactive Status.** Licensees requesting an inactive status during the renewal of their active license must submit a written request and pay the established fee. (3-20-20)T

**02. Inactive License Status.** All continuing education requirements will be waived for any year or portion thereof that a licensee maintains an inactive license and is not actively practicing in Idaho. (3-20-20)T

**03. Reinstatement to Full Licensure from Inactive Status.** An inactive licensee may reinstate to active status by submitting a completed, board-approved application and paying the appropriate fee, provide proof of ABGC certification and one (1) year of continuing education immediately preceding application. (3-20-20)T

**313. -- 499. (RESERVED)**

**500. CONTINUING EDUCATION.**

All licensees must comply with the following continuing education requirements: (3-20-20)T

**01. Requirement.** Beginning with the second renewal of their license, a licensee will be required to complete a minimum of two (2) Continuing Education Units (CEUs) within the preceding twelve (12) months or one (1) CEU and one (1) Professional Activity Credit (PAC) within the preceding twelve (12) months. (3-20-20)T

**02. Documentation.** Each licensee will maintain documentation verifying continuing education course attendance and curriculum, or completion of the educational activity for a period of five (5) years from the date of completion. This documentation will be subject to audit by the Board. (3-20-20)T

**a.** Documented evidence of meeting the continuing education course requirement must be in the form of a certificate or letter from the sponsoring entity that includes verification of attendance by the licensee, the title of the activity, the subject material covered, the dates and number of hours credited, and the presenter's full name and professional credentials. Documented evidence of completing a continuing education activity must be in such form as to document both completion and date of the activity. (3-20-20)T

**b.** A licensee must submit the verification documentation to the Board, if requested by the Board. If a licensee fails to provide the Board with acceptable documentation of the hours attested to on the renewal application, the licensee may be subject to disciplinary action. (3-20-20)T

**03. Waiver.** The Board may for good cause waive the requirements of this rule. The licensee should request the waiver in advance of renewal and must provide any information requested by the Board to assist in substantiating hardship cases. This waiver is granted at the sole discretion of the Board. (3-20-20)T

**04. Carryover of Continuing Education Hours.** CEUs and PACs not claimed in the current renewal year may be claimed in the next renewal year. A maximum of two (2) CEUs or one (1) PAC and one (1) CEU may be carried forward from the immediately preceding year, and may not be carried forward more than one renewal year. (3-20-20)T

**501. -- 699. (RESERVED)**

**700. UNPROFESSIONAL AND UNETHICAL CONDUCT.**

Unprofessional and unethical conduct is conduct that does not conform to the guidelines for genetic counseling contained within the (NSGC) Code of Ethics, incorporated by reference into Section 004 of these rules and approved by the Board as the Idaho Code of Ethics. (3-20-20)T

**701. -- 899. (RESERVED)**

**900. DISCIPLINE.**

**01. Disciplinary Action.** If the Board determines that grounds for discipline exist for violations of Title 54, Chapter 56, Idaho Code, violations of these rules, or both, it may impose disciplinary sanctions against the licensee. (3-20-20)T

**901. -- 999. (RESERVED)**

**IDAPA 24 – DIVISION OF OCCUPATIONAL AND PROFESSIONAL LICENSES**

**24.25.01 – RULES OF THE IDAHO DRIVING BUSINESSES LICENSURE BOARD**

**DOCKET NO. 24-2501-2000F (FEE RULE)**

**NOTICE OF OMNIBUS RULEMAKING – ADOPTION OF TEMPORARY RULE**

**EFFECTIVE DATE:** The effective date of the temporary rules being adopted through this omnibus rulemaking is the adjournment date of the second regular session of the 65th Idaho State Legislature - March 20, 2020.

**AUTHORITY:** In compliance with Sections 67-5226, Idaho Code, notice is hereby given this agency has adopted a temporary rule. The action is authorized pursuant to Section 54-5403, Idaho Code.

**DESCRIPTIVE SUMMARY:** The following is the required finding and concise statement of its supporting reasons for adopting a temporary rule:

This temporary rulemaking adopts the following chapter under IDAPA 24.25.01:

**IDAPA 24.25**

*24.25.01, Rules of the Idaho Driving Businesses Licensure Board.*

**TEMPORARY RULE JUSTIFICATION:** Pursuant to Sections 67-5226(1) and 67-5226(2), Idaho Code, the Governor has found that temporary adoption of the rule is appropriate for the following reasons:

These temporary rules are necessary to protect the public health, safety, and welfare of the citizens of Idaho and confer a benefit on its citizens. These temporary rules implement the duly enacted laws of the state of Idaho, provide citizens with the detailed rules and standards for complying with those laws, and assist in the orderly execution and enforcement of those laws. The expiration of these rules without due consideration and processes would undermine the public health, safety, and welfare of the citizens of Idaho and deprive them of the benefit intended by these rules. These rules govern the credentials required to instruct Idaho’s student drivers and protect the public sharing the roadways with student drivers. Allowing these rules to expire would mean the dissolution of the curriculum standards for students in private driving schools, suspension of the standards driving instructors and driving businesses are required to maintain, and removal of an alternative form of driver’s education for Idaho students and their families.

**FEE SUMMARY:** Pursuant to Section 67-5226(2), the Governor has found that the fees or charges being imposed or increased are justified and necessary to avoid immediate danger and the fees are described herein:

The fees or charges, authorized in Section 54-5404, Idaho Code, are part of the agency’s 2021 budget that relies upon the existence of these fees or charges to meet the state’s obligations and provide necessary state services. Failing to reauthorize these temporary rules would create immediate danger to the state budget, immediate danger to necessary state functions and services, and immediate danger of a violation of Idaho’s constitutional requirement that it balance its budget.

The following is a specific description of the fees or charges:

<b>FEE TYPE</b>	<b>AMOUNT (Not to Exceed)</b>
Application	\$25
Original Instructor License and Annual Renewal	\$25
Instructor Apprentice Permit	\$25
Original Business License and Annual Renewal	\$125
Reinstatement	As provided in Section 67-2614, Idaho Code

**ASSISTANCE ON TECHNICAL QUESTIONS:** For assistance on technical questions concerning the temporary rule, contact Rob McQuade at (208) 334-3233.

DATED this February 21, 2020.

Kelley Packer  
Division Administrator  
Division of Occupational and Professional Licenses  
700 W. State Street  
P.O. Box 83720  
Boise, ID 83720  
Phone: (208) 334-3233  
Fax: (208) 334-3945

**24.25.01 – RULES OF THE IDAHO DRIVING BUSINESSES LICENSURE BOARD**

**000. LEGAL AUTHORITY.**

In accordance with Section 54-5403, Idaho Code, the Idaho Driving Businesses Licensure Board hereby promulgates rules that implement the provisions of Chapter 54, Title 54, Idaho Code. (3-20-20)T

**001. TITLE AND SCOPE.**

These rules are cited as IDAPA 24.25.01, “Rules of the Idaho Driving Businesses Licensure Board.” (3-20-20)T

**002. CHANGES IN LICENSEE INFORMATION.**

**01. Information Update.** Each licensee must keep the Division current on the information that the licensee has placed on record with the Division. If a change occurs to the information that a licensee provided to the Division under Rules 150, 225, or 250, the licensee must notify the Division in writing of the change within twenty (20) calendar days after the change occurs. The licensee must provide the Division, upon request, with appropriate documentation reflecting the change. (3-20-20)T

**02. Address for Notification Purposes.** The most recent mailing address on file with the Division will be used for purposes of all written communication with a licensee including, but not limited to, notification of renewal and notices related to disciplinary actions. Each licensee must keep the Division informed of the licensee’s current mailing address. (3-20-20)T

**003. -- 099. (RESERVED)**

**100. ORGANIZATION.**

**01. Meetings.** The Board meets at least annually at such times and places as designated by the Chairman, or upon the written request of two (2) members of the Board. (3-20-20)T

**a.** All meetings are held in accordance with the Idaho Open Meeting Law, Chapter 23, Title 67, Idaho Code. (3-20-20)T

**b.** A minimum of three (3) Board members constitutes a quorum and may exercise all powers and authority conferred on the Board in order to hold a meeting of the Board. A majority vote of the Board members present at a meeting is considered the action of the Board as a whole. (3-20-20)T

**02. Organization of the Board.** At the first meeting of each fiscal year, the Board elects from its members a Chairman, who assumes the duty of the office immediately upon such selection. (3-20-20)T

**101. -- 149. (RESERVED)**

**150. APPLICATION.**

Each applicant for a license, permit, or other authority from the Board must submit a complete application on Board-approved application forms. The application must be accompanied by required fee(s). Applications received less than seven (7) days prior to a Board meeting may be held over to the next meeting. The Board also will not review incomplete applications, including applications submitted without the required fee(s). Further, an applicant must provide, or facilitate the provision of, any supplemental information or documents requested by the Board. Any application on file with the Board where an applicant has failed to respond to a Board request or where the application has lacked activity for twelve (12) consecutive months will be deemed denied and will be terminated upon thirty (30) days written notice to the applicant unless good cause is established to the Board. (3-20-20)T

**151. -- 174. (RESERVED)**

**175. FEES.**

All fees are non-refundable.

<b>FEE TYPE</b>	<b>AMOUNT (Not to Exceed)</b>
Application	\$25
Original Instructor License and Annual Renewal	\$25



FEE TYPE	AMOUNT (Not to Exceed)
Instructor Apprentice Permit	\$25
Original Business License and Annual Renewal	\$125
Reinstatement	As provided in Section 67-2614, Idaho Code

(3-20-20)T

**176. -- 199. (RESERVED)**

**200. RENEWAL OF LICENSE.**

**01. Application for Renewal.** In order to renew a license, a licensee must annually submit a timely, completed, Board-approved renewal application form and pay the required renewal fees. All renewals are subject to audit. When applying for renewal, the licensee must meet the following requirements: (3-20-20)T

**a.** The licensee must certify that the licensee continues to satisfy all requirements for the licensee’s type of licensure, as set forth in Rules 225 and 250, and that the licensee is, and has been, in full compliance with Rule 007. The licensee must further certify that the licensee is in compliance with the Board’s continuing education requirements. (3-20-20)T

**b.** An instructor licensee also must certify that the licensee does not suffer from any physical or mental condition or disease that would impair the licensee’s ability to safely instruct drivers. (3-20-20)T

**c.** Every two (2) years, a driving instructor licensee must obtain a new medical certificate of the kind described in Subsection 250.05. The instructor licensee must annually certify that the licensee is in compliance with the requirements. (3-20-20)T

**d.** A business licensee that offers a Board-approved instructor apprentice training program must certify that the licensee’s program has maintained compliance with the Board’s program approval criteria as specified in Rule 275. (3-20-20)T

**02. Reinstatement.** Any license cancelled for failure to renew may be reinstated in accordance with Section 67-2614, Idaho Code, and subject to Subsection 201.01.c., below. (3-20-20)T

**201. CONTINUING EDUCATION.**

In order to protect the public health and safety and promote the public welfare, the Board has adopted the following rules for continuing education. (3-20-20)T

**01. Continuing Education (CE) Requirement.** Each Idaho licensed driving instructor must annually complete a minimum of eight (8) hours of continuing education. (3-20-20)T

**a.** The licensee must certify on the licensee’s renewal application that the licensee has complied with the annual CE requirements for the preceding twelve (12) months. The Board may conduct such continuing education audits and require verification of attendance as deemed necessary to ensure compliance with the CE requirements. (3-20-20)T

**b.** A licensee is considered to have satisfied the CE requirements for the first renewal of the initial license. (3-20-20)T

**c.** Prior to reinstatement of a license lapsed, canceled, or otherwise non-renewed for less than five (5) years, the applicant must provide proof of attendance of eight (8) hours of continuing education for the previous twelve (12) months. A license that has lapsed, been canceled, or otherwise not renewed for more than five (5) years may be reinstated in accordance with Section 67-2614, Idaho Code. (3-20-20)T

**02. Hours.** Credit for continuing education hours will only be given for actual time in attendance or for the time spent participating in the educational activity. One (1) hour of continuing education is equal to sixty (60) minutes. Courses taken by correspondence or on-line may be approved for continuing education if the courses require an exam or other proof of successful completion. Only four (4) hours of the required continuing education may be from correspondence, on-line, or self-study in each renewal period. The remaining hours must be in an interactive setting that allows participants to communicate directly with the instructor. Each licensee must maintain proof of attendance or successful completion documentation of all continuing education courses for a period of three (3) years. (3-20-20)T

**03. Providers/Sponsors/Subjects of Continuing Education.** The continuing education must be provided by a nationally or regionally accredited college or university, a national or state driver education and traffic safety association such as the Idaho Association of Professional Driving Businesses, Driving School Association of the Americas, the American Driver Traffic Safety Education Association, and the American Automobile Association, transportation and law enforcement agencies, or other person or entity approved by the Board and must be germane to driver education. (3-20-20)T

**04. Verification of Attendance.** Each licensee must maintain verification of attendance by securing authorized signatures or other documentation from the course instructors or sponsoring institution substantiating any and all hours attended by the licensee. (3-20-20)T

**05. Failure to Fulfill the Continuing Education Requirements.** The license will not be renewed for a licensee who fails to certify compliance with CE requirements. A licensee who makes a false attestation regarding compliance with the CE requirements is subject to disciplinary action by the Board. (3-20-20)T

**06. Special Exemption.** The Board has authority to make exceptions for reasons of individual hardship, including health, when certified by a medical doctor, or other good cause. Each licensee must provide any information requested by the Board to assist in substantiating hardship cases. This exemption is granted at the sole discretion of the Board. (3-20-20)T

**07. Carryover of Continuing Education Hours.** Continuing education hours not claimed in the current renewal year may be claimed in the next renewal year. A maximum of eight (8) hours may be carried forward from the immediately preceding year, and may not be carried forward more than one (1) renewal year. (3-20-20)T

**202 -- 224. (RESERVED)**

**225. DRIVING BUSINESS LICENSE.**

A driving business license enables a licensee to operate a driver education business at one (1), principal classroom location as designated in the application. The licensee may also utilize secondary locations for classroom instruction, so long as the business does not conduct driver education at any given secondary location for more than sixty (60) days in a one-year period. A driving business license is not transferable. The business licensee must conspicuously display the license at the business's principal classroom location. Each applicant must apply as required by Rule 150. (3-20-20)T

**01. Applicant Identity.** The applicant must provide such identifying information as may be requested by the Board including, without limitation, the following: (3-20-20)T

**a.** The applicant's legal name (i.e., the name of the natural person or business entity to be issued the license) and assumed business name(s), if any. (3-20-20)T

**b.** The applicant's social security number, if the applicant has no employees and is a natural person (including a sole proprietor acting under an assumed business name). If the applicant has employees or is not a natural person (e.g., is a general or limited partnership, corporation, limited liability partnership, or limited liability company), then the applicant must provide its employer identification number. (3-20-20)T

**c.** The names and addresses of the applicant's officers and shareholders having a twenty-five percent (25%) or greater ownership interest (if a corporation), members and managers (if a limited liability company), and

partners (if a partnership). (3-20-20)T

d. The applicant's contact information, including its mailing address, physical address, and telephone number. (3-20-20)T

**02. Criminal History Background Check.** The applicant, if a natural person, and all persons listed under Paragraph 225.01.c. and Subsection 225.05 of these rules, must submit to a current, fingerprint-based criminal history check conducted by an organization approved by the Board. Each applicant must ensure that such persons submit a full set of their fingerprints, and any relevant fees, to the Division which will forward the fingerprints and fees to the organization that conducts the fingerprint based criminal history background check. The application will not be processed until the Division has received the completed fingerprint-based criminal history background checks. (3-20-20)T

**03. Classroom Locations and Certificates of Occupancy.** Each applicant must list all principal and secondary classroom locations to be utilized by the business. The applicant must provide a certificate of occupancy issued to the building/room by the local fire marshal or the fire marshal's designated agent, for each classroom location other than a location in a public or private school building, government building, church, or synagogue. (3-20-20)T

**04. Certificate of Vehicle Insurance.** The certificate of vehicle insurance for each vehicle utilized by the driving business for driver education must accompany the application. The minimum coverage will include: (3-20-20)T

a. Medical Payment for each person - five thousand dollars (\$5,000); and either (3-20-20)T

b. Limit of liability (Combined single limit) - five hundred thousand (\$500,000) to apply to bodily injury and/or property damage; or (3-20-20)T

c. Limit of liability (Split limit). Bodily injury - two hundred-fifty thousand (\$250,000) per person/ five hundred thousand (\$500,000) each accident; Property damage - two hundred-fifty thousand (\$250,000) each accident. (3-20-20)T

**05. Licensed Instructors.** Before beginning to offer driver education, and at all times while offering driver education, a driving business must employ or have contracted with one (1) or more licensed driving instructors to teach the classroom instruction phase and behind-the-wheel training phase of the driver education to be provided by the business. A driving business must submit to the Division a current list of such licensed instructors with applications for original licensure and reinstatement. A driving business must keep such list current and available for inspection upon request by the board or its authorized agent. The list must be kept at its primary place of business and retained for five (5) years. (3-20-20)T

**06. Vehicles.** An applicant for a driving business license must submit to the Division a list of the vehicles that the business will utilize when offering driver education. A business licensee may not utilize vehicles that do not appear on the list. Each vehicle must have dual control brake pedals, safety restraints for all passengers, a side view mirror on each side of the vehicle, and an additional rear view mirror or compatible viewing device for the exclusive use of the instructor. A driving business must ensure that students are not allowed in a listed vehicle unless the vehicle is in a safe and proper operating condition. (3-20-20)T

a. Initial Inspection. An applicant may not include a vehicle on a business's vehicle list unless the vehicle has passed a vehicle inspection performed by an ASE mechanic or vehicle technician within the two (2) month period preceding the application. The inspection must be documented on the Board-approved inspection form included at Appendix A to these rules, or on such other similar forms as may be approved by the Board. The person who inspected the vehicle must sign the form, certifying that the vehicle generally is in a safe and proper operating condition, and that each inspected item passed inspection or, if found to be in need of repair, was repaired on a given date. The application must be accompanied by a separate, signed form for each listed vehicle. (3-20-20)T

b. Annual Inspection. A business licensee must ensure that each vehicle passes an inspection every twelve (12) months, and that the inspection is performed by an ASE mechanic or vehicle technician documented on

the Board-approved form referenced in Paragraph 225.06.a. of these rules. If a vehicle fails an annual inspection, the business licensee must withdraw the vehicle from service. The business licensee may not use the vehicle for behind-the-wheel training until the vehicle passes a subsequent inspection and the business licensee has submitted to the Division the inspection form evidencing that the vehicle has passed. (3-20-20)T

**c.** Incident Inspection. If a vehicle incident occurs that requires an investigation and report by law enforcement, or in which the damage exceeds one thousand five hundred dollars (\$1,500), the business licensee must withdraw the vehicle from service. The business licensee may not use the vehicle for behind-the-wheel training until the vehicle passes inspection by an ASE mechanic or vehicle technician and the business licensee has submitted to the Division the inspection form evidencing that the vehicle has passed. (3-20-20)T

**d.** Signage. The business licensee must ensure that the outside of each vehicle is equipped with safely secured signs. Signs must include “Student Driver,” “Driver Education,” “Driver Training,” “Driving School,” or similar language that clearly designates the vehicle as a driver training vehicle. (3-20-20)T

**07. Course of Instruction.** Each applicant, for an original business license, must provide with its application the course of instruction the applicant will use when instructing students. The applicant must demonstrate, to the Board’s satisfaction, that the course of instruction is designed to produce safe and effective drivers and is educationally sound. The course of instruction must be based on the minimum curriculum components outlined in Rule 226, and consists of: (3-20-20)T

**a.** Not less than thirty (30) hours of classroom instruction; and (3-20-20)T

**b.** Not less than six (6) hours of behind-the-wheel practice driving; and (3-20-20)T

**c.** Not less than six (6) hours of student, in-vehicle observation of other persons (e.g., parents, other student drivers, etc.) driving the vehicle. (3-20-20)T

**08. On-line Instruction.** In addition to, or in lieu of offering classroom instruction at a physical classroom location, a business licensee may offer classroom instruction to students via the internet. While a business licensee may utilize a third party to offer on-line classroom instruction, the business licensee is responsible for ensuring that the instruction content meets the requirements of these rules and is approved by the Board. (3-20-20)T

**09. Instructor Apprenticeship Training Program.** A driving business may offer a Board-approved instructor apprenticeship training program under the conditions specified in Rule 275. (3-20-20)T

**226. DRIVING BUSINESS -- MINIMUM CURRICULUM COMPONENTS.**

In order to assure consistency among driving businesses, it is necessary that every business licensee ensure that its driver education curriculum include the following minimum curriculum components: (3-20-20)T

**01. Component One for Classroom.** (3-20-20)T

**a.** Conducting a parent/student orientation and course overview. (3-20-20)T

**02. Component Two for Classroom.** (3-20-20)T

**a.** Identifying vehicle gauges, alert, and warning symbols. (3-20-20)T

**b.** Preparing to drive. (3-20-20)T

**c.** Protecting occupants. (3-20-20)T

**03. Component Three for Classroom.** (3-20-20)T

**a.** Identifying road signs and signals. (3-20-20)T

**b.** Identifying lane markings. (3-20-20)T

- 04. Component Four for Classroom.** (3-20-20)T
  - a. Understanding basic traffic laws, including right-of-way rules. (3-20-20)T
- 05. Component Five for Classroom.** (3-20-20)T
  - a. Using good habits for reduced risk driving. (3-20-20)T
  - b. Using time and space management systems and strategies. (3-20-20)T
- 06. Component Six for Classroom.** (3-20-20)T
  - a. Explaining the effect of gravity and energy of motion on a vehicle. (3-20-20)T
  - b. Understanding procedures to maintain vehicle balance and traction. (3-20-20)T
  - c. Identify strategies to negotiate hills and curves. (3-20-20)T
- 07. Component Seven for Classroom.** (3-20-20)T
  - a. Identifying strategies to use when driving in rural and urban environments. (3-20-20)T
  - b. Identifying strategies to use when driving on freeways. (3-20-20)T
- 08. Component Eight for Classroom.** (3-20-20)T
  - a. Identifying strategies to use when driving in bad weather. (3-20-20)T
  - b. Identifying strategies to use when encountering roadside emergencies. (3-20-20)T
- 09. Component Nine for Classroom.** (3-20-20)T
  - a. Understanding ways to cooperate with other roadway users, including bicyclists. (3-20-20)T
  - b. Identifying responsibilities after a collision. (3-20-20)T
  - c. Identifying the procedure for obtaining a driver’s license. (3-20-20)T
  - d. Identifying and avoiding common driver distractions. (3-20-20)T
  - e. Identifying ways to prevent drowsiness while driving. (3-20-20)T
  - f. Resisting aggressive driving behaviors. (3-20-20)T
- 10. Component Ten for Classroom.** (3-20-20)T
  - a. Explaining the effects of alcohol on the body. (3-20-20)T
  - b. Explaining the effects of alcohol on the driving task. (3-20-20)T
  - c. Correlating drinking and driving with vehicle crashes. (3-20-20)T
  - d. Identifying Idaho laws related to drinking and driving. (3-20-20)T
  - e. Explaining the dangers of alcohol and other drug use. (3-20-20)T

- 11. **Component Eleven for In-Car.** (3-20-20)T
    - a. Performing pre-drive procedure. (3-20-20)T
    - b. Identifying vehicle controls. (3-20-20)T
    - c. Starting the vehicle. (3-20-20)T
    - d. Backing the vehicle. (3-20-20)T
    - e. Demonstrating approved steering technique. (3-20-20)T
    - f. Smoothly stopping the vehicle. (3-20-20)T
    - g. Demonstrating proper signaling and turning technique. (3-20-20)T
    - h. Recognizing relevant signs and markings. (3-20-20)T
    - i. Distinguishing between four-way and two-way stops. (3-20-20)T
  - 12. **Component Twelve for In-Car.** (3-20-20)T
    - a. Negotiating controlled and uncontrolled intersections. (3-20-20)T
    - b. Negotiating hills and curves. (3-20-20)T
    - c. Angle parking in a parking lot. (3-20-20)T
    - d. Driving in rural environment. (3-20-20)T
    - e. Making lane changes. (3-20-20)T
  - 13. **Component Thirteen for In-Car.** (3-20-20)T
    - a. Driving in an urban environment (with one-way and two-way streets, if available). (3-20-20)T
    - b. Dealing with signal lights, pedestrians, and city traffic. (3-20-20)T
    - c. Performing a perpendicular park. (3-20-20)T
    - d. Merging onto the freeway. (3-20-20)T
    - e. Driving on the freeway. (3-20-20)T
    - f. Exiting the freeway and merging with traffic on surface streets. (3-20-20)T
  - 14. **Component Fourteen for In-Car.** (3-20-20)T
    - a. Performing a parallel park/street park. (3-20-20)T
    - b. Performing turnabouts. (3-20-20)T
    - c. Passing another vehicle. (3-20-20)T
    - d. Driving independently with the instructor. (3-20-20)T
227. **DRIVING BUSINESS - COURSE OF INSTRUCTION.**

**01. Student Permit Required.** No enrollee of any class D driver's training course will be allowed to attend classes or participate in driving instruction unless he has obtained a class D driver's training instruction permit, or a class D instruction permit, as provided in Section 49-307(4), Idaho Code. (3-20-20)T

**02. In-Car Documentation.** A business licensee must ensure that each listed vehicle contains documentation that identifies each student and the student's permit number. Permits will be given to the students following the completion of the course and used during the required graduate licensing process. (3-20-20)T

**03. Maximum Daily Driving and Observation Time.** Neither a business licensee nor an instructor licensee may permit an enrolled student to receive more than two (2) hours of behind-the-wheel driving time per day. Maximum observation time is two (2) hours per student, per day, and may be completed with a parent or legal guardian. (3-20-20)T

**04. Maximum Number of Students In Vehicle.** Neither a business licensee nor an instructor licensee may permit more than three (3) students in a vehicle at one (1) time. (3-20-20)T

**05. Grading Criteria.** A business licensee may not permit a student to graduate from the business's driver education program unless the student has achieved an eighty percent (80%) or higher in each of the three (3) course areas described in Subsection 225.07. The business licensee must utilize written grading criteria for each of the minimum components in Rule 226. Criteria may include student attitude and such other criteria as the driving business may deem appropriate. The business licensee must maintain records of the student's grades. (3-20-20)T

**06. Driving Log.** Each driving instructor must complete a log for each student's behind-the-wheel driving and each driving business licensee must ensure that its driving instructors complete the log. The log must include, for each student, at least the student's name, birthdate, phone number, driving permit number, class date, instructor's name, lesson objective, total instruction time, total observation time, final grade, and date the student passed. (3-20-20)T

**07. Reporting.** A business licensee will send student performance information as prescribed by the Idaho Division of Motor Vehicles (DMV) to the DMV no later than five (5) p.m. on the third business day following completion of the course. (3-20-20)T

**08. Parental Involvement.** Each business licensee should encourage parental involvement in the education of the student. (3-20-20)T

**09. Record Retention.** The business licensee must maintain all logs and other records required under Rule 227 for at least three (3) years from date on which the student completes, or is no longer enrolled in, the business's driver education course. The business licensee may not release these records without written consent from the student and the student's parent or legal guardian. The Board and its agents, however, may inspect these records at any time. (3-20-20)T

**228. DRIVING BUSINESS - INITIAL AUDIT.**

After July 1, 2009, all new driving business licensees issued licenses will automatically be audited for compliance with the Board's laws and rules following their first renewal. (3-20-20)T

**229. -- 249. (RESERVED)**

**250. DRIVING INSTRUCTOR LICENSE.**

**01. Application.** Each applicant for a driving instructor license must apply as required by Rule 150. Each applicant is required to provide his name, date of birth, and contact information, including mailing address and telephone number, on the Board-approved application form. (3-20-20)T

**02. Age.** An applicant for a driving instructor license must be at least twenty-one (21) years old. (3-20-20)T

**03. Driving Record and Drivers License.** Each applicant must submit a copy of a valid driver's license in good standing and a copy of a satisfactory driving record. An unsatisfactory record includes, but is not limited to, two (2) moving violations in the past twelve (12) months, or suspension or revocation of a driver's license in the last thirty-six (36) months, or a conviction involving alcohol or controlled substances within the last thirty-six (36) months. (3-20-20)T

**04. Criminal History Background Check.** Each applicant must submit to a current, fingerprint-based criminal history check conducted by an organization approved by the Board. Each applicant must submit a full set of the applicant's fingerprints, and any relevant fees, to the Division which will forward the fingerprints and fees to the organization that conducts the fingerprint based criminal history background check. The application will not be processed until the completed fingerprint-based criminal history background check has been received. (3-20-20)T

**05. Medical Certificate.** A driving instructor licensee may not provide in-vehicle instruction to students if the instructor suffers from a medical condition that may impair the instructor's ability to safely instruct student drivers. Accordingly, each applicant for an instructor's license must obtain a medical examination performed by a licensed medical professional. The examination must be completed within two (2) years preceding the application. The applicant must submit a medical examiner's certificate, issued and signed by a licensed, qualified medical professional documenting that the examination occurred and that the applicant does not suffer from any physical or mental condition or disease that would impair the applicant's ability to safely instruct student drivers. If a medical condition exists, the applicant must re-certify as the medical professional requires and submit that information to the Board. (3-20-20)T

**06. Education.** Each applicant must submit written evidence, satisfactory to the Board, of having graduated from a high school or a regionally or nationally accredited college or university, or of having obtained a GED. (3-20-20)T

**07. Instructor Apprenticeship Training Program.** Applicants for licensure must demonstrate to the Board's satisfaction that they have successfully completed all required classroom instruction and behind-the-wheel training hours from a Board-approved instructor apprenticeship training program or have met the requirements for a waiver of the apprenticeship training program as set forth in these rules. The applicant must have undertaken and completed the apprenticeship training program within the five (5) year period immediately preceding the application. (3-20-20)T

**a.** Proof of successful completion must include written certificate from a Board-approved apprenticeship training program certifying that the applicant has satisfactorily completed the program. An applicant need not have completed all required classroom instruction and behind-the-wheel training hours through a single program so long as the last program attended by the applicant ensures itself, and its business licensee certifies to the Board that the applicant has satisfactorily completed all required hours through Board-approved apprenticeship training programs. (3-20-20)T

**b.** A person may not enroll in an apprenticeship training program unless the person has applied for, paid for, and obtained an apprenticeship permit from the Board. The applicant must apply on Board-approved forms, which must identify the applicant and the business licensee in whose approved apprenticeship training program the applicant will be enrolled. The individual applicant must establish that they are at least twenty-one (21) years old, hold a valid driver's license and a satisfactory driver license record, have passed a fingerprint based criminal history background check, and have obtained a medical certificate consistent with the requirements of Subsections 250.02 through 250.05. An apprenticeship permit automatically expires one (1) year after issuance. The Board also may suspend or revoke an apprenticeship permit, and refuse to issue another permit, if the permittee engages in any act or omission that would subject the permittee to discipline if the permittee had an instructor's license. No one may be a permittee for more than three (3) years. (3-20-20)T

**08. Waiver of Instructor Apprenticeship Training Program.** An applicant is entitled to a waiver of the apprenticeship training program if they possess the requisite training and experience as set forth below. (3-20-20)T

**a.** An applicant who holds a current active unrestricted equivalent driving instructor license from another state qualifies for a waiver of the apprenticeship training program requirement. The applicant is responsible



to provide proof to the Board that they hold a current unrestricted driving instructor license from another state, and that said license is equivalent to an Idaho driver instructor license in its qualifications and scope of practice; or  
(3-20-20)T

**b.** An applicant who has held within the past five (5) years an active and unrestricted public driver education instructor license issued by the Idaho State Department of Education and has completed eight (8) hours of continuing education within the prior year or an individual who has completed the Idaho State Department of Education driving instructor program within the past five (5) years and has completed eight (8) hours of continuing education within the prior year qualifies for a waiver of the apprenticeship training program requirement. The applicant is responsible to provide proof to the Board that they meet the requirements herein. (3-20-20)T

**251. -- 274. (RESERVED)**

**275. INSTRUCTOR APPRENTICESHIP TRAINING PROGRAM.**

**01. Application for Approval.** A business licensee may operate a Board-approved instructor apprenticeship training program. The business licensee must apply for program approval on forms provided by the Board, and submit with the application such documentation as the Board may require to enable the Board to assess whether the proposed program meets the Board's approval criteria, as specified in Subsections 275.03 through 275.08 of these rules. (3-20-20)T

**02. Suspension or Revocation of Approval and Discipline.** If an approved program fails to consistently adhere to the approval criteria in Subsections 275.03 through 275.08 of these rules, the Board may suspend or revoke the approval. Further, if a business licensee that operates an approved program fails to cooperate with the Board in any inspection or audit of the program, the licensee may be disciplined. (3-20-20)T

**03. Apprentices.** The business licensee must ensure that all persons who enroll in the licensee's program possess a valid instructor apprenticeship training permit from the Board. (3-20-20)T

**04. Instruction and Training Hours.** The Board must be satisfied that the program has designed its proposed instruction and training to produce safe and effective driving instructors. The business licensee must ensure that the program includes at least the following instruction and training components: (3-20-20)T

**a.** Each apprentice must receive at least sixty (60) hours of classroom instruction covering the curriculum components for student classroom instruction specified in Subsections 226.01 through 226.10 of these rules. These hours may also be completed through on-line or internet based instruction. (3-20-20)T

**b.** Each apprentice must receive at least one hundred eight (108) hours of behind-the-wheel-training covering the curriculum components for student in-car instruction specified in Subsections 226.11 through 226.14 of these rules. When an apprentice begins to provide behind-the-wheel driving instruction to students, a program instructor must supervise the apprentice by riding in the vehicle with the apprentice and students for the first six (6) hours. A program instructor also must ride in the vehicle with the apprentice and students to evaluate the apprentice during the final two (2) hours of the apprentice's behind-the-wheel training. (3-20-20)T

**05. Instructors.** The business licensee must ensure that only licensed driving instructors are allowed to teach in the program. A list of the instructors must accompany the application for approval. (3-20-20)T

**06. Recordkeeping.** The business licensee must ensure that the program maintains progress records for each apprentice. A program instructor and the apprentice must sign and date the records each month, and copies of the records must be provided to the apprentice. The records must, at a minimum, identify each lesson completed, the number of hours of instruction involved in the lesson, the date the apprentice completed the lesson, the instructor who taught the lesson, and whether the apprentice passed. When an apprentice's course of instruction has been completed or terminated, the program business licensee must maintain the records of the apprentice's progress, and the total hours recorded and maintained by the program for a period of five (5) years from completion or termination date. These records are subject to inspection by the Board at any time. (3-20-20)T

**07. Certificate of Proficiency.** The program must provide each apprentice with a certificate of

proficiency evidencing all hours satisfactorily completed by the apprentice while in the program, and that the apprentice is proficient in all areas covered by the certificate. (3-20-20)T

**08. Discontinuance of Program.** If the business licensee ceases to operate the program, the business licensee must provide the program's current and prior apprentices with any progress or other records that the program is required to maintain under this Section. (3-20-20)T

**276. -- 449. (RESERVED)**

**450. DISCIPLINE.**

**01. Grounds for Discipline.** In addition to the grounds for discipline listed in Section 54-5408, Idaho Code, grounds for discipline also include: (3-20-20)T

**a.** Failure to cooperate with an inspection or audit conducted by the Board or its agents including, without limitation, any continuing education audit, as specified in Section 54-5403(6), Idaho Code. Failure to cooperate includes, without limitation, failure to provide documentation requested by the Board or its agents during an inspection or audit of the licensee's compliance with Board laws or rules. (3-20-20)T

**b.** Violating any of the following standards of conduct that have been adopted by the Board: (3-20-20)T

**i.** A licensee must not use fraud or deception in procuring or renewing, or in attempting to procure or renew, a license, permit, or other authorization issued by the Board. (3-20-20)T

**ii.** A licensee must not aid, abet, or assist any person or entity in conduct for which a license or permit is required under Idaho Driving Businesses Act, unless the person or entity has the required license or permit. (3-20-20)T

**iii.** A licensee must comply with final orders of the Board issued in contested cases to which the licensee is a party. (3-20-20)T

**02. Disciplinary Sanctions.** If the Board determines that grounds for discipline exist, it may impose disciplinary sanctions against the licensee including, without limitation, any or all of the following: (3-20-20)T

**a.** Revoke or suspend the licensee's license(s); (3-20-20)T

**b.** Restrict or limit the licensee's practice; (3-20-20)T

**c.** Require the licensee to pay an administrative fine not to exceed one thousand dollars (\$1000) for each violation identified in the Board's order. (3-20-20)T

**d.** Require the licensee to pay all or part of the costs and fees incurred by the Board in the investigation and prosecution of the licensee, including without limitation, all costs and fees incurred by the Board in proceedings upon which the order was entered. (3-20-20)T

**451. -- 999. (RESERVED)**

**APPENDIX “A”**

<b>IDAHO DRIVING BUSINESSES LICENSURE BOARD VEHICLE INSPECTION REPORT</b>											
					DATE						
BUSINESS OWNER/OPERATOR AND BUSINESS NAME					INSPECTORS NAME (PRINT OR TYPE)						
ADDRESS											
CITY, STATE, ZIP CODE					VEHICLE IDENTIFICATION (LIC. PLATE NO. & VIN)						
VEHICLE TYPE (YEAR, MAKE and MODEL)					ODOMETER READING						
<b>VEHICLE COMPONENTS INSPECTED</b>											
OK	Needs Repair	Repaired Date	Item	OK	Needs Repair	Repaired Date	Item	OK	Needs Repair	Repaired Date	Comments
			<b>1. BRAKES SYSTEM</b>				<b>7. LIGHTING DEVICES</b>				List any other condition which may prevent safe operation of this vehicle and whether or not the repair has been made.
			a. service brakes				a. headlights high and low beam				
			b. parking brake system				b. brake lights				
			c. brake drums/rotors/pads				c. taillights				
			d. brake hoses				d. turn signals				
			e. brake tubing				e. parking lights				
			f. low pressure warning device				f. other				
			g. hydraulic brakes				<b>8. SUSPENSION</b>				
			h. vacuum system				a. Any damaged or loose U-bolt(s), spring hangers or other part(s) that may cause axle to shift				
			i. dual control brake with stopping distance 20mph				b. spring assembly				
			<b>2. EXHAUST SYSTEM</b>				c. torque, radius or tracking components				
			a. any exhaust system determined to be leaking				d. wheel alignment				
			b. emission control				<b>9. ELECTRICAL SYSTEM</b>				
			<b>3. FUEL SYSTEM</b>				a. horn				
			a. visible leak				b. switches				
			b. fuel tank cap missing				c. wiring				
			<b>4. STEERING MECHANISM</b>				d. starting system				
			a. steering wheel free play				<b>10. VISIBILITY</b>				
			b. steering column				a. dual side view mirrors				
			c. front axle beam and all steering components other than steering column				b. rearview mirror				
			d. steering gear box				c. inside instructor mirror				
			e. pitman arm				d. windshield wipers				
			f. power steering				c. defroster				
			g. ball and socket joints				<b>11. INTERIOR</b>				
			h. tie rods and drag links				a. seatbelts for all occupants				
			i. nuts				b. airbag readiness light				
			j. steering system								
			<b>5. TIRES</b>								
			tire condition and wear								
			<b>6. WINDSHIELD GLAZE</b>								
			cracks, discoloration or lack of clarity								
<b>Mechanic Verification</b>											
I verify I have inspected this vehicle and completed this form. I certify that the vehicle appears to be in a safe and proper operating condition, and that each inspected item passed inspection, or if found to be in need of repair, was repaired on the date indicated.											
_____				_____				_____			
Print Name				ASE ID #				Signature			

# IDAPA 24 – DIVISION OF OCCUPATIONAL AND PROFESSIONAL LICENSES

## 24.26.01 – RULES OF THE IDAHO BOARD OF MIDWIFERY

### DOCKET NO. 24-2601-2000F (FEE RULE)

#### NOTICE OF OMNIBUS RULEMAKING – ADOPTION OF TEMPORARY RULE

**EFFECTIVE DATE:** The effective date of the temporary rules being adopted through this omnibus rulemaking is the adjournment date of the second regular session of the 65th Idaho State Legislature - March 20, 2020.

**AUTHORITY:** In compliance with Sections 67-5226, Idaho Code, notice is hereby given this agency has adopted a temporary rule. The action is authorized pursuant to Sections 54-5504, Idaho Code.

**DESCRIPTIVE SUMMARY:** The following is the required finding and concise statement of its supporting reasons for adopting a temporary rule:

This temporary rulemaking adopts the following chapter under IDAPA 24.26.01:

**IDAPA 24.26**

- 24.26.01, *Rules of the Idaho Board of Midwifery.*

**TEMPORARY RULE JUSTIFICATION:** Pursuant to Sections 67-5226(1) and 67-5226(2), Idaho Code, the Governor has found that temporary adoption of the rule is appropriate for the following reasons:

These temporary rules are necessary to protect the public health, safety, and welfare of the citizens of Idaho and confer a benefit on its citizens. These temporary rules implement the duly enacted laws of the state of Idaho, provide citizens with the detailed rules and standards for complying with those laws, and assist in the orderly execution and enforcement of those laws. The expiration of these rules without due consideration and processes would undermine the public health, safety, and welfare of the citizens of Idaho and deprive them of the benefit intended by these rules. These rules govern the qualifications, formulary, and certain standards of practice of midwives in Idaho. Allowing these rules to expire would harm licensees and would impose a barrier to care, harming the public health, safety, and welfare of the citizens of Idaho.

**FEE SUMMARY:** Pursuant to Section 67-5226(2), the Governor has found that the fees or charges being imposed or increased are justified and necessary to avoid immediate danger and the fees are described herein:

The fees or charges, authorized in Section 54-5509, Idaho Code, are part of the agency’s 2021 budget that relies upon the existence of these fees or charges to meet the state’s obligations and provide necessary state services. Failing to reauthorize these temporary rules would create immediate danger to the state budget, immediate danger to necessary state functions and services, and immediate danger of a violation of Idaho’s constitutional requirement that it balance its budget.

The following is a specific description of the fees or charges:

APPLICATION	FEE (Not to Exceed)
Initial Application	\$200
Initial License	\$800 (amount will be refunded if license not issued)
Renewal	\$850 (amount will be refunded if license not renewed)
Reinstatement	\$50

**ASSISTANCE ON TECHNICAL QUESTIONS:** For assistance on technical questions concerning the temporary rule, contact Rob McQuade at (208) 334-3233.

DATED this February 21, 2020.

Kelley Packer  
Division Administrator  
Division of Occupational and Professional Licenses  
700 W. State Street  
P.O. Box 83720  
Boise, ID 83720  
Phone: (208) 334-3233  
Fax: (208) 334-3945

## 24.26.01 – RULES OF THE IDAHO BOARD OF MIDWIFERY

### 000. LEGAL AUTHORITY.

In accordance with Section 54-5504, Idaho Code, the Idaho Board of Midwifery has promulgated rules that implement the provisions of Chapter 55, Title 54, Idaho Code. (3-20-20)T

### 001. TITLE AND SCOPE.

01. **Title.** These rules are titled IDAPA 24.26.01, “Rules of the Idaho Board of Midwifery.” (3-20-20)T

02. **Scope.** These rules establish the framework for licensure of midwives and the provisions for what midwives are allowed to do, what they may not do, when they must advise their clients to seek other medical advice and when to transport a client. (3-20-20)T

### 002. INCORPORATION BY REFERENCE.

The following documents are incorporated by reference into these rules, and are available at the Board’s office and through the Board’s website: (3-20-20)T

01. **Prevention of Perinatal Group B Streptococcal Disease.** Published by the Centers for Disease Control and Prevention, MMWR 2010;59 (No. RR 10), dated November 19, 2010, referenced in Paragraph 350.01.d. (3-20-20)T

02. **Essential Documents of the National Association of Certified Professional Midwives.** Copyright date 2004, referenced in Subsection 356.01. (3-20-20)T

03. **2016 Job Analysis Survey.** Published by the North American Registry of Midwives (NARM). (3-20-20)T

### 003. -- 019. (RESERVED)

### 020. ORGANIZATION.

At the first meeting of each fiscal year, the Board elects from its members a Chairman, who assumes the duty of the office immediately upon such selection. (3-20-20)T

### 021. -- 099. (RESERVED)

### 100. QUALIFICATIONS FOR LICENSURE.

01. **Applications.** Applications for licensure must be submitted on Board-approved forms. (3-20-20)T

02. **Qualifications.** Applicants for licensure must submit a completed application, required application and licensing fees, and documentation, acceptable to the Board, establishing that the applicant: (3-20-20)T

a. Currently is certified as a CPM by NARM or a successor organization. (3-20-20)T

b. Has successfully completed Board-approved, MEAC-accredited courses in pharmacology, the treatment of shock/IV therapy, and suturing specific to midwives. (3-20-20)T

03. **Incomplete or Stalled Applications.** The applicant must provide or facilitate the provision of any supplemental third party documents that may be required by the Board. If an applicant fails to respond to a Board request or an application has lacked activity for twelve (12) consecutive months, the application on file with the Board is deemed denied and it will be terminated upon thirty (30) days written notice, unless good cause is established to the Board. (3-20-20)T

### 101. -- 174. (RESERVED)

### 175. FEES.

Unless otherwise provided for, all fees are non-refundable.

APPLICATION	FEE (Not to Exceed)
Initial Application	\$200
Initial License	\$800 (amount will be refunded if license not issued)
Renewal	\$850 (amount will be refunded if license not renewed)
Reinstatement	\$50

(3-20-20)T

**176. -- 199. (RESERVED)**

**200. RENEWAL OF LICENSE.**

**01. Complete Practice Data.** The information submitted by the licensed midwife must include complete practice data for the calendar year preceding the date of the renewal application. Such information includes: (3-20-20)T

- a.** The number of clients to whom the licensed midwife has provided care; (3-20-20)T
- b.** The number of deliveries, including; (3-20-20)T
  - i.** The number of cesareans; (3-20-20)T
  - ii.** The number of vaginal births after cesarean (VBACs); (3-20-20)T
- c.** The average, oldest, and youngest maternal ages; (3-20-20)T
- d.** The number of primiparae; (3-20-20)T
- e.** All APGAR scores below five (5) at five (5) minutes; (3-20-20)T
- f.** The number of prenatal transfers and transfers during labor, delivery and immediately following birth, including; (3-20-20)T
  - i.** Transfers of mothers; (3-20-20)T
  - ii.** Transfers of babies; (3-20-20)T
  - iii.** Reasons for transfers; (3-20-20)T
  - iv.** Transfers of all newborns being admitted to the neonatal intensive care unit (NICU) for more than twenty four (24) hours. (3-20-20)T
- g.** Any perinatal deaths occurring up to six weeks post-delivery, broken out by: (3-20-20)T
  - i.** Weight; (3-20-20)T
  - ii.** Gestational Age; (3-20-20)T
  - iii.** Age of the baby; (3-20-20)T
  - iv.** Stillbirths, if any; (3-20-20)T

**h.** Any significant neonatal or perinatal problem, not listed above, during the six (6) weeks following birth. (3-20-20)T

**02. Current Cardiopulmonary Resuscitation Certification.** A licensed midwife to renew their license must certify on their renewal application that they possess a current certification in adult, infant, and child cardiopulmonary resuscitation and in neonatal resuscitation obtained through completion of American Heart Association or the Health and Safety Institute approved cardiopulmonary resuscitation courses and American Academy of Pediatrics approved neonatal resuscitation courses. (3-20-20)T

**03. Continuing Education Verification.** When a licensed midwife submits a renewal application, the licensed midwife must certify by signed affidavit that the annual continuing education requirements set by the Board have been met. The Board may conduct such continuing education audits and require verification of attendance as deemed necessary to ensure compliance with continuing education requirements. (3-20-20)T

**201. -- 299. (RESERVED)**

**300. CONTINUING EDUCATION REQUIREMENT.**

**01. Annual Continuing Education Requirement.** A licensed midwife must successfully complete a minimum of ten (10) continuing education hours per year for the year preceding renewal. Two (2) of these hours must be in peer review participation as described in Subsection 300.06. One (1) continuing education hour equals one (1) clock hour. A licensed midwife is considered to have satisfied the annual continuing education requirement for the first renewal of the initial license. (3-20-20)T

**02. Subject Material.** The subject material of the continuing education must be germane to the practice of midwifery and either acceptable to NARM as counting towards recertification of a licensed midwife as a CPM or otherwise approved by the Board. (3-20-20)T

**03. Verification of Attendance.** Each licensed midwife must maintain verification of attendance by securing authorized signatures or other documentation from the course instructors or sponsoring institution substantiating any hours attended. This verification must be maintained by the licensed midwife for no less than seven (7) years and provided to the Board upon request by the Board or its agent. (3-20-20)T

**04. Distance Learning and Independent Study.** The Board may approve a course of study for continuing education credit that does not include the actual physical attendance of the licensed midwife in a face-to-face setting with the course instructor. Distance Learning or Independent Study courses will be eligible for continuing education credits if approved by NARM or upon approval of the Board. (3-20-20)T

**05. Requests for Board Approval.** All requests for Board approval of educational programs must be made to the Board in writing at least sixty (60) days before the program is scheduled to occur. Requests must be accompanied by a statement that includes: (3-20-20)T

- a.** The name of the instructor or instructors; (3-20-20)T
- b.** The date and time and location of the course; (3-20-20)T
- c.** The specific agenda for the course; (3-20-20)T
- d.** The number of continuing education credit hours requested; and (3-20-20)T
- e.** A statement of how the course is believed to be germane to the practice of midwifery. (3-20-20)T

**06. Peer Review System.** As part of the Board's annual continuing education requirement, each licensed midwife must participate in peer review activities for a minimum of two (2) hours per year. (3-20-20)T

**a.** The purpose of peer review is to enable licensed midwives to retrospectively present and review cases in an effort to further educate themselves about the appropriateness, quality, utilization, and ethical performance



of midwifery care. (3-20-20)T

**b.** Licensed midwives are responsible for organizing their own peer review sessions. At least three (3) licensed midwives or CPMs must participate in a peer review session in order for the session to count towards a licensed midwife's annual two-hour peer review activity requirement. (3-20-20)T

**c.** Each licensed midwife must make a presentation that must include, without limitation, the following information: (3-20-20)T

i. Total number of clients currently in the licensed midwife's care; (3-20-20)T

ii. The number of upcoming due dates for clients in the licensed midwife's practice; (3-20-20)T

iii. The number of women in the licensed midwife's practice that are postpartum; (3-20-20)T

iv. The number of births the licensed midwife has been involved with since the last peer review session; and (3-20-20)T

v. One (1) or more specific cases arising since the licensed midwife's last peer review session. The licensed midwife must present any cases involving serious complications or the transport of a mother or baby to the hospital. (3-20-20)T

**d.** The information presented in a peer review session is confidential. The identities of the client, other health care providers, and other persons involved in a case may not be divulged during the peer review session. (3-20-20)T

**07. Carryover Hours.** A licensed midwife may carryover a maximum of five (5) hours of continuing education to meet the next year's continuing education requirement. (3-20-20)T

**08. Hardship Waiver.** The Board may waive the continuing education requirement for good cause. The licensed midwife must request the waiver and provide the Board with any information requested to assist the Board in substantiating the claimed hardship. (3-20-20)T

**301. -- 324. (RESERVED)**

**325. INFORMED CONSENT.**

**01. Informed Consent Required.** A licensed midwife must obtain and document informed consent from a client before caring for that client. The informed consent must be documented on an informed consent form, signed and dated by the client, in which the client acknowledges, at a minimum, the provisions listed in Section 54-5511, Idaho Code and the following: (3-20-20)T

**a.** Instructions for obtaining a copy of the Essential Documents of the NACPM and 2016 Job Analysis Survey, published by NARM; (3-20-20)T

**b.** Instructions for filing complaints with the Board; (3-20-20)T

**02. Record of Informed Consent.** All licensed midwives must maintain a record of all signed informed consent forms for each client for a minimum of nine (9) years after the last day of care for such client. (3-20-20)T

**326. -- 349. (RESERVED)**

**350. FORMULARY.**

**01. Midwifery Formulary.** A licensed midwife may obtain and administer, during the practice of midwifery, the following: (3-20-20)T

- a. Oxygen; (3-20-20)T
- b. Oxytocin, misoprostol, and methylergonovine as postpartum antihemorrhagic agents; (3-20-20)T
- c. Injectable local anesthetic for the repair of lacerations that are no more extensive than second degree; (3-20-20)T
- d. Antibiotics to the mother for group b streptococcus prophylaxis consistent with the guidelines set forth in Prevention of Perinatal Group B Streptococcal Disease, published by the Centers for Disease Control and Prevention; (3-20-20)T
- e. Epinephrine to the mother administered for anaphylactic shock; (3-20-20)T
- f. Intravenous fluids for stabilization of the woman; (3-20-20)T
- g. Rho (d) immune globulin; (3-20-20)T
- h. Phytonadione; and (3-20-20)T
- i. Eye prophylactics to the baby. (3-20-20)T

**02. Other Legend Drugs.** During the practice of midwifery a licensed midwife may not obtain or administer legend drugs that are not listed in the midwifery formulary. Drugs of a similar nature and character may be used if determined by the Board to be consistent with the practice of midwifery and provided that at least one hundred twenty (120) days' advance notice of the proposal to allow the use of such drugs is given to the Board of Pharmacy and the Board of Medicine and neither Board objects to the addition of such drugs to the midwifery formulary. (3-20-20)T

**351. USE OF FORMULARY DRUGS.**

A licensed midwife may use the drugs described in the midwifery formulary according to the following protocol describing the indication for use, dosage, route of administration and duration of treatment:

<b>Drug</b>	<b>Indication</b>	<b>Dose</b>	<b>Route of Administration</b>	<b>Duration of Treatment</b>
Oxygen	Maternal/Fetal Distress	10-12 L/min. 10 L/min.	Bag and mask Mask	Until maternal/fetal stabilization is achieved or transfer to hospital is complete
	Neonatal Resuscitation	10-12 L/min. 10 L/min.	Bag and mask Mask	Until stabilization is achieved or transfer to a hospital is complete
Oxytocin (Pitocin)	Postpartum hemorrhage only	10 Units/ml	Intramuscularly only	1-2 doses Transport to hospital required if more than two doses are administered
Lidocaine HCl 2%	Local anesthetic for use during postpartum repair of lacerations or episiotomy	Maximum 50 ml	Percutaneous infiltration only	Completion of repair

<b>Drug</b>	<b>Indication</b>	<b>Dose</b>	<b>Route of Administration</b>	<b>Duration of Treatment</b>
Penicillin G (Recommended)	Group B Strep Prophylaxis	5 million units initial dose, then 2.5 million units every 4 hours until birth	IV in $\geq$ 100 ml LR, NS or D <sub>5</sub> LR	Birth of baby
Ampicillin Sodium (Alternative)	Group B Strep Prophylaxis	2 grams initial dose, then 1 gram every 4 hours until birth	IV in $\geq$ 100 ml NS or LR	Birth of baby
Cefazolin Sodium (drug of choice for penicillin allergy with low risk for anaphylaxis)	Group B Strep Prophylaxis	2 grams initial dose, then 1 gram every 8 hours	IV in $\geq$ 100 ml LR, NS or D <sub>5</sub> LR	Birth of baby
Clindamycin Phosphate  (drug of choice for penicillin allergy with high risk for anaphylaxis)	Group B Strep Prophylaxis	900 mg every 8 hours	IV in $\geq$ 100 ml NS (not LR)	Birth of baby
Epinephrine HCl 1:1000	Treatment or post-exposure prevention of severe allergic reactions	0.3 ml	Subcutaneously or intramuscularly	Every 20 minutes or until emergency medical services arrive  Administer first dose then immediately request emergency services
Lactated Ringer's (LR)  5% Dextrose in Lactated Ringer's solution (D <sub>5</sub> LR)  0.9% Sodium Chloride (NS)  Sterile Water	To achieve maternal stabilization    Reconstitution of antibiotic powder	1 - 2 liter bags  First liter run in at a wide-open rate, the second liter titrated to client's condition  As directed	Intravenously with $\geq$ 18 gauge catheter   As directed	Until maternal stabilization is achieved or transfer to a hospital is complete   Birth of Baby
Cytotec (Misoprostol)	Postpartum hemorrhage only	800 mcg	Rectally is the preferred method Orally is allowed	1-2 doses  Transport to hospital required if more than one dose is administered

Drug	Indication	Dose	Route of Administration	Duration of Treatment
Rho(d) Immune Globulin	Prevention of Rho (d) sensitization in Rho (d) negative women	300 mcg	Intramuscularly	Single dose at any gestation for Rho (d) negative, antibody negative women within 72 hours of spontaneous bleeding or abdominal trauma.  Single dose at 26-28 weeks gestation for Rho (d) negative, antibody negative women  Single dose for Rho (d) negative, antibody negative women within 72 hours of delivery of Rho (d) positive infant, or infant with unknown blood type
Phytonadione	Prophylaxis for Vitamin K Deficiency Bleeding	1 mg	Intramuscularly	1 dose
0.5% Erythromycin Ophthalmic Ointment	Prophylaxis of Neonatal Ophthalmia	1 cm ribbon in each eye	Topical	1 dose

(3-20-20)T

**352. OBTAINING, STORING, AND DISPOSING OF FORMULARY DRUGS.**

A licensed midwife must adhere to the following protocol for obtaining, storing, and disposing of formulary drugs during the practice of midwifery. (3-20-20)T

**01. Obtaining Formulary Drugs.** A licensed midwife may obtain formulary drugs as allowed by law, including, without limitation, from: (3-20-20)T

**a.** A person or entity that is licensed as a Wholesale Distributor by the Idaho State Board of Pharmacy; and (3-20-20)T

**b.** A retail pharmacy, in minimal quantities for office use. (3-20-20)T

**02. Storing Formulary Drugs.** A licensed midwife must store all formulary drugs in secure areas suitable for preventing unauthorized access and for ensuring a proper environment for the preservation of the drugs. However, licensed midwives may carry formulary drugs to the home setting while providing care within the course and scope of the practice of midwifery. (3-20-20)T

**03. Disposing of Formulary Drugs.** A licensed midwife must dispose of formulary drugs using means that are reasonably calculated to guard against unauthorized access by persons and harmful excretion of the drugs into the environment. The means that may be used include, without limitation: (3-20-20)T

**a.** Transferring the drugs to a reverse distributor who is registered to destroy drugs with the U.S. Drug Enforcement Agency; (3-20-20)T

**b.** Removing the drugs from their original containers, mixing them with an undesirable substance such as coffee grounds or kitty litter, putting them in impermeable, non-descript containers such as empty cans or sealable bags, and throwing the containers in the trash; or (3-20-20)T

c. Flushing the drugs down the toilet if the accompanying patient information instructs that it is safe to do so. (3-20-20)T

**353. -- 354. (RESERVED)**

**355. MEDICAL WASTE.**

A licensed midwife must dispose of medical waste during the practice of midwifery according to the following protocol: (3-20-20)T

**01. Containers for Non-Sharp, Medical Waste.** Medical waste, except for sharps, must be placed in disposable containers/bags which are impervious to moisture and strong enough to preclude ripping, tearing or bursting under normal conditions of use. The bags must be securely tied so as to prevent leakage or expulsion of solid or liquid waste during storage, handling or transport. The containment system must have a tight-fitting cover and be kept clean and in good repair. All bags used for containment of medical waste must be clearly identified by label or color, or both. (3-20-20)T

**02. Containers for Sharps.** Sharps must be placed in impervious, rigid, puncture-resistant containers immediately after use. Needles must not be bent, clipped or broken by hand. Rigid containers of discarded sharps must either be labeled or colored like the disposable bags used for other medical waste, or placed in such labeled or colored bags. (3-20-20)T

**03. Storage Duration.** Medical waste may not be stored for more than seven (7) days, unless the storage temperature is below thirty-two (32) degrees Fahrenheit. Medical waste must never be stored for more than ninety (90) days. (3-20-20)T

**04. Waste Disposal.** Medical waste must be disposed of by persons knowledgeable in handling of medical waste. (3-20-20)T

**356. SCOPE AND PRACTICE STANDARDS.**

A licensed midwife must adhere to the following scope and practice standards when providing antepartum, intrapartum, postpartum, and newborn care. (3-20-20)T

**01. NACPM Scope and Practice Standards.** The Board adopts the Essential Documents of the National Association of Certified Professional Midwives as scope and practice standards for licensed midwives. All licensed midwives must adhere to these scope and practice standards during the practice of midwifery to the extent such scope and practice standards are consistent with the Board's enabling law, Chapter 55, Title 54, Idaho Code. (3-20-20)T

**02. Conditions for Which a Licensed Midwife May Not Provide Care.** A licensed midwife may not provide care for a client with conditions listed in Section 54-5505(1)(e)(i), Idaho Code. (3-20-20)T

**03. Conditions for Which a Licensed Midwife May Not Provide Care Without Health Care Provider Involvement.** A licensed midwife may not provide care for a client with a history of the disorders, diagnoses, conditions, or symptoms listed in Section 54-5505(1)(e)(ii), Idaho Code, unless such disorders, diagnoses, conditions or symptoms are being treated, monitored or managed by a licensed health care provider. For purposes of this Paragraph, in Section 54-5505(1)(e)(ii), Idaho Code, "history" means a "current history" and "illegal drug use" means "illegal drug abuse or addiction." Before providing care to such a client, the licensed midwife must notify the client in writing that the client must obtain the described physician care as a condition to the client's eligibility to obtain maternity care from the licensed midwife. The licensed midwife must, additionally, obtain the client's signed acknowledgment that the client has received the written notice. (3-20-20)T

**04. Conditions for Which a Licensed Midwife Must Recommend Physician Involvement.** Before providing care for a client with a history of any of the disorders, diagnoses, conditions or symptoms listed in Section 54-5505(1)(e)(iii), Idaho Code, a licensed midwife must provide written notice to the client that the client is advised to see a physician licensed under Chapter 18, Title 54, Idaho Code, or under an equivalent provision of the law of a state bordering Idaho, during the client's pregnancy. Additionally, the licensed midwife must obtain the client's

signed acknowledgment that the client has received the written notice. (3-20-20)T

**05. Conditions for which a Licensed Midwife must Facilitate Hospital Transfer.** (3-20-20)T

**a.** Conditions. A licensed midwife must facilitate the immediate transfer of a client to a hospital for emergency care if the client has any of the disorders, diagnoses, conditions or symptoms listed in Section 54-5505(1)(e)(iv), Idaho Code, and the following: (3-20-20)T

**i.** Maternal fever in labor of more than 100.4 degrees Fahrenheit, in the absence of environmental factors; (3-20-20)T

**ii.** Suggestion of fetal jeopardy, such as frank bleeding before delivery, any abnormal bleeding (with or without abdominal pain), evidence of placental abruption, meconium with non-reassuring fetal heart tone patterns where birth is not imminent, or abnormal fetal heart tones with non-reassuring patterns where birth is not imminent; (3-20-20)T

**b.** Plan for Emergency Transfer and Transport. When facilitating a transfer under Subsection 356.05, the licensed midwife must notify the hospital when the transfer is initiated, accompany the client to the hospital, if feasible, or communicate by telephone with the hospital if the licensed midwife is unable to be present personally. The licensed midwife must also ensure that the transfer of care is accompanied by the client's medical record, which must include items defined in Section 54-5505(1)(e)(v), Idaho Code, and if feasible, the licensed midwife's assessment of the client's current medical condition and description of the care provided by the licensed midwife before transfer. (3-20-20)T

**c.** Transfer or Termination of Care. A midwife who deems it necessary to transfer or terminate care pursuant to the laws and rules of the Board or for any other reason must transfer or terminate care and will not be regarded as having abandoned care or wrongfully terminated services. (3-20-20)T

**357. -- 359. (RESERVED)**

**360. NEWBORN TRANSFER OF CARE OR CONSULTATION.**

**01. Newborn Transfer of Care.** Conditions for which a licensed midwife must facilitate the immediate transfer of a newborn to a hospital for emergency care: (3-20-20)T

**a.** Respiratory distress defined as respiratory rate greater than eighty (80) or grunting, flaring, or retracting for more than one (1) hour. (3-20-20)T

**b.** Any respiratory distress following delivery with moderate to thick meconium stained fluid. (3-20-20)T

**c.** Central cyanosis or pallor for more than ten (10) minutes. (3-20-20)T

**d.** Apgar score of six (6) or less at five (5) minutes of age. (3-20-20)T

**e.** Abnormal bleeding. (3-20-20)T

**f.** Any condition requiring more than six (6) hours of continuous, immediate postpartum evaluation. (3-20-20)T

**g.** Any vesicular skin lesions. (3-20-20)T

**h.** Seizure-like activity. (3-20-20)T

**i.** Any bright green emesis. (3-20-20)T

**j.** Poor feeding effort due to lethargy or disinterest in nursing for more than two (2) hours

immediately following birth. (3-20-20)T

**02. Newborn Consultation Required.** Conditions for which a licensed midwife must consult a Pediatric Provider (Neonatologist, Pediatrician, Family Practice Physician, Advanced Practice Registered Nurse, or Physician Assistant): (3-20-20)T

**a.** Temperature instability, defined as a rectal temperature less than ninety-six point eight (96.8) degrees Fahrenheit or greater than one hundred point four (100.4) degrees Fahrenheit documented two (2) times more than fifteen (15) minutes apart. (3-20-20)T

**b.** Murmur lasting more than twenty-four (24) hours immediately following birth. (3-20-20)T

**c.** Cardiac arrhythmia. (3-20-20)T

**d.** Congenital anomalies. (3-20-20)T

**e.** Birth injury. (3-20-20)T

**f.** Clinical evidence of prematurity, including but not limited to, low birth weight of less than two thousand five hundred (2,500) grams, smooth soles of feet, or immature genitalia. (3-20-20)T

**g.** Any jaundice in the first twenty-four (24) hours after birth or significant jaundice at any time. (3-20-20)T

**h.** No stool for more than twenty-four (24) hours immediately following birth. (3-20-20)T

**i.** No urine output for more than twenty-four (24) hours. (3-20-20)T

**j.** Development of persistent poor feeding effort at any time. (3-20-20)T

**361. -- 449. (RESERVED)**

**450. UNPROFESSIONAL CONDUCT.**

**01. Standards of Conduct.** If a licensed midwife or an applicant for licensure, renewal, or reinstatement has engaged in unprofessional conduct, the Board may refuse to issue, renew, or reinstate the applicant's license and may discipline the licensee. Unprofessional conduct includes, without limitation, those actions defined in Section 54-5510, Idaho Code, and any of the following: (3-20-20)T

**a.** Having a license suspended, revoked, or otherwise disciplined in this or any other state or jurisdiction; (3-20-20)T

**b.** Having been convicted of any felony, or of a lesser crime that reflects adversely on the person's fitness to be a licensed midwife. Such lesser crimes include, but are not limited to, any crime involving the delivery of health care services, dishonesty, misrepresentation, theft, or an attempt, conspiracy or solicitation of another to commit a felony or such lesser crimes. (3-20-20)T

**c.** Violating any standards of conduct set forth in these rules, whether or not specifically labeled as such, and including without limitation any scope and practice standards, record-keeping requirements, notice requirements, or requirements for documenting informed consent. (3-20-20)T

**02. Discipline.** If the Board determines that a licensed midwife has engaged in unprofessional conduct, it may impose discipline against the licensed midwife that includes, without limitation, the following: (3-20-20)T

**a.** Require that a licensed midwife practice midwifery under the supervision of another health care provider. The Board may specify the nature and extent of the supervision and may require the licensed midwife to enter into a consultation, collaboration, proctoring, or supervisory agreement, written or otherwise, with the other

health care provider; (3-20-20)T

**b.** Suspend or revoke a license; (3-20-20)T

**c.** Impose a civil fine not to exceed one thousand dollars (\$1,000) for each violation of the Board's laws and rules; and (3-20-20)T

**d.** Order payment of the costs and fees incurred by the Board for the investigation and prosecution of the violation of the Board's laws and rules. (3-20-20)T

**451. -- 999. (RESERVED)**



# IDAPA 24 – DIVISION OF OCCUPATIONAL AND PROFESSIONAL LICENSES

## 24.27.01 – RULES OF THE IDAHO STATE BOARD OF MASSAGE THERAPY

### DOCKET NO. 24-2701-2000F (FEE RULE)

#### NOTICE OF OMNIBUS RULEMAKING – ADOPTION OF TEMPORARY RULE

**EFFECTIVE DATE:** The effective date of the temporary rules being adopted through this omnibus rulemaking is the adjournment date of the second regular session of the 65th Idaho State Legislature - March 20, 2020.

**AUTHORITY:** In compliance with Sections 67-5226, Idaho Code, notice is hereby given this agency has adopted a temporary rule. The action is authorized pursuant to Section 54-4007, Idaho Code.

**DESCRIPTIVE SUMMARY:** The following is the required finding and concise statement of its supporting reasons for adopting a temporary rule:

This temporary rulemaking adopts the following chapter under IDAPA 24.27.01:

**IDAPA 24.27**

- 24.27.01, *Rules of the Idaho State Board of Massage Therapy.*

**TEMPORARY RULE JUSTIFICATION:** Pursuant to Sections 67-5226(1) and 67-5226(2), Idaho Code, the Governor has found that temporary adoption of the rule is appropriate for the following reasons:

These temporary rules are necessary to protect the public health, safety, and welfare of the citizens of Idaho and confer a benefit on its citizens. These temporary rules implement the duly enacted laws of the state of Idaho, provide citizens with the detailed rules and standards for complying with those laws, and assist in the orderly execution and enforcement of those laws. The expiration of these rules without due consideration and processes would undermine the public health, safety, and welfare of the citizens of Idaho and deprive them of the benefit intended by these rules. These rules protect the health, safety, and welfare of the public through ensuring massage therapy services are provided by those have met minimum qualifications to perform massage therapy. Allowing these rules to expire would harm current licensees, applicants, and the public because the minimum standards of competency would lapse.

**FEE SUMMARY:** Pursuant to Section 67-5226(2), the Governor has found that the fees or charges being imposed or increased are justified and necessary to avoid immediate danger and the fees are described herein:

The fees or charges, authorized in Section 54-4008, Idaho Code, are part of the agency’s 2021 budget that relies upon the existence of these fees or charges to meet the state’s obligations and provide necessary state services. Failing to reauthorize these temporary rules would create immediate danger to the state budget, immediate danger to necessary state functions and services, and immediate danger of a violation of Idaho’s constitutional requirement that it balance its budget.

The following is a specific description of the fees or charges:

FEE TYPE	AMOUNT (Not to Exceed)
Application	\$50
Original License	\$65
Annual Renewal	\$65
License by Endorsement	\$75
Temporary License	\$25
Provisional Permit	\$25

<b>FEE TYPE</b>	<b>AMOUNT (Not to Exceed)</b>
Reinstatement	As provided in Section 67-2614, Idaho Code
Examination	Established by Administrator

**ASSISTANCE ON TECHNICAL QUESTIONS:** For assistance on technical questions concerning the temporary rule, contact Rob McQuade at (208) 334-3233.

DATED this February 21, 2020.

Kelley Packer  
Division Administrator  
Division of Occupational and Professional Licenses  
700 W. State Street  
P.O. Box 83720  
Boise, ID 83720  
Phone: (208) 334-3233  
Fax: (208) 334-3945

## 24.27.01 – RULES OF THE IDAHO STATE BOARD OF MASSAGE THERAPY

### 000. LEGAL AUTHORITY.

These rules are hereby prescribed and established pursuant to the authority vested in the Idaho State Board of Massage Therapy by the provisions of Section 54-4007, Idaho Code. (3-20-20)T

### 001. TITLE AND SCOPE.

01. **Title.** The rules are titled IDAPA 24.27.01, “Rules of the Idaho State Board of Massage Therapy.” (3-20-20)T

02. **Scope.** These rules implement the purposes and intent of Title 54, Chapter 40, Idaho Code, to regulate the profession of massage therapy in the interest of the public health, safety, and welfare. (3-20-20)T

### 002. -- 009. (RESERVED)

### 010. DEFINITIONS.

01. **Approved Massage Program.** A massage therapy program conducted by an entity that is registered with the Idaho State Board of Education pursuant to Chapter 24, Title 33, Idaho Code, or with a comparable authority in another state, and that meets the entry-level educational requirements as set forth in Section 600 of these rules. (3-20-20)T

02. **Clinical Work.** Supervised, hands-on training in a classroom setting. (3-20-20)T

03. **Code of Ethics.** The Idaho Code of Ethics for Massage Therapy attached to these rules as Appendix A. (3-20-20)T

04. **CPR.** Cardiopulmonary resuscitation. (3-20-20)T

05. **Standards of Practice.** The Standards of Practice of Massage Therapy attached to these rules as Appendix B. (3-20-20)T

### 011. -- 099. (RESERVED)

### 100. ORGANIZATION AND OPERATIONS OF THE BOARD.

01. **Meetings.** The Board meets at least annually and at other such times and places as designated by the Chairman or upon the written request of any three (3) members of the Board. (3-20-20)T

a. A minimum of three (3) Board members constitutes a quorum and shall be required for the transaction of business. A majority vote of the quorum present at a meeting is considered the action of the Board as a whole. (3-20-20)T

b. The Chairman is a voting member. (3-20-20)T

02. **Organization.** At the first meeting of each fiscal year, the Board elects from its members a Chairman, who assumes the duty of the office immediately upon such selection. (3-20-20)T

### 101. -- 199. (RESERVED)

### 200. APPLICATION.

01. **Filing an Application.** Applicants for licensure must submit a complete application, verified under oath, to the Board at its official address. The application must be on the forms approved by the Board and submitted together with the appropriate fee(s) and supporting documentation. (3-20-20)T

02. **Supplemental Documents.** The applicant must provide or facilitate the provision of any supplemental third party documents that may be required under the qualifications for the license being sought. (3-20-20)T

### 201. -- 249. (RESERVED)

**250. FEES.**

All fees are non-refundable except that, if a license is not issued, the license fee will be refunded

<b>FEE TYPE</b>	<b>AMOUNT (Not to Exceed)</b>
Application	\$50
Original License	\$65
Annual Renewal	\$65
License by Endorsement	\$75
Temporary License	\$25
Provisional Permit	\$25
Reinstatement	As provided in Section 67-2614, Idaho Code
Examination	Established by Administrator

(3-20-20)T

**251. -- 299. (RESERVED)**

**300. REQUIREMENTS FOR ORIGINAL LICENSURE.**

The Board may grant a license to an applicant for licensure who completes an application as set forth in Section 200 of these rules and meets the following general, education, and examination requirements: (3-20-20)T

**01. General.** (3-20-20)T

**a.** An applicant must provide evidence of being at least eighteen (18) years of age. (3-20-20)T

**b.** An applicant must certify that he/she has not been found guilty, convicted, received a withheld judgment, or suspended sentence for a felony or a crime involving moral turpitude, or if the applicant has been found guilty, convicted, received a withheld judgment, or suspended sentence for such a crime, the applicant must submit a written statement of suitability for licensure as set forth in Section 306 of these rules. (3-20-20)T

**c.** An applicant must certify that he/she has not been convicted of a crime under any municipal, state, or federal narcotic or controlled substance law, or if the applicant has been convicted of such a crime, the applicant must submit a written statement of suitability for licensure as set forth in Section 306 of these rules. (3-20-20)T

**d.** An applicant must certify that their license has not been subject to any disciplinary action by a regulatory entity in another state, territory or country including, but not limited to, having an application for licensure denied. If the applicant or their license has been subject to discipline, the applicant must submit a written statement of suitability for licensure as set forth in Section 306 of these rules. (3-20-20)T

**301. -- 304. (RESERVED)**

**305. APPROVED EXAMINATIONS.**

Approved examinations are the following examinations or another nationally recognized competency examination in massage therapy that is approved by the Board. (3-20-20)T

**01. Approved Examinations.** (3-20-20)T

**a.** Massage and Bodywork Licensing Examination (MBLEx) as administered by the Federation of State Massage Therapy Boards (FSMTB); (3-20-20)T

**b.** National Certification Examination for Therapeutic Massage and Bodywork (NCETMB) or

National Certification Examination for Therapeutic Massage (NCETM) as administered by the National Certification Board for Therapeutic Massage and Bodywork (NCBTMB), if taken before February 1, 2015. (3-20-20)T

**c.** Other nationally recognized competency examinations in massage therapy that are approved by the Board. A written request for approval must be submitted to the Board together with supporting documentation as may be requested by the Board. (3-20-20)T

**02. Successful Passage.** A passing score, or successful passage of the exam, will be determined by the entity administering the exam. (3-20-20)T

**03. Date of Exam.** The passage of the exam may have occurred prior to the effective date of these rules. (3-20-20)T

**306. WRITTEN STATEMENT OF SUITABILITY FOR LICENSURE.**

An applicant who or whose license has a conviction, finding of guilt, withheld judgment, or suspended sentence for a felony or crime involving moral turpitude, has a conviction for any crime under any municipal, state, or federal narcotic or controlled substance law, or has been subject to discipline in another state, territory or country must submit with his application a written statement and any supplemental information establishing his current suitability for licensure. (3-20-20)T

**01. Consideration of Factors and Evidence.** The Board considers the following factors or evidence: (3-20-20)T

**a.** The severity or nature of the crime or discipline; (3-20-20)T

**b.** The period of time that has passed since the crime or discipline under review; (3-20-20)T

**c.** The number or pattern of crimes or discipline or other similar incidents; (3-20-20)T

**d.** The circumstances surrounding the crime or discipline that would help determine the risk of repetition; (3-20-20)T

**e.** The relationship of the crime or discipline to the practice of massage therapy; (3-20-20)T

**f.** The applicant's activities since the crime or discipline under review, such as employment, education, participation in treatment, payment of restitution, or any other factors that may be evidence of current rehabilitation; and (3-20-20)T

**g.** Any other information regarding rehabilitation or mitigating circumstances. (3-20-20)T

**02. Interview.** The Board may, at its discretion, grant an interview of the applicant. (3-20-20)T

**03. Applicant Bears the Burden.** The applicant bears the burden of establishing his current suitability for licensure. (3-20-20)T

**307. -- 309. (RESERVED)**

**310. REQUIREMENTS FOR LICENSURE BY ENDORSEMENT.**

The Board may grant a license to an applicant for licensure by endorsement who completes an application as set forth in Section 200 and meets the following requirements: (3-20-20)T

**01. Holds a Current License.** The applicant must be the holder of a current active license or certificate in good standing in the profession, and at the level for which a license is being sought, issued by the authorized regulatory entity in another state. The state must have licensing or certification requirements substantially equivalent to or higher than those required for new applicants in Idaho. The certification of licensure or certification must be received by the Board from the issuing agency; (3-20-20)T

**02. Has Not Been Disciplined.** The applicant or his/her license must have not been voluntarily surrendered, revoked, or suspended by any regulatory entity. The Board may consider an applicant who, or whose license, has been restricted, denied, sanctioned, or otherwise disciplined. If the applicant or his/her license has been subject to discipline, the applicant must submit a written statement of suitability for licensure as set forth in Section 306 of these rules; (3-20-20)T

**03. Is of Good Moral Character.** The applicant must not have been found guilty, convicted, received a withheld judgment, or suspended sentence for any felony or any crime involving moral turpitude. If the applicant has been found guilty, convicted, received a withheld judgment, or suspended sentence for such a crime the applicant must submit a written statement of suitability for licensure as set forth in Section 306 of these rules; and (3-20-20)T

**04. Has Not Been Convicted of a Drug Offense.** The applicant must not have been convicted of any crime under any municipal, state, or federal narcotic or controlled substance law. If the applicant has been convicted of such a crime, the applicant must submit a written statement of suitability for licensure as set forth in Section 306 of these rules. (3-20-20)T

**311. -- 319. (RESERVED)**

**320. TEMPORARY LICENSE.**

**01. General.** Any person who has submitted to the Board a complete application for licensure by examination under Section 54-4009, Idaho Code, or by endorsement under Section 54-4010, Idaho Code, together with the required fees, may apply for a temporary license to practice massage therapy while their application is being processed by the Board. (3-20-20)T

**02. Duration.** An applicant will be issued only one (1) temporary license that will be valid for a period not to exceed four (4) months or until the Board acts upon the licensure application, whichever occurs first. (3-20-20)T

**321. -- 329. (RESERVED)**

**330. PROVISIONAL PERMIT.**

Upon application to the Board and payment of the required fees, an applicant may be issued a provisional permit to practice massage therapy if the applicant meets all the requirements for licensure under section 54-4009, Idaho Code, except for having successfully passed a nationally recognized competency examination in massage therapy that is approved by the Board as described in Subsection 305.01. (3-20-20)T

**01. General.** A provisional permit will be issued subject to the following conditions: (3-20-20)T

**a.** The applicant must certify that the applicant will take the next scheduled examination for licensure approved by the Board, and that the applicant has not failed two (2) previous examinations for licensure; and (3-20-20)T

**b.** A licensed massage therapist certifies to the Board that the applicant will practice massage therapy only under the supervision of the licensed massage therapist while both are in the same location. (3-20-20)T

**02. Duration and Renewal.** An applicant will be issued only one (1) provisional permit that is valid for a period not to exceed six (6) months or until the applicant is issued a temporary license or the Board acts upon the massage therapist license application, whichever occurs first. A provisional permit may only be renewed once upon a showing of good cause. (3-20-20)T

**331. -- 399. (RESERVED)**

**400. RENEWAL OR EXPIRATION OF LICENSE.**

A license expires on the license holder's birth date. The individual must annually renew the license before the license holder's birth date. Licenses not so renewed will be immediately canceled in accordance with Section 67-2614, Idaho Code. (3-20-20)T

**01. Renewal.** A license must be renewed before it expires by submitting a complete application for renewal on forms approved by the Board together with the renewal fee. As part of a complete renewal application, the licensee will attest to completion of the required continuing education pursuant to Section 500 of these rules. False attestation of satisfaction of the continuing education requirements on a renewal application subjects the licensee to disciplinary action, including revocation. (3-20-20)T

**02. Reinstatement.** A license that has been canceled for failure to renew may be reinstated in accordance with Section 67-2614, Idaho Code. (3-20-20)T

**a.** Within five (5) years of cancellation, an applicant seeking reinstatement must submit to the Board evidence that the applicant has completed the required continuing education together with a complete renewal application and appropriate fee(s). (3-20-20)T

**i.** The applicant must submit evidence of completion of continuing education hours totaling the hours required at the time of cancellation and for each year the license was canceled. (3-20-20)T

**ii.** The applicant must pay a reinstatement fee as set forth in Section 250 of these rules. (3-20-20)T

**b.** After five (5) years of cancellation, the applicant will be treated as a new applicant, and application must be made on the same forms and in the same manner as an application for an original license in accordance with Section 200 of these rules. (3-20-20)T

**401. -- 499. (RESERVED)**

**500. CONTINUING EDUCATION.**  
All licensees must comply with the following continuing education requirements: (3-20-20)T

**01. Requirement.** Beginning with the second renewal of their license, a licensee is required to complete a minimum of six (6) hours of continuing education, which includes one (1.0) hour in ethics, within the preceding twelve (12) months that meet the requirements in Sections 501, 502 and 503 of these rules. (3-20-20)T

**a.** An hour is defined as fifty (50) minutes out of each sixty (60) minute segment. (3-20-20)T

**b.** Continuing education credit will only be given for actual time in attendance or for the time spent participating in the educational activity. (3-20-20)T

**c.** The educational course setting may include a classroom, conference, seminar, on-line or a virtual classroom. (3-20-20)T

**d.** If the licensee completes two (2) or more courses having substantially the same content during any one (1) renewal period, the licensee will only receive continuing education credit for one (1) of the courses. (3-20-20)T

**02. Documentation.** Each licensee must maintain documentation verifying continuing education course attendance and curriculum, or completion of the educational activity for a period of five (5) years from the date of completion. This documentation will be subject to audit by the Board. (3-20-20)T

**a.** Documented evidence of meeting the continuing education course requirement must be in the form of a certificate or letter from the sponsoring entity that includes verification of attendance by the licensee, the title of the activity, the subject material covered, the dates and number of hours credited, and the presenter's full name and professional credentials. Documented evidence of completing a continuing education activity must be in such form as to document both completion and date of the activity. (3-20-20)T

**b.** A licensee must submit the verification documentation to the Board, if requested by the Board. In the event a licensee fails to provide the Board with acceptable documentation of the hours attested to on the renewal application, the licensee may be subject to disciplinary action. (3-20-20)T

**03. Waiver.** The Board may waive the requirements of this rule for reasons of individual hardship, including health or other good cause. The licensee should request the waiver in advance of renewal and must provide any information requested by the Board to assist in substantiating hardship cases. This waiver is granted at the sole discretion of the Board. (3-20-20)T

**04. Carryover of Continuing Education Hours.** Continuing education hours not claimed in the current renewal year may be claimed in the next renewal year. A maximum of six (6) hours may be carried forward from the immediately preceding year, and may not be carried forward more than one renewal year. (3-20-20)T

**05. Exemption.** A licensee is exempt from the continuing education requirements under this Section for the period between the initial issuance of the original license and the first expiration date of that license. (3-20-20)T

**501. APPROVAL OF CONTINUING EDUCATION COURSES.**

Approved continuing education courses are those courses and programs that meet the requirements of these rules, and are approved, sponsored, or provided by the following entities or organizations, or otherwise approved by the Board: (3-20-20)T

**01. A College or University.** Accredited by a nationally recognized accrediting agency as recognized by the United States Secretary of Education; (3-20-20)T

**02. Federal, State or Local Governmental Entities;** and (3-20-20)T

**03. National and State Massage Therapy Associations.** (3-20-20)T

**04. Provider Course Approval.** Other courses may be approved by the Board based upon documentation submitted by a continuing education provider. Requests for approval of courses made by the provider must be submitted on a form approved by the Board that includes: (3-20-20)T

**a.** The nature and subject of the course and its relevancy to the practice of massage therapy; (3-20-20)T

**b.** The name of instructor(s) and their qualifications; (3-20-20)T

**c.** The date, time and location of the course; (3-20-20)T

**d.** The specific agenda for the course; (3-20-20)T

**e.** The number of continuing education hours requested; (3-20-20)T

**f.** The procedures for verification of attendance; and (3-20-20)T

**g.** Other information as may be requested by the Board. (3-20-20)T

**h.** Upon review of all information requested, the Board may deny any request for a course that does not meet the requirements of Idaho law or rule. Board approval of a course will be granted for a period not to exceed five (5) years, or until the course materials or instructors are changed, whichever may occur first. (3-20-20)T

**05. Licensee Course Approval.** Other courses may be approved by the Board based upon documentation submitted by the licensee. All requests for approval must be made to the Board in writing and include the nature and subject of the course and its relevancy to the practice of massage therapy, name of instructor(s) and their qualifications, date, time and location of the course, and procedures for verification of attendance. (3-20-20)T

**502. CONTINUING EDUCATION ACTIVITIES.**

The following educational activities qualify for continuing education as set forth: (3-20-20)T



**01. Teaching a Course For The First Time, Not to Exceed Six Hours.** A report must be submitted, including the name of the course, course outline, qualifications for teaching, number of hours taught, number of participants taught, date and location of the training. (3-20-20)T

**02. Publishing Articles or Books.** The hours awarded as determined at the discretion of the Board. (3-20-20)T

**03. Self Study.** Using books, audio tapes, video tapes, DVD's, research materials, professional publications, online sources, and/or other electronic sources/methods documented by a type-written two-page report summarizing the study content. (3-20-20)T

**503. CONTENT OF CONTINUING EDUCATION.**

The content of continuing education activities and course content must be germane to the practice of massage therapy as defined in Section 54-4002, Idaho Code, and courses in ethics must also be specific to legal issues, law, standards of practice, or ethics. (3-20-20)T

**01. Continuing Education.** Content germane to the practice of massage therapy includes, but is not limited to: (3-20-20)T

**a.** Applications of massage and bodywork therapy for specific needs, conditions, or client populations. (3-20-20)T

**b.** Client assessment protocols, skills for client record keeping, strategies for interfacing with other health care providers. (3-20-20)T

**c.** Use of external agents such as water, sound, heat, cold, or topical applications of plant or mineral-based substances. (3-20-20)T

**d.** Body-centered or somatic psychology, psychophysiology, or interpersonal skills which may include communication skills, boundary functions, dual relationships, transference, counter-transference, and projection. (3-20-20)T

**e.** Standards of practice, professional ethics, or state laws. (3-20-20)T

**f.** Strategies for the marketing of massage and bodywork therapy practices. (3-20-20)T

**g.** Theory or practice of ergonomics as applied to therapists or clients. (3-20-20)T

**h.** Hygiene, methods of infectious disease control, organization and management of the treatment environment. (3-20-20)T

**i.** Body sciences, which may include anatomy, physiology, kinesiology or pathology, as they apply to massage therapy. (3-20-20)T

**j.** Certified CPR or first aid training. (3-20-20)T

**504. -- 599. (RESERVED)**

**600. EDUCATIONAL PROGRAM STANDARDS.**

Approved educational programs are those programs conducted by an entity that meet the definition in Section 010 and that consist of a minimum of five hundred (500) hours of in-class supervised hours of coursework and clinical work that meets the following entry-level educational standards: (3-20-20)T

**01. Coursework Content and Hours.** Coursework must include the following content areas and minimum hours: (3-20-20)T

**a.** Two hundred (200) hours in massage and bodywork assessment, theory, and application;

- (3-20-20)T
- b.** One hundred twenty-five (125) hours in body systems including anatomy, physiology, and kinesiology; (3-20-20)T
  - c.** Forty (40) hours in pathology; (3-20-20)T
  - d.** Twenty-five (25) hours in business and ethics; and (3-20-20)T
- 02. Clinical Work.** A minimum of one hundred ten (110) hours must be clinical work. (3-20-20)T
- a.** Students are not permitted to render any clinical services to clients until students have completed at least twenty percent (20%) of the required hours of instruction. (3-20-20)T
  - b.** All clinical services must be performed under the supervision of a person fully licensed. (3-20-20)T

**601. SUPERVISION.**

**01. Supervision of Clinical Work.** The supervising massage therapist must consult with the student, evaluate student performance and be physically present and available to render direction in person and on the premises where massage therapy is being provided. (3-20-20)T

**02. Supervision of Fieldwork.** The supervising massage therapist must be available to render direction either in person or by means of telecommunications but is not required to be physically present on the premises where massage therapy is being provided. (3-20-20)T

**602. -- 699. (RESERVED)**

**700. SCOPE OF PRACTICE.**

All licensees must practice in a competent manner consistent with their level of education, training, and experience. (3-20-20)T

**701. -- 749. (RESERVED)**

**750. STANDARDS OF PRACTICE.**

All licensees must comply with the Idaho Standards of Practice for Massage Therapy as approved by the Board and attached as Appendix B. (3-20-20)T

**751. -- 799. (RESERVED)**

**800. CODE OF ETHICS.**

All licensees must comply with the Code of Ethics for Massage Therapy as approved by the Board and attached to these rules as Appendix A. (3-20-20)T

**801. -- 899. (RESERVED)**

**900. DISCIPLINE.**

If the Board determines that grounds for discipline exist for violations of Title 54, Chapter 40, Idaho Code, violations of these rules, or both, it may impose disciplinary sanctions against the licensee including, without limitation, any or all of the following: (3-20-20)T

- 01. Refuse License.** Refuse to issue, renew, or reinstate a license; (3-20-20)T
- 02. Revoke License.** Revoke or suspend the licensee's license(s); (3-20-20)T
- 03. Restrict License.** Condition, restrict, or limit the licensee's practice, license, or both; (3-20-20)T

**04. Administrative Fine.** Impose an administrative fine not to exceed one thousand dollars (\$1,000) for each violation of the Board's laws or rules; and (3-20-20)T

**05. Licensee Costs.** Order a licensee to pay the costs and fees incurred by the Board in the investigation, prosecution, or both, of the licensee for violation(s) of the Board's laws, rules, or both. (3-20-20)T

**901. -- 999. (RESERVED)**

### **IDAHO BOARD OF MASSAGE THERAPY CODE OF ETHICS -- APPENDIX A**

Preamble: This Code of Ethics is a summary statement of the standards of conduct that define ethical practice of massage therapy. All licensees are responsible for maintaining and promoting ethical practice.

A licensee shall:

**1.** Conduct all business and professional activities honestly and within their scope of practice and all applicable legal and regulatory requirements.

**2.** Inform clients of the limitations of the licensee's practice, the limitations of massage therapy, and the contraindications for massage therapy.

**3.** Refer the client to other professionals or services if the treatment or service is beyond the licensee's scope of practice.

**4.** Not engage in any sexual conduct, sexual activities, or sexualizing behavior involving a client, even if the client attempts to sexualize the relationship. Sexual activity includes any verbal and/or nonverbal behavior for the purpose of soliciting, receiving, or giving sexual gratification.

**5.** Be truthful in advertising and marketing, and not misrepresent services, charges for services, credentials, training, experience or results.

**6.** Safeguard the confidentiality of all client information, unless disclosure is requested by the client in writing or as allowed or required by law.

**7.** Obtain informed and voluntary consent from clients.

**8.** Allow a client the right to refuse, modify or terminate treatment regardless of prior consent given.

**9.** Provide draping and treatment in a way that ensures the safety, comfort, and privacy of the client.

**10.** Possess the right to refuse to treat any person or part of the body.

**11.** Refuse any gifts or benefits that are intended to influence a referral, decision, treatment or the professional relationship between the licensee and the client.

**12.** Report to the Idaho Board of Massage Therapy any unlicensed practice of massage therapy, and any evidence indicating unethical, incompetent or illegal acts committed by a licensee or individual.

**13.** Do no harm to the physical, mental, and emotional well being of clients.

**IDAHO BOARD OF MASSAGE THERAPY STANDARDS OF PRACTICE --  
APPENDIX B**

**Standard I: Professionalism**

In his/her professional role the licensee shall:

1. Cooperate with any Board investigation regarding any alleged violation of the Massage Therapy law or rules.
2. Use professional verbal, nonverbal, and written communications.
3. Provide an environment that is safe for the client and which meets all legal requirements for health and safety.
4. Use standard precautions to ensure professional hygienic practices and maintain a level of personal hygiene appropriate for practitioners in the therapeutic setting.
5. Wear clothing that is clean and professional.
6. Obtain voluntary and informed consent from the client, or written informed consent from client's legal guardian, prior to initiating the treatment plan.
7. If applicable, conduct an accurate needs assessment, develop a plan of care with the client, and update the plan as needed.
8. Use appropriate draping to protect the client's physical and emotional privacy. When clients remain dressed for seated massage or sports massage, draping is not required.
9. Not practice under the influence of alcohol, drugs, or any illegal substances, with the exception of legal or prescribed dosage of medication which does not impair the licensee.

**Standard II: Legal and Ethical Requirements**

In his/her professional role the licensee shall:

1. Maintain accurate and complete client billing and records. Client Records includes notes written by a licensee and kept in a separate client file that indicates the date of the session, areas of complaint as stated by client, and observations made and actions taken by the licensee.
2. Report within thirty (30) days to the Idaho Board of Massage Therapy any felony or misdemeanor criminal convictions of the licensee.

**Standard III: Confidentiality**

In his/her professional role the licensee shall:

1. Protect the confidentiality of the client's identity in conversations, all advertisements, and any and all other matters unless disclosure of identifiable information is requested or permitted by the client in writing or is required or allowed by law.
2. Protect the interests of clients who are minors or clients who are unable to give voluntary and informed consent by securing written informed consent from an appropriate third party or guardian.
3. Solicit only information that is relevant or reasonable to the professional relationship.

4. Maintain the client files for a minimum period of seven (7) years.
5. Store and dispose of client files in a secure manner.

**Standard IV: Business Practices**

In his/her professional role the licensee shall:

1. Not use sensational, sexual, or provocative language and/or pictures to advertise or promote their business.
2. Display/discuss a schedule of fees in advance of the session that is clearly understood by the client or potential client.
3. Make financial arrangements in advance that are clearly understood by, and safeguard the best interests of, the client or consumer.

**Standard V: Roles and Boundaries**

In his/her professional role the licensee shall:

1. Not participate in client relationships that could impair professional judgment or result in exploitation of the client.

**Standard VI: Prevention of Sexual Misconduct**

In his/her professional role the licensee shall:

1. Not engage in any behavior that sexualizes, or appears to sexualize, the client/licensee relationship.
2. Not participate in a sexual relationship or sexual conduct with the client, whether consensual or otherwise, from the beginning of the client/licensee relationship and for a minimum of twelve (12) months after the termination of the client/licensee relationship.
3. In the event that the client initiates sexual behavior, clarify the purpose of the therapeutic session and, if such conduct does not cease, terminate or refuse the session.

# IDAPA 24 – DIVISION OF OCCUPATIONAL AND PROFESSIONAL LICENSES

## 24.28.01 – RULES OF THE BARBER AND COSMETOLOGY SERVICES LICENSING BOARD

### DOCKET NO. 24-2801-2000F (FEE RULE)

#### NOTICE OF OMNIBUS RULEMAKING – ADOPTION OF TEMPORARY RULE

**EFFECTIVE DATE:** The effective date of the temporary rules being adopted through this omnibus rulemaking is the adjournment date of the second regular session of the 65th Idaho State Legislature - March 20, 2020.

**AUTHORITY:** In compliance with Sections 67-5226, Idaho Code, notice is hereby given this agency has adopted a temporary rule. The action is authorized pursuant to Sections 54-5807, Idaho Code, and 54-5822.

**DESCRIPTIVE SUMMARY:** The following is the required finding and concise statement of its supporting reasons for adopting a temporary rule:

This temporary rulemaking adopts the following chapter under IDAPA 24.28.01:

#### **IDAPA 24.28**

- 24.28.01, *Rules of the Barber and Cosmetology Services Licensing Board.*

**TEMPORARY RULE JUSTIFICATION:** Pursuant to Sections 67-5226(1) and 67-5226(2), Idaho Code, the Governor has found that temporary adoption of the rule is appropriate for the following reasons:

These temporary rules are necessary to protect the public health, safety, and welfare of the citizens of Idaho and confer a benefit on its citizens. These temporary rules implement the duly enacted laws of the state of Idaho, provide citizens with the detailed rules and standards for complying with those laws, and assist in the orderly execution and enforcement of those laws. The expiration of these rules without due consideration and processes would undermine the public health, safety, and welfare of the citizens of Idaho and deprive them of the benefit intended by these rules. These rules govern the qualifications and standards for licensees in the barber and cosmetology services industry, as well as the hygiene and sanitation standards of establishments which offer those services. Failing to reauthorize these rules would deprive the Board of the ability to protect the public health, safety, and welfare of the citizens of Idaho.

**FEE SUMMARY:** Pursuant to Section 67-5226(2), the Governor has found that the fees or charges being imposed or increased are justified and necessary to avoid immediate danger and the fees are described herein:

The fees or charges, authorized in Section 54-5822, Idaho Code, are part of the agency's 2021 budget that relies upon the existence of these fees or charges to meet the state's obligations and provide necessary state services. Failing to reauthorize these temporary rules would create immediate danger to the state budget, immediate danger to necessary state functions and services, and immediate danger of a violation of Idaho's constitutional requirement that it balance its budget.

The following is a specific description of the fees or charges:

<b>FEE TYPE</b>	<b>AMOUNT (Not to Exceed)</b>	<b>RENEWAL (Not to Exceed)</b>
Original License for Individual Licenses	\$25	\$25
Instructor License	\$30	\$30
Original License for Establishments	\$20	\$20
Original License for Schools	\$300	\$85
Original License or Registration for Facilities	\$20	\$20
Registration for Apprentice	\$25	
Certificate for Makeup Artist	\$25	

<b>FEE TYPE</b>	<b>AMOUNT (Not to Exceed)</b>	<b>RENEWAL (Not to Exceed)</b>
License by Endorsement	\$35	
Reinstatement	\$35	
Examination	As set by the Administrator	

**ASSISTANCE ON TECHNICAL QUESTIONS:** For assistance on technical questions concerning the temporary rule, contact Rob McQuade at (208) 334-3233.

DATED this February 21, 2020.

Kelley Packer  
Division Administrator  
Division of Occupational and Professional Licenses  
700 W. State Street  
P.O. Box 83720  
Boise, ID 83720  
Phone: (208) 334-3233  
Fax: (208) 334-3945

## 24.28.01 – RULES OF THE BARBER AND COSMETOLOGY SERVICES LICENSING BOARD

### 000. LEGAL AUTHORITY.

These rules are hereby prescribed and established pursuant to the authority vested in the Barber and Cosmetology Services Licensing Board by the provisions of Section 54-5807, Idaho Code. (3-20-20)T

### 001. TITLE AND SCOPE.

**01. Title.** The rules are titled IDAPA 24.28.01, “Rules of the Barber and Cosmetology Services Licensing Board.” (3-20-20)T

**02. Scope.** These rules implement the purposes and intent of Chapter 58, Title 54, Idaho Code, to regulate the professions of barbering and cosmetology in the interest of the public health, safety, and welfare. (3-20-20)T

### 002. -- 009. (RESERVED)

### 010. DEFINITIONS.

**01. Clean.** Removal of visible or surface debris, washing with soap and water, detergent or chemical “cleaner.” Cleaning reduces the number and slows the growth of pathogens on both porous and non-porous surfaces. Cleaning prepares non-porous items for disinfection, but cleaning does not make multi-use items safe for use. (3-20-20)T

**02. Clinical Services or Clinical Work.** Performing hands-on acts or techniques within the scope of practice of a profession regulated by the Board. (3-20-20)T

**03. Disinfect.** The process of making a non-porous item safe for use. Disinfecting requires the use of a chemical intended to kill or denature a bacteria, virus or fungus. Items to be disinfected must be cleaned prior to disinfection. Ultraviolet (UV) light is not acceptable for disinfection. (3-20-20)T

**04. Disinfectant.** Disinfectant registered by the United States Environmental Protection Agency (EPA) and is bactericidal, virucidal and fungicidal with effectiveness against staphylococcus aureus (including methicillin-resistant staphylococcus aureus (MRSA)), human immunodeficiency virus (HIV) and hepatitis B (HEPB). This includes EPA registered Sodium Hypochlorite 5.25% or higher (household bleach) with instructions for disinfection, diluted as instructed on the label and observing the five (5) minute contact time listed on the manufacturer’s label. Bleach must be active (not expired) with a manufacture date of less than six (6) months prior to use. (3-20-20)T

**05. Establishment.** Establishment means a place licensed under Chapter 58, Title 54, Idaho Code, other than a licensed school or licensed facility, where barber-styling, cosmetology, or electrology is practiced. (3-20-20)T

**06. Facility.** A retail cosmetics dealer, a retail thermal styling equipment dealer, or a makeover or glamour photography business. (3-20-20)T

**07. First-Aid Kit.** First-aid kit means a packaged and identifiable assortment of medical supplies, including adhesive bandages, skin antiseptic, disposable gloves, and gauze. (3-20-20)T

**08. Makeup.** Makeup means makeup, cosmetics, or any pigment product that is used to cover, camouflage, or decorate the skin. (3-20-20)T

**09. Patron.** Patron means any person who receives the services of anyone licensed, certificated or otherwise regulated by the provisions of Chapter 58, Title 54, Idaho Code. (3-20-20)T

**10. Record of Instruction.** The final documentation of total hours and operations completed by a student that is maintained by a school or, in the case of an apprentice, by the instructor. (3-20-20)T

**11. Single-Use.** Any non-electrical item that cannot be properly cleaned and disinfected is considered single-use. This includes, but is not limited to, pumice stones, buffing blocks, wooden cuticle pushers, cotton balls, pads or swabs, toe separators and flip flops, and all nail files or emery boards that are not made entirely of metal, glass, or crystal. (3-20-20)T

**12. Sterilize.** The eradication of all microbial life through the use of heat, steam or chemical sterilants.



Items to be sterilized must be cleaned prior to sterilization. (3-20-20)T

**13. Sterilant.** Autoclaves or dry heat sterilizers approved by the United States Food and Drug Administration and spore tested through an independent lab at least once every thirty (30) days. Sterilants must be used only as instructed by the manufacturer. Spore testing results and maintenance records for the most recent twelve (12) months must be kept onsite at the establishment. (3-20-20)T

**011. UPDATE OF RECORDS.**

Applicants, licensees, registrants, and certificants are responsible for keeping their records updated with the Division. All changes including name changes and change of address must be submitted in writing to the Division within thirty (30) days. The most recent mailing address on file with the Division will be used for purposes of all written communication with a licensee, registrant, or certificant including notification of renewal and notices related to disciplinary actions. (3-20-20)T

**012. -- 099. (RESERVED)**

**100. ORGANIZATION AND OPERATIONS OF THE BOARD.**

**01. Meetings.** The Board shall meet at least annually and at other such times and places as designated by the Chairman, upon the request of the governor, or upon the written request of a majority of the members of the Board. (3-20-20)T

**a.** A minimum of four (4) Board members shall constitute a quorum and shall be required for the transaction of business, provided at least one (1) board member of the relevant profession is present when any board action is taken that affects the profession, its licensees, or its applicants. A majority vote of the quorum present at a meeting shall be considered the action of the Board as a whole. (3-20-20)T

**b.** The Chairman shall be a voting member. (3-20-20)T

**02. Organization.** At the first meeting of each fiscal year, the Board shall elect from its members a Chairman, who shall assume the duty of the office immediately upon such selection. (3-20-20)T

**a.** The Chairman shall preside at all meetings when present, appoint all committees with the consent of the Board, and otherwise perform all duties pertaining to the office of Chairman. (3-20-20)T

**b.** The Division shall act as an agent of the Board and shall be the official keeper of all records of the Board. The Division shall provide such services as may be authorized by Chapter 26, Title 67, Idaho Code, and as defined under contract between the Division and the Board. (3-20-20)T

**101. -- 199. (RESERVED)**

**200. APPLICATION.**

**01. Filing an Application.** Applicants for licensure, certification, or registration shall submit a complete application, verified under oath, to the Board at its official address. The application shall be on the forms approved by the Board and submitted together with the appropriate fee(s) and supporting documentation. (3-20-20)T

**02. Supporting Documents.** The applicant must provide or facilitate the provision of any supporting third party documents that may be required under the qualifications for the license, certificate, or registration being sought. (3-20-20)T

**03. Applications Must Be Complete.** Applications shall not be considered complete until all required information, documents, and fees are received by the Board. (3-20-20)T

**04. Application Deadline Date.** Applications received less than seven (7) days prior to a Board meeting may be held over to the next meeting. (3-20-20)T

**05. Lack of Activity.** If an applicant fails to respond to a Board request or an application has lacked activity for twelve (12) consecutive months, the application on file with the Board will be deemed denied and will be terminated upon a thirty (30) day written notice, unless good cause is demonstrated to the Board. (3-20-20)T

**201. -- 249. (RESERVED)**

**250. FEES.**

All fees are non-refundable.

(3-20-20)T

<b>FEE TYPE</b>	<b>AMOUNT (Not to Exceed)</b>	<b>RENEWAL (Not to Exceed)</b>
Original License for Individual Licenses	\$25	\$25
Instructor License	\$30	\$30
Original License for Establishments	\$20	\$20
Original License for Schools	\$300	\$85
Original License or Registration for Facilities	\$20	\$20
Registration for Apprentice	\$25	
Certificate for Makeup Artist	\$25	
License by Endorsement	\$35	
Reinstatement	\$35	
Examination	As set by the Administrator	

(3-20-20)T

**251. -- 299. (RESERVED)**

**300. QUALIFICATIONS FOR ALL LICENSES OR CERTIFICATES FOR INDIVIDUALS.**

In addition to other qualifications set forth in these rules, each applicant for licensure or certification must meet the following general qualifications: (3-20-20)T

**01. Age.** Be at least sixteen and one-half (16 ½) years of age. (3-20-20)T

**02. Education.** Successful completion of at least two (2) years of high school or have attained an equivalent education as determined by the Board as evidenced by: (3-20-20)T

**a.** High school transcripts, a copy of a high school diploma, or a letter written on high school stationery, signed by an officer of the high school, indicating that the applicant has satisfactorily completed the tenth grade and is eligible to commence the eleventh grade; or (3-20-20)T

**b.** Documents establishing admission to or graduation from an associates, bachelors, or graduate degree program from an accredited college or university; or (3-20-20)T

**c.** Successful passage of the General Educational Development (G.E.D.) Test; or (3-20-20)T

**d.** Any test approved by the Department of Education to establish education equivalency shall be approved by the Board when an applicant receives a score approved by the Department of Education as meeting the equivalency requirement; or (3-20-20)T

**e.** Other proof of satisfactory completion of the tenth grade with eligibility to commence the eleventh grade. (3-20-20)T

**03. Good Moral Character.** (3-20-20)T

**a.** An applicant must certify that he/she has not been found guilty, been convicted, or received a withheld judgment or suspended sentence for a felony or a crime involving moral turpitude. If the applicant has been found guilty, been convicted, or received a withheld judgment or suspended sentence for such a crime, the applicant must submit a written statement of suitability for licensure or certification as set forth in Section 312 of these rules.

(3-20-20)T

**b.** An applicant must certify that he/she or his/her license has not been subject to any disciplinary action by a regulatory entity in another state, territory, or country including, but not limited to, having an application for licensure denied. If the applicant or his/her license has been subject to discipline, the applicant must submit a written statement of suitability for licensure or certification as set forth in Section 312 of these rules.

(3-20-20)T

**301. QUALIFICATIONS FOR ORIGINAL BARBER LICENSE.**

The Board may grant a license to an applicant for licensure as a barber who completes an application as set forth in Section 200 of these rules, pays the required fee, and who meets the following general, education, experience, and examination qualifications:

(3-20-20)T

**01. General.** Meet the requirements prescribed in Section 300 of these rules. (3-20-20)T

**02. Education.** Successful completion and graduation from a program of barbering consisting of not less than nine hundred (900) hours of instruction in a licensed barber school, or the following equivalent instruction:

(3-20-20)T

**a.** For a currently licensed cosmetologist, a licensed barber school must credit eight hundred (800) hours toward the required nine hundred (900) hours for a barber course. The school must submit for the Board's approval a written explanation of how the credited hours and the remaining hours of instruction will be allotted among the subjects in the barber course curriculum, provided that the remaining hours of instruction must at a minimum include the following:

(3-20-20)T

i. Barber theory, including male haircuts; and (3-20-20)T

ii. Shaving. (3-20-20)T

**b.** For a currently licensed barber in another state, territory, possession or country, and who does not meet the qualifications for licensure by endorsement, fifty (50) hours of instruction may be credited for each three (3) months of practical experience in barbering.

(3-20-20)T

**03. Examination.** Successful passage of a barber examination approved by the Board. (3-20-20)T

**302. QUALIFICATIONS FOR ORIGINAL BARBER-STYLIST LICENSE.**

The Board may grant a license to an applicant for licensure as a barber-stylist who completes an application as set forth in Section 200 of these rules, pays the required fee, and meets the following general, education, and examination qualifications:

(3-20-20)T

**01. General.** Meet the requirements prescribed in Section 300 of these rules. (3-20-20)T

**02. Education.** Successful completion and graduation from a program of barber-styling consisting of not less than one thousand five hundred (1,500) hours of instruction in a licensed barber school, or the following equivalent instruction:

(3-20-20)T

**a.** For a currently licensed cosmetologist, a licensed barber school must credit of one thousand four hundred (1,400) hours toward the required one thousand five hundred (1,500) hours for a barber-stylist course. The school must submit for the Board's approval a written explanation of how the credited hours and the remaining hours of instruction will be allotted among the subjects in the barber-stylist course curriculum, provided that the remaining hours of instruction must at a minimum include the following:

(3-20-20)T

- i. Barber theory, including male haircuts; and (3-20-20)T
- ii. Shaving. (3-20-20)T
- b.** For a currently licensed barber-stylist in another state, territory, possession or country, fifty (50) hours of instruction may be credited for each three (3) months of practical experience in barber-styling. (3-20-20)T

**03. Examination.** Successful passage of a barber-stylist examination approved by the Board. (3-20-20)T

**303. QUALIFICATIONS FOR ORIGINAL COSMETOLOGIST LICENSE.**

The Board may grant a license to an applicant for licensure as a cosmetologist who completes an application as set forth in Section 200 of these rules, pays the required fee, and meets the following general, education, and examination qualifications: (3-20-20)T

**01. General.** Meet the requirements prescribed in Section 300 of these rules. (3-20-20)T

**02. Education.** Successful completion and graduation from a program of cosmetology consisting of not less than one thousand six hundred (1,600) hours of instruction in a licensed cosmetology school or completed at least three thousand two hundred (3,200) hours in an apprenticeship that meets the requirements of Section 550 of these rules, or the following equivalent instruction: (3-20-20)T

**a.** For a currently licensed barber-stylist, a licensed cosmetology school must credit one thousand three hundred (1,300) hours toward the required one thousand six hundred (1,600) hours for a cosmetology course. The school must submit for the Board's approval a written explanation of how the credited hours and the remaining hours of instruction will be allotted among the subjects in the cosmetology course curriculum, provided that the remaining hours of instruction must at a minimum include the following: (3-20-20)T

- i. Nail technology; (3-20-20)T
- ii. Esthetics; and (3-20-20)T
- iii. Cosmetology theory, including female hairstyling. (3-20-20)T

**b.** For a currently licensed barber, a licensed cosmetology school must credit nine hundred (900) hours toward the required one thousand six hundred (1,600) hours for a cosmetology course. The school must submit for the Board's approval a written explanation of how the credited hours and the remaining hours of instruction will be allotted among the subjects in the cosmetology course curriculum, provided that the remaining hours of instruction must at a minimum include the following: (3-20-20)T

- i. Working on the hair with chemicals; (3-20-20)T
- ii. Nail technology; (3-20-20)T
- iii. Esthetics; and (3-20-20)T
- iv. Cosmetology theory, including female hairstyling. (3-20-20)T

**c.** A currently licensed esthetician, haircutter, or nail technician must be given credit of two hundred (200) hours toward the required one thousand six hundred (1,600) hours for a cosmetology course or four hundred (400) hours toward the required three thousand two hundred (3,200) hours as a cosmetology apprentice. (3-20-20)T

**d.** For a currently certificated makeup artist in this state, a licensed cosmetology school may credit up to fifty (50) hours toward the required instructional hours for a cosmetology course, or a licensed instructor may credit up to one hundred (100) hours toward the required apprenticeship hours. (3-20-20)T

**e.** For an esthetician, haircutter, or nail technician student, a licensed cosmetology school may credit

eighty percent (80%) of accumulated hours, but no more than two hundred (200) hours, toward the required instructional hours for a cosmetology course. (3-20-20)T

**f.** For a currently licensed cosmetologist in another state, territory, possession or country, one hundred (100) hours of instruction or two hundred (200) hours as an apprentice may be credited for each six-month period of practical experience in cosmetology. (3-20-20)T

**03. Examination.** Successful passage of the cosmetology examination approved by the Board. (3-20-20)T

**304. QUALIFICATIONS FOR ORIGINAL ELECTROLOGIST LICENSE.**

The Board may grant a license to an applicant for licensure as an electrologist who completes an application as set forth in Section 200 of these rules, pays the required fee, and meets the following general, education, and examination qualifications: (3-20-20)T

**01. General.** Meet the requirements prescribed in Section 300 of these rules. (3-20-20)T

**02. Education.** Successful completion and graduation from a program of electrology consisting of not less than six hundred (600) hours of instruction in a licensed cosmetology school approved to teach electrology or successful completion of at least one thousand two hundred (1,200) hours in an apprenticeship that meets the requirements of Section 550 of these rules. For a currently licensed electrologist in another state, territory, possession or country, forty (40) hours of instruction or eighty (80) hours as an apprentice may be credited for each six-month period of practical experience in electrology. (3-20-20)T

**03. Examination.** Successful passage of the electrologist examination conducted or approved by the Board. (3-20-20)T

**305. QUALIFICATIONS FOR ORIGINAL ESTHETICIAN LICENSE.**

The Board may grant a license to an applicant for licensure as an esthetician who completes an application as set forth in Section 200 of these rules, pays the required fee, and meets the following general, education, and examination qualifications: (3-20-20)T

**01. General.** Meet the requirements prescribed in Section 300 of these rules. (3-20-20)T

**02. Education.** Successful completion and graduation from a program of esthetics consisting of not less than six hundred (600) hours of instruction in a licensed cosmetology school or successful completion of at least one thousand two hundred (1,200) hours in an apprenticeship that meets the requirements of Section 550 of these rules, or the following equivalent instruction: (3-20-20)T

**a.** For a currently certificated makeup artist in this state, a licensed cosmetology school may credit up to fifty (50) hours toward the required instructional hours for an esthetics course or, a licensed instructor may credit up to one hundred (100) hours toward the required apprenticeship hours. (3-20-20)T

**b.** A licensed cosmetology school may credit one-seventh (1/7) of accumulated hours toward the required instructional hours for an esthetics course for a cosmetology student. (3-20-20)T

**c.** For a currently licensed esthetician in another state, territory, possession or country, sixty (60) hours of instruction or one hundred twenty (120) hours as an apprentice may be given for each six-month period of practical experience in esthetics. (3-20-20)T

**03. Examination.** Successful passage of the esthetician examination approved by the Board. (3-20-20)T

**306. QUALIFICATIONS FOR ORIGINAL HAIRCUTTER LICENSE.**

The Board may grant a license to an applicant for licensure as a haircutter who completes an application as set forth in Section 200 of these rules, pays the required fee, and meets the following general, education, and examination qualifications: (3-20-20)T

- 01. General.** Meet the requirements prescribed in Section 300 of these rules. (3-20-20)T
- 02. Education.** Successful completion of and graduation from a program of haircutting consisting of not less than nine hundred (900) hours of instruction in a licensed cosmetology school or the following equivalent instruction: (3-20-20)T
- a.** A licensed cosmetology school may credit one-seventh (1/7) of accumulated hours toward the required instructional hours for a haircutter course for a cosmetology student. (3-20-20)T
- b.** For a currently licensed haircutter in another state, territory, possession or country, ninety (90) hours of instruction or one hundred twenty (120) hours as an apprentice may be credited for each six-month period of practical experience in haircutting, hair design, or cosmetology. (3-20-20)T

**307. QUALIFICATIONS FOR ORIGINAL NAIL TECHNICIAN LICENSE.**

The Board may grant a license to an applicant for licensure as a nail technician who completes an application as set forth in Section 200 of these rules, pays the required fee, and meets the following general, education, and examination qualifications: (3-20-20)T

- 01. General.** Meet the requirements prescribed in Section 300 of these rules. (3-20-20)T
- 02. Education.** Successful completion and graduation from a program of nail technology consisting of not less than four hundred (400) hours of instruction in a cosmetology school approved by the Board or completed at least eight hundred (800) hours in an apprenticeship that meets the requirements of Section 550 of these rules, or the following equivalent instruction: (3-20-20)T
- a.** A licensed cosmetology school may credit one-seventh (1/7) of accumulated hours toward the required instructional hours for a nail technology course for a cosmetology student. (3-20-20)T
- b.** For a currently licensed nail technician in another state, territory, possession or country, forty (40) hours of instruction or eighty (80) hours as an apprentice may be credited for each six-month period of practical experience in nail technology. (3-20-20)T

- 03. Examination.** Successful passage of the nail technician examination approved by the Board. (3-20-20)T

**308. QUALIFICATIONS FOR MAKEUP ARTIST CERTIFICATE.**

The Board may grant a certificate to an applicant for certification as a makeup artist who completes an application as set forth in Section 200 of these rules, pays the required fee, and meets the following general and education/training requirements: (3-20-20)T

- 01. General.** Meet the requirements prescribed in Section 300 of these rules. (3-20-20)T
- 02. Education/Training.** Successful completion of instruction of not less than one hundred (100) hours in makeup artistry, which must include instruction and practical experience in safety and infection control. Hours may be classroom instruction, training, practical experience, or a combination. Instruction may be received from one or more of the following sources: (3-20-20)T
- a.** A cosmetology school licensed in this state or another state, territory, possession, or country; (3-20-20)T
- b.** A cosmetology or esthetics instructor licensed in this state or another state, territory or possession; (3-20-20)T
- c.** A retail cosmetics dealer licensed in this state or another state, territory or possession; or (3-20-20)T

- d. Other source of instruction that includes: (3-20-20)T
    - i. Knowledgeable and experienced instructor with a record of safe practices; (3-20-20)T
    - ii. Instruction in client safety and safe product selection; and (3-20-20)T
    - iii. Hands-on practice and training in infection control. (3-20-20)T
  - e. Any combination of the sources listed in Subsections 308.02.a. through d. of these rules. (3-20-20)T
- 03. Documentation of Education/Training.** An applicant may present proof of education/training in makeup artistry in the following ways: (3-20-20)T
- a. A current cosmetology or esthetician license from another state, territory, possession or country. (3-20-20)T
  - b. Transcripts or records of instruction. (3-20-20)T
  - c. Documentation of work history and training as an employee for a retail cosmetics dealer licensed in this state or another state, territory or possession of the United States. (3-20-20)T
  - d. Membership in the International Alliance of Theatrical Stage Employees Make-Up Artists and Hair Stylists Guild or other similar organization whose membership requirements meet or exceed the requirements of these rules. (3-20-20)T
  - e. Documentation of other training/experience must include: (3-20-20)T
    - i. Identity and qualifications of the person delivering the instruction/training; (3-20-20)T
    - ii. Method of instruction/training and amount of hands-on training provided; and (3-20-20)T
    - iii. Subject matters covered, particularly pertaining to topics listed in Subsection 308.02.d. of these rules. (3-20-20)T
- 04. Additional Education/Training.** The Board may require an applicant who does not have a documented record of sufficient training in safety and infection control to obtain additional training or other demonstration of competency in that area. (3-20-20)T

**309. QUALIFICATIONS FOR ORIGINAL BARBER OR BARBER-STYLIST INSTRUCTOR LICENSE.**

The Board may grant a license to an applicant for licensure as a barber instructor or barber-stylist instructor who completes an application as set forth in Section 200 of these rules, pays the required fee, and meets the following licensure, education, experience, and examination qualifications: (3-20-20)T

- 01. Licensure.** Hold a current barber license for a barber instructor applicant or hold a current barber-stylist or cosmetologist license for a barber-stylist instructor applicant. (3-20-20)T
- 02. Education and Experience.** At least five (5) years of experience as a licensed barber for a barber instructor applicant or as a licensed barber-stylist for a barber-stylist instructor applicant or have satisfactorily completed: (3-20-20)T
  - a. A minimum six (6) month course of barber instructing for a barber instructor applicant or barber-stylist instructing for a barber-stylist instructor applicant as a student in a licensed barber school, provided that the course consist of no less than nine hundred (900) hours; or (3-20-20)T
  - b. A minimum three (3) month course of barber instructing for a barber instructor applicant or barber-

stylist instructing for a barber-stylist instructor applicant as a student in a licensed barber school, if the applicant has at least two (2) years of experience as a licensed barber for a barber instructor applicant or as a barber-stylist for a barber-stylist instructor applicant, provided that the course consist of no less than five hundred (500) hours; or

(3-20-20)T

c. Hold a cosmetology instructor license in this state. (3-20-20)T

**03. Examination.** Successful passage of the instructor examination approved by the Board. (3-20-20)T

**04. Single License Required to Practice and Instruct.** The holder of a license issued by the board who is subsequently issued an instructor license is permitted to maintain a single license to practice. An instructor license issued by the board permits the holder to both practice and instruct only within the scope of the license(s) held under Subsection 01 of this rule. The holder of a cosmetologist license who is subsequently issued a barber-stylist instructor license may not practice or instruct elements of barbering or barber-styling that are outside the definition of cosmetology unless the licensee also has been issued a license as a barber or barber-stylist by the board. (3-20-20)T

**310. QUALIFICATIONS FOR ORIGINAL COSMETOLOGY INSTRUCTOR LICENSE.**

The Board may grant a license to an applicant for licensure as an instructor of cosmetology, electrology, esthetics, or nail technology who completes an application as set forth in Section 200 of these rules, pays the required fee, and meets the following licensure, education, experience, and examination qualifications: (3-20-20)T

**01. General.** Meet the requirements prescribed in Section 300 of these rules. (3-20-20)T

**02. Licensure.** Hold a current license as a cosmetologist, electrologist, esthetician, or nail technician. (3-20-20)T

**03. Education or Equivalent.** Earned twelve (12) college credit hours or the equivalent. Credit hours must be obtained from the Education Department, Speech Communications Department or from the Psychology/Sociology Department and other credit at the discretion of the Board. Equivalency is determined as: (3-20-20)T

a. Completion of teaching seminars focusing on cosmetology, nail technology, esthetics, or electrology approved by the Board. Fourteen (14) clock hours is equivalent to one (1) semester college credit hour in an approved seminar. Verification of satisfactory completion must be submitted to the Board for its approval; or (3-20-20)T

b. Verified satisfactory teaching as a qualified instructor from another state for one (1) of the previous three (3) years immediately prior to application; or (3-20-20)T

c. Successful passage of the instructor examination approved by the Board. (3-20-20)T

**04. Experience.** At least five (5) years of experience as a licensed cosmetologist, electrologist, esthetician, or nail technician, which must be immediately preceding the application, or have satisfactorily completed: (3-20-20)T

a. A minimum six (6) month course of cosmetology instructing as a student in a licensed cosmetology school, provided that the course consist of no less than nine hundred (900) hours; or (3-20-20)T

b. A minimum three (3) month course of cosmetology instructing as a student in a licensed cosmetology school, if the applicant has at least two (2) years of experience as a licensed cosmetologist, electrologist, esthetician, or nail technician, provided that the course consist of no less than five hundred (500) hours; or (3-20-20)T

c. Hold a barber or barber-stylist instructor license in this state. (3-20-20)T

**05. Single License Required to Practice and Instruct.** The holder of a license issued by the Board who is subsequently issued an instructor license is permitted to maintain a single license to practice. An instructor license issued by the Board permits the holder to both practice and instruct only within the scope of the license(s)



held under Subsection 310.02 of this rule. (3-20-20)T

**311. APPROVED EXAMINATION.**

Approved examinations shall be the written and practical examination provided by the National Interstate Council of State Boards of Cosmetology (NIC) for the discipline for which licensure is sought. A passing score must be obtained on both the written and practical examination. A passing score will be determined by NIC. (3-20-20)T

**312. WRITTEN STATEMENT OF SUITABILITY FOR LICENSURE OR CERTIFICATION.**

An applicant who or whose license has a conviction, finding of guilt, withheld judgment, or suspended sentence for a felony or crime involving moral turpitude, or has been subject to discipline in another state, territory or country must submit with his/her application a written statement and any supplemental information establishing his/her current suitability for licensure or certification. (3-20-20)T

**01. Consideration of Factors and Evidence.** The Board shall consider the following factors or evidence: (3-20-20)T

- a.** The severity or nature of the crime or discipline; (3-20-20)T
- b.** The period of time that has passed since the crime or discipline under review; (3-20-20)T
- c.** The number or pattern of crimes or discipline or other similar incidents; (3-20-20)T
- d.** The circumstances surrounding the crime or discipline that would help determine the risk of repetition; (3-20-20)T
- e.** The relationship of the crime or discipline to the practice of barbering or cosmetology; (3-20-20)T
- f.** The applicant's activities since the crime or discipline under review, such as employment, education, participation in treatment, payment of restitution, or any other factors which may be evidence of current rehabilitation; and (3-20-20)T
- g.** Any other information regarding rehabilitation or mitigating circumstances. (3-20-20)T

**02. Interview.** The board may, at its discretion, grant an interview of the applicant. (3-20-20)T

**03. Applicant Bears the Burden.** The applicant shall bear the burden of establishing his/her current suitability for licensure or certification. (3-20-20)T

**313. REQUIREMENTS FOR LICENSURE BY ENDORSEMENT.**

The Board may grant a license to an applicant for licensure by endorsement who completes an application as set forth in Section 200 of these rules and meets the following requirements: (3-20-20)T

**01. General Requirements.** The applicant must: (3-20-20)T

- a.** Be at least eighteen (18) years of age; (3-20-20)T
- b.** Meet the education requirements set forth in Subsection 300.02 of these rules; and (3-20-20)T
- c.** Meet the good moral character requirements set forth in Subsection 300.03 of these rules. (3-20-20)T

**02. Hold a Current License and Have Experience.** The applicant must be the holder of a current active license or certificate of qualification in the profession and at the level for which a license is being sought, issued by the authorized regulatory entity in another state, territory, possession, or foreign country. The certification of licensure must be received by the Board from the issuing agency; and (3-20-20)T

- a.** Must show that the state, territory, possession, or foreign country has licensing requirements

substantially equivalent to or higher than those required for new applicants in Idaho; or (3-20-20)T

**b.** Document at least one (1) year of actual practice under certification or licensure in the three (3) years immediately prior to application in the profession for which a license is being sought. (3-20-20)T

**314. -- 324. (RESERVED)**

**325. LICENSURE AND OPERATION OF PRIMARY AND CONTIGUOUS ESTABLISHMENTS.**

Except as otherwise provided in statute and these rules, a licensed individual must practice within a licensed establishment. An establishment may be licensed as a primary establishment or a contiguous establishment that operates within a primary establishment. (3-20-20)T

**01. Primary Establishment License.** A primary establishment license may be issued and annually renewed only under the following conditions: (3-20-20)T

**a.** Application for establishment license shall be made on forms furnished by the Board and shall include plans and specifications complying with the Board's safety and disinfection requirements. The fully completed application form, with the required fees, must be submitted to the Board and a license issued prior to the opening or operation of any barber or cosmetology primary establishment; and (3-20-20)T

**b.** There is a clearly defined and designated working floor space of adequate dimension to allow the safe and sanitary practice of any one (1) or combination of defined practices of cosmetology or barber-styling for all individual stations that may be in operation in addition to any restroom and access areas; and (3-20-20)T

**c.** There is an approved hot and cold running water source and drainage system that is available to any contiguous establishment or other establishment or facility that may exist; and must be within the perimeters of the licensed establishment and separate from the toilet facilities; and (3-20-20)T

**d.** There are restroom facilities conveniently located and accessible from within the building in which the primary establishment is located and which shall be accessible from the primary area and to all areas designated for the operation of contiguous establishments. Restroom facilities shall contain an approved hot and cold running water source and approved drainage system. The water source shall be in addition to the work area facilities; and (3-20-20)T

**e.** Any areas designated by the primary establishment for the operation of contiguous establishments shall be clearly defined and fixed, and shall provide adequate dimension to allow the safe and sanitary practice of any one or a combination of the defined practices of cosmetology or barber-styling for all stations that may be operated in that area. (3-20-20)T

**f.** The holder of the primary establishment license is responsible for complying with the safety and disinfection requirements and all other applicable statutes and rules for the designated licensed area of the primary establishment, including areas that are cooperatively or jointly used as "common areas" such as shampoo bowls, restrooms, entrance or reception areas. (3-20-20)T

**02. Contiguous Establishment License.** A contiguous establishment license may be issued and annually renewed only under the following conditions: (3-20-20)T

**a.** Application for establishment license shall be made on forms furnished by the Board. The fully completed application form, with the required fees, must be submitted to the Board and a license issued prior to the opening or operation of any barber or cosmetology contiguous establishment; and (3-20-20)T

**b.** The contiguous establishment is associated with a currently licensed primary establishment and a holder of the primary establishment license provides proof that the primary shop is equipped to meet the safety and disinfection requirements and rules of the Board; and (3-20-20)T

**c.** The contiguous establishment shall only operate in the contiguous establishment designated areas within the associated primary establishment. (3-20-20)T

d. The holder of the contiguous establishment license will be responsible for complying with the safety and disinfection requirements and all other applicable statutes and rules for the contiguous designated area where it operates. (3-20-20)T

**03. Businesses Other Than a Licensed Establishment or Facility.** Businesses other than one licensed under Chapter 58, Title 54, Idaho Code, and living quarters shall be separate and apart. Home establishments must provide a separate outside entrance directly into the establishment and substantial partitions or walls shall extend from the floor to not less than seven (7) feet high, separating the establishment from adjoining rooms used for business or domestic purposes. All doors to an establishment from adjacent rooms shall be closed. (3-20-20)T

**04. Conditions for Issuance.** No primary establishment license may be issued which includes or overlaps all or any portion of an existing establishment license. (3-20-20)T

**326. ESTABLISHMENT CHANGES IN OWNERSHIP OR LOCATION.**

Whenever a change of ownership or fixed location of an establishment occurs, an original license fee must be paid and compliance with all rules concerning a new establishment must be met before a new license will be issued. Establishment licenses are not transferable. (3-20-20)T

**01. Board Must Be Informed of All Changes.** The Board must be informed in writing of any and all changes of ownership and location of establishments. (3-20-20)T

**02. Deletion of an Owner.** Deletion of an owner in a multiple ownership may be effected by filing a written statement with the Board signed by the person withdrawing and the remaining owner(s). (3-20-20)T

**03. Transfer of Ownership.** If the transfer involves change of corporate structure or deleting one (1) or more owners, a written notarized statement signed by all former owners as registered with the Board shall be accepted. (3-20-20)T

**04. Addition of an Owner.** Addition of an owner to a multiple ownership constitutes a change in ownership and the requirements for a new establishment apply. (3-20-20)T

**05. Out of Business.** Whenever any establishment ceases operation at the licensed location, the owner(s) or authorized agent of the establishment shall notify the Board by submitting: (3-20-20)T

a. A signed letter by the owner(s) or authorized agent advising that the establishment is out of business; or (3-20-20)T

b. The establishment license bearing the signature of the owner(s) or authorized agent and marked out-of-business; or (3-20-20)T

c. For a contiguous establishment license, a signed statement by the associated primary establishment advising that the contiguous establishment is out of business. (3-20-20)T

d. In the event that the Board has not been notified about the cessation of operations pursuant to this rule and documentation or evidence has been obtained that an establishment has ceased operation at the licensed location, the Board may cancel the establishment license upon a thirty (30) day written notice to the owner(s) or authorized agent of the establishment. (3-20-20)T

**06. License Status.** A new primary establishment license will not be issued for any location that is currently licensed as a primary establishment at the time of application. (3-20-20)T

**327. RETAIL COSMETICS DEALER LICENSE.**

The Board may grant a retail cosmetic dealer license to allow the application of cosmetic products to customers' faces in connection with the sale of the products. An applicant for a retail cosmetic dealer license must complete an application as set forth in Section 200 of these rules, pay the required fee, and meet the following requirements: (3-20-20)T

**01. Requirements.** All retail cosmetic dealers shall provide an area within the business premises for disinfection and storage of equipment and supplies necessary to perform any cosmetic application services provided. The business premises must have: (3-20-20)T

- a. Access to hot and cold running water; (3-20-20)T
- b. Access to restroom facilities; (3-20-20)T
- c. Disinfectants, as defined in these rules; (3-20-20)T
- d. Single-use samples, wipes, spatulas or other dispensing techniques designed to prevent contamination of the cosmetic product; and (3-20-20)T
- e. First-aid kit. (3-20-20)T

**02. Change in Ownership or Location.** Licenses are not transferable. Whenever a change of ownership or location of a facility occurs, a new application for a facility license must be submitted together with the required fee to the Board, and all the facility requirements must be met. (3-20-20)T

**03. Cessation of Operation.** Whenever any facility ceases operation at the licensed location, the owner(s) shall notify the Board in writing that the facility is out of business and the facility license shall be submitted to the Division. In the event that the Board has not been notified about the cessation of operations pursuant to this rule and documentation or evidence has been obtained that the facility has ceased operation at the licensed location, the Board may cancel the facility license upon a thirty (30) day written notice to the owner(s) or authorized agent of the facility. (3-20-20)T

**328. RETAIL THERMAL STYLING EQUIPMENT DEALER REGISTRATION.**

The Board may grant a registration as a retail thermal styling equipment dealer to an applicant who completes an application as set forth in Section 200 of these rules, pay the required fee, and meet the following requirements: (3-20-20)T

**01. Training.** The dealer is responsible to train all employees on the proper and safe use of the thermal styling equipment and all disinfection related to the demonstration of the equipment prior to permitting an employee's use of the equipment on customers. (3-20-20)T

**02. Requirements.** All retail thermal styling equipment dealers shall provide the equipment and supplies necessary to perform any demonstration of the thermal styling equipment. The area where the demonstration is being performed must have: (3-20-20)T

- a. Disinfectants, as defined in these rules; and (3-20-20)T
- b. First-aid kit. (3-20-20)T

**03. Change in Ownership or Location.** Registrations are not transferable. Whenever a change of ownership or location of a facility occurs, a new application for a registration must be submitted together with the required fee to the Board, and all the facility requirements must be met. (3-20-20)T

**04. Cessation of Operation.** Whenever any facility ceases operation at the licensed location, the owner(s) shall notify the Board in writing that the facility is out of business and the registration shall be submitted to the Division. In the event that the Board has not been notified about the cessation of operations pursuant to this rule and documentation or evidence has been obtained that the facility has ceased operation at the registered location, the Board may cancel the facility registration upon a thirty (30) day written notice to the owner(s) or authorized agent of the facility. (3-20-20)T

**329. -- 399. (RESERVED)**

**400. RENEWAL OR EXPIRATION OF LICENSE.**

A licensee must renew his/her/its license annually as set forth in Section 67-2614, Idaho Code, and may reinstate his/her/its license within five (5) years after expiration as provided in Section 67-2614, Idaho Code. (3-20-20)T

**401. -- 499. (RESERVED)**

**500. BARBER AND COSMETOLOGY SCHOOL REQUIREMENTS.**

The Board may grant a license to an applicant for licensure to operate a barber or cosmetology school who completes an application as set forth in Section 200 of these rules, pays the required fee, and who meets the following requirements: (3-20-20)T

**01. Premises.** The premises of a barber or cosmetology school must: (3-20-20)T

**a.** Possess sufficient apparatus and equipment for the proper and full teaching of all subjects or its curriculum. Each barber school must have at least one (1) barber chair that shall be of such construction that it may be readily cleaned and it shall be mechanically workable and in good working order. Space between barber chairs and the workstand or wall shall be adequate so that no student will be hampered in the performance of his/her work. (3-20-20)T

**b.** Provide adequate space, ventilation, lighting, and facilities to safely accommodate all students, instructors, and customers. (3-20-20)T

**c.** Have classroom and training areas equipped with sufficient seating capacity and work stations for all enrolled students. (3-20-20)T

**d.** Provide a restroom with a sink with hot and cold running water and approved drainage system. (3-20-20)T

**02. Faculty or Instructors.** A school must be under the direct, personal supervision at all times of a licensed cosmetology instructor if a cosmetology school or a licensed barber or barber-stylist instructor if a barber school and must employ and maintain a licensed instructor for every twenty (20) students or fraction thereof, with an instructor trainee counting as an instructor for the purposes of the student-instructor ratio. (3-20-20)T

**a.** An instructor shall teach only those subject areas for which the instructor has been issued a license by the Board to practice. (3-20-20)T

**b.** Instructors must devote their time during school or class hours to instructing students rather than engaging in occupational practice. (3-20-20)T

**03. Operations.** A barber or cosmetology school must: (3-20-20)T

**a.** Maintain regular class and instruction hours, establish grades and hold monthly examinations. This information will be transferred to the record of instruction; (3-20-20)T

**b.** Prescribe a school term for training in all aspects of the practice being taught; and (3-20-20)T

**c.** Offer school hours for the purpose of instruction on at least five (5) days per week. (3-20-20)T

**04. Curriculum.** A school must submit a curriculum and course catalog that covers the subjects, as set forth in Section 54-5815(1)(g), Idaho Code, relating to the profession for which the school is seeking approval to teach. Any proposed changes to a curriculum or catalog must be approved by the Board. The submission must identify what specific changes are being made to the curriculum. (3-20-20)T

**05. Clinical Work.** Each school shall advertise to the public that it is a school and that all work is done by students. The clinic area shall not have connecting entrances to establishments or businesses other than barber or cosmetology schools. (3-20-20)T

a. Students shall not be permitted to render any clinical service to patrons until students have completed at least five percent (5%) of the required hours of instruction. (3-20-20)T

b. All clinical work shall be performed under the supervision of a licensed instructor. (3-20-20)T

c. Clinical work shall be recorded on the record of instruction for each month. (3-20-20)T

**06. Outside School Activities.** Schools may credit a student with a maximum of thirty (30) hours toward the required hours of instruction for a course of instruction for activities that take place outside the school. These hours must be approved by the instructor. (3-20-20)T

**07. Student Records To be Maintained by the School.** A school must maintain the following records for each enrolled student: (3-20-20)T

a. Proof of age showing student is no less than sixteen and one-half (16 ½) years of age; (3-20-20)T

b. Proof of showing student has satisfactorily completed two (2) years of high school (tenth grade) or having equivalent education as evidenced in a manner identified in Subsection 300.02 of these rules; (3-20-20)T

c. Daily attendance record for each student; (3-20-20)T

d. Record of instruction for each student showing the classroom hours, the clinical hours, and operations done for each month in which the student is enrolled; and (3-20-20)T

e. When a student's course of instruction has been completed or terminated, the completed operations, and number of hours of instruction are to be recorded by the school on the record of instruction form. This form is to be provided to the student and maintained by the school for five (5) years from completion or termination. (3-20-20)T

**08. Change in Ownership or Location.** (3-20-20)T

a. Licenses are not transferable. (3-20-20)T

b. A new application must be submitted to the Board and a license issued for a new or additional location or a change of ownership of an existing school. (3-20-20)T

**09. Cessation of School.** When a school ceases to operate as a school, the school must provide each enrolled student his/her records of instruction at or before the cessation of operations. (3-20-20)T

**501. RULES FOR COSMETOLOGY SCHOOLS APPROVED TO TEACH ELECTROLOGY.**

The Board may grant a license to an applicant to operate an electrology school to an applicant who completes an application as set forth in Section 200 of these rules, pays the required fee, and meets the following requirements: (3-20-20)T

**01. Premises.** Schools provide a minimum of three hundred (300) square feet of designated floor space per six (6) students. (3-20-20)T

**02. Required Equipment.** Each school shall have the following equipment, which is considered the minimum equipment necessary for the proper instruction of students. This amount of equipment is based on six (6) students. (3-20-20)T

a. Work stations equal to seventy-five percent (75%) of total enrollment; (3-20-20)T

b. Two (2) brands of machines, one (1) of which has three (3) method capability: Galvanic, Thermolysis, and Blend; (3-20-20)T

c. Two (2) treatment tables and adjustable technician chairs; (3-20-20)T

- d. Two (2) swing arm lamps with magnifying lens; (3-20-20)T
  - e. Two (2) magnifying glasses; (3-20-20)T
  - f. Tweezers; (3-20-20)T
  - g. One (1) basin with approved water source; (3-20-20)T
  - h. Necessary sanitation equipment for implements; and (3-20-20)T
  - i. Closed storage cabinet. (3-20-20)T
- 03. Student Supplies.** Each student is to be issued a basic kit containing two (2) tweezers, disposable probes, eye shields, disposable gloves, before treatment solution, after treatment lotion, hair pins or clips, and one (1) sharps container. (3-20-20)T
- 04. Faculty or Instructors.** A school must be under the direct, personal supervision at all times of one (1) licensed electrologist instructor for every six (6) students or portion thereof being trained therein. (3-20-20)T
- 05. Curriculum.** A school must submit a curriculum and course catalog that covers the subjects relating to electrology as set forth in Section 54-5815(1)(g)(iv), Idaho Code. Any changes to a curriculum or catalog must be approved by the Board prior to implementing the proposed changes. The submission must identify what specific changes are being made to the curriculum. (3-20-20)T
- 06. Clinical Work.** A cosmetology school approved to teach electrology must meet the same requirements regarding clinical work as a school of cosmetology as set forth in Subsection 500.05 of these rules. (3-20-20)T
- 07. Student Records To be Maintained by the School.** Records required of cosmetology schools approved to teach electrology shall be maintained in accordance with the records required for schools of cosmetology as set forth in Subsection 500.06 of these rules. (3-20-20)T
- 08. Change in Ownership or Location.** (3-20-20)T
- a. Licenses are not transferable. (3-20-20)T
  - b. A new application must be submitted to the Board and a license issued for a new or additional location or a change of ownership of an existing school. (3-20-20)T
- 09. Cessation of School.** When a school ceases to operate as a school, the school must provide each enrolled student his/her records of instruction at or before the cessation of operations. (3-20-20)T
- 502. EDUCATIONAL PROGRAM STANDARDS FOR COURSES OF INSTRUCTION.**  
A licensed school must maintain the following educational program standards for each course of instruction for which it is approved to teach. (3-20-20)T
- 01. Barber.** Coursework must include courses in the following content areas: (3-20-20)T
    - a. Haircut; (3-20-20)T
    - b. Blow dry (does not include haircut); (3-20-20)T
    - c. Shampoo; (3-20-20)T
    - d. Shave and Beard Trim; (3-20-20)T

- e. Facial; (3-20-20)T
- f. Hair and Scalp Treatment; (3-20-20)T
- g. Curling Iron; and (3-20-20)T
- h. Hygiene and disinfection shall be taught on a continuing basis and indicated on the record of instruction. (3-20-20)T
- 02. Barber-Stylist.** Coursework must include courses in the following content areas: (3-20-20)T
  - a. Haircut; (3-20-20)T
  - b. Style/blow dry (does not include haircut); (3-20-20)T
  - c. Shampoo; (3-20-20)T
  - d. Permanent Wave; (3-20-20)T
  - e. Shave and Beard Trim; (3-20-20)T
  - f. Facial; (3-20-20)T
  - g. Color/Bleach/Rinse; (3-20-20)T
  - h. Hair and Scalp Treatment; (3-20-20)T
  - i. Curling Iron; and (3-20-20)T
  - j. Hygiene and disinfection shall be taught on a continuing basis and indicated on the record of instruction. (3-20-20)T
- 03. Cosmetology.** A record of the operations completed by each student shall be maintained and include the following: (3-20-20)T
  - a. Creative hair styling which shall include hair styles, wet sets/styling, thermal styles, fingerwaving, braiding/free styling; (3-20-20)T
  - b. Scalp Treatments; (3-20-20)T
  - c. Permanent Waves (All Methods); (3-20-20)T
  - d. Haircutting/shaping which shall include scissor and razor/clipper; (3-20-20)T
  - e. Bleaching; (3-20-20)T
  - f. Tinting; (3-20-20)T
  - g. Semi Permanent/Temporary Color; (3-20-20)T
  - h. Frosting/Highlights; (3-20-20)T
  - i. Facials; (3-20-20)T
  - j. Makeup Application; (3-20-20)T
  - k. Waxing; (3-20-20)T



- l.** Manicures which shall include plain and oil; (3-20-20)T
- m.** Pedicures (3-20-20)T
- n.** Artificial Nails; and (3-20-20)T
- o.** Hygiene and disinfection shall be taught on a continuing basis and indicated on the record of instruction. (3-20-20)T
- 04. Esthetics.** The recorded operations completed by each student shall be maintained and include the following: (3-20-20)T

  - a.** Massage and manipulation application of lotions, creams, tonics, solutions, skin care masks, and similar cosmetic preparations and their effects on the skin and body; (3-20-20)T
  - b.** Cleansing, steaming, exfoliation, and extraction procedures; (3-20-20)T
  - c.** Cosmetics and makeup application; (3-20-20)T
  - d.** Machine Application: use of mechanical or electrical equipment; (3-20-20)T
  - e.** Bacteriology, disinfection and sterilization, and safety precautions; (3-20-20)T
  - f.** Human anatomy, physiology and histology of skin care; (3-20-20)T
  - g.** Follicle growth cycle and hair removal procedures; (3-20-20)T
  - h.** Skin analysis, conditions, disorders, and diseases; and (3-20-20)T
  - i.** Hygiene and disinfection shall be taught on a continuing basis and indicated on the record of instruction. (3-20-20)T
- 05. Nail Technology.** The recorded operations completed by each student shall be maintained and include the following: (3-20-20)T

  - a.** Form nails; (3-20-20)T
  - b.** Finished tips; (3-20-20)T
  - c.** Wraps and mends; (3-20-20)T
  - d.** Basic manicures and pedicures; and (3-20-20)T
  - e.** Hygiene and disinfection shall be taught on a continuing basis and indicated on the record of instruction. (3-20-20)T
- 06. Haircutter.** The recorded operations completed by each student shall be maintained and include the following: (3-20-20)T

  - a.** Haircutting and Hair shaping; (3-20-20)T
  - b.** Creative hair styling which shall include hair styles, wet sets/styling, thermal styles, fingerwaving, braiding/free styling; (3-20-20)T
  - c.** Use of cutting implements; (3-20-20)T

- d. Basic shampooing and conditioning; and (3-20-20)T
- e. Hygiene and disinfection shall be taught on a continuing basis and indicated on the record of instruction. (3-20-20)T
- 07. Electrology.** The recorded operations completed by each student shall be maintained and include the following: (3-20-20)T
  - a. Bacteriology, disinfection and sterilization, safety precautions, anatomy, and physiology; (3-20-20)T
  - b. Electricity which shall include the nature of electrical current, principles of operating electrical devices and the various safety precautions used when operating electrical equipment; (3-20-20)T
  - c. Electrolysis which shall include the use and study of galvanic current; (3-20-20)T
  - d. Thermolysis, including the use and study of high frequency current, automatic and manual; (3-20-20)T
  - e. A combination of high frequency and galvanic currents; (3-20-20)T
  - f. The study and cause of hypertrichosis; and (3-20-20)T
  - g. Hygiene and disinfection shall be taught on a continuing basis and indicated on the record of instruction. (3-20-20)T
- 08. Instructor.** The recorded operations completed by each student shall be maintained and include the following: (3-20-20)T
  - a. Lesson planning; (3-20-20)T
  - b. Audio-Visual aid preparation; (3-20-20)T
  - c. Theory class; (3-20-20)T
  - d. Practical demonstrations; (3-20-20)T
  - e. Testing and evaluation theory; (3-20-20)T
  - f. Testing and evaluation; and (3-20-20)T
  - g. Clinic floor supervision. (3-20-20)T

**503. -- 549. (RESERVED)**

**550. APPRENTICE REGISTRATION AND APPRENTICESHIPS.**

The Board may issue a registration as an apprentice to allow a person to engage in the practice of cosmetology, nail technology, esthetics, electrology, or makeup artistry while completing the required instructional hours for a license or certificate. An apprentice may only practice under direct supervision as provided below. (3-20-20)T

- 01. Application and Qualifications.** An applicant must submit a completed application on a form approved by the Board, pay the required fee, and meet the following qualifications: (3-20-20)T
  - a. Be at least sixteen and one-half (16 ½) years of age; (3-20-20)T
  - b. Have successfully completed at least two (2) years of high school or have attained an equivalent education as determined by the board as evidenced in a manner identified in Subsection 300.02 of these rules;

(3-20-20)T

**c.** Have certification from the establishment that the applicant is enrolled as an apprentice in the establishment; (3-20-20)T

**d.** Identify the names and license numbers of the licensed cosmetologists, electrologists, estheticians, and nail technicians employed in the establishment in which the applicant will serve as an apprentice; and (3-20-20)T

**e.** Identify the name(s) and license number(s) of the licensed cosmetology, electrology, esthetics, or nail technology instructor who will instruct the applicant during the apprenticeship. (3-20-20)T

**02. Instruction.** The instructor for any apprenticeship must submit to the Board a curriculum for the entire course of apprenticeship instruction. The Board must approve the curriculum prior to the beginning of instruction. The curriculum must cover the subjects relating to the profession for which the apprentice is pursuing licensure as set forth in Section 54-5815(1)(g), Idaho Code. (3-20-20)T

**03. Supervision.** There must be at least one (1) licensed instructor and one (1) separate supervising licensee for each apprentice in the establishment at all times when an apprentice is being trained, except that an electrology apprentice may be supervised solely by the electrology instructor. (3-20-20)T

**a.** The instructor must be licensed to teach the profession for which the registrant is pursuing licensure and the supervising licensee must be licensed to practice the profession for which the apprentice is pursuing licensure. (3-20-20)T

**b.** An instructor may not train more than three (3) currently registered apprentices, except that an electrology instructor may not train more than one (1) currently registered electrology apprentice. (3-20-20)T

**c.** An establishment may not have more than six (6) currently registered apprentices, unless otherwise approved by the Board. (3-20-20)T

**d.** An establishment or an instructor under current discipline may not supervise an apprentice. (3-20-20)T

**e.** An apprentice shall not be permitted to render any clinical service to patrons until the apprentice has completed at least five percent (5%) of the required hours of instruction. (3-20-20)T

**04. Recordkeeping.** Establishments employing an apprentice shall keep a daily work record of the attendance of the apprentice and a record of the types of instruction given and the work performed by the apprentice as set forth below. (3-20-20)T

**a.** An apprentice must be given monthly progress records, and the monthly record shall be signed and dated by the apprentice and the instructor. The establishment shall maintain the records for a period of five (5) years following completion or termination of the apprentice instruction. (3-20-20)T

**b.** When an apprentice's course of instruction has been completed or terminated, the completed operations and number of hours of instruction are to be recorded by the establishment on the Record of Instruction Form. The instructor must submit the Record of Instruction to the Board within fourteen (14) days of the completion of the apprenticeship. The establishment must maintain a copy of the Record of Instruction for a period of five (5) years from completion or termination date. (3-20-20)T

**c.** Attendance, instruction, and work records must be kept in the establishment in which the apprentice is employed. (3-20-20)T

**d.** Apprenticeship records are subject to inspection by the Board at any time. (3-20-20)T

**05. Termination of Registration.** A registration as an apprentice is valid from the date of issuance until the apprentice is no longer enrolled as an apprentice in the establishment identified on the apprentice's

application. (3-20-20)T

**a.** When an apprentice discontinues a course of study, the establishment must complete a Record of Instruction Form with the total number of hours worked and the types of instruction given to the apprentice. The Record of Instruction Form must be submitted to the Board within thirty (30) days of the discontinuance of the apprenticeship. If an apprentice discontinues a course of instruction and does not transfer to another salon within sixty (60) days, the apprentice registration is automatically canceled and is to be submitted to the Board along with the Record of Instruction. (3-20-20)T

**b.** When an establishment where apprentices are being trained ceases operation as an establishment, the establishment must submit the records of instruction for each apprentice to the Board within thirty (30) days. (3-20-20)T

**c.** An apprentice who has discontinued a course of study must apply for and be granted a new registration under Subsection 550.01 of these rules, prior to resuming instruction. (3-20-20)T

**06. Out of State Apprenticeship.** An applicant who has received instruction as an apprentice in another state must file with the Board a copy of the record of instruction from the out of state apprenticeship. For purposes of this section, the record of instruction will be a statement which gives detailed information regarding operations and hours of instruction, and which is to be verified by the licensing agency or instructor(s) in the state in which the instruction was obtained. (3-20-20)T

**551. -- 699. (RESERVED)**

**700. SCOPE OF PRACTICE.**

All licensees shall practice in a competent manner consistent with their level of education, training, and experience. (3-20-20)T

**701. -- 709. (RESERVED)**

**710. PRACTICE OUTSIDE OF A LICENSED ESTABLISHMENT.**

All licensees and certificants must practice in a place or establishment that is licensed for such practice, except as provided for in Section 54-5804, Idaho Code, or when the services provided by the licensee or certificant are limited to the following: (3-20-20)T

**01. Hair Styling.** Arranging, styling, dressing of the hair. Trimming of the hair may be performed when it is incidental to the arranging, styling, or dressing of the hair, including facial hair such as beards, mustaches, and eyebrows. (3-20-20)T

**02. Coloring.** Wash out topical color, tinted powder, spray or chalk to temporarily camouflage the hair.

**03. Extensions.** Application of extensions with non-permanent adhesive or thread, such as clip in hair, halos, wig and toupees. (3-20-20)T

**04. Temporary Hair Removal.** Tweezing of hairs on the face and neck. (3-20-20)T

**05. Cleansing.** Cleansing of the face for the limited purpose of removing makeup and debris and cosmetic preparations for the application of makeup. (3-20-20)T

**06. Nail Services.** Application of nail polish by painting without the use of a lamp or light, removal of polish that is incidental to the painting of the nail, and shaping of the nail with a single-use emery board. (3-20-20)T

**07. Makeup Application.** Application of makeup. (3-20-20)T

**08. Safety and Disinfection.** All licensees and certificants must comply with the safety and disinfection rules applicable to the services being performed, regardless of the location where the services are performed. (3-20-20)T

**711. -- 799. (RESERVED)**

**800. UNPROFESSIONAL CONDUCT.**

A licensee shall not engage in unprofessional conduct in the course of his/her practice. Unprofessional conduct is conduct which has endangered or is likely to endanger the health, welfare, or safety of the public and includes, but is not limited to, the following: (3-20-20)T

- 01. Use of MMA.** Use of Methyl Methacrylate acid (MMA); (3-20-20)T
- 02. Use of Skin Cutting Instruments.** Use of skin cutting instruments, including razor-type callus shavers, credo blades, microplane, or other rasps or graters designed to remove corns or calluses by cutting below the skin surface. The presence of such instruments creates a presumption of the instrument's use; (3-20-20)T
- 03. Use of UV Sterilizers.** Use of ultraviolet (UV) sterilizers for disinfection. This does not prohibit the use of ultraviolet dryers or lamps used to dry or cure nail products; (3-20-20)T
- 04. Use of Roll-on Wax.** Use of roll-on wax, except that single-use roll-on wax cartridges are acceptable when they are disposed of immediately after use; (3-20-20)T
- 05. Double-Dipping.** Placing an item or instrument that has been used on a person into a wax pot or other container that holds wax, a compound, solution, or other cosmetic preparation that will be used for more than one (1) than patron. This prohibited practice is commonly referred to as double-dipping; (3-20-20)T
- 06. Reuse of Single-Use or Porous Items.** Use of single-use or porous items on more than one (1) patron. The presence of used single-use or porous items, which have not been disposed of, creates a presumption of the item's use or intended use on more than one patron. (3-20-20)T
- 07. Apprentices.** Failure to adequately supervise, instruct, or train an apprentice; (3-20-20)T
- 08. Inspections and Investigations.** Interference with an inspection or investigation conducted by or on behalf of the Board; (3-20-20)T
- 09. Disease Transmission Prevention.** Performing a service on a patron who has an open sore or a known contagious disease of a nature that may be transmitted by performing the procedure, unless the licensee takes medically-approved measures to prevent transmission of the disease; or (3-20-20)T
- 10. Practice Outside Scope of Training.** Performing services or using machines or devices outside the licensee's area of training, expertise, competence, or scope of practice for the license held. (3-20-20)T

**801. -- 849. (RESERVED)**

**850. INSPECTION OF ESTABLISHMENTS, SCHOOLS AND FACILITIES.**

All establishments, schools, and facilities shall be subject to inspection by the Board or its agents during business hours without notice to ensure the safe operation of each establishment, school, or facility and to ensure continued compliance with Chapter 58, Title 54, Idaho Code, and these rules. (3-20-20)T

- 01. Form.** The Board may adopt a form which identifies those general items that will be inspected and a level of compliance necessary for issuance or renewal of a license and for which a failure to meet that level is grounds for discipline. Violations of the Chapter 58, Title 54, Idaho Code, or these rules that are not listed on the form but that are found during inspection are also grounds for discipline. (3-20-20)T
- 02. Classification Card.** Following an inspection, each establishment, school, and facility, except for retail thermal styling equipment dealers, will receive classification as follows: 100%–90% = "A"; 89%–80% = "B"; 79% and below = "C." The "C" classification denotes an unacceptable level of compliance and a reinspection is required. (3-20-20)T

**03. Reinspection.** A facility, school, or establishment not found to be at an acceptable level of compliance must make improvements within thirty (30) days. The Board may allow an establishment, school, or facility to continue to operate during that period. The Board may take action prior to any reinspection when the circumstances represent an immediate danger to the public health, safety, or welfare. (3-20-20)T

**851. SAFETY AND DISINFECTION FOR ESTABLISHMENTS AND SCHOOLS.**

All establishments and schools must take every precaution to prevent the transfer of disease-causing pathogens between people and comply with Chapter 58, Title 54, Idaho Code. At a minimum the establishment or school must meet the following requirements: (3-20-20)T

**01. Premises.** Establishments and schools must be separated from living areas by substantial walls and/or closable doors. All establishments and schools must be maintained in an orderly manner and shall be heated, lighted, and ventilated so as to be safe and comfortable to the operators and patrons. Floors, walls, ceilings, furniture, and all other fixtures shall be kept clean and in good repair at all times. (3-20-20)T

**02. Instrument Cleaning.** All instruments and items used by operators shall be thoroughly cleaned after each use and prior to disinfection. (3-20-20)T

**03. Instrument Disinfection or Sterilization.** All instruments and items used by operators shall be disinfected or sterilized after cleaning and prior to use on each patron, with a disinfectant or sterilant as defined in these rules. All disinfectant must be mixed and changed according to the manufacturers' instructions. Disinfection methods such as immersion, sprays, and wipes may be used. Contact time listed on the disinfectant's label must be adhered to in all circumstances. Items or surfaces must remain completely immersed in disinfectant, or visibly wet if using sprays or wipes, for the full amount of contact time. (3-20-20)T

**04. Single-Use and Porous Instruments.** Instruments and items that are intended for single use or that are porous shall be immediately disposed of in a waste container after each use on a patron or given to the patron to take home for personal use, provided that the instruments may not be brought back to the establishment for future use. (3-20-20)T

**05. Waxes and Waxing Services.** Paraffins, waxes and all other solutions or compounds shall be covered and maintained free of any foreign contaminants. Only disinfected or unused, single-use items may be placed into a container that holds wax or paraffins. Waxes and paraffins must be dispensed for use on a patron in the following manner: (3-20-20)T

**a.** Wax may be removed from a multi-use wax pot for use on a patron by one of the following methods: (3-20-20)T

i. Single-use spatula disposed of after a single dip/application; (3-20-20)T

ii. Disinfected plastic spatulas with one disinfected spatula used for each dip into the wax pot; or (3-20-20)T

iii. Placement of all wax needed for entire service in a single-use, disposable cup or a container that can be properly cleaned and disinfected, such as a stainless steel bowl. The cup, any remaining wax, and all single-use applicators must be immediately disposed of at the conclusion of the service. This is the only instance in which a single applicator may be used for an entire service. (3-20-20)T

**b.** Paraffin wax must be portioned out for each patron in a bag or other container, or dispensed in a manner that prevents contamination of the unused supply. All portions used on a patron must be disposed of immediately following use. (3-20-20)T

**06. Makeup Services.** All makeup and makeup services must follow the requirements in Section 852 of these rules. (3-20-20)T

**07. Nail Services.** A licensee must comply with the following disinfection procedures between every patron: (3-20-20)T

- a. All pedicure bowls, basins or tubs must be cleaned and disinfected prior to each use as follows: (3-20-20)T
  - i. Empty pedicure bowl. (3-20-20)T
  - ii. Remove all removable parts, including screens, foot plates, impellers and fans. (3-20-20)T
  - iii. Clean removable parts with soap or detergent and water, rinse, and immerse parts in disinfectant following manufacturer's directions for proper contact time. (3-20-20)T
  - iv. Scrub bowl with soap or detergent and rinse with clean water. (3-20-20)T
  - v. Replace removable cleaned and disinfected parts. (3-20-20)T
  - vi. Fill bowl and add disinfectant to achieve proper concentration. (3-20-20)T
  - vii. Allow disinfectant solution to sit, or run through system for bowls with circulating water for the manufacturer's recommended contact time. (3-20-20)T
  - viii. Drain the tub, rinse and air dry or wipe dry with clean paper towel. (3-20-20)T
- b. Metal drill bits may be soaked in acetone to remove nail product. When removed from the acetone, they must be cleaned using soap, water, and a brush, and then rinsed prior to immersion in disinfectant. Drill bits must remain in disinfectant for the full contact time. (3-20-20)T

**08. Water Supply and Hand Washing.** Water supplies shall be from an approved source. Sufficient basins with hot and cold running water, approved drainage systems, soap and single-use towels shall be conveniently located within the work area. Operators and students shall wash their hands with running water and soap prior to providing service to any patron. When hand washing is not practicable, hand sanitizer of at least seventy percent (70%) alcohol may be used. (3-20-20)T

**09. Restroom Facilities.** Clean, adequate and convenient restroom facilities, located and accessible from within the building where the shop or school is located, shall be available for use by operators and patrons. A basin with hot and cold running water, approved drainage systems, soap and single-use towels shall be provided within said facilities. All operators and students must wash their hands with running water and soap and then dry their hands with a single-use towel after using the restroom. (3-20-20)T

**10. Safety.** Clearly identifiable first-aid kit must be readily accessible on the premises. No animals are allowed in shops or schools except service dogs trained to do work or perform tasks for persons with disabilities. The definition of service animals and disabilities shall be as set forth in U.S. Department of Justice Regulations at 28 C.F.R. Section 36.104 effective August 11, 2016. (3-20-20)T

**11. Licenses and Classification Cards.** All establishments and schools must be licensed prior to their operation and must be under the direct supervision of a licensed operator. A current establishment and/or school license, valid operator license(s), a copy of these safety and disinfection rules, and a valid classification card shall be conspicuously displayed in the work area of each establishment or school for the information of operators, Board agents, and the public. (3-20-20)T

**852. SAFETY AND DISINFECTION FOR RETAIL COSMETICS DEALER FACILITIES AND MAKEOVER OR GLAMOUR PHOTOGRAPHY BUSINESSES.**

All retail cosmetic dealers and makeover or glamour photography businesses must take every precaution to prevent the transfer of disease-causing pathogens between people and must comply with Chapter 58, Title 54, Idaho Code. At a minimum the dealer or business must meet the following requirements: (3-20-20)T

**01. Cake, Loose, or Liquid Makeup.** All makeup that comes in a cake, loose, or liquid form, must be transferred to a palette with a disinfected or single-use spatula for use with a single customer and in a manner to

prevent any contamination. Any excess make-up must be disposed of immediately following use on or by a customer. (3-20-20)T

**02. Makeup Pencils.** Make-up pencils that require a sharpener must be sharpened prior to each use. Sharpeners must be cleaned and disinfected in accordance with Subsections 851.02 and 851.03 of these rules. Eyeliner that does not require a sharpener must have a portion transferred to a palette with a disinfected or single-use spatula for use on a single customer. (3-20-20)T

**03. Mascara.** Single-use applicators must be used in the application of mascara. (3-20-20)T

**04. Brushes and Implements.** All implements and applicators, including brushes, that are used on customers or made available to be used by customers must be stored, cleaned, and disinfected or disposed of in accordance with Section 851 of these rules. (3-20-20)T

**05. Displays.** All make-up should be covered when not in use. When make-up displays are accessible to the public, single-use applicators for all make-up must be readily available. (3-20-20)T

**06. Water Supply and Restroom Facilities.** The facility or business must meet the requirements in Subsection 851.11 of these rules. (3-20-20)T

**07. First-aid Kit.** The facility or business must have a clearly identifiable first-aid kit readily accessible on the premises. (3-20-20)T

**08. Licenses and Classification Card.** All retail cosmetics dealers and glamour or makeover photography businesses must be licensed prior to their operation. A current license, a copy of these safety and disinfection rules, and a valid classification card shall be conspicuously displayed in the work area of each facility for the information of employees, Board agents, and the public. (3-20-20)T

**853. SAFETY AND DISINFECTION FOR RETAIL THERMAL STYLING DEALER FACILITIES.**  
All retail thermal styling equipment dealers must take every precaution to prevent the transfer of disease-causing pathogens between people and must comply with Chapter 58, Title 54, Idaho Code. At a minimum the dealer must meet the following requirements: (3-20-20)T

**01. Cleaning, Disinfection, and Storage.** All implements and electrical equipment used on a customer must be cleaned, disinfected, and stored in accordance with Subsections 851.02, 851.03, 851.04, and 851.06 of these rules. (3-20-20)T

**02. First-aid Kit.** The facility or business must have a clearly identifiable first-aid kit readily accessible on the premises. (3-20-20)T

**03. Registration and Classification Card.** All retail thermal styling equipment dealers must be registered prior to their operation. A current registration, a copy of these safety and disinfection rules, and a valid classification card shall be conspicuously displayed in the work area of each facility for the information of employees, Board agents, and the public. (3-20-20)T

**854. -- 999. (RESERVED)**



# IDAPA 24 – DIVISION OF OCCUPATIONAL AND PROFESSIONAL LICENSES

## 24.29.01 – RULES OF PROCEDURE OF THE IDAHO CERTIFIED SHORTHAND REPORTERS BOARD

### DOCKET NO. 24-2901-2000F (FEE RULE)

#### NOTICE OF OMNIBUS RULEMAKING – ADOPTION OF TEMPORARY RULE

**EFFECTIVE DATE:** The effective date of the temporary rules being adopted through this omnibus rulemaking is the adjournment date of the second regular session of the 65th Idaho State Legislature - March 20, 2020.

**AUTHORITY:** In compliance with Sections 67-5226, Idaho Code, notice is hereby given this agency has adopted a temporary rule. The action is authorized pursuant to Section 54-3107, Idaho Code.

**DESCRIPTIVE SUMMARY:** The following is the required finding and concise statement of its supporting reasons for adopting a temporary rule:

This temporary rulemaking adopts the following chapter under IDAPA 24.9.01:

#### **IDAPA 24.29**

- 24.29.01, *Rules of the Rules of the Procedure of the Idaho Certified Shorthand Reporters Board.*

**TEMPORARY RULE JUSTIFICATION:** Pursuant to Sections 67-5226(1) and 67-5226(2), Idaho Code, the Governor has found that temporary adoption of the rule is appropriate for the following reasons:

These temporary rules are necessary to protect the public health, safety, and welfare of the citizens of Idaho and confer a benefit on its citizens. These temporary rules implement the duly enacted laws of the state of Idaho, provide citizens with the detailed rules and standards for complying with those laws, and assist in the orderly execution and enforcement of those laws. The expiration of these rules without due consideration and processes would undermine the public health, safety, and welfare of the citizens of Idaho and deprive them of the benefit intended by these rules. These rules govern the qualifications and criteria for shorthand reporters in Idaho. Allowing these rules to expire would harm recent efforts made to reduce barriers to entry into the profession and would adversely effect the Board's ability to admit new licensees, harming the welfare of prospective licensees and the industries the Board serves.

**FEE SUMMARY:** Pursuant to Section 67-5226(2), the Governor has found that the fees or charges being imposed or increased are justified and necessary to avoid immediate danger and the fees are described herein:

The fees or charges, authorized in Section 54-3110, Idaho Code, are part of the agency's 2021 budget that relies upon the existence of these fees or charges to meet the state's obligations and provide necessary state services. Failing to reauthorize these temporary rules would create immediate danger to the state budget, immediate danger to necessary state functions and services, and immediate danger of a violation of Idaho's constitutional requirement that it balance its budget.

The following is a specific description of the fees or charges:

	<b>Initial License</b>	<b>Renewal</b>	<b>Late Fee</b>	<b>Other</b>
Broker	\$160	\$160	\$25	
Salesperson	\$160	\$160	\$25	
Business Entity	\$50	\$50	\$25	
Branch Office	\$50	\$50	\$25	
Cooperative License	\$100			
Education or License History				\$10

	<b>Initial License</b>	<b>Renewal</b>	<b>Late Fee</b>	<b>Other</b>
License Certificate				\$15

**ASSISTANCE ON TECHNICAL QUESTIONS:** For assistance on technical questions concerning the temporary rule, contact Rob McQuade at (208) 334-3233.

DATED this February 21, 2020.

Kelley Packer  
Division Administrator  
Division of Occupational and Professional Licenses  
700 W. State Street  
P.O. Box 83720  
Boise, ID 83720  
Phone: (208) 334-3233  
Fax: (208) 334-3945

**24.29.01 – RULES OF PROCEDURE OF THE IDAHO CERTIFIED  
SHORTHAND REPORTERS BOARD**

**000. LEGAL AUTHORITY.**

These rules are adopted under the authority of Section 54-3107, Idaho Code. (3-20-20)T

**001. TITLE AND SCOPE.**

These rules are titled IDAPA 24.29.01, “Rules of Procedure of the Idaho Certified Shorthand Reporters Board.” These rules establish procedures for the organization and operation of the Board. (3-20-20)T

**002. -- 100. (RESERVED)**

**101. COMMITTEES.**

**01. Appointment.** Regular or special committees may be appointed by the chairman and present reports to the Board at the time specified or at the earliest regular or special meeting of the Board. A special voluntary committee from the public, which may include members of the Board, may be formed to render special services during examinations or as the Board may assign to them. (3-20-20)T

**02. Certificates.** Certificates of registration shall be issued to each certified shorthand reporter, as prescribed by the Title 54, Chapter 31, on forms adopted by the Board. Certificates shall be displayed by certified shorthand reporters in their place of business. Each certificate shall bear an individual number as assigned to that particular Certified Shorthand Reporter by the Board. (3-20-20)T

**102. -- 124. (RESERVED)**

**125. FEES.**

All fees are non-refundable.

FEE TYPE	AMOUNT (Not to Exceed)
Application	\$50
Examination	\$50
Renewal	\$75
Examination preparation materials	\$20

(3-20-20)T

**126. -- 200. (RESERVED)**

**201. WRITTEN STATEMENT OF SUITABILITY FOR LICENSURE OR PERMIT.**

An applicant or licensee who has a conviction, finding of guilt, withheld judgment, or suspended sentence for any crime other than a minor traffic offense must submit with their application a written statement and any supplemental information establishing their current suitability for licensure. (3-20-20)T

**01. Consideration of Factors and Evidence.** The Board shall consider the following factors or evidence: (3-20-20)T

- a. The severity or nature of the crime; (3-20-20)T
- b. The period of time that has passed since the crime under review; (3-20-20)T
- c. The number or pattern of crimes; (3-20-20)T
- d. The circumstances surrounding the crime that would help determine the risk of repetition; (3-20-20)T
- e. The relationship of the crime or discipline to the practice of shorthand reporting; (3-20-20)T
- f. The applicant's activities since the crime under review, such as employment, education,

participation in treatment, payment of restitution, or any other factors which may be evidence of current rehabilitation; and (3-20-20)T

**g.** Any other information regarding rehabilitation or mitigating circumstances. (3-20-20)T

**02. Interview.** The Board may, at its discretion, grant an interview of the applicant. (3-20-20)T

**03. Applicant Bears the Burden.** The applicant shall bear the burden of establishing his current suitability for licensure. (3-20-20)T

**202. -- 299. (RESERVED)**

**300. EXAMINATIONS.**

**01. Examination Process.** (3-20-20)T

**a.** Late applicants shall not be admitted to the examination room. (3-20-20)T

**b.** Picture identification shall be shown by all applicants before taking an examination. (3-20-20)T

**c.** Examinees are forbidden to receive any unauthorized assistance during the examination. Communication between examinees or possession of unauthorized material or devices during the examination is strictly prohibited. (3-20-20)T

**d.** Only scheduled examinees, Board members, and authorized personnel shall be admitted to the examination room. (3-20-20)T

**02. Scope of Examination.** (3-20-20)T

**a.** The complete examining procedure for certification as a certified shorthand reporter consists of two (2) sections. The first section is the written examination covering subjects as are ordinarily given in a school of court reporting and which are common to all fields of practice. The second section is the skills portion which shall consist of the following segments and speeds. (3-20-20)T

**i.** Question and Answer -- Five (5) minutes at two hundred twenty-five (225) words per minute. (3-20-20)T

**ii.** Jury Charge -- Five (5) minutes at two hundred (200) words per minute. (3-20-20)T

**iii.** Literary -- Five (5) minutes at one hundred eighty (180) words per minute. (3-20-20)T

**iv.** Density of Exam -- The syllabic content of the dictated exam shall be one point four (1.4). (3-20-20)T

**b.** The examination is the same for all applicants. (3-20-20)T

**c.** The examining committee, which shall consist of three Board members, shall inform applicants of the approximate time allowed for typing the skills portion of the examination. (3-20-20)T

**d.** The written examination and the three (3) skills segments can be passed individually for the Idaho examination. (3-20-20)T

**03. Grading.** (3-20-20)T

**a.** Each applicant must attain a grade of seventy-five percent (75%) or above to pass the written examination and ninety-five percent (95%) or above in each segment to pass the skills portion. (3-20-20)T

**b.** Every applicant receiving a grade of less than seventy-five percent (75%) in the written examination shall be deemed to have failed such examination and shall have the application denied without prejudice. (3-20-20)T

**c.** Every applicant receiving a grade of less than ninety-five percent (95%) in each of the skills segments of the examination shall be deemed to have failed such examination and shall have the application denied without prejudice. (3-20-20)T

**d.** An applicant failing either the written section, or the skills portion, and having filed a new application for examination, shall be required to take and pass within a two-year period only the section for which a failing grade was received. (3-20-20)T

**04. Inspection of Examination.** (3-20-20)T

**a.** An applicant who fails to obtain a passing grade in the skills portion may inspect his/her examination papers at such times and locations as may be designated by the Board. Inspection of such examination papers shall be permitted within a thirty (30) day period after receipt of notice by the applicant of his/her failure to pass the examination. (3-20-20)T

**b.** At the time of inspection no one other than the examinee or his/her attorney and a representative of the Board shall have access to such examination papers. (3-20-20)T

**05. Inspection Review.** (3-20-20)T

**a.** Within thirty (30) days after the date notice of the results of the examination has been mailed to him/her, an applicant who was unsuccessful in the examination may petition the Board for a review of his/her examination papers. (3-20-20)T

**b.** The petition for review shall be made in writing stating the reason for such review and citing the item or items against which the request is directed. (3-20-20)T

**c.** The Board shall, upon receiving such petition for review, conduct a hearing at the next scheduled Board meeting. (3-20-20)T

**06. Retention of Examinations.** The Board shall retain for at least six (6) months, all examination papers and notes submitted by applicants. (3-20-20)T

**301. -- 399. (RESERVED)**

**400. TEMPORARY PERMIT.**

**01. Eligibility.** (3-20-20)T

**a.** Any one (1) or more of the following shall be considered as minimum evidence that the applicant is qualified to hold a temporary permit: (3-20-20)T

**i.** Hold a Certificate of Merit Reporter (RMR) issued by the National Court Reporters Association (NCRA); (3-20-20)T

**ii.** Hold a Certificate of Registered Professional Reporter (RPR) issued by the National Court Reporters Association (NCRA); (3-20-20)T

**iii.** Hold a Certified Shorthand Reporter certificate, or its equivalent, in good standing from another state; (3-20-20)T

**iv.** Hold a diploma or certificate of completion of all requirements to graduate from a National Court Reporter Association (NCRA) approved school; (3-20-20)T

v. Has otherwise demonstrated his/her proficiency by a certificate from an agency from another state. (3-20-20)T

b. The applicant must have a high school diploma or equivalent. (3-20-20)T

**02. Permit.** All temporary permits shall be issued for a period of one (1) year and may be renewable for a single additional year if, before the permit expires, the permit holder: (3-20-20)T

a. Submits a written renewal request to the Board; (3-20-20)T

b. Establishes that they have passed at least one (1) skills segment of the Idaho Certified Shorthand Reporter Examination, the Registered Professional Reporter Examination (RPR), or the Registered Merit Reporter Examination (RMR); and (3-20-20)T

c. Pays the required fees as set forth in this Chapter. (3-20-20)T

**401. -- 499. (RESERVED)**

**500. DISCIPLINARY PENALTY.**

Costs and fees. The Board may order anyone licensed under Title 54, Chapter 31, Idaho Code, who is found by the Board to be in violation of the provisions of Title 54, Chapter 31, Idaho Code, to pay the costs and fees incurred by the Board in the investigation or prosecution of the licensee. (3-20-20)T

**501. -- 999. (RESERVED)**

# IDAPA 25 – IDAHO OUTFITTERS AND GUIDES LICENSING BOARD

## DOCKET NO. 25-0101-2000F (FEE RULE)

### NOTICE OF OMNIBUS RULEMAKING – ADOPTION OF TEMPORARY RULE

**EFFECTIVE DATE:** The effective date of the temporary rule being adopted through this omnibus rulemaking is the adjournment date of the second regular session of the 65th Idaho State Legislature - March 20, 2020.

**AUTHORITY:** In compliance with Sections 67-5226, Idaho Code, notice is hereby given this agency has adopted a temporary rule. The action is authorized pursuant to Section 36-2107, Idaho Code.

**DESCRIPTIVE SUMMARY:** The following is the required finding and concise statement of its supporting reasons for adopting a temporary rule:

This temporary rulemaking adopts the following chapter under IDAPA 25:

#### **IDAPA 25**

- 25.01.01 *Rules of the Outfitters and Guides Licensing Board*

**TEMPORARY RULE JUSTIFICATION:** Pursuant to Sections 67-5226(1) and 67-5226(2), Idaho Code, the Governor has found that temporary adoption of the rule is appropriate for the following reasons:

These temporary rules are necessary to protect the public health, safety, and welfare of the citizens of Idaho and confer a benefit on its citizens. These temporary rules implement the duly enacted laws of the state of Idaho, provide citizens with the detailed rules and standards for complying with those laws, and assist in the orderly execution and enforcement of those laws. The expiration of these rules without due consideration and processes would undermine the public health, safety, and welfare of the citizens of Idaho and deprive them of the benefit intended by these rules.

**FEE SUMMARY:** Pursuant to Section 67-5226(2), the Governor has found that the fee(s) or charge(s) being imposed or increased is justified and necessary to avoid immediate danger and the fee(s) is described herein:

The fees or charges, authorized in Section 36-2108, Idaho Code, are part of the agency's 2021 budget that relies upon the existence of these fees or charges to meet the state's obligations and provide necessary state services. Failing to reauthorize these temporary rules would create immediate danger to the state budget, immediate danger to necessary state functions and services, and immediate danger of a violation of Idaho's constitutional requirement that it balance its budget.

The following is a specific description of the fees or charges:

- Outfitters: application fee: \$400; annual license fee online: \$400; annual license fee offline: \$450; late penalty: \$150; major amendment: \$200; and minor amendment: \$35.
- Designated Agents: application fee: \$50; annual license fee online: \$140; annual license fee offline: \$160; major amendment: \$20; and minor amendment: \$20.
- Guides: application fee: \$20; annual license fee online: \$105; annual license fee offline: \$115; major amendment: \$20; and minor amendment: \$20.

**ASSISTANCE ON TECHNICAL QUESTIONS:** For assistance on technical questions concerning the temporary rule, contact Lori Thomason at (208) 327-7380.

DATED this February 18, 2020.

Lori Thomason, Executive Director  
Outfitters and Guides Licensing Board  
1365 North Orchard Street #172  
Boise, Idaho 83706  
Phone: (208) 327-7380  
Fax: (208) 327-7382

# IDAPA 25 – IDAHO OUTFITTERS AND GUIDES LICENSING BOARD

## 25.01.01 – RULES OF THE OUTFITTERS AND GUIDES LICENSING BOARD

### 000. LEGAL AUTHORITY.

These rules have been promulgated in accordance with the Idaho Administrative Procedures Act and pursuant to authority granted in the Outfitters and Guides Act. (3-20-20)T

### 001. TITLE AND SCOPE.

These rules are titled IDAPA 25.01.01, “Rules of the Outfitters and Guides Licensing Board.” The purpose is to implement, administer, and enforce the Act to establish uniform standards for licensing outfitted and guided activities to protect the public and protect, enhance, and facilitate management of Idaho's fish, wildlife, and recreational resources. (3-20-20)T

### 002. DEFINITIONS.

The Act defines certain terminology applicable to its interpretation and administration (Section 36-2102, Idaho Code). Further definitions, for the purposes of enforcement of the Act and these Rules are: (3-20-20)T

**01. Act.** Title 36, Chapter 21, Idaho Code, commonly known as the Outfitters and Guides Act, as amended. (3-20-20)T

**02. Allocated Tag.** A hunting tag that has been allocated by the IFGC pursuant to section 36-408(4), Idaho Code. (3-20-20)T

**03. Authorized Person.** An investigator or enforcement agent in the employ of the Board, a conservation officer of the IFGC, or any local, state, or federal law enforcement officer. (3-20-20)T

**04. Booking Agent.** Any individual, firm, business, partnership, or corporation that makes arrangements for the use of the services of a licensed outfitter and receives compensation therefore. A booking agent does not supply personnel or facilities and services to outfitter clientele. (3-20-20)T

**05. Capped Zone.** A game management area, unit or zone for which the Idaho Fish and Game Commission has limited or “capped” the number of deer or elk tags available for use in a general season hunt. (3-20-20)T

**06. Classified River.** For the purpose of these rules, specific sections of some whitewater river or streams which are considered more hazardous than others have been designated “classified.” Classified rivers are denoted by an asterisk (\*) in the list of rivers contained in Subsection 059.01. (3-20-20)T

**07. Compensation or Consideration.** The receipt or taking of goods, services, or cash in exchange for outfitted or guided activities. A bona fide charging of out-of-pocket travel expenses by members of a recreational party is not deemed compensation. However, such out-of-pocket expenses may not include depreciation, amortization, wages, or other recompense. (3-20-20)T

**08. Controlled Hunt.** A hunt for a species that has a season structure and other conditions determined by the IFGC and that has a limited number of tags that are distributed by random drawing to hunters. (3-20-20)T

**09. Desert.** A region of scarce rainfall and vegetation in areas often having great differences between day, night and seasonal temperatures. A desert is a land surface ranging from level, plateau land, or undulating to sharply breaking hill-lands and sand dunes that, in addition, may be broken by poor to well-defined, deeply entrenched drainage systems, rims, cliffs, and escarpments. (3-20-20)T

**10. Designated Agent.** A licensed individual who is employed as an agent by any person, firm, partnership, corporation, or other organization or combination thereof that is licensed as an outfitter and who, together with the licensed outfitter, is responsible and accountable for the conduct of the licensed outfitter's operations. (3-20-20)T

**11. Enforcement Agent.** An individual employed by the Board having the power of peace officers to enforce the provisions of the Act and these Rules. (3-20-20)T

**12. Facilities and Services.** The provision of personnel, lodging (tent, home, lodge, or hotel/motel),



transportation (other than by commercial carrier), guiding, preparation and serving of food and equipment, or any other accommodation for the benefit of clientele in the conduct of outdoor recreational activities as designed in Section 36-2102(b), Idaho Code. (3-20-20)T

**13. First Aid Card.** A valid card or other evidence demonstrating that the individual has successfully completed an applicable American Red Cross course or equivalent course that is acceptable to the Board. (3-20-20)T

**14. Fishing.** Fishing activities on those waters and for those species described in the rules of the IFGC, IDAPA 13.01.11, “Rules Governing Fish,” general fishing seasons and any anadromous fishing rules; for purposes of the Act, fishing is defined as follows: (3-20-20)T

**a.** Anadromous fishing means fishing for salmon or steelhead trout. (3-20-20)T

**b.** Float boat fishing means the use of floatboats without motors for the conduct of fishing as a major activity on those waters open to commercial activities as set forth in Section 059. (3-20-20)T

**c.** Fly fishing means a licensed activity restricted to the use of fly fishing equipment and procedures, as defined by IFGC rules. (3-20-20)T

**d.** Incidental fishing means fishing conducted as a minor activity. (3-20-20)T

**e.** Power boat fishing means the use of power boats in conduct of fishing as a major activity on those Idaho waters open to commercial outfitting activities as set forth in Section 059. (3-20-20)T

**f.** Walk and wade fishing means fishing conducted along or in a river, stream, lake or reservoir, and may include the use of personalized flotation equipment, but does not include the use of watercraft. (3-20-20)T

**15. Float Boats.** Watercraft (inflatable watercraft, dories, drift boats, canoes, catarafts, kayaks, sport yaks, or other small watercraft) propelled by, and moving with the stream flow, maneuvered by oars, paddles, sweeps, pike poles or by motors for downstream steerage only. Downstream steerage does not include holding or upstream travel of a watercraft with a motor. Excluded as float boats are personal flotation devices, innertubes, air mattresses, or similar devices. (3-20-20)T

**16. Hazardous Excursions.** Outfitted or guided activities conducted outside municipal limits in a desert or mountainous environment that may constitute a potential danger to the health, safety, or welfare of participants involved. These activities include, but are not limited to: day or overnight trailrides, backpacking, technical mountaineering/rock climbing, cross-country skiing, backcountry alpine skiing, llama and goat packing, snowmobiling, survival courses, guiding courses, rescue courses, fishing courses, motored and non-motored cycling, wagon rides, sleigh rides, and dog sled rides. (3-20-20)T

**17. Hunting.** The pursuit of any game animal or bird and all related activities including packing of client camp equipment, supplies, game meat and clients to and from a hunting camp. (3-20-20)T

**18. IFGC.** The Idaho Department of Fish and Game or the Idaho Fish and Game Commission. (3-20-20)T

**19. Minor Amendment.** All outfitter license amendment requests that can be processed by the Board without requiring outside research or recommendation of a land managing agency or other agency before the Board takes final action on said amendment request. (3-20-20)T

**20. Major Activity.** A licensed activity, the nature of which requires a significant commitment of time and effort by an outfitter in its execution and is intended to provide a significant amount of income to an outfitter. (3-20-20)T

**21. Major Amendment.** All outfitter license amendment requests requiring Board research or recommendation of a land management agency or other agency before the Board takes final action on the amendment request. (3-20-20)T

**22. Minor or Incidental Activity.** A licensed activity the nature of which is carried out in conjunction with a major activity, but is not the primary purpose of the excursion. (3-20-20)T

**23. Mountainous.** A region receiving limited to abundant annual precipitation with an associated vegetative cover of grass, weeds, shrubs, or trees. Cool summer temperatures and cold winter temperatures prevail. A mountainous area is a land surface ranging from level to gently rolling low hills to elevated lands that are often broken with poor to well-developed, deeply entrenched drainage systems, rims, cliffs, and escarpments to steep-sided land masses of impressive size and height. (3-20-20)T

**24. New Opportunity.** A proposed commercial outfitted activity to be conducted in an area where no similar commercial outfitted activity has been conducted in the past. (3-20-20)T

**25. Operating Area.** The area assigned by the Board to an outfitter for the conduct of outfitting activities. (3-20-20)T

**26. Operating Plan.** A detailed schedule or plan of operation which an outfitter proposes to follow in the utilization of licensed privileges, areas, or activities. (See Subsection 018.03). (3-20-20)T

**27. Outfitted Tag Use.** The following definitions of outfitted tag use apply for purposes of the designation of allocated tags in capped zones and controlled hunts as set forth in Section 057 of these rules. Outfitted tag use for a capped zone is the number of tags used by clients of an outfitter for the species for the type of allocated tags being designated. Outfitted tag use for a controlled hunt zone, unit, or game management area is the number tags used by clients of an outfitter in the hunt that has a species, season structure, and other conditions most closely matching the controlled hunt for which allocated tags are being designated. Until such time as the IDFG is able to collect and verify outfitted tag use as provided in Section 36-408(4) Idaho Code, outfitted tag use shall be based on an outfitter's use reports, or the best data available, and subject to verification by documentation or other reliable information acceptable to the Board. (3-20-20)T

**28. Out-of-Pocket Costs.** The direct costs attributable to a recreational activity. Such direct costs do not include: (3-20-20)T

- a.** Compensation for either sponsors or participants; (3-20-20)T
- b.** Amortization or depreciation of debt or equipment; or (3-20-20)T
- c.** Costs of non-expendable supplies. (3-20-20)T

**29. Power Boats.** All motorized watercraft used on Idaho waters open to commercial outfitting activities. Excluded as power boats are hovercraft, jetskis or similar devices, and float boats using motors for downstream steering. (3-20-20)T

**30. Relinquish.** The failure to re-apply at the expiration of a license; the loss through nonuse, inactivity, revocation, or voluntary surrender of a license; or other loss of license. (3-20-20)T

**31. Third Party Agreement.** The allowing of the conduct of an outfitted or guided activity by the outfitter licensed to conduct those activities by any persons not directly employed by said outfitter. (See Section 023). (3-20-20)T

**32. Trainee.** A person not less than sixteen (16) years of age pursuing the necessary experience or skill qualifications for a guide license. A trainee may not provide any direct guiding services for clients, but may assist while under direct supervision. (3-20-20)T

**33. Training Log.** A form approved by the Board and completed in detail and attested to by the outfitter documenting the training completed by a person pursuing training or licensure as a guide pursuant to these rules. The log is maintained and made available for inspection by the Board or its agent by the outfitter during the time the guide is employed by the outfitter and for one (1) complete license year following the termination of

employment of the guide, and for three (3) years from the date of an accident or incident jeopardizing the health, safety or welfare of a client, in which the trainee or guide is involved. (3-20-20)T

**34. Unethical/Unprofessional Conduct.** Any activity(ies) by an outfitter or guide which is inappropriate to the conduct of the outfitting or guiding profession. These activities include, but are not limited to: (3-20-20)T

**a.** Providing false, fraudulent or misleading information to the Board or another governmental entity regulating outfitting activities including the use or verification of allocated tags; (3-20-20)T

**b.** Violation of an order of the Board; (3-20-20)T

**c.** Failure to provide services as advertised or contracted; (3-20-20)T

**d.** Harassment of the public in their use of Idaho’s outdoor recreational opportunities; (3-20-20)T

**e.** Violation of state or federal fish and game laws or rules or to condone or willfully allow a client's violation of those laws and rules; (3-20-20)T

**f.** For a licensed boating outfitter or guide, violation of the Idaho Safe Boating Act (Title 67, Chapter 70, Idaho Code) and IDAPA 26.01.30 “Idaho Safe Boating Rules”; (3-20-20)T

**g.** Engaging in unlicensed activities or conducting outfitter/guide services outside the operating area for which the licensee is licensed; (3-20-20)T

**h.** Disregard for the conservation, maintenance or enhancement of fish, game, land and water resources; (3-20-20)T

**i.** Killing a client's game or catching a client’s fish. (3-20-20)T

**j.** Failure to pay a supplier of goods or services to the outfitter business; (3-20-20)T

**k.** Failure to pay state taxes; (3-20-20)T

**l.** Operating in a manner which endangers the health, safety, or welfare of the public. (3-20-20)T

**m.** Selling lifetime excursions, lifetime hunts, or selling of outfitted activities to an individual for the life of that individual and collecting fees accordingly. (3-20-20)T

**n.** Operating under a name that is not associated with the license issued by the Board; or (3-20-20)T

**o.** Interference with private landowners, public land management agencies, and/or stockmen and their rights and privileges. (3-20-20)T

**35. Watercraft.** A boat or vessel propelled mechanically or manually, capable of operating on inland water surfaces. Excluded as watercraft are hovercraft, jetskis, personal flotation devices (PFD's), or similar devices. (3-20-20)T

**003. -- 004. (RESERVED)**

**005. LICENSE PRODUCTION.**

A license or proof of licensure must be in possession of the licensee while engaged in outfitting or guiding and be produced upon the request of an authorized person. (3-20-20)T

**006. FIRST AID KIT.**

A first aid kit must be present and available on every outfitted excursion. (3-20-20)T

**007. LICENSE RESTRICTIONS.**

**01. Qualified.** All outfitters must be qualified to guide or employ a licensed guide(s) qualified for the activity(ies) for which the outfitter is licensed. (3-20-20)T

**02. Review.** An outfitter's qualifications to guide will be reviewed by the Board and, if approved, a guide license will be issued at no additional fee. (3-20-20)T

**03. Qualifications.** The qualification(s) of an outfitter or guide licensee are determined in accordance with the Act and these rules. (3-20-20)T

**04. Limitation.** A limitation in number of clientele served, operating area, or any other criteria affecting the safety, health, and welfare, of the public or viability of the fish, and wildlife, or other natural resources will be imposed in licensing where such limitation is deemed necessary by the Board in accordance with the Act and these rules. (3-20-20)T

**05. Temporary Employment.** An outfitter may employ a licensed guide who is not currently licensed under the outfitter's license in the case of temporary employment, or short term "loan" or transfer (less than fifteen (15) days duration and not on a routine basis) of a guide between outfitters, or termination of employment of a guide upon completion of the seasonal activity for which the guide was employed. The employing outfitter or authorized agent must keep written documentation of the loan or transfer and dates and times. Repeated transfers or loans of guides require a license amendment. (3-20-20)T

**008. EMPLOYMENT OF OUTFITTERS.**

An outfitter may guide for another outfitter or rent or lease equipment or services as follows: (3-20-20)T

**01. Other Outfitter.** An outfitter may guide for another outfitter when properly employed by that outfitter and approved by the Board. (3-20-20)T

**02. Other.** If an outfitter is employed to guide activities not covered by his own guide license, the outfitter must apply to the Board for a license amendment and submit the employing outfitter certification prescribed in Subsection 034.02. (3-20-20)T

**03. No Sharing of Profits.** While an outfitter is employed as a guide by another outfitter, the outfitters may not share profits or equipment and/or animals other than leased equipment and/or leased animals. An outfitter when employed as a guide may only render personal services as would any other guide. (3-20-20)T

**04. Agreement.** When an outfitter utilizes equipment from another outfitter or a guide in the provision of facilities, services and transportation to clientele, a written notice of usage must be filed with the Board including a current certificate or proof of non-owner liability insurance. (3-20-20)T

**009. (RESERVED)**

**010. COMPLIANCE WITH LAWS.**

All licensees must comply with all local, state, and federal laws, and they must report all violations to a law enforcement officer. In instances where violations of local, state, or federal laws have occurred, such violations will be handled in accordance with the following discretionary criteria: (3-20-20)T

**01. Violations.** An applicant who has never held an outfitter or a guide license and who has been convicted of a violation of local, state, or federal law may be required to appear before the Board. Each such conviction will be appraised and a decision to approve or deny the application will be based upon the nature and the circumstances of the violation. (3-20-20)T

**02. Examination by Board.** When a license holder is convicted of a violation of local, state, or federal law, the Board will examine the nature of the violation and the circumstances in determining whether or not a hearing will be held for the purpose of restricting, suspending or revoking the outfitter or guide license or imposing an administrative fine for any violation. Any such violator may be required to appear before the Board before a license

will be issued for the following year. (3-20-20)T

**011. (RESERVED)**

**012. OUTFITTER RESPONSIBILITIES.**

An outfitter is responsible for: (3-20-20)T

**01. Camps.** Maintaining safe and sanitary camps at all times. (3-20-20)T

**02. General.** Providing clean, fresh drinking water, protecting all food from contamination, and disposing of all garbage, debris, and human waste in the manner prescribed by regulations concerning use of private and public lands. (3-20-20)T

**03. Livestock Facilities.** Ensuring that livestock facilities are kept separate from camp facilities, and that streams are protected from contamination. (3-20-20)T

**04. Emergency Provisions.** Ensuring that all cross-country and backcountry alpine skiing and technical mountaineering/rock climbing tours have the necessary emergency provisions with them. (3-20-20)T

**05. Actions.** The actions of all guides, and other persons, while in the scope of their employment. (3-20-20)T

**013. -- 014. (RESERVED)**

**015. ANNUAL DATE, FEES, AND PAYMENT.**

**01. Due Date.** All outfitter and designated agent license applications must be completed and received by the Board by January 31 of each year. (3-20-20)T

**02. Penalty Fee.** When a completed renewal application is filed with the Board after the last day of the license year, a penalty fee must be paid before the license is issued. (3-20-20)T

**03. License Lapsed and Relinquished.** All licenses expire on March 31, and when a completed outfitter application has not been received by the Board after ninety (90) days after the last day of the license year the license is deemed relinquished, and a renewal application will not be accepted for licensure. (3-20-20)T

**04. Payment.** (3-20-20)T

**a.** Prior to the issuance of a license, an applicant must submit the appropriate fee. (3-20-20)T

**b.** The applicant must pay an annual license fee for each license issued, except for an outfitter licensed as a guide for the outfitter's operation. (3-20-20)T

**05. Fees.**

Type	Application	Annual License - Online	Annual License - Offline	Late Penalty	Amendment - Major	Amendment - Minor
<b>Outfitter</b>	\$400	\$400	\$450	\$150	\$200	\$35
<b>Designated Agent</b>	\$50	\$140	\$160	n/a	\$20	\$20
<b>Guide</b>	\$20	\$105	\$115	n/a	\$20	\$20

(3-20-20)T

**016. -- 017. (RESERVED)**

**018. NEW OUTFITTER OR OUTFITTER LICENSE AMENDMENT APPLICATION.**

A complete application for a new outfitter license, outfitter license major amendment, or new landowner statement in existing areas must, in addition to all other requirements include: (3-20-20)T

**01. Name.** The name(s) registered with the Idaho Secretary of State as an assumed business name, the name of the business entity, or both. (3-20-20)T

**02. Other Signatures.** Signed landowner or land manager statement from: (3-20-20)T

**a.** The affected state and federal land managers in all areas where an outfitter plans to utilize lands administered by the state or federal government (this may involve memorandum of understanding procedures as applicable to proposed operation on national forest or public domain lands); and, (3-20-20)T

**b.** Private land owners, or their agents, where an outfitter applicant proposes to use such private lands in his operation. (3-20-20)T

**03. Operating Plan.** An operating plan that includes, among other things, the following: (3-20-20)T

**a.** A list of the activities to be conducted in the operating area(s) requested. (3-20-20)T

**b.** A detailed map showing the operating area(s) requested for each activity and a worded description of the boundaries of said operating area(s), described in terms of rivers, creeks, and ridges with prominent reference coordinates (section, township, and range). (3-20-20)T

**c.** An outfitter whose operation is solely on rivers, streams, lakes or reservoirs should specify put-in and take-out points but need not send maps. (3-20-20)T

**d.** A detailed description of how and when each operating area(s) will be used for each activity. (3-20-20)T

**e.** The proposed number of guests intended to be accommodated for each activity within the proposed operating area(s). (3-20-20)T

**f.** A list of the names and locations of camps that will be used for each activity, and whether on public or private land. (3-20-20)T

**g.** A list of the basic equipment, facilities, and livestock, and proof of financial capability necessary to conduct the proposed outfitted activity or business. (3-20-20)T

**h.** The number, title (guide, lead guide, etc.), and principal activities of individuals to be employed in the business operation. (3-20-20)T

**i.** A plan to assure the safety and provide for emergency medical care of guests. (3-20-20)T

**04. Insurance.** Current certificate or proof of insurance for the following: (3-20-20)T

**a.** Insurance coverage against loss resulting from liability imposed by law for bodily injury or death or damage to property suffered by any person, excluding employees, caused by the outfitter's operation, in the minimum amount of one hundred thousand (\$100,000) per accident, with the aggregate of three hundred thousand (\$300,000), because of bodily injury or death occurring in an accident. (3-20-20)T

**b.** Insurance coverage on vehicles carrying passengers against loss resulting from liability for bodily injury or death or property damage suffered by any person caused by the outfitter's operation, in the amount of three hundred thousand (\$300,000) for vehicles carrying one (1) to fifteen (15) passengers, and in the minimum amount of five hundred thousand (\$500,000) for vehicles carrying sixteen (16) or more passengers. (3-20-20)T

**05. Designated Agent.** When the applicant is a corporation, firm, partnership, or other organization or combination thereof, the designation at least one (1) designated agent who is a qualified outfitter, covered by the outfitter's bond, and who will be responsible for the outfitting business. The designated agent must apply for and be granted a license. (3-20-20)T

**06. Hearing.** If more than one (1) applicant submits a complete application with landowner statement(s), a hearing will be held to decide the successful applicant. (3-20-20)T

**07. Existing Operating Area.** A licensed outfitter may be given priority for any opportunities within the outfitter's existing operating area boundaries. (3-20-20)T

**019. (RESERVED)**

**020. EXAMINATION.**

All new applicants applying for an outfitter or designated agent license must successfully pass a written and/or oral examination on the Act, the rules, and general outfitting procedures. An applicant who fails the test may retake it after a five (5) day waiting period. (3-20-20)T

**021. EVALUATION OF THE OUTFITTER APPLICATION.**

In evaluating an outfitter application the Board will consider, but not be limited to, the following criteria: (3-20-20)T

**01. Qualifications.** Applicant's qualifications under the Act and these rules. (3-20-20)T

**02. Need for Services.** The public need for the proposed service(s) in the area requested on the application. (3-20-20)T

**03. Other.** The extent of the applicant's experience, knowledge, and ability in the area and in the conduct of activities requested. (3-20-20)T

**04. Previous Record.** The applicant's previous record. (3-20-20)T

**05. Accessibility of Area.** The accessibility and use by the general public and commercial use already licensed in the area. (3-20-20)T

**06. Area Requested.** The probable impact on the area should additional licenses be issued. (3-20-20)T

**07. Operating Plan.** The adequacy and acceptability of the proposed operating plan. (3-20-20)T

**a.** The applicant's knowledge of financial and business management needs and practices. (3-20-20)T

**b.** The applicant's ability to manage and direct personnel and guests. (3-20-20)T

**022. ISSUANCE OF AN OUTFITTER LICENSE.**

In order to safeguard the health, safety, and welfare of the public and for the conservation of wildlife resources, the Board may place a limit on the number of outfitter licenses issued within an operating area. (3-20-20)T

**023. THIRD PARTY AGREEMENTS.**

An outfitter may not sublet or enter into any third party agreements involving the use of his activity(ies), operating area(s), or license. (3-20-20)T

**01. Employed.** No outfitter may allow any person to conduct any of the activities for which he is licensed unless said person is employed directly by the outfitter as a guide. (3-20-20)T

**02. Other Activities.** Any arrangement wherein an outfitter licensed to conduct outfitted activity(ies) in an operating area(s) knowingly allows, condones, or otherwise abets and supports the conduct of outfitting activity(ies) by another, wherein said outfitter does not assume full and complete responsibility for all clients booked

for such activity(ies), constitutes an unlawful third party agreement. Complete responsibility includes providing liability insurance to cover the client, collection of fees paid for the activity(ies), payment of user fees and taxes, and making the client aware as to who is the responsible outfitter(s). Such unlawful activity(ies) is grounds for discipline as unethical and unprofessional conduct in addition to any other penalties which may be assessed for violations of these rules or the laws of the state of Idaho. (3-20-20)T

**03. Booking Agent.** This Rule does not apply to the conduct of a booking agent or an agreement between two (2) or more outfitters in which the outfitters provide services to the same party or parties within their respective operating areas. (3-20-20)T

**024. STANDARDS FOR NON-USE.**

In order to carry out the intent of the Act to promote and encourage participation in the enjoyment and use of the state's natural resources and fish and game and ensure an outfitter adequately serves the public, the Board will monitor, prioritize, and fairly administer identified remedies based on, among other factors, interest or demand for the particular activity or area and as set forth in this rule. (3-20-20)T

**01. Requirement.** The Board may annually review the outfitter's use reports for the preceding three (3) years to determine whether any licensed activity or operating area fall within non-use. If the outfitter falls within non-use, a "notice of non-use" may be issued to the outfitter. (3-20-20)T

**02. Definitions.** (3-20-20)T

**a.** Non-use. When an outfitter is making zero (0) or negligible use of major licensed activities for any two (2) of the three (3) preceding years unless the lack of use is due to an act of nature or because of state or federal agency restrictions on hunting or fishing that limit the ability of the outfitter to seek and accommodate clients; (3-20-20)T

**b.** Zero (0) use. No recorded use by an outfitter of their licensed area or activities; (3-20-20)T

**c.** Negligible use. An unreasonable lack of use as determined by the Board for any one (1) or more of the particular activities in the assigned operating area. Typically, use may be determined by comparison of use levels for the same activity(s) in similar operating areas. Other factors in determining use are found in Subsection 024.04. (3-20-20)T

**03. Process.** (3-20-20)T

**a.** The notice of non-use will include the activity(s) and operating area(s) that appear to be in non-use and an explanation of how the determination was made. The outfitter will be given the opportunity to correct the use records by supplying staff with evidence of use, prior to a hearing being scheduled. If adequate proof of use is not provided, the matter will be scheduled for a hearing. (3-20-20)T

**b.** When the Board determines that any activity or operating area has had zero (0) use or negligible use, certain requirements may be imposed by the Board up to and including revocation of some or all of the outfitter's operating areas and activities. (3-20-20)T

**04. Examples of Acceptable Use:** (3-20-20)T

**a.** Paying clients participating in activities occurring within a designated operating area; (3-20-20)T

**b.** Donated trips; (3-20-20)T

**c.** Outfitter initiated applications for controlled hunts in their licensed operating area; (3-20-20)T

**d.** Outfitter initiated applications for trophy species; and (3-20-20)T

**e.** Use in conformance with a current and accepted operating plan. (3-20-20)T



**05. Required Records.** Outfitters may be required to submit client records that include the name, address, and date of activity of individual clients or groups for a period of three (3) consecutive years. (3-20-20)T

**06. Non-Use During a Sale.** Board staff reviews all full or partial business sales for non-use. If it is determined a major activity or operating area has had zero (0) or negligible use, the Board may review the sale and the issuance of a license may be denied. In some instances the Board may approve the sale with notification to the buyer that use must be established within the following two (2) out of the next three (3) years or the area or activity may be removed from their license. (3-20-20)T

**07. Waiver of Compliance.** The Board may waive compliance with the non-use standard upon a showing of good cause, including an act of nature, state or federal agency seasonal restrictions on hunting or fishing or personal circumstances such as illness or injury that limit the ability of the outfitter to seek and accommodate clients. An outfitter must apply for a waiver prior to the beginning of the license year or immediately upon the event constituting good cause. If a federal permit holder is requesting zero (0) or negligible use, the request for a waiver must be accompanied by a Land Manager's Statement. (3-20-20)T

**025. OUTFITTER RENEWAL.**

All licenses expire on March 31 and every application for license renewal for an outfitter and designated agent must be complete and submitted by January 31 of the license year and include a use report containing an activity, use, and harvest report on the actual use during the preceding year and other information about outfitting or guiding activities. (3-20-20)T

**026. OPERATING AREA ADJUSTMENTS.**

An outfitter's operating area may be adjusted for reasons of wildlife harvest, where territorial conflict exists, or for the safety of persons utilizing the services of outfitters. (3-20-20)T

**01. Hearing.** If the Board determines that a hearing is necessary prior to the adjustment of a licensee's operating area, such hearing will be conducted in accordance with the Idaho Administrative Procedures Act, Title 67, Chapter 52, Idaho Code, and all affected parties will be afforded an opportunity to participate. (3-20-20)T

**02. Consideration.** In determining whether to adjust an operating area for reasons of wildlife harvest, the Board or the hearing officer considers, among other things, the following: (3-20-20)T

**a.** Any changes in wildlife harvest, including any increase or decrease in wildlife harvest attributable to the licensee's activity(ies). (3-20-20)T

**b.** Any new limitation(s) imposed or recommendation(s) made regarding wildlife harvest in the operating area(s) by any governmental agency since the issuance of the license. (3-20-20)T

**c.** Any environmental change(s) that have occurred in the operating area(s) that affect wildlife management. (3-20-20)T

**d.** Any undesirable wildlife impact(s) that may be ameliorated by a territorial adjustment. (3-20-20)T

**e.** Any new information discovered since the issuance of the license regarding wildlife management in the operating area(s). (3-20-20)T

**03. Consideration.** In determining whether to adjust an operating area for reasons of territorial conflict, the Board or the hearing officer considers, among other things, the following: (3-20-20)T

**a.** Any incident(s) of territorial conflict and how they might be ameliorated by a territorial adjustment. (3-20-20)T

**b.** The extent of each licensee's legal use of the disputed area. (3-20-20)T

**c.** Any public or client safety concerns that might be ameliorated by or might arise from the inclusion of the disputed area as part of a particular licensee's operation. (3-20-20)T

**d.** Any environmental or operational factors that indicate which licensee will be able to make the best use of the disputed area in providing services to the public considering, among other things, each licensee's licensed activity(ies) and the relationship of that activity(ies) to the activity(ies) conducted in the disputed area, each licensee's total operating area, the financial stability of each licensee, and the accessibility of the disputed area from adjacent operating area(s). (3-20-20)T

**e.** Any recommendation(s) submitted by any governmental agency that regulates or manages land or wildlife within the disputed area. (3-20-20)T

**04. Safety Adjustment.** In determining whether to adjust an operating area for reasons of safety of persons using the services of an outfitter, the Board or hearing officer considers, among other things, the following: (3-20-20)T

**a.** Any change(s) in the environmental condition(s) in the area that may pose a threat to the health and safety of persons using the operating area. (3-20-20)T

**b.** Any change(s) in the manner or amount of public use of the operating area since the issuance of the license that may pose a threat to the health and safety of persons using the operating area. (3-20-20)T

**c.** Any change(s) in a licensee's manner of operation within the operating area that may affect clientele safety considering, among other things, change(s) in the condition(s) of the licensee's capability or equipment. (3-20-20)T

**d.** Any safety-related incident(s) that have occurred in the operating area. (3-20-20)T

**e.** Any safety concern(s) expressed by any governmental agency that regulates or manages land or wildlife within the operating area. (3-20-20)T

**f.** Any new information discovered since the issuance of the license regarding safety. (3-20-20)T

**027. OUTFITTER LICENSE PRIORITY.**

Priority for licensure in any outfitter's operating area may be maintained by submitting a complete application for a license for the ensuing license period before the expiration date of the current license. (3-20-20)T

**028. OUTFITTER BUSINESS PURCHASE, LICENSE CONSIDERATIONS.**

**01. Sale of Outfitting Business.** The sale of an outfitting business requires an application for a new outfitter license by the purchaser, provided that the Board may give priority for licensure to an applicant who has negotiated a purchase agreement with a licensee if the applicant meets all other requirements. (3-20-20)T

**02. Notification to Clients.** When an existing operation is acquired by another outfitter, all clients who have booked with the original outfitter must be promptly notified and refunded any advanced payment, unless the client is satisfied with the new arrangements. (3-20-20)T

**029. OUTFITTER BOND OR INSURANCE CANCELLATION.**

An outfitter or designated agent must immediately notify the Board when their bond or insurance is canceled. The cancellation of an outfitter license bond or insurance by the insurer is grounds for emergency suspension of the outfitter's license under Section 67-5247, Idaho Code. (3-20-20)T

**030. OUTFITTER WAITING LISTS.**

When there are more outfitter applications for an outfitter operating area than the maximum number of licenses allowing such activity, or when an individual wishes to be considered in an area to which another outfitter has historically been licensed, the Board will maintain a list of such individuals for notification of an available opening. If there is no waiting list for an area, the Board may proceed with the license application or may employ a competitive application process. (3-20-20)T

**01. Waiting List.** The waiting list will be maintained for each individual river, lake and reservoir outlined in Section 059 and for each specific IFGC unit listed in IDAPA 13.01.08, “Rules Governing the Taking of Big Game Animals in the State of Idaho.” (3-20-20)T

**02. Outfitter Application or Outfitter Amendment Form.** A complete new outfitter application or outfitter amendment form must be submitted for each river section, lake and reservoir and for each specific IFGC unit and all activities for which the individual desires licensure. (3-20-20)T

**03. Length of Time Name Is on Waiting List.** A name on the waiting list will be maintained for a period of five (5) years or until December 31 of the fifth year that the name is placed on the list, whichever comes first. (3-20-20)T

**04. When Available Outfitting Opening Occurs.** When, or if, an available opening does occur and public announcement is made, the Board will use the waiting list for direct notification by mail of interested parties, and will select a qualified candidate from those who apply. Any person on the list who remains interested in obtaining a license following notification of availability must re-apply by submitting all necessary forms and fees during the open period as announced by the Board in order to have his application considered. (3-20-20)T

**05. When an Operating Area Is Relinquished by the Licensee.** If an existing operating area (hunting, boating, or other) is relinquished by the licensee, the Board may publicize the area's availability and accept written applications for licensure for a thirty (30) day period of time from the date of public notice. The Board will then consider the qualifications of all applicants and license the area to the candidate determined to be most qualified including the consideration of criteria used to consider new or amendment outfitter applications. (3-20-20)T

**031. -- 033. (RESERVED)**

**034. GUIDE APPLICATION REQUIREMENTS - GENERAL.**

To be complete, an application for a guide license must: (3-20-20)T

**01. First Aid Card.** Be accompanied by an affidavit signed by the employing outfitter that the applicant will have a current, valid first aid card before they are employed as a guide. (3-20-20)T

**02. Signatures.** Be attested to by the applicant and certified by the licensed outfitter(s) who wishes to employ the applicant as a guide that the applicant: (3-20-20)T

**a.** Is qualified to perform the type of guiding activity(ies) for which the applicant seeks licensure. (3-20-20)T

**b.** Has extensive, first-hand knowledge of the operating area(s) and water(s) in or on which the applicant will be guiding. (3-20-20)T

**c.** If the applicant is land based, is able to read and understand a map and compass or operate a global positioning system (GPS) or other computerized map system. (3-20-20)T

**d.** If the applicant is water based, is proficient in reading the water and handling the type of boat required to be used. (3-20-20)T

**e.** Provide directly from the outfitter a training log or documentation demonstrating satisfaction of the training requirements pursuant to Sections 035 through 042, 044, 046, 047 and 048 of these rules, as applicable for the activities sought to be licensed to guide. (3-20-20)T

**03. Amendment.** A guide may apply for an amendment to add additional employing outfitters or additional activities by submitting complete application that includes certification from the outfitter that training requirements for the area and activity to be added have been met and proof of such training will be available at the Board's request. (3-20-20)T

**035. GUIDE APPLICATION REQUIREMENTS - HUNTING.**

A guide applicant for big game hunting may be licensed either as an apprentice guide or as a guide. (3-20-20)T

**01. Apprentice Guide.** A new applicant may be licensed as an apprentice guide to pursue training necessary for licensure as a guide by submitting a completed application form and fee. (3-20-20)T

**02. Apprentice Guide.** An apprentice guide may assist a hunting guide in the scope of training, but may not be primarily responsible for guiding a hunt. (3-20-20)T

**03. Guide.** In addition to Section 034, a new hunting guide applicant must have the following minimum training. (3-20-20)T

**a.** Been in the outfitter's operating area(s) for at least ten (10) days and is knowledgeable of trails, terrain, drainages, and game habits and habitat. (3-20-20)T

**b.** Be able to care for meat and trophies, including the ability to correctly cape an animal and with adequate training to be able to instruct and assist clients in the proper care of meat. (3-20-20)T

**04. Upgraded.** A licensed apprentice guide may apply by amendment to upgrade a guide license when the required training is completed as certified by the employing outfitter, and a copy of the completed training form is submitted to the Board. (3-20-20)T

**036. (RESERVED)**

**037. BOATMAN LICENSE TRAINEES.**

A trainee boatman may not obtain a guide license until training is complete and may not operate a boat except as prescribed in Section 040 and provided that the boat trainee must be in a boat operated by a licensed boatman, or one in which the operation is closely monitored by a licensed boatman. The licensed boatman need not be in the same boat during training as long as the trainee's activity is closely monitored. (3-20-20)T

**038. FLOAT BOAT GUIDE -- UNCLASSIFIED RIVERS.**

An applicant for a float boat guide on unclassified rivers and streams must have one (1) complete commercial float boat trip on each of the rivers applied for, (complete trip means the total section of river designated by the Board in Subsection 059.01), under the supervision of a float boat guide licensed for each of those rivers. (3-20-20)T

**039. FLOAT BOAT GUIDE -- CLASSIFIED RIVERS.**

A float boat guide on a classified river must be licensed as a float boatman or a float lead boatman according to his experience on that specific river. Each trip on a classified river must have a lead boat operated by a guide licensed as a lead boatman for that specific river and all other boats participating in that trip must follow the lead boat and must be operated by a guide licensed as a boatman or a lead boatman for that specific river. (Note exception for trainees in Section 040). (3-20-20)T

**040. FLOAT BOATMAN QUALIFICATIONS -- CLASSIFIED RIVERS.**

An applicant for a float boatman license on classified rivers may qualify in one (1) of three (3) ways: (3-20-20)T

**01. General.** Three (3) complete float boat trips on each of the classified rivers applied for under the direct supervision of a float boatman licensed for that river (complete trip means the total section of river designated by the Board in Subsection 059.01), or he must have had one (1) or more complete float boat trips on each of the classified rivers applied for under the direct supervision of a float boatman licensed for that river with the remaining trip(s) in a boat with no more than one (1) other trainee, following a licensed float boatman for that river, but he must not have passengers in the boat. (3-20-20)T

**a.** Allowances may be made for experience gained as a commercial boat operator on selected whitewater rivers with characteristics similar to Idaho's classified rivers; e.g. Colorado River (Grand Canyon or Cataract Canyon), Yampa River, Rogue River, American and Toulumne Rivers, other Idaho classified rivers, or the unclassified section of the Salmon River from North Fork to Corn Creek, provided the applicant has logged at least five hundred (500) miles as a commercial float boat operator on one (1) or more of those rivers. (3-20-20)T

**b.** To document this experience, a statement signed by the applicant under oath or affirmation and notarized must be recorded on a form provided by the Board office that includes precise put-in and take-out points, miles logged for each trip, and the names and addresses of the boat operators who have employed them. (3-20-20)T

**02. Other.** Logged at least five hundred (500) miles as a commercial float boat guide on any rivers applicable to Subsection 040.01.a., and must have one (1) complete float boat trip on each river applied for under the direct supervision of a float boatman licensed for that river, or in a boat with no more than one (1) other trainee, following a float boatman licensed for that river, but there must not be any passengers in the boat. (Complete trip means the total section of river designated by the Board in Subsection 059.01). (3-20-20)T

**03. Float Lead Boatman.** Or, hold a license as a float lead boatman on a classified Idaho river and complete one (1) complete float boat trip on each other classified river applied for, under the direct supervision of a float boatman licensed for that river, or in a boat with no more than one (1) other trainee, following a float boatman licensed for that river, but he must not have passengers in the boat. (Complete trip means the total section of river designated by the Board in Subsection 059.01.) (3-20-20)T

**041. FLOAT LEAD BOATMAN QUALIFICATIONS.**

An applicant for a float lead boatman license must have six (6) complete float boat trips except that upon Board approval, a licensee may train on and be licensed for a specific reach of a section only. (Complete trip means the total section or reach of a section of river designated by the Board in Subsection 059.01). One (1) trip must have been within the sixty (60) months preceding the date of the application on each of the classified rivers applied for. (3-20-20)T

**042. POWER BOAT GUIDE.**

To qualify for a power boat guide license on the following waters, an applicant must have spent the following power boating hours that are distributed as evenly as possible along the total length or section of river or area of the lake or reservoir and under the direct supervision of a power boat guide licensed for the body of water for which qualification is sought: (3-20-20)T

**01. Classified Rivers.** Fifty (50) hours on the total length of the river or section of river designated on the application by the Board for which he wishes to operate, except that an applicant may have spent twenty-five (25) hours on each section for the Salmon River from the mouth of the Middle Fork to Salmon Falls, Salmon Falls to Ludwig Rapids, and Ludwig Rapids to Vinegar Creek or Spring Bar. (3-20-20)T

**02. Unclassified Rivers and Streams.** At least ten (10) hours on the total length of the river or section of river designated by the Board on the application for which he wishes to operate. (3-20-20)T

**03. Lakes and Reservoirs.** Ten (10) hours on the lake or reservoir on which he wishes to operate. (3-20-20)T

**04. Log.** The outfitter must maintain a log of this experience recorded on a form provided by the Board, showing the dates, river, lake or reservoir, location of put-in, destination, take-out, hours logged, and signature of outfitter. (3-20-20)T

**043. (RESERVED)**

**044. SKIING, NON-HAZARDOUS AND HAZARDOUS TERRAIN OUTFITTER, DESIGNATED AGENT, SKI GUIDE AND SKI GUIDE TRAINEE.**

**01. Applications.** (3-20-20)T

**a.** An outfitter, designated agent or guide must submit an outfitter or a guide application with current outfitter operating plan, if required, ski resume, and avalanche training certificates. (3-20-20)T

**b.** The Technical Advisory Committee (TAC) will evaluate and advise the Board on the scope and appropriate designations for licensure of any application for outfitting or guiding principally in non-hazardous and hazardous terrain skiing. The TAC is a five (5) member body of qualified backcountry ski outfitters and ski guides

appointed by the Executive Director and confirmed by the Board. (3-20-20)T

**02. Designations and Qualifications for Outfitters, Designated Agents, Guides and Trainees.** The designations and qualifications are as follows: (3-20-20)T

**a.** Level I ski guide (non-hazardous terrain, principally sub-alpine or skiing operations in forests). Is qualified to lead ski tours in the outfitter's operating area. One (1) year training as a ski guide assistant in a non-hazardous backcountry setting. Level I Ski Guides may work in hazardous terrain as a Level II Ski Guide Trainee under the supervision of a Level II Ski Guide. Level I Ski Guides are required to have: (3-20-20)T

i. Level I field-based avalanche training consisting of a twenty-four (24) hour curriculum submitted and an instructor roster; (3-20-20)T

ii. Knowledge of Outfitters Scope of Operation including logistics, services, terrain; and (3-20-20)T

**b.** Level II ski guide (hazardous terrain with a high degree of avalanche exposure). Has in-depth ski guiding experience on hazardous terrain and has the following qualifications: (3-20-20)T

i. Two (2) winter seasons training with licensed Level II Ski Outfitter or Guide or equivalent work experience with another Level II ski operation which conduct services principally in hazardous or avalanche terrain; (3-20-20)T

ii. Advanced First Aid, WFR, or EMT of a minimum of forty-eight (48) hours; (3-20-20)T

iii. Level I and Level II field-based avalanche training consisting of at least forty-eight (48) hours curriculum with a submitted instructor roster; (3-20-20)T

iv. Knowledge of the Outfitters Scope of Operation including logistics, services, terrain; and (3-20-20)T

**03. Outfitters.** Outfitters who conduct winter ski-based operations may be designated as: (3-20-20)T

**a.** Level I: self-propelled, with snowcat, or with snowmobile assisted including day skiing, hut skiing in non-hazardous terrain; (3-20-20)T

**b.** Level II: self-propelled including day skiing, hut skiing, multi-day expeditions, in hazardous terrain; or (3-20-20)T

**c.** Level II skiing operations with snowcats, helicopters, or ski from out of bounds from ski areas. (3-20-20)T

**04. Outfitters Plan of Operation.** The outfitter's operating plan will include a plan for snowpack, terrain and avalanche safety assessment, additional transport utilized (i.e., snowmobiles, snowcats, helicopters) and instruction and training plans of guides working around related equipment, and any additional safety and training standards for guides. (3-20-20)T

**05. Field Supervisor.** The Outfitter must employ at least one individual acting as a field supervisor who is a working Guide with the appropriate level of licensing for the operation and a minimum of five (5) years working at that level of guiding as to the scope of the operation, unless the outfitter or Designated Agent has this experience. (3-20-20)T

**06. Ski Guide Trainee.** An outfitter may employ an unlicensed trainee, provided the trainee may only assist when under the direct supervision of a licensed guide and a trainee may not provide guided services to clients. A trainee who applies for licensure must have thirty (30) days experience with a licensed ski guide in the outfitter's operating area and meet all other qualifications of Section 044. (3-20-20)T

**045. (RESERVED)**

**046. TECHNICAL MOUNTAINEERING/ROCK CLIMBING GUIDE.**

Any applicant for a technical mountaineering/rock climbing guide license must submit to the Board a detailed explanation of the applicant's qualifications, experience, and training. (3-20-20)T

**047. SNOWMOBILING GUIDE.**

An applicant for a snowmobiling guide license must: (3-20-20)T

**01. Snowmobiling Techniques.** Have working knowledge of snowmobiling techniques; (3-20-20)T

**02. Avalanche.** Have good leadership qualities and be knowledgeable in regards to potential avalanche conditions and proper route selection; (3-20-20)T

**03. Hypothermia.** Be knowledgeable in the treatment of hypothermia and in winter survival techniques; and (3-20-20)T

**04. Mechanics.** Have knowledge of the mechanical characteristics of snowmobiles and other equipment being used. (3-20-20)T

**048. POWER BOAT FISHING GUIDE -- (LAKES AND RESERVOIRS).**

All applicants for a power boat fishing guide license must possess the ability and knowledge to: (3-20-20)T

**01. Maneuver or Pilot.** Maneuver or pilot a power boat upon Idaho lakes and reservoirs open to power boat fishing. (3-20-20)T

**02. Operation.** Have operated a power boat for a minimum of ten (10) hours upon the lakes and reservoirs being requested. (3-20-20)T

**03. Law.** Comply with the Idaho Safe Boating Act (Title 67, Chapter 70, Idaho Code). (3-20-20)T

**049. -- 050. (RESERVED)**

**051. PLACEMENT OF HUNTING CAMPS AND LEAVING OUTFITTER'S OPERATING AREA, BIG GAME HUNTING AND INCIDENTAL TRAPPING.**

**01. Hot Pursuit of Bear and Cougar With Hounds and Hot Pursuit Agreements.** The Board may approve a minor amendment to allow an outfitter licensed for bear and cougar hunting to enter into an adjacent area with a client for hot pursuit of bear and cougar hunting when hunting with hounds, provided that the pursuit starts inside the outfitter's licensed area. The application for minor amendment must include: (3-20-20)T

**a.** Written permission from all outfitters whose licensed area(s) will be directly involved in the hunt and which will be provided annually to the Board; (3-20-20)T

**b.** Written permission from all applicable landowners or land managers; (3-20-20)T

**c.** With prior Board approval, on a case by case basis and under special circumstances, the Board may waive the requirement for approval from the adjacent outfitter. (3-20-20)T

**02. Camps.** A hunting outfitter may not place a camp, nor cause one to be placed, in an area for which he is not licensed, except as identified in his approved operating plan. Whenever possible, camps used for big game hunting must be placed well within the operating area and not near the boundary line. (3-20-20)T

**03. Wolf Trapping Incidental to Big Game Hunts.** Outfitters licensed for big game hunting and for hunting wolves may qualify to provide wolf trapping as a hazardous excursion during the course of big game hunting as a minor (incidental) activity during open wolf trapping season as set forth below. (3-20-20)T

**a.** The Outfitter or Designated Agent and guide must have completed the mandatory wolf trapping

education class prior to the activity taking place. The outfitter is responsible for maintaining the certificate(s) of completion on file and making it available for inspection. (3-20-20)T

- b.** Wolf trapping may not be advertised, promoted, or booked as an outfitted or guided service. (3-20-20)T
- c.** Outfitter or Designated Agent may not kill or allow domestic livestock or animals to be killed for use as bait while in their operating area or to use live animals as bait and will be otherwise expected to follow existing state laws regarding handling of domestic livestock. (3-20-20)T
- d.** A trapped animal must be killed quickly and humanely. It cannot be released and then “hunted” or killed. (3-20-20)T
- e.** Outfitters and guides may not directly engage a client in trapping activities handle or be involved with handling traps or trapped animals. Clients may be allowed to: (3-20-20)T

  - i.** Hunt and kill any free ranging animal for which they have an appropriate license and tag, except when the animal is in or within two hundred (200) yards of the Outfitter's or guide's trap line. (3-20-20)T
  - ii.** Accompany a properly licensed guide who is checking the outfitter's traps provided the client is directly accompanied by that guide at all times. (3-20-20)T
  - iii.** Only observe the handling of trapped animals by properly licensed guides. (3-20-20)T
- f.** Guides who have completed the required education in Paragraph 051.01.a. are subject to the following: (3-20-20)T

  - i.** Guides may check their employing outfitter's or their own wolf traps as per state requirements as part of outfitted, big game hunts. (3-20-20)T
  - ii.** May not provide services to the same client for two (2) different outfitters within a five (5) day period. (3-20-20)T

**052. BOAT TRANSPORT OF HUNTING CLIENTS.**

A boatman licensee (either power or float) must not transport big game hunters to any big game hunting area unless licensed to outfit for big game hunting in that area or is in the employ of the licensed outfitter for that area. (3-20-20)T

**053. CONTROLLED HUNTS OUTSIDE OUTFITTER'S OPERATING AREA.**

The Board may authorize an outfitter who is licensed for a controlled hunt species to conduct a one-time hunt for a controlled hunt outside of the outfitter's licensed area when the outfitter submits a minor amendment fee and a written request with the following: (3-20-20)T

- 01. Written Permission.** Written permission from all outfitters whose licensed area(s) will be directly involved in the hunt and all applicable landowners or land managers; (3-20-20)T
- 02. Identification of Hunter.** The hunter name and address, hunting license, tag and permit numbers, controlled hunt number, and dates of hunt. (3-20-20)T
- 03. Compensation Between Outfitters.** No compensation is permitted between outfitters participating in the conduct of a controlled hunt in another outfitter's area, unless the outfitter supplies a service for that compensation. (3-20-20)T

**054. BOAT EQUIPMENT REQUIREMENTS.**

Each float or power boat must be identified as follows: (3-20-20)T

- 01. Identification.** Identification recorded with the Board on the outfitter application consisting of



words, names, or letters not less than three (3) inches in height, and be of a contrasting color indicating the current licensed outfitter and that is placed above the water line on each side of the bow or stern of the boat utilized by that outfitter in letters. (Does not apply to single person boats or two (2) person inflatable boats). (3-20-20)T

**02. Clearwater.** On Sections CL2 and CL3 of the Clearwater River, a sticker affixed to the surface of any boat used for anadromous fishing that is not less than eight (8) inches in height and placed immediately adjacent to the identification words, names or letters on each side of the boat towards the bow, identifying the boat as operated by a licensed outfitter. Stickers will be provided and sold annually by the Board or a vendor designated by the Board. (3-20-20)T

**055. BOATING CLIENT/GUIDE RATIO.**

All float boats, occupied by three (3) or more clients, must be under the control of a licensed guide; except a boat guide trainee may operate a boat under the direct supervision of a licensed boatman, or may train as indicated in Section 040. Kayaks and canoes and clients rowing rafts that they provide are exempt from this rule. (3-20-20)T

**056. (RESERVED)**

**057. DESIGNATION OF ALLOCATED DEER AND ELK TAGS.**

Beginning with the 2021 big game season setting, the Board will designate allocated tags to eligible outfitter operations as prescribed by Section 36-2107(j), Idaho Code, and when necessary, based on an outfitter's proportional use within the capped zone or controlled hunt zone, unit, or game management area as set forth in this section. For purposes of this section, an eligible outfitter operation is an outfitter whose licensed activities include hunting the species for the type of allocated tag being designated. (3-20-20)T

**01. Calculation and Designation of Allocated Tags.** Pursuant to Section 36-2107(j), Idaho Code and as set forth below, an outfitter's number of designated allocated tags will be the outfitter's base allocation number plus a proportional share of any surplus allocated tags based on outfitted tag use as set forth below, or when there is an insufficient number of allocated tags to satisfy each outfitter's base allocation, the outfitter's proportional use. The result is the number of allocated tags designated for the outfitter operation. The Board will notify outfitters of the number of designated allocated tags and the underlying basis for the designation. The designation applies until the next big game season setting by the Idaho Fish and Game Commission. (3-20-20)T

**a.** An outfitter's base allocation number is: (3-20-20)T

**i.** For a capped zone, the average of the last two (2) years of an outfitter's outfitted tag use. (3-20-20)T

**ii.** For a controlled hunt, the highest year within the last two (2) years of an outfitter's outfitted tag use. (3-20-20)T

**b.** An outfitter's proportional use is calculated by dividing an individual outfitter's base allocation by the total of the base allocations of all outfitters in the capped zone or controlled hunt zone, unit, or game management area, and then multiplying by the total number of allocated tags for the capped zone or controlled hunt. (3-20-20)T

**c.** When a calculation results in a partial tag, the calculation will be rounded up when a decimal equals or exceeds zero point six (0.6) and rounded down when a decimal is less than zero point six (0.6). (3-20-20)T

**d.** When there are remaining allocated tags after the Board has designated tags pursuant to Paragraphs a and b of this rule, the Board will designate remaining allocated tags based on the following priorities and in the following order: (3-20-20)T

**i.** All eligible outfitters whose base allocation number is zero (0) and who want to be designated allocated tags are designated at least one (1) allocated tag; (3-20-20)T

**ii.** Eligible outfitters with the fewest number of designated allocated tags have an equal number of designated allocated tags when possible; (3-20-20)T

iii. Based on a random drawing between the eligible outfitters with the fewest number of designated allocated tags provided that an outfitter is not designated more allocated tags than another outfitter that has a greater base allocation number; (3-20-20)T

iv. Based on the greater base allocation number between the eligible outfitters with the fewest number of designated allocated tags. (3-20-20)T

e. When there is a deficit of allocated tags to satisfy each outfitter's proportional use, the Board will identify the group of outfitters whose base allocation number was rounded up, and the deficit will be resolved against the outfitter whose base allocation number prior to rounding is closest to zero point six (0.6). In the event there are two outfitters with the same unrounded base allocation number closest to zero point six (0.6), the deficit will be resolved against one of those outfitters based on a random drawing. (3-20-20)T

**02. Stipulation by Outfitters.** Outfitters in a capped zone or for a controlled hunt may submit to the Board a written stipulation determining the number of allocated tags designated for each outfitter within the capped zone or for the controlled hunt. The stipulation must be signed by all eligible outfitters for the capped zone or controlled hunt. If the Board accepts the stipulation, the stipulation will be effective until the Idaho Fish and Game Commission sets the next big game season. (3-20-20)T

a. On or before November 1, any outfitter may petition the Board to withdraw from the stipulation for good cause. If the Board grants the withdrawal, then the Board will calculate and designate the allocated tags among the outfitters in that capped zone or controlled hunt according to Subsection 01 of this rule. (3-20-20)T

b. A stipulation only applies to the designation of allocated tags by the Board. (3-20-20)T

**03. Objection to Calculation.** An outfitter that believes the calculation is incorrect may object by filing a petition in accordance with the Idaho administrative procedures act with the Board along with any supporting information or documentation. (3-20-20)T

a. The Board will notify all other eligible outfitters in the capped zone or for the controlled hunt of the petition. (3-20-20)T

b. The outfitter bears the burden of establishing that the calculation was incorrect. (3-20-20)T

**04. Hardship Request.** An outfitter may submit to the Board a written request to maintain a previous base allocation number when the outfitter can demonstrate hardship, including health, act of nature, state of federal restrictions on hunting or access or other good cause that prohibited or limited the outfitter's ability to seek and accommodate clients and impacted the outfitter's use of designated allocated tags. The outfitter must provide any information requested by the Board to assist in substantiating hardship cases. The hardship request must also be approved by the Idaho Department of Fish and Game to retain the outfitted hunter tag use history in respective hunt. (3-20-20)T

**05. Change in Operating Area or Owner of Business.** When an outfitting business is sold or when an operating area is adjusted and designated allocated tags are associated with the affected operating area, the board will transfer the associated designated allocated tags to the new owner. (3-20-20)T

**058. NUMBER OF OUTFITTERS AND GUIDES LIMITED.**

Big Lost and Little Lost Rivers and the Big Wood and the Little Wood Rivers -- All reaches from headwaters to the termination of the flow of the Big Lost and the Little Lost Rivers and all reaches of the Big Wood and Little Wood Rivers are limited to a maximum of five (5) outfitters on both rivers combined. (3-20-20)T

**059. RIVER, LAKE AND RESERVOIR POWER AND FLOAT OUTFITTER LIMITS.**

The following rivers and streams or sections that lie totally or partially within the state of Idaho are open to commercial boating operations by outfitters and guides. The Board may open other rivers and streams or sections upon a petition to adopt rules under Section 67-5230, Idaho Code. (3-20-20)T

**01. Licensable Waters -- River Sections (BL1) Blackfoot River through (PR1) Priest River --**

Table.

River/Section	Maximum No. Power	Maximum No. Float
<b>(BL1) Blackfoot River</b> - Morgan Bridge to Trail Creek Bridge	none	2
<b>(BO1) Boise River, South Fork</b> - Danskin Bridge to the Neal Bridge EXCEPT on weekends or holidays. Each outfitter may use only one (1) boat for fishing only with a maximum of two (2) fisherman. No overnight camping or walk-and-wade fishing allowed.	none	2
<b>(BO1A) Boise River</b> - Eckert Road Bridge to Main Street Bridge.	none	
<b>(BO1B) Boise River</b> - Main Street Bridge to West side of Garden City limits.	none	
<b>(BO2) Boise River</b> - Downstream from the west side of the Garden City municipal limits to the east side of the Caldwell municipal limits. Each outfitter may use at any time a maximum of four (4) boats for boating activities. The Board may approve adjustments of these boat limitations to accommodate canoeing or kayaking activities that are part of an outfitters operating plan.	none	2
<b>(CF1) Clark Fork River</b> - Montana stateline to Lake Pend Oreille (boating closing date September 30)	4 outfitters for either power or float or combination thereof	
<b>(CL1) Clearwater River</b> - Lowell to the Lower Bridge at Kooskia. Each outfitter may use at any one time a maximum of (a) three (3) boats for fishing, and (b) five (5) boats for other boating activities. Fishing may not be conducted downstream from the Upper Bridge at Kooskia by CL1 outfitters. The Board may approve adjustments of these boat limitations to accommodate canoeing or kayaking activities that are part of an outfitter's operating plan.	none	5
<b>(CL2) Clearwater River</b> - The Upper Bridge at Kooskia to the Orofino Bridge. Each outfitter may use at any one time a maximum of (a) three (3) boats for fishing, and (b) five (5) boats for other boating activities. The Board may approve adjustments of these boat limitations to accommodate canoeing or kayaking activities that are part of an outfitter's operating plan.	6	10
<b>(CL3) Clearwater River</b> - The Orofino Bridge to the mouth of the Clearwater River with the Snake River at Lewiston. Each outfitter may use at any one time a maximum of (a) three (3) boats for fishing, and (b) five (5) boats for other boating activities. The Board may approve adjustments of these boat limitations to accommodate canoeing or kayaking activities that are part of an outfitters operating plan.	10	10

River/Section	Maximum No. Power	Maximum No. Float
* (NFCL) North Fork Clearwater River - Kelly Forks Bridge downstream to backwaters of Dworshak Reservoir	none	4
(CDNF) Headwaters of North Fork Coeur d'Alene - Including tributaries (Independence and Tee Pee Creeks) upstream from Devils Elbow Campground. Three (3) walk and wade only licenses. Up to four (4) clients on the river at one time per license.	none	none
(CD1) Coeur d'Alene River - Devil's Elbow to South Fork confluence. Fishing limit is two (2) float boats per license with a maximum of two (2) clients at a time per boat. Two (2) additional walk and wade licenses can be issued. Walk and wade limited to a maximum of two (2) clients at a time per license.	none	1
(CD2) Coeur d'Alene River - South Fork confluence downstream to Cataldo Mission Boat Ramp. Fishing limit is one (1) float boat per license with a maximum of two (2) clients or two walk and wade clients per license at a time. Walk and wade activities do not have to be initiated from a float boat.	none	1
(CD3) Lateral (Coeur d'Alene chain) Lakes - Connected by the Coeur d'Alene river. Cataldo Mission Boat Ramp to Highway 97 Bridge. A limit of one (1) power boat per license with a maximum of two (2) clients at a time or a limit of one (1) guide per license and two (2) float tubes at a time or two (2) clients walking and wading. The walk and wade activities must be associated with the power boating.	3	none
* (JB1) Jarbidge/Bruneau Rivers	none	4
(KO1) Kootenai River - Montana stateline to Canada boundary	5	5
(LCL1) Little North Fork Clearwater River - Mouth of Canyon Creek to first bridge on the Little North Fork Clearwater River. Fishing only. Each outfitter may use only two (2) boats per day with a maximum of two (2) fishermen per boat.	none	2
* (LO1) Lochsa River	none	5
(MO1) Moyie River - Canada boundary to Bonners Ferry Municipal Dam (boating closing date July 20)	none	5

River/Section	Maximum No. Power	Maximum No. Float
* (OW1) Owyhee River - Nevada stateline to Oregon stateline or South Fork to confluence with Owyhee River and continuing on to a take-out point.	none	6
(PN1) Payette River, North Fork - Payette Lakes Outlet to Hartsell Bridge. Restrictions: NO FISHING ALLOWED. Four (4) boat or ten (10) canoe limit per trip, and only two (2) trips per day per outfitter.	none	2
(PN1A) Payette River, North Fork - Cascade City Park, 1/4 mile south of Cascade on Highway 55 to Cabarton. Restrictions: Catch and release for TROUT ONLY, other species F & G rules apply. No stopping by commercial groups from 1/4 mile above to 1/4 mile below heron nesting trees. Four (4) boat or ten (10) canoe limit per trip, and only two (2) trips per day per outfitter.	none	2
(PN2) Payette River, North Fork - Cabarton to Smiths Ferry Bridge	none	5
(PS1) Payette River, South Fork - Grandjean to Deadwood River	none	5
* (PS2) Payette River, South Fork - Deadwood River to Banks	none	5
(PA1) Payette River - Banks to Black Canyon Dam	none	5
(PO1) Pend Oreille River	5	5
(PR1) Priest River - Dickensheet Campground to Priest River City	none	5

(3-20-20)T

**02. Licensable Waters -- River Sections (MF1) Middle Fork Salmon River Through (SE2) Selway River -- Table.**

River/Section	Maximum No. Power	Maximum No. Float
*##(MF1) Salmon River, Middle Fork - Boundary Creek to Cache Bar on the Salmon River	none	27
(SA1) Salmon River - First bridge across Salmon River above Redfish Lake Creek to Torrey's Bar	none	6

River/Section	Maximum No. Power	Maximum No. Float
<p><b>(SA2) Salmon River</b> - Torrey's Bar to first Highway 93 bridge above Challis. Each outfitter may use at any one time a maximum of (a) three (3) boats for fishing, and (b) five (5) boats for other boating activities. The Board may approve adjustments of these boat limitations to accommodate canoeing or kayaking activities that are a part of an outfitter's operating plan.</p>	none	5
<p><b>(SA3) Salmon River</b> - First Highway 93 bridge above Challis to Kilpatrick River access. Each outfitter may use at any one time a maximum of (a) three (3) boats for fishing, and (b) five (5) boats for other boating activities. The Board may approve adjustments of these boat limitations to accommodate canoeing or kayaking activities that are a part of an outfitter's operating plan.</p>	none	6
<p><b>(SA4A) Salmon River</b> - Kilpatrick River access to North Fork - License period from May 1 to September 30. Each outfitter may use at any one time a maximum of (a) three (3) boats for fishing and (b) five (5) boats for other boating activities. The Board may approve adjustments of these boat limitations to accommodate canoeing or kayaking activities that are part of an outfitter's operating plan.</p>	5	11
<p><b>(SA4B) Salmon River</b> - Kilpatrick River access to North Fork - License period from October 1 to April 30. Each power boat outfitter may use at any one time a maximum of one (1) boat and each float boat outfitter may use at any one time a maximum of three (3) boats.</p>	2	8
<p><b>(SA5) Salmon River</b> - North Fork to Corn Creek</p>	3	9
<p><b>###(SA6) Salmon River</b> - Corn Creek to Spring Bar Boat Ramp with no outfitter fishing below Vinegar Creek from September 15 through March 31 except that on a case-by-case basis, outfitter fishing may occur when permitted by the BLM and with the notification to and concurrence of the Board Executive Director.</p>	14	31
<p><b>* (SA7A) Salmon River</b> - Vinegar Creek to Hammer Creek - License period from March 15 to October 15. No power boating is allowed from the Saturday before Memorial Day through Labor Day from 10:30 a.m./Mountain Time to 5:00 p.m./Mountain Time daily between the Riggins City Boat Dock and Lucile.</p>	10	26

River/Section	Maximum No. Power	Maximum No. Float
* <b>(SA7B) Salmon River</b> - Power boats from Vinegar Creek to Spring Bar Boat Ramp and float boats from Vinegar Creek to Island Bar Boat Ramp, open from September 15 to March 31 only. Each float boat outfitter may use at any one time a maximum of three (3) boats for fishing, or two (2) additional boats for fishing when permitted by the BLM and with the notification to and concurrence of the Board Executive Director; and each power boat outfitter may use at any one time a maximum of two (2) boats for fishing, or one (1) additional boat for fishing when permitted by the BLM and with the notification to and concurrence of the Board Executive Director.	6	12
* <b>(SA7C) Salmon River</b> - Riggins City Park Boat Ramp to Hammer Creek. Three (3) designated outfitters may utilize float boats to fish from the Riggins City Boat Dock to Hammer Creek during the period from September 15 to March 31.	none	3
*** <b>(SA8) Salmon River</b> - Hammer Creek to Heller Bar or Lewiston on the Snake River	15	35
* <b>(SE1) Selway River</b> - Paradise Campground to Selway Falls	none	4
<b>(SE2) Selway River</b> - Selway Falls to the mouth of the Selway River at Lowell. Each outfitter may use at any one time a maximum of (a) three (3) boats for fishing, and (b) five (5) boats for other boating activities. The Board may approve adjustments to these boat limitations to accommodate canoeing or kayaking activities that are part of an outfitter's operating plan.	none	5

(3-20-20)T

**03. Licensable Waters -- River Sections (SH1) Henry's Fork Snake River Through (TE3) Teton River -- Table.**

River/Section	Maximum No. Power	Maximum No. Float
<b>(SH1) Snake River, Henry's Fork</b> - Henry's Lake Outlet to Hatchery Ford. (Each outfitter may use at any one time a maximum of (a) eight (8) boats for fishing No more than three (3) of these boats may be used at any one time on any of the following river reaches: Henry's Lake Outlet to Island Park Dam, Island Park Dam to Last Chance, Last Chance to Osborn Bridge, and Osborn Bridge to Hatchery Ford), and (b) five (5) boats for other boating activities. The Board may approve adjustments to these boat limitations to accommodate canoeing or kayaking activities that are part of an outfitter's operating plan.	none	7

River/Section	Maximum No. Power	Maximum No. Float
<p><b>(SH2) Snake River, Henry's Fork</b> - Mesa Falls to St. Anthony. Each outfitter may use at any one time a maximum of (a) eight (8) boats for fishing, no more than three (3) of these boats may be used at any one time on any one of the following river reaches: Mesa Falls to Warm River, Warm River to Ashton Dam, and Ashton Dam to St. Anthony, and (b) five (5) boats for other boating activities. The Board may approve adjustments of these boat limitations to accommodate canoeing or kayaking activities that are part of an outfitter's operating plan.</p>	none	8
<p><b>(SH3) Snake River, Henry's Fork</b> - No more than three (3) boats for fishing may be used by an outfitter at any one (1) time in each of the following river sections:</p> <ul style="list-style-type: none"> <li>a) St. Anthony to Red Road Bridge Boat Access (i.e., Parker/Salem or Fort Henry)</li> <li>b) Red Road Bridge Boat Access to Warm Slough Boat Access</li> <li>c) Warm Slough Boat Access to Menan Boat Access</li> </ul> <p>No outfitter may have more than six (6) boats on the SH3 in any one (1) day.</p> <p>When permitted by the BLM and with the notification to and concurrence of the IOGLB Executive Director, each outfitter may be allowed adjustments to the maximum boat limits in order to accommodate non-fishing boating activities (e.g., canoeing, paddle boards, and kayaks) and hazardous excursions that are part of an outfitter's operating plan. These adjustments must be reviewed and approved annually.</p> <p>IOGLB licenses are for the entire SH3 segment; a section of SH3 cannot be separated from SH3 for the purposes of selling a portion of an outfitter's business.</p>	none	4



River/Section	Maximum No. Power	Maximum No. Float
<p><b>(SS1) Snake River - South Fork</b> - No more than four (4) boats per section/per day may be used by an outfitter at any one (1) time in each of the following river sections:</p> <ul style="list-style-type: none"> <li>a) Palisades Dam to the Conant Boat Access;</li> <li>b) Conant Boat Access to Fullmer Boat Access. Exception: Not more than eight (8) boats would be permitted in Section (b) on the same day, provided that no more than four (4) of said boats are in this Section after 11:00 a.m. due to overnight use at designated outfitter camps;</li> <li>c) Fullmer Boat Access to Byington Boat Access;</li> <li>d) Byington Boat Access to Lorenzo Boat Access; and</li> <li>e) Lorenzo Boat Access to Menan Boat Access;</li> </ul> <p>Additionally, no outfitter may have more than twelve (12) boats on the SS1 in any one day.</p> <p>A one-time per year exception after July 15 may be granted from Conant Boat Access to Byington Boat Access that would allow two (2) additional boats per section to accommodate large client groups. During this one-time exception, if the two (2) additional boats do not accommodate the large client group, additional boats must come from slots allocated to other outfitters. The maximum daily boat limit for SS1 may not be exceeded. This would require written concurrence from the BLM/USFS and the IOGLB Executive Director.</p> <p>Float boats may use motors (5HP or less) for downstream steerage only within the entire SS1 reach. Downstream steerage would not include holding or upstream travel of watercraft with a motor.</p> <p>IOGLB licenses are for the entire SS1 segment; a section of SS1 cannot be separated from SS1 for the purposes of selling a portion of an outfitter's business.</p>	None*	8**
<p>* Each licensed float boat outfitter may use one (1) supply boat (float or power) that does not carry clients. During periods of preparing overnight camps (i.e., setting up tents and portable toilet facilities, boating in grills and other cooking supplies) for the season, usually May or June of each year; and removing the same items listed above from overnight camps at the end of the season, usually October or November; multiple supply boats may be used.</p> <p>** One (1) license additional for waterfowl hunting covering both BLM and USFS managed lands and waters for the South Fork (Palisades Dam to Wolf Flats Boat Access) may be issued. This license opportunity is in addition to the eight (8) float licenses and is limited to providing waterfowl hunting during waterfowl hunting season as defined by Idaho Fish and Game Rules and where no more than two (2) float or power boat boats per day per section a and b only can be used by the outfitter at any one time for that purpose. Fishing may not be provided or conducted unless the outfitter is also licensed and permitted as one (1) of the eight (8) outfitters addressed in this rule who may not provide hunting activities. This business opportunity may be sold separately.</p>		

River/Section	Maximum No. Power	Maximum No. Float
<p><b>(SN1) Snake River</b> - For each license/permit issued, no more than four (4) boats per section/per day may be used by an outfitter at any one time in each of the following river sections:</p> <p>a) Menan Boat Access to Mike Walker Boat Access (includes Federally managed lands);</p> <p>b) Mike Walker Boat Access to Gem State Power Plant (includes non-Federal lands).</p> <p>Float boats may use motors (5HP or less) for downstream steerage only within the entire SS1 reach. Downstream steerage would not include holding or upstream travel of watercraft with a motor.</p> <p>OGLB licenses are for the entire SN1 segment; a section of SN1 cannot be separated from SN1 for the purposes of selling a portion of an outfitter's business.</p>	3 outfitters either float or power or combination thereof	
<p><b>(SN2) Snake River</b> - Gem State Power Plant downstream to headwaters of American Falls Reservoir</p>	3	3
<p><b>(SN3) Snake River</b> - American Falls Dam to Massacre Rocks State Park</p>	3	3
<p><b>(SN4) Snake River</b> - Massacre Rocks State Park to Milner Dam</p>	3	3
<p>* <b>(SN5) Snake River</b> - Milner Dam to Star Falls</p>	none	3
<p>* <b>(SN6) Snake River</b> - Star Falls to Twin Falls</p>	none	5
<p><b>(SN7) Snake River</b> - Twin Falls to Lower Salmon Falls Dam</p>	3	3
<p><b>(SN8) Snake River</b> - Lower Salmon Falls Dam to Bliss Dam</p>	3	5
<p><b>(SN9) Snake River</b> - Bliss Dam to headwaters of C.J. Strike Reservoir</p>	5	5
<p><b>(SN10) Snake River</b> - C.J. Strike Dam to Walter's Ferry</p>	5 outfitters for either power or float or combination thereof	
<p><b>(SN11) Snake River</b> - Walter's Ferry to headwaters of Brownlee Reservoir</p>	5	none

River/Section	Maximum No. Power	Maximum No. Float
* (SN12) Snake River - Hells Canyon Dam to Pittsburg Landing	18	15
* (SN13) Snake River - Hells Canyon Dam to Pittsburg Landing, two (2) one-day float trips only	none	2
(SN14) Snake River - Pittsburg Landing to Heller Bar or Lewiston	19	15
(SN15) Snake River - Washington/Oregon stateline to Lewiston	Limitations pending. (This section is set aside for future rules of fishing only outfitters.)	
(SJ1) St. Joe River - St. Joe River Headwaters to Red Ives. No outfitted boating. One (1) walk and wade only fishing outfitter.	none 2	none
(SJ2) St. Joe River - Red Ives to Avery. In addition to one (1) float boat license, three (3) walk and wade only outfitters. No fishing from float boats, boat clients may fish via walk and wade.	none	1
(SJ3) St. Joe River - Avery to St. Joe City Bridge	none	2
(SJ4) St. Joe River - St. Joe City Bridge to Lake Coeur d'Alene	2	none
(SM1) St. Maries River	5	5
(TE1) Teton River - Upper put-in to Cache Bridge, motors not to exceed 10 hp	5 outfitters for either power or float or combination thereof	
(TE2) Teton River - Cache Bridge to Harrop Bridge, motors not to exceed 10 hp	6 outfitters for either power or float or combination thereof	

River/Section	Maximum No. Power	Maximum No. Float
<p><b>(TE3) Teton River</b> - No more than two (2) boats per section/per day may be used by an outfitter at any one time in each of the following river sections: a), b), d), e) and f). No more than four (4) boats per section/per day may be used by an outfitter at any one time on river section c) and where two (2) boats from same outfitter must be spaced at three-hour (3) intervals:</p> <p>a) Harrop Bridge Boat Access to Felt Dam Boat Access;  b) Felt Dam Boat Access to Spring Hollow Boat Access;  c) Spring Hollow Boat Access to Teton Dam Site Boat Access;  d) Teton Dam Site Boat Access to Hog Hollow Bridge Boat Access  e) Hog Hollow Bridge Boat Access to Teton Highway;  f) Teton Highway to confluence with the Henrys Fork of the Snake River.</p> <p>Note: No boat access exists at the confluence with the Henrys Fork of the Snake River. Outfitters would utilize Hibbard Bridge or Warm Slough Access on SH3. No fishing on SH3</p> <p>No outfitter may have more than eight (8) boats on the TE3 in any one day.</p> <p>Float boats may use motors not to exceed 10 hp in section a) (Harrop Bridge to Felt Dam Access) only. Float boats may use motors (5HP or less) for downstream steerage only in sections d), e) and f). Motors are not allowed in other sections. Downstream steerage does not include holding or upstream travel of watercraft with a motor.</p> <p>IOGLB licenses are for the entire TE3 segment; a section of TE3 cannot be separated from TE3 for the purposes of selling a portion of an outfitter's business.</p>	none	5

\* Classified rivers

## Floatboat and powerboat outfitters on these sections are considered within their area of operations when hiking from the river or fishing in tributaries away from the river, but does not include overnight activities. Conflicts with land-based outfitters will be handled on a case-by-case basis. (3-20-20)T

**04. Other -- Table.** The following lakes and reservoirs or portions thereof that lie totally or partially within the state of Idaho are open to fishing by outfitters with the following limitations:

Lake or Reservoir	Maximum No. of Operators	Maximum No. Boats per Operator per Lake or Reservoir
Lake Coeur d'Alene	8	1
Dworshak Reservoir	7	2
Hayden Lake	1	2
Henry's Lake	8	2
Island Park Reservoir	7	2
Magic Reservoir	3	2
Palisades Reservoir	10	2

Lake or Reservoir	Maximum No. of Operators	Maximum No. Boats per Operator per Lake or Reservoir
Lake Pend Oreille	11	1
Priest Lake	5	1
American Falls Reservoir	3	2
C.J. Strike Reservoir	4	2
Brownlee Reservoir	5	2
Oxbow Reservoir	3	2
Hells Canyon Reservoir	3	2

(3-20-20)T

**05. Other Lakes and Reservoirs.** All other Idaho lakes and reservoirs are limited to two (2) outfitters with a maximum of two (2) boats (float or power) per outfitter. (3-20-20)T

**060. (RESERVED)**

**061. TECHNICAL MOUNTAINEERING/ROCK CLIMBING.**

Any outfitter applicant for technical mountaineering/rock climbing must appear before the Board to explain in full detail his qualifications, experience, plans, and areas of operation demonstrating the necessary specialized training and skill. (3-20-20)T

**062. (RESERVED)**

**063. SNOWMOBILING.**

In addition to other requirements, outfitters and guides for snowmobiling must ensure the following: (3-20-20)T

**01. Non-Groomed Trails.** All machines are accompanied by at least one (1) guide for one (1) through five (5) snowmachines, two (2) guides for six (6) through twelve (12) snowmachines, and one (1) additional guide for each additional ten (10) snowmachines. The maximum number of snowmachines allowed in one (1) group may not exceed thirty (30). One (1) guide leads and one (1) trails where more than five (5) snowmachines are involved. (3-20-20)T

**02. Groomed Trails.** All machines are accompanied by at least one (1) guide for one (1) through fifteen (15) snowmachines, and two (2) guides for sixteen (16) through a total of thirty (30) snowmachines. One (1) guide leads and one (1) trails where more than fifteen (15) machines are involved. The maximum number of snowmachines allowed in one group may not exceed thirty (30). (3-20-20)T

**03. Emergency Equipment.** All snowmobiling tours have with them necessary emergency equipment, tools, and spare parts for the machine(s) in use. (3-20-20)T

**04. Reduction in Guide Ratios.** An outfitter may apply to the Board to reduce the number of guides on non-groomed trails to one (1) guide for six (6) through twelve (12) snowmachines and the number of guides on groomed trails to one (1) guide for sixteen (16) through thirty (30) snowmachines, when the guide has electronic communication for summoning assistance at all times during the excursion. (3-20-20)T

**064. AUTHORIZATION FOR GRANTING, DENIAL AND REVOCATION OF LICENSES.**

**01. Executive Director Authorizations.** The Executive Director is authorized to grant, issue or deny, temporary authorizations, licenses and license amendments, hot pursuit agreements and designations of allocated tags with the concurrence of the Board, under the following conditions: (3-20-20)T

**a.** The Executive Director may grant and issue all routine temporary authorizations, license applications, amendments and related matters when the applicant does not have any convictions for fish and game violations or other violations of the grounds enumerated in Section 36-2113(a), Idaho Code, has not falsified or provided any misleading information to the Board, and otherwise qualifies for licensure. (3-20-20)T

**b.** The Executive Director may grant all license applications which otherwise qualify for licensure, but which have violations of the grounds enumerated in Section 36-2113(a), Idaho Code, which occurred five (5) years prior to the date of application, except that a license will not be granted by the Executive Director to an applicant who has a felony conviction of any nature, or conviction of a flagrant violation pursuant to Section 36-1402(e), Idaho Code. (3-20-20)T

**c.** The Executive Director may grant a license with probationary status for conviction of minor fish and game violations or violations enumerated in Section 36-2113(a), Idaho Code, that occurred at least five (5) years prior to the date of application, excluding felony convictions. (3-20-20)T

**d.** The Executive Director may defer granting or denying any license or related matter to the Board for action by the Board. (3-20-20)T

**e.** The Executive Director may not waive fees. (3-20-20)T

**02. Board Conditions.** The Board may grant or deny a license pursuant to the provisions of Sections 36-2109 and 36-2113, Idaho Code, under the following conditions: (3-20-20)T

**a.** The Board may grant a license to an applicant with convictions of violations enumerated in Section 36-2113(a), Idaho Code, which are over five (5) years old and may place the licensee on probation. (3-20-20)T

**b.** The Board may grant a license to an applicant with convictions of violations enumerated in Section 36-2113(a), Idaho Code, which are less than five (5) years old and may place the licensee on probation. (3-20-20)T

**c.** The Board will proceed with the denial of an applicant for a hunting or fishing outfitter or guide license or proceed with the revocation process on a licensee upon conviction of a flagrant violation pursuant to Section 36-1402(e), Idaho Code, unless unusual mitigating circumstances exist. (3-20-20)T

**065. -- 066. (RESERVED)**

**067. INSPECTIONS.**

Outfitter camps and equipment may be inspected at any time by an authorized person or any member of the Board with a written report submitted to the Board to ensure adequate equipment and gear is utilized and maintained in a manner which meets minimum standards of public acceptability and which meets the requirements of applicable local, state, or federal laws and rules. (3-20-20)T

**068. ADMINISTRATIVE FINES/PROBATION/RESTRICTIONS.**

**01. Penalties -- Table.** In addition to suspension, probation, restriction or revocation of a license, the following penalties may be applied to that licensee or those licensees found to have violated the provisions of the Act, these rules, or both.

I.C. Section 36-2113(a)	First Offense	Second Offense	Third Offense
1.	\$100 - \$500 Fine	\$500 - \$5,000 Fine	Suspension or Revocation of License

<b>I.C. Section 36-2113(a)</b>	<b>First Offense</b>	<b>Second Offense</b>	<b>Third Offense</b>
<b>2.</b>	Probation/Restriction of License	\$100 - \$500 Fine	\$500 - \$5,000 Fine
<b>3.</b>	All Penalties Are Within The Board's Discretion.		
<b>4.</b>	Probation/Restriction of License	\$100 - \$500 Fine	\$500 - \$5,000 Fine
<b>5.</b>	\$100 - \$300 Fine	\$100 - \$500 Fine	\$500 - \$5,000 Fine
<b>6.</b>	Probation/Restriction of License	\$100 - \$500 Fine	\$500 - \$5,000 Fine
<b>7.</b>	Probation/Restriction of License	\$100 - \$500 Fine	\$500 - \$5,000 Fine
<b>8.</b>	\$100 - \$500 Fine	\$500 - \$5,000 Fine	Suspension or Revocation of License
<b>9.</b>	\$100 - \$500 Fine	\$500 - \$5,000 Fine	Suspension or Revocation of License
<b>10.</b>	\$100 - \$500 Fine	\$500 - \$2,500 Fine	\$2,500 - \$5,000 Fine
<b>11.</b>	\$100 - \$300 Fine	\$100 - \$500 Fine	\$500 - \$5,000 Fine
<b>12.</b>	\$100 - \$500 Fine	\$500 - \$2,500 Fine	\$2,500 - \$5,000 Fine
<b>13.</b>	All Penalties Are Within The Board's Discretion.		
<b>14.</b>	\$100 - \$300 Fine	\$100 - \$500 Fine	\$500 - \$5,000 Fine

(3-20-20)T

**02. Restrictions.** No license will be issued while any outstanding administrative fine monies are due unless an arrangement has been made and approved by the Board for the payment of same. (3-20-20)T

**03. Terms of Probation.** Typical terms of probation are that there are no violations of local, state or federal laws or ordinances, and no amendments to the license during the term of probation, and other restrictions as the Board orders. (3-20-20)T

**069. -- 999. (RESERVED)**

## IDAPA 26 – DEPARTMENT OF PARKS AND RECREATION

### DOCKET NO. 26-0000-2000F (FEE RULE)

#### NOTICE OF OMNIBUS RULEMAKING – ADOPTION OF TEMPORARY RULE

**EFFECTIVE DATE:** The effective date of the temporary rules being adopted through this omnibus rulemaking is the adjournment date of the second regular session of the 65th Idaho State Legislature - March 20, 2020.

**AUTHORITY:** In compliance with Section 67-5226, Idaho Code, notice is hereby given this agency has adopted a temporary rule. The action is authorized pursuant to Sections 67-4223, 67-7115, and 67-7116, Idaho Code.

**DESCRIPTIVE SUMMARY:** The following is the required finding and concise statement of its supporting reasons for adopting a temporary rule:

This temporary rulemaking adopts the following chapters under IDAPA 26, rules of the Department of Parks and Recreation:

#### **IDAPA 26**

- 26.01.10, *Rules Governing the Administration of Temporary Permits on Lands Owned by the Idaho Department of Parks and Recreation;*
- 26.01.20, *Rules Governing the Administration of Park and Recreation Areas and Facilities;*
- 26.01.33, *Rules Governing the Administration of the Land and Water Conservation Fund Program.*

**TEMPORARY RULE JUSTIFICATION:** Pursuant to Sections 67-5226(1) and 67-5226(2), Idaho Code, the Governor has found that temporary adoption of the rule is appropriate for the following reasons:

These temporary rules are necessary to protect the public health, safety, and welfare of the citizens of Idaho and confer a benefit on its citizens. These temporary rules implement the duly enacted laws of the state of Idaho, provide citizens with the detailed rules and standards for complying with those laws, and assist in the orderly execution and enforcement of those laws. The expiration of these rules without due consideration and processes would undermine the public health, safety, and welfare of the citizens of Idaho and deprive them of the benefit intended by these rules.

**FEE SUMMARY:** Pursuant to Section 67-5226(2), the Governor has found that the fee(s) or charge(s) being imposed or increased is justified and necessary to avoid immediate danger and the fee(s) is described herein:

The fees or charges, authorized in Sections 67-4223, 67-7115, and 67-7116, Idaho Code, are part of the agency's 2021 budget that relies upon the existence of these fees or charges to meet the state's obligations and provide necessary state services. Failing to reauthorize these temporary rules would create immediate danger to the state budget, immediate danger to necessary state functions and services, and immediate danger of a violation of Idaho's constitutional requirement that it balance its budget.

The following is a specific description of the fees or charges:

- IDAPA 26.01.10, Rules Governing the Administration of Temporary Permits on Lands Owned by the Idaho Department of Parks and Recreation. Fees related to: temporary permit processing, compensation, application and enforcement.
- IDAPA 26.01.20, Rules Governing the Administration of Park and Recreation Areas and Facilities. Fees related to motor vehicle entrance, parking violations, camping, reservations (placing, modifying, and canceling), vessel moorage, overnight use, surcharges, group facility use, winter access, returned checks, and winter recreation programs. During 2019, Idaho Department of Parks and Recreation held negotiated rule-making and published proposed and pending rules to update fee caps and combine fees currently found in IDAPA 26.01.36 Rules Governing the Winter Recreational Parking Permit Program. Due to an implementation issue, we pulled the pending rules from consideration for the 2020 Legislative Session. We have included the amended IDAPA 26.01.20 in this omnibus action. The following charts detail the proposed fee changes:
  - Replace the existing campsite types with a simplified list. Add a new campsite type related to hike-in/ bike-in as requested through public comment.



New Campsite Types to Be Implemented November 1, 2020	Fee Caps
Basic Campsite: site may have water	\$34/day
Electric Campsite: site has electricity and may have water	\$42/day
Full Hook-up Campsite: site has electricity, water, and sewer	\$46/day
Hike-in/Bike-in Campsite	\$12/person/day
<b>Remove Current Campsite Types</b>	
<del>Primitive Campsite</del>	<del>\$23/day</del>
<del>Standard Campsite</del>	<del>\$26/day</del>
<del>Serviced Campsite/W</del>	<del>\$30/day</del>
<del>Serviced Campsite/E</del>	<del>\$30/day</del>
<del>Serviced Campsite/W, E</del>	<del>\$34/day</del>
<del>Serviced Campsite/W, E, SWR</del>	<del>\$36/day</del>
<del>Amenity Fee for Central Water</del>	<del>\$2/day</del>
<del>Amenity Fee for Flush Toilets/Showers</del>	<del>\$2/day</del>

- Raise the caps on the following fees:

Type	Proposed Fee Cap	Existing Fee Cap
Fee Collection Surcharge	\$25/day	\$10/day
Daily MVEF	\$7/day/vehicle	\$5/day/vehicle
Commercial Motor Vehicle Entrance	\$50/day/vehicle	\$25/day/vehicle
Admission	\$20/person	\$10/person
Overnight Use of Parking Areas	\$20/night/vehicle, trailer, or vehicle with attached trailer	\$10/night/vehicle, trailer, or vehicle with attached trailer
Camping Cabins and Yurts	\$500/night	\$200/night
Each additional person above the base occupancy of the overnight facility	\$12/person/night	\$3/person/night
Vessel Launching	MVEF or \$7/day/vessel	MVEF or \$5/day/vessel

- Add new fees related to extra vehicles, pets, and cleaning fees:

Type	Fee Cap
Extra Vehicle	\$8/day
Pets	\$15/pet/night

Type	Fee Cap
Cleaning	\$50

- IDAPA 26.01.33, Rules Governing the Administration of the Land and Water Conservation Fund Program. Service fee to administer and manage process to convert property from a recreation use.

**ASSISTANCE ON TECHNICAL QUESTIONS:** For assistance on technical questions concerning the temporary rule, contact Anna Canning, Management Services Administrator, (208) 514-2252.

Dated this 20th day of February, 2020.

Anna Borchers Canning  
Management Services Administrator  
Idaho Department of Parks and Recreation  
5657 Warm Springs Avenue, Boise, ID  
P.O. Box 83720  
Boise, ID 83720-0065

**26.01.10 – RULES GOVERNING THE ADMINISTRATION OF TEMPORARY PERMITS ON LANDS OWNED BY THE IDAHO DEPARTMENT OF PARKS AND RECREATION**

**000. LEGAL AUTHORITY.**

These rules set forth procedures concerning the issuance of temporary permits on all lands owned by the Idaho Department of Parks and Recreation. Requests for permits on lands administered, but not owned by IDPR must be made directly to the land owner. These rules are promulgated pursuant to Idaho Code Section 67-4223(a) and are construed in a manner consistent with the duties and responsibilities of the Idaho Parks and Recreation Board as set forth in Idaho Code Title 67, Chapter 42. These rules are not be construed as affecting any valid existing rights.

(3-20-20)T

**001. TITLE AND SCOPE.**

**01. Title.** The title of this chapter is cited in full as Idaho Department of Parks and Recreation Rules, IDAPA 26.01.10, “Rules Governing the Administration of Temporary Permits on Lands Owned by the Idaho Department of Parks and Recreation.”

(3-20-20)T

**02. Scope.** These rules are intended to set forth the procedures for the administration of temporary permits on lands owned by the department.

(3-20-20)T

**002. -- 009. (RESERVED)**

**010. DEFINITIONS.**

**01. Board.** The Idaho Parks and Recreation Board or such representative as may be designated by the board.

(3-20-20)T

**02. Department and IDPR.** The Idaho Department of Parks and Recreation.

(3-20-20)T

**03. Director.** The director of the Idaho Department of Parks and Recreation or such representative as may be designated by the director.

(3-20-20)T

**04. Grantee.** The party to whom a temporary permit is granted and their assigns and successors in interest.

(3-20-20)T

**05. Grantor.** The State of Idaho and its assigns and successors in interest.

(3-20-20)T

**06. Park Manager.** The person responsible for administering and supervising a specific state park area, or department owned land not yet a state park, as designated by the director of the Idaho Department of Parks and Recreation.

(3-20-20) T

**07. Person.** An individual, partnership, association, or corporation qualified to do business in the state of Idaho, and any federal, state, county or local unit of government.

(3-20-20)T

**08. Temporary Permit.** An instrument authorizing a temporary use of IDPR owned land for the construction, operation and maintenance of specific typically linear elements including but not limited to power and telephone lines, roadways, driveways, sewer lines, natural gas lines and water lines.

(3-20-20)T

**011. -- 049. (RESERVED)**

**050. POLICY.**

**01. Issuing Authority.** Temporary permits are issued by the director in lieu of easements, and are required for all activities on or over IDPR owned land.

(3-20-20)T

**02. Discretion.** The board retains absolute discretion to grant or withhold a temporary permit on land which it owns.

(3-20-20)T

**03. Consent Required.** Temporary permits, their amendment, renewal and assignment and all subsequent actions are not valid without the written consent of the director.

(3-20-20)T

**04. Modifications.** Temporary permits and subsequent modifications, assignments and renewals require a formal application, and payment of a processing fee to reimburse the agency for staff time devoted to processing the request.

(3-20-20)T

**05. Purpose Compatible.** The purpose for which the temporary permit is sought must not interfere with the existing or anticipated values, objectives, or operation of department owned lands. (3-20-20)T

**06. Compensation.** An appropriate compensation for use of department-owned lands, as set out in Section 150 of this chapter, must be paid to the IDPR in cash or in the form of offsetting benefits to be determined by the director. (3-20-20)T

**07. Control.** At all times the control of gates, roads and park lands is retained by the State. The permit granted is for the grantee's use only, is revocable for cause, is issued for a specific period of time, not to exceed ten (10) years, but usually five (5) years or less, and automatically expires if not used for a period of one (1) year. (3-20-20)T

**051. -- 099. (RESERVED)**

**100. PROCESSING FEES.**

**01. Issuance or Modification.** The processing fee for a new temporary permit, or modification of an existing temporary permit, is one-hundred dollars (\$100), which must be received from all applicants before processing can proceed. The processing fees are designed to offset processing costs and are nonrefundable. (3-20-20)T

**02. Assignment or Renewal.** The processing fee for assignment or renewal of an existing temporary permit is twenty-five dollars (\$25), and must be received before processing can proceed. The processing fees are designed to offset processing costs and are nonrefundable. (3-20-20)T

**101. -- 149. (RESERVED)**

**150. COMPENSATION.**

**01. Payable in Advance.** Cash compensation for the entire term of the temporary permit will be collected from the applicant prior to issuance. (3-20-20)T

**02. Cost per Acre.** Cash compensation for a temporary permit is charged at a rate of fifty dollars (\$50) per acre of IDPR land utilized per year or any portion thereof, and is specified in the temporary permit. Temporary permits of less than one (1) year in duration will not be prorated. (3-20-20)T

**03. Noncash Compensation.** Offsetting (non-cash) compensation for a temporary permit may be approved on an individual basis by the director, and the terms of the agreement must be outlined in the temporary permit. (3-20-20)T

**04. Nonrefundable.** Compensation to IDPR for a temporary permit is non-refundable, except as set out in Subsection 200.08 of this chapter. (3-20-20)T

**151. -- 199. (RESERVED)**

**200. STANDARD CONDITIONS.**

All temporary permits issued are subject to the following standard conditions: (3-20-20)T

**01. Term Limited.** The use and term of a temporary permit is limited solely to that specifically stated in the instrument. (3-20-20)T

**02. Utilities.** Except under special circumstances with approval of the director, all utilities must be installed underground. (3-20-20)T

**03. Construction, Operation and Maintenance.** The grantee must construct, maintain and operate at grantee's sole expense the facility for which the temporary permit is granted, and maintain the permit site in a

condition satisfactory to the Park Manager. (3-20-20)T

**04. Compliance with Laws.** The grantee will comply with all applicable state and local laws, rules, and ordinances, including but not limited to: state fire laws and all rules of the State Land Board pertaining to forest and watershed protection, and with the Stream Channel Protection Act as designated in Chapter 38, Title 42 of the Idaho Code. (3-20-20)T

**05. Wetlands.** The grantee will comply with all state and federal statutes, rules, and regulations pertaining to wetlands protection. (3-20-20)T

**06. Land and Water Conservation Fund.** Temporary permits on land located within Land and Water Conservation Fund 6(f) boundaries, their amendment, renewal, assignment and all subsequent actions must be subject to the terms and the requirements of the Land and Water Conservation Fund Act of 1965 (P.L. 88-578, 16 U.S.C.S. Section 4601-4 et seq.). (3-20-20)T

**07. Hold Harmless.** The grantee, its agents and contractors must indemnify and hold harmless the department, the state of Idaho and its representatives against and from any and all demands, claims or liabilities of every nature whatsoever, arising directly or indirectly from or in any way connected with the use authorized under the temporary permit. (3-20-20)T

**08. Withdrawal for Park Use.** Should the land be needed for park development or recreation use, the director reserves the right to order the change of location or the removal of any structure(s) or facility(ies) authorized by a temporary permit at any time. Any such change or removal will be made at the sole expense of the grantee, its successors or assigns. When a temporary permit is terminated prior to its stated expiration date pursuant to this provision, the grantee will receive a pro-rata refund of compensation paid. (3-20-20)T

**09. Permits Not Exclusive.** The temporary permit is not exclusive to the grantee, and must not prohibit the department from granting other permits or franchise rights of like or other nature to other public or private entities, nor must it prevent the department from using or constructing roads and structures over or near the lands encompassed by the temporary permit, or affect the department's right to full supervision or control over any or all lands which are part of the temporary permit. (3-20-20)T

**10. Cancellation.** The director may cancel the temporary permit or amend any of the conditions of the temporary permit if the grantee fails to comply with any or all of the provisions, or requirements set forth or through willful or unreasonable neglect, fails to heed or comply with notices given. (3-20-20)T

**11. Removal of Facilities.** Upon termination of the temporary permit for any reason including cancellation, expiration, or relinquishment, the grantee must have thirty (30) days from the date of termination to remove any facilities and improvements constructed by the grantee, and must restore the permit site to the satisfaction of the park manager. Upon written request, and for good cause shown, the director may allow a reasonable additional time for the removal of improvements and facilities and the restoration of the site. (3-20-20)T

**201. -- 249. (RESERVED)**

**250. SPECIAL CONDITIONS.**

Special conditions addressing unique situations may be included in the temporary permit to protect natural or park resources, or to safeguard public health, safety or welfare. (3-20-20)T

**251. -- 299. (RESERVED)**

**300. APPLICATION PROCEDURE.**

**01. Contents of Application.** A temporary permit application must contain: (3-20-20)T

**a.** A temporary permit application/action form; (3-20-20)T

**b.** A plat of the proposed permit location; (3-20-20)T

c. The appropriate application fee; (3-20-20)T

d. An acceptable written legal description based on a survey of the centerline, or a metes and bounds survey of the temporary permit tract. The survey must be performed by a registered professional land surveyor as required by Idaho Code Section 54-1229. (3-20-20)T

**02. Engineering Certification.** As required in Section 58-601, Idaho Code, for any application for a ditch, canal or reservoir, the plats and field notes must be certified by the engineer under whose direction such surveys or plans were made and four (4) copies filed with the department and one (1) copy with the director, Idaho Department of Water Resources. (3-20-20)T

**03. Application Submission.** Temporary permit applications must be submitted to the Park Manager of the park in which the permit is requested. The park manager will forward it for processing as outlined in Section 800. of this chapter. (3-20-20)T

**301. -- 349. (RESERVED)**

**350. MODIFICATION OF EXISTING TEMPORARY PERMIT.**

A modification of an existing temporary permit must be processed in the same manner as a new application. Modification includes change of use, enlarging the permit area, or changing the location of the permit area. Modification does not include ordinary maintenance, repair, or replacement of existing facilities. (3-20-20)T

**351. -- 399. (RESERVED)**

**400. ASSIGNMENT.**

temporary permits issued by the director cannot be assigned without the approval of the director. To request approval of an assignment, the assignor and assignee must complete the department's standard temporary permit application/action form and forward it and the assignment fee to the park manager, for processing as outlined in Section 800 of this chapter. (3-20-20)T

**401. -- 449. (RESERVED)**

**450. RENEWAL.**

Renewal of temporary permits may be sought by completing a temporary permit application/action form and forwarding it together with the renewal fee to the park manager for processing as outlined in Section 800 of this chapter. Renewal applications must be submitted at least forty-five (45) days prior to the expiration date of the temporary permit. (3-20-20)T

**451. -- 499. (RESERVED)**

**500. ABANDONMENT.**

A temporary permit not used for the purpose for which it was granted for a period of one (1) year is presumed abandoned and must automatically terminate. The director must notify the grantee in writing of the termination. The grantee must have thirty (30) days from the date of the written notice to reply in writing to the director to show cause why the temporary permit should be reinstated. Within thirty (30) days of receipt of the statement to show cause, the director must notify the grantee in writing as to the director's decision concerning reinstatement. The grantee must have thirty (30) days after receipt of the director's decision to request to appear before the board as outlined in Section 003 of this chapter. Removal of property from and restoration of the site is governed by Subsection 200.11 of this chapter. (3-20-20)T

**501. -- 549. (RESERVED)**

**550. RELINQUISHMENT.**

The Grantee may voluntarily relinquish a temporary permit any time by submitting a temporary permit application/action Form to the park manager. Upon relinquishment, removal of property from and restoration of the site is governed by Subsection 200.11 of this chapter. (3-20-20)T

**551. -- 599. (RESERVED)**

**600. EXPIRATION.**

Upon expiration, and absent a request for renewal of the temporary permit, removal of property from and restoration of the site is governed by Subsection 200.11 of this chapter. (3-20-20)T

**601. -- 649. (RESERVED)**

**650. CANCELLATION.**

The director may cancel a temporary permit if the grantee fails to comply with any or all of its provisions, terms, conditions, or rules; or through willful or unreasonable neglect, fails to heed or comply with notices given. (3-20-20)T

**651. -- 699. (RESERVED)**

**700. ENFORCEMENT.**

Should it become necessary to enforce the terms of a temporary permit in a court of law and the grantor prevails, the grantee must pay all costs and fees. (3-20-20)T

**701. -- 749. (RESERVED)**

**750. ADMINISTRATION.**

**01. Bureau Responsible.** The IDPR Development Bureau must be responsible for uniform statewide administration of all IDPR temporary permits. (3-20-20)T

**02. Disposition of Fees.** All processing and compensation fees collected from applicants must be sent to the fiscal section for deposit into the appropriate account. (3-20-20)T

**03. Status Report.** The IDPR Development Bureau must maintain an up-to-date status report on all temporary permits issued. (3-20-20)T

**751. -- 799. (RESERVED)**

**800. PROCESSING.**

**01. Receipt of Application.** Upon receipt of a properly filed temporary permit application/action form and the appropriate application fee, the park manager must review the application and forward it, together with his comments, to the region supervisor. The region supervisor must review the application and forward his comments along with the temporary permit application/action package, to the chief, Development Bureau, IDPR for processing. (3-20-20)T

**02. Time.** Processing of temporary permit application/action forms must not exceed one hundred twenty (120) days from the date of acceptance of a complete application by the park manager. Applications not acted on within one hundred twenty (120) days are deemed denied. (3-20-20)T

**03. Notification.** All applicants must be notified in writing, by the development bureau chief, of the approval or denial of their application. (3-20-20)T

**801. -- 999. (RESERVED)**

**26.01.20 – RULES GOVERNING THE ADMINISTRATION OF PARK  
AND RECREATION AREAS AND FACILITIES**

**000. LEGAL AUTHORITY.**

The Idaho Parks and Recreation Board is authorized under Section 67-4223, Idaho Code, to adopt, amend, or rescind rules as may be necessary for the proper administration of Title 67, Chapter 42, Idaho Code, and the use and protection of lands and facilities subject to its jurisdiction. The board is also authorized to further define and make specific the provisions regarding the winter recreational parking permit program as set forth in Sections 67-7115 through 67-7118, Idaho Code. (3-20-20)T

**001. TITLE AND SCOPE.**

**01. Title.** The title of this chapter is cited in full as Idaho Department of Parks and Recreation Rules, IDAPA 26.01.20, “Rules Governing the Administration of Park and Recreation Areas and Facilities.” (3-20-20)T

**02. Scope.** This chapter establishes fees for and rules governing the use of lands and facilities administered by the Department and the winter recreational parking permit; establishes procedures for obtaining individual and group use reservations; sets rules regarding visitor behavior and use of park lands and facilities; and authorizes employees to enforce these rules. (3-20-20)T

**002. -- 009. (RESERVED)**

**010. DEFINITIONS.**

**01. ADA.** Americans with Disabilities Act (3-20-20)T

**02. Annual Motor Vehicle Entrance Fee Sticker.** A sticker that allows a single motor vehicle to enter Idaho State Parks without being charged a motor vehicle entrance fee. (3-20-20)T

**03. Annual Motor Vehicle Entrance Fee Sticker Replacement.** Replacement due to a motor vehicle sale or damage to an existing annual motor vehicle entrance fee sticker. (3-20-20)T

**04. Board.** The Idaho Parks and Recreation Board, a bipartisan, six (6) member board, appointed by the Governor. (3-20-20)T

**05. Camping Unit.** The combined equipment and people capacity that a campsite or facility will accommodate. (3-20-20)T

**06. Camping Day.** (3-20-20)T

**a.** For individual and group campsites the period between 2 p.m. of one (1) calendar day and 1 p.m. of the following calendar day. (3-20-20)T

**b.** For individual and group facilities, the period between 4 p.m. of one (1) calendar day and 12 noon of the following calendar day. (3-20-20)T

**07. Campsite.** (3-20-20)T

**a.** Individual. An area within a department managed campground designated for camping use by an individual camping unit or camping party that includes a defined area for either a tent pad or RV pad/area and may include a table and/or grill. The definition includes companion campsites. (3-20-20)T

**b.** Group. An area within a department managed campground designated for group camping use or a block of individual campsites designated for group use within a campground primarily managed for individual use. (3-20-20)T

**08. Commercial Motor Vehicle.** A vehicle that has seating capacity of more than fifteen (15) persons including the driver, or that is maintained for the transportation of persons for hire, compensation or profit. (3-20-20)T

**09. Day Use.** Use of any non-camping lands and/or facilities between the hours of 7 a.m. and 10 p.m. unless otherwise posted. (3-20-20)T

**10. Department.** The Idaho Department of Parks and Recreation. (3-20-20)T



- 11. Designated Beach.** Waterfront areas designated by the park or program manager for water-based recreation activities. The length and width of each designated beach will be visibly identified with signs. (3-20-20)T
- 12. Designated Roads and Trails.** Facilities recognizable by reasonable formal development, signing, or posted rules. (3-20-20)T
- 13. Director.** The director and chief administrator of the department, or the designee of the director. (3-20-20)T
- 14. Division Administrator.** An employee, or designee, within the department that has supervisory authority over park and program managers. (3-20-20)T
- 15. Dock and Boating Facility.** Floats, piers, and mooring buoys owned or operated by the department. (3-20-20)T
- 16. Encroachments.** Non-recreational uses of lands under the control of the board including any utilization for personal, commercial, or governmental use by a non-department entity. (3-20-20)T
- 17. Extra Vehicle.** An additional motor vehicle without built-in temporary living quarters or sleeping accommodations registered to a camp site. (3-20-20)T
- 18. Facilities.** (3-20-20)T
- a.** Individual. A camping structure within department managed lands designated for use by an individual camping unit. (3-20-20)T
- b.** Group. A camping structure within department managed lands designated for group use. (3-20-20)T
- c.** Day Use. A non-camping area or structure within department managed lands designated for group use during day use periods. (3-20-20)T
- 19. Group Use.** Twenty-five (25) or more people, or any group needing special considerations or deviations from normal department rules or activities. (3-20-20)T
- 20. Idaho State Parks Passport.** A sticker, purchased from any county Department of Motor Vehicles' office in the state of Idaho, that matches a particular motor vehicle license number and expiration date, allowing that vehicle to enter Idaho State Parks without being charged a motor vehicle entrance fee. (3-20-20)T
- 21. Idaho State Parks Passport Replacement.** Replacement due to a motor vehicle registration transfer or damage to an existing passport. (3-20-20)T
- 22. Motor Vehicle.** Every vehicle that is self-propelled except for vehicles moved solely by human power, electric bikes, and motorized wheelchairs. (3-20-20)T
- 23. Motor Vehicle Entrance Fee (MVEF).** A fee charged for entry to or operation of a motor vehicle in an Idaho State Park. (3-20-20)T
- 24. Overnight Use.** Use of any non-camping lands for the parking of motor vehicles or trailers not associated with a campsite between the hours of 10 p.m. and 7 a.m. unless otherwise posted. (3-20-20)T
- 25. Overnight Use Fee.** A fee charged for overnight use of non-camping lands between the hours of 10 p.m. and 7 a.m. (3-20-20)T
- 26. Park or Program Manager.** The person, or the person's designee, responsible for administering and supervising particular lands, facilities, and employees that are under the jurisdiction of the department. (3-20-20)T

**27. Recreational Vehicle (RV).** A vehicular type unit primarily designed as temporary living quarters for recreational, camping, sleeping, or travel use, which either has its own motive power or is mounted on or drawn by another vehicle. The entities are travel trailer, camping trailer, truck camper, fifth-wheel trailer, and motorhome (all as defined in Section 39-4201, Idaho Code) and including buses or van type vehicles which are converted to recreation, camping, or sleeping use. It does not include pickup hoods, shells, or canopies designed, created, or modified for occupational use. (3-20-20)T

**28. Vessel.** Every description of watercraft, including a seaplane on the water, used or capable of being used as a means of transportation on water, but not including float houses, diver's aids operated and designed primarily to propel a diver below the surface of the water, and non-motorized devices not designed or modified to be used as a means of transportation on the water such as inflatable air mattresses, single inner tubes, and beach and water toys as defined in Section 67-7003(22), Idaho Code. (3-20-20)T

**011. PURCHASE, EXPIRATION, DISPLAY AND PLACEMENT OF MVEF AND PASSPORT STICKERS.**

- 01. Daily MVEF.** (3-20-20)T
- a.** The daily MVEF may be purchased at any Idaho state park or online. (3-20-20)T
  - b.** The daily MVEF expires at 10 p.m. on date of purchase or as posted; MVEF for overnight camping use expires upon checkout which is 1 p.m. for a campsite and 12 noon for a facility. (3-20-20)T
  - c.** The proof of purchase of the MVEF must be visible and properly displayed. (3-20-20)T
- 02. Annual MVEF.** (3-20-20)T
- a.** The Annual MVEF may be purchased at any Idaho state park, the department's central or regional offices, or online. (3-20-20)T
  - b.** The Annual MVEF expires December 31 of the year issued. (3-20-20)T
  - c.** The Annual MVEF sticker must be visible, legible at all times, and permanently affixed to the vehicle as follows. For vehicles with a windshield, the sticker must be clearly displayed on the lower corner of the driver's side windshield. For vehicles without a windshield, the sticker must be clearly displayed in a similar location. (3-20-20)T
- 03. Annual MVEF Sticker Replacement.** (3-20-20)T
- a.** The applicant may apply at any Idaho state park or at the department's central or regional offices for a replacement sticker due to damage. (3-20-20)T
  - b.** The applicant must establish proof of purchase of the original Annual MVEF. (3-20-20)T
  - c.** Display and placement of the replacement sticker must comply with Subsection 011.02.c. of this chapter. (3-20-20)T
- 04. Idaho State Parks Passport.** (3-20-20)T
- a.** The Idaho State Parks Passport may be purchased from any county department of motor vehicles office in the state of Idaho. (3-20-20)T
  - b.** Idaho State Parks Passport expires concurrent with the expiration of that vehicle's registration. (3-20-20)T
  - c.** Display and placement of the Idaho State Parks Passport sticker must comply with Subsection

011.02.c of this chapter. (3-20-20)T

**05. Idaho State Parks Passport Sticker Replacement.** (3-20-20)T

**a.** The applicant may apply in person to a county department of motor vehicles office for a replacement sticker. (3-20-20)T

**b.** Display and placement of the replacement sticker must comply with Subsection 011.02.c. of this chapter. (3-20-20)T

**012. -- 074. (RESERVED)**

**075. AUTHORITY CONFERRABLE ON EMPLOYEES - ENFORCEMENT.**

**01. Director Authority.** The director may, pursuant to Section 67-4239, Idaho Code, authorize any employee of the department to exercise any power granted to, or perform any duty imposed upon the director. (3-20-20)T

**02. Park or Program Manager Authority.** A park or program manager may establish and enforce all rules, including interim rules. Interim rules apply to the public safety, use, and enjoyment or protection of natural, cultural, or other resources within lands administered by the department. Interim rules will be posted for public view and will be consistent with established state laws and these rules. Interim rules expire in one hundred twenty (120) days from the established effective date unless approved by the board. (3-20-20)T

**03. Additional Park or Program Manager Authority.** A park or program manager may deny entry to, or reservation of, any department day use area, campsite, or facility, to any individual or group whose prior documented behavior has violated department rules, whose activities are incompatible with operations, or whose activities will violate department rules. (3-20-20)T

**076. -- 099. (RESERVED)**

**100. PENALTIES FOR VIOLATIONS.**

Failure of any person, persons, partnership, corporation, concessionaire, association, society, or any fraternal, social or other organized groups to comply with these rules constitutes an infraction. (3-20-20)T

**01. Civil Claim.** The penalty established in this chapter does not prevent the department from filing a civil claim against a violator to collect damages incurred to lands, resources, or facilities administered by the Department. (3-20-20)T

**02. Violators.** In addition to the penalty provided in chapter, or any other existing laws of the state of Idaho, any person failing to comply with any section of these rules or federal, state, or local laws, rules, or ordinances applicable under the circumstances, is a trespasser upon state land and subject to expulsion from any department managed lands for a period of time not less than forty-eight (48) hours. (3-20-20)T

**101. -- 124. (RESERVED)**

**125. PRESERVATION OF PUBLIC PROPERTY.**

The destruction, injury, defacement, removal, or disturbance in or of any public building, sign, equipment, monument, statue, marker, or any other structures; or of any tree, flower, or other vegetation; or of any cultural artifact or any other public property of any kind, is prohibited unless authorized by the park or program manager of a specific area. (3-20-20)T

**126. -- 149. (RESERVED)**

**150. USE OF MOTOR VEHICLES.**

Except where otherwise provided, motor vehicles may enter or be operated in park and recreation areas and facilities only upon payment of the motor vehicle entrance fee or display of a valid Idaho state Parks Passport or Annual Motor

Vehicle Entrance Fee sticker. All motor vehicles must stay on authorized established department roadways or parking areas except for trails and areas which are clearly identified by signs for off-road use. Drivers and motor vehicles operated within lands administered by the department must be licensed or certified as required under state law. The operators of all motor vehicles must comply with the motor vehicle entrance fee requirements, speed and traffic rules of the department, and all other federal, state, local laws, and ordinances governing traffic on public roads. (3-20-20)T

**01. Use of Parking Spaces for Persons With a Disability.** Special zones and parking spaces within state parks are designated and signed for exclusive use by vehicles displaying a special license plate or card denoting legal handicap status as provided in Section 49-213, Idaho Code. (3-20-20)T

**02. Overdriving Road Conditions and Speeding Prohibited.** No person may drive a vehicle at a speed greater than the posted speed or a reasonable and prudent speed under the conditions, whichever is less. Every person must drive at a safe and appropriate speed when traveling on park roads, in congested areas, when pedestrians or bicyclists are present, or by reason of weather or hazardous highway conditions as provided in Section 49-654, Idaho Code. (3-20-20)T

**03. Safety Helmets.** Persons under eighteen (18) years of age must wear a protective safety helmet when riding upon a motorcycle, motorbike, utility type vehicle, or an all-terrain vehicle as operator or passenger as provided in Section 49-666, Idaho Code. (3-20-20)T

**04. Snowmobile Operation.** No person may operate a snowmobile on any regularly plowed park road unless authorized by park or program manager. Access on non-plowed roads and trails are only permitted when authorized by the park or program manager. (3-20-20)T

**05. Compliance with Posted Regulatory Signs.** Persons operating vehicles within state parks are required to obey posted regulatory signs as provided in Section 49-807, Idaho Code. (3-20-20)T

**06. Obedience to Traffic Direction.** No person may willfully fail or refuse to comply with any lawful order or directions of any park employee invested with authority to direct, control, or regulate traffic within a state park. (3-20-20)T

**07. Restrictions.** The operation of motor vehicles within a designated campground is restricted to ingress and egress to a campsite or other in-park destination by the most direct route. (3-20-20)T

**08. Official Use.** This rule does not prohibit official use of motor vehicles by department employees anywhere within lands administered by the department. (3-20-20)T

**09. Commercial Motor Vehicle.** Commercial motor vehicles may only enter or be operated in park and recreation areas and facilities upon payment of the appropriate daily fee. (3-20-20)T

**151. PARKING VIOLATIONS.**

**01. Land or Facilities Administered by the Department.** No person may stop, stand, or park a motor vehicle or trailer anywhere within land or facilities administered by the department unless proof of payment of all required fees or other lawful authorization for entry is plainly visible and properly displayed. (3-20-20)T

**02. Designated Campgrounds.** No person may stop, stand, or park a motor vehicle within designated campgrounds unless proof of payment of the applicable campsite fees is plainly visible and properly displayed. (3-20-20)T

**03. Designated Overnight Use Area.** Except for authorized campers, no person may stop, stand, park, or leave a motor vehicle or trailer unattended outside day use hours unless the motor vehicle or trailer is in a designated overnight use area and proof of payment of the overnight-use fee is plainly visible and properly displayed. (3-20-20)T

**04. Fee Collection Surcharge.** Any person stopping, standing, or parking a motor vehicle or trailer

without payment or properly displaying proof of payment of all required fees is subject to the fee collection surcharge as provided in Subsection 225.06 and Section 245 of this chapter. (3-20-20)T

**05. Citations for Violations.** Citations for violations of this section may be issued to the operator of the motor vehicle. If the operator cannot be readily identified, the citation may be issued to the registered owner or lessee of the motor vehicle, subject to the provisions of Section 67-4237, Idaho Code. (3-20-20)T

**152. -- 174. (RESERVED)**

**175. PUBLIC BEHAVIOR.**

**01. Resisting and Obstructing a Park Employee.** Persons may not willfully resist, delay, obstruct, or interfere with any park employee in his or her duties to protect the state's resources and facilities and to provide a safe place to recreate. (3-20-20)T

**02. Day Use.** Between the hours of 10 p.m. and 7 a.m., unless otherwise posted, all personal property must be removed from day use areas. (3-20-20)T

**03. Quiet Hours.** Within lands administered by the department, the hours between 10 p.m. and 7 a.m. are considered quiet hours unless otherwise posted. During that time, users are restricted from the production of noise that may be disturbing to other users. (3-20-20)T

**04. Noise.** Amplified sound, poorly muffled vehicles, loud conduct, or loud equipment are prohibited within lands administered by the department, except in designated areas or by authority of the park or program manager. (3-20-20)T

**05. Alcohol.** State laws regulating alcoholic beverages and public drunkenness are enforced within lands administered by the department. (3-20-20)T

**06. Littering.** Littering is prohibited within lands administered by the department. (3-20-20)T

**07. Smoking.** Persons may not smoke within park structures or facilities, or at posted "no smoking" outdoor areas. (3-20-20)T

**08. Trespass.** It is unlawful to enter, use, or occupy land or facilities administered by the department where such lands or facilities are posted against entry, use, or occupancy, except as authorized by the department. (3-20-20)T

**09. Pets.** Pets are allowed within lands administered by the department only if confined or controlled on a leash not longer than six (6) feet in length. No person may allow their pet to create a disturbance which might be bothersome to other users. Excepting persons with disabilities who are assisted by service animals, no person may permit their pet animals to enter or remain on any swim area or beach. Pet owners are responsible to clean up after their animals. Pet owners may not leave pets unattended. Areas for exercising pets off leash may be designated by the park or program manager. Department employees may impound or remove any stray or unattended animals at the owner's expense. (3-20-20)T

**10. Fires.** The use of fires is restricted to fire rings, grills or other places otherwise designated by the park or program manager. All fires must be kept under control at all times and must be extinguished before checking out of the campsite or whenever fire is left unattended. Areas may be closed to open fires during extreme fire danger. (3-20-20)T

**11. Fireworks.** No person may use fireworks of any kind within lands administered by the department, except under special permit issued by the director for exhibition purposes, and then only by persons designated by the director. (3-20-20)T

**12. Protection of Wildlife.** All molesting, feeding, injuring, or killing of any wild creature is strictly prohibited, except as provided by action of the board and as established in board policy. Persons in possession of wildlife, which may be legally taken within state park boundaries, must comply with Idaho Fish and Game rules. (3-20-20)T

**13. Protection of Historical, Cultural and Natural Resources.** The digging, destruction or removal of historical, cultural or natural resources is prohibited. Collection for scientific and educational purposes may be allowed through a permit. (3-20-20)T

**14. Personal Safety, Firearms.** No person may purposefully or negligently endanger the life of any person or creature within any land administered by the department. No person may discharge firearms or other projectile firing devices within any lands administered by the department, except as follows: in the lawful defense of person, persons, or property; in the course of lawful hunting; for exhibition; or at designated ranges as authorized by the director. (3-20-20)T

**15. Non-traditional Recreational Activities.** Non-traditional recreational activities such as model airplane and glider operations, geo-caching, gold panning, drone operation, and metal detecting may be authorized by the park or program manager if such activities do not interfere with traditional uses of the park and are consistent with preservation of park resources. (3-20-20)T

**176. -- 199. (RESERVED)**

**200. CAMPING.**

**01. Occupancy and Capacity.** (3-20-20)T

**a.** Occupancy. Camping is permitted only in designated campsites, areas, or facilities. A campsite or facility will be determined occupied only after all required fees have been paid, registration information completed, and all permits properly displayed. Unique circumstances may arise, and specific sites or facilities by virtue of design may require exceptions to the capacity limits. (3-20-20)T

**b.** Campsite Capacity. Maximum capacity limits on each campsite are subject to each site's design and size. Unless otherwise specified, and provided the combined equipment and people fit within the designated camping area of the site selected, the maximum capacity will be one (1) family unit or a party of no more than eight (8) persons, two (2) tents and two (2) motor vehicles. No more than one (1) RV may occupy a site. Two (2) motorcycles are the equivalent of one (1) motor vehicle when determining campsite capacity. Each motorcycle will be subject to the MVEF. In general, companion campsites have double the capacity listed above. (3-20-20)T

**c.** Facility Capacity. Maximum capacity limits on each facility are based on facility design, size, and applicable occupancy code. (3-20-20)T

**02. Self Registration.** In those areas so posted, campers must register themselves for the use of campsites and facilities, paying all required fees as provided for herein and in accordance with all posted instructions. (3-20-20)T

**03. Length of Stay.** Except as provided herein, no person, party or organization may be permitted to camp on any lands administered by the department for more than fifteen (15) days in any thirty (30) consecutive day period. This applies to both reservation and "first come first served" customers. The department operations division administrator may authorize shorter or longer periods for any individual area. (3-20-20)T

**04. Registration.** All required fees must be paid, registration information completed, and all permits properly displayed prior to occupying a campsite or facility. Saving or holding campsites or facilities for individuals not physically present at the time of registration for "first come first served" camping is prohibited. (3-20-20)T

**05. Condition of Campsite.** Campers must keep their individual or group campsite or facility and other use areas clean. (3-20-20)T

**06. Liquid Waste Disposal.** All gray water and sewage wastes must be held in self-contained units or collected in water-tight receptacles in compliance with state adopted standards and dumped in sanitary facilities provided for the disposal of such wastes. (3-20-20)T

**07. Motorized Equipment.** No generators or other motorized equipment emitting sound and exhaust are permitted to be operated during quiet hours. (3-20-20)T

**08. Campsite Parking.** All motor vehicles and trailers, must fit entirely within the campsite parking pad/area provided with the assigned individual or group campsite or facility. All equipment that does not fit entirely within the designated campsite parking area must be parked at another location within the campground, or outside the campground, as may be designated by the park or program manager. If no outside parking is available, the park or program manager may require the party to register on a second campsite, if available. (3-20-20)T

**09. Equipment.** All camping equipment and personal belongings of a camper must be maintained within the assigned individual or group campsite or facility perimeter. (3-20-20)T

**10. Check Out.** Customers are required to clean, vacate, and check out of registered campsites or facilities as follows: (3-20-20)T

**a.** Individual or group campsite by 1 p.m. of the day following the last paid night of camping. (3-20-20)T

**b.** Individual or group facility by 12 noon of the day following the last paid night of camping. (3-20-20)T

**11. Visitors.** Individuals visiting campers must park in designated areas, except with permission of the park or program manager. Visitors must conform to established day use hours and day use fee requirements. (3-20-20)T

**12. Responsible Party.** The individual reserving or registering to use an individual or group campsite or facility is responsible for ensuring compliance with the rules within this chapter. (3-20-20)T

**13. Camping.** Camping in individual or group facility sites is prohibited unless in areas specifically designated for camping or by authorization of the park or program manager. (3-20-20)T

**14. ADA Designated Campsites.** Although the department offers campsites that are designated and built to meet ADA accessibility requirements, these campsites are not managed exclusively for ADA use. (3-20-20)T

**15. ADA Accessible Facilities.** Although the department offers facilities that provide for ADA accessibility, these facilities are not managed exclusively for ADA use. (3-20-20)T

## **201. BOATING FACILITIES.**

The provisions of this section do not apply to department-operated marinas which provide moorage on a lease or long-term rental basis. (3-20-20)T

**01. Moorage and Use of Marine Facilities.** No person or persons may moor or berth a vessel of any type in a department-owned or operated park or marine area that is signed for other use. Vessel moorage is limited to no more than fifteen (15) days in any consecutive thirty (30) day period. (3-20-20)T

**02. Moorage Fees.** Vessels moored between 10 p.m. and 7 a.m. at designated facilities will be charged an overnight moorage fee. (3-20-20)T

**03. Use of Onshore Campsites.** If any person or persons from a vessel moored at a department boating facility also occupies any designated campsite onshore, all required fees for such campsite(s) must be paid in addition to any moorage fee provided herein. (3-20-20)T

**04. Self-Registration.** In those areas so posted, boaters must register themselves for the use of marine facilities and onshore campsites, paying all required moorage and campsite fees as provided for herein and in accordance with all posted instructions. (3-20-20)T

## **202. OVERNIGHT USE.**

**01. Occupancy.** Overnight use is permitted only in designated areas. Overnight use is only allowed after all required fees have been paid, registration information completed, and all permits properly displayed.

(3-20-20)T

**02. Overnight Use Fees.** Motor vehicles or trailers not associated with campers between 10:00 p.m. and 7:00 a.m. at designated facilities will be charged an overnight use fee.

(3-20-20)T

**03. Self Registration.** In those areas so posted, overnight users must register themselves for the use of overnight use areas, paying the appropriate fees as provided for herein and in accordance with all posted instructions.

(3-20-20)T

**04. Length of Stay.** Except as provided herein, no person, party, or organization may be permitted to utilize overnight use areas on any lands administered by the department for more than fifteen (15) days in any thirty (30) consecutive-day period. This applies to both reservation and “first come first served” customers. The director may authorize shorter or longer periods for any individual area.

(3-20-20)T

**05. Registration.** All required fees must be paid, registration information completed, and all permits properly displayed prior to occupying an overnight use area.

(3-20-20)T

**06. Check Out.** Overnight users are required to check out by 1 p.m. of the day following the last paid overnight of use.

(3-20-20)T

**07. Responsible Party.** The individual purchasing an overnight use permit or the registered owner of the motor vehicle or trailer is responsible for ensuring compliance with the rules within this chapter.

(3-20-20)T

**08. Overnight Use.** Overnight use is prohibited except in areas specifically designated for overnight use or by authorization of the park or program manager.

(3-20-20)T

### **203. WATERFRONT AREAS.**

**01. Swimming.** Swimming or water contact is at an individual’s own risk.

(3-20-20)T

**02. Restrictions on Designated Beaches.** No glass containers or pets are allowed on designated beaches or swim areas.

(3-20-20)T

**03. Restricted Areas.** Vessels must remain clear of designated beaches and other areas signed and buoyed for public safety.

(3-20-20)T

**04. Ramps and Docks.** The use of docks located next to boat ramps is limited to the active launching and loading of boats.

(3-20-20)T

**05. Compliance with Laws.** Vessels operating on public waters administered by the department must fully comply with the Idaho Safe Boating Act, Title 67, Chapter 70 and the Marine Sewage Disposal Act, Title 67, Chapter 75, Idaho Code, and the rules promulgated thereunder. The director may establish rules prohibiting the use of boat motors or to limit the horsepower capacity on those vessels operating on waters administered by the department.

(3-20-20)T

### **204. WINTER RECREATION PROGRAMS.**

The department manages two winter recreation programs: the winter access program which provides for recreation within state parks and the winter recreational parking pass program which provides for recreation outside of state parks.

(3-20-20)T

**01. Winter Access Program.** The purpose of the winter access program is to fund state park services such as maintaining parking areas, providing warming facilities and winter-accessible restroom facilities, regularly grooming trails, signing ski routes, and having ski patrol services available. Any person using winter access program facilities must purchase and properly display a daily or season pass. Winter access program areas are designated by



board policy. (3-20-20)T

**02. Winter Recreational Parking Permits.** The purpose of the winter recreational parking permit program, known as “Park N Ski”, is to designate winter recreational parking locations and use the funds from permit sales to maintain the designated parking areas. Winter recreational parking areas are designated by board policy. (3-20-20)T

**a. Permit.** Any person parking a vehicle in a designated winter recreation parking location must purchase and properly display a winter recreation parking permit, except, snowmobilers may park their transportation vehicles in a designated parking area without displaying a parking permit when a current snowmobile validation sticker is affixed to the snowmobile. (3-20-20)T

**b. Designation of Primary Use Area.** The purchaser of a permit will be allowed to designate on the appropriate form, a primary winter recreational parking use area. The full portion of fees not allocated to the vendor or the department will be apportioned to the designated use area. Should a purchaser fail to designate a primary use area, those fees will be apportioned to a use area determined by the department. (3-20-20)T

**c. Parking Restrictions.** No person may park a vehicle in a designated winter recreational parking location in such a manner as to deprive other users of reasonable access to all or part of the remainder of that parking area. (3-20-20)T

**d. Permit Location.** An annual winter recreational parking permit must be permanently affixed on the front window of the vehicle nearest the driver’s seat. A temporary three-day permit must be displayed on the vehicle’s dashboard with the dated side displayed to the front of the vehicle in such a manner that it is completely visible and kept in legible condition. (3-20-20)T

**e. Replacement Permits.** No person may file or attempt to file for a duplicate annual winter recreational parking permit unless the original permit was stolen or destroyed. A temporary three (3) day winter recreational parking permit which is lost, stolen, or destroyed will not be reissued. (3-20-20)T

**f. Transfer.** No person may transfer or attempt to transfer an annual winter recreational parking permit decal or a temporary three-day permit from the vehicle upon which it was legally permitted and placed. (3-20-20)T

**g. Permit Expiration.** The annual winter recreational parking permit is valid until the expiration date printed on the decal. The temporary winter recreational parking permit is valid for only the three (3) consecutive days written on the permit. (3-20-20)T

**205. -- 224. (RESERVED)**

**225. FEES AND SERVICES.**

**01. Authority.** (3-20-20)T

**a.** All fees in this chapter are maximum fees unless otherwise stated. The board has the authority to set actual fees by board policy. (3-20-20)T

**b.** Park and program managers have the authority to set fees for goods available for resale, equipment rentals, and services provided by employees to enhance the users experience unique to the individual park or program. (3-20-20)T

**02. Payment.** Visitors must pay all required fees. (3-20-20)T

**03. Camping.** Camping fees include the right to use designated campsites and facilities for the period camp fees are paid. Utilities and facilities may be restricted by weather or other factors. (3-20-20)T

**04. Group Use.** (3-20-20)T

**a.** Groups of twenty-five (25) persons or more, or any group needing special considerations or deviations from these rules must obtain a permit. Permits may be issued after arrangements have been made for proper sanitation, population density limitations, safety of persons and property, and regulation of traffic. (3-20-20)T

**b.** Permits for groups of up to two hundred fifty (250) people may be approved by the park manager with thirty (30) days advance notice. Permits for groups of two hundred fifty (250) or more people may be approved by the director with forty-five (45) days advance notice. (3-20-20)T

**c.** Group use fees for day use facilities, general use areas, and events may be negotiated by the park or program manager and will generally not fall below the cost of providing services. MVEF is required unless specifically waived by the park or program manager. (3-20-20)T

**05. Fees and Deposits.** Fees and deposits, including cleaning fees or damage/cleaning deposits, may be required for certain uses or the reservation of certain facilities unique to an individual park. Where deposits are required, they are to be paid prior to check-in (3-20-20)T

**06. Fee Collection Surcharge.** A surcharge may be added to all established fees when the operator of a motor vehicle or responsible party of a camping unit fails to pay all required fees or fails to properly display proof of payment for required fees prior to entering a park area or occupying a campsite. If the surcharge is assessed, and the operator of the vehicle or responsible party is not present, all required fees in addition to the surcharge will be assessed against the registered owner of the motor vehicle or camping unit. (3-20-20)T

**07. Admission Fees.** An admission fee may be charged for internal park facilities which provide an educational opportunity or require special accommodations. (3-20-20)T

**08. Cooperative Fee Programs.** The department may collect and disperse fees in cooperation with fee programs of other state and federal agencies. (3-20-20)T

**09. Encroachment Permit Application Fee.** The department may assess an encroachment application fee as set by the board to cover administrative costs incurred by the department in reviewing the application and the site, and in preparing the appropriate document(s). (3-20-20)T

**10. Sales Tax.** Applicable sales tax may be added to all sales. (3-20-20)T

**11. Returned Checks.** The cost to the agency for returned checks will be passed on to the issuer of the insufficient funds check. (3-20-20)T

**226. -- 244. (RESERVED)**

**245. FEE SCHEDULE: FEE COLLECTION SURCHARGE.**

Category	Fee
Fee Collection Surcharge	\$25/day

(3-20-20)T

**246. (RESERVED)**

**247. FEE SCHEDULE: ENTRANCE.**

Category	Fee
Daily MVEF	\$7/day/vehicle
Annual MVEF	\$40/year/vehicle

<b>Category</b>	<b>Fee</b>
Annual MVEF Replacement	\$5/vehicle
Idaho State Parks Passport	\$10/year/vehicle
Idaho State Parks Passport Replacement	\$2/vehicle
Commercial Motor Vehicle Entrance	\$50/day/vehicle
Admission	\$20/person

(3-20-20)T

**248. -- 249. (RESERVED)**

**250. FEE SCHEDULE: INDIVIDUAL CAMPSITE OR FACILITY.**

<b>Category</b>	<b>Fee</b>
Basic Campsite: site may have water	\$34/day
Electric Campsite: site has electricity and may have water	\$42/day
Full Hook-up Campsite: site has electricity, water, and sewer	\$46/day
Companion Campsite: site has electricity and may have water	\$84/day
Hike-in/Bike-in Campsite	\$12/person/day
Extra Vehicle	\$8/day
Overnight Use of Parking Areas	\$20/night/vehicle, trailer, or vehicle with attached trailer
Use of Campground Showers by Non-campers	\$3/person/day
Camping Cabins and Yurts	\$500/night
Each additional person above the base occupancy of camping cabin or yurt	\$12/person/night
Pets	\$15/pet/night
Cleaning	\$50

(3-20-20)T

**251. -- 253. (RESERVED)**

**254. FEE SCHEDULE: GROUP CAMPSITE OR FACILITY.**

Group Facility Fees. Reservation service fee, designated group campground or facility.

(3-20-20)T

<b>Category</b>	<b>Fee</b>
Reservation Service Charge (non-transferable, non-refundable)	\$25
Group use of day use facility, overnight facility, or group camp (set by park or program manager)	Varies
Each additional person above the base occupancy of the overnight facility	\$12/person/night

(3-20-20)T

**255. (RESERVED)**

**256. FEE SCHEDULE: BOATING FACILITIES.**

Boating Facilities:

<b>Category</b>	<b>Fee</b>
Vessel Launching	MVEF or \$7/ day/vessel
Overnight moorage at dock or buoy, person staying at campsite or facility and not staying on the vessel	\$9/night
Overnight moorage at dock, person staying on vessel	\$10/night
Overnight moorage at buoy, person staying on vessel	\$9/night

(3-20-20)T

**257. -- 258. (RESERVED)**

**259. FEE SCHEDULE: WINTER RECREATION PROGRAMS.**

<b>Category</b>	<b>Fee</b>
Winter Access Daily Pass, individual	\$6/person/day
Winter Access Daily Pass, family	\$100/family/season
Winter Access Season Pass, individual	\$50/person/season
Winter Access Season Pass, couple	\$75/couple/season
Winter Recreation Parking, temporary three-day permit	\$10/three days
Winter Recreation Parking, annual permit	\$30/year

(3-20-20)T

**260. -- 274. (RESERVED)**

**275. CRITERIA FOR RESERVATIONS.**

**01. Responsible Party.**

(3-20-20)T

**a.** The person booking reservations for an individual campsite or facility is responsible for ensuring compliance with the rules within this chapter. (3-20-20)T

**b.** The person booking reservations for multiple individual campsites is designated the group leader and is responsible for ensuring compliance with the rules within this chapter. The group leader may approve another person to register for a campsite as the primary occupant prior to check-in or at the park. Once the primary occupant registers for the campsite, the primary occupant becomes the responsible party. (3-20-20)T

**c.** The person booking reservations for a group campsite or facility is designated the group leader and is responsible for ensuring compliance with the rules within this chapter. (3-20-20)T

**02. Reservation Service Charges, Individual or Group Campsite or Facility.** Reservations are non-transferable (from one party to another). Reservation fees are non-refundable. (3-20-20)T

**a.** A reservation service charge may be assessed for each individual or group campsite or facility

reserved. (3-20-20)T

**b.** The service charge for an individual campsite or facility will be waived for campers with a current Idaho RV registration sticker and reimbursed to the department by the RV Program. (3-20-20)T

**03. Cleaning Fee.** A cleaning fee or a damage/cleaning deposit may be required by the park or program manager as a condition of reservation. (3-20-20)T

**04. Confirmation Requirements.** (3-20-20)T

**a.** Confirmation of an individual campsite or facility reservation. Full payment of all required fees must be made before a reservation is confirmed. (3-20-20)T

**b.** Confirmation of a designated group campground, group campsite, or group facility reservation. Before a reservation is confirmed, the group leader must: (3-20-20)T

**i.** Supply primary occupant (point of contact) name, address, and phone number for multiple bookings of individual campsites for a group. (3-20-20)T

**ii.** Pay all required fees for each campsite or facility reserved. (3-20-20)T

**05. Reservation Modifications.** A reservation service fee will be assessed for any modification to a previously made reservation that involves reducing the planned length of stay, or to change the reservation dates where part of the new stay includes part of the original stay booked (rolling window). Modifications that change the original stay so that no part of the new stay includes part of the original stay are to be considered a cancellation and re-book will be mandatory to keep a reservation. With the exception of the reservation service charge as defined in Section 276, any overpaid fees will be reimbursed at the time the reservation is modified. (3-20-20)T

**06. Reservation Cancellations.** (3-20-20)T

**a.** Individual Campsite or Facility. A reservation service fee will be assessed for the cancellation of a reservation. This service fee will be assessed for each campsite or facility involved. If the customer cancels after the scheduled arrival date the customer forfeits all usage fees for the time period already expired. Cancellations received after checkout time will result in the forfeiture of that day's usage fees for the campsite or facility. At no time will the customer be charged a cancellation fee that exceeds the amount originally paid. The IDPR or its reservation service provider may cancel a customer's reservation for insufficient payment of fees due. With the exception of the reservation service fees, all fees paid will be reimbursed at the time the reservation is cancelled. (3-20-20)T

**b.** Park Board Designated Special Use Campsites and Facilities. A reservation service fee will be assessed for the cancellation of a reservation. If a cancellation for a group facility occurs twenty-one (21) or fewer calendar days prior to arrival, the customer forfeits the first night or daily facility usage fees (base rate). If a cancellation for a group facility occurs more than twenty-one (21) calendar days prior to arrival, a cancellation charge will be assessed. If the customer cancels after the arrival date the customer forfeits all usage fees for the time period already expired. Cancellations received after checkout time will result in the forfeiture of that day's usage fees for the campsite or facility. At no time will the customer be charged a cancellation fee that exceeds the amount originally paid. The department or its reservation service provider may cancel a customer's reservation for insufficient payment of fees due. An individual site cancellation fee applies to each campsite in a group campground. With the exception of the reservation service fees, all fees paid will be reimbursed at the time the reservation is cancelled. (3-20-20)T

**07. Insufficient Payment.** The department may cancel a customer's reservation for insufficient payment of fees due. (3-20-20)T

**276. FEE SCHEDULE: RESERVATIONS.**

<b>Category</b>	<b>Fee</b>
Reservation Service Charge, individual campsite or facility	Current RV sticker or \$10/campsite or facility
Reservation Service Charge, group reservation for campsite or facility	\$25
Modification	\$10/campsite or facility
Cancellation, individual campsite or facility, prior to check-in time	\$10/campsite or facility
Cancellation, individual campsite or facility, after check-in time	First night's fee
Cancellation, special use campsite or facility, more than 21 days in advance	\$50/facility
Cancellation, individual campsite or facility, 21 days or less in advance	First night's or daily usage fee

(3-20-20)T

**277. -- 399. (RESERVED)**

**400. PARK CAPACITIES.**

Where applicable, park or program managers may limit or deny access to an area whenever it has reached its designated capacity. (3-20-20)T

**401. -- 499. (RESERVED)**

**500. LIVESTOCK.**

Grazing of livestock is not permitted within lands administered by the department. Exceptions may be made by the board for grazing permits or otherwise permitting the use of lands administered by the department for livestock. The use of saddle or other recreational livestock is prohibited on trails, roadways, and other areas unless designated through signing for that purpose or with permission of the park or program manager. (3-20-20)T

**501. -- 576. (RESERVED)**

**577. SPREADING OF HUMAN ASHES.**

Persons may spread human ashes on lands owned by the Idaho Department of Parks and Recreation. The exact location must be pre-approved by the park or program manager. Persons may not spread ashes in the water within a state park. The department does not assign or convey any rights or restrictions by allowing the placement of ashes on the land, and there are no restrictions in the ability of the landowner to operate, develop, or otherwise use the land at their sole discretion without any obligation associated with the placement of ashes on the land. (3-20-20)T

**578. -- 624. (RESERVED)**

**625. ADVERTISEMENTS/PROMOTIONS/DEMONSTRATIONS.**

**01. Printed Material.** Public notices, public announcements, advertisements, or other printed matter may only be posted or distributed in a special area approved by the park or program manager. (3-20-20)T

**02. Political Advertising.** Political advertising is strictly prohibited within any lands administered by the Department. (3-20-20)T

**03. Demonstrations.** Public demonstrations are limited to areas approved by the park or program manager and subject to an approved permit issued after arrangements for sanitation, population density limitations,

safety of persons and property, and regulation of traffic are made. (3-20-20)T

**626. -- 649. (RESERVED)**

**650. AUTHORIZED OPERATIONS.**

No person, firm, or corporation may operate any concession, business, or enterprise within lands administered by the Department without written permission or permit from the board. No person(s), partnership, corporation, association or other organized groups may: (3-20-20)T

**01. Beg or Solicit for Any Purpose.** (3-20-20)T

**02. Game or Operate a Gaming Device of Any Nature.** (3-20-20)T

**03. Abandon Any Property.** Leave any property on department lands. Leaving property is prohibited unless registered in a campsite or permitted by the park or program manager. Property left on department lands for more than twenty-four (24) hours may be removed at the owner's expense. (3-20-20)T

**651. -- 674. (RESERVED)**

**675. DEPARTMENT RESPONSIBILITY.**

The department is not responsible for damage to, or theft of personal property within lands administered by the department. All visitors use facilities and areas at their own risk. (3-20-20)T

**676. NONDISCRIMINATION.**

No person may discriminate in any manner against any person or persons because of race, color, national origin, religion, gender, age or disability within lands administered by the department. Facilities constructed or maintained with, and programs supported by the cross-country skiing recreation account must be available for public use without discrimination and must comply with requirements as set out in the Americans with Disabilities Act. (3-20-20)T

**677. -- 999. (RESERVED)**

**26.01.33 – RULES GOVERNING THE ADMINISTRATION OF THE LAND  
AND WATER CONSERVATION FUND PROGRAM**

**000. LEGAL AUTHORITY.**

The Idaho Parks and Recreation Board is authorized under Section 67-4223, Idaho Code, to adopt, amend, or rescind rules as may be necessary for proper administration of the department and its programs. (3-20-20)T

**001. TITLE AND SCOPE.**

**01. Title.** The title of this chapter is cited in full as Idaho Department of Parks and Recreation Rules, IDAPA 26.01.33, “Rules Governing the Administration of the Land and Water Conservation Fund Program.” (3-20-20)T

**02. Scope.** This chapter establishes procedures for the administration of the Land and Water Conservation Fund program, including requirements for project application, eligibility, review, award, and management. (3-20-20)T

**002. -- 009. (RESERVED)**

**010. DEFINITIONS.**

As used in this chapter: (3-20-20)T

**01. Acquisition.** The gaining of rights of public use by purchase or donation of fee or less than fee interests in real property. (3-20-20)T

**02. Board.** The Idaho Parks and Recreation Board, a bipartisan, six (6) member board, appointed by the governor. (3-20-20)T

**03. Development.** The act of physically improving an area or constructing facilities necessary to increase its ability to serve outdoor recreation purposes. (3-20-20)T

**04. Director.** The director and chief administrator of IDPR or the designee of the director. Designated by the governor to serve as the State Liaison Officer for the LWCF program. (3-20-20)T

**05. Evaluation Committee.** Representatives from federal, state and local agencies with expertise in community development or public outdoor recreation needs. The committee determines acceptability of projects based on technical criteria, rates LWCF projects, and assists IDPR staff in making funding priority recommendations to the Idaho Parks and Recreation Board. (3-20-20)T

**06. Grants Program.** All funding programs administered by IDPR. (3-20-20)T

**07. IDPR.** The Idaho Department of Parks and Recreation. (3-20-20)T

**08. LWCF.** The Land and Water Conservation Fund, a federal grant program that provides fifty percent (50%) matching grants to states, and through states to local governments, for the planning, acquisition and development of public outdoor recreation areas and facilities. (3-20-20)T

**09. NPS.** The National Park Service. (3-20-20)T

**10. Open Project Selection Process (OPSP).** The overall objective decision making process by which IDPR selects LWCF projects for funding. (3-20-20)T

**11. Participation Manual and Internal Procedures Manuals.** A compilation of state procedures, rules, and instructions that have been assembled in manual form and that have been approved by the board for dissemination to the public and public agencies that may wish to participate in grant programs of IDPR or that outline operation of the Land and Water Conservation Program by IDPR for staff use. (3-20-20)T

**12. Planning.** The development of documents and programs to identify and propose actions for managing recreational resources and the preparation and review of designs and specifications for such resources. (3-20-20)T

**13. Priority Needs Assessment.** Incorporates SCORTP related activities that refined Idaho’s priorities for LWCF obligation. These area are reflected in the OPSP criteria (see Section 440 of this chapter). (3-20-20)T



**14. Project.** The undertaking that is or may be funded in whole or in part with funds administered by IDPR. (3-20-20)T

**15. Retroactive Cost.** Costs incurred after receipt of application but prior to the execution of the project contract. (3-20-20)T

**16. SCORP/SCORTP.** Statewide Comprehensive Outdoor Recreation Plan/Statewide Comprehensive Outdoor Recreation and Tourism Plan. (3-20-20)T

**17. Scope Element.** A specific item, for example, one (1) facility or amenity, listed on a project application or project agreement that is a part of the whole. (3-20-20)T

**18. Sponsor.** A state or local government agency that solicits a grant of funds from IDPR for a projector is responsible for administering the grant or funding of an approved application or completed project. (3-20-20)T

**19. State Liaison Officer (SLO).** The director is designated by the governor to serve as the State Liaison Officer to the National Park Service for the LWCF program. The chief of the Recreation Resources Bureau is designated as the Alternate State Liaison Officer. (3-20-20)T

**011. -- 049. (RESERVED)**

**050. GENERAL PROVISIONS.**

Federal Land and Water Conservation Fund (LWCF) grants are available through IDPR for the acquisition or development of land to be used for outdoor recreation or for the combined acquisition and development of land to be used for outdoor recreation. Any land acquired or developed with these funds are held in perpetuity for outdoor recreation or, with approval from IDPR and NPS, be replaced with land of equal or higher fair market value, recreation utility and location. LWCF grants may be used for SCORTP activities. (3-20-20)T

**051. -- 064. (RESERVED)**

**065. COMPLIANCE WITH LAWS.**

LWCF administration is subject to all applicable state and federal statutes, rules, regulations, ordinances and requirements. (3-20-20)T

**066. -- 079. (RESERVED)**

**080. FUND ALLOCATION.**

**01. Eligible Applicants.** Governmental agencies that are eligible to receive or apply for the grant funds include incorporated cities, counties, state agencies, recreation districts and other state or local governmental agencies authorized to provide general public recreation facilities. (3-20-20)T

**02. Allocation of Funds.** Idaho's cost of administering the SCORTP program, the LWCF program and a contingency fund are deducted from the state's annual apportionment. The remaining funds are divided fifty percent (50%) for local governmental agencies and fifty percent (50%) for state agencies. This policy may be altered in any year at the discretion of the board. (3-20-20)T

**a.** To assure that the needs of rural areas are met, twenty percent (20%) of the amount dedicated for local governmental agencies is dedicated for use by governmental agencies of five thousand (5,000) population or less. If the cumulative request of the governmental agencies of five thousand (5,000) population or less is more than the twenty percent (20%) of the amount dedicated for local governmental agencies, governmental agencies of five thousand (5,000) population or less may compete for the total remaining allocation. (3-20-20)T

**b.** If the total cost for a single project of a governmental agency with a population of five thousand (5,000) or less requires over one-half (1/2) of the twenty percent (20%) dedicated for use by governmental agencies

of five thousand (5,000) population or less, that project will compete with the large governmental agency projects.  
(3-20-20)T

**03. Exceptions.** The board may suspend (through formal action at the board meeting at which LWCF grant requests are considered) any provision of Subsection 080.02 of this chapter if the allocation is too small to warrant viable projects.  
(3-20-20)T

**04. Project Requests Insufficient.** The board is not required to distribute all available funds. IDPR staff may recommend, and the board determine, to reject projects with evaluation scores so low as to be noncompetitive.  
(3-20-20)T

**081. -- 094. (RESERVED)**

**095. CONTINGENCY FUND.**  
Twenty percent (20%) of the total allocation may be held out for needed cost overruns, special projects, and emergency needs. Any unused funds at the end of the funding cycle are obligated through the normal process.  
(3-20-20)T

**096. -- 109. (RESERVED)**

**110. SPONSOR'S MATCHING SHARE.**  
The sponsor will be reimbursed up to fifty percent (50%) of the approved project cost. The sponsor's share can be either local funds, acceptable state funds, force account, or donation of privately owned lands, goods or services. Reimbursement varies according to the type of project and total project cost (see Section 515 of this chapter). The use of specific types of sponsor's share match may be adjusted in any year at the discretion of the board (see Section 140.04 of this chapter).  
(3-20-20)T

**111. -- 124. (RESERVED)**

**125. PROJECT TIME LIMITATIONS.**  
The project must be completed by the applicant within twenty-four (24) months of the federal contract signing.  
(3-20-20)T

**126. -- 139. (RESERVED)**

**140. ELIGIBLE PROJECTS.**

**01. Generally.** LWCF grants are available for up to fifty percent (50%) of the cost to acquire or develop land that is to be used for outdoor recreation purposes and is to be held in perpetuity for public outdoor recreation uses.  
(3-20-20)T

**02. Less Than Fee Acquisition.** Acquisition of less than fee interest, such as easements and development right, must be considered in the same manner as simple fee acquisition subject to the following conditions:  
(3-20-20)T

- a.** The interest cannot be revocable; (3-20-20)T
- b.** The value can be supported through standard appraisal techniques; and (3-20-20)T
- c.** Recreation can be demonstrated as the primary purpose of the acquisition. (3-20-20)T

**03. Ineligible Projects.** Acquisitions or developments that do not contribute directly to general public outdoor recreation facilities or activities are ineligible for LWCF funding. Acquisition of leases are not eligible.  
(3-20-20)T

**04. SCORTP.** LWCF grants are available for up to fifty percent (50%) of the cost of the SCORTP.  
(3-20-20)T

**141. -- 154. (RESERVED)**

**155. ELIGIBLE PROJECT COSTS.**

IDPR may place restrictions on reimbursement of some acquisition and development costs. (3-20-20)T

**156. -- 169. (RESERVED)**

**170. ACQUISITION OF PUBLICLY OWNED LANDS.**

The cost to the sponsor of land purchased from another public agency is generally not eligible for matching assistance. (3-20-20)T

**171. -- 184. (RESERVED)**

**185. ACQUISITION OF STRUCTURES.**

Structures that are proposed to be retained and are incidental to the land are eligible for LWCF matching funds if they are to be used primarily for support facilities for outdoor recreation activities. The anticipated use must be clearly identified in the project application so that IDPR may exercise reasonable judgment in determining the eligibility of the structure for funding assistance. (3-20-20)T

**186. -- 199. (RESERVED)**

**200. WAIVER OF RETROACTIVELY.**

**01. Generally.** The SLO may grant permission to a sponsor to proceed prior to normal processing of an application through a written waiver of retroactively. This is not be construed as a qualitative approval of the proposed project. Should the project subsequently be approved, the costs incurred must be eligible for assistance. (3-20-20)T

**02. NPS Waiver Required.** The SLO may not grant a waiver of retroactivity until the NPS has issued its waiver of retroactivity. A waiver may be granted only if LWCF moneys are available and only if an emergency situation warrants it. (3-20-20)T

**03. Limitations.** Retroactive development costs are not eligible for reimbursement, other than expenses necessary for planning a development project and then only if it is specifically requested in the project application. (3-20-20)T

**201. -- 214. (RESERVED)**

**215. ENCUMBRANCES.**

Property rights obtained with LWCF assistance must be free of all reservations or encumbrances that would limit the use of the site disproportionate to the public benefit. (3-20-20)T

**216. -- 229. (RESERVED)**

**230. ACQUISITION COSTS EXCEEDING FAIR MARKET VALUE.**

An approved appraisal is an acceptable estimate of property value (see Section 350 of this chapter). The negotiation between a willing seller and a willing buyer may set a price that is higher than the appraisal, and this market place value can be considered along with the appraised value in establishing the reasonable limits of assistance. If the sponsor believes that the negotiated price is a better indication of market value, yet it is higher than the appraised value, a detailed and well documented statement of this differences must be submitted, together with a formal request for a cost increase (see Section 620 of this chapter). (3-20-20)T

**231. -- 259. (RESERVED)**

**260. ACQUISITIONS INVOLVING COMPATIBLE MULTIPLE USES.**

Nonrecreation uses, such as timber management, grazing, and other natural resource uses, may be carried out on

lands acquired with LWCF assistance if they are clearly compatible with and secondary to recreation use, and are approved by IDPR prior to execution of the project contract. (3-20-20)T

**261. -- 274. (RESERVED)**

**275. ACQUISITIONS INVOLVING NONRECREATION USE.**

**01. Nonrecreation Use Limited.** Lands acquired with LWCF assistance are immediately dedicated to public outdoor recreation and therefore, in the interim period between acquisition and planned development, the public cannot be denied use. In some instances during this period the temporary continuation of nonrecreation uses of LWCF assisted areas may be appropriate if not at the expense of public use. Continuation of existing nonrecreation uses must be approved by IDPR. When approved by IDPR, the used will be phased out within three (3) years from the date of the acquisition. (3-20-20)T

**02. Life Estates.** Life estates, whereby an owner is allowed to use the property to the end of his life, is an allowable nonrecreation use provided all of the following conditions are met: (3-20-20)T

**a.** The life estate must not totally limit public use of the site; (3-20-20)T

**b.** The value of the life estate is not included within the total project cost as established through acceptable appraisal techniques; and (3-20-20)T

**c.** The life estate provisions are approved by IDPR. (3-20-20)T

**276. -- 289. (RESERVED)**

**290. PUBLIC PARK AND SCHOOL DEVELOPMENT PROJECTS.**

Projects clearly designed and located to meet identified needs for general public recreation, as well as to provide school districts with outdoor education, physical education, and recreation facilities may be eligible for funding, provided general public recreation is clearly the primary use. (3-20-20)T

**291. -- 304. (RESERVED)**

**305. DONATED REAL PROPERTY AS MATCHING SHARE.**

**01. Generally.** The value of privately owned donated real property may be used as a portion or as all of the sponsor's matching share of an approved project when the transfer of title to the sponsor has not been accomplished prior to the execution by IDPR of the project contract, unless such action has been previously approved by IDPR under the waiver of retroactivity procedure (see Section 200 of this chapter). (3-20-20)T

**02. Limitations.** The donation must consist of real property that would normally qualify for LWCF funding. If the donation does not adjoin the tract being acquired or is not being developed as part of the project then it must stand on its own merits as an acceptable public recreation area in order to be considered an eligible donation. It also must be within the jurisdiction of the sponsor. (3-20-20)T

**03. Appraisal Required.** The value of the donation must be established by an appraisal report prepared under the provision of Section 350 of this chapter. Any portion of the value of the donation not utilized by the sponsor for matching in the project is not available for subsequent projects. The amount of donation that is matchable is the value of the land donation up to the limit of the local agency's share of the project. The maximum reimbursed by IDPR may never exceed the cash expended on the project. (3-20-20)T

**306. -- 319. (RESERVED)**

**320. DONATED GOODS AND SERVICES AS MATCHING SHARE.**

**01. Generally.** Donated services, materials and equipment are eligible for reimbursement. Allowable rates must be agreed upon by IDPR prior to initiation of construction and must be in accordance with current federal

regulations and state rules. Partial reimbursement on projects involving such donations are limited to the amount of actual cash outlay by the grantee. (3-20-20)T

**02. Excess Value.** Donated services above the needs for a project are not eligible for further funding assistance. (3-20-20)T

**03. Requirements.** Donated services may be furnished by professional and technical personnel, consultants, and other skilled or unskilled labor. The services must be an integral and necessary part of an approved project. Rates for donated services must be consistent with those paid for similar work in other activities of the state or local government. In those instances in which the required skills are not found in the sponsor's organization, rates must be consistent with those paid for similar work in the labor market in which the sponsor competes for the kind of services involved. (3-20-20)T

**321. -- 334. (RESERVED)**

**335. FORCE ACCOUNT AS MATCHING SHARE.**

All or a portion of the sponsor's share can be provided through force account (i.e., use of sponsor's staff and equipment) when such contributions are verifiable from the sponsor's records, are not included as contributions for any other IDPR program, and are necessary and reasonable for proper and efficient accomplishment of the project. (3-20-20)T

**336. -- 349. (RESERVED)**

**350. APPRAISAL REQUIREMENTS.**

A real estate appraisal is required for all land to be acquired. The appraisal must be prepared and paid for by the sponsor. The type of appraisal to be used must be determined by the cost of the property, and difficulty of the appraisal assignment. All appraisal must be done according to "Uniform Appraisal Standards for Federal Land Acquisitions." (3-20-20)T

**351. -- 364. (RESERVED)**

**365. APPRAISAL REVIEWS.**

IDPR reviews appraisals as necessary. Any appraisal report that does not meet the basic content requirement or use correct analysis procedures must be corrected to the satisfaction of IDPR. All costs are paid by the sponsor. (3-20-20)T

**366. -- 379. (RESERVED)**

**380. REVENUE FEASIBILITY STUDIES.**

At the discretion of the SLO, a feasibility report prepared by a fiscal specialist may be required prior to funding consideration by the board. Specifically, it must provide the SLO with detailed financial information and data that is incorporated in staff recommendations to the board. This report is paid for by the sponsor. (3-20-20)T

**381. -- 394. (RESERVED)**

**395. TECHNICAL REVIEW.**

At the discretion of the SLO, a technical report prepared by a licensed, certified engineer may be required prior to funding consideration by the board. This report is paid for by the sponsor. (3-20-20)T

**396. -- 409. (RESERVED)**

**410. FUNDING CYCLE.**

**01. Generally.** A funding cycle is held at a minimum of once every two (2) years with the following exception: subject to the level of funding, the board may suspend (through formal action at any regular meeting) a funding cycle. (3-20-20)T

- 02. Procedure.** The funding cycle consists of the following: (3-20-20)T
- a.** Notification to begin a funding cycle must be made no less than ninety (90) days before applications are due. (3-20-20)T
  - b.** The evaluation committee meeting must be held within one hundred twenty (120) days of the application due date. (3-20-20)T
  - c.** Recommendations must be formulated by IDPR staff within thirty (30) days following the evaluation committee meeting and must be made to the board no later than the next regularly scheduled meeting. (3-20-20)T
  - d.** Subject to the level of funding, the board may suspend (through formal action at any regular meeting) the evaluation committee meeting and may elect to adopt staff recommendations. (3-20-20)T
- 03. Fees.** At the discretion of the SLO, fees may be charged for the various stages of any funding cycle. When charged, fees are assessed equally on all applicants. Fees charge may not exceed fifty dollars (\$50) for all stages combined. (3-20-20)T

**411. -- 424. (RESERVED)**

**425. APPLICATION PROCEDURE.**

- 01. Initial Review.** Participation manuals are available to guide sponsors in preparing projects for funding consideration. Materials submitted for consideration are reviewed by IDPR staff for completeness and for project eligibility. Once all application materials are submitted and a project is determined to be potentially eligible under criteria established in the OPSP, IDPR will ask the sponsor to make a presentation to the evaluation committee. (3-20-20)T
- 02. Eligible Projects.** Eligible projects are ranked according to the (OPSP (see Section 440 of this chapter) and approved by the board (see Section 470 of this chapter). Full federal application materials must be submitted to NPS for final funding approval (see Section 485 of this chapter). (3-20-20)T

**426. -- 439. (RESERVED)**

**440. OPEN PROJECT SELECTION PROCESS (OPSP).**

- 01. Generally.** The procedures outlined in OPSP through the SCORTP process are for the purpose of defining criteria that a proposed LWCF project must meet in order to be eligible for funding, and to establish priorities on the basis of which competing eligible projects can be rated objectively. The intent is to ensure that available funds are used to fund those projects that most nearly satisfy the intent of the LWCF Act, and the recreational needs of the people of Idaho. (3-20-20)T
- 02. Requirements.** Requirements for the SCORTP and the OPSP can be found in the "LWCF Participation Manual," available from IDPR or NPS. (3-20-20)T
- 03. Availability.** Copies of the SCORTP and the OPSP criteria used in prioritizing those projects submitted for LWCF assistance may be obtained from IDPR or NPS. Typically, this criteria is provided in all LWCF application guidelines. (3-20-20)T
- 04. Suspension of OPSP.** Subject to the level of funding, the board may elect to suspend OPSP (through formal action at any regular meeting). (3-20-20)T

**441. -- 454. (RESERVED)**

**455. EVALUATION COMMITTEE.**

**01. Composition.** The evaluation committee includes representatives with experience in community development or public outdoor recreation. The committee ranks projects based on its review of the application and a presentation by the sponsor. It rates all projects based on the selected criteria found in OPSP. The evaluation committee includes nine (9) members as follows: (3-20-20)T

**a.** Three (3) members are representatives of state and federal agencies with a technical relationship to community development or the outdoor recreation needs in the state. (3-20-20)T

**b.** One (1) member represents a community of five thousand (5,000) population or more (3-20-20)T

**c.** One (1) members represents a community of five thousand (5,000) population or less. (3-20-20)T

**d.** One (1) member represents the interests of ethnic minorities. (3-20-20)T

**e.** One (1) member represents the interests of the elderly. (3-20-20)T

**f.** One (1) member represents the interests of people with disabilities. (3-20-20)T

**g.** One (1) member must be from the board. (3-20-20)T

**02. Quorum.** A quorum is required to conduct committee business. Five (5) people constitute a quorum. (3-20-20)T

**03. Appointment and Term.** Members are appointed by and serve at the discretion of the SLO for three (3) funding sessions and may be reappointed, except, the board member must be selected by and serve at the discretion of the board. As necessary, the SLO provides public notice of available seats. Any interested individual or organization may nominate individuals to serve on the committee. (3-20-20)T

**456. -- 469. (RESERVED)**

**470. BOARD REVIEW AND APPROVAL.**

The board reviews and approves projects according to the priority list provided by IDPR staff. Applications are submitted to NPS according to priority after LWCF moneys have been appropriated by congress and allocated to the state. (3-20-20)T

**471. -- 484. (RESERVED)**

**485. NPS PROJECT APPROVAL.**

When a project is approved by NPS, the announcement is made by one of the state's congressional delegation following notification from IDPR. All appraisals, title and deed work must be finalized prior to submitting a project to NPS. (3-20-20)T

**486. -- 499. (RESERVED)**

**500. PROCEEDING ON THE PROJECT.**

After project approval, the IDPR staff assists the sponsor in meeting the requirements of the LWCF including providing information on the steps and required documentation for acquisition and development projects along with financial responsibilities and allowable costs. The sponsor must complete work on the project according to the scope elements in the state/local agreement. (3-20-20)T

**501. -- 514. (RESERVED)**

**515. DISBURSEMENT OF FUNDS.**

**01. Authorization.** Except as otherwise provided herein, the SLO must authorize disbursement of funds allocated to a project through reimbursement basis. The LWCF program is a reimbursement program, which means that the participants initially pay all project costs and then seek reimbursement through IDPR. (3-20-20)T

**02. Documentation.** Reimbursement not be made by IDPR until deed, title insurance and appraisal requirements are satisfied on all projects. Reimbursement may be made on development or combination acquisition and development projects once construction shows evidence and reasonable progress toward the completion of all scope elements and LWCF requirements. (3-20-20)T

**03. Partial Reimbursement.** Partial reimbursement is not made for projects where the project sponsor's matching share is less than fifteen thousand dollars (\$15,000). When reimbursement is granted prior to project completion, the sponsor receives a reimbursement for fifty percent (50%) of the eligible costs incurred less a fifteen percent (15%) hold back. When the project has been completed and receives final approval from IDPR, the sponsor is paid the fifteen percent (15%) hold back. If multiple payments are to be incurred as part of the project, the final payment may be used as the fifteen percent (15%) hold back. (3-20-20)T

**04. Request for Reimbursement.** Reimbursement must be requested by local governmental agencies on voucher forms provided by IDPR and includes all required documentation. The sponsor will receive a reimbursement for fifty percent (50%) of the eligible costs incurred. The amount of reimbursement must never exceed the cash expended on the project. (3-20-20)T

**05. Advance Payment.** An advance payment is a payment made to a sponsor upon its request before cash outlays are made by the sponsor or payment made through the use of predetermined payment schedules before such payments are due. Advance payment may be made subject to the conditions outlined below: (3-20-20)T

**a.** IDPR will consider the payment of advances on development projects where the matching share is non-cash, and on acquisition projects where funds must be available up front in order to prevent the loss of an available site to other interested buyers. Such advances must receive prior approval of NPS. A written request must be submitted by the sponsor to IDPR to initiate the process. (3-20-20)T

**b.** Advances must be timed and procedures observed to assure that cash withdrawals occur only as and when essential to meet the needs of the project sponsors. Advances are limited to the minimum amounts needed and timed to be in accord with the requirements of carrying out the purpose of the approved project. Any moneys advanced to the sponsor are public moneys (owned by the federal government and the State of Idaho) and must be deposited in a bank with FDIC insurance coverage and the balances exceeding the FDIC coverage must be collaterally secure. (3-20-20)T

**c.** One (1) month after the advance has been received, the sponsor must submit a billing indicating expenditures made from the advanced funds. This will be used by IDPR as a basis for liquidating obligations, reducing the advance account and making charges to the appropriate cost account. (3-20-20)T

**d.** At least monthly, IDPR reviews the sponsor's disbursements of advanced funds for reasonableness of cash balances on hand. In the event IDPR determines a sponsor is making insufficient progress using advanced funds, IDPR may request an immediate refund. (3-20-20)T

**516. -- 529. (RESERVED)**

**530. PROJECT CONTRACT.**

For every funded project, a project contracts must be executed. The project contract must be prepared by the IDPR staff subsequent to approval of the project. Upon execution by the sponsor, the parties are thereafter bound by the project contract terms. The sponsor may not proceed with the project until the project contract has been executed. IDPR may not execute a project contract until federal funding has been authorized by NPS. (3-20-20)T

**531. -- 544. (RESERVED)**

**545. CONTROL AND TENURE.**

The sponsor has title to or adequate control and tenure of the area to be developed. The sponsor must list all outstanding rights or interests held by others in the property to be developed. In the event that outstanding rights later prove to be incompatible with public outdoor recreation uses of the site, the sponsor assumes the responsibility for having to replace the facilities developed with state or federal assistance with others of at least equal value and



reasonably equivalent usefulness and location at the sole cost of the sponsor. (3-20-20)T

**546. -- 559. (RESERVED)**

**560. APPLICABILITY.**

All LWCF requirements apply to each area or facility, regardless of the extent of LWCF assistance. When LWCF development assistance is given to a project limited to less than a complete recreational property, all lands immediately adjacent to that LWCF development that are designated as recreational property must be identified as being within the LWCF project boundary and must be subject to LWCF guidelines. (3-20-20)T

**561. -- 574. (RESERVED)**

**575. SPONSOR COMMITMENT.**

A proclamation from the sponsor's governing body committing the project and the sponsor to LWCF requirements must be submitted to IDPR prior to IDPR project approval. (3-20-20)T

**576. -- 589. (RESERVED)**

**590. RESTRICTION ON TITLE.**

Land acquired in fee or developed with outdoor recreation funds must be dedicated to outdoor recreation use in perpetuity by a recorded "Deed of Right to Use Land for Public Recreation Purposes" (Deed of Right) that conveys a real property interest to the public. This must be executed and recorded by the sponsor after it has taken title to the property, and before it applies for reimbursement. (3-20-20)T

**591. -- 604. (RESERVED)**

**605. RECORDS.**

Project records must be maintained by the state and sponsor for three (3) years after final payment. The material must be maintained beyond the required three (3) year period if audit findings have not been resolved. Property records must be maintained in perpetuity. (3-20-20)T

**606. -- 619. (RESERVED)**

**620. PROJECT AMENDMENTS, COST INCREASES AND TIME EXTENSIONS.**

**01. Amendments.** The project contract may be amended by execution of a project amendment. All amendment requests must be made in writing and must include a detailed justification. Sponsors are expected to complete projects as originally proposed and evaluated. However, amendments for minor changes in scope may be requested. Cost increases of twenty-five percent (25%) or more or changes in project elements that change the total project cost by twenty-five percent (25%) or more require that the project be presented as a totally new proposal and compete through the OPSP (see Sections 440 through 485 of this chapter) during a current funding cycle. Should the revised project not receive enough points to be funded, the sponsor is required to complete the scope of the project as originally proposed at its expense or return any funds reimbursed so that the project may be canceled and the funds reallocated. This does not apply to SCORTP projects. (3-20-20)T

**02. Cost Increases on Development Projects.** For cost increase requests on development projects to be considered, all of the following requirements must be met: (3-20-20)T

**a.** The increase, or any portion thereof, is to be used only for costs incurred on elements specified in the project agreement; and (3-20-20)T

**b.** The sponsor has initiated implementation of the project in a timely manner and has had little control over the condition causing the cost overrun. (3-20-20)T

**03. Cost Increases on Acquisition Projects.** Acquisition project cost increases must meet all of the following conditions: (3-20-20)T

- a. The increased market value is supported by an acceptable appraisal; (3-20-20)T
- b. The sponsor has diligently pursued the acquisition; and (3-20-20)T
- c. If increased relocation costs have caused a cost overrun, an explanation is required. (3-20-20)T

**04. Condemnation.** Acquisition cost increases based on condemnation awards, if granted, must be based on compensation for the property and direct relocation costs; no court or legal costs are eligible for reimbursement. (3-20-20)T

**05. Basis for Cost Increase.** Cost increase requests for development projects are based on the total approved costs. Cost increase requests for acquisition projects are based on a parcel by parcel determination. (3-20-20)T

**06. Extensions of Time.** Extensions of time limitations will be considered if based on unavoidable circumstances such as condemnation of property for acquisition projects and delays due to unusually poor weather or unavailability of supplies for a development project. Extensions are generally granted in six (6) month intervals. Avoidable project delays may result in loss of funding with the sponsor being required to return any funds reimbursed so that the project can be canceled. (3-20-20)T

**621. -- 634. (RESERVED)**

**635. DEVELOPMENT PROJECT CONTRACT REQUIREMENTS.**  
Development projects require competitive bidding according to state and federal statutes. (3-20-20)T

**636. -- 649. (RESERVED)**

**650. CONVERSION TO OTHER USES.**

**01. Generally.** Property acquired or developed with LWCF assistance is not converted to other than public outdoor recreation uses without prior approval of the SLO and the NPS regional director. The SLO has authority to disapprove conversion requests or to reject proposed property substitutions. (3-20-20)T

**02. Prerequisites to Approval of Conversion.** IDPR will only consider a conversion request once the following prerequisites have been met: (3-20-20)T

- a. All practical alternatives to the conversion have been evaluated and rejected on a sound basis. (3-20-20)T
- b. At least thirty (30) days prior to IDPR submitting a request to NPS to convert LWCF properties, the sponsors must hold a public hearing. (3-20-20)T
- c. The fair market value of the property to be converted has been established and the property proposed for substitution is of at least equal fair market value as established by a state approved appraisal. (3-20-20)T
- d. The property proposed for replacement is of reasonably equivalent usefulness and location as that being converted. It must be administered by the same political jurisdiction as the converted property. (3-20-20)T
- e. The property proposed for substitution meets the eligibility requirements for LWCF assisted acquisition. The replacement property constitutes or is part of a viable recreation area. (3-20-20)T
- f. Public land may not be used for substitution on acquisition projects unless it meets the criteria for an eligible acquisition project. However, in the case of development projects for which the state match was not derived from the cost of the purchase or value of a donation of the land to be converted, public land not currently dedicated to recreation or conservation use may be used as replacement land even if this land is transferred from one public agency to another without cost. (3-20-20)T

- g.** All necessary coordination with other federal agencies has been satisfactorily accomplished. (3-20-20)T
- h.** The guidelines for environmental evaluation have been satisfactorily completed and considered. (3-20-20)T
- i.** The proposed conversion and substitution are in accord with the SCORTP. (3-20-20)T
- j.** Staff consideration of the above points reveals no reason for disapproval and the project files are so documented. (3-20-20)T
- k.** It should also be noted that the acquisition of one (1) parcel of land may be used in satisfaction of several approved conversions. However, previously acquired property cannot be used to satisfy substitution requirements except in the case of development projects. (3-20-20)T

**03. Project Amendments.** Approved conversions require amendments in the project contract when the property to be substituted is off site or when replacement of property is deferred. (3-20-20)T

**04. Fees.** Deposit, cost and fees for the administration and management of the LWCF conversion process must be as follows: (3-20-20)T

**a.** The sponsor is required to pay a deposit of two and five-tenths percent (2.5%) of the appraised value of the property or the total cost of the project grant, whichever is greater. This deposit may not be less than one thousand dollars (\$1,000). (3-20-20)T

**b.** IDPR will charge the sponsor for all administrative costs relating to the conversion and a service fee of one percent (1%) of the current appraised value of the converted property. The service fee may not exceed three thousand five hundred dollars (\$3,500) for each converted tract of property. (3-20-20)T

**c.** The administrative costs and the service fee will be deducted from the deposit. The sponsor will be reimbursed the remaining amount upon the successful completion of the conversion. Any incidental costs exceeding the deposit will be paid by the sponsor. (3-20-20)T

**651. -- 664. (RESERVED)**

**665. USER FEES, CHARGES AND INCOME.**

**01. User Fees.** User or other types of fees may be charged in connection with facilities developed with LWCF grants, provided that the fees and charges are commensurate with the value of recreation services or opportunities furnished and are in the prevailing range of public fees and charges for the particular activity involved. Discrimination on the basis of residence, including preferential reservation or membership systems and annual permit systems, is prohibited except to the extent that reasonable differences in admission and other fees may be maintained on the basis of residence. (3-20-20)T

**02. Nonrecreational User Fees.** Nonrecreational income that accrues to an outdoor recreation area other than the intended recreational use, including income from land management practices, must derive from use that is consistent with, and complementary to, the intended outdoor recreational use of the area. Gross nonrecreational income that accrues during the project period established in the project contract must be used to reduce the total cost of the project. Gross nonrecreational income that accrues subsequent to the ending date identified in the project contracts must be used only to offset the expense of operation and maintenance of the facility. (3-20-20)T

**666. -- 679. (RESERVED)**

**680. PERMANENT PROJECT SIGNS.**

Permanent public acknowledgment of LWCF assistance at project sites is required on at least one (1) prominently

placed area identification sign. The LWCF symbol established and provided by IDPR must be used for such acknowledgment at the project site entrance, or other appropriate locations. The sponsor may desire to provide a more detailed identification. IDPR staff must approve the sponsor's park sign prior to its construction to ensure proper designation is included. (3-20-20)T

**681. -- 694. (RESERVED)**

**695. ARCHITECTURAL BARRIERS.**

Sponsors in the LWCF programs must assure that persons with disabilities are not precluded from the use of LWCF assisted recreational facilities. (3-20-20)T

**696. -- 709. (RESERVED)**

**710. UNIFORM RELOCATION COMPLAINT PROCEDURE.**

The two (2) appeal procedure recommended by NPS are an appeal to the SLO and then to the board for resolution (see IDAPA 26.01.01, Section 250, "Rules of Administrative Procedure of the Idaho Park and Recreation Board"). (3-20-20)T

**711. -- 724. (RESERVED)**

**725. AVAILABILITY TO USERS.**

**01. Nondiscrimination.** Property must be open to entry and use by all persons regardless of race, color, or national origin. Discrimination is also prohibited on the basis of age, disability, religion or gender. (3-20-20)T

**02. Seasons and Hours.** Facilities must be kept open for public use at reasonable hours and times of the year based on intended use. (3-20-20)T

**726. -- 739. (RESERVED)**

**740. CIVIL RIGHTS COMPLAINT PROCEDURE.**

An opportunity is provided for filing civil rights complaints. A written complaint must be filed with the SLO within one hundred eighty (180) days from the date the alleged discrimination occurred. Within ten (10) working days of IDPR receiving the complaint, the complainant must be notified of action that has been or must be taken to resolve the complaint. An investigation must be conducted by the deputy director or his designee within thirty (30) working days of IDPR's receipt of the complaint. The SLO or SLO's designee must send a written response to the complainant regarding the results of the investigation within thirty (30) working days of the time the investigation began. If dissatisfied with the results of the investigation, the complainant may submit a written request for reconsideration to the SLO within ten (10) days of the receipt of resolution. The complainant may also file a complaint with the Idaho Human Rights Commission and The Office of Equal Opportunity. Addresses are available from IDPR. (3-20-20)T

**741. -- 999. (RESERVED)**

# IDAPA 27 – IDAHO BOARD OF PHARMACY

## DOCKET NO. 27-0101-2000F (FEE RULE)

### NOTICE OF OMNIBUS RULEMAKING – ADOPTION OF TEMPORARY RULE

**EFFECTIVE DATE:** The effective date of the temporary rule being adopted through this omnibus rulemaking is the adjournment date of the second regular session of the 65th Idaho State Legislature - March 20, 2020.

**AUTHORITY:** In compliance with Sections 67-5226, Idaho Code, notice is hereby given this agency has adopted a temporary rule. The action is authorized pursuant to Section(s) Uniform Controlled Substances Act, Title 37, Chapter 27, Idaho Code; the Idaho Pharmacy Act, the Idaho Wholesale Drug Distribution Act, and the Idaho Legend Drug Donation Act, Title 54, Chapter 17, Idaho Code.

**DESCRIPTIVE SUMMARY:** The following is the required finding and concise statement of its supporting reasons for adopting a temporary rule:

This temporary rulemaking adopts the following chapter under IDAPA 27:

#### IDAPA 27

- 27.01.01, *Rules of the Idaho State Board of Pharmacy*

**TEMPORARY RULE JUSTIFICATION:** Pursuant to Sections 67-5226(1) and 67-5226(2), Idaho Code, the Governor has found that temporary adoption of the rule is appropriate for the following reasons:

These temporary rules are necessary to protect the public health, safety, and welfare of the citizens of Idaho and confer a benefit on its citizens. These temporary rules implement the duly enacted laws of the state of Idaho, provide citizens with the detailed rules and standards for complying with those laws, and assist in the orderly execution and enforcement of those laws. The expiration of these rules without due consideration and processes would undermine the public health, safety, and welfare of the citizens of Idaho and deprive them of the benefit intended by these rules. This docket also incorporates minor rule changes related to the COVID-19 response adopted in an open meeting.

**FEE SUMMARY:** Pursuant to Section 67-5226(2), the Governor has found that the fee(s) or charge(s) being imposed or increased is justified and necessary to avoid immediate danger and the fee(s) is described herein:

The fees or charges, authorized in Section 54-1701, Idaho Code, Idaho Code, are part of the agency's 2021 budget that relies upon the existence of these fees or charges to meet the state's obligations and provide necessary state services. Failing to reauthorize these temporary rules would create immediate danger to the state budget, immediate danger to necessary state functions and services, and immediate danger of a violation of Idaho's constitutional requirement that it balance its budget.

The following is a specific description of the fees or charges:

Fee Schedule:

- Licenses and Registrations -- Professionals.

License/Registration	Initial Fee	Annual Renewal Fee
Pharmacist License	\$140	\$130
Nonresident PIC Registration	\$290	\$290
Pharmacist Intern	\$50	\$50
Technician	\$35	\$35
Practitioner Controlled Substance Registration	\$60	\$60

- Certificates of Registration and Licensure -- Facilities.

<b>License/Registration</b>	<b>Initial Fee</b>	<b>Annual Renewal Fee</b>
Drug Outlet (unless otherwise listed)	\$100	\$100
Wholesale License	\$180	\$180
Wholesale Registration	\$150	\$150
Central Drug Outlet (Nonresident)	\$500	\$250
Mail Service Pharmacy	\$500	\$250
Durable Medical Equipment Outlet	\$50	\$50
Outsourcing Facility (Nonresident)	\$500	\$250
Manufacturer	\$150	\$150
Veterinary Drug Outlet	\$35	\$35

- Late Fees and Reinstatements.

<b>Category</b>	<b>Fee</b>
Late payment processing fee	\$50
License or registration reinstatement fee	One-half (1/2) of the amount of the annual renewal

- Administrative Services.

<b>Category</b>	<b>Fee</b>
Experiential hours certification	\$25
Duplicate pharmacist certificate of licensure	\$35

**ASSISTANCE ON TECHNICAL QUESTIONS:** For assistance on technical questions concerning the temporary rule, contact Nicki Chopski at 208-334-2356.

Dated this 14th day of February, 2020.

Nicki Chopski  
Executive Director  
Idaho Board of Pharmacy  
1199 W Shoreline Lane, Suite 303  
Boise, ID 83702-9103  
Phone 208-334-2356  
Fax 208-334-3536

# IDAPA 27 – BOARD OF PHARMACY

## 27.01.01 – RULES OF THE IDAHO STATE BOARD OF PHARMACY

### 000. LEGAL AUTHORITY.

This chapter is adopted under the legal authority of the Uniform Controlled Substances Act, Title 37, Chapter 27, Idaho Code; the Idaho Pharmacy Act, the Idaho Wholesale Drug Distribution Act, and the Idaho Legend Drug Donation Act, Title 54, Chapter 17, Idaho Code; and specifically pursuant to Sections 37-2702, 37-2715, 54-1717, 54-1753, and 54-1755, Idaho Code. (3-20-20)T

### 001. TITLE AND SCOPE.

**01. Title.** The title of this chapter is “Rules of the Idaho State Board of Pharmacy,” IDAPA 27, Title 01, Chapter 01. (3-20-20)T

**02. Scope.** The scope of this chapter includes, but is not limited to, provision for, and clarification of, the Board’s assigned responsibility to: (3-20-20)T

**a.** Regulate and control the manufacture, distribution, and dispensing of controlled substances within or into the state, pursuant to the Uniform Controlled Substances Act, Section 37-2715, Idaho Code; and (3-20-20)T

**b.** Regulate and control the practice of pharmacy, pursuant to the Idaho Pharmacy Act, Title 54, Chapter 17, Idaho Code. (3-20-20)T

### 002. – 009. (RESERVED)

### 010. DEFINITIONS AND ABBREVIATIONS (A – N).

The definitions set forth in Sections 54-1705 and 37-2701, Idaho Code, are applicable to these rules. (3-20-20)T

**01. ACCME.** Accreditation Council for Continuing Medical Education. (3-20-20)T

**02. Accredited School or College of Pharmacy.** A school or college that meets the minimum standards of the ACPE and appears on its list of accredited schools or colleges of pharmacy. (3-20-20)T

**03. ACPE.** Accreditation Council for Pharmacy Education. (3-20-20)T

**04. ADS – Automated Dispensing and Storage.** A mechanical system that performs operations or activities, other than compounding or administration, relative to the storage, packaging, dispensing, or distribution of drugs and that collects, controls, and maintains transaction information. (3-20-20)T

**05. Change of Ownership.** A change of majority ownership or controlling interest of a drug outlet licensed or registered by the Board. (3-20-20)T

**06. CME.** Continuing medical education. (3-20-20)T

**07. Collaborative Pharmacy Practice.** A pharmacy practice whereby one (1) or more pharmacists or pharmacies jointly agree to work under a protocol authorized by one (1) or more prescribers to provide patient care and DTM services not otherwise permitted to be performed by a pharmacist under specified conditions or limitations. (3-20-20)T

**08. CPE.** Continuing pharmacy education. (3-20-20)T

**09. CPE Monitor.** An NABP service that allows pharmacists to electronically keep track of CPE credits from ACPE-accredited providers. (3-20-20)T

**10. DEA.** United States Drug Enforcement Administration. (3-20-20)T

**11. Distributor.** A supplier of drugs manufactured, produced, or prepared by others to persons other than the ultimate consumer. (3-20-20)T

**12. DME Outlet.** A registered outlet that may hold for sale at retail durable medical equipment (DME)

and the following prescription drugs: pure oxygen for human application, nitrous oxide, sterile sodium chloride, and sterile water for injection. (3-20-20)T

**13. DTM – Drug Therapy Management.** Selecting, initiating, or modifying drug treatment pursuant to a collaborative pharmacy practice agreement. (3-20-20)T

**14. FDA.** United States Food and Drug Administration. (3-20-20)T

**15. Flavoring Agent.** An additive in food or drugs in the minimum quantity necessary to produce its intended effect. (3-20-20)T

**16. Floor Stock.** Drugs or devices not labeled for a specific patient that are maintained at a nursing station or other department of an institutional facility, excluding the pharmacy, for the purpose of administering to patients of the facility. (3-20-20)T

**17. FPGEC Certification.** Foreign Pharmacy Graduate Examination Committee Certification. (3-20-20)T

**18. Hazardous Drug.** Any drug listed as such by the National Institute for Occupational Safety and Health or any drug identified by at least one (1) of the following criteria: carcinogenicity; teratogenicity or developmental toxicity; reproductive toxicity in humans; organ toxicity at low doses in humans or animals; genotoxicity; or new drugs that mimic existing hazardous drugs in structure or toxicity. (3-20-20)T

**19. HIPAA.** Health Insurance Portability and Accountability Act of 1996 (Public Law 104-191). (3-20-20)T

**20. Limited Service Outlet.** Limited service outlets include, but are not limited to, sterile product pharmacies, remote dispensing pharmacies, facilities operating narcotic treatment programs, DME outlets, prescriber drug outlets, outsourcing facilities, nuclear pharmacies, cognitive service pharmacies, correctional facilities, offsite ADSs for non-emergency dispensing, reverse distributors, mobile pharmacies, and analytical or research laboratories. (3-20-20)T

**21. NABP.** National Association of Boards of Pharmacy. (3-20-20)T

**22. NAPLEX.** North American Pharmacists Licensure Examination. (3-20-20)T

**23. NDC.** National Drug Code. (3-20-20)T

**011. DEFINITIONS AND ABBREVIATIONS (O – Z).**

The definitions set forth in Sections 54-1705 and 37-2701, Idaho Code, are applicable to these rules. In addition, the following terms have the meanings set forth below: (3-20-20)T

**01. Parenteral Admixture.** The preparation and labeling of sterile products intended for administration by injection. (3-20-20)T

**02. Pharmaceutical Care Services.** A broad range of pharmacist-provided cognitive services, activities and responsibilities intended to optimize drug-related therapeutic outcomes for patients. Pharmaceutical care services may be performed independent of, or concurrently with, the dispensing or administration of a drug or device and also encompasses services provided by way of DTM under a collaborative practice agreement. Pharmaceutical care services are not limited to, but may include one (1) or more of the following: (3-20-20)T

**a.** Performing or obtaining necessary assessments of the patient’s health status, including the performance of health screening activities that may include, but are not limited to, obtaining finger-stick blood samples; (3-20-20)T

**b.** Reviewing, analyzing, evaluating, formulating or providing a drug utilization plan; (3-20-20)T



- c.** Monitoring and evaluating the patient’s response to drug therapy, including safety and effectiveness; (3-20-20)T
- d.** Providing counseling education, information, support services, and resources applicable to a drug, disease state, or a related condition or designed to enhance patient compliance with therapeutic regimens; (3-20-20)T
- e.** Coordinating and integrating pharmaceutical care services within the broader health care management services being provided to the patient; and (3-20-20)T
- f.** Ordering and interpreting laboratory tests. (3-20-20)T
- g.** Performing drug product selection or substitution as provided in these rules. (3-20-20)T
- 03. PDMP.** Prescription Drug Monitoring Program. (3-20-20)T
- 04. Prepackaging.** The act of transferring a drug, manually or using an automated system, from a manufacturer’s original container to another container prior to receiving a prescription drug order. (3-20-20)T
- 05. Prescriber.** An individual currently licensed, registered, or otherwise authorized to prescribe and administer drugs in the course of professional practice. (3-20-20)T
- 06. Purple Book.** The list of licensed biological products with reference product exclusivity and biosimilarity or interchangeability evaluations published by the FDA under the Public Health Service Act. (3-20-20)T
- 07. Readily Retrievable.** Records are considered readily retrievable if they are able to be completely and legibly produced upon request within seventy-two (72) hours. (3-20-20)T
- 08. Reconstitution.** The process of adding a diluent to a powdered medication to prepare a solution or suspension, according to the product’s labeling or the manufacturer’s instructions. (3-20-20)T
- 09. Restricted Drug Storage Area.** The area of a drug outlet where prescription drugs are prepared, compounded, distributed, dispensed, or stored. (3-20-20)T
- 10. Technician.** A term to indicate an individual authorized by registration with the Board to perform pharmacy support services under the direction of a pharmacist. (3-20-20)T
- 11. Therapeutic Equivalent Drugs.** Products assigned an “A” code by the FDA in the Approved Drug Products with Therapeutic Equivalence Evaluations (Orange Book) and animal drug products published in the FDA Approved Animal Drug Products (Green Book). (3-20-20)T
- 12. USP.** United States Pharmacopeia. (3-20-20)T
- 13. USP-NF.** United State Pharmacopeia-National Formulary. (3-20-20)T
- 14. VAWD – Verified Accredited Wholesale Distributor.** An accreditation program for wholesale distributors offered through NABP. (3-20-20)T
- 012. – 099. (RESERVED)**

**SUBCHAPTER A – GENERAL PROVISIONS**  
**(Rules 100 through 199 – Standard Provisions)**

**100. PRACTICE OF PHARMACY: GENERAL APPROACH.**

To evaluate whether a specific act is within the scope of pharmacy practice in or into Idaho, or whether an act can be delegated to other individuals under their supervision, a licensee or registrant of the Board must independently determine whether: (3-20-20)T

- 01. Express Prohibition.** The act is expressly prohibited by: (3-20-20)T
- a.** The Idaho Pharmacy Act, Title 54, Chapter 17, Idaho Code; (3-20-20)T
  - b.** The Uniform Controlled Substances Act, Title 37, Chapter 27, Idaho Code; (3-20-20)T
  - c.** The rules of the Idaho State Board of Pharmacy; or (3-20-20)T
  - d.** Any other applicable state or federal laws, rules or regulations. (3-20-20)T
- 02. Education, Training, and Experience.** The act is consistent with licensee or registrant's education, training, and experience. (3-20-20)T
- 03. Standard of Care.** Performance of the act is within the accepted standard of care that would be provided in a similar setting by a reasonable and prudent licensee or registrant with similar education, training and experience. (3-20-20)T

**101. PRESCRIBER PERFORMANCE OF PHARMACY FUNCTIONS.**

For the purposes of this chapter, any function that a pharmacist may perform may similarly be performed by an Idaho prescriber or may be delegated by an Idaho prescriber to appropriate support personnel, in accordance with the prescriber's practice act. (3-20-20)T

**102. WAIVERS OR VARIANCES.**

- 01. Criteria.** The board may grant or deny, in whole or in part, a waiver of, or variance from, specified rules if the granting of the waiver or variance is consistent with the Board's mandate to promote, preserve and protect public health, safety and welfare. (3-20-20)T
- 02. Emergency Waiver.** In the event of an emergency declared by the President of the United States, the Governor of the State of Idaho, or by any other person with legal authority to declare an emergency, the Executive Director of the Board may waive any requirement of these rules for the duration of the emergency. (3-20-20)T
- 03. Emergency Rulemaking Authority.** In the event of an emergency declared by the President of the United States or the Governor of the State of Idaho, or by any other person with legal authority to declare an emergency, and in response to the COVID-19 pandemic, the Executive Director of the Board may adopt temporary rules for the duration of the emergency. (3-20-20)T

**103. BOARD INSPECTIONS AND INVESTIGATIONS.**

- 01. Records Subject to Board Inspection.** Records created, maintained, or retained by Board licensees or registrants in compliance with statutes or rules enforced by the Board must be made available for inspection upon request by Board inspectors or authorized agents. It is unlawful to refuse to permit or to obstruct a Board inspection. (3-20-20)T
- 02. Inspections.** Prior to the commencement of business, as applicable, and thereafter at regular intervals, registrants and licensees must permit the Board or its compliance officers to enter and inspect the premises and to audit the records of each drug outlet for compliance with laws enforced by or under the Board's jurisdiction. (3-20-20)T
- 03. Inspection Deficiencies.** Deficiencies noted must be promptly remedied, and if requested, the Board office notified of corrective measures. One (1) follow-up inspection may be performed by the Board at no cost. For additional follow-up inspections, the drug outlet will be charged actual travel and personnel costs incurred in the inspection to be paid within ninety (90) days of inspection. (3-20-20)T
- 04. Inspection Reports.** Inspection reports must be reviewed with the Board inspector and signed by an agent of the drug outlet upon completion of the exit interview. (3-20-20)T

**05. Investigations.** Licensees or registrants must fully cooperate with Board investigations conducted to confirm compliance with laws enforced by the Board, to gather information pertinent to a complaint received by the Board, or to enforce disciplinary actions. (3-20-20)T

**104. UNPROFESSIONAL CONDUCT.**

The following acts or practices by any licensee or registrant are declared to be specifically, but not by way of limitation, unprofessional conduct and conduct contrary to the public interest. (3-20-20)T

**01. Unethical Conduct.** Conduct in the practice of pharmacy or in the operation of a pharmacy that may reduce the public confidence in the ability and integrity of the profession of pharmacy or endangers the public health, safety, and welfare. A violation of this section includes committing fraud, misrepresentation, negligence, concealment, or being involved in dishonest dealings, price fixing, or breaching the public trust with respect to the practice of pharmacy. (3-20-20)T

**02. Lack of Fitness.** A lack of fitness for professional practice due to incompetency, personal habits, drug or alcohol dependence, physical or mental illness, or for any other cause that endangers public health, safety, or welfare. (3-20-20)T

**03. On-Duty Intoxication or Impairment.** Intoxication, impairment, or consumption of alcohol or drugs while on duty, including break periods after which the individual is expected to return to work, or prior to reporting to work. (3-20-20)T

**04. Diversion of Drug Products and Devices.** Supplying or diverting drugs, biologicals, and other medicines, substances, or devices legally sold in pharmacies that allows the circumvention of laws pertaining to the legal sale of these articles. (3-20-20)T

**05. Unlawful Possession or Use of Drugs.** Possessing or using a controlled substance without a lawful prescription drug order. A failed drug test creates a rebuttable presumption of a violation of this rule. (3-20-20)T

**06. Prescription Drug Order Noncompliance.** Failing to follow the instructions of the person writing, making, or ordering a prescription as to its refills, contents, or labeling except as provided in these rules. (3-20-20)T

**07. Failure to Confer.** Failure to confer with the prescriber when necessary or appropriate or filling a prescription if necessary components of the prescription drug order are missing or questionable. (3-20-20)T

**08. Excessive Provision of Controlled Substances.** Providing an excessive amount of controlled substances. Evidentiary factors of a clearly excessive amount include, but are not limited to, the amount of controlled substances furnished and previous ordering patterns (including size and frequency of orders). (3-20-20)T

**09. Failure to Counsel or Offer Counseling.** Failing to counsel or offer counseling, unless specifically exempted or refused. (3-20-20)T

**10. Substandard, Misbranded, Adulterated, or Expired Products.** Manufacturing, compounding, delivering, distributing, dispensing, or permitting to be manufactured, compounded, delivered, distributed or dispensed substandard, misbranded, or adulterated drugs or preparations or those made using secret formulas. Failing to remove expired drugs from stock. (3-20-20)T

**11. Prescriber Incentives.** Allowing a commission or rebate to be paid, or personally paying a commission or rebate, to a person writing, making, or otherwise ordering a prescription. (3-20-20)T

**12. Exclusive Arrangements.** Participation in a plan or agreement that compromises the quality or extent of professional services or limits access to provider facilities at the expense of public health or welfare. (3-20-20)T

**13. Failure to Report.** Failing to report to the Board any violation of statutes or rules pertaining to the

practice of pharmacy or any act that endangers the health, safety, or welfare of patients or the public. (3-20-20)T

**14. Failure to Follow Board Order.** Failure to follow an order of the Board. (3-20-20)T

**15. Use of False Information.** Knowingly using false information in connection with the prescribing, delivering, administering, or dispensing of a controlled substance or other drug product. (3-20-20)T

**16. Standard of Care.** Acts or omissions within the practice of pharmacy which fail to meet the standard provided by other qualified licensees or registrants in the same or similar setting. (3-20-20)T

**17. Unnecessary Services or Products.** Directly promoting or inducing for the provisions of health care services or products that are unnecessary or not medically indicated. (3-20-20)T

**18. Controlled Substance Non-Compliance.** Violating provisions of the federal Controlled Substances Act or Title 37, Chapter 27, Idaho Code. (3-20-20)T

**105. – 199. (RESERVED)**

**SUBCHAPTER B – RULES GOVERNING LICENSURE AND REGISTRATION**  
**(Rules 200 through 299 – Standard Provisions)**

**200. BOARD OF PHARMACY LICENSURE AND REGISTRATION.**

The Board will issue or renew a license or certificate of registration upon application and determination that the applicant has satisfied the requirements of applicable statutes, and any additional criteria specified by these rules. Licenses or registrations must be obtained prior to engaging in these practices or their supportive functions. (3-20-20)T

**201. LICENSURE AND REGISTRATION: GENERAL REQUIREMENTS.**

**01. Board Forms.** Initial licensure and registration applications, annual renewal applications, and other forms used for licensure, registration, or other purposes must be in such form as designated by the Board. (3-20-20)T

**02. Incomplete Applications.** Information requested on the application or other form must be provided and submitted to the Board office with the applicable fee or the submission will be considered incomplete and will not be processed. Applications that remain incomplete after six (6) months from the date of initial submission will expire. (3-20-20)T

**03. On-Time Annual Renewal Application.** Licenses and registrations must be renewed annually prior to expiration to remain valid. Timely submission of the renewal application is the responsibility of each licensee or registrant. Licenses and certificates of registration issued to individuals will expire annually on the last day of the individual's birth month, and on December 31 for facilities, unless an alternate expiration term or date is stated in these rules. (3-20-20)T

**04. Late Renewal Application.** Failure to submit a renewal application prior to the expiration date will cause the license or registration to lapse and will result in the assessment of a late fee and possible disciplinary action. A lapsed license or registration is invalid until renewal is approved by the Board and if not renewed within thirty (30) days after its expiration will require reinstatement. (3-20-20)T

**05. Exemption.** New licenses and registrations issued ten (10) weeks or less prior to the renewal due date are exempt from the renewal requirements that year only. (3-20-20)T

**06. Cancellation and Registration.** Failure to maintain the requirements for any registration will result in the cancellation of the registration. (3-20-20)T

**07. Reinstatement of License or Registration.** Unless otherwise specified in Board rule, consideration of a request for reinstatement of a license or registration will require a completed application on a

Board form, submission of a completed fingerprint card, as applicable, and payment of any applicable fees due or delinquent at the time reinstatement is requested. (3-20-20)T

**08. Parent or Legal Guardian Consent.** No person under the age of eighteen (18), unless an emancipated minor, may submit an application for licensure or registration without first providing the Board with written consent from a parent or legal guardian. (3-20-20)T

**202. BOARD FEES.**

**01. Fee Determination and Collection.** Pursuant to the authority and limitations established by Sections 37-2715 and 54-1720(5)(a), Idaho Code, the Board has determined and will collect fees for the issuance, annual renewal, or reinstatement of licenses and certificates of registration to persons and drug outlets engaged in acts or practices regulated by the Board. (3-20-20)T

**02. Time and Method of Payment.** Fees are due at the time of application, submission, or request. Fees are payable to the “Idaho State Board of Pharmacy,” are non-refundable, and will not be prorated. (3-20-20)T

**03. Fee for Dishonored Payment.** A reasonable administrative fee may be charged for a dishonored check or other form of payment. If a license or registration application has been approved or renewed by the Board and payment is subsequently dishonored, the approval or renewal is immediately canceled on the basis of the submission of an incomplete application. The board may require subsequent payments to be made by cashier’s check, money order, or other form of guaranteed funds. (3-20-20)T

**04. Overpayment of Fees.** “Overpayment” refers to the payment of any fee in excess of the listed amount. Refunds issued will be reduced by a reasonable processing fee. (3-20-20)T

**05. Fee Exemption for Controlled Substance Registrations.** Persons exempt pursuant to federal law from fee requirements applicable to controlled substance registrations issued by the DEA are also exempt from fees applicable to controlled substance registrations issued by the Board. (3-20-20)T

**203. FEE SCHEDULE.**

**01. Licenses and Registrations -- Professionals.**

License/Registration	Initial Fee	Annual Renewal Fee
Pharmacist License	\$140	\$130
Nonresident PIC Registration	\$290	\$290
Pharmacist Intern	\$50	\$50
Technician	\$35	\$35
Practitioner Controlled Substance Registration	\$60	\$60

(3-20-20)T

**02. Certificates of Registration and Licensure -- Facilities.**

License/Registration	Initial Fee	Annual Renewal Fee
Drug Outlet (unless otherwise listed)	\$100	\$100
Wholesale License	\$180	\$180
Wholesale Registration	\$150	\$150
Central Drug Outlet (Nonresident)	\$500	\$250

License/Registration	Initial Fee	Annual Renewal Fee
Mail Service Pharmacy	\$500	\$250
Durable Medical Equipment Outlet	\$50	\$50
Outsourcing Facility (Nonresident)	\$500	\$250
Manufacturer	\$150	\$150
Veterinary Drug Outlet	\$35	\$35

(3-20-20)T

**03. Late Fees and Reinstatements.**

Category	Fee
Late payment processing fee	\$50
License or registration reinstatement fee	One-half (1/2) of the amount of the annual renewal

(3-20-20)T

**04. Administrative Services.**

Category	Fee
Experiential hours certification	\$25
Duplicate pharmacist certificate of licensure	\$35

(3-20-20)T

**204. – 209. (RESERVED)**

**210. DETERMINATION OF NEED FOR NONRESIDENT LICENSURE OR REGISTRATION.**

**01. Independent Practice.** Nonresident pharmacists must be licensed if engaged in the independent practice of pharmacy across state lines and not practicing for an Idaho registered drug outlet. (3-20-20)T

**02. Practice for an Idaho Registered Drug Outlet.** A nonresident pharmacist serving as the PIC for an Idaho registered nonresident drug outlet must be registered to practice into Idaho. All other nonresident pharmacists who are employed by, or affiliated with, and practicing for the Idaho registered nonresident drug outlet, but who are not the PIC, are exempt from license and registration requirements for practice into Idaho. (3-20-20)T

**03. Multistate Pharmacists.** Multistate pharmacists, as defined in Section 54-1723B, Idaho Code, are exempt from separate licensure or registration in Idaho. (3-20-20)T

**04. Exemption from Separate Controlled Substance Registration.** All pharmacists who are practicing in or into Idaho are exempt from obtaining a separate controlled substance registration, but are subject to compliance with all requirements under Title 37, Chapter 27, Idaho Code. (3-20-20)T

**211. PHARMACIST LICENSURE BY EXAMINATION.**

To be considered for licensure, a person must satisfy the requirements of Section 54-1722(1)(a) through (e), Idaho Code, submit to the Board an application for licensure by examination, and meet the following: (3-20-20)T

**01. Graduates of U.S. Pharmacy Schools.** Graduate from an ACPE-accredited school or college of pharmacy within the United States. (3-20-20)T

**02. Graduates of Foreign Pharmacy Schools.** Graduate from a school or college of pharmacy located outside of the United States, submit certification by the FPGEC, and complete a minimum of seventeen hundred forty (1,740) experiential hours as verified on an employer's affidavit signed by a pharmacist licensed and practicing in the United States. The Board may request verifiable business records to document the hours. (3-20-20)T

**03. Licensure Examinations.** Qualified applicants must pass the NAPLEX in accordance with NABP standards. A candidate who fails the NAPLEX three (3) times must complete at least thirty (30) hours of continuing education accredited by an ACPE-accredited provider prior to being eligible to sit for each subsequent reexamination. Candidates are limited to five (5) total NAPLEX attempts. (3-20-20)T

**212. PHARMACIST LICENSURE BY RECIPROCITY.**

An applicant for pharmacist licensure by reciprocity must satisfy the requirements of Section 54-1723, Idaho Code, and submit a preliminary application for licensure transfer through NABP. An applicant whose pharmacist license is currently restricted by a licensing entity in another state must appear before the Board to petition for licensure by reciprocity. An applicant not actively engaged in the practice of pharmacy during the year preceding the date of application may have to complete intern hours for each year away from the practice of pharmacy. (3-20-20)T

**213. PHARMACIST LICENSE RENEWAL: CPE REQUIREMENTS.**

Each pharmacist applicant for license renewal must complete fifteen (15) CPE hours each calendar year between January 1 and December 31. (3-20-20)T

**01. ACPE.** At least twelve (12) of the CPE hours obtained must be from programs by an ACPE that have a participant designation of "P" (for pharmacist) as the suffix of the ACPE universal program number. ACPE credits must be reported to and documented in CPE Monitor in order to be accepted. (3-20-20)T

**02. CME.** A maximum of three (3) of the hours may be obtained from CME, if the credits are: (3-20-20)T

**a.** Obtained from an ACCME accredited provider; and (3-20-20)T

**b.** A certificate is furnished that identifies the name of the ACCME accredited provider and a clear reference to its accreditation status, the title of the CME program, the completed hours of instruction, the date of completion, and the name of the individual obtaining the credit. Upon audit, all CME certificates must be submitted to the Board. (3-20-20)T

**03. Alternative to CPE.** If audited, a pharmacist may substitute a current certification by a nationally accredited pharmacy practice-specific specialty certification program. (3-20-20)T

**214. PHARMACIST LICENSE: REINSTATEMENT.**

The Board may, at its discretion, consider reinstatement of a pharmacist license upon receipt of a completed application, background check, and payment of the reinstatement and other fees due or delinquent at the time reinstatement is requested. (3-20-20)T

**01. Satisfactory Evidence.** Reinstatement applicants must provide satisfactory evidence of completion of a minimum of thirty (30) CPE hours within the twenty-four (24) months prior to reinstatement and compliance with any direct orders of the Board. (3-20-20)T

**02. Additional Requirements.** A pharmacist reinstatement applicant may be required to appear before the Board. The Board may also, at its discretion, impose additional requirements on a pharmacist reinstatement applicant who has not practiced as a pharmacist for the preceding twelve (12) months or longer that may include taking and passing an examination, completion of intern hours, completion of additional CPE hours, or other requirements determined necessary to acquire or demonstrate professional competency. (3-20-20)T

**215. NONRESIDENT PIC REGISTRATION TO PRACTICE PHARMACY INTO IDAHO.**

To be registered as a nonresident PIC, an applicant must submit an application on a Board form including, but not limited to: (3-20-20)T

**01. Individual License Information.** Current pharmacist licensure information in all other states, including each state of licensure and each license number; (3-20-20)T

**02. Facility License Information.** The license or registration number of the facility for which the applicant will be practicing. (3-20-20)T

**216. PHARMACIST INTERN REGISTRATION.**

**01. Registration Requirements.** To be approved for and maintain registration as a pharmacist intern, the applicant must: (3-20-20)T

**a.** Currently be enrolled and in good standing in an accredited school or college of pharmacy, pursuing a professional degree in pharmacy; or (3-20-20)T

**b.** Be a graduate of an accredited school or college of pharmacy within the United States and awaiting examination for pharmacist licensure; or (3-20-20)T

**c.** Be a graduate of a school or college of pharmacy located outside the United States, obtain certification by the FPGEC, and be awaiting finalization of pharmacist licensure. (3-20-20)T

**02. Renewal.** (3-20-20)T

**a.** Current Students. A pharmacist intern registration must be renewed annually by July 15; however, the renewal fee will be waived, if renewed on time, for the duration of the student's enrollment in the school or college of pharmacy. Following graduation, if a pharmacist license application has been submitted, the pharmacist intern license will be extended at no cost for up to six (6) additional months from the date of application as a pharmacist, after which time the individual will need to submit a new application to continue to be a pharmacist intern. (3-20-20)T

**b.** Pharmacy Graduates. A graduate pharmacist intern registration may be obtained and renewed once within one (1) year from the date of issuance. The Board may, at its discretion, grant additional time to complete internship experience if unique circumstances present. (3-20-20)T

**217. – 219. (RESERVED)**

**220. TECHNICIAN REGISTRATION.**

**01. Registration Requirements.** A person may apply for registration as a technician if the person satisfies the following requirements: (3-20-20)T

**a.** Age. Be at least sixteen (16) years of age; (3-20-20)T

**b.** Education. Be a high school graduate or the recipient of a high school equivalency diploma or currently enrolled and in good standing in a high school or college supervised program. (3-20-20)T

**c.** Exemption from Criminal Background Check. Technician candidates under the age of eighteen (18) are exempt from the fingerprint-based criminal history check requirement of Idaho Code. (3-20-20)T

**02. Certified Technician Registration.**

To be approved for registration as a certified technician, a person must have obtained and maintained certified pharmacy technician (CPhT) status through the Pharmacy Technician Certification Board (PTCB), the National Healthcareer Association (NHA), or their successors. (3-20-20)T

**221. – 223. (RESERVED)**

**224. PRACTITIONER CONTROLLED SUBSTANCE REGISTRATION.**

Any practitioner in Idaho who intends to prescribe, administer, dispense, or conduct research with a controlled



substance must first obtain an Idaho practitioner controlled substance registration and: (3-20-20)T

**01. State License.** Hold a valid license or registration to prescribe medications from a licensing entity established under Title 54, Idaho Code. (3-20-20)T

**02. DEA Registration.** Hold a valid federal DEA registration, if required under federal law. (3-20-20)T

**225. – 229. (RESERVED)**

**230. DRUG OUTLET LICENSURE AND REGISTRATION: GENERAL REQUIREMENTS.**

A license or a certificate of registration is required for drug outlets prior to doing business in or into Idaho. A license or certificate of registration will be issued by the Board to drug outlets pursuant to, and in the general classifications defined by, Section 54-1729, Idaho Code. (3-20-20)T

**01. New Drug Outlet Inspections.** Following the issuance of a new license or registration, each drug outlet will be inspected to confirm that the facility is compliant with applicable law. A change of ownership of a currently registered pharmacy will not require an onsite inspection of a new pharmacy registration unless a change of location occurs. (3-20-20)T

**02. License and Registration Transferability.** Drug outlet licenses and registrations are location and owner specific and are nontransferable as to person or place. (3-20-20)T

**03. Nonresident Drug Outlet.** The Board may license or register a drug outlet licensed or registered under the laws of another state if the other state's standards are comparable to those in Idaho and acceptable to the Board, evidenced by an inspection report. (3-20-20)T

**04. Change of Ownership or Location.** The registrant must notify the Board of a drug outlet's change of ownership or location at least ten (10) days prior to the event on a Board form, the completion of which shall be treated as an application for a new license or registration. When a licensee or registrant has made a timely and complete application for a new license or registration as stated in this rule, the existing license does not expire until the application has been finally determined by the Board, and, in case the application is denied or the terms of the new license limited, until the last day for seeking review of the Board order. This does not preclude the Board from taking immediate action to protect the public interest. (3-20-20)T

**05. Permanent Closing.** A registrant must notify the Board and the general public of the pharmacy's permanent closing at least ten (10) days prior to closing. The notice must include the proposed date of closure, and the new location of the prescription files. The notice to the board is to include the location where the closing inventory record of controlled substances is retained. (3-20-20)T

**06. Exemption from Separate Controlled Substance Registration.** All drug outlets doing business in or into Idaho who hold a valid license or registration from the Board are exempt from obtaining a separate controlled substance registration, but are subject to compliance with all requirements under Title 37, Chapter 27, Idaho Code. (3-20-20)T

**07. Sterile Preparation Endorsement.** A drug outlet engaged in sterile preparation must obtain a single endorsement for one (1) or more hood or aseptic environmental control devices. (3-20-20)T

**231. -- 239. (RESERVED)**

**240. WHOLESALER LICENSURE AND REGISTRATION.**

**01. Wholesaler Licensure.** In addition to the information provided in Section 54-1753, Idaho Code, the following information must be provided under oath by each applicant for wholesaler licensure as part of the initial licensing procedure and for each renewal on a Board form: (3-20-20)T

**a.** Any felony conviction or any conviction of the applicant relating to wholesale or retail prescription

drug distribution or distribution of controlled substances. (3-20-20)T

**b.** Any discipline of the applicant by a regulatory agency in any state for violating any law relating to wholesale or retail prescription drug distribution or distribution of controlled substances. (3-20-20)T

**02. VAWD Accreditation.** The Board will recognize a wholesaler's VAWD accreditation by NABP for purposes of reciprocity and satisfying the new drug outlet inspection requirements of these rules. (3-20-20)T

**03. Wholesaler Registration.** Except when licensed pursuant to the Idaho Wholesale Drug Distribution Act and these rules, a wholesaler that engages in wholesale distribution of DME supplies, prescription medical devices, or products that contain pseudoephedrine in or into Idaho must be registered by the Board. (3-20-20)T

**241. – 249. (RESERVED)**

**250. MANUFACTURER REGISTRATION.** Manufacturers must be registered as follows: (3-20-20)T

**01. Mail Service Pharmacy.** Those that ship, mail, or deliver dispensed prescription drugs or devices to an Idaho resident will be registered by the Board as a mail service pharmacy. (3-20-20)T

**02. Manufacturer.** Those engaged in wholesale distribution will be registered as a manufacturer and comply with the Idaho Wholesale Drug Distribution Act and rules, as applicable. (3-20-20)T

**251. – 299. (RESERVED)**

**SUBCHAPTER C – DRUG OUTLET PRACTICE STANDARDS**  
**(Rules 300 through 399 – Drug Outlet Practice Standards)**

**300. DRUG OUTLETS: MINIMUM FACILITY STANDARDS.** A resident drug outlet that dispenses prescription drugs to patients in Idaho must meet the following minimum requirements: (3-20-20)T

**01. Security and Privacy.** A drug outlet must be constructed and equipped with adequate security to protect its equipment, records and supply of drugs, devices and other restricted sale items from unauthorized access, acquisition or use. All protected health information must be stored and maintained in accordance with HIPAA. (3-20-20)T

**02. Controlled Substance Storage.** Drug outlets that dispense prescription drugs must store controlled substances in accordance with federal law. (3-20-20)T

**03. Authorized Access to the Restricted Drug Storage Area.** Access to the restricted drug storage area must be limited to authorized personnel. (3-20-20)T

**04. Staffing.** A drug outlet must be staffed sufficiently to allow for appropriate supervision, to otherwise operate safely and, if applicable, to remain open during the hours posted as open to the public for business. (3-20-20)T

**05. Electronic Recordkeeping System.** A drug outlet that dispenses more than twenty (20) prescriptions per day must use an electronic recordkeeping system to establish and store patient medication records and prescription drug order, refill, transfer information, and other information necessary to provide safe and appropriate patient care. The electronic recordkeeping system must have audit trail functionality that documents for each prescription drug order the identity of each individual involved at each step of its processing, filling, and dispensing or, alternatively, the identity of the pharmacist or prescriber responsible for the accuracy of these processes. (3-20-20)T

**301. DRUG OUTLETS THAT DISPENSE PRESCRIPTION DRUGS: MINIMUM PRESCRIPTION FILLING REQUIREMENTS.**

Unless exempted by these rules, each drug outlet that dispenses prescription drugs to patients in Idaho must meet the following minimum requirements either at the drug outlet or through offsite pharmacy services: (3-20-20)T

**01. Valid Prescription Drug Order.** Prescription drugs may only be dispensed pursuant to a valid prescription drug order as set forth in Subchapter E of these rules. (3-20-20)T

**02. Prospective Drug Review.** Prospective drug review must be provided. (3-20-20)T

**03. Labeling.** Each drug must bear a complete and accurate label as set forth in these rules. (3-20-20)T

**04. Verification of Dispensing Accuracy.** Verification of dispensing accuracy must be performed to compare the drug stock selected to the drug prescribed. If not performed by a pharmacist or prescriber, an electronic verification system must be used that confirms the drug stock selected to fill the prescription is the same as indicated on the prescription label. A compounded drug may only be verified by a pharmacist or prescriber. (3-20-20)T

**05. Patient Counseling.** Counseling must be provided. (3-20-20)T

**302. DRUG OUTLETS THAT DISPENSE DRUGS TO PATIENTS WITHOUT AN ONSITE PHARMACIST OR PRESCRIBER.**

A drug outlet that dispenses drugs to patients in Idaho that does not have a pharmacist or prescriber onsite to perform or supervise pharmacy operations must comply with the following requirements: (3-20-20)T

**01. Security and Access.** (3-20-20)T

**a.** Maintain video surveillance with an adequate number of views of the full facility and retain a high quality recording for a minimum of ninety (90) days. (3-20-20)T

**b.** Utilize proper identification controls of individuals accessing the restricted drug storage area to ensure access is limited, authorized, and regularly monitored. (3-20-20)T

**02. Technology.** The video and audio communication system used to counsel and interact with each patient or patient's caregiver, must be clear, secure, and HIPAA-compliant. (3-20-20)T

**03. Controlled Substances Inventories.** (3-20-20)T

**a.** Keep a perpetual inventory for all Schedule II controlled substances; and (3-20-20)T

**b.** If a perpetual inventory is not kept for all Schedule III through V substances, the pharmacist or prescriber must inventory and audit at least three (3) random controlled substances quarterly. (3-20-20)T

**04. Self-Inspection.** Complete and retain a monthly in-person self-inspection of the drug outlet by a pharmacist or prescriber using a form designated by the Board. (3-20-20)T

**05. Technical Limitation Closure.** The drug outlet must be, or remain, closed to the public if any component of the surveillance or video and audio communication system is malfunctioning, until system corrections or repairs are completed. (3-20-20)T

**06. Exemption for Self-Service Systems.** A self-service ADS that is operating as a drug outlet is exempt from the video surveillance requirement and the self-inspection requirement of this rule. In addition, if counseling is provided by an onsite prescriber or pharmacist, a self-service ADS is exempt from the video and audio communication system requirements of this rule. (3-20-20)T

**07. Exemption for Veterinarians.** Veterinarians practicing in accordance with their Idaho practice act are exempt from this rule. (3-20-20)T

**303. DRUGS STORED OUTSIDE OF A DRUG OUTLET FOR RETRIEVAL BY A LICENSED HEALTH PROFESSIONAL.**

Drugs may be stored in an alternative designated area outside the drug outlet, including, but not limited to, floor stock, in an emergency cabinet, in an emergency kit, or as emergency outpatient drug delivery from an emergency room at a registered institutional facility, provided the following conditions are met: (3-20-20)T

**01. Supervising Drug Outlet.** Drugs stored in such a manner must remain under the control of, and be routinely monitored by, the supervising drug outlet. (3-20-20)T

**02. Secure Storage.** The area is appropriately equipped to ensure security and protection from diversion or tampering. (3-20-20)T

**03. Controlled Substances.** Controlled substances may only be stored in an alternative designated area as permitted by, and in accordance with, federal law. (3-20-20)T

**04. Stocking and Replenishing.** Stocking or replenishing drugs in an alternative designated area may be performed by a pharmacist or prescriber, or by appropriate support personnel using either an electronic verification system or a two (2) person checking system. (3-20-20)T

**304. – 349. (RESERVED)**

**SUBCHAPTER D – RULES GOVERNING PHARMACIST PRESCRIPTIVE AUTHORITY**  
**(Rules 350 through 399 – Rules Governing Pharmacist Prescriptive Authority)**

**350. PHARMACIST PRESCRIBING: GENERAL REQUIREMENTS.**

In accordance with Section 54-1704, Idaho Code, a pharmacist may independently prescribe drugs, drug categories and devices provided the following general requirements are met: (3-20-20)T

**01. Education.** The pharmacist may only prescribe drugs or devices for conditions for which the pharmacist is educationally prepared and for which competence has been achieved and maintained. (3-20-20)T

**02. Patient-Prescriber Relationship.** The pharmacist may only issue a prescription for a legitimate medical purpose arising from a patient-prescriber relationship as defined in Section 54-1733, Idaho Code. (3-20-20)T

**03. Patient Assessment.** The pharmacist must obtain adequate information about the patient's health status to make appropriate decisions based on the applicable standard of care and the best available evidence. (3-20-20)T

**04. Collaboration with Other Health Care Professionals.** The pharmacist must recognize the limits of the pharmacist's own knowledge and experience and consult with and refer to other health care professionals as appropriate. (3-20-20)T

**05. Follow-Up Care Plan.** The pharmacist must develop and implement an appropriate follow-up care plan, including any monitoring parameters, in accordance with clinical guidelines. (3-20-20)T

**06. Notification.** The pharmacist must inquire about the identity of the patient's primary care provider; and, if one is identified by the patient, provide notification within five (5) business days following the prescribing of a drug. In the instance in which the pharmacist is prescribing to close a gap in care or to supplement a valid prescription drug order, the pharmacist must alternatively notify the provider of record. (3-20-20)T

**07. Documentation.** The pharmacist must maintain documentation adequate to justify the care provided, including, but not limited to the information collected as part of the patient assessment, the prescription record, and the follow-up care plan. (3-20-20)T

**08. Prescribing Exemption.** The general requirements set forth in this section do not apply to collaborative pharmacy practice agreements, nonprescription drugs and devices, and the individually named drug products listed in Section 54-1704, Idaho Code. (3-20-20)T

**351. COLLABORATIVE PHARMACY PRACTICE.**

Collaborative pharmacy practice may be performed in accordance with an agreement that contains the following elements: (3-20-20)T

- 01. Identification.** Identification of the parties to the agreement; (3-20-20)T
- 02. Scope.** The pharmacist's scope of practice authorized by the agreement, including a description of the types of permitted activities and decisions; and (3-20-20)T
- 03. Monitoring.** A described method for a prescriber to monitor compliance with the agreement. (3-20-20)T

**352. -- 399. (RESERVED)**

**SUBCHAPTER E – FILLING AND DISPENSING PRESCRIPTION DRUGS**  
**(Rules 400 through 499 – Filling and Dispensing Prescription Drugs)**

**400. PRESCRIPTION DRUG ORDER: VALIDITY.**

Prior to filling or dispensing a prescription drug order, a pharmacist must verify its validity. (3-20-20)T

- 01. Invalid Prescription Drug Orders.** A prescription drug order is invalid if not issued by a licensed prescriber for a legitimate medical purpose, and within the course and scope of the prescriber's professional practice and prescriptive authority. (3-20-20)T
- 02. Antedating or Postdating.** A prescription drug order is invalid if antedated or postdated. (3-20-20)T
- 03. Tampering.** A prescription drug order is invalid if, at the time of presentation, it shows evidence of alteration, erasure, or addition by any person other than the person who wrote it. (3-20-20)T
- 04. Prescriber Self-Use.** A prescription drug order written for a controlled substance is invalid if written for the prescriber's own use. (3-20-20)T
- 05. Digital Image Prescriptions.** A digital image of a prescription drug order is invalid if it is for a controlled substance or if the patient intends to pay cash for the drug in whole. (3-20-20)T

**401. PRESCRIPTION DRUG ORDER: MINIMUM REQUIREMENTS.**

A prescription drug order must comply with applicable requirements of federal law and, except as differentiation is permitted for an institutional drug order, include at least the following: (3-20-20)T

- 01. Patient's Name.** The patient's or authorized entity's name and: (3-20-20)T
  - a.** If for a controlled substance, the patient's full name and address; and (3-20-20)T
  - b.** If for an animal, the species. (3-20-20)T
- 02. Date.** The date issued. (3-20-20)T
- 03. Drug Information.** The drug name, strength, and quantity. (3-20-20)T
- 04. Directions.** The directions for use. (3-20-20)T
- 05. Prescriber Information.** The name and, if for a controlled substance, the address and DEA registration number of the prescriber. (3-20-20)T
- 06. Signature.** A signature sufficient to evidence a valid prescription of either the prescriber or, if a

renewal of a previous prescription, the prescriber's agent, when authorized by the prescriber. (3-20-20)T

**07. Institutional Drug Order Exemptions.** An institutional drug order may exempt the patient's address, the dosage form, quantity, prescriber's address, and prescriber's DEA registration number. (3-20-20)T

**08. Exemptions for Non-Controlled Substances.** A prescriber may omit drug information and directions if the prescriber makes an indication for the pharmacist to finalize the patient's drug therapy plan. (3-20-20)T

#### **402. FILLING PRESCRIPTION DRUG ORDERS: PRACTICE LIMITATIONS.**

**01. Drug Product Selection.** Drug product selection is allowed only between therapeutic equivalent drugs. If a prescriber orders by any means that a brand name drug must be dispensed, then no drug product selection is permitted. (3-20-20)T

**02. Partial Filling.** A prescription drug order may be partially filled within the limits of federal law. The total quantity dispensed in partial fillings must not exceed the total quantity prescribed. (3-20-20)T

**03. Refill Authorization.** A prescription drug order may be refilled when permitted by state and federal law and as specifically authorized by the prescriber. A pharmacist may also refill a prescription for a non-controlled drug when the prescriber is not available for authorization. (3-20-20)T

#### **403. FILLING PRESCRIPTION DRUG ORDERS: ADAPTATION.**

Upon patient consent, a pharmacist may adapt drugs as specified in this rule, provided that the prescriber has not indicated that adaptation is not permitted. (3-20-20)T

**01. Change Quantity.** A pharmacist may change the quantity of medication prescribed if: (3-20-20)T

**a.** The prescribed quantity or package size is not commercially available; (3-20-20)T

**b.** The change in quantity is related to a change in dosage form or therapeutic interchange; (3-20-20)T

**c.** The change is intended to dispense up to the total amount authorized by the prescriber including refills; or (3-20-20)T

**d.** The change extends a maintenance drug for the limited quantity necessary to coordinate a patient's refills in a medication synchronization program. (3-20-20)T

**02. Change Dosage Form.** A pharmacist may change the dosage form of the prescription if it is in the best interest of patient care, so long as the prescriber's directions are also modified to equate to an equivalent amount of drug dispensed as prescribed. (3-20-20)T

**03. Complete Missing Information.** A pharmacist may complete missing information on a prescription if there is evidence to support the change. (3-20-20)T

**04. Documentation.** A pharmacist who adapts a prescription in accordance with these rules must document the adaptation in the patient's record. (3-20-20)T

#### **404. FILLING PRESCRIPTION DRUG ORDERS: DRUG PRODUCT SUBSTITUTION.**

Drug product substitutions in which a pharmacist dispenses a drug product other than that prescribed are allowed only as follows: (3-20-20)T

**01. Hospital.** Pursuant to a formulary or drug list prepared by the pharmacy and therapeutics committee of a hospital; (3-20-20)T

**02. Institutional Facility.** At the direction of the quality assessment and assurance committee of an institutional facility; (3-20-20)T

**03. Drug Shortage.** Upon a drug shortage, a pharmacist may substitute another drug for a prescribed drug, so long as the prescriber's directions are also modified to equate to an equivalent amount of the drug dispensed; (3-20-20)T

**04. Biosimilars.** A pharmacist may substitute an interchangeable biosimilar product for a prescribed biological product if: (3-20-20)T

**a.** The biosimilar has been determined by the FDA to be interchangeable and published in the Purple Book; (3-20-20)T

**b.** The prescriber does not indicate by any means that the prescribed biological product must be dispensed; and (3-20-20)T

**c.** The name of the drug and the manufacturer or the NDC number is documented in the patient medical record. (3-20-20)T

**05. Therapeutic Interchange.** A pharmacist may substitute a drug with another drug in the same therapeutic class provided the patient opts-in and the substitution lowers the cost to the patient or occurs during a drug shortage. (3-20-20)T

**405. FILLING PRESCRIPTION DRUG ORDERS: TRANSFERS.**

A prescription drug order may be transferred within the limits of federal law. Drug outlets using a common electronic file are exempt from transfer limits. (3-20-20)T

**406. LABELING STANDARDS.**

All prescription drugs must be in an appropriate container and bear information that identifies the drug product, any additional components as appropriate, and the individual responsible for its final preparation. (3-20-20)T

**01. Standard Prescription Drug.** A prescription drug for outpatient dispensing must be labeled in accordance with federal law. (3-20-20)T

**02. Parenteral Admixture.** If one (1) or more drugs are added to a parenteral admixture, the admixture's container must include the date and time of the addition, or alternatively, the beyond use date. (3-20-20)T

**03. Prepackaged Product.** The containers of prepackaged drugs must include an expiration date that is the lesser of the manufacturer's original expiration date, one (1) year from the date the drug is prepackaged, or a shorter period if warranted. (3-20-20)T

**04. Repackaged Drug.** If a previously dispensed drug is repackaged, it must contain the serial number and contact information for the original dispensing pharmacy, as well as a statement that indicates that the drug has been repackaged, and the contact information of the repackaging pharmacy. (3-20-20)T

**05. Distributed Compounded Drug Product.** Compounded and sterile prepackaged drug product distributed in the absence of a patient specific prescription must be labeled as follows: (3-20-20)T

**a.** If from a pharmacy, the statement: "not for further dispensing or distribution." (3-20-20)T

**b.** If from an outsourcing facility, the statement: "not for resale." (3-20-20)T

**407. PRESCRIPTION DELIVERY: RESTRICTIONS.**

**01. Acceptable Delivery.** A drug outlet that dispenses drugs to patients in Idaho may deliver filled prescriptions in accordance with federal law, as long as appropriate measures are taken to ensure product integrity and safety. (3-20-20)T

**02. Pick-up or Return by Authorized Personnel.** Filled prescriptions may be picked up for or

returned from delivery by authorized personnel from a secured delivery area. (3-20-20)T

**408. DESTRUCTION OR RETURN OF DRUGS OR DEVICES: RESTRICTIONS.**

A drug outlet registered with the DEA as a collector may collect controlled and non-controlled drugs for destruction in accordance with applicable federal law. Otherwise a dispensed drug or prescription device may only be accepted for return as follows: (3-20-20)T

**01. Potential Harm.** When the pharmacist determines that harm could result if the drug is not returned. (3-20-20)T

**02. Did Not Reach Patient.** Non-controlled drugs that have been maintained in the custody and control of the institutional facility, dispensing pharmacy, or their related clinical facilities may be returned if product integrity can be assured. Controlled substances may only be returned from a hospital daily delivery system under which a pharmacy dispenses no more than a seventy-two (72) hour supply for a drug order. (3-20-20)T

**03. Donation.** Those that qualify for return under the provisions of the Idaho Legend Drug Donation Act as specified in Section 54-1762, Idaho Code. (3-20-20)T

**409. -- 499. (RESERVED)**

**SUBCHAPTER F – REPORTING REQUIREMENTS AND DRUG OUTLET RECORDKEEPING**  
**(Rules 500 through 599 – Reporting Requirements and Drug Outlet Recordkeeping)**

**500. RECORDKEEPING: MAINTENANCE AND INVENTORY REQUIREMENTS.**

**01. Records Maintenance and Retention Requirement.** Unless an alternative standard is stated for a specified record type, form, or format, records required to evidence compliance with statutes or rules enforced by the Board must be maintained and retained in a readily retrievable form and location for at least three (3) years from the date of the transaction. (3-20-20)T

**02. Prescription Retention.** A prescription drug order must be retained in a readily retrievable manner by each drug outlet and maintained in accordance with federal law: (3-20-20)T

**03. Inventory Records.** Each drug outlet must maintain a current, complete and accurate record of each controlled substance manufactured, imported, received, ordered, sold, delivered, exported, dispensed or otherwise disposed of by the registrant. Drug outlets must maintain inventories and records in accordance with federal law. An annual inventory must be conducted at each registered location no later than seven (7) days after the date of the most recent inventory in a form and manner that satisfies the inventory requirements of federal law. Drugs stored outside a drug outlet in accordance with these rules must be regularly inventoried and inspected to ensure that they are properly stored, secured, and accounted for. Additional inventories are necessary when required by federal law. (3-20-20)T

**04. Rebuttal Presumption of Violation.** Evidence of an amount of a controlled substance that differs from the amount reflected on a record or inventory required by state or federal law creates a rebuttable presumption that the registrant has failed to keep records or maintain inventories in conformance with the recordkeeping and inventory requirements of state and federal law. (3-20-20)T

**05. Drug Distributor Records.** Wholesalers and other entities engaged in wholesale drug distribution must maintain inventories and records or transactions pertaining to the receipt and distribution or other disposition of drugs in accordance with federal law that include at least: (3-20-20)T

**a.** The source of the drugs, including the name and principal address of the seller or transferor, and the address of the location from which the drugs were shipped; (3-20-20)T

**b.** The identity and quantity of the drugs received and distributed or disposed of; (3-20-20)T

**c.** The dates of receipt and distribution or other disposition of the drugs; and (3-20-20)T



d. Controlled substance distribution invoices, in the form and including the requirements of federal law. (3-20-20)T

06. **Central Records Storage.** Records may be retained at a central location in compliance with federal law. (3-20-20)T

07. **Electronic Records Storage.** Records may be electronically stored and maintained if they remain legible and are in a readily retrievable format, and if federal law does not require them to be kept in a hard copy format. (3-20-20)T

**501. REPORTING REQUIREMENTS.**

01. **Theft or Loss of Controlled Substances.** A registrant must report to the Board on the same day reported to the DEA a theft or loss of a controlled substance that includes the information required by federal law. (3-20-20)T

02. **Individual and Outlet Information Changes.** Changes in employment or changes to information provided on or with the initial or renewal application must be reported to the Board within ten (10) days of the change. (3-20-20)T

03. **Drug Distributor Monthly Reports.** An authorized distributor must report specified data on drugs distributed at least monthly to the Board in a form and manner prescribed by the Board. (3-20-20)T

**502. -- 599. (RESERVED)**

**SUBCHAPTER G – PRESCRIPTION DRUG MONITORING PROGRAM REQUIREMENTS**  
**(Rules 600 through 699 – Prescription Drug Monitoring Program Requirements)**

**600. CONTROLLED SUBSTANCES: PDMP.**  
Specified data on controlled substances must be reported by the end of the next business day by all drug outlets that dispense controlled substances in or into Idaho and prescribers that dispense controlled substances to humans. (3-20-20)T

01. **Online Access to PDMP.** To obtain online access, a prescriber or pharmacist, or their delegate must complete and submit a registration application and agree to adhere to the access restrictions and limitations established by law. (3-20-20)T

02. **Use Outside Scope of Practice.** Information obtained from the PDMP must not be used for purposes outside the prescriber's or pharmacist's scope of professional practice. A delegate may not access the PDMP outside of their supervisor's scope of professional practice. (3-20-20)T

03. **Profile Requests.** Authorized persons without online access may obtain a profile by completing a Board form and submitting it to the Board office with proof of identification and other credentials necessary to confirm the requestor's authorized status pursuant to Section 37-2726, Idaho Code. (3-20-20)T

**601. – 699. (RESERVED)**

**SUBCHAPTER H – RULES GOVERNING DRUG COMPOUNDING**  
**(Rules 700 through 799 – Rules Governing Drug Compounding)**

**700. COMPOUNDING DRUG PREPARATIONS.**  
Any compounding that is not permitted herein is considered manufacturing. (3-20-20)T

01. **Application.** This rule applies to any person, including any business entity, authorized to engage in the practice of non-sterile compounding, sterile compounding, and sterile prepackaging of drug products in or into

- Idaho, except these rules do not apply to: (3-20-20)T
- a. Compound positron emission tomography drugs; (3-20-20)T
  - b. Radiopharmaceutics; (3-20-20)T
  - c. The reconstitution of a non-sterile drug or a sterile drug for immediate administration; (3-20-20)T
  - d. The addition of a flavoring agent to a drug product; and (3-20-20)T
  - e. Product preparation of a non-sterile, non-hazardous drug according to the manufacturer's FDA approved labeling. (3-20-20)T
- 02. General Compounding Standards.** (3-20-20)T
- a. Active Pharmaceutical Ingredients. All active pharmaceutical ingredients must be obtained from an FDA registered manufacturer. FDA registration as a foreign manufacturer satisfies this requirement. (3-20-20)T
  - b. Certificate of Analysis (COA). Unless the active pharmaceutical ingredient complies with the standards of an applicable USP-NF monograph, a COA must be obtained for all active pharmaceutical ingredients procured for compounding and retained for a period of not less than three (3) years from the date the container is emptied, expired, returned, or disposed of. The following minimum information is necessary on the COA: product name, lot number, expiration date, and assay. (3-20-20)T
  - c. Equipment. Equipment and utensils must be of suitable design and composition and cleaned, sanitized, or sterilized as appropriate prior to use. (3-20-20)T
  - d. Disposal of Compromised Drugs. When the correct identity, purity, strength, and sterility of ingredients and components cannot be confirmed (in cases of, for example, unlabeled syringes, opened ampoules, punctured stoppers of vials and bags, and containers of ingredients with incomplete labeling) or when the ingredients and components do not possess the expected appearance, aroma, and texture, they must be removed from stock and isolated for return, reclamation, or destruction. (3-20-20)T
- 03. Prohibited Compounding.** Compounding any drug product for human use that the FDA has identified as presenting demonstrable difficulties in compounding or has withdrawn or removed from the market for safety or efficacy reasons is prohibited. (3-20-20)T
- 04. Limited Compounding.** (3-20-20)T
- a. Triad Relationship. A pharmacist may compound a drug product in the usual course of professional practice for an individual patient pursuant to an established prescriber/patient/pharmacist relationship and a valid prescription drug order. (3-20-20)T
  - b. Commercially Available Products. A drug product that is commercially available may only be compounded if not compounded regularly or in inordinate amounts and if: (3-20-20)T
    - i. It is medically warranted to provide an alternate ingredient, dosage form, or strength of significance; or (3-20-20)T
    - ii. The commercial product is not reasonably available in the market in time to meet the patient's needs. (3-20-20)T
  - c. Anticipatory Compounding. Limited quantities of a drug product may be compounded or sterile prepackaged prior to receiving a valid prescription drug order based on a history of receiving valid prescription drug orders for the compounded or sterile prepackaged drug product. (3-20-20)T
- 05. Drug Compounding Controls.** (3-20-20)T

**a.** Policies and Procedures. In consideration of the applicable provisions of USP Chapter 795 concerning pharmacy compounding of non-sterile preparations, USP Chapter 797 concerning sterile preparations, Chapter 1075 of the USP-NF concerning good compounding practices, and Chapter 1160 of the USP-NF concerning pharmaceutical calculations, policies and procedures for the compounding or sterile prepackaging of drug products must ensure the safety, identity, strength, quality, and purity of the finished product, and must include any of the following that are applicable to the scope of compounding practice being performed: (3-20-20)T

- i. Appropriate packaging, handling, transport, and storage requirements; (3-20-20)T
- ii. Accuracy and precision of calculations, measurements, and weighing; (3-20-20)T
- iii. Determining ingredient identity, quality, and purity; (3-20-20)T
- iv. Labeling accuracy and completeness; (3-20-20)T
- v. Beyond use dating; (3-20-20)T
- vi. Auditing for deficiencies, including routine environmental sampling, quality and accuracy testing, and maintaining inspection and testing records; (3-20-20)T
- vii. Maintaining environmental quality control; and (3-20-20)T
- viii. Safe limits and ranges for strength of ingredients, pH, bacterial endotoxins, and particulate matter. (3-20-20)T

**b.** Accuracy. Components including, but not limited to, bulk drug substances, used in the compounding or sterile prepackaging of drug products must be accurately weighed, measured, or subdivided, as appropriate. The amount of each active ingredient contained within a compounded drug product must not vary from the labeled potency by more than the drug product's acceptable potency range listed in the USP-NF monograph for that product. If USP-NF does not publish a range for a particular drug product, the active ingredients must not contain less than ninety percent (90%) and not more than one hundred ten percent (110%) of the potency stated on the label. (3-20-20)T

**c.** Non-Patient Specific Records. Except for drug products that are being compounded or sterile prepackaged for direct administration, a production record of drug products compounded or sterile prepackaged in anticipation of receiving prescription drug orders or distributed in the absence of a patient specific prescription drug order ("office use") solely as permitted in these rules, must be prepared and kept for each drug product prepared, including: (3-20-20)T

- i. Production date; (3-20-20)T
- ii. Beyond use date; (3-20-20)T
- iii. List and quantity of each ingredient; (3-20-20)T
- iv. Internal control or serial number; and (3-20-20)T
- v. Initials or unique identifier of all persons involved in the process or the compounder responsible for the accuracy of these processes. (3-20-20)T

**701. STERILE PREPARATION.**

**01. Application.** In addition to all other applicable rules in this chapter, including the rules governing Compounding Drug Preparations, these rules apply to all persons, including any business entity, engaged in the practice of sterile compounding and sterile prepackaging in or into Idaho. (3-20-20)T

**02. Dosage Forms Requiring Sterility.** The sterility of compounded biologics, diagnostics, drugs, nutrients, and radiopharmaceuticals must be maintained or the compounded drug preparation must be sterilized when prepared in the following dosage forms: (3-20-20)T

- a. Aqueous bronchial and nasal inhalations, except sprays and irrigations intended to treat nasal mucosa only; (3-20-20)T
- b. Baths and soaks for live organs and tissues; (3-20-20)T
- c. Injections (for example, colloidal dispersions, emulsions, solutions, suspensions); (3-20-20)T
- d. Irrigations for wounds and body cavities; (3-20-20)T
- e. Ophthalmic drops and ointments; and (3-20-20)T
- f. Tissue implants. (3-20-20)T

**03. Compounder Responsibilities.** Compounders and sterile prepackagers are responsible for ensuring that sterile products are accurately identified, measured, diluted, and mixed and are correctly purified, sterilized, packaged, sealed, labeled, stored, dispensed, and distributed, as well as prepared in a manner that maintains sterility and minimizes the introduction of particulate matter; (3-20-20)T

- a. Unless following manufacturer's guidelines or another reliable literature source, opened or partially used packages of ingredients for subsequent use must be properly stored as follows; (3-20-20)T
  - i. Opened or entered single-dose containers, such as bags, bottles, syringes, and vials of sterile products and compounded sterile preparations are to be used within one (1) hour if opened in non-sterile conditions, and any remaining contents must be discarded; (3-20-20)T
  - ii. Single-dose vials needle-punctured in a sterile environment may be used up to six (6) hours after initial needle puncture; (3-20-20)T
  - iii. Opened single-dose ampules may not be stored for any time period; and (3-20-20)T
  - iv. Multiple-dose containers that are formulated for removal of portions on multiple occasions because they contain antimicrobial preservatives, may be used for up to twenty-eight (28) days after initial opening or entering, unless otherwise specified by the manufacturer; (3-20-20)T
- b. Water-containing compounded sterile products that are non-sterile during any phase of the compounding procedure must be sterilized within six (6) hours after completing the preparation in order to minimize the generation of bacterial endotoxins; (3-20-20)T

c. No food, drinks, or materials exposed in patient care and treatment areas may enter ante-areas, buffer areas, or segregated areas where components and ingredients of sterile preparations are prepared. (3-20-20)T

**04. Environmental Controls.** Except when prepared for immediate administration, the environment for the preparation of sterile preparations in a drug outlet must be in an isolated area, designed to avoid unnecessary traffic and airflow disturbances, and equipped to accommodate aseptic techniques and conditions. (3-20-20)T

- a. Hoods and aseptic environmental control devices must be certified for operational efficiency as often as recommended by the manufacturer or at least every six (6) months or if relocated. (3-20-20)T
- b. Filters must be inspected and replaced in accordance with the manufacturer's recommendations. (3-20-20)T

**05. Sterile Preparation Equipment.** A drug outlet in which sterile preparations are prepared must be equipped with at least the following: (3-20-20)T

a. Protective apparel including gowns, masks, and sterile (or the ability to sterilize) non-vinyl gloves, unless written documentation can be provided from the aseptic isolator manufacturer that any component of garbing is not necessary; (3-20-20)T

b. A sink; (3-20-20)T

c. A refrigerator for proper storage of additives and finished sterile preparations prior to delivery when necessary; and (3-20-20)T

d. An appropriate laminar airflow hood or other aseptic environmental control device such as a laminar flow biological safety cabinet, or a comparable compounding area when authorized by USP Chapter 797. (3-20-20)T

**06. Documentation Requirements.** The following documentation must also be maintained by a drug outlet in which sterile preparations are prepared: (3-20-20)T

a. Justification of beyond use dates assigned, pursuant to direct testing or extrapolation from reliable literature sources; (3-20-20)T

b. Training records, evidencing that personnel are trained on a routine basis and are adequately skilled, educated, and instructed; (3-20-20)T

c. Audits appropriate for the risk of contamination for the particular sterile preparation including: (3-20-20)T

i. Visual inspection to ensure the absence of particulate matter in solutions, the absence of leakage from bags and vials, and the accuracy of labeling with each dispensing; (3-20-20)T

ii. Periodic hand hygiene and garbing competency; (3-20-20)T

iii. Media-fill test procedures (or equivalent), aseptic technique, and practice related competency evaluation at least annually by each compounder or sterile prepackager; (3-20-20)T

iv. Environmental sampling testing at least upon registration of a new drug outlet, following the servicing or re-certification of facilities and equipment, or in response to identified problems with end products, staff techniques or patient-related infections, or every six (6) months. (3-20-20)T

v. Gloved fingertip sampling testing at least annually for personnel who compound low- and medium-risk level compounded sterile preparations and every six (6) months for personnel who compound high-risk level compounded sterile preparations. (3-20-20)T

vi. Sterility testing of high risk batches of more than twenty-five (25) identical packages (ampules, bags, vials, etc.) before dispensing or distributing; (3-20-20)T

d. Temperature, logged daily; (3-20-20)T

e. Beyond use date and accuracy testing, when appropriate; and (3-20-20)T

f. Measuring, mixing, sterilizing, and purification equipment inspection, monitoring, cleaning, and maintenance to ensure accuracy and effectiveness for their intended use. (3-20-20)T

**07. Policy and Procedures Manual.** Maintain a policy and procedures manual to ensure compliance with this rule. (3-20-20)T

**702. HAZARDOUS DRUGS PREPARATION.**

In addition to all other applicable rules in this chapter, including the rules governing Compounding Drug Preparations

and Sterile Preparation, these rules apply to all persons, including any business entity, engaged in the practice of compounding or sterile prepackaging with hazardous drugs. Such persons must: (3-20-20)T

**01. Ventilation.** Ensure the storage and compounding areas have sufficient general exhaust ventilation to dilute and remove any airborne contaminants. (3-20-20)T

**02. Ventilated Cabinet.** Utilize a ventilated cabinet designed to reduce worker exposures while preparing hazardous drugs. (3-20-20)T

**a.** Sterile hazardous drugs must be prepared in a dedicated Class II biological safety cabinet or a barrier isolator of appropriate design to meet the personnel exposure limits described in product material safety data sheets; (3-20-20)T

**b.** When asepsis is not required, a Class I BSC, powder containment hood or an isolator intended for containment applications may be sufficient. (3-20-20)T

**c.** A ventilated cabinet that re-circulates air inside the cabinet or exhausts air back into the room environment is prohibited, unless: (3-20-20)T

**i.** The hazardous drugs in use will not volatilize while they are being handled; or (3-20-20)T

**ii.** Written documentation from the manufacturer attesting to the safety of such ventilation. (3-20-20)T

**03. Clear Identification.** Clearly identify storage areas, compounding areas, containers, and prepared doses of hazardous drugs. (3-20-20)T

**04. Labeling.** Label hazardous drugs with proper precautions, and dispense them in a manner to minimize risk of hazardous spills. (3-20-20)T

**05. Protective Equipment and Supplies.** Provide and maintain appropriate personal protective equipment and supplies necessary for handling hazardous drugs, spills and disposal. (3-20-20)T

**06. Contamination Prevention.** Unpack, store, prepackage, and compound hazardous drugs separately from other inventory in a restricted area in a manner to prevent contamination and personnel exposure until hazardous drugs exist in their final unit-of-use packaging. (3-20-20)T

**07. Compliance With Laws.** Comply with applicable local, state, and federal laws including for the disposal of hazardous waste. (3-20-20)T

**08. Training.** Ensure that personnel working with hazardous drugs are trained in hygiene, garbing, receipt, storage, handling, transporting, compounding, spill control, clean up, disposal, dispensing, medical surveillance, and environmental quality and control. (3-20-20)T

**09. Policy and Procedures Manual.** Maintain a policy and procedures manual to ensure compliance with this rule. (3-20-20)T

### **703. OUTSOURCING FACILITY.**

**01. Federal Act Compliance.** An outsourcing facility must ensure compliance with 21 U.S.C. Section 353b of the Federal Food, Drug and Cosmetic Act. (3-20-20)T

**02. Adverse Event Reports.** Outsourcing facilities must submit to the Board a copy of all adverse event reports submitted to the secretary of Health and Human Services in accordance with Section 310.305 of Title 21 of the Code of Federal Regulations. (3-20-20)T

### **704. MEDICATION LIMITATIONS.**

**01. Chloroquine/Hydroxychloroquine Prescriptions.** No prescription for chloroquine or hydroxychloroquine may be dispensed unless all of the following apply: (3-20-20)T

**a.** The prescription bears a written diagnosis from the prescriber consistent with the evidence for its use; (3-20-20)T

**b.** The prescription is limited to no more than a fourteen (14) day supply; and (3-20-20)T

**c.** No refills may be permitted unless a new prescription is furnished. (3-20-20)T

**d.** The provisions of paragraphs 704.01.b and 704.01.c, of this rule, do not apply if the patient was previously established on the medication prior to the effective date of this rule. (3-20-20)T

**02. Oral Azithromycin Prescriptions.** No prescription for oral azithromycin may be dispensed unless all of the following apply: (3-20-20)T

**a.** The prescription bears a written diagnosis from the prescriber consistent with the evidence for its use; (3-20-20)T

**b.** The prescription is limited to no more than a five (5) day supply; and (3-20-20)T

**c.** No refills may be permitted. (3-20-20)T

**d.** The provisions of paragraphs 704.02.b and 704.02.c, of this rule, do not apply if the patient was previously established on the medication prior to the effective date of this rule. (3-20-20)T

**705. – 999. (RESERVED)**

## IDAPA 32 – ENDOWMENT FUND INVESTMENT BOARD

DOCKET NO. 32-0101-2000F (FEE RULE)

### NOTICE OF OMNIBUS RULEMAKING – ADOPTION OF TEMPORARY RULE

**EFFECTIVE DATE:** The effective date of the temporary rule being adopted through this omnibus rulemaking is the adjournment date of the second regular session of the 65th Idaho State Legislature - March 20, 2020.

**AUTHORITY:** In compliance with Sections 67-5226, Idaho Code, notice is hereby given this agency has adopted a temporary rule. The action is authorized pursuant to Section 57-728(2), Idaho Code, which gives the Endowment Fund Investment Board authority to promulgate rules necessary to discharge EFIB's duties for the administration of the Credit Enhancement Program.

**DESCRIPTIVE SUMMARY:** The following is the required finding and concise statement of its supporting reasons for adopting a temporary rule:

This temporary rulemaking adopts the following chapter under IDAPA 32.01.01:

#### **IDAPA 32**

- 32.01.01, *Rule Governing the Credit Enhancement Program for School Districts*

**TEMPORARY RULE JUSTIFICATION:** Pursuant to Sections 67-5226(1) and 67-5226(2), Idaho Code, the Governor has found that temporary adoption of the rule is appropriate for the following reasons:

These temporary rules are necessary to protect the public health, safety, and welfare of the citizens of Idaho and confer a benefit on its citizens. These temporary rules implement the duly enacted laws of the state of Idaho, provide citizens with the detailed rules and standards for complying with those laws, and assist in the orderly execution and enforcement of those laws. The expiration of these rules without due consideration and processes would undermine the public health, safety, and welfare of the citizens of Idaho and deprive them of the benefit intended by these rules.

**FEE SUMMARY:** Pursuant to Section 67-5226(2), the Governor has found that the fee(s) or charge(s) being imposed or increased is justified and necessary to avoid immediate danger and the fee(s) is described herein:

The fees or charges, authorized in Section 57-728, Idaho Code, are part of the agency's 2021 budget that relies upon the existence of these fees or charges to meet the state's obligations and provide necessary state services. Failing to reauthorize these temporary rules would create immediate danger to the state budget, immediate danger to necessary state functions and services, and immediate danger of a violation of Idaho's constitutional requirement that it balance its budget.

The following is a specific description of the fees or charges: This rule indicates that the Endowment Fund Investment Board will charge school districts an application fee of \$500 and a one-time bond guarantee fee equal to two one hundredths of one percent (0.02% or two basis points) of the Total Debt Service.

**ASSISTANCE ON TECHNICAL QUESTIONS:** For assistance on technical questions concerning the temporary rule, contact Chris Anton, Manager of Investments, Endowment Fund Investment Board, 816 West Bannock Street, Suite 301, Boise, ID 83702, (208)334-3312.

DATED this 13th day of February, 2020.

Chris Anton, Manager of Investments  
Endowment Fund Investment Board  
816 West Bannock Street, Suite 301  
Boise, ID 83702  
Phone: (209) 334-3312  
Fax: (208) 334-3786



## IDAPA 32 – ENDOWMENT FUND INVESTMENT BOARD

### 32.01.01 – RULES GOVERNING THE CREDIT ENHANCEMENT PROGRAM FOR SCHOOL DISTRICTS

#### 000. LEGAL AUTHORITY.

Section 57-728(2), Idaho Code, gives the Endowment Fund Investment Board authority to promulgate rules necessary to the discharge of the EFIB's duties for the administration of the Credit Enhancement Program. 2010 Idaho Attorney General Opinion 01 concludes that the EFIB must charge fees to offset the costs of the Credit Enhancement Program to the Endowments. (3-20-20)T

#### 001. TITLE AND SCOPE

01. **Title.** These rules are titled IDAPA 32, Title 01, Chapter 01, "Rules Governing the Credit Enhancement Program for School Districts." (3-20-20)T

02. **Scope.** These rules contain the provisions for implementation of the Credit Enhancement Program. (3-20-20)T

#### 002. -- 009. (RESERVED)

#### 010. DEFINITIONS AND REFERENCES.

01. **Administrative Fees.** Application Fees and Pass-through Fees charged to School Districts applying for and receiving guarantees under the Credit Enhancement Program. (3-20-20)T

02. **Application Fee.** The amount determined by the EFIB and set forth in this chapter as the cost of reviewing applications to the Credit Enhancement Program and administering the Credit Enhancement Program. (3-20-20)T

03. **Credit Enhancement Program.** The Credit Enhancement Program for School District Bonds established in Section 57-728, Idaho Code. (3-20-20)T

04. **EFIB.** Endowment Fund Investment Board. (3-20-20)T

05. **Endowments.** The trusts granted to the state of Idaho by the Idaho Admission Bill, 26 Statutory Laws 215, chapter 656 as amended. The Endowments include the Public School Endowment established by Idaho Admission Bill sections 4 and 13. (3-20-20)T

06. **Guarantee Fee.** The amount determined by the EFIB and set forth in this chapter as the cost of guaranteeing a school bond under the Credit Enhancement Program. The cost of guaranteeing a school bond includes the difference in the investment return to the Public School Endowment projected by the EFIB to arise from the guarantee and additional costs to the Endowments arising from investment of the Public School Endowment in the Credit Enhancement Program. (3-20-20)T

07. **Guaranty Program.** The Idaho School Bond Guaranty Program established in Title 33, Chapter 53, Idaho Code. (3-20-20)T

08. **Pass-Through Fee.** A direct cost to the EFIB for reviewing an application to the Credit Enhancement Program or for issuing a note to pay a debt service payment under the Credit Enhancement Program. Direct costs include the costs billed to the EFIB by legal, accounting, and financial professionals. (3-20-20)T

09. **School District.** As defined in Section 33-5302, Idaho Code. (3-20-20)T

10. **Total Debt Service.** The total amount to be repaid to bond purchasers over the stated maturity of the School District bond (principal plus interest). (3-20-20)T

#### 011. -- 019. (RESERVED)

#### 020. APPLICATION.

01. **Required Materials.** School Districts must submit the following application materials to the EFIB:

(3-20-20)T

**a.** Correspondence from the Idaho State Treasurer certifying that the School District has been approved to participate in the Guaranty Program and setting forth the maximum credit enhancement amount available to the School District within the limitations set forth in Section 57-728(8), Idaho Code. (3-20-20)T

**b.** A fully completed application form as prescribed by the EFIB from time to time executed by a party authorized to bind the School District. (3-20-20)T

**c.** Copies of the complete audited financial statements of the School District prepared pursuant to Section 33-701, Idaho Code, for the preceding three (3) fiscal years and the adopted budget for the current fiscal year. (3-20-20)T

**d.** Upon request of the EFIB, documentation substantiating the information set forth in materials submitted pursuant to Subsection 020.01 of these rules. (3-20-20)T

**02. Submission Deadlines.** School Districts may submit an application at any time. (3-20-20)T

**021. -- 029. (RESERVED)**

**030. FEES.**

**01. Guarantee Fee.** School Districts must remit to the EFIB a one-time fee equal to two one-hundredths of one percent (0.02% or two basis points) of the Total Debt Service. When Paid. School Districts must remit the Guarantee Fee to the EFIB within five (5) days of the sale of bonds guaranteed by the Credit Enhancement Program. The EFIB will deposit the Guarantee Fee in the Public School Endowment. (3-20-20)T

**02. Administrative Fees.** (3-20-20)T

**a.** Application Fee. School Districts shall submit to the EFIB an Application Fee of five hundred dollars (\$500). School Districts shall submit the Application Fee to the EFIB with the application materials. The EFIB will use Application Fees to pay costs of reviewing applications and administering the Credit Enhancement Program. At the conclusion of each fiscal year, the EFIB will deposit unexpended Application Fees in the Public School Endowment. (3-20-20)T

**b.** Pass-through Fee. The EFIB may incur a Pass-through Fee related to the review of an application in its discretion. The EFIB will not invoice a School District for Pass-through Fees related to the review of an application without the prior written approval of the School District. The EFIB may incur a Pass-through Fee related to the issuance of a note without prior approval of the School District. The EFIB will invoice School Districts for the full amount of any Pass-through Fees related to the issuance of a note. School Districts shall remit each invoiced Pass-through Fee to the EFIB within thirty (30) days of invoice. The EFIB will use a Pass-through Fee to pay the direct costs to the EFIB under the Credit Enhancement Program giving rise to the fee. (3-20-20)T

**031. -- 039. (RESERVED)**

**040. APPROVAL AND DENIAL OF APPLICATIONS.**

**01. Review Periods.** The EFIB will provide written approval or denial of an application within twenty (20) days of the submission of all required materials. If the Board requests substantiating documentation, the EFIB will provide written approval or denial of the application within twenty (20) days of the submission of the substantiating documentation. (3-20-20)T

**02. Delegation of Review and Approval.** (3-20-20)T

**a.** Staff Review. The EFIB may delegate review of applications to EFIB staff. (3-20-20)T

**b.** Experts. The EFIB may engage experts to review an application. Experts include legal, accounting,

and financial professionals. (3-20-20)T

**c.** Staff Approval. The EFIB may delegate approval of applications to the EFIB's manager of investments. (3-20-20)T

**03. Discretionary Investment.** The EFIB will invest in a School District bond issuance under the Credit Enhancement Program in its sole discretion and within its fiduciary responsibilities as trustees of the financial assets of the Endowments. The EFIB may deny an application for participation in the Credit Enhancement Program if the EFIB determines the investment is not in the best interests of one (1) or more of the Endowments. (3-20-20)T

**04. Denial of Application for Unpaid Fees.** The EFIB may deny an application for participation in the Credit Enhancement Program if a School District has not paid a fee under a pending application or a prior guarantee issued by the Credit Enhancement Program. (3-20-20)T

**041. -- 999. (RESERVED)**

# IDAPA 33 – REAL ESTATE COMMISSION

## DOCKET NO. 33-0101-2000F (FEE RULE)

### NOTICE OF OMNIBUS RULEMAKING – ADOPTION OF TEMPORARY RULE

**EFFECTIVE DATE:** The effective date of the temporary rule being adopted through this omnibus rulemaking is the adjournment date of the second regular session of the 65th Idaho State Legislature - March 20, 2020.

**AUTHORITY:** In compliance with Sections 67-5226, Idaho Code, notice is hereby given this agency has adopted a temporary rule. The action is authorized pursuant to Section 54-2097, Idaho Code.

**DESCRIPTIVE SUMMARY:** The following is the required finding and concise statement of its supporting reasons for adopting a temporary rule:

This temporary rulemaking adopts the following chapter under IDAPA 33:

**IDAPA 33**

- 33.01.01, *Rules of the Idaho Real Estate Commission*

**TEMPORARY RULE JUSTIFICATION:** Pursuant to Sections 67-5226(1) and 67-5226(2), Idaho Code, the Governor has found that temporary adoption of the rule is appropriate for the following reasons:

These temporary rules are necessary to protect the public health, safety, and welfare of the citizens of Idaho and confer a benefit on its citizens. These temporary rules implement the duly enacted laws of the state of Idaho, provide citizens with the detailed rules and standards for complying with those laws, and assist in the orderly execution and enforcement of those laws. The expiration of these rules without due consideration and processes would undermine the public health, safety, and welfare of the citizens of Idaho and deprive them of the benefit intended by these rules.

**FEE SUMMARY:** Pursuant to Section 67-5226(2), the Governor has found that the fee(s) or charge(s) being imposed or increased is justified and necessary to avoid immediate danger and the fee(s) is described herein:

The fees or charges, authorized in Section 54-2020, Idaho Code, are part of the agency’s 2021 budget that relies upon the existence of these fees or charges to meet the state’s obligations and provide necessary state services. Failing to reauthorize these temporary rules would create immediate danger to the state budget, immediate danger to necessary state functions and services, and immediate danger of a violation of Idaho’s constitutional requirement that it balance its budget.

The following is a specific description of the fees or charges:

- IDAPA 33.01.01.100:

	Initial License	Renewal	Late Fee	Other
Broker	\$160	\$160	\$25	
Salesperson	\$160	\$160	\$25	
Business Entity	\$50	\$50	\$25	
Branch Office	\$50	\$50	\$25	
Cooperative License	\$100			
Education History				\$10
License Certificate				\$15

**ASSISTANCE ON TECHNICAL QUESTIONS:** For assistance on technical questions concerning the temporary rule, contact MiChell Bird (208)334-3285.

DATED this February 21, 2020.

MiChell Bird  
Executive Director  
Idaho Real Estate Commission  
575 E. Parkcenter Blvd. Ste 180  
Boise, ID 83706  
Phone: (208) 334-3285  
Fax: (208)334-2050

# IDAPA 33 – REAL ESTATE COMMISSION

## 33.01.01 – RULES OF THE IDAHO REAL ESTATE COMMISSION

### 000. LEGAL AUTHORITY.

The Rules of the Idaho Real Estate Commission contained herein have been adopted pursuant to Section 54-2007, Idaho Code. Any violation of these rules, or of any provision of Chapter 20, Title 54, or Chapter 18, Title 55, Idaho Code, is sufficient cause for disciplinary action as prescribed in Sections 54-2059, 54-2060, or 55-1811, Idaho Code. (3-20-20)T

### 001. TITLE AND SCOPE.

**01. Title.** These rules are titled IDAPA 33.01.01, “Rules of the Idaho Real Estate Commission,” IDAPA 33, Title 01, Chapter 01. (3-20-20)T

**02. Scope.** These rules contain the requirements for implementation and enforcement of the Idaho Real Estate License Law, the Idaho Real Estate Brokerage Representation Act, and the Subdivided Lands Disposition Act, contained in Chapter 20, Title 54, or Chapter 18, Title 55, Idaho Code. (3-20-20)T

### 002. – 005. (RESERVED)

### 006. ELECTRONIC SIGNATURES.

Electronic signatures are permissible in accordance with the Uniform Electronic Transactions Act, Title 28, Chapter 50. (3-20-20)T

### 007. -- 099. (RESERVED)

## Rules 100 through 199

## APPLICATION, LICENSURE, AND TERMINATION OF LICENSES

### 100. FEES.

License and other fees:

	Initial License	Renewal	Late Fee	Other
Broker	\$160	\$160	\$25	
Salesperson	\$160	\$160	\$25	
Business Entity	\$50	\$50	\$25	
Branch Office	\$50	\$50	\$25	
Cooperative License	\$100			
Education or License History				\$10
License Certificate				\$15

(3-20-20)T

### 101. – 104. (RESERVED)

### 105. CONDITIONS TO RENEW EXPIRED LICENSE.

The Commission may accept a licensee’s application to renew an expired license upon the following conditions:

(3-20-20)T

**01. Payment of Late Fee.** The applicant must pay the late license renewal fee. (3-20-20)T

**02. Renewal After Expiration of Active License.** If an active license expires, the licensee must complete and submit with the application an attestation that during the period the license was expired, the licensee either did or did not do or attempt to do any acts described in the definitions of real estate broker or salesperson in

Section 54-2004, Idaho Code.

(3-20-20)T

**03. Investigate or Discipline a Licensee.** Nothing in this Section limits the ability of the Commission to investigate or discipline a licensee for violating Subsection 54-2018(3), Idaho Code, or for violating any other provision of the Real Estate License Law or these rules. (3-20-20)T

**106. -- 116. (RESERVED)**

**117. MANDATORY ERRORS AND OMISSIONS INSURANCE.**

Every licensee, upon obtaining or renewing an active real estate license in the state of Idaho will have in effect and maintain a policy of errors and omissions insurance as required by Section 54-2013, Idaho Code, to cover all activities contemplated under Chapter 20, Title 54, Idaho Code and will certify such coverage to the Commission in the form and manner prescribed by statute, these rules, and any policy adopted by the Commission. (3-20-20)T

**118. INSURANCE PLAN.**

The Commission will make available to all active licensees, subject to terms and availability from a qualified insurance carrier, a policy of Errors and Omissions Insurance under a Group Plan obtained by the Commission. Licensees may obtain errors and omissions insurance independently of the Group Policy available through the Commission, subject, however, to the terms and conditions set forth in these rules. (3-20-20)T

**01. Insurance Carrier.** For the purposes of Section 118: (3-20-20)T

**a.** Shall maintain an A.M. Best Company rating of B+ or better, and an A.M. Best Financial Size Category of Class VI or higher; (3-20-20)T

**b.** Is and will remain for the policy term duly authorized by the Idaho Department of Insurance to do business in the state of Idaho as an insurance carrier; and (3-20-20)T

**c.** Is and will remain for the policy term qualified and authorized by the Idaho Department of Insurance to write policies of errors and omissions insurance in Idaho of the type contemplated by these rules. (3-20-20)T

**02. Approved Policy.** The policy shall cover all activities contemplated under Chapter 20, Title 54, Idaho Code, be subject to such terms and conditions as are customary in the insurance industry for policies of errors and omissions insurance, which are otherwise permissible under Idaho law and the rules of the Idaho Insurance Department, and which are contained in a policy of insurance which has been approved by the Department of Insurance. That policy shall provide, at a minimum, the following terms and conditions:

	Limit Liability Coverage for Each Occurrence Not Less Than	Annual Aggregate Limit Not Less Than
Individual License Coverage	\$100,000*	\$300,000*
Firm Coverage	\$500,000*	\$1,000,000*
*Not including costs of investigation and defense		

(3-20-20)T

**a.** A deductible amount of not greater than three thousand five hundred dollars (\$3,500), which includes costs of investigation and defense; (3-20-20)T

**b.** A policy period equal to each licensee's two (2) year license renewal date or the prorated equivalent, or, if an annually renewable policy, a statement of the policy period, and in either case, the policy shall provide for continuous coverage during the policy period; (3-20-20)T

**c.** An extended reporting period per insured of at least ninety (90) days following termination of the

policy period; and (3-20-20)T  
d. Prior acts coverage shall be offered to licensees with continuous past coverage. (3-20-20)T

**119. (RESERVED)**

**120. CERTIFICATION A PREREQUISITE FOR LICENSE ISSUANCE OR RENEWAL.**  
Issuance or renewal of an active license requires certification of compliance that satisfies the requirements of Section 54-2013, Idaho Code. (3-20-20)T

**121. FAILURE TO MAINTAIN INSURANCE.**  
Failure of a licensee to obtain and maintain insurance coverage required by Section 54-2013, Idaho Code, regardless whether coverage is later obtained and made retroactive by the carrier, will result in denial or inactivation of any active license and will be deemed insufficient application for licensure under Section 67-5254, Idaho Code. A late insurance renewal is considered failure to maintain insurance. Failure to maintain insurance shall be grounds for disciplinary action. (3-20-20)T

**122. FALSIFICATION OF CERTIFICATES.**  
Any licensee who, acting alone or in concert with others, willfully or knowingly causes or allows a certificate of coverage to be filed with, or produced to, the Commission which is false, fraudulent, or misleading, will be subject to disciplinary action, including but not limited to suspension or revocation of license, in accordance with Chapter 52, Title 67, Idaho Code; provided, however, that nothing herein will entitle such licensee to notice and hearing on the automatic inactivation of license. (3-20-20)T

**123. -- 299. (RESERVED)**

**Rules 300 through 399**  
**BUSINESS CONDUCT**

**300. DISPUTES CONCERNING COMMISSIONS AND FEES.**  
The Idaho Real Estate Commission will not be involved in the resolution of disputes between licensees or between licensees and buyers and sellers concerning matters of commissions or fees. (3-20-20)T

**301. (RESERVED)**

**302. TITLE OPINIONS.**  
No real estate broker or sales associate will pass judgment upon or give an opinion with respect to the marketability of the title to property in any transaction. (3-20-20)T

**303. LEGAL OPINIONS.**  
A broker or sales associate will not discourage any party to a real estate transaction from seeking the advice of an attorney. (3-20-20)T

**304. (RESERVED)**

**305. EDUCATION RECORDS ACCESS.**  
As provided for in Section 74-106, Idaho Code, the Commission may enable a designated broker to access and review the education record of any licensee currently licensed with the broker. (3-20-20)T

**306. -- 399. (RESERVED)**

**Rules 400 through 499**  
**CONTINUING EDUCATION**

**400. -- 401. (RESERVED)**



**402. APPROVED TOPICS FOR CONTINUING EDUCATION.**

Continuing education is to assure that licensees possess the knowledge, skills, and competency necessary to function in a manner that protects and serves the public interest, or that promotes the professionalism and business proficiency of the licensee. The knowledge or skills taught in an elective course will enable licensees to better serve real estate consumers. (3-20-20)T

**01. Topics Approved by the Commission.** Topic areas for continuing education, as provided for in Sections 54-2023 and 54-2036, Idaho Code, will be approved by the Commission as they pertain to real estate brokerage practice and actual real estate knowledge. (3-20-20)T

**02. Topics Not Eligible for Continuing Education Credits.** Topics which are specifically exam preparation in nature or not directly related to real estate brokerage practice will not be eligible for approval. (3-20-20)T

**403. -- 499. (RESERVED)**

**Rules 500 through 599**  
**EDUCATION TEACHING STANDARDS**

**500. MINIMUM TEACHING STANDARDS.**

All courses offered for credit by a certified provider will be taught in accordance with the standards and written policies adopted by the Real Estate Commission. Course instructors will conduct themselves in a professional manner when performing instructional duties and will not engage in conduct that criticizes, degrades, or disparages the Commission, any student, other instructor, brokerage, agency, or organization. (3-20-20)T

**01. Certification Requirement.** A course required to be taught by a Commission-certified or Commission-approved instructor will be taught only by an instructor that is currently approved or certified for that course. (3-20-20)T

**02. Outlines and Curriculum.** A course must be taught in accordance with the course outline or curriculum approved by the Commission. (3-20-20)T

**03. Attendance Requirement.** The course instructor will adhere to the Commission's written attendance policy and credit hours will only be submitted for students who have successfully met the attendance requirements for which the course was approved. (3-20-20)T

**04. Maintaining Exam Security.** The instructor will take reasonable steps to protect the security of course examinations and will not allow students to retain copies of final course examinations or the exam answer key. (3-20-20)T

**05. Use of Exam Questions Prohibited.** The instructor will not obtain or use, or attempt to obtain or use, in any manner or form, Idaho real estate licensing examination questions. (3-20-20)T

**501. -- 999. (RESERVED)**

## IDAPA 34 – SECRETARY OF STATE

### DOCKET NO. 34-0000-2000F (FEE RULE)

#### NOTICE OF OMNIBUS RULEMAKING – ADOPTION OF TEMPORARY RULE

**EFFECTIVE DATE:** The effective date of the temporary rules being adopted through this omnibus rulemaking is the adjournment date of the second regular session of the 65th Idaho State Legislature - March 20, 2020.

**AUTHORITY:** In compliance with Sections 67-5226, Idaho Code, notice is hereby given this agency has adopted a temporary rule. The action is authorized pursuant to Sections 67-903(9) and 28-9-526, Idaho Code.

**DESCRIPTIVE SUMMARY:** The following is the required finding and concise statement of its supporting reasons for adopting a temporary rule:

This temporary rule adopts the following chapters under IDAPA 34:

#### **IDAPA 34**

- 34.05.01, *Rules Governing Farm Products Central Filing System*
- 34.05.02, *Rules Governing Liens in Crops for Seed or Liens in Crops for Farm Labor*
- 34.05.03, *Rules Governing Requests for Information – Form UCC-4-Fees*
- 34.05.06, *Rules Governing Lien Filings Under the UCC*

**TEMPORARY RULE JUSTIFICATION:** Pursuant to Sections 67-5226(1) and 67-5226(2), Idaho Code, the Governor has found that temporary adoption of the rule is appropriate for the following reasons:

These temporary rules are necessary to protect the public health, safety, and welfare of the citizens of Idaho and confer a benefit on its citizens. These temporary rules implement the duly enacted laws of the state of Idaho, provide citizens with the detailed rules and standards for complying with those laws, and assist in the orderly execution and enforcement of those laws. The expiration of these rules without due consideration and processes would undermine the public health, safety, and welfare of the citizens of Idaho and deprive them of the benefit intended by these rules.

**FEE SUMMARY:** Pursuant to Section 67-5226(2), the Governor has found that the fee(s) or charge(s) being imposed or increased is justified and necessary to avoid immediate danger and the fee(s) is described herein:

The fees or charges, authorized in Sections 22-4716, 28-9-525, Idaho Code, are part of the agency's 2021 budget that relies upon the existence of these fees or charges to meet the state's obligations and provide necessary state services. Failing to reauthorize these temporary rules would create immediate danger to the state budget, immediate danger to necessary state functions and services, and immediate danger of a violation of Idaho's constitutional requirement that it balance its budget.

The following is a specific description of the fees or charges: This rulemaking does not impose a fee or charge, or increase a fee or charge, beyond what was previously approved and codified in the prior rules.

- Fee for information only on all notices when filed online is \$10.
- Fee for information and images on all notices when filed online is an additional \$10.
- Fee for a filing not submitted online is an additional \$20.

#### **UCC Search**

- The fee for searching online is \$3.
- The fee for copies of individually identified UCC documents of four or more pages is \$.25 per page.
- The fee for copies of individual documents is \$1 per page.

#### **Federal Tax Lien**

- The fee for filing is \$6.
- The fee for additional attachment is \$1 per page.
- The fee for a search for information only is \$6.
- The fee for combination searches available with UCC search for information only is \$10.
- The fee for combination searches available with UCC search for information and copies is \$16.

**State Tax Lien**

- There is no fee for filing.
- The fee for a search for information only is \$6.
- The fee for combination searches available with UCC search for information only is \$10.
- The fee for combination searches available with UCC search for information and copies is \$16.

**State Agencies**

- The fee for a search for information only is \$6.
- The fee for combination searches available with UCC search for information only is \$10.
- The fee for combination searches available with UCC search for information and copies is \$16.

**Seed and Farm Labor Liens**

- The fee for filing online is \$4.
- The fee for a search for information only is \$6.
- The fee for combination searches available with UCC search for information only is \$10.
- The fee for combination searches available with UCC search for information and copies is \$16.

**Agriculture Commodity Liens**

- The fee for filing is \$5.
- The fee for a search for information only is \$6.
- The fee for combination searches available with UCC search for information only is \$10.
- The fee for combination searches available with UCC search for information and copies is \$16.

**Farm Product Liens**

- The fee for filing online is \$10.
- The fee for filing is handwritten is \$14.
- The fee for a search for information only is \$6.
- The fee for combination searches available with UCC search for information only is \$10.
- The fee for combination searches available with UCC search for information and copies is \$16.
- The fees are being imposed pursuant to Section 28-9-525, Idaho Code.

**ASSISTANCE ON TECHNICAL QUESTIONS:** For assistance on technical questions concerning the temporary rule, contact Chad Houck (208) 334-2852.

DATED this February 21, 2020.

Chad Houck, Deputy Secretary of State  
Administrative Division  
700 West Jefferson Street, Room E205  
PO Box 83720  
Boise, ID 83720-0080  
(208) 334-2852

## 34.05.01 – RULES GOVERNING FARM PRODUCTS CENTRAL FILING SYSTEM

### 000. LEGAL AUTHORITY.

In accordance with Sections 67-903(9), 28-9-523(g), and 28-9-524, Idaho Code, the Secretary of State has authority to promulgate administrative rules in order to execute the duties of the Office of the Secretary of State. This authority includes rules to implement and maintain the USDA certified Idaho Central Filing System, in accordance with P.L. 99-198, Section 1324 of the Federal Food Security Act (1985) and Title 9, CFR Part 205 (2010). (3-20-20)T

### 001. TITLE AND SCOPE.

**01. Title.** These rules shall be cited as IDAPA 34.05.01, “Rules Governing Farm Products Central Filing System,” IDAPA 34, Title 05, Chapter 01. (3-20-20)T

**02. Scope.** These rules shall govern the requirements for the filing of Farm Products Financing Statements, for the filing of amendments to Farm Products Financing Statements, and for the compilation and distribution of a master list of Farm Products Financing Statements, and portions of the master list. (3-20-20)T

### 002. -- 009. (RESERVED)

### 010. DEFINITIONS.

The definitions set forth in Section 28-9-102, Idaho Code, apply with full force and effect to all provisions and sections of these rules. Where terms used in this rule are not explicitly or completely defined herein, definitions and usage of terms from the Legal Authority in Section 000 of these rules are applicable. (3-20-20)T

**01. Crop Year.** (3-20-20)T

**a.** For a plant or plant product, the calendar year in which it is harvested or to be harvested. (3-20-20)T

**b.** For mammals, the calendar year in which they are born or acquired. (3-20-20)T

**c.** For bees and worms, the calendar year in which they are alive in adult form. (3-20-20)T

**d.** For poultry and the products of mammals, poultry, and bees (i.e., milk, eggs, and honey), the calendar year in which they are sold or to be sold. (3-20-20)T

**e.** For fish and other aquaculture, the calendar year in which they are harvested or to be harvested. (3-20-20)T

**02. Farm Products Financing Statement.** A financing statement covering farm products. (3-20-20)T

**03. Item on a Master List or Portion of a Master List.** An entry on a master list or portion of a master list relating to one (1) Farm Products Financing Statement and one (1) debtor listed thereon. (3-20-20)T

**04. PML Grouping.** That related group of farm products which will appear on one (1) PML. (3-20-20)T

### 011. ABBREVIATIONS.

Where abbreviations used in these rules are not explicitly or completely defined herein, definitions and usage of abbreviations from the Legal Authority in Section 000 of these rules are applicable. (3-20-20)T

**01. CS.** A cumulative supplement to a PML which contains all additions to, changes to, and deletions from the PML which have been filed since the most recent publication of the complete PML. (3-20-20)T

**02. PML.** A portion of the master list, which covers Farm Products Financing Statements relating to a particular farm product or group of farm products. (3-20-20)T

**03. SOS.** Idaho Secretary of State. (3-20-20)T

**04. USDA.** United States Department of Agriculture. (3-20-20)T

### 012. -- 019. (RESERVED)

**020. UNIQUE IDENTIFIER NUMBER (UIN).**

**01. UIN System.** The Secretary of State's Office shall use a UIN system that has been approved and certified by the USDA for the Idaho Central Filing System in place of the former use of complete social security numbers as a means of debtor identification. (3-20-20)T

**02. Social Security Numbers and Tax Identification Numbers.** With the use of UINs, as approved by the USDA, the SOS will no longer require or accept social security numbers or tax identification numbers, in total, on Farm Products Financing Statements. Only the last four (4) digits shall be required and used. The SOS will not provide social security numbers or tax identification numbers, in total, to any person or business entity, in any format, from Farm Products Financing Statements. (3-20-20)T

**021. -- 099. (RESERVED)**

**100. FARM PRODUCTS FINANCING STATEMENT REQUIREMENTS.**

**01. Form.** A Farm Products Financing Statement must meet the requirements of Section 28-9-502, Idaho Code, and must be filed on SOS form "UCC-1F." (3-20-20)T

**02. Completion of Form.** Form UCC-1F must be completed in accordance with instructions provided by the SOS. (3-20-20)T

**101. AMENDMENT, ASSIGNMENT, CONTINUATION, AND TERMINATION OF A FARM PRODUCTS FINANCING STATEMENT.**

**01. Form.** An amendment, assignment, or continuation of a Farm Products Financing Statement must be filed on SOS form "UCC-3F." (3-20-20)T

**02. Completion of Form.** Form UCC-3F must be completed in accordance with instructions provided by the SOS. (3-20-20)T

**03. Termination.** Termination of a Farm Products Financing Statement will be done either by the secured party's signature on the termination signature line on the original of the UCC-1F or by checking the termination box on the UCC-3F. (3-20-20)T

**102. FARM PRODUCTS FINANCING STATEMENTS UNDER THE UNIFORM COMMERCIAL CODE.**

Unless otherwise provided for in this chapter, Farm Products Financing Statements shall be governed by IDAPA 34.05.06, "Administrative Rules Governing Lien Filings Under the UCC," with the following exceptions: (3-20-20)T

**01. IDAPA 34.05.06.101.05 "File Number."** Subsection 101.05 only applies in that a unique number shall be assigned. For Farm Products Financing Statements, the filing type shall be designated as "F" followed by a number that is assigned sequentially. The filing number bears no relation to the time of filing and is not an indicator of priority. (3-20-20)T

**02. IDAPA 34.05.06.108 "Acceptable Forms."** Section 108 does not apply to Farm Products Financing Statements. (3-20-20)T

**03. IDAPA 34.05.06.111 "Filing Fees."** Section 111 does not apply to Farm Products Financing Statements. (3-20-20)T

**04. IDAPA 34.05.06.115.01 "Individually Identified Documents."** Subsection 115.01 does not apply to Farm Products Financing Statements. Copies of Farm Products Financing Statements shall be made available either from a computer terminal in the reception area in the filing office or through any medium otherwise accepted by the filing office. There is a charge of one dollar (\$1) per page for copies of Farm Products Financing Statements pursuant to Section 28-9-523(k), Idaho Code. (3-20-20)T

**05. IDAPA 34.05.06.202.02 “Additional Debtor Identification.”** Subsection 202.02 does not apply to Farm Products Financing Statements. (3-20-20)T

**06. IDAPA 34.05.06.301.01 “Identification Numbers.”** Subsection 301.01 applies, however, each Farm Products Financing Statement is identified by its file number as described in Subsection 102.01 of these rules. (3-20-20)T

**07. IDAPA 34.05.06.301.05 “Status of Financing Statement.”** Subsection 301.05 does not apply to Farm Products Financing Statements. (3-20-20)T

**08. IDAPA 34.05.06.302.01 “Individual Name Fields.”** Subsection 302.01 applies, however, no indicator is used to distinguish the name as that of an individual. (3-20-20)T

**09. IDAPA 34.05.06.302.05 “No Assumed Business Names.”** Subsection 302.05 does not apply to Farm Products Financing Statements. However, if an assumed business name is used as the debtor name, the required information shall be as indicated in Subsection 020.02 of these rules. (3-20-20)T

**10. IDAPA 34.05.06.303.01 “Single Field.”** Subsection 303.01 applies, however, no indicator is used to distinguish the name as that of an organization. (3-20-20)T

**11. IDAPA 34.05.06.303.03 “No Assumed Business Name.”** Subsection 303.03 does not apply to Farm Products Financing Statements. However, if an assumed business name is used as the debtor name, the required information shall be as indicated in Subsection 020.02 of these rules. (3-20-20)T

**12. IDAPA 34.05.06.306.02 “Status of Debtor.”** Subsection 306.02 does not apply to Farm Products Financing Statements. (3-20-20)T

**13. IDAPA 34.05.06.306.03 “Status of Financing Statement.”** Subsection 306.03 does not apply to Farm Products Financing Statements. (3-20-20)T

**14. IDAPA 34.05.06.310 “Termination.”** Section 310 does not apply to Farm Products Financing Statements. (3-20-20)T

**15. IDAPA 34.05.06.312 “Procedure Upon Lapse.”** Section 312 only applies to Farm Products Financing Statements in that a Farm Products Financing Statement lapses on its lapse date. Upon lapse of a Farm Products Financing Statement, the information management system shall cause the Farm Products Financing Statement to no longer be made available to the searcher. (3-20-20)T

**16. IDAPA 34.05.06.407 “Data Entry of Names - Designated Fields.”** Section 407 applies to Farm Products Financing Statements, however, the filer is not required to designate whether a name is an individual or an organization. (3-20-20)T

**17. IDAPA 34.05.06.408 “Data Entry of Names - No Designated Fields.”** Section 408 does not apply to Farm Products Financing Statements. (3-20-20)T

**18. IDAPA 34.05.06.410.02 “Name and Address of Each Debtor.”** Subsection 410.02 applies to Farm Products Financing Statements, however, each debtor name is removed from the searchable index upon lapse or termination. (3-20-20)T

**19. IDAPA 34.05.06.411.03 “Amendment Financing Statement Lapses.”** Subsection 411.03 applies to Farm Products Financing Statements, however, each debtor name is removed from the searchable index upon lapse or termination. (3-20-20)T

**20. IDAPA 34.05.06.413 through IDAPA 34.05.06.504.** Sections 413 through 504 do not apply to Farm Products Financing Statements. (3-20-20)T

**103. -- 199. (RESERVED)**

**200. COLLATERAL INFORMATION CODES.**

Codes are used to describe farm product collateral on the Farm Products Financing Statements and amendments, on the master list maintained by the SOS, and on the PMLs distributed to registered buyers, commission merchants, and selling agents. Assignment of farm product codes and PML Groupings, county codes, and farm product unit codes shall be done by the SOS. The SOS will provide a list of the established codes upon request. (3-20-20)T

**01. PML Groupings and Farm Product Codes.** The table of PML Groupings, farm products, and their codes is as follows:

<b>PML No.</b>	<b>PML Grouping</b>	<b>FP Code</b>	<b>FP Name</b>
01	Wheat and Buckwheat	010	Wheat
		011	Buckwheat
02	Feed and Oil Grains	020	Barley
		021	Rye (including Triticale)
		022	Oats
		023	Sorghum Grain
		024	Flaxseed
		025	Safflower
		026	Rape (including Canola)
		027	Field Corn
		028	Millet
03	Hay	030	Hay
04	Ensilage	040	Ensilage
05	Potatoes	050	Potatoes
06	Sugar Beets	060	Sugar Beets
07	Dry Beans	070	Dry Beans
08	Dry Peas, Lentils and Garbanzos	080	Dry Peas
		081	Lentils
		082	Garbanzos (Chick Peas)
09	Sweet Corn	090	Sweet Corn

PML No.	PML Grouping	FP Code	FP Name
10	Onions and Garlic	100	Onions
		101	Onion Seed
		102	Garlic
11	Mint	110	Mint
12	Hops	120	Hops
13	Popcorn & Sunflower Seeds	130	Popcorn
		131	Sunflower Seeds
14	Soybeans	140	Soybeans
15	Rice	150	Rice
16	Seeds	160	Grass for Seed
		161	Alfalfa for Seed
		162	Other Hay Legumes for Seed
		163	Garden Vegetables and Flower Seeds
		164	Seed Potatoes
		165	Row Crops for Seed
17	Vegetables & Melons	170	Green Peas
		171	Tomatoes
		172	Lettuce
		173	Cucumbers
		174	Broccoli
		175	Cauliflower
		176	Lima Beans
		177	Green Beans
		178	Melons
		179	Carrots
		180	Turnips



<b>PML No.</b>	<b>PML Grouping</b>	<b>FP Code</b>	<b>FP Name</b>
		181	Asparagus
		182	Spinach and Collards
		183	Pumpkins and Squash
		184	Radishes
		185	Peppers
		186	Herbs
19	Fruits	190	Apples
		191	Apricots
		192	Cherries
		193	Nectarines
		194	Peaches
		195	Pears
		196	Plums
20	Berries	200	Strawberries
		201	Raspberries
21	Nursery Products	210	Sod
		211	Nursery Stock (Trees and Shrubs)
		212	Christmas Trees
		213	Flowers and Potted Plants
22	Mushrooms	220	Mushrooms
23	Grapes	230	Grapes
50	Beef Animals	500	Beef Cattle and Calves
		501	Beefalo
		502	Bison
51	Sheep, Wool	510	Sheep and Lambs Goats and Llamas
		511	Wool
		512	Goats

PML No.	PML Grouping	FP Code	FP Name
		513	Llamas
52	Hogs	520	Hogs
53	Dairy	530	Dairy Cattle
		531	Milk
54	Equines	540	Horses
		541	Mules
		542	Donkeys and Burros
55	Chickens and Eggs	550	Chickens
		551	Eggs
56	Other Fowl	560	Turkeys
		561	Ducks
		562	Geese
		563	Game Birds
		564	Ostriches, Emus, and Rheas
57	Mink, Rabbits and Fox	570	Mink and Pelts
		571	Rabbits
		572	Fox and Pelts
58	Apiary Products	580	Bees
		581	Honey
		582	Bees Wax
59	Fish and Other Aquaculture	590	Fish and Other Aquaculture
60	Big Game Animals (Deer and Elk)	600	Big Game Animals (Deer and Elk)
61	Worms	610	Worms

PML No.	PML Grouping	FP Code	FP Name
62	Semen	620	Cattle Semen
		621	Horse Semen

(3-20-20)T

**02. County Codes.** The table of county codes is as follows. Unless otherwise indicated, counties are in Idaho.

00	All Idaho Counties						
01	Ada	16	Cassia	31	Lewis	46	Garfield, Wa.
02	Adams	17	Clark	32	Lincoln	47	Pend Orielle, Wa.
03	Bannock	18	Clearwater	33	Madison	48	Spokane, Wa.
04	Bear Lake	19	Custer	34	Minidoka	49	Whitman, Wa.
05	Benewah	20	Elmore	35	Nez Perce	50	Malheur, Or.
06	Bingham	21	Franklin	36	Oneida	51	Elko, Nv.
07	Blaine	22	Fremont	37	Owyhee	52	Box Elder, Ut.
08	Boise	23	Gem	38	Payette	53	Cache, Ut.
09	Bonner	24	Gooding	39	Power	54	Rich, Ut.
10	Bonneville	25	Idaho	40	Shoshone	55	Lincoln, Wy.
11	Boundary	26	Jefferson	41	Teton	56	Teton, Wy
12	Butte	27	Jerome	42	Twin Falls	57	Beaverhead, Mt.
13	Camas	28	Kootenai	43	Valley	58	Lincoln, Mt
14	Canyon	29	Latah	44	Washington	59	Sanders, Mt.
15	Caribou	30	Lemhi	45	Asotin, Wa.	99	Not in Table

(3-20-20)T

**03. Unit Codes.** The table for codes for units used to indicate the amount of a FP covered is as follows:

A - acres	G - gallons	T - tons
B - bushels	H - head	V - hives
C - hundred weight	L - pounds	W - lugs
E - cases	N - bins	X - boxes
F - flats	S - sacks	Z - stubs

(3-20-20)T

**201. REGISTRATION OF BUYERS, COMMISSION MERCHANTS, AND SELLING AGENTS -- SUBSCRIPTION TO A PML.**

**01. Form.** Registration of buyers, commission merchants, and selling agents must be on SOS form "UCC-5F."  
 (3-20-20)T

**02. Right to Subscribe - Number.** Registration entitles the registrant to subscribe for PMLs. Each registrant will be assigned a permanent registration number by the SOS. (3-20-20)T

**03. Duration.** Registration is effective for a period of one (1) year. Renewal of registration may be filed at any time after ninety (90) days prior to expiration of a current registration period. The registrant must indicate his registration number on the renewal registration form. (3-20-20)T

**04. Change of Name or Address.** Notice of a registrant's change of name or address must be made in writing to the SOS. (3-20-20)T

**05. Initial Subscription.** Subscriptions for PMLs may be made at the time of registration or at any time during the period for which the registrant is registered, provided that no subscription for a PML will run beyond the calendar quarter in which the registration period expires. Subscriptions made at the time of registration must be made on the UCC-5F. (3-20-20)T

**06. Other Subscription.** Subscriptions made other than at the time of registration must be made on SOS form "UCC-6F." The registrant must indicate his registration number on the subscription form. (3-20-20)T

**07. Period of Subscription.** A subscription for any PML may be annual or by calendar quarter or quarters, which quarter or quarters may be at a specified time in the future. (3-20-20)T

**08. Initial Distribution.** If a subscription starts at any time other than the start of a calendar quarter, the registrant will receive the most recent complete compilation of the PML, and all distributions of PMLs for the remainder of the calendar quarter. (3-20-20)T

**09. Special Subscription.** If the registrant subscribes for a PML for fewer than all counties or crop years, the registrant must indicate the county codes of the desired counties or the desired crop years, or both. If no county codes or crop years are indicated, the PML will cover all counties and crop years. (3-20-20)T

**10. Copy of Rules.** At the time of registration, each registrant will be provided with a copy of these rules. (3-20-20)T

**202. -- 299. (RESERVED)**

**300. FORM AND DISTRIBUTION OF A PML AND CS.**

**01. Content of List.** Each PML includes data from all Farm Products Financing Statements which cover a particular PML Grouping. (3-20-20)T

**02. PML Publication Dates.** Each PML is published in complete form on the first regularly scheduled bi-weekly publication date in each calendar quarter. A PML may at other times be published in complete form at the discretion of the SOS when that appears to be more economical than to publish a CS. (3-20-20)T

**03. Supplementation.** At bi-weekly intervals following the publication of each PML, the SOS publishes a CS for each PML. The CS includes all additions, deletions and changes which have occurred since the publication of the last complete PML. Additions are in the same form and cross-indexed in the same way as items on the PML. Deletions and changes need only refer to the affected item in either the PML or the "addition" section of the CS, and state what action has been taken or what change has been made to that item. (3-20-20)T

**04. Cut-Off.** In order to be included on a PML or CS, a Farm Products Financing Statement must be received by the SOS at least one (1) business day prior to publication. (3-20-20)T

**05. Schedule.** At the beginning of each calendar quarter, the SOS distributes to each registrant a schedule of proposed publication dates for that calendar quarter. The SOS may, for good cause, deviate from the schedule, but every PML and CS will be clearly marked with the actual date of publication. In no case will there be more than eighteen (18) days between publications of PMLs and associated CSs. (3-20-20)T

**301. GENERATION OF AD HOC INFORMATION REPORTS.**

**01. Options.** Upon the request of any person, the SOS will provide a list organized or limited according to: (3-20-20)T

- a. An individual farm product or a PML Grouping; (3-20-20)T
- b. Alphabetical order by debtor name; (3-20-20)T
- c. By order of UIN; (3-20-20)T
- d. County; or (3-20-20)T
- e. Crop year. (3-20-20)T

**02. Internal Organization.** When the request is for organization or limitation on the criteria specified in Paragraphs 301.01.a., 301.01.d., and 301.01.e., of these rules, the list will be organized alphabetically within each resulting group unless the request specifies otherwise. (3-20-20)T

**03. Additional Criteria.** The request may specify additional criteria for further organization or limitation within the first grouping. (3-20-20)T

**302. REQUESTS FOR INFORMATION.**

Requests for information on Farm Products Financing Statements will comply with IDAPA 34.05.03, "Rules Governing Requests For Information -- Form UCC-4 -- Fees." (3-20-20)T

**303. FEES.**

**01. Farm Products Financing Statement.** Farm Products Financing Statement and changes thereto (UCC-1F, UCC-2F and UCC-3F). (3-20-20)T

a. The fee for filing either a UCC-1F or a UCC-3F is provided in IDAPA 34.05.06, "Administrative Rules Governing Lien Filings Under the UCC - Farm Product Liens," Section 606. (3-20-20)T

b. There is no charge for filing a complete termination of a Farm Products Financing Statement. (3-20-20)T

**02. Registration of Buyers, Commission Merchants, and Selling Agents.** (3-20-20)T

a. The fee for the annual registration of each buyer, commission merchant, or selling agent is thirty dollars (\$30). (3-20-20)T

b. The registration fee must be paid at the time of registration. (3-20-20)T

c. There is no fee for filing notice of a registrant's change of name or address. (3-20-20)T

**03. Subscription to PMLs by Buyers, Commission Merchants, and Selling Agents.** (3-20-20)T

a. The fee for subscribing to one (1) PML for one (1) year is:

Internet Download (DL)	CD-ROM (CD)	Paper
\$30	\$40	\$200

(3-20-20)T

b. New subscriptions purchased at any time after the beginning of a registration period will be prorated to the current or next fiscal quarter, such that the end of the new subscription coincides with the end of the

- customer's registration period. (3-20-20)T
- c. The subscription fee must be paid at the time the subscription is made. (3-20-20)T
- 04. Ad Hoc Lists.** (3-20-20)T
- a. The fee for generating an ad hoc list as provided in Section 301 of these rules, is thirty-five dollars (\$35) per hour for programming and analysis and eighty-five dollars (\$85) per hour of computer time required to produce the list. In addition thereto, there is a fee of one dollar (\$1) per printed page of the list so generated. (3-20-20)T
  - b. The fee for the generation of the list must be paid prior to or upon receipt of the list. (3-20-20)T
- 05. Fees for Requests for Information.** The fees for requests for information on Farm Products Financing Statements, both written and verbal, and for copies of Farm Products Financing Statements reported on the certificate, are provided in IDAPA 34.05.03, "Rules Governing Requests For Information -- Form UCC-4 -- Fees." (3-20-20)T
- 304. -- 999. (RESERVED)**

**34.05.02 – RULES GOVERNING LIENS IN CROPS FOR SEED  
OR LIENS IN CROPS FOR FARM LABOR**

**000. LEGAL AUTHORITY.**

In accordance with Sections 67-903(9), 45-313(3), and 45-316, Idaho Code, the Secretary of State has authority to promulgate administrative rules in order to execute the duties of the Office of the Secretary of State. (3-20-20)T

**001. TITLE AND SCOPE.**

**01. Title.** These rules shall be cited as IDAPA 34.05.02, “Rules Governing Liens in Crops for Seed or Liens in Crops for Farm Labor,” IDAPA 34, Title 05, Chapter 02. (3-20-20)T

**02. Scope.** These rules shall govern the requirements for the filing, amendment, or termination of liens in crops for seed or liens in crops for farm labor, as well as the creation and distribution of a master list of liens in crops for seed or liens in crops for farm labor. (3-20-20)T

**002. -- 009. (RESERVED)**

**010. DEFINITIONS.**

The definitions set forth in Section 45-302, Idaho Code, apply with full force and effect to all provisions and sections of these rules. Where terms used in this rule are not defined herein, definitions and usage of terms from the Legal Authority in Section 000 of these rules are applicable. (3-20-20)T

**01. Family.** A group of related persons living together as one economic unit, comprised of parents and children, including step-children. (3-20-20)T

**02. Farm Laborer.** Anyone who provides farm labor used in the production of crops. When a business entity contracts for and provides such labor, e.g., aerial spraying or custom harvesting, the entity and not its individual employees shall be deemed to be the farm laborer. When individuals provide such labor directly to a producer, each individual is a farm laborer, whether or not they have been organized as a work crew or are members of a family which works as a unit. (3-20-20)T

**03. Notice of Claim of Lien.** A written notice on the public record of a claimant’s lien in the crops of a producer. (3-20-20)T

**04. SOS.** Idaho Secretary of State. (3-20-20)T

**011. -- 099. (RESERVED)**

**100. REQUIREMENTS FOR NOTICE OF CLAIM OF LIEN.**

**01. Form.** The form for a notice of claim of lien shall be designated “SL-1.” (3-20-20)T

**a.** Form SL-1 must be completed in accordance with instructions provided by the SOS. (3-20-20)T

**b.** Collateral information codes shall be used to indicate the crop and the county where the crop is grown. The collateral information codes shall be assigned by the SOS. The SOS will provide a list of the established codes upon request. (3-20-20)T

**02. Supplement.** If there is insufficient space on the form SL-1 for all producer and claimant information, the excess will be entered on a supplement form designated “SL-2.” (3-20-20)T

**101. AMENDMENT, ASSIGNMENT, EXTENSION, AND RELEASE OF CLAIM OF LIEN.**

**01. Form.** The form for amendment, assignment, extension, and release of claim of lien shall be designated “SL-3.” (3-20-20)T

**a.** Form SL-3 must be completed in accordance with instructions provided by the SOS. (3-20-20)T

**b.** Collateral information codes shall be used to indicate the crop and the county where the crop is grown. The collateral information codes shall be assigned by the SOS. The SOS will provide a list of the established codes upon request. (3-20-20)T

**02. Supplement.** If there is insufficient space on the first page of the form SL-3 for all information, the excess shall be entered on an attached second page SL-3. (3-20-20)T

**102. -- 199. (RESERVED)**

**200. REGISTRATION AND SUBSCRIPTION FOR LIST OF LIENS IN CROPS FOR SEED OR LIENS IN CROPS FOR FARM LABOR.**

Any person may register and subscribe for regular distribution of lists of all presently effective notices of claim of liens in crops for seed or liens in crops for farm labor which have been filed under this rule. Unless otherwise set forth in this chapter, the registration and subscription for the list of liens in crops for seed or liens in crops for farm labor shall be administered by the rules as set forth in IDAPA 34.05.01, "Rules Governing Farm Products Central Filing System," Section 201. (3-20-20)T

**201. LIST OF NOTICES OF CLAIM OF LIEN (LIST).**

**01. Compilation and Distribution.** The SOS shall compile and distribute to subscribers therefore, a list which shall include all presently effective notices of claim of liens in crops for seed or liens in crops for farm labor. (3-20-20)T

**02. Schedule.** The list will be published on a bi-weekly schedule to be established by the SOS. (3-20-20)T

**03. Cut-Off.** In order to be included on a list, a notice of claim of lien must be received by the SOS at least one (1) business day prior to publication. (3-20-20)T

**04. Schedule.** At the beginning of each quarter, the SOS will distribute to each registrant a schedule of proposed publication dates for that calendar quarter. The SOS may, for good cause, deviate from the schedule, but every list will be marked with the actual date of publication. In no case will there be more than eighteen (18) days between publications of lists. (3-20-20)T

**202. -- 299. (RESERVED)**

**300. REQUEST FOR INFORMATION.**

Requests for information on notices of claim of liens in crops for seed or liens in crops for farm labor, both written and verbal, will comply with IDAPA 34.05.03, "Rule Governing Requests For Information -- Form UCC-4 -- Fees." (3-20-20)T

**301. FEES.**

**01. Notice of Claim of Lien.** (3-20-20)T

**a.** The fee is four dollars (\$4) if the form is typed or machine printed, and is eight dollars (\$8) if hand written. (3-20-20)T

**b.** The fee shall be paid at the time of filing. (3-20-20)T

**02. Notice of Amendment, Assignment, or Extension.** (3-20-20)T

**a.** The fee is four dollars (\$4) if the form is typed or machine printed, and is eight dollars (\$8) if hand written. (3-20-20)T

**b.** The fee shall be paid at the time of filing. (3-20-20)T

**03. Notice of Release.** No fee charged. (3-20-20)T

**04. Registration and Subscription for List of Notices.** The fees for registration and subscription shall be as set forth in IDAPA 34.05.01, "Rules Governing Farm Products Central Filing System," Subsections 303.02 and



303.03.

(3-20-20)T

**05. Fees for Requests for Information.** The fees for requests for information on notices of claim of liens in crops for seed or liens in crops for farm labor, both written and verbal, and for copies of notices of claim of liens in crops for seed or liens in crops for farm labor reported on the certificate, are provided in IDAPA 34.05.03, “Rules Governing Requests For Information -- Form UCC-4 -- Fees.” (3-20-20)T

**302. -- 999. (RESERVED)**

### 34.05.03 – REQUESTS FOR INFORMATION – FORM UCC-4 – FEES

#### 000. LEGAL AUTHORITY AND REFERENCES.

- 01. Title 28, Chapter 9, Part 4, Idaho Code. (3-20-20)T
- 02. Title 45, Chapters 2 and 3, Idaho Code. (3-20-20)T
- 03. Title 67, Chapter 52, Idaho Code. (3-20-20)T
- 04. IDAPA 34, Title 05, Chapter 01, “Farm Products Central Filing System.” (3-20-20)T
- 05. IDAPA 34, Title 05, Chapter 02, “Liens in Crops, For Seed and Farm Labor.” (3-20-20)T

#### 001. -- 003. (RESERVED)

#### 004. DEFINITIONS.

- 01. SOS. Secretary of State. (3-20-20)T
- 02. EFS. An effective financing statement relating to farm products, as described in IDAPA 34.05.01, “Rules Governing Farm Products Central Filing System, Office of the Secretary of State.” (3-20-20)T
- 03. **Notice of Lien in Crops.** A notice of claim of lien in crops for seed or farm labor, as described in IDAPA 34.05.02, “Rules Governing Liens in Crops, For Seed, and Farm Labor,” Office of the Secretary of State. (3-20-20)T
- 04. **Notice of Federal Lien.** A notice of lien in personal property filed by the Internal Revenue Service or other federal entity pursuant to Title 45, Chapter 2, Idaho Code. (3-20-20)T
- 05. UCCFS. A financing statement filed pursuant to Sections 28-9-402 and 28-9-403, Idaho Code, other than one relating to farm products. (3-20-20)T
- 06. **Notices.** A collective term used in this rule to include all of the notices and financing statements described in the foregoing Subsections 004.02 through 004.05, as well as all ancillary documents pertaining thereto. (3-20-20)T
- 07. **Debtor.** As used in this rule, “Debtor” shall include a licensee under Title 45, Chapter 2, Idaho Code, and a producer under Title 45, Chapter 3, Idaho Code. (3-20-20)T
- 08. **Secured Party.** As used in this rule, “Secured Party” shall include the federal government under Title 45, Chapter 2, Idaho Code and a claimant under Title 45, Chapter 3, Idaho Code. (3-20-20)T

#### 005. -- 010. (RESERVED)

#### 011. REQUESTS FOR INFORMATION.

- 01. **Content.** Upon the request of any person, the SOS shall issue a certificate showing all notices of the types included in a request naming a particular debtor. The certificate shall include the date and hour of filing of each notice, and the name and address of each secured party named therein. If the requested notices include EFS’s or notices of liens in crops, the certificate shall further include other information described in IDAPA 34.05.01, Subsection 017.03, “Rules Governing Farm Products Central Filing System,” Office of the Secretary of State, and IDAPA 34.05.02, Subsection 015.04, “Rules Governing Liens in Crops, For Seed and Farm Labor,” Office of the Secretary of State, as applicable. (3-20-20)T
- 02. **Form.** The SOS shall prescribe an approved form for such requests, designated “UCC-4.” Other forms may be used, provided they contain all the necessary information and provided that the fee for use of a non-standard form is paid. After January 31, 1993, only the form UCC-4 with a revision date of 10/92 or later will be held to be a standard form. Prior to that date, previously approved forms UCC-4 and UCC-4F will be held to be standard forms for the purposes for which they were intended; e.g. a form UCC-4F may be used to request information on EFS’s, notices of liens in crops, or both; an old UCC-4 may be used to request information on UCCFS’s, and if noted on the UCC-4, on notices of federal liens. A verbally conveyed request will be treated as a non-standard form request. (3-20-20)T

**012. VERBAL REQUESTS FOR INFORMATION.**

**01. SOS Responsibility.** Upon the verbal request of any person, the SOS shall provide, within twenty-four (24) hours, a verbal report of the filing of any notices naming a particular debtor. The SOS will include in the report as much of the information described in Section 011, supra., as the requesting party wants. (3-20-20)T

**02. Time Computation.** In computing the twenty-four (24) hour period, weekends and holidays shall not be counted, pursuant to Section 59-1007, Idaho Code. (3-20-20)T

**03. Attempts to Respond.** If the verbal report is to be made telephonically and the requesting party cannot be reached at the stated telephone number within the twenty-four (24) hour period, the SOS shall attempt to reach the requesting party over an additional twenty-four (24) hour period. If at the end of that time the requesting party has not been reached, the SOS shall be deemed to have fulfilled his obligation to make a timely verbal report. A log of each attempted call shall be maintained by the SOS. At least three (3) attempts to reach the requesting party shall be made in each twenty-four (24) hour period, if the requesting party cannot be reached earlier. (3-20-20)T

**04. Written Confirmation.** The SOS shall follow the verbal report with written confirmation, which shall be in the form of a certificate in response to a non-standard information request as prescribed in Section 011, supra. (3-20-20)T

**013. FEES.**

**01. Single Type.** The fee for the certificate of the SOS showing all notices of a single type is six dollars (\$6). (3-20-20)T

**02. Multiple Types.** The fee for the certificate of the SOS showing all notices of more than one (1) type is ten dollars (\$10). (3-20-20)T

**03. Copies.** The fee for requesting copies of the notices reported on the certificate is six dollars (\$6). (3-20-20)T

**04. Non-Standard.** The fee for use of a non-standard form or for submission of a form which is not typed is four dollars (\$4). (3-20-20)T

**05. Verbal Report.** The fee for providing a verbal report of notices naming a particular debtor is ten dollars (\$10). (3-20-20)T

**06. Single Copies.** The fee for a copy of any notice, when the requesting party provides the document number to the SOS, is one dollar (\$1) per page. (3-20-20)T

**07. Service Suspension.** Notwithstanding any other provision of this rule, cash payment in advance will be required from a requesting party against whom the SOS holds an account receivable more than sixty (60) days past due or which exceeds one hundred dollars (\$100). (3-20-20)T

**014. -- 999. (RESERVED)**

## 34.05.06 – RULES GOVERNING LIEN FILINGS UNDER THE UCC

### 000. LEGAL AUTHORITY AND REFERENCES.

In accordance with Sections 67-903(9) (1977) and 28-9-526 (2001), Idaho Code, the Secretary of State has authority to promulgate administrative rules in order to execute the duties of the Office; this authority includes rules to implement Revised Article 9 of the Uniform Commercial Code, House Bill 205 (2001). (3-20-20)T

### 001. TITLE AND SCOPE.

**01. Title.** These rules shall be cited as IDAPA 34.05.06, “Rules Governing Lien Filings Under the UCC,” IDAPA 34, Title 05, Chapter 06. (3-20-20)T

**02. Scope.** These rules shall govern the filing, acceptance, indexing and searching of financing statements in the Secretary of State’s Office under Article 9 of the Uniform Commercial Code, as amended in 2001. (3-20-20)T

### 002. -- 100. (RESERVED)

## SUBCHAPTER 1 – GENERAL PROVISIONS

### 101. DEFINITIONS.

For the purpose of the rules contained in this chapter, the following definitions apply: (3-20-20)T

**01. Amendment.** A UCC document that purports to amend the information contained in a financing statement. Amendments include assignments, continuations and terminations. (3-20-20)T

**02. Assignment.** An amendment that purports to reflect an assignment of all or a part of a secured party’s power to authorize an amendment to a financing statement. (3-20-20)T

**03. Continuation.** An amendment that purports to continue the effectiveness of a financing statement. (3-20-20)T

**04. Correction Statement.** A UCC document that purports to indicate that a financing statement is inaccurate or wrongfully filed. (3-20-20)T

**05. File Number.** The unique identifying information assigned to an initial financing statement by the filing officer for the purpose of identifying the financing statement and UCC documents relating to the financing statement in the filing officer's information management system. For a financing statement with an initial financing statement filed on or prior to June 30, 2001, the file number includes the seven-digit (7) number assigned to the financing statement by the filing officer. For a financing statement with an initial financing statement filed on or after July 1, 2001, the file number includes three (3) segments; the year of filing expressed as a four-digit (4) number, followed by a unique seven-digit (7) number assigned to the financing statement by the filing office and ending with a one-digit (1) verification number assigned by the filing office but algorithmically derived from the numbers in the first two (2) segments. The filing number bears no relation to the time of filing and is not an indicator of priority. (3-20-20)T

**06. Filing Office and Filing Officer.** The Idaho Secretary of State’s Office. (3-20-20)T

**07. Financing Statement.** An initial financing statement and all UCC documents that relate to the initial financing statement. (3-20-20)T

**08. Individual.** A human being, or a decedent in the case of a debtor that is such decedent's estate. (3-20-20)T

**09. Initial Financing Statement.** A UCC document containing the information required to be in an initial financing statement pursuant to Section 2 of these rules which, when filed, causes the filing office to establish the initial record of the existence of a financing statement in the filing office's UCC information management system. (3-20-20)T

**10. Organization.** A legal person who is not an individual under Subsection 101.08. (3-20-20)T

**11. Remitter.** A person who tenders a UCC document to the filing officer for filing, whether the person

is a filer or an agent of a filer responsible for tendering the document for filing. "Remitter" does not include a person responsible merely for the delivery of the document to the filing office, such as the postal service or a courier service but does include a service provider who acts as a filer's representative in the filing process. (3-20-20)T

**12. Secured Party of Record.** With respect to a financing statement, a secured party or representative of a secured party named on the initial financing statement or, if an assignee is designated on the initial financing statement, instead shall mean the secured party or representative named as such assignee, and shall mean each other secured party or secured party representative named as an additional or substitute secured party on any amendment. Revised Article 9 provides that a person remains a secured party of record until the authorized filing of an amendment indicating that the person is no longer a secured party or secured party representative. However, as the filing officer cannot determine if such an amendment is in fact authorized, a secured party of record on a financing statement is not deleted from the filing officer's information management system until the financing statement lapses. (3-20-20)T

**13. Termination.** An amendment intended to indicate that the related financing statement has ceased to be effective with respect to the secured party authorizing the termination. (3-20-20)T

**14. UCC.** The Uniform Commercial Code as enacted in this state, Section 28-11-101, et seq., Idaho Code. (3-20-20)T

**15. UCC Document.** An initial financing statement, a correction statement or any amendment, including an assignment, a continuation, or a termination. The word "document" in the term "UCC document" shall not be deemed to refer exclusively to paper or paper-based writings. In due time, UCC documents may be expressed or transmitted electronically or through media other than such writings. (Note: this definition is used for the purpose of these rules only. The use of the term "UCC document" in these rules has no relation to the definition of the term "document" in Section 28-9-102(a)(30), Idaho Code.) (3-20-20)T

**102. SINGULAR AND PLURAL FORMS.** Singular nouns shall include the plural form, and plural nouns shall include the singular form, unless the context otherwise requires. (3-20-20)T

**103. PLACE OF FILING.** The Secretary of State's Office is the filing office for filing UCC documents relating to all types of collateral except for timber to be cut, as-extracted collateral (Section 28-9-102(a)(6), Idaho Code) and, when the relevant financing statement is filed as a fixture filing, goods which are or are to become fixtures. (3-20-20)T

**104. FILING OFFICE IDENTIFICATION.** In addition to the promulgation of these rules, the filing office will disseminate information of its location, mailing address, telephone and facsimile numbers, and its internet and other electronic "addresses" through usual and customary means. (3-20-20)T

**105. OFFICE HOURS.** Although the filing office maintains regular office hours, it receives transmissions by facsimile twenty-four (24) hours per day, three hundred sixty-five (365) days per year, except for scheduled maintenance and unscheduled interruptions of service. Electronic filings may be available in the near future, and will be possible twenty-four (24) hours per day, three hundred sixty-five (365) days per year, except for scheduled maintenance and unscheduled interruptions of service. (3-20-20)T

**106. UCC DOCUMENT DELIVERY.** UCC documents may be tendered for filing at the filing office as follows: (3-20-20)T

**01. Personal Delivery, at the Filing Office's Street Address.** The file time for a UCC document delivered by this method is when delivery of the UCC document is accepted by the filing office (even though the UCC document may not yet have been accepted for filing and subsequently may be rejected). (3-20-20)T

**02. Courier Delivery, at the Filing Office's Street Address.** The file time for a UCC document delivered by this method is, notwithstanding the time of delivery, the next close of business following the time of delivery (even though the UCC document may not yet have been accepted for filing and may be subsequently

rejected). A UCC document delivered after regular business hours or on a day the filing office is not open for business will have a filing time of the close of business on the next day the filing office is open for business.

(3-20-20)T

**03. Postal Service Delivery to the Filing Office's Mailing Address.** The file time for a UCC document delivered by this method is the next close of business following the time of delivery (even though the UCC document may not yet have been accepted for filing and may be subsequently rejected). A UCC document delivered after regular business hours or on a day the filing office is not open for business will have a filing time of the close of business on the next day the filing office is open for business.

(3-20-20)T

**04. Facsimile Delivery to the Filing Office's Facsimile Filing Telephone Number.** The file time for a UCC document delivered by this method is, notwithstanding the time of delivery, 5 p.m. on the day the filing office is open to the public next following the time of delivery (even though the UCC document may not yet have been accepted for filing and may be subsequently rejected). A UCC document delivered after regular business hours or on a day the filing office is not open for business will have a filing time of the close of business on the next day the filing office is open for business.

(3-20-20)T

**107. SEARCH REQUEST DELIVERY.**

UCC search requests may be delivered to the filing office by any of the means by which UCC documents may be delivered to the filing office. Requirements concerning search requests are set forth in Section 501. UCC search requests upon a debtor named on an initial financing statement may be made by an appropriate indication on the face of the initial financing statement form if the form is entitled to be filed with the standard form fee and the relevant search fee is also tendered with the initial financing statement

(3-20-20)T

**108. ACCEPTABLE FORMS.**

The forms set forth in Section 28-9-521, Idaho Code, shall be accepted by the filing office. Forms approved by the International Association of Corporation Administrators on or prior to July 1, 2001, and forms approved by the filing office shall be accepted.

(3-20-20)T

**109. -- 110. (RESERVED)**

**111. FILING FEES.**

Section 28-9-525, Idaho Code.

(3-20-20)T

**01. Filing Fee.** The fee for filing and indexing a UCC document of one (1) or two (2) pages communicated on paper or in a paper-based format (including facsimiles) is six dollars \$(6). If there are additional pages, the fee is twelve dollars (\$12). When available, the fee for filing and indexing a UCC document communicated by a medium authorized by these rules which is other than on paper or in a paper-based format shall be three dollars (\$3).

(3-20-20)T

**02. UCC Search Fee.** The fee for a UCC search request communicated on paper or in a paper-based format is twelve dollars (\$12).

(3-20-20)T

**112. (RESERVED)**

**113. METHODS OF PAYMENT.**

Filing fees and fees for public records services may be paid by the following methods:

(3-20-20)T

**01. Cash.** Payment in cash shall be accepted if paid in person at the filing office.

(3-20-20)T

**02. Checks.** Personal checks, business checks, bank-certified checks or cashiers checks and money orders shall be accepted for payment if they are drawn on a bank acceptable to the filing office or if the drawer is acceptable to the filing office.

(3-20-20)T

**03. Prepaid Account.** A remitter may open an account for prepayment of filing fees by submitting an application furnished by the filing officer. Fees may be prepaid in amounts not less than fifty dollars (\$50). The filing officer shall issue an account number to be used by a remitter who chooses to pay filing fees in advance. The filing

officer shall deduct filing fees from the remitter's prepaid account when authorized to do so by the remitter. (3-20-20)T

**114. OVERPAYMENT AND UNDERPAYMENT POLICIES.**

**01. Overpayment.** The filing officer shall refund the amount of an overpayment exceeding two dollars (\$2) to the remitter. The filing officer shall refund an overpayment of two dollars (\$2) or less only upon the written request of the remitter. (3-20-20)T

**02. Underpayment.** Upon receipt of a document with an insufficient fee, the filing officer shall do one (1) of the following. (3-20-20)T

**a.** A notice of the deficiency shall be sent to the remitter and the document shall be held for a period of ten (10) days from the date of the notice, in anticipation of receipt of the fee. Upon receipt of the fee, the document will be filed as of the time and date of receipt of the full filing fee. If the fee has not been received within ten (10) days of the date of the notice, the document shall be returned to the remitter with a written explanation for the refusal to accept the document; or (3-20-20)T

**b.** The document shall be returned to the remitter as provided in Section 205. A refund of a partial payment may be included with the document or delivered under separate cover. (3-20-20)T

**115. PUBLIC RECORDS SERVICES.**

Public records services are provided on a non-discriminatory basis to any member of the public on the terms described in these rules. The following methods are available for obtaining copies of UCC documents and copies of data from the UCC information management system. (3-20-20)T

**01. Individually Identified Documents.** Copies of individually identified UCC documents are available either from a computer terminal in the reception area in the filing office or through any medium otherwise accepted by the filing office. There is a charge of twenty-five cents (\$.25) per page for printed information, but only if four (4) or more pages are printed. (3-20-20)T

**02. Bulk Copies of Documents.** Bulk copies of UCC documents are available in TIF (image) format on CD-ROM. (3-20-20)T

**03. Data from the Information Management System.** A list of available data elements from the UCC information management system, and the file layout of the data elements, are available from the filing officer upon request. Data from the information management system is available as follows: (3-20-20)T

**a.** Full Extract. A bulk data extract of information from the UCC information management system is available on a monthly basis. (3-20-20)T

**b.** Format. Extracts from the UCC information management system are available in ASCII .txt format on CD-ROM. (3-20-20)T

**04. Direct On-Line Services.** On-line services providing UCC information are available on a subscription basis from the State's Internet Portal Manager, Idaho Information Consortium, Inc., d/b/a Access Idaho. A description of subscription services is available from the filing officer or Access Idaho. (3-20-20)T

**116. FEES FOR PUBLIC RECORDS SERVICES.**

Fees for public records services are established as follows: (3-20-20)T

**01. Charge for Paper Copies.** The charge for paper copies of individual documents is twenty-five cents (\$.25) per page if no staff assistance is utilized and one dollar (\$1) per page with staff assistance. Facsimile charge is an additional fifty cents (\$.50) per page. (3-20-20)T

**02. Data From the Information Management System.** The charge for a full extract is one hundred twenty-five dollars (\$125) per monthly delivery. (3-20-20)T

**117. NEW PRACTICES AND TECHNOLOGIES.**

The filing officer may adopt practices and procedures to accomplish receipt, processing, maintenance, retrieval and transmission of, and remote access to, Article 9 filing data by means of electronic, voice, optical and/or other technologies, and, without limiting the foregoing, to maintain and operate, in addition to or in lieu of a paper-based system, a non-paper-based Article 9 filing system utilizing any of such technologies. In developing and utilizing technologies and practices, the filing officer shall, to the greatest extent feasible, take into account compatibility and consistency with technologies, practices, policies and regulations adopted in connection with Article 9 filing systems in other states. (3-20-20)T

**118. -- 199. (RESERVED)**

**SUBCHAPTER 2 – ACCEPTANCE AND REFUSAL OF DOCUMENTS**

**200. ROLE OF FILING OFFICER.**

**01. Duties and Responsibilities.** The duties and responsibilities of the filing officer with respect to the administration of the UCC are ministerial. (3-20-20)T

**02. What the Filing Officer Does Not Do.** In accepting for filing or refusing to file a UCC document pursuant to these rules, the filing officer does not: (3-20-20)T

- a. Determine the legal sufficiency or insufficiency of a document. (3-20-20)T
- b. Determine that a security interest in collateral exists or does not exist. (3-20-20)T
- c. Determine that information in the document is correct or incorrect, in whole or in part. (3-20-20)T
- d. Create a presumption that information in the document is correct or incorrect, in whole or in part. (3-20-20)T

**201. DUTY TO FILE.**

Provided that there is no ground to refuse acceptance of the document under Section 202, a UCC document is filed upon its receipt by the filing officer with the filing fee and the filing officer shall promptly assign a file number to the UCC document and index it in the information management system. (3-20-20)T

**202. GROUNDS FOR REFUSAL OF UCC DOCUMENT.**

The following grounds are the sole grounds for the filing officer's refusal to accept a UCC document for filing. As used herein, the term "legible" is not limited to refer only to written expressions on paper: it requires, when appropriate, a machine-readable transmission for electronic transmissions and an otherwise readily decipherable transmission in other cases. (3-20-20)T

**01. Debtor Name and Address.** An initial financing statement or an amendment that purports to add a debtor shall be refused if the document fails to include a legible debtor name and address for a debtor, in the case of an initial financing statement, or for the debtor purporting to be added in the case of such an amendment. If the document contains more than one debtor name or address and some names or addresses are missing or illegible, the filing officer shall index the legible name and address pairings, and provide a notice to the remitter containing the file number of the document, identification of the debtor name(s) that was (were) indexed, and a statement that debtors with illegible or missing names or addresses were not indexed. (3-20-20)T

**02. Additional Debtor Identification.** An initial financing statement or an amendment adding one or more debtors shall be refused if the document fails to identify whether each named debtor (or each added debtor in the case of such an amendment) is an individual or an organization, if the last name of each individual debtor is not identified, or if, for each debtor identified as an organization, the document does not include in legible form the organization's type, state of organization and organization number (or a statement that it does not have an organization number). UCC documents, including the UCC1 and UCC3, should not contain Social Security Account Numbers or other Taxpayer identification numbers although there are spaces for this information on the approved



UCC1 and UCC3 form. If these numbers are entered on the forms, the filing officer shall cause them not to be readable on the scanned image retained by the filing office. (3-20-20)T

**03. Secured Party Name and Address.** An initial financing statement, an amendment purporting to add a secured party of record, or an assignment, shall be refused if the document fails to include a legible secured party (or assignee in the case of an assignment) name and address. If the document contains more than one secured party (or assignee) name or address and some names or addresses are missing or illegible, the filing officer shall index the legible name and address pairings, and provide a notice to the remitter containing the file number of the document, identification of the secured party (or assignee) names that were indexed, and a statement that secured parties with illegible or missing names or addresses were not indexed. (3-20-20)T

**04. Lack of Identification of Initial Financing Statement.** A UCC document other than an initial financing statement shall be refused if the document does not provide a file number of a financing statement which exists in the UCC information management system and which has not lapsed. (3-20-20)T

**05. Other Required Information.** A UCC document that does not identify itself as an initial financing statement or as another type of UCC document shall be refused. (3-20-20)T

**06. Timeliness of Continuation.** A continuation shall be refused if it is not received during the six (6) month period concluding on the day upon which the related financing statement would lapse. (3-20-20)T

**a. First Day Permitted.** The first day on which a continuation may be filed is the date of the month corresponding to the date upon which the financing statement would lapse, six (6) months preceding the month in which the financing statement would lapse. If there is no such corresponding date during the sixth month preceding the month in which the financing statement would lapse, the first day on which a continuation may be filed is the last day of the sixth month preceding the month in which the financing statement would lapse, although filing by certain means may not be possible on such date if the filing office is not open on such date. (3-20-20)T

**b. Last Day Permitted.** The last day on which a continuation may be filed is the date upon which the financing statement lapses. (3-20-20)T

**07. Fee.** A document shall be refused if the document is accompanied by less than the full filing fee tendered by a method described in Section 113. (3-20-20)T

**08. Means of Communication.** UCC documents communicated to the filing office by a means of communication not authorized by the filing officer for the communication of UCC documents shall be refused. (3-20-20)T

**203. (RESERVED)**

**204. TIME LIMIT.**

The filing officer shall determine whether criteria exist to refuse acceptance of a UCC document for filing not later than the second business day after the date the document would have been filed had it been accepted for filing and shall index a UCC document not so refused within the same time period. (3-20-20)T

**205. PROCEDURE UPON REFUSAL.**

If the filing officer finds any basis under Section 202 to refuse acceptance of a UCC document, the filing officer shall return the document, if written, to the remitter and refund the filing fee. The filing office shall send a notice that contains the date and time the document would have been filed had it been accepted for filing (unless such date and time are stamped on the document), and a brief description of the reason(s) for refusal to accept the document under Section 202. The notice shall be sent to a secured party or the remitter as provided in Subsection 401.02.b. no later than the second business day after of the determination to refuse acceptance of the document. A refund may be delivered with the notice or under separate cover. (3-20-20)T

**206. ACKNOWLEDGMENT.**

**01. When Filing Is a Paper or Paper-Based UCC Document.** At the request of a filer or remitter

who files a paper or paper-based UCC document, the filing officer shall either: (3-20-20)T

**a.** Send to said filer or remitter an image of the record of the UCC document showing the file number assigned to it and the date and time of filing; or (3-20-20)T

**b.** If such filer or remitter provides a copy of such UCC document, note the file number and the date and time of filing on the copy and deliver or send it to said filer or remitter. (3-20-20)T

**02. When Filing Is Not a Paper or Paper-Based UCC Document.** When appropriate for UCC documents not filed in paper or paper-based form, the filing officer shall communicate to the filer or remitter the information in the filed document, the file number and the date and time of filing. (3-20-20)T

**207. OTHER NOTICES.**

Nothing in these rules prevents a filing officer from communicating to a filer or a remitter that the filing officer noticed apparent potential defects in a UCC document, whether or not it was filed or refused for filing. However, the filing office is under no obligation to do so and may not have the resources to do so. THE RESPONSIBILITY FOR THE LEGAL EFFECTIVENESS OF FILING RESTS WITH FILERS AND REMITTERS AND THE FILING OFFICE BEARS NO RESPONSIBILITY FOR SUCH EFFECTIVENESS. (3-20-20)T

**208. REFUSAL ERRORS.**

If a secured party or a remitter demonstrates to the satisfaction of the filing officer that a UCC document that was refused for filing should not have been, the filing officer will file the UCC document as provided in these rules with a filing date and time assigned when such filing occurs. The filing officer will also file a filing officer statement that states the effective date and time of filing which shall be the date and time the UCC document was originally tendered for filing. The lapse date shall be calculated based upon the date the UCC document was originally tendered. (3-20-20)T

**209. -- 299. (RESERVED)**

**SUBCHAPTER 3 – UCC INFORMATION MANAGEMENT SYSTEM**

**300. POLICY STATEMENT.**

The filing officer uses an information management system to store, index, and retrieve information relating to financing statements. The information management system includes an index of the names of debtors named on financing statements which have not been lapsed for more than one (1) year. (3-20-20)T

**301. PRIMARY DATA ELEMENTS.**

The primary data elements used in the UCC information management system are the following: (3-20-20)T

**01. Identification Numbers.** (3-20-20)T

**a.** Each initial financing statement is identified by its file number as described in Subsection 101.05. Identification in the form of the file number of the initial financing statement is stamped on written UCC documents or is otherwise permanently associated with the record maintained for UCC documents in the UCC information management system. A record is created in the information management system for each initial financing statement and all information comprising such record is maintained in such system. Such record is identified by the same information assigned to the initial financing statement. (3-20-20)T

**b.** A UCC document other than an initial financing statement is identified by a unique file number assigned by the filing officer. In the information management system, records of all UCC documents other than initial financing statements are linked to the record of their related initial financing statement. (3-20-20)T

**02. Type of Document.** The type of UCC document from which data is transferred is identified in the information management system from information supplied by the remitter. (3-20-20)T

**03. Filing Date and Filing Time.** The filing date and filing time of UCC documents are stored in the information management system. Calculation of the lapse date of an initial financing statement is based upon the

filing date or the effective filing date as provided in Section 208 of these rules. (3-20-20)T

**04. Identification of Parties.** The names and addresses of debtors and secured parties are transferred from UCC documents to the UCC information management system using one (1) or more data entry or transmittal techniques. (3-20-20)T

**05. Status of Financing Statement.** In the information management system, each financing statement has a status of active or inactive. (3-20-20)T

**06. Lapse Indicator.** An indicator is maintained by which the information management system identifies whether or not a financing statement will lapse and, if it does, when it will lapse. The lapse date is determined as provided in Section 404. (3-20-20)T

**302. NAMES OF DEBTORS WHO ARE INDIVIDUALS.**

The definition of “individual” is found in Subsection 101.08. This rule applies to the name on a UCC document of a debtor or a secured party who is an individual. (3-20-20)T

**01. Individual Name Fields.** The names of individuals are stored in the same files as the names of organizations. Separate data entry fields are established for first (given), middle (given), and last names (surnames or family names) of individuals, and an indicator is marked with “I” to distinguish the name as that of an individual. The filing officer assumes no responsibility for the accurate designation of the components of a name but will accurately enter the data in accordance with the filer's designations. (3-20-20)T

**02. Titles and Prefixes Before Names.** Titles and prefixes, such as “Doctor,” “Reverend,” “Mr.,” and “Ms.,” should not be entered in the UCC information management system. However, as provided in Section 407, when a UCC document is submitted with designated name fields, the data will be entered in the UCC information management system exactly as it appears. (3-20-20)T

**03. Titles and Suffixes After Names.** Titles or indications of status such as “M.D.” and “esquire” shall not be entered in the UCC information management system. Suffixes, such as “Sr.,” “Jr.,” “I,” “II,” and “III,” and “Est” (estate) are entered in a field designated for name suffixes. (3-20-20)T

**04. Truncation -- Individual Names.** Personal name fields in the UCC database are fixed in length. Although filers should continue to provide full names on their UCC documents, a name that exceeds the fixed length is entered as presented to the filing officer, up to the maximum length of the data entry field. The length of data entry name fields are as follows. (3-20-20)T

**a.** First name: Fifty (50) characters. (3-20-20)T

**b.** Middle name: Fifty (50) characters. (3-20-20)T

**c.** Last name: Two hundred fifty-five (255) characters. (3-20-20)T

**d.** Suffix: Ten (10) characters. (3-20-20)T

**05. No Assumed Business Names.** An assumed business name, whether or not on file under Chapter 5, Title 53, Idaho Code, is not the legal name of the individual using the assumed business name. (3-20-20)T

**303. NAMES OF DEBTORS THAT ARE ORGANIZATIONS.**

This rule applies to the names of organizations which are debtors or secured parties on a UCC document. (3-20-20)T

**01. Single Field.** The names of organizations are stored in the same files as the names of individuals. The name of an organization is stored in the last-name field only, and an indicator is marked with “O” to distinguish the name as that of an organization. The filing officer assumes no responsibility for the accurate designation of an organizational name but will accurately enter the data in accordance with the filer's designations. (3-20-20)T

**02. Truncation-Organization Names.** The organization name field in the UCC database is fixed in

length. The maximum length is two hundred fifty-five (255) characters. Although filers should continue to provide full names on their UCC documents, a name that exceeds the fixed length is entered as presented to the filing officer, up to the maximum length of the data entry field. (3-20-20)T

**03. No Assumed Business Names.** An assumed business name, whether or not on file under Chapter 5, Title 53, Idaho Code, is not the legal name of the organization using the assumed business name. (3-20-20)T

**304. ESTATES.**

Although they are not human beings, estates are treated as if the decedent were the debtor under Section 302. "Est" should be entered in the suffix field. (3-20-20)T

**305. TRUSTS.**

If the trust is named in its organic document(s), its full legal name, as set forth in such document(s), is used. Such trusts are treated as organizations. If the trust is not so named, the name of the settlor is used. If a settlor is indicated to be an organization, the name is treated as an organization name. If the settlor is an individual, the name is treated as an individual name. A UCC document that uses a settlor's name should include other information provided by the filer to distinguish the debtor trust from other trusts having the same settlor and all financing statements filed against trusts or trustees acting with respect to property held in trust should indicate the nature of the debtor. If this is done in, or as part of, the name of the debtor, it will be entered as if it were a part of the name under Sections 407 and 408. (3-20-20)T

**306. INITIAL FINANCING STATEMENT.**

Upon the filing of an initial financing statement the status of the parties and the status of the financing statement shall be as follows: (3-20-20)T

**01. Status of Secured Party.** Each secured party named on an initial financing statement shall be a secured party of record, except that if the UCC document names an assignee, the secured party/assignor shall not be a secured party of record and the secured party/assignee shall be a secured party of record. (3-20-20)T

**02. Status of Debtor.** The status of a debtor named on the document shall be active and shall continue as active until one (1) year after the financing statement lapses. (3-20-20)T

**03. Status of Financing Statement.** The status of the financing statement shall be active. A lapse date shall be calculated, five (5) years from the file date, unless the initial financing statement indicates that it is filed with respect to a public-financing transaction or a manufactured-home transaction, in which case the lapse date shall be thirty (30) years from the file date; or, if the initial financing statement indicates that it is filed against a transmitting utility, in which case there shall be no lapse date. A financing statement remains active until one (1) year after it lapses, or if it is indicated to be filed against a transmitting utility, until one (1) year after it is terminated with respect to all secured parties of record. (3-20-20)T

**307. AMENDMENT.**

Upon the filing of an amendment the status of the parties and the status of the financing statement shall be as follows: (3-20-20)T

**01. Status of Secured Party and Debtor.** An amendment shall affect the status of its debtor(s) and secured party(ies) as follows: (3-20-20)T

**a. Collateral Amendment or Address Change.** An amendment that amends only the collateral description or one (1) or more addresses has no effect upon the status of any debtor or secured party. If a statement of amendment is authorized by less than all of the secured parties (or, in the case of an amendment that adds collateral, less than all of the debtors), the statement affects only the interests of each authorizing secured party (or debtor). (3-20-20)T

**b. Debtor Name Change.** An amendment that changes a debtor's name has no effect on the status of any debtor or secured party, except that the related initial financing statement and all UCC documents that include an identification of such initial financing statement shall be cross-indexed in the UCC information management system so that a search under either the debtor's old name or the debtor's new name will reveal such initial financing

statement and such related UCC documents. Such a statement of amendment affects only the rights of its authorizing secured party(ies). (3-20-20)T

**c. Secured Party Name Change.** An amendment that changes the name of a secured party has no effect on the status of any debtor or any secured party, but the new name is added to the index as if it were a new secured party of record. (3-20-20)T

**d. Addition of a Debtor.** An amendment that adds a new debtor name has no effect upon the status of any party to the financing statement, except the new debtor name shall be added as a new debtor on the financing statement. The addition shall affect only the rights of the secured party(ies) authorizing the statement of amendment. (3-20-20)T

**e. Addition of a Secured Party.** An amendment that adds a new secured party shall not affect the status of any party to the financing statement, except that the new secured party name shall be added as a new secured party on the financing statement. (3-20-20)T

**f. Deletion of a Debtor.** An amendment that deletes a debtor has no effect on the status of any party to the financing statement, even if the amendment purports to delete all debtors. (3-20-20)T

**g. Deletion of a Secured Party.** An amendment that deletes a secured party of record has no effect on the status of any party to the financing statement, even if the amendment purports to delete all secured parties of record. (3-20-20)T

**02. Status of Financing Statement.** An amendment shall have no effect upon the status of the financing statement, except that a continuation may extend the period of effectiveness of a financing statement. (3-20-20)T

**308. ASSIGNMENT OF POWERS OF SECURED PARTY OF RECORD.**

**01. Status of the Parties.** An assignment shall have no effect on the status of the parties to the financing statement, except that each assignee named in the assignment shall become a secured party of record. (3-20-20)T

**02. Status of Financing Statement.** An assignment shall have no effect upon the status of the financing statement. (3-20-20)T

**309. CONTINUATION.**

**01. Continuation of Lapse Date.** Upon the timely filing of one (1) or more continuations by any secured party(ies) of record, the lapse date of the financing statement shall be postponed for five (5) years. (3-20-20)T

**02. Status of Parties.** The filing of a continuation shall have no effect upon the status of any party to the financing statement. (3-20-20)T

**03. Status of Financing Statement.** Upon the filing of a continuation statement, the status of the financing statement remains active. (3-20-20)T

**310. TERMINATION.**

**01. Status of Parties.** The filing of a termination shall have no effect upon the status of any party to the financing statement. (3-20-20)T

**02. Status of Financing Statement.** A termination shall have no effect upon the status of the financing statement and the financing statement shall remain active in the information management system until one (1) year after it lapses, unless the termination relates to a financing statement that indicates it is filed against a transmitting utility, in which case the financing statement will become inactive one (1) year after it is terminated with respect to all

secured parties of record. (3-20-20)T

**311. CORRECTION STATEMENT.**

**01. Status of Parties.** The filing of a correction statement shall have no effect upon the status of any party to the financing statement. (3-20-20)T

**02. Status of Financing Statement.** A correction statement shall have no effect upon the status of the financing statement. (3-20-20)T

**312. PROCEDURE UPON LAPSE.**

If there is no timely filing of a continuation with respect to a financing statement, the financing statement lapses on its lapse date but no action is then taken by the filing office. On the first anniversary of such lapse date, the information management system renders or is caused to render the financing statement inactive and the financing statement will no longer be made available to a searcher unless inactive statements are requested by the searcher and the financing statement is still retrievable by the information management system. (3-20-20)T

**313. -- 399. (RESERVED)**

**SUBCHAPTER 4 – FILING AND DATA ENTRY PROCEDURES**

**400. POLICY STATEMENT.**

This section contains rules describing the filing procedures of the filing officer upon and after receipt of a UCC document. It is the policy of the filing officer to file promptly a document that conforms to these rules. Except as provided in these rules, data is transferred from a UCC document to the information management system exactly as the data is set forth in the document. Personnel who create reports in response to search requests type search criteria exactly as set forth on the search request. No effort is made to detect or correct errors of any kind. (3-20-20)T

**401. DOCUMENT INDEXING AND OTHER PROCEDURES BEFORE ARCHIVING.**

**01. Cash Management.** Transactions necessary to payment of the filing fee are performed. (3-20-20)T

**02. Document Review.** The filing office determines whether a ground exists to refuse the document under Section 202. (3-20-20)T

**a. File Stamp.** If there is no ground for refusal of the document, the document is stamped or deemed filed and a unique identification number and the filing date is stamped on the document or permanently associated with the record of the document maintained in the UCC information management system. The sequence of the identification number is not an indication of the order in which the document was received. (3-20-20)T

**b. Correspondence.** If there is a ground for refusal of the document, notification of refusal to accept the document is prepared as provided in Section 205. If there is no ground for refusal of the document, an acknowledgment of filing is prepared as provided in Section 206. Acknowledgment of filing or notice of refusal of a UCC document is sent to the secured party (or the first secured party if there are more than one (1)) named on the UCC document or to the remitter if the remitter so requests by regular mail or by overnight courier if the remitter provides a prepaid waybill or access to the remitter's account with the courier. (3-20-20)T

**402. FILING DATE.**

The filing date of a UCC document is the date the UCC document is received with the proper filing fee if the filing office is open to the public on that date; or, if the filing office is not so open to the public on that date, the filing date is the next date the filing office is so open, except that, in each case, UCC documents received after 5 p.m. shall be deemed received on the following day. The filing officer may perform any duty relating to the document on the filing date or on a date after the filing date. (3-20-20)T

**403. FILING TIME.**

The filing time of a UCC document is determined as provided in Section 106. (3-20-20)T

**404. LAPSE DATE AND TIME.**

A lapse date is calculated for each initial financing statement (unless the debtor is indicated to be a transmitting utility). The lapse date is the same date of the same month as the filing date in the fifth year after the filing date or relevant subsequent fifth anniversary thereof if a timely continuation statement is filed, but if the initial financing statement indicates that it is filed with respect to a public-finance transaction or a manufactured-home transaction, the lapse date is the same date of the same month as the filing date in the thirtieth year after the filing date. The lapse takes effect at midnight at the end of the lapse date. The relevant anniversary for a February 29 filing date shall be March 1 in the fifth year following the year of the filing date. (3-20-20)T

**405. ERRORS OF THE FILING OFFICER.**

The filing office may correct the errors of filing officer personnel in the UCC information management system at any time. If the correction is made after the filing officer has issued a certification date that includes the filing date of a corrected document, the filing officer shall file a filing officer statement in the UCC information management system identifying the record to which it relates, the date of the correction and explaining the nature of the corrective action taken. The notation shall be preserved as long as the record is preserved in the UCC information management system. (3-20-20)T

**406. ERRORS OTHER THAN FILING OFFICE ERRORS.**

An error by a filer is the responsibility of such filer. It can be corrected by filing an amendment or it can be disclosed by a correction statement. (3-20-20)T

**407. DATA ENTRY OF NAMES – DESIGNATED FIELDS.**

A filing should designate whether a name is a name of an individual or an organization and, if an individual, also designate the first, middle and last names and any suffix. When this is done, Subsections 407.01 through 407.03 shall apply: (3-20-20)T

**01. Organization Names.** Organization names are entered into the UCC information management system exactly as set forth in the UCC document, even if it appears that multiple names are set forth in the document or if it appears that the name of an individual has been included in the field designated for an organization name. (3-20-20)T

**02. Individual Names.** On a form that designates separate fields for first, middle, and last names and any suffix, the filing officer enters the names into the first, middle, and last name and suffix fields in the UCC information management system exactly as set forth on the form. (3-20-20)T

**03. Designated Fields Encouraged.** The filing office encourages the use of forms that designate separate fields for individual and organization names and separate fields for first, middle, and last names and any suffix. Filers should be aware that the inclusion of a name in an incorrect field or the failure to transmit a name accurately to the filing office may cause a filing to be ineffective. (3-20-20)T

**408. DATA ENTRY OF NAMES -- NO DESIGNATED FIELDS.**

A UCC document that is an initial financing statement or an amendment that adds a debtor to a financing statement and that fails to specify whether the debtor is an individual or an organization shall be refused by the filing office. If it is accepted for filing in error, the following rules in Subsections 408.01 through 408.04 shall apply: (3-20-20)T

**01. Identification of Organizations.** A name is treated as an organization name if it contains words or abbreviations that indicate status such as the following and similar words or abbreviations in foreign languages: association, church, college, company, co., corp., corporation, inc., limited, ltd., club, foundation, fund, L.L.C., limited liability company, institute, society, union, syndicate, GmbH, S.A. de C.V., limited partnership, L.P., limited liability partnership, L.L.P., trust, business trust, co-op, cooperative and other designations established by statutes to indicate a statutory organization. In cases where organization or individual status is not designated by the filer and is not clear, the filing officer will use his own judgment. (3-20-20)T

**02. Identification of Individuals.** A name is entered as the name of an individual and not the name of an organization when the name is followed by a title substantially similar to one (1) of the following titles, or the equivalent of one (1) of the following titles in a foreign language: proprietor, sole proprietor, proprietorship, sole proprietorship, partner, general partner, president, vice president, secretary, treasurer, M.D., O.D., D.D.S., attorney at

law, Esq., accountant, CPA. In such cases, the title is not entered. (3-20-20)T

**03. Individual and Organization Names on a Single Line.** Where it is apparent that the name of an individual and the name of an entity are stated on a single line and not in a designated individual name field, the name of the individual and the name of the entity shall be entered as two (2) separate debtors, one (1) as an individual and one (1) as an entity. Additional filing fees for the amendment to add additional debtor name(s) may be required. (3-20-20)T

**04. Individual Names.** The failure to designate the last name of an individual debtor in an initial financing statement or an amendment adding such debtor to a financing statement should cause a filing to be refused. If the filing is accepted in error, or if only the last name is designated, the following data entry rules apply: (3-20-20)T

**a. Freestanding Initials.** An initial in the first position of the name is treated as a first name. An initial in the second position of the name is treated as a middle name. (3-20-20)T

**b. Combined Initials and Names.** An initial and a name to which the initial apparently corresponds is entered into one (1) name field only [e.g. “D. (David)” in the name “John D. (David) Rockefeller” is entered as “John” (first name); “D. (David)” (middle name); “Rockefeller” (last name)]. (3-20-20)T

**c. Multiple Individual Names on a Single Line.** Two (2) individual names contained in a single line are entered as two different debtors [e.g. the debtor name “John and Mary Smith” is entered as two (2) debtors: “John Smith” and “Mary Smith”]. (3-20-20)T

**d. One Word Names.** A one (1) word name is entered as a last name [e.g. “Charro” is treated as a last name]. (3-20-20)T

**e. Nicknames.** A nickname is entered in the name field together with the name preceding the nickname, or if none, then as the first name (e.g., “William (Bill) Jones”). (3-20-20)T

**409. VERIFICATION OF DATA ENTRY.**  
The filing officer uses double key entry to verify the accuracy of data entry tasks. (3-20-20)T

**410. INITIAL FINANCING STATEMENT.**

**01. New Record Bears the Unique UCC File Number.** A new record is opened in the UCC information management system for each initial financing statement. The new record bears the unique file number of the financing statement and the date and time of filing. (3-20-20)T

**02. Name and Address of Each Debtor.** The name and address of each debtor that are legibly set forth in the financing statement are entered into the record of the financing statement. Each such debtor name is included in the searchable index and is not removed until one (1) year after the financing statement lapses. (3-20-20)T

**03. Name and Address of Each Secured Party.** The name and address of each secured party that are legibly set forth in the financing statement are entered into the record of the financing statement. (3-20-20)T

**04. Record Is Indexed According to the Name of the Debtor.** The record is indexed according to the name of the debtor(s) and is maintained for public inspection. (3-20-20)T

**05. Lapse Date.** A lapse date is established for the financing statement, and the lapse date is maintained as part of the record. No lapse date is established for a financing statement which indicates it is filed against a transmitting utility. (3-20-20)T

**411. AMENDMENT.**

**01. Date and Time of Filing Amendment.** A record is created for the amendment that bears the file number for the amendment and the date and time of filing. (3-20-20)T



**02. Amendment Initial Financing Statement.** The record of the amendment is associated with the record of the related initial financing statement in a manner that causes the amendment to be retrievable each time a record of the financing statement is retrieved. (3-20-20)T

**03. Amendment Financing Statement Lapses.** The name and address of each additional debtor and secured parties are entered into the UCC information management system in the record of the financing statement. Each such additional debtor name is added to the searchable index and is not removed until one (1) year after the financing statement lapses. (3-20-20)T

**04. New Lapse Date Is Established.** If the amendment is a continuation, a new lapse date is established for the financing statement and maintained as part of its record. (3-20-20)T

**412. CORRECTION STATEMENT.**

A record is created for the correction statement that bears the file number for the correction statement and the date and time of filing. The record of the correction statement is associated with the record of the related initial financing statement in a manner that causes the correction statement to be retrievable each time a record of the financing statement is retrieved. (3-20-20)T

**413. GLOBAL FILINGS.**

**01. Filing a Single UCC Document.** The filing officer may accept for filing a single UCC document for the purpose of amending more than one (1) financing statement, for one (1) or both of the following purposes: (3-20-20)T

**a.** Amendment to change secured party name; or (3-20-20)T

**b.** Amendment to change secured party address. (3-20-20)T

**02. Global Filing.** A global filing shall consist of a written document describing the requested amendment on a form approved by the filing office. Acceptance of a global filing is conditioned upon the determination of the filing officer and is within the filing officer's sole discretion. (3-20-20)T

**414. NOTICE OF BANKRUPTCY.**

The filing officer shall take no action upon receipt of a notification, formal or informal, of a bankruptcy proceeding involving a debtor named in the UCC information management system. (3-20-20)T

**415. -- 499. (RESERVED)**

**SUBCHAPTER 5 – SEARCH REQUESTS AND REPORTS**

**500. GENERAL REQUIREMENTS.**

The filing officer maintains for public inspection a searchable index for all records of UCC documents that provides for the retrieval of a record by the name of the debtor and by the file number of the initial financing statement to which the record relates and which associates each initial financing statement and each filed UCC document relating to the initial financing statement. (3-20-20)T

**501. SEARCH REQUESTS.**

Search requests shall contain the following information: (3-20-20)T

**01. Name Searched.** A search request should set forth the full correct name of a debtor or the name variant desired to be searched and must specify whether the debtor is an individual or an organization. The full name of an individual should consist, whenever possible, of a first, middle, and last name, followed by any suffix that may apply to the name. The full name of an organization shall consist of the name of the organization as stated on the articles of incorporation or other organic documents in the state or country of organization or the name variant desired to be searched. A search request will be processed using the name in the exact form it is submitted. (3-20-20)T

**02. Requesting Party.** The name and address of the person to whom the search report is to be sent. (3-20-20)T

**03. Fee.** The appropriate fee shall be enclosed, payable by a method described in Section 113. (3-20-20)T

**502. OPTIONAL INFORMATION.**

A UCC search request may contain any of the following information: (3-20-20)T

**01. Copies of Documents.** A request that copies of documents referred to in the report be included with the report. The request may limit the copies requested by limiting them by reference to the city of the debtor, the date of filing, or a range of filing dates on the financing statements located by the related search. The request may ask for copies of UCC documents identified on the primary search response. (3-20-20)T

**02. Debtor Name.** A request that the search of a debtor name be limited to debtors in a particular city. A report created by the filing officer in response to such a request shall contain the following statement: "A search limited to a particular city, the date of filing, or a range of filing dates may not reveal all filings against the debtor searched and the searcher bears the risk of relying on such a search." (3-20-20)T

**03. Mode of Delivery.** Instructions on the mode of delivery requested, if other than by ordinary mail, will be honored if the requested mode is at the time available to the filing office. (3-20-20)T

**503. RULES APPLIED TO SEARCH REQUESTS.**

Search results are created by applying standardized search logic to the name presented to the filing officer by the person requesting the search. Human judgment does not play a role in determining the results of the search, except with respect to supplemental responses regarding individual debtor names that are not automated. The following, and only the following, rules are applied to conduct searches: (3-20-20)T

**01. No Limit on Number of Search Matches.** There is no limit to the number of matches that may be returned in response to the search criteria. (3-20-20)T

**02. Not Case Sensitive.** No distinction is made between upper and lower case letters. (3-20-20)T

**03. Punctuation.** Punctuation marks and accents are disregarded. (3-20-20)T

**04. Words and Abbreviations at the End of a Name.** Words and abbreviations at the end of a name that indicate the existence or nature of an organization as set forth in the "Ending Noise Words" list as promulgated and adopted by the International Association of Corporation Administrators, as amended from time to time, are disregarded (e.g., company, limited, incorporated, corporation, limited partnership, limited liability company or abbreviations of the foregoing). (3-20-20)T

**05. "The" Disregarded.** The word "the" at the beginning of the search criteria is disregarded. (3-20-20)T

**06. Spaces.** All spaces are disregarded. (3-20-20)T

**07. Initials.** For first and middle names of individuals, initials are equated with all names that begin with such initials, and no middle name or initial is equated with all middle names and initials. (3-20-20)T

**08. Names Searched On.** After taking the preceding rules into account to modify the name of the debtor requested to be searched and to modify the names of debtors contained in active financing statements in the UCC information management system, the search will reveal only names of debtors that are contained in active financing statements and, as modified, exactly match the name requested, as modified. (3-20-20)T

**504. SEARCH RESPONSES.**

Reports created in response to a search request shall include the following: (3-20-20)T

- 01. Filing Officer.** Identification of the filing officer and the certification of the filing officer required by the UCC. (3-20-20)T
- 02. Report Date.** The date the report was generated. (3-20-20)T
- 03. Name Searched.** Identification of the name searched. (3-20-20)T
- 04. Certification Date.** The certification date applicable to the report; i.e., the date and time through which the search is effective to reveal all relevant UCC documents filed on or prior to that date. (3-20-20)T
- 05. Identification of Initial Financing Statements.** Identification of each unlapsed initial financing statement filed on or prior to the certification date and time corresponding to the search criteria, by name of debtor, by identification number, and by file date and file time. (Lapsed financing statements remain active for one (1) year after the lapse date and may be requested on the search form.) (3-20-20)T
- 06. History of Financing Statement.** For each initial financing statement on the report, a listing of all related UCC documents filed by the filing officer on or prior to the certification date. (3-20-20)T
- 07. Copies.** Copies of all UCC documents revealed by the search and requested by the searcher. (3-20-20)T
- 505. -- 599. (RESERVED)**

#### **SUBCHAPTER 6 – OTHER NOTICES OF LIENS**

**600. POLICY STATEMENT.**

The purpose of the rules in this section is to describe non-UCC liens maintained by the filing office. These liens are treated by the filing officer in a manner similar to UCC documents and are included, on request, with the reports described in Sections 504 and 505. (3-20-20)T

**601. NOTICE OF FEDERAL TAX LIEN.**

- 01. Filing.** Pursuant to Section 45-202, Idaho Code, federal tax liens on business entities, estates, and trusts are filed at the Secretary of State's Office. (3-20-20)T
- a. Fee.** (3-20-20)T
- i.** The fee for filing is six dollars (\$6); (3-20-20)T
- ii.** If there is an attachment there is an additional fee of one dollar (\$1) per page. (3-20-20)T
- b. Duration.** Pursuant to the Internal Revenue Code, federal tax liens have a duration of ten (10) years. (3-20-20)T
- 02. Mechanics of Search.** (3-20-20)T
- a. Fee for Search.** (3-20-20)T
- i.** Six dollars (\$6) for information only; (3-20-20)T
- ii.** Twelve dollars (\$12) for information and copies. (3-20-20)T
- b. Combination Search Available with UCC Search:** (3-20-20)T
- i.** Ten dollars (\$10) for information; (3-20-20)T
- ii.** Sixteen dollars (\$16) for information and copies. (3-20-20)T

**602. NOTICE OF STATE TAX LIEN.**

- 01. Filing.** (3-20-20)T
  - a.** Where to File. The Secretary of State accepts electronic filings from the Idaho Tax Commission pursuant to Chapter 19, Title 45, Idaho Code, and Title 63, Idaho Code. (3-20-20)T
  - b.** Fee. None. (3-20-20)T
  - c.** Duration. Five (5) years. (3-20-20)T
- 02. Mechanics of Search.** (3-20-20)T
  - a.** Fee for Search. (3-20-20)T
    - i.** Six dollars (\$6) for information only; (3-20-20)T
    - ii.** Twelve dollars (\$12) for information and copies. (3-20-20)T
  - b.** Combination Search Available with UCC Search: (3-20-20)T
    - i.** Ten dollars (\$10) for information; (3-20-20)T
    - ii.** Sixteen dollars (\$16) for information and copies. (3-20-20)T

**603. NOTICE OF OTHER LIEN IN FAVOR OF A GOVERNMENTAL BODY (NATURE AND DURATION).**

- 01. State Agencies.** Generally under Chapter 19, Title 45, Idaho Code. (3-20-20)T
  - a.** Department of Commerce and Labor, Chapter 13, Title 72, Idaho Code (unemployment insurance-five year duration). (3-20-20)T
  - b.** Department of Commerce and Labor, Chapter 6, Title 45, Idaho Code (wage claims-five (5) year duration). (3-20-20)T
  - c.** Department of Health and Welfare, Chapter 12, Title 7, Idaho Code (child support-indefinite duration). (3-20-20)T
  - d.** Department of Health and Welfare, Chapter 2, Title 56, Idaho Code (medical assistance-five (5) year duration). (3-20-20)T
- 02. Counties.** Chapter 35, Title 31, Idaho Code (indigent medical-indefinite duration). (3-20-20)T
- 03. Mechanics of Search.** (3-20-20)T
  - a.** Fee for Search. (3-20-20)T
    - i.** Six dollars (\$6) for information only; (3-20-20)T
    - ii.** Twelve dollars (\$12) for information and copies. (3-20-20)T
  - b.** Combination Search Available with UCC Search: (3-20-20)T
    - i.** Ten dollars (\$10) for information; (3-20-20)T

- ii. Sixteen dollars (\$16) for information and copies. (3-20-20)T

**604. SEED AND FARM LABOR LIENS.**

**01. Mechanics of Filing.** Seed and farm labor liens pursuant to Chapter 3, Title 45, Idaho Code are filed in the same manner as initial financing statements and may use only forms prescribed by the Secretary of State's Office. They are indexed by debtor name and will be revealed, on request, by searches under Sections 504 and 505. (3-20-20)T

- a. Where to File. Seed and farm labor liens are filed with the filing office. (3-20-20)T

- b. Fee. (3-20-20)T

- i. Four dollars (\$4), if typed; (3-20-20)T

- ii. Eight dollars (\$8), if handwritten. (3-20-20)T

- c. Duration. (3-20-20)T

- i. Farm labor liens remain in effect for twelve (12) months after filing and may be extended for six (6) months. (3-20-20)T

- ii. Seed liens remain in effect for sixteen (16) months and may be extended for six (6) months. (3-20-20)T

- 02. Mechanics of Search.** (3-20-20)T

- a. Fee for Search. (3-20-20)T

- i. Six dollars (\$6) for information only; (3-20-20)T

- ii. Twelve dollars (\$12) for information and copies. (3-20-20)T

- b. Combination Search Available with UCC Search: (3-20-20)T

- i. Ten dollars (\$10) for information; (3-20-20)T

- ii. Sixteen dollars (\$16) for information and copies. (3-20-20)T

**605. AGRICULTURE COMMODITY LIENS.**

**01. Mechanics of Filing.** Agricultural commodity liens pursuant to Chapter 18, Title 45, Idaho Code are filed in the same manner as initial financing statements and may use only forms prescribed by the Secretary of State's Office. These types of liens are indexed by debtor name and will be revealed, on request, by searches under Sections 504 and 505. (3-20-20)T

- a. Fee. Five dollars (\$5). (3-20-20)T

- b. Duration. Ninety (90) days. (3-20-20)T

- 02. Mechanics of Search.** Fee for search: (3-20-20)T

- a. Five dollars (\$5), if combined with other searches; (3-20-20)T

- b. Ten dollars (\$10) for information; (3-20-20)T

- c. Sixteen dollars (\$16) for information and copies. (3-20-20)T

**606. FARM PRODUCT LIENS.**

**01. Mechanics of Filing.** (3-20-20)T

**a.** Pursuant to Section 28-9-526, Idaho Code, farm product liens are filed in the same manner as initial financial statements and may use only forms prescribed by the Secretary of State's Office. They are indexed by debtor name and will be revealed, on request, by searches under Sections 504 and 505. (3-20-20)T

**b.** Where to File. Farm product liens are filed with the filing office. (3-20-20)T

**c.** Fee. (3-20-20)T

**i.** Ten dollars (\$10), if typed; (3-20-20)T

**ii.** Fourteen dollars (\$14), if handwritten; (3-20-20)T

**iii.** For attachments, it is an additional one dollar (\$1) per printer page. (3-20-20)T

**d.** Duration. Farm product liens remain in effect for five (5) years and may be extended to five (5) years if continuation is received six (6) months prior to lapse. (3-20-20)T

**02. Mechanics of Search.** (3-20-20)T

**a.** Fee for Search: (3-20-20)T

**i.** Six dollars (\$6) for information only; (3-20-20)T

**ii.** Twelve dollars (\$12) for information and copies. (3-20-20)T

**b.** Combination Search Available with UCC Search: (3-20-20)T

**i.** Ten dollars (\$10) for information; (3-20-20)T

**ii.** Sixteen dollars (\$16) for information and copies. (3-20-20)T

**607. -- 999. (RESERVED)**

## IDAPA 36 – IDAHO STATE BOARD OF TAX APPEALS

DOCKET NO. 36-0101-2000F (FEE RULE)

### NOTICE OF OMNIBUS RULEMAKING – ADOPTION OF TEMPORARY RULE

**EFFECTIVE DATE:** The effective date of the temporary rule being adopted through this omnibus rulemaking is the adjournment date of the second regular session of the 65th Idaho State Legislature - March 20, 2020.

**AUTHORITY:** In compliance with Sections 67-5226, Idaho Code, notice is hereby given this agency has adopted a temporary rule. The action is authorized pursuant to Section 63-3808, Idaho Code.

**DESCRIPTIVE SUMMARY:** The following is the required finding and concise statement of its supporting reasons for adopting a temporary rule:

This temporary rulemaking adopts the following chapter under IDAPA 36:

#### **IDAPA 36**

- 36.01.01, *Idaho Board of Tax Appeals Rules*

**TEMPORARY RULE JUSTIFICATION:** Pursuant to Sections 67-5226(1) and 67-5226(2), Idaho Code, the Governor has found that temporary adoption of the rule is appropriate for the following reasons:

These temporary rules are necessary to protect the public health, safety, and welfare of the citizens of Idaho and confer a benefit on its citizens. These temporary rules implement the duly enacted laws of the state of Idaho, provide citizens with the detailed rules and standards for complying with those laws, and assist in the orderly execution and enforcement of those laws. The expiration of these rules without due consideration and processes would undermine the public health, safety, and welfare of the citizens of Idaho and deprive them of the benefit intended by these rules.

**FEE SUMMARY:** Pursuant to Section 67-5226(2), the Governor has found that the fee or charge being imposed is justified and necessary to avoid immediate danger and the fee is described herein:

The fee or charge, authorized in Section 63-3808, Idaho Code, is part of the agency's 2021 budget that relies upon the existence of this fee or charge to meet the state's obligations and to provide necessary state services. Failing to reauthorize these temporary rules would create immediate danger to the state budget, immediate danger to necessary state functions and services, and immediate danger of a violation of Idaho's constitutional requirement that it balance its budget.

The following is a specific description of the fees or charges: This rulemaking does not impose a fee or charge, or increase a fee or charge, beyond what was previously approved and codified in the prior rules. The Board of Tax Appeals operates with one fee rule, Board Rule 151.03. The rule provides a ten-dollar (\$10) cost, to a non-party, for providing a certified copy of a hearing recording.

**ASSISTANCE ON TECHNICAL QUESTIONS:** For assistance on technical questions concerning the temporary rule, contact Steve Wallace at 208-334-3354.

DATED this February 14, 2020.

Steve Wallace, Director  
Idaho Board of Tax Appeals  
1673 W. Shoreline Drive, Suite 120, Boise, ID 83702  
P.O. Box 36, Boise, ID 83720-0088  
Phone: (208) 334-3354  
Fax: (208) 334-4060

# IDAPA 36 – IDAHO STATE BOARD OF TAX APPEALS

## 36.01.01 – IDAHO BOARD OF TAX APPEALS RULES

### 000. LEGAL AUTHORITY (RULE 0).

These rules are promulgated in accordance with Section 63-3808, Idaho Code. (3-20-20)T

### 001. TITLE AND SCOPE (RULE 1).

01. **Title.** These rules are titled IDAPA 36.01.01, “Idaho Board of Tax Appeals Rules.” (3-20-20)T

02. **Scope.** These rules govern procedures before the Idaho Board of Tax Appeals (hereinafter “Board”). (3-20-20)T

### 002. -- 009. (RESERVED)

### 010. DEFINITIONS (RULE 10).

As used in this chapter: (3-20-20)T

01. **Appellant.** A party filing an appeal with the Board. (3-20-20)T

02. **Board.** The Idaho Board of Tax Appeals, board members, presiding officer, or hearing officer as the context may dictate whenever it occurs in this chapter. (3-20-20)T

03. **Case File.** The official record maintained by the Board regarding an appeal. (3-20-20)T

04. **Comparable Sales.** Recently sold properties that are similar in locational and physical characteristics to the property being appraised. “Recently sold property” is property with a sale date prior to the effective date of valuation. (3-20-20)T

05. **De Novo.** The Board decides questions of fact and of law based on the evidence and legal arguments presented before the Board. A de novo review means the parties must present anew any previously submitted evidence or argument they wish to have considered. New evidence and argument may also be presented. (3-20-20)T

06. **Ex Parte.** A communication on behalf of one (1) party with the Board where the other side is not present or included. (3-20-20)T

07. **Parcel.** Each separate property ownership as represented by the county assessment rolls. (3-20-20)T

08. **Party.** A person or governmental subdivision or agency authorized to appear before the Board. (3-20-20)T

09. **Presiding Officer or Hearing Officer.** A member of the Board or other person assigned to conduct a conference or hearing for the Board. (3-20-20)T

10. **Respondent.** A party answering or otherwise responding to an appeal. (3-20-20)T

11. **Subject Property.** The property under discussion. (3-20-20)T

12. **Substantive Issue.** An issue where a right, interest or privilege of any party is involved that may be prejudiced as opposed to minor or mere procedural matter. (3-20-20)T

### 011. ABBREVIATIONS (RULE 11).

01. **BTA.** Idaho Board of Tax Appeals. (3-20-20)T

02. **BOE.** County Board of Equalization. (3-20-20)T

03. **STC.** Idaho State Tax Commission. (3-20-20)T



**012. ORGANIZATION (RULE 12).**

The Chairman of the Board serves as the administrative officer. (3-20-20)T

**01. Election.** The Chairman will be elected annually by the board members in consideration of experience with the Board and the member's availability to serve and support the Board's administrative duties. (3-20-20)T

**02. Power.** The Chairman will oversee the issuance of acknowledgment letters and notices, and is authorized to perform all other procedural duties such as issuing orders on nonsubstantive rulings without a formal meeting of the Board. (3-20-20)T

**013. -- 019. (RESERVED)**

**020. PROCEDURE GOVERNED (RULE 20).**

**01. Procedure.** These rules govern all practice and procedure before the Board. Except as provided in Rules 800 through 860, these rules are affirmatively promulgated to supersede IDAPA 04.11.01, et seq., "Idaho Rules of Administrative Procedure of the Attorney General". (3-20-20)T

**02. Purpose.** The purpose for the establishment of the Idaho Board of Tax Appeals is to provide a fully independent, fair, and less expensive opportunity for taxpayers and other parties to appeal from most tax related decisions of county boards of equalization and the State Tax Commission. (3-20-20)T

**021. LIBERAL CONSTRUCTION (RULE 21).**

These rules will be liberally construed to secure just, speedy, and economical determination of all issues presented to the Board. (3-20-20)T

**022. -- 029. (RESERVED)**

**030. REPRESENTATION AND PRACTICE BEFORE THE BOARD (RULE 30).**

To the extent authorized by law the right to appear and practice before the Board is limited as follows: (3-20-20)T

**01. Natural Persons.** A natural person may represent himself or herself or be represented by an attorney. (3-20-20)T

**02. Corporations.** Duly authorized directors or officers of corporations representing the corporations for which they are, respectively, directors or officers; (3-20-20)T

**03. Limited Liability Company (LLC).** A duly authorized member, or a manager of a manager-managed LLC, representing the LLC for which they are, respectively, a member or manager; (3-20-20)T

**04. Partnerships, Joint Ventures and Trusts.** Duly authorized partners, joint venturers, or trustees representing their respective partnerships, joint ventures or trusts; (3-20-20)T

**05. Authorized Attorneys.** Attorneys duly authorized and qualified to practice in the courts of the state of Idaho; (3-20-20)T

**06. Public Officers.** Public officers or designated representatives when representing the governmental agency; (3-20-20)T

**031. INITIAL PLEADING -- LISTING OF REPRESENTATIVES (RULE 31).**

The initial pleading of each party must name the party's qualified representative for service of documents and include the representative's address for receiving documents. Service of documents on the named representative is valid service upon the party. If no person is explicitly named as representative, the person signing the initial pleading will be considered the representative. (3-20-20)T

**032. SUBSTITUTION OF REPRESENTATIVE (RULE 32).**

A party's representative may be changed by notice to the Board and to all other parties when the proceedings are not unreasonably delayed. The presiding officer may permit substitution of a representative at hearing. (3-20-20)T

**033. PARTICIPATION BY TAXING AUTHORITY (RULE 33).**

In proceedings where a taxing authority may participate, or in any instance where a report or recommendation of the taxing authority may be considered in reaching a decision, at the timely request of a party or upon the Board's motion, an informed representative of the taxing authority shall appear at hearing and be available for examination. When such a representative is summoned, the taxing authority may further participate in the hearing as a party. (3-20-20)T

**034. (RESERVED)**

**035. CONDUCT (RULE 35).**

A party, representative or witness shall conduct themselves in all Board proceedings in an ethical, respectful, and courteous manner. (3-20-20)T

**036. ENFORCEMENT (RULE 36).**

The Board and each party to an appeal are responsible for the efficient, just, and speedy conduct of the formal hearing and other proceedings before the Board. Board members or the assigned hearing officer may impose sanctions on a party for delays, the failure to comply with a subpoena or discovery order, for discovery procedure abuses, and for any other matter regarding conduct of the appeal. Board sanctions include, but are not limited to, dismissal of an appeal or the granting of default judgment. (3-20-20)T

**037. EX PARTE COMMUNICATIONS (RULE 37).**

**01. Prohibited Ex Parte.** Unless permitted by law, the Board shall not communicate regarding any substantive issue with any party, except upon notice and opportunity for all parties to participate in the communication. (3-20-20)T

**02. Permitted Ex Parte.** The Board may communicate ex parte with a party concerning a procedural or administrative matter. (3-20-20)T

**038. -- 044. (RESERVED)**

**045. NOTICE OF APPEAL: CONTENTS (RULE 45).**

**01. Basic Contents.** An appeal must be in writing and contain clear and concise statements of the matters that lay foundation for the relief claim that may be granted by the Board. (3-20-20)T

**02. Additional Contents.** The appeal shall further contain: (3-20-20)T

**a.** Appellant's full name, mailing address and telephone number; (3-20-20)T

**b.** The tax year(s) associated with the appeal; and (3-20-20)T

**c.** A signed statement by a natural person/appellant or by a qualified representative that the notice of appeal contents are correct. (3-20-20)T

**03. Appeal Filed by an Attorney or Representative.** An appeal filed by a qualified representative shall contain: (3-20-20)T

**a.** The representative's name, official title, mailing and street addresses, telephone number; and (3-20-20)T

**b.** If the representative is an attorney, the Idaho State Bar License number. (3-20-20)T

**04. Change in Address or Phone Number.** A party or representative must provide written notice to the Board and other parties of any change in contact information. (3-20-20)T

**046. NOTICE OF APPEAL: BOE APPEALS (RULE 46).**

**01. Separate Notice.** Each parcel assessment appealed must use a separate Board Appeal Form or separate notice of appeal. (3-20-20)T

**02. BOE Appeal.** An appeal brought under Section 63-511, Idaho Code, the notice of appeal shall contain: (3-20-20)T

**a.** A legal description of the property relating to the appeal; (3-20-20)T

**b.** A copy of the county board of equalization's final decision, and when available, the decision's postmarked mailing envelope or any accompanying certificate of service; (3-20-20)T

**c.** For a valuation appeal, a clear declaration of the alleged market value for the subject property. For a property tax exemption claim, the Idaho Code section(s) associated with the claim and a summary of the factual basis supporting why exempt status should be granted or denied; and (3-20-20)T

**d.** A copy of the final tax assessment notice for the assessment appealed. (3-20-20)T

**03. Filing Place.** A BOE appeal must be filed with the county auditor in the county in which the property assessment originated. (3-20-20)T

**047. NOTICE OF APPEAL: STC APPEALS (RULE 47).**

An appeal brought under Section 63-3049 or 63-707, Idaho Code, shall contain: (3-20-20)T

**01. Attachment.** A copy of the written decision being appealed; (3-20-20)T

**02. Objections.** A list of objections to the STC's decision and the basis for said objections; (3-20-20)T

**03. Amount in Dispute.** A statement of the amount in dispute for each applicable tax year or period; and (3-20-20)T

**04. Security Deposit.** When applicable, proof of compliance with the deposit requirements in Section 63-3049(b), Idaho Code, in the form of a receipt or documented acknowledgment from the STC. (3-20-20)T

**048. ACKNOWLEDGMENT (RULE 48).**

**01. Acknowledgment Letter.** An acknowledgment letter will be mailed within fourteen (14) days of the receipt of an appeal in the Board's office. The Board may acknowledge multiple appeals by the same party with a single letter. Such acknowledgment does not constitute a formal consolidation of the appeals. (3-20-20)T

**02. Defective Appeal.** If an appeal is found to be materially defective, untimely, or not substantially in compliance with the requirements of this chapter the Board may dismiss such appeal. (3-20-20)T

**049. (RESERVED)**

**050. ANSWER TO APPEAL (RULE 50).**

A respondent or intervenor may file with the Board an answer to a notice of appeal. The answer shall be filed at least fifteen (15) days prior to hearing. (3-20-20)T

**051. (RESERVED)**

**052. COUNTY AUDITOR REQUIREMENT (RULE 52).**

**01. Contents.** Upon receiving a notice of appeal to the Board under Section 63-511, Idaho Code, the county auditor shall transmit to the Board: (3-20-20)T

**a.** A copy of the notice of appeal including the date of receipt, and if received by mail, a copy of the mailing envelope; (3-20-20)T

**b.** The exhibits or other evidence considered by the BOE; (3-20-20)T

**c.** A copy of the initial appeal to the BOE; (3-20-20)T

**d.** A copy of any decision made or action taken by the BOE together with the mailing date of the notice of decision or other proof of service; (3-20-20)T

**e.** A copy of the certified minutes for related BOE proceedings, or a verbatim record provided on its own distinct storage device; and (3-20-20)T

**f.** When applicable, a certificate that the BOE failed to act on the appeal in the time required. (3-20-20)T

**02. Minutes.** The minutes should include at a minimum: (3-20-20)T

**a.** The full name of persons appearing before the BOE in the appeal; (3-20-20)T

**b.** Clear identification of the parcel number associated with the assessment appealed; and (3-20-20)T

**c.** The decision made by the BOE specifying the value determined or exempt status decided for each parcel. (3-20-20)T

**053. -- 054. (RESERVED)**

**055. CONSOLIDATION (RULE 55).**

Whenever two (2) or more ad valorem cases from the same county or different counties involve the same or substantially similar issues and the same or similar property, or where the same or similar issues exist in other tax type cases, the Board may issue a written or verbal order consolidating the cases. There shall be no consolidation of cases where the rights of any party would be prejudiced. Parties may also request a consolidation. Prior to issuing a consolidation order, the Board will consider whether the parcels are contiguous, any response given to a consolidation request, and any other matters deemed appropriate in judging whether consolidation would likely be beneficial. (3-20-20)T

**056. -- 059. (RESERVED)**

**060. FORM OF PLEADINGS (RULE 60).**

**01. Form.** Pleadings, except those filed on Board forms, submitted by a party and intended to be part of the record should be double-spaced: (3-20-20)T

**a.** State the title of the pleading and the appeal number at the top of the cover page; (3-20-20)T

**b.** Include the name, mailing and street address, and if available, the telephone and FAX number of the person filing the document; and (3-20-20)T

**c.** Be signed by a qualified representative. (3-20-20)T

**061. SERVICE OF DOCUMENTS (RULE 61).**

**01. Service.** A notice, motion, brief, or other document submitted to the Board will be served upon all other parties' representatives of record. Service by regular mail is adequate service. A Board notice, order, or final

decision is served upon a party's representative of record. The Board may direct documents be served on persons who are not parties. (3-20-20)T

**02. Proof of Service.** Every document filed with the Board must be accompanied by a certificate of service. The following is an example:

CERTIFICATE OF SERVICE

I HEREBY CERTIFY that on this \_\_\_\_\_ day of \_\_\_\_\_, 20XX I caused to be served a true copy of the foregoing attached document by the method indicated below and addressed to each of the following:

(representative's name)	_____	U.S. Mail, Postage Prepaid
(mailing address)	_____	Hand Delivered
	_____	Overnight Mail
	_____	Certified Mail
(Signature)	_____	
(printed name of person signing)	_____	

(3-20-20)T

**062. DEFECTIVE, INSUFFICIENT OR LATE PLEADING (RULE 62).**

A defective, insufficient, or untimely pleading may be returned, denied, or dismissed.

(3-20-20)T

**063. AMENDMENTS TO PLEADINGS -- WITHDRAWAL OF PLEADINGS (RULE 63).**

The presiding officer may allow any pleading to be amended or corrected or any omission to be supplied. Pleadings will be liberally construed, and defects that do not affect substantial rights of the parties will be disregarded. A party desiring to withdraw an appeal should file a notice of withdrawal and serve all parties with a copy. (3-20-20)T

**064. (RESERVED)**

**065. COMPUTATION OF TIME (RULE 65).**

In computing any period of time prescribed or allowed by these rules or by any applicable statute, the day of the act, event or default from which the designated period begins to run shall not be included. The last day of the period so computed shall be included in the count unless it is a weekend or legal holiday, in which event the period runs until the end of the next business day. (3-20-20)T

**066. FILING (RULE 66).**

**01. Document Filing Place.** A document filed with the Board shall be filed at the Board's mailing address or street address. (3-20-20)T

**02. Number of Copies.** Unless otherwise indicated by the Board, one (1) copy shall be filed. (3-20-20)T

**03. Fax Filing.** A filing by facsimile (fax) transmission is permitted for a notice of withdrawal or settlement, and for a notice or motion requiring an immediate response by the Board. Except for a notice of withdrawal, an original must be mailed to the Board and served on all other parties the same day. (3-20-20)T

**a.** The transmission must be legible and received in its entirety during office hours for it to be considered filed on the transmission date. (3-20-20)T

b. When making a filing by fax, if another party to the case is equipped with fax facilities, the service on that party should include fax service. (3-20-20)T

c. The originating party shall assume the risk in fax filing and retain proof of filing by fax. (3-20-20)T

**067. -- 069. (RESERVED)**

**070. PREHEARING CONFERENCE (RULE 70).**

**01. Subject of Conference.** The Board may direct parties to appear before it to consider: (3-20-20)T

a. Any and all matters that can be agreed upon. (3-20-20)T

b. Formulating or simplifying the issues. (3-20-20)T

c. Stipulations which will avoid unnecessary proof. (3-20-20)T

d. Preliminary motions to be made prior to the hearing. (3-20-20)T

e. Requiring respondent and appellant to furnish to each other and the Board a list of all witnesses to be called by the parties at the hearing. (3-20-20)T

f. The limitation of the number of expert or lay witnesses and the disclosure of the identity of persons having knowledge of relevant facts and who may be called as a witness. (3-20-20)T

g. The scheduling of discovery, hearings, or other time sensitive matters. (3-20-20)T

h. Discussing settlement. (3-20-20)T

i. Fair hearing procedures. (3-20-20)T

j. Such other matters that may expedite orderly and speedy conduct as will aid in the disposition of the controversy. (3-20-20)T

**02. Notice of Prehearing Conference.** Notice of the place, date and hour of a prehearing conference will be served at least fourteen (14) days before the time set for the conference, unless the presiding officer finds it necessary or appropriate for the conference to be held earlier. Notices for prehearing conference contain the same information as notices of hearing regarding the Board's obligations under the American with Disabilities Act. (3-20-20)T

**03. Failure to Appear.** Failure of either party to appear at the time and place appointed by the Board under Rule 70 may result in a dismissal of the appeal or the granting of said appeal. (3-20-20)T

**04. Prehearing Order.** The Board or its designate may prepare or require the preparation of an order reciting the findings and action taken at such conference. A prehearing order will control the course of subsequent proceedings unless modified by the Board for good cause. (3-20-20)T

**05. Determination Upon Results of Conference.** If, after the prehearing conference provided for in Rule 70, and after appropriate notice to the parties, the Board determines that there is sufficient evidence and stipulation upon which it can make a decision, it may determine the appeal without conducting a hearing. (3-20-20)T

**071. (RESERVED)**

**072. MOTIONS (RULE 72).**

- 01. Form and Contents.** A motion should: (3-20-20)T
- a.** Fully state the facts upon which it is based; (3-20-20)T
  - b.** Refer to the particular provision of statute, rule, order, notice, or other controlling law upon which it is based; and (3-20-20)T
  - c.** State the relief sought. (3-20-20)T
- 02. Oral Argument.** If the moving party desires oral argument on the motion it must state so in the motion. (3-20-20)T
- 03. Prehearing Motions.** Unless otherwise provided in these rules, a prehearing motion must be filed at least fifteen (15) days prior to a scheduled hearing to be considered by the Board. (3-20-20)T
- 04. Answer to Motion.** An answer to a motion, or a request for additional time to respond, may be filed within ten (10) days after the filing of the motion. (3-20-20)T
- 073. (RESERVED)**
- 074. BRIEFS (RULE 74).**  
The Board may order briefs from the parties prior to the hearing of the evidence or after said hearing. (3-20-20)T
- 075. DISCOVERY (RULE 75).**
- 01. Written Permission.** A party to a pending appeal may engage in discovery limited to a single discovery request upon the written order of the Board. The following procedures govern discovery: (3-20-20)T
- a.** The request for discovery must be filed within twenty (20) days of the mailing date of the Board's appeal acknowledgment letter. (3-20-20)T
  - b.** The request should contain a statement covering the reasons the discovery is useful to the preparation of the appeal. (3-20-20)T
  - c.** The request must include a complete copy of the discovery request. (3-20-20)T
  - d.** Discovery must be completed at least ten (10) days prior to the scheduled hearing, unless otherwise ordered by the Board. (3-20-20)T
  - e.** The Board may deny a discovery request that does not comply with the requirements of this chapter. (3-20-20)T
  - f.** Discovery responses shall be served simultaneously on all other parties. At the same time, the responding party shall file with the Board a notice stating when and on whom the response was served. The actual contents of discovery responses will not be filed with the Board unless the order so directs. Discovery responses shall be signed by a qualified representative, and in the instance of interrogatory answers, the response shall also be signed by the person answering. Such signatures constitute a certification that the signer has reviewed the responses or answers and attests to their completeness and accuracy. (3-20-20)T
  - g.** The discovery order may provide that voluminous answers need not be served so long as the documents are made available for inspection and copying under reasonable terms. (3-20-20)T
- 02. Scope and Method of Discovery: BOE Appeals.** The method of discovery is limited to production requests and written interrogatories. The scope of discovery must pertain to the subject property, comparable sale, or a comparable rental. (3-20-20)T
- a.** The scope of discovery also includes: (3-20-20)T

i. Information or records concerning an appraisal, assessment, financial statement or related schedule, a completed study or report, and contracts including a sale agreement; (3-20-20)T

ii. The identity of individuals who will be called to testify as witnesses and a summary of their expected testimony; and (3-20-20)T

iii. For an exemption appeal, information or documents relating to the claimed exemption. (3-20-20)T

b. In a valuation case the request for production of documents or written interrogatories is limited to information from the last three (3) years preceding the assessment date unless otherwise specified by the Board. (3-20-20)T

c. The request for production of documents shall specifically identify each document requested. The request for inspection of land or other property shall be in accordance with the Idaho Rules of Civil Procedure. (3-20-20)T

d. The Board may limit or expand the above scope and method of discovery when it deems such action is appropriate. (3-20-20)T

**03. Scope and Method of Discovery: STC Appeals.** (3-20-20)T

a. Production requests, requests for admissions and written interrogatories are permissible methods of discovery. The Board may limit the scope and method of discovery when it deems such action appropriate. (3-20-20)T

b. A deposition may be taken when allowed by the Board. (3-20-20)T

**04. Supplementation of Response.** The party responding to a discovery order is under a continuing duty to promptly supplement an earlier response upon the availability of new information. (3-20-20)T

**05. Special Case.** The Board may order additional or reciprocal discovery not provided by this rule. (3-20-20)T

**06. Sanctions.** Failure to substantially comply with Board ordered discovery in a good faith attempt at full compliance, may result in one or more sanctions up to and including a dismissal or default judgment of the appeals. (3-20-20)T

**076. -- 084. (RESERVED)**

**085. INTERVENTION (RULE 85).**

**01. Intervention of Right.** Upon written application received fifteen (15) days prior to the hearing of an appeal, anyone shall be permitted to intervene in an appeal when: (3-20-20)T

a. The applicant demonstrates in writing an interest relating to the property or transaction which is the subject of the action that is not adequately represented by existing parties; and (3-20-20)T

b. The Idaho State Tax Commission may intervene as a matter of right. (3-20-20)T

**02. Permissive Intervention.** Upon written application received at least fifteen (15) days prior to the hearing of an appeal a person may be permitted to intervene: (3-20-20)T

a. In an appeal brought under Section 63-511, Idaho Code, when an applicant can show in writing that he is a person aggrieved by the BOE decision; (3-20-20)T

b. When an applicant's claim or defense and the main action have a question of law or fact in



common; or (3-20-20)T

**c.** When a party to an action relies for ground of claim or defense upon any statute or executive order administered by a federal or a state governmental officer or agency or upon any regulation, order, requirement or agreement issued or made pursuant to the statute or executive order, the officer or agency may be permitted to intervene in the action. (3-20-20)T

**d.** The Board may deny or conditionally grant a petition to intervene for untimely filing that fails to state good cause for the late filing, to prevent disruption or undue delay, due to prejudice to existing parties or undue broadening of the issues, or for other reasons. An intervener who does not file a timely petition is bound by orders and notices earlier entered as a condition of granting the untimely petition. (3-20-20)T

**086. -- 099. (RESERVED)**

**100. FAIR HEARING (RULE 100).**

**01. Hearing Opportunity.** All parties shall be afforded an opportunity for a fair hearing to present evidence and argument. (3-20-20)T

**02. Purpose of Hearing.** The Board's goal in conducting hearings is the acquisition of sufficient, accurate evidence to support a fair and just determination of the issues on appeal. (3-20-20)T

**03. Notice of Hearing -- Mailing.** A notice of hearing shall be mailed at least twenty (20) days before the date set for hearing. (3-20-20)T

**04. Setting of Hearing.** The Board will schedule a reasonably convenient time and place where each party may appear and offer evidence and argument in support of their position. (3-20-20)T

**05. Telephonic Hearing.** The Board may conduct a telephonic hearing wherein each participant has an opportunity to participate in the entire hearing. (3-20-20)T

**06. Notice of Hearing -- Contents.** The notice of hearing shall include: (3-20-20)T

**a.** A statement of the place, date, and time of the hearing; (3-20-20)T

**b.** A statement of the legal authority under which the hearing is to be held; (3-20-20)T

**c.** A reference to the sections of statute or rule concerning the conduct of the hearing; (3-20-20)T

**d.** The name of the hearing officer who is scheduled to conduct the hearing; and (3-20-20)T

**e.** A short and simple statement of the matters asserted or the issues involved. (3-20-20)T

**07. Conference or Recess.** The presiding officer may convene the parties before hearing or recess the hearing to discuss formulation of issues, admissions of fact or identification of documents to avoid unnecessary proof, exchange of documents, exhibits or prepared testimony, limitation of witnesses, establishment of order of procedure, and other matters that may expedite an orderly hearing. (3-20-20)T

**101. FAILURE TO APPEAR (RULE 101).**

**01. Default or Dismissal.** Failure of either party to appear at the time and place appointed by the Board may result in a dismissal of that appeal or of the granting of the appeal. (3-20-20)T

**02. Waiver of Appearance.** Upon written stipulation of parties that no facts are at issue, an appeal may be submitted to the Board without oral argument. However, the Board may require appearance for argument or presentation of evidence. (3-20-20)T

**102. WITHDRAWAL (RULE 102).**

An appellant may withdraw the notice of appeal in writing, by electronic filing, or on the record at hearing. (3-20-20)T

**103. -- 104. (RESERVED)**

**105. INFORMAL DISPOSITION -- SETTLEMENT (RULE 105).**

Any appeal may be dismissed by the Board by stipulation, agreed settlement, consent order, or default. For good cause shown and upon written motion made within ten (10) days of entry of a Board order, the Board may set aside such order. (3-20-20)T

**01. Formalizing Agreements.** An agreement by the parties may be put on the record or may be reduced to writing and filed with the Board. (3-20-20)T

**02. Confidentiality.** Settlement negotiations in a contested case are confidential, unless all participants to the negotiation agree to the contrary in writing. Facts disclosed, offers made and all other aspects of negotiation (except agreements reached) in settlement negotiations are not part of the record. (3-20-20)T

**03. Consideration of Settlement.** The Board may convene an evidentiary hearing to consider the reasonableness of the settlement and whether acceptance of the settlement is consistent with the Board's charge under the law. (3-20-20)T

**04. Burden of Proof.** Proponents of a proposed settlement carry the burden of showing that the settlement is in accordance with the law. (3-20-20)T

**106. PRESIDING OFFICER (RULE 106).**

Any member of the Board or assigned hearing officer may preside at the hearing and shall have power to: (3-20-20)T

**01. Oath or Affirmation.** Administer oaths or affirmations, call a party or other person present at hearing as a witness, examine witnesses and receive evidence; (3-20-20)T

**02. Hearing.** Regulate the course of the hearing and maintain an orderly proceeding; (3-20-20)T

**03. Motions.** Dispose of procedural requests, motions or similar matters; (3-20-20)T

**04. Certification by Board.** Make decisions or proposals for decisions subject to certification by a majority of the Board; (3-20-20)T

**05. Official Record.** Develop a full and accurate record and certify the record of said appeal on behalf of the Board; and (3-20-20)T

**06. Other Action.** Take any other appropriate action reasonable under the circumstances. (3-20-20)T

**107. PROCEDURE AND TESTIMONY (RULE 107).**

**01. Preliminary Procedure.** The presiding officer shall call the proceeding for hearing and proceed to take the appearances and act upon any pending motion. Parties may then make opening statements. (3-20-20)T

**02. Testimony.** All testimony, except matters noticed officially or entered by stipulation at hearings or prehearing conference, shall be taken only on oath or affirmation. (3-20-20)T

**03. Order of Procedure.** The appellant shall present first with the respondent and any intervenor then presenting. Parties may then make closing statements. The presiding officer may require the submission of briefs in addition to, or in lieu of, closing arguments. A maximum of two (2) weeks is normally allowed to submit these briefs. The presiding officer may prescribe a different procedure than herein provided. (3-20-20)T

**04. Presentation of Evidence.** Evidence may be presented in the following order: (3-20-20)T

- a. Evidence is presented by appellant. (3-20-20)T
- b. Evidence is presented by any intervening or opposing party. (3-20-20)T
- c. Rebuttal evidence is presented by appellant. (3-20-20)T
- d. Surrebuttal evidence is presented by any intervening or opposing party. (3-20-20)T
- 05. Examination of Witness.** Regarding any witness who testifies, the following examination may be conducted: (3-20-20)T
  - a. Direct examination by the party who called the witness. (3-20-20)T
  - b. Cross-examination by any intervening or opposing party. (3-20-20)T
  - c. Redirect examination by the party who called the witness. (3-20-20)T
  - d. Recross-examination by any intervening or opposing party. (3-20-20)T
  - e. Examination by the presiding officer. (3-20-20)T

**108. -- 109. (RESERVED)**

**110. STIPULATIONS (RULE 110).**

With the approval of the presiding officer the parties may stipulate as to any fact at issue. The stipulation may be filed, or offered through an exhibit or by oral statement shown upon the hearing record. Any such stipulation shall be binding upon all parties so stipulating and may be regarded by the Board as evidence. The Board, however, may require evidence of the facts stipulated, notwithstanding the stipulation. (3-20-20)T

**111. CONTINUANCE (RULE 111).**

**01. Continuances.** A continuance may be ordered by the Board upon filing of a timely and written motion containing the stipulated agreement and signature of all parties. Timely means at least fifteen (15) days prior to a noticed hearing date. The motion shall show a detailed good cause and contain the specific time extension requested. (3-20-20)T

**02. Consideration.** Continuances are disfavored by the Board. The Board may grant a single continuance only when unusual and highly pressing circumstances are present. In no instance shall an extension cause a delay in proceedings for more than three (3) months. In no instance may a second continuance be granted. (3-20-20)T

**112. -- 114. (RESERVED)**

**115. OFFICIAL NOTICE (RULE 115).**

The Board may take official notice of judicially cognizable facts. In addition, the Board may take notice of general, technical, financial, or scientific facts within the Board's specialized knowledge. Parties shall be notified either before or during the hearing of the material noticed. Parties shall be given a reasonable opportunity to object, review, examine, and rebut or contest the information sought to be noticed. (3-20-20)T

**116. OPEN HEARINGS AND CLOSED DELIBERATIONS (RULE 116).**

**01. Public Hearings.** Hearings conducted by the Board are open to the public except where confidential evidence is being taken under a protective order. (3-20-20)T

**02. Closed Deliberations.** The Board may recess to closed deliberations for the limited purpose of deciding the matter before it. (3-20-20)T

**117. RULES OF EVIDENCE (RULE 117).**

**01. Evidence, Admissibility and Evaluation.** Evidence should be taken by the Board to assist the parties' development of the record. The presiding officer is not bound by the Idaho Rules of Evidence. No informality in any proceeding or in the manner of taking testimony invalidates evidence. The presiding officer may exclude evidence that is irrelevant, immaterial, unduly repetitious, or inadmissible on constitutional or statutory grounds, or on the basis of any privilege recognized in Idaho. All other evidence may be admitted if it is of a type commonly relied upon by prudent persons in the conduct of serious affairs. When proceedings will be expedited and the parties' interests not substantially prejudiced, evidence may be received in written form. The Board's experience, technical competence and specialized knowledge may be used in the evaluation of evidence. (3-20-20)T

**02. Documentary Evidence.** Upon request, parties shall be given an opportunity to compare the copy with the whole of the original document. Filing of a document does not signify its receipt in evidence, and only those documents which have been received in evidence shall be considered as evidence in the official record of the case. (3-20-20)T

**03. Prepared Testimony.** The presiding officer may order a witness's prepared testimony previously distributed to all parties be included in the record of hearing as if read. Admissibility of prepared testimony is subject to the standards expressed in this rule. (3-20-20)T

**04. Objections.** Where objections are made to the admission or exclusion of evidence, the grounds relied upon shall be stated briefly at the time of objection and before the start of closing statements. (3-20-20)T

**05. Evidentiary Rulings.** The presiding officer shall rule on the admissibility of all evidence and may grant exceptions to the requirements of this rule in the interest of justice. Such rulings may be reviewed by the Board. An evidence ruling may be deferred to the entire Board by the presiding officer or taken under advisement. The presiding officer may receive evidence subject to a motion to strike at the conclusion of the hearing. (3-20-20)T

**06. Offer of Proof.** An Offer of Proof for the record consists of a statement of the substance of the evidence to which objection has been sustained. Where the presiding officer rules evidence inadmissible, the party seeking to introduce such evidence makes an Offer of Proof to have such evidence considered by the Board. (3-20-20)T

**07. Failure to Produce Evidence -- Adverse Inference.** The Board may draw an adverse inference when a party or witness fails to produce requested evidence which is reasonably in the party or witness's control. (3-20-20)T

**08. Post-Hearing Evidence.** Unless allowed by the presiding officer, no post-hearing evidence will be accepted. (3-20-20)T

**118. EXHIBIT (RULE 118).**

**01. Custody.** The Board shall keep all original exhibits unless otherwise provided by law. (3-20-20)T

**02. Marking.** Exhibits will be marked to indicate the sponsoring and offering party. (3-20-20)T

**03. Form.** An exhibit prepared for hearing should be typed or printed on eight and one-half inch (8 1/2") by eleven inch (11") white paper, except a map, chart, photograph or non-documentary exhibit may be introduced on the size or kind of medium customarily used for them. (3-20-20)T

**04. Copies.** A copy of each documentary exhibit must be furnished to each party present and to the presiding officer, except for unusually bulky or voluminous exhibits that have previously been made available for the parties' inspection. Copies must be of good quality. (3-20-20)T

**05. Objection.** An exhibit identified at hearing is subject to appropriate and timely objection before the start of closing statements. A presented exhibit to which no objection is made is automatically admitted into evidence

without motion.

(3-20-20)T

**119. -- 124. (RESERVED)**

**125. CONFIDENTIALITY -- PROTECTIVE ORDERS (RULE 125).**

The decisions and official records in appeals before the Board are public records and are subject to disclosure unless otherwise provided by Title 74, Chapter 1, Idaho Code, or when a protective order, consistent with Title 74, Chapter 1, Idaho Code, is issued. A party may file a motion for a protective order showing good cause why specific information should remain confidential. The motion must include an affidavit as to the truthfulness of the contents. If another party opposes the request, that party must file a written objection within ten (10) days. (3-20-20)T

**126. -- 138. (RESERVED)**

**139. SCOPE OF APPEAL IN AD VALOREM CASE (RULE 139).**

In an appeal brought under Section 63-511, Idaho Code, where the appellant challenges only the value or exempt status upon either the land or the improvements on the land, the Board shall have jurisdiction to determine the value or exempt status over the entire property. The Board shall have the power to increase or decrease the value of property in a market value appeal. If the Board finds that a property classification is in error, it shall determine the correct classification. (3-20-20)T

**140. DECISIONS AND ORDERS (RULE 140).**

**01. Submission for a Decision.** The proceeding will stand submitted for decision after the record is closed by the presiding officer or as otherwise prescribed by the Board. (3-20-20)T

**02. Proposed Orders.** Prior to a final decision on the merits the Board may request proposed findings of fact and conclusions of law from each party. (3-20-20)T

**03. Notice.** Parties' representatives shall be notified by mail of any final decision or order. (3-20-20)T

**04. Decisions.** A decision of the Board will be based on the official record for the case. The Board shall hear and determine appeals as de novo proceedings. Decisions shall contain factual findings and conclusions of law upon which the Board's determination is based. (3-20-20)T

**141. -- 144. (RESERVED)**

**145. RECONSIDERATION -- REHEARING (RULE 145).**

**01. Time for Filing and Service.** A party adversely affected by a final decision may move for reconsideration or rehearing within ten (10) days of the time the decision is mailed. Service on other parties is required. The petitioner must file a supporting brief making a strong showing of good cause why reconsideration or rehearing should be granted. Where the presentation of additional evidence is sought, the motion shall include the reason why such evidence was not presented previously. (3-20-20)T

**02. Consideration.** Reconsideration or rehearing may be granted if, in reaching the decision the Board has overlooked or misconceived some material fact or statement of law; misconceived a material question in the case; found insufficient evidence in the record; or a party is found to have been denied the opportunity for a fair hearing. (3-20-20)T

**03. Answer.** Within ten (10) days after a motion for reconsideration or rehearing is filed, another party may file a response in support of or in opposition to said motion. (3-20-20)T

**04. Disposition.** A motion for reconsideration or rehearing shall be deemed denied if, within thirty (30) days from the date the petition is received by the Board, no response is made by the Board. (3-20-20)T

**146. -- 150. (RESERVED)**

**151. OFFICIAL RECORD (RULE 151).**

- 01. Content.** The record shall include: (3-20-20)T
- a.** All notices of proceedings; (3-20-20)T
  - b.** All appeals, petitions, complaints, protests, motions, and answers filed in the proceeding; (3-20-20)T
  - c.** All intermediate or interlocutory rulings; (3-20-20)T
  - d.** All evidence received; (3-20-20)T
  - e.** All offers of proof, however made; (3-20-20)T
  - f.** All briefs, memoranda, proposed orders of the parties, statements of position or support, and objections, but not discovery responses; (3-20-20)T
  - g.** All evidentiary rulings on testimony, exhibits, or offers of proof; (3-20-20)T
  - h.** All taxing authority data submitted in connection with the consideration of the proceeding; (3-20-20)T
  - i.** A statement of matters officially noticed; (3-20-20)T
  - j.** All preliminary orders, final orders, and orders on reconsideration or rehearing; and (3-20-20)T
  - k.** The recording or transcript specified in Rule 151.02. (3-20-20)T
- 02. Verbatim Record.** The official recording of hearings will be taken by means of a recorder. A party requesting a court reporter shall bear the expense of the reporter's fees. If the reporter's transcript is deemed by the Board to be the official transcript, the party requesting the reporter shall furnish the Board a transcript free of charge. (3-20-20)T
- 03. Cost.** A certified copy of a recording will be provided at the cost of ten dollars (\$10). A party may receive one (1) copy at no charge. (3-20-20)T

**152. -- 154. (RESERVED)**

**155. SUBPOENA (RULE 155).**

- 01. Issuance of Subpoena.** Upon a motion in writing, or upon the Board's own initiative without motion, the Board may issue a subpoena requiring: (3-20-20)T
- a.** The attendance of a witness from any place in Idaho; (3-20-20)T
  - b.** The production of documents from any place in Idaho; or (3-20-20)T
  - c.** The production of any book, paper, document, or tangible thing kept within or without Idaho to any designated place of deposition or hearing for the purpose of taking testimony or examining a document before the Board. (3-20-20)T
- 02. Motion Contents and Timing.** The motion shall be in writing and include a showing of relevance and the reasonable scope of the testimony or specific items sought. The motion for subpoena shall be filed at least fifteen (15) days before the date and time set forth in the subpoena, exceptions may be granted upon a showing of good cause. (3-20-20)T

**03. Service.** Service, and the filing of the proof of such service with the Board, shall be the responsibility of the requesting party. (3-20-20)T

**04. Fees.** A witness summoned pursuant to subpoena shall be paid by the party at whose instance they appear the same fees and mileage allowed by law to a witness in civil cases in the district court. (3-20-20)T

**05. Motion to Quash.** The Board, upon motion to quash may: (3-20-20)T

**a.** Quash or modify the subpoena if it is unreasonable or requires evidence not relevant to any matter in issue; or (3-20-20)T

**b.** Condition denial of the motion upon reasonable conditions. (3-20-20)T

**156. REQUEST FOR TRANSCRIPT (RULE 156).**

The party requesting a written transcript shall make the arrangements for preparation of transcript and payment of the fee directly with the transcriber. (3-20-20)T

**157. -- 999. (RESERVED)**

**IDAPA 37 – IDAHO DEPARTMENT OF WATER RESOURCES  
IDAHO WATER RESOURCE BOARD**

**DOCKET NO. 37-0000-2000F (FEE RULE)**

**NOTICE OF OMNIBUS RULEMAKING – ADOPTION OF TEMPORARY RULE**

**EFFECTIVE DATE:** The effective date of the temporary rules being adopted through this omnibus rulemaking is the adjournment date of the second regular session of the 65th Idaho State Legislature - March 20, 2020.

**AUTHORITY:** In compliance with Sections 67-5226, Idaho Code, notice is hereby given this agency has adopted a temporary rule. The action is authorized pursuant to Sections 42-238(12), 42-603, 42-1414, 42-1701A(1), 42-1714, 42-1709, 42-1721, 42-1734(19), 42-1761, 42-1762, 42-1765, 42-1414, 42-1805(8), 42-3803, 42-3913, 42-3914, 42-3915, 42-4001 42-4010, 67-2356, and 67-5206(5), Idaho Code.

**DESCRIPTIVE SUMMARY:** The following is the required finding and concise statement of its supporting reasons for adopting a temporary rule:

This temporary rulemaking adopts the following chapters under IDAPA 37:

**IDAPA 37**

- 37.01.01, *Rules of Procedure of the Idaho Department of Water Resources*
- 37.02.03, *Water Supply Bank Rules*
- 37.03.01, *Adjudication Rules*
- 37.03.02, *Beneficial Use Examination Rules*
- 37.03.03, *Rules and Minimum Standards for the Construction and Use of Injection Wells*
- 37.03.04, *Drilling for Geothermal Resources Rules*
- 37.03.05, *Mine Tailings Impoundment Structures Rules*
- 37.03.06, *Safety of Dams Rules*
- 37.03.07, *Stream Channel Alteration Rules*
- 37.03.08, *Water Appropriation Rules*
- 37.03.09, *Well Construction Standards and Rules*
- 37.03.10, *Well Driller Licensing Rules*

**TEMPORARY RULE JUSTIFICATION:** Pursuant to Sections 67-5226(1) and 67-5226(2), Idaho Code, the Governor has found that temporary adoption of the rule is appropriate for the following reasons:

These temporary rules are necessary to protect the public health, safety, and welfare of the citizens of Idaho and confer a benefit on its citizens. These temporary rules implement the duly enacted laws of the state of Idaho, provide citizens with the detailed rules and standards for complying with those laws, and assist in the orderly execution and enforcement of those laws. The expiration of these rules without due consideration and processes would undermine the public health, safety, and welfare of the citizens of Idaho and deprive them of the benefit intended by these rules.

**FEE SUMMARY:** Pursuant to Section 67-5226(2), the Governor has found that the fee(s) or charge(s) being imposed or increased is justified and necessary to avoid immediate danger and the fee(s) is described herein:

The fees or charges, authorized in Title 42, Idaho Code, as further specified below, are part of the agency's 2021 budget that relies upon the existence of these fees or charges to meet the state's obligations and provide necessary state services. Failing to reauthorize these temporary rules would create immediate danger to the state budget, immediate danger to necessary state functions and services, and immediate danger of a violation of Idaho's constitutional requirement that it balance its budget.

The following is a specific description of the fees or charges:

IDAPA 37.01.01 establishes the rules of procedure governing contested case proceedings before IDWR and the IWRB. It also addresses filing fees associated with such proceedings. This chapter was adopted under the legal authority of Sections 42-1701A(1), 42-1734(19), 42-1805(8), 67-2356 and 67- 5206(5), Idaho Code.



IDAPA 37.02.03 governs IWRB's operation and management of the water supply bank authorized by statute. The purpose of the water supply bank is to encourage the highest beneficial use of water; provide a source of adequate water supplies to benefit new and supplemental water users; and provide a source of funding for improving water user facilities and efficiencies. It also establishes lease and rental fees that are used to carry out the program which are credited to IWRB's revolving development and water management accounts. This chapter was adopted under the legal authority of Section 42-1762, Idaho Code.

IDAPA 37.03.01 implements the filing of notices of claims to water rights claimed under state law and the collection of fees for filing notices of claims to water rights acquired under state law in general adjudications. Idaho is currently in the midst of the North Idaho Adjudication (NIA) and IDWR has recently commenced the Palouse Basin Adjudication and anticipates commencing the final phase of the NIA—the Clark Fork-Pend Oreille River Basin adjudication—sometime after 2020. The Rule is integral to the processing of these general adjudications. This chapter was adopted under the legal authority of Sections 42-1414, and 42-1805(8), Idaho Code.

IDAPA 37.03.02 governs the examination requirements necessary to consider and determine the extent of application of water to beneficial use accomplished under a water right permit. The Rule also establishes that field examinations can be conducted by certified water right examiners appointed by the Director. Finally, the Rule governs licensing examination fees which are used to offset costs incurred by IDWR in reviewing and determining the extent of beneficial use. This chapter was adopted under the legal authority of Section 42-1805(8), Idaho Code.

IDAPA 37.03.03 governs injection wells in Idaho. The Rule requires all injection wells to be permitted and constructed in accordance with the Well Construction Standards Rules (IDAPA 37.03.09), which protect ground water resources from quality impairment. It is also necessary to maintain this Rule in order for the IWRB to maintain compliance with federal law, under which authority Idaho regulates the permitting, construction, and operation of certain injection wells within the state. Finally, the Rule governs inventory and permit fees which are used to partially fund the operation of the Underground Injection Control program in Idaho. This chapter was adopted under the legal authority of Sections 42-3913, 42-3914, and 42-3915, Idaho Code.

IDAPA 37.03.04 governs the regulation of geothermal resource exploration and development and ensure that such activities occur in the public interest. The Rule allows Idaho's geothermal policy, "to maximize the benefits to the entire state which may be derived from the utilization of our geothermal resources, while minimizing the detriments and costs of all kinds which could result from their utilization" is met. The Rule also requires fees for geothermal exploratory wells, production wells, injection wells, and amendments to permits, as set forth in Idaho Code Sections 42-4003 and 4011.

IDAPA 37.03.05 establishes acceptable construction standards and governs IDWR's design and technical review of mine tailing and water impoundment structures. The Rule also supports the collection of a fee to review plans, drawings, and specifications pertaining to any mine tailings impoundment structure.

IDAPA 37.03.06 establishes acceptable standards for construction of dams and establishes guidelines for safety evaluation of new or existing dams. The Rule applies to all new dams, to existing dams to be enlarged, altered or repaired, and maintenance of certain existing dams, as specifically provided in the Rule. This chapter also establishes the collection of a fee to review plans, drawings, and specifications pertaining to the construction, enlargement, alteration, or repair of small high-risk, intermediate, or large dams. This chapter was adopted pursuant to Section 42-1714, Idaho Code.

IDAPA 37.03.07 governs the permitting of stream channel alterations that are of a common type, which do not propose alterations which will be a hazard to the stream channel and its environment. This chapter also establishes the collection of stream channel alteration statutory filing fees as authorized in Idaho Code Section 42-3803.

IDAPA 37.03.08 governs appropriations from all sources of unappropriated public water in the state of Idaho under the authority of Chapter 2, Title 42, Idaho Code. Sources of public water include rivers, streams, springs, lakes and groundwater. The rules are also applicable to the reallocation of hydropower water rights (i.e. Swan Falls Trust Water) held in trust by the state of Idaho. The Rule also implements the application, re-advertisement, and mailing fees set forth in Idaho Code Sections 42-221F and 42-203(A)3.

IDAPA 37.03.09 governs IDWR's statutory responsibility for the statewide administration of the rules governing well construction. These rules establish minimum standards for the construction of all new wells and the modification and decommissioning (abandonment) of existing wells. The intent of the Rule is to protect ground water resources of the state against waste and contamination. The Rule also implements the drilling permit fees set forth in Idaho Code Section 42-235.

IDAPA 37.03.10 establishes the requirements and procedures for obtaining and renewing authorization to drill wells in the state of Idaho. The rules also establish the requirements and procedures for obtaining authorization to operate drilling equipment under the supervision of a licensed driller. The licensing rules are applicable to all individuals and companies drilling or contracting to drill wells. The rules also implement the application licensing fees set forth in Idaho Code Section 42-238.

In summary, the fee categories described in the attached rules include: (1) administrative appeals filing fees; (2) water supply bank lease and rental fees; (3) adjudication application fees; (4) water right licensing examination fees; (5) injection well inventory and permit fees; (6) geothermal well permit fees; (7) design review fees for mine tailings impoundment structure and select dams; (8) stream channel alteration statutory filing fees; (9) water right application, re-advertisement, and mailing fees; (10) well drilling permit fees; and (11) application licensing fees for well drillers.

**ASSISTANCE ON TECHNICAL QUESTIONS:** For assistance on technical questions concerning the temporary rule, contact Mathew Weaver, Deputy Director at (208) 287-4800.

DATED this 21st of February, 2020.

Gary Spackman, Director  
Idaho Department of Water Resources  
322 E. Front Street  
PO Box 83720  
Boise, ID 83720  
Phone: (208) 287-4800

# IDAPA 37 – DEPARTMENT OF WATER RESOURCES

## 37.01.01 – RULES OF PROCEDURE OF THE IDAHO DEPARTMENT OF WATER RESOURCES

### SUBCHAPTER A – GENERAL PROVISIONS (Rules 0 through 99)

#### 000. LEGAL AUTHORITY (RULE 0).

This chapter is adopted under the legal authority of Sections 42-1701A(1), 42-1734(19), 42-1805(8), 67-2356 and 67-5206(5), Idaho Code. (3-20-20)T

#### 001. TITLE AND SCOPE (RULE 1).

01. **Title.** The title of this chapter is “Rules of Procedure of the Idaho Department of Water Resources.” (3-20-20)T

02. **Scope.** This chapter contains the rules of procedure that govern contested case proceedings before the Department of Water Resources and the Water Resource Board of the state of Idaho. (3-20-20)T

#### 002. -- 004. (RESERVED)

#### 005. DEFINITIONS (RULE 5).

As used in this chapter: (3-20-20)T

01. **Administrative Code.** The Idaho administrative code established in Chapter 52, Title 67, Idaho Code. (3-20-20)T

02. **Agency.** The Department of Water Resources or the Water Resource Board acting within their respective authority to make rules or to determine contested cases. (3-20-20)T

03. **Agency Action.** Agency action means: (3-20-20)T

a. The whole or part of a rule or order; (3-20-20)T

b. The failure to issue a rule or order; (3-20-20)T

c. An agency’s performance of, or failure to perform, any duty placed on it by law. (3-20-20)T

04. **Agency Head.** An individual or body of individuals in whom the ultimate legal authority of the agency is vested by any provision of law. (3-20-20)T

05. **Board.** The Idaho Water Resource Board. (3-20-20)T

06. **Bulletin.** The Idaho administrative bulletin established in Chapter 52, Title 67, Idaho Code. (3-20-20)T

07. **Contested Case.** A proceeding which results in the issuance of an order. (3-20-20)T

08. **Coordinator.** The Administrative Rules Coordinator Prescribed in Section 67-5202, Idaho Code. (3-20-20)T

09. **Department.** The Idaho Department of Water Resources. (3-20-20)T

10. **Director.** The agency head of the Idaho Department of Water Resources. (3-20-20)T

11. **Document.** Any proclamation, executive order, notice, rule or statement of policy of an agency. (3-20-20)T

12. **Electronically Signed Communication.** A message that has been processed by a computer in such a manner that ties the message to the individual that signed the message in accordance with Rules 306 through 311 of

these rules. (3-20-20)T

**13. License.** The whole or part of any agency permit, certificate, approval, registration, charter, or similar form of authorization required by law, but does not include a license required solely for revenue purposes. (3-20-20)T

**14. Official Text.** The text of a document issued, prescribed, or promulgated by an agency in accordance with this chapter, and is the only legally enforceable text of such document. (3-20-20)T

**15. Order.** An agency action of particular applicability that determines the legal rights, duties, privileges, immunities, or other legal interests of one (1) or more specific persons. (3-20-20)T

**16. Party.** Each person or agency named or admitted as a party, or properly seeking and entitled as of right to be admitted as a party. (3-20-20)T

**17. Person.** Any individual, partnership, corporation, association, governmental subdivision or agency, or public or private organization or entity of any character. For purposes of electronic signature rules, a human being or any organization capable of signing a document, either legally or as a matter of fact. (3-20-20)T

**18. Provision of Law.** The whole or a part of the state or federal constitution, or of any state or federal: (3-20-20)T

a. Statute; or (3-20-20)T

b. Rule or decision of the court. (3-20-20)T

**19. Publish.** To bring before the public by publication in the bulletin or administrative code, or as otherwise specifically provided by law. (3-20-20)T

**20. Rule.** The whole or a part of an agency statement of general applicability that has been promulgated in compliance with the provisions of Chapter 52, Title 67, Idaho Code, and that implements, interprets, or prescribes: (3-20-20)T

a. Law or policy, or (3-20-20)T

b. The procedure or practice requirements of an agency. The term includes the amendment, repeal, or suspension of an existing rule, but does not include: (3-20-20)T

i. Statements concerning only the internal management or internal personnel policies of an agency and not affecting private rights of the public or procedures available to the public; (3-20-20)T

ii. Declaratory rulings issued pursuant to Section 67-5232, Idaho Code; (3-20-20)T

iii. Intra-agency memoranda; or (3-20-20)T

iv. Any written statements given by an agency which pertain to an interpretation of a rule or to the documentation of compliance with a rule. (3-20-20)T

**21. Rulemaking.** The process for formulation, adoption, amendment or repeal of a rule. (3-20-20)T

**22. Signer.** A person who signs a communication, including an electronically signed communication with the use of an acceptable technology to uniquely link the message with the person sending it. (3-20-20)T

**006. (RESERVED)**

**007. OFFICE – OFFICE HOURS – MAILING ADDRESS AND STREET ADDRESS (RULE 7).**

**01. State Office.** The mailing address of the state office of the Idaho Department of Water Resources

and the office of the Idaho Water Resource Board is P.O. Box 83720, Boise, Idaho 83720-0098; the street address, subject to change, is 322 East Front Street, 6th Floor, Boise, Idaho 83702; the telephone number is (208) 287-4800; and the Facsimile Machine number is (208) 287-6700. Documents may be filed at the state office during regular business hours of 8:00 am to 5:00 pm Monday through Friday. (3-20-20)T

**008. FILING OF DOCUMENTS -- NUMBER OF COPIES (RULE 8).**

In all rulemakings or contested cases, an original of all documents shall be filed with the Director of the Department of Water Resources or the Chairman of the Idaho Water Resource Board, as the case may be, showing service upon all other parties. No copies in addition to the original document need be filed with the agency unless requested by the agency. (3-20-20)T

**009. -- 049. (RESERVED)**

**050. PROCEEDINGS GOVERNED (RULE 50).**

Rules 100 through 799 govern procedure before the Department and the Board in contested cases, unless otherwise provided by rule, notice or order of the agency. The Department and the Board through the promulgation of these rules decline in whole to adopt the contested case portion of the "Idaho Rules of Administrative Procedure of the Attorney General," cited as IDAPA 04.11.01.100 through 04.11.01.799. Rulemaking before the Department and the Board shall be governed by Rules 800 through 860 of the "Idaho Rules of Administrative Procedure of the Attorney General," cited as IDAPA 04.11.01.800 through 04.11.01.860. (3-20-20)T

**051. REFERENCE TO AGENCY (RULE 51).**

Reference to the agency in these rules includes the agency director, the board, hearing officer appointed by the agency or the board, or presiding officer, as context requires. Reference to the agency head means the agency director or the board, as context requires, or such other officer designated by the agency head or the board to review recommended or preliminary orders. (3-20-20)T

**052. LIBERAL CONSTRUCTION (RULE 52).**

The rules in this chapter will be liberally construed to secure just, speedy and economical determination of all issues presented to the agency. Unless prohibited by statute, the agency may permit deviation from these rules when it finds that compliance with them is impracticable, unnecessary or not in the public interest. Unless required by statute, or otherwise provided by these rules, the Idaho Rules of Civil Procedure and the Idaho Rules of Evidence do not apply to contested case proceedings conducted before the agency. (3-20-20)T

**053. COMMUNICATIONS WITH AGENCY (RULE 53).**

All written communications and documents that are intended to be part of an official record for a decision in a contested case must be filed with the officer designated by the agency. Unless otherwise provided by statute, rule, order or notice, documents are considered filed when received by the officer designated to receive them, not when mailed, or otherwise transmitted. (3-20-20)T

**054. IDENTIFICATION OF COMMUNICATIONS (RULE 54).**

Parties' communications addressing or pertaining to a given proceeding should be written under that proceeding's case caption and case number, if applicable. General communications by other persons should refer to case captions, case numbers, permit or license numbers, or the like, if this information is known. (3-20-20)T

**055. SERVICE BY AGENCY (RULE 55).**

Unless otherwise provided by statute or these rules, the officer designated by the agency to serve rules, notices, complaints, and orders issued by the agency may serve these documents by regular mail or by certified mail, return receipt requested, to a party's last known mailing address or by personal service. Unless otherwise provided by statute, these rules, order or notice, service of orders and notices is complete when a copy, properly addressed and stamped, is deposited in the United States mail, or the Statehouse mail if the party is a state employee or state agency. The officer designated by the agency to serve documents in a proceeding must serve all orders and notices in a proceeding on the representatives of each party designated pursuant to these rules for that proceeding and upon other persons designated by these rules or by the agency. (3-20-20)T

**056. COMPUTATION OF TIME (RULE 56).**

Whenever statute, these or other rules, order, or notice requires an act to be done within a certain number of days of a

given day, the given day is not included in the count, but the last day of the period so computed is included in the count. If the day the act must be done is Saturday, Sunday or a legal holiday, the act may be done on the first day following that is not Saturday, Sunday or a legal holiday. (3-20-20)T

**057. ADDITIONAL TIME AFTER SERVICE BY MAIL (RULE 57).**

Whenever a party has the right or is required to do some act or take some proceedings within a prescribed period after the service of a notice or other paper upon the party and the notice or paper is served upon the party by mail, three (3) days shall be added to the prescribed period. This rule, however, shall not extend the time for filing a protest, a petition for reconsideration of a preliminary, recommended or final order before the agency, the time for filing exceptions with the agency head to a preliminary or recommended order, or the time for filing an appeal with the district court from a final decision of the agency. (3-20-20)T

**058. FEES AND REMITTANCES (RULE 58).**

If submitted by mail, fees and remittances to the agency may be paid by money order, bank draft or check payable to agency. Remittances in currency or coin, submitted by mail, are strongly discouraged and are wholly at the risk of the remitter, and the agency assumes no responsibility for their loss. The agency may, upon the completion of necessary arrangements by the agency, accept the payment of fees and remittances by credit card. Filings required to be accompanied by a fee are not complete until the fee is paid. (3-20-20)T

**059. -- 099. (RESERVED)**

**100. INFORMAL PROCEEDINGS DEFINED (RULE 100).**

Informal proceedings are proceedings in contested cases authorized by statute, rule or order of the agency to be conducted using informal procedures, i.e., procedures without a record to be preserved for later agency or judicial review, without the necessity of representation according to Rule 230, without formal designation of parties, without the necessity of hearing examiners or other presiding officers, or without other formal procedures required by these rules for formal proceedings. Unless prohibited by statute, an agency may provide that informal proceedings may precede formal proceedings in the consideration of a rulemaking or a contested case. (3-20-20)T

**101. INFORMAL PROCEDURE (RULE 101).**

Statute authorizes and these rules encourage the use informal proceedings to settle or determine contested cases. Unless prohibited by statute, the agency may provide for the use of informal procedure at any stage of a contested case. Informal procedure may include individual contacts, consistent with Rule 417, by or with the agency staff asking for information, advice or assistance from the agency staff, or proposing informal resolution of formal disputes under the law administered by the agency. Informal procedures may be conducted in writing, by telephone or television, or in person. (3-20-20)T

**102. FURTHER PROCEEDINGS (RULE 102).**

If statute provides that informal procedures shall be followed with no opportunity for further formal administrative review, then no opportunity for later formal administrative proceedings must be offered following informal proceedings. Otherwise, except as provided in Rule 103, any person participating in an informal proceeding must be given an opportunity for a later formal administrative proceeding before the agency, at which time the parties may fully develop the record before the agency. (3-20-20)T

**103. INFORMAL PROCEEDINGS DO NOT EXHAUST ADMINISTRATIVE REMEDIES (RULE 103).**

Unless all parties agree to the contrary in writing, informal proceedings do not substitute for formal proceedings and do not exhaust administrative remedies, and informal proceedings are conducted without prejudice to the right of the parties to present the matter formally to the agency. Settlement offers made in the course of informal proceedings are confidential and shall not be included in the agency record of a subsequent formal proceeding. (3-20-20)T

**104. FORMAL PROCEEDINGS (RULE 104).**

Formal proceedings, which are governed by rules of procedure other than Rules 100 through 103, must be initiated by a document (generally a notice, order or complaint if initiated by the agency) or another pleading listed in Rules 210 through 280 if initiated by another person. Formal proceedings may be initiated by a document from the agency informing the party(ies) that the agency has reached an informal determination that will become final in the absence of further action by the person to whom the correspondence is addressed, provided that the document complies with the requirements of Rules 210 through 280. Formal proceedings can be initiated by the same document that initiates

informal proceedings. (3-20-20)T

**105. -- 149. (RESERVED)**

**150. PARTIES TO CONTESTED CASES LISTED (RULE 150).**

Parties to contested cases before the agency are called applicants or claimants or appellants, petitioners, complainants, respondents, protestants, or intervenors. On reconsideration or appeal within the agency parties are called by their original titles listed in the previous sentence. (3-20-20)T

**151. APPLICANTS/CLAIMANTS/APPELLANTS (RULE 151).**

Persons who seek any right, license, award or authority from the agency are called “applicants” or “claimants” or “appellants.” (3-20-20)T

**152. PETITIONERS (RULE 152).**

Persons not applicants who seek to modify, amend or stay existing orders or rules of the agency, to clarify their rights or obligations under law administered by the agency, to ask the agency to initiate a contested case (other than an application or complaint), or to otherwise take action that will result in the issuance of an order or rule, are called “petitioners.” (3-20-20)T

**153. COMPLAINANTS (RULE 153).**

Persons who charge other person(s) with any act or omission are called “complainants.” In any proceeding in which the agency itself charges a person with an act or omission, the agency is called “complainant.” (3-20-20)T

**154. RESPONDENTS (RULE 154).**

Persons against whom complaints are filed or about whom investigations are initiated are called “respondents.” (3-20-20)T

**155. PROTESTANTS (RULE 155).**

Persons who oppose an application or claim or appeal and who have a statutory right to contest the right, license, award or authority sought by an applicant or claimant or appellant are called “protestants.” (3-20-20)T

**156. INTERVENORS (RULE 156).**

Persons, not applicants or claimants or appellants, complainants, respondents, or protestants to a proceeding, who are permitted to participate as parties pursuant to Rules 350 through 354 are called “intervenors.” (3-20-20)T

**157. RIGHTS OF PARTIES AND OF AGENCY STAFF (RULE 157).**

Subject to Rules 558, 560, and 600, all parties and agency staff may appear at hearing or argument, introduce evidence, examine witnesses, make and argue motions, state positions, and otherwise fully participate in hearings or arguments. (3-20-20)T

**158. PERSONS NOT PARTIES -- INTERESTED PERSONS (RULE 158).**

Persons other than the persons named in Rules 151 through 156 are not parties for the purpose of any statute or rule addressing rights or obligations of parties to a contested case. Persons not parties who have an interest in a proceeding are called “interested persons.” Interested persons may participate in a proceeding as “public witnesses” in accordance with Rule 355. (3-20-20)T

**159. -- 199. (RESERVED)**

**200. INITIAL PLEADING BY PARTY -- LISTING OF REPRESENTATIVES (RULE 200).**

The initial pleading of each party at the formal stage of a contested case (be it an application or claim or appeal, petition, complaint, protest, motion, or answer) must name the party’s representative(s) for service and state the representative’s(s’) address(es) for purposes of receipt of all official documents. No more than two (2) representatives for service of documents may be listed in an initial pleading. Service of documents on the named representative(s) is valid service upon the party for all purposes in that proceeding. If no person is explicitly named as the party’s representative, the person signing the pleading will be considered the party’s representative. If an initial pleading is signed by more than one (1) person without identifying the representative(s) for service of documents, the presiding officer may select the person(s) upon whom documents are to be served. If two (2) or more parties or persons file

identical or substantially like initial pleadings, the presiding officer may limit the number of parties or persons required to be served with official documents in order to expedite the proceeding and reasonably manage the burden of service upon the parties and the agency. (3-20-20)T

**201. TAKING OF APPEARANCES -- PARTICIPATION BY AGENCY STAFF (RULE 201).**

The presiding officer at a formal hearing or prehearing conference will take appearances to identify the representatives of all parties or other persons. In all proceedings in which the agency staff will participate, or any report or recommendation of the agency staff (other than a recommended order or preliminary order prepared by a hearing officer) will be considered or used in reaching a decision, at the timely request of any party the agency staff must appear at any hearing and be made available for cross-examination and otherwise participate in the hearing, at the discretion of the presiding officer, in the same manner as a party. (3-20-20)T

**202. REPRESENTATION OF PARTIES AT HEARING (RULE 202).**

**01. Appearances and Representation.** To the extent authorized or required by law, appearances and representation of parties or other persons at formal hearing or prehearing conference must be as follows: (3-20-20)T

**a.** Natural Person. A natural person may represent himself or herself or be represented by a duly authorized employee, attorney, or family member, or by a next friend if the person lacks full legal capacity to act for himself or herself. (3-20-20)T

**b.** A partnership may be represented by a partner, duly authorized employee, or attorney. (3-20-20)T

**c.** A corporation may be represented by an officer, duly authorized employee, or attorney. (3-20-20)T

**d.** A municipal corporation, local government agency, unincorporated association or nonprofit organization may be represented by an officer, duly authorized employee, or attorney. (3-20-20)T

**e.** A state, federal or tribal governmental entity or agency may be represented by an officer, duly authorized employee, or attorney. (3-20-20)T

**02. Representatives.** The representatives of parties at hearing, and no other persons or parties appearing before the agency, are entitled to examine witnesses and make or argue motions. (3-20-20)T

**203. SERVICE ON REPRESENTATIVES OF PARTIES AND OTHER PERSONS (RULE 203).**

From the time a party files its initial pleading in a contested case, that party must serve and all other parties must serve all future documents intended to be part of the agency record upon all other parties' representatives designated pursuant to Rule 200, unless otherwise directed by order or notice or by the presiding officer on the record. The presiding officer may order parties to serve past documents filed in the case upon those representatives. The presiding officer may order parties to serve past or future documents filed in the case upon persons not parties to the proceedings before the agency. (3-20-20)T

**204. WITHDRAWAL OF PARTIES (RULE 204).**

Any party may withdraw from a proceeding in writing or at hearing. (3-20-20)T

**205. SUBSTITUTION OF REPRESENTATIVE -- WITHDRAWAL OF REPRESENTATIVE (RULE 205).**

A party's representative may be changed and a new representative may be substituted by notice to the agency and to all other parties so long as the proceedings are not unreasonably delayed. The presiding officer at hearing may permit substitution of representatives at hearing in the presiding officer's discretion. Persons representing a party who wish to withdraw their representation of a party in a proceeding before the agency must immediately file in writing a notice of withdrawal of representation and serve that notice on the party represented and all other parties. (3-20-20)T

**206. CONDUCT REQUIRED (RULE 206).**

Representatives of parties and parties appearing in a proceeding must conduct themselves in an ethical and courteous manner. Smoking is not permitted at hearings. (3-20-20)T



**207. -- 209. (RESERVED)**

**210. PLEADINGS LISTED -- MISCELLANEOUS (RULE 210).**

Pleadings in contested cases are called applications or claims or appeals, petitions, complaints, protests, motions, answers, and consent agreements. Affidavits or declarations under penalty of perjury may be filed in support of any pleading. A party's initial pleading in any proceeding must comply with Rule 200, but the presiding officer may allow documents filed during informal stages of the proceeding to be considered a party's initial pleading without the requirement of resubmission to comply with this rule. All pleadings filed during the formal stage of a proceeding must be filed in accordance with Rules 300 through 303. A party may adopt or join any other party's pleading. Two (2) or more separately stated grounds, claims or answers concerning the same subject matter may be included in one (1) pleading. (3-20-20)T

**211. -- 219. (RESERVED)**

**220. APPLICATIONS/CLAIMS/APPEALS -- DEFINED -- FORM AND CONTENTS (RULE 220).**

All pleadings requesting a right, license, award or authority from the agency are called "applications" or "claims" or "appeals." All pleadings must be submitted on Department approved forms if available. Applications or claims or appeals not submitted on Department approved forms should: (3-20-20)T

**01. Facts.** Fully state the facts upon which they are based. (3-20-20)T

**02. Refer to Provisions.** Refer to the particular provisions of statute, rule, order, or other controlling law upon which they are based. (3-20-20)T

**03. Other.** State the right, license, award, or authority sought. (3-20-20)T

**221. -- 229. (RESERVED)**

**230. PETITIONS -- DEFINED -- FORM AND CONTENTS (RULE 230).**

**01. Pleadings Defined.** All pleadings requesting the following are called "petitions:" (3-20-20)T

**a.** Modification, amendment or stay of existing orders or rules; (3-20-20)T

**b.** Clarification, declaration or construction of the law administered by the agency or of a party's rights or obligations under law administered by the agency; (3-20-20)T

**c.** The initiation of a contested case not an application, claim or complaint or otherwise taking action that will lead to the issuance of an order or a rule; (3-20-20)T

**d.** Rehearing; or (3-20-20)T

**e.** Intervention. (3-20-20)T

**02. Petitions.** Petitions should: (3-20-20)T

**a.** Fully state the facts upon which they are based; (3-20-20)T

**b.** Refer to the particular provisions of statute, rule, order or other controlling law upon which they are based; (3-20-20)T

**c.** State the relief desired; and (3-20-20)T

**d.** State the name of the person petitioned against (the respondent), if any. (3-20-20)T

**231. -- 239. (RESERVED)**

**240. COMPLAINTS -- DEFINED -- FORM AND CONTENTS (RULE 240).**

- 01. Complaints - Defined.** All pleadings charging other person(s) with acts or omissions under law administered by the agency are called “complaints.” (3-20-20)T
- 02. Form and Contents.** Complaints must: (3-20-20)T
- a.** Be in writing; (3-20-20)T
  - b.** Fully state the acts or things done or omitted to be done by the persons complained against by reciting the facts constituting the acts or omissions and the dates when they occurred; (3-20-20)T
  - c.** Refer to statutes, rules, orders or other controlling law involved; (3-20-20)T
  - d.** State the relief desired; (3-20-20)T
  - e.** State the name of the person complained against (the respondent). (3-20-20)T

**241. -- 249. (RESERVED)**

**250. PROTESTS -- DEFINED -- FORM AND CONTENTS (RULE 250).**

- 01. Protests - Defined.** All pleadings opposing an application or claim or appeal as a matter of right are called “protests.” (3-20-20)T
- 02. Form and Contents.** Protests should: (3-20-20)T
- a.** Fully state the facts upon which they are based, including the protestant’s claim of right to oppose the application or claim; (3-20-20)T
  - b.** Refer to the particular provisions of statute, rule, order or other controlling law upon which they are based; and (3-20-20)T
  - c.** State any proposed limitation (or the denial) of any right, license, award or authority sought in the application. (3-20-20)T

**251. -- 259. (RESERVED)**

**260. MOTIONS -- DEFINED -- FORM AND CONTENTS -- TIME FOR FILING (RULE 260).**

- 01. Motions - Defined.** All other pleadings requesting the agency to take any other action in a contested case, except consent agreements or pleadings specifically answering other pleadings, are called “motions.” (3-20-20)T
- 02. Form and Contents.** Motions should: (3-20-20)T
- a.** Fully state the facts upon which they are based; (3-20-20)T
  - b.** Refer to the particular provision of statute, rule, order, notice, or other controlling law upon which they are based; and (3-20-20)T
  - c.** State the relief sought. (3-20-20)T
- 03. Other.** If the moving party desires oral argument or hearing on the motion, it must state so in the motion. Any motion to dismiss, strike or limit an application or claim or appeal, complaint, petition, or protest must be filed before the answer is due or be included in the answer, if the movant is obligated to file an answer. If a motion is directed to an answer, it must be filed within fourteen (14) days after service of the answer. Other motions may be

filed at any time upon compliance with Rule 565. (3-20-20)T

**261. -- 269. (RESERVED)**

**270. ANSWERS -- DEFINED -- FORM AND CONTENTS -- TIME FOR FILING (RULE 270).**

All pleadings responding to the allegations or requests of applications or claims or appeals, complaints, petitions, or motions are called “answers.” (3-20-20)T

**01. Answers to Pleadings Other than Motions.** Answers to applications, claims, appeals, complaints, or petitions when required to be filed by provision of statute, rule, or order must be filed and served on all parties of record within twenty-one (21) days after service of the pleading being answered, unless order or notice modifies the time within which answer may be made, or a motion to dismiss is made within twenty-one (21) days. When an answer is not timely filed under this rule, the presiding officer may issue a notice of default against the respondent pursuant to Rule 700. Answers to applications or claims, complaints, or petitions, must admit or deny each material allegation of the applications or claims, complaint, or petition. Any material allegation not specifically admitted shall be considered to be denied. Matters alleged by cross-complaint or affirmative defense must be separately stated and numbered. This rule does not prevent a party from filing a responsive pleading in instances not required under these rules. (3-20-20)T

**02. Answers to Motions.** Answers to motions may be filed by persons or parties who are the object of a motion or by parties opposing a motion within fourteen (14) days of the filing of the motion. The time to file an answer to a motion may be enlarged or shortened by the presiding officer upon a showing of good cause by a party. The presiding officer may act upon a prehearing motion under Rule 565. (3-20-20)T

**271. -- 279. (RESERVED)**

**280. CONSENT AGREEMENTS -- DEFINED -- FORM AND CONTENTS (RULE 280).**

Agreements between the agency or agency staff and another person(s) in which one (1) or more person(s) agree to engage in certain conduct mandated by statute, rule, order, case decision, or other provision of law, or to refrain from engaging in certain conduct prohibited by statute, rule, order, case decision, or other provision of law, are called “consent agreements.” Consent agreements are intended to require compliance with existing law. (3-20-20)T

**01. Requirements.** Consent agreements must: (3-20-20)T

**a.** Recite the parties to the agreement; and (3-20-20)T

**b.** Fully state the conduct proscribed or prescribed by the consent agreement. (3-20-20)T

**02. Additional.** In addition, consent agreements may: (3-20-20)T

**a.** Recite the consequences of failure to abide by the consent agreement; (3-20-20)T

**b.** Provide for payment of civil or administrative penalties authorized by law; (3-20-20)T

**c.** Provide for loss of rights, licenses, awards or authority; (3-20-20)T

**d.** Provide for other consequences as agreed to by the parties; and (3-20-20)T

**e.** Provide that the parties waive all further procedural rights (including hearing, consultation with counsel, etc.) with regard to enforcement of the consent agreement. (3-20-20)T

**281. -- 299. (RESERVED)**

**300. FILING DOCUMENTS WITH THE AGENCY -- NUMBER OF COPIES -- FACSIMILE TRANSMISSION (FAX) -- ELECTRONICALLY SIGNED DOCUMENTS (RULE 300).**

An original and necessary copies (if any are required by the agency) of all documents intended to be part of an agency record must be filed with the officer designated by the agency to receive filing in the case. Pleadings and other

documents not exceeding ten (10) pages in length requiring urgent or immediate action may be filed by facsimile transmission (FAX). Whenever any document is filed by FAX, the original must be mailed by United States mail or physically delivered to the agency the next working day. A document required to be accompanied by a filing fee shall not be filed with the agency until the fee is received. There shall be no limit as to the number of pages of a facsimile copy which was not transmitted directly to the agency by the facsimile machine process. The Department will accept electronic signatures and electronically signed communications complying with the requirements of Rules 306 through 311 and Sections 67-2351 through 67-2357, Idaho Code, for all communications, filings and transactions with the Department. (3-20-20)T

**301. FORM OF PLEADINGS (RULE 301).**

**01. Pleadings.** All pleadings, except those on agency forms, submitted by a party and intended to be part of an agency record should: (3-20-20)T

- a. Be submitted on white eight and one-half inch (8 1/2") by eleven inch (11") paper copied on one (1) side only; (3-20-20)T
- b. State the case caption, case number, if applicable, and title of the document; (3-20-20)T
- c. Include on the upper left corner of the first page the name(s), mailing and street address(es), and telephone and FAX number(s) of the person(s) filing the document or the person(s) to whom questions about the document can be directed; and (3-20-20)T
- d. Have at least one inch (1") left and top margins. (3-20-20)T

**02. Form.** Documents complying with this rule will be in the following form:

Name of Representative  
Mailing Address of Representative  
Street Address of Representative (if different)  
Telephone Number of Representative  
FAX Number of Representative (if there is one)  
Attorney/Representative for (Name of Party)

BEFORE THE AGENCY

(Title of Proceeding)	)	CASE NO.	
	)		
	)	(TITLE OF DOCUMENT)	
	)		(3-20-20)T

**302. SERVICE ON PARTIES AND OTHER PERSONS (RULE 302).**

All documents intended to be part of the agency record for decision must be served upon the representatives of each party of record concurrently with filing the original with the officer designated by the agency to receive filings in the case. (3-20-20)T

**303. PROOF OF SERVICE (RULE 303).**

Every document filed with and intended to be part of the agency record must be attached to or accompanied by proof of service by the following or similar certificate:

I HEREBY CERTIFY (swear or affirm) that I have this day of, served the foregoing (name(s) of document(s) upon all parties of record in this proceeding, (by delivering a copy thereof in person: (list names)) (by mailing a copy thereof, properly addressed with postage prepaid, to: (list names)).  
(Signature) (3-20-20)T

**304. DEFECTIVE, INSUFFICIENT OR LATE PLEADINGS (RULE 304).**

Defective, insufficient or late pleadings may be returned or dismissed. (3-20-20)T

**305. AMENDMENTS TO PLEADINGS – WITHDRAWAL OF PLEADINGS (RULE 305).**

The presiding officer may allow any pleading to be amended or corrected or any omission to be supplied. Pleadings will be liberally construed, and defects that do not affect substantial rights of the parties will be disregarded. A party desiring to withdraw a pleading must file a notice of withdrawal of the pleading and serve all parties with a copy. Unless otherwise ordered by the presiding officer, the notice is effective fourteen (14) days after filing. (3-20-20)T

**306. ELECTRONICALLY SIGNED COMMUNICATIONS (RULE 306).**

The Department will accept electronic signatures and electronically signed communications complying with the requirements of Rules 306 through 311 and Sections 67-2351 through 67-2357, Idaho Code, for all communications, filings and transactions with the Department. For an electronic signature to be valid for use by the Department, it must be created by a technology that is accepted for use by the Department. (3-20-20)T

**307. CRITERIA FOR ACCEPTABLE ELECTRONIC SIGNATURE TECHNOLOGY (RULE 307).**

For an electronic signature technology to be accepted for use by the Department, it must comply with the following criteria: (3-20-20)T

**01. Statutory Criteria.** An acceptable electronic signature technology must be capable of creating signatures that conform to the requirements set forth in Section 67-2354, Idaho Code: (3-20-20)T

- a.** It is unique to the person using it; (3-20-20)T
- b.** It is capable of verification; and (3-20-20)T
- c.** It conforms to the applicable rules promulgated by the Department pursuant to Section 67-2356, Idaho Code. (3-20-20)T

**02. Additional Criteria.** An electronic signature technology acceptable to the Department also must be capable of creating a signature that satisfies the following additional criteria: (3-20-20)T

- a.** It is under the sole control of the person using it; (3-20-20)T
- b.** It is linked to the data in such a manner that if the data are changed, the electronic signature is invalidated; and (3-20-20)T
- c.** It meets International Standards Organization ISO X.509 standard. (3-20-20)T

**308. PUBLIC KEY CRYPTOGRAPHY (RULE 308).**

The technology known as Public Key Cryptography is an accepted technology for use by the Department, provided that the electronic signature is created consistent with the provisions in these rules. (3-20-20)T

**01. Terminology.** For purposes of Rules 306 through 311, and unless the context expressly indicates otherwise, the following terms shall have the meanings here ascribed to them: (3-20-20)T

- a.** Approved certification authority. The Certification Authority authorized and accepted by the State of Idaho to issue certificates for electronic signature transactions involving the State; (3-20-20)T
- b.** Asymmetric cryptosystem. A computer algorithm or series of algorithms that utilize(s) two (2) different keys with the following characteristics: (3-20-20)T
  - i.** Identifies the certification authority issuing it; (3-20-20)T
  - ii.** One (1) key verifies a given message; and (3-20-20)T
  - iii.** The keys have the property that, knowing one (1) key, it is computationally infeasible to discover the other key. (3-20-20)T

- c.** Certificate. A computer-based record that: (3-20-20)T
- i.** Identifies the certification authority issuing it; (3-20-20)T
  - ii.** Names or identifies its subscriber; (3-20-20)T
  - iii.** Contains the subscriber's public key; (3-20-20)T
  - iv.** Is electronically signed by the Certification Authority issuing or amending it; and (3-20-20)T
  - v.** Conforms to widely-used industry standards. (3-20-20)T
- d.** Certification authority. A person or entity that issues a certificate, or in the case of certain certification processes, certifies amendments to an existing certificate; (3-20-20)T
- e.** Electronic message. An electronic representation of information intended to serve as a written communication with the Department; (3-20-20)T
- f.** Electronically signed communication. A message that has been processed by a computer in such a manner that ties the message to the individual that signed the message; (3-20-20)T
- g.** Key pair. A private key and its corresponding public key in an asymmetric cryptosystem. The keys have the property that the public key can verify an electronic signature that the private key creates; (3-20-20)T
- h.** Private key. The key of a key pair used to create an electronic signature; (3-20-20)T
- i.** Proof of identification. The document or documents presented to a Certification Authority to establish the identity of a subscriber; (3-20-20)T
- j.** Public key. The key of a pair used to verify an electronic signature; (3-20-20)T
- k.** Subscriber. A person who: (3-20-20)T
- i.** Is the subject listed in a certificate; (3-20-20)T
  - ii.** Accepts the certificate; and (3-20-20)T
  - iii.** Holds a private key which corresponds to a public key listed in that certificate. (3-20-20)T
- l.** Technology. The computer hardware or software-based method or process used to create electronic signatures. (3-20-20)T
- 02. Electronic Signature to Be Unique.** Section 67-2354, Idaho Code, requires that an electronic signature be "unique to the person using it." A public key-based electronic signature may be considered unique to the person using it if: (3-20-20)T
- a.** The private key used to create the signature on the document is known only to the signer; (3-20-20)T
  - b.** The electronic signature is created when a person runs a message through a one-way function, creating a message digest, then encrypting the resulting message digest using an asymmetrical cryptosystem and the signer's private key; (3-20-20)T
  - c.** Although not all electronically signed communications will require the signer to obtain a certificate, the signer is capable of being issued a certificate to certify that he or she controls the key pair used to create the signature; and (3-20-20)T

d. It is computationally infeasible to derive the private key from knowledge of the public key. (3-20-20)T

**03. Signature Capable of Verification.** Section 67-2354, Idaho Code, requires that an electronic signature be “capable of verification.” A public-key based electronic signature is capable of verification: (3-20-20)T

a. If the acceptor of the electronically signed document can verify the document was electronically signed by using the signer’s public key; (3-20-20)T

b. If a certificate is a required component of a transaction, the certificate was valid; and (3-20-20)T

c. If a certificate is a required component of a transaction, the issuing Certification Authority identifies which, if any, form(s) of proof of identification it required of the signer prior to issuing the certificate. (3-20-20)T

**04. Electronic Signature Must Meet ISO X.509 Standards.** The electronic signature must meet International Standards Organization ISO X.509 standards. (3-20-20)T

**05. Approved Certification Authority.** The Department shall only accept certificates from an Approved Certification Authority. (3-20-20)T

**309. CRITERIA FOR ACCEPTING AN ELECTRONIC SIGNATURE (RULE 309).** The following criteria shall be used in determining the acceptability of electronic signatures: (3-20-20)T

**01. Level of Security Used to Identify the Signer.** Prior to accepting an electronic signature, the Department shall ensure that the level of security used to identify the signer of a document is sufficient for the transaction being conducted. (3-20-20)T

**02. Level of Security Used to Transmit the Signature.** Prior to accepting an electronic signature, the Department shall ensure that the level of security used to transmit the signature is sufficient for the transaction being conducted. (3-20-20)T

**03. Certificate Format Used by the Signer.** If a certificate is a required component of an electronic signature transaction, the Department shall ensure that the certificate format used by the signer is sufficient for the security and interoperability needs of the Department. (3-20-20)T

**310. RETENTION OF CERTIFICATES (RULE 310).** All electronically signed messages received by the Department in accordance with this rule, as well as any information resources necessary to permit access to the message and to verify the electronic signature, shall be retained by the Department as necessary to comply with applicable law pertaining to records retention requirements for that message. (3-20-20)T

**311. ELECTRONIC SIGNATURE REPUDIATION (RULE 311).** It is the responsibility of the rightful holder of the private key to maintain the private key’s security. Repudiation of an electronically signed and transmitted message may only occur by the determination of a court of competent jurisdiction that the private key of the rightful holder was compromised through no fault of the rightful holder and without knowledge on the part of the rightful holder. It is the legal prerequisite for a claim of repudiation that the repudiator have filed a notice of revocation with the Certification Authority prior to making the claim of repudiation. (3-20-20)T

**312. -- 349. (RESERVED)**

**350. ORDER GRANTING INTERVENTION NECESSARY (RULE 350).** Persons not applicants or claimants or appellants, petitioners, complainants, protestants, or respondents to a proceeding who claim a direct and substantial interest in the proceeding may petition for an order from the presiding officer granting intervention to become a party, if a formal hearing is required by statute to be held in the proceeding. (3-20-20)T

**351. FORM AND CONTENTS OF PETITIONS TO INTERVENE (RULE 351).**

Petitions to intervene must comply with Rules 200, 300, and 301. The petition must set forth the name and address of the potential intervenor and must state the direct and substantial interest of the potential intervenor in the proceeding. If affirmative relief is sought, the petition must state the relief sought and the basis for granting it. (3-20-20)T

**352. TIMELY FILING OF PETITIONS TO INTERVENE (RULE 352).**

Petitions to intervene must be filed at least fourteen (14) days before the date set for formal hearing, or by the date of the prehearing conference, whichever is earlier, unless a different time is provided by order or notice. Petitions not timely filed must state a substantial reason for delay. The presiding officer may deny or conditionally grant petitions to intervene that are not timely filed for failure to state good cause for untimely filing, to prevent disruption, prejudice to existing parties or undue broadening of the issues, or for other reasons. Intervenors who do not file timely petitions are bound by orders and notices earlier entered as a condition of granting the untimely petition. (3-20-20)T

**353. GRANTING PETITIONS TO INTERVENE (RULE 353).**

If a timely-filed petition to intervene shows direct and substantial interest in any part of the subject matter of a proceeding and does not unduly broaden the issues, the presiding officer will grant intervention, subject to reasonable conditions, unless the applicant's interest is adequately represented by existing parties. If it appears that an intervenor has no direct or substantial interest in the proceeding, the presiding officer may dismiss the intervenor from the proceeding. (3-20-20)T

**354. ORDERS GRANTING INTERVENTION -- OPPOSITION (RULE 354).**

No order granting a petition to intervene will be acted upon sooner than seven (7) days after its filing, except in a hearing in which any party may be heard or except where no objection to the intervention is made. Any party opposing a petition to intervene by motion must file the motion within seven (7) days after receipt of the petition to intervene and serve the motion upon all parties of record and upon the person petitioning to intervene. (3-20-20)T

**355. PUBLIC WITNESSES (RULE 355).**

Persons not parties and not called by a party who testify at hearing are called "public witnesses." Public witnesses do not have parties' rights to examine witnesses or otherwise participate in the proceedings as parties. Public witnesses' written or oral statements and exhibits are subject to examination and objection by parties. Subject to Rules 557 and 559, public witnesses have a right to introduce evidence at hearing by their written or oral statements and exhibits introduced at hearing, except that public witnesses offering expert opinions at hearing or detailed analysis or detailed exhibits must comply with Rule 528 with regard to filing and service of testimony and exhibits to the same extent as expert witnesses of parties. A person intending to present public witness testimony shall provide five (5) days notice prior to the hearing. The notice shall include the name and address of the witness and the general nature or subject matter of the testimony to be given. If the notice is not given, the public testimony will be allowed only at the discretion of the presiding officer upon a finding of good cause. (3-20-20)T

**356. -- 399. (RESERVED)**

**400. FORM AND CONTENTS OF PETITION FOR DECLARATORY RULINGS (RULE 400).**

Any person petitioning for a declaratory ruling on the applicability of a statute, rule or order administered by the agency must substantially comply with this rule. (3-20-20)T

**01. Form.** The petition shall: (3-20-20)T

**a.** Identify the petitioner and state the petitioner's interest in the matter; (3-20-20)T

**b.** State the declaratory ruling that the petitioner seeks; and (3-20-20)T

**c.** Indicate the statute, order, rule, or other controlling law, and the factual allegations upon which the petitioner relies to support the petition. (3-20-20)T

**02. Legal Assertions.** Legal assertions in the petition may be accompanied by citations of cases and/or statutory provisions. (3-20-20)T



**401. NOTICE OF PETITION FOR DECLARATORY RULING (RULE 401).**

Notice of petition for declaratory ruling may be issued in a manner designed to call its attention to persons likely to be interested in the subject matter of the petition. (3-20-20)T

**402. PETITIONS FOR DECLARATORY RULINGS TO BE DECIDED BY ORDER (RULE 402).**

**01. Final Agency Action.** The agency’s decision on a petition for declaratory ruling on the applicability of any statute, rule or order administered by the agency is a final agency action decided by order. (3-20-20)T

**02. Content.** The order issuing the declaratory ruling shall contain or must be accompanied by a document containing the following paragraphs or substantially similar paragraphs: (3-20-20)T

**a.** This is a final agency action issuing a declaratory ruling. (3-20-20)T

**b.** Pursuant to Sections 67-5270 and 67-5272, Idaho Code, any party aggrieved by this declaratory ruling may appeal to district court by filing a petition in the District Court in the county in which: (3-20-20)T

**i.** A hearing was held; (3-20-20)T

**ii.** The declaratory ruling was issued; (3-20-20)T

**iii.** The party appealing resides; or (3-20-20)T

**iv.** The real property or personal property that was the subject of the declaratory ruling is located. (3-20-20)T

**c.** This appeal must be filed within twenty-eight (28) days of the service date of this declaratory ruling. See Section 67-5273, Idaho Code. (3-20-20)T

**403. -- 409. (RESERVED)**

**410. APPOINTMENT OF HEARING OFFICERS (RULE 410).**

A hearing officer is a person other than the agency head appointed to hear contested cases on behalf of the agency. Unless otherwise provided by statute or rule, hearing officers may be employees of the agency or independent contractors. Hearing officers may be (but need not be) attorneys. Hearing officers who are not attorneys should ordinarily be persons with technical expertise or experience in issues before the agency. The appointment of a hearing officer is a public record available for inspection, examination and copying. (3-20-20)T

**411. HEARING OFFICERS CONTRASTED WITH AGENCY HEAD (RULE 411).**

Agency heads are not hearing officers, even if they are presiding at contested cases. The term “hearing officer” as used in these rules refers only to officers subordinate to the agency head. (3-20-20)T

**412. DISQUALIFICATION OF OFFICERS HEARING CONTESTED CASES (RULE 412).**

Pursuant to Section 67-5252, Idaho Code hearing officers are subject to disqualification for bias, prejudice, interest, substantial prior involvement in the case other than as a presiding officer, status as an employee of the agency, lack of professional knowledge in the subject matter of the contested case, or any other reason provided by law or for any cause for which a judge is or may be disqualified. Any party may promptly petition for the disqualification of a hearing officer after receiving notice that the officer will preside at a contested case or upon discovering facts establishing grounds for disqualification, whichever is later. Any party may assert a blanket disqualification for cause of all employees of the agency hearing the contested case, other than the agency head, without awaiting the designation by a presiding officer. A hearing officer whose disqualification is requested shall determine in writing whether to grant the petition for disqualification, stating facts and reasons for the hearing officer’s determination. Disqualification of agency heads, if allowed, will be pursuant to Sections 74-404 and 67-5252(4), Idaho Code. (3-20-20)T

**413. SCOPE OF AUTHORITY OF HEARING OFFICERS (RULE 413).**

The scope of hearing officers' authority may be restricted in the appointment by the agency. (3-20-20)T

**01. Scope of Authority.** Unless the agency otherwise provides hearing, officers have the standard scope of authority, which is: (3-20-20)T

**a.** Authority to schedule cases assigned to the hearing officer, including authority to issue notices of default, of prehearing conference and of hearing, or to provide for the use of informal procedure, as appropriate; (3-20-20)T

**b.** Authority to schedule and compel discovery, when discovery is authorized before the agency, and to require advance filing of expert testimony, when authorized before the agency; (3-20-20)T

**c.** Authority to preside at and conduct hearings, accept evidence into the record, rule upon objections to evidence, rule on dispositive motions upon completion of the applicant's or petitioner's case in chief, and otherwise oversee the orderly presentations of the parties at hearing; and (3-20-20)T

**d.** Authority to issue a written decision of the hearing officer, including a narrative of the proceedings before the hearing officer and findings of fact, conclusions of law, and recommended or preliminary orders by the hearing officer, following the submission of evidence through stipulation of the parties, affidavits, exhibits, or hearing testimony. (3-20-20)T

**02. Limitation.** The hearing officer's scope of authority may be limited from the standard scope, either in general, or for a specific proceeding. For example, the hearing officer's authority could be limited to scope in Rule Subsection 413.01.c. (giving the officer authority only to conduct hearing), with the agency retaining all other authority. Hearing officers can be given authority with regard to the agency's rules as provided in Rule 416. (3-20-20)T

**414. PRESIDING OFFICER(S) (RULE 414).**

One (1) or more members of the agency board, the agency director, or duly appointed hearing officers may preside at hearing as authorized by statute or rule. When more than one (1) officer sits at hearing, they may all jointly be presiding officers or may designate one (1) of them to be the presiding officer. (3-20-20)T

**415. CHALLENGES TO STATUTES (RULE 415).**

A hearing officer in a contested case has no authority to declare a statute unconstitutional. However, when a court of competent jurisdiction whose decisions are binding precedent in the state of Idaho has declared a statute unconstitutional, or when a federal authority has preempted a state statute or rule, and the hearing officer finds that the same state statute or rule or a substantively identical state statute or rule that would otherwise apply has been challenged in the proceeding before the hearing officer, then the hearing officer shall apply the precedent of the court or the preemptive action of the federal authority to the proceeding before the hearing officer and decide the proceeding before the hearing officer in accordance with the precedent of the court or the preemptive action of the federal authority. (3-20-20)T

**416. REVIEW OF RULES (RULE 416).**

When an order is issued by the agency head in a contested case, the order may consider and decide whether a rule of that agency is within the agency's substantive rulemaking authority or whether the rule has been promulgated according to proper procedure. The agency head may delegate to a hearing officer the authority to recommend a decision on issues of whether a rule is within the agency's substantive rulemaking authority or whether the rule has been promulgated according to proper procedure or may retain all such authority itself. (3-20-20)T

**417. EX PARTE COMMUNICATIONS (RULE 417).**

Unless required for the disposition of a matter specifically authorized by statute to be done ex parte, a presiding officer serving in a contested case shall not communicate, directly or indirectly, regarding any substantive issue in the contested case with any party, except upon notice and opportunity for all parties to participate in the communication. The presiding officer may communicate ex parte with a party concerning procedural matters (e.g., scheduling). Ex parte communications from members of the general public not associated with any party are not required to be reported by this rule. A party to a contested agency proceeding shall not communicate directly or indirectly with the presiding officer or the agency head regarding any substantive issue in the contested case. When a presiding officer or

the agency head becomes aware of an ex parte communication regarding any substantive issue from a party or representative of a party during a contested case, the presiding officer or agency head shall place a copy or written summary of the communication in the file for the case and order the party providing the communication to serve a copy of the communication or written summary upon all parties of record. Repeated violations of this rule shall be cause for the presiding officer to dismiss an action or to dismiss a party from an action. Written communications from a party showing service upon all other parties are not ex parte communications. (3-20-20)T

**418. -- 499. (RESERVED)**

**500. ALTERNATIVE RESOLUTION OF CONTESTED CASES (RULE 500).**

The Idaho Legislature encourages informal means of alternative dispute resolution (ADR). For contested cases, the means of ADR include, but are not limited to, settlement negotiations, mediation, fact finding, mini-trials, and arbitration, or any combination of them. These alternatives can frequently lead to more creative, efficient and sensible outcomes than may be attained under formal contested case procedures. An agency may use ADR for the resolution of issues in controversy in a contested case if the agency finds that such a proceeding is appropriate. An agency may, for example, find that using ADR is not appropriate if it determines that an authoritative resolution of the matter is needed for precedential value, that formal resolution of the matter is of special importance to avoid variation in individual decisions, that the matter significantly affects persons who are not parties to the proceeding, or that a formal proceeding is in the public interest. (3-20-20)T

**501. NEUTRALS (RULE 501).**

When ADR is used for all or a portion of a contested case, the agency may provide a neutral to assist the parties in resolving their disputed issues. The neutral may be an employee of the agency or of another state agency or any other individual who is acceptable to the parties to the proceeding. A neutral shall have no official, financial, or personal conflict of interest with respect to the issues in controversy, unless such interest is disclosed in writing to all parties and all parties agree that the neutral may serve. (3-20-20)T

**502. CONFIDENTIALITY (RULE 502).**

Communications in an ADR proceeding shall not be disclosed by the neutral or by any party to the proceeding unless all parties to the proceeding consent in writing, the communication has already been made public, or is required by court order, statute or agency rule to be made public. (3-20-20)T

**503. -- 509. (RESERVED)**

**510. PURPOSES OF PREHEARING CONFERENCES (RULE 510).**

The presiding officer, or an authorized employee of the agency, may by order or notice issued to all parties convene a prehearing conference in a contested case for the purposes of formulating or simplifying the issues, obtaining concessions of fact or identification of documents to avoid unnecessary proof, scheduling discovery (when discovery is allowed), arranging for the exchange of proposed exhibits or prepared testimony, limiting witnesses, discussing settlement offers or making settlement offers, scheduling hearings, establishing procedure at hearings, and addressing other matters that may expedite orderly conduct and disposition of the proceeding or its settlement. (3-20-20)T

**511. NOTICE OF PREHEARING CONFERENCE (RULE 511).**

Notice of the place, date and hour of a prehearing conference will be served at least fourteen (14) days before the time set for the prehearing conference, unless the presiding officer finds it necessary or appropriate for the conference to be held earlier. Notices for prehearing conference must contain the same information as notices of hearing with regard to an agency's obligations under the American with Disabilities Act. (3-20-20)T

**512. RECORD OF CONFERENCE (RULE 512).**

Prehearing conferences may be held formally (on the record) or informally (off the record) before or in the absence of a presiding officer, according to order or notice. Agreements by the parties to the conference may be put on the record during formal conferences or may be reduced to writing and filed with the agency after formal or informal conferences. (3-20-20)T

**513. ORDERS RESULTING FROM PREHEARING CONFERENCE (RULE 513).**

The presiding officer, or an authorized employee of the agency, may issue a prehearing order or notice based upon the results of the agreements reached at or rulings made at a prehearing conference. A prehearing order will control the

course of subsequent proceedings unless modified by the presiding officer for good cause. (3-20-20)T

**514. FACTS DISCLOSED NOT PART OF THE RECORD (RULE 514).**

Facts disclosed, offers made and all other aspects of negotiation (except agreements reached) in prehearing conferences in a contested case are not part of the record. (3-20-20)T

**515. -- 519. (RESERVED)**

**520. KINDS AND SCOPE OF DISCOVERY LISTED (RULE 520).**

**01. Kinds of Discovery.** The kinds of discovery recognized and authorized by these rules in contested cases are: (3-20-20)T

- a.** Depositions; (3-20-20)T
- b.** Production requests or written interrogatories; (3-20-20)T
- c.** Requests for admission; (3-20-20)T
- d.** Subpoenas; and (3-20-20)T
- e.** Statutory inspection, examination (including physical or mental examination), investigation, etc. (3-20-20)T

**02. Rules of Civil Procedure.** Unless otherwise provided by statute, rule, order or notice, the scope of discovery, other than statutory inspection, examination, investigation, etc., is governed by the Idaho Rules of Civil Procedure (see Idaho Rule of Civil Procedure 26(b)). (3-20-20)T

**521. WHEN DISCOVERY AUTHORIZED (RULE 521).**

No party before the agency is entitled to engage in discovery unless the party moves for an order authorizing discovery and the agency issues an order authorizing the requested discovery, or upon agreement of all parties to the discovery that discovery may be conducted. The presiding officer shall provide a schedule for discovery in the order authorizing discovery, but the order authorizing and scheduling discovery need not conform to the timetables of the Idaho Rules of Civil Procedure. A party, upon reasonable notice to other parties and all persons affected thereby, may apply for an order compelling discovery in a manner consistent with the provisions of Rule 37(a) of the Idaho Rules of Civil Procedure. The agency or agency staff may conduct statutory inspection, examination, investigation, etc., at any time without filing a motion to authorize discovery. (3-20-20)T

**522. RIGHTS TO DISCOVERY RECIPROCAL (RULE 522).**

All parties to a proceeding have a right of discovery of all other parties to a proceeding according to Rule 521 and to the authorizing statutes and rules. The presiding officer may by order authorize or compel necessary discovery authorized by statute or rule. (3-20-20)T

**523. DEPOSITIONS (RULE 523).**

Depositions may be taken in accordance with the Idaho Rules of Civil Procedure for any purpose allowed by statute, the Idaho Rules of Civil Procedure, or rule or order of the agency. (3-20-20)T

**524. PRODUCTION REQUESTS OR WRITTEN INTERROGATORIES AND REQUESTS FOR ADMISSION (RULE 524).**

Production requests or written interrogatories and requests for admission may be taken in accordance with the Idaho Rules of Civil Procedure for any purpose allowed by statute, the Idaho Rules of Civil Procedure, or rule or order of the agency. (3-20-20)T

**525. SUBPOENAS (RULE 525).**

The agency may issue subpoenas upon a party's motion or upon its own initiative. The agency upon motion to quash made promptly, and in any event, before the time to comply with the subpoena, may quash the subpoena, or condition denial of the motion to quash upon reasonable terms. (3-20-20)T

**526. STATUTORY INSPECTION, EXAMINATION, INVESTIGATION, ETC. -- CONTRASTED WITH OTHER DISCOVERY (RULE 526).**

This rule recognizes, but does not enlarge or restrict, an agency's statutory right of inspection, examination (including mental or physical examination), investigation, etc. This statutory right of an agency is independent of and cumulative to any right of discovery in formal proceedings and may be exercised by the agency whether or not a person is party to a formal proceeding before the agency. Information obtained from statutory inspection, examination, investigation, etc., may be used in formal proceedings or for any other purpose, except as restricted by statute or rule. The rights of deposition, production request or written interrogatory, request for admission, and subpoena, can be used by parties only in connection with formal proceedings before the agency. (3-20-20)T

**527. ANSWERS TO PRODUCTION REQUESTS OR WRITTEN INTERROGATORIES AND TO REQUESTS FOR ADMISSION (RULE 527).**

Answers to production requests or written interrogatories and to requests for admission shall be filed or served as provided by the order compelling discovery. Answers must conform to the requirements of the Idaho Rules of Civil Procedure. The order compelling discovery may provide that voluminous answers to requests need not be served so long as they are made available for inspection and copying under reasonable terms. (3-20-20)T

**528. FILING AND SERVICE OF DISCOVERY-RELATED DOCUMENTS (RULE 528).**

Notices of deposition, cover letters stating that production requests, written interrogatories or requests for admission have been served, cover letters stating answers to production requests, written interrogatories, or requests for admission have been served or are available for inspection under Rule 527, and objections to discovery must be filed and served as provided in the order authorizing discovery. (3-20-20)T

**529. EXHIBIT NUMBERS (RULE 529).**

The agency assigns exhibit numbers to each party. (3-20-20)T

**530. PREPARED TESTIMONY AND EXHIBITS (RULE 530).**

Order, notice or rule may require a party or parties to file before hearing and to serve on all other parties prepared expert testimony and exhibits to be presented at hearing. Assigned exhibit numbers should be used in all prepared testimony. (3-20-20)T

**531. SANCTIONS FOR FAILURE TO OBEY ORDER COMPELLING DISCOVERY (RULE 531).**

The agency may impose all sanctions recognized by statute or rules for failure to comply with an order compelling discovery, including but not limited to the sanctions listed in paragraphs (A), (B), and (C) of Rule 37(b)(2) of the Idaho Rules of Civil Procedure. (3-20-20)T

**532. PROTECTIVE ORDERS (RULE 532).**

As authorized by statute or rule, the agency may issue protective orders limiting access to information generated during settlement negotiations, discovery, or hearing. (3-20-20)T

**533. -- 549. (RESERVED)**

**550. NOTICE OF HEARING (RULE 550).**

Notice of the place, date and hour of hearing will be served on all parties at least fourteen (14) days before the time set for hearing, unless the agency finds by order that it is necessary or appropriate that the hearing be held earlier. Notices must comply with the requirements of Rule 551. Notices must list the names of the parties (or the lead parties if the parties are too numerous to name), the case number or docket number, the names of the presiding officers who will hear the case, the name, address and telephone number of the person to whom inquires about scheduling, hearing facilities, etc., should be directed, and the names of persons with whom the documents, pleadings, etc., in the case should be filed if the presiding officer is not the person who should receive those documents. If no document previously issued by the agency has listed the legal authority of the agency to conduct the hearing, the notice of hearing must do so. The notice of hearing shall state that the hearing will be conducted under these rules of procedure and inform the parties where they may read or obtain a copy. (3-20-20)T

**551. FACILITIES AT OR FOR HEARING AND A.D.A. REQUIREMENTS (RULE 551).**

All hearings must be held in facilities meeting the accessibility requirements of the Americans with Disabilities Act,

and all notices of hearing must inform the parties that the hearing will be conducted in facilities meeting the accessibility requirements of the Americans with Disabilities Act. All notices of hearing must inform the parties and other persons notified that if they require assistance of the kind that the agency is required to provide under the Americans with Disabilities Act in order to participate in or understand the hearing, the agency will supply that assistance upon request a reasonable number of days before the hearing. The notice of hearing shall explicitly state the number of days before the hearing that the request must be made. (3-20-20)T

**552. HOW HEARINGS HELD (RULE 552).**

Hearings may be held in person or by telephone or television or other electronic means, if each participant in the hearing has an opportunity to participate in the entire proceeding while it is taking place. (3-20-20)T

**553. CONDUCT AT HEARINGS (RULE 553).**

All persons attending a hearing must conduct themselves in a respectful manner. Smoking is not permitted at hearings. The presiding officer may exclude persons from the hearing who refuse to conduct themselves in a respectful manner. Disruptive conduct that is serious in nature shall be cause for dismissal of a disrupting party from the proceeding. (3-20-20)T

**554. CONFERENCE AT HEARING (RULE 554).**

In any proceeding the presiding officer may convene the parties before hearing or recess the hearing to discuss formulation or simplification of the issues, admissions of fact or identification of documents to avoid unnecessary proof, exchanges of documents, exhibits or prepared testimony, limitation of witnesses, establishment of order of procedure, and other matters that may expedite orderly conduct of the hearing. The presiding officer shall state the results of the conference on the record. (3-20-20)T

**555. PRELIMINARY PROCEDURE AT HEARING (RULE 555).**

Before taking evidence the presiding officer will call the hearing to order, take appearances of parties, and act upon any pending motions or petitions. The presiding officer may allow opening statements as necessary or appropriate to explain a party's presentation. (3-20-20)T

**556. CONSOLIDATION OF PROCEEDINGS (RULE 556).**

The agency may consolidate two (2) or more proceedings for hearing upon finding that they present issues that are related and that the rights of the parties will not be prejudiced. In consolidated hearings the presiding officer determines the order of the proceeding. (3-20-20)T

**557. STIPULATIONS (RULE 557).**

Parties may stipulate among themselves to any fact at issue in a contested case by written statement filed with the presiding officer or presented at hearing or by oral statement at hearing. A stipulation binds all parties agreeing to it only according to its terms. The agency may regard a stipulation as evidence or may require proof by evidence of the facts stipulated. The agency is not bound to adopt a stipulation of the parties, but may do so. If the agency rejects a stipulation, it will do so before issuing a final order, and it will provide an additional opportunity for the parties to present evidence and arguments on the subject matter of the rejected stipulation. (3-20-20)T

**558. ORDER OF PROCEDURE (RULE 558).**

The presiding officer may determine the order of presentation of witnesses and examination of witnesses. (3-20-20)T

**559. TESTIMONY UNDER OATH (RULE 559).**

All testimony presented in formal hearings will be given under oath. Before testifying each witness must swear or affirm that the testimony the witness will give before the agency is the truth, the whole truth, and nothing but the truth. (3-20-20)T

**560. PARTIES AND PERSONS WITH SIMILAR INTERESTS (RULE 560).**

If two (2) or more parties or persons have substantially like interests or positions, to expedite the proceeding and avoid duplication, the presiding officer may limit the number of them who testify, examine witnesses, or make and argue motions and objections. (3-20-20)T

**561. CONTINUANCE OF HEARING (RULE 561).**

The presiding officer may continue proceedings for further hearing. (3-20-20)T

**562. RULINGS AT HEARINGS (RULE 562).**

The presiding officer rules on motions and objections presented at hearing. When the presiding officer is a hearing officer, the presiding officer's rulings may be reviewed by the agency head in determining the matter on its merits and the presiding officer may refer or defer rulings to the agency head for determination. (3-20-20)T

**563. ORAL ARGUMENT (RULE 563).**

The presiding officer may set and hear oral argument on any matter in the contested case on reasonable notice according to the circumstances. (3-20-20)T

**564. BRIEFS -- MEMORANDA -- PROPOSED ORDERS OF THE PARTIES -- STATEMENTS OF POSITION -- PROPOSED ORDER OF THE PRESIDING OFFICER (RULE 564).**

In any contested case, any party may ask to file briefs, memoranda, proposed orders of the parties or statements of position, and the presiding officer may request briefs, proposed orders of the parties, or statements of position. The presiding officer may issue a proposed order and ask the parties for comment upon the proposed order. (3-20-20)T

**565. PROCEDURE ON PREHEARING MOTIONS (RULE 565).**

The presiding officer may consider and decide prehearing motions with or without oral argument or hearing. Unless otherwise provided by the presiding officer upon a showing of good cause by a party, when a motion has been filed, all parties joining in, answering to or responding to the motion(s) will have fourteen (14) days from the time of filing of the motion in which to respond. (3-20-20)T

**566. JOINT HEARINGS (RULE 566).**

The agency may hold joint hearings with federal agencies, with agencies of other states, and with other agencies of the state of Idaho. When joint hearings are held, the agencies may agree among themselves which agency's rules of practice and procedure will govern. (3-20-20)T

**567. -- 599. (RESERVED)**

**600. RULES OF EVIDENCE -- EVALUATION OF EVIDENCE (RULE 600).**

Evidence should be taken by the agency to assist the parties' development of a record, not excluded to frustrate that development. The presiding officer at hearing is not bound by the Idaho Rules of Evidence. No informality in any proceeding or in the manner of taking testimony invalidates any order. The presiding officer, with or without objection, may exclude evidence that is irrelevant, unduly repetitious, inadmissible on constitutional or statutory grounds, or on the basis of any evidentiary privilege provided by statute or recognized in the courts of Idaho. All other evidence may be admitted if it is of a type commonly relied upon by prudent persons in the conduct of their affairs. The agency's experience, technical competence and specialized knowledge may be used in evaluation of evidence. (3-20-20)T

**601. DOCUMENTARY EVIDENCE (RULE 601).**

Documentary evidence may be received in the form of copies or excerpts. Upon request, parties shall be given an opportunity to compare the copy with the original if available. (3-20-20)T

**602. OFFICIAL NOTICE -- AGENCY STAFF MEMORANDA (RULE 602).**

Official notice may be taken of any facts that could be judicially noticed in the courts of Idaho and of generally recognized technical or scientific facts within the agency's specialized knowledge. Parties shall be notified of the specific facts or material noticed and the source of the material noticed, including any agency staff memoranda and data. Notice that official notice will be taken should be provided either before or during the hearing, and must be provided before the issuance of any order that is based in whole or in part on facts or material officially noticed. Parties must be given an opportunity to contest and rebut the facts or material officially noticed. When the presiding officer proposes to notice agency staff memoranda or agency staff reports, responsible staff employees or agents shall be made available for cross-examination if any party timely requests their availability. (3-20-20)T

**603. DEPOSITIONS (RULE 603).**

Depositions may be offered into evidence. (3-20-20)T

**604. OBJECTIONS -- OFFERS OF PROOF (RULE 604).**

Grounds for objection to the admission or exclusion of evidence must be stated briefly at the time the evidence is offered. Formal exceptions to rulings admitting or excluding evidence are unnecessary and need not be taken. An offer of proof for the record consists of a statement of the substance of the excluded evidence. When a party objects to the admission of evidence, the presiding officer will rule on the objection, or, if the presiding officer is a hearing officer, the presiding officer may receive the evidence subject to later ruling by the agency head or refer the matter to the agency head. (3-20-20)T

**605. PREPARED TESTIMONY (RULE 605).**

The presiding officer may order a witness's prepared testimony previously distributed to all parties to be included in the record of hearing as if read. Admissibility of prepared testimony is subject to Rule 600. (3-20-20)T

**606. EXHIBITS (RULE 606).**

Exhibit numbers may be assigned to the parties before hearing. Exhibits prepared for hearing should ordinarily be typed or printed on eight and one-half inch (8 1/2") by eleven inch (11") white paper, except that maps, charts, photographs and non-documentary exhibits may be introduced on the size or kind of paper customarily used for them. A copy of each documentary exhibit must be furnished to each party present and to the presiding officer, except for unusually bulky or voluminous exhibits that have previously been made available for the parties' inspection. Copies must be of good quality. Exhibits identified at hearing are subject to appropriate and timely objection before the close of proceedings. Exhibits to which no objection is made are automatically admitted into evidence without motion of the sponsoring party. Neither motion pictures, slides, opaque projections, videotapes, audiotapes nor other materials not capable of duplication by still photograph or reproduction on paper shall be presented as exhibits without approval of the presiding officer prior to the hearing. (3-20-20)T

**607. -- 609. (RESERVED)**

**610. CONFIDENTIALITY OF SETTLEMENT NEGOTIATIONS (RULE 610).**

Settlement negotiations in a contested case are confidential, unless all participants to the negotiation agree to the contrary in writing. Facts disclosed, offers made and all other aspects of negotiation (except agreements reached) in settlement negotiations in a contested case are not part of the record. (3-20-20)T

**611. SUGGESTION FOR OR INQUIRY ABOUT SETTLEMENTS (RULE 611).**

Through notice or order or on the record at prehearing conference or hearing, the presiding officer may inquire of the parties in any proceeding whether settlement negotiations are in progress or are contemplated or may invite settlement of an entire proceeding or certain issues. (3-20-20)T

**612. CONSIDERATION OF SETTLEMENTS (RULE 612).**

Settlements must be reviewed under this rule. When a settlement is presented to the presiding officer, the presiding officer will prescribe procedures appropriate to the nature of the settlement to consider the settlement. For example, the presiding officer could summarily accept settlement of essentially private disputes that have no significant implications for administration of the law for persons other than the affected parties. On the other hand, when one (1) or more parties to a proceeding is not party to the settlement or when the settlement presents issues of significant implication for other persons, the presiding officer may convene an evidentiary hearing to consider the reasonableness of the settlement and whether acceptance of the settlement is consistent with the agency's charge under the law. (3-20-20)T

**613. BURDENS OF PROOF (RULE 613).**

Proponents of a proposed settlement carry the burden of showing that the settlement is in accordance with the law. The presiding officer may require the development of an appropriate record in support of or opposition to a proposed settlement as a condition of accepting or rejecting the settlement. (3-20-20)T

**614. SETTLEMENT NOT BINDING (RULE 614).**

The presiding officer is not bound by settlement agreements that are not unanimously accepted by all parties or that have significant implications for persons not parties. In these instances, the presiding officer will independently review any proposed settlement to determine whether the settlement is in accordance with the law. (3-20-20)T

**615. -- 649. (RESERVED)**



**650. RECORD FOR DECISION (RULE 650).**

- 01. Official Record.** The agency shall maintain an official record for each contested case and (unless statute provides otherwise) base its decision in a contested case on the official record for the case. (3-20-20)T
- 02. Contents of Record.** The record for a contested case shall include: (3-20-20)T
- a.** All notices of proceedings; (3-20-20)T
  - b.** All applications or claims or appeals, petitions, complaints, protests, motions, and answers filed in the proceeding; (3-20-20)T
  - c.** All intermediate or interlocutory rulings of hearing officers or the agency head; (3-20-20)T
  - d.** All evidence received or considered (including all transcripts or recordings of hearings and all exhibits offered or identified at hearing); (3-20-20)T
  - e.** All offers of proof, however made; (3-20-20)T
  - f.** All briefs, memoranda, proposed orders of the parties or of the presiding officers, statements of position, statements of support, and exceptions filed by parties or persons not parties; (3-20-20)T
  - g.** All evidentiary rulings on testimony, exhibits, or offers of proof; (3-20-20)T
  - h.** All staff memoranda or data submitted in connection with the consideration of the proceeding; (3-20-20)T
  - i.** A statement of matters officially noticed; and (3-20-20)T
  - j.** All recommended orders, preliminary orders, final orders, and orders on reconsideration. (3-20-20)T

**651. RECORDING OF HEARINGS (RULE 651).**

All hearings shall be recorded on audiotape or videotape at the agency's expense. The agency may provide for a transcript of the proceeding at its own expense. Any party may have a transcript prepared at its own expense. If the transcript prepared at the expense of a party is deemed by the presiding officer to be the official transcript of the hearing, the party shall furnish the agency a transcript without charge. (3-20-20)T

**652. -- 699. (RESERVED)**

**700. NOTICE OF PROPOSED DEFAULT AFTER FAILURE TO APPEAR OR RESPOND (RULE 700).**

If an applicant or claimant or appellant, petitioner, protestant, complainant, or moving party fails to appear at the time and place set for hearing, or prehearing conference, on an application or claim or appeal, petition, complaint, or motion, or fails to respond to a written information inquiry, the presiding officer may serve upon all parties a notice of a proposed default order denying the application or claim or appeal, petition, complaint, or motion. The notice of a proposed default order shall include a statement that the default order is proposed to be issued because of a failure of the applicant or claimant or appellant, petitioner, complainant or moving party to appear at the time and place set for hearing or prehearing conference, or to respond to the information inquiry. The notice of proposed default order may be mailed to the last known mailing address of the party proposed to be defaulted. (3-20-20)T

**701. SEVEN DAYS TO CHALLENGE PROPOSED DEFAULT ORDER (RULE 701).**

Within seven (7) days after the service of the notice of proposed default order, the party against whom it was filed may file a written petition requesting that a default order not be entered. The petition must state the grounds why the petitioning party believes that default should not be entered. (3-20-20)T

**702. ISSUANCE OF DEFAULT ORDER (RULE 702).**

The agency shall promptly issue a default order or withdraw the notice of proposed default order after expiration of

the seven (7) days for the party to file a petition contesting the default order or receipt of a petition. If a default order is issued, all further proceedings necessary to complete the contested case shall be conducted without participation of the party in default (if the defaulting party is not a movant) or upon the results of the denial of the motion (if the defaulting party is a movant). All issues in the contested case shall be determined, including those affecting the defaulting party. Costs may be assessed against a defaulting party. (3-20-20)T

**703. -- 709. (RESERVED)**

**710. INTERLOCUTORY ORDERS (RULE 710).**

Interlocutory orders are orders that do not decide all previously undecided issues presented in a proceeding, except the agency may by order decide some of the issues presented in a proceeding and provide in that order that its decision on those issues is final and subject to review by reconsideration or appeal, but is not final on other issues. Unless an order contains or is accompanied by a document containing one (1) of the paragraphs set forth in Rules 720, 730 or 740 or a paragraph substantially similar, the order is interlocutory. The following orders are always interlocutory: orders initiating complaints or investigations; orders joining, consolidating or separating issues, proceedings or parties; orders granting or denying intervention; orders scheduling prehearing conferences, discovery, hearing, oral arguments or deadlines for written submissions; and orders compelling or refusing to compel discovery. Interlocutory orders may be reviewed by the officer issuing the order pursuant to Rules 711, 760, and 770. (3-20-20)T

**711. REVIEW OF INTERLOCUTORY ORDERS (RULE 711).**

Any party or person affected by an interlocutory order may petition the officer issuing the order to review the interlocutory order. The officer issuing an interlocutory order may rescind, alter or amend any interlocutory order on the officer's own motion, but will not on the officer's own motion review any interlocutory order affecting any party's substantive rights without giving all parties notice and an opportunity for written comment. (3-20-20)T

**712. CONTENTS OF ORDERS (RULE 712).**

Pursuant to Section 67-5248, Idaho Code, an order that determines the legal rights or interests of one (1) or more parties must be in writing and shall include the following: (3-20-20)T

**01. Findings of Fact and Conclusions of Law.** An order shall contain a reasoned statement in support of the decision. Findings of fact, if set forth in statutory language, shall be accompanied by a concise and explicit statement of the underlying facts of record supporting the findings. Findings of fact must be based exclusively on the evidence in the record of the contested case and on matters officially noticed in that proceeding. (3-20-20)T

**02. Statement of Available Procedure.** An order shall contain a statement of the available procedures and applicable time limits for seeking reconsideration or other administrative relief. (3-20-20)T

**713. -- 719. (RESERVED)**

**720. RECOMMENDED ORDERS (RULE 720).**

**01. Recommended Orders -- Definition.** Recommended orders are orders issued by a person other than the agency head that will become a final order of the agency only after review of the agency head (or the agency head's designee) pursuant to Section 67-5244, Idaho Code. (3-20-20)T

**02. Contents of Recommended Orders.** Every recommended order must contain or be accompanied by a document containing the following paragraphs or substantially similar paragraphs: (3-20-20)T

**a.** This is a recommended order of the hearing officer. It will not become final without action of the agency head. Any party may file a petition for reconsideration of this recommended order with the hearing officer issuing the order within fourteen (14) days of the service date of this order. The hearing officer issuing this recommended order will dispose of any petition for reconsideration within twenty-one (21) days of its receipt, or the petition will be considered denied by operation of law. See Section 67-5243(3), Idaho Code. (3-20-20)T

**b.** Within fourteen (14) days after (a) the service date of this recommended order, (b) the service date of a denial of a petition for reconsideration from this recommended order, or (c) the failure within twenty-one (21)

days to grant or deny a petition for reconsideration from this recommended order, any party may in writing support or take exceptions to any part of this recommended order and file briefs in support of the party's position with the agency head or designee on any issue in the proceeding. If no party files exceptions to the recommended order with the agency head or designee, the agency head or designee will issue a final order within fifty-six (56) days after:

(3-20-20)T

- i. The last day a timely petition for reconsideration could have been filed with the hearing officer; (3-20-20)T
- ii. The service date of a denial of a petition for reconsideration by the hearing officer; or (3-20-20)T
- iii. The failure within twenty-one (21) days to grant or deny a petition for reconsideration by the hearing officer. (3-20-20)T

c. Written briefs in support of or taking exceptions to the recommended order shall be filed with the agency head (or designee of the agency head). Opposing parties shall have fourteen (14) days to respond. The agency head or designee may schedule oral argument in the matter before issuing a final order. The agency head or designee will issue a final order within fifty-six (56) days of receipt of the written briefs or oral argument, whichever is later, unless waived by the parties or for good cause shown. The agency may remand the matter for further evidentiary hearings if further factual development of the record is necessary before issuing a final order. (3-20-20)T

**721. -- 729. (RESERVED)**

**730. PRELIMINARY ORDERS (RULE 730).**

**01. Preliminary Orders -- Definition.** Preliminary orders are orders issued by a person other than the agency head that will become a final order of the agency unless reviewed by the agency head (or the agency head's designee) pursuant to Section 67-5245, Idaho Code. (3-20-20)T

**02. Contents of Preliminary Order.** Every preliminary order must contain or be accompanied by a document containing the following paragraphs or substantially similar paragraphs: (3-20-20)T

a. This is a preliminary order of the hearing officer. It can and will become final without further action of the agency unless any party petitions for reconsideration before the hearing officer issuing it or appeals to the hearing officer's superiors in the agency. Any party may file a petition for reconsideration of this preliminary order with the hearing officer issuing the order within fourteen (14) days of the service date of this order. The hearing officer issuing this order will dispose of the petition for reconsideration within twenty-one (21) days of its receipt, or the petition will be considered denied by operation of law. See Section 67-5243(3), Idaho Code. (3-20-20)T

b. Within fourteen (14) days after: (3-20-20)T

i. The service date of this preliminary order; (3-20-20)T

ii. The service date of the denial of a petition for reconsideration from this preliminary order; or (3-20-20)T

iii. The failure within twenty-one (21) days to grant or deny a petition for reconsideration from this preliminary order, any party may in writing appeal or take exceptions to any part of the preliminary order and file briefs in support of the party's position on any issue in the proceeding to the agency head (or designee of the agency head). Otherwise, this preliminary order will become a final order of the agency. (3-20-20)T

c. If any party appeals or takes exceptions to this preliminary order, opposing parties shall have fourteen (14) days to respond to any party's appeal within the agency. Written briefs in support of or taking exceptions to the preliminary order shall be filed with the agency head (or designee). The agency head (or designee) may review the preliminary order on its own motion. (3-20-20)T

d. If the agency head (or designee) grants a petition to review the preliminary order, the agency head

(or designee) shall allow all parties an opportunity to file briefs in support of or taking exceptions to the preliminary order and may schedule oral argument in the matter before issuing a final order. The agency head (or designee) will issue a final order within fifty-six (56) days of receipt of the written briefs or oral argument, whichever is later, unless waived by the parties or for good cause shown. The agency head (or designee) may remand the matter for further evidentiary hearings if further factual development of the record is necessary before issuing a final order. (3-20-20)T

**e.** Pursuant to Section 42-1701A(3), Idaho Code, unless the right to a hearing before the Department or the Board is otherwise provided by statute, any person aggrieved by any decision, determination, order or action of the director of the Department or any applicant for any permit, license, certificate, approval, registration, or similar form of permission required by law to be issued by the director, who is aggrieved by a denial or conditional approval ordered by the director, and who has not previously been afforded an opportunity for a hearing on the matter shall be entitled to a hearing before the director to contest the denial or conditional approval upon filing with the director, within fifteen (15) days after receipt of the denial or conditional approval, a written petition stating the grounds for contesting the action by the director and requesting a hearing. (3-20-20)T

**f.** Pursuant to Sections 67-5270 and 67-5272, Idaho Code, if this preliminary order becomes final, any party aggrieved by the final order or orders previously issued in this case may appeal the final order and all previously issued orders in this case to district court by filing a petition in the district court of the county in which: (3-20-20)T

i. A hearing was held; (3-20-20)T

ii. The final agency action was taken; (3-20-20)T

iii. The party seeking review of the order resides; or (3-20-20)T

iv. The real property or personal property that was the subject of the agency action is located. (3-20-20)T

**g.** This appeal must be filed within twenty-eight (28) days of this preliminary order becoming final. See Section 67-5273, Idaho Code. The filing of an appeal to district court does not itself stay the effectiveness or enforcement of the order under appeal. (3-20-20)T

**731. -- 739. (RESERVED)**

**740. FINAL ORDERS (RULE 740).**

**01. Final Order -- Definition.** Final orders are preliminary orders that have become final under Rule 730 pursuant to Section 67-5245, Idaho Code, or orders issued by the agency head pursuant to Section 67-5246, Idaho Code, or emergency orders, including cease and desist or show cause orders, issued by the agency head pursuant to Section 67-5247, Idaho Code. (3-20-20)T

**02. Content of Final Order.** Every final order issued by the agency head must contain or be accompanied by a document containing the following paragraphs or substantially similar paragraphs: (3-20-20)T

**a.** This is a final order of the agency. Any party may file a petition for reconsideration of this final order within fourteen (14) days of the service date of this order. The agency will dispose of the petition for reconsideration within twenty-one (21) days of its receipt, or the petition will be considered denied by operation of law. See Section 67-5246(4), Idaho Code. (3-20-20)T

**b.** Pursuant to Section 42-1701A(3), Idaho Code, unless the right to a hearing before the Department or the Board is otherwise provided by statute, any person aggrieved by any decision, determination, order or action of the director of the Department or any applicant for any permit, license, certificate, approval, registration, or similar form of permission required by law to be issued by the director, who is aggrieved by a denial or conditional approval ordered by the director, and who has not previously been afforded an opportunity for a hearing on the matter shall be entitled to a hearing before the director to contest the denial or conditional approval upon filing with the director, within fifteen (15) days after receipt of the denial or conditional approval, a written petition stating the grounds for

contesting the action by the director and requesting a hearing. (3-20-20)T

**c.** Pursuant to Sections 67-5270 and 67-5272, Idaho Code, any party aggrieved by this final order or orders previously issued in this case may appeal this final order and all previously issued orders in this case to district court by filing a petition in the district court of the county in which: (3-20-20)T

i. A hearing was held; (3-20-20)T

ii. The final agency action was taken; (3-20-20)T

iii. The party seeking review of the order resides; or (3-20-20)T

iv. The real property or personal property that was the subject of the agency action is located. (3-20-20)T

**d.** An appeal must be filed within twenty-eight (28) days (a) of the service date of this final order, (b) of an order denying petition for reconsideration, or (c) the failure within twenty-one (21) days to grant or deny a petition for reconsideration, whichever is later. See Section 67-5273, Idaho Code, and Rule 84 of the Idaho Rules of Civil Procedure. The filing of an appeal to district court does not itself stay the effectiveness or enforcement of the order under appeal. (3-20-20)T

**741. -- 749. (RESERVED)**

**750. ORDER NOT DESIGNATED (RULE 750).**

If an order does not designate itself as recommended, preliminary or final at its release, but is designated as recommended, preliminary or final after its release, its effective date for purposes of reconsideration or appeal is the date of the order of designation. If a party believes that an order not designated as a recommended order, preliminary order or final order according to the terms of these rules should be designated as a recommended order, preliminary order or final order, the party may move to designate the order as recommended, preliminary or final, as appropriate. (3-20-20)T

**751. -- 759. (RESERVED)**

**760. MODIFICATION OF ORDER ON PRESIDING OFFICER'S OWN MOTION (RULE 760).**

A hearing officer issuing a recommended or preliminary order may modify the recommended or preliminary order on the hearing officer's own motion within fourteen (14) days after issuance of the recommended or preliminary order by withdrawing the recommended or preliminary order and issuing a substitute recommended or preliminary order. The agency head may modify or amend a final order of the agency (be it a preliminary order that became final because no party challenged it or a final order issued by the agency head itself) at any time before notice of appeal to District Court has been filed or the expiration of the time for appeal to District Court, whichever is earlier, by withdrawing the earlier final order and substituting a new final order for it. (3-20-20)T

**761. -- 769. (RESERVED)**

**770. CLARIFICATION OF ORDERS (RULE 770).**

Any party or person affected by an order may petition to clarify any order, whether interlocutory, recommended, preliminary or final. Petitions for clarification from final orders do not suspend or toll the time to petition for reconsideration or appeal the order. A petition for clarification may be combined with a petition for reconsideration or stated in the alternative as a petition for clarification and/or reconsideration. (3-20-20)T

**771. -- 779. (RESERVED)**

**780. STAY OF ORDERS (RULE 780).**

Any party or person affected by an order may petition the agency to stay any order, whether interlocutory or final. Interlocutory or final orders may be stayed by the judiciary according to statute. The agency may stay any interlocutory or final order on its own motion. (3-20-20)T

**781. -- 789. (RESERVED)**

**790. PERSONS WHO MAY APPEAL (RULE 790).**

Pursuant to Section 67-5270, Idaho Code, any party aggrieved by a final order of an agency in a contested case may appeal to district court. Pursuant to Section 67-5271, Idaho Code, a person is not entitled to judicial review of an agency action in district court until that person has exhausted all administrative remedies available with the agency, but a preliminary, procedural, or intermediate agency action or ruling is immediately reviewable in district court if review of the final agency action would not provide an adequate remedy. (3-20-20)T

**791. NOTICE OF APPEAL (RULE 791).**

The notice of appeal must be filed with the district court and served on the agency and all parties. (3-20-20)T

**01. Filing Appeal.** Pursuant to Section 67-5272, Idaho Code, appeals may be filed in the district court of the county in which: (3-20-20)T

- a.** The hearing was held; (3-20-20)T
- b.** The final agency action was taken; (3-20-20)T
- c.** The party seeking review of the agency action resides; or (3-20-20)T
- d.** The real property or personal property that was the subject of the agency is located. (3-20-20)T

**02. Filing Deadline.** Pursuant to Section 67-5273, Idaho Code, and Rule 84 of the Idaho Rules of Civil Procedure a petition for judicial review of a final order in a contested case must be filed within twenty-eight (28) days: (3-20-20)T

- a.** Of the service date of the final order; (3-20-20)T
- b.** Of the denial of the petition for reconsideration; or (3-20-20)T
- c.** The failure within twenty-one (21) days to grant or deny the petition for reconsideration. (3-20-20)T

**792. -- 999. (RESERVED)**

### 37.02.03 – WATER SUPPLY BANK RULES

**000. LEGAL AUTHORITY (RULE 0).**

This chapter is adopted under the legal authority of Section 42-1762, Idaho Code. (3-20-20)T

**001. TITLE AND SCOPE (RULE 1).**

**01. Title.** The title of this chapter is IDAPA 37.02.03, “Water Supply Bank Rules.” (3-20-20)T

**02. Scope.** These rules were first adopted by the Water Resource Board in October 1980 as mandated by Section 42-1762, Idaho Code enacted in 1979. The rules govern the Board’s operation and management of a Water Supply Bank provided for in Sections 42-1761 to 42-1766, Idaho Code. The purposes of the Water Supply Bank, as defined by statute, are to encourage the highest beneficial use of water; provide a source of adequate water supplies to benefit new and supplemental water uses; and provide a source of funding for improving water user facilities and efficiencies. These rules are to be used by the Water Resource Board in considering the purchase, sale, lease or rental of natural flow or stored water, the use of any funds generated therefrom, and the appointment of local committees to facilitate the lease and rental of stored water. The purchase, sale, lease or rental of water shall be in compliance with state and federal law. The adoption of these rules is not intended to prevent any person from directly selling or leasing water by transactions outside the purview of the Water Supply Bank Rules where such transactions are otherwise allowed by law. (3-20-20)T

**002. -- 009. (RESERVED)**

**010. DEFINITIONS (RULE 10).**

**01. Board.** The Idaho Water Resource Board. (3-20-20)T

**02. Board's Water Supply Bank.** The water exchange market operated directly by the Board to facilitate marketing of water rights. (3-20-20)T

**03. Director.** The Director of the Idaho Department of Water Resources. (3-20-20)T

**04. Department.** The Idaho Department of Water Resources. (3-20-20)T

**05. Lease.** To convey by contract a water right to the Board’s water supply bank or stored water to a rental pool operated by a local committee. (3-20-20)T

**06. Local Committee.** The committee which has been designated by action of the Board to facilitate marketing of stored water by operating a rental pool pursuant to Section 42-1765, Idaho Code. (3-20-20)T

**07. Natural Flow.** Water or the right to use water that exists in a spring, stream, river, or aquifer at a certain time and which is not the result of the storage of water flowing at a previous time. (3-20-20)T

**08. Rent.** To convey by contract a water right from the Board’s water supply bank or stored water from a rental pool. (3-20-20)T

**09. Rental Pool.** A market for exchange of stored water operated by a local committee. (3-20-20)T

**10. Stored Water.** Water made available by detention in surface reservoirs or storage space in a surface reservoir. (3-20-20)T

**11. Water Right.** The right to divert and beneficially use the public waters of the state of Idaho including any storage entitlement. (3-20-20)T

**12. Water Supply Bank.** The water exchange market operated by the Water Resource Board pursuant to Section 42-1761 through 42-1766, Idaho Code, and these rules and is a general term which includes the Board’s water supply bank and rental pools. (3-20-20)T

**13. Year.** A time period of twelve (12) consecutive months. (3-20-20)T

**14. Person.** Any company, corporation, association, firm, agency, individual, partnership, Indian tribe, government or other entity. (3-20-20)T

**011. -- 024. (RESERVED)**

**025. ACQUISITION OF WATER RIGHTS FOR THE BOARD'S WATER SUPPLY BANK (RULE 25).**

**01. General.** The Board may purchase, lease, accept as a gift or otherwise obtain rights to natural flow or stored water and credit them to the Board's water supply bank. These water rights may then be divided or combined into more marketable blocks provided that there is no injury to other right holders, or enlargement of use of the water rights, and the change is in the local public interest. Any person proposing to sell or lease water rights to the Board's water supply bank, or to otherwise make water available through the water supply bank for the purposes of Section 42-1763A, Idaho Code, shall file a completed application with the Director on a forms or in a format provided by the Department and provide such additional information as the Board or Director may require in evaluating the proposed transaction. The completed application form shall state the period of time a water right is offered for lease, or the period of time that storage water will be released for fish migration purposes in accordance with Section 42-1763A, Idaho Code, and the payment terms, if any, requested by the applicant. (3-20-20)T

**02. Application.** Submitted with the completed application shall be: (3-20-20)T

**a.** Evidence that the water right has been recorded through court decree, permit or license issued by the Department. If the right is included in an ongoing adjudication, a copy of the claim is required; (3-20-20)T

**b.** Proof of current ownership of the water right by the applicant; (3-20-20)T

**c.** Information that the water right has not been lost through abandonment, or forfeiture as defined by Section 42-222(2), Idaho Code; (3-20-20)T

**d.** Evidence to demonstrate the relative availability of water in the source to fill the water right; and (3-20-20)T

**e.** The written consent of such company, corporation or irrigation district to the proposed sale or lease must accompany the application if the right to the use of the water, or the use of the diversion works or irrigation system is represented by shares of stock in a company or corporation, or if such works or system is owned or managed by an irrigation district. (3-20-20)T

**f.** A lease application filing fee of two hundred fifty dollars (\$250) per water right up to a maximum total of five hundred dollars (\$500.00) for overlapping water rights which have a common place of use or common diversion rate or diversion volume. The lease filing fee described herein shall be deposited in the Water Administration Account and shall not apply to applications to lease stored water into rental pools described in Rule 40. (3-20-20)T

**03. Review.** Upon receipt of the completed application the Director will review it for completeness and make such further review as he deems necessary to adequately brief the Board on the proposed transaction. (3-20-20)T

**04. Inadequate Application.** If an application is not complete, the Director will correspond with the applicant to obtain the needed information. If the requested information is not returned in thirty (30) days, the application will no longer be considered a valid request to place a water right into the Board's water supply bank. (3-20-20)T

**05. Consideration.** The Board may consider an application at any regular or special meeting. (3-20-20)T

**06. Criteria.** The Board will consider the following in determining whether to accept an offered water right into the Board's water supply bank: (3-20-20)T

**a.** Whether the applicant is the current owner, title holder or contract water user of the water right proposed to be transferred to the Board's water supply bank or has authority to act on behalf of the owner; (3-20-20)T



- b.** Whether all necessary consents have been filed with the Board; (3-20-20)T
- c.** Whether the information available to the Board indicates that the water right has been abandoned or forfeited; (3-20-20)T
- d.** Whether the offering price or requested rental rate is reasonable; (3-20-20)T
- e.** Whether acquisition of the water right will be contrary to the State Water Plan; (3-20-20)T
- f.** Whether the application is in the local public interest as defined in Section 42-1763, Idaho Code; (3-20-20)T
- g.** The probability of selling or renting the water right from the Board's water supply bank. (3-20-20)T
- h.** Whether there are sufficient funds on hand to acquire the water right for the Board's water supply bank, provided that, if there are insufficient funds, or if in the opinion of the Board, existing funds should not immediately be expended for such acquisition, the Board may find that the water right should be acquired on a contingency basis, with payment to be made to the seller or lessor only after water is subsequently sold or rented from the Board's water supply bank, and (3-20-20)T
- i.** Such other factors as determined to be appropriate by the Board. (3-20-20)T

**07. Resolution of Board.** The Board may by resolution accept an application to sell or lease a water right to the Board's water supply bank, or to otherwise make water available through the water supply bank for the purposes of Section 42-1763A, Idaho Code. An application to lease together with the resolution accepting it becomes a lease and the water right is placed into the Board's water supply bank upon adoption of the resolution. A resolution accepting an application to sell a right to the Board's water supply bank will provide authority for the chairman of the Board to enter an agreement to purchase the water right. The resolution may include conditions of approval, including but not limited to, the following: (3-20-20)T

- a.** A condition providing the length of time the water right will be retained in the Board's water supply bank. (3-20-20)T
- b.** A condition describing the terms for payment to the owner of the water right and the sale or rental price from the Board's water supply bank. (3-20-20)T
- c.** Other conditions as the Board determines appropriate, including a condition recognizing that water is being made available through the water supply bank pursuant to the provisions of Section 42-1763A, Idaho Code, for purposes of fish migration. (3-20-20)T

**08. Placement of Water Right.** Effect of placement of a water right into the Board's water supply bank. (3-20-20)T

- a.** Upon acceptance of a water right into the Board's water supply bank, the owner of the right may withdraw the right within thirty (30) days of acceptance into the bank if the owner does not agree with the conditions of acceptance. (3-20-20)T
- b.** Upon acceptance of a water right into the Board's water supply bank, the owner of the water right is not authorized to continue the diversion and use of the right while it is in the Board's water supply bank, unless the water right is for hydropower and is placed in the Board's water supply bank to be released for salmon migration and power production purposes. (3-20-20)T
- c.** A water right which has been accepted shall remain in the Board's water supply bank for the period designated by the Board unless removed by resolution of the Board. (3-20-20)T

**d.** The owner of the water right shall remain responsible to take actions required to claim the water right in an adjudication or other legal action concerning the water right and to pay taxes, fees, or assessments related to the water right. (3-20-20)T

**e.** The forfeiture provisions of Section 42-222(2), Idaho Code are tolled during the time period the water right is in the Board's water supply bank, pursuant to the provisions of Section 42-1764, Idaho Code. (3-20-20)T

**026. -- 029. (RESERVED)**

**030. SALE OR RENTAL OF WATER RIGHTS FROM THE BOARD'S WATER SUPPLY BANK (RULE 30).**

**01. General.** The Board may in its discretion initiate the process to sell or rent water rights from the Board's water supply bank to achieve the purposes stated in Rule 1. The Board may from time to time, as water rights are available, authorize the Director to announce the availability of the rights from the Board's water supply bank, establishing a time and date for receiving applications in the office of the Director to purchase or rent the water rights. An application shall be on a form or in a format provided by the Director. The sale or rental price shall be the price, if any, as determined by the Board. The Director will evaluate applications with respect to the purposes of Rule 1, as to whether there will be injury to other water rights, whether the proposal would constitute an enlargement of the water right, whether the water will be put to a beneficial use, whether the water supply available from applicable rights in the Board's water supply bank is sufficient for the use intended, and whether the proposal is in the local public interest. For applications submitted pursuant to the interim authority provided by Section 42-1763A, Idaho Code, the Director will only make an evaluation as to whether the proposed use of water will cause injury to other water rights. The Director may defer the evaluation of potential injury to other water rights conditioned upon the right of any affected water right holder to petition the Director pursuant to Section 42-1766, Idaho Code, to revoke or modify the rental approval upon a showing of injury. (3-20-20)T

**02. Notice.** The Director may give notice of an intended rental as he deems necessary, provided that prior to approving any application for purchase, or for rental for a period of more than five (5) years, he shall give notice as required in Section 42-222(1), Idaho Code. (3-20-20)T

**03. Approval.** Sale or rental shall be approved only for use of water within the state of Idaho. The Director shall consider in determining whether to approve a rental of water for use outside of the state of Idaho those factors enumerated in Section 42-401(3), Idaho Code, except that this evaluation shall not be required for applications submitted pursuant to the interim authority provided by Section 42-1763A, Idaho Code. (3-20-20)T

**04. Consideration.** All applications received on or prior to the announced date for receiving applications shall be considered as having been received at the same time. Applications received after the close of the application date may be considered only if sufficient available water remains in the Board's water supply bank after all acceptable, timely applications have been filed. (3-20-20)T

**05. Authorized to Rent.** The Director is authorized to rent water rights offered by the Board from the Board's water supply bank for a period up to five (5) years, but shall submit applications for purchase, or rental for a period of more than five (5) years to the Board for action. The Director will advise the Board on applications which require Board approval under Rule Subsection 025.06 whether he can approve the application in whole or in part or with conditions to comply with Section 42-1763, Idaho Code. (3-20-20)T

**06. Board Review.** The Board will review applications for purchase or which propose the rental of water rights for a duration of more than five (5) years, and may approve, approve with conditions or may reject the applications as the Board determines to best meet the purposes of Rule 1 and promote the interest of the people of the state of Idaho. (3-20-20)T

**07. Order of Consideration.** When renting water from the bank, the Director and the Board shall consider rental of water rights in the order the rights were leased to the bank, with first consideration for the rights which have continuously been in the bank the longest period of time provided the rights are suitable for the purpose of the renter. (3-20-20)T

**031. -- 034. (RESERVED)**

**035. HANDLING OF MONEY ASSOCIATED WITH THE BOARD'S WATER SUPPLY BANK (RULE 35).**

Payments received by the Department from the sale or rental of water rights from the Board's water supply bank shall be handled as follows: (3-20-20)T

**01. Credited Amount.** Ten percent (10%) of the gross amount received from the sale or rental of a water right from the Board's water supply bank and the entire lease application fee received pursuant to Rule 025 shall be credited to the Water Administration Account created by Section 42-238a, Idaho Code, or to the federal grant fund if the payment is received from a federal agency, for administrative costs of operating the Water Supply Bank. The ten percent (10%) charge described herein shall not apply to stored water rented from the rental pools described in Rule 040. (3-20-20)T

**02. Excess Funds.** Any funds in excess of the amount needed to compensate the owner of the water right in accordance with the resolution accepting the water right into the Board's water supply bank and the administrative charge of Rule Subsection 035.01 shall be credited to the Water Management Account created by Section 42-1760, Idaho Code, for use by the Board for the purposes of Rule 1. (3-20-20)T

**036. -- 039. (RESERVED)**

**040. APPOINTMENT OF LOCAL RENTAL POOL COMMITTEES (RULE 40).**

**01. Board Meetings for Committee Appointments.** The Board may at any regular or special meeting to consider appointing an entity to serve as a local committee to facilitate the lease and rental of stored water. At least ten (10) days prior to the meeting, the entity seeking appointment shall provide to the Director information concerning the organization of the entity, a listing of its officers, a copy of its bylaws and procedures, if applicable, a copy of the proposed local committee procedures, pursuant to which the local committee would facilitate the lease and rental of stored water, together with a copy of each general lease and rental form proposed to be used by the local committee. The local committee procedures must be approved by the Board and must provide for the following: (3-20-20)T

- a.** Determination of priority among competing applicants to lease stored water to the rental pool and to rent stored water from the rental pool; (3-20-20)T
- b.** Determination of the reimbursement schedule for those leasing stored water into the rental pool; (3-20-20)T
- c.** Determination of the rental price charge to those renting stored water from the rental pool; (3-20-20)T
- d.** Determination of the administrative charge to be assessed by the local committee; (3-20-20)T
- e.** Allocation of stored water leased to the bank but not rented; (3-20-20)T
- f.** Notification of the Department and the watermaster of any rentals where stored water will be moved from the place of use authorized by the permit, license, or decree establishing the stored water right; (3-20-20)T
- g.** Submittal of applications to rent water from the rental pool for more than five (5) years to the Board for review and approval as a condition of approval by the local committee; (3-20-20)T
- h.** Prevention of injury to other water rights; (3-20-20)T
- i.** Protection of the local public interest, except for applications submitted pursuant to the interim authority provided by Section 42-1763A, Idaho Code; (3-20-20)T

**j.** Consistency with the conservation of water resources within the state of Idaho, except for applications submitted pursuant to the interim authority provided by Section 42-1763A, Idaho Code; (3-20-20)T

**k.** Management of rental pool funds as public funds pursuant to the Public Depository Law, Chapter 1, Title 57, Idaho Code. (3-20-20)T

**02. Local Committee Procedures.** The local committee procedures shall provide that a surcharge of ten percent (10%) of the rental fee charged per acre foot of stored water rented from the rental pool shall be assessed and credited to the revolving development account and the water management account established in Sections 42-1752 and 42-1760, Idaho Code, in such proportion as the Board in its discretion shall determine. Such moneys, together with moneys accruing to or earned thereon, shall be set aside, and made available until expended, to be used by the Board for the purposes of Rule 1 unless the surcharge is prohibited by statute, compact or inter-governmental agreement. (3-20-20)T

**03. Review by Director.** The Director will review the local committee procedures and submit them along with the Director's recommendation to the Board. The lease and rental form must receive the Director's approval. The Board may designate the applying entity as the local committee for a period not to exceed five (5) years. A Certificate of Appointment will be issued by the Board. The Board may extend the appointment for additional periods up to five (5) years, upon written request of the local committee. The Board may revoke a designation upon request of the local committee, or after a hearing pursuant to the promulgated Rules of Practice and Procedure of the Board, if the Board determines that the local committee is no longer serving a necessary purpose or is not abiding by its own approved procedures, these rules or applicable statutes. (3-20-20)T

**04. Annual Report.** The local committee shall report annually on the activity of the rental pool on forms provided by the Board. (3-20-20)T

**05. Submission of Amendments to Procedures to Board.** Amendments to the approved procedures of an appointed local committee which change the amount charged for the rental of stored water shall be submitted to the Board by April 1st of any year. The amendment will be considered approved by the Board unless specifically disapproved at the first regular Board meeting following the amendment action of the local committee. The Board may, upon good cause being determined by the Board, specifically approve of amendments submitted after April 1 of any year. (3-20-20)T

**041. -- 999. (RESERVED)**

## 37.03.01 – ADJUDICATION RULES

### 000. LEGAL AUTHORITY.

These rules are adopted under the legal authorities of Section 42-1414, and 42-1805(8), Idaho Code. (3-20-20)T

### 001. TITLE AND SCOPE.

**01. Title.** These rules are titled IDAPA 37.03.01, “Adjudication Rules.” (3-20-20)T

**02. Scope.** These rules implement statutes governing the filing of notices of claims to water rights acquired under state law and the collection of fees for filing notices of claims to water rights acquired under state law in general adjudications, as provided in Sections 41-1409, 42-1414 and 42-1415, Idaho Code. (3-20-20)T

### 002. -- 009. (RESERVED)

### 010. DEFINITIONS.

**01. Amendment Fee.** The additional fee payable at the time of filing an amendment to a claim, as provided in Section 42-1414(2), Idaho Code. (3-20-20)T

**02. Aquaculture.** The use of water for propagation of fish, shell fish, and any other animal or plant product naturally occurring in an underwater environment. (3-20-20)T

**03. Aquaculture Fee.** The variable fee payable for aquaculture use, as provided in Section 42-1414(1)(b)(iii), Idaho Code, which shall be calculated for each cfs and fraction thereof to the nearest dollar. (3-20-20)T

**04. Claim.** A notice of claim to a water right acquired under state law, as provided in Section 42-1409(4), Idaho Code. (3-20-20)T

**05. Department.** The Idaho Department of Water Resources. (3-20-20)T

**06. Director.** The Director of the Idaho Department of Water Resources. (3-20-20)T

**07. Domestic Use.** Domestic use as defined in Section 42-1401A(4), Idaho Code. (3-20-20)T

**08. Flat Fee.** The per claim fee for filing claims, as provided in Section 42-1414(1)(a), Idaho Code. (3-20-20)T

**09. Late Fee.** The additional fee payable for the filing of late claims, as provided in Section 42-1414(3), Idaho Code. (3-20-20)T

**10. Per Acre Fee.** The variable fee for irrigation use, as provided in Section 42-1414(1)(b)(i), Idaho Code, which shall be calculated for each acre and fraction thereof rounded to the next whole acre. (3-20-20)T

**11. Per Cfs Fee.** The variable fee payable for other uses, as provided in Section 42-1414(1)(b)(iii), (iv) and (v), Idaho Code, which shall be calculated for each cfs and fraction thereof to the nearest dollar. (3-20-20)T

**12. Per Kilowatt Fee.** The variable fee payable for power generation use, as provided in Section 42-1414(1)(b)(ii), Idaho Code, which shall be calculated for each kilowatt and fraction thereof. (3-20-20)T

**13. State Law Claim Form.** The department’s form entitled “Notice of Claim to a Water Right Acquired Under State Law as provided in Section 42-1409(4), Idaho Code. (3-20-20)T

**14. Stock Watering Use.** Stock watering use as defined in Section 42-1401A(11), Idaho Code. (3-20-20)T

**15. Total Fee.** The fee payable for filing a claim, which consists of the flat fee plus any applicable variable fee and late fee. (3-20-20)T

**16. Variable Fee.** The fee payable for filing claims in addition to the flat fee, as provided in Section 42-1414(1)(b), Idaho Code. (3-20-20)T

**17. Water Delivery System.** All structures and equipment used for diversion, storage, transportation, and use of water from the water source to and including each place of use. (3-20-20)T

**18. Water Delivery Organization.** An irrigation district, a water utility, a municipality, or any similar claimant of a water right who diverts water pursuant to the water right claimed and delivers the water to others who make beneficial use of the water diverted by the water delivery organization pursuant to the water right claimed by the water delivery organization. (3-20-20)T

**011. ABBREVIATIONS.**

**01. AF.** An acre foot (feet). (3-20-20)T

**02. CFS.** Cubic foot (feet) per second. (3-20-20)T

**03. NA.** Not applicable. (3-20-20)T

**04. PIN.** Parcel identification number. (3-20-20)T

**012. -- 024. (RESERVED)**

**025. GENERAL.**

**01. Requirement to Pay.** All persons filing claims to water rights acquired under state law or amendments to claims to water rights acquired under state law shall be required to pay filing fees as set forth by statute and these rules. (3-20-20)T

**02. Method of Payment.** Fees shall be paid in legal tender of the United States; or by money order, certified check, cashier's check, personal check, or by electronic payment on-line payable to the department in legal tender of the United States. Two-party checks will not be accepted. (3-20-20)T

**03. Personal Check.** If a personal check in payment of a flat fee, a variable fee, or a late fee, is returned unpaid to the department or the debit or credit card payment is rejected by the financial institution, the claims covered by the returned check or the rejected debit or credit card will be rejected and returned to the claimant. If a personal check in payment of an amendment fee is returned unpaid to the department or the debit or credit card payment is rejected by the financial institution, the amended claim will be rejected and returned to the claimant, but the original claim will still be in effect. (3-20-20)T

**04. Time of Payment.** Flat fees and variable fees shall be payable to the department at the time of filing a claim. Amendment fees shall be payable to the department at the time of filing the amended claim. Late fees shall be payable at the time of filing the late claim. (3-20-20)T

**05. Government Voucher.** Fees payable by government agencies (other than agencies of foreign governments) may be paid when due by government voucher. If full payment of the voucher is not received within forty-five (45) days of the date the voucher is received, the unpaid voucher will be treated as a returned check as provided in Subsection 025.03. (3-20-20)T

**06. Rejection of Claim.** Claims submitted without the correct filing fee shall be rejected and returned to the claimant. (3-20-20)T

**07. Fire-Fighting.** A claim is not required to be filed for water used solely to extinguish an existing fire on private or public lands, structures, or equipment, or to prevent an existing fire from spreading to private or public lands, structures, or equipment endangered by an existing fire pursuant to Section 42-201(3), Idaho Code. A claim is required for the use of water for domestic purposes in regularly maintained firefighting stations and for the storage of water for fighting future fires. (3-20-20)T

**026. -- 029. (RESERVED)**

**030. FLAT FEES.**

**01. Small Domestic and Stock Water.** A flat fee of twenty-five dollars (\$25) shall be payable for each claim for domestic use and/or stock watering use meeting the definition of domestic use and/or stock watering use in Rule 010. (3-20-20)T

**02. Other Claims.** A flat fee of fifty dollars (\$50) shall be payable for each claim that does not meet the criteria of Subsection 030.01. (3-20-20)T

**031. -- 034. (RESERVED)**

**035. VARIABLE FEES.**

**01. General.** For each claim not meeting the criteria of Subsection 030.01, there may be a variable fee in addition to the flat fee. (3-20-20)T

**02. Per Acre Fee.** (3-20-20)T

**a.** A fee of one dollar (\$1.00) per acre shall be required for claims for irrigation use. (3-20-20)T

**b.** The per acre fee shall only be charged once against a particular acre, regardless of the number of claims filed for the irrigation of that acre or the number of claimants filing claims for the irrigation of that acre. (3-20-20)T

**c.** The per acre fee shall be payable by the first person to file a claim for the irrigation of a particular acre. (3-20-20)T

**d.** The per acre fee for an irrigation project where the canals constructed cover an area of twenty-five thousand (25,000) acres or more, or irrigation districts organized and existing as such under the laws of the state of Idaho, or for beneficial use by more than five (5) water users in an area of less than twenty-five thousand (25,000) acres shall be determined based upon the acreage claimed to be irrigated by the project or irrigation district within the boundaries of the project or irrigation district. (3-20-20)T

**03. Per Kilowatt Fee.** (3-20-20)T

**a.** A per kilowatt of capacity (manufacturer's nameplate rating) fee of three dollars and fifty cents (\$3.50) per kilowatt, or two hundred fifty thousand dollars (\$250,000.00), whichever is less, shall be required for claims for power use. (3-20-20)T

**b.** The per kilowatt fee shall be determined based upon the total generating capacity of all generators in which the water right claimed is used. (3-20-20)T

**c.** The total per kilowatt fee for all claims filed for a single hydropower facility shall not exceed the per kilowatt fee for the total generating capacity of all generators in the hydropower facility. (3-20-20)T

**04. Per CFS Fee.** (3-20-20)T

**a.** A fee of ten dollars (\$10) per cfs for aquaculture shall be required. A fee of one hundred dollars (\$100) per cfs for all other uses shall be required except for irrigation, power, and domestic and stock watering uses meeting the definition of domestic and stock watering use in Section 010. (3-20-20)T

**b.** For a claim to water for more than one (1) public purpose, the per cfs fee shall only be charged once per cfs claimed. Public purposes shall include public in-stream flows, lake level maintenance, wildlife, aesthetic beauty, and recreation. (3-20-20)T

**c.** If there is a seasonal variation in the number of cfs claimed, the per cfs fee shall be based upon the maximum number of cfs claimed for any period during a single calendar year. (3-20-20)T

**d.** The per cfs fee shall apply to claims for water quality improvement, recreation, aesthetic purposes, and any other purpose not expressly listed at Section 42-1414(1), Idaho Code, except as otherwise provided by these rules. (3-20-20)T

**05. Claims Including Storage.** (3-20-20)T

**a.** The variable fee for a claim that includes storage shall be based upon the ultimate use of the water stored. If the claim states purposes other than diversion to storage, storage, and diversion from storage, the total variable fee will be determined as provided in Subsection 035.06. (3-20-20)T

**b.** No variable fee shall be payable for water claimed for ground water recharge purposes. (3-20-20)T

**c.** For purposes of determining the per cfs fee for amounts of water claimed in af, one (1) cfs equals one and ninety-eight one-hundredths (1.98) af per day of diversion to storage. (3-20-20)T

**d.** No variable fee shall be payable for minimum by-pass flows. (3-20-20)T

**06. Multiple Purpose Claims.** If a claimant claims more than one (1) purpose of use on a single claim, the variable fee will be the total of the variable fees payable for each purpose of use. (3-20-20)T

**07. Exceptions.** No variable fee shall be payable for claims or portions of claims for fire-fighting purposes if a claim is required under Subsection 025.07 or for domestic use and/or stock watering use meeting the definitions of domestic use and stock watering use in Section 010. (3-20-20)T

**036. -- 044. (RESERVED)**

**045. AMENDMENT FEES.**

When a claimant files an amendment to a claim, the total fee shall be recalculated as if the amended claim were the original claim. If the total fee as recalculated is greater than the total fee paid at the time the claim was filed, the amendment fee shall be the difference between the two (2) amounts. No refund shall be made if the total fee as recalculated is less than the total fee paid at the time the claim was filed. (3-20-20)T

**046. -- 049. (RESERVED)**

**050. LATE FEES.**

**01. Late Fee Payable.** A late fee shall be payable when a claim is filed after the date set forth in the first commencement notice mailed to the claimant or the claimant's predecessor in interest pursuant to Sections 42-1414(3), Idaho Code. (3-20-20)T

**02. Waiver.** The late fee may be waived by the director for good cause shown. (3-20-20)T

**051. -- 054. (RESERVED)**

**055. REFUNDS.**

Fees shall not be refunded or returned except where the fee was miscalculated at the time the claim was filed or as expressly provided in these rules. (3-20-20)T

**056. -- 059. (RESERVED)**

**060. SUFFICIENCY OF CLAIMS.**

**01. Single Claim.** Except for claims based on both state law and federal law, a single claim may describe only one (1) water right. A claim that describes more than one (1) water right will be rejected and returned along with any fees paid, and must be refiled as multiple claims. (3-20-20)T



**02. State Law Claim Form -- Minimum Requirements.** Claims filed on the state law claim form shall contain the following information: (3-20-20)T

**a.** Name, Address and Phone Number of Claimant. The name, address, and phone number of the claimant and all co-claimants claiming the water right jointly with the claimant shall be listed at item one (1) of the form. (3-20-20)T

**b.** Date of Priority. The date of priority shall be listed at item two (2) of the form, and shall include month, day and year. Only one (1) priority may be stated unless the claim is based upon both state and federal law as provided in Subsection 060.01. If more than one (1) priority date is stated, the claim will be rejected and returned along with any fees paid, and must be refiled as multiple claims. (3-20-20)T

**i.** Within thirty (30) days, unless an extension by the director or his designee is approved, the claimant shall provide evidence of the priority date to support the water right claimed. If the claimant fails to provide evidence of priority, the form may be rejected and returned with no refund of the fees paid. (3-20-20)T

**c.** Source of Water Supply. The source of water supply shall be stated at item three (3) of the form. (3-20-20)T

**i.** For surface water sources, the source of water shall be identified by the official name listed on the U.S. Geological Survey Quadrangle map. If no official name has been given, the name in local common usage should be listed. If there is no official or common name, the source should be described as “unnamed stream” or “spring.” The first named downstream water source to which the source is tributary shall also be listed. For ground water sources, the source shall be listed as “ground water.” (3-20-20)T

**ii.** Only one (1) source shall be listed unless the claim is for a single water delivery system that has more than one (1) source, or the claim is for a single licensed or decreed right that covers more than one (1) water delivery system. If more than one (1) source is listed and the claim is not for a single water delivery system that has more than one (1) source, and the claim is not for a single licensed or decreed water right that covers more than one (1) water delivery system, the claim will be rejected and returned along with any fees paid, and must be refiled as multiple claims. (3-20-20)T

**d.** Location of Point of Diversion. For claims other than in-stream flows, the location of the point(s) of diversion shall be listed at item four (4) part (a) of the form. For claims to in-stream flows, the beginning and ending points of the claimed in-stream flow shall be listed at item four (4) part (b) of the form. (3-20-20)T

**i.** The location of the point of diversion shall be described to nearest forty (40) acre tract (quarter-quarter section) or government lot number, and shall include township number (including north or south designations), range number (including east or west designations), section number, and county. (3-20-20)T

**ii.** The claimant shall also list the Parcel Number or Parcel Identification Number (PIN) as assigned by the county assessor’s office for the parcel where the water is diverted unless no Parcel Number or PIN is recorded for the property at the point of diversion. (3-20-20)T

**iii.** If the point of diversion is located in a platted subdivision, a plat of which has been recorded in the county recorder’s office for the county in which the subdivision is located, the claimant shall also list the subdivision name, block number and lot number in item thirteen (13) of the form (remarks section). (3-20-20)T

**iv.** A claim to a water right that includes storage shall state the point at which water is impounded (applicable only to on-stream reservoirs) or the point at which water is diverted to storage (applicable only to off-stream reservoirs), the point at which water is released from storage into a natural stream channel (applicable only where a natural stream channel is used to convey stored water), and the point at which water is rediverted (applicable only where a natural channel is used to convey stored water). (3-20-20)T

**v.** Only one (1) point of diversion shall be listed unless the claim is for a single water delivery system that has more than one (1) point of diversion, or the claim is for a single licensed or decreed water right that covers more than one (1) water delivery system. If more than one (1) point of diversion is listed and the claim is not for a

single water delivery system that has more than one (1) point of diversion, and the claim is not for a single licensed or decreed water right that covers more than one (1) water delivery system, the claim will be rejected and returned along with any fees paid, and must be refiled as multiple claims. (3-20-20)T

e. Description of Diversion Works. The diversion works shall be described at item five (5) of the form. (3-20-20)T

i. The description shall include all major components of the water delivery system, such as dams, reservoirs, ditches, pipelines, pumps, wells, headgates, etc. The description shall also include those dimensions of major components which affect the diversion capacity of the water delivery system. The description shall also state whether the ditches are lined and/or covered, the depth of wells, the horsepower capacity of pumps, and whether headgates are automatic or equipped with locks and/or measuring devices. (3-20-20)T

ii. The description shall include the dates and a description of any changes in use (including change in point of diversion, place of use, purpose of use, and period of use) or enlargements in use (including an increase in the amount of water diverted, the number of acres irrigated, or additional uses of water), and as to those dimensions required to be described above, the dimensions as originally constructed and as enlarged. (3-20-20)T

iii. Water delivery organizations shall describe the water delivery system up to and including the point where responsibility for water distribution is assumed by entities other than the water delivery organization. (3-20-20)T

f. Purpose of Use and Period of Use. Each purpose for which water is claimed, the period of use for each purpose for which water is claimed, and the amount of water claimed for each purpose for which water is claimed shall be listed at item six (6) of the form. Period of use shall include the month and day of the first and last day of use. For example, the period of use for domestic use is often January 1st through December 31st. (3-20-20)T

i. The purpose may be described in general terms such as irrigation, industrial, municipal, mining, power generation, fish propagation, domestic, stock watering, etc. (3-20-20)T

ii. A claim to a water right that includes storage shall be broken down into component purposes with the ultimate use(s) of the stored water indicated. The component purposes of a storage right are diversion to storage (not applicable to on-stream reservoirs), storage, and diversion from storage (not applicable where the ultimate use is an in-reservoir public purpose). Detention of water in a holding pond that can be filled in less than twenty-four (24) hours at the claimed diversion rate is not required to be claimed as storage. The amount of water claimed shall be limited to the active storage capacity of the reservoir unless a past practice of refilling the reservoir during the water year (October 1 to September 30) is shown or the claim is for a licensed or decreed right that includes refill. If a past practice of refilling the reservoir is shown or if the claim is for a licensed or decreed right that includes refill, the total amount of water claimed for the calendar year and the entire period during which diversion to storage or impoundment occurs shall be indicated. (3-20-20)T

iii. The amount of water claimed for each purpose for which water is claimed shall not exceed the amount of water beneficially used for the purpose claimed, and the period of use for each purpose claimed shall not exceed the period in which water is beneficially used for the purpose claimed. (3-20-20)T

iv. The amount of water diverted shall be listed in cfs, and the amount of water stored shall be listed in af per annum. (3-20-20)T

g. Amount of Water Claimed. The total amount of water claimed shall be listed at item seven (7) of the form. The total amount of water claimed shall not exceed the total of the amounts listed at item six (6) of the form, or the total diversion capacity of the diversion system, whichever is less. (3-20-20)T

h. Description of Non-Irrigation Uses. Non-irrigation uses shall be fully described at item eight (8) of the form. For domestic uses, the number of households served shall be described; for stock watering uses, the type of stock and number of each type of stock shall be described. (3-20-20)T

i. If the claimant's domestic use does not meet the definition of domestic use in Subsection 010.07,

the form will be rejected and returned unless the appropriate variable fee is paid. (3-20-20)T

ii. The claimant shall also state whether the stock watering use is in-stream, or whether water is diverted from the source for stock watering. Both types of stock watering cannot be filed on the same claim form; each type requires a separate claim. (3-20-20)T

iii. Domestic use for organization camps and public campgrounds shall be fully described, including but not limited to the number of camp units, water faucets, flush toilets, showers, and sewer connections. Description of domestic use for organization camps and public campgrounds shall also include the average and peak number of individuals using the facility, and the periods when peak or average rates of usage occur. (3-20-20)T

i. Place of Use. The place of use for each purpose for which water is claimed shall be listed at item nine (9) of the form, except that the place of use for in-stream flows for public purposes need not be listed if the place of use is fully described as the stream between the beginning and ending points listed as the points of diversion. (3-20-20)T

i. Except claims for irrigation projects and irrigation districts meeting the criteria described in Subsection 060.i.ii. below, the number of acres irrigated shall be described by entering the appropriate numbers in the appropriate boxes for each forty (40) acre tract or government lot on the form. For other uses, a symbol or letter corresponding to the purpose for which water is claimed shall be placed in the appropriate box for each forty (40) acre tract or government lot on the form. (3-20-20)T

ii. Claims for an irrigation project where the canals constructed cover an area of twenty-five thousand (25,000) acres or more, or irrigation districts organized and existing as such under the laws of the state of Idaho, or for beneficial use by more than five (5) water users in an area of less than twenty-five thousand (25,000) acres shall be accompanied by a map showing the boundaries of the project or irrigation district, and shall state the total number of acres irrigated within the boundaries of the project or irrigations district. The project or district shall submit a map of the boundary of the place of use and, when available, a digital boundary defined in Section 42-202(B)(2), Idaho Code. (3-20-20)T

iii. The claimant shall also list the Parcel Number or Parcel Identification Number (PIN) as assigned by the county assessor's office for the parcel where the water is used unless no Parcel Number or PIN is recorded for the property at the place of use or the PIN is the same as the PIN shown in item four (4) for the point of diversion. (3-20-20)T

j. County of Place of Use. The county(ies) in which the place(s) of use is (are) located shall be listed at item ten (10) of the form. (3-20-20)T

k. Authority to Assert Claim. The claimant shall indicate at item eleven (11) of the form whether the claimant is the owner of the place(s) of use. If the claimant is not the owner of the place(s) of use, the claimant shall describe in the remarks section of the form the claimant's authority to assert the claim. Unless the claimant is a water delivery organization, the claimant shall also state the name, address, and phone number of the owner(s) of the place of use in item thirteen (13) (remarks section) of the form. (3-20-20)T

l. Other Water Rights. The claimant shall describe at item twelve (12) of the form any other water rights used at the same place and for the same purpose as the right claimed. If there are no other water rights used at the same place and for the same purpose as the right claimed, the claimant shall state "NA" or "none." (3-20-20)T

m. Remarks. At item thirteen (13) of the form, the claimant may submit any additional, relevant information not specifically requested. If the space provided is not sufficient, remarks shall be set forth on a separate piece of paper and attached to the form. All separate attachments must be specifically referenced in the remarks section of the form. (3-20-20)T

n. Maps. An aerial photograph or USGS quadrangle map shall be included with the claim, unless the claim meets the definition of domestic use and stock watering use as defined in Section 010 or unless the claim is submitted electronically through the department's online claim filing website. The point(s) of diversion, place(s) of use, and the water delivery system shall be identified on the aerial photograph or USGS quadrangle map. (3-20-20)T

**o.** Basis of Claim. The basis of the claim shall be indicated at item fourteen (14) of the form. If a water right number has been assigned by the department to the right claimed, the water right number shall also be indicated. If a water right number has not been assigned and the water right is based upon a decree, the claimant shall list the title and date of the decree, the case number, and the court that issued the decree. If the basis of claim is a beneficial use (also known as the constitutional method of appropriation), the claimant shall provide a short description of events or history of the development of the water right. (3-20-20)T

**p.** Signature. Each claim must be signed by the claimant at item fifteen (15) of the form, unless the claim is submitted electronically through the department's online claim filing website. Each claimant, through submission of a signed claim or through submission of a claim by means of the department's online claim filing website, solemnly swears or affirms under penalty of perjury that the statements contained in the notice of claim are true and correct. (3-20-20)T

**i.** For claims submitted through the department's online claim filing website, the form shall be submitted by a person listed as the claimant at item one (1) of the form unless the person submitting the form has authority to submit the form for the claimant or claimants. Claims by corporations, municipalities or other organizations shall be submitted by an officer of the corporation or an elected official of the municipality or an individual authorized by the organization to submit the form. (3-20-20)T

**ii.** For claims that are not submitted by means of the internet, the form must be signed by each of the persons listed as claimants at item one (1) of the form unless the signatory has authority to sign for the claimant or claimants. Claims by corporations, municipalities or other organizations shall be signed by an officer of the corporation or an elected official of the municipality or an individual authorized by the organization to sign the form. The signatory's title shall be indicated with the signature. (3-20-20)T

**q.** Notice of Appearance. If notices to be sent by the director to the claimant are to be sent to the claimant's attorney, the claimant's attorney shall list the attorney's name and address and sign and date the form at item sixteen (16) of the form. (3-20-20)T

**03. State Law Claim Form -- Insufficient Claims, Waivers.** (3-20-20)T

**a.** Claims filed on the state law claim form that do not contain the information required by Subsection 060.02 shall be rejected and returned along with any fees paid, unless otherwise provided by these rules. (3-20-20)T

**b.** The director may waive the minimum information requirements of Subsection 060.02 and accept the claim for good cause shown. (3-20-20)T

**04. Further Information.** This Rule 060 sets forth minimum requirements for the filing of claims. The director may request further information in support of the assertions contained in a claim as part of the investigation of the water system and the claims pursuant to Section 42-1410, Idaho Code. (3-20-20)T

**061. -- 064. (RESERVED)**

**065. REJECTED AND RETURNED CLAIMS.**

**01. Rejected Claims.** Rejected claims shall be returned to the claimant by ordinary mail at the most recent address shown by department records. The rejected claim shall be accompanied by a notice of rejection that states generally the reason(s) for rejection. (3-20-20)T

**02. Refiled Claims.** Claims that have been rejected and returned to the claimant may be refiled with the appropriate fees and appropriate information at any time prior to the deadline for filing the original claim. Claims refiled after the deadline for filing the original claim will be subject to the late fee, unless the claim is refiled within thirty (30) days from the date of mailing the rejected claim by the department. (3-20-20)T

**066. -- 999. (RESERVED)**

## 37.03.02 – BENEFICIAL USE EXAMINATION RULES

### 000. LEGAL AUTHORITY (RULE 0).

The director of the Department of Water Resources adopts these rules under the authority provided by Section 42-1805(8), Idaho Code. (3-20-20)T

### 001. TITLE AND SCOPE (RULE 1).

Sections 42-217 and 42-221, Idaho Code, requires a license examination fee be submitted together with the written proof of beneficial use or that a field examination report prepared by a certified water right examiner be submitted together with the written proof of beneficial use. The statutes also provided that field examinations could be conducted by certified water right examiners appointed by the director. (3-20-20)T

**01. Examination Requirements.** The examination requirements listed are intended as a guide to establish acceptable standards to determine the extent of application of water to beneficial use. The requirements are not intended to restrict the application of other sound examination principles by water right examiners. The director will evaluate any deviation from the standards hereinafter stated as they pertain to the review of any given examination. Water right examiners are encouraged to submit new ideas which will advance the art and provide for the public benefit. (3-20-20)T

**02. Rules.** These rules shall not be construed to deprive or limit the director of the Department of Water Resources of any exercise of powers, duties and jurisdiction conferred by law, nor to limit or restrict the amount or character of data, or information which may be required by the director from any owner of a water right permit or authorized representative for the proper administration of the law. (3-20-20)T

### 002. -- 008. (RESERVED)

### 009. APPLICABILITY (RULE 9).

**01. Proof of Beneficial Use.** These rules apply to all permits for which proof of beneficial use is not yet due and has not been submitted to the department. (3-20-20)T

**02. Examination.** These rules apply to all permits for which an examination has not been conducted. (3-20-20)T

**03. Re-Examination.** These rules apply to all permits that have been examined but the license has not been issued due to a request for a re-examination by the permit holder. (3-20-20)T

**04. Examination Fee.** The examination fee requirements of these rules do not apply to a permit for single family domestic use, stockwatering, or other small uses for which the use does not exceed four one-hundredths (0.04) cfs or four (4) AF/year. The examination fee is required for multiple use permits which exceed four one-hundredths (0.04) cfs or four (4) AF/year even though single family domestic use or stockwater use is included as one (1) of the uses on the permit. (3-20-20)T

### 010. DEFINITIONS (RULE 10).

Unless the context otherwise requires, the following definitions govern these rules. (3-20-20)T

**01. Acre-Foot (AF).** A volume of water sufficient to cover one (1) acre of land one (1) foot deep and is equal to forty-three thousand, five hundred sixty (43,560) cubic feet. (3-20-20)T

**02. Acre-Foot/Annum.** An annual volume of water that may be diverted under a given use or right. (3-20-20)T

**03. Amendment.** A change in point of diversion, place, period or nature of use or other substantial change in the method of diversion or use of a permitted water right. (3-20-20)T

**04. Capacity Measurement.** The maximum volume of water impounded in the case of reservoirs or the maximum rate of diversion from the source as determined by actual measurement of the system during normal operation. (3-20-20)T

**05. Certified Water Right Examiner.** A professional engineer or professional geologist, qualified and registered in the state of Idaho who has the knowledge and experience necessary to satisfactorily complete water right field examinations as determined by the Director, and who has been appointed by the Director, Idaho Department of Water Resources as a certified water right examiner. A certified water right examiner is commonly termed a field

examiner, water right examiner or examiner. A certified water right examiner is an impartial investigator and reporter of the information required by the Director to determine the extent of beneficial use established in compliance with a permit. Department employees are authorized to conduct water right examinations at the discretion of the Director.

(3-20-20)T

**06. Conveyance Works.** The ditches, pipes, conduits or other means by which water is carried or moved from the point of diversion to the place of use. Storage works, if any, such as a dam can be considered part of the conveyance works.

(3-20-20)T

**07. Cubic Foot Per Second (CFS).** A rate of flow approximately equal to four hundred forty-eight and eight tenths (448.8) gallons per minute and also equals fifty (50) miner's inches.

(3-20-20)T

**08. Department.** The Idaho Department of Water Resources.

(3-20-20)T

**09. Director.** The Director of the Idaho Department of Water Resources.

(3-20-20)T

**10. Duty of Water.** The quantity of water necessary when economically conducted and applied to land without unnecessary loss as will result in the successful growing of crops.

(3-20-20)T

**11. Examination or Field Examination.** An on-site inspection or investigation to determine the extent of application of water to beneficial use and to determine compliance with terms and conditions of the water right permit.

(3-20-20)T

**12. Field Report.** The form provided by the Department upon which the examiner records the data gathered and describes the extent of diversion of water and application to beneficial use. The report is fully termed beneficial use field report and is also termed a field examination report.

(3-20-20)T

**13. Headworks or Diversion Works.** The constructed barriers or devices on the source of water (surface water or ground water) by which water can be diverted from its natural course of flow and/or measured.

(3-20-20)T

**14. License.** The certificate issued by the Director in accordance with Section 42-219, Idaho Code confirming the extent of diversion and beneficial use of the water that has been made in conformance with the permit conditions.

(3-20-20)T

**15. License Examination Fee.** The fee required in Section 42-221K, Idaho Code, and is also termed an examination fee.

(3-20-20)T

**16. Legal Subdivision.** A tract of land described by the government land survey and usually is described by government lot or quarter-quarter, section, township and range. A lot and block of a subdivision plat recorded with the county recorder may be used in addition to the government lot, quarter-quarter, section, township and range description.

(3-20-20)T

**17. Measuring Device.** A generally accepted structure or apparatus used to determine a rate of flow or volume of water. Examples are weirs, meters, and flumes. Less typical devices may be accepted by the Director on a case-by-case basis.

(3-20-20)T

**18. Nature of Use.** The characteristic use for which water is applied. Examples are domestic, irrigation, mining, industrial, fish propagation, power generation, municipal, etc.

(3-20-20)T

**19. Period of Use.** The time period during which water under a given right can be beneficially used.

(3-20-20)T

**20. Permit Holder or Owner.** The person, association, or corporation to whom a permit has been issued or assigned as shown by the records of the Department.

(3-20-20)T

**21. Permit or Water Right Permit.** The water right document issued by the Director authorizing the

diversion and use of unappropriated public water of the state or water held in trust by the state. (3-20-20)T

**22. Place of Use (P.U. or POU).** The location where the beneficial use is made of the diverted water. (3-20-20)T

**23. Point of Diversion (P.D. or POD).** The location on the public source of water from which water is diverted. Examples are pump intake, headgate, well locations, and dam locations. (3-20-20)T

**24. Project Works.** A general term which includes diversion works, conveyance works, and any devices which may be used to measure the water or to apply the water to the intended use. Improvements which have been made as a result of application of water, such as land preparation for cultivation, are not a part of the project works. (3-20-20)T

**25. Proof of Beneficial Use.** The submittal required in Section 42-217, Idaho Code. This submittal is commonly termed proof. (3-20-20)T

**26. Source.** The name of the natural water body at the point of diversion. Examples are Snake River, Smith Creek, ground water, spring, etc. (3-20-20)T

**011. ABBREVIATIONS.**

**01. AF.** Acre-Foot or Acre-Feet. (3-20-20)T

**02. CFS.** Cubic Foot Per Second. (3-20-20)T

**03. P.D. or POD.** Point of Diversion. (3-20-20)T

**04. P.U. or POU.** Place of Use. (3-20-20)T

**05. USGS.** United States Geological Survey. (3-20-20)T

**012. -- 024. (RESERVED)**

**025. AUTHORITY OF REPRESENTATIVE (RULE 25).**

**01. Proof of Beneficial Use.** When the proof of beneficial use, field report, and drawings are filed by the water right examiner on behalf of an owner, written evidence of authority to represent the owner shall be filed with the proof, field report, and drawings. (3-20-20)T

**02. Responsibility.** It is the responsibility of the permit holder or authorized representative to submit proof of beneficial use and provide for the timely submission of a completed field report by the due date in acceptable form to the director by either paying the required examination fee to the department or by employing a certified water right examiner. (3-20-20)T

**026. -- 029. (RESERVED)**

**030. QUALIFICATION, EXAMINATION AND APPOINTMENT OF CERTIFIED WATER RIGHT EXAMINER (RULE 30).**

**01. Consideration.** Any professional engineer or geologist qualified and registered in the state of Idaho who has the knowledge and experience necessary to satisfactorily complete water right field examinations as determined by the Director shall be considered for appointment as a water right examiner upon application to the Director. The application shall be in the form prescribed by the Director and shall be accompanied by a non-refundable fee in the amount provided by statute. (3-20-20)T

**02. Information.** The Director may require an applicant for appointment to the position of water right examiner to provide detailed information of past experience, provide references, and to satisfactorily complete a

written or oral examination. (3-20-20)T

**03. Denial.** If the Director determines an applicant is not qualified, the application will be denied. If the Director determines an applicant is qualified, a certificate of appointment will be issued. (3-20-20)T

**04. Expiration.** Every water right examiner certificate of appointment shall expire March 31 of each year unless renewed by application in the manner prescribed by the Director. A non-refundable fee in the amount provided by statute shall accompany an application for renewal. (3-20-20)T

**05. Refusal or Revocation.** An appointment or renewal may be refused or revoked by the Director at any time upon a showing of reasonable cause. A party aggrieved by an action of the Director may request an administrative hearing pursuant to Section 42-1701A (3), Idaho Code. (3-20-20)T

**06. Reconsideration.** An application for appointment or renewal which has been refused or revoked by the Director may not be reconsidered for six (6) months. (3-20-20)T

**07. Liability.** The state of Idaho shall not be liable for the compensation of any water right examiner other than department employees. The permit holder shall be responsible for costs associated with proof submittal including examination and field report preparation. (3-20-20)T

**08. Examinations.** The Director may authorize sufficiently knowledgeable and experienced department employees to conduct water right examinations during the course and scope of their employment with the department. Upon termination of employment with the department, such examiners, unless reappointed as a non-department certified examiner under provisions of these rules, are not authorized to conduct field examinations. The fee provisions of these rules do not apply to department employees. (3-20-20)T

**09. Ingress or Egress Authority.** Appointment as a water right examiner does not grant ingress or egress authority to non-department examiners and does not convey authority unless explicitly prescribed in these rules. (3-20-20)T

**10. Reports.** The Director will not accept a field examination report prepared by a certified water right examiner or a department employee who has any past or present interest, direct or indirect, in either the water right permit, the land or any enterprise benefiting, or likely to benefit, from the water right. Among those that the Director will presume to have an actual or potential conflict of interest and from whom he will not accept a field examination report are the following: (3-20-20)T

**a.** The person or persons owning the water right permit or the land or enterprise benefiting from the water right permit, members of their families (spouse, parents, grandparents, lineal descendants including those that are adopted, lineal descendants of parents; and spouse of lineal descendants), and their employees. (3-20-20)T

**b.** The person or persons, who sold or installed the diversion works or distribution system. (3-20-20)T

**11. Money Received.** All moneys received by the department under the provisions of these rules shall be deposited in the water administration fund created under Section 42-238a, Idaho Code. (3-20-20)T

**031. -- 034. (RESERVED)**

**035. EXAMINATION FOR BENEFICIAL USE (RULE 35).**

**01. Field Report.** (3-20-20)T

**a.** All items of the field report must be completed and must provide sufficient information for the Director to determine the extent of the water right developed in order for the report to be acceptable to the Director. (3-20-20)T

**b.** Permitted uses partially developed by the permit holder shall be described in detail. Permitted uses which were not developed by the permit holder shall be noted. Uses determined to exist which are not authorized by



the permit being examined shall also be described in detail. (3-20-20)T

**c.** A concise description of the diversion works and a general description of the distribution works shall be given. This description must trace the water from the point of diversion to the place of use and the return to a public water source, if any. Any reservoir, diversion dam, headgate, well, canal, flume, pump and other related structure shall be included. If water is stored, the timing and method of storage, release, redirection and conveyance to the place of use shall be described. The make, capacity, serial number and model number of all pumps, boosters or measuring devices associated with the point of diversion at the source of the water supply shall be described on the field examination report. Schematic diagrams, photographs, and maps sufficient to locate and describe the diversion, conveyance and usage systems shall also be provided in the examination report. (3-20-20)T

**d.** Any interconnection of the water use being examined with other water rights or with other conveyance systems shall be described on the field report. Interconnection includes, but is not limited to, sharing the same point of diversion, distribution system, place of use, or beneficial use. The examination report shall also include an evaluation of how the water use being examined is distinct from prior existing water rights and provides an alternate source of water or increment of beneficial use not authorized by prior existing water rights. (3-20-20)T

**e.** If water is returned to a public water source after use, a legal description of the point where the water is returned and source to which discharge is made shall be provided. Examples of uses which generally have an effluent discharge include fish propagation and power facilities. (3-20-20)T

**f.** The method of compliance with each condition of approval of a permit shall be shown on the field report by the examiner. (3-20-20)T

**g.** If the water is used for irrigation, the boundaries of the irrigated areas and the location of the project works providing water to each shall be platted on the maps submitted with the report and the full or partial acreage in each legal subdivision of forty (40) acres or government lot shall be shown. (3-20-20)T

**h.** Irrigated acreage shall be shown on the field report to the nearest whole acre in a legal subdivision except the acreage shall be shown to the nearest one-tenth (0.10) acre for permits covering land of less than ten (10) acres. (3-20-20)T

**i.** Where a permit has been developed as separate distribution systems from more than one point of diversion, the separate areas irrigated from each point of diversion shall be shown on the maps submitted with the report and the legal subdivisions embracing the irrigated areas for each such respective point of diversion together with the total irrigated area shall be described. (3-20-20)T

**j.** For each use of water the examiner shall report an annual diversion volume based on actual beneficial use during the development period for the permit. The method of determining the annual diversion volume shall be shown. The annual diversion volume shall account for seasonal variations in factors affecting water use, including seasonal variations in water availability. For irrigation, the volume shall be based on the field headgate requirements in the map titled Irrigation Field Headgate Requirement appended to these rules (see Appendix A located at the end of this chapter). Annual diversion volumes for heating and cooling uses may be adjusted to account for documented weather conditions during any single heating or cooling season from among the fifty (50) years immediately prior to submitting proof of beneficial use for the permit. For storage uses that include filling the reservoir and periodically replenishing evaporation and seepage losses throughout the year, the annual diversion volume shall be the sum of the amounts used for filling and for replenishment. Volumes may include reasonable conveyance losses actually incurred by the water user. The following water uses are exempt from the volume reporting requirement: (3-20-20)T

- i. Diversion to storage. (Volume should be reported for the storage use, such as irrigation storage.) (3-20-20)T
- ii. Domestic uses as defined in Section 42-111, Idaho Code. (3-20-20)T
- iii. In-stream watering of livestock. (3-20-20)T

- iv. Fire protection. (Volume is required for fire protection storage.) (3-20-20)T
- v. On-stream, run-of-the-river, non-consumptive power generation uses. (3-20-20)T
- vi. Minimum stream flows established pursuant to Chapter 15, Title 42, Idaho Code. (3-20-20)T
- vii. Municipal use by an incorporated city or other entity serving users throughout an incorporated city, except the following situations that do require a volume to be reported: (3-20-20)T
- (1) The permit or amended permit was approved with a volume limitation; or (3-20-20)T
- (2) The permit was not approved for municipal use but can be amended and licensed for a municipal use established during the authorized development period for the permit. (3-20-20)T
- viii. Irrigation using natural stream flow diverted from a stream or spring. (Volumes must be reported for irrigation uses from ponds, lakes and ground water and for irrigation storage and irrigation from storage.) (3-20-20)T
- k. The total number of holding/rearing ponds and the dimensions and volume of the ponds shall be shown on the field report for fish rearing or fish propagation use. The annual volume shall be calculated based on the changes of water per hour. (3-20-20)T
- l. Information shall be submitted concerning the beneficial use that has been made of the water unless the purpose of use is for irrigation. For example, for stockwater use, the number and type of stock watered shall be provided. Similar indications of the extent of beneficial use shall be provided for all other non-irrigation uses. (3-20-20)T
- m. The period during each year that the water is used shall be described for each use. (3-20-20)T
- n. For permits having more than one (1) use, the diversion rate measured for each use, the annual diversion volume determined for each use (unless specifically exempted by rule or statute), and the place of use for each use shall be described. (3-20-20)T
- o. The amount (rate and/or volume) of water shall be limited by the smaller of the permitted amount, the amount upon which the license examination fee is paid, the capacity of the diversion works or the amount beneficially used prior to submitting proof of beneficial use, including any statutory limitation of the duty of water. (3-20-20)T
- p. Suggested amendments shall be noted on the field report when the place of use, point of diversion, period or nature of use is different from the permit. Suggested amendments shall be based on actual use, not on potential use. (3-20-20)T
- q. An aerial photo marked to depict the point(s) of diversion and place(s) of use for each use must accompany each field report unless waived by the Director. If existing photos are not available, the Director will accept a USGS Quadrangle map at the largest scale available. (3-20-20)T
- r. Unless required as a condition of permit approval, an on-site examination and direct measurement of the diversion rate are not required for the following water uses if the beneficial use, place of use, season of use, and point of diversion can be confirmed by documentary means such as well driller reports, property tax records, receipts and other records of the permit holder, or photographs, including aerial photographs: (3-20-20)T
- i. Irrigation up to five (5) acres. (3-20-20)T
- ii. Storage of up to fourteen point six (14.6) acre-feet of water solely for stock watering purposes. (3-20-20)T
- iii. Any uses other than irrigation or storage if the total combined diversion rate for all the uses

established in connection with the permit does not exceed twenty-four one hundredths (0.24) cubic feet per second.  
(3-20-20)T

**02. Field Report Acceptability.** (3-20-20)T

**a.** All field reports shall be prepared by or under the supervision of certified water right examiners or authorized department employees. Reports submitted by certified water right examiners must be properly endorsed with an engineer or geologist seal and signature. Field reports received from certified water right examiners will be accepted if the report includes all the information required to complete the report and provides the information required by Rule Subsection 035.01. (3-20-20)T

**b.** Field reports not completed as required by these rules will be returned to the certified water right examiner for completion. If the date for submitting proof of beneficial use has passed, the penalty provisions of Rule 055 shall apply. (3-20-20)T

**c.** If the Director determines that a field report prepared by a certified water right examiner is acceptable but that additional information is needed to clarify the field report, he will notify the examiner in writing of the information required. If the additional information is not submitted within thirty (30) days or within the time specified in the written notice, the priority date of the permit will be advanced one (1) day for each day the information submittal is late. Failure to submit the required information within one (1) year of the date of the department's request is cause for the Director to take action to cancel the permit. (3-20-20)T

**d.** Field reports which indicate that a measuring device or lockable controlling works, required as a condition of approval of the permit, has not been installed, are not acceptable and will be returned to the examiner unless the measuring device requirement or lockable controlling works requirement has been formally waived or modified by the Director. (3-20-20)T

**03. General.** (3-20-20)T

**a.** For irrigation purposes, the duty of water shall not exceed five (5) acre feet of stored water for each acre of land to be irrigated or more than one (1) cubic foot per second for each fifty (50) acres of land to be irrigated unless it can be shown to the satisfaction of the Director that a greater amount is necessary. (3-20-20)T

**b.** For irrigated acreage of five (5) acres or less, a diversion rate up to three one-hundredths (0.03) cfs per acre may be allowed on the license to be issued by the Director. (3-20-20)T

**c.** Conveyance losses of water from the point of diversion to the place of use which are determined by actual measurement may be allowed by the Director if the loss is determined by the Director to be reasonable. (3-20-20)T

**d.** The duty of water described in Subsections 035.03.a. or 035.03.b. may be exceeded if the department has authorized a greater diversion rate per acre when the permit was issued and good cause acceptable to the Director has been demonstrated. (3-20-20)T

**e.** For irrigation systems which cover twenty-five thousand (25,000) acres or more, within irrigation districts organized and existing under the laws of the state of Idaho, and for irrigation projects developed under a permit held by an association, company, corporation, or the United States to deliver surface water to more than five (5) water users under an annual charge or rental, the field report does not need to describe the irrigated land by legal subdivision, but may describe generally the lands under the project works if the total irrigated acres has been accurately determined and is shown on the field report. The amount of water beneficially used under such projects must be shown on the field report. (3-20-20)T

**036. -- 039. (RESERVED)**

**040. WATER MEASUREMENT (RULE 40).**

**01. Measurement Terminology.** (3-20-20)T

a. Rate of flow measurements shall be shown in units of cubic feet per second (cfs) with three (3) significant figures and no more precision than hundredths. (3-20-20)T

b. Volume measurements shall be shown in units of acre-feet (AF) with three (3) significant figures, and no more precision than tenths. (3-20-20)T

**02. Rate of Diversion.** The rate of diversion measurement shall be conducted as close as reasonably possible to the source of supply and shall be measured with the project works fully in place operating at normal capacity. For example, if a sprinkler system is used for irrigation purposes, discharge from the pump must be measured with the sprinkler system connected. (3-20-20)T

**03. Measurements.** Water measurements may be made by vessel, weir, meter, rated flume, reservoir capacity table or other standard method of measurement acceptable to the Director. The field report shall describe the method used in making the measurement, the date when made, the name of the person making the measurement, the legal description of the location where the measurement was taken and shall include sufficient information, including current meter notes, rating tables, and/or calibration information to enable the Director to check the quantity of water measured in each case. (3-20-20)T

**04. Unacceptable Measurements.** Theoretical diversion rates or theoretical carrying capacities are not acceptable as a measure of the rate of diversion except as indicated in these rules and for some diversion systems where the flow rate cannot be measured accurately due to the physical characteristics of the diversion and distribution system. (3-20-20)T

**05. Method.** Rate of flow measurements shall be determined using equipment and methods capable of obtaining an accuracy of plus or minus ten percent (10%). (3-20-20)T

**041. -- 044. (RESERVED)**

**045. DRAWINGS, MAP, AND SCHEMATIC DIAGRAM (RULE 45).**

The following provisions shall apply to the submittal of drawings, maps, photos and the schematic diagrams. (3-20-20)T

**01. Submittal of Drawings, Maps, Photos and Schematic Diagrams.** Drawings, maps, photos and schematic diagrams used as an attachment to the field report shall be on eight and one-half by eleven (8 1/2 x 11) inch paper whenever possible. (3-20-20)T

**02. Attachment Sheets.** Attachment sheets shall depict information on one (1) side only. (3-20-20)T

**03. Scale of Map.** The map depicting the point of diversion and place of use shall be of a reasonable scale but not less than two (2) inches equals one (1) mile. The map shall show the location of the point(s) of diversion to the nearest forty (40) acre tract or to a ten (10) acre tract for springs. The location of ditches, canals, mainlines, distribution systems and the place of use by forty (40) acre tract must be shown. (3-20-20)T

**04. Drawings.** Drawings need to generally depict the size and type of diversion works, measuring device, conveyance system, water application method, and the location of any measurements taken. (3-20-20)T

**05. Photographs.** Photographs of the diversion works, the typical distribution works and other prominent features of the system shall be provided with the field report. (3-20-20)T

**046. -- 049. (RESERVED)**

**050. LICENSE EXAMINATION FEE (RULE 50).**

**01. Examinations Conducted by Department Staff.** (3-20-20)T

a. The examination fee shall be payable to the Department of Water Resources unless the field

examination is conducted by a certified water right examiner. (3-20-20)T

**b.** The department will not conduct an examination for which the fee has not been paid to the department unless exempted in Rule Subsection 009.04, except that for any prior examination, whether conducted by a certified water right examiner or by department staff, the department may conduct a supplemental examination on its own initiative at any time. No examination fee shall be charged for a supplemental examination conducted by the department on its own initiative. (3-20-20)T

**c.** A license shall not be issued for an amount of water in excess of the amount covered by the examination fee. Subsequent to the examination and prior to a license being issued, the Director will notify the permit holder that the licensed amount will be limited because an insufficient examination fee was paid. The permit holder will be allowed thirty (30) days after the notice is mailed to pay the additional examination fee, along with a late payment penalty of twenty-five dollars (\$25) or twenty percent (20%) of the amount of the additional required fee whichever is more. If payment is received within the thirty (30) day period, the rate or volume licensed shall not be reduced by reason of the examination fee. If payment is not received within the thirty (30) day period, the rate or volume licensed shall be limited by the original examination fee paid. For the purpose of determining advancement of priority for late fee as provided in Section 42-217, Idaho Code, fees shall not be considered as having been paid until paid in full, including any subsequent fee. (3-20-20)T

**d.** Excess examination fees are non-refundable. (3-20-20)T

**e.** An examination fee equal to the initial examination fee paid to the department shall be paid for a re-examination made at the request for the permit holder except upon a showing of error by the department on the initial examination. (3-20-20)T

**02. Examinations Conducted by Non-Department Certified Water Right Examiners.** (3-20-20)T

**a.** The examination fee required by Section 42-217, Idaho Code is not applicable for examination conducted by or under the supervision of certified water right examiners. (3-20-20)T

**b.** A permit holder may not choose to have the examination conducted by the department after selecting a certified water right examiner. (3-20-20)T

**c.** After submitting proof of beneficial use and paying an examination fee to the department, but before the department's actual examination, a permit holder may submit an examination report completed by a certified water right examiner. Because the examination fee is an essential component of timely proof submittal, the department will not refund the examination fee. (3-20-20)T

**051. -- 054. (RESERVED)**

**055. PENALTY (RULE 55).**

**01. Permits for Which Proof Has Not Been Submitted.** The submittal required is the proof and the examination fee or the proof and a completed field report. (3-20-20)T

**02. Failure to Submit.** Failure to submit either the license examination fee or an acceptable field examination report prepared by or under the supervision of a certified water right examiner by the proof due date is cause to lapse the permit pursuant to Section 42-218a, Idaho Code, unless an extension of time pursuant to Section 42-204, Idaho Code, extending the proof of beneficial use due date has been approved. (3-20-20)T

**056. -- 999. (RESERVED)**

Appendix A

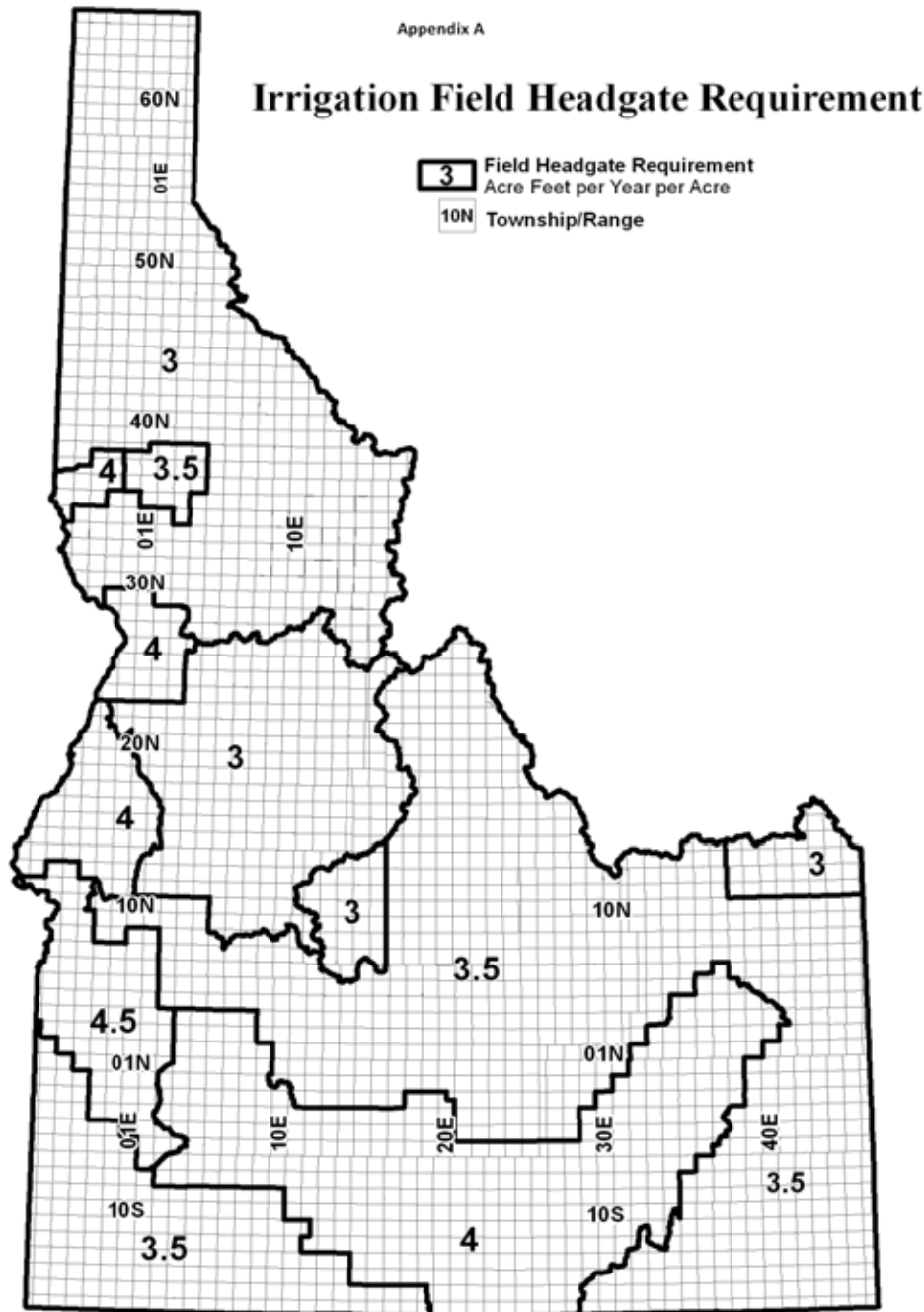

### 37.03.03 – RULES AND MINIMUM STANDARDS FOR THE CONSTRUCTION AND USE OF INJECTION WELLS

#### 000. LEGAL AUTHORITY.

This Chapter is adopted under the legal authority of Sections 42-3913, 42-3914, and 42-3915, Idaho Code.

(3-20-20)T

#### 001. TITLE AND SCOPE.

**01. Title.** These rules are titled IDAPA 37.03.03 “Rules and Minimum Standards for the Construction and Use of Injection Wells.”

(3-20-20)T

**02. Scope.** These rules and minimum standards are for construction and use of injection wells in the state of Idaho. Upon promulgation, these rules apply to all injection wells (see Rule Subsection 035.01). The construction and use of Class I, III, IV, or VI injection wells are prohibited by these rules. Class IV wells are also prohibited by federal law. These rules and minimum standards for construction and use of injection wells apply to all injection wells in the state of Idaho, except in Indian lands. All injection wells shall be permitted and constructed in accordance with the “Well Construction Standards Rules” found in IDAPA 37.03.09 which are authorized under Section 42-238, Idaho Code.

(3-20-20)T

**03. Rule Coverage.** In the event that a portion of these rules is less stringent than the minimum requirements for injection wells as established by Federal regulations, the correlative Federal requirement will be used to regulate the injection well.

(3-20-20)T

**04. Variance of Methods.** The Director may approve the use of a different testing method or technology if it is no less protective of human health and the environment, will not allow the migration of injected fluids into a USDW, meets the intent of the rule, and yields information or data consistent with the original method or technology required. A request for review by the Director must be submitted in writing by the applicant, permit holder, or operator and be included with all pertinent information necessary for the Director to evaluate the proposed testing method or technology.

(3-20-20)T

#### 002. INCORPORATION BY REFERENCE.

**01. Incorporated Document.** IDAPA 37.03.03 adopts and incorporates by reference those ground water quality standards found in Section 200 of IDAPA 58.01.11, “Ground Water Quality Rule,” of the Department of Environmental Quality.

(3-20-20)T

**02. Document Availability.** Copies of the incorporated document may be found at the central office of the Idaho Department of Water Resources, 322 East Front Street, Boise, Idaho, 83720-0098 or online through the department or state websites.

(3-20-20)T

#### 003. -- 009. (RESERVED)

#### 010. DEFINITIONS.

**01. Abandonment.** See “permanent decommissionion.

(3-20-20)T

**02. Abandoned Well.** See “permanent decommissionion”.

(3-20-20)T

**03. Agricultural Runoff Waste.** Excess surface water from agricultural fields generated during any agricultural operation, including runoff of irrigation tail water, as well as natural drainage resulting from precipitation, snowmelt, and floodwaters, and is identical to the statutory phrase “irrigation waste water” found in Idaho Code 42-3902.

(3-20-20)T

**04. Applicant.** Any owner or operator submitting an application for permit to construct, modify or maintain an injection well to the Director of the Department of Water Resources.

(3-20-20)T

**05. Application.** The standard Department forms for applying for a permit, including any additions, revisions or modifications to the forms.

(3-20-20)T

**06. Aquifer.** Any formation that will yield water to a well in sufficient quantities to make production of water from the formation reasonable for a beneficial use, except when the water in such formation results solely from fluids deposited through an injection well.

(3-20-20)T

- 07. Beneficial Use.** One (1) or more of the recognized beneficial uses of water including but not limited to, domestic, municipal, irrigation, hydropower generation, industrial, commercial, recreation, aquifer recharge and storage, stockwatering and fish propagation uses, as well as other uses which provide a benefit to the user of the water as determined by the Director. Industrial use as used for purposes of these rules includes, but is not limited to, manufacturing, mining and processing uses of water. (3-20-20)T
- 08. Best Management Practice (BMP).** A practice or combination of practices that are more effective than other techniques at preventing or reducing contamination of ground water and surface water by injection well operation. (3-20-20)T
- 09. Casing.** A pipe or tubing of appropriate material, of varying diameter and weight, lowered into a borehole during or after drilling in order to support the sides of the hole and thus prevent the walls from caving, to prevent loss of drilling fluid into porous ground, or to prevent water, gas, or other fluid from entering or leaving the hole. (3-20-20)T
- 10. Cementing.** The operation whereby a cement slurry is pumped into a drilled hole and/or forced behind the casing. (3-20-20)T
- 11. Cesspool.** An injection well that receives sanitary waste without benefit of a treatment system or treatment device such as a septic tank. Cesspools sometimes have open bottom and/or perforated sides. (3-20-20)T
- 12. Coliform Bacteria.** All of the aerobic and facultative anaerobic, gram-negative, non-spore forming, rod-shaped bacteria that either ferment lactose broth with gas formation within forty-eight (48) hours at thirty-five degrees Celsius (35C), or produce a dark colony with a metallic sheen within twenty-four (24) hours on an Endo-type medium containing lactose. (3-20-20)T
- 13. Confining Bed.** A body of impermeable or distinctly less permeable material stratigraphically adjacent to one (1) or more aquifers. (3-20-20)T
- 14. Construct.** To create a new injection well or to convert any structure into an injection well. (3-20-20)T
- 15. Contaminant.** Any physical, chemical, biological, or radiological substance or matter. (3-20-20)T
- 16. Contamination.** The introduction into the natural ground water of any physical, chemical, biological, or radioactive material that may: (3-20-20)T
- a.** Cause a violation of Idaho Ground Water Quality Standards found in IDAPA 58.01.11 “Ground Water Quality Rule” or the federal drinking water quality standards, whichever is more stringent; or (3-20-20)T
  - b.** Adversely affect the health of the public; or (3-20-20)T
  - c.** Adversely affect a designated or beneficial use of the State’s ground water. Contamination includes the introduction of heated or cooled water into the subsurface that will alter the ground water temperature and render the local ground water less suitable for beneficial use. (3-20-20)T
- 17. Conventional Mine.** An open pit or underground excavation for the production of minerals. (3-20-20)T
- 18. Decommission.** To remove a well from operation such that injection through the well is not possible. See “permanent decommission” and “unauthorized decommission”. (3-20-20)T
- 19. DEQ.** The Idaho Department of Environmental Quality. (3-20-20)T
- 20. Deep Injection Well.** An injection well which is more than eighteen (18) feet in vertical depth below land surface. (3-20-20)T



21. **Department.** The Idaho Department of Water Resources. (3-20-20)T
22. **Director.** The Director of the Idaho Department of Water Resources. (3-20-20)T
23. **Disposal Well.** A well used for the disposal of waste into a subsurface stratum. (3-20-20)T
24. **Draft Permit.** A prepared document indicating the Director's tentative decision to issue or deny, modify, revoke and reissue, terminate, or reissue a "permit." Permit conditions, compliance schedules, and monitoring requirements are typically included in a "draft permit". A notice of intent to terminate a permit, and a notice of intent to deny a permit are types of "draft permits." A denial of a request for modification, revocation and reissuance, or termination is not a "draft permit." (3-20-20)T
25. **Drilling Fluid.** Any number of liquid or gaseous fluids and mixtures of fluids and solids (such as solid suspensions, mixtures and emulsions of liquids, gases, and solids) used in operations to drill boreholes into the earth. (3-20-20)T
26. **Drywell.** An injection well completed above the water table so that its bottom and sides are typically dry except when receiving fluids. (3-20-20)T
27. **Endangerment.** Injection of any fluid which exceeds Idaho ground water quality standards, or federal drinking water quality standards, whichever is more stringent, that may result in the presence of any contaminant in ground water which supplies or can reasonably be expected to supply any public or non-public water system, and if the presence of such contaminant may result in such a system not complying with any ground water quality standard or may otherwise adversely affect the health of persons or result in a violation of ground water quality standards that would adversely affect beneficial uses. (3-20-20)T
28. **Exempted Aquifer.** An "aquifer" or its portion that meets the criteria in the definition of USDW but which has been recategorized as "other" according to the procedures in IDAPA 58.01.11 "Ground Water Quality Rule". (3-20-20)T
29. **Existing Injection Well.** An "injection well" other than a "new injection well." (3-20-20)T
30. **Experimental Technology.** A technology which has not been proven feasible under the conditions in which it is being tested. (3-20-20)T
31. **Facility or Activity.** Any UIC "injection well," or another facility or activity that is subject to regulation under the UIC program. (3-20-20)T
32. **Fault.** A surface or zone of rock fracture along which there has been displacement. (3-20-20)T
33. **Flow Rate.** The volume per time unit given to the flow of gases or other fluid substance which emerges from an orifice, pump, turbine or passes along a conduit or channel. (3-20-20)T
34. **Fluid.** Any material or substance which flows or moves, whether in a semisolid, liquid, sludge, gaseous or any other form or state. (3-20-20)T
35. **Formation.** A body of consolidated or unconsolidated rock characterized by a degree of lithologic homogeneity which is prevailing, but not necessarily, tabular and is mappable on the earth's surface or traceable in the subsurface. (3-20-20)T
36. **Generator.** Any person, by site location, whose act or process produces hazardous waste identified or listed in 40 CFR part 261. (3-20-20)T
37. **Ground Water.** Any water that occurs beneath the surface of the earth in a saturated formation of rock or soil. (3-20-20)T

- 38. Ground Water Quality Standards.** Standards found in IDAPA 58.01.11, “Ground Water Quality Rule,” Section 200. (3-20-20)T
- 39. Hazardous Waste.** Any substance defined by IDAPA 58.01.05, “Rules and Standards for Hazardous Waste.” (3-20-20)T
- 40. Indian Lands.** “Indian Country” as defined in 18 U.S.C. 1151. That section defines Indian Country as: (3-20-20)T
- a.** All land within the limits of any Indian reservation under the jurisdiction of the United States government, notwithstanding the issuance of any patent, and, including rights-of-way running through the reservation; (3-20-20)T
- b.** All dependent Indian communities within the borders of the United States whether within the original or subsequently acquired territory thereof, and whether within or without the limits of a State; and (3-20-20)T
- c.** All Indian allotments, the Indian titles to which have not been extinguished, including rights-of-way running through the same. (3-20-20)T
- 41. Individual Subsurface Sewage Disposal System.** For the purpose of these rules, any standard or alternative disposal system which injects sanitary waste from single family residential septic systems, or non-residential septic systems which are used solely for the disposal of sanitary waste and have the capacity to serve fewer than twenty (20) people a day. (3-20-20)T
- 42. Improved Sinkhole.** A naturally occurring karst depression or other natural crevice found in volcanic terrain and other geologic settings which have been modified by man for the purpose of directing and emplacing fluids into the subsurface. (3-20-20)T
- 43. Injection.** The subsurface emplacement of fluids through an injection well. (3-20-20)T
- 44. Injection Well.** Any feature that is operated to allow injection which also meets at least one (1) of the following criteria: (3-20-20)T
- a.** A bored, or driven shaft whose depth is greater than the largest surface dimension; (3-20-20)T
- b.** A dug hole whose depth is greater than the largest surface dimension; (3-20-20)T
- c.** An improved sinkhole; or (3-20-20)T
- d.** A subsurface fluid distribution system. (3-20-20)T
- 45. Injection Zone.** A geological “formation”, or those sections of a formation receiving fluids through an “injection well.” (3-20-20)T
- 46. IWRB.** Idaho Water Resource Board. (3-20-20)T
- 47. Large Capacity Cesspools.** Any cesspool used by a multiple dwelling, community or regional system for the disposal of sanitary wastes (for example: a duplex or an apartment building) or any cesspool used by or intended to be used by twenty (20) or more people per day (for example: a rest stop, campground, restaurant or church). (3-20-20)T
- 48. Large Capacity Septic System.** Class V wells that are used to inject sanitary waste through a septic tank and do not meet the criteria of an individual subsurface sewage disposal system. (3-20-20)T
- 49. Maintain.** To allow, either expressly or by implication, an injection well to exist in such condition as to accept or be able to accept fluids. Unless a well has been permanently decommissioned pursuant to the criteria

- contained in these rules it is considered to be capable of accepting fluids. (3-20-20)T
- 50. Modify.** To alter the construction of an injection well, but does not include cleaning or redrilling operations which neither deepen nor increase the dimensions of the well. (3-20-20)T
- 51. Motor Vehicle Waste Disposal Wells.** Injection wells that receive or have received fluids from vehicle repair or maintenance activities, such as an auto body repair shop, automotive repair shop, new and used car dealership, specialty repair shop (transmission and muffler repair shop), or any facility that does any vehicular repair work. (3-20-20)T
- 52. New Injection Well.** An “injection well” which began to be used for injection after a UIC program for the State applicable to the well is approved or prescribed. (3-20-20)T
- 53. Open-Loop Heat Pump Return Wells.** Injection wells that receive surface water or ground water that has been passed through a heat exchange system for cooling or heating purposes. (3-20-20)T
- 54. Operate.** To allow fluids to enter an injection well by action or inaction of the operator. (3-20-20)T
- 55. Operator.** Any individual, group of individuals, partnership, company, corporation, municipality, county, state agency, taxing district, federal agency or other entity that operates or proposes to operate any injection well. (3-20-20)T
- 56. Owner.** Any individual, group of individuals, partnership, company, corporation, municipality, county, state agency, taxing district, federal agency or other entity owning land on which any injection well exists or is proposed to be constructed. (3-20-20)T
- 57. Packer.** A device lowered into a well to produce a fluid-tight seal. (3-20-20)T
- 58. Perched Aquifer.** Ground water separated from an underlying main body of ground water by an unsaturated zone. (3-20-20)T
- 59. Permanent Decommission.** The discontinuance of use of an injection well in a method approved by the Director such that the injection well no longer has the capacity to inject fluids and the upward or downward migration of fluid is prevented. This also includes the disposal and proper management of any soil, gravel, sludge, liquids, or other materials removed from or adjacent to the injection well in accordance with all applicable Federal, State, and local regulations and requirements. (3-20-20)T
- 60. Permit.** An authorization, license, or equivalent control document issued by the Department. (3-20-20)T
- 61. Person.** Any individual, association, partnership, firm, joint stock company, trust, political subdivision, public or private corporation, state or federal governmental department, agency or instrumentality, or any other legal entity which is recognized by law. (3-20-20)T
- 62. Point of Beneficial Use.** The top or surface of a USDW, directly below an injection well, where water is available for a beneficial use. (3-20-20)T
- 63. Point of Diversion for Beneficial Use.** A location such as a producing well or spring where ground water is taken under control and diverted for a beneficial use. (3-20-20)T
- 64. Point of Injection.** The last accessible sampling point prior to waste being released into the subsurface environment through an injection well. For example, the point of injection for a Class V septic system might be the distribution box. For a drywell, it is likely to be the well bore itself. (3-20-20)T
- 65. Pressure.** The total load or force per unit area acting on a surface. (3-20-20)T
- 66. Radioactive Material.** Any material, solid, liquid or gas which emits radiation spontaneously.

- Radioactive geologic materials occurring in their natural state are not included. (3-20-20)T
- 67. Radioactive Waste.** Any fluid which contains radioactive material in concentrations which exceed those established for discharges to water in an unrestricted area by 10 CFR 20.1302.(b)(2)(i) and Table 2 in Appendix B of 10 CFR 20. (3-20-20)T
- 68. RCRA.** The Solid Waste Disposal Act as amended by the Resource Conservation and Recovery Act of 1976. (3-20-20)T
- 69. Remediation Project.** Use of an injection well for the removal, treatment or isolation of a contaminant from ground water through actions or the removal or treatment of a contaminant in ground water as approved by the Director. (3-20-20)T
- 70. Residential (Domestic) Activities.** Human activities that generate liquid or solid waste in any public, private, industrial, commercial, municipal, or other facility. (3-20-20)T
- 71. Sanitary Waste.** Any fluid generated through residential (domestic) activities, such as food preparation, cleaning and personal hygiene. This term does not include industrial, municipal, commercial, or other non-residential process fluids. (3-20-20)T
- 72. Schedule of Compliance.** A schedule of remedial measures including an enforceable sequence of actions or operations leading to compliance with the standards. (3-20-20)T
- 73. Septic System.** An injection well that is used to inject sanitary waste below the surface. A septic system is typically comprised of a septic tank and subsurface fluid distribution system or disposal system. (3-20-20)T
- 74. Shallow Injection Well.** An injection well which is less than or equal to eighteen (18) feet in vertical depth below land surface. (3-20-20)T
- 75. Site.** The land or water area where any “facility or activity” is physically located or conducted, including adjacent land used in connection with the facility or activity. (3-20-20)T
- 76. State.** The state of Idaho. (3-20-20)T
- 77. Stratum (plural strata).** A single sedimentary bed or layer, regardless of thickness, that consists of generally the same kind of rock material. (3-20-20)T
- 78. Subsidence.** The lowering of the natural land surface in response to: Earth movements; lowering of fluid pressure; removal of underlying supporting material by mining or solution of solids, either artificially or from natural causes; compaction due to wetting (Hydrocompaction); oxidation of organic matter in soils; or added load on the land surface. (3-20-20)T
- 79. Subsurface Fluid Distribution System.** An assemblage of perforated pipes, drain tiles, or other similar mechanisms intended to distribute fluids below the surface of the ground. (3-20-20)T
- 80. UIC.** The Underground Injection Control program under Part C of the Safe Drinking Water Act, including an “approved State program.” (3-20-20)T
- 81. Unauthorized Decommission.** The decommissioning of any injection well that has not received the approval of the Department prior to decommissioning, or was not decommissioned in a method approved by the Director. These wells may have to be properly decommissioned when discovered by the Director to ensure that the well prevents commingling of aquifers or is no longer capable of injection. (3-20-20)T
- 82. Underground Injection.** See “injection.” (3-20-20)T
- 83. Underground Source of Drinking Water (USDW).** An aquifer or its portion: (3-20-20)T

- a. Which: (3-20-20)T
  - i. Supplies any public water system; or (3-20-20)T
  - ii. Contains a sufficient quantity of ground water to supply a public water system; or (3-20-20)T
  - (1) Currently supplies drinking water for human consumption; or (3-20-20)T
  - (2) Contains fewer than ten thousand (10,000) mg/l total dissolved solids; and (3-20-20)T
  - b. Which is not an exempted aquifer. (3-20-20)T
- 84. Unreasonable Contamination.** Endangerment of a USDW or the health of persons or other beneficial uses by injection. See “endangerment.” (3-20-20)T
- 85. Water Quality Standards.** Refers to those standards found in Idaho Department of Environmental Quality Rules, IDAPA 58.01.02, “Water Quality Standards” and IDAPA 58.01.11, “Ground Water Quality Rule.” (3-20-20)T
- 86. Well.** For the purposes of these rules, “well” means “injection well.” (3-20-20)T
- 011. -- 014. (RESERVED)**
- 015. VIOLATIONS, FORMAL NOTIFICATION AND ENFORCEMENT.**
- 01. Violations.** It shall be a violation of these rules for any owner or operator to: (3-20-20)T
    - a. Fail to comply with a permit or authorization, or terms or conditions thereof; (3-20-20)T
    - b. Fail to comply with applicable standards for water quality; (3-20-20)T
    - c. Fail to comply with any permit application notification or filing requirement; (3-20-20)T
    - d. Knowingly make any false statement, representation or certification in any application, report, document or record filed pursuant to these rules, or terms and conditions of an issued permit; (3-20-20)T
    - e. Falsify, tamper with or knowingly render inaccurate any monitoring device or method required to be maintained or utilized by the terms and conditions of an issued permit; (3-20-20)T
    - f. Fail to respond to any formal notification of a violation when a response is required; or (3-20-20)T
    - g. Decommission a well in an unauthorized manner. (3-20-20)T
  - 02. Additional.** It shall be a violation of these rules for any person to construct, operate, maintain, convert, plug, decommission or conduct any other activity in a manner which results or may result in the unauthorized injection of a hazardous waste or of a radioactive waste by an injection well. (3-20-20)T
  - 03. Formal Notification.** Formal notification of violations may be communicated to the owner or operator with a letter, a notice of violation, a compliance or enforcement order or other appropriate means. (3-20-20)T
  - 04. Enforcement.** Violation of any of the provisions of the Injection Well Act (Chapter 39, Title 42, Idaho Code) or of any rule, regulation, standard or criteria pertaining to the Injection Well Act may result in the Director initiating an enforcement action as provided under Chapters 17 and 39, Title 42, Idaho Code. (3-20-20)T
- 016. -- 019. (RESERVED)**

**020. HEARING BEFORE THE WATER RESOURCE BOARD.**

**01. General.** All hearings before the IWRB will be conducted in accordance with Chapter 52, Title 67, Idaho Code, at a place convenient to the owner and/or operator. For purposes of such hearings, the IWRB or its designated hearing officer shall have power to administer oaths, examine witnesses, and issue in the name of the said Board subpoenas requiring testimony of witnesses and the production of evidence relevant to any matter in the hearing. Judicial review of the final determination by the IWRB may be secured by the owner by filing a petition for review as prescribed by Chapter 52, Title 67, Idaho Code, in the District Court of the county where the injection well is situated or proposed to be located. The petition for review shall be served upon the Chairman of the IWRB and upon the Attorney General. (3-20-20)T

**02. Hearings on Conditional Permits, Disapproved Applications, or Petitions for Exemption.** Any owner or operator aggrieved by the approval or disapproval of an application, or by conditions imposed upon a permit, or any person aggrieved by the Director's decision on a petition for exemption under Section 025 of these rules, shall be afforded an opportunity for a hearing before the IWRB or its designated hearing officer. Written notice of such grievance shall be transmitted to the Director within thirty (30) days after receipt of notice of such approval, disapproval or conditional approval. Such hearing shall be held for the purpose of determining whether the permit shall be issued, whether the conditions imposed in a permit are reasonable, whether a change in circumstances warrants a change in conditions imposed in a valid permit, or whether the Director's decision on a petition for exemption should not be changed. (3-20-20)T

**03. Hearings on Permit Cancellations.** When the Director has reason to believe the operation of an injection well for which a permit has been issued is interfering with the right of the public to withdraw water for beneficial uses, or is causing unreasonable contamination of a drinking or other ground water source as provided for in Title 42, Chapter 39, Idaho Code, the permit may be canceled by the Director. Prior to the cancellation of such permit there shall be a hearing before the IWRB for the purpose of determining whether or not the permit should be canceled. At such hearing, the Director shall be the complaining party. At least thirty (30) days prior to the hearing, a notice, which shall be in accordance with Chapter 52, Title 67, Idaho Code, shall be sent by certified mail to the owner or operator whose permit is proposed to be canceled. The Board shall affirm, modify, or reject the Director's decision and make its decision in the form of an order to the Director. (3-20-20)T

**021. -- 034. (RESERVED)**

**035. CLASSIFICATION OF INJECTION WELLS.**

**01. Classification of Injection Wells.** For the purposes of these rules, injection wells are classified as follows: (3-20-20)T

**a. Class I:** (3-20-20)T

i. Wells used by generators of hazardous waste or owners or operators of hazardous waste management facilities to inject hazardous waste beneath the lowermost formation containing, within one-quarter (1/4) mile of the well bore, an underground source of drinking water. (3-20-20)T

ii. Other industrial and municipal disposal wells which inject fluids beneath the lowermost formation containing, within one-quarter (1/4) mile of the well bore, an underground source of drinking water. (3-20-20)T

iii. Radioactive waste disposal wells which inject fluids below the lowermost formation containing an underground source of drinking water within one-quarter (1/4) mile of the well bore. (3-20-20)T

**b. Class II. Wells used to inject fluids:** (3-20-20)T

i. Which are brought to the surface in connection with natural gas storage operations, or conventional oil or natural gas production and may be commingled with waste waters from gas plants, dehydration stations, or compressor stations which are an integral part of production operations, unless those waters are classified as a hazardous waste at the time of injection. (3-20-20)T

- ii. For enhanced recovery of oil or natural gas; and (3-20-20)T
- iii. For storage of hydrocarbons which are liquid at standard temperature and pressure. (3-20-20)T
- c. Class III. Wells used to inject fluids for extraction of minerals including: (3-20-20)T
  - i. Mining of sulfur by the Frasch process; (3-20-20)T
  - ii. In situ production of uranium or other metals; this category includes only in-situ production from ore bodies which have not been conventionally mined. Solution mining of conventional mines such as stopes leaching is included in Class V. (3-20-20)T
  - iii. Solution mining of salts or potash. (3-20-20)T
- d. Class IV: (3-20-20)T
  - i. Wells used by generators of hazardous waste or of radioactive waste, by owners or operators of hazardous waste management facilities, or by owners or operators of radioactive waste disposal sites to dispose of hazardous waste or radioactive waste into a formation which within one-quarter (1/4) mile of the well contains an underground source of drinking water. (3-20-20)T
  - ii. Wells used by generators of hazardous waste or of radioactive waste, by owners or operators of hazardous waste management facilities, or by owners or operators of radioactive waste disposal sites to dispose of hazardous waste or radioactive waste above a formation which within one-quarter (1/4) mile of the well contains an underground source of drinking water. (3-20-20)T
  - iii. Wells used by generators of hazardous waste or owners or operators of hazardous waste management facilities to dispose of hazardous waste, which cannot be classified under Subparagraphs 035.01.a.i. or 035.01.d.i. or 035.01.d.ii. of this rule (e.g., wells used to dispose of hazardous waste into or above a formation which contains an aquifer which has been exempted pursuant to Section 025 of these rules). (3-20-20)T
- e. Class V -- All injection wells not included in Classes I, II, III, IV, or VI. (3-20-20)T
- f. Class VI. (3-20-20)T
  - i. Wells that are not experimental in nature that are used for geologic sequestration of carbon dioxide beneath the lowermost formation containing a USDW; or (3-20-20)T
  - ii. Wells used for geologic sequestration of carbon dioxide that have been granted a waiver of the injection depth requirements pursuant to requirements at 40 CFR Section 146.95; or (3-20-20)T
  - iii. Wells used for geologic sequestration of carbon dioxide that have received an expansion to the areal extent of an existing Class II enhanced oil recovery or enhanced gas recovery aquifer exemption pursuant to Section 025 of these rules. (3-20-20)T
- 02. Subclassification.** Class V wells are subclassified as follows: (3-20-20)T
  - a. 5A5-Electric Power Generation. (3-20-20)T
  - b. 5A6-Geothermal Heat. (3-20-20)T
  - c. 5A7-Heat Pump Return. (3-20-20)T
  - d. 5A8-Aquaculture Return Flow. (3-20-20)T
  - e. 5A19-Cooling Water Return. (3-20-20)T

<b>f.</b>	5B22-Saline Water Intrusion Barrier.	(3-20-20)T
<b>g.</b>	5D2-Storm Runoff.	(3-20-20)T
<b>h.</b>	5D3-Improved Sinkholes.	(3-20-20)T
<b>i.</b>	5D4-Industrial Storm Runoff.	(3-20-20)T
<b>j.</b>	5F1-Agricultural Runoff Waste.	(3-20-20)T
<b>k.</b>	5G30-Special Drainage Water.	(3-20-20)T
<b>l.</b>	5N24 <sup>1</sup> -Radioactive Waste Disposal.	(3-20-20)T
<b>m.</b>	5R21-Aquifer Recharge.	(3-20-20)T
<b>n.</b>	5S23-Subsidence Control.	(3-20-20)T
<b>o.</b>	5W9-Untreated Sewage.	(3-20-20)T
<b>p.</b>	5W10-Cesspools.	(3-20-20)T
<b>q.</b>	5W11-Septic Systems (General).	(3-20-20)T
<b>r.</b>	5W12-Waste Water Treatment Plant Effluent.	(3-20-20)T
<b>s.</b>	5W20-Industrial Process Water.	(3-20-20)T
<b>t.</b>	5W31-Septic Systems (Well Disposal).	(3-20-20)T
<b>u.</b>	5W32-Septic System (Drainfield).	(3-20-20)T
<b>v.</b>	5X13-Mine Tailings Backfill.	(3-20-20)T
<b>w.</b>	5X14-Solution Mining.	(3-20-20)T
<b>x.</b>	5X15-In-Situ Fossil Fuel Recovery.	(3-20-20)T
<b>y.</b>	5X16-Spent Brine Return Flow.	(3-20-20)T
<b>z.</b>	5X25-Experimental Technology.	(3-20-20)T
<b>aa.</b>	5X26-Aquifer Remediation.	(3-20-20)T
<b>bb.</b>	5X27-Other Wells.	(3-20-20)T
<b>cc.</b>	5X28 <sup>1</sup> -Motor Vehicle Waste Disposal Wells.	(3-20-20)T
<b>dd.</b>	5X29-Abandoned Water Wells.	(3-20-20)T

<sup>1</sup> The construction and operation of wells in these subclasses is currently illegal in Idaho.

**036. -- 039. (RESERVED)**

**040. AUTHORIZATIONS, PROHIBITIONS AND EXEMPTIONS.**

**01. Authorizations.** Construction and use of Class V deep injection wells may be authorized by permit



as approved by the Director in accordance with these rules. (3-20-20)T

**02. Prohibitions.** (3-20-20)T

**a.** These rules prohibit the permitting, construction, or use of any Class I, III IV, or VI injection well. (3-20-20)T

**b.** No owner or operator shall construct, operate, maintain, convert, plug, abandon, or conduct any other injection activity in a manner that allows or causes the movement of fluid containing any contaminant into underground sources of drinking water, if the presence of that contaminant may cause a violation of any primary or secondary drinking water regulation, under IDAPA 58.01.11, “Ground Water Quality Rule,” Section 200 or may otherwise adversely affect the health of persons. The applicant for a permit shall have the burden of showing that the requirements of Paragraph 040.02.c. are met. (3-20-20)T

**c.** Notwithstanding any other provision of this section, the Director may take emergency action upon receipt of information that a contaminant which is present in or likely to enter a public water system or underground source of drinking water may present an imminent and substantial endangerment to the health of persons. (3-20-20)T

**d.** Construction of large capacity cesspools, motor vehicle waste disposal wells, radioactive waste disposal wells, and untreated sewage disposal wells is prohibited. Construction and use of other Class V shallow injection wells are authorized by these rules without permit provided that: (3-20-20)T

**i.** Required inventory information is submitted to the Director pursuant to Subsection 070.01 of this rule. (3-20-20)T

**ii.** Use of the shallow injection well shall not result in unreasonable contamination of a USDW or cause a violation of surface or ground water quality standards that would affect a beneficial use. (3-20-20)T

**e.** Class IV injection wells used to inject contaminated ground water that has been treated and is being reinjected into the same formation from which it was drawn are not prohibited by these rules if such injection is approved by EPA, or Idaho, pursuant to provisions for cleanup of releases under the Comprehensive Environmental Response, Compensation, and Liability Act of 1980 (CERCLA), 42 U.S.C. 9601–9657, or pursuant to requirements and provisions under the Resource Conservation and Recovery Act (RCRA), 42 U.S.C. 6901 through 6987. (3-20-20)T

**f.** All large capacity cesspools must be properly decommissioned by January 1, 2005. A cease and desist order may be issued to the owner or the operator when a large capacity cesspool is found to be a threat to the ground water resources as described in Paragraph 070.01.c. (3-20-20)T

**g.** All motor vehicle waste disposal wells must be properly decommissioned by January 1, 2005. A cease and desist order may be issued to the owner or the operator when a motor vehicle waste disposal well is found to be a threat to the ground water resources as described in Paragraph 070.01.c. (3-20-20)T

**h.** The Construction, operation or maintenance of any non-experimental Class V geologic sequestration well is prohibited. (3-20-20)T

**i.** Owners or operators of shallow injection wells are prohibited from injecting into the well upon failure to submit inventory information in a timely manner pursuant to Paragraph 070.01.a. of these rules. (3-20-20)T

**03. Exemptions.** (3-20-20)T

**a.** The UIC inventory and fee requirements of these rules do not apply to individual subsurface sewage disposal system wells. These systems are, however, subject to the permitting and fee requirements of IDAPA 58.01.03 “Individual/Subsurface Sewage Disposal Rules,” Title 39, Chapter 1 and Title 39, Chapter 36, Idaho Code. (3-20-20)T

**b.** State or local government entities are exempt from the permit requirements of these rules for wells

associated with highway and street construction and maintenance projects, but shall submit shallow injection well inventory information for said wells and shall comply with all other requirements of these rules. (3-20-20)T

**c.** Mine tailings backfill (5X13) wells are authorized by rule as part of mining operations. They are therefore exempt from the ground water quality standards and permitting requirements of these rules provided that their use is limited to the injection of mine tailings only. The use of any 5X13 well(s) shall not result in water quality standards at points of diversion for beneficial use being exceeded or otherwise affect a beneficial use. Should water quality standards be exceeded or beneficial uses be affected, the Director may order the wells to be put under the permit requirements of these rules, or the wells may be required to be remediated or closed. As a condition of their use, the Director may require the construction and sampling of monitoring wells by the owner/operator. 5X13 wells are subject to the inventory requirements of Subsection 070.01. (3-20-20)T

**041. -- 069. (RESERVED)**

**070. CLASS V: CRITERIA AND STANDARDS.**

**01. Class V Shallow Injection Well Requirements. (3-20-20)T**

**a.** Authorization. As a condition of authorization, all owners or operators of shallow Class V injection wells, including improved sinkholes used for aquifer recharge, that dispose of nonhazardous and nonradioactive wastes are required to submit a Shallow Injection Well Inventory Form to the Department no later than thirty (30) days prior to commencement of construction for each new well or no later than thirty (30) days after the discovery of an existing injection well that has not previously been inventoried with the Department. Forms are available from any Department office or at the Department website at <http://www.idwr.idaho.gov>. State or local government entities shall submit the following inventory information for wells associated with highway and street construction and maintenance projects. (3-20-20)T

- i. Facility name and location; and (3-20-20)T
- ii. County in which the injection well(s) is (are) located; and (3-20-20)T
- iii. Ownership of the well(s); and (3-20-20)T
- iv. Name, address and phone number of legal contact; and (3-20-20)T
- v. Type or function of the well(s); and (3-20-20)T
- vi. Number of wells of each type; and (3-20-20)T
- vii. Operational status of the well(s). (3-20-20)T

**b.** Inventory Fees. For shallow injection wells constructed after July 1, 1997, the Shallow Injection Well Inventory Form shall be accompanied by a fee as specified in Section 42-3905, Idaho Code, payable to the Department of Water Resources. State or local government entities are exempt from Shallow Injection Well Inventory Form filing fees for wells associated with highway and street construction and maintenance, but shall comply with all other requirements of these rules. (3-20-20)T

**c.** Permit Requirements. If operation of a shallow Class V injection well is causing or may cause unreasonable contamination of a USDW, or cause a violation of the ground water quality standards at a place of beneficial use, the Director shall require immediate cessation of the injection activity. Where a Class V injection well is owned or operated by an entity other than a state or local entity involved in highway and street construction and maintenance, the Director may authorize continued operation of the well through a permit that specifies the terms and conditions of acceptable operation. (3-20-20)T

**d.** Permanent Decommission. Owners or operators of shallow injection wells shall notify the Director not less than thirty (30) days prior to permanent decommissioning of any shallow injection well. Permanent decommissioning shall be accomplished in accordance with procedures approved by the Director. (3-20-20)T

e. Inter-Agency Cooperation. The Department may seek the assistance of other government agencies, including cities and counties, health districts, highway districts, and other departments of state government to inventory, monitor and inspect shallow injection wells, where local assistance is needed to prevent deterioration of ground water quality, and where injection well operation overlaps with water quality concerns of other agencies or local governing entities. Assistance is to be negotiated through a memorandum of understanding between the Department and the local entity, agency, or department, and is subject to the approval of the Director. (3-20-20)T

**02. Class V Deep Injection Well Requirements. (3-20-20)T**

**a. Application Requirements. (3-20-20)T**

i. No person shall continue to maintain or use an unauthorized injection well after the effective date given in Section 42-3903, Idaho Code, unless a permit therefor has been issued by the Director. No injection well requiring a permit under Subsection 070.02 shall be constructed, modified or maintained after the effective date given in Section 42-3903, Idaho Code, unless a permit therefor has been issued by the Director. No injection well requiring a permit shall continue to be used after the expiration of the permit issued for such well unless another application for permit therefor has been received by the Director. All applications for permit shall be on forms furnished by the Director. (3-20-20)T

ii. Each application for permit to construct, modify or maintain an injection well, as required by these rules, shall be accompanied by a filing fee as specified in Section 42-3905, Idaho Code, payable to the Department of Water Resources. For the purposes of these rules, all wells or groups of wells associated with a “Remediation Project” may be administered as one (1) “well” at the discretion of the Director. (3-20-20)T

**b. Application Information Required.** An applicant shall submit the following information to the Director for all injection wells to be authorized by permit, unless the Director determines that it is not needed in whole or in part, and issues a written waiver to the applicant: (3-20-20)T

- i. Facility name and location; (3-20-20)T
- ii. Name, address and phone number of the well operator; (3-20-20)T
- iii. Class, subclass and function of the injection well (see Section 035); (3-20-20)T
- iv. Latitude/longitude or legal description of the well location to the nearest ten (10) acre tract; (3-20-20)T
- v. Ownership of the well; (3-20-20)T
- vi. County in which the injection well is located; (3-20-20)T
- vii. Construction information for the well; (3-20-20)T
- viii. Quantity and general character of the injected fluids; (3-20-20)T
- ix. Status of the well; (3-20-20)T
- x. A topographic map or aerial photograph extending one (1) mile beyond property boundaries, depicting: (3-20-20)T
  - (1) Location of the injection well and associated facilities described in the application; (3-20-20)T
  - (2) Locations of other injection wells; (3-20-20)T
  - (3) Approximate drainage area, if applicable; (3-20-20)T

- (4) Hazardous waste facilities, if applicable; (3-20-20)T
- (5) All wells used to withdraw drinking water; (3-20-20)T
- (6) All other wells, springs and surface waters. (3-20-20)T
- xi. Distance and direction to nearest domestic well; (3-20-20)T
- xii. Depth to ground water; and (3-20-20)T
- xiii. Alternative methods of waste disposal. (3-20-20)T
- c.** Additional Information. The Director may require the following additional information for Class V injection wells to assess potential effects of injection: (3-20-20)T
- well: i. A topographic map showing locations of the following within a two (2) mile radius of the injection well: (3-20-20)T
  - (1) All wells producing water; (3-20-20)T
  - (2) All exploratory and test wells; (3-20-20)T
  - (3) All other injection wells; (3-20-20)T
  - (4) Surface waters (including man-made impoundments, canals and ditches); (3-20-20)T
  - (5) Mines and quarries; (3-20-20)T
  - (6) Residences; (3-20-20)T
  - (7) Roads; (3-20-20)T
  - (8) Bedrock outcrops; and (3-20-20)T
  - (9) Faults and fractures. (3-20-20)T
- ii. Additional maps or aerial photographs of suitable scale to accurately depict the following: (3-20-20)T
  - (1) Location and surface elevation of the injection well described in this permit; (3-20-20)T
  - (2) Location and identification of all facilities within the property boundaries; (3-20-20)T
  - (3) Locations of all wells penetrating the proposed injection zone or within a one-quarter (1/4) mile radius of the injection well; (3-20-20)T
  - (4) Maps and cross sections depicting all underground sources of drinking water to include vertical and lateral limits within a one-quarter (1/4) mile radius of the injection well, their position relative to the injection zone and the direction of water movement: local geologic structures; regional geologic setting. (3-20-20)T
- iii. A comprehensive report of the following information: (3-20-20)T
  - (1) A tabulation of all wells penetrating the proposed injection zone, listing owner, lease holder and operator; well identification (permit) number; size, weight, depth and cementing data for all strings of casing; (3-20-20)T
  - (2) Description of the quality and quantity of fluids to be injected; (3-20-20)T

- (3) Geologic, hydrogeologic, and physical characteristics of the injection zone and confining beds; (3-20-20)T
  - (4) Engineering data for the proposed injection well; (3-20-20)T
  - (5) Proposed operating pressure; (3-20-20)T
  - (6) A detailed evaluation of alternative disposal practices; (3-20-20)T
  - (7) A plan of corrective action for wells penetrating the zone of injection, but not properly sealed or decommissioned; and (3-20-20)T
  - (8) Contingency plans to cope with all shut-ins or well failures to prevent the migration of unacceptable fluids into underground sources of drinking waters. (3-20-20)T
- iv. Name, address and phone number of person(s) or firm(s) supplying the technical information and/or designing the injection well; (3-20-20)T
  - v. Proof that the applicant is financially responsible, through a performance bond or other appropriate means, to decommission the injection well in a manner approved by the Director. (3-20-20)T
- d. Other Information.** The Director may require of any applicant such additional information as may be necessary to demonstrate that the proposed or existing injection well will not endanger a USDW. The Director will not complete the processing of an application for which additional information has been requested until such time as the additional information is supplied. The Director may return any incomplete application and will not process such application until such time as the application is received in complete form. (3-20-20)T
- 03. Application Processing.** (3-20-20)T
- a. Draft Permit.** After all application information is received and evaluated, the Director will prepare a draft permit or denial, which will include the application for permit, permit conditions or reasons for denial, and any compliance schedules or monitoring requirements. In preparing the draft permit or denial, the Director shall consider the following factors: (3-20-20)T
    - i. The availability of economic and practical alternative means of disposal; (3-20-20)T
    - ii. The application of best management practices to the facilities and/or area draining into the well; (3-20-20)T
    - iii. The availability of economical, practical means of treating or otherwise reducing the amount of contaminants in the injected fluids; (3-20-20)T
    - iv. The quality of the receiving ground water, its category, its present and future beneficial uses or interconnected surface water; (3-20-20)T
    - v. The location of the injection well with respect to drinking water supply wells; and (3-20-20)T
    - vi. Compliance with the IDAPA 58.01.11, “Ground Water Quality Rule.” (3-20-20)T
  - b. Public Notice.** The Director will provide public notice of any draft permit to construct, maintain or modify a Class V injection well by means of a legal notice in a newspaper of general circulation in the county in which the well is located. The Director may give additional notice as necessary to adequately inform the interested public and governmental agencies. There shall be a period of at least thirty (30) days following publication for any interested person to submit written comments and to request a fact-finding hearing. The hearing will be held by the Director if deemed necessary. (3-20-20)T

c. Review by the Directors of Other State Agencies. The Directors of other state agencies, as determined by the Director, shall be provided the opportunity to review and comment on draft permits. Comments shall be submitted to the Director within thirty (30) days of the public or legal notice. (3-20-20)T

d. Open-Loop Heat Pump Return Wells (Subclass 5A7). (3-20-20)T

i. An open-loop heat pump return well greater than eighteen (18) feet in depth to be used solely for disposal of heat pump water at a rate not exceeding fifty (50) gpm does not require a draft permit and is not subject to a recurring permit cycle, however, registration of the well with the Department and submittal of a filing fee as specified in Section 42-3905, Idaho Code is required. The Director reserves the right to override the exemptions from the draft permit and permit cycle requirements. (3-20-20)T

ii. An open-loop heat pump return well greater than eighteen (18) feet in depth to be used solely for disposal of heat pump return water at a rate exceeding fifty (50) gpm is subject to the requirements of Subsections 070.02 and 070.03 of these rules. (3-20-20)T

e. Fact-Finding Hearings. At the Director's discretion, or upon motion of any interested individual, the Director may elect to hold a fact-finding hearing. Said hearing will be held at a location in the geographical area of the injection well. Notice of said hearing will be provided at least thirty (30) days in advance of the hearing by regular mail to the applicant and to the person or persons requesting the hearing. Public notice of the fact-finding hearing will be made by means of press release to a newspaper of general circulation in the county of the application. (3-20-20)T

**04. The Director's Action On Draft Permits and Duration Of Approved Permits.** The role of the Director is to determine whether or not the injection wells and their respective owners or operators are in compliance with the intent of these rules, thus protecting the ground waters of the state against unreasonable contamination or deterioration of quality and preserving them for diversion to beneficial uses. (3-20-20)T

a. Consideration. The Director will consider the following factors in taking final action on draft permits: (3-20-20)T

i. The likelihood and consequences of the injection well system failing; (3-20-20)T

ii. The long term effects of such disposal or storage; (3-20-20)T

iii. The recommendations and related justifications of the Directors of other state agencies and the public; (3-20-20)T

iv. The potential for violation of ground water quality standards at the point of injection or the point of beneficial use; and (3-20-20)T

v. Compliance with the Idaho Ground Water Quality Plan. (3-20-20)T

b. Issuance of Permit. After considering the draft permit for construction, modification, or maintenance, and all matters relating thereto, the Director shall issue a permit if the standards and criteria of Subsection 070.05 will be met and USDW's will not otherwise be unreasonably affected. If the Director finds that the standards and criteria cannot be met or that ground water sources cannot otherwise be protected from unreasonable contamination at all times, the draft permit may be denied or a permit may be issued with conditions designed to protect ground water sources. The Director's decision shall be in writing and a copy shall be mailed by regular mail to the applicant and to all persons who commented in writing on the draft permit or appeared at a hearing held to consider the draft permit. (3-20-20)T

c. Permit Conditions and Requirements. Any permit issued by the Director shall contain conditions to insure that ground water sources will be protected from waste, unreasonable contamination, or deterioration of ground water quality that could result in violations of the ground water quality standards. In addition to specific construction, operation, maintenance and monitoring requirements that the Director finds necessary, each permit shall be subject to the standard conditions and requirements of this rule. (3-20-20)T

- d. Construction Requirements. (3-20-20)T
- i. Well drillers or other persons involved with the construction of any injection well requiring a permit shall not commence construction on the facility until a certified copy of the approved permit is obtained from the Director. (3-20-20)T
- ii. Deep injection wells shall be constructed by a licensed water well driller to conform with the current Minimum Well Construction Standards and the conditions of the permit, except that a driller's license is not required for the construction of a driven mine shaft or a dug hole. (3-20-20)T
- iii. Shallow injection wells authorized by permit shall be constructed in accordance with the conditions of the permit. Rule-authorized shallow injection wells shall be constructed as shown or described in the inventory submittal. (3-20-20)T
- iv. Injection wells shall be constructed to prevent the entrance of any fluids other than specified in the permit. (3-20-20)T
- v. Injection wells shall be constructed to prevent waste of artesian fluids or movement of fluids from one aquifer into another. (3-20-20)T
- vi. When construction or modification of an injection well has been completed, the owner or operator shall inform the Director of completion on a form provided by the Department. (3-20-20)T
- vii. A sampling port shall be provided if the injection well system is enclosed. (3-20-20)T
- viii. All new injection wells constructed into alluvial formations shall have a minimum ten (10) foot separation from the bottom of the well and seasonal high ground water. (3-20-20)T
- (1) Injection wells installed into fractured basalt are exempt from separation distances. (3-20-20)T
- (2) The Director may reduce separation distance requirements if the quality of injected fluids are improved through additional treatment or BMPs. (3-20-20)T
- (3) Heat pump return wells (sub-class 5A7) are exempt from the separation distance requirement of this section. (3-20-20)T
- e. Operational Conditions. (3-20-20)T
- i. The injection well shall not be used until the construction, operation and maintenance requirements of the permit are met and provisions are made for any required inspection, monitoring and record keeping. (3-20-20)T
- ii. Injection of any contaminant at concentrations exceeding the standards set in Paragraph 070.05.c. into a present or future drinking or other ground water source that may cause a health hazard or adversely affect a designated and protected use is prohibited. (3-20-20)T
- iii. The injection well owner or operator shall develop approved procedures to detect constructional or operational failure in a timely fashion, and shall have contingency plans to cope with the well failure. (3-20-20)T
- iv. Authorized representatives of the Department shall be allowed to enter, inspect and/or sample: (3-20-20)T
- (1) The injection well and related facilities; (3-20-20)T
- (2) The owner or operator's records of the injection operation; (3-20-20)T

- (3) Monitoring instrumentation associated with the injection operation; and (3-20-20)T
- (4) The injected fluids. (3-20-20)T
- v. The injection facilities shall be operated and maintained to achieve compliance with all terms and conditions of this permit. (3-20-20)T
- (1) Proper operation and maintenance includes effective performance, adequate funding, operator staffing and training, and adequate laboratory and process controls, including appropriate quality assurance procedures; (3-20-20)T
- (2) If compliance cannot be met, the owner shall take corrective action as determined by the Director or terminate injection. (3-20-20)T
- vi. The owner shall mitigate any adverse effects resulting from non-compliance with the terms and conditions of the permit. (3-20-20)T
- vii. If the injection well was constructed prior to issuance of the permit, the well shall be brought into compliance with the terms and conditions of the permit in accordance with the schedule of compliance issued by the Director. (3-20-20)T
- viii. The permit shall not convey any property rights. (3-20-20)T
- f. Conditions of Permanent Decommissioning. (3-20-20)T
- i. Notice of intent to permanently decommission a well shall be submitted to the Director not less than thirty (30) days prior to commencement of the decommissioning activity. (3-20-20)T
- ii. The method of permanent decommissioning for all injection wells shall be approved by the Director prior to commencement of the decommissioning activity. (3-20-20)T
- iii. Notice of completion of permanent decommission shall be submitted to the Director within thirty (30) days of completion. (3-20-20)T
- iv. All deep injection wells that are to be permanently decommissioned shall be plugged in accordance with current Well Construction Standards. (3-20-20)T
- v. Following permanent cessation of use, or where an injection well is not completed, the Director shall be notified. Decommissioning procedures or other action, as prescribed by the Director, shall be conducted. (3-20-20)T
- vi. The injection well owner or operator has the responsibility to insure that the injection operation is decommissioned as prescribed. (3-20-20)T
- g. Duration of Approved Permits. The length of time that a permit may be in effect for Class V wells requiring permits shall not exceed ten (10) years. (3-20-20)T

**05. Standards For The Quality of Injected Fluids and Criteria For Location and Use. (3-20-20)T**

a. General. These standards, which are minimum standards that are to be adhered to for all deep injection wells and shallow injection wells requiring permits and rule-authorized wells not requiring permits, are based on the premise that if the injected fluids meet ground water quality standards for physical, chemical and radiological contaminants, and if ground water produced from adjacent points of diversion for beneficial use meets the water quality standards as defined in Section 010 of these rules, then that aquifer will be protected from unreasonable contamination and will be preserved for diversion to beneficial uses. The Director may, however, when it is deemed necessary, require specific injection wells to be constructed and operated in compliance with additional requirements, such as best management practices (BMPs), so as to protect the ground water resource from



deterioration and preserve it for diversion to beneficial use. (3-20-20)T

**b.** Waivers. A waiver of one (1) or more standards may be granted by the Director if it can be demonstrated by the applicant that the contaminants in injected fluid will not endanger a ground water source for any present or future beneficial use. (3-20-20)T

**c.** Standards for Quality of Fluids Injected into Class V Wells. (3-20-20)T

**i.** Ground water quality standards for chemical and radiological contaminants in injected fluids. After the effective date of these standards, the following limits shall not be exceeded in injected fluids from a well when such fluids will or are likely to reach a USDW: (3-20-20)T

(1) Chemical contaminants. The concentration of each chemical contaminant in the injected fluids shall not exceed the ground water quality standard for that chemical contaminant, or the concentration of each contaminant in the receiving water, whichever requirement is less stringent; and (3-20-20)T

(2) Radiological contaminants. Radiological levels of the injected fluids shall not exceed those levels specified by the ground water quality standards. (3-20-20)T

**ii.** Restrictions on injection of fluids containing biological contaminants. The following restrictions apply to biological contaminants included in the ground water quality standard in injected fluids. Coliform bacteria: injected fluids containing coliform bacteria are subject to the following restrictions: (3-20-20)T

(1) Contamination of ground water produced at any existing point of diversion for beneficial use, or any point of diversion for beneficial use developed in the future, by injected fluids is prohibited; (3-20-20)T

(2) The Director may require the use of best management practices (BMPs) to reduce the concentration of coliform bacteria in the injected fluids; (3-20-20)T

(3) The Director may require the use of water treatment technology, including ozonation and chlorination devices, sand filters, and settling pond specifications to reduce the concentration of coliform bacteria in injected fluids; (3-20-20)T

(4) Ground water produced from points of diversion for beneficial use adjacent to injection wells that dispose of fluids containing coliform bacteria in concentrations greater than the current ground water quality standard shall be subject to monitoring for bacteria by the owner/operator of the injection well. A waiver of the monitoring requirement may be granted by the Director when it can be demonstrated that injection will not result in unreasonable contamination of ground water produced from these adjacent points; (3-20-20)T

(5) Construction of new Subclass 5F1 injection wells, and other shallow and deep injection wells, as specified by the Director, that are likely to exceed the current ground water quality standard for coliform bacteria at the point of beneficial use is prohibited; and (3-20-20)T

(6) At no time shall any fluid containing or suspected of containing fecal contaminants of human origin be injected into any Class V injection well authorized under these rules. (3-20-20)T

**iii.** Physical, visual and olfactory characteristics. The following restrictions apply to physical, visual and olfactory characteristics of injected fluids. Temperature, color, odor, turbidity, conductivity and pH: the temperature, color, odor, conductivity, turbidity, pH or other characteristics of the injected fluid may not result in the receiving ground water becoming less suitable for diversion to beneficial uses, as determined by the Director. (3-20-20)T

**iv.** Contamination by an injection well of ground water produced at an existing point of diversion for beneficial use, or a point of diversion for beneficial use developed in the future, shall not exceed water quality standards defined in Section 010 of these rules. (3-20-20)T

**d.** Criteria for Location and Use of Class V Wells Requiring Permits. (3-20-20)T

i. A Class V well requiring a permit may be required to be located a minimum distance, as determined from Table 1, from any point of diversion for beneficial use that could be harmed by bacterial contaminants. This requirement is not applicable to injection wells injecting wastes of quality equal to or better than adopted ground water quality standards in all respects. In addition, Class V wells may be required to be located at such a distance from a point of diversion for beneficial use as to minimize or prevent ground water contamination resulting from unauthorized or accidental injection, as determined by the Director. (3-20-20)T

ii. These location requirements in Table 1 may be waived, as per Paragraph 070.05.b., when the applicant can demonstrate that any springs or wells within the calculated perimeter of the generated perched water zone will not be contaminated by the applicant’s waste disposal or injection well. Monitoring by the applicant of the production wells or springs in question may be required to demonstrate that they are not being contaminated.

<b>Determined Radii of Perched Water Zones Based on Maximum Average Weekly Injection Rates (cfs) of Class V Injection Wells *</b>	
<b>Injection (cfs)</b>	<b>Radius of Generated Perched Water Zone (ft)</b>
0 - 0.20	800
0.20 - 0.60	1,400
0.61 - 1.00	1,800
1.01 - 2.00	2,500
2.01 - 3.00	3,000
3.01 - 4.00	3,500
4.01 - 5.00	4,000
Greater than 5.00	As determined by the Director

\* Injection rates shall be based on the average volume of wastes injected by the well during the week of greatest injection in an average water year. (3-20-20)T

e. Standards for the Quality of Fluids Injected by Subclass 5A7 Wells (Open-Loop Heat Pump Return). (3-20-20)T

i. The quality of fluids injected by a Subclass 5A7 injection well shall comply with ground water quality standards or shall be equal to the quality of the ground water source to the heat pump, whichever is less stringent. (3-20-20)T

ii. If the quality of the ground water source does not meet ground water quality standards, the injected fluids must be returned to the formation containing the ground water source. (3-20-20)T

iii. The temperature of the injected fluids shall not impair the designated beneficial uses of the receiving ground water. (3-20-20)T

iv. All Rule-authorized Injection Wells shall conform to the ground water quality standards at the point of injection and not cause any water quality standards to be violated at any point of beneficial use. (3-20-20)T

**06. Monitoring, Record Keeping and Reporting Requirements.** The Director may require monitoring, record keeping and reporting by any owner or operator if the Director finds that the well may adversely affect a ground water source or is injecting a contaminant that could have an unacceptable effect upon the quality of the ground waters of the state. (3-20-20)T

a. Monitoring. (3-20-20)T

i. Any injection authorized by the Director shall be subject to monitoring and record keeping requirements as conditions of the permit. Such conditions may require the installation, use and maintenance of monitoring equipment or methods. The Director may require where appropriate, but is not limited to, the following: (3-20-20)T

(1) Monitoring of injection pressures and pressures in the annular space between casings; (3-20-20)T

(2) Flow rate and volumes; (3-20-20)T

(3) Analysis of quality of the injected fluids for contaminants that are subject to limitation or reduction under the conditions of the permit; or contaminants which the Director determines could have an unacceptable effect on the quality of the ground waters of the state, and which the Director has reason to believe are in the injected fluids; (3-20-20)T

(4) Monitoring of ground water through special monitoring wells or existing points of diversion for beneficial use in the zone of influence as determined by the Director; (3-20-20)T

(5) A demonstration of the integrity of the casing, tubing or seal of the injection well. (3-20-20)T

ii. The frequency of required monitoring shall be specified in the permit when issued, except that the Director at any time may, in writing, require additional monitoring and reporting. (3-20-20)T

iii. All monitoring tests and analysis required by permit conditions shall be performed in a state certified laboratory or other laboratory approved by the Director. (3-20-20)T

iv. Any field instrumentation used to gather data, when specified as a condition of the permit, shall be required by the Director to be tested and maintained in such a manner as to ensure the accuracy of the data. (3-20-20)T

v. All samples and measurements taken for the purpose of monitoring shall be representative of the monitoring activity and fluids injected. (3-20-20)T

**b.** Record Keeping. The permittee shall maintain records of all monitoring activities to include: (3-20-20)T

i. Date, time and exact place of sampling; (3-20-20)T

ii. Person or firm performing analysis; (3-20-20)T

iii. Date of analysis, analytical methods used and results of analysis; (3-20-20)T

iv. Calibration and maintenance of all monitoring instruments; and (3-20-20)T

v. All original tapes, strip charts or other data from continuous or automated monitoring instruments. (3-20-20)T

**c.** Reporting. (3-20-20)T

i. Monitoring results obtained by the permittee pursuant to the monitoring requirements prescribed by the Director shall be reported to the Director as required by permit conditions. (3-20-20)T

ii. The Director shall be notified in writing by the permittee within five (5) days after the discovery of violation of the terms and conditions of the permit. If the injection activity endangers human health or a public or domestic water supply, use of the injection well shall be immediately discontinued and the owner or operator shall immediately notify the Director. Notification shall contain the following information: (3-20-20)T

- (1) A description of the violation and its cause; (3-20-20)T
  - (2) The duration of the violation, including dates and times; if not corrected or use of the well discontinued, the anticipated time of correction; and (3-20-20)T
  - (3) Steps being taken to reduce, eliminate and prevent recurrence of the injection. (3-20-20)T
  - iii. Where the owner or operator becomes aware of failure to submit any relevant facts in any permit application or report to the Director, that person shall promptly submit such facts or information. (3-20-20)T
  - iv. The permittee shall furnish the Director, within a time specified by the Director, any information which the Director may request to determine compliance with the permit. (3-20-20)T
  - v. All applications for permits, notices and reports submitted to the Director shall be signed and certified. (3-20-20)T
  - vi. The Director shall be notified in writing of planned physical alterations or additions to any facility related to the permitted injection well operation. (3-20-20)T
  - vii. Additional information to be reported to the Director in writing: (3-20-20)T
    - (1) Transfer of ownership; (3-20-20)T
    - (2) Any change in operational status not previously reported; (3-20-20)T
    - (3) Any anticipated noncompliance; and (3-20-20)T
    - (4) Reports of progress toward meeting the requirements of any compliance schedule attached or assigned to this permit. (3-20-20)T
- 07. Permit Assignable.** Permits may be assignable to a new owner or operator of an injection well if the new owner or operator, within thirty (30) days of the change, notifies the Director of such change. The new owner or operator shall be responsible for complying with the terms and conditions of the permit from the time that such change takes place. (3-20-20)T

**071. -- 999. (RESERVED)**

## 37.03.04 – DRILLING FOR GEOTHERMAL RESOURCES RULES

### 000. LEGAL AUTHORITY (RULE 0).

The Idaho Department of Water Resources, through authority granted by Section 42-4001 through Section 42-4015, Idaho Code, is the regulatory agency for the drilling, operation, maintenance, and abandonment of all geothermal wells in the state. The Department's authority also includes regulatory jurisdiction over other related operations and environmental hazards pertaining to the exploration and development of geothermal resources. (3-20-20)T

### 001. TITLE AND SCOPE (RULE 1).

The geothermal policy of the state of Idaho as stated in Section 42-4001, Idaho Code, is as follows: "It is the policy and purpose of this state to maximize the benefits to the entire state which may be derived from the utilization of our geothermal resources, while minimizing the detriments and costs of all kinds which could result from their utilization. This policy and purpose is embodied in this act which provides for the immediate regulation of geothermal resource exploration and development in the public interest." (3-20-20)T

### 002. -- 009. (RESERVED)

### 010. DEFINITIONS (RULE 10).

For the purpose of these rules, the following definitions apply. (3-20-20)T

**01. Applicant.** Any person submitting an application to the Department of Water Resources for a permit for the construction and operation of any well or injection well. (3-20-20)T

**02. Board.** The Idaho Water Resource Board. (3-20-20)T

**03. BOPE.** An abbreviation for Blow Out Prevention Equipment which is designed to be attached to the casing in a geothermal well in order to prevent a blow out of the drilling mud. (3-20-20)T

**04. Completion.** A well is considered to be completed thirty (30) days after drilling operations have ceased unless a suspension of operation is approved by the Director, or thirty (30) days after it has commenced producing a geothermal resource, whichever occurs first, unless drilling operations are resumed before the end of the thirty (30) day period or at the end of the suspension. (3-20-20)T

**05. Conductor Pipe.** The first and largest diameter string of casing to be installed in the well. This casing extends from land surface to a depth great enough to keep surface waters from entering and loose earth from falling in the hole and to provide anchorage for blow out prevention equipment prior to setting surface casing. (3-20-20)T

**06. Department.** The Idaho Department of Water Resources. (3-20-20)T

**07. Director.** The Director of the Idaho Department of Water Resources. (3-20-20)T

**08. Drilling Logs.** The recorded description of the lithologic sequence encountered in drilling a well. (3-20-20)T

**09. Drilling Operations.** The actual drilling, re-drilling, or recompletion of the well for production or injection including the running and cementing of casing and the installation of well head equipment. Drilling operations do not include perforating, logging, and related operations after the casing has been cemented. (3-20-20)T

**10. Exploratory Well.** A well drilled for the discovery and/or evaluation of geothermal resources either in an established geothermal field or in unexplored areas. Exploratory well does not include holes six (6) inches in diameter or less if they are used for gathering geotechnical data such as, but not limited to, heat flow, earth temperature, temperature gradient and/or seismic measurements, provided said holes are not greater than one thousand (1000) feet in depth below land surface and provided the material medium is not intended to be encountered. (3-20-20)T

**11. Geothermal Area.** The same general land area which in its subsurface is underlain or reasonably appears to be underlain by geothermal resources from or in a single reservoir, pool, or other source or interrelated sources, as such area or areas may be designated from time to time by the Director. (3-20-20)T

**12. Geothermal Field.** An area designated by the Director which contains a well or wells capable of commercial production of geothermal resources. (3-20-20)T

**13. Geothermal Resource.** The natural heat energy of the earth, the energy in whatever form which may be found in any position and at any depth below the surface of the earth, present in, resulting from, or created by, or which may be extracted from such natural heat and all minerals in solution or other products obtained from the material medium of any geothermal resource. Geothermal resources are found and hereby declared to be sui generis, being neither a mineral resource nor a water resource but they are also found and hereby declared closely related to and possibly affecting and affected by water and mineral resources in many instances. (3-20-20)T

**14. Injection Well.** Any special well, converted producing well, or reactivated or converted abandoned well employed for injecting material into a geothermal area or adjacent area to maintain pressures in a geothermal reservoir, pool, or other source, or to provide new material or to serve as a material medium therein, or for reinjecting any material medium or the residue thereof, or any by-product of geothermal resource exploration or development into the earth. (3-20-20)T

**15. Intermediate String or Casing.** The casing installed within the well to seal out brackish water, caving zones, etc., below the bottom of the surface casing. Such strings may either be lapped into the surface casing or extend to land surface. (3-20-20)T

**16. Material Medium.** Any substance including, but not limited to, naturally heated fluids, brines, associated gasses and steam in whatever form, found at any depth and in any position below the surface of the earth, which contains or transmits the natural heat energy of the earth, but excluding petroleum, oil, hydrocarbon gas, or other hydrocarbon substances. (3-20-20)T

**17. Notice of Intent or Notice.** A written statement to the Director that the applicant intends to do work. (3-20-20)T

**18. Observation Well.** A small diameter well drilled strictly for monitoring purposes. In no case shall an observation well be completed for production of geothermal resources or for use as an injection well. (3-20-20)T

**19. Operator.** Any person drilling, maintaining, operating, pumping, or in control of any well. The term operator also includes owner when any well is or has been or is about to be operated by or under the direction of the owner. (3-20-20)T

**20. Owner.** The owner of the geothermal lease or well and includes operator when any well is operated or has been operated or is about to be operated by any person other than the owner. (3-20-20)T

**21. Permit.** A permit issued pursuant to these rules for the construction and operation of any well or injection well. (3-20-20)T

**22. Person.** Any individual natural person, general or limited partnership, joint venture, association, cooperative organization, corporation, whether domestic or foreign, agency or subdivision of this or any other state or municipal or quasi-municipal entity whether or not it is incorporated. (3-20-20)T

**23. Production String.** The casing or tubing through which a geothermal resource is produced. This string extends from the producing zone to land surface. (3-20-20)T

**24. Production Well.** Any well which is commercially producing or is intended for commercial production of a geothermal resource. (3-20-20)T

**25. Surface Casing.** The first string of casing which is run after the conductor pipe to anchor blow out prevention equipment and to seal out all existing groundwater zones. (3-20-20)T

**26. Suspension of Operations.** The cessation of drilling, redrilling, or alteration of casing before the well is officially abandoned or completed. All suspensions must be authorized by the Director. (3-20-20)T

**27. Waste.** Any physical waste including, but not limited to: (3-20-20)T

**a.** Underground waste resulting from inefficient, excessive, or improper use, or dissipation of

geothermal energy, or of any geothermal resource pool, reservoir, or other source; or the locating, spacing, constructing, equipping, operating, or producing of any well in a manner which results, or tends to result in reducing the quantity of geothermal energy to be recovered from any geothermal area in the state; (3-20-20)T

**b.** The inefficient above-ground transporting and storage of geothermal energy; and the locating, spacing, equipping, operating, or producing of any well or injection well in a manner causing or tending to cause unnecessary or excessive surface loss or destruction of geothermal energy; the escape into the open air from a well of steam or hot water in excess of what is reasonably necessary in the efficient development or production of a well. (3-20-20)T

**28. Well.** Any excavation or other alteration in the earth's surface or crust by means of which the energy of any geothermal resource and/or its material medium is sought or obtained. (3-20-20)T

**011. -- 024. (RESERVED)**

**025. DRILLING (RULE 25).**

**01. General.** All wells shall be drilled in such a manner as to protect or minimize damage to the environment, waters usable for all beneficial purposes, geothermal resources, life, health, or property. (3-20-20)T

**02. Permits and Notices.** (3-20-20)T

**a.** Permit to Drill for Geothermal Resources. Any person, owner, or operator who proposes to construct a well for the production of or exploration for geothermal resources or to construct an injection well shall first apply to the Director for permit. Application for permit shall be on department form 4003-1. Any person, owner, or operator who proposes to construct a hole for the gathering of geotechnical data shall file a notice of intent with the Director twenty (20) days prior to construction. Written approval of the Director is required before construction may begin. The notice of intent shall show the hole location, proposed depth, hole size, construction methods, intended use and abandonment plan together with other information as required by the Director. (3-20-20)T

**b.** Permit to Deepen or Modify an Existing Well. If the owner or operator plans to deepen, redrill, plug, or perform any operation that will in any manner modify the well, an application shall be filed with the Director and written approval must be received prior to beginning work. Application for permit to alter a geothermal well shall be on department form 4003-2. (3-20-20)T

**c.** Application for Permit to Convert to Injection. If the owner or operator plans to convert an existing geothermal well into an injection well with no change of mechanical condition, an application for permit shall be filed with the Director and written approval must be received prior to beginning injection. Application for permit shall be made on department form 4003-3. (3-20-20)T

**d.** Amendment of Permit. No well may be owned or operated by any person whose name does not appear on the permit or permit application and no changes in departure from the procedures, location, data, or persons specified on the face of a permit shall be allowed until an amendment to such permit is approved by the Director. Application for amendment shall be made on department form 4003-1. (3-20-20)T

**e.** Notice to Other Agencies. Notice of applications, permits, orders, or other actions received or issued by the Director may be given to any other agency or entity which may have information, comments, or jurisdiction over the activity involved. The Director may enter into a memorandum of understanding with other agencies to eliminate duplication of applications or other efforts. (3-20-20)T

**f.** No filing fee shall be charged for filing a notice of intent to construct a hole for gathering geotechnical data, for abandonment, or for the drilling of an observation well. (3-20-20)T

**g.** No application shall be accepted and filed by the Director until such filing fee has been deposited with the Director. (3-20-20)T

**03. Bonds.** (3-20-20)T

**a.** The Director shall require as a condition of every permit every operator or owner who engages in the construction, alteration, testing, or operation of the well to file with the Director on a form prescribed by the Director a bond indemnifying the state of Idaho providing good and sufficient security conditioned upon the performance of the duties required by these regulations and the Geothermal Resource Act and the proper abandonment of any well covered by such permit. Such bond shall be in an amount which is not less than ten thousand dollars (\$10,000) for each individual well. (3-20-20)T

**b.** Bonds remain in force for the life of the well or wells and may not be released until the well or wells are properly abandoned or another valid bond is substituted therefor. Any person who acquires the ownership or operation of any well or wells shall within five (5) days after acquisition file with the Director an indemnity bond in the sum of ten thousand dollars (\$10,000) for each well acquired. The Director reserves the right to request additional bonding prior to abandonment if deemed necessary. (3-20-20)T

**04. Well Spacing.** (3-20-20)T

**a.** Any well drilled for the discovery and production of geothermal resources or as an injection well shall be located more than one hundred (100) feet from and within the outer boundary of the parcel of land on which the well is situated, or more than one hundred (100) feet from a public road, street, or highway dedicated prior to the commencement of drilling. This requirement may be modified or waived by the Director upon written request. (3-20-20)T

**b.** For several contiguous parcels of land in one or different ownerships that are operated as a single geothermal field, the term outer boundary line means the outer boundary line of the land included in the field. In determining the contiguity of any such parcels of land, no street, road, or alley lying within the lease or field shall be determined to interrupt such contiguity. (3-20-20)T

**c.** The Director shall approve the proposed well spacing programs or prescribe such modifications to the programs as he deems necessary for proper development giving consideration to such factors as, but not limited to, topographic characteristics of the area, hydrologic, geologic, and reservoir characteristics of the area, the number of wells that can be economically drilled to provide the necessary volume of geothermal resources for the intended use, minimizing well interference, unreasonable interference with multiple use of lands, and protection of the environment. (3-20-20)T

**d.** Directional Drilling. Where the surface of the parcel of land containing one acre or more is unavailable for drilling, the surface well location may be located upon property which may or may not be contiguous. Such surface well locations shall not be less than twenty five (25) feet from the outer boundary of the parcel on which it is located, nor less than twenty-five (25) feet from an existing street or road. The production or injection interval of the well shall not be less than one hundred (100) feet from the outer boundary of the parcel into which it is drilled. Directional surveys must be filed with the Director for all wells directionally drilled. (3-20-20)T

**05. Casing.** (3-20-20)T

**a.** General. All wells shall be cased in such a manner as to protect or minimize damage to the environment, usable ground waters, geothermal resources, life, health, and property. The permanent well head completion equipment shall be attached to the production casing or to the intermediate casing if production casing does not reach the surface. No permanent well head equipment may be attached to any conductor or surface casing alone. The specification for casing strength shall be determined by the Director on a well-to-well basis. All casing reaching the surface shall provide adequate anchorage for blow out prevention equipment, hole pressure control, and protection for natural resources. Sufficient casing shall be run to reach a depth below all known or reasonably estimated groundwater levels to prevent blow outs or uncontrolled flows. The following casing requirements are general but should be used as guidelines in submitting applications for permit to drill. (3-20-20)T

**b.** Conductor Pipe. A minimum of forty (40) feet of conductor pipe shall be installed. The annular space is to be cemented solid to the surface. A twenty-four (24) hour cure period for the grout must be allowed prior to drilling out the shoe unless additives sufficient, as determined by the Director, are used to obtain early strength. An annular blow out preventer shall be installed on all exploratory wells and on development wells when deemed



necessary by the Department. (3-20-20)T

c. **Surface Casing.** The surface casing hole shall be logged with an induction electrical log or equivalent or gamma-neutron log before running casing. This requirement may be waived by the Director. Permission to waive this requirement must be granted by the Director in writing prior to running surface casing. This casing shall provide for control of formation fluids, protection of shallow usable groundwater, and for adequate anchorage for blow out prevention equipment. All surface casing shall be cemented solid to the surface. A twenty-four (24) hour cure period shall be allowed prior to drilling out the shoe of the surface casing unless additives sufficient, as determined by the Director, are used to obtain early strength. (3-20-20)T

i. A minimum of two hundred (200) feet of surface casing shall be set in areas where pressures and formations are unknown. In no case may surface casing be set at a depth less than ten percent (10%) of the proposed total depth of the well. (3-20-20)T

ii. In areas of known high formation pressure, surface casing shall be set at the depth determined by the Director after a study of geologic conditions in the area. (3-20-20)T

iii. In areas where subsurface geological conditions are variable or unknown, surface casing shall be in accordance with specifications as outlined in a. above. The casing must be seated through a sufficient series of low permeability, competent lithologic units such as claystone, siltstone, basalt, etc., to insure a solid anchor for blow out prevention equipment and to protect usable groundwater from contamination. Additional casing may be required if the first string has not been cemented through a sufficient series of such beds, or a rapidly increasing thermal gradient or formation pressures are encountered. (3-20-20)T

iv. The temperature of the return drilling mud shall be monitored continuously during the drilling of the surface casing hole. Either a continuous temperature-monitoring device shall be installed and maintained in a working condition or the temperature shall be read manually. In either case, the return temperature shall be entered into the log book for each thirty (30) feet of depth drilled. (3-20-20)T

v. Blow out prevention equipment capable of shutting in the well during any operation shall be installed on the surface casing and maintained ready for use at all times. BOPE pressure tests shall be performed by the operator for department personnel on all exploratory wells prior to drilling out the shoe of the surface casing. The decision to perform BOPE pressure tests on other types of wells shall be made on a well-to-well basis by the Director. The Director must be notified five (5) days in advance of a scheduled pressure test. Permission to proceed with the test sooner may be given orally by the Director upon request by the operator. (3-20-20)T

d. **Intermediate Casing.** Intermediate casing shall be required for protection against anomalous pressure zones, cave-ins, washouts, abnormal temperature zones, uncontrollable lost circulation zones or other drilling hazards. Intermediate casing strings when installed shall be cemented solidly to the surface or to the top of the casing. (3-20-20)T

e. **Production Casing.** Production casing may be set above or through the producing or injection zone and cemented either below or just above the objective zones. Sufficient cement shall be used to exclude overlying formation fluids from the geothermal zone, to segregate zones, and to prevent movement of fluids behind the casing into possible fresh groundwater zones. Production casing shall either be cemented solid to the surface or lapped into the intermediate casing if run. If the production casing is lapped into an intermediate string, the casing overlap shall be at least fifty (50) feet, the lap shall be cemented solid, and the lap shall be pressure tested to insure its integrity. (3-20-20)T

**06. Electric Logging.** All wells except observation wells shall be logged with an induction electrical log or equivalent or gamma-neutron log from the bottom of the hole to the bottom of the conductor pipe. This requirement may be modified or waived by the Director upon written request. (3-20-20)T

**026. -- 029. (RESERVED)**

**030. RECORDS (RULE 30).**

**01. General.** The owner or operator of any well shall keep or cause to be kept a careful and accurate log, core record, temperature logs, and history of the drilling of the well. These records shall be kept in the nearest office of the owner or operator or at the well site and together with all other reports of the owner and operator regarding the well shall be subject to inspection by the Director during business hours. All records unless otherwise specified must be filed with the Director within thirty (30) days of completion of the well. (3-20-20)T

**02. Records to Be Filed with the Director.** (3-20-20)T

**a. Drilling Logs and Core Record.** The drilling log shall include the lithologic characteristics and depths of formations encountered, the depth and temperatures of water-bearing and steam-bearing strata, the temperatures, chemical compositions and other chemical and physical characteristics of fluids encountered from time to time so far as ascertained. The core record shall show the depth, lithologic character, and fluid content of cores obtained so far as determined. (3-20-20)T

**b. Well History.** The history shall describe in detail in chronological order on a daily basis all significant operations carried out and equipment used during all phases of drilling, testing, completion, and abandonment of any well. (3-20-20)T

**c. Well Summary Report.** The well summary report shall accompany the core record and well history reports. It is designed to show data pertinent to the condition of a well at the time of completion of work done. (3-20-20)T

**d. Production Records.** The owner or operator of any well producing geothermal resources shall file with the Director on or before the 20th day of each month for the preceding month a statement of production utilized in such a form as the Director may designate. Copies of monthly geothermal energy report forms are available from the Director; however, production data can be submitted on non-department forms such as computer print-outs if they have been approved by the Director. (3-20-20)T

**e. Injection Records.** The owner or operator of any well injecting geothermal fluids or waste water for any purpose shall file with the Director on or before the twentieth day of each month for the preceding month a report of the injection in such form as the Director may designate. Copies of monthly injection report forms are available from the Director. Injection data may be submitted on non-department forms if they have been approved by the Director. (3-20-20)T

**f. Electric Logs and Directional Surveys, If Conducted.** Electric logs and directional surveys shall be filed with the Director within sixty (60) days of completion, cessation of drilling operations, excluding any approved suspension of operations, or abandonment of any well. Like copies shall be filed upon recompletion of any well. Upon a showing of hardship, the Director may extend the time within which to comply for a period not to exceed six (6) additional months. (3-20-20)T

**03. Confidential Status.** Information on file with the Director is open to public inspection except any reports, logs, records, or histories derived from the drilling of a well and filed with the Director shall not be available for public inspection and shall be kept confidential by the Director for a period of one year from receipt provided, however, that the Director may use any such reports, logs, records, or histories in any action in any court to enforce the provisions of the Geothermal Act or any order or regulation adopted hereunder. (3-20-20)T

**04. Inspection of Records.** The records filed by an operator with the Director which relates to the data gathered from the drilling operation shall be open to inspection only to those authorized in writing by the operator and designated personnel. The records of any operator filed for a completed or producing well that has been transferred by sale, lease, or otherwise shall be available to the new owner or lessee for his inspection or copying and shall be available for inspection or copying by others upon written authorization of such new owner or lessee. (3-20-20)T

**031. -- 034. (RESERVED)**

**035. BLOW OUT PREVENTION (RULE 35).**

**01. Unexplored Areas.** (3-20-20)T

**a.** A department employee may be present at the well at any time during the initial phases of drilling until the surface casing has been cemented and the BOPE has been satisfactorily pressure tested. The Department employee may be present during any drilling operations at the well and if in his opinion conditions warrant he may order additional casing to be run. (3-20-20)T

**b.** A logging unit equipped to continuously record the following data shall be installed and operated continuously by a technician approved by the Director after drilling out the shoe of the conductor pipe until the well has been drilled to the total depth. (3-20-20)T

i. Drilling mud temperature (in and out). (3-20-20)T

ii. Drilling mud pit level. (3-20-20)T

iii. Drilling mud pump volume. (3-20-20)T

iv. Drilling mud weight. (3-20-20)T

v. Drilling rate. (3-20-20)T

vi. Hydrocarbon and hydrogen sulfide gas volume (with alarm). (3-20-20)T

**c.** An annular BOPE with a minimum working pressure of one thousand (1,000) PSI shall be installed on the surface casing. If unusual conditions are anticipated, a BOPE may be required on the conductor pipe. (3-20-20)T

**d.** If drilling mud temperature out, reaches one hundred twenty-five (125) Degrees C (Celsius), drilling operations shall cease, drilling mud circulation will continue and the Director must be notified immediately. The operator must obtain the Director's approval of his proposed course of action prior to resuming drilling operations. (3-20-20)T

**e.** The above requirements for BOPE may be modified by the Director and any proposed modification by the applicant must be approved by the Director in writing. (3-20-20)T

**02. Explored Areas.** (3-20-20)T

**a.** A gate valve with a minimum working pressure rating of three hundred (300) PSI must be installed on the well head. (3-20-20)T

**b.** The temperature of the return mud shall be monitored continuously. Either a continuous temperature monitoring device shall be installed and maintained in working condition or the temperature shall be read manually. In either case, return mud temperatures shall be entered into the log book for each thirty (30) feet of depth drilled. (3-20-20)T

**c.** An annular BOPE with a minimum working pressure of one thousand (1,000) PSI shall be installed on the surface casing. (3-20-20)T

**d.** Additional requirements may be set forth by the Director depending upon the knowledge of the area. Such requirements will be set forth on the approved application for permit to drill a geothermal well. Modification of said requirements may be made in the field by Department personnel monitoring construction of the well. (3-20-20)T

**036. -- 039. (RESERVED)**

**040. INJECTION WELLS (RULE 40).**

**01. Construction.** The owner or operator of a proposed injection well or series of injection wells shall

provide the Director with such information he deems necessary for evaluation of the impact of such injection on the geothermal reservoir and other natural resources. Such information shall include existing reservoir conditions, method of injection, source of injection fluid, estimates of daily amount of material medium to be injected, zones or formations affected, and analysis of fluid to be injected and of the fluid from the intended zone of the injection. Such information shall be on department form 4003-3. (3-20-20)T

**02. Surveillance.** (3-20-20)T

**a.** When an operator or owner proposes to drill or modify an injection well or convert a producing or idle well to an injection well, he shall be required to demonstrate to the Director by means of a test that the casing has complete integrity. This test shall be conducted in a method approved by the Director. (3-20-20)T

**b.** To establish the integrity of the annular cement above the shoe of the casing, the owner or operator shall make sufficient surveys within thirty (30) days after injection is started into a well to prove that all the injected fluid is confined to the intended zone of injection. Thereafter, such surveys shall be made at least every two (2) years or more often if necessary. The Director shall be notified forty-eight (48) hours in advance of such surveys in order that a representative may be present if deemed necessary. If in the Director's opinion such tests are not necessary, he may grant a waiver excepting the operator from such tests. (3-20-20)T

**c.** After the well has been placed on injection, the injection well site will be visited periodically by Department personnel. The operator or owner will be notified of any necessary remedial work. Unless modified by the Director, this work must be performed within ninety (90) days or approval for the injection well issued by the Director will be rescinded. (3-20-20)T

**041. -- 044. (RESERVED)**

**045. ABANDONMENT (RULE 45).**

**01. Objectives.** The objectives of abandonment are to block interzonal migration of fluids so as to: (3-20-20)T

**a.** Prevent contamination of fresh water or other natural resources; (3-20-20)T

**b.** Prevent damage to geothermal reservoirs; (3-20-20)T

**c.** Prevent loss of reservoir energy; (3-20-20)T

**d.** Protect life, health, environment and property. (3-20-20)T

**02. General Requirements.** The following are general requirements which are subject to review and modification for individual wells or field conditions. (3-20-20)T

**a.** A notice of intent to abandon geothermal resource wells is required to be filed with the Director five (5) days prior to beginning abandonment procedures. A permit to abandon may be given orally by the Director provided the operator submits a written request for said abandonment on a form approved by the Director within twenty-four (24) hours of the oral request. (3-20-20)T

**b.** A history of geothermal resource wells shall be filed within sixty (60) days after completion of abandonment procedures. (3-20-20)T

**c.** All wells abandoned shall be monumented and the description of the monument shall be included in the history of well report. Such monument shall consist of a four (4) inch diameter pipe ten (10) feet in length of which four (4) feet shall be above ground. The remainder shall be embedded in concrete. The name, number, and location of the well shall be shown on the monument. Alternate methods of monumentation may be approved by the Director where land surface use indicates the above described method is not satisfactory. (3-20-20)T

**d.** Good quality heavy drilling fluid shall be used to replace any water in the hole and to fill all

- portions of the hole not plugged with cement. (3-20-20)T
- e.** All cement plugs with a possible exception of the surface plug shall be pumped into the hole through drill pipe or tubing. (3-20-20)T
  - f.** All open annuli shall be filled solid with cement to the surface. (3-20-20)T
  - g.** A minimum of one hundred (100) feet of cement shall be emplaced straddling the interface or transition zone at the base of groundwater aquifers. (3-20-20)T
  - h.** One hundred (100) feet of cement shall straddle the placement of the shoe plug on all casings including conductor pipe. (3-20-20)T
  - i.** A surface plug of either neat cement or concrete mix shall be in place from the top of the casing to at least fifty (50) feet below the top of the casing. (3-20-20)T
  - j.** All casing shall be cut off at least five (5) feet below land surface. (3-20-20)T
  - k.** Cement plugs shall extend at least fifty (50) feet over the top of any liner installed in the well. (3-20-20)T
  - l.** Abandonment. Injection wells are required to be abandoned in the same manner as other wells. (3-20-20)T
  - m.** Other abandonment procedures may be approved by the Director if the owner or operator can demonstrate that the geothermal resource, groundwaters, and other natural resources will be protected. Such approval must be given in writing by the Director prior to the beginning of any abandonment procedures. (3-20-20)T
  - n.** Within five (5) days after the completion of the abandonment of any well or injection well, the owner or operator of the abandoned well or injection well shall report in writing to the Director on such form as may be prescribed by the Director on all work done with respect to the abandonment. (3-20-20)T

**046. -- 049. (RESERVED)**

**050. MAINTENANCE (RULE 50).**

**01. General.** All well heads, separators, pumps, mufflers, manifolds, valves, pipelines, and other equipment used for the production of geothermal resources shall be maintained in good condition in order to prevent loss of or damage to life, health, property, and natural resources. (3-20-20)T

**02. Corrosion.** All surface well head equipment and pipelines and subsurface casing and tubing will be subject to periodic corrosion surveillance in order to safeguard health, life, property, and natural resources. (3-20-20)T

**03. Tests.** The Director may require such tests or remedial work as in his judgment are necessary to prevent damage to life, health, property, and natural resources, to protect geothermal reservoirs from damage or to prevent the infiltration of detrimental substances into underground or surface water suitable for irrigation or other beneficial uses to the best interest of the neighboring property owners and the public. Such tests may include, but are not limited to, casing tests, cementing tests, and equipment tests. (3-20-20)T

**051. -- 054. (RESERVED)**

**055. HEARINGS, NOTICE, PROCEDURE (RULE 55).**

Any applicant or the Director shall have the right to a hearing concerning the propriety of issuing a permit for which an application has been filed. Any applicant who desires a hearing pursuant to Section 42-4004, Idaho Code, must file a written request therefor with the Director of the Department of Water Resources. Any person may file a petition with the Director requesting that the Director hold a hearing concerning the propriety of issuing a permit for which an

application has been filed. The petitioner must serve a copy of the petition upon the applicant and set forth in the petition all reasons for requesting the hearing. The applicant may respond to the petition within ten (10) days of its service. However, failure of the applicant to respond shall not be prejudicial to his right to appear at the hearing and present such evidence as he deems proper, if the Director grants the petition for such hearing. The hearing shall be set by the Director at any location deemed appropriate. Notice of the time and location shall be served on the applicant and/or the petitioner by the Director at least twenty (20) days before said date by certified mail addressed to applicant's address as stated in the application and to the petitioner at the address given in the petition. The hearing shall be conducted in the manner prescribed in the general rules and procedures of the Department. (3-20-20)T

**056. -- 059. (RESERVED)**

**060. HEARINGS ON REFUSED, LIMITED, OR CONDITIONED PERMIT (RULE 60).**

Any applicant who is granted a limited or conditioned permit, or who is denied a permit or any person aggrieved by a decision of the Director may seek a hearing on said action of the Director by serving on the Director written notice and request for a hearing before the Board within thirty (30) days of service of the Director's decision. Said hearing will be set, conducted, and notice given as set forth in Rule 055 above. Any applicant may appeal the decision of the Board to the District Court within thirty (30) days of service of the decision. All hearings under this rule shall be conducted in the manner prescribed in the general rules and procedures of the Department. (3-20-20)T

**061. -- 064. (RESERVED)**

**065. PENALTIES (RULE 65).**

**01. Order by Director.** If the Director finds that any person is constructing, operating, or maintaining any hole, well or injection well not in accordance with any applicable permit or in a fashion so as to involve an unreasonable risk of, or so as to cause, damage to life or property or subsurface, surface, or atmospheric resources, the Director may issue an order to such person to correct or to stop such practices as are found to be improper and to mitigate any injury of any sort caused by such practices. (3-20-20)T

**02. Enforcement by Director.** The Director may enforce any provision of this act or any order or regulation issued or adopted pursuant thereto by an appropriate action in the District Court. The Director may bring action in the District Court to have enjoined any threatened noncompliance with any provision of this act or any order or regulation adopted pursuant hereto or any threatened harm to life, property, or surface, subsurface or atmospheric resources which would be caused by such noncompliance. (3-20-20)T

**03. Willful Violations or Failure to Comply.** Any willful violations of or failure to comply with any provision of these rules, or if such order or regulation has been served on such person or is otherwise known to him, any valid order or regulation issued or adopted hereto shall be a misdemeanor punishable by fine of up to five thousand dollars (\$5,000) for each offense or a sentence of up to six (6) months in a county jail or both; each day of a continuing violation shall be a separate offense under this subdivision. A responsible or principal executive officer or any corporate person may be liable under this subdivision if such corporate person is not in compliance with any provision of this act or with any valid order or regulation adopted pursuant hereto. (3-20-20)T

**066. -- 069. (RESERVED)**

**070. FORMS (RULE 70).**

Forms required by these rules. (3-20-20)T

**01. Samples of Forms.** Samples of all forms required by these rules are available from the Department to interested parties upon request. (3-20-20)T

**02. Forms.** The forms include the following: (3-20-20)T

**a.** Form 4003-1, Application for Permit to Drill for Geothermal Resources; (3-20-20)T

**b.** Form 4003-2, Application for Permit to Alter a Geothermal Well; (3-20-20)T

- c.** Form 4003-3, Application for Permit to Convert a Well to a Geothermal Injection Well; (3-20-20)T
  - d.** Form 4005, Geothermal Resources Surety Bond; (3-20-20)T
  - e.** Form 4007, Notice of Intent to Abandon a Well; (3-20-20)T
  - f.** Form 4009, Report of Abandonment of a Well; (3-20-20)T
  - g.** Form 4010-1, Monthly Injection Report for Geothermal Wells; and (3-20-20)T
  - h.** Form 4010-2, Monthly Energy Report for Geothermal Wells. (3-20-20)T
- 071. -- 999. (RESERVED)**

## 37.03.05 – MINE TAILINGS IMPOUNDMENT STRUCTURES RULES

### 000. LEGAL AUTHORITY (RULE 0).

These rules are adopted pursuant to Section 42-1714, Idaho Code. (3-20-20)T

### 001. TITLE AND SCOPE (RULE 1).

**01. Title.** These rules are titled IDAPA 37.03.05, “Mine Tailings Impoundment Structures Rules.” (3-20-20)T

**02. Scope.** (3-20-20)T

**a.** These rules and standards will only apply to structures upon which construction, lift construction, enlargement, or alteration is underway on or after July 1, 1978. Under no circumstances shall these rules be construed to deprive or limit the Director of the Department of Water Resources of any exercise of powers, duties and jurisdiction conferred by law, nor to limit or restrict the amount or character of data, or information which may be required by the Director from any owner of a mine tailings impoundment structure for the proper administration of the law. (3-20-20)T

**b.** The design requirements listed are intended as a guide to establish acceptable standards of construction. They are not intended to restrict the application of other sound design principles by engineers. The Director will evaluate any deviation from the standards hereinafter stated as they pertain to the safety of any given mine tailings impoundment structure. Engineers are encouraged to submit new ideas which will advance the art and provide for the public safety. (3-20-20)T

### 002. -- 009. (RESERVED)

### 010. DEFINITIONS (RULE 10).

Unless the context otherwise requires, the following definitions govern these rules. (3-20-20)T

**01. Board.** The Idaho Water Resource Board. (3-20-20)T

**02. Director.** The Director of the Idaho Department of Water Resources. (3-20-20)T

**03. Department.** The Idaho Department of Water Resources. (3-20-20)T

**04. Mine Tailings Impoundment Structure.** Any artificial embankment which is or will be more than thirty (30) feet in height measured from the lowest elevation of the toe to the maximum crest elevation constructed for the purpose of storing mine tailings slurry. (3-20-20)T

**05. Mine Tailings Slurry.** All slurry wastes from a mineral processing or mining operation. (3-20-20)T

**06. Mine Tailings Storage Capacity.** The total storage volume of the impoundment when filled with tailings to the maximum approved design storage elevation. (3-20-20)T

**07. Borrowed Fill Embankment.** Any embankment constructed of borrowed earth materials and which is designed for construction by conventional earth moving equipment. (3-20-20)T

**08. Reservoir.** Any basin which contains or will contain the material impounded by the mine tailings impoundment structure. (3-20-20)T

**09. Owner.** Includes any of the following who own, control, operate, maintain, manage, or propose to construct a mine tailings impoundment structure or reservoir. (3-20-20)T

**a.** The state of Idaho and any of its departments, agencies, institutions and political subdivisions; (3-20-20)T

**b.** The United States of America and any of its departments, bureaus, agencies and institutions; provided that the United States of America are not required to pay any of the fees required by Section 42-1713, Idaho Code, and shall submit plans, drawings and specifications as required by Section 42-1721, Idaho Code, for information purposes only; (3-20-20)T



- c. Every municipal or quasi-municipal corporation; (3-20-20)T
- d. Every public utility; (3-20-20)T
- e. Every person, firm, association, organization, partnership, business, trust, corporation or company; (3-20-20)T
- f. The duly authorized agents, lessees, or trustees of any of the foregoing; (3-20-20)T
- g. Receivers or trustees appointed by any court for any of the foregoing. (3-20-20)T
- 10. Alterations, Repairs or Either of Them.** Only such alterations or repairs as may directly affect the safety of the mine tailings impoundment structure or reservoir, as determined by the Director. (3-20-20)T
- 11. Enlargement.** Any change in or addition to an existing mine tailings impoundment structure or reservoir, which raises or may raise the storage capacity of the structure, as defined in Rule Subsection 010.06. (3-20-20)T
- 12. Days Used in Establishing Deadlines.** Calendar days including Sundays and holidays. (3-20-20)T
- 13. Certificate of Approval.** A certificate issued by the Director for the mine tailings impoundment structure listing restrictions imposed by the Director, and without which no new mine tailings impoundment structures shall be allowed to impound mine tailings slurry or water and no existing impoundment shall be allowed to impound water or continue deposition of mine tailings slurry. The structure will be recertified every two (2) years, unless the Director determines that the structure is unsafe. (3-20-20)T
- 14. Engineer.** A registered professional engineer, licensed as such by the state of Idaho. (3-20-20)T
- 011. -- 024. (RESERVED)**
- 025. AUTHORITY OF REPRESENTATIVE (RULE 25).**  
When plans, drawings and specifications are filed by another person in behalf of an owner, written evidence of authority to represent the owners shall be filed with the plans, drawings and specifications. (3-20-20)T
- 026. -- 029. (RESERVED)**
- 030. FORMS (RULE 30).**  
Forms required by these rules. (3-20-20)T
- 01. Samples of Forms.** Samples of all forms required by these rules are available from the Department to interested parties upon request. (3-20-20)T
- 02. Form 1721.** Construction of a mine tailings impoundment structure requires the filing of Form 1721. (3-20-20)T
- 031. -- 034. (RESERVED)**
- 035. PLANS, DRAWINGS, AND SPECIFICATIONS (RULE 35).**  
The following provisions apply in submitting plans, drawings, and specifications. (3-20-20)T
- 01. Submission of Plans, Drawings, and Specification.** Any owner who shall desire to construct, or enlarge, or alter or repair any mine tailings impoundment structure shall submit duplicate copies of plans, drawings, and specifications prepared by an engineer for the proposed work to the Director with required fees. An owner who desires to construct a continuously raised tailings impoundment structure shall submit duplicate copies of plans, drawings, and specifications prepared by an engineer, showing the stages of lift height, by periods of time, and ultimate design height. (3-20-20)T

**02. Application for and Receipt of Written Approval.** Construction of a new mine tailings impoundment structure or enlargement, or non-emergency alteration or repairs on existing mine tailings impoundment structures shall not be commenced until the owner has applied and obtained written approval of the plans, drawings, and specifications covering the work. In emergency situations, the owner shall make the required alterations or repairs necessary to relieve the emergency, and notify the Director. (3-20-20)T

**03. Preparation and Submission of Plans.** Plans must be prepared on a good grade of tracing linen or a good quality vellum or mylar. Transparent copies reproducible by standard duplicating processes, if accurate, legible and permanent, will be accepted. Plans may initially be submitted in the form of nonreproducible paper prints. After reviewing the plans, the Director will notify the owner of any required changes. (3-20-20)T

**04. Scale of Plans and Drawings.** Plans and drawings shall be of sufficiently large scale with an adequate number of views and proper dimensions, so that drawings may be readily interpreted and studied. (3-20-20)T

**05. Dimensions of Plans.** All sheets for a set of plans shall have an outside dimension of twenty-four by thirty-six (24 x 36) inches. A margin of two (2) inches on the left-hand end and a margin of one-half (1/2) inch on the other three sides must be provided, making the available work space twenty-three (23) x thirty-three and one-half (33 1/2) inches. (3-20-20)T

**06. Plans.** The plans shall include the following: (3-20-20)T

**a.** A topographic map of the mine tailings impoundment structure site showing the location of the proposed mine tailings impoundment structure by section, township and range, and location of spillway or diversion structures, outlet works, and all borings, test pits, borrow pits; (3-20-20)T

**b.** A profile along the mine tailings impoundment structure axis showing the locations, elevations, and depths of borings or test pits, including logs of bore hole and/or test pits; (3-20-20)T

**c.** A maximum cross-section of the mine tailings impoundment structure showing elevation and width of crest, slopes of upstream and downstream faces, thickness of any proposed riprap, zoning of the earth embankment (if any), location of cutoff and bonding trenches, elevations, size and type of decant systems, valves, operating mechanism, and dimensions of all other essential structural elements such as cutoff walls, filters, embankment zones, etc.; (3-20-20)T

**d.** Detailed drawings describing the outlet system, i.e., decant line, barge pump system, siphon system; (3-20-20)T

**e.** If a spillway is used, a curve showing the discharge capacity in cubic feet per second of the spillway vs. gage height of the storage pool level above the spillway crest up to the maximum high water level, and the formula used in making such determinations; (3-20-20)T

**f.** If a stream diversion is created, a tabulation of the discharge capacity in cubic feet per second of any diversion works and of the diversion channel vs. flow depth through the diversion works or channel up to maximum capacity of the system, and the formulas used in making such determinations; (3-20-20)T

**g.** Where staged construction will take place and no spillway exists, a curve showing maximum safe operating level for the tailings as a function of embankment height and the design criteria used to arrive at this; (3-20-20)T

**h.** Detailed plans, including cross-sections and profile, of the spillway or diversion works and any associated channels; (3-20-20)T

**i.** Plans for monitoring and/or recovering seepage from the reservoir in those instances where safety of the impoundment may be affected; (3-20-20)T

**j.** An operation plan; (3-20-20)T

- k.** An emergency procedure plan for protection of life and property; (3-20-20)T
- l.** An abandonment plan that assures the Director to his satisfaction that, upon completion of the mining operation, the site will be in a safe maintenance-free condition. (3-20-20)T
- 07. Specifications.** Specifications shall include provisions acceptable to the Director for adequate observation, inspection and control of the work by a registered professional engineer during the period of construction. (3-20-20)T
- 08. Provision Included with Plans.** The specifications shall provide that the plans and specifications may not be materially changed without prior written consent of the Director. (3-20-20)T
- 09. Provisions Included with Specifications.** The specifications shall provide that certain stages of construction shall not proceed without the approval of the Director. Those stages requiring approval are as follows: (3-20-20)T
- a.** After clearing and excavation of foundation and prior to placing any fill material; (3-20-20)T
- b.** After installation of the decant conduit and any proposed collars and before placing any backfill material around conduit; (3-20-20)T
- c.** After construction is completed (first stage starter dike if staged construction) and before any water or mine tailings slurry is stored in the reservoir; (3-20-20)T
- d.** Before each successive enlargement of the impoundment structure; (3-20-20)T
- e.** After each stage of enlargement of the impoundment structure is completed and before storage is allowed to exceed the level approved for the previous approved stage; (3-20-20)T
- f.** At such other times as determined necessary by the Director. The Director will, within seven (7) days after notification by the engineer, inspect and if satisfactory, approve the completed stage of construction. Owners are encouraged to give prior notice to the Department, so that the inspection can be scheduled to prevent delays. (3-20-20)T
- 10. Inspections, Examinations, and Tests.** All materials and workmanship may be subject to inspection, examination and test by the Director at any and all reasonable times during manufacture and/or construction and at any and all places where such manufacture and/or construction are carried on. (3-20-20)T
- 11. Rejection of Defective Material.** The Director shall have the right to require the owner or engineer to reject defective material and workmanship or require its correction. Rejected workmanship shall be corrected and rejected material shall be replaced with proper material. (3-20-20)T
- 12. Suspension of Work.** The Director may order the engineer to suspend any work that may be subject to damage by climatic conditions. (3-20-20)T
- 13. Responsibility of Engineer.** These provisions shall not relieve the engineer of his responsibility to assure that construction is accomplished in accordance to approved plans and specifications or to suspend work on his own motion. (3-20-20)T
- 14. Detailing Provisions of Specifications.** The specifications shall state in sufficient detail, all provisions necessary to ensure that construction is accomplished in an acceptable manner and provide needed control for construction to ensure that a safe structure is constructed. (3-20-20)T
- 15. Required Information.** The following information shall be submitted with the plans and specifications. (3-20-20)T

- 16. Engineer's Report.** An engineer's report giving details necessary for analysis of the structure and appurtenances. Included as a part of the report where applicable shall be the following: (3-20-20)T
- a.** Formulas and assumptions used in designs; (3-20-20)T
  - b.** Hydrologic data used in determining runoff from the drainage areas; (3-20-20)T
  - c.** Engineering properties of each type of material to be used in the embankment and of the foundation areas; (3-20-20)T
  - d.** Stability analysis, including an evaluation of overturning, sliding, upstream and downstream slopes and foundation stability; (3-20-20)T
  - e.** Geologic description of reservoir area, including evaluation of landslide potential; (3-20-20)T
  - f.** Chemical analysis of all materials composing the slurry; (3-20-20)T
  - g.** Earthquake design loads must be evaluated at all sites located east of Range 22 E., Boise Meridian. This area corresponds to Seismic Zone 3 as designated by the Recommended Guidelines of the National Dam Safety Program. Earthquake analysis may be required at other impoundment structure sites if deemed necessary by the Director; (3-20-20)T
  - h.** A seepage analysis of the embankment and reservoir bottom; (3-20-20)T
  - i.** A hydraulic analysis of the outlet system and spillway, diversion work or diversion channel; (3-20-20)T
  - j.** Engineering properties and the weathering characteristics of the proposed tailings to be stored in the impoundment; (3-20-20)T
  - k.** Other information which would aid in evaluating the safety of the design. (3-20-20)T
- 17. Filing of Additional Information.** The Director may require the filing of such additional information which in his opinion is necessary to assess safety or waive any requirement herein cited if in his opinion it is unnecessary. (3-20-20)T

**036. -- 039. (RESERVED)**

**040. BONDING (RULE 40).**

An active surety bond or other means of acceptable surety payable to the Director of the Department of Water Resources shall be on file with the Director throughout the active life of the tailings disposal site. The purpose of this bond is to provide a means by which the tailings impoundment can be placed in a safe maintenance-free condition if abandoned by the owner without conforming to an abandonment plan approved by the Director. (3-20-20)T

**01. Filing of Bond.** The bond shall be filed prior to any issuance by the Director of a certificate of approval for use of the mine tailings impoundment structure to impound mine tailings slurry and shall run for the two (2) year approval period covered on the certificate of approval. (3-20-20)T

**02. Provisions of Bond.** Bond provisions shall provide that the surety may be held liable for a period of up to five (5) years following notice of default on the bond. (3-20-20)T

**03. Amount of Bond.** The bond amount will be set by the Director and is subject to revision each time it is renewed. The owner must obtain approval for the amount of his surety bond prior to each renewal. (3-20-20)T

**04. Cost Estimate Submitted by Engineer.** In order to provide a basis for setting the bond amount, the engineer shall submit a cost estimate acceptable to the Director, together with conceptual details needed to arrive at the estimate, for abandonment of the facility at each proposed stage of its construction. (3-20-20)T

**05. Current Costs for Abandonment.** Bond amount will be based on current costs for abandonment of the facility based on the approved cost estimate for abandonment at the present construction condition or the next approved proposed stage, whichever represents the larger bond amount. (3-20-20)T

**06. Determination of Bond Amount.** If the final abandonment is determined to be the most costly condition, the owner may elect to use this as a basis for bonding throughout the life of the project. The Director may, however, revise the bonding amount to reflect updated costs when he feels it is necessary in order to maintain a realistic bond. (3-20-20)T

**07. Filing Initial Bond.** The initial bond shall be filed upon completion of the first stage of construction and before the required certificate of approval is issued to allow storage of mine tailings slurry in the impoundment. No certificate of approval shall be renewed prior to filing by the owner of a bond renewal in an amount approved by the Director. (3-20-20)T

**08. Filing Copy of Performance Bond.** Upon the filing of a copy of a performance bond with the Director, covering the terms and conditions of a state of Idaho mineral lease or an approved reclamation plan, in which these documents specify compliance with a plan of restoration of all mining operations, including the tailings impounding structure, the Director may determine the bond required of this section has been met, if the amount of the bond accurately reflects the cost associated with the abandonment plan provided by the owner. (3-20-20)T

**041. -- 044. (RESERVED)**

**045. MINE TAILINGS IMPOUNDMENT STRUCTURES DESIGN CRITERIA (RULE 45).**

The following minimum design criteria shall be used for all mine tailings impoundment structures designed for installation in Idaho. These limitations are intended to serve as guidelines for a broad range of circumstances, and engineers should not consider them as a restriction to the use of other sound design criteria. Deviation from this established criteria will be considered by the Director in approving plans and specifications. (3-20-20)T

**01. Embankment Slopes.** (3-20-20)T

**a.** For construction of borrowed fill embankments, in the absence of a stability analysis, the slopes shall be:

Upstream slope	2:1 or flatter
Downstream slope	2:1 or flatter

(3-20-20)T

**b.** Construction by the upstream method shall not be used in the area of the state east of Range 22 E., Boise Meridian, unless the engineer can provide evidence that the construction and operation of the tailings impoundment will achieve a relative density of sixty percent (60%) or greater in the embankment and tailings to prevent liquefaction during earthquake loading. (3-20-20)T

**c.** Safety factors for the embankment shall be at least one and five-tenths (1.5) for static loads and a minimum of one (1) for the static plus the appropriate earthquake load. (3-20-20)T

**d.** To insure sufficient permeability and stability of the embankment, designs will require utilizing materials other than the tailings, when the tailings materials: (3-20-20)T

**i.** Contain greater than seventy-five percent (75) passing the #200 standard U.S. sieve, or fifty percent (50%) passing the #325 standard U.S. sieve; (3-20-20)T

**ii.** Contain phosphate clays; (3-20-20)T

**iii.** The design calls for the water to be impounded against the embankment; (3-20-20)T

iv. Have other properties which makes them unsuitable for use as construction materials. (3-20-20)T

e. Embankments designed for the storage of hazardous levels of radioactive materials shall, in addition to any requirements of these regulations, meet the criteria outlined in the Nuclear Regulatory Commission Regulatory Guide 3.11 and the Idaho Radiation Control Regulations administered by the Idaho Department of Environmental Quality. (3-20-20)T

f. The design shall consider the need for drains and/or operational procedures to promote consolidation and insure that a low phreatic surface is maintained within the embankment. Drainage pipe shall not be used beneath embankments where excessive or differential settlement may cause failure of the pipes and subsequent piping of the tailings or embankment. When the quality of the mine tailings slurry is such that it will adversely affect the quality of the existing groundwater, the design should be coordinated with the Department and the Department of Environmental Quality to insure that all applicable permits are obtained. (3-20-20)T

g. Instrumentation of the embankment and/or foundation will be required to insure that the structure is functioning satisfactorily. Standpipe piezometers with an inside diameter greater than one-half (1/2) inch will not be acceptable for use in fine-grained or cohesive soils in order to minimize response time. (3-20-20)T

h. Tailings impoundment structures which are constructed using the tailings shall not be constructed or raised during freezing weather to prevent frost lenses in the embankment. Sufficient freeboard must be provided during the summer construction season if the disposal operation is to continue during the winter. (3-20-20)T

i. If tailings are to be discharged during times of freezing weather and the embankment is to be constructed using either the upstream or centerline method, the pond shall be of sufficient size to insure that any ice formed in the tailings pond area melts during the next warm season. (3-20-20)T

**02. Top Width Embankment. (3-20-20)T**

a. In the absence of a stability analysis, the minimum top width for mine tailings impoundment structures shall be:

$$W = 2 (H \text{ to } 1/2 \text{ power}) + 4, \text{ minimum}$$

W = Top width  
H = Embankment height (3-20-20)T

b. The minimum top width for any tailings embankment is ten (10) feet. (3-20-20)T

**03. Cutoff Trenches or Walls. (3-20-20)T**

a. Cutoff trenches, if needed, shall be used to bond the fill through relatively pervious material to an impervious stratum or zone. The bond area shall extend up the abutments to the maximum high water or tailings impoundment elevation. Cutoff (keylock) trenches which are to be backfilled with compacted fill shall be wide enough to allow the free movement of excavation and compaction equipment. Side slopes shall be no steeper than 1:1 for depths up to twelve (12) feet, and no steeper than one and one-half (1 1/2) to one (1) for greater depths to provide for proper compaction. Flatter slopes may be required for safety and stability. (3-20-20)T

b. Concrete cutoff walls may be used to bond fills to smooth rock surfaces in a similar manner as cutoff trenches and they shall be entrenched in the rock to a depth approximately one-half (1/2) the thickness of the cutoff wall. Concrete cutoff walls shall be doweled into the rock a minimum of twelve (12) inches with a maximum spacing of eighteen (18) inches for three-quarter (3/4) inch steel dowels. Concrete walls shall have a minimum projection of three (3) feet perpendicular to the rock surface and shall have a minimum thickness of twelve (12) inches. (3-20-20)T

**04. Borrowed Fill Embankment. (3-20-20)T**

a. The approved earth materials (silt soils are seldom acceptable) shall be zoned as shown in the plans and placed in the embankment in continuous, approximately level layers. Compaction shall be based on ASTM D-

698 for cohesive soils and a minimum compaction of ninety-five percent (95%) of the laboratory Standard Proctor dry density is required. Compaction of cohesionless soils shall insure a relative density of sixty percent (60%) or greater. (3-20-20)T

**b.** An acceptable working range of moisture content for the fill material shall be established and maintained. (3-20-20)T

**c.** The material shall be compacted by means of a loaded sheepsfoot roller, vibratory roller, or other acceptable means, to the required density. (3-20-20)T

**d.** No rock shall be left in the fill material which has a maximum dimension exceeding the lift thickness. The fill material shall be free of brush and organic materials. (3-20-20)T

**e.** The fill shall be carried up simultaneously the full design width of the structure, and the top of the fill shall be kept substantially level at all times or slope slightly toward the reservoir. (3-20-20)T

**f.** No frozen or cloddy fill material shall be used, and no material shall be placed upon frozen, muddy or unscarified surfaces. (3-20-20)T

**g.** All materials used in the embankment shall meet all the stability and seepage requirements as shown by a design analysis of the structure and shall be properly installed to meet these requirements. (3-20-20)T

**05. Riprap.** (3-20-20)T

**a.** All dams shall be protected from wave action. In cases where water is stored directly against the mine tailings impoundment structure or where wave action at maximum pool level during design inflow events would affect the integrity of the embankment, the Director may require use of riprap or other protective measures. (3-20-20)T

**b.** If riprap is used the design shall specify the rock size and extent of blanket required to prevent erosion. (3-20-20)T

**06. Outlet Systems.** (3-20-20)T

**a.** Reservoirs must safely handle the design inflow for all areas draining into the reservoir. This may be done either by storing the entire design inflow or by having an outlet system or combination of systems adequate to safely pass the design inflow. If the tailings reservoir is situated on a stream channel, an outlet system or an approved alternative system capable of meeting downstream flow requirements must be provided. (3-20-20)T

**b.** The minimum design inflow for all reservoirs shall be the flood with one percent (1%) probability of occurrence. The Director may require a greater design inflow be used in instances of high hazard, for larger mine tailings impoundment structures, or when the inflow is to be entirely stored in the reservoir during the flood period. (3-20-20)T

**c.** The outlet system may be composed of one (1) or a combination of the following: decant line, spillway, stream channel diversion to bypass the reservoir. The system will be determined by individual reservoir conditions. Unless removal of the mine tailings impoundment structure and reservoir is part of the abandonment plan, the outlet system shall be maintained in perpetuity, unless it is demonstrated that an outlet system is not needed. (3-20-20)T

**d.** Outlet systems will not be allowed if their use would release toxic, highly turbid, radioactive or otherwise hazardous flows from the reservoir. In these cases the design inflow must either be entirely stored or diverted around the reservoir. (3-20-20)T

**e.** All spillways shall be stabilized to discharge flow through the use of concrete, masonry, riprap or sod, if not constructed in resistant rock. (3-20-20)T

**f.** Wherever possible, the spillway shall be constructed independent of the impoundment structure. It shall lead the water far enough away from the mine tailings impoundment structure so as not to endanger the structure. (3-20-20)T

**g.** A diversion system must not subject the mine tailings impoundment structure to erosion during the design inflow event. All stream diversions shall conform to the minimum standards for stream channel alterations as written by this Department. (3-20-20)T

**h.** Decant conduits, if under the embankment, shall be laid on a firm, stable foundation and normally must not be placed on fill. They shall have a minimum inside diameter of twelve (12) inches and one (1) of the following provisions included in the design: (3-20-20)T

**i.** The owner shall have the conduit inspected by photographic or video tape equipment and a copy of the inspection provided to the Department, if a problem is suspected; or (3-20-20)T

**ii.** The conduit shall be completely plugged with concrete and/or suitable material, for that portion which extends through the embankment, if a nonrepairable problem occurs within the conduit. The conduit shall consist of material which has been shown to possess the qualities necessary to perform in the environment of the specific tailings impoundment. The design life of the conduit shall be greater than the life of the mine tailings impoundment structure. The portion of the conduit through the embankment shall be completely filled with concrete, or other suitable material, and the riser portion of the conduit capped, upon abandonment of the mine tailings impoundment structure. (3-20-20)T

**i.** All decant conduits, if under the embankment, shall have a seepage path through the impervious zone at least equivalent in length to the maximum head above the downstream end of the system. Only one third (1/3) the horizontal distance through the impervious zone will be utilized when calculating the length of the seepage path. Collars may be used to satisfy this requirement, but all collars shall extend a minimum of three (3) feet outside the conduit. Collars shall be spaced at intervals of at least seven (7) times their height and no collar may be closer to the outer surface of the impervious zone than the distance it extends out from the conduit. (3-20-20)T

**j.** More than two (2) decant conduits are not to be used, unless special conditions warrant. (3-20-20)T

**07. Freeboard.** A minimum freeboard of two (2) feet plus wave height (H) shall be provided on the crest of the mine tailings impoundment structure during passage of the design inflow.

$H = 1.95 (F \text{ to } 1/2 \text{ power})$   
F = Fetch in miles across water surface at a design maximum level. (3-20-20)T

**08. Records.** All instrumentation shall be read and recorded on a regular basis, and all records must be available for inspection by Department personnel on request. (3-20-20)T

**09. Inspection and Completion Reports.** (3-20-20)T

**a.** It is the responsibility of the engineer to submit test reports along with periodic inspection and progress reports to the Director. (3-20-20)T

**b.** Upon completion of each approved stage of construction, a letter shall be sent to the Director, giving a short, narrative account covering all items of work. As-built plans shall be submitted to the Director if the completed project was substantially changed from the plans originally approved. (3-20-20)T

**10. Abandonment.** An abandonment plan which provides a stable, maintenance-free condition when the mine tailings impoundment is no longer being regularly maintained by the owner or the owner has ceased to use the site for disposal of mine tailings slurry, shall be submitted to the Director by the owner. The plan shall provide a safe condition by providing for removal of the tailings, or construction of a maintenance-free spillway or diversion works where needed to accommodate runoff. The plan shall include provisions to prevent water storage behind, and erosion of, the mine tailings impoundment structure and the impounded tailing. A conceptual plan which includes an engineering design report, detailed enough to provide the required cost estimate for bonding purposes, will be



required prior to the approval of the proposed project. Detailed construction plans must be approved by the Director prior to implementation of any abandonment work. The Director shall notify the owner upon acceptance of completion of abandonment in accordance with the approved plan. (3-20-20)T

**046. -- 049. (RESERVED)**

**050. DAMS STORING TAILING AND WATER (RULE 50).**

Construction of dams intended to store water in excess of the water being decanted in the tailing placement operation shall also meet the requirements for water storage reservoirs specified in the Department's Rules for the Safety of Dams. The Director may waive any or all of these requirements if, in the opinion of the Director, sound engineering design supplied by the owner indicates such requirements are not applicable. (3-20-20)T

**051. -- 054. (RESERVED)**

**055. PROVISIONS OF CHAPTER 17, TITLE 42, IDAHO CODE (RULE 55).**

The provisions of Sections 42-1709 through 42-1721, Idaho Code, are a part of these rules. (3-20-20)T

**056. -- 999. (RESERVED)**

### 37.03.06 – SAFETY OF DAMS RULES

#### 000. LEGAL AUTHORITY (RULE 0).

These rules are adopted pursuant to Chapter 17, Section 42-1714, Idaho Code, and implement the provisions of Sections 42-1709 through 42-1721, Idaho Code. (3-20-20)T

#### 001. TITLE AND SCOPE (RULE 1).

**01. Title.** These rules are titled IDAPA 37.03.06, “Safety of Dams Rules.” (3-20-20)T

**02. Scope.** (3-20-20)T

**a.** The requirements that follow are intended as a guide to establish acceptable standards for construction and to provide guidelines for safety evaluation of new or existing dams. The rules apply to all new dams, to existing dams to be enlarged, altered or repaired, and maintenance of certain existing dams, as specifically provided in the rules. The Director will evaluate any deviation from the standards hereinafter stated as they pertain to the safety of any given dam. The standards are not intended to restrict the application of other sound engineering design principles. Engineers are encouraged to submit new ideas which will advance the state of the art and provide for the public safety. (3-20-20)T

**b.** Under no circumstances shall these rules be construed to deprive or limit the Director of the Department of Water Resources of any exercise of powers, duties and jurisdiction conferred by law, nor to limit or restrict the amount or character of data, or information which may be required by the Director from any owner of a dam for the proper administration of the law. State sovereignty as expressed in Policy 1A of the adopted State Water Plan for independent review and approval of dam construction, operation and maintenance will not be waived due to any overlapping jurisdiction from federal agencies. (3-20-20)T

#### 002. -- 009. (RESERVED)

#### 010. DEFINITIONS (RULE 10).

Unless the context otherwise requires, the following definitions govern these rules. (3-20-20)T

**01. Active Storage.** The water volume in the reservoir stored for irrigation, water supply, power generation, flood control, or other purposes but does not include flood surcharge. Active storage is the total reservoir capacity in acre-feet, less the inactive and dead storage. (3-20-20)T

**02. Alterations, Repairs or Either of Them.** Only such alterations or repairs as may directly affect the safety of the dam or reservoir, as determined by the Director. Alterations, repairs does not include routine maintenance items. (See Rule Subsections 055.02.a. and 055.02.b.) (3-20-20)T

**03. Appurtenant Structures.** Ancillary features (e.g. outlets, tunnels, gates, valves, spillways, auxiliary barriers) used for operation of a dam, which are owned by the dam owner or the owner has responsible control. (3-20-20)T

**04. Board.** The Idaho Water Resource Board. (3-20-20)T

**05. Certificate of Approval.** A certificate issued by the Director for all dams listing restrictions imposed by the Director, and without which no new dams shall be allowed by the owner to impound water. A certificate of approval is also required for existing dams before impoundment of water is authorized. (3-20-20)T

**06. Dam.** Any artificial barrier together with appurtenant works, which is or will be ten (10) feet or more in height or has or will have an impounding capacity at maximum storage elevation of fifty (50) acre-feet or more. Height of a dam is defined as the vertical distance from the natural bed of the stream or watercourse at the downstream toe of the barrier, as determined by the Director, or from the lowest elevation of the outside limit of the barrier, if it is not across a stream channel or watercourse, to the maximum water storage elevation. (3-20-20)T

**07. Small Dams.** Artificial barriers twenty (20) feet or less in height that are capable of storing less than one hundred (100) acre-feet of water. (3-20-20)T

**08. Intermediate Dams.** Artificial barriers more than twenty (20) feet, but less than forty (40) feet in height, or are capable of storing one hundred (100) acre-feet or more, but less than four thousand (4,000) acre-feet of water. (3-20-20)T

- 09. Large Dams.** Artificial barriers forty (40) feet or more in height or are capable of storing four thousand (4,000) acre-feet or more of water. (3-20-20)T
- 10. Department Jurisdiction.** The following are not subject to department jurisdiction: (3-20-20)T
- a.** Artificial barriers constructed in low risk areas as determined by the Director, which are six (6) feet or less in height, regardless of storage capacity. (3-20-20)T
- b.** Artificial barriers constructed in low risk areas as determined by the Director, which impound ten (10) acre-feet or less at maximum water storage elevation, regardless of height. (3-20-20)T
- c.** Artificial barriers in a canal used to raise or lower water therein or divert water therefrom. (3-20-20)T
- d.** Fills or structures determined by the Director to be designed primarily for highway or railroad traffic. (3-20-20)T
- e.** Fills, retaining dikes or structures, which are under jurisdiction of the Department of Environmental Quality, designed primarily for retention and treatment of municipal, livestock, or domestic wastes, or sediment and wastes from produce washing or food processing plants. (3-20-20)T
- f.** Levees, that store water regardless of storage capacity. Levee means a retaining structure alongside a natural lake which has a length that is two hundred (200) times or more greater than its greatest height measured from the lowest elevation of the toe to the maximum crest elevation of the retaining structure. (3-20-20)T
- 11. Days Used in Establishing Deadlines.** Calendar days including Sundays and holidays. (3-20-20)T
- 12. Dead Storage.** The water volume in the bottom of the reservoir stored below the lowest outlet and generally is not withdrawn from storage. (3-20-20)T
- 13. Department.** The Idaho Department of Water Resources. (3-20-20)T
- 14. Design Evaluation.** The engineering analysis required to evaluate the performance of a dam relative to earthquakes, floods or other site specific conditions that are anticipated to affect the safety of a dam or operation of appurtenant facilities. (3-20-20)T
- 15. Director.** The Director of the Idaho Department of Water Resources. (3-20-20)T
- 16. Engineer.** A registered professional engineer, licensed as such by the state of Idaho. (3-20-20)T
- 17. Enlargement.** Any change in or addition to an existing dam or reservoir, which raises or may raise the water storage elevation of the water impounded by the dam. (3-20-20)T
- 18. Factor of Safety.** A ratio of available shear strength to shear stress, required for stability. (3-20-20)T
- 19. Flood Surcharge.** A variable volume of water temporarily detained in the upper part of a reservoir, in the space (or part thereof) that is filled by excess runoff or flood water, above the maximum storage elevation. Flood surcharge cannot be retained either because of physical or administrative factors but is passed through the reservoir and discharged by the spillway(s) until the reservoir level has been drawn down to the maximum storage elevation. (3-20-20)T
- 20. Inflow Design Flood (IDF).** The flood specified for designing the dam and appurtenant facilities. (3-20-20)T
- 21. Maximum Credible Earthquake.** The largest earthquake that reasonably appears capable of occurring under the conditions of the presently known geological environment. (3-20-20)T

**22. Operation Plan.** A specific plan that will assure the project is safely managed for its intended purpose and which provides reservoir operating rule curves or specific limits and procedures for controlling inflow, storage, and/or release of water, diverted into, passed through or impounded by a dam. (3-20-20)T

**23. Owner.** Includes any of the following who own, control, operate, maintain, manage, hold the right to store and use water from the reservoir or propose to construct a dam or reservoir. (3-20-20)T

**a.** The state of Idaho and any of its departments, agencies, institutions and political subdivisions; (3-20-20)T

**b.** The United States of America and any of its departments, bureaus, agencies and institutions; provided that the United States of America are not required to pay any of the fees required by Section 42-1713, Idaho Code, and shall submit plans, drawings and specifications as required by Section 42-1712, Idaho Code, for information purposes only; (3-20-20)T

**c.** Every municipal or quasi-municipal corporation. (3-20-20)T

**d.** Every public utility; (3-20-20)T

**e.** Every person, firm, association, organization, partnership, business trust, corporation or company; (3-20-20)T

**f.** The duly authorized agents, lessees, or trustees of any of the foregoing; (3-20-20)T

**g.** Receivers or trustees appointed by any court for any of the foregoing. (3-20-20)T

**24. Reservoir.** Any basin which contains or will contain the water impounded by a dam. (3-20-20)T

**25. Storage Capacity.** The total storage in acre-feet at the maximum storage elevation. (3-20-20)T

**26. Water Storage Elevation.** The maximum elevation of the water surface which can be obtained by the dam or reservoir. It is further defined as the storage level attained when the reservoir is filled to capacity (i.e. to the spillway crest) or an authorized storage level attained by installing flashboards to increase the reservoir capacity, or a specified upper storage limit, which is attained by operation of movable gates that raises the reservoir to a controlled operating level. The maximum storage elevation is an equivalent term of water storage elevation. (3-20-20)T

**27. Release Capability.** The ability of a dam to pass excess water through the spillway(s) and outlet works and otherwise discharge. (3-20-20)T

**011. -- 024. (RESERVED)**

**025. DAM SIZE CLASSIFICATION AND RISK CATEGORY (RULE 25).**

**01. Size Classification.** The following table defines the height and storage capacity limits used by the Department to classify dams:

Size Classification	Height (ft)		Storage Capacity
Small	20 ft. or less	and	Less than 100 acre-ft.
Intermediate	More than 20 ft. but less than 40 ft.	or	100 Acre-ft or more, but less than 4000 acre ft
Large	40 ft. or more	or	4000 acre-ft., or more

(3-20-20)T

**02. Risk Category.** The following table describes categories of risk used by the Department to classify losses and damages anticipated in down-stream areas, that could be attributable to failure of a dam during typical flow conditions.

<b>Risk Category</b>	<b>Dwellings</b>	<b>Economic Losses</b>
Low	No permanent structures for human habitation.	Minor damage to land, crops, agricultural, commercial or industrial facilities, transportation, utilities or other public facilities or values.
Significant	No concentrated urban development, 1 or more permanent structures for human habitation which are potentially inundated with flood water at a depth of 2 ft. or less or at a velocity of 2 ft. per second or less.	Significant damage to land, crops, agricultural, commercial or industrial facilities, loss of use and/or damage to transportation, utilities or other public facilities or values.
High	Urban development, or any permanent structure for human habitation which are potentially inundated with flood water at a depth of more than 2 ft. or at a velocity of more than 2 ft. per second.	Major damage to land, crops, agricultural, commercial or industrial facilities, loss of use and/or damage to transportation, utilities or other public facilities or values.

(3-20-20)T

**03. Determination of Size and Risk Category.** The Director shall determine the size and risk category of a new or existing dam. (3-20-20)T

**026. -- 029. (RESERVED)**

**030. AUTHORITY OF REPRESENTATIVE (RULE 30).**

When plans, drawings and specifications are filed by another person on behalf of an owner, written evidence of authority to represent the owner shall be filed with the plans, drawings and specifications. (3-20-20)T

**031. -- 034. (RESERVED)**

**035. FORMS (RULE 35).**

Forms required by these rules are available from the Department to interested parties upon request. Construction of a small dam requires the filing of Form 1710 and construction of an intermediate or large dam requires the filing of Form 1712. (3-20-20)T

**036. -- 039. (RESERVED)**

**040. CONSTRUCTION PLANS, DRAWINGS AND SPECIFICATIONS (RULE 40).**

The following provisions shall apply in submitting plans, drawings and specifications. (3-20-20)T

**01. Submission of Duplicate Plans, Drawings and Specifications.** Any owner who shall desire to construct, enlarge, alter or repair any intermediate or large dam, shall submit duplicate plans, drawings and specifications prepared by an engineer for the proposed work to the Director with required fees. The Director may, however, require the submittal of plans, drawings and specifications prior to the construction of any dam. (3-20-20)T

**02. Applying for and Obtaining Written Approval.** Construction of a new dam or enlargement, alteration or repairs on existing dams shall not be commenced until the owner has applied for and obtained written approval of the plans, drawings and specifications. Alteration or repairs do not include routine maintenance for which prior approval is not required. (See Rule Subsections 055.02.a and 055.02.b) (3-20-20)T

**03. Plans Shall Be Prepared on a Good Quality Vellum or Mylar.** Transparent copies reproducible by standard duplicating processes, if accurate, legible and permanent, will be accepted. Plans may initially be submitted in the form of nonreproducible paper prints. After reviewing the plans, the Director will notify the owner of any required changes. (3-20-20)T

**04. Preparation and Submission of Plans.** Plans and drawings shall be of a sufficient scale with an adequate number of views showing proper dimensions, so that the plans and drawings may be readily interpreted and so that the structure and appurtenances can be built in conformance with the plans and drawings. (3-20-20)T

**05. Information Included with Plans.** Plans for new dams shall include the following information and plans for enlargement, alteration or repair of an existing dam shall include as much of the following information as required by the Director to adequately describe the enlargement, alteration or repair and the affect on the existing dam or its appurtenant facilities: (3-20-20)T

**a.** A topographic map of the dam site showing the location of the proposed dam by section, township and range, and location of spillway, outlet works, and all borings, test pits, borrow pits; (3-20-20)T

**b.** A profile along the dam axis showing the locations, elevations, and depths of borings or test pits, including logs of bore holes and/or test pits; (3-20-20)T

**c.** A maximum cross-section of the dam showing elevation and width of crest, slopes of upstream and downstream faces, thickness of riprap, zoning of earth embankment, location of cutoff and bonding trenches, elevations, size and type of outlet conduit, valves, operating mechanism and dimensions of all other essential structural elements such as cutoff walls, filters, embankment zones, etc.; (3-20-20)T

**d.** Detailed drawings showing plans, cross and longitudinal sections of the outlet conduits, valves and controls for operating the same, and trash racks; (3-20-20)T

**e.** A curve or table showing the capacity of the reservoir in acre-feet vs gauge height (referenced to a common project datum) of the reservoir storage level, and the computations used in making such determinations. (3-20-20)T

**f.** A curve or table showing the outlet discharge capacity in cubic feet per second vs gauge height of reservoir storage level, and the equation used in making such determination; (3-20-20)T

**g.** A curve showing the spillway discharge capacity in cubic feet per second vs gauge height of the reservoir or flood surcharge level above the spillway crest and the equation used in making such determinations; (3-20-20)T

**h.** Detailed drawings of spillway structure(s), cross-sections of the channel heading to and from the spillway and a spillway profile; (3-20-20)T

**i.** Plans for flow measuring devices capable of providing an accurate determination of the flow of the stream above and below the reservoir, and a permanent reservoir or staff gauge near the outlet of the reservoir plainly marked in feet and tenths of a foot referenced to a common project datum; (3-20-20)T

**j.** Plans or drawings of instruments, recommended by the owner's engineer to monitor performance of intermediate or large dams to assure safe operation, or as may be required by the Director to monitor any dam regardless of size, that is situated upstream of a high risk area. (3-20-20)T

**06. Specifications.** Specifications shall include provisions acceptable to the Director for adequate observation, inspection and control of the work by a registered professional engineer, during the period of construction. (3-20-20)T

**07. Changes to Specifications.** The specifications shall not be materially changed without prior written consent of the Director. Significant design changes, while construction is underway, shall be submitted for the Director's review and approval. (3-20-20)T

**08. Inspections.** The owner shall provide for and allow inspections by the Department to assure the dam and appurtenant structures are constructed in conformance with the approved plans and specifications, or as may be revised by the engineer and approved by the Director if there are unforeseen conditions discovered during site excavation or construction of the dam which potentially jeopardize the future integrity and safety of the dam. Certain stages of construction shall not proceed without inspection and approval by the Director, including the following:

(3-20-20)T

**a.** After clearing and excavation of the foundation area and cutoff trench and prior to placing any fill material. (3-20-20)T

**b.** After installation of the outlet conduit and collars and before placing any backfill material around the conduit; (3-20-20)T

**c.** After construction is completed and before any water is stored in the reservoir. (3-20-20)T

**d.** At such other times as determined necessary by the Director. The Director will, upon seven (7) days notice, inspect and if satisfactory, approve the completed stage of construction. The Director may conduct inspections upon shorter notice upon good reason being shown or upon a schedule jointly agreed upon by the Director and the owner. (3-20-20)T

**09. Inspection, Examination and Testing of Materials.** All materials and workmanship shall be subject to inspection, examination and testing by the Director at any and all times. (3-20-20)T

**10. Rejection of Defective Material.** The Director shall have the right to require the owner or engineer to reject defective material and workmanship or require its removal or correction respectively. Rejected workmanship shall be corrected and rejected material shall be replaced with proper material. (3-20-20)T

**11. Suspension of Work.** The Director may order the engineer to suspend any work that may be subject to damage by inclement weather conditions. (3-20-20)T

**12. Responsibility of Engineer.** These provisions shall not relieve the engineer of his responsibility to assure that construction is accomplished in accordance with the approved plans and specifications or to suspend work on his own motion. (3-20-20)T

**13. Detailing Provisions of Specifications.** The specifications shall state in sufficient detail, all provisions necessary to insure that construction is accomplished in an acceptable manner and provide needed control of construction to insure that a safe structure is constructed. (3-20-20)T

**14. Design Report.** Owners proposing to construct, enlarge, alter or repair an intermediate or large dam shall submit an engineering or design evaluation report with the plans and specifications. The engineering report shall include as much of the following information as necessary to present the technical basis for the design and to describe the analyses used to evaluate performance of the structure and appurtenances. (3-20-20)T

**a.** All technical reference(s); equations and assumptions used in the design; (3-20-20)T

**b.** Hydrologic data used in determining runoff from the drainage areas; reservoir flood routing(s); and hydraulic evaluations of the outlet(s) and the spillway(s). (3-20-20)T

**c.** Engineering properties of the foundation area and of each type of material to be used in the embankment. (3-20-20)T

**d.** A stability analysis, including an evaluation of overturning, sliding, slope and foundation stability and a seepage analysis; (3-20-20)T

**i.** Seismic design loads shall be evaluated and applied at all large dams to be located in significant or high risk areas, in Seismic Zone 3, which for purposes of these rules is the area in Idaho east of Range 22 East, Boise

Meridian. The evaluation required of large dams, that are classified significant or high risk, shall use the maximum ground motion/ acceleration generated by the maximum credible earthquake, which could affect the dam site.

(3-20-20)T

ii. Seismic analysis may be required as determined by the Director for large dams located above high risk areas in Seismic Zone 2, which for purposes of these rules is the area in Idaho west of Range 22 East, Boise Meridian.

(3-20-20)T

**15. Additional Information/Waiver.** The Director may require the filing of such additional information which in his opinion is necessary or waive any requirement herein cited if in his opinion it is unnecessary.

(3-20-20)T

**16. Alternate Plans.** The Director may accept plans and specifications or portions thereof prepared for other agencies which are determined to meet the requirements of Rule 40.

(3-20-20)T

**041. -- 044. (RESERVED)**

**045. OPERATION PLAN (RULE 45).**

An operation plan is required as described in the following rules and shall provide procedures for emergency operations and include guidelines and procedures for inspection, operation and maintenance of the dam and appurtenances, including any instruments required to monitor performance of the dam during normal operating cycles, critical filling or flood periods, or as may be required to monitor new or existing dams subject to earthquake effects.

(3-20-20)T

**01. New, Reconstructed or Enlarged Dams.** Prior to the initial filling of the reservoir or refilling the reservoir for a reconstructed or enlarged dam in the following categories, the owner shall file with the Director an operation plan for review and approval:

(3-20-20)T

- a. Small, high risk. (3-20-20)T
- b. Intermediate, significant risk. (3-20-20)T
- c. Intermediate, high risk. (3-20-20)T
- d. Large, any risk category. (3-20-20)T

**02. Existing Dams.** Unless exempted by the Director, owners of the following categories of dams shall file an operation plan with the Director on or before July 1, 1992 for review and approval:

(3-20-20)T

- a. Intermediate, high risk. (3-20-20)T
- b. Large, significant risk. (3-20-20)T
- c. Large, high risk. (3-20-20)T

**03. Alternate Plans.** The Director may accept existing studies or plans in lieu of an operation plan if the Director determines the information provided fulfills the requirements of Rule 45.

(3-20-20)T

**046. -- 049. (RESERVED)**

**050. NEW INTERMEDIATE OR LARGE DAMS (RULE 50).**

The following minimum criteria shall be used to evaluate the design of intermediate or large earthfill dams in Idaho. These standards are intended to serve as guidelines for a broad range of circumstances, and engineers should not consider them as a restriction to the use of other sound engineering design principles. Exclusion from this established criteria will be considered by the Director on a case-by-case basis in approving plans and specifications and evaluating dams. Dams constructed of other materials shall comply with these criteria as found appropriate by the Director and with other engineering criteria approved by the Director.

(3-20-20)T



**01. Embankment Stability.** Slope stability analyses shall determine the appropriate upstream and downstream slopes. Unless slope stability analysis determines otherwise, the embankment slopes shall be:

Upstream slope	3:1 or flatter
Downstream slope	2:1 or flatter

(3-20-20)T

**a.** For large high and significant hazard dams and intermediate high hazard dams the embankment shall be designed, constructed and maintained to assure stability under static loads and prevent instability due to seepage or uplift forces, or drawdown conditions. Transmission of seepage through the embankment, abutments and foundation shall be controlled to prevent internal removal of material and instability where seepage erodes or emerges. (3-20-20)T

**b.** The design analysis shall consider the need for installing filters, filter fabric and/or toe drains to stabilize the fill and protect against piping of the embankment fill material. (3-20-20)T

**c.** The minimum factor of safety for a dam under steady state condition shall be 1.5. During rapid drawdown of the reservoir, the minimum factor of safety for the embankment shall be 1.2. For dams constructed in Seismic Zone 3, the minimum factor of safety under seismic load shall be 1.0. (3-20-20)T

**d.** The stability of an embankment subjected to earthquake ground motions can be analyzed by dynamic response or pseudo-static analyses. Pseudo-static analyses are acceptable for embankment dams constructed of soils that will not build-up excess pore pressures due to shaking, nor sustain more than fifteen percent (15%) strength loss during earthquake events, otherwise the stability of an embankment dam shall be analyzed by a dynamic response method. A pseudo-static analysis simplifies the structural analysis (i.e. the resultant force of the seismic occurrence is represented by a static horizontal force applied to the critical section to derive the factor of safety against sliding along an assumed shear surface). The value of the horizontal force used in the pseudo-static analysis, is the product of the seismic coefficient and the weight of the assumed sliding mass. (3-20-20)T

**e.** Slope deformation analyses are required for dams located in Seismic Zone 3, that are constructed of cohesionless soils and/or on foundations which are subject to liquefaction, when the peak acceleration at the site is anticipated to exceed 0.15g. (3-20-20)T

**f.** The design analyses for new dams located in high risk areas (in Seismic Zone 2 or 3) shall include geologic and seismic reports, location of faults and history of seismicity. (3-20-20)T

**g.** Where in the opinion of the Director, embankment design or conditions warrant, instrumentation of the embankment and/or foundation will be required. (3-20-20)T

**h.** The design analyses for new large dams located in high risk areas (in Seismic Zone 3) shall include an evaluation of potential landslides in the vicinity of the dam or immediate area of the reservoir, which could cause damage to the dam or appurtenant structures, obstruct the spillway or suddenly displace water in the reservoir causing the dam to overtop. If potential landslides pose such a threat, they shall be stabilized against sliding, with a minimum factor of safety of 1.5. (3-20-20)T

**02. Top Width.** The crest width shall be sufficient to provide a safe percolation gradient through the embankment at the level of the maximum storage elevation. The minimum crest width (top of embankment) shall be determined by:

$$W = H / 5 + 10$$

W = Width, in feet  
H = Structural Height, in feet

The minimum top width for any dam is twelve (12) feet. (3-20-20)T

**03. Cutoff Trenches or Walls.** Cutoff trenches shall be excavated through relatively pervious

foundation material to an impervious stratum or zone. The trench shall be backfilled with suitable material, compacted to the specified density. The cutoff trench shall extend up the abutments to the maximum storage elevation. (3-20-20)T

**a.** Cutoff trenches shall be wide enough to allow the free movement of excavation and compaction equipment. Side slopes shall be no steeper than one to one (1:1) for depths up to twelve (12) feet, and no steeper than one and one half to one (1 1/2:1) for greater depths to provide for proper compaction. Flatter slopes may be required for safety and stability. (3-20-20)T

**b.** Concrete cutoff walls may be used to bond fills to smooth rock surfaces in a similar manner as cutoff trenches and shall be entrenched in the rock to a depth approximately one-half the thickness of the cutoff wall. Concrete cutoff walls shall be doweled into the rock a minimum of eight (8) inches with a maximum spacing of eighteen (18) inches for three-fourths (3/4) inch steel dowels. Concrete walls shall have a minimum projection of three (3) feet perpendicular to the rock surface and shall have a minimum thickness of twelve (12) inches. (3-20-20)T

**04. Impervious Core Material.** The approved earth materials (silt soils are seldom acceptable) shall be zoned as shown in the plans and placed in the embankment in continuous, approximately level layers, having a thickness of not more than six (6) inches before compaction. Compaction shall be based on ASTM D-698. A minimum compaction of ninety-five percent (95%) is required. (3-20-20)T

**a.** An acceptable working range of moisture content for the core material shall be established and maintained. (3-20-20)T

**b.** The material shall be compacted by means of a loaded sheepsfoot or pneumatic roller to the required density. (3-20-20)T

**c.** No rock shall be left in the core material which has a maximum dimension of more than four (4) inches. The core material shall be free of organic and extraneous material. (3-20-20)T

**d.** The core material shall be carried up simultaneously the full width and length of the dam, and the top of the core material shall be kept substantially level at all times, or slope slightly toward the reservoir. (3-20-20)T

**e.** No frozen or cloddy material shall be used, and no material shall be placed upon frozen, muddy or unscarified surfaces. (3-20-20)T

**f.** All materials used in the dam shall meet the stability and seepage requirements as shown by a design analysis of the structure and shall be properly installed to meet these requirements. (3-20-20)T

**05. Drains.** Toe or chimney drains or free draining downstream material shall be installed where necessary to maintain the phreatic line within the downstream toe. (3-20-20)T

**a.** Filter design for chimney drains, filter blankets and toe drains in clay and silt soils shall be selected using the following design criteria, unless deviations are substantiated by laboratory tests. All tests are subject to review and approval by the Director.

D15 filter/D15 base > 5 but < 20

D15 filter/D85 base < 5

D50 filter/D50 base < 25

D85 filter > 2 times diameter of pipe perforations, or 1.2 times width of pipe slots. (3-20-20)T

**b.** Filter material requirements are determined by comparing the particle size distribution of the filter to the particle size distribution of the materials to be protected;

e.g. D50 filter

D50 material to be protected

Where D is the particle size passing a mechanical (sieve) analysis expressed as a percentage by weight. (3-20-20)T

c. The base material should be analyzed considering the portion of the material passing the No. 4 sieve, for designing filters for base materials that contain gravel size particles. To assure internal stability and prevent segregation of the filter material, the coefficient of uniformity (D60/D10) shall not be greater than 20. (3-20-20)T

d. The minimum thickness of filter blankets and chimney drains shall be twelve (12) inches, with the maximum size particle passing the one (1) inch sieve. The maximum particle size may be increased with increasing thickness of the filter, by the rate of one (1) inch per foot of filter. However, the maximum particle shall not exceed three (3) inches. Zoned filters and chimney drains must not be less than twelve (12) inches thick per each zone. The width of granular filters shall not be less than the width of the installation equipment unless the plans and specifications include construction procedures adequate to insure the integrity of a narrower width. (3-20-20)T

e. Perforated drain pipes must have a minimum of six (6) inches of drain material around the pipe. The maximum particle size shall not exceed one-half (1/2) inch unless the layer thickness is increased at the rate of one (1) inch per foot of filter. Underdrains and collection pipes must be constructed of noncorrosive material. (3-20-20)T

**06. Freeboard.** The elevation of the top of the embankment shall be constructed and maintained above the flood surcharge level to prevent the dam from overtopping during passage of the inflow design flood and to provide freeboard for wind generated waves. Camber shall be included in the design and incorporated in the construction of the top of the embankment, unless waived by the Director. Camber may be estimated by multiplying the structural height of the dam by five percent (5%). (3-20-20)T

a. The height of wind generated waves (H) moving across a surcharged reservoir can be estimated by the following equation:

$H = 1.95 (F/2)$  where F = fetch, the distance in miles across the reservoir, measured perpendicular to the major axis of the dam. (3-20-20)T

b. For large, high risk dams the minimum freeboard shall be two (2) feet plus wave height during passage of the one percent (1%) flood or equal to the surcharge elevation of the reservoir during passage of the inflow design flood whichever is greater. (3-20-20)T

c. Estimation of the height of the wind generated wave using the empirical equation in Rule 050.06.a. shall not preclude a more conservative design including consideration of fill materials, embankment zoning, slope surface protection, drainage or other safety factors. (3-20-20)T

**07. Riprap.** All dams which are subject to erosion shall be protected from wave action. The design engineer, with approval of the Director, shall determine whether or not rock riprap or other protection is necessary. (3-20-20)T

a. Where rock riprap is used, it shall be placed on a granular bedding material, and extend up the slope, from three (3) feet below the normal minimum operating level to the top of the dam. (3-20-20)T

b. Where riprap is required by Rule Subsection 055.07, pipes, cables, brush, tree growth, dead growth, logs, or floating debris are not acceptable substitutes for rock riprap and granular bedding material. (3-20-20)T

**08. Outlet Conduits.** All reservoirs shall be provided with an outlet conduit of sufficient capacity to prevent interference with natural streamflow through the reservoir to the injury of downstream appropriators unless waived by the Director. In addition to any natural flow releases, the outlet conduit should be of sufficient capacity to pass at the same time, the maximum water requirement of the owner. A larger outlet conduit may be required to provide adequate release capability as determined by the Director. (3-20-20)T

a. Outlet conduits shall be laid on a firm, stable foundation and normally not be placed on fills which

can consolidate, allow differential settlement, and cause separation or misalignment of the pipe. Unless otherwise required, the outlet shall have a minimum inside diameter of twelve (12) inches. The conduits shall be of reinforced concrete or of metal pipe encased in concrete, poured with a continuous seal between the concrete and the trench except as otherwise approved by the Director. Void spaces and uncompacted areas shall not be covered over when the outlet trench is backfilled. Outlets shall be properly aligned on an established grade and may be supported on a concrete cradle, or otherwise supported and kept aligned when the outlet is covered. (3-20-20)T

**b.** Asphalt dipped or other metal pipe is not acceptable unless it is encased in concrete. Exceptions may be made only where conditions warrant, but in no case shall the reasonable life expectancy of the pipe be less than the design life of the dam. (3-20-20)T

**c.** All outlet conduits shall have a seepage path through the impervious zone at least equivalent in length to the maximum head above the downstream end of the system. Only one-third (1/3) the horizontal distance through the impervious zone will be utilized when calculating the length of the seepage path. Collars may be used to satisfy this requirement but all collars shall extend a minimum of two (2) feet outside the conduit for dams up to thirty (30) feet in height and a minimum of three (3) feet for dams above that height. Collars shall be spaced at intervals of at least seven (7) times their height and no collar may be closer to the outer surface of the impervious zone than the distance it extends out from the conduit. (3-20-20)T

**d.** The use of multiple conduits is allowed only upon the written approval of the Director. (3-20-20)T

**09. Gates.** All conduits shall be gated on the upstream end, unless otherwise approved by the Director, with either a vertical or an inclined gate. All conduits shall be vented directly behind the gate unless otherwise determined by the Director. Reservoirs storing water during the winter and subject to severe ice conditions shall have inclined gate controls enclosed in a protective sleeve which is buried. All gate stem pedestals shall be made of concrete. All trash racks shall slope toward the reservoir. At least one (1) of the sides of the inlet structure shall be open to allow water to flow into the outlet conduit and shall be covered with a trash rack. Trash racks should be designed with bars primarily in one (1) direction so they can be cleaned. If fish screens are used, they shall be placed over the trash rack and shall be removable for cleaning, or of the self-cleaning type. (3-20-20)T

**10. Outlet Controls.** Outlet controls shall be installed at a stable location, on the crest or on an elevated platform, or within an enclosure when required, which is readily accessible, but secured to prevent unauthorized operation. (3-20-20)T

**11. Release Capability.** Based on the size of the dam and on the risk category assigned by the Director, the release capability of a dam shall equal or exceed the inflow design flood in the following table:

<b>Downstream Risk Category</b>	<b>Size Classification</b>	<b>Inflow Design Flood</b>
Low	Small	Q50
	Intermediate	Q100
	Large	Q500
Significant	Small	Q100
	Intermediate	Q500
	Large	0.5 PMF
High	Small	Q100
	Intermediate	0.5 PMF
	Large	PMF

NOTE: The inflow design flood(s) indicated in the table include specific frequency floods (2%/50yr, 1%/100 yr.)

expressed in terms of exceedance with a probability the flood will be equaled or exceeded in any given year (a fifty (50) year flood has a two percent (2%) chance of occurring in any given year and a one hundred (100) year flood has a one percent (1%) chance of occurring in any given year); or PMF - probable maximum flood, which may be expected from the most severe combination of meteorologic and hydrologic conditions that are reasonably possible in the region. The PMF is derived from the probable maximum precipitation (PMP) which is the greatest theoretical depth of precipitation for a given duration that is physically possible over a particular drainage area at a certain time of year. (3-20-20)T

**a.** All spillways shall be stabilized for the discharge of flow by the use of concrete, masonry, riprap or sod, if not constructed in resistant rock. (3-20-20)T

**b.** Where site conditions allow, the spillway shall be constructed independent of embankment dams. The spillway(s) shall guide the discharge of water away from the dam embankment so as not to erode or endanger the structure. (3-20-20)T

**c.** The minimum base width of an open-channel spillway shall be ten (10) feet. Conduits or siphon pipes other than glory hole spillways are not acceptable substitutes for an open-channel spillway. (3-20-20)T

**d.** The effectiveness of spillways shall be undiminished by bridges, fences, pipelines or other structures. (3-20-20)T

**e.** Unless expressly authorized in writing by the Director, or approved as an integral part of an operation plan, stop logs or flashboards shall not be installed in spillways. (3-20-20)T

**12. Reservoir Site.** The dam site shall be cleared of all trees, brush, large rocks, and debris unless otherwise waived by the Director. The reservoir site shall be cleared of all woody material, growth or debris that is large enough to lodge in the spillway, or outlet works, except as otherwise approved by the Director. (3-20-20)T

**13. Inspection and Completion Reports.** As construction proceeds, it is the responsibility of the engineer to submit test reports (e.g. soil material analyses, density tests, concrete strength tests) along with periodic inspection and progress reports to the Director. (3-20-20)T

**a.** Upon completion of construction the owner or his engineer shall provide the Director a short, written narrative account of all items of work. Record drawings and revised specifications shall be submitted to the Director if the completed project has been substantially changed from the plans and construction specifications originally approved. (3-20-20)T

**b.** The engineer representing the owner shall certify that construction, reconstruction, enlargement, replacement or repair of the dam and appurtenances was completed in accordance with the record drawings and specifications, or as revised. (3-20-20)T

**051. -- 054. (RESERVED)**

**055. EXISTING INTERMEDIATE OR LARGE DAMS (RULE 55).**

All dams regulated by the department shall be operated and maintained to retain the embankment dimensions and the hydraulic capacity of the outlet works and spillway(s) as designed and constructed, or as otherwise required by these rules. (3-20-20)T

**01. Analyses Required.** The analyses required by Rule 40 are not applicable to existing dams except as required in Rule Subsections 055.01.a. and 055.01.e. unless for good cause, the Director specifically requires the analyses. Dams constructed of other than earth material shall comply with these criteria, as determined by the Director, or with other engineering criteria approved by the Director. (3-20-20)T

**a.** For large, significant or high risk dams, the release capability required by Rule Subsection 050.11 shall be evaluated and applied to the structure. Dams of other size and risk are required to provide the release capability of Rule Subsection 050.11 but are not required to conduct the analyses. (3-20-20)T

**b.** Every dam, unless exempted by the Director shall have a spillway with a capacity to pass a flood of one percent (1%) (two percent (2%) for small low hazard dams) occurring with the reservoir full to the spillway crest at the beginning of the flood while maintaining the freeboard required by Rule Subsection 050.06. (3-20-20)T

**c.** The Director may waive the spillway requirement for dams proposing off stream storage or upon a showing acceptable to the Director. (3-20-20)T

**d.** The release capability can include the capacity of spillway(s) and outlet(s), diversion facilities, or other appurtenant structures, and any approved operating procedures which utilize upstream storage, diversion and flood routing storage to pass flood events. The remainder of the required release capacity, if any, may be met by the following: (3-20-20)T

**i.** Reconstruction, enlargement or addition of spillway(s), outlet(s), diversion facilities or other appurtenant structures. (3-20-20)T

**ii.** A showing acceptable to the Director that failure of the dam during a flood of the specified magnitude described in Rule Subsection 050.11 would not substantially increase downstream damages over and above the losses and damages that would result from any natural flood up to that magnitude. (3-20-20)T

**iii.** A showing acceptable to the Director that the release capability of the dam together with other emergency release modes such as a controlled failure or overtopping of the dam would not result in a larger rate of discharge than the rate of inflow to the reservoir. (3-20-20)T

**iv.** A showing acceptable to the Director that limiting physical factors unique to the dam site exist that prevent construction of a spillway or other release capability mechanisms during a flood of the specified magnitude described in Rule Subsection 050.11 provided the owner implements storage operational procedures and/or provides for emergency warning to protect life and property. (3-20-20)T

**e.** For large, high risk dams, the seismic design loads shall be evaluated and applied to dams located east of Range 22E, B.M. The evaluation shall use the maximum ground motion/acceleration generated by the maximum credible earthquake. (3-20-20)T

**f.** The Director may accept existing studies relative to requirements of Rule Subsections 055.01.a. and 055.01.e., if the Director determines the information provided fulfills the requirements of Rule Subsections 055.01.a. and 055.01.e. (3-20-20)T

**g.** The Director may allow until July 1, 1992 for completion of the analyses required in Rule Subsections 055.01.a. and 055.01.g. and may allow the owner of an existing dam a compliance period of up to ten years for completing the studies, to complete structural modifications or implement other improvements necessary to provide the release capability determined to be required (Rule Subsection 055.01.a.) or complete structural modifications necessary to assure the dam and appurtenant facilities will safely function under earthquake loads (Rule Subsection 055.01.g.). (3-20-20)T

**h.** Within thirty (30) days after completing the analyses required in Rule Subsection 055.01.a. or 055.01.g., the owner of an existing dam that is deficient in either case (Rule Subsection 055.01.a. or 055.01.g.) shall file with the Director a schedule outlining the dates work or construction items will be completed. (3-20-20)T

**02. Other Requirements.** (3-20-20)T

**a.** Routine maintenance items include the following: (3-20-20)T

**i.** Eradication of rodents and filling animal burrows. (3-20-20)T

**ii.** Removal of vegetation and debris from the dam. (3-20-20)T

**iii.** Restoring original dimensions of the dam by the addition of fill material. (3-20-20)T

- iv. Addition of bedding or riprap material which will not increase the height or storage capacity. (3-20-20)T
- v. Repair or replacement of gates, gate stems, seals, valves, lift mechanisms or vent pipes with similar equipment. (3-20-20)T
- vi. Repair or replacement of wingwalls, headwalls or aprons including spalling concrete. (3-20-20)T
- b.** The following are not routine maintenance items: (3-20-20)T
  - i. Reconstruction of embankment slopes. (3-20-20)T
  - ii. Replacement, reconstruction or extension of outlets. (3-20-20)T
  - iii. Foundation stabilization. (3-20-20)T
  - iv. Filter or drain construction or replacement. (3-20-20)T
  - v. Spillway size alteration or modification. (3-20-20)T
  - vi. Installation of instrumentation or piezometers. (3-20-20)T
  - vii. Release capability modification. (3-20-20)T
- c.** Items not specifically described in Rule Subsections 055.02.a. and 055.02.b. will be determined by the Director to be included in one rule or the other upon receipt of a written request from the owner or his representative seeking such a determination. (3-20-20)T
- d.** Where riprap is required to prevent erosion and to maintain a stable embankment, pipes, cables, brush, tree growth, logs, or floating debris are not acceptable substitutes for rock riprap and granular bedding material. Dams or portions thereof which are stable without riprap, are not required to have riprap. (3-20-20)T
- e.** Upon completion of reconstruction of a dam or feature of a dam included in Rule Subsection 055.02.b., the owner or his engineer shall provide the Director a short written narrative account of all items of work. Record drawings and revised specifications shall be submitted to the Director if the completed project has been substantially changed from the plans and construction specifications originally approved. (3-20-20)T
- f.** Upon request, the owner of every dam shall provide his name and address to the Director and shall advise the Director of future changes in ownership. If the owner does not reside in Idaho, the owner shall provide the name and address of the person residing in Idaho who is responsible for the operation, maintenance and repair of the dam. (3-20-20)T

**056. -- 061. (RESERVED)**

**060. SMALL DAM DESIGN CRITERIA (RULE 60).**

The following provisions apply to small dams. (3-20-20)T

**01. Design and Construction of Small Dams.** Design and construction of small dams located in high risk areas as determined by the Director require submittal of fees, plans and specifications prepared by an engineer and shall follow the same general criteria established under Rules 40, 45, 50, and 55. Other small dams not determined to be in a high risk area shall follow the same general criteria established under Rules 50 and 55 or larger dams, except that submittal of plans, specifications and test results is not required. (3-20-20)T

**02. Notification Prior to Construction.** The owner shall notify the Director in writing ten (10) calendar days prior to commencing construction. (3-20-20)T

**03. Approval Required.** The owner shall not proceed with the following stages of construction

without approval from the Director. (3-20-20)T

- a. After clearing and excavation of the foundation area and cutoff trench, and prior to placing any fill material; (3-20-20)T
- b. After installation of the outlet conduit, and before placing any backfill material around the conduit; (3-20-20)T
- c. After construction is completed, and before any water is stored in the reservoir; (3-20-20)T
- d. At such other times as determined necessary by the Director. The Director, will, upon seven (7) day notice, inspect and, if satisfactory, approve the completed stage of construction. (3-20-20)T

**04. Notification upon Completion of Construction.** The owner shall in writing notify the Director upon completion of construction. (3-20-20)T

**061. -- 064. (RESERVED)**

**065. DAMS STORING TAILINGS AND WATER (RULE 65).**

**01. Construction of Dams Storing Fifty Acre-Feet or More.** Construction of dams intended to store or likely to store fifty (50) acre-feet or more of water in excess of the water contained in the tailings material shall meet the requirements specified in Rules 40, 45, 50 and 55 of these rules. The Director may waive any or all of these requirements if, in the opinion of the Director, sound engineering design provided by the owner indicates such requirements are not applicable. (3-20-20)T

**02. Abandonment Plan.** An abandonment plan which provides a stable, maintenance-free condition at any time tailings are not being actively placed for an extended period of time, as determined by the Director, shall be submitted to the Director by the owner of a dam storing tailings and water. This rule may be waived by the Director if determined not to be applicable. (3-20-20)T

**066. -- 999. (RESERVED)**



### 37.03.07 – STREAM CHANNEL ALTERATION RULES

#### 000. LEGAL AUTHORITY (RULE 0).

The purpose of these rules and minimum standards is to specify procedures for processing and considering applications for stream channel alterations under the provisions of Title 42, Chapter 38, Idaho Code. (3-20-20)T

#### 001. TITLE AND SCOPE (RULE 1).

01. **Title.** These rules are titled IDAPA 37.03.07, “Stream Channel Alteration Rules.” (3-20-20)T

02. **Scope.** The minimum standards are intended to enable the Director to process, in a short period of time, those applications which are of a common type and which do not propose alterations which will be a hazard to the stream channel and its environment. It is intended that these rules and minimum standards be administered in a reasonable manner, giving due consideration, to all factors affecting the stream and adjacent property. (3-20-20)T

#### 002. -- 009. (RESERVED)

#### 010. DEFINITIONS (RULE 10).

01. **Alteration.** To obstruct, diminish, destroy, alter, modify, relocate or change the natural existing shape of the channel or to change the direction of flow of water of any stream channel within or below the mean high water mark. It includes removal of material from the stream channel and emplacement of material or structures in or across the stream channel where the material or structure has the potential to affect flow in the channel as determined by the director. (3-20-20)T

02. **Applicant.** Any individual, partnership, company, corporation, municipality, county, state or federal agency, their agent, or other entity proposing to alter a stream channel or actually engaged in constructing a channel alteration, whether authorized or not. (3-20-20)T

03. **Board.** The Idaho Water Resource Board. (3-20-20)T

04. **Continuously Flowing Water.** A sufficient flow of water that could provide for migration and movement of fish, and excludes those reaches of streams which, in their natural state, normally go dry at the location of the proposed alteration. IDWR will assume, subject to information to the contrary, that the USGS quadrangle maps accurately depict whether a stream reach is continuously flowing, at the location of the proposed alteration. Such exclusion does not apply to minor flood channels that are a part of a stream which is continuously flowing in the reach where the alteration is located. Also, such exclusion does not apply to streams which may be dry as a result of upstream diversion or storage of water. (3-20-20)T

05. **Department.** The Idaho Department of Water Resources. (3-20-20)T

06. **Drop Structures, Sills and Barbs.** Physical obstructions placed within a stream channel for the purpose of stabilizing the channel by decreasing stream gradient and velocity and by dissipating stream energy. (3-20-20)T

07. **Director.** The Director of the Idaho Department of Water Resources. (3-20-20)T

08. **Mean High Water Mark.** A water level corresponding to the “natural or ordinary high water mark” as defined in Section 58-104(9), Idaho Code, and is the line which the water impresses on the soil by covering it for sufficient periods of time to deprive the soil of its terrestrial vegetation and destroy its value for commonly accepted agricultural purposes. (3-20-20)T

09. **Non-Powered Sluice Equipment.** Equipment which is powered only by human strength. (3-20-20)T

10. **Plans.** Maps, sketches, engineering drawings, photos, work descriptions and specifications sufficient to describe the extent, nature, and location of the proposed stream channel alteration and the proposed method of accomplishing the alteration. (3-20-20)T

11. **Repair.** Any work needed or accomplished, to protect, maintain, or restore any water diversion structure and the associated stream channel upstream and downstream as necessary for the efficient operation of the water diversion structure. (3-20-20)T

**12. Stream Channel.** A natural water course of perceptible extent with definite beds and banks which confines and conducts continuously flowing water. The channel referred to is that which exists at the present time, regardless of where the channel may have been located at any time in the past. For the purposes of these rules only, the beds of lakes and reservoir pool areas are not considered to be stream channels. (3-20-20)T

**13. Base Flood Elevation.** The Base Flood (BF) is referred to as the one hundred (100) year flood and is a measure of flood magnitude based on probability. The base flood has a one percent chance of occurring or being exceeded in any given year, with the Base Flood Elevation (BFE) being the level of flooding reached during the BF or the one hundred (100) year flood event. (3-20-20)T

**011. -- 024. (RESERVED)**

**025. EXEMPTIONS (RULE 25).**

**01. Work on Existing or Proposed Reservoir Projects.** Permits are not required under the provisions of Title 42, Chapter 38 for construction work on any existing or proposed reservoir project, including the dam, and such areas downstream as the Director may determine is reasonably necessary for construction and maintenance of the dam. (3-20-20)T

**02. Snake and Clearwater Rivers.** Permits are not required for work within that portion of the Snake and Clearwater rivers from the state boundary upstream to the upper boundary of the Port of Lewiston Port District as it now exists or may exist in the future. (3-20-20)T

**03. Cleaning, Maintenance, Construction or Repair Work.** No permit is required of a water user or his agent to clean, maintain, construct, or repair any diversion structure, canal, ditch, or lateral or to remove any obstruction from a stream channel which is interfering with the delivery of any water under a valid existing water right or water right permit. (3-20-20)T

**04. Removal of Debris.** No permit is required for removal of debris from a stream channel provided that no equipment will be working in the channel and all material removed will be disposed of at some point outside the channel where it cannot again reenter the channel. (3-20-20)T

**026. -- 029. (RESERVED)**

**030. APPLICATIONS (RULE 30).**

**01. Joint Application Permit Form.** The Department of Water Resources, Department of Lands, and the U.S. Army Corps of Engineers have developed a joint application for permit form which will suffice for the required application under the Stream Protection Act. An application should be filed at least sixty (60) days before the applicant proposes to start the construction and shall be upon the joint application form furnished by the Department. The application shall be accompanied by plans which clearly describe the nature and purpose of the proposed work. (3-20-20)T

**02. Applicant Following Minimum Standards.** In those cases where the applicant intends to follow the minimum standards (Rule 055), detailed plans may be eliminated by referring to the specific minimum standard; however, drawings necessary to adequately define the extent, purpose, and location of the work will still be required. Plans shall include some reference to water surface elevations and stream boundaries to facilitate review. The application should show the mean high water mark on the plans; however, any water surface or water line reference available will be helpful as long as this reference is described. (Examples: present water surface, low water, high water.) (3-20-20)T

**03. Submission of Copies.** The applicant shall submit one (1) copy of all necessary plans along with the application form. When drawings submitted are larger than eight and one half by eleven (8 1/2 x 11), the applicant shall provide the number of copies specified by the department. (3-20-20)T

**04. Stream Channel Alteration Permit.** Any applicant proposing to operate a vacuum or suction dredge within or below the mean high water mark of a stream channel shall apply for and obtain a stream channel

alteration permit. The vacuum or suction dredge shall only be operated in accordance with the conditions of the permit and with the applicable rules. (3-20-20)T

**031. -- 034. (RESERVED)**

**035. APPLICATION REVIEW (RULE 35).**

**01. Prior to Issuance of Permit.** The following items shall be among those considered by the Director prior to issuing a permit: (3-20-20)T

- a.** What is the purpose of doing the work? (3-20-20)T
- b.** What is the necessity and justification for the proposed alteration? (3-20-20)T
- c.** Is the proposal a reasonable means of accomplishing the purpose? (3-20-20)T
- d.** Will the alteration be a permanent solution? (3-20-20)T
- e.** Will the alteration pass anticipated water flows without creating harmful flooding or erosion problems upstream or downstream? (3-20-20)T
- f.** What effect will the alteration have on fish habitat? (3-20-20)T
- g.** Will the materials used or the removal of ground cover create turbidity or other water quality problems? (3-20-20)T
- h.** Will the alteration interfere with recreational use of the stream? (3-20-20)T
- i.** Will the alteration detract from the aesthetic beauty of the area? (3-20-20)T
- j.** What modification or alternative solutions are reasonably possible which would reduce the disturbance to the stream channel and its environment and/or better accomplish the desired goal of the proposed alteration? (3-20-20)T
- k.** Is the alteration to be accomplished in accordance with the adopted minimum standards? (3-20-20)T
- l.** Are there public safety factors to consider? (3-20-20)T

**02. Proposed Alteration Which Does Not Follow Minimum Standards.** In those cases where a proposed alteration does not follow the minimum standards, a copy of the application will be sent for review to those state agencies requesting notification. The Director shall provide for review by the Department of Lands, copies of applications on navigable rivers. The Director will provide a copy of any other application requested by the Department of Lands and may request review by other state agencies regardless of whether or not the proposed alteration will comply with the minimum standards. (3-20-20)T

**036. -- 039. (RESERVED)**

**040. APPROVAL (RULE 40).**

**01. Conformance to Application.** All work shall be done in accordance with the approved application, subject to any conditions specified by the department. (3-20-20)T

**02. Permits Allowed Without Review.** A permit may be approved by the Director of the Department of Water Resources without review by other agencies in situations where the work is of a nature not uncommon to the particular area and where it is clear that the work will not seriously degrade the stream values except on navigable rivers which require review by the Department of Lands. All work approved in this manner shall be accomplished in

accordance with the minimum standards. (3-20-20)T

**03. Reinstatement of Expired Permit.** A permit which has expired may be reinstated by the Director after review by other agencies as determined by the Director. (3-20-20)T

**041. -- 044. (RESERVED)**

**045. ENFORCEMENT OF ACT (RULE 45).**

**01. Written Orders Issued by Designated Employees of Department.** Employees of the Department designated by the Director may issue written orders directing an applicant to cease and desist, to ensure proper notice to applicants who are found to be altering a stream without a permit or not in compliance with the conditions of a permit. Such orders shall be in effect immediately upon issuance and will continue in force until a permit is issued or until the order is rescinded by the Director. (3-20-20)T

**02. Failure to Comply with Stream Protection Act.** Failure to comply with any of the provisions of the Stream Protection Act (Chapter 38, Title 42, Idaho Code), may result in issuance of an Idaho uniform citation and/or the cancellation of any permit by the Director without further notice and the pursuit in a court of competent jurisdiction, such civil or criminal remedies as may be appropriate and provided by law. The Director may allow reasonable time for an applicant to complete stabilization and restoration work. (3-20-20)T

**046. -- 049. (RESERVED)**

**050. EMERGENCY WAIVER (RULE 50).**

**01. Waiver of Provisions of Stream Protection Act.** Section 42-3808, Idaho Code, provides for waiver of the provisions of the Stream Protection Act in emergency situations where immediate action must be taken to protect life or property including growing crops. The Director will not consider failure to submit an application for a stream channel alteration far enough ahead of the desired starting time of the construction work as an emergency situation. (3-20-20)T

**02. Verbal Waivers.** A verbal waiver may be granted initially; however, all verbal requests for waivers shall be followed up by the applicant in writing within fifteen (15) days of any initial authorization to do work. If the applicant is unable to contact the Director to obtain an emergency waiver, he may proceed with emergency work; however, he must contact the Director as soon as possible thereafter. Proving that a bonafide emergency did actually exist will be the responsibility of the applicant. (3-20-20)T

**03. Emergency Waiver.** Work authorized by an emergency waiver shall be limited to only that which is necessary to safeguard life or property, including growing crops, during the period of emergency. (3-20-20)T

**04. Conformance to Conditions of Waiver.** The applicant shall adhere to all conditions set by the Director as part of a waiver. (3-20-20)T

**05. Waivers Granted by Designated Employees.** The Director may delegate the authority to grant waivers to designated employees of the Department. Names and telephone numbers of such employees will be made available to any interested applicant upon request. (3-20-20)T

**051. -- 054. (RESERVED)**

**055. MINIMUM STANDARDS (RULE 55).**

These standards are intended to cover the ordinary type of stream channel alteration and to prescribe minimum conditions for approval of such construction. Unless otherwise provided in a permit, these standards shall govern all stream channel alterations in this state. An applicant should not assume that because an application utilizes methods set forth in these standards it will automatically be approved. These minimum standards include the following items: (3-20-20)T

**01. Construction Procedures.** (3-20-20)T

- 02. **Dumped Rock Riprap.** (3-20-20)T
- 03. **Drop Structures, Sills and Barbs.** (3-20-20)T
- 04. **Culverts and Bridges.** (3-20-20)T
- 05. **Removal of Sand and Gravel Deposits.** (3-20-20)T
- 06. **Suction Dredges and Non-Powered Sluice Equipment.** (3-20-20)T
- 07. **Piling.** (3-20-20)T
- 08. **Pipe Crossings.** (3-20-20)T
- 09. **Concrete Plank Boat Launch Ramps.** (3-20-20)T

**056. CONSTRUCTION PROCEDURES (RULE 56).**

**01. Conformance to Procedures.** Construction shall be done in accordance with the following procedures unless specific approval of other procedures has been given by the Director. When an applicant desires to proceed in a manner different from the following, such procedures should be described on the application. (3-20-20)T

**02. Operation of Construction Equipment.** No construction equipment shall be operated below the existing water surface without specific approval from the Director except as follows: Fording the stream at one (1) location only will be permitted unless otherwise specified; however, vehicles and equipment will not be permitted to push or pull material along the streambed below the existing water level. Work below the water which is essential for preparation of culvert bedding or approved footing installations shall be permitted to the extent that it does not create unnecessary turbidity or stream channel disturbance. Frequent fording will not be permitted in areas where extensive turbidity will be created. (3-20-20)T

**03. Temporary Structures.** Any temporary crossings, bridge supports, cofferdams, or other structures that will be needed during the period of construction shall be designed to handle high flows that could be anticipated during the construction period. All structures shall be completely removed from the stream channel at the conclusion of construction and the area shall be restored to a natural appearance. (3-20-20)T

**04. Minimizing Disturbance of Area.** Care shall be taken to cause only the minimum necessary disturbance to the natural appearance of the area. Streambank vegetation shall be protected except where its removal is absolutely necessary for completion of the work adjacent to the stream channel. (3-20-20)T

**05. Disposal of Removed Materials.** Any vegetation, debris, or other material removed during construction shall be disposed of at some location out of the stream channel where it cannot reenter the channel during high stream flows. (3-20-20)T

**06. New Cut of Fill Slopes.** All new cut or fill slopes that will not be protected with some form of riprap shall be seeded with grass and planted with native vegetation to prevent erosion. (3-20-20)T

**07. Fill Material.** All fill material shall be placed and compacted in horizontal lifts. Areas to be filled shall be cleared of all vegetation, debris and other materials that would be objectionable in the fill. (3-20-20)T

**08. Limitations on Construction Period.** The Director may limit the period of construction as needed to minimize conflicts with fish migration and spawning, recreation use, and other uses. (3-20-20)T

**057. DUMPED ROCK RIPRAP (RULE 57).**

- 01. **Placement of Riprap.** Riprap shall be placed on a granular bedding material or a compact and

stable embankment. (3-20-20)T

**02. Sideslopes of Riprap.** Sideslopes of riprap shall not be steeper than 2:1 (2' horizontal to 1' vertical) except at ends of culverts and at bridge approaches where a 1 1/2:1 sideslope is standard. (3-20-20)T

**03. Minimum Thickness of Riprap.** The minimum thickness of the riprap layer shall equal the dimension of the largest size riprap rock used or be eighteen (18) inches, whichever is greater. When riprap will be placed below high water level, the thickness of the layer shall be fifty percent (50%) greater than specified below. (3-20-20)T

**04. Riprap Protection.** Riprap protection must extend at least one (1) foot above the anticipated high water surface elevation in the stream. (3-20-20)T

**05. Rock Used for Riprap.** Rock for riprap shall consist of sound, dense, durable, angular rock fragments, resistant to weathering and free from large quantities of soil, shale, and organic matter. The length of a rock shall not be more than three (3) times its width or thickness. Rounded cobbles, boulders, and streambed gravels are not acceptable as dumped riprap. (3-20-20)T

**06. Size and Gradation of Riprap.** Riprap size and gradation are commonly determined in terms of the weight of riprap rock. The average size of riprap rock shall be at least as large as the maximum size rock that the stream is capable of moving. The maximum size of riprap rock used shall be two (2) to five (5) times larger than the average size. (3-20-20)T

**07. Methods Used for Determining Gradation of Riprap.** There are many methods used for determining the gradation of riprap rock. One of these many acceptable methods is shown in Table 1 below the Far West States (FWS) method shown in APPENDIX A - Table 1A at the end of this chapter.

GRADATION OF RIPRAP IN POUNDS		
Max. Weight of Stone required (lbs)	Min. and Max. Range in weight of Stones (lbs)	Weight Range 75 percent of Stones (lbs)
150	25 - 150	50 - 150
200	25 - 200	50 - 200
250	25 - 250	50 - 250
400	25 - 400	100 - 400
600	25 - 600	150 - 600
800	25 - 800	200 - 800
1000	50 - 1000	250 - 1000
1300	50 - 1300	325 - 1300
1600	50 - 1600	400 - 1600
2000	75 - 2000	600 - 2000
2700	100 - 2700	800 - 2700

(3-20-20)T

**08. Use of Filter Material.** A blanket of granular filter material or filter fabric shall be placed between the riprap layer and the bank in all cases where the bank is composed of erodible material that may be washed out from between the riprap rock. Filter material shall consist of a layer of well-graded gravel and coarse sand at least six (6) inches thick. (3-20-20)T

**09. Toe Protection.** Some suitable form of toe protection shall be provided for riprap located on erodible streambed material. (3-20-20)T

**a.** Various acceptable methods of providing toe protection are shown in APPENDIX B at the end of this chapter. (3-20-20)T

**b.** In addition to the approved methods of providing toe protection as shown in APPENDIX B at the end of this chapter, any other reasonable method will be considered by the Director during review of a proposed project. (3-20-20)T

**10. Extension of Riprap Area.** Riprap shall extend far enough upstream and downstream to reach stable areas, unless protected against undermining at ends by the method shown in APPENDIX C, Figure 3 at the end of this chapter. On extremely long riprap sections, it is recommended that similar cutoff sections be used at several intermediate points to reduce the hazard that would be created if failure of the riprap occurred at any one (1) location. (3-20-20)T

**11. Finished Surface.** Placement shall result in a smooth, even finished surface. Compaction is not necessary. (3-20-20)T

**12. Placement of Riprap.** The full course thickness of the riprap shall be placed in one (1) operation. Dumping riprap long distances down the bank or pushing it over the top of the bank with a dozer shall be avoided if possible. Material should be placed with a backhoe, loader, or dragline. Dumping material near its final position on the slope or dumping rock at the toe and bulldozing it up the slope is a very satisfactory method of placement, if approval is obtained for the use of equipment in the channel. (3-20-20)T

**13. Design Procedure.** Design procedure using the Far West States (FWS) method. (3-20-20)T

**a.** The FWS method uses a single equation to deal with variables for riprap. (3-20-20)T

$$D75 = 3.5/CK \text{ WDS for Channel Banks}$$

where:  $D75$  = Size of the rock at seventy five percent (75%) is finer in gradation, in inches.

$W$	=	Specific weight of water, usually 62.4 lbs./cu.ft.
$D$	=	Depth of flow in stream, in feet in flood stage
$S$	=	Channel slope or gradient, in ft/ft.
$C$	=	A coefficient relating to curvature in the stream
$K$	=	A coefficient relating to steepness of bank slopes

(3-20-20)T

**b.** The coefficient,  $C$ , is based on the ratio of the radius of curvature of the stream, ( $CR$ ), to the water surface width, ( $WSW$ ), so it is necessary for the user to make field determination of these values. The coefficient varies from 0.6 for a curve ratio of 4 to 6, up to 1.0 for a straight channel. If the computed ratio for a particular project is less than 4, the designer should consider some modification less than 4.

<b>CR/WSW</b>	<b>C</b>
4 - 6	0.60
6 - 9	0.75
9 - 12	0.90
Straight Channel	1.00

(3-20-20)T

c. The coefficient, K, ranges from 0.5 for a 1.5:1 sideslope to 0.87 for 3:1 sideslope. No values are given for steeper or flatter slopes. Slopes steeper than 1.5:1 are not recommended. If slopes flatter than 3:1 are desired, it would be conservative to use the K-value for 3:1 slopes.

<b>Bankslope</b>	<b>K</b>
1.5:1	0.50
1.75:1	0.63
2.0:1	0.72
2.5:1	0.80
3.0:1	0.87

(3-20-20)T

Table 1A in APPENDIX A, located at the end of this chapter.

**058. DROP STRUCTURES, SILLS AND BARBS (RULE 58).**

**01. Drop Structures.** A drop structure shall be constructed of rocks, boulders and/or logs placed within a stream channel to act as a low level dam. Placement of a drop structure perpendicular to stream flow will decrease the stream gradient, dissipate stream energy and decrease stream velocity through an increase in water surface elevation immediately above the structure. Drop structures shall comply with the following criteria: (3-20-20)T

a. Maximum water surface differential across (upstream water surface elevation minus downstream water surface elevation) a drop structure shall not exceed two (2) feet. The department shall approve the final elevation of any structure. (3-20-20)T

b. Rock drop structures shall be constructed of clean, sound, dense, durable, angular rock fragments, and/or boulders of size and gradation, such that the stream is incapable of moving the material during peak flows. Rocks shall be keyed into the stream banks to minimize the likelihood of bank erosion. (See Figure 8 in APPENDIX H located at the end of this chapter). (3-20-20)T

c. Log drop structures are acceptable in four (4) designs including the single log dam, the stacked log dam, the three (3) log dam, and the pyramid log dam. Log ends shall be keyed into both banks at least one-third (1/3) of the channel width or a distance sufficient to prevent end erosion. To prevent undercutting, the bottom log shall be imbedded in the stream bed or hardware cloth, cobbles or boulders shall be placed along the upper edge. Minimum log size for a single log structure shall be determined by on-site conditions and shall be placed to maintain flow over the entire log to prevent decay. Each log drop structure must be accompanied by downstream scour protection, such as a rock apron (See Figure 9 in APPENDIX I located at the end of this chapter). (3-20-20)T

d. All drop structures shall be constructed to facilitate fish passage and centralized scour pool development. (3-20-20)T

**02. Sills.** A sill shall be constructed of the same material and in the same manner as a drop structure. The top of the sill may not exceed the elevation of the bottom of the channel. The purpose of a sill is to halt the upstream movement of a headcut, thus precluding the widening or deepening of the existing channel. (See Figure 10 in APPENDIX J located at the end of this chapter). (3-20-20)T

**03. Barb or Partial Drop Structure.** A barb or partial drop structure shall be constructed in the same manner and of the same material as a drop structure and placed into the stream channel to act as a low level dam and grade control structure. The barb will decrease stream gradient, dissipate stream energy and redirect stream flow. (3-20-20)T



- a.** Barbs shall be constructed of clean, sound, dense, angular rock fragments, of size and gradation such that the stream is incapable of moving the material during peak flows. (3-20-20)T
- b.** Barbs shall be constructed with a downstream angle of no less than one hundred (100) degrees and no greater than one hundred thirty-five (135) degrees unless otherwise specified. (3-20-20)T
- c.** Barbs shall “extend” into the channel a distance of not more than twenty percent (20%) of the width of the channel unless otherwise specified by the Director. (3-20-20)T
- d.** Barbs shall be keyed into the bank a distance equal to or greater than the width of the structure and down to bed level. Whenever moisture is encountered in the construction of the keyways, willow cuttings or clumps shall be placed before and during rock placement in such a manner that the base of the cutting is in permanent moisture and the top extends a minimum of six (6) inches above grade (see Figure 11 in APPENDIX K located at the end of this chapter). (3-20-20)T

**059. CULVERTS AND BRIDGES (RULE 59).**

**01. Culverts and Bridges.** Culverts and bridges shall be capable of carrying streamflows and shall not significantly alter conditions upstream or downstream by causing flooding, turbidity, or other problems. The appearance of such installations shall not detract from the natural surroundings of the area. (3-20-20)T

**02. Location of Culverts and Bridges.** Culverts and bridges should be located so that a direct line of approach exists at both the entrance and exit. Abrupt bends at the entrance or exit shall not exist unless suitable erosion protection is provided. (3-20-20)T

**03. Ideal Gradient.** The ideal gradient (bottom slope) is one which is steep enough to prevent silting but flat enough to prevent scouring due to high velocity flows. It is often advisable to make the gradient of a culvert coincide with the average streambed gradient. (3-20-20)T

**a.** Where a culvert is installed on a slope steeper than twenty percent (20%), provisions to anchor the culvert in position will be required. Such provisions shall be included in the application and may involve the use of collars, headwall structures, etc. Smooth concrete pipe having no protruding bell joints or other irregularities shall have such anchoring provisions if the gradient exceeds ten percent (10%). (3-20-20)T

**04. Size of Culvert or Bridge Opening.** The size of the culvert or bridge opening shall be such that it is capable of passing design flows without overtopping the streambank or causing flooding or other damage. (3-20-20)T

**a.** Design flows shall be based upon the following minimum criteria:

<b>Drainage Area</b>	<b>Design Flow Frequency</b>
Less than 50 sq. mi.	25 Years
Over 50 sq. mi. or more	50 years or greatest flow of record, whichever is more

(3-20-20)T

**b.** For culverts and bridges located on U.S. Forest Service or other federal lands, the sizing should comply with the Forest Practices Act as adopted by the federal agencies or the Department of Lands. (3-20-20)T

**c.** For culverts or bridges located in a community qualifying for the national flood issuance program, the minimum size culvert shall accommodate the one hundred (100) year design flow frequency. (3-20-20)T

**d.** If the culvert or bridge design is impractical for the site, the crossing may be designed with additional flow capacity outside the actual crossing structure, provided there is no increase in the Base Flood

Elevation.

(NOTE: When flow data on a particular stream is unavailable, it is almost always safe to maintain the existing gradient and cross-section area present in the existing stream channel. Comparing the proposed crossing size with others upstream or downstream is also a valuable means of obtaining information regarding the size needed for a proposed crossing.) (3-20-20)T

**e.** Minimum clearance shall be at least one (1) foot at all bridges. This may need to be increased substantially in the areas where ice passage or debris may be a problem. Minimum culvert sizes required for stream crossings: (3-20-20)T

i. Eighteen (18) inch diameter for culverts up to seventy (70) feet long; (3-20-20)T

ii. Twenty-four (24) inch diameter for all culverts over seventy (70) feet long. (3-20-20)T

**f.** In streams where fish passage is of concern as determined by the director, an applicant shall comply with the following provisions and/or other approved criteria to ensure that passage will not be prevented by a proposed crossing. (3-20-20)T

**g.** Minimum water depth shall be approximately eight (8) inches for salmon and steelhead and at least three (3) inches in all other cases. (3-20-20)T

**h.** Maximum flow velocities for streams shall not exceed those shown in Figure 17 in APPENDIX N, located at the end of this chapter, for more than a forty-eight (48) hour period. The curve used will depend on the type of fish to be passed. (3-20-20)T

**i.** Where it is not feasible to adjust the size or slope to obtain permissible velocities, the following precautions may be utilized to achieve the desired situation. (3-20-20)T

**j.** Baffles downstream or inside the culvert may be utilized to increase depth and reduce velocity. Design criteria may be obtained from the Idaho Fish and Game Department. (3-20-20)T

**k.** Where multiple openings for flow are provided, baffles or other measures used in one (1) opening only shall be adequate provided that the opening is designed to carry the main flow during low-flow periods. (3-20-20)T

**05. Construction of Crossings.** When crossings are constructed in erodible material, upstream and downstream ends shall be protected from erosive damage through the use of such methods as dumped rock riprap, headwall structures, etc., and such protection shall extend below the erodible streambed and into the banks at least two (2) feet unless some other provisions are made to prevent undermining. (3-20-20)T

**a.** Where fish passage must be provided, upstream drops at the entrance to a culvert will not be permitted and a maximum drop of one (1) foot will be permitted at the downstream end if an adequate jumping pool is maintained below the drop. (3-20-20)T

**b.** Downstream control structures such as are shown in Figure 18 in APPENDIX O, located at the end of this chapter, can be used to reduce downstream erosion and improve fish passage. They may be constructed with gabions, pilings and rock drop structures. (3-20-20)T

**06. Multiple Openings.** Where a multiple opening will consist of two (2) or more separate culvert structures, they shall be spaced far enough apart to allow proper compaction of the fill between the individual structures. The minimum spacing in all situations shall be one (1) foot. In areas where fish passage must be provided, only one (1) opening shall be constructed to carry all low flows. Low flow baffles may be required to facilitate fish passage. (3-20-20)T

**07. Areas to be Filled.** All areas to be filled shall be cleared of vegetation, topsoil, and other unsuitable material prior to placing fill. Material cleared from the site shall be disposed of above the high water line of the stream. Fill material shall be reasonably well-graded and compacted and shall not contain large quantities of silt,

sand, organic matter, or debris. In locations where silty or sandy material must be utilized for fill material, it will be necessary to construct impervious sections both upstream and downstream to prevent the erodible sand or silt from being carried away (see Figure 19, APPENDIX P, located at the end of this chapter), Sideslopes for fills shall not exceed one and one half to one (1.5:1). Minimum cover over all culvert pipes and arches shall be one (1) foot.  
(3-20-20)T

**08. Installation of Pipe and Arch Culvert.** All pipe and arch culverts shall be installed in accordance with manufacturer's recommendations. (3-20-20)T

**a.** The culvert shall be designed so that headwaters will not rise above the top of the culvert entrance unless a headworks is provided. (3-20-20)T

**060. REMOVAL OF SAND AND GRAVEL DEPOSITS (RULE 60).**

**01. Removal of Sand and Gravel.** This work consists of removal of sand and gravel deposits from within a stream channel. The following conditions shall be adhered to unless other methods have been specified in detail on the application and approved by the Director. (3-20-20)T

**02. Removal Below Water Surface.** Sand and gravel must not be removed below the water surface existing at the time of the work. Where work involves clearing a new channel for flow, removal of material below water level will be permitted to allow this flow to occur; however, this must not be done until all other work in the new channel has been completed. (3-20-20)T

**03. Buffer Zone.** A buffer zone of undisturbed streambed material at least five (5) feet in width or as otherwise specified by the Director shall be maintained between the work area and the existing stream. The applicant shall exercise reasonable precautions to ensure that turbidity is kept to a minimum and does not exceed state water quality standards. (3-20-20)T

**04. Movement of Equipment.** Equipment may cross the existing stream in one (1) location only, but shall not push or pull material along the streambed while crossing the existing stream. (3-20-20)T

**05. Disturbing Natural Appearance of Area.** Work must be done in a manner that will least disturb the natural appearance of the area. Sand and gravel shall be removed in a manner that will not leave unsightly pits or other completely unnatural features at the conclusion of the project. (3-20-20)T

**061. SUCTION DREDGES AND NON-POWERED SLUICE EQUIPMENT (RULE 61).**

**01. Standards for Suction Dredges.** The following standards shall apply only to uses of suction dredges with nozzle diameter of five (5) inches or less and rated at fifteen (15) HP or less and non-powered sluice equipment moving more than one-quarter (1/4) cubic yard per hour. (3-20-20)T

**02. Operating Permit.** A permit for the operation of a suction dredge may authorize the use of the dredge within a drainage basin or a large portion of a drainage basin except as otherwise determined by the Director. (3-20-20)T

**03. Mechanized Equipment Prohibited Below High Water Mark.** There shall be no use of mechanized equipment below the mean high water mark except for the dredge itself, and any life support system necessary to operate the dredge. (3-20-20)T

**04. Operation of Dredge.** The operation of the dredge shall be done in a manner so as to prevent the undercutting of streambanks. (3-20-20)T

**05. Permit Required for Non-Powered Operation -- More Than Five People.** A permit shall be required for any non-powered operation in which more than five (5) people are working the same area. (3-20-20)T

**06. Permit Required for Non-Powered Operation -- More Than Thirty-Three Percent of Stream Width.** A permit shall be required for any non-powered operation if the disturbed area exceeds thirty-three percent

(33%) of the stream width at the mining location. (3-20-20)T

**07. Limitation of Mining Sites.** Only one (1) mining site per one hundred (100) linear feet of stream channel shall be worked at one (1) time unless waived by the Director. (3-20-20)T

**062. PILING (RULE 62).**

**01. Standards for Pilings.** The following standards apply to a piling associated with a boat or swimming dock, a log boom, a breakwater, or bridge construction. (3-20-20)T

**02. Replacement of Pilings.** In replacing a piling the old piling shall be completely removed from the channel, secured to the new piling or cut at stream bed level. (3-20-20)T

**03. Condition of Pilings.** Chemicals or compounds used for protection of piles and lumber shall be thoroughly dried to prevent bleeding, weeping or dissolution before placing such piles and lumber over, in or near water. (3-20-20)T

**04. Prohibited Materials.** The application of creosote, arsenicals or phentachlorophenol (Penta) to timber shall not occur in, or over water. (3-20-20)T

**063. PIPE CROSSINGS (RULE 63).**

**01. Standards for Pipe Crossings.** The following standards apply to pipe crossings to be installed below the bed of a stream or river such as utility crossings of a gas line, sewer line, electrical line, communication line, water line or similar line. (3-20-20)T

**02. Depth of Line.** The line shall be installed below the streambed to a depth which will prevent erosion and exposure of the line to free flowing water. In areas of high stream velocity where scouring may occur, the pipe shall be encased in concrete or covered with rock riprap to prevent the pipeline from becoming exposed. (3-20-20)T

**03. Pipe Joints.** The joints shall be welded, glued, cemented or fastened together in a manner to provide a water tight connection. (3-20-20)T

**04. Construction Methods.** Construction methods shall provide for eliminating or minimizing discharges of turbidity, sediment, organic matter or toxic chemicals. A settling basin or cofferdam may be required for this purpose. (3-20-20)T

**05. Cofferdam.** If a cofferdam is used, it shall be completely removed from the stream channel upon completion of the project. (3-20-20)T

**06. Revegetation of Disturbed Areas.** Areas disturbed as a result of the alteration shall be revegetated with plants and grasses native to these areas. (3-20-20)T

**064. CONCRETE PLANK BOAT LAUNCH RAMPS (RULE 64).**

**01. Construction of Concrete Plank Boat Launch Ramps.** Concrete plank boat launch ramps, shall be constructed with individual sections of precast, reinforced concrete planks linked together to provide a stable non-erosive water access. Typical plank size is twelve feet by fourteen inches by four inches (12' x 14" x 4"). (See Figure 20, APPENDIX Q, located at the end of this chapter). (3-20-20)T

**02. Construction of Planks.** All planks shall be constructed with Type II low alkali cement. (3-20-20)T

**03. Concrete Planks.** All concrete planks shall have a smooth form finish, free of rock pockets and loose materials. Figure 22 shows a typical launch plank detail. (See Figures 21 and 22 in APPENDIXES R and S). (3-20-20)T

**04. Assembly of Planks.** The planks shall be assembled out of the water and slid into place on a constructed launch ramp where water velocities do not exceed two (2) feet per second. In waters exceeding (2) feet per second the ramp sections shall be linked together and fastened to pre-positioned stringers anchored into the launch ramp. (See Figure 23, APPENDIX T, located at the end of this chapter). (3-20-20)T

**05. Water Depth.** The water depth above the lower end of the ramp section shall not be less than three (3) feet during low level or low flow periods. (See Figure 20, APPENDIX Q, located at the end of this chapter). (3-20-20)T

**06. Construction of Boat Ramp.** The boat launch ramp shall have a base constructed of sound, dense, durable, angular rock resistant to weathering and free from soil, shale and organic materials. Rounded cobbles, boulders and streambed material are not acceptable as base material in areas with stream flow velocities greater than two (2) fps. Base materials shall be covered with a layer of (three-fourths inches (3/4" min.) crushed rock with a minimum depth of two inches (2"). The ramp shall have a minimum and maximum slope of ten percent (10%) and fifteen percent (15%) respectively, and shall be constructed in a manner to avoid long incursions into the stream channel. All ramps and fill material shall be protected with rock riprap in accordance with Rule 057 when stream flow velocities exceed two (2) fps. (See Figure 24, APPENDIX U, located at the end of this chapter). (3-20-20)T

**065. -- 069. (RESERVED)**

**070. HEARINGS ON DENIED, LIMITED, OR CONDITIONED PERMIT OR OTHER DECISIONS OF THE DIRECTOR (RULE 70).**

Any applicant who is granted a limited or conditioned permit, or who is denied a permit, may seek a hearing on said action of the Director by serving on the Director written notice and request for a hearing before the Board within fifteen (15) days of receipt of the Director's decision. Said hearing will be set, conducted, and notice given as set forth in the Rules promulgated by the Board under the provisions of Title 67, Chapter 52, Idaho Code. (3-20-20)T

**071. -- 999. (RESERVED)**

**APPENDIX A**  
**Table 1A**

**Riprap Gradation Using FWS Method**

<b>% Finer by Weight (Lbs.)</b>	<b>Minimum Size (Lbs.)</b>	<b>Maximum Size (Lbs.)</b>
D <sub>100</sub>	1.33 X D <sub>75</sub>	2.0 X D <sub>75</sub>
D <sub>75</sub>	1.0 X D <sub>75</sub>	1.67 X D <sub>75</sub>
D <sub>50</sub>	0.67 X D <sub>75</sub>	1.17 X D <sub>75</sub>
D <sub>25</sub>	0.33 X D <sub>75</sub>	0.77 X D <sub>75</sub>
D <sub>0</sub>	None	0.33 X D <sub>75</sub>

APPENDIX B

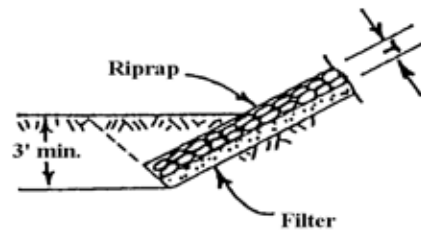

**METHOD 1:** This is most suited to areas where the toe is dry during construction.

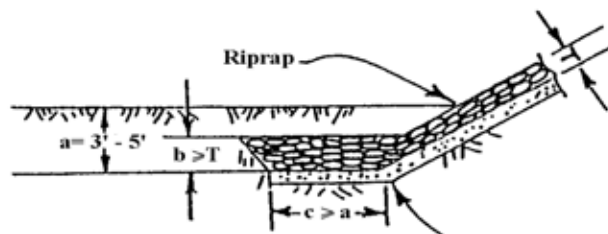

**METHOD 2:** Used when streambed is very wet or groundwater present makes using Method 1 impractical.

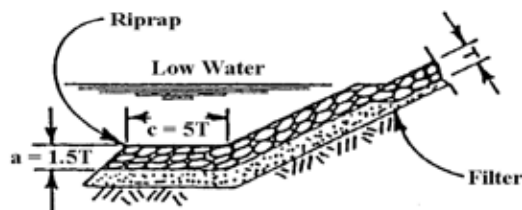

**METHOD 3:** Often used when toe is underwater during construction. Both Methods 2 and 3 utilize the idea that undermining will cause rock at toe blanket to settle into eroded area providing protection during scouring.

FIGURE 2. Acceptable toe protection

APPENDIX B (CONTINUED)

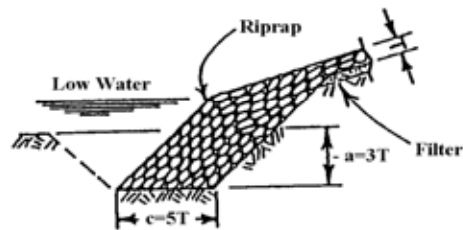

**METHOD 4:** Used underwater in areas with extremely bad streambed erosion conditions which make Method 3 unfeasible. This method may also be preferred where Method 3 would destroy fish spawning beds.

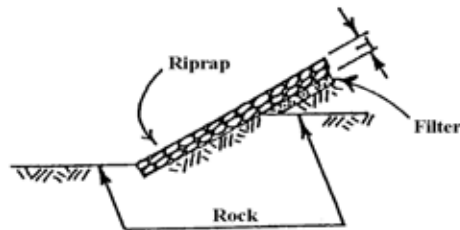

**METHOD 5:** When the streambed is non-erodible, no special provisions for toe protection are needed other than insuring that the riprap is well keyed to the rock.

FIGURE 2. Acceptable toe protection *continued*

APPENDIX C

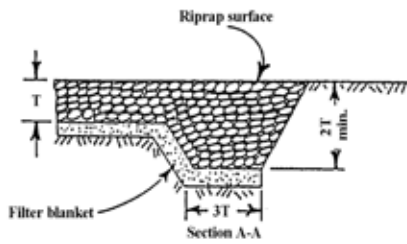
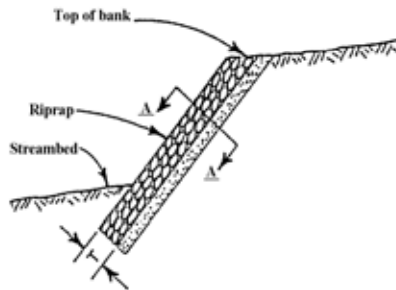

View shown above is cross section at end of riprap looking down along the sideslope toward streambed.

FIGURE 3. Protection against undermining

APPENDIX D

FIGURE 4. Mattress Construction

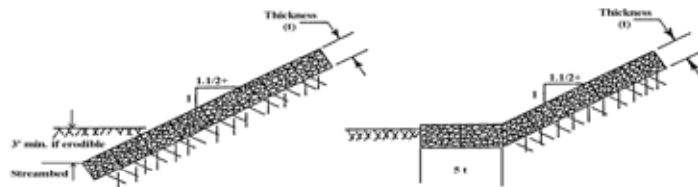



APPENDIX E

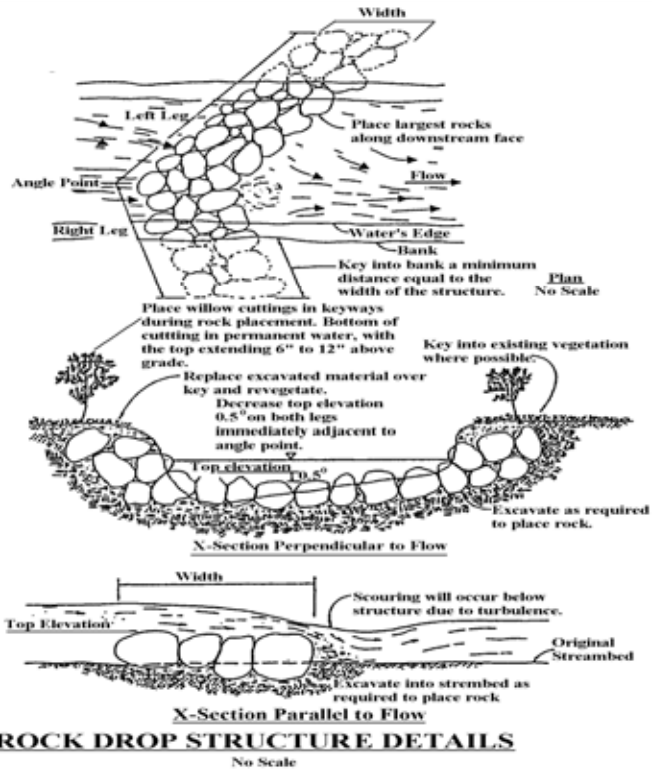

APPENDIX F

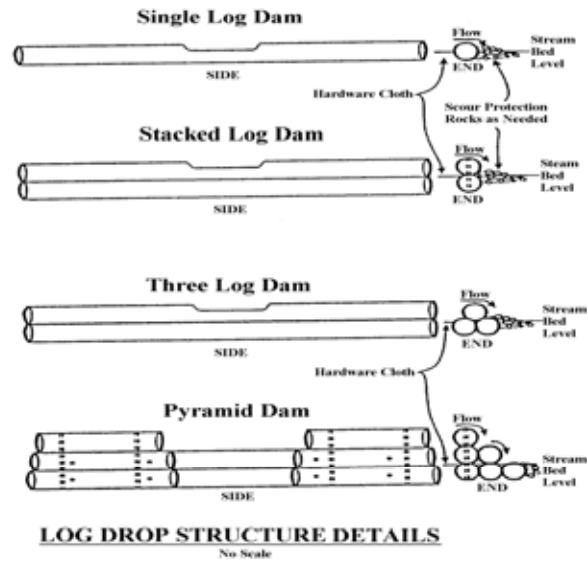

APPENDIX G

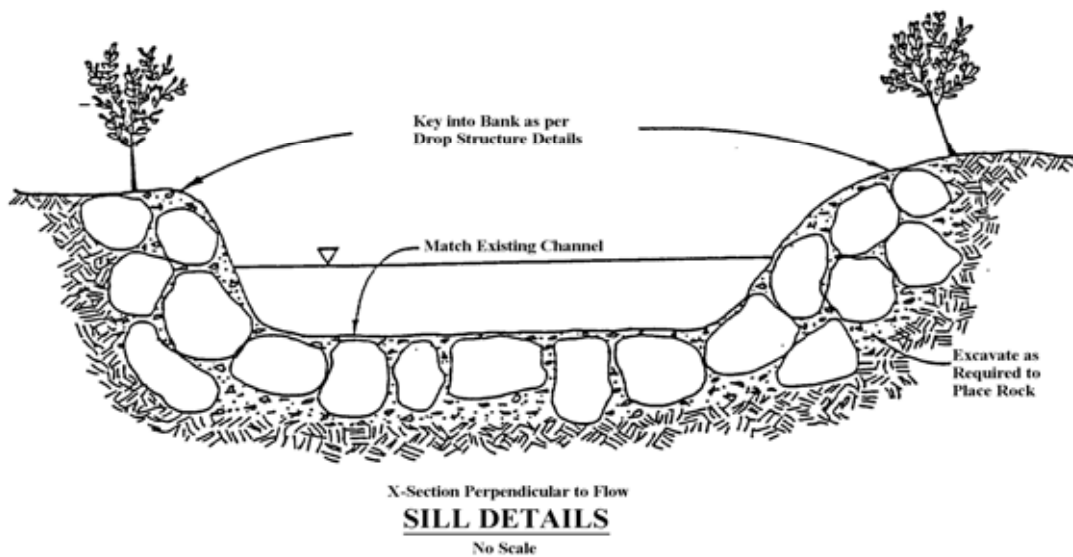

APPENDIX H

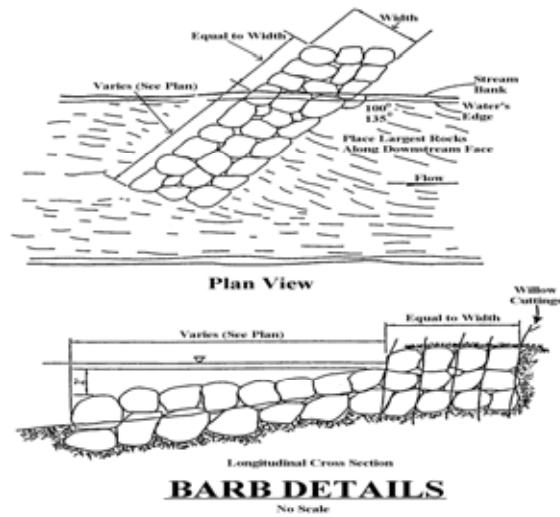

APPENDIX I

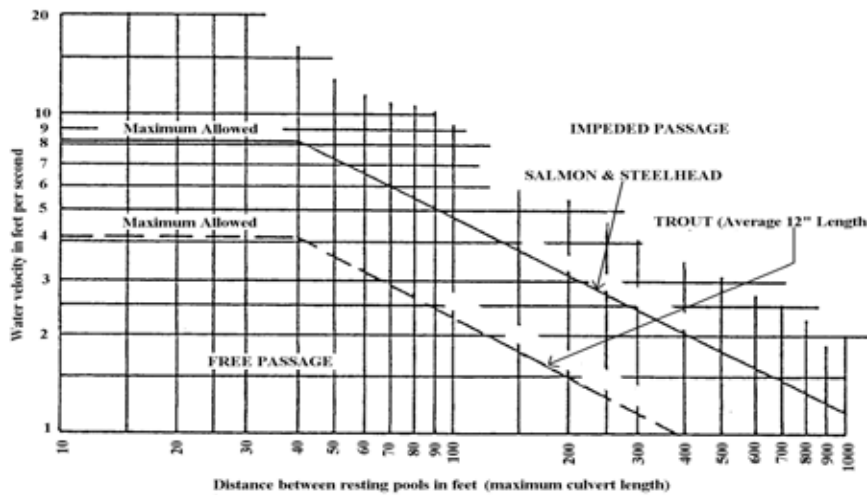

FIGURE 17. Swimming capability of migrating salmon and trout (Alaskan Curve)

APPENDIX J

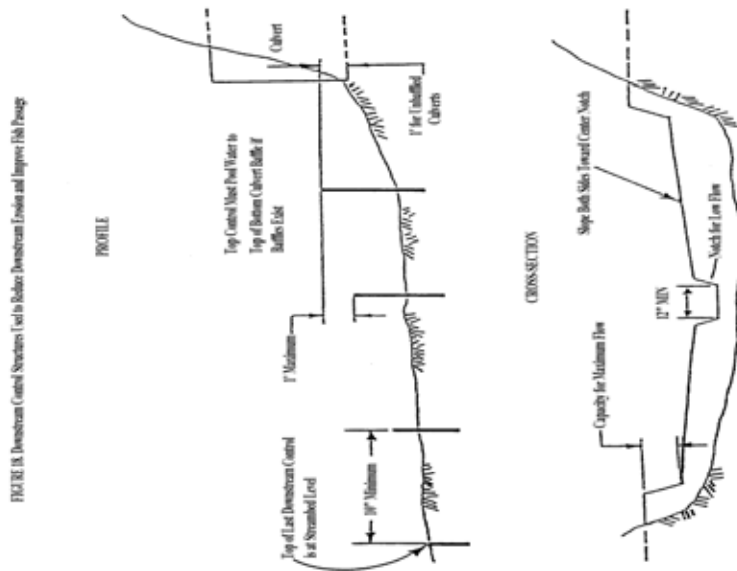

FIGURE 18. Downstream Control Structures Used to Reduce Downstream Erosion and Improve Fish Passage

APPENDIX K

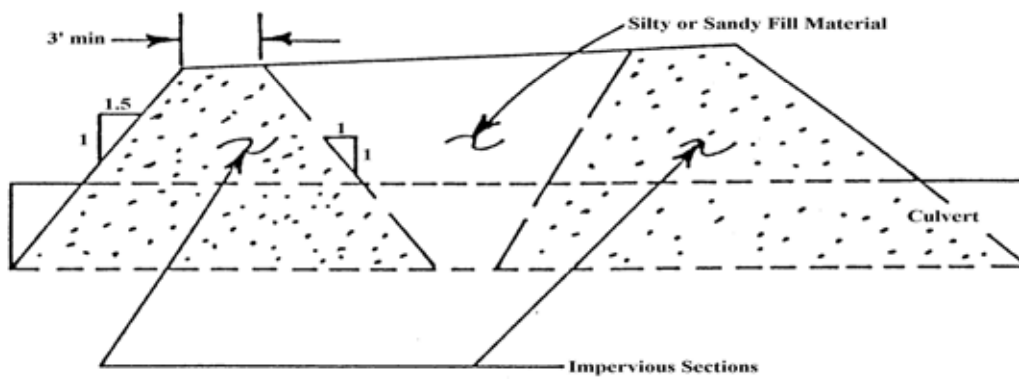
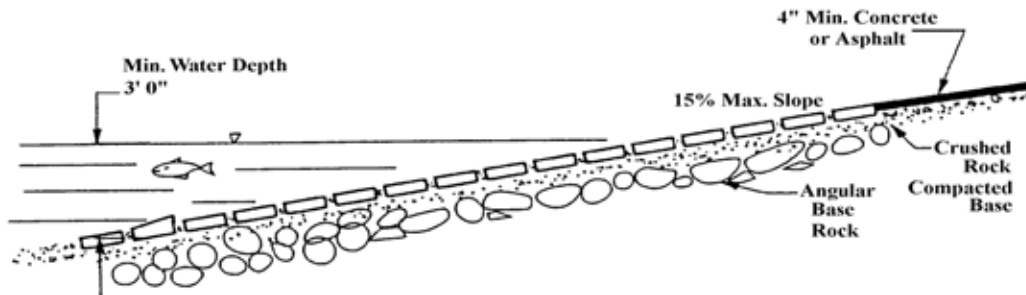

FIGURE 19. Culvert Backfill Using Silty or Sandy Material

APPENDIX L



**LAUNCH RAMP SECTION**

No Scale  
Figure 20

APPENDIX M

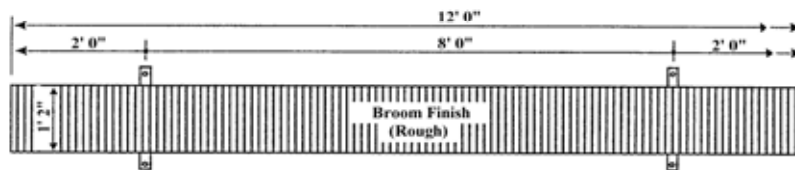

**CONCRETE PLANK**

No Scale  
Figure 21

APPENDIX N

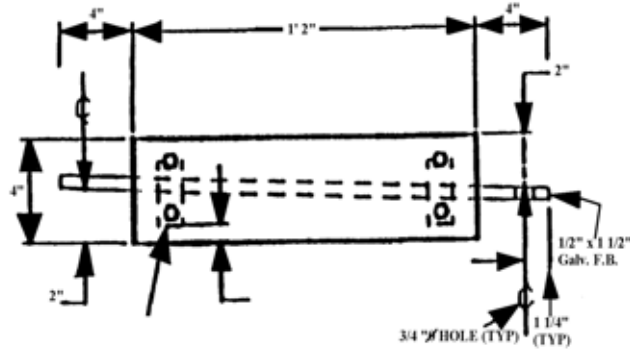

**CONCRETE LAUNCH PLANK DETAIL**

No Scale  
Figure 22

APPENDIX O

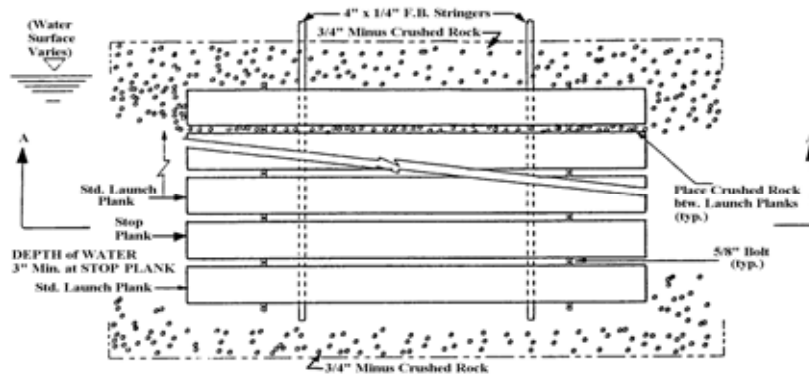

Place crushed rock as shown. Position stringers under planks in order shown and secure with 5/8" bolts. Slide planks on stringers, adding planks as needed, to desired water depth. Stringers consist of 2 - 4" x 1/4" x 20' lng. std. flat bar w/ clevis pin hole one end. Pull flat bar stringers up grade from water when planks are positioned and bolted together, remove when last plank has been set in place.

**CONCRETE LAUNCH-PLAN VIEW**

Figure 23  
No Scale

APPENDIX P

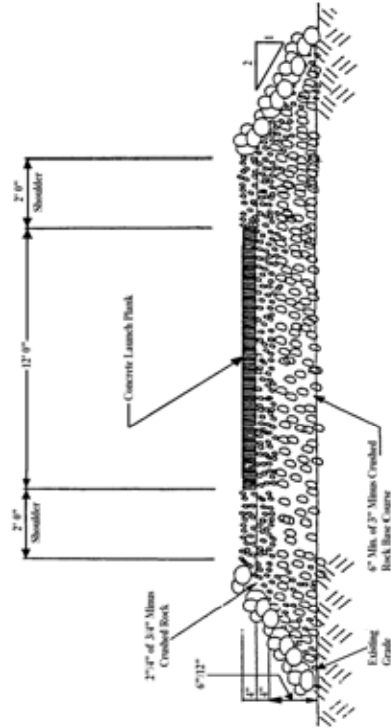

**CONCRETE LAUNCH - CROSS-SECTION**

No Scale  
Figure 24

## 37.03.08 – WATER APPROPRIATION RULES

### 000. LEGAL AUTHORITY (RULE 0).

The Director of the Department of Water Resources adopts these rules under the authority provided by Section 42-1805(8), Idaho Code. (3-20-20)T

### 001. TITLE AND SCOPE (RULE 1).

**01. Title.** These rules are titled IDAPA 37.03.08, “Water Appropriation Rules.” (3-20-20)T

**02. Scope.** (3-20-20)T

**a. Background and Purpose.** The 1985 Idaho Legislature authorized reallocation of certain hydropower water rights to new upstream beneficial uses. The reallocation is to be accomplished using statutes designed to provide for the appropriation of unappropriated public water supplemented by a public interest review of those reallocations which significantly reduce existing hydropower generation. These rules provide the procedures for obtaining the right to divert and use unappropriated public water as well as water previously appropriated for hydropower use which has been placed in trust with the State of Idaho and is subject to reallocation. Guidelines are provided for the filing and processing of applications, and criteria are established for determining the actions to be taken by the Director. (3-20-20)T

**b. Scope and Applicability.** These rules are applicable to appropriations from all sources of unappropriated public water in the state of Idaho under the authority of Chapter 2, Title 42, Idaho Code. Sources of public water include rivers, streams, springs, lakes and groundwater. The rules are also applicable to the reallocation of hydropower water rights held in trust by the state of Idaho. The rules are applicable to all applications to appropriate water filed with the Department of Water Resources prior to the effective date of these rules upon which an action to approve or deny the application is pending and to all applications filed subsequent to adoption of the rules and regulations. In addition, the rules are applicable to existing permits to appropriate water required to be reviewed under the provisions of Section 42-203D, Idaho Code. (3-20-20)T

### 002. -- 009. (RESERVED)

### 010. DEFINITIONS (RULE 10).

Unless the context otherwise requires, the following definitions govern these rules: (3-20-20)T

**01. Acre-Foot (AF).** A volume of water sufficient to cover one (1) acre of land one (1) foot deep and is equal to forty-three thousand five hundred sixty (43,560) cubic feet. (3-20-20)T

**02. Advertisement.** The action taken by the Director to provide notice, usually by publication of a legal notice in one (1) or more newspapers, of a proposed appropriation or other notice required in administration of his duties and responsibilities. (3-20-20)T

**03. Applicant.** The person, corporation, association, firm, governmental agency or other entity, or the holder of a permit being reprocessed pursuant to Section 42-203D, Idaho Code, who initiates an appropriation of water or related water matter for the Director’s consideration. (3-20-20)T

**04. Application for Permit.** The written request to the department on forms furnished by the department proposing to appropriate the public waters or trust waters of the state. (3-20-20)T

**05. Board.** The Idaho Water Resource Board. (3-20-20)T

**06. Beneficial Use.** One (1) or more of the recognized beneficial uses of water including but not limited to, domestic, municipal, irrigation, hydropower generation, industrial, commercial, recreation, stockwatering and fish propagation uses for which permits to appropriate water can be issued as well as other uses which provide a benefit to the user of the water as determined by the Director. Industrial use as used for purposes of these rules includes, but is not limited to, manufacturing, mining and processing uses of water. (3-20-20)T

**07. Cubic Foot Per Second (CFS).** A rate of flow approximately equal to four hundred forty-eight and eight-tenths (448.8) gallons per minute and also equals fifty (50) Idaho miner’s inches. (3-20-20)T

**08. DCMI.** An acronym for domestic, commercial, municipal and industrial. In these rules it designates certain classes of these uses presumed to satisfy public interest requirements. Domestic use, for purposes of this definition, is water for one or more households and water used for all other purposes including irrigation of a



residential lot in connection with each of the households where the diversion to each household does not exceed thirteen thousand (13,000) gallons per day. Also for purposes of this definition, commercial, municipal and industrial uses are any such uses which do not deplete the system containing the trust water more than two (2) acre feet per day. (3-20-20)T

**09. Department.** The Idaho Department of Water Resources. (3-20-20)T

**10. Director.** The Director of the Idaho Department of Water Resources. (3-20-20)T

**11. Legal Subdivision.** A tract of land described by the government land survey and usually is described by government lot or quarter-quarter, section, township and range. A lot and block of a subdivision plat recorded with the county recorder may be used in addition to the quarter-quarter, section, township and range description. (3-20-20)T

**12. Permit or Water Right Permit.** The water right document issued by the Director authorizing the diversion and use of unappropriated public water of the state or water held in trust by the state. (3-20-20)T

**13. Priority, or Priority of Appropriation, or Priority Date.** The date of appropriation established in the development of a water right. The priority of a water right for public water or trust water is used to determine the order of water delivery from a source during times of shortage. The earlier or prior date being the better right. (3-20-20)T

**14. Project Works.** A general term which includes diversion works, conveyance works, and any devices which may be used to apply the water to the intended use. Improvements which have been made as a result of application of water, such as land preparation for cultivation, are not a part of the project works. (3-20-20)T

**15. Single Family Domestic Purposes.** Water for household use or livestock and water used for all other purposes including irrigation of up to one half (1/2) acre of land in connection with said household where total use is not in excess of thirteen thousand (13,000) gallons per day. (3-20-20)T

**16. Subordinated Water Right.** A water right used for hydropower generation purposes that is subject to depletion without compensation by upstream water rights which are initiated later in time and which are for a purpose other than hydropower generation purposes. (3-20-20)T

**17. Trust Water.** That portion of an unsubordinated water right used for hydropower generation purposes which is in excess of a minimum stream flow established by state action either with agreement of the holder of the hydropower right as provided by Section 42-203B(5), Idaho Code or without an agreement as provided by Section 42-203B(3), Idaho Code. (3-20-20)T

**18. Unappropriated Water.** The public water of the state of Idaho in streams, rivers, lakes, springs or groundwater in excess of that necessary to satisfy prior rights including prior rights reserved by federal law. (3-20-20)T

**011. -- 024. (RESERVED)**

**025. GENERAL DESCRIPTION OF THE PROCEDURE TO BE USED FOR ALLOCATION (RULE 25).**

**01. Applications to Appropriate Unappropriated Water and Water Held in Trust.** Applications to appropriate unappropriated water and water held in trust as provided by Section 42-203B(3), Idaho Code, will be evaluated using the criteria of Section 42-203A, Idaho Code, which requires an assessment to be made of the impact of the proposed use on water availability for existing water rights, the adequacy of the water supply for the proposed use, whether the application is filed for speculative purposes, the financial ability of the applicant to complete the project, and the effect of the proposed use on the local public interest. (3-20-20)T

**02. Applications to Appropriate Water from Sources Held by State in Trust.** Applications to appropriate water from sources on which the state holds water in trust, pursuant to Section 203B(5), Idaho Code, will be processed in a three-step analysis. Evaluation will consider the purposes of "trust water" established in Section 42-

203B, Idaho Code.

(3-20-20)T

**a.** First, the proposed use must be evaluated using the procedures and criteria of Section 42-203A, Idaho Code. If all criteria of Section 42-203A(5), Idaho Code, are satisfied, the application may be approved for unappropriated water. If the application does not satisfy the criteria of Section 42-203A(5) b, c, d, and e, Idaho Code, or is found to reduce the water to existing water rights other than those held in trust by the state, the application will be denied. If the application satisfies all criteria of Section 42-203A(5), Idaho Code, except Section 42-203A(5)a, Idaho Code, but is found to reduce water held in trust by the state, the application will be reviewed under criteria of Section 42-203C, Idaho Code. (3-20-20)T

**b.** Second, Section 42-203C, Idaho Code, requires a determination of whether the proposed use will significantly reduce, individually or cumulatively with existing uses and other uses reasonably likely to exist within twelve months of the proposed use, the amount of trust water available to the holder of the water right used for power production that is defined by agreement pursuant to subsection (5) of Section 42-203B, Idaho Code (hereinafter termed “significant reduction”). If a significant reduction will not occur, the application may be approved without an evaluation of the public interest criteria of Section 42-203C(2), Idaho Code. (3-20-20)T

**c.** Third, based upon a finding of significant reduction, the proposed use will be evaluated in terms of the public interest criteria of Section 42-203C(2), Idaho Code. (3-20-20)T

**026. -- 029. (RESERVED)**

**030. LOCATION AND NATURE OF TRUST WATER (RULE 30).**

**01. Snake River Water Rights Agreement.** The legislation ratifying the Snake River water rights agreement between the state of Idaho and Idaho Power Company places in trust a part of the flows available to Idaho Power Company under its hydropower water rights in the Snake River Basin between Swan Falls Dam and Milner Dam. The flows subject to the trust water provisions and reallocation under Section 42-203C(2), Idaho Code, are as follows: (3-20-20)T

**a.** Trust water flows under the Snake River water rights agreement are located in the Snake River between Swan Falls Dam located in Section 18, Township 2 South, Range 1 East, Boise Meridian (B.M.) and Milner Dam located in Sections 28 and 29, Township 10 South, Range 21 East, Boise Meridian (B.M.) and all surface and groundwater sources tributary to the Snake River in that reach. (3-20-20)T

**b.** Surface water and groundwater tributary to the Snake River upstream from Milner Dam is not trust water. After giving notice and considering public comment, the Director will designate the area in which groundwater is presumed to be tributary to the Snake River upstream from Milner Dam. Modification or changes in the designated boundary may be made only after providing notice and considering public comment. The area presently designated as tributary to the Snake River in the Milner Dam to Swan Falls Dam reach is appended to these rules (See Attachment A in APPENDIX A located at the end of this chapter), for information purposes only. (3-20-20)T

**c.** Trust water flows under the Snake River water rights agreement are those occurring in the Snake River and tributaries in the geographic area designated in Subsection 030.01.a. that exceed the established minimum stream flows but are less than the water rights for hydropower generating facilities in the Swan Falls Dam to Milner Dam reach of Snake River, to the extent such rights were unsubordinated prior to the Snake River water rights agreement. Minimum average daily flows have been established by action of the Board and legislature at the U.S. Geological Survey gauging station located near Murphy (Section 35, Township 1 South, Range 1 West B.M.) in the amount of three thousand nine hundred (3900) cfs from April 1 to October 31 and five thousand six hundred (5600) cfs from November 1 to March 31, and at Milner gauging station located in Section 29, Township 10 South, Range 21 East, B.M. in the amount of zero (0) cfs from January 1 to December 31. (3-20-20)T

**02. Trust Water Created by State Action.** Section 42-203B(3), Idaho Code, provides that trust water can be created by state action establishing a minimum flow without an agreement with the holder of the hydropower water right. Allocation of trust water so established will be pursuant to state law except the criteria of Section 42-203C, Idaho Code, will not be considered. (3-20-20)T

**03. Sources of Public Water Not Trust Water.** The following sources of public water are not trust water and are not subject to the public interest provisions of Section 42-203C, Idaho Code: (3-20-20)T

**a.** Sources or tributaries to sources upon which no hydropower generating facilities are located downstream within the state of Idaho. (3-20-20)T

**b.** Sources or tributaries to sources which have a state hydropower water right permit or license or Federal Energy Regulatory Commission license which have not been subordinated, and the state of Idaho has not entered into an agreement with the holder of the hydropower water right pursuant to Section 42-203B(2), Idaho Code, and the State of Idaho has not established a minimum stream flow for purposes of protecting hydropower generation. (3-20-20)T

**c.** Sources or tributaries to sources for which a state hydropower water right permit or license, or the Federal Energy Regulatory Commission license included a subordination condition. Such flows are considered to be public waters subject to appropriation under the provisions of Section 42-203A, Idaho Code. (3-20-20)T

**d.** Flows in excess of established rights including rights used for hydropower purposes. Such flows are unappropriated waters subject to allocation under Section 42-203A, Idaho Code. (3-20-20)T

**e.** Flows in the Snake River upstream from Milner Dam and all surface and groundwater tributaries to that reach. Such flows are subject to allocation under Section 42-203A, Idaho Code, without consideration of water rights existing downstream from Milner Dam (Reference: 42-203B(2), Idaho Code). (3-20-20)T

**031. -- 034. (RESERVED)**

**035. APPLICATION REQUIREMENTS (RULE 35).**

**01. General Provisions.** (3-20-20)T

**a.** No person shall commence the construction of any project works or commence the diversion of the public water or trust water of the state of Idaho from any source without first having filed an application for permit to appropriate the water or other appropriate form with the department and received approval from the Director, unless exempted by these rules or by statute. (3-20-20)T

**b.** Any person proposing to commence a diversion of the public water or the trust water of the state of Idaho from a groundwater source for single family domestic purposes is exempt from the application and permit requirements of Subsection 035.01.a. (3-20-20)T

**c.** Any person watering livestock directly from a natural stream or natural lake without the use of a constructed diversion works is exempt from Subsection 035.01.a. (3-20-20)T

**d.** All applications for permit to appropriate public water or trust water of the state of Idaho shall be on the form provided by the department entitled "Application for Permit to Appropriate the Public Waters of the State of Idaho" and include all necessary information as described in Subsection 035.03. An application for permit that is not complete as described in Subsection 035.03 will not be accepted for filing and will be returned along with any fees submitted to the person submitting the application. No priority will be established by an incomplete application. Applications meeting the requirements of Subsection 035.03. will be accepted for filing and will be endorsed by the department as to the time and date received. The acceptability of applications requiring clarification or corrections shall be determined by the Director. (3-20-20)T

**e.** The department will correspond with the applicant concerning applications which have been accepted for filing by the department which require clarification or correction of the information required by Subsection 035.03. If the additional or corrected information is supplied after thirty (30) days, the priority date of the application will be determined by the date the additional or corrected information is received by the department unless the applicant has requested within the thirty (30) day period additional time to provide the information, has shown good reasons for needing additional time, and the Director has granted additional time. (3-20-20)T

f. Failure to submit the additional or corrected information is cause for the Director to void the department's records of the application. (3-20-20)T

**02. Effect of an Application.** (3-20-20)T

a. Any application that seeks to appropriate water from a source upon which the state holds trust water shall be considered an application for appropriation of unappropriated water. If the Director determines unappropriated water is not available, the application, if otherwise approvable, will be reviewed for compliance with provisions of Section 42-203C, Idaho Code. (3-20-20)T

b. The priority of an application for unappropriated or trust water is established as of the time and date the application is received in complete form along with the statutory fee in any official office of the department. The priority of the application remains fixed unless changed by action of the Director in accordance with applicable law. (3-20-20)T

c. An application for permit to appropriate water is not a water right and does not authorize diversion or use of water until approved by the Director in accordance with statutes in effect at the time the application is approved. (3-20-20)T

d. An applicant's interest in an application for permit to appropriate water is personal property. An assignment of interest in an application must include evidence satisfactory to the Director that the application was not filed for speculative purposes. (3-20-20)T

**03. Requirements for Applications to Be Acceptable for Filing.** (3-20-20)T

a. The following information shall be shown on an application for permit form and submitted together with the statutory fee to an office of the department before the application for permit may be accepted for filing by the department. (3-20-20)T

i. The name and post office address of the applicant shall be listed. If the application is in the name of a corporation, the names and addresses of its directors and officers shall be provided. If the application is filed by or on behalf of a partnership or joint venture, the application shall provide the names and addresses of all partners and designate the managing partner, if any. (3-20-20)T

ii. The name of the water source sought to be appropriated shall be listed. For surface water sources, the source of water shall be identified by the official geographic name listed on the U.S. Geological Survey Quadrangle map. If the source has not been named, it can be described as "unnamed," but the system or river to which it is tributary shall be identified. For groundwater sources, the source shall be listed as "groundwater." Only one source shall be listed on an application unless the application is for a single system which will have more than one source. (3-20-20)T

iii. The legal description of the point of diversion and place of use shall be listed. The location of the point(s) of diversion and the place of use shall be described to the nearest forty (40) acre subdivision or U.S. Government Lot of the Public Land Survey System. The location of springs shall be described to the nearest ten (10) acre tract. Subdivision names, lot and block numbers and any name in local common usage for the point of diversion, or place of use shall be included in the comments section of the application form. If irrigation is listed as a purpose of use, the number of acres in each forty (40) acre subdivision of the place of use shall be listed. (3-20-20)T

iv. The quantity of water to be diverted shall be listed as a rate of flow in cubic feet per second and/or as a volume to be stored in acre-feet per year for each purpose of use requested. (3-20-20)T

v. Impoundment (storage) applications shall show the maximum acre-feet requirement per year which shall not exceed the storage capacity of the impoundment structure unless the application describes a plan of operation for filling the reservoir more than once per year. (3-20-20)T

vi. Every offshore storage impoundment application shall show a maximum rate of diversion to storage as well as the total storage volume. (3-20-20)T

vii. The nature of the proposed beneficial use or uses of the water shall be listed. While the purpose may be described in general terms such as irrigation, industrial or municipal, a description sufficient to identify the proposed use or uses of the water shall also be included. (3-20-20)T

viii. The period of each year during which water will be diverted, stored and beneficially used shall be listed. The period of use for irrigation purposes shall coincide with the annual periods of use shown in Figure 1 in APPENDIX B (located at the end of this chapter), unless it can be shown to the satisfaction of the Director that a different period of use is necessary. (3-20-20)T

ix. The proposed method of diversion, conveyance system and system for distributing and using the water shall be described. (3-20-20)T

x. The period of time required for completion of the project works and application of water to the proposed use shall be listed. This period of time shall not exceed the time required to diligently and uninterruptedly apply the water to beneficial use and shall not exceed five (5) years. (3-20-20)T

xi. A map or plat of sufficient scale (not less than two (2) inches equal to one (1) mile) to show the project proposed shall be included. The map or plat shall agree with the legal descriptions and other information shown on the application. (3-20-20)T

xii. The application form shall be signed by the applicant listed on the application or evidence must be submitted to show that the signator has authority to sign the application. An application in more than one (1) name shall be signed by each applicant unless the names are joined by “or” or “and/or.” (3-20-20)T

xiii. Applications by corporations, companies or municipalities or other organizations shall be signed by an officer of the corporation or company or an elected official of the municipality or an individual authorized by the organization to sign the application. The signator’s title shall be shown with the signature. (3-20-20)T

xiv. Applications may be signed by a person having a current “power of attorney” authorized by the applicant. A copy of the “power of attorney” shall be included with the application. (3-20-20)T

xv. Applications to appropriate water in connection with Carey Act or Desert Land Entry proposals shall include evidence that appropriate applications have been filed for the lands involved in the proposed project. (3-20-20)T

xvi. The application form shall be accompanied with a fee in the amount required by Section 42-221A, Idaho Code. (3-20-20)T

**04. Amended Applications.** (3-20-20)T

**a.** Applications for permit shall be amended whenever significant changes to the place, period or nature of the intended use, method or location of diversion or proposed use of the water or other substantial changes from that shown on the pending application are intended. An application shall be amended if the proposed change will result in a greater rate of diversion or depletion (see Subsection 035.04.c.), if the point of diversion, place of use, or point of discharge of the return flow are to be altered, if the period of the year that water will be used is to be changed, or if the nature of the use is to be changed. (3-20-20)T

**b.** An application can be amended to clarify the name of the source of water but may not be amended to change the source of water. (3-20-20)T

**c.** An amendment which increases the rate of diversion, increases the volume of water diverted per year or the volume of water depleted, lengthens the period of use, or adds an additional purpose of use shall result in the priority of the application for permit being changed to the date the amended application is received by the department. (3-20-20)T

**d.** An application for permit may be amended by endorsement by the applicant or his agent on the

original application for permit form which endorsement shall be initialed and dated. If the changes required to the information on the application are, in the judgment of the Director, substantial enough to cause confusion in interpreting the application form, the amended application shall be submitted on a new application for permit form to be designated as an amended application. (3-20-20)T

**e.** An amended application shall be accompanied by the additional fee required by Section 42-221A, Idaho Code, if the total rate of diversion or total volume of storage requested is increased and by the fee required by Section 42-221F, Idaho Code, for readvertising if notice of the original application has been published. (3-20-20)T

**f.** If the applicant's name or mailing address changes, the applicant shall in writing notify the department of the change. (3-20-20)T

**036. -- 039. (RESERVED)**

**040. PROCESSING APPLICATIONS FOR PERMIT AND REPROCESSING PERMITS (RULE 40).**

**01. General.** (3-20-20)T

**a.** Unprotested applications, whether for unappropriated water or trust water, will be processed using the following general steps: (3-20-20)T

- i. Advertisement and protest period; (3-20-20)T
- ii. Department review of applications and additional information, including department field review if determined to be necessary by the Director; (3-20-20)T
- iii. Fact finding hearing if determined to be necessary by the Director; (3-20-20)T
- iv. Director's decision; (3-20-20)T
- v. Section 42-1701A, Idaho Code, hearing, if requested; and (3-20-20)T
- vi. Director's decision affirmed or modified. (3-20-20)T

**b.** Protested applications, whether for unappropriated water or trust water, will be processed using the following general steps: (3-20-20)T

- i. Advertisement and protest period; (3-20-20)T
- ii. Hearing and/or conference; (3-20-20)T
- iii. Department review of applications, hearing record and additional information including department field review if determined to be necessary by the Director. (3-20-20)T
- iv. Proposed decision (unless waived by parties); (3-20-20)T
- v. Briefing or oral argument in accordance with the department's adopted Rules of Procedure. (3-20-20)T
- vi. Director's decision accepting or modifying the proposed decision. (3-20-20)T

**c.** The Director's decision rejecting and denying approval of an application for permit filed for diversion from a source previously designated as a critical groundwater area or upon which a moratorium has previously been entered may be issued without advertisement of the application. (3-20-20)T

**d.** An applicant may request in writing that commencement of processing of his or her application be delayed for a period not to exceed one (1) year or that processing be interrupted for a period not to exceed six (6)

months. The Director at his discretion may approve the request unless he determines that others will be injured by the delay or that the applicant seeks the delay for the purpose of speculation, or that the public interest of the people of Idaho will not be served by the delay. The Director may approve a request for delay for a shorter period of time or upon conditions, and may renew the approval upon written request. (3-20-20)T

**02. Public Notice Requirement.** (3-20-20)T

**a.** Applications for permit which have not been advertised. (3-20-20)T

i. Advertisement of applications for permit proposing a rate of diversion of ten (10) cfs or less or storage of one thousand (1000) AF or less shall comply with Section 42-203A, Idaho Code. The first required advertisement will be published on the first or third Thursday of a month when published in daily newspapers and on the first or third publishing day of the month for weekly newspapers. (3-20-20)T

ii. Advertisement of applications for permit in excess of the amounts in Subsection 040.02.a.i. shall comply with Subsection 040.02.a.i. and shall also be published in a newspaper or newspapers to achieve statewide circulation. (3-20-20)T

iii. Statewide circulation with respect to Section 42-203A(2), Idaho Code, shall be obtained by publication of a legal notice at least once each week for two (2) successive weeks in a newspaper, as defined in Section 60-106, Idaho Code, of general circulation in the county in which the point of diversion is located and by publication of a legal notice at least once each week for two (2) successive weeks in at least one (1) daily newspaper, as defined in Section 60-107, Idaho Code, published in each of the department's four (4) administrative regions and determined by the Director to be of general circulation within the department's region within which it is published. The administrative regions of the department are identified on Figure 2 in APPENDIX C (located at the end of this chapter). The names of newspapers used for statewide publication are available from any department office. (3-20-20)T

**b.** Applications for permit which have been advertised. (3-20-20)T

i. Notice of applications for permit for water from the Snake River between Swan Falls Dam and Milner Dam or surface and groundwater tributaries to that reach of Snake River which were advertised prior to July 1, 1985 and have been held without final action by the department due to the Swan Falls controversy shall be readvertised by the Director in accordance with Subsection 040.02.a. as appropriate to allow opportunity for protests to be entered with respect to the public interest criteria of Section 42-203C(2), Idaho Code. (3-20-20)T

ii. Applications for permit from the Snake River or surface and groundwater sources upstream from Milner Dam which have been held without action due to the Swan Falls controversy may be processed without readvertisement. (3-20-20)T

iii. The applicant shall pay the readvertisement fee provided in Section 42-221F, Idaho Code, prior to the readvertisement. (3-20-20)T

iv. Failure to pay the readvertising fee within thirty (30) days after the applicant is notified to do so is cause for the Director to void the application. (3-20-20)T

**c.** Notice of existing permits. (3-20-20)T

i. Existing permits appropriating water held in trust by the state of Idaho issued prior to July 1, 1985, unless exempted by Subsection 040.02.c.ii. shall be subject to the review requirements of Section 42-203D, Idaho Code, and shall be readvertised in accordance with Subsection 040.02.a. as appropriate. The review is limited to the criteria described in Section 42-203C(2), Idaho Code. (3-20-20)T

**ii.** Permits exempt from the provisions of Section 42-203D, Idaho Code, include: (3-20-20)T

**(1)** Permits appropriating water not held in trust by the state of Idaho; (3-20-20)T

(2) Permits for DCMI uses, stockwater uses and other essentially non-consumptive uses as determined by the Director; and (3-20-20)T

(3) Permits for which an acceptable proof of beneficial use submittal was received by the department prior to July 1, 1985, or permits for which an acceptable proof of beneficial use was submitted after July 1, 1985, if evidence satisfactory to the Director has been received to show that the permit was fully developed prior to July 1, 1985 to the extent claimed on the proof of beneficial use. (3-20-20)T

iii. Holders of permits subject to the review requirement of Section 42-203D, Idaho Code, shall pay in advance, upon the request of the Director, the readvertising fee required by Section 42-221F, Idaho Code. (3-20-20)T

iv. Failure to pay the readvertising fee within thirty (30) days after the applicant is notified to do so is cause for the Director to cancel the permit. (3-20-20)T

**03. Protests, Intervention, Hearings, and Appeals.** (3-20-20)T

**a. Protests.** (3-20-20)T

i. Protests against the approval of an application for permit or against a permit being reprocessed shall comply with the requirements for pleadings as described in the department's adopted Rules of Procedure. (3-20-20)T

ii. Protests against the approval of an application for permit or against a permit being reprocessed will only be considered if received by the department after receipt of the application by the department and prior to the expiration of the protest period announced in the advertisement unless the protestant successfully intervenes in the proceeding. (3-20-20)T

iii. General statements of protest (blanket protests) against appropriations for a particular class of use or from a particular source of water will not be considered as valid protests by the Director. (3-20-20)T

**b. Intervention.** Requests to intervene in a proceeding pending before the department shall comply with the Department's adopted Rules of Procedure. (3-20-20)T

**c. Hearings.** Hearings will be scheduled and held in accordance with the department's adopted Rules of Procedure. (3-20-20)T

**d. Appeals.** Any final decision of the Director may be appealed in accordance with Section 42-1701A, Idaho Code. (3-20-20)T

**04. Burden of Proof.** (3-20-20)T

**a.** Burden of proof is divided into two (2) parts: first, the burden of coming forward with evidence to present a prima facie case, and second, the ultimate burden of persuasion. (3-20-20)T

**b.** The burden of coming forward with evidence is divided between the applicant and the protestant as follows: (3-20-20)T

i. The applicant shall bear the initial burden of coming forward with evidence for the evaluation of criteria (a) through (d) of Section 42-203A(5), Idaho Code; (3-20-20)T

ii. The applicant shall bear the initial burden of coming forward with evidence for the evaluation of criterion (e) of Section 42-203A(5), Idaho Code, as to any factor affecting local public interest of which he is knowledgeable or reasonably can be expected to be knowledgeable. The protestant shall bear the initial burden of coming forward with evidence for those factors relevant to criterion (e) of Section 42-203A(5), Idaho Code, of which the protestant can reasonably be expected to be more cognizant than the applicant. (3-20-20)T

iii. The protestant shall bear the initial burden of coming forward with evidence for the evaluation of



the public interest criteria of Section 42-203C(2), Idaho Code, and of demonstrating a significant reduction, except that the applicant shall provide details of the proposed design, construction, and operation of the project and directly associated operations to allow the impact of the project to be evaluated. (3-20-20)T

c. The applicant has the ultimate burden of persuasion for the criteria of Section 42-203A, Idaho Code, and the protestant has the ultimate burden of persuasion for the criteria of Section 42-203C, Idaho Code. (3-20-20)T

d. For unprotested applications or permits to be reprocessed, the Director will evaluate the application, information submitted pursuant to Subsection 040.05.c. and information in the files and records of the department, and the results of any studies the department may conduct to determine compliance with the appropriate criteria. (3-20-20)T

e. In protested matters the Director will take official notice of information as described in the department's adopted Rules of Procedure, and will, prior to considering, circulate to the parties information from department studies and field examinations concerning the protested application or permit being reprocessed, if such information has not otherwise been made a part of the hearing record. (3-20-20)T

**05. Additional Information Requirements.** (3-20-20)T

a. For unprotested applications and permits being reprocessed, the additional information required by Subsection 040.05.c. shall be submitted within thirty (30) days after the Director notifies the applicant that the application or permit is being reviewed for decision. The Director may extend the time within which to submit the information upon request by the applicant and upon a showing of good cause. Failure to submit the required information within the time period allowed will be cause for the Director to void an application or to advance the priority of a permit being reprocessed by the number of days that the information submittal is late. The Director will provide opportunity for hearing as provided in Section 42-1701A, Idaho Code. (3-20-20)T

b. For protested applications or protested permits being reprocessed, the information required by Subsection 040.05.c. may be requested by the Director to be submitted within thirty (30) days after notification by the Director, may be made a part of the record of the hearing held to consider the protest, or may be made available in accordance with any pre-hearing discovery procedures. Failure to submit the required information within the time period allowed will be cause for the Director to void an application or to advance the priority of a permit being reprocessed by the number of days that the information submittal is late. (3-20-20)T

c. The following information shall be submitted for applications to appropriate unappropriated water or trust water and for permits being reprocessed for trust water. The additional information submittal requirements of this rule are waived for filings which seek to appropriate five (5) cfs or less or storage of five hundred acre-feet (500 AF) or less and for filings seeking reallocation of trust water which the Director determines will reduce the flow of the Snake River measured at Murphy Gauge by not more than two (2) acre-feet per day. For filings proposing irrigation as a purpose of use, the additional information is required if more than two hundred (200) acres will be irrigated. However, the Director may specifically request submittal of any of the following information for any filing, as he determines necessary. Information relative to the effect on existing water rights, Section 42-203A(5)(a), Idaho Code, shall be submitted as follows: (3-20-20)T

i. For applications appropriating springs or surface streams with five (5) or fewer existing users, either the identification number, or the name and address of the user, and the location of the point of diversion and nature of use for each existing water right shall be submitted. (3-20-20)T

ii. For applications appropriating groundwater, a plat shall be submitted locating the proposed well relative to all existing wells and springs and permitted wells within a one-half mile radius of the proposed well. (3-20-20)T

iii. Information shall be submitted concerning any design, construction, or operation techniques which will be employed to eliminate or reduce the impact on other water rights. (3-20-20)T

d. Information relative to sufficiency of water supply, Section 42-203A(5)(b), Idaho Code, shall be

submitted as follows:

(3-20-20)T

i. Information shall be submitted on the water requirements of the proposed project, including, but not limited to, the required diversion rate during the peak use period and the average use period, the volume to be diverted per year, the period of year that water is required, and the volume of water that will be consumptively used per year. (3-20-20)T

ii. Information shall be submitted on the quantity of water available from the source applied for, including, but not limited to, information concerning flow rates for surface water sources available during periods of peak and average project water demand, information concerning the properties of the aquifers that water is to be taken from for groundwater sources, and information on other sources of supply that may be used to supplement the applied for water source. (3-20-20)T

e. Information relative to good faith, delay, or speculative purposes of the applicant, Section 42-203A(5)(c), Idaho Code, shall be submitted as follows: (3-20-20)T

i. The applicant shall submit copies of deeds, leases, easements or applications for rights-of-way from federal or state agencies documenting a possessory interest in the lands necessary for all project facilities and the place of use or if such interest can be obtained by eminent domain proceedings the applicant must show that appropriate actions are being taken to obtain the interest. Applicants for hydropower uses shall also submit information required to demonstrate compliance with Sections 42-205 and 42-206, Idaho Code. (3-20-20)T

ii. The applicant shall submit copies of applications for other needed permits, licenses and approvals, and must keep the department apprised of the status of the applications and any subsequent approvals or denials. (3-20-20)T

f. Information Relative to Financial Resources, Section 42-203A(5)(d), Idaho Code, shall be submitted as follows: (3-20-20)T

i. The applicant shall submit a current financial statement certified to show the accuracy of the information contained therein, or a financial commitment letter along with the financial statement of the lender or other evidence to show that it is reasonably probable that financing will be available to appropriate the water and apply it to the beneficial use proposed. (3-20-20)T

ii. The applicant shall submit plans and specifications along with estimated construction costs for the project works. The plans shall be definite enough to allow for determination of project impacts and implications. (3-20-20)T

g. Information Relative to Conflict with the Local Public Interest, Section 42-203A(5)(e), Idaho Code, shall be submitted as follows: The applicant shall seek comment and shall submit all letters of comment on the effects of the construction and operation of the proposed project from the governing body of the city and/or county and tribal reservation within which the point of diversion and place of use are located, the Idaho Department of Fish and Game, the Idaho Department of Environmental Quality, and any irrigation district or canal company within which the proposed project is located and from other entities as determined by the Director. (3-20-20)T

h. The following information Relative to the Public Interest Criteria of Section 42-203C(2), Idaho Code, shall be submitted by an applicant seeking reallocation of trust water for a project which the Director determines will reduce the flow of the Snake River by more than two (2) acre-feet per day. For filings proposing irrigation as a purpose of use, the additional information is required if more than two hundred (200) acres will be irrigated. The Director may request any or all of the following information for any filing seeking the reallocation of trust water. (3-20-20)T

i. A project design and estimate of cost of development shall be submitted. For applications appropriating more than twenty-five (25) cfs, or ten thousand (10,000) AF of storage, or generating more than five (5) megawatts, the information shall be prepared and submitted by a qualified engineer licensed under the provisions of Chapter 12, Title 54, Idaho Code, unless waived by the Director. The design shall be definite enough to reflect the project's impacts and implications as required in subsequent rules. (3-20-20)T

ii. If the project proposes development for irrigation purposes, information shall be submitted on crop rotation, including acreages, for lands when newly developed. (3-20-20)T

iii. Information shall be submitted concerning the number and kinds of jobs that will be created or eliminated as a direct result of project development including both the construction and operating phases of the project. If jobs are seasonal, the estimated number of months per year of employment shall be submitted. (3-20-20)T

iv. For applications or permits being reprocessed for more than twenty-five (25) cfs, or more than ten thousand (10,000) AF of storage, or more than five (5) megawatts, information shall be submitted concerning the changes to community services that will be required during the construction and operation phases of the project including, but not limited to, changes to schools, roads, housing, public utilities and public health and safety facilities, if any. (3-20-20)T

v. Information shall be submitted concerning the source of energy for diverting and using water for the project, the estimated instantaneous demand and total amount of energy that will be used, the efficiency of use, and energy conservation methods. (3-20-20)T

vi. Information shall be submitted concerning the location, amount, and quality of return flow water, and any water conservation features of the proposed project. (3-20-20)T

vii. If the project proposes irrigation as a use, information shall be submitted concerning the kinship, if any, of the operator of the land to be irrigated by the project to the applicant, the location and acreage of other irrigated lands owned, leased, or rented by the applicant, the names, addresses and number of shares held by each shareholder if the applicant is a corporation, evidence of tax-exempt status if a corporation is so claiming, a soil survey prepared in accordance with the U.S. Soil Conservation Service irrigatable land classification system, and a schedule for bringing into production the project lands. (3-20-20)T

**041. -- 044. (RESERVED)**

**045. EVALUATION CRITERIA (RULE 45).**

**01. Criteria for Evaluating All Applications to Appropriate Water.** The Director will use the following criteria in evaluating whether an application to appropriate unappropriated water or trust water should be approved, denied, approved for a smaller amount of water or approved with conditions. (3-20-20)T

**a.** Criteria for determining whether the proposed use will reduce the quantity of water under existing water rights. A proposed use will be determined to reduce the quantity of water under an existing water right (i.e., injure another water right) if: (3-20-20)T

i. The amount of water available under an existing water right will be reduced below the amount recorded by permit, license, decree or valid claim or the historical amount beneficially used by the water right holder under such recorded rights, whichever is less. (3-20-20)T

ii. The holder of an existing water right will be forced to an unreasonable effort or expense to divert his existing water right. Protection of existing groundwater rights are subject to reasonable pumping level provisions of Section 42-226, Idaho Code; or (3-20-20)T

iii. The quality of the water available to the holder of an existing water right is made unusable for the purposes of the existing user's right, and the water cannot be restored to usable quality without unreasonable effort or expense. (3-20-20)T

iv. An application that would otherwise be denied because of injury to another water right may be approved upon conditions which will mitigate losses of water to the holder of an existing water right, as determined by the Director. (3-20-20)T

v. The provisions of Subsection 045.01.a.v. are not intended to require compensation or mitigation for

loss of flow to holders of subordinated hydropower rights or those from which trust water is reallocated. (3-20-20)T

**b.** Criteria for determining whether the water supply is insufficient for the proposed use. The water supply will be determined to be insufficient for the proposed use if water is not available for an adequate time interval in quantities sufficient to make the project economically feasible (direct benefits to applicant must exceed direct costs to applicant), unless there are noneconomic factors that justify application approval. In assessing such noneconomic factors, the Director will also consider the impact on other water rights if the project is abandoned during construction or after completion, the impact on public resource values, and the cost to local, state and federal governments of such an abandonment. (3-20-20)T

**c.** Criteria for determining whether the application is made in good faith. The criteria requiring that the Director evaluate whether an application is made in good faith or whether it is made for delay or speculative purposes requires an analysis of the intentions of the applicant with respect to the filing and diligent pursuit of application requirements. The judgment of another person's intent can only be based upon the substantive actions that encompass the proposed project. Speculation for the purpose of this rule is an intention to obtain a permit to appropriate water without the intention of applying the water to beneficial use with reasonable diligence. Speculation does not prevent an applicant from subsequently selling the developed project for a profit or from making a profit from the use of the water. An application will be found to have been made in good faith if: (3-20-20)T

i. The applicant shall have legal access to the property necessary to construct and operate the proposed project, has the authority to exercise eminent domain authority to obtain such access, or in the instance of a project diverting water from or conveying water across land in state or federal ownership, has filed all applications for a right-of-way. Approval of applications involving Desert Land Entry or Carey Act filings will not be issued until the United States Department of Interior, Bureau of Land Management has issued a notice classifying the lands suitable for entry; and (3-20-20)T

ii. The applicant is in the process of obtaining other permits needed to construct and operate the project; and (3-20-20)T

iii. There are no obvious impediments that prevent the successful completion of the project. (3-20-20)T

**d.** Criteria for determining whether the applicant has sufficient financial resources to complete the project. (3-20-20)T

i. An applicant will be found to have sufficient financial resources upon a showing that it is reasonably probable that funding is or will be available for project construction or upon a financial commitment letter acceptable to the Director. This showing is required as described in Subsection 040.05.c. or at the time the hearing provided by Subsection 040.05.c. is conducted. (3-20-20)T

ii. A governmental entity will be determined to have satisfied this requirement if it has the taxing, bonding or contracting authority necessary to raise the funds needed to commence and pursue project construction in accordance with the construction schedule. (3-20-20)T

**e.** Criteria for determining whether the project conflicts with the local public interest. The Director will consider the following, along with any other factors he finds to be appropriate, in determining whether the project will conflict with the local public interest: (3-20-20)T

i. The effect the project will have on the economy of the local area affected by the proposed use as determined by the employment opportunities, both short and long term, revenue changes to various sectors of the economy, short and long term, and the stability of revenue and employment gains; (3-20-20)T

ii. The effect the project will have on recreation, fish and wildlife resources in the local area affected by the proposed use; and (3-20-20)T

iii. An application which the Director determines will conflict with the local public interest will be denied unless the Director determines that an over-riding state or national need exists for the project or that the

project can be approved with conditions to resolve the conflict with the local public interest. (3-20-20)T

**02. Criteria for Evaluating Whether a Proposed Use of Trust Water Will Cause a Significant Reduction.** Reference: Section 42-203C(1), Idaho Code and Subsection 025.02.b. For purposes of reallocating trust water made available by the Snake River water rights agreement, an application for permit or a permit being reprocessed, will be presumed to not cause a significant reduction if the Director determines that it complies with both the individual and cumulative tests for evaluating significant reduction as provided in Subsections 045.02.a. and 045.02.b. (3-20-20)T

**a.** Individual test for evaluating significant reduction. A proposed use will be presumed to not cause a significant reduction if when fully developed and its impact is fully felt, the use will individually reduce the flow of the Snake River measured at Murphy Gauge by not more than two (2) acre-feet per day. An irrigation project of two hundred (200) acres or less located anywhere in the Snake River Basin above Murphy Gauge proposing to use trust water is presumed to not reduce the flow at Murphy Gauge by more than two (2) acre-feet per day. The presumption of this section is not applicable to applications or permits to be reprocessed which the Director determines to be part of a larger development. (3-20-20)T

**b.** Cumulative test for evaluating significant reduction. A proposed use will be presumed to not cause a significant reduction, if the use, when fully developed and its impact is fully felt and when considered cumulatively with other existing uses and other uses reasonably likely to exist within twelve (12) months of the proposed use, will not deplete the flow of Snake River measured at Murphy Gauge by more than: (3-20-20)T

**i.** Forty thousand (40,000) acre-feet per calendar year when considered with all other uses approved for development of trust water during that calendar year; (3-20-20)T

**ii.** Forty thousand (40,000) acre-feet per calendar year using a four (4) year moving average when considered with all other uses approved for development of trust water during that four (4) year period; and (3-20-20)T

**iii.** Twenty thousand (20,000) acre-feet per calendar year from filings approved for reallocation of trust water which meet the criteria of Subsection 045.02.a. (3-20-20)T

**c.** The Director will determine on a case-by-case basis from available information whether a permit to be reprocessed or an application for trust water which exceeds the flow depletion limits of Subsection 045.02, or one which meets the flow depletion limits but has been protested, will cause a significant reduction. In making this determination, the Director will consider: (3-20-20)T

**i.** The amount of the reduction in hydropower generation that the proposed use will cause individually and cumulatively with other uses expected to be developed within twelve (12) months of the proposed use as compared to the existing hydropower generation output of the affected facility or facilities. (3-20-20)T

**ii.** The relative importance of the affected hydropower facility or facilities to other sources of electrical power generation available to the holder of the facility or facilities. (3-20-20)T

**iii.** The timing of the reduction in hydropower generation both on an annual basis and on a long-term basis considering the lag time between the beginning of diversion by the proposed use and the resulting reduction in hydropower generation. (3-20-20)T

**iv.** The effect of the reduction in hydropower generation on the unit cost of hydropower from the facility or facilities and the average cost of electrical power offered by the holder of the facility. (3-20-20)T

**v.** The terms of contracts, mortgages, or regulatory permits and licenses which require the holder of the hydropower generation facility to retain the capability to produce hydroelectric power at a specific level. (3-20-20)T

**d.** Other provisions of these rules notwithstanding, applications or permits to be reprocessed proposing a direct diversion of water for irrigation purposes from the Snake River between Milner Dam and Swan

Falls Dam or from tributary springs in this reach are presumed to cause a significant reduction. (3-20-20)T

e. Other provisions of these rules notwithstanding, applications or permits to be reprocessed for DCMI purposes are presumed to not cause a significant reduction. (3-20-20)T

**03. Criteria for Evaluating Public Interest.** If the Director determines that a proposed use of trust water held by the state pursuant to Section 42-203B(5), Idaho Code, will cause a significant reduction, the Director will consider the criteria of Section 42-203C(2), Idaho Code, before acting on the application or permit being reprocessed. The Director shall consider and balance the relative benefits and detriments for each factor required to be weighed under Section 42-203C(2), Idaho Code, to determine whether a proposed reduction of the amount of water available for power production serves the greater public interest. The Director shall evaluate whether the proposed use sought in the permit being reprocessed or the application will provide the greater benefit to the people of the state of Idaho when balanced against other uses for the same water resource. In evaluating the public interest criteria, the Director will use the following guidelines: (3-20-20)T

a. The Director will consider the potential benefits both direct and indirect, and that the proposed use would provide to the state and local economy. The economic appraisal shall be based upon generally accepted economic analysis procedures which uniformly evaluate the following factors within the state of Idaho and the county or counties directly affected by the project: (3-20-20)T

i. Direct project benefits. (3-20-20)T

ii. Indirect benefits including net revenues to the processing, transportation, supply, service and government sectors of the economy. (3-20-20)T

iii. Direct project costs, to include the opportunity cost of previous land use. (3-20-20)T

iv. Indirect project costs, including verifiable costs to government in net lost revenue and increased regulation costs, verifiable reductions in net revenue resulting from losses to other existing instream uses, and the increased cost of replacing reduced hydropower generation from unsubordinated hydropower generating facilities. (3-20-20)T

b. The Director will consider the impact the proposed use would have upon the electric utility rates in the state of Idaho, and the availability, foreseeability and cost of alternative energy sources to ameliorate such impact. These evaluations will include the following considerations: (3-20-20)T

i. Projections of electrical supply and demand for Idaho and the Pacific Northwest made by the Bonneville Power Administration and the Northwest Power Planning Council and information available from the Idaho Public Utilities Commission or from the electric utility from whose water right trust water is being reallocated. (3-20-20)T

ii. The long term reliability of the substitute source and the cost of alternatives including the resulting impact on electrical rates. (3-20-20)T

c. The Director will consider whether the proposed use will promote the family farming tradition in the state of Idaho. For purposes of this evaluation, the Director will use the following factors. (3-20-20)T

d. If the total land to be irrigated by the applicant, including currently owned and leased irrigated land and land proposed to be irrigated in the application and other applications and permits of the applicant, do not exceed nine hundred sixty (960) acres, the application will be presumed to promote the family farming tradition. (3-20-20)T

e. If the requirement of Subsection 045.03.c.i. is not met, the Director will consider the extent the applicant conforms to the following characteristics: (3-20-20)T

i. The farming operation developed or expanded as a result of the application is operated by the applicant or a member of his family (spouse, parents or grandparents, lineal descendants, including those that are adopted, lineal descendants of parents; and spouse of lineal descendants); (3-20-20)T

ii. In the event the application is filed in the name of a partnership, one or more of the partners shall operate the farming operation; and (3-20-20)T

iii. If the application is in the name of a corporation, the number of stockholders does not exceed fifteen (15) persons, and one or more of the stockholders operates the farming operation unless the application is submitted by an irrigation district, drainage district, canal company or other water entity authorized to appropriate water for landowners within the district or for stockholders of the company all of whom shall meet the family farming criteria. (3-20-20)T

f. The Director will consider the promotion of full economic and multiple use development of the water resources of the state of Idaho. In this regard, the extent to which the project proposed complies with the following factors will be considered: (3-20-20)T

- i. Promotes and conforms with the adopted State Water Plan; (3-20-20)T
- ii. Provides for coordination of proposed and existing uses of water to maximize the beneficial use of available water supplies; (3-20-20)T
- iii. Utilizes technology economically available to enhance water and energy use efficiency; (3-20-20)T
- iv. Provides multiple use of the water, including multipurpose storage; (3-20-20)T
- v. Allows opportunity for reuse of return flows; (3-20-20)T
- vi. Preserves or enhances water quality, fish, wildlife, recreation and aesthetic values; (3-20-20)T
- vii. Provides supplemental water supplies for existing uses with inadequate supplies. (3-20-20)T

g. The Director will consider whether a proposed use, which includes irrigation, will conform to a staged development policy of up to twenty thousand (20,000) acres per year or eighty thousand (80,000) acres in any four (4) year period in the Snake River drainage above Murphy Gauge. In applying this criteria, the Director will consider the following: (3-20-20)T

i. "Above Murphy gauge" means the Snake River and any of its surface or groundwater tributaries upstream from Murphy gauge which gauge is located on the Snake River approximately four (4) miles downstream from Swan Falls Dam from which trust water is to be reallocated; (3-20-20)T

ii. Twenty thousand (20,000) acres per year or eighty thousand (80,000) acres per four (4) year period is a four (4) year moving average of Twenty thousand (20,000) acres/year of permits issued during a calendar year for irrigation development. If permits for development of less than twenty-thousand (20,000) acres are issued in a year, additional development in excess of twenty-thousand (20,000) acres can be permitted in succeeding years. Likewise, if more than twenty thousand (20,000) acres is permitted in one year (recognizing that a single large project could exceed twenty thousand (20,000) acres) the permitted development in succeeding years must be correspondingly less to maintain no greater than a twenty thousand (20,000) acres/year average for any four (4) year period; (3-20-20)T

iii. The criteria of Subsection 045.03.g. applies to multiple-use projects with irrigation as a principal purpose. Projects which use irrigation as only an incidental purpose, such as the land treatment of waste, shall not be included within this policy; and (3-20-20)T

iv. An application determined by the Director to be otherwise approvable but found to exceed the acreage limitations, when considered with other applications approved for development, may be approved with conditions providing for the construction of project works and beneficial use of water to be commenced in a future year. (3-20-20)T

h. No single public interest criterion will be entitled to greater weight than any other public interest criterion. (3-20-20)T

i. Until such time as the studies prescribed in Policy 32 I of the State Water Plan are completed and accepted by the Idaho Water Resource Board, applications and permits reprocessed which propose to divert water to surface storage from the Snake River and surface tributaries upstream from Murphy Gauging Station shall be presumed to satisfy the public interest criteria of Section 42-203C(2), Idaho Code. Applications or reprocessed permits which are approved prior to completion of the studies, will not be subject to additional reprocessing. (3-20-20)T

j. Applications for permit for trust water sources filed prior to July 1, 1985, for projects for which diversion and beneficial use was complete prior to October 1, 1984, are presumed to satisfy the public interest criteria of Section 42-203C(2), Idaho Code. (3-20-20)T

k. Applications or permits to be reprocessed proposing a direct diversion of water for irrigation purposes from the Snake River between Milner Dam and Swan Falls Dam or from tributary springs in this reach are presumed not to be in the public interest as defined by Section 42-203C, Idaho Code. Such proposals, are presumed to prevent the full economic and multiple use of water in the Snake River Basin and to adversely affect hydropower availability and electrical energy rates in the state of Idaho. (3-20-20)T

l. Proposed DCMI uses which individually do not have a maximum consumptive use of more than two acre-feet/day are presumed to meet the public interest criteria of Section 42-203C(2), Idaho Code, unless protested. (3-20-20)T

**046. -- 049. (RESERVED)**

**050. CONDITIONS OF APPROVAL (RULE 50).**

**01. Issuance of Permits with Conditions.** The Director may issue permits with conditions to insure compliance with the provisions of Title 42, Chapter 2, Idaho Code, other statutory duties, the public interest, and specifically to meet the criteria of Section 42-203A, Idaho Code, and to meet the requirements of Section 42-203C, Idaho Code, to the fullest extent possible including conditions to promote efficient use and conservation of energy and water. (3-20-20)T

**02. Requirements to Mitigate Impact of Flow Depletion.** Permits to be reprocessed or applications approved to appropriate water from the main stem of the Snake River between Milner and Murphy gauging station for diversion to off-stream storage during the period November 1 to March 31 shall include requirements to mitigate, in accordance with the State Water Plan, the impact of flow depletions on downstream generation of hydropower. (3-20-20)T

**03. Applications and Existing Permits That Are Junior and Subordinate.** Applications and existing permits approved for hydropower generation shall be junior and subordinate to all rights to the use of water, other than hydropower, within the state of Idaho that are initiated later in time than the priority of the application or existing hydropower permit. A subordinated permit shall not give rise to any right or claim against future rights to the use of water, other than hydropower, within the state of Idaho initiated later in time than the priority of the application or existing hydropower permit. A permit issued for hydropower purposes shall contain a term condition on the hydropower use in accordance with Section 42-203B(6), Idaho Code. (3-20-20)T

**04. Permanent Flow Measuring Device Requirement.** Applications approved for on-stream storage reservoirs will, unless specifically waived by the Director, require permanent flow measuring devices both upstream and downstream from the reservoir. (3-20-20)T

**05. Well Spacing and Well Construction Requirements.** Applications approved for diversion of groundwater may include conditions requiring well spacing and well construction requirements. (3-20-20)T

**06. Reprocessed Permits.** Permits reprocessed pursuant to Section 42-203D, Idaho Code, may be cancelled, modified or conditioned by the Director to make the permit comply in every way with any permit that would be issued for the same purpose based upon a new application processed under these rules. (3-20-20)T



**07. Voiding Approval of Permit.** Permits may be conditioned to authorize the Director to void the approval of the permit if he determines that the applicant submitted false or misleading information on the application or supporting documents. (3-20-20)T

**08. Retention of Jurisdiction.** The Director may condition permits to retain jurisdiction to insure compliance with the design, construction and operation provisions of the permit. (3-20-20)T

**09. Insuring Minimum Stream Flows and Prior Rights.** The Director may condition permits to insure that established minimum stream flows and prior rights including prior rights reserved by federal law are not injured. (3-20-20)T

**10. Insuring Compliance with Water Quality Standards.** The Director may condition permits to insure compliance with Idaho's water quality standards. (3-20-20)T

**11. Insuring Assignment of Interest.** The Director may condition a permit issued for trust water to require that any amendment (Section 42-211, Idaho Code), transfer (Section 42-222, Idaho Code), or assignment of interest in the permit by any method whatsoever shall not result in the project failing to meet the public interest criteria of Section 42-203C, Idaho Code except, however, lenders obtaining title to the project through default will have a reasonable period of time, as determined by the Director, to meet such criteria or to convey the project to a person or entity that does meet the criteria. (3-20-20)T

**051. -- 054. (RESERVED)**

**055. MORATORIUM (RULE 55).**

**01. Applications for Permit.** (3-20-20)T

**a.** The Director may cease to approve applications for permit in a designated geographical area upon finding a need to: (3-20-20)T

i. Protect existing water rights; (3-20-20)T

ii. Insure compliance with the provisions of Chapter 2, Title 42, Idaho Code; and (3-20-20)T

iii. Prevent reduction of flows below a minimum stream flow which has been established by the Director or the board pursuant to applicable law. (3-20-20)T

**b.** Notice of the Director's action to cease application approval will be by: (3-20-20)T

i. Summary Order served by certified mail upon the then existing affected applicants; and (3-20-20)T

ii. Publication of the order for three (3) consecutive weeks in a newspaper or newspapers of general circulation in the area affected. (3-20-20)T

**c.** Objections to the Director's action shall be considered under the department's adopted Rules of Procedure and applicable law. (3-20-20)T

**02. Permits.** (3-20-20)T

**a.** To the extent a permit has not been developed, the Director may cancel, or modify permits for which proof of beneficial use has not been submitted in a designated geographical area as an extension of Subsection 055.01. (3-20-20)T

**b.** Notice of the Director's action to cancel or modify permits shall be by: (3-20-20)T

i. Summary Order served by certified mail upon the affected permit holders in the designated area. (3-20-20)T



ii. Publication of the order for three (3) consecutive weeks in a newspaper or newspapers of general circulation in the area. (3-20-20)T

c. Objections to the Director's action shall be considered under the department's adopted Rules of Procedure and applicable law. (3-20-20)T

**056. -- 999. (RESERVED)**

APPENDIX A

Geographic Area From Which Groundwater Is Determined To Be Tributary To The Snake River In The Milner Dam To Swan Falls Dam Reach.

-  Tributary Area
-  Perched Aquifers Not Tributary But Deep Regional Aquifer Is Tributary.

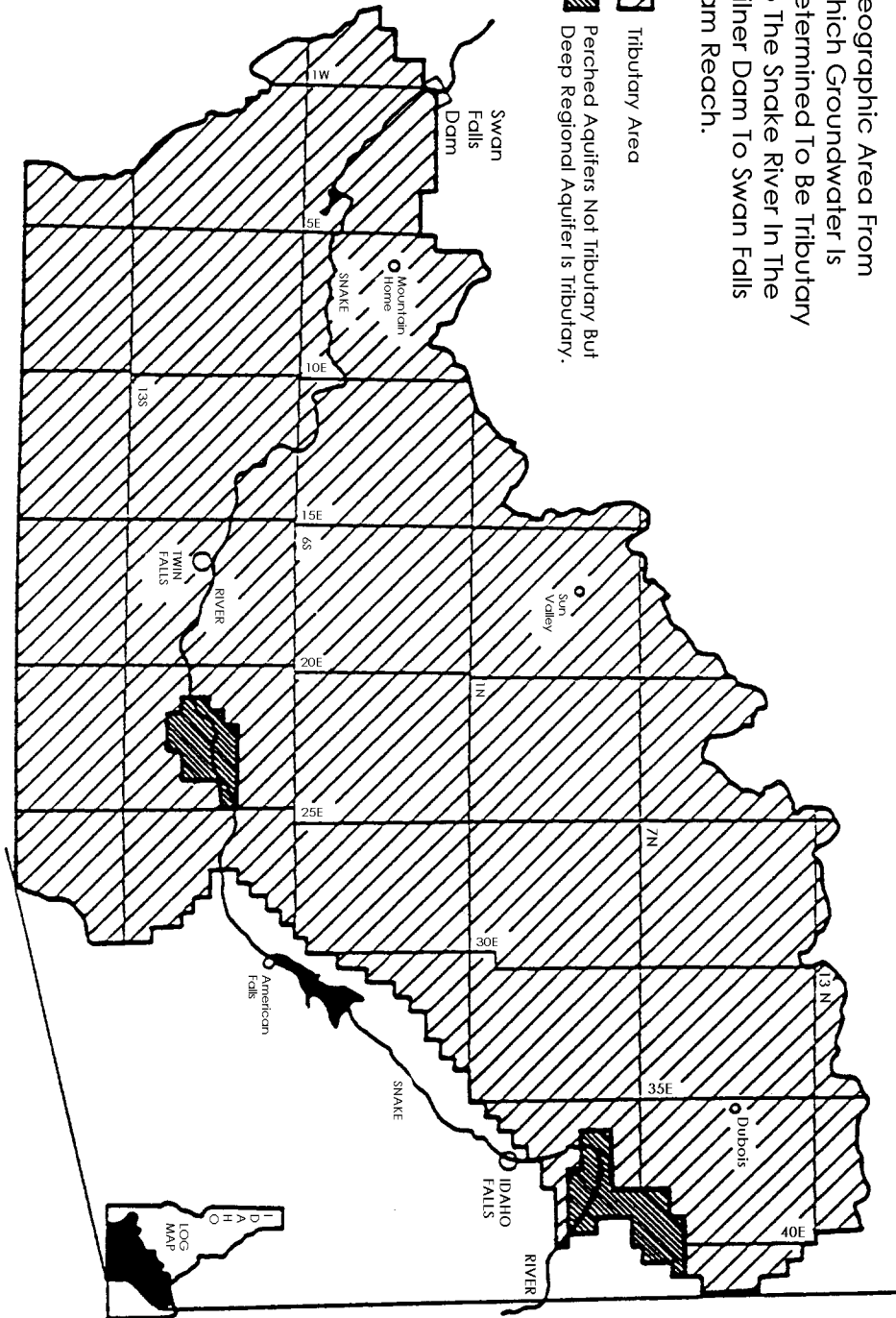

APPENDIX B

SUGGESTED IRRIGATION SEASONS  
IN IDAHO

50% chance of a 28<sup>0</sup> frost occurring  
before or after the dates given.

-  March 1 - December 1
-  March 15 - November 15
-  April 1 - November 1
-  April 15 - October 15

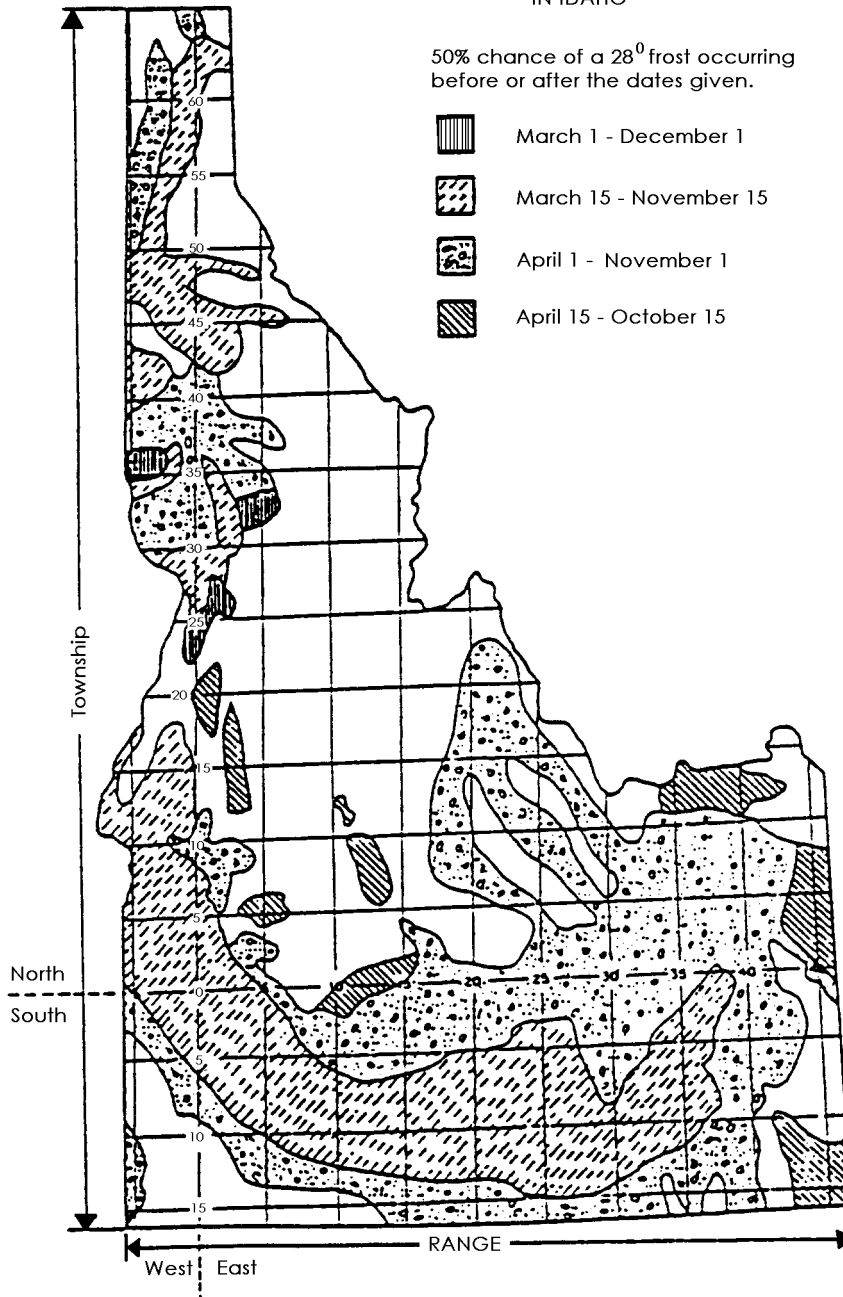

APPENDIX C

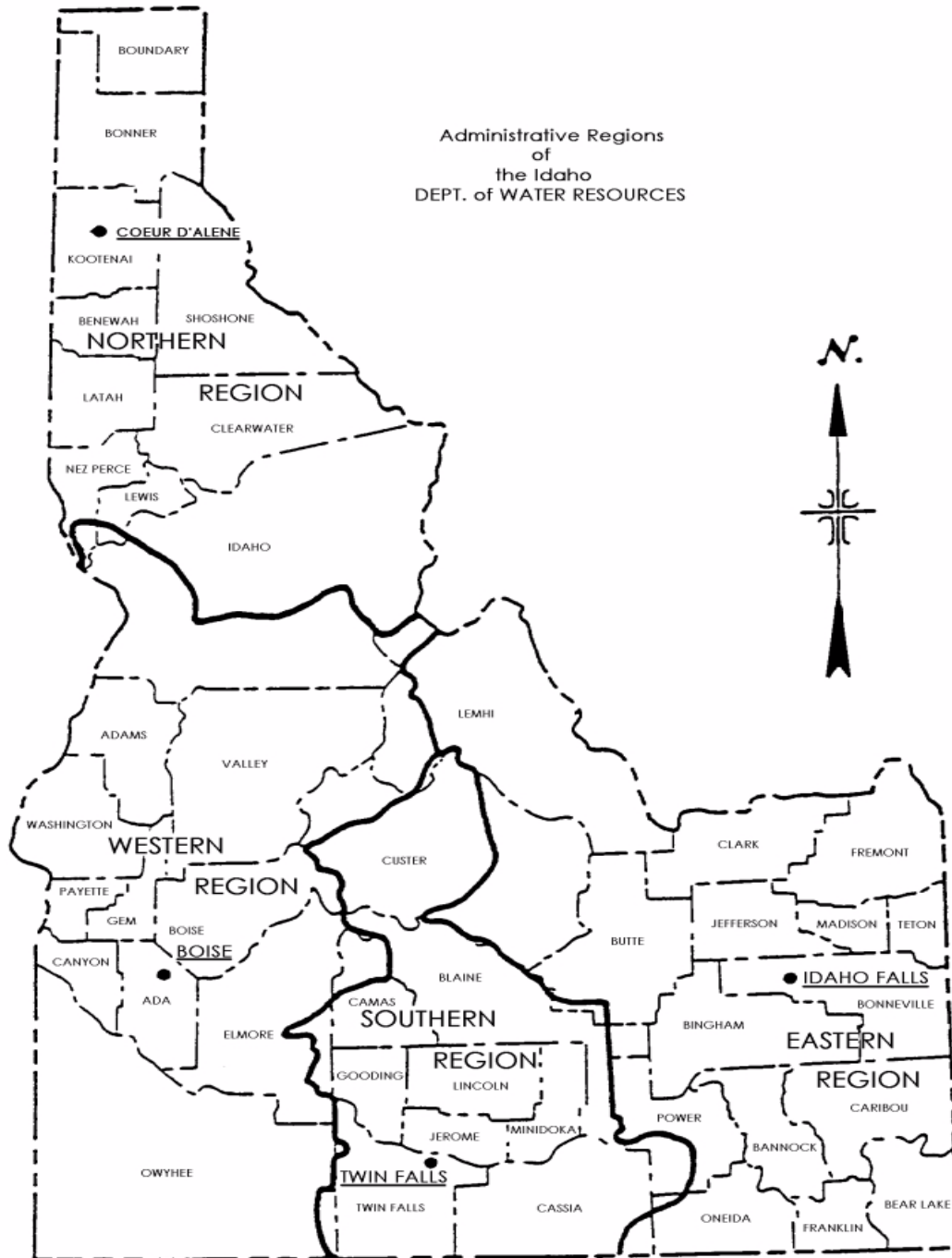

## 37.03.09 – WELL CONSTRUCTION STANDARDS RULES

### 000. LEGAL AUTHORITY (RULE 0).

The Idaho Water Resource Board adopts these administrative rules with the authority provided by Section 42-238(12), Idaho Code. (3-20-20)T

### 001. TITLE AND SCOPE (RULE 1).

**01. Title.** These rules are cited as IDAPA 37.03.09, “Well Construction Standards Rules.” (3-20-20)T

**02. Scope.** The Department of Water Resources has statutory responsibility for the statewide administration of the rules governing well construction. These rules establish minimum standards for the construction of all new wells and the modification and decommissioning (abandonment) of existing wells. The intent of the rules is to protect the ground water resources of the state against waste and contamination. These rules are applicable to all water wells, monitoring wells, low temperature geothermal wells, injection wells, cathodic protection wells, closed loop heat exchange wells, and other artificial openings and excavations in the ground that are more than eighteen (18) feet in vertical depth below land surface as described in these rules pursuant to Section 42-230 Idaho Code. Some artificial openings and excavations do not constitute a well. For the purposes of these rules, artificial openings and excavations not defined as wells are described in Subsection 045.03 of these rules. Any time that such an artificial opening or excavation is constructed, modified, or decommissioned (abandoned) the intent of these rules must be observed. If waste or contamination is attributable to this type of artificial opening or excavation, the artificial opening or excavation must be modified, or decommissioned (abandoned) as determined by the Director. (3-20-20)T

### 002. -- 009. (RESERVED)

### 010. DEFINITIONS (RULE 10).

Unless the context otherwise requires, the following definitions apply to these rules. (3-20-20)T

**01. Approved Seal or Seal Material.** Seal material must consist of bentonite chips, pellets, or granules, bentonite grout, neat cement, or neat cement grout as defined by these rules. No other materials may be used unless specifically authorized by the Director (3-20-20)T

**02. Annular Space.** The space, measured as one-half (1/2) the difference in diameter between two (2) concentric cylindrical objects, one of which surrounds the other, such as the space between the walls of a drilled hole (borehole) and a casing or the space between two (2) strings of casing. (3-20-20)T

**03. Aquifer.** Any geologic formation(s) that will yield water to a well in sufficient quantities to make the production of water from the formation feasible for beneficial use. (3-20-20)T

**04. Area of Drilling Concern.** An area designated by the Director in which drillers must comply with additional standards to prevent waste or contamination of ground or surface water due to such factors as aquifer pressure, vertical depth of the aquifer, warm or hot ground water, or contaminated ground or surface waters, in accordance with Section 42-238(7), Idaho Code. (3-20-20)T

**05. Artesian Water.** Any water that is confined in an aquifer under pressure so that the water will rise in the well casing or drilled hole above the elevation where it was first encountered. This term includes water of flowing and non-flowing wells. (3-20-20)T

**06. Artificial Filter Pack.** Clean, rounded, smooth, uniform, sand or gravel placed in the annular space around a perforated well casing or well screen. A filter pack is frequently used to prevent the movement of finer material into the well casing and to increase well efficiency. (3-20-20)T

**07. Bentonite.** A commercially processed and packaged, low permeability, sodium montmorillonite clay certified by the NSF International for use in well construction, sealing, plugging, and decommissioning (abandonment). All bentonite products used in the construction or decommissioning (abandoning) of wells must have a permeability rating not greater than  $10^{-7}$  (ten to the minus seven) cm/sec. (3-20-20)T

**a.** Chips. Bentonite composed of pieces ranging in size from one-quarter (1/4)-inch to one (1) inch on their greatest dimension. (3-20-20)T

**b.** Granules (also Granular). Bentonite composed of pieces ranging in size from one thirty-seconds (1/32) inch (#20 standard mesh) to seven thirty-seconds (7/32) inch (#3 standard mesh) on their greatest dimension. (3-20-20)T

- c.** Bentonite Grout. A mixture of bentonite specifically manufactured for use as a well sealing or plugging material and potable water to produce a grout with an active solids content not less than twenty-five percent (25%) by weight e.g., (twenty-five percent (25%) solids content by weight = fifty (50) pounds bentonite per eighteen (18) gallons of water). (3-20-20)T
- d.** Pellets. Bentonite manufactured for a specific purpose and composed of uniform sized, one-quarter (1/4) inch, three-eighths (3/8) inch, or one-half (1/2) inch pieces on their greatest dimension. (3-20-20)T
- 08. Board.** The Idaho Water Resource Board. (3-20-20)T
- 09. Bore Diameter.** The diameter of the hole in the formation made by the drill bit or reamer. (3-20-20)T
- 10. Borehole (also Well Bore).** The subsurface hole created during the drilling process. (3-20-20)T
- 11. Bottom Hole Temperature of an Existing or Proposed Well.** The temperature of the ground water encountered in the bottom of a well or borehole. (3-20-20)T
- 12. Casing.** The permanent conduit installed in a well to provide physical stabilization, prevent caving or collapse of the borehole, maintain the well opening and serve as a solid inner barrier to allow for the installation of an annular seal. Casing does not include temporary surface casing, well screens, liners, or perforated casing as otherwise defined by these rules. (3-20-20)T
- 13. Cathodic Protection Well.** Any artificial excavation in excess of eighteen (18) feet in vertical depth constructed for the purpose of protecting certain metallic equipment in contact with the ground. Commonly referred to as cathodic protection. (3-20-20)T
- 14. Closed Loop Heat Exchange Well.** A ground source thermal exchange well constructed for the purpose of installing any underground system through which fluids are circulated but remain isolated from direct contact with the subsurface or ground water. (3-20-20)T
- 15. Conductor Pipe.** The first and largest diameter string of permanent casing to be installed in a low temperature geothermal resource well. (3-20-20)T
- 16. Confining Layer.** A subsurface zone of low-permeability earth material that naturally acts to restrict or retard the movement of water or contaminants from one zone to another. The term does not include topsoil. (3-20-20)T
- 17. Consolidated Formations.** Naturally-occurring geologic formations that have been lithified (turned to stone) such as sandstone and limestone, or igneous rocks such as basalt and rhyolite, and metamorphic rocks such as gneiss and slate. (3-20-20)T
- 18. Contaminant.** Any physical, chemical, ion, radionuclide, synthetic organic compound, microorganism, waste, or other substance that does not occur naturally in ground water or that naturally occurs at a lower concentration. (3-20-20)T
- 19. Contamination.** The introduction into the natural ground water of any physical, chemical, biological or radioactive material that may: (3-20-20)T
- a.** Cause a violation of Idaho Ground Water Quality Standards; or (3-20-20)T
- b.** Adversely affect the health of the public; or (3-20-20)T
- c.** Adversely affect a designated or beneficial use of the State's ground water. Contamination includes the introduction of heated or cooled water into the subsurface that will alter the ground water temperature and render the local ground water less suitable for beneficial use, or the introduction of any contaminant that may cause a

violation of IDAPA 58.01.11, “Ground Water Quality Rule.” (3-20-20)T

**20. Decommissioned (Abandoned) Well.** Any well that has been permanently removed from service and filled or plugged in accordance with these rules so as to meet the intent of these rules. A properly decommissioned well will not: (3-20-20)T

- a. Produce or accept fluids; (3-20-20)T
- b. Serve as a conduit for the movement of contaminants inside or outside the well casing; or (3-20-20)T
- c. Allow the movement of surface or ground water into unsaturated zones, into another aquifer, or between aquifers. (3-20-20)T

**21. Decontamination.** The process of cleaning equipment intended for use in a well in order to prevent the introduction of contaminants into the subsurface and contamination of natural ground water. (3-20-20)T

**22. Department.** The Idaho Department of Water Resources. (3-20-20)T

**23. Dewatering Well.** A well constructed for the purpose of improving slope stability, drying up borrow pits, or intercepting seepage that would otherwise enter an excavation. (3-20-20)T

**24. Director.** The Director of the Idaho Department of Water Resources or his duly authorized representatives. (3-20-20)T

**25. Disinfection.** The introduction of chlorine or other agent or process approved by the Director in sufficient concentration and for the time required to inactivate or kill fecal and Coliform bacteria, indicator organisms, and other potentially harmful pathogens. (3-20-20)T

**26. Draw Down.** The difference in vertical distance between the static water level and the pumping water level. (3-20-20)T

**27. Drive Point (also known as a Sand Point).** A conduit pipe or casing through which ground water of any temperature is sought or encountered created by joining a “drive point unit” to a length of pipe and driving the assembly into the ground. (3-20-20)T

**28. Exploratory Well.** A well drilled for the purpose of discovering or locating new resources in unproven areas. They are used to extract geological, hydrological, or geophysical information about an area. (3-20-20)T

**29. Global Positioning System (GPS).** A global navigational receiver unit and satellite system used to triangulate a geographic position. (3-20-20)T

**30. Hydraulic Conductivity.** A measurement of permeability. (3-20-20)T

**31. Hydraulic Fracturing.** A process whereby water or other fluid is pumped under high pressure into a well to further fracture the reservoir rock or aquifer surrounding the production zone of a well to increase well yield. (3-20-20)T

**32. Injection Well.** Any excavation or artificial opening into the ground which meets the following three (3) criteria: (3-20-20)T

- a. It is a bored, drilled or dug hole, or is a driven mine shaft or driven well point; and (3-20-20)T
- b. It is deeper than its largest straight-line surface dimension; and (3-20-20)T
- c. It is used for or intended to be used for subsurface placement of fluids. (3-20-20)T



- 33. Intermediate String or Casing.** The casing installed and sealed below the surface casing within a low temperature geothermal resource well to isolate undesirable water or zones below the bottom of the surface casing. Such strings may either be lapped into the surface casing or extend to land surface. (3-20-20)T
- 34. Liner.** (3-20-20)T
- a.** A conduit pipe that can be removed from the borehole or well that is used to serve as access and protective housing for pumping equipment and provide a pathway for the upward flow of water within the well. (3-20-20)T
- b.** Liner does not include casing required to prevent caving or collapse, or both, of the borehole or serve as a solid inner barrier to allow for the installation of an annular seal. (3-20-20)T
- 35. Mineralized Water.** Any naturally-occurring ground water that has an unusually high amount of chemical constituents dissolved within the water. Water with five thousand (5000) mg/L or greater total dissolved solids is considered mineralized. (3-20-20)T
- 36. Modify.** To deepen a well, increase or decrease the diameter of the casing or the well bore, install a liner, place a screen, perforate existing casing or liner, alter the seal between the casing and well bore, or alter the well to not meet well construction standards. (3-20-20)T
- 37. Monitoring Well.** Any well more than eighteen (18) feet in vertical depth constructed to evaluate, observe or determine the quality, quantity, temperature, pressure or other characteristics of the ground water or aquifer. (3-20-20)T
- 38. Neat Cement.** A mixture of water and cement in the ratio of not more than six (6) gallons of water to ninety-four (94) pounds of Portland cement (neat cement). Other cement grout mixes may be used if specifically approved by the Director. (3-20-20)T
- 39. Neat Cement Grout.** Up to five percent (5%) bentonite by dry weight may be added per sack of cement (neat cement grout) and the water increased to not more than six and one-half (6.5) gallons per sack of cement. Other neat cement mixes may be used if specifically approved by the Director. These grouts must be mixed and installed in accordance with the American Petroleum Institute Standards - API Class A through H. As found in API RP10B, "Recommended Practice for Testing Oil Well Cements and Cement Additives," current edition or other approved standards. (3-20-20)T
- 40. Oxidized Sediments.** Sediments, characterized by distinct coloration, typically shades of brown, red, or tan, caused by the alteration of certain minerals in an environment with a relative abundance of oxygen. (3-20-20)T
- 41. Perforated Well Casing.** Well casing that has been modified by the addition of openings created by drilling, torch cutting, saw cutting, mechanical down-hole perforator, or other method. (3-20-20)T
- 42. Pitless Adaptor or Pitless Unit.** An assembly of parts designed for attachment to a well casing which allows buried pipe to convey water from the well or pump and allows access to the interior of the well casing for installation or removal of the pump or pump appurtenances, while maintaining a water tight connection through the well casing and preventing contaminants from entering the well. (3-20-20)T
- 43. Potable Water.** Water of adequate quality for human consumption. (3-20-20)T
- 44. Pressure Grouting (Grouting).** The process of pumping and placing an approved grout mixture into the required annular space, by positive displacement from bottom to top using a tremie pipe, Halliburton method, float shoe, or other method approved by the Director. (3-20-20)T
- 45. Production Casing.** The casing or tubing through which a low temperature geothermal resource is produced. This string extends from the producing zone to land surface. (3-20-20)T

- 46. Public Water System.** A system for the provision to the public of water for human consumption through pipes or, after August 5, 1998, other constructed conveyances, if such system has at least fifteen (15) service connections, regardless of the number of water sources or configuration of the distribution system, or regularly serves an average of at least twenty-five (25) individuals daily at least sixty (60) days out of the year. Such term includes: (3-20-20)T
- a.** Any collection, treatment, storage, and distribution facilities under the control of the operator of such system and used primarily in connection with such system; and (3-20-20)T
  - b.** Any collection or pretreatment storage facilities not under such control that are used primarily in connection with such system. (3-20-20)T
  - c.** Such term does not include any “special irrigation district.” (3-20-20)T
  - d.** A public water system is either a “community water system” or a “non-community water system.” (3-20-20)T
- 47. Reduced Sediments.** Sediments, characterized by distinct coloration, typically shades of blue, black, gray, or green, caused by the alteration of certain minerals in an oxygen poor environment. (3-20-20)T
- 48. Remediation Well.** A well used to inject or withdraw fluids, vapor, or other solutions approved by the Director for the purposes of remediating, enhancing quality, or controlling potential or known contamination. Remediation wells include those used for air sparging, vapor extraction, or injection of chemicals for remediation or in-situ treatment of contaminated sites. (3-20-20)T
- 49. Sand.** Any sediment particle retained on a U.S. standard sieve #200 (Seventy-five hundredths (0.075) mm to two (2) mm). (3-20-20)T
- 50. Screen (Well Screen).** A commercially produced structural tubular retainer with standard sized openings to facilitate production of sand free water. (3-20-20)T
- 51. Seal or Sealing.** The placement of approved seal material in the required annular space between a borehole and casing, between casing strings, or as otherwise required to create a low permeability barrier and prevent movement or exchange of fluids. Seals are required in the construction of new wells, repair of existing wells, and in the decommissioning (abandonment) of wells. Seals are essential to the prevention of waste and contamination of ground water. (3-20-20)T
- 52. Start Card.** An expedited drilling permit process for the construction of cold water, single-family residential wells. (3-20-20)T
- 53. Static Water Level.** The height at which water will rise in a well under non-pumping conditions. (3-20-20)T
- 54. Surface Casing.** The first string of casing in a low temperature geothermal resource well which is set and sealed after the conductor pipe to anchor blow out prevention equipment and to case and seal out all existing cold ground water zones. (3-20-20)T
- 55. Temporary Surface Casing.** Steel pipe used to support the borehole within unstable or unconsolidated formations during construction of a well that will be removed following the installation of the permanent well casing and prior to or during placement of an annular seal. (3-20-20)T
- 56. Thermoplastic/PVC Casing.** Plastic piping material meeting the requirements of ASTM F 480 and specifically designed for use as well casing. (3-20-20)T
- 57. Transmissivity.** The capacity of an aquifer to transmit water through its entire saturated thickness. (3-20-20)T

**58. Tremie Pipe.** A small-diameter pipe used to convey grout, dry bentonite products, or filter pack materials into the annular space, borehole, or well from the bottom to the top of a borehole or well. (3-20-20)T

**59. Unconfined Aquifer.** An aquifer in which the water table is in contact with and influenced by atmospheric pressure through pore spaces in the overlying formation(s). (3-20-20)T

**60. Unconsolidated Formation.** A naturally-occurring earth formation that has not been lithified. Alluvium, soil, sand, gravel, clay, and overburden are some of the terms used to describe this type of formation. (3-20-20)T

**61. Unstable Unit.** Unconsolidated formations, and those portions of consolidated formations, that are not sufficiently hard or durable enough to sustain an open borehole without caving or producing obstructions without the aid of fluid hydraulics or other means of chemical or physical stabilization. (3-20-20)T

**62. Unusable Well.** Any well that can not be used for its intended purpose or other beneficial use authorized by law. (3-20-20)T

**63. Waiver.** Approval in writing by the Director of a written request from the well driller and the well owner proposing specific variance from the minimum well construction standards. (3-20-20)T

**64. Waste.** The loss, transfer, or subsurface exchange of a ground water resource, thermal characteristic, or natural artesian pressure from any aquifer caused by improper construction, misuse, or failure to properly maintain a well. Waste includes: (3-20-20)T

**a.** The flow of water from an aquifer into an unsaturated subsurface zone; (3-20-20)T

**b.** The transfer or mixing, or both, of waters from one aquifer to another (aquifer commingling); or (3-20-20)T

**c.** The release of ground water to the land surface whenever such release does not comply with an authorized beneficial use. (3-20-20)T

**65. Water Table.** The height at which water will rise in a well; also the upper surface of the zone of saturation in an unconfined aquifer. This level will change over time due to changes in water supply and aquifer impacts. (3-20-20)T

**66. Well.** (3-20-20)T

**a.** An artificial excavation or opening in the ground more than eighteen (18) feet in vertical depth below land surface by which ground water of any temperature is sought or obtained. The depth of a well is determined by measuring the maximum vertical distance between the land surface and the deepest portion of the well. Any water encountered in the well is considered to be obtained for the purpose of these rules; or (3-20-20)T

**b.** Any waste disposal and injection well, as defined in Section 42-3902, Idaho Code. (3-20-20)T

**c.** Well does not mean: (3-20-20)T

**i.** A hole drilled for mineral exploration; or (3-20-20)T

**ii.** Holes drilled for oil and gas exploration which are subject to the requirements of Section 47-320, Idaho Code; or (3-20-20)T

**iii.** Holes drilled for the purpose of collecting soil samples above the water table. (3-20-20)T

**67. Well Development.** The act of bailing, jetting, pumping, or surging water in a well to remove drilling fluids, fines, and suspended materials from within a completed well and production zone in order to establish

the optimal hydraulic connection between the well and the aquifer. (3-20-20)T

**68. Well Driller or Driller.** Any person who operates drilling equipment, or who controls or supervises the construction of a well, and is licensed under Section 42-238, Idaho Code (3-20-20)T

**69. Well Drilling or Drilling.** The act of constructing a new well or modifying or changing the construction of an existing well. (3-20-20)T

**70. Well Owner.** Any person, firm, partnership, co-partnership, corporation, association, or other entity, or any combination of these, who owns the property on which the well is or will be located or has secured ownership of the well by means of a deed, covenant, contract, easement, or other enforceable legal instrument for the purpose of benefiting from the well. (3-20-20)T

**71. Well Rig (Drill Rig).** Any power driven percussion, rotary, boring, digging, jetting or auguring machine used in the construction of a well. (3-20-20)T

**011. -- 024. (RESERVED)**

**025. CONSTRUCTION OF COLD WATER WELLS (RULE 25).**

All persons constructing wells must comply with the requirements of Section 42-238, Idaho Code, and IDAPA 37.03.10, "Well Driller Licensing Rules." The standards specified in Rule 25 apply to all wells with a bottom hole temperature of eighty-five (85) degrees Fahrenheit or less. Wells with a bottom hole temperature greater than eighty-five (85) degrees Fahrenheit, but less than two hundred twelve (212) degrees Fahrenheit, must meet the requirements of Rule 30 in addition to meeting the requirements of Rule 25. These standards also apply to any waste disposal and injection well as defined in Section 42-3902, Idaho Code. (3-20-20)T

**01. General.** The well driller must construct each well as follows: (3-20-20)T

**a.** In accordance with these rules and with the conditions of approval of any drilling permit issued pursuant Section 42-235, Idaho Code, and in a manner that will prevent waste and contamination of the ground water resources of the state of Idaho. The adopted standards are minimum standards which must be adhered to in the construction of all new wells, and in the modification or decommissioning (abandonment) of existing wells. The well driller is charged with the responsibility of preventing waste or contamination of the ground water resources during the construction, modification or abandonment of a well. The Director may add conditions of approval to a drilling permit issued pursuant to Rule 45 of these rules to require that a well be constructed, modified, or decommissioned (abandoned) in accordance with additional standards when necessary to protect ground water resources and the public health and safety from existing contamination and waste or contamination during the construction, modification or decommissioning (abandonment) of a well. (3-20-20)T

**b.** In consideration of the geologic and ground water conditions known to exist or anticipated at the well site. (3-20-20)T

**c.** Such that it is capable of producing, where obtainable, the quantity of water to support the allowed or approved beneficial use of the well, subject to law; (3-20-20)T

**d.** Meet the siting and separation distance requirements in the table in this Subsection (025.01.d.). Additional siting and separation distance requirements are set forth by the governing district health department and the Idaho Department of Environmental Quality rules at IDAPA 58.01.03, "Individual/Subsurface Sewage Disposal Rules," and IDAPA 58.01.08, "Idaho Rules for Public Drinking Water Systems".

Separation of Well from:	Minimum Separation Distance (feet)
Existing Public Water Supply well, separate ownership	- 50

Separation of Well from:	Minimum Separation Distance (feet)
Other existing well, separate ownership	- 25
Septic drain field	- 100
Septic tank	- 50
Drainfield of system with more than 2,500 GPD of sewage inflow	- 300*
Sewer line - main line or sub-main, pressurized, from multiple sources	- 100
Sewer line - main line or sub-main, gravity, from multiple sources	- 50
Sewer line - secondary, pressure tested, from a single residence or building	- 25
Effluent pipe	- 50
Property line	- 5
Permanent buildings, other than those to house the well or plumbing apparatus, or both	- 10
Above ground chemical storage tanks	- 20
Permanent (more than six months) or intermittent (more than two months) surface water	- 50
Canals, irrigation ditches or laterals, & other temporary (less than two months) surface water	- 25
*This distance may be less if data from a site investigation demonstrates compliance with IDAPA 58.01.03, "Individual/Subsurface Sewage Disposal Rules," separation distances.	

(3-20-20)T

**02. Waivers.** In unique cases where the Director concludes that the ground water resources will be protected against waste and contamination and the public health and safety are not compromised, a waiver of specific standards required by these rules may be approved prior to constructing, decommissioning, or modifying a well.

(3-20-20)T

**a.** To request a waiver the well driller and well owner must: (3-20-20)T

**i.** Jointly submit a detailed plan and written request identifying a specific Rule or Rules proposed to be waived. Additionally, the plan must detail the well construction process that will be employed in lieu of complete Rule compliance: (3-20-20)T

**ii.** Prior to submittal, the well driller and the well owner must sign the plan and written request acknowledging concurrence with the request; and (3-20-20)T

**iii.** Submit the plan and request by facsimile, e-mail, or letter. (3-20-20)T

**b.** The Director will evaluate and respond to the request within ten (10) business days of receiving the request. (3-20-20)T

**i.** If the request for waiver is approved, the intent of the rules will be served and all standards not waived will apply. Waivers approved by the Director will not supersede requirements of other regulatory agencies without specific concurrence from that agency. Work activity related to a waiver request will not proceed until a written or verbal approval is granted by the Director. (3-20-20)T

**ii.** Any verbal approval will be followed by a written approval. (3-20-20)T

**03. Records.** In order to enable a comprehensive survey of the extent and occurrence of the state’s ground water resource, the coordinates of every newly constructed, modified or decommissioned (abandoned) well location must be identified by latitude and longitude with a global positioning system (GPS) and recorded on the driller’s report in degrees and decimal minutes and within the nearest 40 acre parcel using the Public Land Survey System. Every well driller must maintain records as described in IDAPA 37.03.10 “Well Driller Licensing Rules,” pursuant to Section 42-238(11), Idaho Code, and provide the well owner with a copy of the approved well drilling permit and a copy of the well driller’s report when submitted to the Director. (3-20-20)T

**04. Casing.** The well driller must install casing in every well. Steel or thermoplastic casing may be installed in any well with a bottom hole temperature of eighty-five (85) degrees Fahrenheit or less. Thermoplastic pipe must not be installed in a well with a bottom hole temperature greater than eighty-five (85) degrees Fahrenheit. All casing to be installed must be new or in like-new condition, free of defects, and clearly marked by the manufacturer with all specifications required by these rules. For all wells the casing must extend at least twelve (12) inches above land surface and finished grade and to a minimum depth below land surface as required by these rules. Concrete slabs around a well casing will be considered finished grade (Figure 01, Appendix A).The well driller must install casing of sufficient strength to withstand calculated and anticipated subsurface forces and corrosive effects. The well driller must install casings sufficiently plumb and straight to allow the installation or removal of screens, liners, pumps and pump columns without causing adverse effects on the operation of the installed pumping equipment. (3-20-20)T

**a. Steel Casing.** When steel casing lengths are joined together, they must be joined by welded joints or screw-couple joints. All connection must be water tight. If steel casing joints are welded, the weld must be at least as thick as the well casing and fully penetrating. Welding rods or flux core wire of at least equal quality to the casing metal must be used. Casing ends to be joined by welding must be properly prepared, beveled and gapped to allow full penetration of the weld. All stick welded joints must have a minimum of two (2) passes including a “root” pass and have minimal undercut when complete. (3-20-20)T

**i.** In addition to meeting these standards, all wells that are constructed for public water systems must meet all of the casing wall thickness requirements set forth by the Idaho Department of Environmental Quality Rules, IDAPA 58.01.08, “Idaho Rules for Public Drinking Water Systems.” (3-20-20)T

**ii.** The well driller must install steel casing that meets or exceeds the American Society of Testing and Materials (ASTM) standard A53, Grade B or American Petroleum Institute (API) 5L Grade B, and that meets the following specifications for wall thickness:

<b>Minimum Single-Wall Steel Well Casing Thickness<sup>1</sup> for Selected Diameters (inches)</b>													
<b>Nominal Diameter (in.)<sup>3</sup></b>	<b>6<sup>2</sup></b>	<b>8</b>	<b>10</b>	<b>12</b>	<b>14</b>	<b>16</b>	<b>18</b>	<b>20</b>	<b>22</b>	<b>24</b>	<b>26</b>	<b>28</b>	<b>30</b>
<b>Depth (ft.)</b>	<b>Nominal Wall Thickness (in.)<sup>1</sup></b>												
<100	0.250	0.250	0.250	0.250	0.250	0.250	0.250	0.250	0.250	0.250	0.250	0.250	0.250
100-200	0.250	0.250	0.250	0.250	0.250	0.250	0.250	0.250	0.250	0.250	0.250	0.250	0.250
200-300	0.250	0.250	0.250	0.250	0.250	0.250	0.250	0.250	0.250	0.250	0.250	0.250	0.250
300-400	0.250	0.250	0.250	0.250	0.250	0.250	0.250	0.250	0.250	0.375	0.375	0.375	0.375
400-600	0.250	0.250	0.250	0.250	0.250	0.250	0.250	0.250	0.375	0.375	0.375	0.375	0.375
600-800	0.250	0.250	0.250	0.250	0.250	0.250	0.375	0.375	0.375	0.375	0.375	0.375	0.375
800-1000	0.250	0.250	0.250	0.250	0.375	0.375	0.375	0.375	0.375	0.375	0.375	0.375	0.375
1000-1500	0.280	0.322	0.365	0.375	0.375	0.375	0.375	0.375	0.375	0.375	0.375	0.375	0.375

Minimum Single-Wall Steel Well Casing Thickness <sup>1</sup> for Selected Diameters (inches)													
Nominal Diameter (in.) <sup>3</sup>	6 <sup>2</sup>	8	10	12	14	16	18	20	22	24	26	28	30
1500-2000	0.280	0.322	0.365	0.375	0.375	0.375	0.375	0.375	0.375	0.375	0.375	0.375	0.375
<p>1 Compliance with the minimum nominal wall thicknesses listed is required for any depth or location where casing is used to prevent caving or collapse, or both, of the borehole or serves as a solid inner barrier to allow for the installation of an annular seal.</p> <p>2 For nominal casing diameters less than six (6) inches, the minimum nominal wall thickness must be equivalent to ASTM Schedule 40.</p> <p>3 For any other casing diameter not addressed herein, prior approval by the Director is required.</p>													

(3-20-20)T

**b.** Thermoplastic Casing. Thermoplastic casing may be used in monitoring wells and cold water wells if drilling of the borehole confirms its suitability for use. (3-20-20)T

i. Thermoplastic casing must conform to ASTM F 480 and NSF-WC. The well driller must not use thermoplastic casing under any condition where the manufacturer's resistance to hydraulic collapse pressure (RHCP) or total depth specifications are exceeded. Thermoplastic casing extending above-ground must be protected from physical and ultraviolet light damage by enclosing it within steel casing extending at least twelve (12) inches above land surface and finished grade and to a minimum depth of eighteen (18) feet below land surface or five (5) feet below land surface for monitoring wells. (3-20-20)T

ii. Thermoplastic pipe used in wells as casing or liner must have a minimum rating of SDR-21. For nominal diameters of four (4) inches or less, a minimum rating of Schedule 40 is required. If used as casing within unconsolidated or unstable consolidated formations, thermoplastic pipe must be centralized and fully supported throughout the unstable zone(s) with filter pack or seal material as required by these rules. (3-20-20)T

iii. All thermoplastic casing and liner must be installed in accordance with the manufacturer's recommendations and specifications, and as required by these rules. The well driller will not treat thermoplastic pipe in any manner that would adversely affect its structural integrity. The well driller must: (3-20-20)T

(1) Ensure that the weight of the pump assembly, if secured to the thermoplastic pipe, does not exceed the weight limitations per manufacturer's recommendations or cause damage to the pipe resulting in breaks or leaks. (3-20-20)T

(2) Not use Type III (high-early strength) Portland cement-based seal materials in direct contact with thermoplastic pipe unless approved by the Director. (3-20-20)T

(3) Not drive, drop, force, or jack thermoplastic pipe into place. Thermoplastic pipe must be lowered or floated into an oversized, obstruction-free borehole. (3-20-20)T

**c.** Perforated Well Casing. Perforated well casing may be used in the construction or decommissioning of a well when such application does not violate any standards required by these rules. (3-20-20)T

**05 Liner.** In addition to well casing, liners may be installed in wells to prevent damage to pumping equipment. Steel or thermoplastic pipe may be installed as liner in a well with a bottom hole temperature of eighty-five (85) degrees Fahrenheit or less. Thermoplastic liner must conform to ASTM F 480 and NSF-WC. Thermoplastic liners must not be used in unconsolidated formations or unstable units. (3-20-20)T

**06. Screen.** Well screens must be used in constructing a well when necessary to avoid sand production (see sand production, Rule 25, Subsection 025.24). Well screens must be commercially manufactured, be slotted,

louvered or wire wrapped, and be installed according to the manufacturer's specifications. (3-20-20)T

**a.** Screens may require a filter pack consisting of sand or gravel to further reduce the quantity of sand produced from the well. (3-20-20)T

**b.** The well driller will not install well screens, perforated casing or filter pack across a confining layer(s) separating aquifers of different pressure, temperature, or quality. (3-20-20)T

**07. Use of Approved Sealing Materials and Required Annular Space.** Well casings must be sealed in the required annular space with approved material to prevent the possible downward movement of contaminated surface waters or other fluids in any annular space around the well casing (Figure 02, Appendix A). Proper sealing is also required to prevent the movement of groundwater either upward or downward from zones of different pressure, temperature or quality within the well or outside the casing. The well driller must notify by phone the Department's appropriate Region Office at least four (4) hours in advance of placing any annular seal to provide Department staff the opportunity to observe seal placement. (3-20-20)T

**a.** All casing to be sealed must be adequately centralized to ensure uniform seal thickness around the well casing. Surface seals must extend to not less than thirty-eight (38) feet below land surface for well depths greater than thirty-eight (38) feet. For well depths less than thirty-eight (38) feet, seals must extend to depths as hereafter required. (3-20-20)T

**b.** Seals are required at depths greater than thirty-eight (38) feet in artesian wells or to seal through confining layers separating aquifers of differing pressure, temperature, or quality in any well. (3-20-20)T

**c.** When a well is modified and the existing casing is moved or the original seal is damaged, or a well driller discovers that a seal was not installed or has been damaged, the well driller must repair, replace, or install a seal around the permanent casing that is equal to or better than required when the well was originally constructed. (3-20-20)T

**d.** Manufactured packers and shale traps may be used as devices to retain approved seal material when installing a required annular seal. Whenever these devices are used to retain seal material, the well driller must comply with the manufacturer's recommendations for installation. (3-20-20)T

**e.** If a temporary casing has been installed, upon completion of the drilling, the annular space must be filled with approved seal material and kept full while withdrawing the temporary casing. Bentonite chips should be used with caution when the annular space between a temporary casing and permanent casing is filled with water. (3-20-20)T

**i.** When attempts at removing a temporary casing are unsuccessful, the casing must be sealed in place by a method approved by the department. (3-20-20)T

**ii.** The well driller must notify the department whenever a temporary casing can not be removed and propose a plan to adequately seal the casing to prevent waste and contamination of the ground water. The plan must detail how the casing will be sealed on the outside to a sufficient depth below land surface in addition to placement of any required formation seals through the interval at which the casing will remain. (3-20-20)T

**f.** For mixed grout seals the minimum annular space required must provide for a uniform seal thickness not less than one (1) inch on all sides of the casing or a borehole at least two (2) inches larger than the outside diameter (OD) of the casing to be sealed (Figure 02, Appendix A). (Note: a seven and seven-eighths (7 7/8) inch diameter (eight (8) inch nominal) borehole around a six and five-eighths (6 5/8) inch OD (six (6) inch nominal casing does not satisfy the minimum annular space requirements). (3-20-20)T

**i.** When placing grout seals with a removable tremie pipe between casing strings or between a borehole and casing, the required annular space must be at least one (1) inch or equal to the OD of the tremie pipe whichever is greater. Permanent tremie pipes will be considered as a casing string and subject to minimum annular space requirements in addition to the annular space requirements around the well casing (Figure 03, Appendix A). (3-20-20)T



ii. All grout seals must be placed from the bottom up, by using an approved method. Bentonite grout must not be used above the water table unless specifically designed and manufactured for such use and approved by the Director in advance. (3-20-20)T

iii. If cement-based grout (neat cement or neat cement grout) is used to create a seal, the casing string sealed must not be moved or driven after the initial set. Construction must not resume for a minimum of twenty-four (24) hours following seal placement; (3-20-20)T

**g.** For dry bentonite seals the minimum annular space required must provide for a uniform seal thickness not less than one and five-eighths (1 5/8) inches on all sides of the casing or a borehole at least four (4) inches larger than the “nominal diameter” of the casing to be sealed. e.g., (six and five-eighths (6 5/8) inch OD (six (6) inch nominal) casing requires a ten and three fourths (10 3/4) inch OD (ten (10) inch nominal) temporary casing or a nine and seven-eighths (9 7/8) inch (ten (10) inch nominal) minimum borehole). Listed below are additional annular space requirements and limitations for placement of dry bentonite seals: (3-20-20)T

i. All dry bentonite seals must be tagged during placement and consider volumetric calculations to verify placement. (3-20-20)T

ii. Installation of dry bentonite seals must be consistent with the manufacturers’ recommendations and specifications for application and placement. (3-20-20)T

iii. Granular bentonite must not be placed through water. (3-20-20)T

iv. If a granular bentonite seal is placed deeper than two hundred (200) feet, the minimum annular space must be increased by at least one (1) inch e.g., (six and five-eighths (6 5/8) inch OD (six (6) inch nominal) casing requires a twelve and three fourths (12 3/4) inch OD (twelve (12) inch nominal) temporary casing or an eleven and seven eights (11 7/8) inch (twelve (12) inch nominal) minimum borehole). (3-20-20)T

v. Bentonite chips may be placed through water or drilling fluid of appropriate viscosity. Bentonite chip seals placed through more than fifty (50) feet of water or drilling fluid will require the minimum annular space to be increased by at least one (1) inch e.g., (six and five-eighths (6 5/8) inch OD (six (6) inch nominal) casing requires a twelve and three fourths (12 3/4) inch OD (twelve (12) inch nominal) temporary casing or an eleven and seven eights (11 7/8) inch (twelve (12) inch nominal) minimum borehole). (3-20-20)T

**08. Sealing of Wells.** Sealing requirements described herein are minimum standards that apply to all wells. The Director may establish alternate minimum sealing requirements in specific areas when it can be determined through detailed studies of the local hydrogeology that a specific alternate minimum will provide protection of the ground water from waste and contamination. (3-20-20)T

**a.** Consolidated Formations. When a water well is drilled into and acquires water from an aquifer that consists of consolidated formations that are above the water table, casing must be installed so that it extends and is sealed to a depth not less than thirty-eight (38) feet (Figure 04, Appendix A). If the well depth is less than thirty-eight (38) feet from land surface, well casing must be installed and sealed five (5) feet into the consolidated formation or to a depth of eighteen (18) feet, whichever is greater. (3-20-20)T

**b.** Unconsolidated Formations without Confining Layers of Clay. When a water well is drilled into and acquires water from an unconfined aquifer that is overlain with unconsolidated formations, such as sand and gravel without confining layers of clay, well casing must extend to at least five (5) feet below the water table and be sealed to a depth not less than thirty-eight (38) feet (Figure 05, Appendix A). If the well depth is less than thirty-eight (38) feet well casing must extend to at least five (5) feet below the water table or eighteen (18) feet, whichever is greater, and be sealed to a depth of at least eighteen (18) feet. (3-20-20)T

i. The extensive (for example, one hundred fifty (150) feet thick or more) unconsolidated, non-stratified, sand and gravel of the Rathdrum Prairie are characterized by extremely high transmissivity and hydraulic conductivity. Under these conditions, sealing wells to depths greater than eighteen (18) feet may not be additionally protective. When a water well is drilled within the boundaries of the Rathdrum Prairie, (shown in Figure 06,

Appendix A of these rules), well casing must extend to at least five (5) feet below the water table and be sealed to a depth not less than eighteen (18) feet (Figure 07, Appendix A). (3-20-20)T

**c.** Unconsolidated Formations with Confining Layers of Clay. When a well is drilled into and acquires water from an aquifer that is overlain by unconsolidated deposits such as sand and gravel, and there are confining layers of clay above the water table, well casing must be installed from the land surface to the confining layer immediately above and in contact with the production zone and sealed to a depth not less than thirty-eight (38) feet (Figure 08, Appendix A). If the well depth is less than thirty-eight (38) feet from land surface, well casing must extend and be sealed into the first confining layer or to a depth of eighteen (18) feet, whichever is greater. (3-20-20)T

**09. Sealing Artesian Wells.** (3-20-20)T

**a.** Unconsolidated Formations. When artesian water is encountered in unconsolidated formations, the production zone or open interval must be limited to zones of like pressure, temperature, and quality. Water encountered in oxidized sediments must not be comingled with water encountered in reduced sediments. Well casing must extend from land surface into the lower most confining layer above the production zone, and must be sealed: (3-20-20)T

i. From land surface to a depth of at least thirty-eight (38) feet; and (3-20-20)T

ii, Through all confining layer(s); and (3-20-20)T

(1) A minimum of five (5) feet of seal material must be placed into or through the lower most confining layer above the production zone (Figure 09, Appendix A); or (3-20-20)T

(2) Five (5) feet into or through the lowermost confining layer above the production zone and continuously to land surface (Figure 09, Appendix A). (3-20-20)T

iii. If the well depth is less than thirty-eight (38) feet, the well must be cased and sealed from land surface to the confining layer in direct contact with the production zone or to a depth of eighteen (18) feet, whichever is greater. (3-20-20)T

**b.** Consolidated Formations. When artesian water is encountered in a consolidated formation, well casing must be installed and sealed from land surface to a depth of at least thirty-eight (38) feet; and (3-20-20)T

i. If the consolidated formation is overlain by a permeable formation(s) and water will rise above the consolidated formation, well casing must extend and be sealed at least five (5) feet into the confining portion of the consolidated formation (Figure 10, Appendix A). (3-20-20)T

ii. If the well depth is less than thirty-eight (38) feet, the well must be cased and sealed from land surface five (5) feet into the confining consolidated formation or to a depth of eighteen (18) feet, whichever is greater. (3-20-20)T

**c.** Control Device. Pursuant to Section 42-1603, Idaho Code, if the well flows at land surface, it must be equipped with a control device approved by the Director, so that the flow can be completely stopped. If leaks occur around the well casing or adjacent to the well, the well must be completed with seals, casing or cement grout to eliminate the leakage. (3-20-20)T

i. Flowing artesian wells must be equipped with an approved pressure gage fitting that will allow access for measurement of shut-in pressure of a flowing well. All pressure gage fittings must include control valves such that the pressure gage can be removed without resulting in artesian flow from the well. (3-20-20)T

ii. The well driller must not move his well drilling rig from the site until all requirements have been satisfied. Some mixing of water may be allowed to develop an adequate water well; however, the mixing must be restricted to water zones of similar pressure, temperature and quality. The driller must take precautions to case and seal out zones which may lead to waste or contamination. (3-20-20)T

**10. Alternative Methods for Sealing Wells.** To accommodate for new technology, and in consideration of the wide variety of drilling equipment used to construct wells, other methods of sealing wells not specifically addressed in these rules may be allowed. The Director may consider specific proposals for alternative methods of sealing on a case by case basis. Director approval or acceptance of such procedures will not constitute a “waiver” of any requirements of these rules. In such cases, the well driller must provide sufficient information for the Director to determine that the full intent of the sealing requirements will be satisfied if an alternative method is employed. If it is determined that a specific alternate method will provide protection of the ground water from waste and contamination, the Director may issue a statement of acceptance qualifying the use and implementation of such methods. (3-20-20)T

**11. Injection Wells.** In addition to meeting the requirements of Rule 25 of these rules, the construction, modification, or decommissioning (abandonment) of all injection wells over eighteen (18) feet in vertical depth must also comply with the IDAPA 37.03.03, “Rules for the Construction and Use of Injection Wells,” and the injection well permit. Drillers must obtain from the Director a certified copy of the permit authorizing construction or modification of an injection well before beginning work. (3-20-20)T

**12. Cathodic Protection Wells.** All cathodic protection wells must be constructed by a licensed well driller in compliance with these rules. A detailed construction plan must be included with the drilling permit application. (3-20-20)T

**13. Monitoring and Remediation Wells.** All monitoring wells and remediation wells must be constructed and maintained in a manner that will prevent waste or contamination and as otherwise required by these rules. When a monitoring well or a remediation well is no longer useful or needed, the owner or operator of the well must decommission (abandon) the well in accordance with Rule 25, Subsection 025.16 of these rules. No person may divert ground water from a monitoring well or a remediation well for any purpose not authorized by the Director. The application for a permit for all monitoring wells and all remediation wells must include a design proposal prepared by a licensed engineer or registered geologist pursuant to Section 42-235, Idaho Code. Blanket permits for monitoring well and remediation well networks may be approved for site-specific monitoring and remediation programs. The designs and specification for monitoring wells and remediation wells must demonstrate that: (3-20-20)T

- a. The ground water resources are protected against waste and contamination; (3-20-20)T
- b. The well(s) will inject or withdraw only fluids, gases or solutions approved by the Director; (3-20-20)T
- c. The well(s) will be constructed so as to prevent aquifer commingling; and (3-20-20)T
- d. The well(s) will be properly decommissioned (abandoned) upon project completion and in accordance with these rules. (3-20-20)T

**14. Closed Loop Heat Exchange Wells.** The well driller must construct closed loop heat exchange wells consistent with these rules. The well driller is not required to install steel casing in such wells. When constructing a closed loop heat exchange well, the well driller must: (3-20-20)T

- a. Construct each borehole of sufficient size to provide the annular space required by these rules. (3-20-20)T
- b. Seal the annular space of each borehole with approved seal material in accordance with these rules; (3-20-20)T
- c. Install fluid-tight circulating pipe, composed of high-density polyethylene, grade PE3408, minimum cell classifications PE355434C or PE345434C conforming to ASTM Standard D3350, or other Director-approved pipe; (3-20-20)T
- d. Join pipe using thermal fusion techniques according to ASTM Standards D-3261 or D-2683. All personnel creating such system joints must be trained in the appropriate thermal fusion technologies; (3-20-20)T
- e. Use only propylene glycol, or other circulating fluid approved by the Director; (3-20-20)T

- f. Ensure that any other system additive is NSF approved and has prior approval from the Director; (3-20-20)T
- g. Pressure test each loop with potable water prior to grout installation; (3-20-20)T
- h. Pressure test the system with potable water prior to installation of the circulating fluid at one hundred percent (100%) of the designed system operating pressure for a minimum duration of twenty-four (24) hours; and (3-20-20)T
- i. Properly repair or decommission (abandon) all loops failing the test by pressure pumping approved seal material through the entire length of each failed loop. After grouting, loop ends must be fused together or capped. (3-20-20)T

**15. Access Port or Pressure Gage.** Upon completion of a well and before removal of the well rig from the site, the well must be equipped with an access port that will allow for measurement of the depth to water or an approved pressure gage fitting that will allow access for measurement of shut-in pressure of an artesian flowing well. All pressure gage fittings must include control valves such that the pressure gage can be removed. Approved access ports are illustrated in Figure 11, APPENDIX A, together with approved locations for pressure gage fittings. Air lines are not a satisfactory substitution for an access port. Nonflowing domestic and stock water wells that are to be equipped with a sanitary seal with a built-in access port are exempt from this requirement. (3-20-20)T

**16. Decommissioning (Abandoning) of Wells.** (3-20-20)T

a. The well owner is charged with maintaining and properly decommissioning (abandoning) a well in a manner that will prevent waste or contamination, or both, of the ground water. No person is allowed to decommission a well in Idaho without first obtaining a driller's license or receiving a waiver of the license requirement from the Director of the Department of Water Resources. Authorization is required from the Director prior to decommissioning any well. Upon decommissioning, the person who decommissioned the well must submit to the Director a report describing the procedure. (3-20-20)T

b. The Director may require decommissioning of a well in compliance with the provisions of these rules, if the well: (3-20-20)T

- i. Does not meet minimum well construction standards; (3-20-20)T
- ii. Meets the definition of an unusable well; (3-20-20)T
- iii. Poses a threat to human health and safety; (3-20-20)T
- iv. Is in violation of IDAPA 58.01.11, "Ground Water Quality Rule"; or (3-20-20)T
- v. Has no valid water right or other authorization acceptable to the Director for use of the well. (3-20-20)T

c. When required by the Director, decommissioning must be done in accordance with the following: (3-20-20)T

i. Cased wells and boreholes without a continuous seal from the top of the intakes or screen to the surface. The well driller must use one (1) of the following methods as applicable: (3-20-20)T

(1) The Director may require that well casing be perforated every five (5) feet from the bottom of the casing to within five (5) feet of the surface. Perforations made must be adequate to allow the free flow of seal material into any voids outside the well casing. There must be at least four equally spaced perforations per section circumference. Approved grout must be pressure pumped to fill any voids outside of the casing. A sufficient volume must be used to completely fill the well and annular space; or (3-20-20)T

- (2) Fill the borehole with approved seal material as the casing is being removed. (3-20-20)T
- ii. Cased wells and boreholes with full-depth seals. If the well is cased and sealed from the top of the screen or production zone to the land surface, the well must be completely filled with approved seal material. (3-20-20)T
- iii. Uncased wells must be completely filled with approved seal material. (3-20-20)T
- iv. Dry hole wells or wells from which the quantity of water to meet a beneficial use cannot be obtained must be decommissioned with cement grout, concrete or other approved seal material in accordance with these rules. (3-20-20)T

**17. Completion of a Well.** The Director will consider that every well is completed when the well drilling equipment has been removed, unless written notice has been given to the Director by the well driller that he intends to return and do additional work on the well within a specified period of time. Upon completion of the well, the well must meet all of the required standards. (3-20-20)T

**a.** Upon completion of drilling and prior to removal of well drilling equipment from a water well site, the top of the casing must be completely covered with: (3-20-20)T

i. A one-fourth inch (1/4") thick solid, new or like-new steel plate with a three-fourths inch (3/4) threaded and plugged access port, welded to and completely covering the casing (Figure 12, Appendix A); or (3-20-20)T

ii. A threaded cap, or a commercially manufactured watertight sanitary well cap (Figure 12, Appendix A); or (3-20-20)T

iii. A commercially manufactured water-tight, snorkel-vented or non-vented well cap on any well susceptible to submergence; or (3-20-20)T

iv. A control device approved by the Director per Section 42-1603, Idaho Code, on any well that flows at land surface (Figure 11, Appendix A). (3-20-20)T

**b.** Upon the completion of every well, the well driller must permanently affix the stainless steel well tag to the steel surface casing in a manner and location that maintains tag legibility. For closed loop heat exchange wells, the well driller must obtain approval for the well tag placement and method of attachment. The well driller must secure each tag by: (3-20-20)T

i. A full-length weld across the top and down each side of the tag; or (3-20-20)T

ii. Using one (1) stainless steel, closed-end domed rivet near each of the four (4) corners of the tag. (3-20-20)T

iii. Prior to welding or riveting, the tag must be pre-shaped to fit the casing such that both sides to be welded or riveted touch the casing and no gaps exist between the tag and casing. (3-20-20)T

**18. Pitless Adapters.** When a pitless adaptor is used (Figure 12, Appendix A), the adaptor should be of the type approved by the NSF International testing laboratory or the approval code adopted by the Pitless Adaptor Division of the Water Systems Council. The pitless adaptor, including the cap or cover, casing extension, and other attachments, must be so designed and constructed to be water tight and to prevent contamination of the potable water supply from external sources. If a permanent surface or outer casing is installed and is cut off or breached to install the pitless adapter on an inner well casing or liner, the space between the permanent outer casing and the liner or inner casing must be sealed. The well owner or person installing the pitless adaptor must then seal the excavation surrounding the pitless adaptor using an approved seal material. (3-20-20)T

**19. Pump Installation.** No person is allowed to install a pump into any well that would cause a violation of Rule 25, of these rules or other applicable rules or state law. (3-20-20)T

**20. Explosives.** Explosives used in well construction must never be detonated inside the required well casing. Approved explosive casing perforators may be exempted by the Director. (3-20-20)T

**21. Hydraulic Fracturing.** Hydraulic fracturing must be performed only by well drillers licensed in Idaho. The pressure must be transmitted through a drill string and must not be transmitted to the well casing. The driller must provide a report to the Director of the fracturing work which must include well location, fracturing depth, fracturing pressures and other data as requested by the Director. (3-20-20)T

**22. Drilling Fluids or Drilling Additives.** The well driller must use only potable water and drilling fluids or drilling additives that are manufactured for use in water wells, are NSF International, American Petroleum Institute (API), or ASTM/ANSI approved; and do not contain a concentration of any substance in excess of Primary Drinking Water Standards, as set forth in IDAPA 58.01.08, "Rules for Public Drinking Water Systems," according to manufacturer's specifications. The well driller may seek approval from the Director to use specific, non-certified products on a case-by-case basis. In addition, the well driller must ensure the containment of all drilling fluids and materials used or produced to the immediate drilling site, and will not dispose of such fluids or materials into any streams, canals, boreholes, wells, or other subsurface pathways. (3-20-20)T

**23. Disinfection and Decontamination.** Upon completion of a well, the driller is responsible for adding the appropriate amount of disinfecting chemical compound and distributing it throughout the well to achieve a uniform concentration for "in place" disinfection of the well. Chlorine compounds used in accordance with the table listed below will satisfy this requirement. Other methods may be used if approved by the Director in advance.

Amount of Chlorine Needed Per 100 Feet of Water in Well			
Casing Diameter (in.)	Gallons of water in casing per 100 ft. of water depth	Amount of 5.25% Sodium Hypochlorite (Unscented Laundry Bleach)	Amount of 65% Calcium Hypochlorite (Chlorine Granules)
6	147	2 ¼ cups	3 tbsp
8	261	4 cups	5 tbsp
10	408	6 ¼ cups	½ cup
12	588	9 cups	¾ cup
16	1044	1 gal	1 ¼ cup
Note: 1 gal = 4 qt = 8 pt = 16 cups; 1 cup = 16 tbsp			
Chlorine granules or tablets must be dissolved and placed into the well as a solution.			
If another concentration of hypochlorite solution is used, the following equation should be used for calculating amounts.			
$(\text{Volume of water in gallons}) \times (0.08) / \% \text{ Hypochlorite (e.g. } 50\% = 50) = \text{cups of hypochlorite}$			
Example: To treat 147 gallons of water using a 50% concentration of hypochlorite solution: $(147 \text{ gallons water}) \times (0.08) / 50 = .23$ (or approximately 1/4) cup of 50% Hypochlorite solution			

(3-20-20)T

**24. Sand Production.** The maximum sand content produced from a well after initial well development must not exceed fifteen (15) ppm. For the purpose of this rule, sand is considered to be any sediment particle retained on a U.S. standard sieve #200 (seventy-five hundredths (0.075) mm to two (2) mm). (3-20-20)T

**a.** When necessary to mitigate sand production the well driller must: (3-20-20)T

- i. Construct each well with properly sized casing, screen(s) or perforated intake(s); and (3-20-20)T
  - ii. Install properly sized filter pack(s); or (3-20-20)T
  - iii. Install pre-packed well screens; or (3-20-20)T
  - iv. Employ other methods approved by the Director. (3-20-20)T
- b.** The Director may grant a waiver exempting a well producing water that exceeds the maximum sand content only if the well driller has met the requirements of Rule 25, Subsection 025.24.a. (3-20-20)T
- c.** Sand production in public water system wells. Wells used in connection with a public water system have more stringent requirements. See IDAPA 58.01.08, "Idaho Rules for Public Water Systems." (3-20-20)T

**25. Well Development and Testing.** For each well the well driller must measure and record the static (non-pumping) water level and the pumping water level, and the production rate. The production rate will be determined by a pump, bailer, air-lift, or other industry approved test of sufficient duration to establish production from the well. For wells with no returns the driller must report no returns and the static water level. This information must be documented on the well driller's report. (3-20-20)T

**026. -- 029. (RESERVED)**

**030. CONSTRUCTION OF LOW TEMPERATURE GEOTHERMAL RESOURCE WELLS AND BONDING (RULE 30).**

**01. General.** Drillers constructing low temperature geothermal resource wells (bottom hole temperature more than eighty-five (85) degrees Fahrenheit and less than two hundred twelve (212) degrees Fahrenheit) must be qualified under the Well Driller Licensing Rules. All low temperature geothermal resource wells must be constructed in such a manner that the resource will be protected from waste due to lost artesian pressure and temperature. The owner or well driller is required to provide bottom hole temperature data, but the Director may make the final determination of bottom hole temperature, based upon information available to him. (3-20-20)T

**a.** All standards and guidelines for construction and decommissioning (abandonment) of cold water wells apply to low temperature geothermal resource wells except as modified by Rule 30, Subsections 030.03, 030.04, and 030.06. (3-20-20)T

**b.** A drilling prospectus must be submitted to and approved by the Director prior to the construction, modification, deepening or decommissioning (abandonment) of any low temperature geothermal resource well. The well owner and the well driller are responsible for the prospectus and subsequent well construction. (3-20-20)T

**02. Well Owner Bonding.** The owner of any low temperature geothermal resource well must file a surety bond or cash bond as required by Section 42-233, Idaho Code, with the Director in an amount not less than five thousand dollars (\$5,000) nor more than twenty thousand dollars (\$20,000) payable to the Director prior to constructing, modifying or deepening the well after July 1, 1987. The bond amount will be determined by the Director within the following guidelines. The bond will be kept in force for one (1) year following completion of the well or until released in writing by the Director, whichever occurs first. (3-20-20)T

**a.** Any well less than three-hundred (300) feet deep with a bottom hole temperature of less than one hundred twenty (120) degrees Fahrenheit and a shut-in pressure of less than ten (10) pounds per square inch gage (psig) at land surface must maintain a bond of five thousand dollars (\$5,000). (3-20-20)T

**b.** The owner of any well three hundred (300) feet to one thousand (1,000) feet deep with a bottom hole temperature of less than one hundred fifty (150) degrees Fahrenheit and a shut-in pressure of less than fifty (50) psig at land surface must maintain a bond of ten thousand dollars (\$10,000). (3-20-20)T

**c.** The owner of any low temperature geothermal resource well not covered by Rule 30, Subsections 030.02.a. and 030.02.b. must maintain a bond of twenty thousand dollars (\$20,000). (3-20-20)T

**d.** The Director may decrease or increase the bonds required if it is shown to his satisfaction that well construction or other conditions merit an increase or decrease. (3-20-20)T

**e.** The bond requirements of Section 42-233, Idaho Code, are applicable to wells authorized by water right permits or licenses having a priority date earlier than July 1, 1987, if the well authorized by the permit or license was not constructed prior to July 1, 1987 or if an existing well constructed within the terms of the permit or license is modified, deepened or enlarged on or after July 1, 1987. (3-20-20)T

**03. Casing.** Low temperature geothermal resource wells must be properly cased and sealed to protect from cooling by preventing intermingling with cold water aquifers. (3-20-20)T

**a.** Steel casing which meets or exceeds the minimum specifications for permanent steel casing of Rule 25, Subsection 025.04 must be installed in every well. The Director may require a more rigid standard for collapse and burst strength as depths or pressures may dictate. Every low temperature geothermal resource well which flows at land surface must have a minimum of forty (40) feet of conductor pipe set and cemented its entire length. (3-20-20)T

**b.** Casing must be installed from twelve (12) inches above land surface into the overlying confining strata of the thermal aquifer. The casing schedule may consist of several different casing strings (i.e. conductor pipe, surface casing, intermediate casing, production casing) which may all extend to land surface or may be overlapped and sealed or packed to prevent fluid migration out of the casing at any depth (Figure 13, Appendix A). (3-20-20)T

**i.** Low temperature geothermal resource wells less than one thousand (1,000) feet deep and which encounter a shut-in pressure of less than fifty (50) psig at land surface must have two (2) strings of casing set and cemented to land surface. Conductor pipe must be a minimum of forty (40) feet in length or ten percent (10%) of the total depth of the well whichever is greater. Surface casing must extend into the confining stratum overlying the aquifer. (3-20-20)T

**ii.** Low temperature geothermal resource wells one thousand (1,000) feet or more in depth or which will likely encounter a shut-in pressure of fifty (50) psig or more at land surface require prior approval of the drilling plan by the Director and must have three strings of casing cemented their total length to land surface. Conductor pipe must be a minimum length of forty (40) feet. Surface casing must be a minimum of two hundred (200) feet in length or ten percent (10%) of the total depth of the well, whichever is greater. Intermediate casing must extend into the confining stratum overlying the aquifer. (3-20-20)T

**c.** Subsection 030.03.b. may be waived if it can be demonstrated to the Director through the lithology, electrical logs, geophysical logs, injectivity tests or other data that formations encountered below the last casing string set, will neither accept nor yield fluids at anticipated pressure to the borehole. (3-20-20)T

**d.** A nominal borehole size of two (2) inches in diameter larger than the Outside Diameter (O.D.) of the casing or casing coupler (whichever is larger) must be drilled. All casing designations must be by O.D. and wall thickness and must be shown to meet a given specification of the American Petroleum Institute, the American Society for Testing and Materials, the American Water Works Association or the American National Standards Institute. The last string of casing set during drilling operations must, at the Director's option, be flanged and capable of mounting a valve or blow out prevention equipment to control flows at the surface before drilling resumes. (3-20-20)T

**04. Sealing of Casing.** All casing must be sealed its entire length with cement or a cement grout mixture unless waived by the Director. The seal material must be placed from the bottom of the casing to land surface either through the casing or tubing or by use of a tremie pipe. The cement or cement grout must be undisturbed for a minimum of twenty-four (24) hours or as needed to allow adequate curing. (3-20-20)T

**a.** A caliper log may be run for determining the volume of cement to be placed with an additional twenty-five (25%) percent on site ready for mixing. If a caliper log is not run, an additional one hundred (100%) percent of the calculated volume of cement must be on site ready for placement. (3-20-20)T

**b.** If there is no return of cement or cement grout at the surface after circulating all of the cement mixture on site, the Director will determine whether remedial work should be done to insure no migration of fluids



around the well bore. (3-20-20)T

c. The use of additives such as bentonite, accelerators, retarders, and lost circulation material must follow manufacturer's specifications. (3-20-20)T

**05. Blow Out Prevention Equipment.** The Director may require the installation of gate valves or annular blow out prevention equipment to prevent the uncontrolled blow out of drilling mud and geothermal fluid. (3-20-20)T

**06. Repair of Wells.** The well driller must submit a drilling prospectus to the Director for review and approval prior to the repair or modification of a low temperature geothermal resource well. (3-20-20)T

**07. Decommissioning (Abandoning) of Wells.** Proper decommissioning (abandonment) of any low temperature geothermal resource well requires the following: (3-20-20)T

a. All cement plugs must be pumped into the hole through drill pipe or tubing. (3-20-20)T

b. All open annuli must be completely filled with cement. (3-20-20)T

c. A cement plug at least one hundred (100) feet in vertical depth must be placed straddling (fifty (50) feet above and fifty (50) feet below) the zone where the casing or well bore meets the upper boundary of each ground water aquifer. (3-20-20)T

d. A minimum of one hundred (100) feet of cement must be placed straddling each drive shoe or guide shoe on all casing including the bottom of the conductor pipe. (3-20-20)T

e. A surface plug of either cement grout or concrete must be placed from at least fifty (50) feet below the top of the casing to the top of the casing. (3-20-20)T

f. A cement plug must extend at least fifty (50) feet above and fifty (50) feet below the top of any liner installed in the well. The Director may waive this rule upon a showing of good cause. (3-20-20)T

g. Other decommissioning (abandonment) procedures may be approved by the Director if the owner or operator can demonstrate that the low temperature geothermal resource, ground waters, and other natural resources will be protected. (3-20-20)T

h. Approval for decommissioning (abandonment) of any low temperature geothermal well must be in writing by the Director prior to the beginning of any decommissioning (abandonment) procedures. (3-20-20)T

**031. -- 034. (RESERVED)**

**035. HEALTH STANDARDS (RULE 35).**

**01. Public Water System Wells.** In addition to meeting these standards, all wells that are constructed for public supply of domestic water must meet all of the requirements set forth by the Idaho Department of Environmental Quality Rules, IDAPA 58.01.08, "Idaho Rules for Public Drinking Water Systems." (3-20-20)T

**02. Special Standards for Construction of Wells When Mineralized or Contaminated Water Is Encountered.** Any time in the construction of a well that mineralized or contaminated water is encountered, the well driller must take the appropriate steps necessary to prevent the poor quality waters from entering the well or moving up or down the annular space around the well casing. The method employed to case and seal out this water will be determined by the well driller, provided all other minimum standards are met. The well driller will take special precautions in the case of filter-packed wells to prevent water of inferior quality from moving vertically in the filter packed portions of the well. All actions taken will be clearly documented on the well driller's report. (3-20-20)T

**03. Distances From Contaminant Sources.** All water wells constructed for domestic use must comply with minimum distances from septic tanks, drain fields, drainfield replacement area and other siting

requirements as set forth in Rule 25, Subsection 025.01.d. (3-20-20)T

**036. OWNERS RESPONSIBILITIES FOR WELL USE AND MAINTENANCE (RULE 36).**

After a well is completed the well owner is responsible for water quality testing, properly maintaining the well, and reporting problems with a well to the Director. All wells must be capped, covered and sealed such that debris cannot enter the well, persons or animals cannot fall into the well, and water cannot enter the well around the outside of the casing. Pursuant to Section 42-1603, Idaho Code, the owner of any artesian well that will flow at land surface is required to apply to the Director for approval of a flow control device. (3-20-20)T

**01. Use.** The well owner must not operate any well in a manner that causes waste or contamination of the ground water resource. Failure to operate, maintain, knowingly allow the construction of any well in a manner that violates these rules, or failure to repair or properly decommission (abandon) any well as herein required will subject the well owner to civil penalties as provided by statute. (3-20-20)T

**02. Maintenance.** The well owner must: (3-20-20)T

**a.** Not allow modification to wells under their control without first obtaining an approved Idaho Department of Water Resources (IDWR) permit, pursuant to Section 42-235, Idaho Code; (3-20-20)T

**b.** Maintain the minimum casing height of twelve (12) inches above land surface and finished grade; (3-20-20)T

**c.** Maintain the appropriate well cap, and control device if required, according to these Rules; and (3-20-20)T

**d.** Not install or allow the installation of any well pump that would cause a violation of the sand production requirements in accordance with these Rules or allow the well to pump in excess of that allowed by a valid water right or domestic exemption. (3-20-20)T

**e.** Maintain the well to prevent waste or contamination of ground waters through leaky casings, pipes, fittings, valves, pumps, seals or through leakage around the outside of the casings, whether the leakage is above or below the land surface. Any person owning or controlling a non-compliant well must have the well repaired by a licensed well driller under a permit issued by the Director in accordance with these Rules. (3-20-20)T

**03. New Construction.** The well owner must not construct or allow construction of any permanent building, except for buildings to house a well or plumbing apparatus, or both, closer than ten (10) feet from an existing well. (3-20-20)T

**04. Maintain All Other Separation Distances.** The well owner must not construct or install, or allow the construction or installation of any object listed in a location closer than that allowed by the table of Rule 25, Subsection 025.01.d. (3-20-20)T

**05. Unusable Wells.** The well owner must have any unusable well repaired or decommissioned (abandoned) by a licensed well driller under a permit issued by the Director in accordance with these Rules. (3-20-20)T

**06. Wells Posing a Threat to Human Health and Safety or Causing Contamination of the Ground Water Resource.** The well owner must have any well shown to pose a threat to human health and safety or cause contamination of the ground water resource immediately repaired or decommissioned (abandoned) by a licensed well driller under a permit issued by the Director in accordance with these Rules. (3-20-20)T

**037. -- 039. (RESERVED)**

**040. AREAS OF DRILLING CONCERN (RULE 40).**

**01. General.** (3-20-20)T

**a.** The Director may designate an “area of drilling concern” to protect public health, or to prevent waste and contamination of ground or surface water, or both, because of factors such as aquifer pressure, vertical depth to the aquifer, warm or hot ground water, or contaminated ground or surface waters. (3-20-20)T

**b.** The designation of an area of drilling concern does not supersede or preclude designation of part or all of an area as a Critical Ground Water Area (Section 42-233a, Idaho Code), Ground Water Management Area (Section 42-233b, Idaho Code), or Geothermal Resource Area (Sections 42-4002 and 42-4003, Idaho Code). (3-20-20)T

**c.** The designation of an area of drilling concern can include certain aquifers or portions thereof while excluding others. The area of drilling concern may include low temperature geothermal resources while not including the shallower cold ground water systems. (3-20-20)T

**02. Bond Requirement. (3-20-20)T**

**a.** The minimum bond to be filed by the well driller with the Director for the construction or modification of any well in an area of drilling concern is ten thousand dollars (\$10,000) unless it can be shown to the satisfaction of the Director that a smaller bond is sufficient. (3-20-20)T

**b.** The Director may determine on a case-by-case basis if a larger bond is required based on the estimated cost to repair, complete or properly decommission (abandon) a well. (3-20-20)T

**03. Additional Requirements. (3-20-20)T**

**a.** A driller must demonstrate to the satisfaction of the Director that he has the experience and knowledge to adequately construct or decommission (abandon) a well which encounters warm water or pressurized aquifers. (3-20-20)T

**b.** A driller must demonstrate to the satisfaction of the Director that he has, or has immediate access to, specialized equipment or resources needed to adequately construct or decommission (abandon) a well. (3-20-20)T

**041. -- 044. (RESERVED)**

**045. DRILLING PERMIT REQUIREMENTS (RULE 45).**

**01. General Provisions. (3-20-20)T**

**a.** Drilling permits are required pursuant to Section 42-235, Idaho Code, prior to construction or modification of any well. (3-20-20)T

**b.** Drilling permits will not be issued for construction of a well which requires another separate approval from the department, such as a water right permit, transfer, amendment or injection well permit, until the other separate permitting requirements have been satisfied. (3-20-20)T

**c.** The Director may allow the use of a start card permit or give verbal approval to a well driller for the construction of cold water single family domestic wells. Start cards must be received by the Department at least two office hours prior to commencing construction of the well. (3-20-20)T

**d.** The Director may give verbal approval to a well driller for the construction of a well for which other permitting requirements have been met, provided that the driller or owner has filed the drilling permit application and appropriate fee. (3-20-20)T

**e.** The Director will not give a verbal approval or allow the use of a start card permit for wells constructed in a designated Area of Drilling Concern, Critical Ground Water Area, or Ground Water Management Area. (3-20-20)T

**f.** A well driller will not construct, drill or modify any well until a drilling permit has been issued, or

verbal approval granted. (3-20-20)T

**02. Effect of a Permit.** (3-20-20)T

**a.** A drilling permit authorizes the construction or modification of a well in compliance with these rules and the conditions of approval on the permit. (3-20-20)T

**b.** A drilling permit does not constitute a water right, injection well permit or other authorization which may be required, authorizing use of water from a well or discharge of fluids into a well. (3-20-20)T

**c.** A drilling permit may not be assigned from one owner to another or from one driller to another. (3-20-20)T

**d.** A drilling permit authorizes the construction of one (1) well, except for blanket monitoring well and blanket remediation well drilling permits. (3-20-20)T

**03. Exclusions.** For the purposes of these Rules, artificial openings and excavations that do not constitute a well and are not subject to the drilling permit requirements must be modified, constructed, or decommissioned (abandoned) in accordance with minimum well construction standards. The Director may require decommissioning (abandonment) of artificial openings and excavations constructed pursuant to Rule 45, Subsection 045.03 of these rules, when the use ceases or if the holes may contribute to waste or contamination of the ground water. The following types of artificial openings and excavations are not considered wells: (3-20-20)T

**a.** Artificial openings and excavations with total depth less than eighteen (18) feet. (3-20-20)T

**b.** Artificial openings and excavations for collecting soil or rock samples, determining geologic properties, or mineral exploration or extraction, including gravel pits. (3-20-20)T

**c.** Artificial openings and excavations for oil and gas exploration for which a permit has been issued pursuant to Section 47-320, Idaho Code. (3-20-20)T

**d.** Artificial openings and excavations constructed for de-watering building or dam foundation excavations. (3-20-20)T

**04. Converting an Artificial Openings or Excavations Not Constructed as a Well for Use as a Well.** Artificial openings and excavations that were not constructed as a well pursuant to a drilling permit, if subsequently converted to obtain water, monitor water quantity or quality, or to dispose of water or other fluids, must be reconstructed by a licensed driller in compliance with well construction standards and drilling permit requirements. (3-20-20)T

**05. Fees.** (3-20-20)T

**a.** Drilling permit fees are as prescribed by Section 42-235, Idaho Code. (3-20-20)T

**b.** The difference between the drilling permit fee required by Section 42-235 Idaho Code as applicable, must be paid when an existing well constructed on or after July 1, 1987, for which the lower drilling permit fee was paid, is authorized by the Director for a use which would require the larger drilling permit fee. (3-20-20)T

**046. -- 049. (RESERVED)**

**050. PENALTIES (RULE 50).**

A person owning or controlling a well that allows waste or contamination of the state's ground water resources or causes a well not to meet the construction standards provided in these Rules is subject to the civil penalties as provided by statute. A driller who violates the foregoing provisions of these well construction standards Rules is subject to enforcement action and the penalties as provided by Statute. (3-20-20)T

051. -- 999. (RESERVED)

APPENDIX A  
Figure 01. Concrete Slabs and Finished Grade

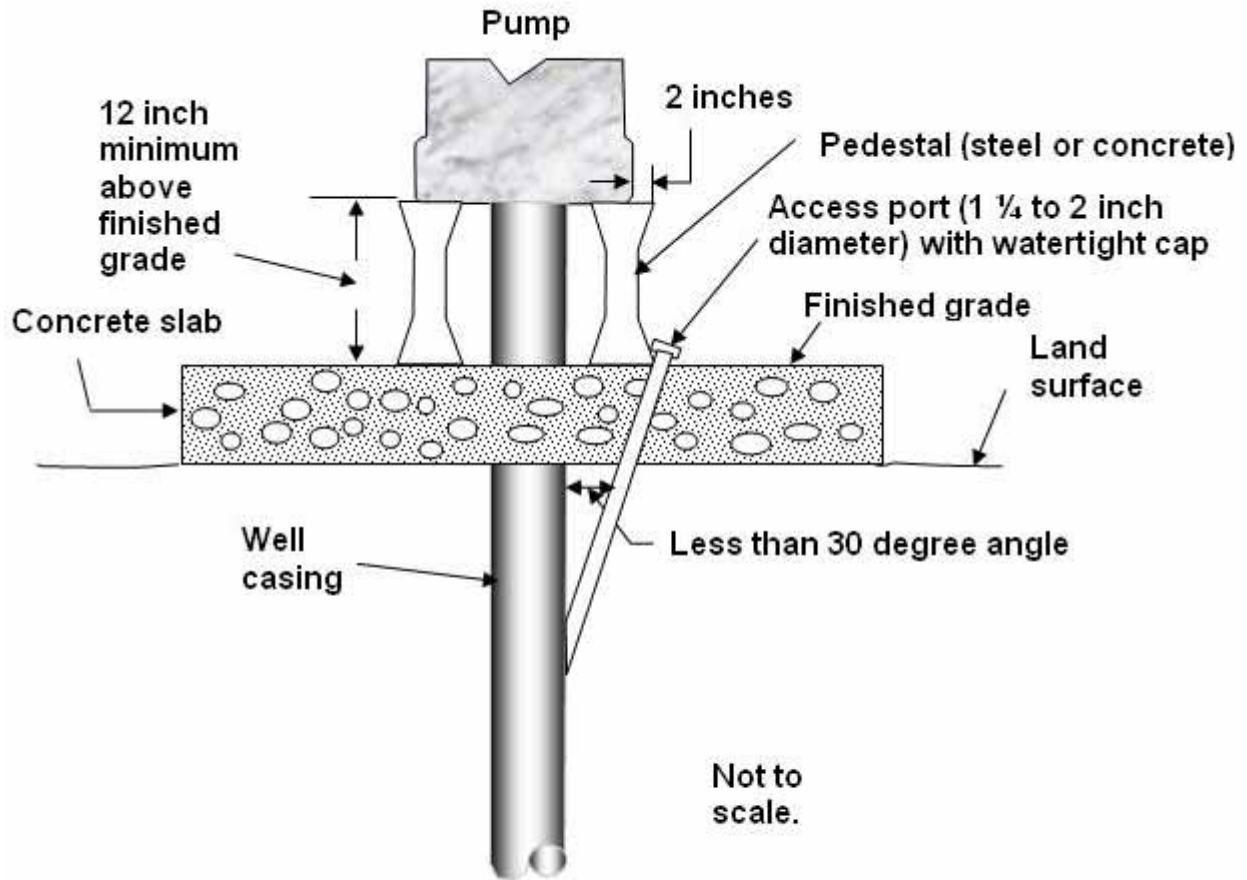

**Note.** Pedestal shall not extend more than two (2) inches past pump base in horizontal direction.

Figure 02. Annular Space and Overbore

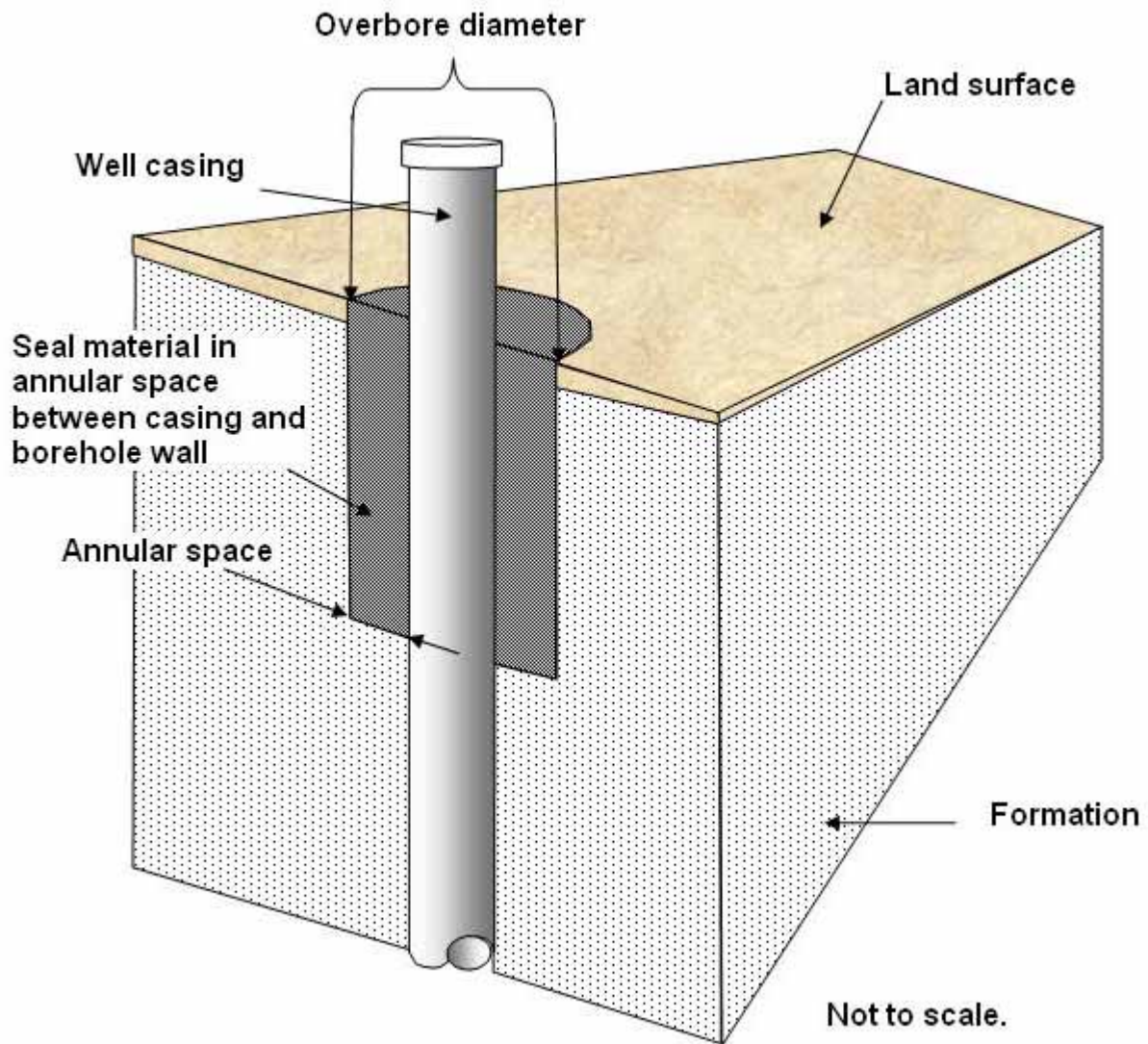

Figure 03. Overbore Requirements When a Tremie Pipe is Left in Place and A Grout Seal Installed

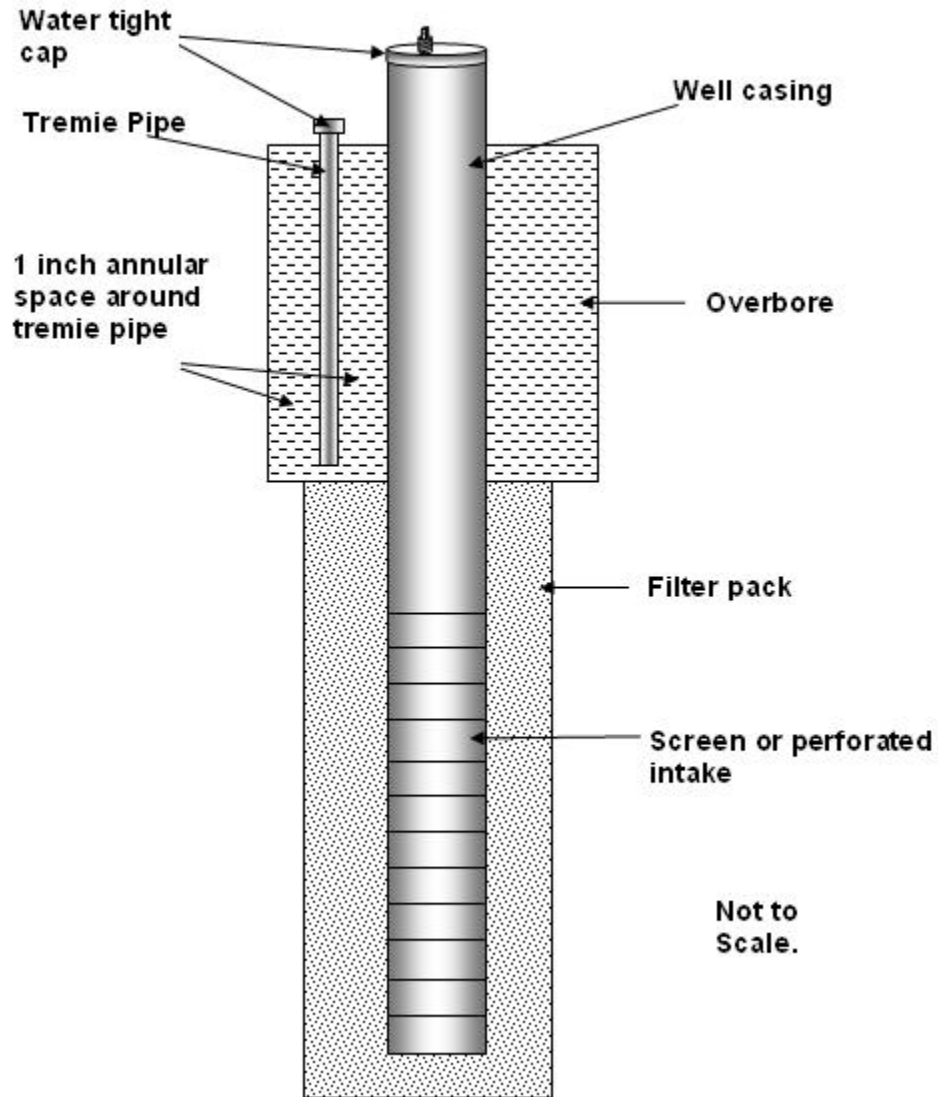

Figure 04. Sealing Requirements in Consolidated Formations

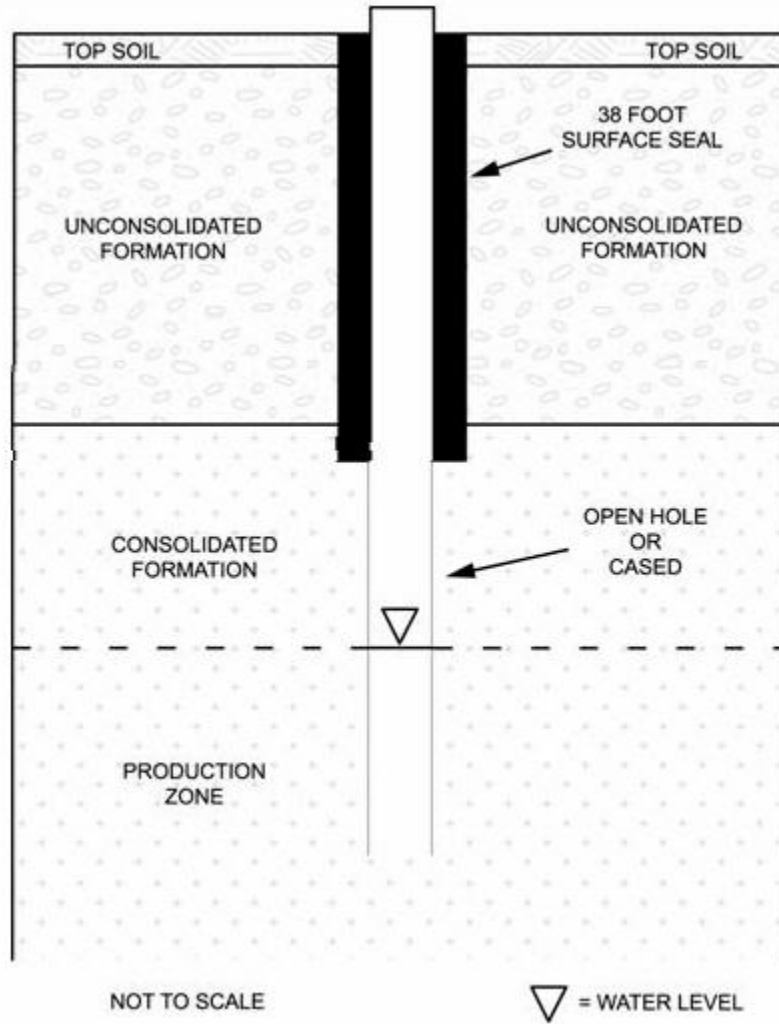



Figure 05. Sealing Requirements in Unconsolidated Formation without Confining Layers

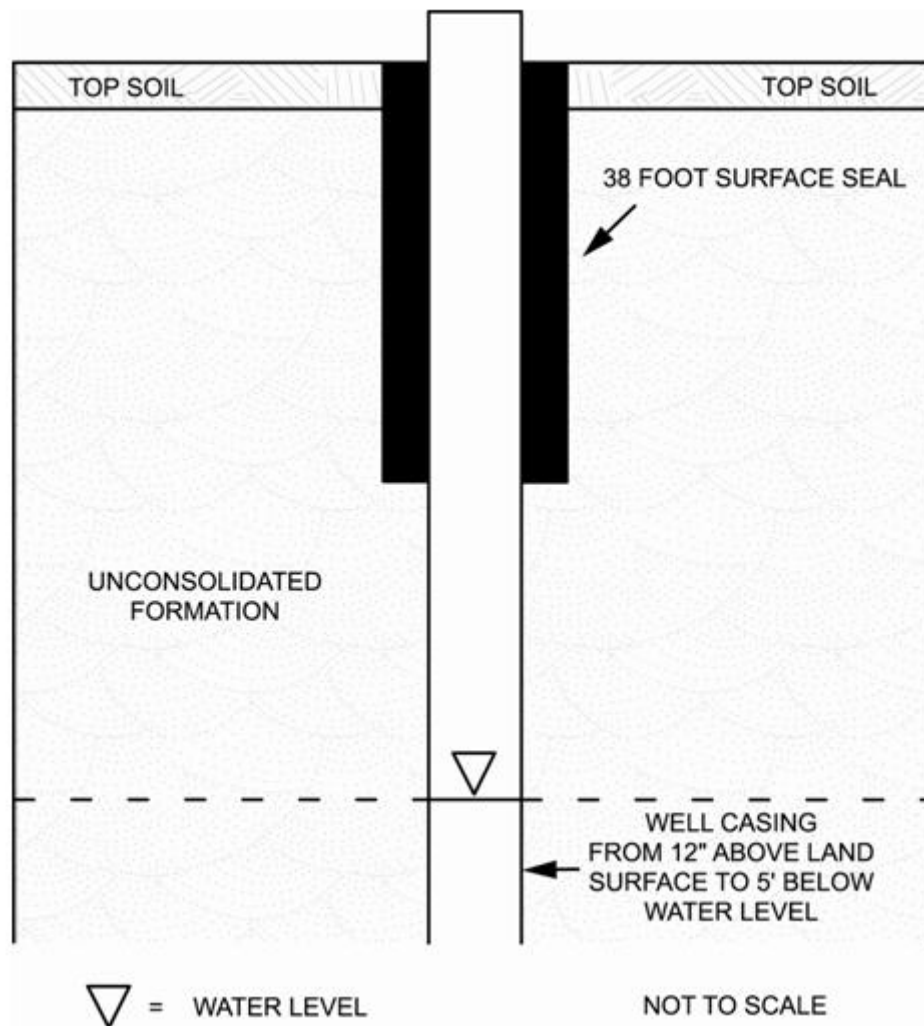

Figure 06. Rathdrum Prairie Boundary

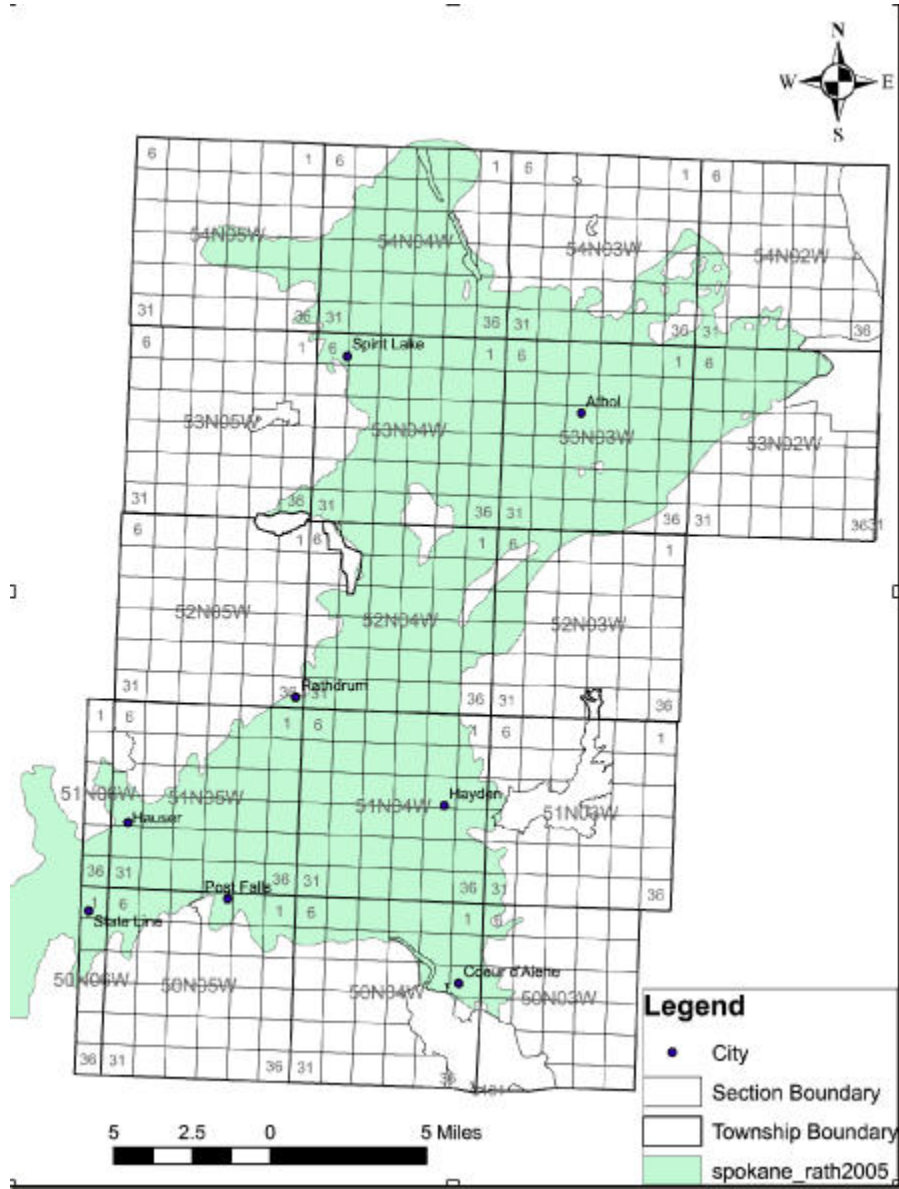

Figure 07. Sealing Requirements in the Rathdrum Prairie

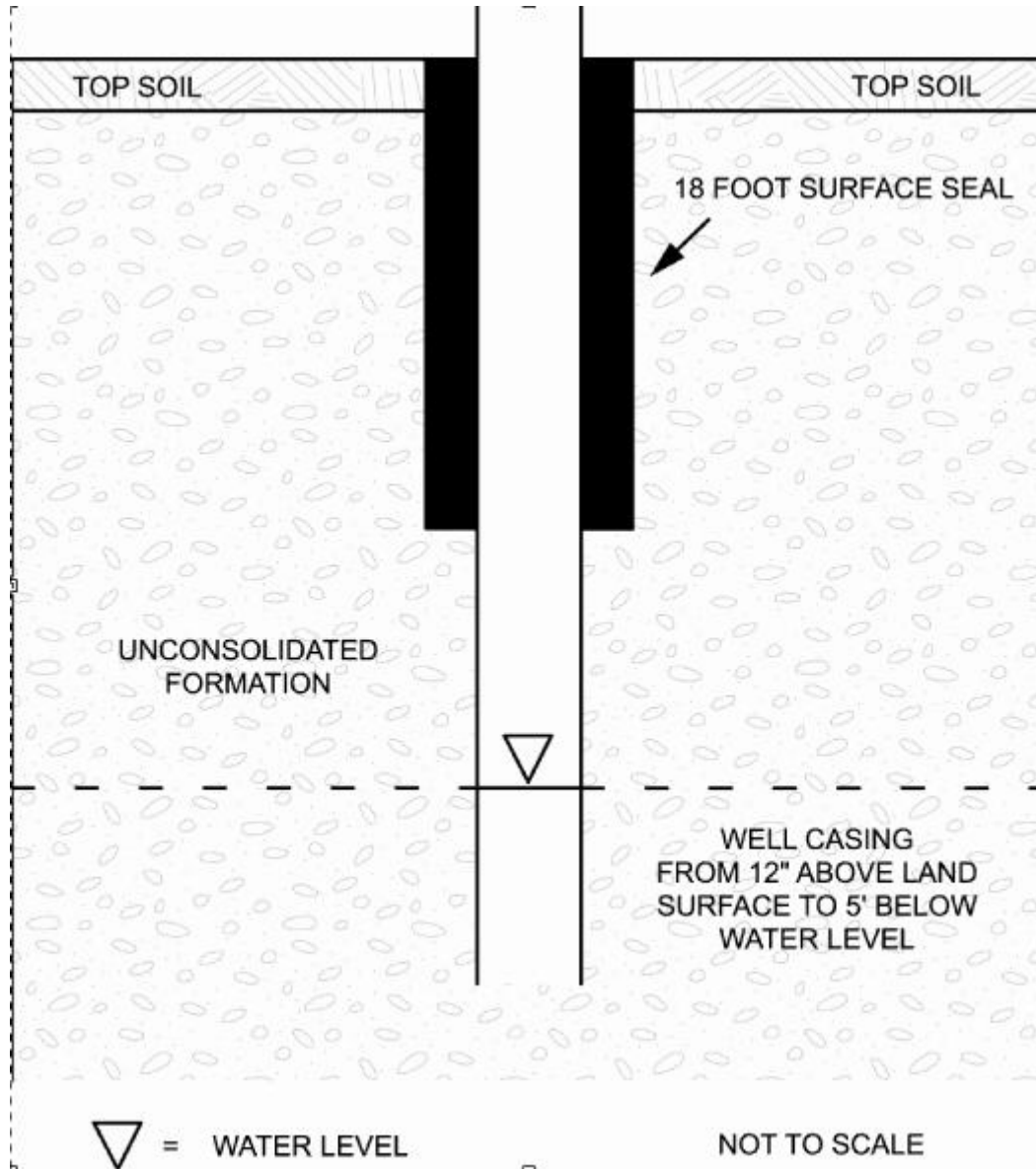

Figure 08. Sealing Requirements in Unconsolidated Formations with Confining Layers

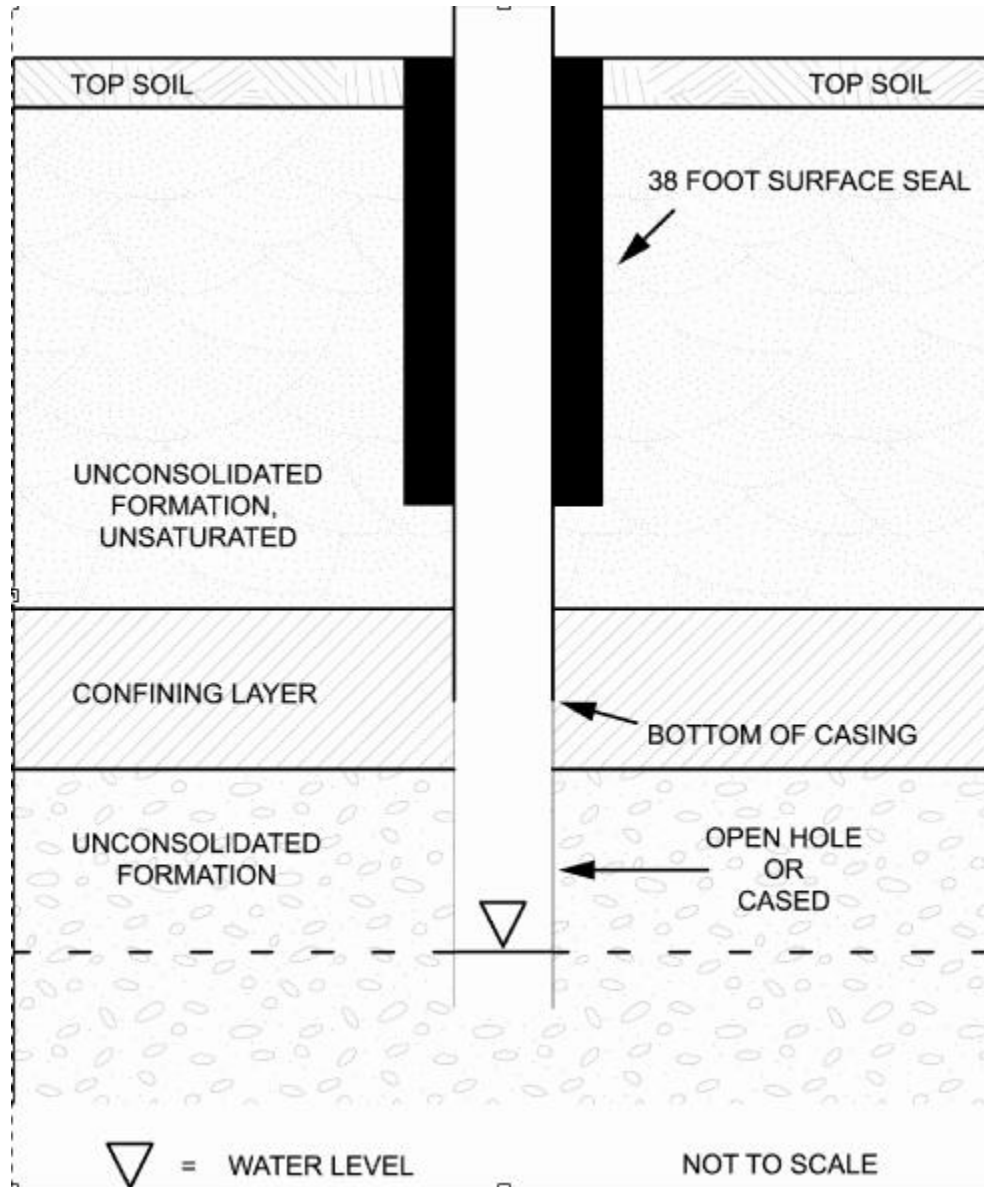

Figure 09. Sealing Requirements for Artesian Wells in Unconsolidated Formations

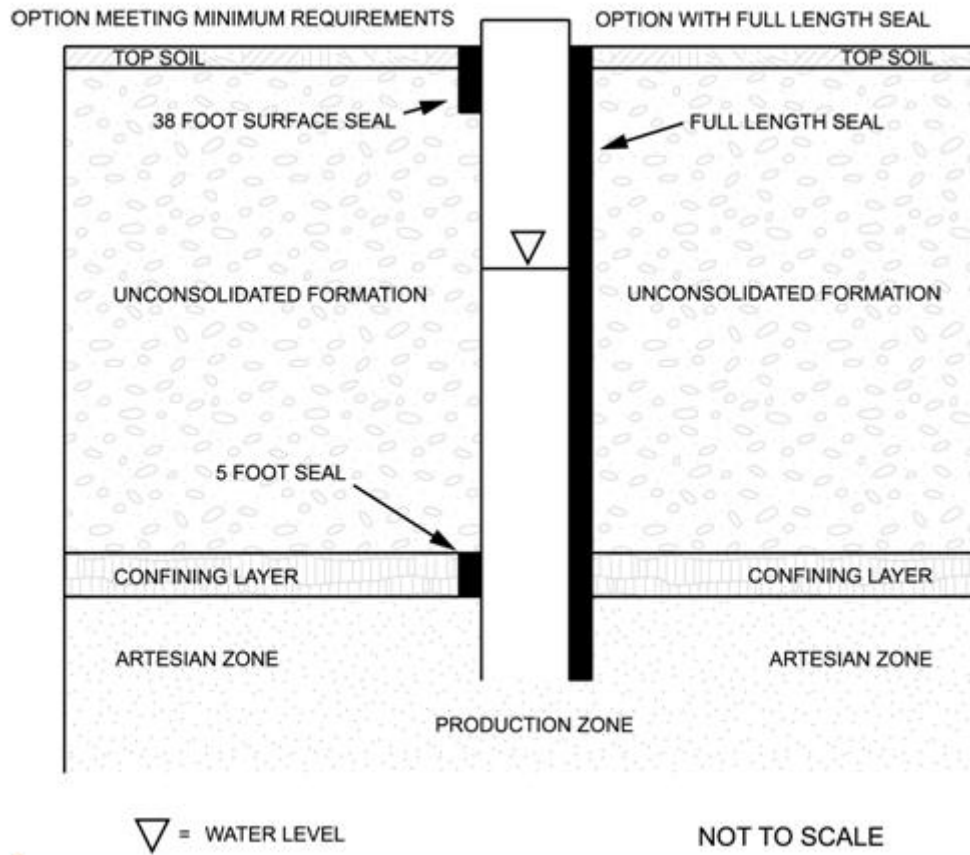

Figure 10. Sealing Requirements for Artesian Wells in Consolidated Formations

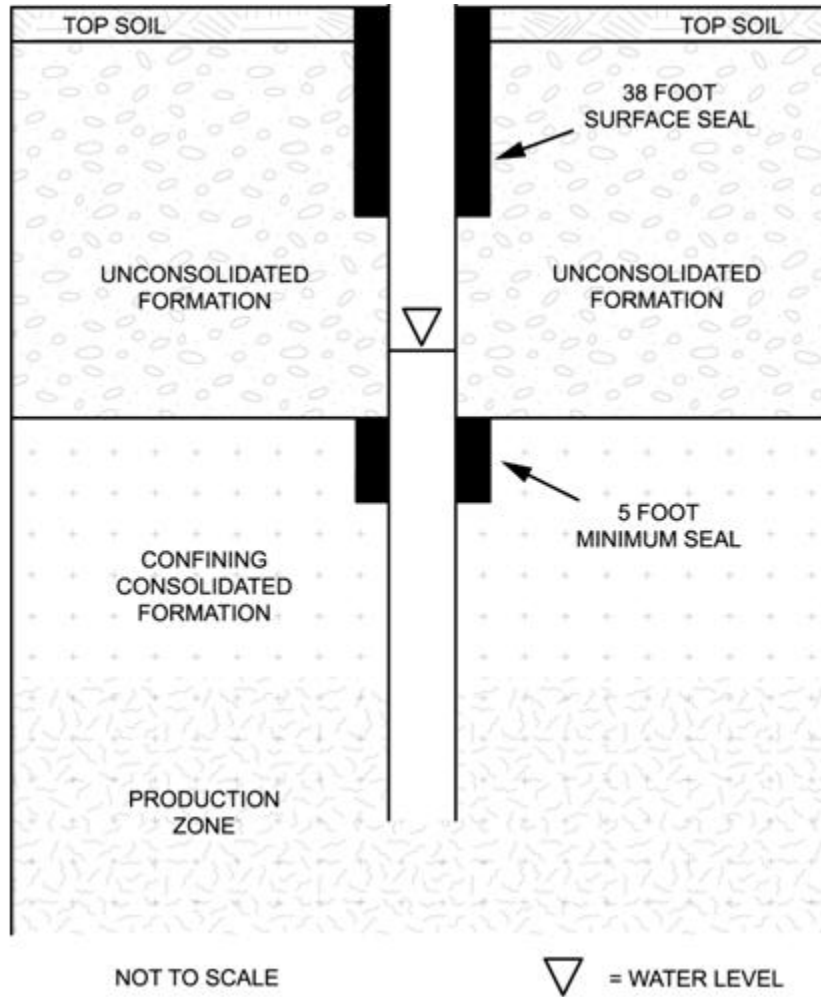
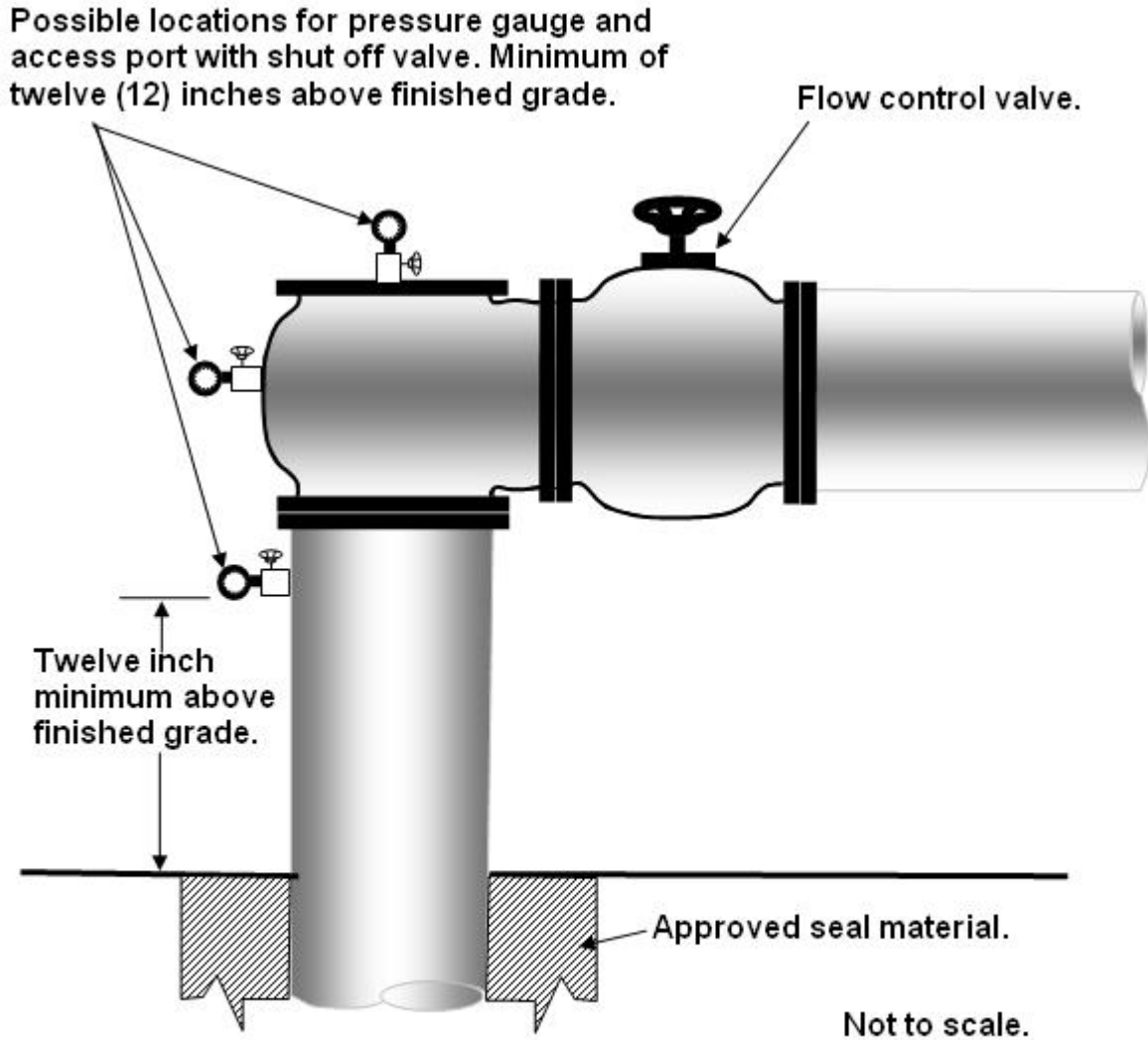

Figure 11. Access Ports, Pressure Gauges, and Control Valves



Note. Application and approval of control device is required on any flowing artesian well per Section 42-1603, Idaho Code.

Figure 12. Well Cap and Access Port

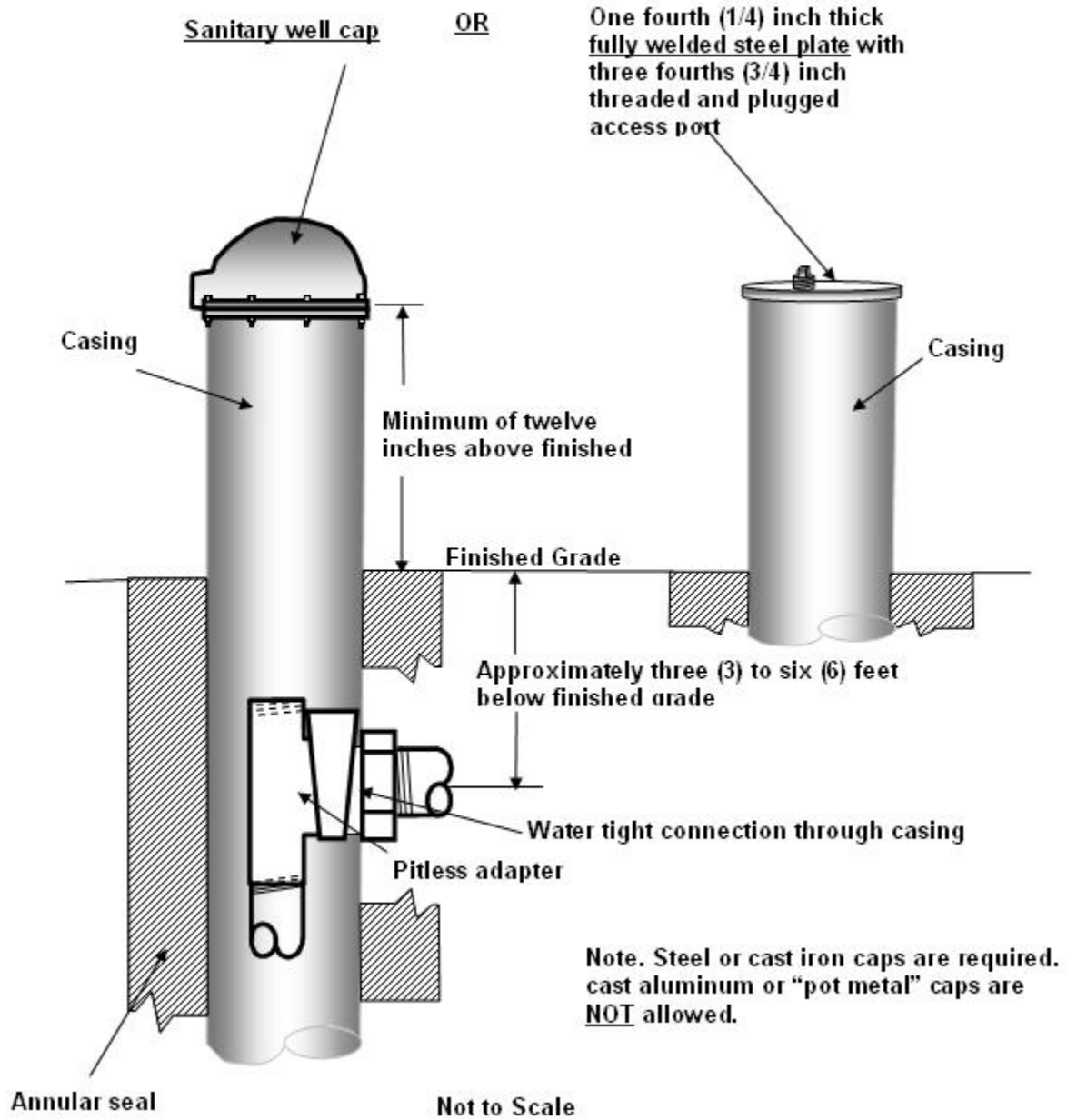
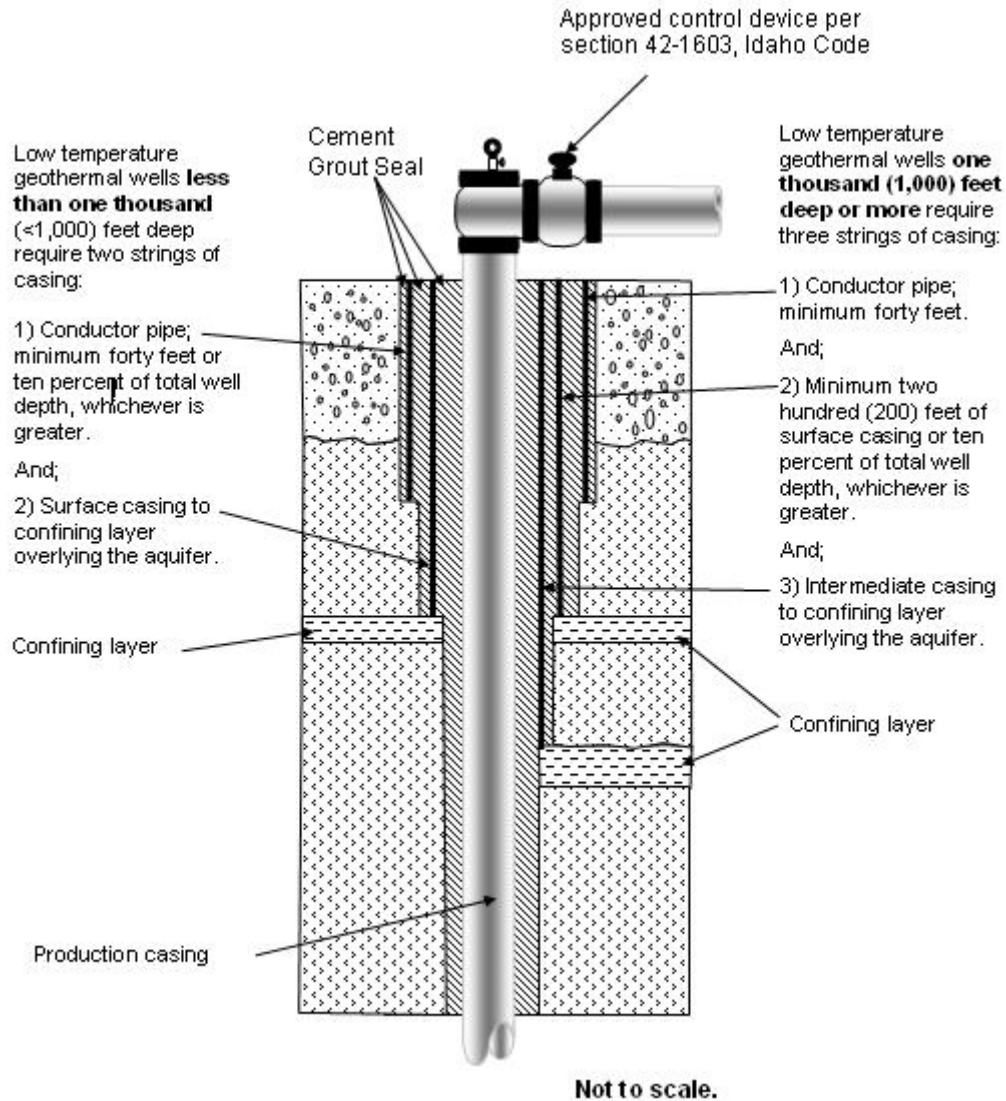



Figure 13. Casing Requirements for Low Temperature Geothermal Wells



## 37.03.10 – WELL DRILLER LICENSING RULES

### 000. LEGAL AUTHORITY (RULE 0).

The Idaho Water Resource Board adopts these rules under the authority provided by Section 42-238, Idaho Code. (3-20-20)T

### 001. TITLE AND SCOPE (RULE 1).

01. **Title.** The title of this chapter is “Well Driller Licensing Rules.” (3-20-20)T

02. **Scope.** These rules establish the requirements and procedures for obtaining and renewing authorization to drill wells in the state of Idaho. The rules also establish the requirements and procedures for obtaining authorization to operate drilling equipment under the supervision of a licensed driller. The licensing rules are applicable to all individuals and companies drilling or contracting to drill wells. (3-20-20)T

### 002. OTHER AUTHORITIES REMAIN APPLICABLE (RULE 2).

Nothing in these rules limits the director’s authority to take alternative or additional actions relating to the licensing of well drillers and permitting of operators as provided by Idaho law. (3-20-20)T

### 003. -- 009. (RESERVED)

### 010. DEFINITIONS (RULE 10).

Unless the context otherwise requires, the following definitions govern these rules. (3-20-20)T

01. **Abandonment.** See Decommissioned Well. (3-20-20)T

02. **Adequate Supervision.** Inspection and observation of each drilling operation and the associated drilling site by the licensed driller that has responsible charge during the critical phases of drilling to assure compliance with well construction standards and drilling permit conditions. (3-20-20)T

03. **Applicant.** An individual that submits to the department a complete application for a license or operator’s permit or a company that submits a complete application for a license. (3-20-20)T

04. **Area of Drilling Concern.** An area designated by the director in accordance with Section 42-238, Idaho Code, within which special drilling procedures and equipment are needed to prevent waste or contamination of the ground water. (3-20-20)T

05. **Auxiliary Equipment.** Powered equipment, other than the drill rig, used for grouting, installing or advancing casing, welding casings and screens, and other tasks necessary for drilling a well. (3-20-20)T

06. **Board.** The Idaho Water Resource Board. (3-20-20)T

07. **Bond.** A cash or surety bond obtained by a licensed driller or company payable to the director to provide funding for abandonment or repair should the driller fail to comply with well construction standards, and to allow information to be collected concerning the drilling of the well if the driller fails to submit a timely, accurate driller’s report. (3-20-20)T

08. **Bottom Hole Temperature of an Existing or Proposed Well.** The temperature of the ground water encountered in the bottom of a well or borehole. (3-20-20)T

09. **Company.** A firm, co-partnership, corporation or association licensed in accordance with these rules to drill or contract to drill wells. (3-20-20)T

10. **Compliance History.** An applicant’s record of compliance with the laws and rules of Idaho and other states relating to drilling of wells. The record includes, but is not limited to, the applicant’s record of obtaining and complying with drilling permits; filing accurate and complete well driller’s reports on time; adhering to well construction standards and other rules relating to drilling; and the number, nature and resolution of violations of laws, rules and conditions on licenses, operator’s permits and drilling permits. (3-20-20)T

11. **Continuing Education.** Education or training pertinent to the drilling industry and the construction, modification or decommissioning of wells. (3-20-20)T

12. **Continuing Education Committee (CEC).** A committee whose purpose is to review and approve

- activities related to continuing education credit. (3-20-20)T
- 13. Credit Unit.** The unit of measurement for continuing education requirements. (3-20-20)T
- 14. Critical Phases of Drilling.** Drilling tasks that require the added experience of a licensed driller to assure completion of the well in accordance with the well construction standards and conditions of drilling permits. These tasks include, but are not limited to, placement of required casings and seals, testing of casings and seals, and resolving problems such as casing or joint failures, heaving formations, lost circulation, and encountering high pressure or high temperature water. (3-20-20)T
- 15. Decommissioned (Abandoned) Well.** Any well which has been permanently removed from service and filled or plugged in accordance with these rules so as to meet the intent of these rules. A properly decommissioned well will not: (3-20-20)T
- a.** Produce or accept fluids; (3-20-20)T
- b.** Serve as a conduit for the movement of contaminants inside or outside the well casing; or (3-20-20)T
- c.** Allow the movement of surface or ground water into unsaturated zones, into another aquifer, or between aquifers. (3-20-20)T
- 16. Department.** The Idaho Department of Water Resources. (3-20-20)T
- 17. Director.** The director of the Idaho Department of Water Resources or his duly authorized representative. (3-20-20)T
- 18. Drilling or Well Drilling.** The act of constructing a new well, or modifying, changing the construction, or decommissioning an existing well. (3-20-20)T
- 19. Drilling Permit.** Authorization by the department to drill a well as provided in Section 42-235, Idaho Code. (3-20-20)T
- 20. Drilling Site.** The location of the drill rig and immediate area where the drill rig and auxiliary equipment are set up to drill a well. (3-20-20)T
- 21. Global Positioning System (GPS).** A global navigational receiver unit and satellite system used to triangulate a geographic position. (3-20-20)T
- 22. License.** A certificate issued by the director to an individual or a company upon meeting the requirements of Section 42-238, Idaho Code, and these rules authorizing the drilling of wells permitted in accordance with Section 42-235, Idaho Code. (3-20-20)T
- 23. Licensed Driller.** An individual having a license to drill wells and is authorized and required to supervise operators in the state of Idaho. (3-20-20)T
- 24. Modify.** To deepen a well, increase or decrease the diameter of the casing or the well bore, install a liner, place a screen, perforate existing casing or liners, alter the seal between the casing and the well bore, or alter the well to not meet well construction standards. (3-20-20)T
- 25. Operator.** An individual holding either a class I or class II operator's permit issued in accordance with these rules. (3-20-20)T
- 26. Operator's Permit.** A certificate issued by the director upon meeting the requirements of Section 42-238, Idaho Code, and these rules allowing the holder to operate a drill rig as provided in these rules. (3-20-20)T
- 27. Principal Driller.** A licensed driller in responsible charge of a company's drilling activities, which

has been designated the principal driller by the company with the department. (3-20-20)T

**28. Responsible Charge.** The responsibility for direction and control of a drilling operation to meet the requirements of these rules including, but not limited to, the following activities: (3-20-20)T

- a. Contracting to drill a well; (3-20-20)T
- b. Coordinate with property owner to locate a well to comply with applicable well construction standards; (3-20-20)T
- c. Setting up drilling equipment at the drilling site; (3-20-20)T
- d. Drilling operations; and (3-20-20)T
- e. Testing the adequacy of casing and seal; (3-20-20)T
- f. Properly completing the well. (3-20-20)T

**29. Start Card.** An expedited drilling permit process for the construction of cold water Single Family residential wells. (3-20-20)T

**30. Well.** An artificial excavation or opening in the ground more than eighteen (18) feet in vertical depth below land surface by which ground water of any temperature is sought or obtained. The depth of a well is determined by measuring the maximum vertical distance between the land surface and the deepest portion of the well. Any water encountered in the well is considered to be obtained for the purpose of these rules. Well also means any waste disposal and injection well as defined by Section 42-3902, Idaho Code. (3-20-20)T

**31. Well Construction Standards.** IDAPA 37.03.09, "Well Construction Standards Rules," adopted by the board. (3-20-20)T

**32. Well Driller's Report or Driller's Report.** A report required by Section 42-238, Idaho Code, describing drilling of the well and supplying information required on forms provided by the department. (3-20-20)T

**33. Well Log.** A diary maintained at the drilling site consistent with Section 42-238, Idaho Code. (3-20-20)T

**34. Well Rig or Drill Rig.** Any power-driven percussion, rotary, boring, digging, jetting, or augering machine used in the drilling of a well. (3-20-20)T

**011. -- 019. (RESERVED)**

**020. APPLICABILITY OF LICENSING REQUIREMENTS (RULE 20).**

**01. Licensing Requirements.** A well shall only be drilled by or under the responsible charge of a licensed driller except that a property owner, who is not licensed, can construct a well on his property for his own use without the aid of power-driven mechanical equipment. (3-20-20)T

**02. Driller to Have Responsible Charge of Other Workers.** A licensed driller shall have responsible charge of all others engaged in a well drilling operation. (3-20-20)T

**03. Operators to Have Permits.** An individual assisting a licensed driller whose duties include operation of a drill rig or auxiliary equipment shall possess an operator's permit as provided in these rules. If the driller is not present at the well site at all times that drilling operations are being conducted, one or more of those operating the equipment in the driller's absence shall have a class II operator's permit. The driller shall provide adequate supervision of class II operators. An individual having a class I operator permit shall be supervised by a licensed driller or a class II operator at all times when operating the drill rig or auxiliary equipment. (3-20-20)T

**04. Laborer Exempted.** An individual whose duties at the drilling site do not include operation of the

drill rig or auxiliary equipment at any time is not required to have either a driller's license or an operator's permit. (3-20-20)T

**05. Company to be Licensed.** No company shall drill or contract to drill a well or wells unless the company has been issued a license and has employed a principal driller as described in accordance with these rules. (3-20-20)T

**06. Drillers to Decommission (Abandon) Wells.** Only licensed drillers may decommission (abandon) wells, except that wells may be decommissioned (abandoned) by the owner after receiving a specific waiver from the Director. (3-20-20)T

**021. CONSTRUCTION AND USE OF HOLES THAT ARE NOT WELLS (RULE 21).**

**01. When a License Is Not Required.** A person drilling a hole that does not meet the definition of a well does not need a driller's license or operator's permit. (3-20-20)T

**02. Holes Not Defined as Wells.** The following list describes the types of holes that are not wells for purposes of these rules: (3-20-20)T

**a.** Holes with total depth less than eighteen (18) feet. (3-20-20)T

**b.** Holes for collecting soil or rock samples, determining geologic properties, or mineral exploration or extraction, including gravel pits. (3-20-20)T

**c.** Holes for oil and gas exploration for which a permit has been issued pursuant to Section 47-320, Idaho Code. (3-20-20)T

**d.** Holes for constructing building foundations or de-watering building or dam foundation excavations. (3-20-20)T

**e.** Holes for the installation of standpipes or piezometers to monitor the saturation of dam embankments or foundations or to measure uplift forces on buildings, dams and other structures. (3-20-20)T

**03. Converting a Hole Not Constructed as a Well for Use as a Well.** A hole that was not constructed as a well by or under the responsible charge of a driller, if subsequently converted to obtain water, to monitor water quantity or quality, or to dispose of water or other fluids, shall be reconstructed by a driller to comply with well construction standards and drilling permit conditions. The owner shall obtain a drilling permit, a water right or other approval if needed, and have the hole inspected and modified by a licensed driller as necessary to meet well construction standards. The driller shall file a driller's report for the well. (3-20-20)T

**022. -- 029. (RESERVED)**

**030. OBTAINING A LICENSE FOR AN INDIVIDUAL DRILLER (RULE 30).**

**01. Application Requirements.** An individual desiring a license shall file with the department a completed application on a form provided by the department accompanied by the following: (3-20-20)T

**a.** The application fee required by Section 42-238, Idaho Code. (3-20-20)T

**b.** Written documentation of drilling experience, compliance history, and the names and addresses of three (3) references to confirm the applicant's drilling experience. (3-20-20)T

**c.** A list of all drill rigs used by or under the responsible charge of the applicant providing the make, model, and type. (3-20-20)T

**d.** The names and addresses of all licensed drillers and permitted operators that will work under the responsible charge of the applicant. (3-20-20)T

**02. Experience Requirements.** (3-20-20)T

**a.** An applicant shall have a minimum of twenty-four (24) months of drilling experience. An applicant will be credited with one (1) month of drilling experience for each one hundred sixty (160) hours of employment as a driller or operator, or the equivalent, as determined by the director. Experience drilling monitoring wells, geothermal wells or other cased wells will be credited as experience by the Director if the equipment and drilling methods are applicable to water well construction. (3-20-20)T

**b.** An applicant for driller's license shall submit evidence to establish that the applicant, as an operator or driller, has successfully constructed a sufficient number of wells within the preceding twenty-four (24) months to demonstrate competency. Evidence of this experience can be demonstrated by the submission of driller's reports bearing the applicant's signature, well reports upon which the driller having responsible charge attests that the applicant drilled the wells or other documentation acceptable to the director. (3-20-20)T

**c.** Twelve (12) of the twenty-four (24) months drilling experience must have occurred within the five (5) year period immediately preceding the filing of the application. (3-20-20)T

**d.** Successful completion of classroom study in geology, well drilling, map reading, and other related subjects may be substituted for up to, but not exceeding, twelve (12) months of drilling experience. The director will determine the number of months of classroom study, up to twelve (12), to be credited as experience. (3-20-20)T

**03. Examination.** An applicant determined by the director to have adequate experience and an acceptable compliance history, as confirmed by references acceptable to the director, is eligible to take a written examination. The examination may include separate sections and shall test the applicant's knowledge of the following: (3-20-20)T

**a.** Idaho statutes and rules relating to appropriation and use of ground water, well drilling, construction and use of injection wells and geothermal wells, and well driller licensing under the provisions of Title 42, Idaho Code. (3-20-20)T

**b.** Land description by government lot, quarter-quarter, section, township and range, and the use of portable GPS units. (3-20-20)T

**c.** Geologic material identification including the use of correct terminology in describing the geologic material. (3-20-20)T

**d.** Well construction principles relating to the proper design, construction, development, and abandonment of wells. (3-20-20)T

**e.** The occurrence, nature, and movement of ground water. (3-20-20)T

**f.** The use of various types of drill rigs and auxiliary equipment. (3-20-20)T

**031. OBTAINING A LICENSE FOR A COMPANY (RULE 31).**

**01. Application Requirements.** A company shall file with the department a complete application for a company license upon a form provided by the department to be accompanied by the following: (3-20-20)T

**a.** The names and addresses of three (3) persons not affiliated with the company, whom the department can contact for information regarding the company's past well drilling operations, if any, and related business activities. (3-20-20)T

**b.** A complete record of the compliance history of the company and the owners and employees of the company. (3-20-20)T

**c.** Designation of a principal driller who shall be a full time employee of the company and shall drill wells only for the company. A licensed driller who renders only occasional, part-time or consulting drilling services

to or for a company may not be designated as the principal driller. (3-20-20)T

**d.** The names and addresses of drillers and operators presently employed. (3-20-20)T

**e.** A list of all drill rigs and other related equipment owned or used by the company providing the make, model, and type. (3-20-20)T

**02. Application Processing.** Applications received under this rule will be processed in accordance with Rule 33. (3-20-20)T

**032. OBTAINING AN OPERATOR'S PERMIT (RULE 32).**

**01. Application for Class I Operator's Permit.** A licensed driller or company proposing to employ a class I operator shall submit a completed application on a form provided by the director. The application shall: (3-20-20)T

**a.** Be accompanied by the fee required by Section 42-238, Idaho Code. (3-20-20)T

**b.** Be signed by the individual seeking the operator's permit and the licensed driller or principal driller of the company proposing to employ the operator. (3-20-20)T

**02. Application for Class II Operator's Permit.** A licensed driller or company proposing to employ an individual who does not currently hold a class II operator's permit shall submit the following: (3-20-20)T

**a.** A completed application on a form provided by the department. (3-20-20)T

**b.** The fee required by Section 42-238, Idaho Code. No fee is required if the applicant is presently permitted as a class I operator, but the expiration date of the permit when converted to a class II operator's permit will remain as originally issued. (3-20-20)T

**c.** Documentation that the operator has successfully constructed a sufficient number of wells, or has constructed wells for a sufficient length of time, or a combination of both to demonstrate competency. (3-20-20)T

**03. Written Examination.** An examination is not required for a class I operator's permit. An otherwise qualified applicant for a class II operator's permit shall obtain a satisfactory score on an examination as provided in Rule 34. The examination may be comprised of separate sections and shall test the applicant's knowledge of the following: (3-20-20)T

**a.** Idaho statutes and rules relating to appropriation and use of ground water, well drilling, construction and use of injection wells and geothermal wells, and well driller licensing under the provisions of Title 42, Idaho Code. (3-20-20)T

**b.** Land description by government lot, quarter-quarter, section, township, and range, and the use of portable GPS units. (3-20-20)T

**c.** Geologic material identification including the use of correct terminology in describing geologic material. (3-20-20)T

**d.** Well drilling principles relating to proper design, construction, development, and abandonment of wells. (3-20-20)T

**e.** The occurrence, nature, and movement of ground water. (3-20-20)T

**04. Operator Drills Only for Licensed Driller or Company.** An operator shall only drill for the licensed driller or company approved by the director. If an operator changes employment to another licensed driller or company, an application for an operator's permit shall be filed as provided in this rule. (3-20-20)T

**05. Processing an Application for Operator's Permit.** The department will process an application for operator's permit in accordance with Rule 33. (3-20-20)T

**033. PROCESSING APPLICATION FOR A DRILLER'S LICENSE OR OPERATOR'S PERMIT (RULE 33).**

**01. Incomplete Application.** If an application is incomplete, not properly signed, or does not include the information required by these rules, the department will advise the applicant in writing of the deficiency. If the deficiencies are not satisfied within ninety (90) days of sending the notice of the deficiency, the application will be void. The application fee is not refundable. (3-20-20)T

**02. Issuance of License.** If the director, upon review of the application, determines that an applicant for license is qualified and the driller has subsequently taken and passed an examination, a notice will be sent to the applicant requesting a bond in an amount determined in accordance with Rule 60 be filed with the department. Upon receipt of a satisfactory bond, the director will issue a license to the applicant. (3-20-20)T

**03. Issuance of Operator's Permits.** If the director determines that an applicant is qualified and has passed an examination, if required, the department will mail a notice and operator's permit card to the principal driller on behalf of the applicant. (3-20-20)T

**04. Driller's License or Operator's Permit Issued With Conditions or Denial of License or Operator's Permit.** The Director may issue a license or operator's permit with specific conditions or limitations based on the applicant's experience and compliance history. The Director may refuse to issue or renew a driller's license permanently or for a designated period of time if the driller has previously constructed wells improperly or constructed a well without a valid driller's license. If the Director determines that the applicant is not qualified, the Director will deny the application. Notice of a denied application or a conditioned license or operator's permit will be given to the applicant in accordance with IDAPA 37.01.01, "Rules of Procedure of the Idaho Department of Water Resources." (3-20-20)T

**034. EXAMINATION PROCEDURES (RULE 34).**

**01. Written Examination.** Written examinations will be offered at department offices on the first Monday of each quarter. If the first Monday is a legal holiday, written examination will be offered on the first Tuesday. Re-examination may be taken at a regularly scheduled examination date during a following quarter and shall be scheduled with the department office originally testing the applicant. (3-20-20)T

**02. Oral Examination.** Successful passage of an oral examination may satisfy all or a part of the written testing requirements under the following circumstances: (3-20-20)T

**a.** The applicant requests an oral rather than a written examination and shows cause acceptable to the director why the examination should be oral rather than written. Applicants desiring to take the examination orally shall request that an oral examination be scheduled allowing at least fifteen (15) days to set an examination date. (3-20-20)T

**b.** The director determines that because of the applicant's compliance history, additional testing is needed to determine the applicant's qualifications. (3-20-20)T

**03. Examination Scoring.** The applicant shall pass each section of the examination with a score of seventy percent (70%) or higher. (3-20-20)T

**04. Assistance Must Be Authorized.** The use of written materials, equipment or other individuals to assist an applicant during an examination is prohibited unless specifically authorized by the department. An applicant receiving unauthorized assistance during an examination may be disqualified and the application may be rejected. An application filed by a disqualified applicant will not be processed for a period of up to one (1) year from the time of disqualification. (3-20-20)T

**035. EXPIRATION AND RENEWAL OF LICENSE (RULE 35).**



**01. Expiration of Licenses.** All licenses expire at the end of the licensing period for which they are issued. The licensing period begins April 1 and ends March 31 of the second year following issuance. (3-20-20)T

**02. Renewal Application.** A license may be renewed by submitting a license renewal application including the following: (3-20-20)T

**a.** A completed application on a form provided by the department. An application to renew a license for an individual licensed driller shall be signed by the individual and an application to renew a license for a company shall be signed by the principal driller. (3-20-20)T

**b.** The renewal fee required by Section 42-238, Idaho Code. (3-20-20)T

**c.** A new bond or continuation certificate for an existing bond covering the licensed driller or company. (3-20-20)T

**d.** If the application is for renewal of a license held by an individual, the application shall include verification that the applicant has obtained the required continuing education credits. (3-20-20)T

**03. Continuing Education Requirements.** Fourteen (14) credit units are required for renewal of a license for an individual for any licensing period beginning on or after April 1, 2011. (3-20-20)T

**04. Welding Competency.** A driller that has been issued a Notice of Violation for welding that does not comply with the well construction standards may be required to obtain a certificate of welding competency from the American Welding Society or similar organization. (3-20-20)T

**036. EXPIRATION AND RENEWAL OF AN OPERATOR'S PERMIT (RULE 36).**

**01. Expiration of Operator's Permits.** Class I and class II operator's permits shall expire on March 31 of the same year that the license of the licensed driller and company employing the operator expires. (3-20-20)T

**02. Renewal Application.** An operator's permit may be renewed by submitting to the department an application for renewal including the following: (3-20-20)T

**a.** A completed application on a form provided by the department. The operator seeking renewal and the driller under whose responsible charge the operator works shall sign the form. (3-20-20)T

**b.** The renewal fee required by Section 42-238, Idaho Code. (3-20-20)T

**c.** For renewal of a class II operator's permit, verification of the required continuing education credit units. (3-20-20)T

**03. Continuing Education Required for Renewals.** Fourteen (14) credit units are required for renewal of a class II operator's permit for a licensing period beginning on or after April 1, 2011. (3-20-20)T

**04. Welding Competency.** An operator's work that has resulted in a Notice of Violation for welding that does not comply with the Well Construction Standards may be required to obtain a certificate of welding competency from the American Welding Society or similar organization. (3-20-20)T

**037. PROCESSING APPLICATION TO RENEW LICENSE OR OPERATOR'S PERMIT (RULE 37).**

**01. Processing Applications for Renewal.** Applications for renewal will be processed in the order received by the department. The department shall receive a complete application for renewal no later than March 15 to assure that the license or operator's permit will remain in force without interruption. If the director determines that the application is complete and the applicant is qualified, the license or operator's permit will be renewed for the period ending on March 31 of the second year after approval of the renewal. (3-20-20)T

**02. Regulatory Compliance Required for Renewals.** A license or operator's permit will not be

renewed if the applicant has not submitted all required driller's reports, applications for drilling permits, fees, agreed civil penalties, has not complied with all orders requiring repair or abandonment of improperly constructed wells or is not otherwise in compliance with Sections 42-235 and 42-238, Idaho Code, and the applicable rules. (3-20-20)T

**03. Compliance History.** If the Director determines that the applicant has exhibited an unacceptable compliance history, the Director may deny renewal, refuse renewal for a specified time, or renew with conditions, including but not limited to an increased bond amount. (3-20-20)T

**04. Renewal of Expired Licenses or Operator's Permits.** A license or an operator's permit which has expired or otherwise not been in effect for a period not exceeding three (3) years shall be renewed in accordance with the requirements of Rule 35 or Rule 36 as appropriate. An applicant for renewal shall provide verification of earned credit units required for the entire period since the license or class II operator's permit was last issued. If a license or operator's permit has been expired or otherwise not effective for a period of more than three (3) years, an application for a new license shall be submitted in accordance with Rule 30 for an individual license, Rule 31 for a company or Rule 32 for an operator's permit. The director may waive the examination requirement if the applicant has been previously licensed or permitted in the state of Idaho. (3-20-20)T

**05. Reuse of Identification Numbers.** The identification number assigned to a license by the department will not be reused if the license has been expired or otherwise not in effect for three (3) years or more except, at the director's discretion, the number may be reissued to the original owner. (3-20-20)T

**06. Condition or Denial of an Application for Renewal.** If the Director determines that the applicant has not or cannot fully comply with these rules, a license or operator's permit may be issued with conditions. If the Director determines that the applicant is not qualified, the Director will deny the application. When there are documented violations of well drilling laws and/or rules, including well construction standards, the Director may consult with the Driller's Advisory Committee, created in accordance with Rule 80, prior to making a decision to issue a conditional license or operator's permit or to deny an application based on the applicant's compliance history. Notice of a denied application or a conditioned license will be given as provided in IDAPA 37.01.01, "Rules of Procedure of the Idaho Department of Water Resources." (3-20-20)T

**038. -- 049. (RESERVED)**

**050. DUTIES AND RESPONSIBILITIES OF DRILLERS, COMPANIES AND OPERATORS (RULE 50).**

**01. Licensed Drillers and Principal Drillers.** All licensed drillers and principal drillers shall: (3-20-20)T

**a.** Allow drilling only by those authorized by and under the supervision required by these rules and according to any conditions of the license or permit. (3-20-20)T

**b.** Complete each well in compliance with IDAPA 37.03.09, "Well Construction Standards Rules," and drilling permit conditions. (3-20-20)T

**c.** Have a valid cash or surety bond in effect, as defined in Rule 60. (3-20-20)T

**d.** Have the license number displayed in a conspicuous place on the drill rig using a metal identification plate provided by the department or other permanent marking approved by the director. The displayed license number shall represent the company or individual driller license under which the well is being drilled. One plate will be issued upon initial licensure with replacement and additional plates available for a fee. (3-20-20)T

**e.** Keep current the department's list of operators and drillers employed by the licensed driller or company, including current addresses for the company, drillers, and operators. The licensed driller or principal driller shall be held responsible for all drilling activity of a driller or operator under their supervision until such notification has been submitted in writing to the department that the driller or operator is no longer employed by the licensed driller or company. (3-20-20)T

**f.** Have at the drilling site the driller's license and drilling permit or other written authorization from

the director to drill the well. (3-20-20)T

**g.** Only drill wells in contaminated areas identified by the department or in areas of drilling concern so designated by the department with specific written authorization of the director. Verbal authorizations to drill and pre-approved drilling permits (start cards) do not authorize drilling in these areas. (3-20-20)T

**h.** Only drill a public drinking water supply well, as defined in IDAPA 58.01.08, "Idaho Rules for Public Drinking Water Systems," low temperature geothermal resource or geothermal resource well with specific written authorization from the director. Verbal authorizations and start card permits (start cards) are not authorized for these uses. (3-20-20)T

**i.** Monitor and record bottom-hole temperature in areas where low temperature geothermal resources are known or suspected or when the well is being constructed pursuant to IDAPA 37.03.09, Rule 30, as a low temperature geothermal resource well. Bottom-hole temperature of every well being constructed pursuant to IDAPA 37.03.09, Rule 30, must be measured, recorded, and reported on the well drillers report. (3-20-20)T

**j.** Maintain a daily well log at the drilling site acceptable to the department and as required by Section 42-238(11), Idaho Code. Pertinent data required to be recorded on the daily log must include information sufficient to complete a well drillers report acceptable to the Director. The driller shall retain the well log for at least one (1) year after the driller's report is submitted to the department. (3-20-20)T

**k.** Submit driller's reports, acceptable to the Director, on forms approved by the department within thirty (30) days following removal of the drill rig from the drilling site at completion of the well. Driller's reports shall be prepared from information recorded on the daily well log. Driller's reports returned to the driller due to deficiencies must be corrected and returned to the department within thirty (30) days of mailing by the department. (3-20-20)T

**l.** Attach a well tag supplied by the department to every well drilled for which a drilling permit is required. The tag shall be affixed permanently to the casing, or other permanent object attached to the well, by a method approved by the Director prior to removing the well rig from the drilling site. (3-20-20)T

**m.** Cause all drilling activity under the supervision of the driller to cease when the driller's license expires, becomes invalid, or is suspended or revoked. (3-20-20)T

**02. Companies.** Companies shall: (3-20-20)T

**a.** Have a principal driller designated with the department at all times. (3-20-20)T

**b.** Notify the department within ten (10) days of the principal driller leaving employment with the company. The company's license shall immediately become void and of no effect when the principal driller leaves employment with the company and shall remain so until the department has been notified in writing that a new principal driller has been employed and designated by the company. Failure to designate a principal driller within ninety (90) days of the departure of the designated principal driller is cause for the director to take action to cancel the company's license. (3-20-20)T

**c.** Maintain a bond in force at all time as required in Rule 60. (3-20-20)T

**03. Operators.** Operators shall: (3-20-20)T

**a.** Have in their possession a valid operator's permit while drilling wells. (3-20-20)T

**b.** Only drill wells as authorized by the operator's permit. (3-20-20)T

**c.** Maintain a complete and accurate well log at the drilling site. (3-20-20)T

**d.** Co-sign with the driller a driller's report upon completion of the well. (3-20-20)T

**051. -- 059. (RESERVED)**

**060. BONDING (RULE 60).**

**01. Bonding Requirements.** Each licensed driller or company shall submit a surety bond or cash bond in an amount determined by the director, within the limits of 42-238, Idaho Code, for each driller employed by the company, payable to the director for the licensing period. (3-20-20)T

**a.** A company shall have a bond, which covers the drilling activities of each driller and operator employed by the company. If the licensed driller drills wells as an individual and not for a company, a separate bond must be filed with the director. (3-20-20)T

**b.** Drillers proposing to drill wells in an area of drilling concern, monitoring wells, public water supply wells, or wells to obtain or likely to encounter water with a bottom hole temperature greater than eighty-five (85) degrees Fahrenheit, shall submit an upgraded bond, in an amount determined by the director, at the time the drilling permit application is processed. Drillers anticipating drilling such wells may, instead, submit adequate bonding at the time of driller license application or renewal. (3-20-20)T

**c.** The amount of the bond, within the limits prescribed in Section 42-238, Idaho Code, will be determined by the director based on the applicant's compliance history, the size and depth of wells the applicant proposes to construct and is authorized to drill, the complexity of the wells, the resource to be recovered, the area of operation of the applicant, the number of drillers and operators employed by a company, and other relevant factors. (3-20-20)T

**d.** All bonds and continuation certificates must be on forms provided or approved by the department. (3-20-20)T

**02. Cash Bonds. (3-20-20)T**

**a.** Acceptable Cash Bonds. Cash bonds shall be in a separate account readily accessible to the director for use as provided in these rules. The director will review cash bond proposals made by an applicant. Cash bonds shall be retained in financial institutions within the state of Idaho unless waived by the director. (3-20-20)T

**b.** Retention. The director will hold cash bonds for two (2) years from the date the driller requests that the bond be released unless replaced by another bond or the director determines that all wells drilled by the driller satisfy well construction standards. The release of a cash bond must be requested in writing. (3-20-20)T

**03. License Void Without Bond.** If the issuing company cancels a bond, the bond expires or otherwise becomes non-effective during the term of a license, the license shall immediately become void and of no further effect until an adequate replacement bond is received by the department. (3-20-20)T

**061. -- 069. (RESERVED)**

**070. CONTINUING EDUCATION (RULE 70).**

**01. Requirements.** Every licensed driller or permitted operator must have earned at the time of renewal the applicable number of credit units required by these rules. The credit units shall have been obtained during the licensing period preceding the application for renewal. (3-20-20)T

**02. Earning Credit Units.** Credit units may be earned for time spent in attendance at workshops, seminars, short courses, and other educational opportunities devoted to drilling or related subjects acceptable to the Director and approved by the continuing education committee (CEC) and in compliance with the CEC guidelines. These may include completion of college courses, correspondence courses, videotaped courses, and other endeavors such as authoring appropriate publications. (3-20-20)T

**03. Documentation.** Documentation to support credit units claimed is the responsibility of the licensed driller and permitted operator. Records required include but are not limited to: (3-20-20)T

a. A log showing the type of activity claimed, sponsoring organization, duration, instructor's name, and credit units. (3-20-20)T

b. Attendance verification records in the form of completion certificates or other official documents providing evidence of attendance and completion. (3-20-20)T

**04. Submittal and Maintenance of Records.** Copies of continuing education records for the preceding license period shall be submitted with applications to renew licenses or permits. These records shall be maintained for a period of three (3) years and shall be available for review by the department at the request of the director. (3-20-20)T

**05. Insufficient Credit Units.** If at the time of renewal, the applicant is unable to provide verification of the required credit units, the director will deny renewal of the driller's license or operator's permit, except as otherwise provided in the following: (3-20-20)T

a. The director may withhold action on an application for renewal for a period not to exceed ninety (90) days to allow the applicant to provide verification of the required credit units. The applicant is not authorized to drill until the verification is provided and the renewal is issued. (3-20-20)T

b. The director may exempt an applicant from all or part of the continuing education requirements if the applicant served on active duty in the armed forces of the United States for one hundred twenty (120) consecutive days or more during the licensing period prior to filing the application for renewal; or the applicant suffered physical disability, serious illness, or other extenuating circumstances that prevented the applicant from earning the required units. (3-20-20)T

c. A licensed driller or operator who has chosen to allow his license or permit to expire or otherwise become of no effect shall be exempt from continuing education requirements unless an application for renewal is filed less than three (3) years after the license or permit expired or otherwise became of no effect. (3-20-20)T

**06. Out-of-State Residents.** The continuing education requirements for a non-resident applicant for a license or operator's permit shall be the same as for resident applicants. (3-20-20)T

**07. Responsibility for Education Development and Implementation.** The Idaho Ground Water Association (IGWA) is delegated responsibility to develop and implement a program for continuing education for review and approval by the director. (3-20-20)T

**071. CONTINUING EDUCATION COMMITTEE CONTINGENCY PLAN (RULE 71).** Should the memorandum of understanding (MOU) and/or the contract between the department and the IGWA be breached, revoked, or not renewed, the CEC shall be organized and administered by the department. (3-20-20)T

**072. -- 079. (RESERVED)**

**080. DRILLER'S ADVISORY COMMITTEE (RULE 80).**

**01. Selection and Duties.** The Director may appoint a driller's advisory committee from the list of drillers holding valid licenses. The Director will solicit appointment recommendations from the IGWA and other licensed drillers. The Director will determine the term of appointment for members of the committee. The committee shall provide recommendations and suggestions concerning revision of these rules, the minimum standards for well construction, significant violations and other matters regarding well drilling. The committee members shall serve on a voluntary basis without compensation. The department will hold meetings at the discretion of the Director. (3-20-20)T

**02. Reimbursement.** Travel costs shall be paid to members of the advisory committee for travel and per diem and for costs associated with attendance of advisory committee meetings held by the department. Reimbursement shall be based on existing department policy covering travel and per diem expenses. (3-20-20)T

**081. -- 089. (RESERVED)**

**090. ENFORCEMENT (RULE 90).**

**01. Violations.** Violations of these rules or Sections 42-235 or 42-238, Idaho Code, will be enforced as provided in Sections 42-238 and 42-1701B, Idaho Code. (3-20-20)T

**02. Enforcement Policy.** An administrative policy providing guidelines for enforcement shall be published and maintained by department staff. A copy of the enforcement guidelines is available upon request at no charge. (3-20-20)T

**091. -- 999. (RESERVED)**

## IDAPA 38 – DEPARTMENT OF ADMINISTRATION

### DOCKET NO. 38-0000-2000F (FEE RULE)

#### NOTICE OF OMNIBUS RULEMAKING – ADOPTION OF TEMPORARY RULE

**EFFECTIVE DATE:** The effective date of the temporary rule being adopted through this omnibus rulemaking is the adjournment date of the second regular session of the 65th Idaho State Legislature - March 20, 2020.

**AUTHORITY:** In compliance with Sections 67-5226, Idaho Code, notice is hereby given this agency has adopted a temporary rule. The action is authorized pursuant to Section 67-5708, Idaho Code, and Senate Concurrent Resolution No. 135 (1976).

**DESCRIPTIVE SUMMARY:** The following is the required finding and concise statement of its supporting reasons for adopting a temporary rule:

This temporary rulemaking adopts the following chapter under IDAPA 38:

#### **IDAPA 38**

- 38.04.04, *Rules Governing Capitol Mall Parking*

**TEMPORARY RULE JUSTIFICATION:** Pursuant to Sections 67-5226(1) and 67-5226(2), Idaho Code, the Governor has found that temporary adoption of the rule is appropriate for the following reasons:

These temporary rules are necessary to protect the public health, safety, and welfare of the citizens of Idaho and confer a benefit on its citizens. These temporary rules implement the duly enacted laws of the state of Idaho, provide citizens with the detailed rules and standards for complying with those laws, and assist in the orderly execution and enforcement of those laws. The expiration of these rules without due consideration and processes would undermine the public health, safety, and welfare of the citizens of Idaho and deprive them of the benefit intended by these rules.

**FEE SUMMARY:** Pursuant to Section 67-5226(2), the Governor has found that the fee(s) or charge(s) being imposed or increased is justified and necessary to avoid immediate danger and the fee(s) is described herein:

The fees or charges, authorized in Section 67-5701 and 67-5708, Idaho Code, are part of the agency's 2021 budget that relies upon the existence of these fees or charges to meet the state's obligations and provide necessary state services. Failing to reauthorize these temporary rules would create immediate danger to the state budget, immediate danger to necessary state functions and services, and immediate danger of a violation of Idaho's constitutional requirement that it balance its budget.

The following is a specific description of the fees or charges:

**Elected Officials Parking Permits.** The governor, lieutenant governor, secretary of state, attorney general, state controller, state treasurer, superintendent of public instruction, Senate pro-tem, and the speaker of the House of Representatives will be provided a reserved parking space at no charge. Additionally, upon request, Capitol Mall Parking will provide the governor four (4) additional reserved parking spaces. The fee for each additional reserved parking space provided to the governor will be the reserved parking permit monthly fee.

**Directors of Executive Branch Departments.** Directors of executive branch departments will be provided a reserved parking space at a cost not to exceed forty dollars (\$40) per month. Executive branch departments will be charged for the reserved parking spaces annually by Capitol Mall Parking.

**Reserved Parking Permits.** The fee for a reserved parking space permit will not exceed forty dollars (\$40) per month.

**General Parking Permits.** The fee for a general parking space permit will not exceed ten dollars (\$10) per month.

**Payment for Parking Permits.** Capitol Mall employees will be charged the respective permit fee in the first

paycheck of each month through a payroll deduction or as determined by the State Controller.

**Legislators.** Legislators who request a Legislator parking space permit must pay the parking permit fee. Legislators and Legislative personnel who request parking spaces must pay the associated space fee for every month that the Legislature is in session.

**State-Owned Vehicles.** State-owned vehicles belonging to the tenant departments will receive state vehicle parking permits for a monthly fee not to exceed fifteen dollars (\$15).

**Replacement Permits.** If a parking permit is lost, stolen or destroyed, the official, Legislator, or Capitol Mall employee will be charged a fee equal to the general permit monthly fee for a new permit. A statement attesting that the parking permit was lost, stolen or destroyed must be signed before Capitol Mall Parking will issue a new permit.

**ASSISTANCE ON TECHNICAL QUESTIONS:** For assistance on technical questions concerning the temporary rule, contact Keith Reynolds, 208-332-1823.

DATED this February 18, 2020.

Keith Reynolds, Director  
Department of Administration  
650 West state Street, Room 100  
P.O. Box 83720  
Boise, ID 83720-0004  
Phone: 208-332-1812  
Fax: 208-334-2307



## IDAPA 38 – DEPARTMENT OF ADMINISTRATION

### 38.04.04 – RULES GOVERNING CAPITOL MALL PARKING

#### 000. LEGAL AUTHORITY.

The following rules are promulgated pursuant to the authority of Section 67-5708, Idaho Code, and Senate Concurrent Resolution No. 135 (1976). (3-20-20)T

#### 001. TITLE AND SCOPE.

01. **Title.** These rules are titled IDAPA 38.04.04, “Rules Governing Capitol Mall Parking.” (3-20-20)T

02. **Scope.** These rules govern parking in the Capitol Mall. (3-20-20)T

#### 002. -- 009. (RESERVED)

#### 010. DEFINITIONS.

01. **Capitol Mall.** The Capitol Mall consists of the following buildings: State Capitol (700 W. Jefferson Street), Joe R. Williams (700 W. State Street), Len B. Jordan (650 W. State Street), State parking garage #1 (550 W. State Street), Pete T. Cenarrusa (450 W. State Street), Division of Public Works (502 N. 4<sup>th</sup> Street), Alexander House (304 W. State Street), State Library (325 W. State Street), 954 Jefferson (954 W. Jefferson Street), Capitol Annex (514 W. Jefferson Street), Blind Commission (341 W. Washington Street), Borah Building (304 N. 8<sup>th</sup> Street), State Parking Garage #2 (608 W. Washington Street); and Idaho Supreme Court (451 W. State Street). (3-20-20)T

02. **Capitol Mall Employee.** A state employee whose assigned work area is in the Capitol Mall, and who receives a state of Idaho-issued paycheck from a tenant of the Capitol Mall. (3-20-20)T

03. **Carpool.** A vehicle carrying two (2) or more Capitol Mall employees who work at the Capitol Mall at least four (4) work days per week. (3-20-20)T

04. **Employee with a Disability.** An employee with a disability as defined in Section 49-117(7)(b), Idaho Code. (3-20-20)T

05. **Executive Branch Departments.** Pursuant to Section 67-2402, Idaho Code, and for purposes of this rule, the following are the departments of the executive branch: Department of Administration, Department of Agriculture, Department of Commerce, Department of Correction, Department of Environmental Quality, Department of Finance, Department of Fish and Game, Department of Health and Welfare, Idaho State Police, Idaho Transportation Department, Industrial Commission, Department of Insurance, Department of Juvenile Corrections, Department of Labor, Department of Lands, Department of Parks and Recreation, Department of Revenue and Taxation, State Board of Education and Department of Water Resources. This definition excludes the Department of Self-Governing Agencies. (3-20-20)T

06. **Facilities Services.** Bureau of Facilities Services, Division of Public Works, Department of Administration. (3-20-20)T

07. **General Parking.** A parking space used for all Capitol Mall employees registered for general parking. (3-20-20)T

08. **Legislative Personnel.** An employee hired by the Legislative branch that receives a state of Idaho-issued paycheck during the Legislative session or is a year round employee of the Legislative branch. (3-20-20)T

09. **Legislator.** A member of the Idaho Senate or the Idaho House of Representatives for the state of Idaho. (3-20-20)T

10. **Reserved Parking.** A parking space assigned to a specific person, vehicle or agency. (3-20-20)T

11. **State Elected Officials.** The governor, lieutenant governor, secretary of state, attorney general, state controller, state treasurer and superintendent of public instruction, for the state of Idaho. (3-20-20)T

12. **Temporary Contract Employee.** An employee of a temporary employment service company who is working temporarily for a tenant of the Capitol Mall, and who does not receive a pay check issued by the state of

Idaho. (3-20-20)T

**13. Visitor.** Any person visiting the Capitol Mall to carry out state business or attend a state-sponsored event. (3-20-20)T

**011. -- 019. (RESERVED)**

**020. PARKING LOT LOCATIONS.**

All Capitol Mall parking lots will be identified by signage. Capitol Mall Parking manages the state-owned parking lots at the following locations: 550 W. State Street Parking Garage, State Parking Garage #1; 608 W. Washington Street, State Parking Garage #2; 10<sup>th</sup> and Jefferson Streets, 8<sup>th</sup> Street between State and Jefferson Streets, and 3<sup>rd</sup> and Washington Streets. Capitol Mall Parking also manages parking spaces in and around the following Capitol Mall buildings: Capitol Annex, Len B. Jordan, Pete T. Cenarrusa, Division of Public Works, Borah Building and Idaho State Library. (3-20-20)T

**021. TYPES OF AVAILABLE PARKING.**

Designated parking spaces are available for reserved parking, state elected officials and directors of executive branch departments, Legislators, carpool, disabled employees and state agency vehicles. All other parking spaces, unless designated as public or visitor parking, are considered general parking. (3-20-20)T

**022. PARKING SPACE ALLOCATION.**

**01. Reserved Parking Spaces.** (3-20-20)T

**a.** Reserved parking spaces are available for state elected officials and directors of executive branch departments as defined in Subsections 010.05 and 010.11 of these rules. Capitol Mall Parking will assign a reserved space to each state elected official and director of executive branch departments upon request. (3-20-20)T

**b.** Reserved parking spaces will be made available to the Senate pro-tem, and the speaker of the House of Representatives. Capitol Mall Parking will assign a reserved space to each individual. (3-20-20)T

**c.** All other Capitol Mall employees may apply for a reserved parking space. General reserved parking spaces are assigned to Capitol Mall employees on a first-come, first-served basis when designated reserved parking spaces become available. (3-20-20)T

**d.** Reserved parking spaces for state elected officials, directors of executive branch departments and Capitol Mall employees are located in the following parking lots only: the first floor of State Parking Garage #1; the first and second floors of State Parking Garage #2, the Pete T. Cenarrusa Building parking lot, and the 8<sup>th</sup> Street parking lot between State and Jefferson Streets. (3-20-20)T

**e.** Capitol Mall Parking will determine the location of all reserved parking spaces. (3-20-20)T

**f.** Reserved parking spaces for state elected officials, directors of executive branch departments and Capitol Mall employees will not exceed twenty-five percent (25%) of parking spaces available within the Capitol Mall. (3-20-20)T

**g.** Capitol Mall employees may not sell, trade or barter the right to use their assigned reserved parking space. Capitol Mall Parking retains the right to assign, reassign, suspend or revoke Capitol Mall employees' reserved parking spaces at any time. (3-20-20)T

**02. Legislators' Parking Spaces.** During Legislative sessions and special sessions, Capitol Mall Parking will make available up to one hundred three (103) reserved Legislator parking spaces to Legislators. (3-20-20)T

**a.** Each Legislator will be assigned a reserved Legislator parking space. A Legislator who elects to park in the Capitol Mall is required to pay the fee for the reserved parking permit. (3-20-20)T

**b.** During the Legislative session, Legislator reserved parking spaces will be on the third floor of State Parking Garage #1, 8th Street parking lot, and the Capitol Annex parking lot and will be clearly marked. The Legislator reserved parking permit is only valid in the assigned reserved parking space; the permit is not valid in any other CMP general parking space during the Legislative session. When the Legislature is not in session, all Legislator parking spaces will be redesignated as general parking spaces. (3-20-20)T

**c.** When the Legislature is not in session, Legislators or Legislative personnel who hold a valid Capitol Mall parking permit, may park in any general parking space. (3-20-20)T

**03. Disabled Employee Parking Spaces.** Capitol Mall Parking will make available reserved disabled employee parking spaces for employees who have a proven disability. (3-20-20)T

**a.** A temporarily or permanently disabled employee who has obtained an Americans with Disabilities Act (ADA) placard issued by the Idaho Transportation Department may request a reserved disabled employee parking space as close as possible to the employee's work location. (3-20-20)T

**b.** A disabled employee requesting a reserved disabled employee parking space must provide either a copy of his Americans with Disabilities Act (ADA) placard issued by the Idaho Transportation Department or a copy of the application to the Idaho Department of Transportation for an Americans with Disabilities Act (ADA) placard. (3-20-20)T

**c.** A temporary reserved disabled employee parking space will be provided to any eligible employee who has applied for an Americans with Disabilities Act (ADA) placard with the Idaho Department of Transportation but has not yet received the placard. A temporary reserved disabled parking space will be made available for five (5) working days only per disabled employee. (3-20-20)T

**d.** Reserved disabled employee parking spaces will be marked with signage. (3-20-20)T

**e.** A permit for a reserved disabled employee parking space will be the same fee as a permit for a general parking space. (3-20-20)T

**04. Carpool Parking Spaces.** Capitol Mall Parking will make available an indeterminate number of carpool parking spaces, which will be clearly marked, to employees who carpool at least four (4) work days per week. (3-20-20)T

**a.** Capitol Mall employees who carpool may request a carpool parking permit from Capitol Mall Parking to use a designated carpool space. (3-20-20)T

**b.** Carpool parking spaces will be available on a first-come, first-served basis for vehicles carrying two (2) or more Capitol Mall employees. All carpooling employees must be employees of the Capitol Mall and at least one (1) carpooling employee must have a general parking space permit. (3-20-20)T

**c.** A permit for a carpool parking space will be the same fee as a permit for a general parking space. (3-20-20)T

**d.** All unoccupied reserved carpool parking spaces will be redesignated as general parking spaces after 9 a.m. work days. (3-20-20)T

**e.** It is a parking violation to park in a reserved carpool parking space when the vehicle is carrying less than two (2) Capitol Mall employees before 9 a.m. (3-20-20)T

**05. State-Owned Vehicles Parking Spaces.** Capitol Mall Parking will make available designated state-owned vehicle parking spaces. (3-20-20)T

**a.** Capitol Mall Parking will make available an indeterminate number of designated state-owned vehicle parking spaces to department tenants of the Capitol Mall. (3-20-20)T

**b.** Designated state-owned vehicle parking spaces will be on the fifth level of the State Parking Garage #1, and will be clearly marked "State Vehicle Only." (3-20-20)T

**c.** A Capitol Mall employee may park his personal vehicle in a designated state-owned vehicle parking space when removing a state vehicle for state purposes. The Capitol Mall employee's personal vehicle must display the reserved state-owned vehicle parking space permit. (3-20-20)T

**d.** A visiting agency employee conducting official business at the Capitol Mall may park a state vehicle in an unoccupied designated state-owned vehicle parking space or in any Capitol Mall visitor parking space. (3-20-20)T

**06. Motorcycle Parking Spaces.** Capitol Mall Parking will make available designated motorcycle parking spaces. (3-20-20)T

**a.** Capitol Mall employees may request a special motorcycle parking permit for motorcycles, at no additional cost, to park in the designated motorcycle parking areas. (3-20-20)T

**b.** In order to receive a motorcycle permit, the Capitol Mall employee must possess a valid general or reserved parking permit. (3-20-20)T

**07. General Parking Spaces.** All other undesignated parking is considered general parking. (3-20-20)T

**a.** All Capitol Mall employees whose parking fees are deducted from their paychecks by the State Controller's Office may request a general parking permit from Capitol Mall Parking. (3-20-20)T

**b.** General parking spaces are available on a first-come, first-served basis, and possession of a valid general parking permit does not guarantee the Capitol Mall employee a general parking space. (3-20-20)T

**08. Visitor Parking Spaces.** Capitol Mall Parking will make available a limited number of parking spaces for visitors and the public visiting the Capitol Mall. (3-20-20)T

**a.** Non-metered three (3) hour visitor parking spaces will be available at the parking lot at the Capitol Annex at 514 W. Jefferson Street and on the south side of the parking lot at the State Library Building at 325 W. State Street, and will be clearly marked. (3-20-20)T

**b.** State-owned vehicles that do not belong to the departments' tenants of the Capitol Mall, and non-Capitol Mall employees visiting the Capitol Mall on business, may park in visitor parking spaces. (3-20-20)T

**c.** Capitol Mall employees may not park in visitor parking spaces between 6 a.m. and 6 p.m., Monday through Friday, excluding legal holidays with the exception of Human Rights Day and Presidents' Day. (3-20-20)T

**d.** The maximum period of use of visitor parking spaces in the Capitol Mall is three (3) hours per day per vehicle. A change from one visitor parking space to another visitor parking space does not increase the maximum period of use for each vehicle beyond three (3) hours per day. (3-20-20)T

**023. -- 029. (RESERVED)**

**030. PARKING PERMITS.** Capitol Mall Parking will issue applicable parking permits to all eligible persons who apply for a permit. (3-20-20)T

**01. Parking Permits for Reserved, Legislator, Disabled Employee, Carpool, State-Owned Vehicles and General Parking.** (3-20-20)T

**a.** Capitol Mall Parking will reissue parking permits once a year. Outdated parking permits must be returned to Capitol Mall Parking. (3-20-20)T

**b.** Capitol Mall Parking will issue the applicable parking permit to each Capitol Mall state elected official, director of an executive branch department, Legislator or employee, with the exception of the carpool parking permit and the special motorcycle parking permit. (3-20-20)T

**c.** Capitol Mall Parking will issue only one (1) parking permit per employee. Capitol Mall Parking will not provide duplicate general parking permits. State elected officials, directors of executive branch departments, and Capitol Mall employees with reserved parking spaces may request a duplicate reserved parking permit for a one-time fee equal to the general permit monthly fee. (3-20-20)T

**d.** All individuals and department tenants are responsible for displaying the parking permit in the front windshield or other prominent location of the parked vehicle at all times. (3-20-20)T

**e.** In the event that a parking permit is stolen, lost or destroyed, the official, Legislator or employee must sign a statement attesting that the parking permit was lost, stolen or destroyed and pay a replacement fee before Capitol Mall Parking will issue a new permit. The replacement fee is equal to the general permit monthly fee. (3-20-20)T

**02. Temporary Monthly Parking Permits. (3-20-20)T**

**a.** An individual performing work or providing services to a department tenant as a Temporary Contract Employee in the Capitol Mall, but who does not receive a state of Idaho-issued paycheck, may purchase a general monthly parking permit at the same cost as a general parking permit from Capitol Mall Parking. (3-20-20)T

**b.** Upon request and receipt of the general parking permit fee, Capitol Mall Parking may issue a monthly general parking permit to the following: (3-20-20)T

**i.** Individuals who do not receive a paycheck issued by the state of Idaho but are performing work or providing services to a department tenant in the Capitol Mall. This includes, but is not limited to, employees of the Idaho Central Credit Union, employees of vendors of the Commission for the Blind and Visually Impaired, and Capitol Mall tenant departments' temporary contract employees. (3-20-20)T

**ii.** Individuals who are employed by the state of Idaho, whose assigned work area is in the Capitol Mall, and who receive a state of Idaho-issued paycheck that is not issued by the State Controller's Office. This includes, but is not limited to, employees of the University of Idaho whose assigned work area is the Capitol Annex occupied by the University of Idaho. (3-20-20)T

**03. Temporary Meeting Parking Permits.** Upon submission of an application by a department tenant in the Capitol Mall, Capitol Mall Parking may issue temporary daily parking permits for meetings hosted by the department tenant. Parking will be allowed only in a limited number of parking spaces in the area designated by the permit and for the date set forth on the permit. (3-20-20)T

**031. PARKING PERMIT FEES.**

Pursuant to Sections 67-5701 and 67-5708, Idaho Code, parking permit fees will be established by the Department of Administration and administered by Capitol Mall Parking. (3-20-20)T

**01. Elected Officials Parking Permits.** The governor, lieutenant governor, secretary of state, attorney general, state controller, state treasurer, superintendent of public instruction, Senate pro-tem, and the speaker of the House of Representatives will be provided a reserved parking space at no charge. Additionally, upon request, Capitol Mall Parking will provide the governor four (4) additional reserved parking spaces. The fee for each additional reserved parking space provided to the governor will be the reserved parking permit monthly fee. (3-20-20)T

**02. Directors of Executive Branch Departments.** Directors of executive branch departments will be provided a reserved parking space at a cost not to exceed forty dollars (\$40) per month. Executive branch departments will be charged for the reserved parking spaces annually by Capitol Mall Parking. (3-20-20)T

**03. Reserved Parking Permits.** The fee for a reserved parking space permit will not exceed forty dollars (\$40) per month. (3-20-20)T

**04. General Parking Permits.** The fee for a general parking space permit will not exceed ten dollars (\$10) per month. (3-20-20)T

**05. Payment for Parking Permits.** Capitol Mall employees will be charged the respective permit fee in the first paycheck of each month through a payroll deduction or as determined by the State Controller. (3-20-20)T

**06. Legislators.** Legislators who request a Legislator parking space permit must pay the parking permit fee. Legislators and Legislative personnel who request parking spaces must pay the associated space fee for every month that the Legislature is in session. (3-20-20)T

**07. State-Owned Vehicles.** State-owned vehicles belonging to the tenant departments will receive state vehicle parking permits for a monthly fee not to exceed fifteen dollars (\$15). (3-20-20)T

**08. Replacement Permits.** If a parking permit is lost, stolen or destroyed, the official, Legislator, or Capitol Mall employee will be charged a fee equal to the general permit monthly fee for a new permit. A statement attesting that the parking permit was lost, stolen or destroyed must be signed before Capitol Mall Parking will issue a new permit. (3-20-20)T

**032. -- 039. (RESERVED)**

**040. PARKING LOT VIOLATIONS.**

**01. Driving Violations.** Any driving violation in a Capitol Mall parking lot or garage may result in the suspension or loss of parking privileges. (3-20-20)T

**a.** It is a violation of these rules to drive or operate a personal vehicle negligently or recklessly in any Capitol Mall parking lot or garage. It is a violation of these rules to drive or operate a vehicle under the influence of illegal substances or alcohol in any Capitol Mall parking lot or garage. (3-20-20)T

**b.** It is a violation for any individual to drive above the posted speed limits or drive against posted directional arrows. (3-20-20)T

**02. Parking Violations.** Any parking violation in a Capitol Mall parking lot or garage may result in the suspension or loss of parking privileges. (3-20-20)T

**a.** It is a violation of these rules to park in a location that is not marked as a parking space within the Capitol Mall. This includes, but is not limited to, parking in or on a driveway, sidewalk or other common driving areas of any parking lot or garage. It is also a violation to park one (1) vehicle in more than one (1) parking space. (3-20-20)T

**b.** It is a violation to park in a Legislator parking space without displaying the appropriate reserved parking permit during the Legislative session or to park in a general parking space without displaying the appropriate general parking permit. (3-20-20)T

**c.** It is a violation to park in a reserved parking space, in a reserved disabled employee parking space, ADA space, or in a reserved carpool parking space before 9 a.m., without displaying the appropriate parking permit. (3-20-20)T

**d.** It is a violation to park a motorcycle in any space not designated for motorcycle parking, unless a valid reserved parking permit is displayed and the motorcycle is parked in the designated reserved parking space. (3-20-20)T

**e.** It is a violation to park or store a personal trailer in a Capitol Mall parking lot. (3-20-20)T

**f.** It is a violation of these rules to: (3-20-20)T

- i. Use an invalid parking permit; (3-20-20)T
- ii. Use a parking permit reported lost or stolen; (3-20-20)T
- iii. Fail to properly display a valid Capitol Mall parking permit; or (3-20-20)T
- iv. Transfer an invalid permit to another person. (3-20-20)T
- g. It is a violation of these rules to park in one or more visitor parking spaces for a period in excess of the maximum period of use set forth in these rules. (3-20-20)T
- h. It is a violation of these rules for a CMP permit holder to park in a visitor parking space at any time. (3-20-20)T

**03. Other Violations.** The Capitol Mall parking lots and garages are private property, and any tampering or other physical defacement of any vehicle parked on the lots or in the garage is considered a violation. (3-20-20)T

**a.** The distribution of flyers or other materials on vehicles parked on Capitol Mall parking lots and in State Parking Garages #1 and #2 is prohibited, and violators will be escorted off the property. (3-20-20)T

**b.** Any individual engaging in suspicious activity or threatening behavior, or an individual loitering in a Capitol Mall parking lot or in State Parking Garages #1 and #2, will be escorted off the property. (3-20-20)T

**c.** Public access is not allowed in State Parking Garages #1 and #2 before 6 a.m. and after 6 p.m. Violators will be considered trespassers. (3-20-20)T

**04. Administrative Appeals.** Alleged violations of these rules are not subject to the provisions of Title 67, Chapter 52, Idaho Code, regarding administrative appeals. (3-20-20)T

**041. ENFORCEMENT.**

**01. Security and Patrol.** Capitol Mall parking lots and State Parking Garages #1 and #2 are secured and patrolled by Capitol Mall Parking, or its authorized representative. (3-20-20)T

**02. Notice of Violation.** Upon witnessing or finding a violation of these rules, Capitol Mall Parking, or its authorized representative, will leave notice with the occupant of the vehicle or on the vehicle parked in violation of these rules. (3-20-20)T

**a.** Notice may be in the form of a warning or a ticket. The warning or ticket will indicate the date and hour of the violation, the nature of the violation, and the name of the Capitol Mall Parking employee or its authorized representative. A warning or ticket may be issued only for those violations that do not cause the loss of a parking space and do not cause a safety hazard. (3-20-20)T

**b.** A ticket may be issued by Capitol Mall Parking, or its authorized representative, for a fine of at least two dollars (\$2), but not more than twenty-five dollars (\$25). (3-20-20)T

**c.** If an individual is determined to have altered, counterfeited or otherwise misused a parking permit, a ticket may be issued by Capitol Mall Parking, or its authorized representative, for a fine not to exceed fifty dollars (\$50). (3-20-20)T

**d.** All tickets issued by Capitol Mall Parking, or its authorized representative, will be forwarded to the city of Boise, county of Ada, for collection or prosecution. (3-20-20)T

**e.** Capitol Mall Parking retains the right to suspend or revoke an individual's parking privileges if the warnings or tickets have been issued or fines imposed for repeated violations. (3-20-20)T

**042. SUSPENSION OR REVOCATION OF PARKING PRIVILEGES.**

**01. Delinquent Payment.** Capitol Mall Parking may suspend or revoke any individual's parking permit if the parking permit fee is unpaid and at least thirty (30) days delinquent. Upon payment in full, Capitol Mall Parking will restore the individual's parking permit. (3-20-20)T

**02. Parking Privileges Suspension.** (3-20-20)T

**a.** Capitol Mall Parking may suspend an individual's parking permit and privileges for up to six (6) months for a violation of these rules. (3-20-20)T

**b.** Any Capitol Mall Parking permit holder, including a temporary parking permit holder, who has been cited for three (3) violations of these rules within six (6) months, may have his parking permit and privileges revoked for up to twelve (12) months. (3-20-20)T

**03. Towing and Impounding.** (3-20-20)T

**a.** Capitol Mall Parking or its authorized representative may tow any vehicle from any Capitol Mall parking lot or the or State Parking Garages #1 and #2, belonging to an individual who has been cited for three (3) or more Capitol Mall parking violations within a twelve-month period. The owner of the vehicle is liable for any service fee owed for releasing the towed and impounded vehicle. (3-20-20)T

**b.** In the event that a vehicle is considered a security risk, Capitol Mall Parking will make reasonable efforts to locate the owner of the vehicle before it is towed. (3-20-20)T

**04. Reactivating a Suspended Permit.** A suspended parking permit may be reactivated after the applicable suspension period ends by reapplying for the automatic payroll deduction plan through Capitol Mall Parking and paying in full of any delinquent parking fees. (3-20-20)T

**043. SURRENDER OF PARKING PERMIT.**

**01. Surrender of Permit.** When an official, Legislator or Capitol Mall employee no longer works in the Capitol Mall or no longer needs to utilize Capitol Mall parking, the individual must submit a request to Capitol Mall Parking to cease automatic payroll deduction or billing for Capitol Mall parking. The individual must surrender the parking permit to Capitol Mall Parking within ten (10) days of the effective date of termination. (3-20-20)T

**02. Cancellation of Automatic Payroll Deduction.** (3-20-20)T

**a.** Capitol Mall Parking will notify the individual's agency's payroll clerk to cease the monthly parking fee deduction. Capitol Mall Parking will not refund a monthly parking fee after a monthly payroll deduction has been made. (3-20-20)T

**b.** Agency payroll clerks must receive a written request from Capitol Mall Parking prior to deleting the monthly parking fee from the employee's payroll deduction schedule. (3-20-20)T

**044. -- 049. (RESERVED)**

**050. LOADING ZONE PARKING SPACES.**

Capitol Mall Parking will designate and mark a limited number of parking spaces to be used for short-term collection or delivery services or by authorized service contractors. It is a violation to park in loading zone parking spaces for any unauthorized purpose. (3-20-20)T

**051. WAIVER OF RULES.**

Pursuant to Section 67-5708, Idaho Code, the administrator for the Division of Public Works may waive any or all of the provisions of these rules if the administrator determines that application could result in discrimination among employees or otherwise violate law. (3-20-20)T

**052. -- 999. (RESERVED)**



## IDAPA 39 – IDAHO TRANSPORTATION DEPARTMENT

### DOCKET NO. 39-0000-2000F (FEE RULE)

#### NOTICE OF OMNIBUS RULEMAKING – ADOPTION OF TEMPORARY RULE

**EFFECTIVE DATE:** The effective date of the temporary rules being adopted through this omnibus rulemaking is the adjournment date of the second regular session of the 65th Idaho State Legislature - March 20, 2020.

**AUTHORITY:** In compliance with Sections 67-5226, Idaho Code, notice is hereby given this agency has adopted temporary rules. The action is authorized pursuant to Sections 40-312 and 49-201, Idaho Code.

**DESCRIPTIVE SUMMARY:** The following is the required finding and concise statement of its supporting reasons for adopting a temporary rule:

This temporary rulemaking adopts the following chapters under IDAPA Title 39:

#### **IDAPA 39**

- 39.02.04, *Rules Governing Manufacturer & New Vehicle Dealer Hearing Fees*
- 39.02.05, *Rules Governing Issuance of Certificate of Title*
- 39.02.22, *Rules Governing Registration and Permit Fee Administration*
- 39.02.26, *Rules Governing Temporary Vehicle Clearance for Carriers*
- 39.02.41, *Rules Governing Special Provisions Applicable to Fees for Services*
- 39.02.60, *Rules Governing License Plate Provisions*
- 39.03.03, *Rules Governing Special Permits – General Conditions and Requirements*

**TEMPORARY RULE JUSTIFICATION:** Pursuant to Sections 67-5226(1) and 67-5226(2), Idaho Code, the Governor has found that temporary adoption of the rule is appropriate for the following reasons:

These temporary rules are necessary to protect the public health, safety, and welfare of the citizens of Idaho and confer a benefit on its citizens. These temporary rules implement the duly enacted laws of the state of Idaho, provide citizens with the detailed rules and standards for complying with those laws, and assist in the orderly execution and enforcement of those laws. The expiration of these rules without due consideration and processes would undermine the public health, safety, and welfare of the citizens of Idaho and deprive them of the benefit intended by these rules.

**FEE SUMMARY:** Pursuant to Section 67-5226(2), the Governor has found that the fees or charges being imposed or increased is justified and necessary to avoid immediate danger and the fees are described herein:

The fees or charges, authorized in Idaho Code are part of the agency's 2021 budget that relies upon the existence of these fees or charges to meet the state's obligations and provide necessary state services. Failing to reauthorize these temporary rules would create immediate danger to the state budget, immediate danger to necessary state functions and services, and immediate danger of a violation of Idaho's constitutional requirement that it balance its budget.

The following is a specific description of the fees or charges:

**39.02.04, Rules Governing Manufacturer and New Vehicle Dealer Hearing Fees:** ITD is required to collect filing fees for hearings when requested by a franchised dealer over disputes with a manufacturer. The Department is required to collect the fees, appoint a hearing officer and ensure all legal expenses including a court reporter, hearing transcripts and witness fees are reimbursed to the Department. Although the Department is not a party to the dispute, Idaho Code and this rule facilitate the hearing process between franchisees and manufacturers. The deposited fee of \$2,000 is utilized to cover initial expenses incurred by the Department. Any remaining part of the deposit is refunded to the dealer and additional expenses are billed to the responsible party. (See §49-1617, Idaho Code)

**39.02.05, Rules Governing Issuance of Certificate of Title:** The \$25 fee assessed under this rule is for an inspection of a vehicle to be performed by the Department's Motor Vehicle Investigators on vehicles with a special construction; including glider kits, replicas, street rods, replica street rods, assembled vehicles and specially constructed vehicles. This fee covers administrative costs of the Motor Vehicle Investigator for the physical

inspection of the vehicle and preparation of necessary documents for the owner to obtain a title from the Department with the correct physical classification of the vehicle. (See §49-504 and §49-525, Idaho Code)

**39.02.22, Rules Governing Registration & Permit Fee Administration:** This rule provides for installment payment plans for commercial motor vehicle registrations. It covers administrative costs for services provided by the Department, which includes a \$50 fee for setting up each installment payment plan. To reinstate a payment plan that has been suspended, a \$40 fee is required. If there are insufficient funds, the rule allows the Department to collect a \$20 insufficient funds fee and provides the Department with the ability to collect a \$40 fee for reinstatement of a revoked or suspended commercial motor vehicle registration. (See §49-434, Idaho Code)

**39.02.26, Rules Governing Temporary Vehicle Clearance for Carriers:** This rule allows the Department to authorize and issue temporary clearance for a carrier who needs to immediately operate a commercial motor vehicle and who is in the process of obtaining and submitting requirements for full issuance of vehicle registration and license plates. This temporary permit provides for a 45-day intermediate clearance at a cost of \$18. (See §49-501, Idaho Code)

**39.02.41, Rules Governing Special Provisions Applicable to Fees for Services:** This rule includes fees associated with the costs of providing records (typically bulk data) for requestors other than law enforcement and specified state agencies which receive records free of charge. Depending on the format and nature of the records requested, there is a base charge of \$75. (See §49-201, Idaho Code)

**39.02.60, Rules Governing License Plate Provisions:** This rule encompasses several license plate programs and their identifiers/formats. It provides for dealer and loaner license plates, standard license plates, restricted vehicle license plates, transporter and wrecker license plates, the personalized plate program criteria, legislatively sponsored license plates and many others. Most fees for plate programs are set in Idaho Code; however there are two that are not and they are established by rule. For vehicle dealer registration and plates, the fee is \$15 annually or the dealer may purchase single trip permits. These are only valid on boat and utility trailers for demonstration purposes. The other fee within this rule is \$12 for standard sample plates to pay for the production of the plate and administrative fees. (See §49-202, Idaho Code)

**39.03.03, Rules Governing Special Permits – General Conditions and Requirements:** This is a new rule that was part of the Department's efforts to consolidate and streamline commercial motor vehicle permit rules and was presented during the 2019 legislative session. The fees set in this rule cover a variety of commercial motor vehicle permits. These fees simply cover administrative costs for processing, issuing and enforcing special permits. This program is revenue-neutral. (See §49-1004, Idaho Code)

**ASSISTANCE ON TECHNICAL QUESTIONS:** For assistance on technical questions concerning the temporary rule, please contact Ramón Hobdey-Sánchez at (208) 334-8810.

DATED this February 6, 2020.

Ramón S. Hobdey-Sánchez, J.D.  
Governmental Affairs Specialist  
Idaho Transportation Department  
3311 W. State Street  
Boise, ID 83703  
Phone: (208) 334-8810  
[ramon.hobdey-sanchez@itd.idaho.gov](mailto:ramon.hobdey-sanchez@itd.idaho.gov)

**39.02.04 – RULES GOVERNING MANUFACTURER AND NEW VEHICLE DEALER HEARING FEES**

**000. LEGAL AUTHORITY.**

This rule is adopted under the authority of Sections 49-201 and 49-1617(4), Idaho Code, and the Vehicle Dealer Act, Chapter 16, Title 49, Idaho Code. (3-20-20)T

**001. TITLE AND SCOPE.**

This rule is titled IDAPA 39.02.04, “Rules Governing Manufacturer and New Vehicle Dealer Hearing Fees,” and clarifies the process of collecting filing fees for hearings conducted by the Department for settling disputes between manufacturers and new vehicle dealers. (3-20-20)T

**002. -- 099. (RESERVED)**

**100. GENERAL PROVISIONS.**

**01. Hearing Officer Appointment.** The Director will appoint a hearing officer to hear the dispute who is not a current employee of either a manufacturer or dealer. (3-20-20)T

**02. Location of Hearings.** All hearings will be held in Ada County, Boise, Idaho. (3-20-20)T

**03. Hearing Filing Fee.** The dealer requesting a hearing shall deposit a filing fee of two-thousand dollars (\$2,000) with the Department. The Department shall apply the filing fee toward the hearing costs which shall include: (3-20-20)T

- a. The hearing officer fee and expenses; (3-20-20)T
- b. Department legal expenses; (3-20-20)T
- c. Department investigative expenses pertaining to the dispute; (3-20-20)T
- d. A court recorder, hearing transcript, any witness fees; and (3-20-20)T
- e. Other Department verifiable expenses. (3-20-20)T

**04. Hearing Fee Refunds and Additional Charges.** If the total verifiable costs of the hearing are less than two-thousand dollars (\$2,000), the Department shall refund the balance. If the costs exceed the two-thousand dollars (\$2,000) filing fee, the Department shall bill the responsible party for the remainder which is payable after the Department renders a decision. (3-20-20)T

**101. -- 999. (RESERVED)**

## 39.02.05 – RULES GOVERNING ISSUANCE OF CERTIFICATES OF TITLE

### 000. LEGAL AUTHORITY.

Under the authority of Sections 49-201, 49-504, 49-507 and 49-525, Idaho Code, the Department adopts the following rule. (3-20-20)T

### 001. TITLE AND SCOPE.

**01. Title.** These rules shall be cited as IDAPA 39.02.05 “Rules Governing Issuance of Certificates of Title.” (3-20-20)T

**02. Scope.** These rules identify requirements for the issuance of certificates of title, pursuant to Title 49, Chapter 5, Idaho Code. (3-20-20)T

### 003. – 009. (RESERVED)

### 010. DEFINITIONS.

**01. Appropriate Governmental Entity.** The agency or organization employing the authorized officers who take an abandoned vehicle into custody or direct a vehicle to be stored or towed. (3-20-20)T

**02. Assembled Vehicle.** A vehicle which has been constructed using parts from two (2) or more vehicles and has the same appearance as a vehicle that was manufactured under a specific make and model by a manufacturer. Changes may include frame and/or cab changes. See Section 305 for title application requirements. (3-20-20)T

**03. Body/Center Passenger Area.** The center structure, either of a unibody or frame-type passenger vehicle, consisting of a unit of sheet metal and structural components that extends from the firewall to the back of the rear seat or to the factory seam separating the rear section or the centerline of the rear wheels, i.e. cowl panel, dash panel, floor pans, center side body panels, side rails, rocker panels, and other such component parts that may be pertinent to this section. (3-20-20)T

**04. Brand.** A description on a certificate of title or title record, as determined by the Department or the equivalent agency of another jurisdiction, which indicates and advises future owners and interested parties that: (3-20-20)T

**a.** The vehicle has or has had a relevant physical condition, modification, construction, alteration or history of use; or (3-20-20)T

**b.** Past or present ownership of the vehicle could not be clearly established to the satisfaction of the Department or the equivalent agency of another jurisdiction. (3-20-20)T

**05. Cab.** The passenger compartment of a common truck or pickup truck. It is a unit of sheet metal and structural components including the top/roof and the cowl which may or may not include glass, instrumentation, steering column and seat. (3-20-20)T

**06. Frame.** The heavy metal structure that supports the auto body and other external component parts on body-over-frame constructed vehicles only. (3-20-20)T

**07. Gray Market Vehicle.** A vehicle manufactured outside of the U.S. for use in other countries that did not meet U.S. Federal Motor Vehicle Safety Standards or Environmental Protection Agency requirements at the time of manufacture. (3-20-20)T

**08. Mileage.** Actual distance that a vehicle has traveled. (3-20-20)T

**09. Replica Street Rod.** A vehicle made to replicate any pre-1949 vehicle which has had a significant drive train update from a more modern vehicle. Changes may include engine, transmission, rear axle and other suspension components. The body will resemble the same as the manufacturer's original issue. See Section 305 for title application requirements. (3-20-20)T

**10. Street Rod Vehicle.** Any pre-1949 manufactured vehicle which has had a significant drive train update from a more modern vehicle. Changes may include engine, transmission, rear axle, and other suspension components. The body will be the same as the manufacturer's original issue. See Section 305 for title application

requirements. (3-20-20)T

**11. Transferee.** Any person to whom the ownership of a motor vehicle is transferred, or any person who, as agent, accepts transfer of ownership of a motor vehicle for another, by purchase, gift or any means other than creation of a security interest. (3-20-20)T

**12. Transferor.** Any person who transfers vehicle ownership or any person who, as agent, transfers the ownership of another's motor vehicle by sale, gift or any means other than creation of a security interest. (3-20-20)T

**011. – 099. (RESERVED)**

**100. GENERAL.**

The Department will issue a Certificate of Title on any vehicle if the applicant can show proper documentation of ownership, there are no undisclosed security interests in the vehicle, and other requirements for titling have been satisfied. Unless otherwise specified in statute or administrative rule, such proper documentation of ownership will be limited to: (3-20-20)T

**01. Certificate of Title.** A valid Idaho Certificate of Title or a valid Certificate of Ownership issued by another state, province or country according to the applicable laws of another state, province or country, which has been duly assigned or transferred to the applicant if issued in another's name. (3-20-20)T

**02. MCO/MSO.** A properly executed Manufacturer's Certificate of Origin (MCO) or Manufacturer's Statement of Origin (MSO) in the case of a new vehicle being titled for the first time. (3-20-20)T

**03. Certificate of Registration.** A Certificate of Registration from a non-titling state, province or country, together with a bill of sale from the registrant if other than the applicant. (3-20-20)T

**04. Transfer by Operation of Law.** In the case of a transfer by operation of law, a certified copy of a valid court order, decree, or instrument upon which the claim of possession and ownership is founded, passing title to the applicant as a matter of law (for example: a property settlement, divorce decree, or execution sale's certificate of sale or bill of sale), together with an affidavit by the person or agent of the person to whom possession of the vehicle so passed, setting forth facts entitling him to possession and ownership. (3-20-20)T

**05. Salvage Vehicles.** For a salvage vehicle, a salvage certificate of title or other salvage ownership document issued by another state, province, or country according to the applicable laws of that state, province, or country, duly assigned or transferred to the applicant if issued in another's name. (3-20-20)T

**06. Specially Constructed Vehicles.** (3-20-20)T

**a.** For a specially constructed vehicle as defined by Section 49-123(p)(i) or (iii), Idaho Code, the original ownership document for the vehicle from which the body or cab being used has been taken unless the vehicle is from a state that requires the ownership document to remain with the frame in which case a copy of the ownership document verified to be a true and correct copy of the original, together with a bill of sale from the owner to whom the ownership document was issued if different than the applicant, and a bill of sale, invoice, or other proof of acquisition for any of the following major components used in the vehicle's construction: (3-20-20)T

i. Frame or rails; (3-20-20)T

ii. Engine or short block; (3-20-20)T

iii. Transmission and/or transfer case; (3-20-20)T

iv. Front and rear clips; or (3-20-20)T

v. Truck bed or box; (3-20-20)T

**b.** Each bill of sale for major component parts is to include the following: (3-20-20)T

- i. Name of purchaser; (3-20-20)T
- ii. Vehicle Identification Number (VIN) or engine number for a motorcycle, if applicable; (3-20-20)T
- iii. Description of major component part (by make, body type, year of manufacture, if applicable); (3-20-20)T
- iv. Purchase price; and (3-20-20)T
- v. Signature of seller. (3-20-20)T
- c.** For a specially constructed vehicle as defined by Section 49-123(p)(ii), Idaho Code, bills of sale, receipts, invoices or other proof of acquisition for the materials used in the construction. (3-20-20)T
- d.** For a specially constructed vehicle as defined by Section 49-123(p)(iv), Idaho Code, a properly executed manufacturer's certificate of origin (MCO) or manufacturer's statement of origin (MSO) for the custom kit, or if no MCO was issued, a factory invoice or bill of sale from the selling dealer, together with a statement certifying no MCO was issued for the kit. (3-20-20)T

**101. – 199. (RESERVED)**

**200. LIEN FILING.**

**01. Date of Lien Filing.** All title applications submitted to the Department or its agent for filing will include the date of filing. (3-20-20)T

**a.** If a lien is listed on a title application, the date the application is received by the Department or its agent will be the date of the filing of the lien. (3-20-20)T

**b.** A lien is perfected as of the date of the filing of a properly completed application with the department or an agent of the department. All liens filed with the department will take priority according to the order in which the properly completed applications are filed with the department or an agent of the department. The priority of liens will not be affected should the department fail to note one or more on the title or on the electronic records of the department due to error. (3-20-20)T

**02. Out-of-State Transfer.** If a lien was previously recorded on an out-of-state title, and the title is being surrendered to Idaho for issuance of a new certificate of title and the lien is still in effect, the Department will honor the previously recorded date shown on the out-of-state title, provided that at least one of the previous owners' names will remain on the new Idaho title. If there is no recorded date on the title, the following will be captured as the recorded date if displayed on the title with priority according to the order listed: (3-20-20)T

**a.** Application date; (3-20-20)T

**b.** Issue date; and (3-20-20)T

**c.** Print date (3-20-20)T

**d.** If none of the aforementioned dates are present, the Department will consider other evidence provided in the documentation submitted with the title application to determine a filing date. (3-20-20)T

**e.** In the event that no other evidence is provided to reasonably determine the date of the lien's filing, the date the title application is filed with the Department will be the recorded date. (3-20-20)T

**03. Name Change Only.** If a name change is being requested on a title containing a recorded lien, and the lien is not being released, the original recorded date will be retained for the lien filing, provided that the new title will retain the name of the same lienholder and at least one (1) of the previous owners. (3-20-20)T

**04. Taxable Transfer of Ownership.** In the case of a taxable transfer of ownership, where the lien was not released, and the new title will have the same lienholder, a new recorded date will be assigned to the lien, unless the lienholder has specified that the new owners have assumed the lien. (3-20-20)T

**05. Lien Assumptions.** If a lienholder specifies that a contract has been assumed by a new owner, and the new owner has assumed the terms of the previous lien, the original date will be retained on the new certificate of title. (3-20-20)T

**201. ODOMETERS.**

**01. Procedures.** (3-20-20)T

**a. Department Requirement.** The Department will enter the odometer reading and status as provided by a dealer or private seller or transferor on the Certificate of Title when printed unless previously recorded as exempt with no reading. (3-20-20)T

**b. Used Vehicle Transferor/Seller Requirements.** When a used vehicle is transferred, the transferor will record the odometer reading on the title certificate using indelible ink. If the vehicle has not been titled or if the title does not contain a space for the information required, the written disclosure will be executed as a separate statement. (3-20-20)T

**c. New Vehicle Transferor/Seller Requirements.** When a new vehicle is retailed, the transferor will provide a written disclosure on the MCO or on a separate document. (3-20-20)T

**d. Use of Power of Attorney.** When the transferor's title is physically held by a lienholder or if the transferor to whom the title was issued has lost the title and the transferee obtains a duplicate title on behalf of the transferor; the transferor may give a power of attorney to his transferee for the purposes of mileage disclosure. (3-20-20)T

**e. Reassignments.** When all available reassignments on a title certificate have been used, subsequent reassignments will be made on a separate reassignment document printed by the Department or by another state's motor vehicle Department. (3-20-20)T

**02. Exemptions.** (3-20-20)T

**a. Transferor/Seller Exemptions.** A transferor is not required to disclose the vehicle's odometer reading for any of the following: (3-20-20)T

i. A vehicle having a gross vehicle weight rating over sixteen thousand (16,000) pounds; (3-20-20)T

ii. A vehicle which is not self-propelled; (3-20-20)T

iii. A vehicle sold directly by the manufacturer to any agency of the United States in conformity with contractual specifications; (3-20-20)T

iv. A vehicle which is ten (10) years old or older. To calculate the vehicle's age, simply subtract the model year from the calendar year; or (3-20-20)T

**b. Manufacturers' Exemptions.** A manufacturer of a new vehicle may transfer, for purposes of resale, to a franchised dealer without disclosure of the vehicle's odometer. (3-20-20)T

**202. VEHICLE IDENTIFICATION NUMBER (VIN) INSPECTIONS.**

**01. Authorized Inspectors.** The following individuals, agents or agencies are authorized to complete Vehicle Identification Number (VIN) inspections: (3-20-20)T

**a.** Peace Officers and Special Agencies Inspections. As part of their regular assigned duties, any city, county, state or federal peace officer, or specified agent of the Department, may complete a VIN inspection. (3-20-20)T

**b.** Vehicle Dealer Inspections. Licensed Idaho vehicle dealers may complete VIN inspections. (3-20-20)T

**c.** Financial Institution Inspections. An employee of any bank that is authorized to do business in Idaho or an employee of any other financial institution registered with the Department of Finance, may complete VIN inspections as a part of normal business activity. (3-20-20)T

**d.** Special Agent Inspections. Other special designated agents of the Department may complete VIN inspections, as stipulated in a formal agreement between the Department and the special agent, i.e. vehicle rental companies allocating portions of their fleets to Idaho. (3-20-20)T

**e.** Out-of-state Inspectors. For a vehicle located in another state, a VIN inspection is acceptable when completed by any city, county, state or federal peace officer, or any employee of the state's vehicle titling and registration agency. (3-20-20)T

**02. VIN Inspections Required.** A VIN inspection is required whenever the current certificate of title was not issued for the vehicle by this state or whenever the Department is dissatisfied with the authenticity or accuracy of the vehicle identification number. (3-20-20)T

**203. – 299. (RESERVED)**

**300. TITLE BRANDING.**

**01. Brand Disclosure.** (3-20-20)T

**a.** Upon sale by a dealer of any salvage or total loss vehicle or branded vehicle or branded certificate of title, disclosure of the vehicle's salvage or branded status, will be conspicuously disclosed to the buyer and a record must be maintained by the dealer. Disclosure may be made on a form as provided by the Department for a report of sale. The buyer must sign that they have received disclosure of the vehicle brand. Proof of disclosure must be submitted to the Department. (3-20-20)T

**b.** Upon sale by a private party of any salvage or total loss vehicle or branded vehicle or vehicle with a branded certificate of title, disclosure of the vehicle's salvage or branded status, will be conspicuously disclosed to the buyer. (3-20-20)T

**02. Branding Time Frame.** Each branded vehicle and branded certificate of title will retain that brand throughout the existence of the vehicle regardless of its age or value unless the brand has an expiration date. (3-20-20)T

**03. Brands Removed.** (3-20-20)T

**a.** If any salvage vehicle leaves the state of Idaho with or without an Idaho salvage certificate of title and such vehicle returns to Idaho, it will once again be subject to the requirements under Idaho Code and this rule. (3-20-20)T

**b.** If a vehicle with a branded Idaho title leaves Idaho and then returns with a title or other ownership document issued by another jurisdiction that has either no brand or a different brand for the same incident that caused the brand on the Idaho title. (3-20-20)T

**i.** If the brand on the Idaho title originated in Idaho, the Idaho brand will be reinstated. This will occur even if the National Motor Vehicle Title Information System (NMVTIS) returns a different brand for the same incident. (3-20-20)T



ii. If the brand on the Idaho title originated in another state, the Idaho title will be issued with any brand retrieved from NMVTIS if for the same incident that caused the brand on the original Idaho title. If no brand is retrieved from NMVTIS for this incident, the brand on the previous Idaho title will be reinstated. (3-20-20)T

**301. BONDED TITLE.**

**01. Conditions and Requirements.** Application may be made for a “bonded title” when the applicant has actual possession of the vehicle but is unable to provide proper documentation of ownership. (3-20-20)T

**a. Proper Documentation Cannot Be Obtained.** The applicant must satisfy the Department that proper documentation to obtain a regular title cannot be obtained. However, the applicant must provide sufficient documentation to satisfy the Department that it is more probable than not that the applicant is the owner of the vehicle. (3-20-20)T

**b. Vehicle Physical Inspection.** The applicant must produce the vehicle for a physical inspection by a representative designated by the Department. (3-20-20)T

**c. Affidavit of Explanation.** The applicant must provide an affidavit explaining the reasons for the absence of a valid Certificate of Title or Certificate of Ownership or other documentation of ownership identified in Section 100 of this rule, and how the vehicle came into the possession of the applicant. A listing of any liens (loans) or encumbrances against the vehicle; the name of the state, province or country where the vehicle was last titled, or last registered if from a non-titling state, province, or country; and the name under which the vehicle was last titled, or last registered if from a non-titling state, province or country is also required. (3-20-20)T

**d. Bond.** The applicant will provide the Department with a bond in the amount of one (1) and one-half (1/2) times the value of the vehicle or a cash deposit of like amount, as provided in Section 49-523(b), Idaho Code. A cash bond will be in the form of a cashier’s check, money order or certified check made payable to the Idaho Transportation Department. The form of the bond will conform to the form ITD 3909, Vehicle Ownership Bond, which can be obtained by calling 208-334-8663 during regular business hours. (3-20-20)T

**e. Vehicle Appraisal.** The applicant will provide an appraisal of the vehicle either by a licensed Idaho automobile dealer on the dealer’s letterhead or other form provided by the Department with dealer’s number, or by a Motor Vehicle Investigator. The appraisal will reflect the current retail value of the vehicle. This appraisal will be considered by the Department to determine the value of the vehicle. (3-20-20)T

**f. Application for Title.** The applicant will apply for title within ninety (90) days of the bond’s issuance. Should the application for title occur more than ninety (90) days from the issue date of the bond or any subsequent rider, the applicant will obtain a rider to provide bond coverage for three (3) years. (3-20-20)T

**g. Bonded Title Brand.** Upon satisfying the Department’s requirements for a bonded title, the applicant will be issued a title bearing the brand “Bonded Title” and the brand’s expiration date, which will be three (3) years from the following: (3-20-20)T

i. Date of issuance of the bond unless a bond rider was issued; or (3-20-20)T

ii. If one or more bond riders were issued, the date of issuance of the most recent bond rider; or (3-20-20)T

iii. Date of receipt of a cash deposit. (3-20-20)T

**02. Bond Surety.** The bond must be issued by a corporate surety, qualified and licensed to do business in Idaho. (3-20-20)T

**03. Claims Against The Bond.** Should any expense, loss or damage occur, for any reason covered by the bond, persons or entities suffering such loss will make claim directly against the principal (applicant) and the surety. If the applicant has made a cash deposit, any claim will be made through the Department’s Motor Vehicle Administrator. (3-20-20)T

**04. Expiration Of Bonding Requirement.** Upon expiration of the brand, the bond or cash deposit will be returned without interest unless the Department has been notified in writing of a pending claim or action to recover on the bond or deposit. If there has been no claim, the applicant may surrender the bonded title and apply for a Certificate of Title free of the bonded title brand. A Certificate of Title free of the bonded title brand will be issued upon certification of the application and payment of any applicable fees per Idaho Code Title 49, Chapters 2 and 5, and any applicable sales or use tax, per Title 63, Chapter 36, Idaho Code. (3-20-20)T

**05. Return Of Bond Prior To Three Year Period.** The bond or cash deposit will be returned prior to the expiration of the brand if the vehicle is no longer registered in this state, and the Department has not been notified of any claim or action to recover on the bond. (3-20-20)T

**06. Sales And Use Tax.** Any sales or use tax will be paid to the Department or to the county assessor prior to issuance of a bonded title. (3-20-20)T

### **302. SPECIALLY CONSTRUCTED VEHICLES.**

**01. Specially Constructed Vehicle Examples.** Some examples of specially constructed vehicles are: Custom built vehicles, such as, kit conversions, homemade camp trailers, other homemade trailers that exceed two thousand (2,000) pounds unladen weight, motorcycles, vessels, snowmobiles, and slide-in truck-mounted campers. (3-20-20)T

**02. Engine Changes.** A vehicle that has an engine of a different make, model or year from the body, frame and running gear is not considered a specially constructed vehicle. These vehicles retain the original title and identification designation. (3-20-20)T

**03. Title Application Requirements.** (3-20-20)T

**a.** The applicant must provide proof of ownership for all significant parts that are replaced, such as frame, body, and other parts that carry vehicle identification numbers. The body must have a properly released title from the former owner. The frame only may be transferred with a bill of sale given by the legal owner showing the vehicle identification number (VIN). Other significant parts that are replaced must be verified by traceable invoices identifying the part or parts if purchased from an established new or used parts outlet. If the other significant parts are purchased from a private party, a bill of sale showing seller's name and address is required. An MCO must accompany the documents for manufactured kits or if no MCO was issued, a factory invoice or bill of sale from the selling dealer, together with a statement certifying no MCO was issued for the kit, is acceptable. (3-20-20)T

**b.** The model year will be the year that the specially constructed vehicle was first titled as a specially constructed vehicle. (3-20-20)T

**c.** he make code as shown on the certificate of title of a specially constructed vehicle will be identified as "SPCN" and the certificate of title will be branded "Specially Constructed." (3-20-20)T

**d.** When the vehicle is in operating condition, an inspection by a motor vehicle investigator is required. A fee of twenty-five dollars (\$25) is required for this inspection and the preparation of the statement of fact and indemnifying affidavit. In addition, if a vehicle identification number is assigned, the fee required by Section 49-202(2)(j), Idaho Code, will be charged. If the vehicle is eligible to be registered for road use, the owner will complete a self-certification on a form prescribed by the department stating that the vehicle is in compliance with Chapter 9, Title 49, Idaho Code, and meets the Federal Motor Vehicle Safety Standards in effect for the model. (3-20-20)T

### **303. REBUILT SALVAGE VEHICLES.**

**01. Rebuilt Salvage Vehicle.** A rebuilt salvage vehicle, as defined by Section 49-123 (2)(m), Idaho Code, includes every "Salvage or Total Loss Vehicle" that has been rebuilt, in compliance with applicable federal motor vehicle safety standards and the requirements of Chapter 9, Title 49, Idaho Code, as regulated by Sections 49-524 and 49-525, Idaho Code. (3-20-20)T

**02. Salvage Vehicles from Other Jurisdictions.** Every vehicle that is coming into Idaho from another jurisdiction with a Salvage Certificate or other equivalent document showing evidence of a total loss payoff such as a bill of sale from an insurance company, or other documentation indicating that the vehicle may have been a salvage or total loss vehicle and any vehicle for which information retrieved from the National Motor Vehicle Title Information System (NMVTIS) indicates it has been reported as “salvage” will be considered salvage unless there is sufficient evidence for the department to determine the salvage document or information retrieved from NMVTIS was in error. These vehicles may not be operated on Idaho highways until rebuilt in compliance with Chapter 9, Title 49, Idaho Code and all federal motor vehicle safety and emission standards in effect for the model year and type of vehicle. They will be issued an Idaho Salvage Certificate unless the other jurisdiction has issued a salvage certificate or other equivalent salvage ownership document. If any salvage vehicle is received by a “salvage pool” (as described in Section 49-120(4), Idaho Code), an Idaho salvage certificate of title must be issued, prior to sale unless the vehicle has a salvage certificate or other equivalent salvage ownership document issued by another jurisdiction. Any vehicle which has been declared junk, pursuant to Sections 49-516 and 49-522, Idaho Code, or is coming from another jurisdiction with a similar endorsement, or is designated by the owner or the insurance company as parts only, destroyed, or dismantled, may not be rebuilt for on-road use. Any vehicle for which information retrieved from NMVTIS indicates it has been reported as having been scrapped or crushed may not be retitled. Any vehicle for which information retrieved from NMVTIS indicates it has been reported by a salvage yard will be considered “salvage” and any vehicle for which information retrieved from NMVTIS indicates it has been reported by a junk yard will be considered “junk” unless otherwise indicated. The provisions of this section will not apply if there is sufficient evidence for the department to determine the information retrieved from NMVTIS was in error. (3-20-20)T

**03. Title Application Requirements for Vehicles Defined as Salvage and Rebuilt Salvage Vehicles.** (3-20-20)T

**a.** The applicant must provide a written statement which includes the vehicle information, vehicle identification numbers, salvage date, and the work done personally by the owner or supervised by the owner to restore the vehicle to the operating condition that existed prior to the event causing the vehicle to be salvaged. (3-20-20)T

**b.** In the event that the applicant did not personally repair the vehicle or supervise its repair, but another party performed the repairs, the applicant will certify to the best of his knowledge the name of the party that did repair the vehicle or personally supervised its repair. This certification shall be made on a salvage vehicle statement. (3-20-20)T

**c.** In the event that repairs were not necessary to bring the vehicle to operating condition pursuant to Chapter 9, Title 49, Idaho Code, the applicant will certify this on a salvage vehicle statement. (3-20-20)T

**d.** The applicant must sign an indemnifying statement agreeing to defend the title in all legal disputes arising out of his possession of the title to the vehicle, and attesting to the fact that all information contained in the statement and its attachments are true and correct. (3-20-20)T

**e.** The new Idaho title issued will be branded “REBUILT SALVAGE.” Such notation will remain on the title and on all subsequent transfers of the title. (3-20-20)T

**04. Salvage Vehicle Damaged Out-of-State.** If a vehicle that is titled in Idaho is damaged in another state or jurisdiction to the extent that the vehicle becomes a “salvage vehicle” as defined by Section 49-123(2)(o), Idaho Code, and the vehicle is not going to be returned to Idaho, the owner or insurer must, upon determining the vehicle to be salvage, notify the purchaser and the Department in writing of the salvage status. If this vehicle returns to Idaho, the title will be branded “Rebuilt Salvage” or carry another jurisdiction's comparable brand forward unless the vehicle has not yet been repaired and has not had a salvage certificate or other salvage ownership document issued by another jurisdiction in which case the owner must obtain an Idaho salvage certificate of title. (3-20-20)T

**304. GLIDER KITS.**

**01. Title Application Requirements.** (3-20-20)T

**a.** An MCO for the glider kit must be submitted with the application for title. (3-20-20)T

**b.** If the applicant dismantles a vehicle presently titled to the applicant and uses the significant parts with the glider kit, either a statement of fact will be prepared or the applicant will complete an affidavit, identifying the significant parts by identifying numbers. If the significant parts were purchased separately from a new or used parts outlet, a bill of sale or invoice is required. If the significant parts were purchased from a private owner, a bill of sale is required. (3-20-20)T

**c.** If the frame and cab that the parts were stripped from will never be used again, i.e., frame and cab destroyed, not salvageable, the title must be surrendered with the application. If the frame or cab can be used again, the owner or motor vehicle investigator will mark the title “frame only” or “cab only.” (3-20-20)T

**d.** The vehicle must be completely assembled and meet the requirements of Chapter 9, Title 49, Idaho Code, and the federal motor vehicle safety standards in effect for the model year at the time of application. (3-20-20)T

**02. Assignment of VIN.** The VIN will be the number assigned to the kit by the manufacturer. In the absence of such number, the motor vehicle investigator will assign a VIN. (3-20-20)T

**03. Model Year.** The model year will be the year of the kit, determined by priority in the following order: (3-20-20)T

**a.** Written statement from the manufacturer. (3-20-20)T

**b.** Seventeen (17) character VIN’s model year designator; (3-20-20)T

**c.** Designation of model year shown on an approved MCO; or (3-20-20)T

**04. Make of Vehicle.** The make of the vehicle will be the make of the glider kit. (3-20-20)T

**05. Title Branded.** The designation “GLIDER KIT VEHICLE” will be branded on the title. (3-20-20)T

**305. TITLE APPLICATION REQUIREMENTS FOR REPLICA, STREET RODS, REPLICA STREET RODS, AND ASSEMBLED VEHICLES.**

**01. Applicant Must Provide Proof of Ownership.** The applicant must provide proof of ownership for all significant parts that are used in replicating or assembling the vehicle. The body must have a properly released title from the previous owner or a title in the applicant’s name. The frame only may be transferred with a copy of a bill of sale given by the legal owner showing the vehicle identification number (VIN). Other significant parts that are used must be verified by traceable invoices identifying the significant part or parts if purchased from an established new or used parts outlet. If the other significant parts are purchased from a private party, a bill of sale showing the seller’s name and address is required. An MCO must accompany the documents for manufactured kits or if no MCO was issued, a factory invoice or bill of sale from the selling dealer together with a statement certifying no MCO was issued for the kit is acceptable. (3-20-20)T

**02. Model Year.** The model year for replica vehicles and replica street rods will be the year that the vehicle replicates. The model year for assembled vehicles and street rods will be the model year of the vehicle body. (3-20-20)T

**03. Inspection by a Motor Vehicle Investigator.** When the vehicle is in operating condition an inspection by a motor vehicle investigator is required. A fee of twenty-five dollars (\$25) is required for this inspection and the preparation of the statement of fact and indemnifying statement. In addition, if a vehicle identification number is assigned, the fee required by Section 49-202(2)(j), Idaho Code, will be charged. If the vehicle is eligible to be registered for road use, the owner will complete a self-certification form prescribed by the Department stating that the vehicle is in compliance with Chapter 9, Title 49, Idaho Code, and meets the federal motor vehicle safety and emission standards in effect for the model year and type of vehicle. (3-20-20)T

**306. -- 399. (RESERVED)**

**400. ABANDONED VEHICLES.**

Abandoned vehicles not claimed before the day of sale will be sold by the appropriate governmental entity if one exists. This regulation will not prevent governmental entities from entering into agreements with other governmental entities to conduct sales. (3-20-20)T

**401. GRAY MARKET VEHICLES.**

**01. Required Documents.** When the owner of a gray market vehicle applies for title and registration, the following documents must be presented. (3-20-20)T

**a.** Statement indemnifying the Department. (3-20-20)T

**b.** Statement of Facts from a motor vehicle investigator, unless waived by the Department based on facts presented by the owner. (3-20-20)T

**c.** All documents relating to ownership including but not limited to; manufacturer's certificate of origin, manufacturer's statement of origin, foreign title, or registration (if the vehicle is not from a titling country), and bills of sale. A complete chain of ownership must be presented from the manufacturer (for new vehicles) or from the last titled owner, or registered owner (if the vehicle is not from a titling country) to all subsequent owners of the vehicle both in the foreign market and the United States. (3-20-20)T

**d.** U.S. Department of Transportation bond release letter. (3-20-20)T

**e.** Environmental Protection Agency (EPA) bond release letter or Independent Commercial Importer (ICI) release letter or Designated Canadian Importer (DCI) release letter or EPA letter of waiver. (3-20-20)T

**02. Designation of Model Year.** The model year for titling and registering gray market vehicles will be determined in an order of priority, based on the following criteria: (3-20-20)T

**a.** The model year used by a specific manufacturer to designate a discrete vehicle model irrespective of the calendar year in which the vehicle was actually produced; (3-20-20)T

**b.** The model year shown on an ownership document issued by that vehicle's country of origin; (3-20-20)T

**c.** Any vehicle manufactured during a twelve (12) month period beginning September 1, and ending August 31, will bear the production year of the calendar year in which August 31 occurs; or (3-20-20)T

**d.** The model year by certification of the importer of record. The certification can be verified against vehicle production dates, based upon substantially similar models of the same make of vehicle. (3-20-20)T

**03. Foreign Documents.** When a foreign manufacturer's certificate of origin, manufacturer's statement of origin, or registration and/or titling documents are presented, a translation of the foreign documents may be required to clarify the information contained in the documents. If required, such translation will be at the owner's expense and certified by the translator as true and correct. (3-20-20)T

**04. Conditional Registration.** Until gray market vehicles meet Idaho registration and titling requirements, the county assessor will issue a conditional registration under the "Conditional Registration" program to allow time for the federal government to act upon the required releases or for the owner to obtain legal ownership documentation. (3-20-20)T

**05. Exception.** When the owner of a gray market vehicle has a current title issued by another state, the other requirements of Section 401 of this rule for title and registration will not apply unless the title carries the brand, "Gray Market Vehicle (not in compliance)" or another brand or notation indicating the vehicle was not brought into compliance with U.S. DOT and EPA requirements. If a gray market vehicle has a current title issued by another state

that carries the brand, “Gray Market Vehicle (not in compliance)” or another equivalent brand or notation and the other requirements of Section 401 of this rule have not been met, the vehicle cannot be registered and the owner may only receive an Idaho title issued with same or equivalent brand or notation. (3-20-20)T

**402. – 899. (RESERVED)**

**900. WAIVER OF TITLING REQUIREMENTS.**

**01. Purpose.** This rule specifies the circumstances under which a person or entity may waive the thirty (30) day requirement to apply for title to a vehicle which has been acquired by operation of law, and to provide that the person or entity, in lieu of having a certificate of title issued in the person’s name, may provide a bill of sale together with the court order or other instrument entitling the person or entity to the vehicle and any existing certificate of title, if available, to the buyer or transferee upon sale or transfer of the vehicle. (3-20-20)T

**02. Law Enforcement Agencies.** Vehicles awarded to law enforcement agencies through operations of law are not required to be titled if the vehicle is not to be put into service by the agency and is to be sold or transferred. In this case, the agency may provide a bill of sale to the purchaser together with a copy of the court order or other instrument awarding the vehicle to the agency, and any existing certificate of title, if available. (3-20-20)T

**03. Inheritance.** Vehicles coming into possession by inheritance will not be required to be titled in the name of the heir when the intent of the heir is not to use or register the vehicle, but to dispose of the vehicle to a transferee. Upon sale or transfer of the vehicle, the heir will provide a bill of sale to the purchaser or gift transfer affidavit to the transferee, together with an affidavit of inheritance or small estate affidavit and any existing certificate of title if available. (3-20-20)T

**901. – 999. (RESERVED)**

## 39.02.22 – RULES GOVERNING REGISTRATION AND PERMIT FEE ADMINISTRATION

### 000. LEGAL AUTHORITY.

This rule, governing registration and permit fee administration as provided for in Sections 49-434 and 49-439, Idaho Code, is adopted under authority of Section 49-201, Idaho Code. (3-20-20)T

### 001. TITLE AND SCOPE.

**01. Title.** This rule is titled IDAPA 39, Title 02, Chapter 22, “Rules Governing Registration and Permit Fee Administration.” (3-20-20)T

**02. Scope.** This rule clarifies the procedures for administering registration and permit fees. (3-20-20)T

### 002. -- 009. (RESERVED)

### 010. DEFINITIONS.

**01. Combination of Vehicles.** A tractor or truck tractor and one (1) or more trailers and/or semitrailers. (3-20-20)T

**02. Customer.** The individual or entity that is registering/permitting the vehicle. The following terms; customer, individual, company or registrant are interchangeable in this rule. (3-20-20)T

**03. Insufficient Funds (ISF).** ISF will be the abbreviation as it pertains to checks written on personal and/or business checking accounts without sufficient funds to cover the check, for payment to the department. (3-20-20)T

**04. Non-Reducible Load.** Defined in IDAPA 39.03.01, Rules Governing Definitions Regarding Special Permits. (3-20-20)T

**05. Probable Cause.** Information sufficient to create a reasonable belief that the registrant of a motor vehicle(s) has either not paid fees due or has under reported miles traveled or has underpaid fees due. (3-20-20)T

**06. Quarterly Report.** The form for registrants to report the laden miles traveled on Idaho highways during the preceding three (3) months when transporting non-reducible vehicles/loads under annual overweight/oversize permits. (3-20-20)T

**07. Revocation of Registration.** The termination of a registrant’s vehicle registrations and authority to operate on Idaho highways for failure to comply with requirements specified by the Department and Idaho Code. (3-20-20)T

**08. Registrant.** A person, firm, or corporation in whose name a vehicle or vehicles are registered, with an Idaho account number assigned by the department. (3-20-20)T

**09. Road Use Fee.** The fee per mile paid for non-reducible vehicles or combinations of vehicles hauling non-reducible loads. The fees are based on the number of axles on the vehicle or combination of vehicles and the total gross weight, in addition to the registration fee. (3-20-20)T

**10. Suspension of Registration.** The temporary withdrawal of a registrant’s vehicle registrations and authority to operate on Idaho highways for failure to comply with requirements specified by the department and Idaho Code. (3-20-20)T

**11. Third-Party Checks.** Checks payable to one entity, and endorsed over to another entity for payment. (3-20-20)T

### 011. -- 099. (RESERVED)

### 100. QUARTERLY ROAD USE FEE REPORTS FOR ANNUAL OVERWEIGHT PERMITS.

To comply with Section 49-1001, Idaho Code, the customer will make quarterly reports of laden only mileage to the department for the movements of non-reducible vehicle/loads, at the appropriate permitted weight level of the annual overweight/oversize permits. These fees are in addition to the registration fees required to be paid to the department. Mileage and road use fees for single trip overweight/oversize permits are calculated and collected at the time of issuance and are not reported quarterly. (3-20-20)T

**101. QUARTERLY ROAD USE FEE REPORTING.**

**01. Quarterly Reporting Forms Issued.** The department will generate an online quarterly report form for each valid annual overweight/oversize permit issued to them. Customers can choose to opt-in and receive a printed form via mail. (3-20-20)T

**02. Use of Quarterly Reporting Form.** The customer is required to report each quarter's information on the form provided online or on a Department printed copy that will be mailed on or before the due date specified on the quarterly report form, even when reporting zero (0) miles traveled. (3-20-20)T

**a.** If the customer does not receive a quarterly report form or report their information online, it is the customer's responsibility to notify the department allowing adequate time to submit the report before the due date. (3-20-20)T

**b.** Any report transmitted through the US Postal Service shall be considered filed and received by the department on the date shown by the post office cancellation mark stamped on the envelope or wrapper containing the report. A postage meter cancellation shall not be considered as a post office cancellation mark. (3-20-20)T

**c.** If the quarterly report form due date falls on a Saturday, Sunday, or legal holiday, the due date will be extended to the next business day. (3-20-20)T

**d.** Quarterly reports not submitted will result in the account being suspended. (3-20-20)T

**03. Information Required on the Quarterly Report Form.** Customers must report the following: (3-20-20)T

**a.** The number of laden miles traveled on Idaho highways when operating under an annual overweight/oversize permit with non-reducible vehicles and/or load that exceed eighty thousand (80,000) pounds and/or legal axle weights for the appropriate weight category for the quarter specified on the quarterly report form, rounded to the next full mile; and the road use fee due; and penalty, if the report is filed after the due date. (3-20-20)T

**b.** Total amount due. (3-20-20)T

**c.** Signature and title of company official, and date of report. All reports filed with the department must be signed by an authorized representative of the company/individual in order to be considered a valid report even if zero (0) miles are being reported. (3-20-20)T

**d.** Address change, if different from quarterly report form. (3-20-20)T

**e.** Customer telephone number (3-20-20)T

**102. -- 199. (RESERVED)**

**200. INSTALLMENT PAYMENTS FOR COMMERCIAL VEHICLE REGISTRATION.**  
The department offers a Payment Plan for registrants in compliance with Sections 49-434, Idaho Code. (3-20-20)T

**01. Requirements to Participate in Installment Payments.** (3-20-20)T

**a.** Participant must sign participation contract agreement. (3-20-20)T

**b.** Only Full Fee and Idaho IRP registration fees are included in the payment plan. Other jurisdictions' IRP fees shall not be included. (3-20-20)T

**c.** Only full annual registration fees shall be included in payment plan. Registrations for less than one full year shall not be included. (3-20-20)T



**d.** Vehicles not registered within thirty (30) days after the previous year registration has expired shall not be eligible for the installment payment option. Submitted applications for registration that have been invoiced, but not paid for, by the last day of the registration effective month shall not be eligible for the installment payment option. (3-20-20)T

**e.** Installment contract requirements do not provide opportunity for registrant to opt out of any remaining installment payments. The balance of the payment plan shall continue to be paid even if the truck is not being operated. (3-20-20)T

**f.** If registrant meets the criteria in Section 300 of this rule, the prorated portion of the Idaho fee shall be credited toward the installment plan or refunded if the plan has been paid in full. (3-20-20)T

**g.** Registrant shall not participate in installment payment plan if the registrant's account has previously been suspended as stated in Subsection 200.06 of this rule. (3-20-20)T

**h.** The contract shall stipulate the payment periods and the installment payment vouchers shall stipulate the due dates of each subsequent payment. (3-20-20)T

**i.** An installment payment plan fee of fifty dollars (\$50) shall be required and collected at the time of setup for each installment payment plan created. (3-20-20)T

**02. Billings, Payments and Due Dates of Installment Plan.** (3-20-20)T

**a.** The department shall upon acceptance of the contract by the registrant, receive one-quarter of the annual registration fee along with the installment payment plan fee, and then shall bill the registrant for three (3) equal installments based upon the previously set payment periods outlined in the contract, which are due by the end of the third, sixth, and ninth months after the effective date of the registration. (3-20-20)T

**b.** Installment payment vouchers will be provided with the initial invoice. (3-20-20)T

**c.** US Postal Service postmark shall be used to determine if payment is received on time. If the envelope is postmarked on or before the last day of the month, the payment shall be considered "on time." (3-20-20)T

**d.** If the last day of the month falls on a Saturday, Sunday or legal holiday, the next business day shall be considered the due date. (3-20-20)T

**e.** Failure to retain provided payment vouchers does not relieve the burden of the registrant to pay the installment amount by the due date. (3-20-20)T

**03. Failure to Pay Installment Payment by Due Date.** (3-20-20)T

**a.** The department shall send out courtesy pre-suspension notices approximately five (5) days after the due date to registrants who have failed to remit payment by the due date printed on the quarterly billing. (3-20-20)T

**b.** The pre-suspension letter shall contain a late penalty fee of ten percent (10%) of the amount due and an additional one percent (1%) for each month or portion of a month that the payment is past due. (3-20-20)T

**c.** Registrant shall pay installment amount portion that is due, plus assessed penalties and interest. (3-20-20)T

**04. Suspension of Registrant's Account Due to Non-Payment of Payment Plan.** Approximately two (2) weeks after pre-suspension notices are mailed to the registrant, the department shall suspend accounts of registrant's that have failed to remit installment payment and/or interest and penalty. (3-20-20)T

**05. Reinstatement Fee for Payment Plan Registration.** (3-20-20)T

**a.** A forty dollar (\$40) reinstatement fee shall be applied to all payment plan accounts that have been suspended. (3-20-20)T

**b.** Registrant must pay quarterly payment portion, penalty and interest, if applicable, and reinstatement fee before suspension shall be cleared from account. (3-20-20)T

**06. Repetitive Suspensions Result.** (3-20-20)T

**a.** After the registrant's account has been suspended for delinquent installment payments two (2) or more times, the registrant shall not be allowed to participate in future payment plan programs unless; (3-20-20)T

**i.** Customer has twelve (12) consecutive months of no suspensions related to the account starting from the month the account is cleared; and (3-20-20)T

**ii.** Customer requests in writing to the department to participate in future installment payment plans and will be allowed to do so. (3-20-20)T

**201. -- 299. (RESERVED)**

**300. REFUNDS.**

**01. Fees Eligible for Refund.** (3-20-20)T

**a.** Commercial vehicle registration is eligible for refund when the criteria in Section 49-434, Idaho Code, are met. (3-20-20)T

**b.** If account has been overpaid, and no other fees are owed to the department. (3-20-20)T

**c.** Unexpired portion of Idaho based fees are refundable for: (3-20-20)T

**i.** A vehicle that has been sold or repossessed; (3-20-20)T

**ii.** A vehicle that has been damaged beyond repair; or (3-20-20)T

**iii.** A vehicle on which the lease has been terminated. (3-20-20)T

**iv.** Other refund requests will be reviewed and approved or denied on a case by case basis. (3-20-20)T

**02. Fees Not Eligible for Refunds.** Other jurisdiction's fees are not refundable by Idaho. (3-20-20)T

**03. Request for Refunds:** (3-20-20)T

**a.** Registrant can make a request for refund of fees from the department. The refund request must include: (3-20-20)T

**i.** Proof of sale or repossession of the vehicle; (3-20-20)T

**ii.** Proof from the insurance company or law enforcement agency that the vehicle has been damaged beyond repair; or (3-20-20)T

**iii.** Proof of lease termination from the leasing company. (3-20-20)T

**b.** Request shall be subject to audit as provided in Idaho Code. (3-20-20)T

**c.** All refund requests shall be reviewed to ensure that all requests are valid and eligible. The Revenue Operations supervisor shall also approve/disapprove refunds. If the refund amount is greater than or equal to one thousand (\$1,000) dollars, a Financial Services manager shall also review and approve/disapprove the request before

refund is processed. (3-20-20)T

**d.** Approval/disapproval shall be indicated by either signature, or electronic approval by means of the department's financial management system. (3-20-20)T

**301. -- 599. (RESERVED)**

**600. INSUFFICIENT FUNDS.**

Insufficient Funds will be indicated by the abbreviation ISF. (3-20-20)T

**01. Payment With Insufficient Fund Check.** If a customer pays a fee by check and the check is returned to the department as ISF, the transaction will be cancelled. The department reserves the right to not accept checks from a customer who has written two (2) or more ISF checks within four (4) years to the department. That customer will have to pay with cash, or verifiable check, or credit card. (3-20-20)T

**02. Suspension of Account.** The department will suspend the customer's account until the customer has paid the amount of the ISF check, along with the twenty dollar (\$20) ISF fee. (3-20-20)T

**03. No Further Transactions.** The department will not complete further transactions with the customer until the customer has paid the amount of the ISF check along with the twenty dollar (\$20) ISF fee. (3-20-20)T

**601. ACCEPTANCE OF CHECKS.**

The department will accept personal checks as form of payment with sufficient proof of identification. If check payment is received by mail, the check will be accepted unless the customer has written two (2) or more ISF checks within four (4) years to the department, per Subsection 600.01 of this rule. (3-20-20)T

**602. CREDIT CARD PAYMENTS.**

The department will accept only Visa, Discover, American Express, or Mastercard for any fees due to or purchases from the department. (3-20-20)T

**603. -- 699. (RESERVED)**

**700. SUSPENSION OF REGISTRATION.**

The department shall suspend the vehicle registration(s) by notifying the registrant in writing sent via first class pre-paid mail to the registrant's last known address if: (3-20-20)T

**01. Failure to Comply.** The registrant fails to comply with a billing letter requesting payment of fees and penalties. (3-20-20)T

**02. Non-Filing by the Registrant.** The registrant does not file quarterly reports or make installment payments to the department. (3-20-20)T

**701. REVOCATION OF REGISTRATION.**

The department shall revoke the vehicle registration(s) if the registrant fails to comply with a suspension notice within fifteen (15) days of receipt of the notice. (3-20-20)T

**702. REQUIREMENTS FOR REINSTATEMENT OF REVOKED OR SUSPENDED VEHICLE REGISTRATION.**

**01. Revocation.** In the case of a revocation, a registrant must pay all fees due and a forty dollar (\$40) reinstatement fee to be reinstated and must also re-register to resume operating. (3-20-20)T

**02. Suspension.** In the case of a suspension all fees, reports, and records required prior to the suspension must be provided to the department, including a forty dollar (\$40) reinstatement fee. (3-20-20)T

**703. REQUIREMENTS FOR COLLECTIONS.**

All unpaid amounts owed to the department may be sent to an external collection agency. Collection agencies may charge a fee for their efforts in collection of a debt as per Section 67-2358, Idaho Code. Accounts that have been assigned to a collection agency must pay the collection agency all fees due. The department will not accept the payment once assigned to the collection agency. (3-20-20)T

**704. -- 799. (RESERVED)**

**800. ENFORCEMENT.**

**01. Delayed Movement.** If the registration of a vehicle is suspended the Ports of Entry shall delay movement of the vehicle until such time as the registrant complies with the condition(s) that caused the suspension. (3-20-20)T

**02. Revoked Registrations.** If a registrant's registrations are revoked for failure to respond to a suspension notice, the motor vehicle cannot be operated on Idaho highways until the registrant complies with Section 702 of this rule. Registrants with outstanding balances owed to the department or revoked registrations are not eligible to purchase trip permits. (3-20-20)T

**801. -- 899. (RESERVED)**

**900. APPEAL PROCEDURE.**

**01. Filing of Appeal.** A registrant wishing to contest a penalty or suspension of a registration or an account may file an appeal within ten (10) days of receipt of the notice. (3-20-20)T

**02. Delivery of Appeal.** The appeal must be either hand delivered or mailed to Compliance Manager, Idaho Transportation Department, P.O. Box 7129, Boise, Idaho 83707-1129. (3-20-20)T

**03. Delivery of Decision.** A copy of the final decision in response to the request will be sent to the registrant. (3-20-20)T

**901. -- 999. (RESERVED)**

**39.02.26 – RULES GOVERNING TEMPORARY VEHICLE CLEARANCE FOR CARRIERS**

**000. LEGAL AUTHORITY.**

This rule is adopted under the authority of Sections 49-201, 49-202, and 49-501, Idaho Code. (3-20-20)T

**001. TITLE AND SCOPE.**

**01. Title.** This rule is titled IDAPA 39.02.26, “Rules Governing Temporary Vehicle Clearance for Carriers,” IDAPA 39, Title 02, Chapter 26. (3-20-20)T

**02. Scope.** This rule provides for temporary vehicle clearance (TVC) procedures in Idaho, self issued by carriers or issued by the Department. (3-20-20)T

**002. -- 009. (RESERVED)**

**010. DEFINITIONS.**

**01. Carrier.** The person or company who is qualified for registration in Idaho, and whose vehicles are issued Temporary Vehicle Clearances. (3-20-20)T

**02. Temporary Vehicle Clearance (TVC).** Temporary clearance issued for immediate operation of a vehicle pending receipt of credentials. (3-20-20)T

**011. -- 099. (RESERVED)**

**100. ADMINISTRATION.**

Temporary Vehicle Clearances, valid for a maximum of forty-five (45) days or to the registration year expiration date, may be issued to a carrier whose account is in good standing. (3-20-20)T

**101. -- 199. (RESERVED)**

**200. ISSUANCE OF TVC.**

**01. Temporary Vehicle Clearances.** Carriers may request temporary vehicle clearances online, from the department or an Idaho port of entry. Fees are payable when the clearance is issued. (3-20-20)T

**201. ISSUANCE OF VEHICLE REGISTRATION (CAB CARD) AND LICENSE PLATE(S).**

**01. Issuance of Vehicle Registration & License Plate(s).** The vehicle registration and license plate(s) may be issued when: (3-20-20)T

**a.** The online application is received by the Department and all licensing requirements are met; (3-20-20)T

**b.** The carrier submits a copy of an Idaho title or title receipt showing that the vehicle is titled in the owners name; (3-20-20)T

**02. Permanent Identification.** When all criteria are met, a registration and a validation plate and/or sticker will be issued. (3-20-20)T

**202. -- 299. (RESERVED)**

**300. COST AND PAYMENT.**

The fee for temporary vehicle clearances issued via facsimile transceiver equipment or self issued by the carrier is eighteen dollars (\$18) per clearance, payable in advance by the carrier. (3-20-20)T

**301. -- 999. (RESERVED)**

**39.02.41 – RULES GOVERNING SPECIAL PROVISIONS APPLICABLE TO FEES FOR SERVICES**

**000. LEGAL AUTHORITY.**

This rule is adopted under the authority of Sections 49-201, Idaho Code. (3-20-20)T

**001. TITLE AND SCOPE.**

This rule is titled IDAPA 39.02.41, “Rules Governing Special Provisions Applicable to Fees for Services,” and identifies special provisions applicable to fees for services not specifically outlined in Title 49, Idaho Code. (3-20-20)T

**002. -- 099. (RESERVED)**

**100. ADMINISTRATION.**

Idaho Code provides for the collection of fees for related services. This rule provides for automation considerations and a fee schedule to uniformly apply the fee provided by Section 49-202(2)(h), Idaho Code. The following fees apply for services and copies of files regarding motor vehicle or other registrations, motor vehicle titles, driver’s licenses or commercial driver’s licenses, and are based on the per hour charge specified in Section 49-202(2)(h), Idaho Code. (3-20-20)T

**01. Paper or Imaged Records.** Copies of supporting driver’s license, registration, or title records from paper or imaged records, based on an average of twenty-four (24) minutes to fully process these requests at the per-hour rate specified in Section 49-202(2)(h), Idaho Code, and rounded to the nearest whole dollar. (3-20-20)T

**02. Automated Records.** Idaho Code does not provide a fee for complete county or statewide automated copies of registration or title files. A fee has been based on the costs to produce special file requests. (3-20-20)T

**a.** A base charge for programs requiring: One (1) to three (3) sorts, seventy-five dollars (\$75). Each additional sort, twenty-five (\$25). (3-20-20)T

**b.** In addition to the above, the computer cost, printer cost and tape access cost, as established by the information technology section will be charged. (3-20-20)T

**c.** Any mailing, shipping or special handling costs will also be added to the charges. (3-20-20)T

**03. Electronic Media Must Be Provided.** Requestors must provide electronic media for this purpose, unless the file can be transmitted electronically. Data is provided in a standard department format. Vehicle or driver history information is not included. The only selection criterion is by counties. (3-20-20)T

**04. Records Provided Free of Charge.** Motor vehicle and driver records will be provided free of charge to the following: (3-20-20)T

**a.** State Agencies. (3-20-20)T

**b.** County Assessors. (3-20-20)T

**c.** County Sheriffs. (3-20-20)T

**d.** Peace Officers requesting records in the performance of their duties as per Section 49-202(3), Idaho Code. (3-20-20)T

**05. Rules for Providing Records Free of Charge.** The Division of Motor Vehicles will observe the following guidelines when providing records free of charge: (3-20-20)T

**a.** Records will be provided free of charge only if they are a standard computer run that does not require special programming and/or sorting. Records requiring special handling will be provided for a fee equal to the cost of the additional handling. (3-20-20)T

**b.** Records will be provided free of charge electronically or on electronic media supplied by the requestor, or as a standard computer printout. All other formats will be provided for a fee equal to the cost of the additional materials. (3-20-20)T

**c.** The Assessor’s Clearinghouse and the Sheriff’s Clearinghouse shall each establish a single

standardized computer printout that will be used for all motor vehicle and driver requests from their respective agencies. (3-20-20)T

**d.** Records access agreements between the Division of Motor Vehicles and government agencies requesting motor vehicle and driver records shall be negotiated and renewed annually, and shall contain a list of all personnel who will have access to the records and/or on-line terminals. (3-20-20)T

**e.** On-line computer installation and equipment shall be charged at a rate defined in the annual agreement. (3-20-20)T

**101. -- 199. (RESERVED)**

**200. LAW ENFORCEMENT INQUIRIES.**

The Department provides full access to motor vehicle files by Law Enforcement at no charge through the Idaho Law Enforcement Telecommunication Systems (ILETS). There is also no charge to Law Enforcement for certified motor vehicle or driver record packets to peace officers. For additional services beyond access to motor vehicle records (special reports, etc...), actual costs incurred by the Department will be charged. (3-20-20)T

**201. JURY LISTS.**

Idaho Code provides for the use of motor vehicle records for jury lists. The Department does not charge the counties for this use. (3-20-20)T

**202. SPECIAL AGREEMENTS.**

**01. Agreements for Services.** The Department may enter into agreements for services and copies of motor vehicle files to requestors with special highway safety and statistical reporting requirements. Initial costs incurred by the Department shall be reimbursed by the requestor. Ongoing charges or fees will be based on the agreement. (3-20-20)T

**02. Right to Receive Information Subject to Idaho Code.** This rule is not intended to imply that a requestor has the right to receive information. The fees, as stipulated in this rule, apply when the requestor is eligible to receive the information, subject to Idaho Code. (3-20-20)T

**203. MISCELLANEOUS.**

The fee for vehicle inquiries by name will be based on the proper fee per vehicle record. Commercial vehicle inquiries shall be based on a per vehicle record fee. (3-20-20)T

**204. -- 999. (RESERVED)**

## 39.02.60 – RULES GOVERNING LICENSE PLATE PROVISIONS

### 000. LEGAL AUTHORITY.

This rule, establishing the policies used to administer Idaho's standard and specialized license plate programs, is adopted under the authority of Section 49-201, Idaho Code. (3-20-20)T

### 001. TITLE AND SCOPE.

**01. Title.** These rules are titled IDAPA 39.02.60 "Rules Governing License Plate Provisions." (3-20-20)T

**02. Scope.** This rule governs license plate provisions for standard license plates not otherwise detailed in Title 49, Idaho Code, and provisions for all specialty program license plates, personalized plates, and special eligibility plates. Subchapter A further establishes provisions for administering the exempt and undercover license plate programs not otherwise detailed in Title 49, Chapter 4, Idaho Code. (3-20-20)T

### 002. -- 009. (RESERVED)

### 010. DEFINITIONS.

**01. Authorized Employees.** Authorized employee as used in this rule means any non-salesperson or employee who is paid compensation for a minimum of thirty (30) hours each week, and appears on the records of the employer as an employee for which social security, income tax, and all deductions required by law have been made. (3-20-20)T

**02. Exempt License Plate.** Standard license plate issued to the entities described in Section 49-426(1), Idaho Code, which are exempt from payment of vehicle operating fees. (3-20-20)T

**03. Exempt Personalized License Plate.** An exempt plate which identifies the agency by a unique identifier specified by the agency that does not conform to the standard exempt identifier listed in Section 400; a plate wherein the serial number portion represents inventory control numbers, badge numbers, radio call signs, or other unique lettering or numbering schemes developed by the requesting agency; plates that are lettered and/or numbered to indicate a person's position in the hierarchy of an agency. (3-20-20)T

**04. Furtherance or Pursuance of Business.** Furtherance or pursuance of business as used in this rule or in Section 49-1627, Idaho Code, means any lawful use of a dealer or loaner plate by an authorized employee of a dealership for the movement of a vehicle to be sold, repaired or transferred from one (1) location to another. (3-20-20)T

**05. Leased or Rented Vehicles.** Leased or rented vehicles owned by the licensed dealer as used in Section 49-1627, Idaho Code, means vehicles titled in the name of the dealership which are leased or rented on a contractual basis to the public. (3-20-20)T

**06. Undercover License Plate.** A standard license plate issued upon application to the Department from an exempt agency with law enforcement authority. Undercover license plates will be randomly issued by the Department, and appear as a standard county plate. (3-20-20)T

**07. Vehicles Not Held in Stock.** Vehicles not held in stock for sale as used in Section 49-1627, Idaho Code, means vehicles titled in the name of the dealership or vehicles which cannot be titled or for which the dealership does not hold title. (3-20-20)T

**08. Vehicles Sold.** Vehicles which have been sold as used in Section 49-1627, Idaho Code, means vehicles for which a dealer has a signed contract of sale or other vehicles not belonging to the dealership. (3-20-20)T

### 011. LICENSE PLATE PROVISIONS FOR ALL LICENSE PLATES.

**01. Plate Numbering and Lettering.** The Idaho Transportation Department is authorized to assign unique plate letter/number spacing schemes and to use specific letter/number combination schemes as needed for the purpose of ensuring unique numbering systems for all license plate programs and to administer the provisions of this rule. (3-20-20)T

**02. Plate Life Expiration Date.** License plates will be valid for the period described in 49-443 (2) and will expire on the last day of the month, consistent with the month of the registration expiration. (3-20-20)T



**012. PROOF OF REGISTRATION FOR NEW, REPLACEMENT, OR REISSUED LICENSE PLATES.**

**01. Proof of Registration Document.** Upon receipt of payment for required registration and program fees proof of registration receipt document may be issued, indicating “license plates on order.” This option will be used whenever license plates are manufactured after the registration transaction has been completed. The proof of registration receipt document will provide proof that the vehicle has been registered and fees have been paid, and the vehicle may be operated until new plates have been received by the registrant. At the discretion of the Department, more than one (1) proof of registration may be issued, if needed, in order to manufacture license plates. (3-20-20)T

**02. Placement of Proof of Registration Document.** The proof of registration receipt document will be displayed in the rear window or on the rear of the vehicle for which it is issued in a manner that is readily legible for a distance of twenty five (25) feet and will be legible throughout the duration of the permit. When issued to a convertible, motorcycle, or other vehicle in which it is not possible to display in the rear window, the proof of registration must be conspicuously displayed where the expiration date of the newly issued plate may be easily read at a distance of twenty five (25) feet, and where it is protected from exposure to weather conditions, which would render it illegible. (3-20-20)T

**03. Issuance of Manually Completed Temporary Registrations When Automated System is Unavailable.** Upon receipt of payment for required registration and program fees, the county may issue a manual temporary registration valid for thirty (30) days, through use of a temporary form provided by the Department, in the event the automated system is unavailable. When the system resumes normal operation, the county office will enter such registration information in the system, and produce the registration form and validation decals and mail to the registered applicant. The manual temporary registration form will be displayed in the rear window of the vehicle for which it is issued in a manner that is readily legible for a distance of twenty five (25) feet and will be legible throughout the duration of the permit. When issued to a convertible, motorcycle, or other vehicle in which it is not possible to display in the rear window, the temporary registration must be conspicuously displayed where the expiration date of the permit may be easily read at a distance of twenty five (25) feet, and where it is protected from exposure to weather conditions, which would render it illegible. (3-20-20)T

**013. -- 099. (RESERVED)**

**100. LICENSE PLATE PROVISIONS FOR STANDARD PLATES.**

**01. County Designations.** The county in which a vehicle is registered will be designated by a number and letter on license plates for passenger cars, pick-up trucks eight thousand (8,000) pounds and under gross weight, hearses, ambulances, wreckers, farm vehicles between eight thousand one (8,001) and sixty thousand (60,000) pounds gross weight, and recreational trailers. The county designators are as follows:

<b>County Designations</b>			
1A - Ada	2A - Adams	1B - Bannock	2B - Bear Lake
3B - Benewah	4B - Bingham	5B - Blaine	6B - Boise
7B - Bonner	8B - Bonneville	9B - Boundary	10B - Butte
1C - Camas	2C - Canyon	3C - Caribou	4C - Cassia
5C - Clark	6C - Clearwater	7C - Custer	E - Elmore
1F - Franklin	2F - Fremont	1G - Gem	2G - Gooding
I - Idaho	1J - Jefferson	2J - Jerome	K - Kootenai
1L - Latah	2L - Lemhi	3L - Lewis	4L - Lincoln
1M - Madison	2M - Minidoka	N - Nez Perce	1O - Oneida
2O - Owyhee	1P - Payette	2P - Power	S - Shoshone
1T - Teton	2T - Twin Falls	V - Valley	W - Washington

(3-20-20)T

**02. Designation for Farm Vehicles.** License plates for farm vehicles between eight thousand one (8,001) and sixty thousand (60,000) pounds gross weight will have the county designator, then a unique serial number followed by the letter "T". (3-20-20)T

**03. Designation for Recreational Vehicles.** License plates for recreational trailers will have the county designator, then a unique serial number followed by the letter "R". (3-20-20)T

**04. Designations for Motor Homes.** License plates for motor homes will have the county designator, then a unique serial number followed by the letter "M". (3-20-20)T

**101. LICENSE PLATE PROVISIONS FOR RESTRICTED VEHICLE PLATES.**

Per Section 49-402 (4), Idaho Code, the Idaho Transportation Department will provide restricted vehicle plates for issuance to all-terrain vehicles, utility type vehicles, and motorbikes. Idaho Transportation Department will provide these plates to county DMV offices and to the Idaho Department of Parks and Recreation (if needed). Per Section 49-443(1), Idaho Code, such plates will be four inch by seven inch (4" x 7") plates, be printed with a combination of letters and numbers as determined by the department, and be printed in black on a white reflective background. Plates will be printed with "Idaho Restricted Vehicle" on the top and no other inscription. The plate will also have a decal placed in the lower left-hand corner indicating the year it is required to be re-placed. The plate will not be valid without the registration sticker, issued pursuant to Section 67-7122, Idaho Code, affixed to the lower right-hand corner of the plate. Idaho restricted vehicle plates may not be personalized. (3-20-20)T

**102. -- 149. (RESERVED)**

**150. VEHICLE DEALER LICENSE PLATES FORMATS.**

**01. Designation for Manufacturers Plates.** Plates issued to manufacturers will bear the designation "MFR" and be numbered from nine thousand (9000) through nine thousand, nine hundred, ninety-nine (9999). (3-20-20)T

**02. Designation for Dealer Plates.** Plates issued to dealers will bear the designation "DLR" and the sequential license plate number will be a maximum of two (2) digits. (3-20-20)T

**a.** If a dealer is issued more than ninety-nine (99) plates, an alpha character will be placed in the first position, followed by a number. (3-20-20)T

**b.** The dealer number will be a maximum of four (4) digits. No dealer number may be preceded by a zero (0): Dealer number one (1), plate number one (1): 1-01; Dealer number one thousand one (1001), plate number one hundred (100): 1001-A1. (3-20-20)T

**c.** Dealer restricted vehicle plates will display the abbreviation "DLR" within the lower left hand box labeled "Restricted Vehicle". The dealer validation sticker will be displayed within the box labeled "Dealer Validation Sticker". (3-20-20)T

**151. VEHICLE DEALER LICENSE PLATES RESTRICTIONS.**

**01. Restrictions.** Restrictions on the use of manufacturer or dealer plates are provided for by Section 49-1627, Idaho Code. In addition, the following restrictions apply: (3-20-20)T

**a.** Authorized employees may operate vehicles displaying dealer plates only when operated in the furtherance of the dealer's business. The authorized employee must carry an identification card issued by the dealer. The identification card will contain the employee name, dealership, date of issue, dealer number and signature of an authorized representative of the dealership and the signature of the employee. This use will be limited to normal business hours unless the operator is in possession of a letter from the dealer listing the specific reason for the after-hour use. (3-20-20)T

**b.** A manufacturer will not display manufacturer plates on vehicle types other than those manufactured by the manufacturer. (3-20-20)T

**c.** A new or used motorcycle dealer will not display motorcycle dealer plates on other vehicle types nor on a new motorcycle that the dealer is not enfranchised to sell. (3-20-20)T

**d.** A new vehicle dealer will not display new vehicle dealer plates on new vehicles that the dealer is not enfranchised to sell. (3-20-20)T

**e.** A new or used motorbike, all terrain vehicle, or utility vehicle dealer will not display dealer restricted vehicle plates on other vehicle types nor on any new motorbike, all terrain vehicle, or utility vehicle that the dealer is not enfranchised to sell. (3-20-20)T

**f.** Vehicles displaying a dealer restricted vehicle plate are not required to display the Idaho Department of Parks and Recreation Off-highway registration to be valid, but are required to be validated in the same manner as are standard dealer plates and display the required annual validation sticker on the restricted plate. Use will be permitted pursuant to Section 49-426 (3) and (4), Idaho Code. (3-20-20)T

**g.** A prospective purchaser will not have in his possession a vehicle belonging to a dealership after normal business hours without a letter of authority from the dealership. (3-20-20)T

**h.** A dealer or manufacturer will not display a dealer plate for purposes other than provided for by law or regulation. (3-20-20)T

**02. Penalties.** In addition to the penalties for violation of plate use provided for in Section 49-236, Idaho Code, a dealer or manufacturer may have his license to do business in Idaho suspended for a period not less than fifteen (15) days nor more than thirty (30) days. (3-20-20)T

**152. VEHICLE DEALER LOANER PLATES.**

**01. Numbering.** Plates will be numbered from LAA001 to LZZ999. (3-20-20)T

**02. Surrender of Plates.** If the dealership license becomes invalid, the dealer must surrender the registration and loaner plates that have been issued. There will be no refund of fees. (3-20-20)T

**03. Vehicle Log.** Dealerships will maintain a vehicle log of each vehicle on which a loaner plate is displayed. The log will be available for inspection by any peace officer or agent of the Department and contain the: (3-20-20)T

**a.** Vehicle Identification Number (VIN) or dealership stock number if such stock number can be traced to the vehicle's VIN; (3-20-20)T

**b.** Date(s) the plates were displayed on a vehicle; (3-20-20)T

**c.** Number printed on the plate displayed; (3-20-20)T

**d.** Name of person authorized to use the plate; and (3-20-20)T

**e.** Purpose for which vehicle was used. (3-20-20)T

**04. Identification Card.** The Department will provide an identification card, (registration) for each plate showing the: (3-20-20)T

**a.** Dealership name and address; (3-20-20)T

**b.** Number printed on the plate; (3-20-20)T

- c. Calendar year for which the registration is valid; (3-20-20)T
- d. Dealer number; (3-20-20)T
- e. Date of issue; and (3-20-20)T
- f. A place for the dealer's signature. (3-20-20)T

**05. Letter of Authorization.** Persons using the plate on loaner vehicles while waiting for their own vehicle to be repaired will have in their possession a letter of authorization or a document showing both the user and dealership name. The document or letter must be signed and dated by an authorized employee of the dealership. (3-20-20)T

**06. Vehicle Use Donation for Civic and Charitable Events.** Licensed dealers may authorize the use of their loaner plates when donating the use of vehicles held in their inventory for civic or charitable events. Such time period will not exceed thirty (30) days. The dealer will provide a letter of authorization to be carried in the vehicle and proof of current liability insurance, as required by Chapter 12, Title 49, Idaho Code. (3-20-20)T

**07. User Fee.** The dealer may charge the user a fee for vehicles held in stock for sale and provided to a customer of a dealership while the customer's vehicle is being repaired. (3-20-20)T

**08. Fees.** The fees charged for dealer loaner plates will be the same as the fees required by Section 49-402, Idaho Code, for new vehicles, and will be in addition to the current Emergency Medical Service (EMS) and plate fees. Applicants for new loaner plates received after January 1 will be charged one-twelfth (1/12) the annual fee required for a new vehicle for each month remaining in the licensing year, including the month of application. The annual EMS and plate fees are not prorated. (3-20-20)T

### **153. VEHICLE DEALER TRANSPORTER REGISTRATION AND PLATE.**

**01. Purpose.** Utility and boat trailers that weigh under two thousand (2,000) pounds unladen may be moved by a manufacturer, dealer, or an employee of either, or by a transporter service contracted by the vehicle's manufacturer or dealer upon registration and payment of an annual fifteen dollar (\$15) transporter plate fee to the department, or by purchase of a single trip permit. These plates may be used only on boat trailers and utility trailers for demonstration purposes, and may be used while laden for demonstration purposes. (3-20-20)T

**02. Numbering of Plates.** Transporter plates will be numbered from PA1 TO PZ9999. Transporter plates are required to be displayed on the rear of the trailer. (3-20-20)T

**03. Renewal of Plates.** The transporter registration and plate are valid for one (1) year from January 1 through December 31 and may be renewed by use of a registration sticker showing the year of validation. (3-20-20)T

**04. Use of Plates.** Transporter plates may be moved by registrants from one (1) utility or boat trailer weighing under two thousand (2,000) pounds unladen to another trailer meeting this criteria during the current registration period. Vehicles towing a laden trailer displaying a transporter plate must be registered within the appropriate gross vehicle weight category for the combined load. (3-20-20)T

**05. Possession of Registration.** When transporting a vehicle displaying a transporter plate, the operator of a towing vehicle will carry the transporter registration in the towing vehicle at all times. (3-20-20)T

**06. Violations.** Violations of this section include: (3-20-20)T

- a. Display of a transporter plate on any vehicle not required to be registered under this Section; and (3-20-20)T
- b. Display of a transporter plate on a vehicle not lawfully under the control of the registration holder. (3-20-20)T

**07. Penalties:** (3-20-20)T

**a.** Violation of this section will be a misdemeanor as provided for by Section 49-236, Idaho Code; and (3-20-20)T

**b.** The plate and registration of anyone who displays a transporter plate other than provided for by this section may be canceled. (3-20-20)T

**154. PROVISIONS FOR WRECKER PLATES.**

**01. Purpose.** Wrecker plates are for the exclusive use of businesses engaged in the towing of a wrecked, abandoned, salvaged, or disabled motorized vehicle. Plates will not be used on vehicles being repossessed. (3-20-20)T

**02. Numbering of Plates.** Plates will be numbered as determined by the department and will display the abbreviation "WRKR" vertically on the left hand side of the plate. (3-20-20)T

**03. Renewal of Plates.** The wrecker registration and plate are valid for one (1) year from January 1 through December 31 and may be renewed by use of a registration sticker showing the year of validation. (3-20-20)T

**04. Use of Plates.** Plates are not to be displayed on the towing power unit vehicle nor are they to be used on a vehicle not being towed. Plates are to be displayed on the rear of the towed vehicle in such a manner as to be visible to vehicles approaching from the rear. Wrecker plates may be moved from one (1) towed motorized vehicle to another vehicle under the direct lawful control of the registration holder. (3-20-20)T

**05. Possession of Registration.** When towing a motorized vehicle displaying a wrecker plate, the operator of the towing vehicle will carry the wrecker plate registration in the towing vehicle. (3-20-20)T

**06. Acquisition/Renewal of Wrecker Plates.** Wrecker plates will be issued and renewed through the department by mail or by fax using an application and renewal process determined by the department. (3-20-20)T

**155. PROVISIONS FOR SPECIAL LICENSE PLATE PROGRAM PREQUALIFICATION AND APPLICATION PROCEDURES.**

**01. Special License Plate Prequalification.** Anyone desiring legislation to establish a Special License Plate Program may make application to the Department on a Special Plate Program application form designed and provided by the Department. If all the prequalification requirements are met by the submission of other documentation, this will also be acceptable. A Special Plate Program Development Guide will also be provided to each applicant, detailing the procedures for the prequalification and application and providing information regarding the steps required to successfully accomplish a special plate program from prequalification through passage of the legislation, statutory requirements and standards for the plate color and license plate design. (3-20-20)T

**02. Special License Plate Approved by the Legislature.** If a special license plate program is approved by the Idaho legislature, prior to production and sale of the special license plates, the sponsor will be meet the requirements outlined in Subsection 155.03 of this rule. (3-20-20)T

**03. Special Plate Requirements:** (3-20-20)T

**a.** The individual responsible for representing the agency requesting the prequalification/application procedure will complete and sign a Special Plate Program application form that will contain a declaration of the responsible individual for certifying compliance with the requirements to the Department. (3-20-20)T

**b.** Responsible individual representing the agency will submit a financial plan detailing the use for the proceeds from the special plate sales. (3-20-20)T

**c.** For non-profit agencies, the responsible individual will provide evidence that the applicant has had 501 (c) Federal Income Tax status for at least two (2) years. (3-20-20)T

**04. Special License Plate Program Application Approval:** (3-20-20)T

**a.** Upon approval of application by Department, applicant will, by September 1, deposit programming and administration fees determined by an estimate of projected programming hours required. One thousand dollars (\$1,000) of this fee will not be refundable. (3-20-20)T

**b.** Applicant will complete and submit a list of two hundred fifty (250) applicants, currently registered in Idaho, who intend to purchase the Specialty License Plates when available. The form may be delivered to the Department by mail or electronic means such as e-mail or facsimile. (3-20-20)T

**05. Submission to the Legislature.** (3-20-20)T

**a.** For those desiring legislation, when all requirements have been met, the Department will forward the completed application to the chairmen of the Transportation and Defense Committees of the Senate and the House of Representatives for consideration in the next Legislative Session. This submission will be on a form developed by the Department or other documentation that meets all the requirements listed in this rule. (3-20-20)T

**b.** For those Special License Plate Programs with enacting legislation that fail to meet the requirements of this Section, the Department will report such finding to the chairmen of the Transportation and Defense Committees of the Idaho State Senate and the House of Representatives, and will not proceed with production and sale of the special plates. (3-20-20)T

**06. Annual Report.** An annual report form, designed and provided by the Department, will be made available to special license plate sponsors. The report will require an accounting of revenues and expenditures associated with the funds collected for the special license plate program. The report will be completed and submitted to the Department by January 1 so that by January 15 of each year the Department has the necessary data compiled and the required information forwarded to the chairmen of the Transportation and Defense Committees of the Idaho State Senate and the House of Representatives. If the agency fails to provide the required report, the Department will suspend special license plate sales for that program until the accounting is provided. Military License Plate programs will not be included in this requirement. (3-20-20)T

**07. Appeals.** The appeals process will allow the applicant for a special license plate program to appeal the Department's decision to deny the application (See Section 003 of this rule). The notice of the appeal will be sent in writing via mail, electronic mail or facsimile within twenty (20) days of the denial. (3-20-20)T

**156. -- 198. (RESERVED)**

**199. LICENSE PLATE PROVISIONS FOR SPECIAL PROGRAM AND PERSONALIZED PLATES FOR TRAILERS.**

Special program and personalized plates may be issued to trailers manufactured primarily for recreational vehicle uses. Such trailers will include camper, tent or fifth-wheel recreational trailers. Trailers with multiple uses such as utility, horse, or boat, with or without recreational vehicle facilities, will be excluded. (3-20-20)T

**200. LICENSE PLATE PROVISIONS FOR SPECIAL PLATES.**

**01. Year of Manufacture Plates.** (3-20-20)T

**a.** Owners of vehicles manufactured up through 1974, excluding model years 1969, 1971, 1972, and 1973, but including and ending with model year 1974, may apply for the renewal and use of previously canceled Idaho license plates which were originally issued to the same category of vehicle, where the year designation of the plate matches the year of manufacture of a motor vehicle. (3-20-20)T

**b.** The license plate must be in serviceable condition as originally manufactured, i.e., cannot be marred, bent, faded, or otherwise damaged to the point it is illegible. If the plate is repainted to bring it to a serviceable condition, the colors will match the original colors as closely as possible and will equal or exceed the original quality. The plate number cannot be a duplicate of a previously manufactured "year of manufacture" plate

still in use. (3-20-20)T

**c.** The application for use of the plate will include a statement signed by the applicant attesting that the applicant understands, if the plate use is approved, the plate does not have reflectorized material which meets the requirements of Section 49-443, Idaho Code. The responsibility for any accident or injury arising out of the possible consequence of not having this reflectorized safety feature on the license plate will be borne by the registrant. (3-20-20)T

**d.** “Classic” or “Old Timer” plates may be used in conjunction with this revived plate at the option of the registrant. (3-20-20)T

**02. Centennial License Plates.** Personalized and regular number plates are available in the centennial format. (3-20-20)T

**03. Disabled Veteran License Plates.** Disabled veteran license plates may, upon the registrant's request, display the international disability symbol to ensure reciprocal parking privileges in all states and provinces. (3-20-20)T

## **201. PROVISIONS FOR LEGISLATIVE LICENSE PLATES.**

**01. Option to Apply.** Members of the Idaho Legislature have the option of applying to the Department's Special Plates Unit for one (1) set of specially numbered license plates bearing the designation “HOUSE” or “SENATE.” (3-20-20)T

**02. Numbering Assignment List.** On or before June 15 each year, the Department will request from the Speaker and Pro Tem a current list of license numbers assigned to all legislators. The Department will request that these lists be returned by September 1 or, in an election year, within fifteen (15) days after the election. (3-20-20)T

**03. Plate Availability.** Upon receipt of the lists, the Department will ensure that a complete set of special legislative license plates will be available for each legislator. (3-20-20)T

## **202. PROVISIONS FOR PERSONALIZED LICENSE PLATES.**

**01. Special Characters or Marks.** No special characters, or punctuation marks, may be used for personalized messages on license plates. (3-20-20)T

**a.** Up to seven (7) letters or any combination of seven (7) letters and numbers and spaces (no half spaces) may be used for personalized messages on eligible six inch by twelve inch (6” x 12”) license plates. (3-20-20)T

**b.** Up to six (6) letters or any combination of six (6) letters and numbers and spaces (no half spaces) may be used for personalized messages on four inch by seven inch (4” x 7”) motorcycle plates. (3-20-20)T

**c.** Up to six (6) letters or any combination of six (6) letters and numbers and spaces (no half spaces) may be used for personalized messages on specialty program license plates. (3-20-20)T

**d.** Disability six inch by twelve inch (6” x 12”) plates will display the international disability symbol followed by up to five (5) letters, numbers, and spaces in the personalized message. Disability four inch by seven inch (4” x 7”) motorcycle plates will display the international disability symbol followed by up to four (4) letters, numbers, and spaces (no half spaces) in the personalized message. (3-20-20)T

**02. Issue of Personalized Plates.** Personalized plates may be issued to vehicles if no specific wording is required on the plate to identify the purpose for which the vehicle is registered. Personalized plates will not be issued if such plates would jeopardize the integrity of unique plate identification requirements. Examples include but are not limited to: (3-20-20)T

**a.** Commercial vehicles registered under the International Registration Plan (IRP), because the

designators PRP are required to be printed on the plate; (3-20-20)T

and **b.** Vehicles for which the designators “PRP” are required to be printed on the plate to identify the use; (3-20-20)T

**c.** Utility, horse, or enclosed car hauling trailers with RV facilities or boat trailers. (3-20-20)T

**03. Specific Requests.** Requests for specific plate letters and/or numbers will be issued on a first come, first served basis. In the event of a request for the same plate by more than one (1) individual, the request with the earliest postmark, e-mail transmission time, or fax transmission time will prevail. If the postmarks are the same, the date stamped upon arrival at the Department will prevail. Applications submitted at county assessors’ offices will be considered valid when date stamped in by the Department. Telephone requests will not be accepted. (3-20-20)T

**04. Lack of Current Plates.** When an applicant for personalized plates does not have current regular number plates: (3-20-20)T

**a.** The Department may issue a thirty (30) day temporary registration to allow time for the billing process for personalized plates. The fee for each thirty (30) day temporary registration will be as required by Section 49-523, Idaho Code. (3-20-20)T

**b.** The Department may, upon payment of all required fees, issue a proof of registration document as provided in Section 012 of these rules. (3-20-20)T

**05. Credits.** When personalized plates are issued before an applicant’s current registration is expired, credit will be given for unexpired registration fees only. (3-20-20)T

**06. Renewing Plates.** The applicant will have the choice of renewing existing personalized plates with validation stickers or ordering a new set of plates at the time of renewal. If new plates are requested, the plate fee will be charged in addition to all other fees that are due. New plates must be purchased every seven (7) years as provided in Section 49-443, Idaho Code. (3-20-20)T

**07. Transfer of Plates.** When personalized plates are issued, the vehicle’s regular number plates may be transferred to another vehicle belonging to the owner. If registration credit is given from the regular number plates to the personalized, the regular number plate registration is canceled. (3-20-20)T

**08. Acceptability of Plates Message.** Acceptability of the personalized license plate message and issuance, denial or cancellation will be determined by the Department based on the following criteria: (3-20-20)T

**a.** The combination of numbers and letters requested or combinations of same may not duplicate an existing combination in use, with the following exception. A duplication is allowed only when the combination of numbers and letters requested is the same on a small (ie: motorcycle sized plate) and a large (ie: passenger car) sized plate. (3-20-20)T

**b.** The message, in any language, may not carry a sexual connotation nor consist of a term that is considered to be one of obscenity, contempt, prejudice, hostility, insult, racial degradation, ethnic degradation, or profanity, or vulgarity, as defined in dictionaries of general use, including, but not limited to, Webster’s Unabridged Dictionary and the Harper & Row New Dictionary of American Slang. (3-20-20)T

**i.** The message may not refer to any of the following: bodily functions, bodily fluids, or intimate body parts; sexual preference or orientation; acts of violence; illegal substances or the use thereof. (3-20-20)T

**ii.** The message may not represent a club, membership, or gang that is commonly known to promote violence, illegal substances or illegal acts. (3-20-20)T

**c.** The criteria in Paragraph 202.08.b. of these rules is not to be considered an exhaustive list. A compilation of offensive or obscene words, terms or letter/number combinations gathered from the experience of Idaho and other states may also be used as a guide. The Department may also rely on information obtained from law



enforcement agencies within or outside of Idaho. (3-20-20)T

**d.** When a complaint is received from the public concerning an issued plate, the name of the complainant will not be recorded nor, if known, revealed. (3-20-20)T

**e.** Final determination regarding applications for questionable messages or cancellation of issued plates will be made by the Division of Motor Vehicles. The determination process will include a first review by technical staff, followed by a second review by supervisory and management staff. An applicant does, however, have a right to a hearing on the decision. (3-20-20)T

**09. Message Preferences.** Applicants may submit three (3) message preferences including the specific meaning of each. The first choice that is available and acceptable will be issued. If none of the preferences are available or acceptable, the applicant will be notified by return mail or email. (3-20-20)T

**10. Recalled Plates.** Personalized plates may be recalled by the Department for the following reasons: (3-20-20)T

**a.** Error in manufacturing; or (3-20-20)T

**b.** Clerical error. (3-20-20)T

**c.** Unacceptable personalized messages as outlined in Paragraph 202.08.b. of these rules. (3-20-20)T

**11. Unexpired Fees.** If a set of personalized plates is recalled, the personalized plate program fee, unexpired portion of the registration fee, E.M.S. fee, plate fee, (if plates are returned to the Department), and all other applicable special plate fees, will be refunded or transferred to a new issue of personalized plates. (3-20-20)T

**12. Expired Plates.** Personalized plates that are allowed to expire will become immediately available for reissue to another applicant. There is no grace period. (3-20-20)T

**203. PROVISIONS FOR FORMER PRISONER OF WAR (POW) LICENSE PLATES.**

**01. Eligible Person.** Any veteran who was a prisoner of war (POW) of an armed enemy of the United States during active service in the armed forces of the United States during the following recognized war periods may be eligible:

WORLD WAR I	April 6, 1917 to November 11, 1918
WORLD WAR II	December 7, 1941 to December 31, 1946
KOREAN WAR	June 27, 1950 to January 31, 1955
VIETNAM WAR	August 5, 1964 to May 7, 1975
USS PUEBLO	January 23, 1968 to December 23, 1968
PERSIAN GULF	August 2, 1990 (Congress has not assigned an ending date.)

(3-20-20)T

**02. Certified Documentation.** Eligibility will be documented by a copy of the applicant's 53.55 or DD-214 Separation from Active Duty papers, or other specific documentation received from the Veterans Administration that certifies that the applicant was a prisoner of war during the recognized war periods stated above. (3-20-20)T

**204. -- 299. (RESERVED)**

**300. PROVISIONS FOR SAMPLE PLATES.**

Sample plates are issued at on the "Scenic Idaho/Famous Potatoes" red, white, and blue plate or Special Program License plates as follows: (3-20-20)T

**01. Plate Size.** Plates carrying the word SAMPLE in both passenger car size (six inches by twelve inches (6" x 12")) and motorcycle size (four inches by seven inches (4" x 7")). (3-20-20)T

**02. Personalized Sample Plates.** Personalized Sample plates are issued on both plate sizes, passenger car with maximum of seven (7) characters and motorcycle size with a maximum of six (6). (3-20-20)T

**a.** The applicant completes an Application for Personalized Sample License Plate Form. (3-20-20)T

**b.** The acceptability screening process used is the same as that used for regular personalized plate application. (3-20-20)T

**c.** The Department will adopt written policy for the issuance of duplicate and replacement sample plates with personalized character combinations. (3-20-20)T

**d.** The department may include other special license plate programs for sample plate sale, when not prohibited by code, or that would not cause a compromise of a special eligibility plate program. (3-20-20)T

**03. Penalties.** There is a penalty for fictitious display of sample plates (Section 49-456, Idaho Code). (3-20-20)T

**301. -- 399. (RESERVED)**

**SUBCHAPTER A – RULES GOVERNING LICENSE PLATES  
FOR GOVERNMENTAL AGENCIES AND TAXING DISTRICTS**

**400. STANDARD EXEMPT PLATE DESIGNATORS.**

The standard exempt license plate designators used to identify the agency, entity, or office will be assigned pursuant to Section 49-443B (2), Idaho Code. (3-20-20)T

**401. ISSUING AGENCY.**

All exempt and undercover license plates will be issued by the Idaho Transportation Department upon receipt of a request from an authorized agency. (3-20-20)T

**402. INFORMATION TO BE PROVIDED BY AN AUTHORIZED AGENCY.**

A request for exempt or undercover plates will contain: (3-20-20)T

**01. Actual Name and Address.** The name and address of the requesting agency. (3-20-20)T

**02. Vehicle Description.** The description of the vehicle(s) to be registered, including the year, the make, model, type, vehicle identification (VIN), color and title number, and truck weight if eight thousand one pounds (8,001 lbs.) or more. (3-20-20)T

**03. Fictitious Name and Address.** The name and address of the registrant to appear on the undercover plate registration, and title records of the Department. (3-20-20)T

**04. Authorized Official.** The request must be signed by an authorized official of the authorized agency. (3-20-20)T

**403. VEHICLE TITLING.**

**01. For Exempt Registration and License Plates.** If the vehicle is not titled, the title transaction will be completed at the local county assessor's office before requesting exempt plates. The control number from the title application may be used in lieu of the title number on the exempt plate request letter. (3-20-20)T

**02. Undercover Vehicle Titling.** The actual name and address of the requesting agency, along with the fictitious name and address of the registrant will be provided directly to the Department on a completed application

approved by the authorized official. (3-20-20)T

**404. EXEMPT AND UNDERCOVER PLATE FEES.**

**01. Department Reimbursement.** State and federal agencies and taxing districts will reimburse the Department the cost of providing license plates. These costs will be determined by the cost of manufacture and the cost to the Department of processing the transaction. (3-20-20)T

**02. Adjusted Fees.** Periodically, fees may be adjusted in accordance with changes in manufacturing costs, postage, employee costs and legislative mandate. (3-20-20)T

**405. EXEMPT PLATE DISPLAY.**

Exempt license plates will be displayed in accordance with Section 49-428, Idaho Code. A pressure-sensitive sticker with the designator "EX" will be provided with each exempt plate and be attached to the plate(s) in the space provided for this purpose. The department may have the EX designator printed in the appropriate space on the plate as an alternative to the sticker. (3-20-20)T

**406. UNDERCOVER PLATE DISPLAY.**

Undercover license plates will be displayed in accordance with Section 49-428, Idaho Code. A pressure-sensitive sticker displaying an expiration date matching the plate number will be attached to the plate(s) in the space provided for this purpose. There will be no discerning markings to indicate that the plate or registration record is in undercover use. (3-20-20)T

**407. ALTERNATIVE PLATES.**

If an authorized agency requests a specialized license plate format normally reserved for the general public, all the statutory special program fees for the plate will be paid, with the exception of the registration (operating) fee, in addition to the department administrative and plate manufacturing fees. Special eligibility plates will not be issued to exempt vehicles. "Special eligibility" requires the individual registrant to meet specific requirements for programs such as: Purple Heart, Disabled Veteran, Disability, Military Reservist, Former Prisoner of War, Congressional Medal of Honor, National Guard and Air National Guard, Radio Amateur, Pearl Harbor Survivor, and Legislative plates. (3-20-20)T

**408. EXEMPT PLATE STATUS.**

**01. Non-Expiring Plates.** Exempt plates are non-expiring and require no annual renewal. (3-20-20)T

**02. Transfer of Plates.** Exempt plates may be transferred between vehicles. If an exempt plate is transferred to another vehicle, a transfer request must be made to the Department's Vehicle Services Section/Special Plates Unit. (3-20-20)T

**03. Reissue of Plates.** Exempt plates will be reissued in accordance with Section 49-443(2), Idaho Code. (3-20-20)T

**409. UNDERCOVER PLATE STATUS.**

**01. Expiration of Plates.** Undercover license plates will expire annually or biennially based upon the application of the authorized agency. Registration status will appear as valid, until expiration date. Renewals must be made to the Department upon expiration of the undercover license plate. (3-20-20)T

**02. Transfer of Plates.** Undercover license plates may be transferred between vehicles. If an undercover license plate is transferred to another vehicle, a transfer request must be made to the Department's Vehicle Services Section/Special Plates Unit. (3-20-20)T

**03. Reissue of Plates.** Undercover plates will be reissued in accordance with Section 49-443(2), Idaho Code. (3-20-20)T

**04. Emission Testing of Undercover Vehicles.** Vehicles issued undercover license plates who list an

address in a county or area of required emission testing will need to check with the emission authority to be exempted from the testing requirement, or test as a typical registered vehicle. (3-20-20)T

**410. -- 999. (RESERVED)**

**39.03.03 – RULES GOVERNING SPECIAL PERMITS –  
GENERAL CONDITIONS AND REQUIREMENTS**

**000. LEGAL AUTHORITY.**

This rule, governing the movement of vehicles or loads that are in excess of the sizes or weights allowed by Sections 49-1001, 49-1002 or 49-1010, Idaho Code, is adopted under the authority of Sections 40-312, 49-201, 49-1001, 49-1004, and 49-1005 Idaho Code. (3-20-20)T

**001. TITLE AND SCOPE.**

**01. Title.** This rule is titled IDAPA 39.03.03, “Rules Governing Special Permits – General Conditions and Requirements,” IDAPA 39, Title 03, Chapter 03. (3-20-20)T

**02. Scope.** This rule states the general conditions and requirements for special permits. (3-20-20)T

**002. -- 009. (RESERVED)**

**010. DEFINITIONS.**

Refer to IDAPA 39.03.01, “Rules Governing Definitions Regarding Special Permits,” for definitions of the terms used in this rule. (3-20-20)T

**01. Loaded Truck.** A truck or truck combination equipped with VLS axles shall be considered to be hauling a load when VLS axles need to be fully deployed to reduce loads on fixed axles and groups of axles that would otherwise exceed legally prescribed weight limits as set forth in Section 49-1001, Idaho Code. (3-20-20)T

**011. – 049. (RESERVED)**

**050. SAFETY INSPECTION REQUIREMENTS FOR PERMITTED VEHICLES AND/OR LOADS.**

**01. Inspections.** All vehicles, tractors, trailers, and dolly converters operating under the authority of a special permit issued by the Department must have a valid annual inspection at the time a permit is issued. The inspection shall be completed in compliance with 49 CFR Part 396.17. (3-20-20)T

**02. Inspectors.** Inspectors completing required annual inspections shall meet the certifications requirement in 49 CFR 396.19 and brake inspector qualification in 49 CFR 396.25. (3-20-20)T

**03. Drivers.** All drivers shall meet the special training requirements for Longer Combination Vehicles as outlined in 49 CFR Part 380. (3-20-20)T

**04. Motor Carriers.** By applying for a special permit, motor carriers self-certify that they have performed inspections as set forth in 49 CFR Part 396.17. (3-20-20)T

**05. Exemption.** Oversize vehicles and/or loads operating under an exemption outlined in Section 67-2901B (2), Idaho Code, are exempt from this safety inspection requirement. (3-20-20)T

**051. – 059. (RESERVED)**

**060. BRAKES.**

Brakes shall meet the Federal Motor Carrier Safety Regulations and shall be maintained to the Federal Motor Vehicle Safety Standards No. 121 in effect at the time the commercial motor vehicle was manufactured. (3-20-20)T

**061. – 069. (RESERVED)**

**070. LIGHTING REQUIREMENTS FOR LOADS TRAVELING AFTER DARK.**

Those over dimensional vehicles and/or loads traveling during hours of darkness shall be required to display lights to mark the extremities of the vehicle and/or loads and shall be in addition to those clearance lights required on legal size vehicles when traveling at night. (3-20-20)T

**01. Standards for Lights on Oversize Vehicles and/or Loads.** (3-20-20)T

**a.** Lights are required on those vehicles traveling sunset to sunrise. (3-20-20)T

**b.** The lights must be visible from a minimum of five hundred (500) feet. (3-20-20)T

- c. The lights may be flashing or steady burning. (3-20-20)T
- d. The color of the lights shall be as follows: (3-20-20)T
  - i. Lights visible from the front of the oversized vehicle and/or loads and the extremities in the middle or near the front of the oversized vehicle and/or load shall be amber. (3-20-20)T
  - ii. Lights visible from the back of the oversized vehicle and/or load and the extremities near the back of the oversized vehicle and/or load shall be red. (3-20-20)T

**02. Standards for Lights on Rear Overhang.** Lights are required when rear overhang exceeds the end of the trailer by four (4') feet or more. (3-20-20)T

- a. If the overhang is two (2') feet wide or less, only one (1) light is required on the end of the overhang. (3-20-20)T
- b. If the overhang is over two (2') feet wide, two (2) lights are required on the end of the overhang to show the maximum width of the overhang. (3-20-20)T

**071. – 079. (RESERVED)**

**080. FLAGGING REQUIREMENTS FOR OVERSIZE VEHICLES AND/OR LOADS.**

Warning flags for oversize vehicles and/or loads, excluding extra-length vehicle combinations, shall be marked by warning flags meeting the following: (3-20-20)T

**01. Warning Flags.** Warning flags are required on all overwidth vehicles and/or loads, and when the rear overhang exceeds the end of the trailer by four (4') feet or more. (3-20-20)T

**02. Size.** Minimum size of flags is eighteen (18") inches by eighteen (18") inches. (3-20-20)T

**03. Color.** Red or fluorescent orange. (3-20-20)T

**04. Placement of Flags.** On overwidth vehicles and/or loads flags shall be placed at the four (4) corners and/or extremities of the vehicle and/or load as follows: (3-20-20)T

- a. Front. Fastened to each front corner of the oversized vehicle and/or load if it exceeds legal width. (3-20-20)T
- b. Rear. Fastened to each rear corner of the oversized vehicle and/or load if it exceeds legal width. (3-20-20)T
- c. Side. Fastened to mark any extremity, when extremity is wider than the front or the rear of the vehicle and/or load. (3-20-20)T
- d. Overhang. If the overhang is two (2') feet wide or less, only one (1) flag is required on the end of the overhang. If the overhang is over two (2') feet wide, two (2) flags are required on the end of the overhang to show the maximum width of the overhang. (3-20-20)T

**081. – 089. (RESERVED)**

**090. SIGN REQUIREMENTS FOR VEHICLES COMBINATIONS INCLUSIVE OF LOAD.**

Refer to IDAPA39.03.05, "Rules Governing Special Permits – Oversize Non-Reducible," for conditions in this rule. (3-20-20)T

**091. – 099. (RESERVED)**

**100. RESPONSIBILITY OF ISSUING AUTHORITY.**

**01. Primary Concerns.** The primary concern of the Department, in the issuance of special permits, shall be the safety and convenience of the general public and the preservation of the highway system. (3-20-20)T

**02. Permit Issuance.** The Department shall, in each case, predicate the issuance of a special permit on a reasonable determination of the necessity and feasibility of the proposed movement. (3-20-20)T

**101. – 199. (RESERVED)**

**200. AUTHORITY TO ISSUE PERMITS.**

The authority to issue permits on state highways is described in Subsection 200.01. Subsection 200.02 describes the Department’s authority to issue special permits on local jurisdiction highways pursuant to an agreement between the Department and the local highway jurisdictions. (3-20-20)T

**01. Special Permit.** The special permit authority of the Department shall cover travel on state highways only and special permits issued by the Department shall be valid only on completed sections of state highway, described on the permit by route number or otherwise. The right to use county highways or city streets is neither granted nor implied. The special permit authority of the Department shall include those sections of state highways within corporate limits of cities and towns, but will not include sections of state highways intersecting with local highways, when travel is occurring on the local highway(s). Contractors hauling loads within the limits of state highway construction projects do not require special permits, but the loads must comply with the weight limits specified in the state highway contract. (3-20-20)T

**02. Authority.** Special permit authority agreed to by the Department and local highway jurisdiction shall include travel on the local jurisdiction’s highways under the rules of this title, IDAPA 39.03.03, “Rules Governing Special Permits – General Conditions and Requirements.” (3-20-20)T

**201. – 299. (RESERVED)**

**300. OFFICES FOR ISSUANCE OF SPECIAL PERMITS.**

The Department shall maintain a centralized special permit office at the Department Headquarters, making permits available electronically at the following listed office and Ports of Entry throughout the State. Permits will be available Monday through Friday, state holidays excluded, from 7:30 a.m. to 5 p.m. Mountain Time. Special permits can also be obtained online at [itd.idaho.gov](http://itd.idaho.gov) or by phone. (3-20-20)T

**01. Headquarters.**  
Idaho Transportation Department  
Special Permit Office  
P.O. Box 7129  
3311 West State Street  
Boise, Idaho 83707-1129  
(208) 334-8420 (3-20-20)T

**02. Huetter Port of Entry, District One.**  
Mile Post 8.5 I-90  
Coeur d’Alene, Idaho 838145  
(208) 769-1551 (3-20-20)T

**03. Lewiston Port of Entry, District Two.**  
33443 US Hwy 95  
Lewiston, Idaho 83501-0837  
(208) 799-4824 (3-20-20)T

**04. East Boise Port of Entry, District Three.**  
Mile Post 66.5 I-84 EB  
Boise, Idaho 83634  
(208) 334-3272 (3-20-20)T

- 05. Cotterell Port of Entry, District Four.**  
Mile Post 229 I-84 EB  
Cotterell, Idaho 8323  
(208) 349-5650 (3-20-20)T
- 06. Inkom Port of Entry, District Five.**  
Mile Post 59 I-15 NB  
Inkom, Idaho 83245  
(208) 775-3322 (3-20-20)T
- 07. Sage Junction Port of Entry, District Six.**  
2452 E 1500 N  
Terreton, Idaho 83450  
(208) 228-3636 (3-20-20)T

**301. – 399. (RESERVED)**

**400. INSURANCE OR BOND FOR EXTRAORDINARY HAZARD.**

Evidence of insurance or the posting of a bond shall be required when necessary because of loads creating an extraordinary hazard to the traveling public or to protect the public investment when a load presents an extraordinary hazard to the highway system. In such cases of extraordinary hazard to the roadway or structures, the Department may require the posting of a cash bond in such amount as to cover the maximum damage that could be expected to occur to the highway with the permittee also required to reimburse the Department for any engineering required to ascertain the extent of damages, if any, occurring to the roadway during the movement of the excessive load.

(3-20-20)T

**401. – 449. (RESERVED)**

**450. RESPONSIBILITY OF PERMITTEE.**

**01. General Responsibilities.** The permittee shall determine and declare the gross weight, distribution of weight, and the dimensions of the vehicle and load and shall submit all other required information before issuance of the permit. The acceptance of a special permit by the permittee is his agreement that the vehicle and load covered by the permit can and will be moved in compliance with the terms and limitations set forth in the permit. When a permit has been accepted by the permittee, such action shall be deemed an unequivocal assurance that he has complied, or will comply with all operating, licensing, and financial responsibility requirements. (3-20-20)T

**02. Permit to Be Carried in Vehicle.** (3-20-20)T

**a.** The special permit must be carried or available electronically in the vehicle to which it refers during the time of movement and shall upon demand be delivered for inspection to any peace officer or authorized agent of the Idaho Transportation Board or any officer or employee charged with the care and protection of the public highways. (3-20-20)T

**b.** When the route of the permitted vehicle will not pass in the vicinity of a state operated transceiver station, the applicant may complete Form ITD-216, APPLICATION FOR SPECIAL PERMIT NUMBER, and provide pertinent information by telephone to the special permit office. If the special permit office approves the application, a special permit number will be assigned to complete the Form ITD-216. Form ITD-216 will serve as evidence of intent to obtain the special permit and will be honored by law enforcement subject to the officer checking with the special permit office. The applicant must qualify for this procedure by obtaining a permit fee account number. The special permit office will complete the Special Permit Form ITD-216 and charge the fee to the applicant's permit fee account number. (3-20-20)T

**03. Certification Load Is Non-Reducible.** Upon application, the permittee must certify that steps have been taken to reduce the dimensions, the weight of vehicle, or the load, or all three, concerned in the permit to legal limitations or, if that is impractical, to reduce the excess to a minimum. (3-20-20)T



**04. Basic Limitations Shall Not Be Exceeded.** Special permits shall not be issued for vehicles or loads in excess of the maximum limitations of size or weight or that otherwise exceed the limitations for loads as set forth in these rules unless exception is made by the Transportation Board, or as otherwise provided herein.

(3-20-20)T

**05. Hazardous Travel Conditions Restrictions.** Extreme caution in the operation of a special-permitted vehicle shall be exercised when hazardous conditions exist. The driver of a permitted vehicle is responsible for checking the conditions of the permitted route before travel. The movement of vehicles or loads operating on valid permits shall automatically become invalid en route when:

(3-20-20)T

**a.** The Idaho Transportation Department, Idaho State Police, or other law enforcement office determines and provides public notice by any available means that a hazardous road condition exists.

(3-20-20)T

**b.** The driver reasonably knows that hazardous road conditions exist along route.

(3-20-20)T

**c.** Whenever a road is marked “Difficult” on 511 or as having a hazardous condition.

(3-20-20)T

**d.** Hazardous road conditions may include, but are not limited to:

(3-20-20)T

**i.** Loss of traction on roadways due to ice, snow, frost, excessive water, or mud;

(3-20-20)T

**ii.** Whenever a roadway is under conditions of wind over forty (40) mph;

(3-20-20)T

**iii.** Visibility is less than five hundred (500) feet due to snow, rain, smoke, dust, or fog;

(3-20-20)T

**iv.** Whenever a roadway becomes obstructed due to snow, water, mud, rocks, or other debris; or

(3-20-20)T

**v.** Whenever a roadway is subject to a natural disaster or emergency.

(3-20-20)T

**06. Delaying Movement.** Enforcement personnel responsible for any section of highway shall carry out enforcement action for violations involving special permit operations and may delay movements.

(3-20-20)T

**451. – 499. (RESERVED)**

**500. ALLOWABLE TOLERANCE, LEGAL OR PERMITTED SIZE LIMITS.**

**01. Determination of Vehicular Dimensions.** Determination of vehicular length and/or width as defined by Idaho Code or by Board rule shall be exclusive of those external devices or appurtenances whose function is related to safe and efficient operation.

(3-20-20)T

**02. Appurtenances.** Rearview mirrors, turn signal lamps, splash and spray suppressant devices; awnings on recreational vehicles, load induced tire bulge, and other noncargo carrying appurtenances shall be excluded from the calculation of allowable width. Front mounted refrigeration units, energy conservation devices, bolsters, mechanical fastening devices, hydraulic lift gates, external front mounted side curtain rollers, and other noncargo carrying appurtenances or devices shall be excluded from a determination of allowable length.

(3-20-20)T

**03. Other Appurtenances.** Other appurtenances not listed above may not extend beyond three (3) inches on each side or end of a vehicle or load. Other appurtenances may include, but shall not be limited to, clearance lights, door handles, handholds, window fasteners, door and window trim, moldings, and load securement devices.

(3-20-20)T

**501. – 509. (RESERVED)**

**510. DROMEDARY TRACTORS.**

A truck tractor containing a dromedary box, deck, or plate in legal operation on or before December 1, 1982, shall be authorized to continue to operate, notwithstanding its cargo carrying capacity, throughout its useful life. Proof of such

legal operation on December 1, 1982, shall rest upon the operator of the equipment. (3-20-20)T

**511. – 519. (RESERVED)**

**520. LOAD OVERHANG.**

The overhang or extension of a load shall not extend beyond the limits as set forth in Section 49-1010, Idaho Code. (3-20-20)T

**521. – 599. (RESERVED)**

**600. GENERAL.**

A special permit, in writing, shall be required for any movement on any completed section of highway under the jurisdiction of the Department by any vehicle or vehicles with reducible or non-reducible loads that exceed the allowable weights or sizes established in Sections 49-1001, 49-1002 and 49-1010, Idaho Code. (3-20-20)T

**601. – 619. (RESERVED)**

**620. COMPLIANCE WITH OTHER LAWS AND ORDINANCES.**

The special permit will be effective only insofar as the Department has authority for its issue and does not release the permittee from complying with other existing laws, local ordinances or resolutions which may govern the movement. (3-20-20)T

**621. – 629. (RESERVED)**

**630. WAIVER OF LIMITATIONS FOR EMERGENCY MOVEMENTS.**

Notwithstanding other provisions of these rules, the Idaho Transportation Board may waive existing permit policy limitations in the event of an emergency, subject to such limitations or special requirements as the Board may impose. (3-20-20)T

**01. Military Emergency Affecting National Security.** Any movement by or for a military or other government agency which is in excess of permit policy maximum limits of weight or size or which is otherwise outside established rules must be certified as a military necessity involving national security before receiving any special consideration to provide any waiver of normal permit rules. Certification of military necessity must be made by an official designated as having such authority by the Department of Defense Directory, issued by the Office of the Chief of Transportation, Department of Army. All applications for military emergency movements must be channeled through the Special Permit Office, Idaho Transportation Department. (3-20-20)T

**02. Emergencies Endangering the Public Health, Safety, or Welfare Including but Not Limited to Fire, Flood, or Earthquake.** During an emergency endangering the public health, safety or welfare, there may be an urgent and immediate need for equipment and it will not be in the public interest to require that a special permit be in the vehicle prior to an over legal movement. Verbal approval to proceed without a special permit in the vehicle may be obtained from the Special Permit Office or an Idaho Port-of-Entry. Once the emergency movement is completed, formal application for a Special Permit must be submitted to the Special Permit Office. (3-20-20)T

**03. Emergency Movement of Implements of Husbandry.** It shall be considered an emergency when an implement of husbandry being operated on an official state holiday or a weekend breaks down and a dealer brings replacement equipment to the farmer that exceeds legal height, length, and weight. Verbal approval to proceed without a special permit in the vehicle may be obtained from the Special Permit on-call staff. That verbal authorization may include escort vehicle requirements based on the route of travel and dimensions of load. Once the emergency movement is completed, the permittee shall make formal application for a permit to the Special Permit Office on the first working day after the occurrence. (3-20-20)T

**04. Economic Emergencies.** When a circumstance occurs in which an economic hardship is expected to result due to the application of existing rules or limitations, the Transportation Board may consider a petition for the temporary waiver of those rules or limitations which are perceived as being the cause of such economic hardship. (3-20-20)T

**631. – 699. (RESERVED)**

**700. SPRING BREAKUP SEASON TYPE OF LOAD RESTRICTIONS.**

Depending upon the type of road construction, the amount of moisture, temperature conditions, and severity of frost heaves and breakup, routes or sections of routes will be posted for restricted loadings to one (1) of the following categories as required to protect the roadway and in the interests of public safety: (3-20-20)T

- 01. Legal Weight.** Maximum of legal allowable weight; (3-20-20)T
- 02. 16,000 Pounds.** Maximum of sixteen thousand (16,000) pounds on any axle; (3-20-20)T
- 03. 14,000 Pounds.** Maximum of fourteen thousand (14,000) pounds on any axle; and (3-20-20)T
- 04. 12,000 Pounds.** Maximum of twelve thousand (12,000) pounds on any axle. (3-20-20)T

**701. – 709. (RESERVED)**

**710. WEIGHT LIMITS BASED ON TIRE SIZES.**

In administering load limits based on tire sizes or width of tires, credit for tubed tires will be based on the manufacturer's width marked on the tire; for example, a ten point zero-zero by twenty-four (10.00 x 24) tire will be given credit for ten (10") inches of tire width. Tubeless tires will be given credit for the width of the conventional tubed tires that they replace. (3-20-20)T

**711. – 719. (RESERVED)**

**720. WIDTH LIMITATION ON TWO LANE ROAD.**

A spring breakup weight restriction to less than legal weight shall automatically place a restriction on width allowed by special permit. On any section of highway restricted to less than legal weight, the maximum width by special permit shall be restricted to twelve feet six (12'6") inches during the period of the weight restriction. (3-20-20)T

**721. – 729. (RESERVED)**

**730. SPEED RESTRICTIONS.**

On those sections of highways which are posted for a maximum of legal loads, or to less than legal loads, trucks and buses with a gross weight of ten thousand (10,000) pounds or more will be restricted in critical areas to a maximum speed of thirty (30) miles per hour. Restricted speed zones will be marked by red and green markers. A red marker will mean speed is restricted to thirty (30) miles per hour and a green marker will mean that legal speed may be resumed. These markers will generally be attached to existing highway sign posts and when properly used will afford protection to the highway subgrade and surface as well as speeding the flow of traffic. (3-20-20)T

**731. – 739. (RESERVED)**

**740. SPECIAL PERMIT POLICY DURING SPRING BREAKUP.**

**01. Suspended Weight Limits.** Normal overweight special permit limits will be suspended on all highways in the area when seasonal load and speed restrictions are imposed. (3-20-20)T

**02. Weight Restrictions.** Spring breakup weight restrictions are primarily concerned with limiting the weight imposed on the highway by individual axles rather than the total gross weight of vehicles or vehicle combination. It will therefore be permissible to issue special permits that exceed legal allowable total gross load for a vehicle combination subject to these conditions: (3-20-20)T

- a.** Minimum tire width is ten (10") inches or larger. (3-20-20)T
- b.** Maximum axle weight on single axle having two (2) single wheels shall not exceed ten thousand (10,000) pounds. (3-20-20)T

c. Maximum axle weight on single axle having four (4) or more tires shall not exceed fourteen thousand (14,000) pounds. (3-20-20)T

d. Permits for nonreducible loads only. (3-20-20)T

**741. – 749. (RESERVED)**

**750. LEGAL WEIGHT LIMITS MAINTAINED ON CERTAIN HIGHWAYS.**

The policy of the Department will be to maintain legal load limits on the Interstate highway system and arterials serving through state traffic or connecting major terminals, unless conditions are such that severe breakup will result. (3-20-20)T

**751. – 759. (RESERVED)**

**760. ENFORCEMENT OF POSTED WEIGHT AND/OR SPEED RESTRICTIONS.**

The Districts will sign and mark affected state highways the day before the weight and/or speed restrictions are in effect. The weight and/or speed restrictions will be enforced the day after the Districts sign and mark a state highway. (3-20-20)T

**761. – 769. (RESERVED)**

**770. TEMPORARY SUSPENSION OF POSTED WEIGHT AND SPEED RESTRICTIONS.**

**01. Why Required.** Spring breakup restrictions are required because of a seasonal characteristic in which freeze/thaw cycles occur, making the roadway unstable and reducing its load-bearing capability. The load-bearing capacity may be temporarily restored by a freeze-up of the pavement after a section has been posted for load and speed restrictions. (3-20-20)T

**02. Temporary Waiver of Spring Breakup.** District Engineers may provide a temporary waiver of the spring breakup restrictions by posting GREEN markers on the speed limit signs, and on other signs, if appropriate, within a section of highway posted for reduced loads. (3-20-20)T

**771. – 779. (RESERVED)**

**780. SPECIAL ALLOWANCES FOR EMERGENCY AND CRITICAL SERVICE VEHICLES.**

District Engineers may allow exceptions to the spring breakup weight restrictions for emergency and critical service vehicle(s), ie. fire trucks, heating fuel trucks, and other such service vehicles that are critical to the health and safety of the public. Documentation of special allowance shall be in writing from the District Engineer and must be carried in the vehicle. (3-20-20)T

**781. – 799. (RESERVED)**

**800. SPECIAL PERMIT FEES COSTS TO BE BORNE BY PERMITTEE.**

The movement of oversize or overweight vehicles or vehicles with special loads is a privilege not accorded every user of the highway. Administrative cost incurred in the processing, issuance and enforcement of special permits shall be borne by such permittees and not by the general traveling public through expenditure of highway user funds. Special permits issued for non-reducible, overweight vehicles and/or loads will be charged a road use fee as set forth in Section 49-1004(2), Idaho Code. Tax supported agencies are required to obtain special permits if their loads exceed the sizes or weights stated in Idaho Code, but they are exempt from paying fees for the permits. (3-20-20)T

**801. – 909. (RESERVED)**

**910. PAYMENT OF SPECIAL PERMIT FEES.**

**01. Payment of Fees.** The Idaho Constitution prohibits the state from extending credit to any individual, corporation, municipality, or association. Permit fees are collectible at the time of issuance. (3-20-20)T

**02. Refund.** Permit fees are not refundable once they have been processed into the Department's accounting system, unless the permittee contacts the Special Permit Office no more than two (2) working days (during office hours) following the start date of the special permit or the Department issued the special permit in error. (3-20-20)T

**03. Permit Costs.** Special permit fees listed below are intended to cover cost of administration and are subject to periodic change depending on costs incurred in processing, issuance, and enforcement of special permit rules. (3-20-20)T

**04. Current Schedule of Fees.** Periodic changes to the fee schedule will be subject to legislative review and approval procedures in accordance with Chapter 52, Title 67, Idaho Code, Administrative Procedure Act. (3-20-20)T

**a.** Oversize only, single trip, thirty dollars (\$30). (3-20-20)T

**b.** Oversize only, two (2) trips, thirty six dollars (\$36). (3-20-20)T

**c.** Oversize single trip exceeding sixteen (16') feet wide, or sixteen (16') feet high or one hundred ten (110') feet long, thirty-three dollars (\$33). (3-20-20)T

**d.** Reducible Loads, annual, twelve (12) consecutive months: Cylindrical hay bales, two (2) wide, Multiple width loads of kiln stacked lumber, reducible loads, up to and including fifteen (15') feet high, Disabled Vehicle, forty-five dollars (\$45). (3-20-20)T

**e.** Oversize Non-Reducible, annual, twelve (12) consecutive months: Manufactured homes, modular building and office trailers; Farm tractors exceeding nine (9') feet width on Interstate and implements of husbandry; Oversize/Overweight Snowplow; Multiple width loads of crane booms; Multiple width loads of conveyor units; East port/Canadian Weight; forty five dollars (\$45). (3-20-20)T

**f.** Extra Length/Weight (reducible) annual, twelve (12) consecutive months, authority to exceed eighty thousand (80,000) lbs. on reducible loads up to one hundred twenty nine thousand (129,000) pounds, or exceeding the length limits imposed in Section 49-1010, Idaho Code, forty five dollars (\$45). (3-20-20)T

**g.** Overweight/Oversize or Overweight only (non-reducible) single trip, thirty-three dollars (\$33). (3-20-20)T

**h.** Overweight/Oversize or Overweight only (non-reducible), two (2) trips, thirty-three dollars (\$33). (3-20-20)T

**i.** Overweight/Oversize (non-reducible) single trip, exceeding sixteen (16') feet wide, or sixteen (16') feet high or one hundred ten (110') feet long, thirty- three dollars (\$33). (3-20-20)T

**j.** Overweight/Oversize (non-reducible) two (2) trips within seven (7) days, exceeding sixteen (16') feet wide, or sixteen (16') feet high or one hundred ten (110') feet long, thirty-three dollars (\$33). (3-20-20)T

**k.** Overweight/Oversize (non-reducible) annual permit fee for twelve (12) consecutive months, one hundred twenty-eight dollars (\$128). (3-20-20)T

**l.** Fee for reissuance or transfers, fifteen dollars (\$15). (3-20-20)T

**m.** Annual special permits purchased online will be five dollars (\$5) less than the listed price. (3-20-20)T

**05. Additional Fees.** The Department may require reimbursement of actual costs incurred for extraordinary services provided, incidental and necessary to the planning and/or movement of loads that require a special permit moving under the requirements of a traffic control plan. (3-20-20)T

911. – 949. (RESERVED)

**950. REVOCATION OF PERMIT FOR NON-COMPLIANCE WITH THE LIMITATIONS OR PROVISIONS OF THE PERMIT.**

**01. Disqualification of Permits.** The permit shall become invalid and the cited vehicle may be disqualified for reissuance of permits if convicted of the following: (3-20-20)T

**a.** The vehicle combination does not satisfy the requirements of Federal Motor Carrier Safety Regulations Part 393. (3-20-20)T

**b.** The vehicle combination violates permitting conditions (other than weight) for the following: (3-20-20)T

**i.** Failure to travel on Extra Length or Up to 129,000 Pound designated routes. (3-20-20)T

**ii.** Failure to properly display required flags and/or signs. (3-20-20)T

**iii.** Failure to provide required number of pilot cars and/or proper placement. (3-20-20)T

**iv.** Failure to provide required lighting for travel during hours of darkness. (3-20-20)T

**v.** Failure to travel during the hours of operation as specified on the permit. (3-20-20)T

**vi.** Failure to comply with wind velocity requirements when moving manufactured housing, office trailers, and modular buildings. (3-20-20)T

**vii.** Failure to comply when travel conditions become hazardous. Hazardous conditions include, but are not limited to, ice, snow or frost; or when visibility is restricted to less than five hundred (500) feet. (3-20-20)T

**c.** The vehicle combination violates weight limits under Section 49-1001 (1)(2) and (9), Idaho Code. (3-20-20)T

**i.** Violating weight limits for single, tandem, tridem, quad, or other type axle groups by more than fifteen percent (15%). (3-20-20)T

**ii.** Violating gross or bridge weight allowances by more than seven percent (7%). (3-20-20)T

**d.** The motor carrier has violated an Out-of-Service order by the Federal Motor Carrier Safety Administration as described in Part 386 (386.73) of the Federal Motor Carrier Safety Regulations. (3-20-20)T

**02. Permit Revocation Process.** A copy of the judgment of conviction from the court and the special permit authorizing operation must be provided to the Permit Office by enforcement personnel. Paperwork will be reviewed for compliance with the provisions of this rule and, if met, notification will be sent to the company informing them of the pending revocation that will occur within ten (10) days of the letter being issued. (3-20-20)T

**03. Disqualification Periods.** When a permit has become invalid, the vehicle identified on the invalidated permit may be disqualified for reapplication for permit for a period of thirty (30) days after the first violation, for a period of six (6) months after the second violation, and for a period of one (1) year after the third violation. (3-20-20)T

**04. Penalties.** In addition to revocation of permits as authorized in this rule, the permittee shall be subject to all applicable penalties provided by law with regard to the provisions violated. (3-20-20)T

951. – 979. (RESERVED)

**980. PERMITTEE RESPONSIBLE FOR INJURY TO PERSONS OR PROPERTY.**

The permittee shall assume all responsibility for injury to persons or damage to public or private property caused directly or indirectly by the transportation of a vehicle or vehicle and load under special permit; and he shall hold harmless the Department and all its officers, agents, employees, and servants from all suits, claims, damages or proceedings, of any kind, as a direct or indirect result of the transportation of the vehicle or vehicle with a load that requires a special permit. (3-20-20)T

**981. – 999. (RESERVED)**

**IDAPA 41 – IDAHO PUBLIC HEALTH DISTRICTS  
(PANHANDLE HEALTH DISTRICT #1)**

**DOCKET NO. 41-0101-2000**

**NOTICE OF OMNIBUS RULEMAKING – ADOPTION OF TEMPORARY RULE**

**EFFECTIVE DATE:** The effective date of the temporary rule being adopted through this omnibus rulemaking is the adjournment date of the second regular session of the 65th Idaho State Legislature - March 20, 2020.

**AUTHORITY:** In compliance with Sections 67-5226, Idaho Code, notice is hereby given this agency has adopted a temporary rule. The action is authorized pursuant to Section 39-413, Idaho Code.

**DESCRIPTIVE SUMMARY:** The following is the required finding and concise statement of its supporting reasons for adopting a temporary rule:

This temporary rule adopts the following chapter under IDAPA 41:

**IDAPA 41**

- 41.01.01, *Rules of Idaho Public Health District #1*

**TEMPORARY RULE JUSTIFICATION:** Pursuant to Section 67-5226(1), Idaho Code, the Governor has found that temporary adoption of the rule is appropriate for the following reasons:

These temporary rules are necessary to protect the public health, safety, and welfare of the citizens of Idaho and confer a benefit on its citizens. These temporary rules implement the duly enacted laws of the state of Idaho, provide citizens with the detailed rules and standards for complying with those laws, and assist in the orderly execution and enforcement of those laws. The expiration of these rules without due consideration and processes would undermine the public health, safety and welfare of the citizens of Idaho and deprive them of the benefit intended by these rules.

**FEE SUMMARY:** This rulemaking does not impose a fee or charge.

**ASSISTANCE ON TECHNICAL QUESTIONS:** For assistance on technical questions concerning the temporary rule, contact Mr. Erik Ketner, PHD#1 Environmental Health Section Manager at (208) 415-5224.

DATED this 19th day of February, 2020.

Joe Righello  
Division Administrator  
Environmental and Health Protection Division  
Panhandle Health District  
8500 N. Atlas Road  
Hayden, Idaho 83835  
Phone: (208) 415-5200  
Fax: (208) 415-5201



**IDAPA 41 – IDAHO PUBLIC HEALTH DISTRICTS  
(PANHANDLE HEALTH DISTRICT #1)**

**41.01.01 – RULES OF IDAHO PUBLIC HEALTH DISTRICT #1**

**000. LEGAL AUTHORITY.**

The rules and standards set forth hereinafter shall be known as the Environmental Code of Panhandle Health District 1. This Code is adopted pursuant to the authority granted to the District Board of Health under Chapter 4, Title 39, Idaho Code. The provisions of the Code are supplementary, and should be interpreted in a manner consistent with Chapter 1, Title 39, Idaho Code and any state or federal laws which establish exclusivity or primacy in a field of rule for another public entity as a matter of law. (3-20-20)T

**01. Conflict.** In the event of any conflict between city or county ordinances or heretofore existing rules of county health boards and departments and this Code, the respective provision which more completely protects public health or the environment, prevails. Nothing in this Code is deemed to prevent the enforcement of any standard, or rule relating to air, water, or health quality now existing or hereinafter adopted by the State Board of Health and Welfare or any interested agency of the federal government. Nothing in this Code is deemed to conflict with the enactment by any city or county in the District of any ordinance or rule placing additional restrictions or limitations which contribute to enhancement of water, air, land, or health quality. Where the provisions of this Code conflict with state or federal statutes or rules which preempt regulation of a particular subject or application of this Code in a particular manner, the preemptive state rule or federal regulation prevails to the extent that application of the conflicting rules cannot be accommodated. (3-20-20)T

**02. Policy.** This Environmental Health Code is based on the recognition that pollution of the air, land, and waters of this district constitutes a menace to public health and welfare, creates public nuisances, is harmful to wildlife, fish, and other aquatic life, and impairs domestic, agricultural, industrial, recreational, and other beneficial uses of air, land, and water. It is the duty of the Board to establish the quality standards of the environment in the interest of health, individual and community alike, and to prevent the outbreak and spread of dangerous and infectious disease. (3-20-20)T

**001. TITLE AND SCOPE.**

**01. Title.** This chapter is titled IDAPA 41.01.01, “Rules of Idaho Public Health District #1.” (3-20-20)T

**02. Scope.** These rules govern issues concerning the mission of Idaho Public Health District #1 as established by the Idaho Legislature, in particular addressing matters of local concern in order to protect public health and the environment in the counties that comprise the District. (3-20-20)T

**002. OFFICE – OFFICE HOURS – MAILING ADDRESS – STREET ADDRESS.**

**01. Office Hours.** 8 a.m. to 5 p.m., except Saturday, Sunday and legal holidays. (3-20-20)T

**02. Mailing and Street Address.** The District’s mailing/street address is: Panhandle Health District, 8500 N. Atlas Road, Hayden, ID 83835. (3-20-20)T

**003. -- 009. (RESERVED)**

**010. DEFINITIONS.**

The following definitions apply: (3-20-20)T

**01. Board.** The Board of Panhandle Health District 1. (3-20-20)T

**02. Code.** Environmental Health Code of Panhandle Health District 1, including the several sections which follow and the entire series of rules now and hereinafter adopted by the Board and by the State Board of Health and Welfare. (3-20-20)T

**03. Floathouse.** A watercraft that is not self-propelled and with a dwelling place on it for habitation by human beings, whether said habitat is seasonal, itinerant, temporary, or permanent; and whether the floathouse is attached to land, floating free in the water, or tied to a fixed structure. (3-20-20)T

**04. Health Officer.** Means the Director of Panhandle Health District 1, or any agent or employee thereof whose duties include enforcement of any provision of this Code. (3-20-20)T

**05. Public Sewage Treatment Facility.** Any sewage collection and treatment system with more than two (2) individual service connections. (3-20-20)T

**06. Variance.** A grant of relief from the literal application of a Panhandle Health District 1 rule upon a showing that undue hardship, related to unique characteristics of a site, would result from literal adherence to such rule. (3-20-20)T

**011. -- 099. (RESERVED)**

**100. WATER QUALITY CONTROL.**

**01. Sewage and Waste Disposal: Political Subdivisions.** Any political subdivision within the District may enter into a sewage management plan agreement with the District, the purpose of which will be to establish permanent sewage disposal practices that will fulfill the needs and goals of the political subdivision and the responsibilities of the District. The Board has authority to enforce the provisions of sewage management plan agreements. (3-20-20)T

**02. Sewage and Waste Disposal: Prohibited Conditions.** (3-20-20)T

**a.** Domestic sewage, septage, sanitary sewage, industrial waste, agricultural waste, sewage effluent, or human excreta is not allowed to remain open to the atmosphere or on the surface of the ground in such a manner so as to be a source of noxious or offensive odors, to be dangerous to health, or to be a public nuisance. (3-20-20)T

**b.** Domestic sewage, sanitary sewage, septage, industrial sewage, industrial waste, agricultural waste, sewage effluent, or human excreta is not allowed to endanger any source or supply of drinking water, or cause damage to any public or private property. (3-20-20)T

**c.** Raw or untreated sewage, septage, or industrial waste, or agricultural waste is not allowed in any body of water, water course, or any underground water drain, any storm water drain, channel, or other surface water drain. (3-20-20)T

**101. -- 109. (RESERVED)**

**110. SEWAGE DISPOSAL ON THE RATHDRUM PRAIRIE IN KOOTENAI COUNTY, IDAHO.**

The Board has determined that extensive use of subsurface wastewater disposal on the Rathdrum Prairie presents a threat to the public health by contamination of the Rathdrum Aquifer, which is a drinking water source. It is the intent of the Board to adopt rules to govern subsurface sewage disposal on the Rathdrum Prairie. (3-20-20)T

**01. Title.** These rules, within this Section, are known and cited as the "Rathdrum Prairie Sewage Disposal Rules." (3-20-20)T

**02. Scope.** The provisions of this Section apply to subsurface sewage disposal systems installed on the Rathdrum Prairie. (3-20-20)T

**03. Definitions.** The following definitions apply to the Rathdrum Prairie sections of these rules. (3-20-20)T

**a. Sewage Loading.** The total liquid volume of sewage produced on any given parcel of land and expressed as gallons/day. (3-20-20)T

**b. Dwelling Equivalent.** The total sewage loading from a single family dwelling. When applied to structures or facilities other than housing units, a dwelling equivalent shall be equal to two-hundred and fifty (250) gallons per day or be equal to twenty (20) persons using a non-residential facility on forty (40) hour per week basis, with no wastewater generation except from restrooms. (3-20-20)T

c. Rathdrum Prairie. That area of land situated in Kootenai County and more particularly defined by the USGS map describing the boundaries of the Rathdrum Prairie Aquifer identified and designated under the authority of Section 1424(e) of the Safe Drinking Water Act (PL 93-523) (Federal Register, Vol. 43, No. 28 -Thursday, February 9, 1978). (3-20-20)T

d. Sewage Management Plan. A method of action, procedure, or arrangement approved by the Panhandle Health District 1 describing how collection, treatment, and disposal of sewage shall be addressed within the boundaries of a political subdivision and include a map of the area affected by the Sewage Management Plan. (3-20-20)T

**04. Subsurface Sewage Disposal Systems. (3-20-20)T**

a. All installations of subsurface sewage disposal systems must be made in compliance with the Code and the rules of the Idaho Department of Environmental Quality. (3-20-20)T

b. A subsurface sewage disposal system for one (1) dwelling equivalent may be installed without requirements other than Subsection 110.04.a., if the system is on a single parcel of land of five (5) acres or larger in surface area and the total loading for that parcel does not exceed one (1) dwelling equivalent per five (5) acres, except where one (1) system is replacing another. Every parcel of land created after December 20, 1977, except as otherwise permitted by these rules, maintains the dwelling equivalent(s) allowed for the original parcel of land. (3-20-20)T

c. No subsurface sewage disposal system may be installed on any parcel of land of less than (5) five acres in surface area except under the following conditions: (3-20-20)T

i. The parcel of land is located within the boundaries of a public sewer district or municipality where the governing board has adopted a Sewage Management Plan approved by the Board which will result in the construction and operation of, or connection to, a central sewage treatment plant. The Sewage Management Plan area must be entirely within the boundaries of the municipality, and the Sewage Management Plan must include a map delineating the boundaries of the Sewage Management Plan Area; (3-20-20)T

ii. Parcels of land less than five (5) acres in size and acquired or established prior to December 20, 1977, will be permitted for a subsurface sewage disposal system for a single-dwelling equivalent, provided such parcels meet all other rules governing individual and subsurface sewage disposal systems; or (3-20-20)T

iii. Where one (1) subsurface sewage disposal system is replacing another with no increase in sewage loading. (3-20-20)T

d. On all developments subject to the provisions of Subsection 110.04.c.iii., the subsurface sewage disposal system needs to have the dry or wet sewer system with necessary laterals installed within the development. All installations needs to be done in coordination with local government planning, and approved by the state Department of Environmental Quality where applicable. (3-20-20)T

e. Upon notification by the Health Officer the owner of any parcel of land utilizing a subsurface sewage disposal system shall disconnect such system from any buildings on his parcel of land and connect the building sewer from the buildings to a collection and treatment system whenever it becomes available for service to his parcel. (3-20-20)T

**111. -- 199. (RESERVED)**

**200. OPEN WATER PROTECTION.**

**01. Boats and Houseboats. (3-20-20)T**

a. It is unlawful for any boat, motorboat, floathouse, sailboat, or any other kind of boat containing wastewater facilities to be on the waters of any stream, river, or lake in Panhandle Health District 1 unless such wastewater facilities shall be sealed to prevent a discharge into any waters. The method of sealing such wastewater

facilities is subject to the approval of Panhandle Health District 1. (3-20-20)T

**b.** Any person authorized by the Health Officer or any law enforcement person may stop and board any boat on the said waters and examine the wastewater facilities on such boats to see that such facilities are properly closed and sealed. (3-20-20)T

**c.** It is unlawful for any person to throw overboard, dump, or otherwise dispose of or discharge, or cause, permit, or suffer to be discharged, any garbage, refuse, rubbish, waste, or sewage from any boat into or upon the waters of any stream, river, lake, or other body of water within the boundaries of Panhandle Health District 1. (3-20-20)T

**d.** If any watercraft located upon the waters of this District is found to have a marine toilet which is not in compliance with the requirements of this section, the Health Officer shall have the following alternative or cumulative powers to: (3-20-20)T

- i.** Cause the marine toilet to be locked and sealed to prevent usage; (3-20-20)T
- ii.** Require such watercraft to be removed from the waters of Panhandle Health District 1 until the marine toilets are made to conform with the requirements of this Code. (3-20-20)T

**02. Public and Private Marinas.** (3-20-20)T

**a.** Any marinas, whether public or private, providing moorage for vessels equipped with on-board wastewater facilities shall provide sewage waste disposal facilities. These facilities shall consist of a pump station that is capable of adequately cleaning waste retention tanks on the largest boat that could reasonably use the moorage. Such plans must be approved by the Department of Environmental Quality. (3-20-20)T

**b.** All marinas, whether public or private, must provide shore-based toilet facilities for their users. (3-20-20)T

**03. Floathouses.** (3-20-20)T

**a.** All floathouses must have approved wastewater facilities. (3-20-20)T

**b.** All discharges from all floathouses, whether old or new, regardless of source, are prohibited. (3-20-20)T

**201. -- 399. (RESERVED)**

**400. CRITICAL MATERIALS AT FIXED FACILITIES ON THE RATHDRUM PRAIRIE IN KOOTENAI COUNTY, IDAHO.**

**01. Purpose and Intent.** The purpose and intent of this section is to provide agencies that are currently involved with emergency planning and emergency response duties and businesses with duties to report their handling of chemicals and other potentially hazardous materials, with a mechanism to meet the mandate of existing rules by facilitating channels of communication. It is also intended to aid in protection of the Rathdrum Prairie Aquifer in Kootenai County, designated as a sole source aquifer by the United States of America, from potential sources of contamination from materials handling and storage at facilities located over or adjacent to the Aquifer. The rules strive to achieve such protection through proper use of secondary containment systems at Fixed Facilities that use, store, manufacture or handle Critical Materials. Reporting these chemicals to the concerned agencies will facilitate coordination among industry, government agencies and response personnel so that they may more successfully meet the requirements of the following: (3-20-20)T

- a.** Title III of the Superfund Amendments and Reauthorization Act of 1986 (SARA III). (3-20-20)T
- b.** The International Fire Code. (3-20-20)T
- c.** The International Building Code. (3-20-20)T

- d.** Local building, planning and zoning codes applicable to lands which overlie the Aquifer. (3-20-20)T
- e.** Any applicable rules administered by any other state, federal or local agency which has jurisdiction over matters related to Critical Materials. (3-20-20)T
- 02. Definitions.** The following have the following definitions: (3-20-20)T
- a.** Container. Any vessel used to hold critical materials. A single container is one not connected to any other container by way of valves, piping, etc. (3-20-20)T
- b.** Critical Material. Any liquid, semi-liquid, flowable, or water soluble solid that is listed on the most current Superfund Amendments and Reauthorization Act, Title III (SARA III) List of Lists published by the Office of Solid Waste and Emergency Response, U.S. Environmental Protection Agency, Washington, D.C. or is required by the U.S. Occupational Safety and Health Administration to have a safety data sheet (SDS). (3-20-20)T
- c.** Critical Materials Compliance Certificate (CMCC). A certificate indicating compliance with the reporting and secondary containment requirements of this rule. (3-20-20)T
- d.** Critical Materials Use Activity. Any undertaking that involves the use, storage, manufacture or handling of Critical Materials at a Fixed Facility above the secondary containment quantity set forth in this rule, or incorporated into this rule by reference. (3-20-20)T
- e.** Director. The Director of Panhandle Health District 1 or his designee. (3-20-20)T
- f.** Fixed Facility. Any established land use, building, dwelling, structure or site upon which or wherein a Critical Material Use Activity is conducted. (3-20-20)T
- g.** Key Box. A durable, locked box that holds keys firefighters or other emergency personnel may use to gain entry into a structure. The key box needs to be a type approved by the local fire chief pursuant to Section 10.209 of the Uniform Fire Code. (3-20-20)T
- h.** Local Emergency Planning Committee (LEPC). A standing committee established by the Office of the Governor through the State Emergency Response Commission (SERC) to fulfill Emergency Planning and Community Right to Know requirements pursuant to SARA III. (3-20-20)T
- i.** Safety Data Sheets (SDS). Documentation required by OSHA to provide a description of the characteristics and potential hazards of a wide range of substances that are potentially Critical Materials. (3-20-20)T
- j.** NFPA 704. The National Fire Protection Association's placarding system used to identify the health hazard, flammability, reactivity and potential to react with water of a particular substance. (3-20-20)T
- k.** Secondary Containment Quantity. The quantity of a Critical Material that requires compliance with this rule. For those Critical Materials specifically listed in the SARA III List of Lists (or as otherwise noted) the following quantities of qualifying substances are subject to this rule: (3-20-20)T
- i.** SARA Section 302 Extremely Hazardous Substances - ten (10) pounds in the aggregate, exclusive of solvent or other medium or, one hundred (100) pounds in the aggregate, inclusive of solvent or other medium. (3-20-20)T
- ii.** CERCLA Hazardous Substances (listed in 40 CFR 302, Table 302.4) - one hundred (100) pounds in the aggregate, exclusive of solvent or other medium or, one thousand (1000) pounds in the aggregate, inclusive of solvent or other medium. (3-20-20)T
- iii.** SARA Section 313 Toxic Chemicals - one hundred (100) pounds in the aggregate, exclusive of solvent or other medium or, one thousand (1000) pounds in the aggregate, inclusive of solvent or other medium.

(3-20-20)T

iv. SARA Section 311 and 312 Chemicals (Not listed in the List of Lists) for which OSHA MSDS must be developed pursuant to OSHA Hazard Communication Standards - five thousand (5000) pounds in the aggregate, inclusive of solvent or other medium. (3-20-20)T

**l.** Secondary Containment System. Site improvements and/or development criteria that are designed to isolate and prevent Critical Materials from entering the soil or surface or ground waters. (3-20-20)T

**m.** Rathdrum Prairie Aquifer (Aquifer). The underground water source identified and designated under the authority of Section 1424(e) of the Safe Drinking Water Act (PL 93- 523) (Federal Register, Vol. 43, No. 28 - Thursday, February 9, 1978). (3-20-20)T

**03. Applicability.** (3-20-20)T

**a.** This rule applies to any person, firm, corporation, or government agency owning, operating, or proposing to locate, establish, or operate a Fixed Facility over the Aquifer or within a recognized Aquifer recharge area in Kootenai County, Idaho. Any Fixed Facility so located shall comply with the requirements of this rule prior to initiation of operation or engaging in any Critical Materials Use Activity, if established after the effective date of this rule. Every owner or operator of a Fixed Facility needs to show compliance with this rule by obtaining a Critical Materials Compliance Certificate appropriate for current operations. (3-20-20)T

**b.** The following activities require a new application to the Panhandle Health District 1 to determine compliance with this rule: (3-20-20)T

i. Establishing a new use that could qualify as a Fixed Facility. (3-20-20)T

ii. Remodeling, operating changes, or expansion of an existing Fixed Facility which would modify the type or quantity of Critical Materials Use Activity. (3-20-20)T

iii. Changes in the location or method of use, storage, manufacture or handling of Critical Materials in any Fixed Facility. (3-20-20)T

iv. A change in ownership or addition of new Critical Materials meeting the quantity thresholds established by this rule at a Fixed Facility. (3-20-20)T

**c.** Any CMCC granted is specific to that action and the application filed therefore. Subsequent actions, meeting the criteria set by Subsection 400.03.b., shall require separate plan reviews and approvals to obtain compliance. (3-20-20)T

**d.** All businesses over the Rathdrum Prairie Aquifer in Kootenai County are subject to inspection in order to determine if they are governed by this rule. (3-20-20)T

**04. Application Requirements of Fixed Facilities Engaged in Critical Materials Use Activities.** Each applicant for a Critical Materials Compliance Certificate must provide. (3-20-20)T

**a.** Sufficient information to allow the Director to determine the type, quantity, and physical state of all Critical Materials that are used, stored, manufactured, or handled at the Fixed Facility location. The Director may require the applicant to provide a complete list of Critical Materials present at the Fixed Facility. (3-20-20)T

**b.** Building plans and site development drawings showing compliance with the secondary containment requirements established by this rule. Such plans shall also provide confirmation that the secondary containment methods are compatible with the materials to be contained and that Critical Materials at the Fixed Facility are isolated from storm water or other surface waters on the site. The Director may require that any such plans be certified by a licensed engineer. The building and/or site plans need to show at least the following: (3-20-20)T

- i. Location of Critical Materials in buildings and other designated site areas. (3-20-20)T
  - ii. Location of Key Box if needed by the local fire chief. (3-20-20)T
  - iii. Location of NFPA 704 placards if needed by the local fire chief. (3-20-20)T
  - c.** Proof of contact and resultant acknowledgment from the agencies named below which have codes, standards, and/or rules which must be met by the applicant with respect to handling of Critical Materials. The Director will designate the agencies needing contact for each Fixed Facility based upon information provided by the applicant. (3-20-20)T
    - i. Local Fire Department. (3-20-20)T
    - ii. Local Emergency Planning Committee. (3-20-20)T
    - iii. Kootenai County Department of Planning and Zoning. (3-20-20)T
    - iv. Kootenai County Building Department. (3-20-20)T
    - v. Applicable City Building Department. (3-20-20)T
    - vi. Applicable City Planning and Zoning Department. (3-20-20)T
    - vii. Bureau of Pesticides, Department of Agriculture. (3-20-20)T
    - viii. Department of Environmental Quality. (3-20-20)T
    - ix. Idaho Department of Water Resources. (3-20-20)T
  - d.** An opportunity for Panhandle Health District 1 to perform an inspection to assure compliance with secondary containment criteria previously approved through the plan review. If approved, and the agency review and reporting checklist (Subsection 400.04.d.) has been completed, a CMCC will be issued. The Director may delegate site inspection duties to officials of a cooperating agency. (3-20-20)T
- 05. Performance Standards for Fixed Facilities.** Each Fixed Facility, as defined in this rule, needs to conform to the following performance standards: (3-20-20)T
- a.** Construct and maintain a secondary containment system for all Critical Materials. Said secondary containment system shall be designed to prevent infiltration of any Critical Materials into the ground in the event that they are released from their original storage containers. (3-20-20)T
  - b.** The secondary containment system and methods must be non-reactive and resistant to the materials to be contained and isolate the Critical Materials at the Fixed Facility from storm water, other surface waters on the site, and from reactive critical materials present in the same Fixed Facility. (3-20-20)T
  - c.** Secondary containment systems must be sized to contain at least one-hundred and ten percent (110%) of the volume of the largest container, or ten percent (10%) of the aggregate volume of all containers, whichever is greater, in any containment area within a Fixed Facility. (3-20-20)T
  - d.** The owner or operator of any Fixed Facility shall report the presence of any Critical Materials Use Activities to the responsible local, state, and federal agencies as specified by statutes, rules, and provisions of this rule. (3-20-20)T
  - e.** Any spilling, leaking, emitting, discharging, escaping, or leaching of any Critical Material into the secondary containment system or the environment must be reported to Panhandle Health District 1 or the local fire department immediately upon discovery of the release. (3-20-20)T

**f.** Should conflict arise among the applications of local, state rules, and federal regulations regarding Critical Materials Use Activities, the rule that provides the greatest degree of protection to the Aquifer shall prevail, except where legal preemption of regulatory authority by state or federal agencies may require application of a different standard of protection. (3-20-20)T

**g.** Each Fixed Facility is subject to biennial inspection to verify continued compliance with these rules. (3-20-20)T

**06. Violation.** Any owner or operator of a Fixed Facility shall be deemed to have violated this rule if: (3-20-20)T

**a.** A Fixed Facility is operated or if Critical Materials Use Activities are conducted on any site without first procuring a Critical Materials Compliance Certificate or if changes are made to Critical Materials Use Activities at a Fixed Facility as set forth in Section 400.03.b. without reapplying for a CMCC for the Fixed Facility. (3-20-20)T

**b.** An owner or operator of a Fixed Facility submits knowingly false or incomplete reports to the Panhandle Health District or other responsible agencies or officials concerning the nature or quantity of Critical Materials present at a Fixed Facility governed by this rule. (3-20-20)T

**c.** An owner or operator fails to implement or maintain secondary containment of Critical Materials at a Fixed Facility as necessitated by this rule. (3-20-20)T

**d.** An owner or operator fails to comply with time and reporting standards for any Critical Materials Use Activities or fails to report any discharge of Critical Materials into the secondary containment system necessitated by this rule. (3-20-20)T

**401. -- 499. (RESERVED)**

**500. CONTAMINANT MANAGEMENT IN THE BUNKER HILL SUPERFUND SITE, SHOSHONE COUNTY, IDAHO.**

**01. Legal Authority.** The Idaho Legislature has given the Board of Health of the District the authority to promulgate rules governing contaminant management pursuant to Section 39-416, Idaho Code. (3-20-20)T

**02. Purpose.** The purpose of these rules is to ensure that activities involving excavations, building development, construction and renovation and grading within the Bunker Hill Superfund Site provide for the installation and maintenance of Barriers and implementation of other Contaminant management standards to preclude the migration of, and particularly, human exposure to Contaminants within the Site as necessary to protect the public health and the environment. It is imperative that redevelopment and future development proceed in a manner which minimizes the release of Contaminants into the air or water to minimize exposure to workers, Site residents and the communities. Further, it is the purpose of these rules to complement existing land use authorities and permitting processes, and to provide a screening process to determine whether proposed activities are subject to these rules. (3-20-20)T

**03. Written Interpretations.** This agency may have written statements and standards which pertain to the interpretation of the rules of this chapter, or to the documentation of compliance with the rules of this chapter. If available, written statements and standards can be inspected and copied at cost at the Panhandle Health District Office, Kellogg, Idaho. (3-20-20)T

**04. Administrative Appeals.** Persons may be entitled to appeal final agency actions authorized under this chapter pursuant to IDAPA 04.11.01, "Idaho Rules of Administrative Procedure of the Attorney General." (3-20-20)T

**05. Definitions.** The following terms are defined as follows: (3-20-20)T

**a.** Applicant. Any person, contractor, public utility, government or other entity that is required to



- apply for an ICP Permit. (3-20-20)T
- b.** Barrier. Any physical structure, material or mechanism which breaks the pathway between contaminants and human receptors, including but not limited to walls, floors, ceilings, soil, asphalt, concrete, fences, control over access, or other structure or covering which separates contaminants from contact with people or keeps contaminants in place. (3-20-20)T
- c.** Board. The Board of Health of the District. (3-20-20)T
- d.** B.O.P. Barrier Option Plan, which will be provided by an Applicant when required; such plans needs to set forth the location and type of Barrier which the Applicant intends to construct as part of the permitted work. (3-20-20)T
- e.** Building Renovation. Construction activity to be performed on any structure involving any ceiling or insulation removal or disturbance of soil in basements or crawl spaces. (3-20-20)T
- f.** Contaminants. Soil or other materials containing, or likely to contain, lead in excess of the levels established in Section 510 of these rules. (3-20-20)T
- g.** Director. The Director of the District. (3-20-20)T
- h.** Disposal. The placement of Contaminants into an authorized permanent repository. (3-20-20)T
- i.** District or PHD. The Idaho Public Health District No. 1 (also the Panhandle Health District). (3-20-20)T
- j.** Excavation. Any digging, breaching or disruption of a soil or other protective Barrier which may expose Contaminants to the environment. (3-20-20)T
- k.** Hearing Officer. A lawyer, engineer or other professional trained in conducting hearings, appointed by the Board for purposes of conducting hearings authorized by these rules. (3-20-20)T
- l.** ICP. The Institutional Controls Program for the Site. (3-20-20)T
- m.** ICP Permit. The Contaminant management authorization for projects subject to these rules. (3-20-20)T
- n.** Large Project. A project within the Site where one (1) cubic yard or more of soil containing Contaminants is disturbed or removed. Large Projects also include, but are not limited to, new building construction, demolition of existing buildings and construction of subdivisions and planned unit developments (PUD's) (and the infrastructure necessary to serve them) and construction within and maintenance of rights-of-way. (3-20-20)T
- o.** Owner. Any person, partnership, or corporation having ownership, title, or dominion over property for which an ICP permit is sought. (3-20-20)T
- p.** Record of Compliance. The record maintained by the District pursuant to Section 011 of these rules for Small Projects. (3-20-20)T
- q.** Site. The Area within the boundaries of the Bunker Hill Superfund Site Allocation Map dated December 10, 1993 attached as Appendix 1 to these rules. (3-20-20)T
- r.** Small Project. A project where less than one (1) cubic yard of soil containing Contaminants is disturbed or interior work that is not Building Renovation. (3-20-20)T
- s.** Working Day. Monday through Friday, but does not include any holiday recognized as such by the state of Idaho. (3-20-20)T

**06. Statement of Intent.** It is the intent of Idaho Public Health District No. 1 (the 'District') to work with local governments, the state of Idaho, the United States Environmental Protection Agency and private parties in managing Contaminants within the regulated area by way of an Institutional Controls Program (herein referred to as the ICP). These rules establish standards for Barrier installation and maintenance, and other Contaminant management practices. These rules govern management of Contaminants by: (3-20-20)T

- a. Requiring ICP permits and requiring barriers for certain construction and excavation activities; (3-20-20)T
- b. Licensing contractors, utilities, and government entities which may disrupt or install Barriers, or otherwise disturb Contaminants; (3-20-20)T
- c. Adopting performance standards; (3-20-20)T
- d. Inspecting for project compliance as required; (3-20-20)T
- e. Regulating the movement and disposal of Contaminants; (3-20-20)T
- f. Making it unlawful to knowingly disrupt a barrier in a fashion likely to expose persons to contaminants. (3-20-20)T

**07. Additional Provisions by District.** In conjunction with these Rules it is the intent of the District to provide, as needed: (3-20-20)T

- a. Technical assistance and testing; (3-20-20)T
- b. Health screening and intervention; (3-20-20)T
- c. That there will be a readily available repository for Contaminants; (3-20-20)T
- d. Clean soil to restore Barriers for Small Projects; (3-20-20)T
- e. Disposal containers to assist in removing contaminated soil for Small Projects and transport and disposal of such soil; (3-20-20)T
- f. Health and safety information and education to licensees and the public; (3-20-20)T
- g. Plastic, gravel and use of vacuums for interior projects; (3-20-20)T
- h. A database tracking system to assist the public, lenders, and potential purchasers of property within the Site; and (3-20-20)T
- i. Guidelines for managing Contaminants. (3-20-20)T

**501. -- 509. (RESERVED)**

**510. THE BUNKER HILL SUPERFUND SITE; APPLICATION OF REGULATIONS.**

These rules apply to the Bunker Hill Superfund Site in Shoshone County, Idaho, more particularly as shown on the Bunker Hill Superfund Site Allocation Map identified as Appendix 1 to these rules. These rules do not apply to operations undertaken at the direction of, under the supervision of, and subject to inspection by, the United States Environmental Protection Agency. (3-20-20)T

- 01. Standards Adopted.** (3-20-20)T
  - a. All Barriers now or hereinafter constructed within the Site shall be maintained and protected. (3-20-20)T

**b.** Except as otherwise provided in this section, Contaminant management is required in connection with any Large or Small Project or Building Renovation involving the breaching or disturbance of a Barrier or the disturbance or migration of Contaminants exceeding one thousand (1000) ppm lead. (3-20-20)T

**c.** No new PUD or subdivision may be occupied where the average concentration of Contaminants exceeds three hundred fifty (350) ppm lead or a single lot exceeds one thousand (1000) ppm lead without Contaminant management on any portion of the property that exceeds these levels. (3-20-20)T

**d.** As necessary to protect public health and the environment, PHD may impose Contaminant management requirements, other than Barrier installations, on projects where soils exhibit lead concentrations in excess of three hundred fifty (350) ppm lead, particularly where a property has been remediated with either six (6) or twelve (12) inches of clean fill but Contaminants in the three hundred fifty to one thousand (350 - 1000) ppm lead range remain below the six (6) or twelve (12) inch depth and those Contaminants may be disturbed by a Large or Small Project. (3-20-20)T

**e.** No person may conduct, except in accordance with these rules, any activity within the Site which breaches a Barrier, may breach a Barrier, or disturbs the same, or otherwise results in a threat to public health or the environment from the migration of Contaminants through tracking on tires or vehicles, visible airborne dust, excavation, transport, disposal, remodeling, demolition, or run-on or run-off from stormwater or in any other manner. (3-20-20)T

**02. Barriers; Construction and Maintenance.** (3-20-20)T

**a.** Barriers are required as necessary to attain the standards described in Section 510. Temporary Barriers also may be required to prevent the migration of Contaminants during construction activities. (3-20-20)T

**b.** Types of acceptable Barriers for specific uses and activities are set forth in Appendices 3, 4, and 5. (3-20-20)T

**c.** All twelve (12) inch permanent permeable exterior Barriers required to be installed under the ICP which overlay soils having lead levels in excess of one thousand (1000) ppm shall have an underlying visual delineator at the twelve (12) inch depth. Visual delineators are not required if the soil underlying the Barrier has tested under one thousand (1000) ppm lead. Permanent impermeable Barriers such as concrete and asphaltic concrete do not require delineators. (3-20-20)T

**d.** The minimum Barrier requirements for residential properties and other properties that are frequently used by children (zero (0) to twelve (12) years) and/or pregnant women are as follows: (3-20-20)T

**i.** All soil which contains lead in excess of one thousand (1000) ppm and lies within twelve inches (12") of the final grade shall be removed, replaced, or covered as appropriate with clean earthen material such that, after all work is completed, the soil remaining in the top twelve inches (12") has less than one thousand (1000) ppm lead. Replacement material must meet the requirements listed in Section 008.06. Acceptable soil removal and Barrier thicknesses for these properties are set forth in Appendix 6. (3-20-20)T

**ii.** Any such property with unrestricted access to an adjacent property not meeting the requirements of Subsection 510.02.a. shall restrict access to such adjacent property. (3-20-20)T

**e.** The minimum Barrier requirements for properties that are not frequently used by children (zero (0) to twelve (12) years) and/or pregnant women are as follows: (3-20-20)T

**i.** All soil which contains lead in excess of one thousand (1000) ppm and lies within six inches (6") of the final grade shall be removed, replaced, or covered as appropriate with clean earthen material such that, after all work is completed, the soil remaining in the top six inches (6") has less than one thousand (1000) ppm lead, and the replacement material meets the requirements listed in Section 510.02.f. (3-20-20)T

**ii.** Acceptable soil removal and Barrier thicknesses for these properties are set forth in Appendix 7. (3-20-20)T

f. No earthen materials containing, on average, more than one hundred (100) ppm of lead or arsenic, nor more than five (5) ppm of cadmium, with no individual sample containing more than one hundred fifty (150) ppm of lead, shall be utilized for a Barrier. (3-20-20)T

g. Should any inconsistency exist between the wording of these rules and the wording in any appendix, the wording in the rule supercedes the wording in the appendix. (3-20-20)T

**03. ICP Permits.** (3-20-20)T

a. ICP Permits are required for: (3-20-20)T

i. Large projects; (3-20-20)T

ii. Building renovations. (3-20-20)T

b. A permit is required for a change in use of property which has Contaminants located thereon to a use which requires an additional or more substantial Barrier; constructing or establishing such additional Barriers shall be required, unless waived by the District. (3-20-20)T

c. A single annual permit covering a specific list of projects may be obtained from the District by entities eligible under Section 015 at the beginning of each year's construction season. (3-20-20)T

**511. CONTAMINANT MANAGEMENT RULES IN THE BUNKER HILL SUPERFUND SITE OPERABLE UNIT #3 INSTITUTIONAL CONTROLS ADMINISTRATIVE AREA, SHOSHONE AND KOOTENAI COUNTIES, IDAHO.**

**01. Purpose.** The purpose of these Rules is to ensure that activities associated with excavation and grading such as infrastructure development and maintenance; building construction and renovation; and land development, redevelopment and/or modification within the Institutional Controls Administrative Area of the Bunker Hill Superfund Site Operable Unit #3 (OU-3) provide for the construction and maintenance of Contaminant Barriers and implementation of other Contaminant management requirements to preclude the release and migration of Contaminants as necessary to protect the public health and the environment. It is imperative that current and future development and construction activities proceed in a manner which minimizes the release of Contaminants into the environment to minimize exposure to Area residents, communities, to workers involved in Area project work, and to environmental receptors. Further, it is the purpose of these Rules to complement existing land use regulations and permitting processes, and to provide a screening process to determine whether proposed activities are subject to these Rules. These Rules will rely upon procedures and provisions applicable to the Institutional Controls Program set forth in Section 500 of these rules. Differences identified in Sections 511 and 512 of these rules, is deemed applicable only to the lands encompassed by OU-3. (3-20-20)T

**02. Implementation Policy and Standards.** Implementation policy and standards which pertain to the interpretation and enforcement of these Rules or to the documentation of compliance with these Rules have been developed by PHD and are available for inspection and/or copying at cost at the PHD office, 114 West Riverside Avenue, Kellogg, Idaho. (3-20-20)T

**03. Administrative Appeals.** Persons may be entitled to appeal final PHD actions authorized under this chapter, pursuant to IDAPA 04.11.01, "Idaho Rules of Administrative Procedure of the Attorney General." (3-20-20)T

**04. Definitions.** The following terms are defined as follows: (3-20-20)T

a. Agricultural Land. Land used for pasturing animals or for cultivation and production of agricultural crops including conservation reserve activities. (3-20-20)T

b. Applicant. Any person, contractor, public utility, government or other entity that is required to apply for an Institutional Controls Program (ICP) Permit. (3-20-20)T

- c.** Access Restrictions. Physical barriers such as fences, barricades, curbs, barrier rocks, trenches, etc. that provide restricted access by vehicles, pedestrians, and animals to contaminated areas. (3-20-20)T
- d.** Barrier. Any physical structure, material or mechanism which acts to break the pathway between Contaminants and human receptors, including but not limited to soil, crushed aggregate/gravel, asphalt and Portland cement concrete, fences, access restrictions, or other structure or covering which separates Contaminants from contact with people or keeps Contaminants in place. (3-20-20)T
- e.** Board. The Board of Health of the Idaho Public Health District No. 1. (3-20-20)T
- f.** B.O.P. Barrier Option Plan, a plan which will be provided by an Applicant, when required, that sets forth the location and type of Barrier which the Applicant intends to construct as part of the permitted work. (3-20-20)T
- g.** Building Construction. Construction activity to be performed for any new structure involving disturbance of soil in excess of one cubic yard. (3-20-20)T
- h.** Building Renovation. Construction activity to be performed on any existing structure involving ceiling or insulation removal, work in dirt crawl spaces or basements, or disturbance of soil in excess of one cubic yard. (3-20-20)T
- i.** CERCLA. Comprehensive Environmental Response, Compensation, and Liability Act. (3-20-20)T
- j.** Commercial Property. Retail, wholesale and secondhand businesses; public and common use areas; public buildings; and undeveloped properties accessed by a maintained road or street and zoned for commercial development as of the date of promulgation of these Rules. (3-20-20)T
- i.** Type I. Commercial Property predominantly used by Sensitive Populations (e.g. daycare facilities, municipal parks, playgrounds, etc.) (3-20-20)T
- ii.** Type II. All other Commercial Property. (3-20-20)T
- k.** Contaminants. Soil or other material containing, or likely to contain, concentrations of lead equal to or greater than one thousand (1000) ppm or concentrations of arsenic equal to or greater than one hundred (100) ppm. (3-20-20)T
- l.** Developed Recreation Area. Commercial and public recreation areas containing constructed features such as boat ramps, picnic areas, and campgrounds outside the city limits of incorporated communities in the Coeur d'Alene River corridor as defined in Subsection 511.04.s. of these rules. The Developed Recreation Areas of the Trail of the Coeur d'Alenes includes all constructed trail surfaces, stop and views, oases (rest stops) and trailheads, exclusive of all undeveloped areas within the trail right of way. (3-20-20)T
- m.** Director. The Director of the Idaho Public Health District No. 1. (3-20-20)T
- n.** Disposal. The placement of Contaminants into an authorized repository. (3-20-20)T
- o.** Environmental Office. PHD office in Kellogg, ID. (3-20-20)T
- p.** Excavation – Any digging, breaching or disruption of soil not including cultivation of Agricultural Lands and gardens or mining activities regulated under other state and federal programs which may release or expose Contaminants to the environment. (3-20-20)T
- q.** Health Officer. The Director or designee. (3-20-20)T
- r.** Hearing Officer. An attorney, engineer or other professional trained in conducting hearings, appointed by the Board for purposes of conducting hearings authorized by these Rules. (3-20-20)T

- s.** Institutional Controls Administrative Area. The Area designated by the Administrative Area Map in Appendix 2 which includes areas of mining, milling, and smelting related contamination in the South Fork of the Coeur d'Alene River corridor from its headwaters to the confluence with the North Fork Coeur d'Alene River and from the confluence of the North and South Fork to the mouth of the River and its confluence with Coeur d'Alene Lake including adjacent floodplains, tributaries, and fill areas. The Area also includes the Trail of the Coeur d'Alenes inside and outside the administrative boundary indicated on the map in Appendix 2 except that portion within the exterior boundaries of the Coeur d'Alene Indian Reservation. The Area does not include any area within OU-1 and OU-2 (Box) which has a separate ICP, or any other area excluded under this rule. The Area also includes areas in the Coeur d'Alene River corridor, as defined above, outside the administrative boundary indicated on the map in Appendix 2 where testing has verified that Contaminants related to mining, milling, and smelting have come to lie and remediation is required. (3-20-20)T
- t.** ICP. The Institutional Controls Program for the Institutional Controls Administrative Area as defined in Subsection 511.05.s. of these rules. (3-20-20)T
- u.** ICP Permit. The Contaminant management authorization for projects subject to these Rules. (3-20-20)T
- v.** Infrastructure. Facilities such as trails, roads, streets, highways, bridges; storm water, drinking water, and wastewater systems; flood prevention systems including dikes and levees; and utilities including electrical power and natural gas systems. (3-20-20)T
- w.** Large Project. A project where one cubic yard or more of soil containing Contaminants is disturbed or removed. Large Projects include, but are not limited to, infrastructure construction and maintenance, building construction, renovation, and demolition, land development or any change in the use of land that may result in the release or migration of Contaminants. (3-20-20)T
- x.** Owner. Any person, partnership, or corporation having ownership, title, or dominion over property for which an ICP permit is required. (3-20-20)T
- y.** PHD. The Idaho Public Health District No. 1 (also the Panhandle Health District). (3-20-20)T
- z.** PUD. Planned Unit Development. (3-20-20)T
- aa.** Record of Compliance. The record maintained by the PHD pursuant to Section 523 of these rules for Small Projects. (3-20-20)T
- bb.** Release. Any excavation, spilling, leaking, pumping, pouring, emitting, emptying, discharging, injecting, escaping, dumping, or disposing of Contaminants into the environment. (3-20-20)T
- cc.** Residential Property. Property used by private individuals or families as a residence, and undeveloped properties accessed by a maintained road or street and zoned for residential development as of the date of promulgation of these Rules. (3-20-20)T
- dd.** Sensitive Populations. Pregnant women and children up to twelve (12) years old. (3-20-20)T
- ee.** Small Project. A project where less than one (1) cubic yard of soil containing Contaminants is disturbed or interior work that is not Building Renovation. (3-20-20)T
- ff.** Trail of the Coeur d'Alenes. All Developed Recreation Areas and undeveloped areas within the former Union Pacific Railroad Mullan and Wallace Branch right of way. (3-20-20)T
- gg.** Working day. Monday through Friday, excluding any legal holiday recognized as such by the State of Idaho. (3-20-20)T
- 05.** **Statement of Intent.** It is the intent of the PHD to work with local governments, the State of Idaho,

the United States Environmental Protection Agency, Federal Land Management Agencies (Bureau of Land Management, USDA Forest Service), Coeur d'Alene Tribe, and private parties in managing Contaminants within the regulated Institutional Controls Administrative Area by way of an ICP. These Rules establish standards for Barrier construction and maintenance, and other Contaminant management practices. These Rules do not address financial liability for Contaminant management resulting from a failure of a CERCLA remedy due to a natural disaster. These Rules govern management of Contaminants by: (3-20-20)T

- a. Requiring ICP permits and requiring barriers for certain construction and excavation activities; (3-20-20)T
- b. Licensing contractors, utilities, and state and local government entities which may disrupt or construct Barriers, or otherwise disturb Contaminants; (3-20-20)T
- c. Adopting performance standards; (3-20-20)T
- d. Inspecting for project compliance as required; (3-20-20)T
- e. Regulating the movement and disposal of Contaminants; (3-20-20)T
- f. Making it unlawful to knowingly disrupt a barrier in a fashion likely to expose persons or the environment to Contaminants; (3-20-20)T
- g. Maintaining records of ICP activities. (3-20-20)T

**06. Additional Provisions by PHD.** In conjunction with these Rules it is the intent of the PHD to provide, depending on project size and complexity and at the discretion of PHD: (3-20-20)T

- a. Technical assistance and soil testing; (3-20-20)T
- b. Health screening and intervention; (3-20-20)T
- c. Readily available repositories for disposal of Contaminants; (3-20-20)T
- d. Clean material to restore Barriers for Small Projects; (3-20-20)T
- e. Disposal containers for Small Projects to assist in removal, transportation and disposal of contaminated soil; (3-20-20)T
- f. Health and safety information and education to licensees and the public; (3-20-20)T
- g. Sheet plastic, crushed aggregate and gravel, or other items as appropriate; (3-20-20)T
- h. A database tracking system to assist the public, lenders, and prospective purchasers of property within the Institutional Controls Administrative Area; (3-20-20)T
- i. Guidelines for managing Contaminants. (3-20-20)T

**512. APPLICATION OF REGULATIONS; INSTITUTIONAL CONTROLS ADMINISTRATIVE AREA.** These Rules apply to the Institutional Controls Administrative Area as defined in Subsection 511.05.s. of these rules. These Rules do not apply to the direct operations of the United States Environmental Protection Agency including directing, supervising, and inspecting project work or on lands owned or otherwise under the jurisdiction, custody and control of the Coeur d'Alene Tribe or the Federal Land Management Agencies such as the USDA Forest Service and the Bureau of Land Management. These Rules do not apply to the Union Pacific Railroad or its contractors when conducting activities within the Trail of the Coeur d'Alenes pursuant to the requirements of the Consent Degree entered August 25, 2000 by the United States District Court for the District of Idaho (Case Nos. 91-0342 and 99-606). (3-20-20)T

**01. Standards Adopted.** (3-20-20)T

**a.** Except as otherwise provided in Section 512 of these rules, contaminant management is required on all properties within the Institutional Controls Administrative Area including properties that have been remediated; properties tested and scheduled for remediation; properties not yet tested; and properties testing below action levels in the top eighteen (18) inches where Large or Small Projects may disturb Contaminants below eighteen (18) inches in excess of one thousand (1000) ppm lead or one hundred (100) ppm arsenic. Contaminant management may include testing of untested areas by the Applicant; testing of deep soils (below eighteen (18) inches) by the Applicant where a project may result in deep excavations; and replacement and repair of remediation Barriers in accordance with Subsection 512.02 of these rules; or other management activities. Contaminant Management on Residential Properties and Commercial Properties existing as of the date of promulgation of these Rules and requiring remediation, but not yet remediated will not require construction of final barriers in accordance with Subsection 512.02 of these rules, by the owner, but may require dust, erosion, health and safety and temporary cap controls to prevent further migration onto lands of others. Final barrier construction will be the responsibility of the state of Idaho and United States Environmental Protection Agency if needed. Applicant performed soil testing will be conducted consistent with sampling and analytic procedures developed by PHD. (3-20-20)T

**b.** Developed Recreation Areas with surface soil containing lead concentrations greater than seven hundred (700) ppm lead and one hundred (100) ppm arsenic shall be capped pursuant to Subsection 512.02.c. of these rules. (3-20-20)T

**c.** Agricultural and undeveloped land within the Institutional Controls Administrative Area are exempt from these Rules unless excavation and grading activities such as soil transport off site or development by the owner or his/her agents on these lands is likely to result in the release or migration of Contaminants from these lands to adjacent non-agricultural or undeveloped areas. (3-20-20)T

**d.** All Barriers existing or hereinafter constructed shall be maintained and protected to original construction specifications. (3-20-20)T

**e.** No new PUD or subdivision containing concentrations of Contaminants exceeding one thousand (1000) ppm lead or one hundred (100) ppm arsenic shall be developed without Contaminant management. (3-20-20)T

**f.** No person may conduct, except in accordance with these Rules, any activity within the Institutional Controls Administrative Area which breaches a Barrier, may breach a Barrier, or disturbs the same, or otherwise results in a threat to public health or the environment from the migration of Contaminants through tracking on tires or vehicles, visible airborne dust, excavation, transport, disposal, renovation, demolition, or run-on or run-off from stormwater or in any other manner on properties tested and requiring remediation and on properties not yet tested within the Institutional Controls Administrative Area (3-20-20)T

**02. Barriers; Construction and Maintenance.** (3-20-20)T

**a.** The minimum Barrier construction requirements for Residential and Type I Commercial Properties are as follows: (3-20-20)T

**i.** All soil which contains lead equal to or in excess of one thousand (1000) ppm or arsenic equal to or in excess of one hundred (100) ppm and lies within twelve (12) inches of the final grade shall be removed and replaced with replacement material meeting the requirements of Subsection 512.02.d. of these rules. (3-20-20)T

**ii.** Any such property with unrestricted access to an adjacent property not meeting the requirements of Subsection 512.01.a. of these rules, shall restrict access to such adjacent property. (3-20-20)T

**b.** The minimum Barrier construction requirement for Type II Commercial Properties is a six (6) inch soil with vegetative cover barrier or six (6) inch crushed rock/gravel barrier or asphalt/Portland cement concrete cap. Excavation may be necessary for the installation of barriers to maintain grade or drainage requirements. (3-20-20)T

**c.** The minimum Barrier construction requirement for Developed Recreation Areas is a six (6) inch



soil with vegetative cover barrier or six (6) inch crushed rock/gravel barrier or asphalt/Portland cement concrete cap. Excavation may be necessary for the installation of barriers to maintain grade or drainage requirements. (3-20-20)T

**d.** All twelve (12) inch deep Barriers of soil or crushed rock/gravel required pursuant to the ICP which overlay soils having concentrations of lead equal to or greater than one thousand (1000) ppm or arsenic concentrations equal to or greater than one hundred (100) ppm shall have an underlying visual delineator at the twelve (12) inch depth. Visual delineators are not required if the soil underlying the Barrier has tested under one thousand (1000) ppm lead and one hundred (100) ppm arsenic. Cap Barriers such as Portland cement and asphalt concrete do not require delineators. (3-20-20)T

**e.** Soil and crushed aggregate/gravel imported for barrier material shall contain less than one hundred (100) ppm lead, thirty five (35) ppm arsenic and five (5) ppm cadmium based on average of backfill sampling results. No single sample of replacement materials may exceed one hundred fifty (150) ppm lead or forty five (45) ppm arsenic. (3-20-20)T

**f.** Barriers needs to be maintained and repaired to original construction specifications. (3-20-20)T

**g.** Contaminated waste material generated in the construction, maintenance and repair of Barriers shall be disposed of in designated repositories or as directed by PHD. (3-20-20)T

**03. ICP Permits.** (3-20-20)T

**a.** Permits are required for Large Projects and Building Renovations. (3-20-20)T

**b.** A permit is required for a project which changes the use of a property containing Contaminants. A new Barrier or additional or more substantial Barrier may be required unless waived by the PHD. (3-20-20)T

**c.** A single annual permit covering a specific list of projects may be obtained from the PHD by entities eligible under Section 531 of these rules, at the beginning of each year's construction season. (3-20-20)T

**513. -- 519. (RESERVED)**

**520. PERMIT APPLICATION AND ADMINISTRATION.**

**01. Application for ICP Permit.** Application for an ICP Permit shall be made in writing at the Kellogg office of the District on forms provided by the District. (3-20-20)T

**02. Applicant Information.** All Applicants shall provide the following information when applying for an ICP Permit with the District: (3-20-20)T

**a.** Name, address and telephone number of the Applicant and the property owner. (3-20-20)T

**b.** Location of the work and whether the work is being done on private or public property, or both. (3-20-20)T

**c.** Description of work. The description must include methods of handling or storing, and transporting contaminated materials. A site plan may be required by the District if one has not been provided pursuant to the permit process. (3-20-20)T

**d.** Dates work will be started and completed. (3-20-20)T

**e.** Such other information as the District requires. (3-20-20)T

**03. Use of Discretion on Requirements by District.** The District may, at its own discretion, waive certain application requirements or information, or require additional or alternative actions or information, depending upon the type and extent of the project and conditions encountered. In no instance may a waiver violate the intent of this rule and/or the Record of Decision for the relevant Operable Unit. (3-20-20)T

**04. Site Inspection or Waiver When Permit Required.** Work requiring a permit may not commence until a site inspection has been made or waived by the District and a permit has been issued. (3-20-20)T

**05. Other Inspections and Requirements.** All permits granted pursuant to this Rule remain subject to such other inspections and requirements prescribed by state or local governments. (3-20-20)T

**06. Work Involving Public Right-of-Way.** If the permit involves work within any public right-of-way, the appropriate agencies must be notified of the work by the entity receiving the permit. (3-20-20)T

**521. INSPECTION.**

The Applicant shall notify the District by telephone when work is completed. Applicants shall call for inspection in accordance with the terms of the permit; forty-eight (48) hours notice (excluding weekends and holidays) to PHD needs to be provided. The inspector will note approval of the work in writing and enter same in the database tracking system, or note reasons for disapproval and steps which must be taken to complete the work. Upon completion of the work to the District's satisfaction, the District's final approval will be noted in the database tracking system. Such entry constitutes the Record of Compliance for such project. All work governed by these regulations is subject to inspection by the District or its designated agents and it is unlawful to obstruct or hinder any official, inspector or designated agent making an inspection. The District may obtain an inspection warrant if access to the property is refused. The District reserves the right to waive the inspection requirement. (3-20-20)T

**522. PERMIT REVOCATION OR STOP WORK ORDER.**

Any Permit may be revoked or a Stop Work Order may be issued, without notice by the District, for non-compliance with or violation of any of the provisions of this chapter or any requirement or limitation of the Permit. If a Permit is revoked, the District may take such steps as are necessary to eliminate any danger from contamination, including completion of work by the District. The Applicant, contractor and/or Owner may be required to pay all costs and expenses for abatement of any danger and/or completion of the project, including legal fees incurred by the District to obtain compliance. The District will endeavor to provide written notice, but reserves the right to act summarily to protect public health and the environment. (3-20-20)T

**523. RECORD OF COMPLIANCE.**

A Record of Compliance for Small Projects which documents compliance with the performance standards established by these rules will be entered into the database tracking system based upon an inspection requested of PHD by the property owner or tenant. The Record signifies the property owner or tenant was informed of and provided with applicable performance standards and guidelines and materially complied with the same. (3-20-20)T

**524. -- 529. (RESERVED)**

**530. CONTRACTOR LICENSING.**

**01. License Required.** Any contractor performing Large Projects, Building Renovation or transportation or disposal of Contaminants within the Site or the Institutional Controls Administrative Area which is likely to expose the contractor, workers or others to Contaminants, must be licensed by the District. There will be no charge for a contractor's license. It is unlawful for a contractor to work on a project requiring an ICP permit without a current contractor's license issued by PHD. A contractor's license will not be required of an owner working on his or her own property. (3-20-20)T

**02. Training.** In order to obtain a contractor's license from the District, the Contractor must have those supervisors involved in activities dealing with Contaminants participate in training approved by the District and pass an annual examination focusing on the reasons for, and methods of, controlling Contaminants. The purpose of the examination is to assure that all of the Contractor's employees are aware of and observe the procedures and standards that will protect themselves and the public from the Contaminants. The District will create and administer the test. The trained supervisor must pass information on to employees as is necessary to protect their health and safety and assure compliance with these rules. The District will provide training which owners and employees may participate in. (3-20-20)T

**03. Bonding.** Any contractor whose license has been revoked by the District within the past three (3)

years must, as a condition of reinstatement and maintaining the status of a licensed contractor, be bonded in the minimum amount of two-thousand dollars (\$2000). Said bond shall be at least five percent (5%) of the cost of any contract the contractor is engaged in whichever is greater, be in a form approved by the District, and must be suitable to insure payment for completion of Barrier work not completed by the Contractor. A cash deposit or other security acceptable to the District may be utilized in lieu of a bond. The District may establish a bonding program for all contractors, if deemed necessary to carry out these Rules. (3-20-20)T

**04. Suspension or Revocation of License.** (3-20-20)T

**a.** Upon a showing that a licensee has violated any provision of these Rules, or has violated any other health or building code within the boundaries of the Site or Institutional Controls Administrative Area, suspension or revocation of license may be imposed. Suspension may be made by any District health officer. Revocation may be made by the Director upon recommendation of the District health officer. Notification of suspension or revocation must be in writing. No suspension may be made for more than thirty (30) days without approval of the Director. Revocation of license may be made by the Director upon a showing of good cause. (3-20-20)T

**b.** Appeal. Suspension or revocation may be appealed by the licensee to the Board in writing within thirty (30) days of receipt of notice of suspension or revocation. Appeal stays the suspension or revocation unless the Director makes a finding that such stay is likely to present a health risk to a person or persons. (3-20-20)T

**c.** Any decision by the Board pertaining to a suspension or revocation of a license may be made only after a licensee has been accorded an opportunity for hearing at which the licensee has a right to appear and be heard, to be represented by counsel, to testify, to present evidence, to call witnesses and to rebut any evidence presented. A transcribable recording of all such hearings will be made and retained for at least six (6) months. Such hearing may be conducted by a hearing officer designated by the Board or by the Board itself. (3-20-20)T

**d.** If a license is revoked, the contractor may, upon payment of any cleanup or remediation costs related to past work, reapply for reinstatement of license after one (1) year, however, a contractor whose license has been revoked may not obtain a new license under a different corporate or partnership status until this provision is satisfied. (3-20-20)T

**531. LICENSES FOR PUBLIC UTILITIES AND GOVERNMENT ENTITIES.**

Upon a demonstration that supervisory employees of a public utility or government entity (city, county, special purpose district, or state of Idaho) have participated in an education program approved by, or provided by, the District, a utility company or government entity may receive an annual license which will allow their employees to perform excavation and grading operations without obtaining individual ICP permits. This license may be granted by the District and will require that the utility comply with performance standards and all other regulations contained herein or adopted by Resolution of the Board. All supervisory employees involved in and responsible for excavation and grading operations shall have participated in a District approved education program. The trained supervisor must pass information on to employees as is necessary to protect their health and safety and assure compliance with these rules. The District will provide training which owners and employees may participate in. Entities licensed under this section shall maintain a log of all excavations and grading operations on a form approved by the District. Such logs need to be forwarded to the District on a regular basis determined by the District. All licensees shall telephone the Shoshone or Kootenai County one-call locating service, as appropriate, prior to any excavation or grading operations. Licenses shall be renewed annually upon a showing that the utility or government entity has operated in compliance with this rule. This license may also be revoked as provided in Subsection 530.04. (3-20-20)T

**532. -- 539. (RESERVED)**

**540. PERFORMANCE OF WORK.**

**01. Completion of Work.** All work done pursuant to an ICP Permit shall be completed in a neat and workmanlike manner and so scheduled as to cause the minimum interference with traffic or public use (if applicable) and a minimum dispersal of Contaminants. (3-20-20)T

**02. Work Delayed by Applicant.** If the work is unduly delayed by the Applicant, and if the public interest reasonably so demands, the District has the authority, upon twenty-four (24) hours' written notice to the

Applicant, to complete the work to the extent that the Barrier is restored and any hazardous material covered or removed. The actual cost of such work by the District (including legal fees), plus fifteen percent (15%) as an overhead charge, shall be charged to and paid by, the Applicant and/or the Owner. (3-20-20)T

**541. PERFORMANCE STANDARDS.**

The Board will adopt, and from time to time amend, performance standards by Resolution; said standards to ensure that work is performed in a safe and responsible manner and specify how work will be completed. Said standards shall be applicable to, but not be limited to, the following: materials handling; dust control; erosion/runoff control; disposal; transportation; barrier construction; demolition; renovation; grading; and subdivision development. Performance standards so adopted will not amend any standard adopted within these rules, and these rules apply should any conflict arise between a rule and a performance standard. (3-20-20)T

**542. APPROVAL OF ALTERNATIVE STANDARDS.**

Any person aggrieved by the substantive requirements of these rules or the performance standards, may appeal these requirements by providing a written request for approval of an alternative standard. The appeal shall be accompanied by an engineering report indicating why the appealing party should be relieved of the requirement for compliance or why the requested alternate standard is appropriate. At the Applicant's expense, the District may consult with its own engineer to confirm the applicability of these rules to the proposed project. The District health officer may approve an alternate standard where such approval does not jeopardize the public welfare or existing Barriers. The decision of the District health officer will be in writing, stating the reasons therefor. (3-20-20)T

**543. OWNER AND APPLICANT RESPONSIBILITY FOR CLAIMS AND LIABILITIES.**

Both the Owner and the Applicant are responsible to ensure that all rules contained herein are complied with. Applicant is responsible for all claims and liabilities arising out of work performed by the Applicant under the ICP Permit or arising out of the Applicant's failure to perform obligations with respect to these regulations. Owner is responsible for all claims and liabilities for work done by the Owner with or without a permit and for work done at the direction of the owner without a permit. Owner remains responsible to complete the project or restore the premises to a safe condition to the satisfaction of the District should the Applicant fail to complete or restore it. (3-20-20)T

**544. -- 899. (RESERVED)**

**900. ADMINISTRATIVE PROCEDURES, EXCEPTIONS, PENALTIES.**

**01. Responsibility of Permit Applicant.** It is the responsibility of any person applying for, or required to apply for, a permit by this Code, to show affirmatively, by all reasonable means, that his undertaking complies with this Code or with any related rules, statutes, or ordinances. (3-20-20)T

**02. Permit Revocation.** Any permit or permission, actual or implied, granted by the Health Officer or his predecessors may be revoked, for cause, by written notice sent to the permit holder or his agent. Any person, association, or corporation who continues to act under such permit or permission actual or implied, more than ten days after the sending or delivery of notice of revocation is presumed to be in violation of this code and subject to the penalties provided herein. (3-20-20)T

**03. Variance Standards.** A variance may be granted only upon an affirmative showing by an applicant that a unique and undue hardship is caused by a physical characteristic of a site that is not of the applicant's making and that approval of the variance would not be contrary to the public interest or to the purposes of the Code. (3-20-20)T

**04. Variance Procedures.** (3-20-20)T

**a.** An applicant for a variance shall obtain a Variance Application Form from Panhandle Health District 1 and, after completing the application form, return it to the Environmental Office. The Variance Application shall require the applicant to provide, in addition to information required by the application form itself, the following (3-20-20)T

**i.** An accurate site plan showing development of the site in question, present and proposed, depicting

all features relevant to the variance request. The Director, or his designee, shall identify information necessary to proper processing of the request if information other than that normally required needs to be supplied. The applicant shall describe the current and proposed use of the site in question. (3-20-20)T

ii. A narrative statement addressing the efforts, including consideration of design alternatives, which the applicant has undertaken to comply with the rule from which a variance is sought. (3-20-20)T

iii. A narrative statement explaining the nature of the hardship, if any, imposed by literal compliance with the rule in question. (3-20-20)T

iv. A narrative statement explaining the effects of the requested variance on the interests of adjoining landowners and/or of the public at large. (3-20-20)T

v. A narrative statement detailing what use could be made of the site in question if the requested variance were not granted. (3-20-20)T

b. The completed Variance Application shall be returned to the Environmental Office accompanied by an initial filing fee as established by the Board. The completed application shall be submitted to the Panhandle Health District 1 Hearing Officer who will determine whether, on its face, it sets forth a colorable claim for a variance from the Code. If the Hearing Officer determines that the application does not set forth a colorable claim for variance, he will return the application to the applicant with a written explanation of the action taken. Said initial determination and the accompanying explanation will be forwarded to the Board which will act upon the Hearing Officer's initial determination by affirming it or remanding it to the Hearing Officer for further proceedings. (3-20-20)T

c. If the Hearing Officer determines that the application presents a colorable claim for a variance, he shall return the application to the Environmental Office with instructions to prepare a notice of public hearing concerning the requested variance. The applicant shall pay an additional processing fee if the Hearing Officer makes such a finding. Said fee may be adjusted as with all other Panhandle Health District 1 fees in accordance with a sliding scale coordinated with Federal poverty standards. (3-20-20)T

d. The Environmental Office staff will notify the applicant that his application has passed the initial screening and that the names and mailing addresses, on self-adhesive labels, of all owners of land located within three hundred (300) feet of the external boundaries of the site in question must be provided. Said names will be provided or checked by a land title company or other business whose commercial purpose it is to provide such information. The applicant is solely responsible for the accuracy of such information. (3-20-20)T

e. Using the mailing list provided by the applicant, notice of public hearing will be sent by first class mail and posted on the site in question in a conspicuous manner. The Environmental Office will maintain records verifying completion of the notification process. Mailing and posting shall be accomplished at least fifteen (15) days prior to the date of the hearing established by the Hearing Officer. (3-20-20)T

f. Upon the appointed date, the Hearing Officer shall conduct a public hearing concerning the variance request. The applicant, Panhandle Health District 1 staff, interested members of the public, and public agency representatives will be allowed to participate in such hearing. The Hearing Officer may establish time limits or other rules of procedure to expedite hearing of the request. The Hearing Officer shall establish a record of the hearing and see that a tape recording is made of the proceedings. Exhibits shall be identified in the record in order that they may be associated with the taped record of the hearing. (3-20-20)T

g. Upon completion of the hearing and compilation of the record in each application, the Hearing officer shall prepare a recommended decision which is transmitted to the Board for final action. The Hearing Officer may recommend that the application be approved, be approved with conditions, or that the application be disapproved. His recommendation shall set forth facts found relevant to the decision, legal principles applicable to the recommended ruling, and conclusions drawn from the hearing process. (3-20-20)T

h. At its next regular meeting, or as soon as the application can be placed upon its agenda, the Board will consider the record compiled and the Hearing Officer's recommendation and decide the request without further hearing by the Board. The Board may accept the recommendation of the Hearing Officer, may reverse the

recommendation, or may modify the recommended decision for reasons to be found in the record. If the Board modifies or reverses the Hearing Officer's recommendation it shall set forth its reasons for doing so in writing with reference to parts of the compiled record or conclusions drawn therefrom. The Board may also elect to remand the request to the Hearing Officer for clarification or for further hearings to obtain information the Board deems essential. Confirmation of the Hearing Officer's recommendation may be accomplished by Board action adopting the Hearing Officer's decision as its own. Appeals from Board action may be taken in accord with provisions of Section 39-418, Idaho Code. (3-20-20)T

**901. (RESERVED)**

**902. VIOLATION AND ENFORCEMENT.**

Violation of any provision of these rules is subject to the following enforcement procedures: (3-20-20)T

**01. Violation of Rules.** Any person, association, or corporation, or the officers thereof, violating any of the provisions of these rules is deemed guilty of a misdemeanor, and upon conviction thereof shall be punished by a fine not exceeding three hundred dollars (\$300), or by imprisonment in the county jail for a term not exceeding six (6) months, or by both such fine and imprisonment. (3-20-20)T

**02. Liability of Violator.** In addition to fine and imprisonment, any person, association, or corporation, or the officers thereof found to be in violation of these rules is liable, by civil action or restitution, for any expense incurred by the District in enforcing this act, or in removing or terminating any nuisance or health hazard. (3-20-20)T

**03. Other Action.** Any person, association, or corporation, or the officers thereof is additionally subject to civil court action, including an injunction or restraining order, and to such penalties, costs, or fees as may be necessary to compel compliance. (3-20-20)T

**04. Successive Days in Violation.** Each successive day in violation shall be considered a separate offense and be subject to individual penalties for each separate offense. (3-20-20)T

**903. -- 999. (RESERVED)**

APPENDIX 1

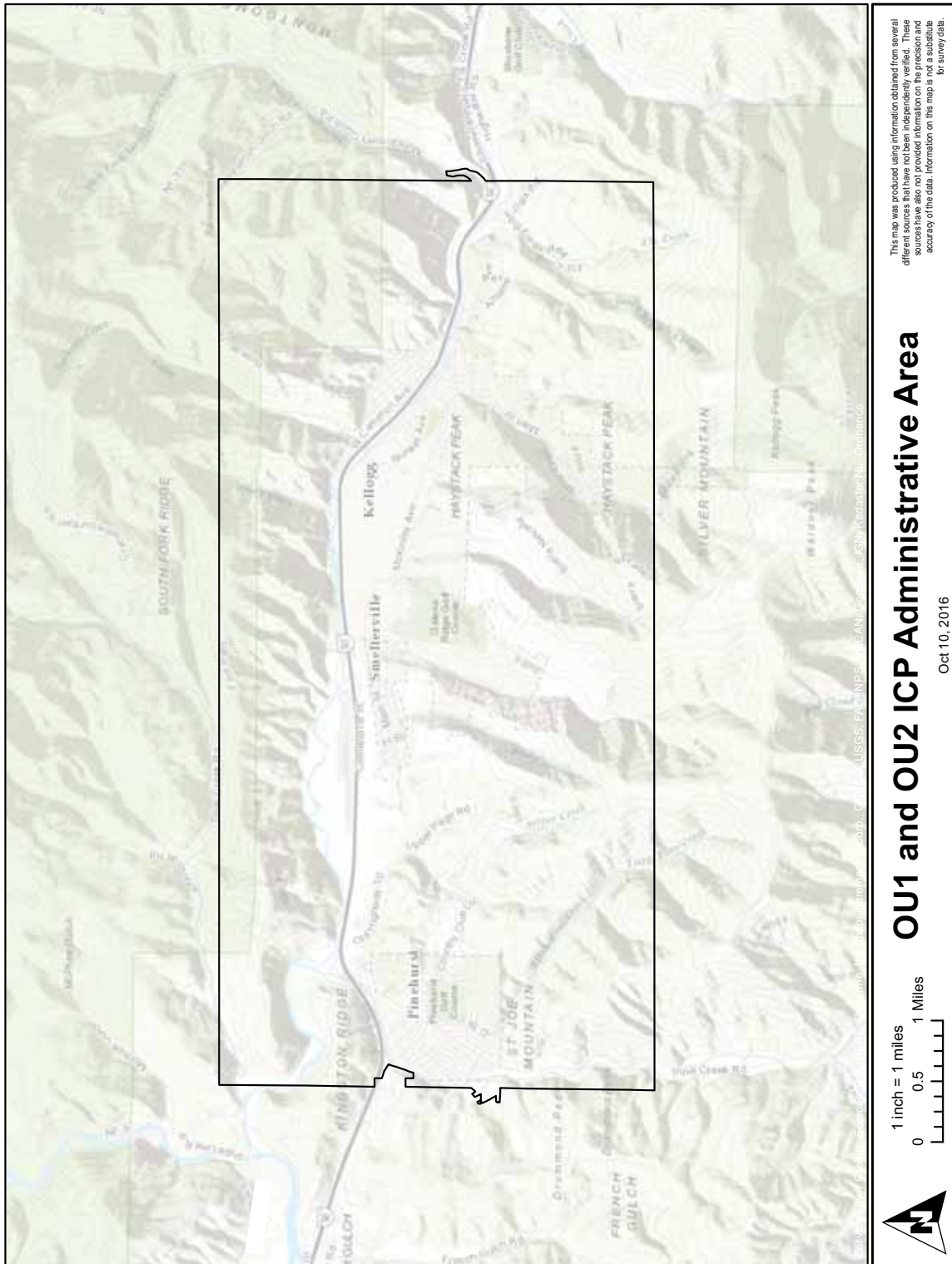

APPENDIX 2

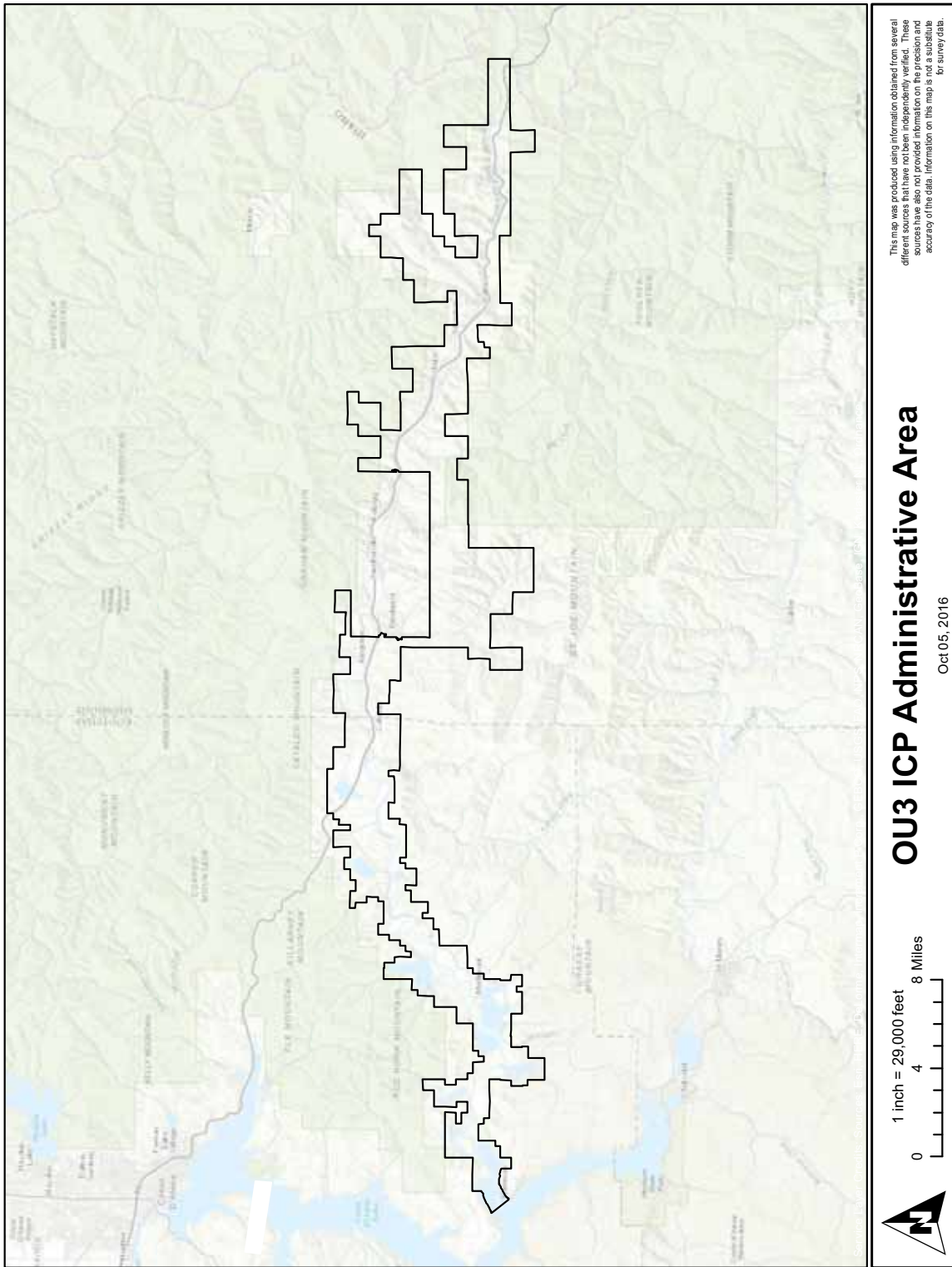



APPENDIX 3

APPLICABILITY OF BARRIER TYPES TO SITE USE ACTIVITIES: RESIDENTIAL

SITE USE ACTIVITIES															
Barrier Type	Building Footprint		Landscaping		Commercial classification of vehicular areas is subject to vehicle weight by volume.							Active Public Use Areas			Open Areas
	Exposed	Sealed with Crawl Space	Flower/Shrub Bed	Lawn Areas	Parking/Loading Areas	Streets	Rural Roads	Alleys & Road Shoulders	Out-door Storage	Drive-ways	Walk-ways	Accessible to Children	Public Out-door Play Equipment	Vacant Lots	
12" Soil Cap	X		X	X							X	X		X	
24" Soil Cap	X		X	X					X		X	X	X	X	
12" Soil Cap with Sod & Grass	X		X	X								X	X	X	
24" Soil Cap with Sod & Grass	X		X						X		X	X	X	X	
6" Compacted Gravel with Restricted Access	X	X		X					X		X			X	
12" Compacted Gravel	X	X							X			X		X	
6" Clay Cap with Restricted Access	X	X												X	
Synthetic Membranes, Tyvek & Plastic		X													
Chip Seal on 12" Compacted Gravel Base	X						X	X	X		X	X	X	X	
Lignosite Spray on 12" Compacted Gravel Base	X						X	X	X		X	X	X	X	
Asphaltic Concrete	X				X	X	X	X	X	X	X	X	X	X	
Concrete	X	X			X	X	X	X	X	X	X	X	X	X	
12" Sand Cap			X												

APPENDIX 4  
APPLICABILITY OF BARRIER TYPES TO SITE USE ACTIVITIES: COMMERCIAL

SITE USE ACTIVITIES															
Barrier Type	Building Footprint		Landscaping		Commercial classification of vehicular areas is subject to vehicle weight by volume.							Active Public Use Areas			Open Areas
	Exposed	Sealed with Crawl Space	Flower/ Shrub Bed	Lawn Areas	Parking/ Loading Areas	Streets	Rural Roads	Alleys & Road Shoulders	Drive-ways	Out-door Storage	Walk-ways	Accessible to Children	Public Out-door Play Equipment	Vacant Lots	
12" Soil Cap	X		X	X								X	X	X	
24" Soil Cap	X		X	X								X	X	X	
12" Soil Cap with Sod & Grass	X		X	X								X	X	X	
24" Soil Cap with Sod & Grass	X		X	X								X	X	X	
6" Compacted Gravel with Restricted Access	X	X												X	
12" Compacted Gravel	X	X							X			X	X	X	
6" Clay Cap with Restricted Access	X													X	
Synthetic Membranes, Tyvek & Plastic		X													
Chip Seal on 12" Compacted Gravel Base	X						X					X	X	X	
Lignosite Spray on 12" Compacted Gravel Base	X						X					X	X	X	
Asphaltic Concrete	X				X	X	X	X	X	X	X	X	X	X	
Concrete	X				X	X	X	X	X	X	X	X	X	X	
12" Sand Cap			X												

APPENDIX 5

APPLICABILITY OF BARRIER TYPES TO SITE USE ACTIVITIES: INDUSTRIAL

SITE USE ACTIVITIES															
Barrier Type	Building Footprint		Landscaping		Commercial classification of vehicular areas is subject to vehicle weight by volume.							Active Public Use Areas			Open Areas
	Exposed	Sealed with Crawl Space	Flower/Shrub Bed	Lawn Areas	Parking/Loading Areas	Streets	Rural Roads	Alleys & Road Shoulders	Drive-ways	Out-door Storage	Walk-ways	Accessible to Children	Public Outdoor Play Equipment	Vacant Lots	
12" Soil Cap	X		X	X								X	X	X	
24" Soil Cap	X		X	X								X	X	X	
12" Soil Cap with Sod & Grass	X		X	X								X	X	X	
24" Soil Cap with Sod & Grass	X		X	X								X	X	X	
6" Compacted Gravel with Restricted Access	X	X												X	
12" Compacted Gravel	X	X					X		X	X	X	X	X	X	
6" Clay Cap with Restricted Access	X													X	
Synthetic Membranes, Tyvek & Plastic		X													
Chip Seal on 12" Compacted Gravel Base	X						X			X	X	X	X	X	
Lignosite Spray on 12" Compacted Gravel Base	X						X			X			X	X	
Asphaltic Concrete	X				X	X	X	X	X	X	X	X	X	X	
Concrete	X	X			X	X	X	X	X	X	X	X	X	X	
12" Sand Cap			X												

<b>APPENDIX 6</b>				
If the soil interval tests out equal to or greater than 1,000 ppm lead		The soil interval tests out less than 1,000 ppm lead		The minimum soil removal and replacement depth is
0 - 1"	AND	1 - 6", 6 - 12"	THEN	6"
1 - 6"		0 - 1", 6 - 12"		6"
6 - 12"		0 - 1", 1 - 6"		12"
12 - 18"		0 - 1", 1 - 6", 6 - 12"		No Action
0 - 1", 1 - 6"		6 - 12"		6"
0 - 1", 6 - 12"		1 - 6"		12"
1 - 6", 6 - 12"		0 - 1"		12"
None		0 - 1", 1 - 6", 6 - 12"		No Action

<b>APPENDIX 7</b>				
If the soil interval tests out equal to or greater than 1,000 ppm lead		The soil interval tests out less than 1,000 ppm lead		The minimum soil removal and replacement depth is
0 - 1"	AND	1 - 6"	THEN	6"
1 - 6"		0 - 1"		6"
6 - 12		0 - 1", 1 - 6"		No Action
None		0 - 1", 1 - 6"		No Action

## IDAPA 42 – IDAHO WHEAT COMMISSION

DOCKET NO. 42-0101-2000F (FEE RULE)

### NOTICE OF OMNIBUS RULEMAKING – ADOPTION OF TEMPORARY RULE

**EFFECTIVE DATE:** The effective date of the temporary rule being adopted through this omnibus rulemaking is the adjournment date of the second regular session of the 65th Idaho State Legislature - March 20, 2020.

**AUTHORITY:** In compliance with Sections 67-5226, Idaho Code, notice is hereby given this agency has adopted a temporary rule. The action is authorized pursuant to Title 22, Chapter 33, Idaho Code.

**DESCRIPTIVE SUMMARY:** The following is the required finding and concise statement of its supporting reasons for adopting a temporary rule:

This temporary rulemaking adopts the following chapter under IDAPA 42:

**IDAPA 42**

- 42.01.01 *Rules of the Idaho Wheat Commission*

**TEMPORARY RULE JUSTIFICATION:** Pursuant to Sections 67-5226(1) and 67-5226(2), Idaho Code, the Governor has found that temporary adoption of the rule is appropriate for the following reasons:

These temporary rules are necessary to protect the public health, safety, and welfare of the citizens of Idaho and confer a benefit on its citizens. These temporary rules implement the duly enacted laws of the state of Idaho, provide citizens with the detailed rules and standards for complying with those laws, and assist in the orderly execution and enforcement of those laws. The expiration of these rules without due consideration and processes would undermine the public health, safety, and welfare of the citizens of Idaho and deprive them of the benefit intended by these rules.

**FEE SUMMARY:** Pursuant to Section 67-5226(2), the Governor has found that the fee(s) or charge(s) being imposed or increased is justified and necessary to avoid immediate danger and the fee(s) is described herein:

The fees or charges, authorized in Section 22-3315, Idaho Code, are part of the agency's 2021 budget that relies upon the existence of these fees or charges to meet the state's obligations and provide necessary state services. Failing to reauthorize these temporary rules would create immediate danger to the state budget, immediate danger to necessary state functions and services, and immediate danger of a violation of Idaho's constitutional requirement that it balance its budget.

The following is a specific description of the fees or charges: Three and one-half cents per bushel collected at point of first purchase.

**ASSISTANCE ON TECHNICAL QUESTIONS:** For assistance on technical questions concerning the temporary rule, contact Blaine Jacobson, 208-334-2353.

DATED this 19th day of February, 2020.

Blaine Jacobson, Executive Director  
Idaho Wheat Commission  
821 W. State Street  
Boise, ID 83706  
Phone: (208) 334-2353  
Fax: (208) 334-2505  
[blaine@idahowheat.org](mailto:blaine@idahowheat.org)

## IDAPA 42 – IDAHO WHEAT COMMISSION

### 42.01.01 – RULES OF THE IDAHO WHEAT COMMISSION

#### 000. LEGAL AUTHORITY.

In accordance with Section 22-3309, Idaho Code, the Idaho Wheat Commission has promulgated rules implementing the provisions of Title 22, Chapter 33, Idaho Code. (3-20-20)T

#### 001. TITLE AND SCOPE.

**01. Title.** These rules are titled IDAPA 42.01.01, “Rules of the Idaho Wheat Commission,” IDAPA 42, Title 01, Chapter 01. (3-20-20)T

**02. Scope.** Pursuant to Section 22-3301, Idaho Code, the rules of the Idaho Wheat Commission promote the public health and welfare of the citizens of our state by providing means for the protection, promotion, study, research, analysis and development of markets concerning the growing and marketing of Idaho wheat. (3-20-20)T

#### 002. -- 009. (RESERVED)

#### 010. DEFINITIONS.

The definitions set forth in Section 22-3303, Idaho Code, apply to this chapter. (3-20-20)T

#### 011 -- 099. (RESERVED)

#### 100. WHEAT TAX RETURN FORM.

**01. Form.** Wheat Tax Return forms are available at the Commission office for use by the first purchaser (buyer) of Idaho grown wheat in transmitting the Idaho wheat tax to the Commission. (3-20-20)T

**02. Procedures.** At the end of each quarter, buyers shall execute the Wheat Tax Return (form). One (1) copy of the form and a check covering the entire amount of all wheat tax collections made during the quarter shall be mailed to the Executive Director of the Commission not later than the fifteenth day of the month at the end of each quarter (October 15, January 15, April 15, and July 15, respectively) of each calendar year. If no wheat has been purchased during any quarter, one (1) copy of the Wheat Tax Return form declaring that no wheat has been purchased, shall be signed and mailed to the Executive Director of the Commission. (3-20-20)T

#### 101. MIXTURES.

When the grain is purchased as wheat, the tax must be collected on the full net weight of the grain purchased. The tax must also be collected on any mixtures containing fifty percent (50%) or more of wheat. (3-20-20)T

#### 102. NET WEIGHT.

The tax must be collected on the net weight of the wheat after deduction of dockage and smut, and not upon the gross weight. (3-20-20)T

#### 103. TRUCKERS.

When a trucker purchases wheat from a grower, it is his responsibility under the law to deduct the tax and remit the amount to the Commission. The trucker in such instances is liable for the deduction of tax. Those who purchase wheat from such truckers are not directly liable for the deduction of tax, but buyers should make sure that the trucker has in fact purchased the wheat from a grower and is not the person who produced the wheat. (3-20-20)T

#### 104. WHEAT DELIVERED ON ACCOUNT OR EXCHANGED FOR OTHER WHEAT.

When wheat is delivered and credited to the account of a grower who is purchasing mixed feeds and other commodities, such transactions are really sales of the wheat delivered. In these cases, the buyer must deduct the tax from the amount credited to the grower and remit to the Commission just as though the sale had been made for cash. On the other hand, if the grower delivers the wheat in exchange for other wheat and no sale of the wheat is involved, the tax should not be deducted. (3-20-20)T

#### 105. END USE.

Idaho wheat is subject to tax when it is first sold or contracted into commercial channels. Beside traditional uses of wheat for flour milling, domestic and export, commercial channels include sale of wheat for use as feed, or any industrial or chemurgic use. (3-20-20)T

**106. -- 199. (RESERVED)**

**200. PENALTY FOR LATE PAYMENT OF WHEAT TAX.**

**01. Interest Penalties.** Any person or firm who makes payment of wheat tax collections to the Commission at a date later than the fifteenth day of the month at the end of each quarter as prescribed in Subsection 100.02 of these rules, is subject to a late payment penalty of fifteen percent (15%) per annum on the amount due, unless that person or firm, within fifteen (15) days of the date, notifies the Commission in writing of any delay in payment and submits the payment of wheat tax collections within thirty (30) days of the prescribed due date. (3-20-20)T

**02. Additional Penalties.** The Commission is entitled, in addition to the penalty of fifteen percent (15%) per annum, to recover from the buyer, all costs, fees, and reasonable attorney's fees incurred in collecting the wheat tax collections and penalty as prescribed in Section 22-3315, Idaho Code. (3-20-20)T

**201. -- 299. (RESERVED)**

**300. WHEAT UNDER COMMODITY CREDIT CORPORATION LOANS.**

**01. Payee.** The Commission will be named as payee to receive three and one half cents (\$.3½) per bushel when the producer's note and loan agreement is executed by the Farm Service Agency (FSA). In such cases, the lending agency will send the tax directly to the Commission. When the producer's note and loan agreement shows that the tax has been deducted and sent to the Commission, it will not be necessary for the buyer to deduct the tax when the wheat is purchased. (3-20-20)T

**02. Tax.** Since the legislature has made the tax a lien prior to all other liens and encumbrances of the wheat, it is necessary for the grain buyer to make sure the tax has been paid in order to obtain clear title to the wheat. The tax should be deducted in all cases where there is not evidence that the tax was previously paid by a lending agency. In case errors occur and the tax is deducted by a lending agency and again deducted by a grain buyer, refund will be made by the Commission. (3-20-20)T

**301. INVOICES AND RECORDS.**

**01. Invoices.** Section 22-3316, Idaho Code, provides for invoices to be delivered to the grower for each purchase. The Wheat Commission is not providing a special form for this purpose and suggests that buyers use the final settlement vouchers of accounts of sale commonly used in Idaho. The amount of the Idaho state wheat tax deducted must be shown on each settlement voucher. (3-20-20)T

**02. Vouchers.** Buyers do not need to send the Commission copies of their settlement vouchers issued to individual growers but should keep copies available for examination by representatives of the Commission at a later date. Where it is not the practice to issue settlement vouchers of accounts of sale, buyers should be sure that they have accurate records of all wheat bought from growers and the amount of wheat bought from each grower. (3-20-20)T

**03. Delivery of Documents to Commission.** The first purchaser of wheat shall complete and return the Report of Tax, or equivalent, to the Commission office at the end of each production year (July 1 through June 30). The report is due on the same date as the final quarter wheat tax as specified in Section 22-3315(1), Idaho Code, and along with the following: (3-20-20)T

- a.** Name or names of the grower and seller; and (3-20-20)T
- b.** Address or addresses of the grower and seller. (3-20-20)T

**302. -- 999. (RESERVED)**

## IDAPA 43 – IDAHO OILSEED COMMISSION

DOCKET NO. 43-0101-2000F (FEE RULE)

### NOTICE OF OMNIBUS RULEMAKING – ADOPTION OF TEMPORARY RULE

**EFFECTIVE DATE:** The effective date of the temporary rule being adopted through this omnibus rulemaking is the adjournment date of the second regular session of the 65th Idaho State Legislature - March 20, 2020.

**AUTHORITY:** In compliance with Sections 67-5226, Idaho Code, notice is hereby given this agency has adopted a temporary rule. The action is authorized pursuant to Section 22-4716, Idaho Code.

**DESCRIPTIVE SUMMARY:** The following is the required finding and concise statement of its supporting reasons for adopting a temporary rule:

This temporary rule adopts the following chapter under IDAPA 43:

#### **IDAPA 43**

- IDAPA 43.01.01, *Rules Governing the Idaho Oilseed Commission*

**TEMPORARY RULE JUSTIFICATION:** Pursuant to Sections 67-5226(1) and 67-5226(2), Idaho Code, the Governor has found that temporary adoption of the rule is appropriate for the following reasons:

These temporary rules are necessary to protect the public health, safety, and welfare of the citizens of Idaho and confer a benefit on its citizens. These temporary rules implement the duly enacted laws of the state of Idaho, provide citizens with the detailed rules and standards for complying with those laws, and assist in the orderly execution and enforcement of those laws. The expiration of these rules without due consideration and processes would undermine the public health, safety, and welfare of the citizens of Idaho and deprive them of the benefit intended by these rules.

**FEE SUMMARY:** Pursuant to Section 67-5226(2), the Governor has found that the fee(s) or charge(s) being imposed or increased is justified and necessary to avoid immediate danger and the fee(s) is described herein:

The fees or charges, authorized in Section 22-4716, Idaho Code, are part of the agency's 2021 budget that relies upon the existence of these fees or charges to meet the state's obligations and provide necessary state services. Failing to reauthorize these temporary rules would create immediate danger to the state budget, immediate danger to necessary state functions and services, and immediate danger of a violation of Idaho's constitutional requirement that it balance its budget.

The following is a specific description of the fees or charges: This rulemaking does not impose a fee or charge, or increase a fee or charge, beyond what was previously approved and codified in the prior rules. If a person is late in paying the assessment on oilseed sold or contacted for, the fee rule sets a late payment penalty of twelve percent (12%) per annum on the amount due.

**ASSISTANCE ON TECHNICAL QUESTIONS:** For assistance on technical questions concerning the temporary rule, contact Benjamin Kelly, 208-888-0988.

DATED this February 18th, 2020.

Benjamin Kelly  
Administrator  
Idaho Oilseed Commission  
55 SW 5th Ave, Suite 100  
Meridian, Idaho 83642  
(208) 888-0988



# IDAPA 43 – IDAHO OILSEED COMMISSION

## 43.01.01 – RULES GOVERNING THE IDAHO OILSEED COMMISSION

### 000. LEGAL AUTHORITY.

The Idaho Oilseed Commission (hereinafter “Commission”) promulgates these rules implementing the provisions of Title 22, Chapter 47, Idaho Code. (3-20-20)T

### 001. TITLE AND SCOPE.

These rules are titled IDAPA 43.01.01, “Rules Governing the Idaho Oilseed Commission.” (3-20-20)T

### 002. -- 009. (RESERVED)

### 010. FIRST PURCHASER RULES.

**01. Designated Quarters.** In accordance with Section 22-4716, Idaho Code, the Commission shall designate the quarters (three (3) month periods) for the purpose of collecting the tax imposed by such statute as follows: (3-20-20)T

**a.** The Commission’s first quarter will begin on the first day of July and end the thirtieth day of September. The first quarter tax is due on or before the fifteenth day of October. (3-20-20)T

**b.** The Commission’s second quarter will begin on the first day of October and end the thirty-first day of December. The second quarter tax is due on or before the fifteenth day of January. (3-20-20)T

**c.** The Commission’s third quarter will begin on the first day of January and end the thirty-first day of March. The third quarter tax is due on or before the fifteenth day of April. (3-20-20)T

**d.** The Commission’s fourth quarter will begin on the first day of April and end the thirtieth day of June. The fourth quarter tax is due on or before the fifteenth day of July. (3-20-20)T

**02. Oilseed Tax Invoice (Form Number 1).** Pursuant to Section 22-4719, Idaho Code, the first purchaser of oilseed is required to complete and send the Oilseed Tax Invoice (Form Number 1) to the Commission office each and every quarter on or before the dates specified in these rules. Form Number 1 shall be on official forms as prescribed by the Commission and be provided to the first purchaser by the Commission and, at a minimum, require the following legible information: (3-20-20)T

**a.** The date of purchases and tax reporting period. (3-20-20)T

**b.** The name and address of the oilseed seller and purchaser. (3-20-20)T

**c.** The net weight of the oilseed sold in pounds or hundredweights. (3-20-20)T

**d.** The total amount of tax deducted from Idaho oilseed producers by the purchaser. (3-20-20)T

**e.** The total amount of tax due the Commission. (3-20-20)T

**03. Late Payment Penalty.** Per Section 22-4716(4), Idaho Code, any person or firm who makes payment to the Commission at a date later than prescribed by law, is subject to a late payment penalty of twelve percent (12%) per annum on the amount due. (3-20-20)T

### 011. -- 499. (RESERVED)

### 500. REFUND APPLICATIONS.

**01. Assessment Refund.** In accordance with Section 22-4717, Idaho Code, any seller may request from the Commission in writing, within thirty (30) days after payment thereof, a refund of all or any portion of an assessment levied on oilseed and paid by such seller. Sellers requesting an oilseed assessment refund, as specified in Section 22-4717, Idaho Code, are required to complete and return a refund application form (Form Number 2) to the Commission office no later than thirty (30) days after payment of the assessment. Form Number 2 will be available through the Commission office. Written requests for refund application forms must be sent to the Commission office.

(3-20-20)T

**02. Refund Application Form Number 2.** Form Number 2 shall, at a minimum, require the following information from the applicant: (3-20-20)T

**a.** The applicant's name and address. (3-20-20)T

**b.** The applicant's federal tax identification number. (3-20-20)T

**c.** The first purchaser or lender who deducted the assessment from the applicant's settlement. (3-20-20)T

**d.** The applicant's date of settlement. (3-20-20)T

**e.** The hundredweight of oilseed sold by the applicant. (3-20-20)T

**f.** The dollar amount of oilseed assessment deducted from the applicant's settlement. (3-20-20)T

**g.** The applicant shall enclose evidence with the application proving the oilseed assessment was deducted by providing a copy of the invoice (Form Number 1) for which the refund is claimed. In the absence of a copy of the invoice, the Commission may, but is not bound to, accept other satisfactory evidence of payment. (3-20-20)T

**501. -- 999. (RESERVED)**

# IDAPA 46 – IDAHO BOARD OF VETERINARY MEDICINE

## DOCKET NO. 46-0101-2000F (FEE RULE)

### NOTICE OF OMNIBUS RULEMAKING – ADOPTION OF TEMPORARY RULE

**EFFECTIVE DATE:** The effective date of the temporary rule being adopted through this omnibus rulemaking is the adjournment date of the second regular session of the 65th Idaho State Legislature - March 20, 2020.

**AUTHORITY:** In compliance with Sections 67-5226, Idaho Code, notice is hereby given this agency has adopted a temporary rule. The action is authorized pursuant to Section 54-2105, Idaho Code.

**DESCRIPTIVE SUMMARY:** The following is the required finding and concise statement of its supporting reasons for adopting a temporary rule:

This temporary rulemaking adopts the following chapter under IDAPA 46:

**IDAPA 46**

- 46.01.01, *Rules of the State of Idaho Board of Veterinary Medicine*

**TEMPORARY RULE JUSTIFICATION:** Pursuant to Sections 67-5226(1) and 67-5226(2), Idaho Code, the Governor has found that temporary adoption of the rule is appropriate for the following reasons:

These temporary rules are necessary to protect the public health, safety, and welfare of the citizens of Idaho and confer a benefit on its citizens. These temporary rules implement the duly enacted laws of the state of Idaho, provide citizens with the detailed rules and standards for complying with those laws, and assist in the orderly execution and enforcement of those laws. The expiration of these rules without due consideration and processes would undermine the public health, safety, and welfare of the citizens of Idaho and deprive them of the benefit intended by these rules. This docket also incorporates minor rule changes related to the COVID-19 response adopted in an open meeting.

**FEE SUMMARY:** Pursuant to Section 67-5226(2), the Governor has found that the fee(s) or charge(s) being imposed or increased is justified and necessary to avoid immediate danger and the fee(s) is described herein:

The fees or charges authorized in Title 54, Chapter 21, Idaho Code, are part of the agency's 2021 budget that relies upon the existence of these fees or charges to meet the state's obligations and provide necessary state services. Failing to reauthorize these temporary rules would create immediate danger to the state budget, immediate danger to necessary state functions and services, and immediate danger of a violation of Idaho's constitutional requirement that it balance its budget.

The following is a specific description of the fees or charges:

	New	Temporary Permit	Active Renewal	Inactive Renewal	Late/ Reinstatement	Re-Activation Fee
Veterinary License	\$275	\$150	\$175	\$50	\$200	\$150
Certified Veterinary Technician	\$125	\$50	\$75	\$25	\$50	\$50
Certified Euthanasia Agency	\$100		\$200		\$50	
Certified Euthanasia Technician	\$100		\$100		\$50	

Administrative Services	
Duplicate Wall License/Certificate	\$25
Veterinary License Verification	\$20

**ASSISTANCE ON TECHNICAL QUESTIONS:** For assistance on technical questions concerning the temporary rule, contact Jeremy Brown at (208) 332-8588.

DATED this February 7, 2020.

Jeremy Brown  
Executive Director  
Idaho Board of Veterinary Medicine  
2230 Old Penitentiary Road  
P.O. Box 7249  
Boise, ID 83707-1249  
Phone: (208) 332-8588  
Fax: (208) 332-8645  
[bovminfo@isda.idaho.gov](mailto:bovminfo@isda.idaho.gov)  
[www.bovm.idaho.gov](http://www.bovm.idaho.gov)

# IDAPA 46 – IDAHO BOARD OF VETERINARY MEDICINE

## 46.01.01 – RULES OF THE STATE OF IDAHO BOARD OF VETERINARY MEDICINE

**000. LEGAL AUTHORITY.**

This chapter is adopted under the legal authority of Title 54, Chapter 21, Idaho Code. (3-20-20)T

**001. TITLE AND SCOPE.**

**01. Title.** The title of this chapter is the “Rules of the State of Idaho Board of Veterinary Medicine,” hereinafter referred to in these rules as the Board. (3-20-20)T

**02. Scope.** These rules govern the licensing procedures, supervision requirements, standards of practice, inspections, and grounds for discipline of veterinarians, veterinary technicians, Committee on Humane Euthanasia members, and certified euthanasia technicians and agencies. The official citation of this chapter is IDAPA 46.01.01, et seq. For example, this Section’s citation is IDAPA 46.01.01.001. (3-20-20)T

**002. -- 004. (RESERVED)**

**005. INCORPORATION BY REFERENCE.**

The Principles of Veterinary Medical Ethics of the American Veterinary Medical Association (AVMA), as adopted and revised April 2016, is incorporated herein by reference in accordance with the provisions of Section 67-5229, Idaho Code. (3-20-20)T

**006. -- 009. (RESERVED)**

**010. LICENSE.**

Change of address. It is the responsibility of each licensed veterinarian to notify the Board office of any change of address. Failure to receive a renewal form from the Board does not constitute an excuse for failure to pay the renewal fee and fulfill the requirements of Section 54-2112, Idaho Code. (3-20-20)T

**011. FEES.**

Fees for licensure and certification are established, as authorized under Title 54, Chapter 21, Idaho Code, by action of the Board, as follows: (3-20-20)T

**01. Fees.**

	New	Temporary Permit	Active Renewal	Inactive Renewal	Late/ Reinstatement	Inactive to Active Fee
Veterinary License	\$275	\$150	\$175	\$50	\$200	\$150
Certified Veterinary Technician	\$125	\$50	\$75	\$25	\$50	\$50
Certified Euthanasia Agency	\$100	-	\$200	-	\$50	-
Certified Euthanasia Technician	\$100	-	\$100	-	\$50	-

(3-20-20)T

**02. Administrative Services.**

Duplicate Wall License/Certificate	\$25
Veterinary License Verification	\$20

(3-20-20)T

**012. MANDATORY CONTINUING VETERINARY EDUCATION.**

**01. Statement of Purpose.** It is of primary importance to the public that veterinarians continue their veterinary education throughout the period of their active practice of veterinary medicine. These rules establish the minimum continuing veterinary education requirements necessary for veterinarians to maintain a license to engage in the practice of veterinary medicine in the state of Idaho. (3-20-20)T

**02. Approved Courses.** Courses and providers accredited by the American Association of Veterinary State Board's Continuing Education Registry and courses and providers approved by the Board. (3-20-20)T

**03. Education Requirements.** (3-20-20)T

**a.** Minimum requirement. Beginning July 1 after the initial license is issued all active veterinarian in the state of Idaho shall complete a minimum of ten (10) credit hours in every two-year period following the date of their admission to the practice of veterinary medicine in this state. (3-20-20)T

**b.** Credit requirements. The following are the minimum and maximum credits that may be earned for each reporting period and the number of credits that may be obtained by participating in on-line or correspondence courses. (3-20-20)T

**i.** A minimum of seven (7) hours of continuing education in veterinary medicine, surgery, and dentistry. (3-20-20)T

**ii.** A maximum of three (3) hours of continuing education in management. (3-20-20)T

**c.** Retention of Original Documentation. The supporting documentation for compliance with continuing education requirements shall not be submitted with the report. Rather, the veterinarian needs to retain original documentation of attendance or completion of ten (10) credit hours of approved courses at least until December 31 following the two-year (2) renewal period covered by the courses. (3-20-20)T

**d.** Audit. Within thirty (30) days of notification of an audit, a veterinarian shall provide to the Board all documentation supporting attendance or completion of the courses reported. (3-20-20)T

**04. Credit for Attendance.** (3-20-20)T

**a.** Credits can be earned by the active member in attendance at an accredited, domestic or foreign, course. No credit will be given for: (3-20-20)T

**i.** Time spent in introductory remarks, coffee and lunch breaks, business meetings or other activities not involving the educational aspects of the course. (3-20-20)T

**ii.** Any course attended before admission to practice veterinary medicine in Idaho. (3-20-20)T

**iii.** Journal and magazine articles, videos or correspondence courses, unless specially approved by the Board. (3-20-20)T

**b.** In cases of solo presentation, the presenter of an approved course shall be entitled to claim one (1) credit hour for each fifty (50) minutes of actual course instruction. By way of limitation, in no case shall the presenter be allowed more than eight (8) credit hours for any particular course or substantially related topic during the applicable two (2) year reporting period, regardless of how many times the course is offered or given. (3-20-20)T

**c.** In cases of panel presentations, the number of continuing credit hours each panel member is entitled to claim shall be calculated by multiplying the actual number of course hours by two (2) and dividing that number by the number of panel members involved. (3-20-20)T

**d.** Carryover Credit. No credit for attending approved courses in continuing veterinary education shall be applicable to any reporting period other than that during which the credit is actually earned. (3-20-20)T

**013. -- 099. (RESERVED)**

**100. CERTIFICATION OF VETERINARY TECHNICIANS.**

**01. Certificate Required.** Any person representing themselves as a veterinary technician, licensed veterinary technician, registered veterinary technician, or certified veterinary technician, shall hold a valid, unexpired certificate to practice veterinary technology in Idaho. (3-20-20)T

**02. Application for Certification -- Contents -- Examinations.** An individual desiring to be certified as a veterinary technician shall make written application to the Board upon a form furnished by the Board. Applicants for certified veterinary technician in Idaho should be of good moral character and reputation. A complete application is valid for a period of one (1) year, contain the applicant's notarized signature, and include: (3-20-20)T

**a.** A copy of a birth certificate or current passport proving that the applicant is eighteen (18) years of age or older. (3-20-20)T

**b.** Documentation of education/training/experience as follows: (3-20-20)T

**i.** A certified copy of a diploma or transcript, or a letter verifying graduation from a veterinary technology program, accredited by the American Veterinary Medical Association; (3-20-20)T

**ii.** A certified copy of a diploma or transcript, or a letter verifying the award of a D.V.M. or V.M.D. degree or equivalent, from an accredited school of veterinary medicine; or (3-20-20)T

**iii.** If a foreign veterinary graduate, a letter from the Educational Commission for Foreign Veterinary Graduates (ECFVG) certifying completion of the ECFVG program or a copy of the ECFVG certificate. (3-20-20)T

**c.** Verification of a criterion-referenced passing score reported by the Professional Examination Service or its designee, or by other designated test vendors or their designees approved by the American Association of Veterinary State Boards on the Veterinary Technician National Examination (VTNE) or other national examination approved by the American Association of Veterinary State Boards or its designated test vendor or by the Board. If such a score is not available, the passing score shall be as reported by the Professional Examination Service or its designee, or by other designated test vendors or their designees approved by the American Association of Veterinary State Boards or by the Board and shall be considered equal to or greater than one and five-tenths (1.5) standard deviation below the mean score of the examination. (3-20-20)T

**i.** The VTNE or other national examination approved by the American Association of Veterinary State Boards or its designated test vendor or by the Board may have been taken at any time. (3-20-20)T

**ii.** Scores for the VTNE or other national examination approved by the American Association of Veterinary State Boards or its designated test vendor or by the Board are to be provided to the Board by the Professional Examination Service or its designee or by other designated test vendors or their designees approved by the American Association of Veterinary State Boards. (3-20-20)T

**d.** A passing score for the jurisprudence examination, which should be ninety percent (90%) or such score as deemed appropriate by the Board. The jurisprudence examination, as prepared by the Board or its designee, may be taken more than once, at three-month intervals. (3-20-20)T

**e.** A completed application, other required documents, and first year's certification fee in the amount established by the Board shall be received at the Board office by the first day of January or June. All application and certification fees are nonrefundable. (3-20-20)T

**101. TEMPORARY CERTIFICATION.**

The Board may, at its discretion, issue a temporary certification. The temporary certification shall be valid for one (1) year or until the next certification review by the Board, whichever comes first, and under no circumstances can a second temporary certification be issued to the same person. A temporary certification will not be issued to any applicant whose certification, license or registration has been revoked in any state for a reason other than nonpayment

of fees or failure to fulfill the renewal requirements. An applicant granted a temporary certification shall provide notarized verification of twelve (12) months of active practice during the past year as a veterinary technician in another state or perform all veterinary technology procedures under the direct supervision of an Idaho licensed veterinarian. (3-20-20)T

**01. Certification Requirements.** Requirements for a temporary certification shall be the same as for the original certification. (3-20-20)T

**02. Responsibility.** Nothing herein shall be construed to relieve the temporary certificate holder of any responsibility or liability for any of their own acts and omissions. (3-20-20)T

**102. MANDATORY CONTINUING EDUCATION FOR CERTIFIED VETERINARY TECHNICIANS.**

**01. Statement of Purpose.** It is of primary importance to the public that certified veterinary technicians continue their veterinary technology education throughout the period of their active practice of veterinary technology. These rules establish the minimum continuing veterinary technology education requirements necessary for certified veterinary technicians to maintain a license to engage in the practice of veterinary technology in Idaho. (3-20-20)T

**02. Approved Courses.** Includes courses and providers listed on the American Association of Veterinary State Board's Continuing Education Registry and courses and providers approved by the Board. (3-20-20)T

**03. Education Requirements.** (3-20-20)T

**a. Minimum requirement.** Each active certified veterinary technician in Idaho shall complete a minimum of seven (7) credit hours of accredited continuing veterinary technology education activity in each and every two-year period following the date of their admission to the practice of veterinary technology in Idaho. (3-20-20)T

**b. Credit requirements.** The following are minimum and maximum credits that may be earned for each reporting period and the number of credits that may be obtained by participating in on-line or correspondence courses. (3-20-20)T

i. A minimum of five (5) hours of continuing education in veterinary technology. (3-20-20)T

ii. A maximum of two (2) hours of continuing education in management. (3-20-20)T

**c. Attendance period.** The attendance period is based upon the fiscal year (July 1 through June 30). (3-20-20)T

i. Retention of original documentation. The supporting documentation for compliance with continuing education requirements shall not be submitted with the report but rather, retained with the certified veterinary technician at least until December 31 following the two-year (2) renewal period covered by the course. (3-20-20)T

ii. Within thirty (30) days of notification of an audit, a certified veterinary technician shall provide to the Board all documentation supporting completion of the courses reported. (3-20-20)T

**04. Credit for Attendance.** Continuing veterinary technology education credits may be earned by attending or presenting approved continuing veterinary technology education. (3-20-20)T

**a. Credits.** One (1) credit hour will be given for each fifty (50) minutes actually spent by the active certificant in attendance at an accredited, domestic or foreign, course. No credit will be given for: (3-20-20)T

i. Time spent in introductory remarks, coffee and lunch breaks, business meetings or other activities not involving the educational aspects of the courses; (3-20-20)T



- ii. Any course attended before admission to practice veterinary technology in Idaho; or (3-20-20)T
- iii. Journal and magazine articles, videos or correspondence courses, unless specially approved by the Board. (3-20-20)T

**b.** In cases of solo presentation, the presenter of an approved course shall be entitled to claim one (1) credit hour for each fifty (50) minutes of actual course instruction. By way of limitation, in no case shall the presenter be allowed more than eight (8) credit hours for any particular course or substantially related topic during the applicable two-year reporting period, regardless of how many times the course is offered or given. (3-20-20)T

**c.** In cases of panel presentations, the number of continuing credit hours each panel member is entitled to claim shall be calculated by multiplying the actual number of course hours by two (2) and dividing that number by the number of panel members involved. (3-20-20)T

**d.** Carryover Credit. No credit for attending approved courses in continuing veterinary technology education is applicable to any reporting period other than that during which the credit is actually earned. (3-20-20)T

### **103. SUPERVISING VETERINARIANS.**

**01. Statement of Purpose.** Veterinarians licensed under the provisions of Title 54, Chapter 21, Idaho Code, are responsible for all temporary licensees and temporary certification holders, certified euthanasia technicians, certified veterinary technicians, veterinary assistants, or any others to whom they delegate the performance of acts pertaining to the practice of veterinary medicine. (3-20-20)T

**02. A Supervising Veterinarian Shall:** (3-20-20)T

**a.** Provide direct supervision for all procedures pertaining to the practice of veterinary medicine that are delegated to a certified veterinary technician, a veterinary technician working under a temporary certification, an assistant or any others with the exception of: (3-20-20)T

i. Routine procedures in the practice of veterinary technology that include, but are not limited to, taking radiographs, weight and temperature, or as determined by the standard of practice for the area. These routine procedures may be performed under the indirect supervision of the veterinarian. (3-20-20)T

ii. Previously prescribed antibiotics and medications, which may be administered, dispensed, and delivered under the indirect supervision of the veterinarian. Previously prescribed antibiotics and medications does not include injectable controlled substances, injectable tranquilizers, injectable sedatives, and injectable or inhalant anesthetics, which may only be administered under the direct supervision of the veterinarian. (3-20-20)T

iii. Emergency situations. In these situations, in order to stabilize the animal, the veterinarian, while en route to the location of the distressed animal, may prescribe treatment and delegate appropriate procedures pertaining to the practice of veterinary medicine under indirect supervision. (3-20-20)T

**b.** Be available to supervise and direct all procedures pertaining to the practice of veterinary medicine that are delegated to others. (3-20-20)T

**c.** Bear legal responsibility for the health, safety and welfare of the animal patient that the temporary licensee, temporary certification holder, certified veterinary technician, assistant, or any others serves. (3-20-20)T

**d.** Not delegate an animal health care task to an unqualified individual. (3-20-20)T

**e.** Make all decisions relating to the diagnosis, treatment, management, and future disposition of an animal patient. (3-20-20)T

**f.** Have examined the animal patient prior to the delegation of any animal health care task to a certified veterinary technician, temporary certification holder, or assistant. The examination of the animal patient

shall be conducted at such times as acceptable veterinary medical practice dictates, consistent with the particular delegated animal health care task. (3-20-20)T

**g.** Diagnose and perform operative dentistry, oral surgery, and teeth extraction procedures. Operative dentistry and oral surgery are considered to be any dental procedure which invades the hard or soft oral tissue including, but not limited to, a procedure that alters the structure of one (1) or more teeth or repairs damaged and diseased teeth, or the deliberate extraction of one (1) or more teeth. Operative dentistry and oral surgery do not include, removal of calculus, soft deposits, plaque, stains, floating to shape the teeth, or smoothing, filing or polishing of tooth surfaces above the gum line. (3-20-20)T

**03. Limitations on Supervising Veterinarians.** Unless otherwise provided by law or rule, a supervising veterinarian shall not authorize a certified veterinary technician, a veterinary technician working under a temporary certification, an assistant or anyone else, other than a licensed veterinarian or a veterinarian holding a valid temporary permit to perform the following functions: (3-20-20)T

**a.** Surgery; (3-20-20)T

**b.** Diagnosis and prognosis of animal disease; (3-20-20)T

**c.** Prescribing drugs, medicines and appliances; or (3-20-20)T

**d.** Diagnosis and performance of procedures that constitute operative dentistry/oral surgery as defined by Section 54-2103(13)(b), Idaho Code. (3-20-20)T

**104. VETERINARY TECHNICIAN CERTIFICATION -- RENEWAL.**

Change of address. It is the responsibility of each certified veterinary technician to notify the Board office of any change of address. Failure to receive a renewal form from the Board does not constitute an excuse for failure to pay the renewal fee and completion of the prescribed form. (3-20-20)T

**105. GROUNDS FOR DISCIPLINE OF VETERINARY TECHNICIANS.**

In addition to the provisions of Section 54-2118, Idaho Code, the Board may refuse to issue, renew, or reinstate the certification of a veterinary technician, or may deny, revoke, suspend, sanction, place on probation, or require voluntary surrender of the certification of a veterinary technician, or may impose other forms of discipline, and enter into consent agreements and negotiated settlements with certified veterinary technicians pursuant to the procedures set forth in Title 67, Chapter 52, Idaho Code, for any of the following reasons: (3-20-20)T

**01. Fraud, Misrepresentation, or Deception.** The employment of fraud, misrepresentation or deception in obtaining certification. (3-20-20)T

**02. Unethical or Unprofessional Conduct.** Unethical or unprofessional conduct is conduct that includes, but is not limited to, any of the following: (3-20-20)T

**a.** False or misleading advertising or solicitation; (3-20-20)T

**b.** Providing any procedure to an animal that constitutes the practice of veterinary medicine or veterinary technology and which has not been delegated by the supervising veterinarian, except in the case of an emergency as defined by Section 54-2103(16), Idaho Code; (3-20-20)T

**c.** Working in conjunction with any unlicensed or uncertified person who is practicing veterinary medicine or veterinary technology; (3-20-20)T

**d.** Failing to apply sanitary methods or procedures in the treatment of any animal; (3-20-20)T

**e.** Physically abusing a patient or failing to conform to the currently accepted standards of care in the field of veterinary technology for any animal under their care; (3-20-20)T

**f.** Practicing veterinary technology in a manner that endangers the health and welfare of the patient or

the public. A certified veterinary technician shall not practice veterinary technology if their ability to practice with reasonable skill and safety is adversely affected by reason of illness, excessive use of alcohol, drugs, narcotics, chemicals, or any other substance, or as a result of any mental or physical disability; (3-20-20)T

**g.** Gross ignorance, incompetence or inefficiency in the practice of veterinary technology as determined by, but not limited to, the practices generally and currently followed and accepted by persons certified to practice veterinary technology in Idaho and the current teaching at accredited programs in veterinary technology; (3-20-20)T

**h.** Intentionally performing a duty, task or procedure in the field of veterinary technology for which the individual is not qualified; (3-20-20)T

**i.** Swearing falsely in any testimony or affidavits relating to, or in the course of, the practice of veterinary technology. (3-20-20)T

**j.** Engaging in conduct of a character likely to deceive or defraud the public. (3-20-20)T

**03. Conviction of Violating Any Federal or State Statute, Rule or Regulation.** Conviction of a charge of violating any federal or state statute or rule or regulation regulating narcotics, dangerous drugs or controlled substances. (3-20-20)T

**04. Conviction of a Charge or Crime.** Being found guilty, convicted, placed on probation, having entered a guilty plea that is accepted by the court, forfeiture of bail, bond or collateral deposited to secure a defendant's appearance, or having received a withheld judgment or suspended sentence by a court of competent jurisdiction in Idaho or any other state of one (1) or more of the following: (3-20-20)T

**a.** Any felony, as defined by Title 18, Chapter 1, Idaho Code; or (3-20-20)T

**b.** Any other criminal act that in any way is related to the practice of veterinary technology as defined by Section 54-2103(47), Idaho Code. (3-20-20)T

**05. Medical Incompetence.** Medical incompetence in the practice of veterinary technology, which means lacking in sufficient medical knowledge or skills or both to a degree likely to endanger the health of patients. (3-20-20)T

**06. Physical or Mental Incompetence.** Physical or mental incompetence, which means the individual's ability to practice veterinary technology with reasonable skill and safety is impaired by reason of illness, excessive use of alcohol, drugs, narcotics, chemicals or any other substance, or as a result of any physical or mental disability. (3-20-20)T

**07. Malpractice or Negligence.** Malpractice or negligence, in the practice of veterinary technology, which includes, but is not limited to: (3-20-20)T

**a.** Treatment in a manner contrary to accepted practices in veterinary technology and with injurious results; (3-20-20)T

**b.** Any professional misconduct or unreasonable lack of professional skill or fidelity in the performance of an act that is part of the practice of veterinary technology; (3-20-20)T

**c.** Performance of an act that is part of the practice of veterinary technology without adequate supervision; except in the case of an emergency as defined by Section 54-2103(16), Idaho Code; or (3-20-20)T

**d.** The negligent practice of veterinary technology, as determined by the standard of practice for the area, that results in injury, unnecessary suffering or death. (3-20-20)T

**08. Cruelty to Animals.** Cruelty to animals, including, but not limited to, the intentional and malicious infliction of pain, physical suffering, injury or death, performance of experimental treatments without the owner's

consent, deprivation of necessary sustenance, withholding of appropriate pain medications or levels of pain medications, or the administration of unnecessary procedures and treatment. Infliction of pain on any animal in self-defense, or to prevent physical harm to others, or in accordance with local custom and culture in moving, handling, treating, dehorning, castrating or performing other procedures on livestock, shall not be considered cruel or physically abusive unless done in an unnecessary or intentionally malicious manner. This provision does not alter Section 25-3514, Idaho Code. (3-20-20)T

**09. Revocation, Suspension, Limitation or Subjection.** The revocation, suspension, limitation, or subjection of a license, certificate or registration or any other disciplinary action by another state or U.S. jurisdiction or voluntary surrender of a license, certificate or registration by virtue of which one is licensed, certified or registered to practice veterinary technology in that state or jurisdiction on grounds other than nonpayment of the renewal fee. (3-20-20)T

**10. Continuing Education.** Failure to comply with the continuing education requirements outlined by Board rules. (3-20-20)T

**11. Failure to Cooperate.** (3-20-20)T

**a.** Failure of any applicant or certificate holder to cooperate with the Board during any investigation, even if such investigation does not personally concern the applicant or certificate holder. (3-20-20)T

**b.** Failure to comply with the terms of any order, negotiated settlement or probationary agreement of the Board. (3-20-20)T

**c.** Failure to comply with the terms for certification renewal or to timely pay certification renewal fees as specified by Section 104 of these rules. (3-20-20)T

**12. Aiding or Abetting.** Knowingly aiding or abetting an unlicensed or uncertified person to practice veterinary medicine or veterinary technology. (3-20-20)T

**13. Current Certification.** Practicing as a certified veterinary technician without a current certification. (3-20-20)T

**14. Acceptance of Fees.** Accepting fees for veterinary technician services from a client. (3-20-20)T

**15. Unlawful Practice.** Representing oneself as a doctor of veterinary medicine, which constitutes the unauthorized practice of veterinary medicine in violation of Title 54, Chapter 21, Idaho Code. (3-20-20)T

**16. Violation of Law, Rules or Order.** Violating or attempting to violate, directly or indirectly, or assisting or abetting the violation or conspiracy to violate any of the provisions of the veterinary law or rules or a written order of the Board issued pursuant to Title 54, Chapter 21, Idaho Code. (3-20-20)T

**106. -- 149. (RESERVED)**

**150. VALID VETERINARIAN/CLIENT/PATIENT RELATIONSHIP.**  
An appropriate veterinarian/client/patient relationship will exist when: (3-20-20)T

**01. Responsibility.** The veterinarian has assumed the responsibility for making medical judgements regarding the health of the animal and the need for medical treatment, and the client (owner or other caretaker) has followed the instructions of the veterinarian. (3-20-20)T

**02. Medical Knowledge.** There is sufficient knowledge of the animal by the veterinarian to initiate at least a general or preliminary diagnosis of the medical condition of the animal. This means that the veterinarian has seen the animal within the last twelve (12) months or is personally acquainted with the keeping and care of the animal, either by virtue of an examination of the animal, or by medically appropriate visits to the premises where the animals are maintained within the last twelve (12) months. (3-20-20)T

**03. Availability.** The practicing veterinarian or designate is readily available for follow-up in case of adverse reactions or failure of the regimen of therapy. (3-20-20)T

**151. UNPROFESSIONAL CONDUCT.**

Any violation of the Principles of the Veterinary Medical Ethics of the American Veterinary Medical Association, these rules, Chapter 21, Title 54, Idaho Code, constitutes unprofessional conduct. Unprofessional conduct includes, but is not limited to: (3-20-20)T

**01. Unsanitary Methods or Procedures.** Failure to apply sanitary methods or procedures in the treatment of any animal, contrary to Board rules. (3-20-20)T

**02. Association with Illegal Practitioners.** Includes, but is not limited to: (3-20-20)T

**a.** Having a professional relationship or connection with, lending one's name to, or otherwise aiding and abetting any illegal or unlicensed practice or practitioner of veterinary medicine and the various branches thereof; (3-20-20)T

**b.** Rendering professional service in association with a person who is not licensed and does not hold a temporary permit; or (3-20-20)T

**c.** Sharing fees with any person, except a licensed veterinarian, for services actually performed. (3-20-20)T

**03. False Testimony.** Swearing falsely in any testimony or affidavits relating to, or in the course of, the practice of veterinary medicine, surgery or dentistry. (3-20-20)T

**04. Gross Ignorance, Incompetence or Inefficiency.** In determining gross ignorance, incompetence or inefficiency in the profession, the Board may take into account all relevant factors and practices including, but not limited to, the practices generally and currently followed and accepted by the persons licensed to practice veterinary medicine in Idaho, the current teaching at accredited veterinary schools, relevant technical reports published in recognized veterinary medical journals, and the desirability of reasonable experimentation in the furtherance of the art of veterinary medicine. (3-20-20)T

**05. Improper Supervision.** Includes, but is not limited to: (3-20-20)T

**a.** Permitting, allowing, causing or directing any individual to perform a duty, task or procedure that they are not qualified to perform. (3-20-20)T

**b.** Providing, permitting, allowing, causing or directing any individual to perform inadequate anesthetic monitoring. Evidence of this monitoring shall be documented in written form and contained within the medical record. (3-20-20)T

**06. Association with Others.** Accepting fees from the providers of animal services or products when referring clients to such providers. (3-20-20)T

**152. CODE OF PROFESSIONAL CONDUCT.**

The Board's code of professional conduct includes, but is not limited to, the following standards of conduct. A veterinarian shall: (3-20-20)T

**01. Veterinarian/Client/Patient Relationship.** Not dispense or prescribe controlled substances, prescription or legend drugs except in the course of their professional practice and after a bona fide veterinarian/client/patient relationship as defined by Section 150 of these rules has been established. (3-20-20)T

**02. Health Certificate.** Not issue a certificate of health unless they have personal knowledge by means of actual examination and appropriate testing of the animal that the animal meets the requirements for issuance of such a certificate. (3-20-20)T

**03. DEA and Controlled Substance Registration.** Notify the Board of the suspension, revocation, or voluntary surrender of their federal Drug Enforcement Administration (DEA) registration and their state controlled substance registration. (3-20-20)T

**04. Ability to Practice.** Not practice veterinary medicine as to endanger the health and welfare of their patients or the public. A veterinarian shall not practice veterinary medicine if their ability to practice with reasonable skill and safety is adversely affected by reason of illness, excessive use of alcohol, drugs, narcotics, chemicals, or any other substance or as a result of any mental or physical disability. (3-20-20)T

**05. Conflicting Interests.** Not represent conflicting interests except by the express consent of all the parties after full disclosure of all the facts. A conflict of interest includes, but not be limited to, accepting a fee from a buyer to inspect an animal for soundness and accepting a fee from the seller. (3-20-20)T

**06. Confidentiality.** Maintain a confidential relationship with their clients, except as otherwise provided by law or required by considerations related to public health and animal health. (3-20-20)T

**a.** The information contained in veterinary medical records is considered confidential. It is unethical for a veterinarian to release this information except by court order or consent of the patient's owner or other caretaker at the time treatment was rendered. (3-20-20)T

**b.** Without express permission of the practice owner, it is unethical for a veterinarian or certified veterinary technician to remove, copy, or use the medical records or any part of any record belonging to the practice or its owner for any purpose other than the business of the practice. (3-20-20)T

**07. Physical Abuse-Patient.** Not physically abuse a patient or fail to conform to the currently accepted standards of care in the veterinary profession for any animal under their care. (3-20-20)T

**08. Preservation of Patient's Body.** Where possible preserve for twenty-four (24) hours the body of any patient that dies while in the veterinarian's care until the owner can be contacted, except as otherwise provided by law. The time of contact or attempted contact with the owner shall be documented in the medical record. The veterinarian is allowed to use the usual manner of disposal if the owner has not made pick-up arrangements within twenty-four (24) hours of the documented contact time. (3-20-20)T

**09. Consent for Transporting.** Obtain written consent from a patient's owner or other caretaker before transporting a patient to another facility for veterinary medical care or any other reason, unless circumstances qualifying as an emergency do not permit obtaining such consent. (3-20-20)T

**10. Patient Record.** Maintain a patient record for each animal or herd that accurately reflects the veterinary problems and interventions and conforms to the standards set forth in Section 154 of these rules. (3-20-20)T

**11. Supervision.** Provide the proper form of supervision required for persons to whom veterinary functions are delegated or assigned. (3-20-20)T

**12. Cooperation with Authorities.** Cooperate with authorities in the investigation of the incompetent, unethical or illegal practice of veterinary medicine by any individual including another veterinarian. (3-20-20)T

**13. Refusal to Render Services.** Have the right to refuse to render veterinary medical services for any reason, or refuse an owner's request to euthanize a healthy or treatable animal. (3-20-20)T

**14. Improper Disposal of Controlled Substances.** Dispose of all controlled substances and the containers, instruments and equipment used in their administration in conformance with the requirements of the Code of Federal Regulations and the Idaho Board of Pharmacy law and rules. (3-20-20)T

**153. STANDARDS OF PRACTICE.** Veterinarians shall adhere to the standards of practice including, but not limited to: (3-20-20)T

**01. Practice Procedures.** A licensed veterinarian shall exercise at least the same degree of care, skill, and diligence in treating patients that is ordinarily used in the same or similar circumstances by members of the veterinary medical profession of similar training and experience in the community in which he practices. (3-20-20)T

**02. Immunization.** When the primary objective is to protect the patient's health and a professionally acceptable immunization procedure is being sought, an examination of the animal by the veterinarian is required prior to each and every immunization procedure, unless the animal has been examined in the last ninety (90) days, except in the practice of large animal medicine where mass immunizations of animal herds is involved or when immunization is performed by the patient's owner. For the purpose of this subsection, the definition of "owner" in addition to ownership as defined by the laws of the ownership of property, non-profit organizations dedicated to the care and treatment of animals is considered the owners of animals in their custody if such organizations are the primary care giver for the animal or if the true owner of such animal cannot be immediately determined. (3-20-20)T

**03. Relationship.** A veterinarian shall establish a valid veterinarian/client/patient relationship as defined by Section 150 of these rules, prior to dispensing, using, prescribing, or selling any controlled substance or legend drug, or the prescribing of an extra-label use of any drug. (3-20-20)T

**04. Dispense and Distribute in Good Faith.** A veterinarian dispensing or distributing any drug or medicine shall dispense or distribute such drug or medicine in good faith, within the context of a valid veterinarian/client/patient relationship as defined by Section 150 of these rules, and shall, except in the case of any drugs and medicines that are in containers that bear a label of the manufacturer with information describing their contents and that are in compliance with the requirements of the Federal Food, Drug, and Cosmetic Act, 21 CFR 201.105, affix or cause to be affixed to the container containing the drug or medicine a label indicating: (3-20-20)T

- a. The date on which such drug or medicine is dispensed; (3-20-20)T
- b. The name of the owner and patient; (3-20-20)T
- c. The last name of the person dispensing such drug or medicine; (3-20-20)T
- d. Directions for use thereof, including dosage and quantity; and (3-20-20)T
- e. The proprietary or generic name of the drug or medicine. (3-20-20)T

**05. Anesthesia Standards.** All anesthetized animals shall be appropriately monitored and under supervision. (3-20-20)T

**154. RECORD KEEPING STANDARDS.**

Every veterinarian shall maintain detailed daily medical records of the animals treated that meet the professional standards set out in Section 153 of these rules. These records may be computerized and shall be readily retrievable to be inspected, duplicated, or submitted when requested by the Board. All records, including electronic records, shall be safeguarded against loss, defacement, tampering, and use by unauthorized personnel. If changes are made to any records (either hard-copy or electronic), the records must clearly reflect what the change is, who made the change, when the change was made, and why. In the case of electronic records, the veterinarian shall keep either a duplicate hard-copy record or a back-up electronic record. Records shall be maintained for a period of three (3) years following the last treatment or examination. Patient medical records shall be maintained for every animal accepted and treated as an individual patient by a veterinarian, or for every animal group (for example, herd, litter, and flock) treated by a veterinarian. (3-20-20)T

- 01. Medical Records.** Medical records shall include, but not be limited to: (3-20-20)T
- a. Name, address and phone number of the animal's owner or other caretaker. (3-20-20)T
  - b. Name and description, sex (if readily determinable), breed and age of animal; or description of group. (3-20-20)T
  - c. Dates (beginning and ending) of custody of the animal. (3-20-20)T

- d.** A short history of the animal's condition as it pertains to the animal's medical status. (3-20-20)T
- e.** Results and notation of each examination, including the animal's condition and diagnosis suspected. (3-20-20)T
- f.** All medications, treatments, prescriptions or prophylaxis given, including amount, frequency, and route of administration for both inpatient and outpatient care. (3-20-20)T
- g.** Diagnostic and laboratory tests or techniques utilized, and results of each. (3-20-20)T
- h.** All anesthetized animals shall be appropriately monitored and under supervision at all times. Evidence of this monitoring shall be documented in writing in the medical record. (3-20-20)T
- 02. Consent Forms.** Consent forms, signed by the patient's owner or other legal caretaker for each surgical or anesthesia procedure requiring hospitalization or euthanasia, shall be obtained, except in emergency situations, for each animal and be maintained on file with the practitioner. (3-20-20)T
- 03. Postoperative Instructions.** Postoperative home-care instructions shall be provided in writing and be noted in the medical record. (3-20-20)T
- 04. Treatment Records.** Veterinarians who practice with other veterinarians shall indicate by recognizable means on each patient's or animal group's medical record any treatment the veterinarian personally performed and which treatments and procedures were delegated to a technician or assistant to perform. The patient's record must also include a notation indicating when the animal was handed-off to another veterinarian or a treatment or procedure delegated to a technician or assistant along with a summary of the animal's condition and diagnosis at the time of the hand-off. (3-20-20)T
- 05. Ownership of Medical Records.** Medical records are the personal property of the hospital or the proprietor of the practice that prepares them. Other veterinarians, including those providing subsequent health needs for a patient, and the patient's owner may receive a copy of the patient's medical record, upon the request of the patient's owner or other caretaker. Records shall be supplied within three (3) business days, counting the day of the request if a business day. (3-20-20)T
- 06. Diagnostic Image Identification and Ownership.** All diagnostic images shall be labeled in the emulsion film or digitally imprinted to identify the veterinarian or premise, the patient, the owner, the date, and anatomical orientation. A diagnostic image is the physical property of the hospital or the proprietor of the practice that prepares it, and it shall be released upon the request of another veterinarian who has the authorization of the owner of the animal to whom it pertains or to the Board. Such diagnostic images shall be returned within a reasonable time to the veterinarian who originally ordered them to be prepared. (3-20-20)T
- 07. Estimates.** A veterinarian shall make available to each client a written estimate on request. (3-20-20)T
- 08. Controlled Substances and Prescription or Legend Drugs.** A controlled substance is any substance classified by the federal Food and Drug Administration or the Idaho Board of Pharmacy in Schedules I through V of the state or federal Controlled Substances Act, Title 37, Chapter 27, Idaho Code, or 21 CFR 1308. A prescription or legend drug is any drug that under federal law is required, prior to being dispensed or delivered, to be labeled with one (1) of the following statements: "Caution federal law prohibits dispensing without a prescription"; or "RX Only"; or "Caution: Federal law restricts this drug to use by or on the order of a licensed veterinarian"; or a drug which is required by any applicable federal or state law or regulation or rule to be dispensed on prescription only, or is restricted to use by practitioners only. A veterinarian shall only dispense or distribute a controlled substance or prescription or legend drug within the context of a valid veterinarian/client/patient relationship as defined by Section 150 of these rules. (3-20-20)T

  - a.** Records shall be kept in compliance with all federal and state laws and be recorded in the patient records along with the initials of the veterinarian who authorized the dispensing or distribution of the controlled



- substances, prescription, or legend drugs. (3-20-20)T
- b.** A separate inventory record shall be kept for each controlled substance by name and strength including: (3-20-20)T
- i.** Records of the receipt, which include all information required by federal law, the date of the receipt, the amount received, the source of receipt, and the invoice number. (3-20-20)T
- ii.** Records of dispensing, which include the date the controlled substance was dispensed, the amount dispensed, the animal's name, identification of the patient record, identification of the person who dispensed the drug, identification of the veterinarian who supervised the dispensing and any other information required by federal law. (3-20-20)T
- c.** Records for all dispensed or distributed prescription or legend drugs shall be maintained in the individual patient or herd record and include the date the drug was dispensed or distribution was authorized, the amount dispensed or distributed, identification of the person who dispensed or authorized distribution of the drug, identification of the veterinarian who supervised the dispensing and any other information required by federal or state law, regulation or rule. (3-20-20)T
- d.** Prescription drug order means a lawful written or verbal order of a veterinarian for a drug. (3-20-20)T
- i.** When prescription drug orders are issued by a licensed veterinarian to be distributed to the animal's owner or legal caretaker by a retail veterinary drug outlet, all orders for prescription or legend drugs shall be written on an official numbered three (3) part order form available through the Idaho Department of Agriculture. The veterinarian shall retain the second copy in their medical record with the original and one (1) copy sent to the retail veterinary drug outlet. The retail veterinary drug outlet shall retain the original and attach the copy of the original to the order for delivery to the animal's owner or legal caretaker. (3-20-20)T
- ii.** Under no circumstances shall a prescription or legend drug be distributed by a retail veterinary drug outlet to an animal's owner or legal caretaker prior to the issuance of either a written or oral prescription drug order from the veterinarian: (3-20-20)T
- (1)** When a written prescription drug order from the veterinarian has been issued to a retail veterinary drug outlet, a copy of the veterinarian's original numbered prescription drug order shall be attached to the prescription or legend drugs that are delivered to the animal's owner or legal caretaker. (3-20-20)T
- (2)** When a retail veterinary drug outlet receives an oral prescription drug order from the veterinarian, the oral order shall be promptly reduced to writing on a Department of Agriculture unnumbered telephone drug order blank. A copy of this completed form shall be attached to the prescription or legend drugs that are delivered to the animal(s)'s owner or legal caretaker. (3-20-20)T
- (3)** When a veterinarian issues an oral prescription drug order to a retail veterinary drug outlet, the oral order shall be followed by a written prescription drug order signed by the veterinarian using the official numbered three (3) part order form and procedures required under these rules. The written order shall be sent promptly by the veterinarian so that it is received by the retail veterinary drug outlet no later than seven (7) days after the retail veterinary drug outlet receives the oral order. The written confirmation order may be hand-delivered, mailed, faxed, attached to an e-mail, or otherwise properly delivered to the retail veterinary drug outlet. (3-20-20)T
- e.** When prescription or legend drugs are dispensed, the labeling on all containers shall be in compliance with the requirements of Paragraph 153.01.d. of these rules. (3-20-20)T
- f.** When controlled substances are dispensed, all containers shall be properly labeled with:(3-20-20)T
- i.** The clinic's name, address, and phone number; (3-20-20)T
- ii.** The name of the client and patient; (3-20-20)T

iii. The drug name and quantity; and (3-20-20)T

iv. The directions for use, including dosage and quantity. (3-20-20)T

**g.** All controlled substances shall be stored, dispensed, and disposed of in accordance with the requirements of the Uniform Controlled Substances Law and Code of Federal Regulations. (3-20-20)T

**09. Return or Disposal of Expired Pharmaceuticals and Biologicals.** Except for controlled substances, which shall be disposed of in accordance with Paragraph 154.08.g. of these rules, all pharmaceuticals and biologicals that have exceeded their expiration date shall be removed from inventory and disposed of appropriately. (3-20-20)T

**155. -- 199. (RESERVED)**

**200. COMMITTEE ON HUMANE EUTHANASIA.**

Pursuant to Section 54-2105(8), Idaho Code, a Committee on Humane Euthanasia (COHE) is established for the purpose of training, examining, and certifying euthanasia agencies and euthanasia technicians. The COHE will consist of no fewer than five (5) members appointed by the Board. At its discretion, the Board may appoint itself as the COHE. New members will be nominated by either the Board or the COHE and be confirmed by the Board. Applicants for a COHE position shall be certified euthanasia technicians (CETs) as defined by Section 54-2103(9), Idaho Code, and employed by a certified euthanasia agency as defined by Section 54-2103(8), Idaho Code, or be an Idaho licensed veterinarian (3-20-20)T

**01. Term.** Each member will serve for three (3) years, at the pleasure of the Board. A COHE member may be eligible for reappointment. If there is a vacancy for any cause, the COHE or the Board shall nominate and confirm a successor to fill the unexpired term. (3-20-20)T

**02. Duties.** The duties of COHE members include, but are not limited to, the following: (3-20-20)T

**a.** Coordinate and provide euthanasia training classes as needed. (3-20-20)T

**b.** Inspect and certify agencies. (3-20-20)T

**c.** Review the applications, records, performance, methods and procedures used by agencies and persons seeking to be certified or to renew their certification as a Certified Euthanasia Agency (CEA) or Certified Euthanasia Technician (CET). (3-20-20)T

**d.** Conduct written and practical examinations for applicants applying for certification and authorize certification through the Board. (3-20-20)T

**e.** Recommend suspension or revocation of a certification when necessary. (3-20-20)T

**03. Compensation.** Members of the COHE will be compensated as provided by Section 59-509(n), Idaho Code. (3-20-20)T

**201. METHODS OF EUTHANASIA, PRE-EUTHANASIA SEDATION, AND CHEMICAL CAPTURE.**

Methods approved by the COHE and used for the purpose of humanely euthanizing, sedating, or remote chemical capturing injured, sick, homeless, or unwanted pets and animals: (3-20-20)T

**01. Euthanasia Drugs.** Any Schedule II non-narcotic or Schedule III non-narcotic euthanasia drug covered by the Controlled Substances Act that has first been approved in writing by the COHE and the Board. A list of approved euthanasia drugs is on file at the Board office. (3-20-20)T

**02. Pre-Euthanasia Sedation Drugs.** Any Schedule III or Schedule IV narcotic or non-narcotic controlled substance as defined by the Controlled Substances Act, or other legend drugs that have been approved for use by CEAs or CETs at a CEA facility. Such pre-euthanasia sedation drugs shall be limited to those approved in

writing by the COHE and the Board. A list of approved pre-euthanasia sedation drugs is on file at the Board office. (3-20-20)T

**03. Remote Chemical Capture Restraint Drugs.** Any Schedule III or Schedule IV narcotic or non-narcotic controlled substance as defined by the Controlled Substances Act, or other legend drugs that have been approved for use by CEAs or CETs. Such remote chemical capture restraint drugs shall be limited to those approved in writing by the COHE and the Board. A list of approved remote chemical capture restraint drugs is on file at the Board office. Use of remote chemical capture is limited to CEAs and CETs who are classified as law enforcement agencies or law enforcement personnel who have successfully completed a Board-approved course in remote chemical capture. (3-20-20)T

**202. PROCUREMENT AND ADMINISTRATION OF APPROVED DRUGS.**

In order for a certified euthanasia agency to obtain approved drugs for euthanizing animals and a certified euthanasia technician to administer such drugs, the following procedure shall be followed: (3-20-20)T

**01. DEA Registration.** A certified euthanasia agency (CEA) shall appoint a person who will be responsible for ordering the approved drugs and who shall submit an application for the agency's registration as a Euthanasia Agency Practitioner-A.S. to the Drug Enforcement Agency (DEA). The CEA shall also designate a certified euthanasia technician (CET) who will be responsible for the security of the agency's approved drugs. (3-20-20)T

**02. Controlled Substance Registration.** Each CET employed by the agency shall apply for a controlled substance registration from the Idaho Board of Pharmacy under their individual name and using the CEA's DEA registration number. (3-20-20)T

**03. Purchase of Approved Drugs.** After the certified euthanasia agency has received a DEA registration number and the CETs at that agency have received their Idaho Board of Pharmacy controlled substance registrations, the designated individual for the agency may on behalf of the agency purchase approved drugs for storage at the CEA location. Approved drugs shall only be obtained from a drug wholesaler. (3-20-20)T

**04. Administration of Approved Drugs.** Certified euthanasia technicians employed by certified euthanasia agencies and registered with the Idaho Board of Pharmacy may perform euthanasia by the administration of approved drugs. (3-20-20)T

**203. FEES.**

**01. Payment.** All fees shall be paid prior to training, examination, certification, and renewal. (3-20-20)T

**02. Refunds.** Fees are non-refundable. (3-20-20)T

**204. CERTIFIED EUTHANASIA AGENCY.**

A certified euthanasia agency is a law enforcement agency, an animal control agency, a humane society, or an animal shelter that has been inspected and certified by the COHE or the Board, Section 54-2103(8), Idaho Code. In order to be certified to purchase and store approved drugs, certified euthanasia agencies shall be inspected by the COHE or the Board and meet the following criteria: (3-20-20)T

**01. Approved Drugs.** Approved drugs shall be kept in a locked cabinet securely attached to the building in which it is housed. (3-20-20)T

**a.** Each agency shall maintain a current written list of CET(s). (3-20-20)T

**b.** Access to the drug storage cabinet shall be limited to licensed veterinary supervisors and assigned CET. Such persons shall be responsible for the security of the approved drugs and allow withdrawal of the approved drugs only to a person certified by the Board and registered with the Idaho Board of Pharmacy to administer such drugs. (3-20-20)T

- c.** All approved drugs shall be prepared according to the manufacturer's instructions. (3-20-20)T
- d.** Needles in a range of sizes that are the appropriate gauge for the intended use. Needles shall be of medical quality, and not be used if they are dirty, clogged, barbed, or might otherwise cause unnecessary discomfort for the animal. (3-20-20)T
- e.** Needles and syringes shall not be reused. (3-20-20)T
- f.** Three (3) different syringe sizes are required: three (3), six (6), and twelve (12) cc. An agency may have other syringe sizes according to its needs. Syringes shall be of medical quality. (3-20-20)T
- g.** Spent needles and syringes shall be disposed of in a manner that makes their re-use impossible. (3-20-20)T
- 02. Proper Storage.** When no CET is on duty, proper storage for approved drugs is in a locked storage cabinet. (3-20-20)T

  - a.** The cabinet shall be of such material and construction that it will withstand strong attempts to break into it. A metal safe is preferred. (3-20-20)T
  - b.** The cabinet shall be securely attached to the building in which it is housed. (3-20-20)T
  - c.** The temperature and environment in the storage cabinet shall be adequate to assure the proper keeping of the drug. (3-20-20)T
- 03. Proper Labeling.** Upon removal from the shipment carton, each individual container of an approved drug shall be labeled with the drug name and strength, the date the drug was prepared, a drug hazard warning label and the name and address of the agency owning the drug. (3-20-20)T
- 04. Temporary Storage.** When a CET is on duty and when animals are being euthanized throughout the workday, approved drugs may be kept in a temporary storage cabinet. When approved drugs are transported in a vehicle, the temporary storage cabinet shall be securely bolted to the vehicle. The cabinet shall be constructed of any strong material and be securely locked when not in use. The key to this cabinet shall be secured by a licensed veterinary supervisor or the lead CET designated on the DEA controlled substance registration, and made available to the CET(s) performing euthanasia that day. (3-20-20)T
- 05. Record Keeping.** Proper record keeping of approved drugs shall include the following: (3-20-20)T

  - a.** Shipment records showing receipt of the approved drugs shall be maintained and include all information required by federal law, the date the shipment was received, the amount, the source, and the invoice number. (3-20-20)T
  - b.** Administration records showing the date an approved drug was: (3-20-20)T

    - i.** Administered; (3-20-20)T
    - ii.** Weight and species of animal; (3-20-20)T
    - iii.** Dosage of each drug administered for pre-euthanasia sedation, euthanasia, and remote chemical capture restraint; (3-20-20)T
    - iv.** Identification of the person who dispensed the approved drugs; and, if applicable; (3-20-20)T
    - v.** Identification of the veterinarian or CET who supervised the dispensing shall be maintained. (3-20-20)T
  - c.** Records of wastage shall be maintained and signed by the CET administering the approved drug

and the CET responsible for security. (3-20-20)T

**d.** A weekly record of the approved drugs on hand, minus the amounts withdrawn for administration, signed by the CET responsible for security. (3-20-20)T

**e.** Disposal records of any expired or unwanted approved drugs shall be maintained. Disposal of unwanted drugs and the containers, instruments, and equipment used in the administration of the approved drugs shall be in conformance with the Idaho Board of Pharmacy law and rules and the Code of Federal Regulations. (3-20-20)T

**f.** All records shall be filed in chronological order in a binder that is labeled with the name of the agency and be kept for a period of three (3) years from the calendar date on the record. (3-20-20)T

**06. Proper Sanitation.** The euthanasia area shall be clean and regularly disinfected. (3-20-20)T

**07. Other Site Conditions.** Other site conditions relevant to the proper euthanasia environment. (3-20-20)T

**a.** Each agency shall have a specific area designated for euthanasia that is: (3-20-20)T

i. A separate room; or (3-20-20)T

or ii. An area that is physically separated from the rest of the agency by a wall, barrier or other divider; (3-20-20)T

iii. An area that is not used for any other purpose while animals are being euthanized. (3-20-20)T

**b.** The euthanasia area shall meet the following minimum standards: (3-20-20)T

i. Lighting shall be bright and even; (3-20-20)T

ii. The air temperature shall be within a reasonable comfort range for both the personnel and animals. A minimum sixty (60) degrees F and maximum ninety (90) degrees F is recommended; (3-20-20)T

iii. The area shall have adequate ventilation that prevents the accumulation of odors. At least one (1) exhaust fan vented directly to the outside is recommended; and (3-20-20)T

iv. The floor of the area shall provide dry, non-slip footing to prevent accidents. (3-20-20)T

**c.** The euthanasia area shall have the following equipment: (3-20-20)T

i. A table or other work area where animals can be handled while being euthanized. (3-20-20)T

ii. A cabinet, table or work bench where the drugs, needles, syringes and clippers can be placed. (3-20-20)T

**d.** The following items and materials shall either be kept in the euthanasia area or brought to the area each time an animal is euthanized: (3-20-20)T

i. A first aid kit that meets minimum first aid supply standards; (3-20-20)T

ii. One (1) or more tourniquets; (3-20-20)T

iii. Standard electric clippers with No. 40 blade; (3-20-20)T

iv. Animal control stick for dogs and animal net for cats (if the agency handles cats); (3-20-20)T

v. Stethoscope; (3-20-20)T

- vi. Disinfectant. (3-20-20)T
- vii. The current certification cards for the CEA and all CETs working at the CEA, which shall be kept together. The CEA is strongly encouraged to keep all DEA and Idaho Board of Pharmacy registration cards together with the certification cards. (3-20-20)T

- e. All equipment shall be in good working order. (3-20-20)T

**08. Equipment Stored.** All equipment shall be stored so that it does not create a safety hazard for the personnel. All drugs and other chemical agents used in the euthanasia area shall be clearly labeled as specified by Subsection 204.03 of these rules. (3-20-20)T

**09. Certification Renewal.** Certifications may be renewed upon successful completion of a facility inspection by a COHE member, a member of the Board or other individual appointed by the COHE and payment of the annual renewal fee. (3-20-20)T

**205. CERTIFIED EUTHANASIA TECHNICIAN.**

**01. Training and Examinations.** The COHE or the Board will develop training sessions and materials that include, but are not limited to, the following topics: (3-20-20)T

- a. Euthanasia: (3-20-20)T
  - i. Animal anatomy; (3-20-20)T
  - ii. Proper animal handling to ease trauma and stress; (3-20-20)T
  - iii. Dosages of chemical agents, record keeping and documentation of usage, storage, handling, and disposal of out-dated drugs and their containers, instruments and equipment used in their administration in accordance with the Idaho Board of Pharmacy law and rules and the Code of Federal Regulations; (3-20-20)T
  - iv. Proper injection techniques; and (3-20-20)T
  - v. Proper use and handling of approved euthanasia drugs and equipment; (3-20-20)T
  - vi. Examination. Following the euthanasia training, a written examination covering the training topics will be given. (3-20-20)T
- b. Remote Chemical Capture: (3-20-20)T
  - i. An overview of remote chemical capture; (3-20-20)T
  - ii. Description and basic mechanism of action of approved drugs; (3-20-20)T
  - iii. Laws, regulations and rules governing remote chemical capture; (3-20-20)T
  - iv. Post-injection care; (3-20-20)T
  - v. Proper use and handling of approved restraint drugs and equipment; (3-20-20)T
  - vi. Human safety; (3-20-20)T
  - vii. Tactics and strategy; and (3-20-20)T
  - viii. Delivery systems and equipment. (3-20-20)T

**02. Certification Standards.** Applicants for certification as a CET shall be eighteen (18) years of age or older and demonstrate proficiency in compliance with the following standards: (3-20-20)T

**a.** Demonstrate competency in euthanasia techniques in the presence of a COHE or Board member, or a person approved by the Board: (3-20-20)T

i. CETs are fully responsible for all actions that take place in the euthanasia area when an animal is brought to the area including, but not limited to, animal handling, use of the proper restraint technique, the proper drug dosage, and drug handling; (3-20-20)T

ii. CETs shall be able to competently perform intravenous injections on dogs and intraperitoneal injections on both dogs and cats. Intravenous injections on cats shall not be required as part of the certification process, but when performed, meet the standards listed in Subparagraph 205.02.a.ii.(1) of these rules. Intracardiac injections on dogs and cats shall not be required as part of the certification process, but when performed, are restricted to the limitations listed in Subparagraph 205.02.a.ii.(3) of these rules. (3-20-20)T

(1) Intravenous Injections: The CET shall be able to competently insert the needle into an animal's vein when an animal is injected by this method. A minimum of two (2) people shall be required for any IV injection. One (1) person shall be a CET and one (1) or more people shall be the handler. The handler does not need to be a CET, but the handler should be trained in human safety and animal handling techniques; (3-20-20)T

(2) Intraperitoneal Injections: The CET shall be able to competently insert the needle into the proper area of the peritoneal cavity when an animal is injected by this method. It is recommended that animals injected by this method be placed into a cage or carrier with no other animals. The cage or carrier shall be covered with cloth or other material that can keep the injected animal isolated from the normal activities in the euthanasia area. Intraperitoneal injections may be administered by a CET without a handler. (3-20-20)T

(3) Intracardiac Injections: Intracardiac injection shall be performed only on an anesthetized animal. CETs shall be able to competently insert the needle into the heart of an anesthetized animal, and intracardiac injections may be administered by a CET without a handler. (3-20-20)T

iii. No other euthanasia injection procedures are permitted in any type of animal with the exception of intramuscular and subcutaneous injections for pre-euthanasia sedation; (3-20-20)T

iv. Oral administration of approved euthanasia drugs is permitted for any animal that cannot be captured or restrained without serious danger to human safety; (3-20-20)T

**b.** Demonstrate proper record keeping. A record of all approved drugs received and used by the agency shall be kept containing the following information: (3-20-20)T

i. A weekly verification of the drug stock on hand, minus the amounts withdrawn for administration, signed by the CET responsible for security; (3-20-20)T

ii. An entry of the date that a new bottle of any approved drug is opened and the volume of the bottle, signed by the CET responsible for security; (3-20-20)T

iii. The species and approximate weight of each animal administered a drug; (3-20-20)T

iv. The amount of the drug that was administered; (3-20-20)T

v. The date the drug was administered; (3-20-20)T

vi. The signature of the CET who administered the drug; (3-20-20)T

vii. A record of the amount of the drug wasted, if any, signed by the CET administering the drug and the CET responsible for security; and (3-20-20)T

viii. A record of any disposal of expired or unwanted approved drugs, other chemical agent or the containers, instruments and equipment used in their administration, signed by the CET and disposed of in accordance with the Idaho Board of Pharmacy law and rules and the Code of Federal Regulations. (3-20-20)T

c. Demonstrate understanding and concern for the needs and humane treatment of individual animals: (3-20-20)T

i. All animals shall be handled in a manner that minimizes stress to the animal and maximizes the personal safety of the CET and the handler. Each animal shall be handled with the least amount of restraint necessary, but human safety is always the primary concern. Handling includes all aspects of moving an animal from one (1) area to another; (3-20-20)T

ii. The use of control sticks and other similar devices shall be limited to fractious or potentially dangerous animals; and (3-20-20)T

iii. Animals shall not be placed in cages or kennels with other breeds or species that are incompatible with the animal in question or be overcrowded in a cage or kennel. (3-20-20)T

d. Demonstrate ability to verify death. The animal should become unconscious and show terminal signs within sixty (60) minutes of drug administration. If any animal does not show any of these signs within the designated time period, the CET shall re-administer the drug. An animal that has received an approved drug orally may be injected with the same or another approved drug after it has become unconscious. Verification is the responsibility of the CET and shall be made by physical examination of the individual animal. One (1) of the following two (2) standards for death shall be met: (3-20-20)T

i. Rigor mortis; or (3-20-20)T

ii. Complete lack of heartbeat (as checked with a stethoscope), complete lack of respiration, and complete lack of corneal and palpebral reflexes. (3-20-20)T

e. Demonstrate ability to communicate with handlers during the euthanasia process. (3-20-20)T

**03. Certification.** (3-20-20)T

a. An individual shall not be certified as a CET until such time as he has successfully passed all of the following: (3-20-20)T

i. A euthanasia written examination; (3-20-20)T

ii. A practical or clinical examination; and (3-20-20)T

iii. An Idaho euthanasia jurisprudence examination. (3-20-20)T

b. The euthanasia written examination is the “written examination” referenced in Subparagraph 205.01.a.vii. of this rule. The practical examination will test the individual’s knowledge and skills in the hands-on application of euthanasia procedures and practices in a clinical setting under the direction of a COHE member, a Board member, or a designee of either the COHE or Board. The Idaho euthanasia jurisprudence examination (which can either be a separate written test or combined with the euthanasia written examination) will be an examination testing the individual’s understanding of Idaho laws and Board rules addressing the practice of euthanasia. Both the euthanasia written examination and the euthanasia jurisprudence examination will be developed by the Board, the COHE, or a designee of either the Board or the COHE. (3-20-20)T

c. A passing score for the euthanasia written examination is eighty percent (80%), or such other score as deemed appropriate by the Board or the COHE. A passing score for the euthanasia jurisprudence examination is ninety percent (90%), or such other score as deemed appropriate by the Board or the COHE. A failed euthanasia jurisprudence examination may be retaken multiple times upon making arrangements acceptable to the Board. (3-20-20)T



**d.** Initial certification and certification renewal training sessions and examinations will be conducted at least once per year prior to July 1, and at such other times deemed necessary by the COHE, the Board, or a designee of either the COHE or the Board. Upon approval of the Board, a COHE member, or the designee of either the Board or the COHE, an individual may take the euthanasia written examination, the practical examination, and the euthanasia jurisprudence examination in any order. (3-20-20)T

**e.** An individual who has passed the written examination, but has not attended a training session and has not passed the practical examination, may serve as a probationary euthanasia technician under the direct supervision of a currently certified CET until such time as the next training course, practical examination and certification are conducted by a COHE member, a Board member, or the designee of either the COHE or the Board. (3-20-20)T

**f.** An individual who has not passed the written examination may not serve as a euthanasia technician. (3-20-20)T

**g.** An individual who attends a training session and passes the written examination but fails the practical examination may serve on probation until he has been re-examined. If the individual fails to pass the practical examination a second time and wishes to apply again, the individual shall attend the next regular training session and written examination. (3-20-20)T

**h.** Upon termination from an agency as defined in Section 204 of these rules, a CET's certification immediately becomes invalid and the CET shall not perform animal euthanasia until employed by another certified euthanasia agency, at which time the certification may be reinstated. (3-20-20)T

**i.** The agency shall notify the Board office in writing within thirty (30) days from the date the CET's employment at that agency is terminated. (3-20-20)T

**j.** If a CET is employed again by a CEA prior to the expiration of their certification, the CEA employer may request reinstatement of the CET's certification. If a CET has not attended a euthanasia training in the three (3)-year period preceding recertification, the CET may not be recertified and will need to reapply for certification, at COHE discretion. (3-20-20)T

**k.** All certifications expire on July 1 of each year. (3-20-20)T

**04. Certification Renewal.** (3-20-20)T

**a.** Certifications may be renewed each year by payment of the annual renewal fee, provided that, every third year following the date of certification, the CET will need to attend a euthanasia training and pay the current training and certification fee prescribed by Section 014 of these rules. (3-20-20)T

**b.** In addition to the above euthanasia training recertification requirement, CETs classified as law enforcement personnel who use chemical capture must recertify in remote chemical capture every third year following their original remote chemical capture certification. (3-20-20)T

**05. Duties.** The duties of a CET include, but are not limited to: (3-20-20)T

**a.** Preparing animals for euthanasia; (3-20-20)T

**b.** Accurately recording the dosages for drugs that are administered and amounts for drugs wasted; (3-20-20)T

**c.** Ordering supplies; (3-20-20)T

**d.** Maintaining the security of all controlled substances and other approved drugs; (3-20-20)T

**e.** Directly supervising probationary CET; (3-20-20)T

- f. Reporting to the Board violations or suspicions of a violation of these rules or any abuse of drugs; (3-20-20)T
- g. Humanely euthanizing animals; and (3-20-20)T
- h. Proper and lawful disposal of euthanized animals and expired or unwanted drugs, other chemical agent or the containers, instruments and equipment used in the administration of approved drugs. (3-20-20)T

**206. GROUNDS FOR DISCIPLINE -- CEAS AND CETs.**

The Board may refuse to issue, renew, or reinstate the certification of a CEA or CET, or may deny, revoke, suspend, sanction, place on probation, or require voluntary surrender of the certification of a CEA or CET, impose other forms of discipline, and enter into consent agreements and negotiated settlements with CEAs and CETs pursuant to the procedures set forth in Title 67, Chapter 52, Idaho Code, for any of the following reasons: (3-20-20)T

- 01. Failure to Carry Out Duties.** Failure to carry out the duties of a CEA or CET. (3-20-20)T
- 02. Abuse of Chemical Substances.** Abuse of any chemical substance by: (3-20-20)T
  - a. Selling or giving chemical substances away; or (3-20-20)T
  - b. Stealing chemical substances; or (3-20-20)T
  - c. The diversion or use of any chemical substances for other than legitimate chemical capture or euthanasia purposes; or (3-20-20)T
  - d. Abetting anyone in the foregoing activities. (3-20-20)T
- 03. Euthanizing of Animals Without Proper Supervision.** Allowing uncertified individuals or probationary CETs to euthanize animals or personally euthanizing animals without proper supervision. (3-20-20)T
- 04. Administration of Approved Drugs Without Proper Supervision.** Allowing uncertified individuals or probationary CETs to administer approved drugs or personally administering approved drugs without proper supervision. (3-20-20)T
- 05. Euthanizing of Animals Without Proper Certification.** Allowing individuals or probationary CETs to euthanize animals or personally euthanizing animals without being properly certified to do so. (3-20-20)T
- 06. Fraud, Misrepresentation, or Deception.** The employment of fraud, misrepresentation of a material fact, or deception by an applicant or certificate holder in securing or attempting to secure the issuance or renewal of a certificate. (3-20-20)T
- 07. Unethical or Unprofessional Conduct.** Unethical or unprofessional conduct means to knowingly engage in conduct of a character likely to deceive or defraud the public and includes, but is not limited to: (3-20-20)T
  - a. Working in conjunction with any agency or person illegally practicing as a CEA or CET; (3-20-20)T
  - b. Failing to provide sanitary facilities or apply sanitary procedures for the euthanizing of any animal; (3-20-20)T
  - c. Euthanizing animals in a manner that endangers the health and welfare of the public. A CET shall not euthanize animals if their ability to practice with reasonable skill and safety is adversely affected by reason of illness, excessive use of alcohol, drugs, narcotics, chemicals, or any other substance or as a result of any mental or physical disability; (3-20-20)T
  - d. Gross ignorance, incompetence or inefficiency in the euthanizing of animals as determined by, but not limited to, the practices generally and currently followed and accepted by persons certified to practice as CETs in

- Idaho; (3-20-20)T
- e. Intentionally performing a duty, task or procedure involved in the euthanizing of animals for which the individual is not qualified; and (3-20-20)T
  - f. Swearing falsely in any testimony or affidavits relating to practicing as a CEA or CET. (3-20-20)T
- 08. Conviction of Violating Any Federal or State Statute, Rule or Regulation.** Conviction of a charge of violating any federal or state statute or rule or regulation regulating narcotics, dangerous drugs or controlled substances. (3-20-20)T
- 09. Conviction of a Charge or Crime.** Being found guilty, convicted, placed on probation, having entered a guilty plea that is accepted by the court, forfeiture of bail, bond or collateral deposited to secure a defendant's appearance, or having received a withheld judgment or suspended sentence by a court of competent jurisdiction in Idaho or any other state of one (1) or more of the following: (3-20-20)T
- a. Any felony, as defined by Title 18, Chapter 1, Idaho Code; or (3-20-20)T
  - b. Any crime constituting or having as an element the abuse of any drug, including alcohol. (3-20-20)T
  - c. Any other criminal act that in any way is related to practicing as a CEA or CET as defined by Section 54-2103(8) and (9), Idaho Code. (3-20-20)T
- 10. Improper Record Keeping.** Failure to follow proper record keeping procedures as outlined in Board rules. (3-20-20)T
- 11. Improper Security for Approved Drugs.** Failure to provide and maintain proper security for approved euthanasia and restraint drugs as outlined in Board rules. (3-20-20)T
- 12. Improper Storage of Equipment and Approved Drugs.** Failure to properly store equipment or approved drugs as outlined in Board rules. (3-20-20)T
- 13. Improper Disposal of Approved Drugs and Equipment.** Failure to properly dispose of approved drugs and the containers, instruments and equipment used in their administration as outlined in Board rules. (3-20-20)T
- 14. Improper Labeling of Approved Drugs.** Failure to properly label approved euthanasia and restraint drugs as outlined by Board rules. (3-20-20)T
- 15. Revocation, Suspension, Limitation or Restriction.** The revocation, suspension, limitation, or restriction of a license, certificate or registration or any other disciplinary action by another state or U.S. jurisdiction or voluntary surrender of a license, certificate or registration by virtue of which one is licensed, certified or registered to practice as a CEA or CET in that state or jurisdiction on grounds other than nonpayment of the renewal fee. (3-20-20)T
- 16. Failure to Cooperate.** (3-20-20)T
- a. Failure of any applicant or certificate holder to cooperate with the Board during any investigation, even if such investigation does not personally concern the applicant or certificate holder; or (3-20-20)T
  - b. Failure to comply with the terms of any order, negotiated settlement, or probationary agreement of the Board; or (3-20-20)T
  - c. Failure to comply with the terms for certification renewal or to timely pay certification renewal fees. (3-20-20)T

17. **Aiding and Abetting.** Knowingly aiding or abetting an uncertified agency or person to practice as a CEA or CET. (3-20-20)T

18. **Current Certification.** Practicing as a CEA or CET without a current certification. (3-20-20)T

19. **Improper Drug Preparation.** Preparing approved drugs, contrary to manufacturer's instructions. (3-20-20)T

20. **Violation of any Law, Rules or Orders.** Violating or attempting to violate, directly or indirectly, or assisting or abetting the violation or conspiracy to violate any provisions of the veterinary law and rules or a written order of the Board issued pursuant to Title 54, Chapter 21, Idaho Code, the Idaho Board of Pharmacy law and rules, or the Code of Federal Regulations. (3-20-20)T

**207. INSPECTION DEFICIENCIES.**

If there are inspection deficiencies with either a CEA or CET, a COHE member or the Board will document in writing areas for correction. The CEA or CET, or both, shall make corrections within the time period specified in the notice of deficiency, and correction will be verified by a COHE or Board member as recorded on the deficiency documentation. If the deficiency has not been corrected, the certification may be revoked by the Board, and the Idaho Board of Pharmacy will be notified. (3-20-20)T

**208. -- 999. (RESERVED)**

# IDAPA 48 – IDAHO GRAPE GROWERS AND WINE PRODUCERS COMMISSION

## DOCKET NO. 48-0101-2000F (FEE RULE)

### NOTICE OF OMNIBUS RULEMAKING – ADOPTION OF TEMPORARY RULE

**EFFECTIVE DATE:** The effective date of the temporary rule being adopted through this omnibus rulemaking is the adjournment date of the second regular session of the 65th Idaho State Legislature - March 20, 2020.

**AUTHORITY:** In compliance with Sections 67-5226, Idaho Code, notice is hereby given this agency has adopted a temporary rule. The action is authorized pursuant to Sections 54-3605(15) and 54-3610, Idaho Code.

**DESCRIPTIVE SUMMARY:** The following is the required finding and concise statement of its supporting reasons for adopting a temporary rule:

This temporary rulemaking adopts the following chapter under IDAPA 48:

#### **IDAPA 48**

- 48.01.01, *Rules of the Idaho Grape Growers and Wine Producers Commission*

**TEMPORARY RULE JUSTIFICATION:** Pursuant to Sections 67-5226(1) and 67-5226(2), Idaho Code, the Governor has found that temporary adoption of the rule is appropriate for the following reasons:

These temporary rules are necessary to protect the public health, safety, and welfare of the citizens of Idaho and confer a benefit on its citizens. These temporary rules implement the duly enacted laws of the state of Idaho, provide citizens with the detailed rules and standards for complying with those laws, and assist in the orderly execution and enforcement of those laws. The expiration of these rules without due consideration and processes would undermine the public health, safety, and welfare of the citizens of Idaho and deprive them of the benefit intended by these rules.

**FEE SUMMARY:** Pursuant to Section 67-5226(2), the Governor has found that the fee(s) or charge(s) being imposed or increased is justified and necessary to avoid immediate danger and the fee(s) is described herein:

The fees or charges, authorized in Section 54-3610 Idaho Code, are part of the agency's 2021 budget that relies upon the existence of these fees or charges to meet the state's obligations and provide necessary state services. Failing to reauthorize these temporary rules would create immediate danger to the state budget, immediate danger to necessary state functions and services, and immediate danger of a violation of Idaho's constitutional requirement that it balance its budget.

The following is a specific description of the fee or charge imposed or increased. This rulemaking does not impose a fee or charge, or increase a fee or charge, beyond what was previously approved and codified in the prior rules. The rule specifies the amount of grape and wine tax to be levied in accordance with statute. The rule also adopts a late payment penalty in accordance with statute.

- Seven dollars (\$7) per ton of grapes purchased by producers in Idaho during the previous calendar year for the production of wine in Idaho.
- Seven dollars (\$7) per ton of grapes harvested by growers in Idaho during the previous calendar year for the purpose of the production of wine in Idaho.
- Seven dollars (\$7) per ton of grapes purchased by producers outside Idaho during the previous calendar year for the purpose of the production of wine in Idaho.
- Four cents (\$.04) per gallons of grape juice purchased by producers outside Idaho during the previous calendar year for the purpose of the production of wine in Idaho.

**ASSISTANCE ON TECHNICAL QUESTIONS:** For assistance on technical questions concerning the temporary rule, contact Brenna Christison, (208) 332-1538.

DATED this 12th day of February 2020.

Brenna Christison  
Operations & Finance Manager  
Idaho Grape Growers and Wine Producers Commission

821 W. State Street  
Boise ID 83702  
(208) 332-1538

# IDAPA 48 – IDAHO GRAPE GROWERS AND WINE PRODUCERS COMMISSION

## 48.01.01 – RULES OF THE IDAHO GRAPE GROWERS AND WINE PRODUCERS COMMISSION

### 000. LEGAL AUTHORITY.

This chapter is adopted in accordance with Section 54-3605(15), Idaho Code. (3-20-20)T

### 001. TITLE AND SCOPE.

**01. Title.** The title of this chapter is IDAPA 48.01.01, “Rules of the Idaho Grape Growers and Wine Producers Commission.” (3-20-20)T

**02. Scope.** These rules include, but are not limited to, levy of taxes and penalties as provided by Section 54-3610, Idaho Code. (3-20-20)T

### 002. DEFINITIONS.

The definitions set forth in Title 54, Chapter 36, Idaho Code, apply to this chapter. (3-20-20)T

### 003. -- 019. (RESERVED)

### 020. TAX AND LATE PAYMENT PENALTY.

**01. Levy and Rate of Tax.** In accordance with Section 54-3610, Idaho Code, a tax is levied and imposed on wineries, grapes grown, used, or purchased, and grape juice purchased for the production of wine in Idaho. The rate of each tax is: (3-20-20)T

**a.** Seven dollars (\$7) per ton of grapes purchased by producers in Idaho during the previous calendar year for the production of wine in Idaho. (3-20-20)T

**b.** Seven dollars (\$7) per ton of grapes harvested by growers in Idaho during the previous calendar year for the purpose of the production of wine in Idaho. (3-20-20)T

**c.** Seven dollars (\$7) per ton of grapes purchased by producers outside Idaho during the previous calendar year for the purpose of the production of wine in Idaho. (3-20-20)T

**d.** Four cents (\$.04) per gallons of grape juice purchased by producers outside Idaho during the previous calendar year for the purpose of the production of wine in Idaho. (3-20-20)T

**02. Minimum Levy.** The minimum taxes paid by any grower or winery is one hundred dollars (\$100) annually. (3-20-20)T

**03. Payment of Tax.** All taxes must be paid on or before June 30 of each year as follows: (3-20-20)T

**a.** The grower harvesting grapes for the production of wine pays the tax levied upon the grower. (3-20-20)T

**b.** Each winery pays the tax levied upon the winery for the production of wine. (3-20-20)T

**c.** Purchasers of grapes grown or grape juice produced outside Idaho pay the taxes levied on such grapes and grape juice. (3-20-20)T

**d.** Purchasers of grape juice produced in Idaho pay the taxes levied on such grape juice. (3-20-20)T

**04. Opt Out Alternative.** A grower or producer may opt out of the levy of tax by submitting a letter to the Commission no later than June 30 of each year stating the grower or producer's name and address, and their intent to opt out of the application of the provisions of Title 54, Chapter 36, Idaho Code, for the upcoming fiscal year. (3-20-20)T

### 021. -- 999. (RESERVED)

## **IDAPA 51 – IDAHO BEEF COUNCIL**

### **DOCKET NO. 51-0101-2000F (FEE RULE)**

#### **NOTICE OF OMNIBUS RULEMAKING – ADOPTION OF TEMPORARY RULE**

**EFFECTIVE DATE:** The effective date of the temporary rule being adopted through this omnibus rulemaking is the adjournment date of the second regular session of the 65th Idaho State Legislature - March 20, 2020.

**AUTHORITY:** In compliance with Sections 67-5226, Idaho Code, notice is hereby given this agency has adopted a temporary rule. The action is authorized pursuant to Section 25-2906 (9), Idaho Code.

**DESCRIPTIVE SUMMARY:** The following is the required finding and concise statement of its supporting reasons for adopting a temporary rule:

This temporary rule adopts the following chapter under IDAPA 51:

#### **IDAPA 51**

- IDAPA 51.01.01, *Rules of the Idaho Beef Council*

**TEMPORARY RULE JUSTIFICATION:** Pursuant to Sections 67-5226(1) and 67-5226(2), Idaho Code, the Governor has found that temporary adoption of the rule is appropriate for the following reasons:

These temporary rules are necessary to protect the public health, safety, and welfare of the citizens of Idaho and confer a benefit on its citizens. These temporary rules implement the duly enacted laws of the state of Idaho, provide citizens with the detailed rules and standards for complying with those laws, and assist in the orderly execution and enforcement of those laws. The expiration of these rules without due consideration and processes would undermine the public health, safety, and welfare of the citizens of Idaho and deprive them of the benefit intended by these rules.

**FEE SUMMARY:** Pursuant to Section 67-5226(2), the Governor has found that the fee(s) or charge(s) being imposed or increased is justified and necessary to avoid immediate danger and the fee(s) is described herein:

The fees or charges, authorized in Section 25-2907 (1), Idaho Code, are part of the agency's 2021 budget that relies upon the existence of these fees or charges to meet the state's obligations and provide necessary state services. Failing to reauthorize these temporary rules would create immediate danger to the state budget, immediate danger to necessary state functions and services, and immediate danger of a violation of Idaho's constitutional requirement that it balance its budget.

The following is a specific description of the fees or charges: Assessments include \$1.50 per head of cattle at the time the cattle are sold. This includes one dollar (\$1.00) required by the National Beef Promotion and Research Act, and fifty cents (\$.50) authorized by Section 25-2907(1), Idaho Code.

**ASSISTANCE ON TECHNICAL QUESTIONS:** For assistance on technical questions concerning the temporary rule, contact T.K. Kuwahara, 208-376-6004.

DATED this February 18, 2020.

T.K. Kuwahara  
Chief Executive Officer  
Idaho Beef Council  
1951 W Frederic Lane  
Boise, ID 83705  
Phone: 208-376-6004  
Fax: 208-376-6002

# IDAPA 51 – IDAHO BEEF COUNCIL

## 51.01.01 – IDAHO BEEF COUNCIL RULES

### 000. LEGAL AUTHORITY.

The Idaho Beef Council is authorized under Section 25-2906(9), Idaho Code, to adopt rules concerning the administration of the Beef Promotion Act. (3-20-20)T

### 001. TITLE AND SCOPE.

These rules are titled IDAPA 51.01.01, “Idaho Beef Council Rules,” IDAPA 51, Title 01, Chapter 01. These rules provide for a coordinated federal and state program of beef promotion and research funded by a one dollar and fifty cents (\$1.50) assessment on each head of cattle marketed in the state of Idaho. (3-20-20)T

### 002. ADMINISTRATIVE APPEALS.

All contested cases are governed by the procedures set forth by the National Beef Promotion and Research Order, 7 CFR 1260, issued by the United States Department of Agriculture. All written communications and documents that are intended to be part of an official record for a decision in a contested case must be filed with the Chief Executive Officer of the Idaho Beef Council. All such documents are considered filed when the original and one (1) copy of each document is received by the Chief Executive Officer of the Idaho Beef Council. (3-20-20)T

### 003. INCORPORATION BY REFERENCE.

The Idaho Beef Council operates under the rules and regulations of the National Beef Promotion and Research Order, 7 CFR 1260 (Federal Register July 18, 1986). (3-20-20)T

### 004. -- 099. (RESERVED)

### 100. FUNDING.

#### 01. Assessments. (3-20-20)T

a. Each producer shall pay an assessment of one dollar and fifty cents (\$1.50) per head of cattle at the time the cattle are sold. This assessment consists of: (3-20-20)T

i. One dollar (\$1) required by the National Beef Promotion and Research Order, and (3-20-20)T

ii. Fifty cents (\$.50) authorized by Section 25-2907(1), Idaho Code. (3-20-20)T

b. Producers selling or marketing cattle in interstate commerce will pay only one (1) assessment per individual sale of cattle. When cattle leave Idaho for the purpose of sale or slaughter, the assessment will be made at the time of brand inspection. When cattle leave Idaho for feeding or pasture where no change of ownership occurs, the promotion assessment will not be made. (3-20-20)T

c. When cattle enter Idaho for sale or slaughter, the assessment will be made only if the assessment has not been paid when the cattle left their state of origin. These cattle will be assessed by the Idaho Brand Inspector, but they will be considered cattle from their state of origin. All assessments will be remitted to the Idaho Beef Council, with these cattle indicated by their state of origin. The Idaho Beef Council will pay to the originating state the assessments due them in a timely manner after payment has been received from the State Brand Inspector. (3-20-20)T

d. The assessment implemented by this rule does not apply to the seller of cattle if the seller certifies that the seller’s only share in the proceeds of a sale of cattle or beef is a sales commission, handling fee or other service fee; or if the seller certifies that he acquired ownership of cattle to facilitate the transfer of ownership of such cattle to a third party, establishes that such cattle are being resold not later than ten (10) days from the date on which the person acquired ownership and certifies that the assessment was collected from the seller when the person acquired ownership. A completed certificate of “non-producer status” must be given to the brand inspector or his agent at the time of inspection. If no certificate is produced the assessment will be levied. (3-20-20)T

02. **Collection.** The State Brand Inspector shall collect the assessment in addition to and at the same time and manner as the fee charged for state brand inspection. The assessment will be submitted each month to the Beef Council, less collection fee. In addition, the State Brand Inspector will submit monthly, a written accounting of total number of head marketed, number of cattle assessed and not assessed (along with copies of the appropriate non-



producer exemption forms), total collections, and state of origin documentation. (3-20-20)T

**03. Refunds.** (3-20-20)T

**a.** Producers/owners of cattle from whom an assessment is collected has the right to request a refund of not more than fifty cents (\$.50) per head (Section 25-2907, Idaho Code). Refund requests must be mailed to the Idaho Beef Council within ninety (90) calendar days of payment of the assessment and include the: (3-20-20)T

i. Name and address of the producer; (3-20-20)T

ii. Name and address of the entity collecting the assessment (brand inspector or livestock market); (3-20-20)T

iii. Number of head on which a refund is requested; (3-20-20)T

iv. Total amount of refund requested; (3-20-20)T

v. Date of assessment; (3-20-20)T

vi. Producer's signature; and (3-20-20)T

vii. Proof of payment of the assessment. (3-20-20)T

**b.** The Idaho Beef Council will process the requested refunds on a calendar quarterly basis. Any refund request that is received by the Idaho Beef Council less than fifteen (15) days from the end of the calendar quarter shall be paid at the end of the next quarter. (3-20-20)T

**101. -- 199. (RESERVED)**

**200. DISBURSEMENTS.**

**01. Collection Fee, Brand Inspector.** The Idaho Beef Council will reimburse the State Brand Inspector for the reasonable and necessary expenses incurred in the collection of the assessment in an amount determined by the Beef Council and the State Brand Inspector, not to exceed five percent (5%) of gross collections. (3-20-20)T

**02. National Beef Promotion and Research Board.** The Idaho Beef Council will forward fifty cents (\$.50) credit per head of cattle assessed to the Cattlemen's Beef Promotion and Research Board. (3-20-20)T

**03. Idaho Beef Council.** Assessment funds remaining after payment of collection fee and disbursement to the National Beef Promotion and Research Board will be retained by the Idaho Beef Council and used to fund its activities and operations. (3-20-20)T

**201. -- 299. (RESERVED)**

**300. PERSONNEL.**

There will be a full time administrator whose title will be "Chief Executive Officer." Additional staff will be hired based upon Idaho Beef Council program needs and budget. (3-20-20)T

**301. -- 999. (RESERVED)**

## IDAPA 52 – IDAHO STATE LOTTERY COMMISSION

DOCKET NO. 52-0103-2000F (FEE RULE)

### NOTICE OF OMNIBUS RULEMAKING – ADOPTION OF TEMPORARY RULE

**EFFECTIVE DATE:** The effective date of the temporary rule being adopted through this omnibus rulemaking is the adjournment date of the second regular session of the 65th Idaho State Legislature - March 20, 2020.

**AUTHORITY:** In compliance with Sections 67-5226, Idaho Code, notice is hereby given this agency has adopted a temporary rule. The action is authorized pursuant to Section 67-7408(1), Idaho Code.

**DESCRIPTIVE SUMMARY:** The following is the required finding and concise statement of its supporting reasons for adopting a temporary rule:

This temporary rule adopts the following chapter under IDAPA 52:

#### **IDAPA 52**

- 52.01.03, *Rules Governing Operations of the Idaho State Lottery*

**TEMPORARY RULE JUSTIFICATION:** Pursuant to Sections 67-5226(1) and 67-5226(2), Idaho Code, the Governor has found that temporary adoption of the rule is appropriate for the following reasons:

These temporary rules are necessary to protect the public health, safety, and welfare of the citizens of Idaho and confer a benefit on its citizens. These temporary rules implement the duly enacted laws of the state of Idaho, provide citizens with the detailed rules and standards for complying with those laws, and assist in the orderly execution and enforcement of those laws. The expiration of these rules without due consideration and processes would undermine the public health, safety, and welfare of the citizens of Idaho and deprive them of the benefit intended by these rules.

**FEE SUMMARY:** Pursuant to Section 67-5226(2), the Governor has found that the fee(s) or charge(s) being imposed or increased is justified and necessary to avoid immediate danger and the fee(s) is described herein:

The fees or charges, authorized in Sections 67-74122, 67-7706, 67-7712 and 67-7715, Idaho Code, are part of the agency's 2021 budget that relies upon the existence of these fees or charges to meet the state's obligations and provide necessary state services. Failing to reauthorize these temporary rules would create immediate danger to the state budget, immediate danger to necessary state functions and services, and immediate danger of a violation of Idaho's constitutional requirement that it balance its budget.

The following is a specific description of the fees or charges: Sub Area 501 allows for an application fee for participating organizations and follow up fees based upon annual gross revenues. Sub Area 601 allows for an annual license fee imposed upon vendors, those businesses or persons who manufacture, sell, distribute, furnish or supply gaming devices to Charitable Gaming organizations. Sub Area 201 allows for an application fee for applicants interested in selling break open (PullTab) products. Rule 205.13 allows for a reduced application fee if a current Lottery product retailer is interested in adding break open (PullTab) products to their portfolio.

**ASSISTANCE ON TECHNICAL QUESTIONS:** For assistance on technical questions concerning the temporary rule, contact Becky Schroeder, Chief Operating Officer, at 208.780.2501.

DATED this February 14, 2020.

Jeffrey R. Anderson, Director  
Idaho State Lottery  
1199 Shoreline Lane, Suite 100  
Boise, ID 83702  
Ph. 208.780.2500

# IDAPA 52 – IDAHO STATE LOTTERY COMMISSION

## 52.01.03 – RULES GOVERNING OPERATIONS OF THE IDAHO STATE LOTTERY

### SUBCHAPTER A – INTRODUCTORY PROVISIONS AND DEFINITIONS

#### 000. LEGAL AUTHORITY.

These rules are adopted under the general legal authority of Title 67, Chapter 74, Idaho Code, and the specific legal authority of Sections 67-7401, 67-7404, 67-7406, 67-7408, and 67-7411, Idaho Code. (3-20-20)T

#### 001. TITLE AND SCOPE.

The title of these rules is IDAPA 52.01.03, “Rules Governing Operations of the Idaho State Lottery.” The rules govern operations of the Idaho State Lottery. The rules also set forth which bingo games and raffles are legal in the state of Idaho and to bring all legal bingo games and raffles in the state of Idaho under the control of the Lottery. (3-20-20)T

#### 002. -- 009. (RESERVED)

#### 010. DEFINITIONS.

As used throughout these rules these terms have the following definitions: (3-20-20)T

**01. Commission.** The Idaho State Lottery Commission established and appointed according to Sections 67-7402, 67-7404(2) and 67-7405, Idaho Code. See Section 67-7702(4), Idaho Code. (3-20-20)T

**02. Commissioner.** A member of the Idaho State Lottery Commission. (3-20-20)T

**03. Director.** The Director of the State Lottery appointed and confirmed according to Section 67-7407, Idaho Code. (3-20-20)T

**04. Lottery.** The Idaho State Lottery created by Section 67-7402, Idaho Code, and, as context requires, the Lottery Commission and the Lottery’s officers and employees. (3-20-20)T

**05. Person.** See definition in Section 67-7702, Idaho Code. (3-20-20)T

#### 011. -- 099. (RESERVED)

### SUBCHAPTER B – OPERATIONS OF THE IDAHO STATE LOTTERY

#### 100. DEFINITIONS.

These rules apply to Subchapter B only: (3-20-20)T

**01. Administrative Costs.** See definition in Section 67-7404, Idaho Code. (3-20-20)T

**02. Benefit.** Any thing, property or money, favorable consideration or advantage, profit, privileges, gain or interest to which a person is not otherwise entitled. (3-20-20)T

**03. Certificate.** The signed document issued by the Director authorizing a retailer to sell Lottery products. (3-20-20)T

**04. Control Person.** A person in a position of authority that is primarily defined according to organizational type. The following are control persons: (3-20-20)T

**a.** In a privately-owned corporation, the officers, directors, and stockholders of the parent company who own five percent (5%) or more of the company’s stock and, if applicable, any of its subsidiaries. (3-20-20)T

**b.** In a publicly-owned corporation, the officers and directors of the parent company and each of its subsidiaries. Additionally, stockholders who own five percent (5%) or more of the corporation’s stock are control persons. (3-20-20)T

**c.** In a trust, the trustee and all persons entitled to receive income or benefit from the trust. (3-20-20)T

- d.** In an association, the members, officers, and directors. (3-20-20)T
- e.** In a partnership or joint venture, the general partners, limited partners, or joint venturers. (3-20-20)T
- f.** A member of the immediate family of any of who is a control person under Paragraphs 010.06.a. through 06.e. of this definition. (3-20-20)T
- g.** A subcontractor of a vendor if the subcontractor performs more than half of the vendor's contract with the Lottery. (3-20-20)T
- 05. Executive Staff.** The director of Lottery Security Division and the deputy directors appointed by the Director. (3-20-20)T
- 06. Expenses.** See definition in Section 67-7404, Idaho Code. (3-20-20)T
- 07. Fiscal Year.** The Lottery's fiscal year of twelve (12) months beginning on July 1 and ending on June 30. (3-20-20)T
- 08. Gift.** A transfer, exchange or delivery of anything, property or money, of any value whatsoever, with or without an expectation by the giver to receive anything, tangible or intangible, in return. (3-20-20)T
- 09. Immediate Family.** A natural person's spouse, children, brother, sister, or parent by blood, marriage, or adoption who resides as a member of the same household in the principal place of residence of any contractor, vendor, retailer, member, or employee of the State Lottery. (3-20-20)T
- 10. Instant Game.** A game in which a ticket is purchased and upon removal of a latex or similar secure covering on the front of the ticket, the ticket bearer determines his or her winnings, if any. (3-20-20)T
- 11. Invitation to Bid.** The solicitation of competitive offers in which specifications, price, and delivery (or project completion) will be the predominant award criteria. (3-20-20)T
- 12. Lottery Contract or Contract.** Any contract entered into either by the Lottery or for the Lottery by another public agency, for the purchase, lease, or sale of goods or services. (3-20-20)T
- 13. Lottery Contractor or Contractor.** See definition in Section 67-7404, Idaho Code. (3-20-20)T
- 14. Lottery Employee or Employee.** Any person who works full- or part-time for the Lottery. (3-20-20)T
- 15. Lottery Game or Game.** Any procedure authorized by the Commission whereby prizes are distributed among persons who have paid, or unconditionally agreed to pay, for tickets or shares which provide the opportunity to win such prizes. Lottery game themes must be approved by the Commission, be consonant with the dignity of the state. (3-20-20)T
- 16. Lottery Game Retailer or Retailer.** See definition in Section 67-7404, Idaho Code. (3-20-20)T
- 17. Lottery Revenue.** See definition in Section 67-7404, Idaho Code. (3-20-20)T
- 18. Lottery Vendor or Vendor.** See definition in Section 67-7404, Idaho Code. (3-20-20)T
- 19. Low, Medium and High Tier Claims.** See definition in Section 67-7404, Idaho Code. (3-20-20)T
- 20. Major Procurement.** See definition in Section 67-7404, Idaho Code. (3-20-20)T
- 21. Net Income.** See definition in Section 67-7404, Idaho Code. (3-20-20)T

22. **On-Line System.** The Lottery’s on-line computer wagering system consisting of ticket issuing terminals, central processing equipment, and a communications network. (3-20-20)T
23. **Play Symbols.** The numbers or symbols appearing in the designated area under the removable covering on the front of the ticket. (3-20-20)T
24. **Prize.** Any award, financial or otherwise, awarded by the Director for successfully playing a Lottery game. (3-20-20)T
25. **Redemption Value.** See definition in Section 67-7404, Idaho Code. (3-20-20)T
26. **Request for Proposal.** The solicitation of competitive proposals, or offers, to be used in part as a basis for making an acquisition, or entering into a contract, when specification and price will not necessarily be the predominant award criteria. (3-20-20)T
27. **Retailer Validation Code.** The symbols found under the removable rub-off covering over the play symbols on the front of each ticket. (3-20-20)T
28. **Sensitive Procurement.** Those procurement actions or contracts, other than “major procurements,” that may either directly or indirectly affect the integrity, security, honesty, and fairness of the operation and administration of the Lottery. A typical example of this class of procurement is the acquisition of security systems that protect the security and integrity of the Lottery. (3-20-20)T
29. **Share.** See definition in Section 67-7404, Idaho Code. (3-20-20)T
30. **State Lottery Act of 1988 or Act.** The Act approved by the legislature creating the Lottery, which became effective November 23, 1988, as amended, which is codified at Title 67, Chapter 74, Idaho Code. (3-20-20)T
31. **Subcontractor.** Any third party not in the employment of a contractor, who is performing all or part of the work in the contractor’s agreement with the Lottery under a separate contract with the contractor. The term “subcontractor” means subcontractor of any tier. (3-20-20)T
32. **Temporary Retailer.** A retailer under contract with the Lottery for a temporary or seasonal period. A temporary contract may be subject to special conditions or limitations that the Director deems prudent. These limitations or conditions may include, but are not limited to: (3-20-20)T
- a. Length of ticket sale period; (3-20-20)T
  - b. Hours or days of sale; (3-20-20)T
  - c. Location of sale; (3-20-20)T
  - d. Specific persons who may sell Lottery tickets; (3-20-20)T
  - e. Specific sporting, charitable, social, or other special events where Lottery tickets may be sold. (3-20-20)T
33. **Provisional Retailer.** A retailer granted a provisional certificate in accordance with these rules. A provisional certificate may contain some or all of the restrictions of a temporary retailer and additional restrictions deemed necessary by the Director. (3-20-20)T
34. **Ticket.** See definition in Section 67-7404, Idaho Code. (3-20-20)T
35. **Ticket Bearer.** The person who has signed the ticket or has possession of the unsigned ticket. (3-20-20)T
36. **Ticket Validation Number or Validation Number.** The multidigit number found on the front of

the ticket. It is either uncovered or found underneath the “Do Not Remove” area on the ticket or any stub. (3-20-20)T

**37. Total Annual Revenue or Annual Revenue.** The sum of all of the Lottery’s proceeds and accrued income that is characterized as a reduction or recovery of expenses. (3-20-20)T

**38. Unclaimed Prize.** Any award, financial or otherwise, of more than twenty-five dollars (\$25) for which there is physical, tangible evidence of eligibility but for which the prize has not been paid within one (1) year. (3-20-20)T

**39. Value.** See definition in Section 67-7404, Idaho Code. (3-20-20)T

**101. OPERATING PROVISIONS.**

**01. Purpose.** These rules are established by the Commission to define and regulate the operation and administration of the Lottery and the Commission. (3-20-20)T

**02. Lottery Commission.** The Commission is charged with the authority and duty to regulate Lottery activities in the state of Idaho, consistent with the Idaho Constitution and the enabling legislation. The headquarters of the Commission and of the Lottery is in Boise. (3-20-20)T

**03. Powers and Duties of the Commission.** (3-20-20)T

**a. Rule Promulgation.** The Commission promulgates rules and conditions under which the statewide Lottery will be conducted. Subjects covered in such rules include but need not be limited to: (3-20-20)T

i. The types of Lottery games to be conducted; (3-20-20)T

ii. The prices of tickets in the Lottery; (3-20-20)T

iii. In general the numbers and sizes of prize disbursements, the manner and frequency of prize drawings, and the manner in which payment will be made to holders of winning tickets; (3-20-20)T

iv. The locations at which Lottery tickets may be sold, the manner in which they are to be sold, and contracting with Lottery vendors, retailers and contractors; (3-20-20)T

v. The manner in which Lottery sales revenues are to be collected; (3-20-20)T

vi. The amount of compensation to be paid to retailers; (3-20-20)T

vii. Other areas relating to the efficient and economical operation and administration of a statewide Lottery consonant with the public interest. (3-20-20)T

**b. Delegation to Director.** In addition to those duties assigned to the Director in the Act, the Commission may, insofar as is consistent with the Idaho Constitution and the Act, delegate the performance of executive or administrative functions to the Director. (3-20-20)T

**04. Time and Place of Meetings.** (3-20-20)T

**a.** Regular meetings of the Commission will be held at least quarterly; the date, time, and place will be set by the Commission and, if possible, with at least two (2) weeks’ advance notice. The Commission may meet with the Director to make recommendations and set policy, to approve or reject reports of the Director, to adopt rules, and to transact other business. (3-20-20)T

**b.** Additional meetings necessary to discharge the business of the Commission may be called from time to time by the chairman or by a quorum of the Commission. (3-20-20)T

**05. Open Meeting Law.** All meetings of the Commission will be held in accordance with Idaho’s

Open Meeting Law, Sections 67-2340, et seq., Idaho Code, and in accordance with Section 67-7442, Idaho Code. All meetings of the Commission are open to the public, except when executive session is allowed for part of the meeting under the Open Meeting Law. (3-20-20)T

**06. Director.** The Director is responsible for the operation of the Lottery and for managing the affairs of the Commission. A Deputy Director designated by the Director may act for the Director in the absence of the Director. If there is a vacancy in the office of Director, the Commission will designate the Deputy Director as Interim Director until the vacancy can be filled. (3-20-20)T

**07. Powers and Duties of the Director.** (3-20-20)T

**a.** The Director has the authority to implement and execute procedures that he may deem appropriate for the efficient administration of the Lottery. The Director may also recommend rules governing the establishment, administration, and operation of the Lottery to the Commission for its approval; (3-20-20)T

**b.** The Director is authorized to employ sufficient staff as may be required to carry out the functions of the Commission and the Lottery; (3-20-20)T

**c.** The Director may contract with retailers for the sale of Lottery games and will suspend or terminate any contract in accordance with the provisions of the Act and the rules of the Commission; (3-20-20)T

**d.** The Director will continuously study and investigate all matters pertinent to the efficient operation of the Lottery; and (3-20-20)T

**e.** The Director will maintain full and complete records of the operation of the Lottery and report on at least a monthly basis to the Commission and to the governor on the status of the Lottery. (3-20-20)T

**f.** The duties and responsibilities of the Director that are not otherwise specified in Idaho law or the rules adopted by the Commission may be maintained as a policy of the Commission for the purpose of establishing a working relationship between the Director and the Commission. (3-20-20)T

**08. Lottery Budgets and Financial Statements.** The Director must: (3-20-20)T

**a.** Submit quarterly financial statements to the Commission, the governor, the state treasurer, and the legislature. The quarterly financial statements must be prepared in accordance with generally accepted accounting principles and include a balance sheet, a statement of operations, a statement of changes in financial position, and related footnotes. The quarterly financial statements must be provided within forty-five (45) days of the last day of each quarter. (3-20-20)T

**b.** Submit annual financial statements to the Commission, the governor, the state treasurer, and each member of the legislature. The annual financial statements must be prepared in accordance with generally accepted accounting principles and must include a balance sheet, a statement of operations, a statement of changes in financial position, and related footnotes. The annual financial statements must be examined by the state controller or a firm of independent certified public accountants in accordance with generally accepted auditing standards and must be provided within ninety (90) days of the last day of the Lottery's fiscal year. (3-20-20)T

**09. Contingency Reserve.** (3-20-20)T

**a.** The Director may, with the approval of the Commission, allot from moneys available to pay administrative expenses an amount to be transferred to a contingency reserve established by the Commission. The money allotted can include amounts retained to fund specific future expenses or can be undesignated as to purpose. (3-20-20)T

**b.** When the Commission approves a contingency reserve, it must determine the amount necessary for a reasonable contingency reserve. (3-20-20)T

**c.** Upon approval of the Commission, money in the contingency reserve may be authorized to be used

for specific purposes of the Lottery or to be used to fund general administrative expenses if there is a revenue shortfall. Expenses funded from the contingency reserve cannot be included with other administrative expenses for purposes of determining compliance with current administrative expenditure limitations. (3-20-20)T

**10. Special Drawings.** (3-20-20)T

**a.** The Director may authorize special drawings to award prizes, such as vacation trips, automobiles, or other tangible items in addition to, or in lieu of, cash awards. The Director will determine the nature and number of awards for each special drawing. Special drawings for promotional awards may be held independently of the Lottery's regular prize drawings or may be incorporated therein. The promotional drawings may be cosponsored and conducted in conjunction with Lottery retailers or other independent businesses. In view of the temporary nature and indeterminate frequency of the promotional awards drawings, a press announcement and normal advertising media will be used to inform the public of the rules and prizes for each special drawing. (3-20-20)T

**b.** Notwithstanding the provisions of Paragraph 100.11.a. of this rule, the Director may, at his discretion, award in-lieu equivalent cash awards to the winners of tangible items, in those instances where the Director deems it appropriate. The value of noncash items will be estimated by using either the cost of the item or its fair-market value. (3-20-20)T

**11. Retail Drawings.** The Director and his designee may authorize retailers to conduct drawings using non-winning Lottery tickets in conjunction with a particular Lottery game. Such authorization will be in writing, specify the type of drawing to be conducted, and forth the methodology to be used in conducting the drawing. (3-20-20)T

**12. Retail Ticket Price Discounts.** (3-20-20)T

**a.** Notwithstanding the price adopted for the retail sale of a ticket in the rules for a specific Lottery game, the Commission may offer discounts for the retail sale of Lottery tickets. (3-20-20)T

**i.** Discounts for the retail sale of Lottery tickets may be offered to the public through the use of coupons approved by the Director or by any other method approved by the Director. (3-20-20)T

**ii.** Coupons that offer a discount on the retail price of Lottery tickets will be distributed using methods designed to reach the public. (3-20-20)T

**b.** Rules for a promotion conducted by the Lottery using retail ticket discounts will be published by the Director and made available at the Lottery's offices and retailer locations. (3-20-20)T

**13. Allocation of Revenues for Prizes.** (3-20-20)T

**a.** Purpose: The primary objective of the Lottery is to produce the maximum amount of net revenues to benefit the public purpose of raising revenue consonant with the dignity of the state and the sensibilities of its citizens. In accomplishing this objective, at least forty-five percent (45%) of the total annual revenues will be returned in the form of prizes. The Lottery may design and conduct games that return more than forty-five percent (45%) of the revenues received from the sale of tickets in the form of prizes as an incentive to increase the total amount of game sales over the level of sales that otherwise would have been reasonably expected using a lower prize percentage. Games may also be authorized that return less than forty-five percent (45%) of that game's revenues so long as forty-five percent (45%) of the total annual revenues is returned as prizes. (3-20-20)T

**b.** Prize payments: In addition to cash prize payments, money set aside by the Lottery and restricted for the payment of prizes is considered in satisfying the requirement of returning at least forty-five percent (45%) of total revenues to the public in the form of prizes. (3-20-20)T

**c.** Averaging game prize payments: Notwithstanding the prize structure adopted for a Lottery game, the amount of revenue returned for prizes among all the games offered by the Lottery may be reallocated so long as at least forty-five percent (45%) of the total revenue earned from all games is returned to the public in the form of prizes on an annual basis. The Director will report to the Commission on any reallocations made pursuant to Section 100 of



these rules. (3-20-20)T

**14. Ownership of Lottery Tickets.** (3-20-20)T

**a.** Except for tickets claimed jointly in accordance with the provisions of Paragraph 100.14.d. of this rule, until a name is printed or placed upon a Lottery ticket in the designated area, the ticket is owned by the bearer, who is entitled to any prize attributable to the ticket. (3-20-20)T

**b.** If more than one (1) name appears on a ticket, the ticket must be claimed in accordance with the joint ownership procedures listed in Paragraph 100.14.d. of this rule. (3-20-20)T

**c.** Groups, family units, clubs, or other organizations may claim a winning ticket if the organization possesses a Federal Employer Identification Number (FEIN) issued by the Internal Revenue Service and that number is shown on the claim form. (3-20-20)T

**d.** If a ticket is claimed to be owned by two (2) or more people, the following steps will be taken for payment of the prize: (3-20-20)T

**i.** All people claiming ownership must complete and sign a claim form and declare their percentage of the prize prior to processing the claim. After the claim form is submitted to the Lottery, the percentage cannot be amended. The percentages claimed must add up to one hundred percent (100%) of the prize. (3-20-20)T

**ii.** At least one (1) of the people claiming ownership of the ticket must sign the ticket and also sign the claim form. (3-20-20)T

**iii.** The Lottery reserves the right to issue a single prize check instead of multiple prize checks to the owners of a ticket if the value of each individual prize check would be less than fifty dollars (\$50). (3-20-20)T

**iv.** Multiple winners of a Lottery prize will be paid only through the Boise Lottery office. Lottery retailers will not be required to pay more than one (1) winner of a single prize. (3-20-20)T

**15. Claims.** (3-20-20)T

**a.** Liability. By submitting a claim, the player agrees that the state, the Commission, the Lottery and all officials, officers, and employees of each are discharged from all further liability upon payment of the prize. (3-20-20)T

**b.** Publicity. By submitting a claim, the player also agrees that the Lottery may use the prize winner's name and photograph for publicity purposes. (3-20-20)T

**c.** Claim period. Prizes may be claimed for a period of one hundred eighty (180) days after the drawing in which the prize was won or from the last day tickets from the specific instant game were sold. Prizes won through an electronic terminal are payable in accordance with the Lottery's rules. If a claim is not made for the prize within the applicable period, the prize money may be added to future prize pools, to be used in addition to prize allotments already allocated, except as provided in Section 67-7433, Idaho Code. (3-20-20)T

**d.** Invalid tickets. If a ticket presented to the Lottery is invalid pursuant to the terms of these rules or the specific game rules, the ticket is not entitled to prize payment. (3-20-20)T

**e.** Ticket a bearer instrument. A ticket is a bearer instrument until signed in the space designated on the ticket for signature. The person who signs the ticket is considered the owner of the ticket. Payment of any prize may be made to a person in possession of an unsigned ticket. All liability of the state, the Commission, the Lottery, the Director, and Lottery employees terminates upon payment. (3-20-20)T

**f.** Time of prize payment. All prizes will be paid within a reasonable time after a claim is verified by the Lottery and a winner is determined. The date of the first installment payment of any prize to be paid in installment payments is the date the claim is validated and processed, unless a different date is specified for a particular game in

these rules or in the specific game rules. Later installment payments will be made approximately weekly, monthly, or annually, from the date the claim is processed and validated in accordance with the type of prize won and the rules applicable to the prize. The Lottery may, at any time, delay any prize payment in order to review a change in circumstances concerning the prize awarded, the payee, or the claim. (3-20-20)T

**g.** Prizes payable for winner's life. If any prize is for the life of the winner, only an individual may claim and receive the prize for life. If a group, corporation, or other organization is the winner, the life of the winner is deemed to be twenty (20) years. (3-20-20)T

**16. Prizes Payable After Death of Winner.** All prizes, and portions of prizes, that remain unpaid at the time of the prize winner's death will be payable to the personal representative of the prize winner's estate once satisfactory evidence of the personal representative's appointment has been provided, and the Director is satisfied that payment to the personal representative is lawful and proper. The Director may rely on a certified copy of a court order appointing a personal representative (or similar person responsible for the prize winner's estate, whether denominated an administrator, executor, executrix, or other representative of the prize winner's estate) or may petition the court to determine the proper payee. Payment to the personal representative of the estate of the deceased owner of any prize winnings will absolve the Director and the Lottery's employees of any further liability for payment of prize winnings. (3-20-20)T

**17. Disability of Prize Winner.** The Lottery may petition any court of competent jurisdiction for a determination of the rightful payee for the payment of any prize winnings that are or may become due to a person under a disability including, but not limited to, mental deficiency, or physical or mental incapacity. (3-20-20)T

**18. Stolen or Lost Tickets.** The Lottery has no responsibility for paying prizes attributable to stolen or lost tickets. (3-20-20)T

**19. Effect of Game Rules.** In purchasing a ticket the player agrees to comply with Title 67, Chapter 74, Idaho Code, these rules, the specific game rules, Lottery instructions and procedures, and the final decisions of the Lottery. The Lottery's decisions and judgments in respect to the determination of winning tickets or any other dispute arising from the payment or awarding of prizes will be final and binding upon all participants in the Lottery. If a dispute between the Lottery and a player occurs as to whether a ticket is a winning ticket and the prize is not paid, the Lottery may, solely at the Director's option, replace the ticket with an unplayed ticket of an equivalent price from any game or refund the price of the ticket. This will be the sole and exclusive remedy of the player. (3-20-20)T

**20. Disputed Prizes.** If there is a dispute, or it appears that there may a dispute concerning payment or ownership of any prize or any other legal issue involving the prize, the Lottery may refrain from making payment of the prize pending a final determination by the Lottery or by a court of competent jurisdiction as to the proper payment of the prize. (3-20-20)T

**21. Sale of Lottery Tickets.** Lottery tickets may be sold for cash, check, money order, credit card, electronic funds transfer, or debit card. (3-20-20)T

## **102. CONFLICT OF INTEREST POLICY.**

**01. Persons Subject to Conflict of Interest Policy.** Every Commissioner, the Director, every Deputy Director, and every other Lottery officer and employee is considered a person subject to this rule on conflict of interest. If a statutory provision, rule, or policy applicable to the Lottery conflicts with Section 67-7443, Idaho Code, the more stringent provision applies. (3-20-20)T

**02. Statements For Economic Interest.** Every person listed in Subsection 110.01 of this rule, is prohibited from directly or indirectly, individually, or as a member of a partnership, or as a shareholder of a corporation, or as a participant in a joint venture or association with any other person, having an interest in dealing in a Lottery game or in the ownership or leasing of property used by or for a Lottery game. (3-20-20)T

**03. Persons Ineligible For Prizes.** Except as provided in Section 67-7440, Idaho Code, the following persons are disqualified from purchasing a Lottery ticket or share, and from receiving a Lottery prize: (3-20-20)T

- a.** Every person listed in Subsection 110.01 of this rule; (3-20-20)T
- b.** Any officer, director, or employee of any vendor of Lottery tickets or manufacturer of equipment used to determine winners in computerized Lottery games, and any of their subcontractors who may affect the security, integrity, or honesty of the Lottery; (3-20-20)T
- c.** Any Lottery contractor or consultant under agreement with the Lottery to review the Lottery's security procedures, and any other contractor or consultant that the Director deems ineligible if the Director reasonably determines that the security, honesty, and integrity of the Lottery may be adversely affected; (3-20-20)T
- d.** An immediate family member of any individual described in Paragraphs 110.03.a., 110.03.b., or 110.03.c. of this rule who is a member of the same household. (3-20-20)T
- 04. Gift Prohibitions.** (3-20-20)T
- a.** Except as provided in Paragraph 110.03.b. of this rule, every person listed in Subsection 110.01 of this rule, including members of their immediate family, are prohibited from soliciting or receiving, directly or indirectly, a gift in excess of fifty dollars (\$50) from any person who might reasonably be expected to receive a benefit from the Lottery. (3-20-20)T
- b.** In appearances before civic groups and other organizations it is permissible to accept a meal if it is offered and it is the established practice of that group or organization. (3-20-20)T
- 05. Persons Prohibited From Providing Services.** The following individuals and entities are prohibited from being a Lottery game retailer, Lottery vendor, or Lottery contractor, and shall not provide audits or study services as specified by Title 67, Chapter 74, Idaho Code: (3-20-20)T
- a.** Every person listed in Subsection 110.01 of this rule; (3-20-20)T
- b.** A member of the immediate family who is a member of the same household of any person listed in Subsection 110.01 of this rule; (3-20-20)T
- 06. Outside Activities Restricted.** (3-20-20)T
- a.** The Director, all Deputy Directors, and all full-time Lottery officers and employees are required to render full-time service to the duties of their positions. Part-time, temporary, or seasonal Lottery employees are required to render service to the extent of their employment with the Lottery and are prohibited from accepting other employment that may conflict with the integrity of the Lottery. (3-20-20)T
- b.** Except when assisting another state lottery, no Commissioner, Director, Deputy Director or other Lottery officer or employee may provide consulting or contractual services, or accept an honorarium related to his State Lottery expertise. (3-20-20)T
- c.** When assisting another state lottery, it is permissible for the other state to reimburse normal travel costs to the individual providing the service, but no honorarium or pay to the individual will be accepted. If the other state has a policy of paying for the time of another state's employee while providing assistance, the payment will be made to the State Lottery. (3-20-20)T
- d.** Nothing contained in Paragraphs 110.06.a. through 110.06.c. of this rule precludes the Lottery from negotiating contracts in which the vendor to the Lottery must bear the expense of Lottery personnel making on-site inspections of the vendor's products or manufacturing facility, auditing the vendor, or other legitimate business reasons for traveling to the vendor's place of business or site of the vendor's records, and person listed in Subsection 110.01 of this rule may engage in travel at the vendor's expense for those legitimate business purposes. Nothing contained in Paragraphs 110.06.a. through 110.06.c. of this rule prevents a Commissioner, Director, Deputy Director or other Lottery officer or employee from participating in and traveling to educational or industry related programs. Actual expenses incurred may be reimbursed by a sponsoring entity if the integrity of the State Lottery is not adversely impacted. (3-20-20)T

**07. Conduct of Commission Business.** Business transactions conducted by the Commission, the Director, Deputy Directors, and all other Lottery officers and employees with Lottery vendors should be conducted in the Lottery's offices to the maximum extent possible. (3-20-20)T

**08. Personal Conduct.** Personal conduct that is illegal or generally considered improper or brings discredit to the Lottery may be subject to appropriate disciplinary action by the Director. (3-20-20)T

**09. Use of Lottery Property.** Every person listed in Subsection 110.01 of this rule is prohibited from using any Lottery vehicle or other Lottery property for personal use, except that telephones, computers, etc., may be used for personal use in the manner ordinarily accepted in an office setting when that use does not result in additional expense to the Lottery and when that use does not contravene state policy. (3-20-20)T

**10. Signature of Conflict Policy Required.** Every person listed in Subsection 110.01 of this rule is required to sign the following conflict of interest policy as a condition of employment. "I have read and understand the pertinent Sections of Idaho Constitution Article 7, Section 10, and Title 59, Chapter 7, Idaho Code, and these conflict of interest policies."

Signature  
Typed Name  
Date

(3-20-20)T

**103. -- 199. (RESERVED)**

**200. LOTTERY CONTRACTING RULES.**

**01. Classification of Lottery Contracts.** (3-20-20)T

**a.** Lottery contracts for the acquisition of materials, supplies, services and personal and professional services are classified according to relative sensitivity, which in turn determines the level of review, procurement method and the extent of disclosure required by Lottery vendors or if no disclosure is required as in the case of Lottery contractors. The three (3) levels of procurement are as follows: (3-20-20)T

**i.** General procurements: These procurements are the least sensitive and are for materials, supplies, equipment, services and personal and professional services required to satisfy the day-to-day administrative, ministerial and operating needs of the Lottery. Disclosure filings by Lottery vendors are not normally required for this class of procurements. Lottery contractors may supply general procurement items. The Lottery may use formal invitations to bid, informal competitive quotes and requests for proposals to solicit contracts for these acquisitions, as may be determined by the Director to be the most appropriate process for a specific acquisition. (3-20-20)T

**ii.** Sensitive procurements: These procurements are of intermediate sensitivity and are for materials, supplies, equipment, services and personal and professional services which may have direct or indirect impact upon the security, credibility and integrity of the Lottery. Also included are special studies and services required by statute (demographic, communications and performance studies). The normal procedure for acquiring the materials and services is by request for proposal; however, the Director may authorize the use of competitive quotes when the cost of the acquisition is less than fifteen thousand dollars (\$15,000). The Director may prescribe special disclosure requirements governing Lottery contractors or vendors for this class of contracts. (3-20-20)T

**iii.** Major procurements: This class is the most sensitive of Lottery contracts. The Lottery Act requires these procurements to be let by the Commission and the filing of comprehensive disclosure statements by Lottery vendors. (3-20-20)T

**b.** The procedures for announcing or soliciting various classes of Lottery contracts outlined in Paragraph 200.01.a. of this rule are intended to be advisory only and do not limit the Commission or the Director in the selection of the most appropriate process to acquire a given product or service. (3-20-20)T

**02. General Policy.** (3-20-20)T

**a.** In all decisions affecting the Lottery, the Commission and Director are specifically directed by statute to take into consideration the particularly sensitive nature of the Lottery and to act in a manner to promote and insure the integrity, security, honesty and fairness of the Lottery. Additionally, the Director, in awarding contracts in response to solicitations for proposals, must award the contracts to the responsible contractor or vendor submitting the lowest and best proposal that provides maximum benefits to the state in relation to cost in the areas of security, competence, experience, timely performance, and maximization of net revenues to benefit the public purpose of the Lottery. Consistent with these statutory directives, it is the policy of the Lottery, to the extent possible, to conduct its contracting affairs in an open, competitive manner. However, the security and integrity of the Lottery are fundamental and overriding considerations in all decisions. (3-20-20)T

**b.** Although the Lottery is exempt from the provisions of Section 67-5715, Idaho Code, it is the policy of the Lottery to conduct its contracting affairs generally in accordance with the state's competitive bidding principles contained in Section 67-5715 et seq., Idaho Code, and consistent with the specific directives contained in Paragraph 200.02.a. of this rule. In implementing this policy, the Lottery reserves the right to use the procedures developed by the Department of Administration as guidelines to govern its procurement actions. Notwithstanding this reservation, the Lottery also reserves the right to use alternate contracting and purchasing practices that take account of market realities and modern or innovative contracting and purchasing methods that are also consistent with the public policy of encouraging competition. These methods may include, but are not limited to, specialized vendor prequalifications, competitive negotiations, performance incentives and disincentives, life cycle costing and solicitations emphasizing the request for proposal process. (3-20-20)T

**c.** When the Lottery uses a Request for Proposal (RFP) for a planned acquisition, the major considerations in determining the contract award will be the quality of the product or service, the likelihood of timely performance, and price. Qualitative factors normally address issues like the Vendor's demonstrated experience in performing comparable projects, performance credibility, availability of qualified personnel and equipment, and other special factors as may apply to a particular contract. The RFP will normally specify the criteria that will be used in the evaluation of offers and the award of the contract. (3-20-20)T

**d.** Because of the specialized character of Lottery contracts, the Lottery will not normally advertise bid proposals. Rather, the Lottery will circulate bid and proposal requests for materials, equipment and services to vendors known to specialize in the required procurement or to vendors that the Lottery may reasonably expect to have an interest in providing such services. The Lottery will develop its mailing lists as the service need arises. (3-20-20)T

**e.** The Director may prepare standard terms and conditions to govern the acquisition of materials, supplies and services by the State Lottery. To the extent possible, the standard terms and conditions should be as uniform as possible with the standard terms and conditions governing contracts entered into by other state agencies. (3-20-20)T

**f.** All major departures from the state contracting guidelines referred to in Paragraph 200.02.b. of this rule will be approved by the Commission. If there is a conflict between the state guidelines and the Lottery's adopted rules, the Lottery's rules take precedence. (3-20-20)T

**03. Delegation of Purchasing Authority.** (3-20-20)T

**a.** Authority is granted to the Director to initiate all purchase actions and enter into and execute contracts for materials, supplies and services, on behalf of the Commission and the Lottery, except as follows: (3-20-20)T

i. General contracts having an estimated one-time or annual cost in excess of fifty thousand dollars (\$50,000); (3-20-20)T

ii. Contracts defined as Sensitive Procurements having a one-time or annual cost of more than fifty thousand dollars (\$50,000); (3-20-20)T

iii. Contracts defined as Major Procurements; (3-20-20)T

iv. All personal service contracts other than major or sensitive procurements having a one-time or annual cost in excess of fifteen thousand dollars (\$15,000); and (3-20-20)T

v. Procurement actions which are executed in a manner other than as provided in the contract exemption guidelines. (3-20-20)T

b. Notwithstanding the provisions of Subparagraph 200.03.a.i. of this rule, the Commission, having once approved a planned procurement action involving a general contract acquisition, grants authority to the Director to execute a contract or contracts for the purchase or service without further action by the Commission. (3-20-20)T

c. The Commission, having once approved a particular contract, delegates authority to the Director to make all disbursements and payments as provided in the contract, without further, specific approval action by the Commission. (3-20-20)T

d. The Commission grants authority to the Director to enter into emergency contracts when immediate and decisive action is required to protect the security, credibility or integrity of the Lottery or a Lottery game. All emergency contracts let by the Director in which the cost exceeds the delegated authority contained in Paragraph 200.03.a. of this rule, must be reported to the Commission within five (5) days of the contract award date, or at the next scheduled Commission meeting, whichever is sooner. Such procurement actions may be taken without competitive bid. The dollar value of a contract awarded by the Director under the provisions of this section may not exceed fifty thousand dollars (\$50,000). Any emergency contract for a major procurement in which the cost exceeds fifty thousand dollars (\$50,000), if not acted upon at a regularly scheduled Commission meeting, is subject to Commission approval by telephonic or electronic vote. (3-20-20)T

**04. State Central Services Agenda.** As provided in Section 67-7408, Idaho Code, the Lottery may contract with other state agencies for the performance of contracting responsibilities that may be required by the Lottery. Those services may include, but are not limited to, the acquisition of Fidelity and Faithful Performance Bonds covering the Commissioners, officers, and employees of the Lottery; bonding of retailers, annuity contracts; general equipment and supplies; equipment financing agreements; and disposal of surplus Lottery property. The Lottery is bound by all statutes and rules governing the actions of the state agency when the Lottery uses such services. (3-20-20)T

**05. Idaho Preference.** (3-20-20)T

a. In all contracts, the Lottery will prefer goods or services that have been manufactured or produced in this state if price, fitness, availability and quality are otherwise equal. (3-20-20)T

b. Where a Lottery contract is awarded to a foreign contractor and the contract price exceeds ten thousand dollars (\$10,000), the contractor must promptly report to the Idaho Tax Commission (ITC) on forms to be provided by ITC the total contract price, terms of payment, length of contract and such other information as the ITC may require before final payment can be received on the Lottery contract. The Lottery must satisfy itself that the requirements of this Paragraph have been complied with before it issues a final payment on a Lottery contract. For the purposes of this Paragraph, a foreign contractor is one who is not domiciled in or registered to do business in Idaho. (3-20-20)T

**06. Equal Opportunity/Affirmative Action Contracts.** The Lottery is an equal opportunity employer and also participates in any on-going state affirmative action programs. (3-20-20)T

**07. Personal Services Contract.** (3-20-20)T

a. Contracts between the Lottery and persons or firms such as advertising agencies, security consultants, auditors, other consultants required to conduct or prepare special studies and reports and other personal services contracts that may be required to fulfill the Lottery's responsibilities, will be awarded as outlined in this Subsection. The award of contracts will be either direct, informal or formal depending upon the sensitivity and estimated dollar value of the contract. In awarding personal services contracts, the Lottery will consider the contractor's qualifications in similar areas of demonstrated competency, availability, experience in successfully performing comparable projects, availability of qualified personnel, likelihood of timely performance, history of cost

containment, compensation requirements and other special factors that may apply to a particular contract. (3-20-20)T

**b.** Direct Award Procedures. (3-20-20)T

i. Any personal services contract having an estimated one-time or annual value of ten thousand dollars (\$10,000) or less may be awarded directly by the Director if the Director believes reasonable steps have been taken to obtain competitive quotes, if feasible, and the award will not negatively affect the security, credibility or integrity of the Lottery. (3-20-20)T

ii. The Director, with the approval of the Commission, may directly award personal services contracts in any appropriate or reasonable amount, without competitive solicitations, when the project consists of work that has been substantially described, planned or otherwise studied in an earlier Lottery contract and the new contract would be a continuation of the earlier project, provided that the earlier contract was awarded by a formal selection procedure. In awarding contracts under this provision the Commission and Director will take into account the effects of that action on the security, credibility and integrity of the Lottery and further ensure that the contract awards will not encourage favoritism or substantially diminish competition and will result in substantial cost savings to the Lottery. (3-20-20)T

iii. The Director, with the approval of the Commission, may directly award personal service contracts without competitive solicitation when an emergency or other condition exists that requires prompt and decisive action. The Commission and Director may exercise the provisions of this Paragraph only when immediate action is required to correct a situation that would threaten integrity, security, honesty, and fairness in the operation and administration of the Lottery or the objective of raising net revenues for the benefit of the public purpose described in the Act. (3-20-20)T

**c.** Informal Award Procedure: The Director may award any personal services contract having an estimated one-time annual value of more than ten thousand dollars (\$10,000), but not more than twenty-five thousand dollars (\$25,000), if the following informal award procedure is followed: (3-20-20)T

i. An attempt is made to obtain a minimum of three (3) competitive quotes. If three (3) quotes are not available, fewer will suffice provided a written record is made of the effort to obtain three (3) quotes. (3-20-20)T

ii. A written record must be maintained of the source and amount of quotes received. (3-20-20)T

iii. The contract award will be made to the lowest priced vendor who best meets the contract award criteria of Paragraph 200.07.a. of this rule. (3-20-20)T

iv. The Director maintains work papers documenting the basis of the award to ensure that the award will not negatively affect the security, credibility and integrity of the Lottery. (3-20-20)T

**d.** Formal Award Procedures: Unless otherwise awarded under the provisions of Subparagraphs 200.07.b.ii. or 200.07.b.iii. of this rule, all personal services contracts having an estimated one-time or annual cost of more than twenty-five thousand dollars (\$25,000) must be awarded according to the formal award procedure, as follows: (3-20-20)T

i. The Lottery will distribute copies of the proposal (usually a Request for Proposal) to Lottery vendors or to appropriate contractors who have indicated an interest, or are anticipated to have an interest, in providing the required service to the Lottery. Every Request for Proposal will include a response deadline date. All responses received by the Lottery after the deadline may be rejected. (3-20-20)T

ii. The Director will appoint an evaluation panel consisting of at least four (4) persons, at least two (2) of whom are members of the Lottery's staff. The Director of Lottery Security will be one of the appointees to evaluate the responses for any project involving the security of the Lottery. (3-20-20)T

iii. The evaluation panel must develop a system to evaluate the vendor responses and score each vendor's response. Based upon this evaluation, the evaluation panel must rank the three (3) best responses and develop an award recommendation. (3-20-20)T

- iv. The contract will be awarded to the vendor who best meets the award criteria. (3-20-20)T
- e. No contract or other agreement for the purpose of providing services to the Lottery may be entered into, renewed, or extended with any person, unless the person certifies in writing, under penalty of perjury, that the person is not in violation of any Idaho tax laws on a form prescribed by the Idaho Tax Commission (ITC). A copy of the certification form may be obtained from the Lottery or the ITC. The original certification must be retained in the Lottery's contract file as required by the state's records retention guidelines. (3-20-20)T
- 08. Major Procurements.** (3-20-20)T
- a. All bid announcements, invitations, or proposals covering major procurements will identify that the planned acquisition is classified as a major procurement. (3-20-20)T
- b. All contracts or procurement actions classified as major procurements will be subject to the disclosure requirements specified in Section 67-7421, Idaho Code. Subsection 010.05 of these rules defines the term "control person" for purposes of disclosure requirements. The Lottery will enclose a copy of the disclosure requirements with each bid announcement or proposed request for such procurement. All disclosure filings are subject to the review and approval of the Director of the Lottery Security Division. Failure of any Lottery vendor to properly execute or timely submit the disclosure requirement may be grounds for rejection of the bid or proposal. (3-20-20)T
- c. No contract for a major procurement with any Lottery vendor may be entered into if any control person of that Lottery vendor has been convicted of a crime, other than traffic infractions. Background checks must be made by the Director of Lottery Security to rigorously enforce this requirement. (3-20-20)T
- d. The Lottery may prequalify Lottery vendors as having met the disclosure filing requirements for major procurements. The disclosure prequalifications may be renewed by July 1 of each year. The prequalifications will satisfy the disclosure requirements of the Act, providing a certification is received from the Lottery vendor at the time of submitting any subsequent bid, proposal or offer and that no changes have occurred in the vendor's status, or that of its control persons, since the last filing of the complete disclosure statement. (3-20-20)T
- e. Each Lottery vendor for a major procurement must maintain its disclosure filing in a current status during the tenure of the contract. Unless otherwise provided in the contract document, any changes in the status of the vendor, any of its listed control persons or additional control persons, must be reported to the Director within fourteen (14) days of the known change, and will require written submission of the same disclosure information to the Commission. (3-20-20)T
- f. Each Lottery vendor for a major procurement is required to post a performance bond with the Commission as provided in Section 67-7427, Idaho Code. The performance bond must be issued by a surety licensed to do business in this state and be for the duration specified in the procurement announcement. (3-20-20)T
- 09. Sensitive Procurements.** (3-20-20)T
- a. All bid announcements, invitations, or Requests for Proposal covering sensitive procurements as defined in Subparagraph 200.01.a.ii. of this rule will identify that the planned acquisition is a sensitive procurement and will be subject to the provisions of this rule. (3-20-20)T
- b. The Director may establish special disclosure requirements governing State Lottery contracts for sensitive procurements that will be included in the procurement announcement. Failure of any Lottery vendor or contractor to properly execute or timely submit the disclosure requirement may be grounds for rejection of the bid or proposal. All disclosure filings are subject to the review and approval of the Director of Lottery Security. (3-20-20)T
- c. No contract for a major procurement with any Lottery vendor may be entered into if any control person of that Lottery vendor has been convicted of a crime, other than traffic infractions. Background checks must be made by the Director of Lottery Security to rigorously enforce this requirement. (3-20-20)T



**d.** The Lottery may prequalify Lottery vendors as having met the disclosure requirements of this rule. The prequalification will satisfy the disclosure filing requirement providing a certification is received from the Lottery vendor, at the time of submitting any subsequent bid, proposal or offer, that no changes have occurred in the vendor's status or any of its principals since the last filing of the full disclosure statement. (3-20-20)T

**e.** Each Lottery vendor for a sensitive procurement must maintain its disclosure filing in a current status during the tenure of the contract. Unless otherwise provided in the contract document, any changes in the vendor's status or any of its principals, must be reported to the Director within fourteen (14) days of the known change, and will require written submission of the same disclosure information to the Commission. (3-20-20)T

**f.** Each Lottery contractor for a sensitive procurement may be required to post a performance bond with the Lottery. The performance bond must be issued by a surety licensed to do business in this state and be for the amount and duration specified in the procurement announcement. (3-20-20)T

**10. Advertising and Promotional Contract.** Because advertising and promotional contracts involve unique marketing strategies for Lottery games, the acquisition of these services and purchases may be made directly without using competitive procurement procedures. The prudent person rule will apply in the award of these contracts or the acquisition of these services. This exemption applies to all advertising and promotional contracts, whether placed through the Lottery's advertising agency or directly by the Commission or the Director. For the purpose of this rule, advertising and promotional contracts include but are not limited to: agreements with radio and television stations, acquisition of prizes, media selection, placement of advertising contracts, promotional printing, art work and development and placement of all forms of commercials and display presentations. (3-20-20)T

**11. Investment Contracts.** The Lottery may enter into contracts for the acquisition of structured settlements, place investments or acquire annuities related to the pay-off of major prize winners without following competitive bidding procedures. The Lottery will follow the prudent person rule in the placement of such investments. (3-20-20)T

**12. Prequalification of Annuity Vendors.** (3-20-20)T

**a.** For the purpose of acquiring annuities related to the pay-off of major prize winners, the Lottery will maintain an ongoing prequalification list of annuity vendors. A vendor must first be prequalified by the Lottery before submitting a bid to the Lottery for the award of an annuity contract. Vendors may submit their qualifications to the Lottery for evaluation any time in the year. (3-20-20)T

**b.** The following criteria must be met by each vendor before being placed on the prequalification list: (3-20-20)T

**i.** Each bidder must be an insurance company licensed to do business in Idaho and have been in business for a period of two (2) years immediately before submitting its bid. (3-20-20)T

**ii.** An insurance company must be a Best's "A+" rated company and have at least a Best's Class VII financial size classification. (3-20-20)T

**iii.** Each bidder's request for qualification must contain: (3-20-20)T

(1) The name, address, telephone number and contact person for the bidder. (3-20-20)T

(2) The current financial statement of the bidder certified by an independent certified public accountant. (3-20-20)T

(3) The names, addresses and telephone numbers of three (3) current or past annuity client references whom the Lottery may contact. (3-20-20)T

**c.** After a vendor has been prequalified, the vendor may submit bids to the Lottery in accordance with the procedures established by the Director. Furthermore, a vendor must keep its qualifications current by promptly reporting any changes in their status to the Lottery. (3-20-20)T

d. The total amount of annuities awarded to an insurance company cannot exceed five percent (5%) of its stated surplus. (3-20-20)T

e. Nothing contained in this rule will preclude a brokerage company from representing or submitting a bid on behalf of a qualified bidder. (3-20-20)T

**201. CRITERIA FOR REVIEW OF RETAILER APPLICATIONS AND CONDUCT OF OPERATIONS.**

**01. Retailer's Application.** Any person interested in obtaining a contract for a certificate to sell Lottery tickets must first file an application on forms provided by the Director. The forms will require disclosure of, but are not limited to, an applicant's personal, financial, and criminal history, and an authorization to investigate the applicant's criminal and credit history. (3-20-20)T

**02. Fees, Procedure, and Criteria Precluding Issuing Contract.** (3-20-20)T

a. All certificate applications must be accompanied by a minimum, nonrefundable, fee of twenty-five dollars (\$25). If a certificate is awarded, an additional, nonrefundable, certificate fee of one hundred dollars (\$100) must be paid. (3-20-20)T

b. A current retailer may be required to complete an additional application or application supplements. If a current retailer requests that the existing certificate be modified to allow the sale of additional Lottery products, no additional application fee will be charged. (3-20-20)T

c. The Lottery may waive the payment of any certificate fee to facilitate an experimental program or a research project. (3-20-20)T

**03. Provisional Certifications.** (3-20-20)T

a. The Lottery may issue a provisional certificate to an applicant for a Lottery certificate after receipt of a fully completed certificate application, the authorization of a complete personal background check, completion of a credit check, and completion of a preliminary background check. The provisional certificate will expire at the time of issuance of the requested certificate or ninety (90) days from the date the provisional certificate was issued, whichever occurs first, unless the provisional certificate is extended by the Lottery. (3-20-20)T

b. No contract shall be made with an applicant: (3-20-20)T

i. Who is under eighteen (18) years of age; (3-20-20)T

ii. Who will be engaged exclusively in the business of selling tickets; (3-20-20)T

iii. Who is an employee of the Lottery; (3-20-20)T

iv. Who is, or is owned or controlled or affiliated with, a supplier of instant tickets or a manufacturer of computer equipment used to operate instant or on-line games, or both; (3-20-20)T

v. Who is not a resident of Idaho, or a corporation that is not incorporated in Idaho or not authorized to do business in Idaho; (3-20-20)T

vi. Who has been found to have violated any rule, regulation, or order of the Commission or the Director; (3-20-20)T

vii. When any person, firm, association, or corporation other than the applicant will participate in the management of the affairs of the applicant. (3-20-20)T

**04. Criteria That May Be Grounds For Refusal.** Before contracting with an applicant, the Director will consider the factors set out below. In considering these factors, the Director will seek to determine which applicants will best serve the economical and efficient operation of a statewide Lottery through their ticket sales. If

any of these factors lead the Director to determine that contracting with the applicant would not promote the economical and efficient operation of a statewide Lottery consonant with the public interest, or would not serve the public interest, convenience, or trust, the Director may deny the application. (3-20-20)T

**a.** The Director will consider the financial responsibility and security of the person and the person's business or activity and consider the person's credit worthiness and integrity in past financial transactions. The Lottery may investigate the credit worthiness of the applicant by using the services of a commercial credit reporting agency. The Director may also consider the physical security of the applicant's place of business to determine whether tickets that will be sold to the applicant and the proceeds from ticket sales will be kept safe. (3-20-20)T

**b.** The Director will consider the accessibility to the public of an applicant's place of business or activity. The Director will contract only with applicants who have regular contact with significant numbers of persons at the applicant's place of business. Before contracting with any organization that has restricted membership policies, the Director must determine whether the restrictions are generally acceptable to the public and whether contracting with that group or organization or similar groups or organizations would best serve the interests of the Lottery. (3-20-20)T

**c.** The Director will consider the sufficiency of existing retailers to serve the public interest. The Director may seek to maximize total ticket sales by encouraging retailers with the highest potential volume in a particular area or neighborhood. (3-20-20)T

**d.** The Director will consider the volume of expected sales by the applicant. In determining the anticipated actual sales volume of the applicant, the Director may rely upon the experience and knowledge of the Lottery's staff as well as any other available professional expertise. The Director will determine whether the volume of an applicant's sales is likely to be sufficient that contracting with the applicant will be economically feasible. (3-20-20)T

**e.** The Director will consider the types of products, services, or entertainment offered at the applicant's place of business. The Director will determine whether the applicant's products, services, or entertainment are generally acceptable to the public and whether they would bear adversely upon the general credibility, integrity, and reputation of the Lottery. (3-20-20)T

**f.** The Director will consider the experience, character, or general fitness of the applicant. Entering into a contract with the applicant must be consistent with the public interest, convenience, and trust. (3-20-20)T

**g.** The Director will consider the veracity and completeness of the information submitted with the retailer's application. The Director will consider the criminal history of the applicant and any person whose name is required to be disclosed under Section 67-7412, Idaho Code, of the Act and may refuse to enter into a contract with any applicant when the applicant or such person has been convicted of violating any of the gambling laws of this state, general or local, or has been convicted at any time of any crime other than traffic infraction. (3-20-20)T

**05. Reporting Changes in Circumstances of The Retailer.** Every change of business structure of a certificated business, such as from a sole proprietorship to a corporation, and every change in the name of a business, must be reported to the Lottery before the change. Substantial changes in the ownership of a certificated business must also be reported to the Lottery before the change. A substantial change of ownership is defined as the transfer of ten percent (10%) or more equity in the certificated business from or to another single individual or legal entity. If a change involves the addition or deletion of one (1) or more existing owners or officers, the certificate holder must submit a certificate application reflecting the change and any other documentation that the Lottery may require. All changes will be reviewed by the Lottery to determine if the existing certificate should be continued. (3-20-20)T

**06. Certificate Not a Vested or Legal Right.** The possession of a certificate issued by the Lottery to any person to act as a retailer in any capacity is a privilege personal to that person and is not a vested or legal right. The possession of a certificate issued by the Lottery to any person to act as a retailer in any capacity does not automatically entitle that person to sell tickets or obtain materials for any particular game. (3-20-20)T

**07. Suspension or Revocation of a Certificate.** The Lottery may suspend or revoke any certificate issued pursuant to these rules for one (1) or more of the following reasons: (3-20-20)T

- a.** Failing to meet or maintain the eligibility criteria for certificate application and issuance established by Title 67, Chapter 74, Idaho Code, or these rules; (3-20-20)T
- b.** Violation of any of the provisions of Title 67, Chapter 74, Idaho Code, these rules, or the certificate terms and conditions; (3-20-20)T
- c.** Failing to file any return or report or to keep records required by the State Lottery (3-20-20)T
- d.** Failing to maintain an acceptable level of financial responsibility as evidenced by the financial condition of the business, incidents of failure to pay taxes or other debts, or by the giving of financial instruments which are dishonored; (3-20-20)T
- e.** Fraud, deceit, misrepresentation, or other conduct prejudicial to the public confidence in the Lottery; (3-20-20)T
- f.** If the public convenience is adequately served by other certificate holders, failure to sell a minimum number of tickets as established by the Lottery; (3-20-20)T
- g.** A history of thefts or other forms of losses of tickets or revenue from the business; (3-20-20)T
- h.** Violating federal, state, or local law or allowing the violation of any of these laws on premises occupied by or controlled by any person over whom the retailer has substantial control; (3-20-20)T
- i.** Obtaining a certificate by fraud, misrepresentation, concealment or through inadvertence or mistake; (3-20-20)T
- j.** Making a misrepresentation of fact to the Commission or the Lottery on any report, record, application form, or questionnaire required to be submitted to the Commission or the Lottery; (3-20-20)T
- k.** Denying the Lottery or its authorized representative, including authorized local law enforcement agencies, access to any place where a certificate activity is conducted; (3-20-20)T
- l.** Failing to promptly produce for inspection or audit any book, record, document, or other item required to be produced by law, these rules, or the terms of the certificate; (3-20-20)T
- m.** Systemically pursuing economic gain in a manner or context that is in violation of the criminal or civil public policy of this state if there is cause to believe that the participation of such person in these activities is inimical to the proper operation of the authorized Lottery; (3-20-20)T
- n.** Failing to follow the instructions of the Lottery for the conduct of any particular game or special event; (3-20-20)T
- o.** Failing to follow security procedures of the Lottery for the management of personnel, handling of tickets, or for the conduct of any particular game or special event; (3-20-20)T
- p.** Misrepresenting a fact to a purchaser, or prospective purchaser, of a ticket, or to the general public with respect to the conduct of a particular game or special event; (3-20-20)T
- q.** Allowing activities on the licensed premises that could compromise the dignity of the state. (3-20-20)T
- 08. Surrender of Certificate Upon Revocation.** Upon revocation or suspension of a retailer's certificate, the retailer must surrender to the Lottery, by a date designated by the Lottery, the certificate and all other Lottery property. (3-20-20)T
- 09. Certified Retailers.** All Lottery retailers must be certified in the manner provided in these rules. Retailers are required to abide by all applicable laws and administrative rules, the terms and conditions of the contract

and certificate, and all other directives and instructions issued by the Lottery. (3-20-20)T

**10. Requirements For The Sale of Tickets.** (3-20-20)T

**a.** Retailers must be knowledgeable about the Lottery and Lottery products and may be required to take training in the operation of Lottery games. Retailers must make the purchase of tickets convenient to the public. (3-20-20)T

**b.** Tickets must be sold at the price designated by the Lottery. Retailers cannot sell tickets for a greater amount than the amount specified by the Lottery. Retailers may sell tickets for a lesser amount for promotional purposes if authorized by the Lottery. (3-20-20)T

**c.** No retailer or any employee or member of a retailer shall attempt to identify a winning ticket before sale of the ticket. (3-20-20)T

**d.** When a retailer is required by its contract with the Lottery to pay a prize to a winner, the retailer must pay the prize whenever the winner tenders a winning ticket during the retailer's normal business hours at the location designated on the retailer's certificate. (3-20-20)T

**e.** Retailers are prohibited from purchasing tickets previously sold by the retailer. (3-20-20)T

**11. Display of Certificate and Other Materials.** Retailers must display the Lottery certificate in an area visible to the general public wherever tickets are being sold and also display point-of-sale material provided by the Lottery in a manner that is readily seen by and available to the public. Retailers may advertise and use or display other appropriate promotional and point-of-sale material. The Lottery may require the removal of objectionable material or the discontinuance of objectionable advertising that may have an adverse impact on the Lottery. (3-20-20)T

**12. Dishonored Checks and Electronic Fund Transfers.** Any payment made to the Lottery by an applicant for a certificate or by a certificated retailer either by a check that is dishonored or by an electronic funds transfer (EFT) that is not paid by the depository, is grounds for immediate denial of the application for a certificate or for suspension or revocation of an existing certificate. The Lottery may assess a surcharge for each dishonored check or EFT. The Lottery may also alter the payment terms of a retailer's certificate and require a retailer to reimburse the Lottery for costs that occur as a result of a dishonored check or EFT. (3-20-20)T

**13. Inspection of Lottery Materials and Retailer Premises.** Retailers must allow the Lottery to enter upon the retailer's certificated premises in order to inspect Lottery materials, tickets, and the premises. All books and records pertaining to the retailer's Lottery activities must be available to the Lottery for inspection and copying during the normal business hours of the retailer and between 8 a.m. and 5 p.m., Monday through Friday. All books and records pertaining to the retailer's Lottery activities are subject to seizure by the Lottery without prior notice. (3-20-20)T

**202. GENERAL INSTANT TICKET GAME OPERATING RULES.**

**01. Instant Games -- Authorized -- Director's Authority.** The Commission hereby authorizes instant games that meet the criteria set forth in these rules. The Director is hereby authorized to select, operate, and contract relating to and for the operation of instant games that meet the criteria set forth in these rules. (3-20-20)T

**02. Definitions.** As used in Section 202 of these rules, these terms have the following definitions: (3-20-20)T

**a.** Instant Ticket Validation Bar Code. The bar code that enables retailers to validate instant tickets. (3-20-20)T

**b.** ITA System. The Instant Ticket Automation system that validates winning instant tickets. (3-20-20)T

**c.** Pack. A package of instant game tickets with a designated number of tickets that may be (but do not have to be) fanfolded and attached to each other by perforations, which perforations the retailer tears when selling a ticket, and that are packaged in plastic shrink-wrapping, foil or some similar outer wrapping material. (3-20-20)T

**d.** Pack-Ticket Number. The number printed on the ticket. A game identification number must be included in the book-ticket number. (3-20-20)T

**e.** Play Symbol Caption. The small printed material appearing below each play symbol which repeats or explains the play symbol. One (1) and only one (1) play symbol captions appears under each play symbol. (3-20-20)T

**f.** Play Symbols. Figures printed in approved ink that appear under each of the rub-off spots on the front of the ticket. (3-20-20)T

**g.** Retailer Validation Code. The small letters found under the removable rub-off covering over the play symbols on the front of the ticket, which the ticket retailer uses to verify winners of twenty-five dollars (\$25) or less. The letters appear in varying locations beneath the removable rub-off covering and among the play symbols. (3-20-20)T

**h.** Ticket. An Idaho instant game ticket. (3-20-20)T

**i.** Ticket Validation Number. The unique number on the front of the ticket. (3-20-20)T

**03. Sale of Tickets.** (3-20-20)T

**a.** No person other than a retailer under a contract for the sale of tickets with the Lottery may sell Lottery tickets, except that nothing in this section prevents a person who may lawfully purchase tickets from making a gift of Lottery tickets to another. (3-20-20)T

**b.** Unless authorized by the Lottery, tickets may not be sold at a location other than the address listed on the retailer's contract with the Lottery. (3-20-20)T

**c.** Nothing in this section prohibits the Commission from designating certain of its agents and employees to sell Lottery tickets directly to the public. (3-20-20)T

**04. Instant Games Ticket Price.** The price of an instant game ticket will be set by the Director. No person may sell a ticket at a price other than that established in accordance with these rules. (3-20-20)T

**05. Prize Structures.** The Director will provide to all Lottery game retailers a detailed tabulation of the estimated number of prizes of each particular prize denomination that are expected to be awarded in each Lottery game and a close approximation of the odds of winning the prizes. (3-20-20)T

**06. Number and Value of Instant Ticket Prizes.** Lottery game prize structures, odds of winning, number of tickets, number and value of prizes, play symbol and captions used for validation will not be adopted by administrative rules. Rather, the Director will submit proposed games to the Commission, who must approve each game's general format before the initiation of each game. All instant games must be conducted in accordance with the rules of the Commission. (3-20-20)T

**07. Official Start of Game.** (3-20-20)T

**a.** Games with a prize structure adopted by the Commission pursuant to Subsection 202.07 of this rule may be started at a time selected by the Director. The Director will publicly announce the starting date of a new game by use of a press release or any other appropriate means. The Director may also issue game information that includes a description of the game, odds of winning a prize, the number and value of prizes, and the play symbols and captions used for prize validation. (3-20-20)T

**b.** Games using a prize structure other than a prize structure previously approved by the Commission

must be approved by the Commission before game tickets can be sold to the public. (3-20-20)T

**08. Determination of Winners.** (3-20-20)T

**a.** Winners of an instant game are determined by the matching or specified alignment of the play symbols on the tickets. The play symbols are revealed by scratching or rubbing off the latex or similar secure material that covers spots on the ticket. The ticket bearer must notify the retailer or the Lottery of the win and submit the winning ticket to the retailer or the Lottery as provided in these rules. The winning ticket must be validated by the Lottery through use of the validation number or by any other means specified by the Director. (3-20-20)T

**b.** Unless otherwise provided by game rules, only the highest instant prize amount will be paid on a given ticket. (3-20-20)T

**c.** No portion of the play symbol captions, retailer validation codes, display printing nor any extraneous matter whatever will be usable or playable as a part of the instant game. (3-20-20)T

**d.** The ticket validation number or any portion thereof is not a play spot and is not usable or playable as such. (3-20-20)T

**e.** In all Lottery games, the determination of prize winners is subject to the general ticket validation requirements set forth in Subsection 200.14, et seq., and Subsection 202.11 of this rule, and the requirements set out on the back of each instant game ticket. (3-20-20)T

**f.** The length of operation of an instant game will be determined by the Director. The start date and closing date of the instant game will be publicly announced. (3-20-20)T

**09. Payment of Prizes.** The procedures for claiming instant ticket prizes are as follows: (3-20-20)T

**a.** Instant ticket prizes of less than six hundred dollars (\$600) may be claimed by one (1) of the following methods: (3-20-20)T

**i.** The claimant may present the winning ticket to any Lottery retailer. The retailer must verify the claim and, if acceptable, make payment of the amount due the claimant. A retailer may pay prizes in cash or by business check, or money order, or any combination thereof. A retailer that pays a prize with a check that is dishonored may be subject to suspension or termination of the retailer's contract. (3-20-20)T

**ii.** If the retailer cannot verify the claim, the claimant must fill out a claim form and the retailer must present the completed form and the disputed ticket to the Director. If the claim is validated, a check will be forwarded to the claimant in payment of the amount due. If the claim is not validated, the claim will be denied and the claimant will be promptly notified. (3-20-20)T

**iii.** The claimant may bring the ticket to the Lottery office or complete a claim form and mail it with the ticket to the Idaho State Lottery (registered mail recommended). Claim forms may be obtained from any Lottery game retailer or from the Lottery. (3-20-20)T

**b.** To claim an instant prize of six hundred dollars (\$600) or more, the claimant must either bring the winning ticket to the Lottery office or complete a claim form and mail the completed form together with the winning ticket to the Idaho State Lottery (registered mail recommended). (3-20-20)T

**c.** Prizes of six hundred dollars (\$600) or more can be paid only from the Boise Lottery office. Upon validation by the Director, a check will be forwarded to the claimant in payment of the amount due, less any applicable federal income tax withholding. (3-20-20)T

**d.** Any ticket not passing all the validation checks is void and ineligible for any prize and will not be paid. However, the Director may, solely at the Director's option, replace an invalid ticket with an unplayed ticket (or ticket of equivalent sales price from any other current game). If a defective ticket is purchased, the only responsibility or liability of the Lottery is the replacement of the defective ticket with another unplayed ticket (or ticket of

equivalent sale price from any other current game). (3-20-20)T

e. All prizes will be paid within a reasonable time after they are awarded and after the claims are verified by the Director. For each prize requiring annual payments, all payments after the first payment will be made on the anniversary date of the first payment in accordance with the type of prize awarded. The Director may, at any time, delay any payment in order to review a change of circumstances concerning the prize awarded, the payee, the claim, or any other matter that may have come to his attention. All delayed payments will be brought up to date immediately upon the Director's confirmation and continue to be paid on each original anniversary date thereafter. (3-20-20)T

**10. Ticket Validation Requirements.** In addition to meeting all of the other requirements in these rules or as may be printed on the back of each instant game ticket, the following validation requirements apply with regard to instant game tickets: (3-20-20)T

- a. To be a valid instant game ticket, the ticket must: (3-20-20)T
  - i. Have been issued by the Director in an authorized manner. (3-20-20)T
  - ii. Not be altered, unreadable, or tampered with in any manner. (3-20-20)T
  - iii. Not be counterfeit in whole or in part. (3-20-20)T
  - iv. Not be stolen nor appear on any list of omitted tickets on file with the Lottery. (3-20-20)T
  - v. Be complete and not blank (or partially blank), miscut, misregistered, defective, or printed or produced in error. (3-20-20)T

vi. Under the opaque covered play area, have play symbols and the correct corresponding captions, exactly one (1) pack-ticket number, exactly one (1) agent verification code, and exactly one (1) validation number as required by each approved set of game rules, all of which must be present in their entirety, legible, right-side up, and not reversed in any manner. (3-20-20)T

vii. The validation number of an apparent winning ticket must appear on the Lottery's official list of validation numbers of winning tickets; and a ticket with that validation number cannot have been previously paid. (3-20-20)T

viii. Pass all additional confidential validation requirements established by the Director. (3-20-20)T

ix. Be signed if the prize is for six hundred dollars (\$600) or more. (3-20-20)T

b. Any ticket not passing all the validation checks in Paragraph 202.11.a. of this rule is void and ineligible for any prize and shall not be paid. However, the Director may, solely at the Director's option, replace an invalid ticket with an unplayed ticket (or tickets of equivalent sales price) from any other current Lottery game. If a defective ticket is purchased, the only responsibility or liability of the Lottery will be the replacement of the defective ticket with another unplayed ticket (or ticket of equivalent sales price from any other current Lottery game). (3-20-20)T

c. The Director may authorize reconstruction of an alleged winning ticket that was not received or cannot be located by the Lottery, provided, the person requesting reconstruction must submit to the Lottery sufficient evidence to enable reconstruction and submit a claim for the prize, if any, for that ticket. If the reconstructed ticket is a winning ticket and meets the validation requirements of Paragraph 202.11.a. of this rule and any specific validation requirements contained in the rules for its specific game, the Director may authorize payment of the prize. Provided, the ticket will not be validated nor the prize paid before the one hundred eighty-first (181) day following the official end of that instant game. A ticket(s) validated pursuant to this Subsection will not entitle the claimant to be entered into the grand prize drawing, if any, for that or any subsequent instant game. (3-20-20)T

**11. Prize Rights Unassignable.** No person's right to a prize already drawn is assignable, except that payment of any prize already drawn may be paid to the estate of a deceased prize winner, and a person other than the



prize winner may be paid the prize to which the winner is entitled as provided by court order. The Director will be discharged of all liability upon payment of a prize pursuant to this rule. (3-20-20)T

**12. Payment of Prizes to Persons Under Eighteen Years of Age.** If a person entitled to a prize for a winning ticket is under the age of eighteen (18) years, the Director may direct payment of the prize to an adult member of the minor's family or to the minor's guardian by a check or draft payable to the adult member of the minor's family or the minor's guardian. The adult member of the minor's family or the minor's guardian will have the same duties and powers as a person designated as a custodian in accordance with Idaho law. For purposes of this Subsection, the terms "adult member of a minor's family" and "guardian of a minor" have the same meaning as in the Idaho Gifts to Minors Law. The Director will be discharged of all liability upon payment of a prize to a minor pursuant to this rule. (3-20-20)T

**13. Prizes Payable After Death or Disability of Owner.** (3-20-20)T

**a.** All prizes, and portions of prizes that remain unpaid at the time of the prize winner's death will be payable to the personal representative of the prize winner's estate once satisfactory evidence of the personal representative's appointment has been provided, and the Director is satisfied that payment to the personal representative is lawful and proper. The Director may rely on a certified copy of a court order appointing a personal representative (or similar person responsible for the prize winner's estate, whether denominated an administrator, executor, executrix, or other representative of the prize winner's estate) or may petition the court to determine the proper payee. Payment to the personal representative of the estate of the deceased owner of any prize winnings will absolve the Director and the Lottery's employees of any further liability for payment of prize winnings. (3-20-20)T

**b.** The Lottery may petition any court of competent jurisdiction for a determination of the rightful payee for the payment of any prize winnings that are or may become due to a person under a disability including, but not limited to, mental deficiency, or physical or mental incapacity. (3-20-20)T

**14. Governing Law.** In purchasing a ticket, the customer agrees to comply with, and abide by, Idaho law, and all rules and final decisions of the Lottery, and all procedures and instructions established by the Lottery or the Director for the conduct of the game. (3-20-20)T

**15. Discharge of All Liability Upon Payment.** The state of Idaho, its agents, officers, employees, and representatives, the Lottery, its Director, agents, officers, employees and representatives, will be discharged of all liability upon payment of a prize or any one (1) installment thereof to the holder of any winning Lottery ticket or in accordance with the information set forth on the claim form supplied by the Director. If there is a conflict between the information on a winning Lottery ticket and the information on the claim form, the Lottery may rely on the claim form after the ticket for which it has been filed has been validated as a winning ticket and, in so doing, it will be relieved of all responsibility and liability in the payment of a prize in accordance with the information set forth therein. The Lottery's decisions and judgments in respect to the determination of a winning ticket or of any other dispute arising from payment or awarding of prizes are final and binding upon all participants in the Lottery unless otherwise provided by law or these rules. If a question arises concerning the winning ticket, a claim form, the payment, or the awarding of any prize, the Lottery may deposit the prize winnings into an escrow fund until it determines the controversy and reaches a decision, or it may petition a court of competent jurisdiction for instructions and a resolution of the controversy. (3-20-20)T

**16. Unclaimed Prize Money.** Any prize not claimed within the specified period will be forfeited and placed into the State Lottery Account. (3-20-20)T

**17. Disclosure.** The Lottery may use the names, addresses, and photographs of winners in any Lottery promotional or publicity campaign. The address used will not contain the winner's street or house number without the winner's consent. The Lottery may condition payment of the prize upon agreement to these terms and conditions. (3-20-20)T

**18. Confidentiality of Tickets.** All retailers and their employees and agents are prohibited from attempting to ascertain the numbers or symbols appearing in the designated areas under the removable latex or similar secure coverings or otherwise attempting to identify winning tickets. (3-20-20)T

**19. Official End of Game.** (3-20-20)T

**a.** The official end of an instant game will be announced by the Lottery. Prizes may be claimed up to one hundred eighty (180) days after the official end of the game. If the final day of the claim period falls on a Saturday, Sunday or a state holiday, the claim period will be extended to the end of the next business day. A player may submit a winning ticket claim for prize payment up to one hundred eighty (180) days after the official end of the game. Depending on the prize amount, the ticket should be submitted to the location specified in Subsection 202.10 of this rule, "Payment of Prizes." To participate in one (1) of the Lottery's special drawings, if any, a player must redeem a ticket that qualifies for entry into that special drawing within the time limits specified by the Director. (3-20-20)T

**b.** A retailer must return to the Lottery all unsold Lottery tickets for each game within ninety (90) days of the official end of that game in order to receive credit from the Lottery as provided in retailer's contract. The Lottery has no obligation to grant credit for tickets returned after the time limit specified in the contract. (3-20-20)T

**203. (RESERVED)**

**204. ON-LINE COMPUTER GAMES.**

**01. On-Line Games -- Authorized -- Director's Authority.** The Commission hereby authorizes the Director to select and operate on-line games which meet the criteria set forth in these rules. (3-20-20)T

**02. Definitions.** As used in Rule 204 these terms have the following definitions: (3-20-20)T

**a.** "Drawing." The procedure determined by the Director by which the Lottery selects the winning combination in accordance with the rules of the game. Drawings are open to the public. (3-20-20)T

**b.** "On-line Game." (3-20-20)T

**i.** A Lottery game in which a player selects a combination of numbers or symbols, the type of game and amount of play, and the drawing date by use of a computer. In return for paying the appropriate price, the player receives a computer-generated ticket with the player's selection printed on it. Each ticket bearer whose valid ticket includes a winning combination will be entitled to a prize if claim is submitted within the specified time period. (3-20-20)T

**ii.** On-line terminal (OLT) instant ticket game having characteristics as defined in Paragraphs 202.02.a., 202.02.b., 202.02.d. and 202.02.i. of these rules. (3-20-20)T

**c.** "On-line Retailer." A person or business authorized by the Lottery to sell on-line tickets. (3-20-20)T

**d.** "On-line Terminal (OLT)." The computer hardware by which an on-line retailer or player enters the combination selected by the player and by which on-line tickets are generated and claims are validated. (3-20-20)T

**e.** "On-line Ticket." A computer-generated ticket issued by an on-line terminal to a player as a receipt for the combination a player has selected. That ticket is the only acceptable evidence of the combination of numbers or symbols selected. (3-20-20)T

**f.** "Ticket Bearer." The person who has signed the on-line ticket or who has possession of an unsigned ticket. (3-20-20)T

**g.** "Validation." The process of determining whether an on-line ticket presented for payment is a winning ticket. (3-20-20)T

**h.** "Winning Combination." One (1) or more numbers or symbols randomly selected by the State Lottery or its designee in a public drawing. (3-20-20)T

- 03. Distribution of Tickets.** (3-20-20)T
- a.** Tickets will be sold by retailers selected by the Director. (3-20-20)T
- b.** The Director is authorized to arrange for the distribution of OLTs, player-activated terminals (PATs), ticket stock, and supplies to certificated retailers. (3-20-20)T
- 04. Sale of Tickets.** (3-20-20)T
- a.** No person other than a retailer under a contract for the sale of tickets with the Lottery may sell on-line Lottery tickets, except that nothing in this section will be construed to prevent a person who may lawfully purchase tickets from making a gift of Lottery tickets to another. (3-20-20)T
- b.** Tickets may not be sold at a location other than the address listed on the retailer's contract with the Lottery. (3-20-20)T
- c.** Nothing in this section prohibits the Director from designating certain of its agents and employees to sell Lottery tickets directly to the public. (3-20-20)T
- 05. On-Line Games Criteria.** (3-20-20)T
- a.** The base price of an on-line ticket will not be less than fifty cents (\$.50), except to the extent of discounts authorized by the Commission. (3-20-20)T
- b.** The price for a ticket in any particular on-line game will be set out in the game rules adopted by the Commission for that game. No person may sell a ticket at a price other than that established in accordance with these rules. On the average, the total of all prizes available to be won in an on-line game will not be less than forty-five percent (45%) of the on-line game's projected revenue. (3-20-20)T
- c.** The manner and frequency of drawings may vary with the type of on-line game as defined in Subparagraph 204.02.b.i. of these rules. (3-20-20)T
- d.** The times, locations, and drawing procedures will be determined by the Director. (3-20-20)T
- e.** OLT instant ticket game as defined in Subparagraph 204.02.b.ii. of these rules will operate with a finite number of tickets per game and a predetermined and guaranteed prize structure approved by the Director. (3-20-20)T
- f.** A ticket bearer entitled to a prize must submit the winning ticket as specified by the Director. The winning ticket must be validated by the Lottery or an on-line retailer through use of the validation number and any other means specified by the Director. (3-20-20)T
- 06. Payment of Prizes.** (3-20-20)T
- a.** To claim an on-line game prize of less than six hundred dollars (\$600) the claimant may present the winning on-line ticket to any on-line retailer, or to the Lottery office: (3-20-20)T
- i.** If the claim is presented to an on-line retailer, the on-line retailer must validate the claim and, if determined to be a winning ticket, pay the amount due the claimant. If the on-line retailer cannot validate the claim, the claimant may obtain and complete a claim form and submit it with the disputed ticket to the Lottery by mail or in person. Upon determination that the ticket is a winning ticket, the Lottery will present or mail a check to the claimant in payment of the amount due. If the ticket is determined to be a non winning ticket, the claim will be denied and the claimant will be promptly notified. Non-winning tickets will not be returned to the claimant. (3-20-20)T
- ii.** If the claim is presented to the Lottery office, the claimant will be required to complete a claim form and submit it with the winning ticket, either by mail or in person. Upon determination that the ticket is a winning ticket, the Lottery will present or mail a check to the claimant in payment of the amount due, less any

withholding required by the Internal Revenue Code. If the ticket is determined to be a non-winning ticket, the claim will be denied and the claimant will be promptly notified. Non-winning tickets will not be returned to the claimant. (3-20-20)T

**b.** To claim an on-line prize of six hundred dollars (\$600) or more, the claimant must obtain and complete a claim form and submit it with the winning ticket to the Lottery office by mail or in person. Prizes of six hundred dollars (\$600) or more can be paid only from the Lottery office. Upon determination that the ticket is a winning ticket, the Lottery will present or mail a check to the claimant in payment of the amount due, less any withholding required by the Internal Revenue Code and the state of Idaho. The amount due will be calculated according to the rules adopted for the particular on-line game. If the ticket is determined to be a non-winning ticket, the claim will be denied and the claimant will be promptly notified. Non-winning tickets will not be returned to the claimant. (3-20-20)T

**c.** All prizes must be claimed within one hundred eighty (180) days from the drawing in which the prize was won. If the final day of the one hundred eighty (180) day period falls on a Saturday, Sunday or a state holiday, the claim period will be extended to the end of the next business day. Any prize not claimed within the specified period will be forfeited and placed into the State Lottery account. (3-20-20)T

**07. Drawings and End of Sales Prior to Drawings.** (3-20-20)T

**a.** Drawings will be conducted in a location and at days and times designated by the Director. (3-20-20)T

**b.** For each type of on-line game, the Director will establish a time before the drawing for the end of sales. (3-20-20)T

**c.** The Director will designate the type of equipment to be used and will establish procedures to randomly select the winning combination for each type of on-line game. Drawing procedures will include provisions for the substitution of backup drawing equipment if the primary drawing equipment malfunctions or fails for any reason. (3-20-20)T

**d.** The equipment used to determine the winning combination will not be electronically or otherwise connected to the central computer or to any tapes, discs, files, etc., generated or produced by the central computer. The drawing results, including sales, number of winners and numbers drawn, will be audited and reviewed after each drawing to assure proper operation and lack of tampering or fraud. (3-20-20)T

**e.** All drawings may be broadcast live on television, provided the facilities for such broadcasts are available and operational and can be done at a reasonable cost. (3-20-20)T

**f.** The Director will establish procedures governing the conduct of drawings for each type of on-line game. The procedures must include provisions for deviations that include but are not limited to: (3-20-20)T

**i.** Malfunction of the drawing equipment before determination of the winning combination; (3-20-20)T

**ii.** Fouled drawing; (3-20-20)T

**iii.** Delayed drawing; and (3-20-20)T

**iv.** Other equipment, facility or personnel difficulties. (3-20-20)T

**g.** If a deviation occurs, the drawing will be completed under the supervision of the Lottery or its designee. The winning combination will be provided to the public. (3-20-20)T

**h.** If, during any live-broadcast drawing for a game, a mechanical failure or operator error causes an interruption in the selection of all numbers or symbols, a "foul" will be called by Lottery security or the Lottery's designee. Any number drawn before a "foul" is called will stand and be deemed official after passing inspection and

certification by Lottery security or the Lottery's designee. (3-20-20)T

**i.** The Director will delay payment of all prizes if any evidence exists or there are grounds for suspicion that tampering or fraud has occurred. Payment will be made after an investigation is completed and the drawing approved by Lottery security or the Lottery's designee. If the drawing is not approved, it will be void and another drawing will be conducted to determine the actual winner. (3-20-20)T

**08. Validation Requirements.** (3-20-20)T

**a.** To be a valid winning on-line ticket, the ticket must: (3-20-20)T

**i.** Have all printing on the ticket in its entirety, be legible, and correspond, using the computer validation file, to the combination and the date printed on the ticket. (3-20-20)T

**ii.** Be intact, not be mutilated, altered, or tampered with in any manner. (3-20-20)T

**iii.** Not be counterfeit or an exact duplicate of another winning ticket. (3-20-20)T

**iv.** Have been issued by an authorized on-line retailer or dispensed by a player-activated terminal in an authorized manner. (3-20-20)T

**v.** Not have been stolen or cancelled. (3-20-20)T

**vi.** Not have been previously paid. (3-20-20)T

**vii.** Pass all other confidential security checks of the Lottery. (3-20-20)T

**viii.** Be signed if the prize is for six hundred dollars (\$600) or more. (3-20-20)T

**b.** A ticket failing any of the validation requirements listed in Paragraph 204.08.a. of this rule is invalid and ineligible for a prize. The final decision on whether a prize is paid will be made by the Director. (3-20-20)T

**c.** If there is a dispute between the Director and a claimant whether a ticket is a winning ticket, and if the Director determines that the ticket is not valid and a prize is not paid, the Director may replace the disputed ticket with a ticket of equivalent sales price for a future drawing of the same type of game. This will be the sole and exclusive remedy of the claimant. (3-20-20)T

**d.** If a defective on-line ticket is purchased, the only responsibility or liability of the Lottery or of the on-line retailer is the replacement of the defective on-line ticket with another on-line ticket of equivalent value for a future drawing of the same type of game. (3-20-20)T

**09. Retailer Duties.** Retailers with an on-line terminal (OLT) must perform the following duties: (3-20-20)T

**a.** Pay costs associated with providing a telephone line or internet or similar connection that must be located as specified by the Lottery. Payment of the telephone line or internet or similar connection is nonrefundable after installation, except if the Lottery denies, through no fault of retailer, the installation of the on-line terminal. (3-20-20)T

**b.** Pay the Lottery for the local monthly telephone or internet or similar charges per OLT as specified by the Lottery. The Lottery will pay for the mileage charges (if any) between the retailer's location and the Lottery's central site. (3-20-20)T

**c.** Hold funds generated from the sale of on-line tickets in trust for the Lottery. At a time specified by the Lottery, the retailer must pay these funds to the Lottery plus the monthly communications charge specified above in Paragraph 204.09.b. of this rule, less: (3-20-20)T

- i. Prizes paid; (3-20-20)T
- ii. Any credit; and (3-20-20)T
- iii. The retailer discount. (3-20-20)T
- d.** Locate the OLT within the retailer's premises at a point-of-sale location approved by the Lottery. The retailer is prohibited from moving an OLT unless the retailer follows the procedures established by the Director, including reimbursing the State Lottery for any telephone or internet or similar charges associated with the change of OLT location if the retailer requested the change. (3-20-20)T
- e.** Provide dedicated AC power to within approximately five (5) feet of the terminal. Dedicated AC power means that there is no other equipment on the line that is to be used for the on-line terminal. The retailer is responsible for all costs associated with providing dedicated AC power. The Lottery will provide a schematic of outlet requirements to the retailer's electrical contractor. (3-20-20)T
- f.** Sell all Lottery games, including but not limited to instant game tickets offered by the Lottery. The retailer agrees to continue the sale of instant tickets from all cash registers or other points of purchase. (3-20-20)T
- g.** Conduct the sale of on-line tickets during all hours and days that the retailer's business is open and the on-line system is functioning. The retailer must post the hours that redemption of winning tickets may take place if these hours are different from the retailer's normal business hours. The retailer must monitor ticket supply levels and give timely notice when any item is in short supply. (3-20-20)T
- h.** Post winning numbers prominently where tickets are sold as soon as possible following the drawing. (3-20-20)T
- i.** Provide secure storage for OLT supplies and a secure area for the OLT. (3-20-20)T
- j.** Exercise due diligence in the operation of the OLT and immediately notify the Lottery and the central computer facility of any telephone line, internet, radio, or OLT malfunction, such as the issuance of invalid on-line Lottery ticket, inability to sell or redeem an on-line ticket, and non-issuance of an on-line ticket. The retailer is prohibited from performing mechanical or electrical maintenance on the OLT. (3-20-20)T
- k.** Replace ribbons and on-line or instant ticket stock and clear paper jams as required for the OLT per the instructions provided by the Lottery. (3-20-20)T
- l.** Pay, without reimbursement, all electricity charges in connection with the operation of OLT. (3-20-20)T
- 10. Payment of Prizes by On-Line Retailers.** (3-20-20)T
  - a.** An on-line retailer must pay to the ticket bearer on-line games prizes of less than six hundred dollars (\$600) for any validated claims presented to that on-line retailer. These prizes must be paid during all normal business hours of the on-line retailer, unless redemption hours differ from normal business hours that have been posted pursuant to Paragraph 204.09.g. of this rule, provided, that the on-line system is operational and claims can be validated. (3-20-20)T
  - b.** An on-line retailer may pay prizes in cash or by business check, certified check, money order, or any combination thereof. An on-line retailer that pays a prize with a check that is dishonored may be subject to suspension or termination of its contract. (3-20-20)T
- 11. Retailer Settlement.** (3-20-20)T
  - a.** On-line retailers must establish an account for deposit of monies derived from on-line games with a financial institution that has the capability of electronic funds transfer (EFT). (3-20-20)T

**b.** The amount deposited must be sufficient to cover monies due the Lottery. The Lottery will withdraw by EFT the amount due the Lottery on the day specified by the Director. If the day specified for withdrawal falls on a state holiday, withdrawal may be delayed until the next business day. (3-20-20)T

**12. Prize Rights Unassignable.** No right of any person to a prize drawn is assignable, except that payment of any prize drawn may be paid to the estate of a deceased prize winner, and that any person may be paid the prize to which the winner is entitled pursuant to an appropriate judicial order. The Director will be discharged of all liability upon payment of a prize pursuant to this rule. (3-20-20)T

**13. Payment of Prizes to Persons Under Eighteen Years of Age.** If a person entitled to a prize for a winning ticket is under the age of eighteen (18) years, the Director may direct payment of the prize to an adult member of the minor's family or to the minor's guardian by a check or draft payable to the adult member of the minor's family or to the minor's guardian. The adult member of the minor's family or the minor's guardian will have the same duties and powers as a person designated as a custodian in accordance with Idaho Law. For purposes of this Subsection the terms "adult member of a minor's family" and "guardian of a minor" have the same meaning as in the Idaho Gifts to Minors Law. The Director will be discharged of all liability upon payment of a prize to a minor pursuant to this rule. (3-20-20)T

**14. Prizes Payable After Death or Disability of Owner.** (3-20-20)T

**a.** All prizes, and portions of prizes, that remain unpaid at the time of the prize winner's death will be payable to the personal representative of the prize winner's estate once satisfactory evidence of the personal representative's appointment has been provided, and the Director is satisfied that payment to the personal representative is lawful and proper. The Director may rely on a certified copy of a court order appointing of a personal representative (or similar person responsible for the prize winner's estate, whether denominated an administrator, executor, executrix, or other representative of the prize winner's estate) or may petition the court to determine the proper payee. Payment to the personal representative of the estate of the deceased owner of any prize winnings will absolve the Director and the Lottery's employees of any further liability for payment of prize winnings. (3-20-20)T

**b.** The Lottery may petition any court of competent jurisdiction for a determination of the rightful payee of any prize winnings that are or may be due to a person under a disability including, but not limited to, minority, mental deficiency, physical or mental incapacity. (3-20-20)T

**15. Discharge of State Lottery Upon Payment.** The state of Idaho, its agents, officers, employees and representatives, the Lottery, its Director, agents, officers, employees and representatives are discharged of all liability upon payment of a prize or any one (1) installment thereof to the holder of any winning Lottery ticket or in accordance with the information set forth on the claim form supplied by the Director. If there is a conflict between the information on a winning Lottery ticket and the information on the claim form, the Lottery may rely on the claim form after the ticket for which it has been filed has been validated as a winning ticket and, in so doing, it will be relieved of all responsibility and liability in the payment of a prize in accordance with the information set forth therein. The Lottery's decisions and judgments in respect to the determination of a winning ticket or of any other dispute arising from payment or awarding of prizes will be final and binding upon all participants in the Lottery unless otherwise provided by law or these rules. If a question arises concerning the winning ticket, a claim form, the payment, or the awarding of any prize, the Lottery may deposit the prize winnings into an escrow fund until it determines the controversy and reaches a decision, or it may petition a court of competent jurisdiction for instructions and a resolution of the controversy. (3-20-20)T

**16. Disclosure.** The Lottery may use the names, addresses, and photographs of winners in any Lottery promotional or publicity campaign. The address used will not contain the winner's street or house number without the winner's consent. The Lottery may condition payment of the prize upon agreement to these terms and conditions. (3-20-20)T

**205. BREAKOPEN INSTANT TICKET GAMES.**

The Commission hereby authorizes the Director to select and operate breakopen instant ticket games that meet the criteria set forth in these rules. (3-20-20)T

- 01. Definitions.** As used in Section 205 of these rules, these terms have the following definitions: (3-20-20)T
- a.** “Authorized Dispensing Device” means any machine, or mechanism designed for use of vending or dispensing of breakopen instant tickets. These devices may include mechanical, electrical, electro-mechanical or other devices approved by the Director of the Lottery pursuant to Section 100 of these rules. (3-20-20)T
  - b.** “Box” means a group of breakopen instant tickets with the same unique serial number. (3-20-20)T
  - c.** “Breakopen Instant Ticket” means a single folded or banded ticket or a card, the face of which is initially covered or otherwise hidden from view to conceal numbers or symbols, or both, a few of which numbers or symbols have been designated in advance and at random as prize winners when, for the opportunity to obtain each such folded or banded ticket or card, view the numbers or symbols thereon and possibly obtain a prize, a person pays an established price to a breakopen instant ticket retailer. (3-20-20)T
  - d.** “Breakopen Instant Ticket Game” means a group of breakopen instant ticket boxes with the same thematic design and prize structure. (3-20-20)T
  - e.** “Breakopen Instant Ticket Retailer” means any person who has been approved, certified and contracted with by the Lottery to sell breakopen instant tickets. (3-20-20)T
  - f.** “Breakopen Instant Ticket Vendor” means any person who produces and provides breakopen instant tickets to the Lottery. (3-20-20)T
  - g.** “Distributor” means any person who purchases or otherwise obtains authorized dispensing devices for use in breakopen instant ticket games from any person and sells or otherwise furnishes such device to another person for the resale of or the display or operation of that device. (3-20-20)T
    - i.** As used in these rules, the term “distributor” includes a person who services and repairs authorized dispensing devices, so long as the person performing such servicing or repairs is approved by the distributor or distributor’s representative, and makes no addition to, or modification or alteration of, the authorized device. (3-20-20)T
    - ii.** A manufacturer who sells or otherwise furnishes authorized dispensing devices not manufactured by him to any other person for resale or for display or operation of that authorized device is also a “distributor.” (3-20-20)T
  - h.** “Distributor’s Representative” means any individual who represents a distributor in any of the distributor’s activities in connection with the sale or furnishing of authorized dispensing device for use in breakopen instant ticket activities. (3-20-20)T
  - i.** “Flare” means a vendor-provided informational sign that, at a minimum, displays the prize structure, the serial number of the sleeve in play, the odds of winning a prize, and the price of the ticket. (3-20-20)T
  - j.** “Manufacturer” means any person who assembles from raw materials or subparts a completed authorized dispensing device or pieces of the authorized device for use in breakopen instant ticket activities and who sells or otherwise furnishes the same to any distributor or retail outlet. (3-20-20)T
  - k.** “Manufacturer’s representative” means any person who represents a manufacturer in any one of the manufacturer’s activities in connection with the sale or furnishing of authorized dispensing device for use in breakopen instant ticket activities. (3-20-20)T
  - l.** “Sleeve” is a portion of a box; and is the smallest unit offered. (3-20-20)T
- 02. Breakopen Instant Ticket Special Inspection.** The Director or authorized representative has the authority to select any breakopen instant ticket sleeve and examine the quality and integrity of the sleeve in any



manner, including pulling all chances remaining thereon: Provided, that if the sleeve so inspected is thereby altered by such inspection in any manner and no defect, alteration, deceptive condition, or other violation is discovered, then the owner shall be reimbursed by the Lottery at the owner's cost for the sleeve or portion thereof, and the sleeve will become the property of the Lottery. Provided further, that for each sleeve inspected which is found to be defective in any area related to a vendor's quality control deficiency, a fee may be assessed by the Director against the vendor of the breakopen instant ticket. (3-20-20)T

**03. Breakopen Instant Ticket Operation.** (3-20-20)T

**a.** No person under the age of eighteen (18) years is allowed to play or sell any breakopen instant tickets. It is the responsibility of the retailer to determine that no unauthorized person is allowed to play or sell breakopen instant tickets. (3-20-20)T

**b.** No retailer is permitted to display or operate any breakopen instant ticket that has in any manner been marked, defaced, tampered with or otherwise placed in a condition, or operated in a manner, that may deceive the public or that affects the chances of winning or losing upon the taking of any chance thereon. (3-20-20)T

**c.** All records, reports, receipts and any unsold tickets relating to a breakopen instant ticket sleeve must be retained on the retailer's premises at least ninety (90) days after the sleeve is removed from play and be made available on demand to representatives of the Idaho Lottery. (3-20-20)T

**04. Breakopen Instant Ticket Price per Play to Be Posted.** No breakopen instant ticket sleeve may be placed for public play unless the cost to the player for each ticket is clearly posted on the flare. The price per ticket will be determined by the Director. (3-20-20)T

**05. Claiming of Prizes.** Prizes must be redeemed on the same day as purchased at the location where the winning ticket was purchased, and prizes will be awarded in cash or by check. (3-20-20)T

**06. Limitation on Breakopen Instant Ticket Dispensing.** No ticket once placed in an authorized dispensing device out for public play may be removed from the authorized device until the sleeve is permanently removed from public play, except only: (3-20-20)T

**a.** Those tickets actually played by players; (3-20-20)T

**b.** Those tickets removed by representatives of the Lottery inspecting the device or sleeve; and (3-20-20)T

**c.** Those tickets temporarily removed during necessary repair or maintenance of the device. Excepting only tickets removed under Paragraphs 205.06.b. and 205.06.c. of this rule, once a ticket has been removed from public play it cannot again be put out for public play. (3-20-20)T

**07. All Devices Must Comply With Requirements.** No retailer may display or put out for play, and no distributor or manufacturer or their representatives may sell or otherwise furnish any device for the dispensing of breakopen instant tickets, unless the device is approved for use by the Director, thereby making it an authorized device. (3-20-20)T

**a.** No person may sell or transfer to another person in this state or for use within this state, nor shall place out for public play, any device for the dispensing of breakopen instant tickets that is not constructed to allow a consumer to clearly see each ticket within the device before playing the device. (3-20-20)T

**b.** No person may put out for public play any device for the dispensing of breakopen instant tickets that is not constructed to provide for at least one (1) sleeve in play in the device. (3-20-20)T

**c.** No person may put out for public play any device for the dispensing of breakopen instant tickets that is designed, used, or constructed, in a manner that detracts from the breakopen instant tickets or that is deceptive in any way, as determined by the Director. (3-20-20)T

**08. Breakopen Instant Ticket Series Assembly and Packaging.** Vendors of breakopen instant ticket games must manufacture, assemble and package each game sleeve in a manner that none of the winning tickets, nor the location or approximate location of any of the winning tickets, can be determined in advance of opening the tickets. All breakopen instant ticket games must be approved and will be distributed and sold exclusively by the Lottery. The Lottery may adopt quality control standards for the manufacture of breakopen instant ticket games. (3-20-20)T

**09. Standards For Flares.** The flare advertising prizes available from the operation of any sleeve of breakopen instant tickets must: (3-20-20)T

**a.** Be placed near or upon the upper face, or on the top, of any authorized device used to dispense breakopen instant tickets in a manner clearly visible to the public; and (3-20-20)T

**b.** Clearly set out each of the prizes available and the combination of numbers or symbols which win prizes. Each flare describing the prizes and winning number or symbols for a sleeve of breakopen instant tickets in play must clearly set out the sleeve number assigned to that sleeve by the vendor. The sleeve number will be placed upon the flare by the vendor. The total number of tickets originally in the sleeve will be placed upon the flare by the vendor. (3-20-20)T

**10. Prize Structure.** The Director will establish a prize structure detailing the estimated number of prizes that are expected to be awarded in each sleeve and a close approximation of the odds of winning such prizes. (3-20-20)T

**11. Retailers Eligible to Sell Breakopen Tickets.** Any person interested in obtaining a contract for a certificate to sell Lottery tickets must file an application on forms provided by the Director that includes, but is not limited to, requiring an applicant's personal, financial, and criminal history, and an authorization to investigate the applicant's criminal and credit history. (3-20-20)T

**12. Retailer Application and Fee.** All applications to sell breakopen instant tickets must be accompanied by a nonrefundable fee of twenty-five dollars (\$25). If a certificate is awarded to sell only breakopen instant tickets, no additional certificate fee is necessary. (3-20-20)T

**13. Certificate Modification.** (3-20-20)T

**a.** Certified instant ticket retailers may apply for a certificate modification to allow for the sale of breakopen instant tickets. A current instant ticket retailer will be required to complete an additional application or application supplements. If a current instant ticket retailer requests that the existing certificate be modified to allow for the sale of breakopen instant tickets, no additional application fee will be charged upon approval. (3-20-20)T

**b.** Certified breakopen instant ticket retailers may apply for a certificate modification to allow for the sale of instant tickets. A current breakopen instant ticket retailer will be required to complete an additional application or application supplements. If a current breakopen instant ticket retailer requests that the existing certificate be modified to allow for the sale of instant tickets, an additional certificate fee of one hundred dollars (\$100) may be charged upon approval. (3-20-20)T

**206. -- 299. (RESERVED)**

### **SUBCHAPTER C – CHARITABLE GAMING RULES OF THE IDAHO STATE LOTTERY**

#### **300. DEFINITIONS.**

As used in these rules, each word defined in this Section has the meaning given here unless a different meaning is clearly required from context: (3-20-20)T

**01. Audit.** The review of documents or other records pertaining to operation of bingo or raffles, including, but not limited to, ledgers, bank statements, checks and deposit records, nightly logs, receipts, register tapes, computer records, contracts and leases, records showing use of all revenues for charitable activities, and tax records, by representatives of the Lottery, the attorney general, other law enforcement agencies, or independent

auditors. (3-20-20)T

**02. Autodaubing Features or Autodaubing.** Electronic bingo card daubers, including software or equipment interfaced with electronic bingo cards that automatically daub the numbers as called without requiring the player to manually input the number called. (3-20-20)T

**03. Bingo.** The traditional game of chance using a card with five (5) rows and five (5) columns containing numbers from a range of one (1) to seventy-five (75) and played for a prize determined before the game begins, as elaborated in Subsection 010.03 of these rules, and other games authorized by Title 67, Chapter 77, Idaho Code, and by these rules, for example, “U-Pick Em.” See Section 67-7702(1), Idaho Code: (3-20-20)T

**a. Bingo Cards, Regular.** Regular bingo cards (reusable or disposable) contain five (5) rows and five (5) columns of squares arranged in a five-by-five (5x5) grid; each square is imprinted with randomly placed numbers from a range of one (1) through seventy-five (75), except for the center square, which may be a free space. The letters “B-I-N-G-O” must also be imprinted on the card in order with one (1) letter above each of the five (5) columns (the letter “B” above the first column and so on). (3-20-20)T

**b. Bingo Cards, Electronic, or Face.** An electronic facsimile of a regular bingo card. See Section 67-7702(6), Idaho Code. (3-20-20)T

**c. Play Method.** Players who have paid consideration for the cards that they are holding compete for a prize by covering numbers on their cards when designators with the same number are randomly drawn and called. The balls or other designators in the selection device are numbered in the same manner as the possible numbers on the bingo cards, from one (1) through seventy-five (75). The winner is the first player to cover a predetermined arrangement of numbers on the players’ cards, for example, any row, column or diagonal of the five (5) rows and (5) columns and two (2) diagonals of the bingo card. Upon approval of the Bingo-Raffle Advisory Board there may be other forms of bingo games allowed, such as, but not limited to, Blackouts, Bonanza, and “U-Pick Em” games. The game begins when the first number is called and ends when a player has covered the previously designated arrangement and declares a bingo. Each winning card must be independently verified by a floor worker and another player by calling back the winning combination of numbers in the predetermined arrangement or by entering the serial number printed on the bingo card into an electronic verification system that can verify whether a card is a winner. (3-20-20)T

**d. Exclusions from Bingo.** Bingo does not include “instant bingo,” which is a game of chance played by the selection of one (1) or more prepackaged cards, with the winner determined by the appearance of a preprinted winning designation on the card. (3-20-20)T

**04. Bingo-Raffle Advisory Board or Board.** The board established and appointed according to Sections 67-7702(2), 67-7703, and 67-7704, Idaho Code. (3-20-20)T

**05. Blackout.** A game of bingo where all numbers are covered on a bingo card. This game is also referred to as “coverall.” (3-20-20)T

**06. Bonanza.** A game of bingo that is played on a prefolded card or on another kind of card on which the numbers are not revealed until the card is purchased and in which a designated number of balls are emitted from the machine in the usual manner and displayed. If there is no “Bingo” called on these numbers, the game may continue with one (1) additional ball emitted at a time until there is a winner. (3-20-20)T

**07. Charitable Contribution Acknowledgment Report Form or CCARF.** A form, prepared by the Director, upon which the recipient of a donation for a charitable purpose must indicate the charitable purpose for which the donation will be used; the name, address, and phone number of the person receiving the donation; and acknowledgement that the recipient will provide any and all information necessary in order for the Director or his representatives to verify that the donation was used for a charitable purpose, as well as any other information needed by the Director to assure that the donation is used for a charitable purpose. See Section 67-7709(2), Idaho Code. (3-20-20)T

**08. Charitable Donation Reporting Form.** A form prepared by the Director, upon which each

licensed organization shall record all charitable donations made from the proceeds of charitable bingo or raffles held during the license year on which they are reporting. This report shall require the names, addresses, contact person's name, contact person's telephone number, dollar amount and purpose of the donation. This report will be submitted to the Lottery along with the Annual Bingo Report or Annual Raffle Report and will be subject to audit as defined in Subsection 010.01. (3-20-20)T

- 09. Charitable Organization.** See definition in Section 67-7702, Idaho Code. (3-20-20)T
- 10. Charitable Purpose.** A purpose of supporting a bona fide charitable organization, as defined by Section 67-7702(3), Idaho Code. (3-20-20)T
- 11. Concessions.** Food and beverages or other incidental items (for example, caps or tee-shirts) unrelated to gaming that are sold to players at bingo games. (3-20-20)T
- 12. Disposable Paper Bingo Card.** A non-reusable, paper bingo card. (3-20-20)T
- 13. Distributor.** Any person who purchases or otherwise obtains or supplies equipment for use in conducting gaming activities, including, but not limited to, bingo or raffles, from any person or entity, and sells or otherwise furnishes such equipment or supplies to any person or entity who engages in gaming activity. (3-20-20)T
- 14. Duck Race.** A charitable raffle as defined in Section 67-7702(5), Idaho Code. (3-20-20)T
- 15. Electronic Bingo Device.** An electronic device used to monitor bingo games as defined by Section 67-7702(7), Idaho Code. Electronic bingo devices may be used to monitor bingo cards ("mind cards") only if they meet the requirements of Section 67-7702(7)(a), Idaho Code. No devices described in Section 67-7702(7)(b), Idaho Code, can be lawfully used in a bingo operation. (3-20-20)T
- 16. Electronic Gaming Devices.** Gaming or gambling devices electronically operated by inserting a coin or token and then pulling a handle or pushing a button to activate the game. Electronic gaming devices can generate points or payout slips for accumulated wins. (3-20-20)T
- 17. Gaming.** Gambling as defined in Section 18-3801, Idaho Code, including gaming authorized by Title 67, Chapters 74 and 77, Idaho Code. (3-20-20)T
- 18. Gross Revenues.** See definition in Section 67-7702, Idaho Code. (3-20-20)T
- a.** For Bingo. All moneys paid by players during a bingo game or session of play bingo, including fees for use of electronic bingo cards or electronic bingo devices, but excluding money paid for concessions. Gross revenues are calculated before any deductions for prizes or other expenses. (3-20-20)T
- b.** For Raffles and Other Gaming Authorized by Title 67, Chapter 77, Idaho Code. All moneys or other value paid to or due to any operator of a raffle or other gaming authorized by Title 67, Chapter 77, Idaho Code, activity for any chance taken or other fees for participation in the raffle or other gaming activity. Gross revenues are calculated before any deductions for prizes or other expenses. (3-20-20)T
- 19. Hard Bingo Cards.** Reusable bingo cards with sliding windows or shutters to cover the numbers on the cards. Hard cards are legal in sessions with less than ten thousand dollars (\$10,000) of annual gross revenue or for special occasions. (3-20-20)T
- 20. Host System.** See definition in Section 67-7702, Idaho Code. (3-20-20)T
- 21. Instant Bingo.** A Lottery game played by the use of premarked cards which, when opened, scratched or otherwise revealed, determine whether the cardholder is a winner without any competition among players. "Instant Bingo" is not a game of "Bingo" as defined by these rules. (3-20-20)T
- 22. License.** A permission issued by the Director of the Lottery to operate bingo games or raffles or to manufacture, sell, distribute, furnish or supply gaming machines, equipment or material. (3-20-20)T

- 23. Licensed Game Operator.** A person who qualifies as a nonprofit or charitable organization who may operate bingo or raffles and who is licensed pursuant to Section 67-7711, Idaho Code. (3-20-20)T
- 24. Licensed Vendor.** A person who manufactures, sells, distributes, furnishes or supplies gaming machines, equipment or material who is licensed pursuant to Section 67-7715, Idaho Code. (3-20-20)T
- 25. Manufacturer.** Any person who fabricates or assembles a completed piece of gaming equipment or pieces of gaming equipment, or supplies completed gaming equipment, or pieces of gaming equipment for use in gaming activities, including, but not limited to, bingo and raffles, and who sells or otherwise furnishes the completed gaming equipment or pieces of gaming equipment to any distributor, operator, or retail outlet. (3-20-20)T
- 26. Net Proceeds of a Charitable Raffle.** The gross revenues of a charitable raffle less the cost of prizes awarded. Net proceeds of a duck race mean gross revenues less the cost of prizes awarded and the rental cost of the ducks used in the race (if there are rental costs). See Section 67-7710(3), Idaho Code. Donated prizes are considered to have no cost and do not reduce the receipts when calculating net proceeds. (3-20-20)T
- 27. Nonprofit Organization.** See definition in Section 67-7702, Idaho Code. (3-20-20)T
- 28. Organization.** A charitable organization or a nonprofit organization. (3-20-20)T
- 29. Raffle.** An event in which prizes are won by random drawings or other selections of a ticket, duck or other means of identifying the one (1) or more persons purchasing chances. See Section 67-7702(14), Idaho Code. Duck races are a form of raffles. See Sections 67-7702(5) and 67-7702(9), Idaho Code. (3-20-20)T
- 30. Reusable Bingo Cards.** Bingo cards constructed out of a durable material that use sliding windows or shutters or chips to cover the numbers and that can be reused from one (1) game to another. (3-20-20)T
- 31. Separate Bank Account.** A bank account in the name of, and controlled by, a charitable or nonprofit organization established for purposes of complying with the accounting requirements of Section 67-7709(1), Idaho Code, regarding accounting for revenues and disbursements for bingo operations. All gross revenues received in connection with licensed bingo games must be placed in the separate bank account. Concessions and other moneys received (if any) from non-gaming revenues should not be deposited in the separate bank account. (3-20-20)T
- 32. Session.** A period of time not to exceed eight (8) hours in any one (1) day in which players are allowed to participate in bingo games operated by a charitable or nonprofit organization. See Sections 67-7702(15) and 67-7708, Idaho Code. (3-20-20)T
- 33. Site System.** See definition in Section 67-7702, Idaho Code. (3-20-20)T
- 34. Tracking.** The documentation of sales by sequentially numbered bingo paper or numbered tickets in raffles. See Section 67-7709(3), Idaho Code. (3-20-20)T
- 35. U-Pick Ems.** A game where players select their own numbers on a two (2) part duplicated bingo card. One (1) copy is retained by the player and used as a bingo card. Numbers are called until there is a winner. The winner is determined by the first player to cover the numbers on a "U-Pick-Em" card. (3-20-20)T
- 36. Vendor.** See definition in Section 67-7702, Idaho Code. (3-20-20)T

**SUB AREA: CONDUCT OF BINGO GAMES**

**301. BINGO BY CHARITABLE OR NONPROFIT ORGANIZATIONS.**

All organizations operating bingo games, whether licensed or unlicensed, must abide by these rules. It is unlawful to conduct bingo sessions or bingo games in violation of Title 67, Chapter 77, Idaho Code, or in violation of these rules, and persons doing so may be subject to administrative, civil or criminal penalties. See Section 67-7707, Idaho Code. Sections 301 through 306 of these rules apply to all bingo operators. Sections 307 through 310 of these rules apply to

operators using paper bingo cards. Sections 311 through 313 of these rules apply to operators using electronic bingo machines, as defined in Section 311 of these rules. Sections 306 through 309 of these rules apply to all bingo operators. (3-20-20)T

**302. NUMBER OF SESSIONS PER WEEK.**

Licensed operators of bingo games are limited to a maximum of three (3) bingo sessions per any calendar week (Sunday-Saturday). None of these sessions may exceed eight (8) consecutive hours in any one (1) day. See Section 67-7708, Idaho Code. A session is determined by the sale of paper for a continuous series of bingo games offered for a predetermined period of time. For special sessions it is permissible to extend the hours past midnight, but all hours past midnight up to 2 a.m. on the following day will count as hours for the day during which the session started. (3-20-20)T

**303. POSTING OF LICENSE AND HOURS.**

The organization's current charitable gaming license issued by the Lottery must be displayed during bingo games and bingo sessions in plain view for all players and interested persons. Lottery Gaming Rules must be kept on site and available during all sessions. Days/hours of operation must be posted in plain view for all players and interested persons. If days or times change, it is the responsibility of the organization to provide written notice to the Lottery. House rules pertaining to bingo must be posted in plain view for all players and interested persons. (3-20-20)T

**304. MEMBERS OF ORGANIZATION IN ATTENDANCE -- TRAINING OF EMPLOYEES.**

At least one (1) member or representative of the licensed organization must be in attendance at each session of bingo to supervise all bingo-related activities of a licensed organization. See Section 67-7711(3), Idaho Code. All bingo game employees, volunteers, and managers of all organizations, whether licensed or unlicensed, must be trained in the proper conduct of the game and the control of funds. (3-20-20)T

**305. EMPLOYEES INELIGIBLE TO PLAY.**

All bingo game employees and managers are prohibited from playing in any game or in any session for which the employee or manager takes part as employee or manager. There should be no conflict of interest perceived by the public. (3-20-20)T

**306. MINORS.**

Persons under the age of eighteen (18) years are prohibited from playing bingo in a game in which a cash prize is offered, or where the prize exceeds twenty-five dollars (\$25) in value for merchandise, or where any merchandise is redeemable, in whole or in part, for cash. See Section 67-7707(2), Idaho Code. Bingo operators may allow minors to work in a bingo game or session as per local house rules. (3-20-20)T

**307. TRACKING REQUIREMENTS IN GAMES USING PAPER BINGO CARDS.**

**01. Bingo Paper -- For Whom Required.** All licensed organizations operating bingo sessions that use paper bingo cards and all organizations exempt from licensing under Section 67-7713, Idaho Code, that use paper bingo cards must track their bingo sales for each session by using sequentially numbered/colored bingo paper. Each such organization must keep a ledger of the numbers of all bingo papers used. The non-reusable colored paper cards must be manufactured with a pre-printed series and a pre-printed serial number on each card. These cards may be assembled in multiple card sheets, single sheets, or packets. A sequential series and serial number must be printed on each individual card. (3-20-20)T

**02. Tracking by Game For Bingo Paper.** The tracking may vary according to games sold at each session (packets, specials, singles, six (6) ons, three (3) ons, etc.) and may be designated by game name or color of paper. (3-20-20)T

**03. Tracking By Bingo Paper Packet.** If sales are completed by packet, then those packets must not be separated for sale as singles. Individual games or packets sold must be recorded sequentially for effective tracking. The tracking records must be retained with permanent records. Tracking records are not required to be submitted with the Annual Bingo Report form. (3-20-20)T

**04. Late Players When Bingo Paper Used.** Packets of bingo paper sold to late players must have the previously played games sheets removed and voided. The tracking must account for sheets removed and voided. (3-20-20)T

**05. Designation of Bingo Paper Color For Games.** Each game is assigned a particular color of paper card. Other colors will not be accepted. (3-20-20)T

**06. Documentation For Bingo Paper.** All bingo paper must be tracked as either sold, damaged, donated, or omitted from the original distributor or manufacturer. Invoices from the distributor or manufacturer and other documentation of transactions involving bingo funds must be kept with the records for that bingo operation. Operators may contact the Lottery Security Division for clarification concerning proper documentation to track sold, damaged, donated, or omitted bingo paper. (3-20-20)T

**308. DUTIES OF BINGO CALLER AND EMPLOYEES OR VOLUNTEERS IN GAMES USING PAPER BINGO CARDS.**

**01. Pre-Game Duties.** Before selecting or calling the first number in any game, the bingo caller must check the machine and balls for defects. This can be done by running all of the balls through the machine and placing them in their assigned slots to determine that there is one (1) ball for each number and only one (1) ball for each number. The caller will draw numbers for the Bonanza, Progressive or Hot Ball games if used and verified by a player. The caller must announce the color of paper card assigned to each game, the pattern or arrangement of squares to be covered to win the game, and the prize amount. (3-20-20)T

**02. Displaying Numbers During Play.** Each time that a number is selected, the bingo caller must display the ball or other designator in a receptacle to prevent it from being placed back into the selection pool. If electronic display boards are used the placement of the selected ball should activate the number or if not, the operator is required to manually activate each number on the board. (3-20-20)T

**03. End of Game.** After a winner has been verified as set forth in Section 108 of these rules, the caller must ask if there are additional winners. After asking for and verifying whether there are additional winners, the game is declared to be completed, and the ball machine must be cleared for the next game. (3-20-20)T

**309. DETERMINING WINNERS WHEN A PLAYER USING A PAPER BINGO CARD CLAIMS TO BE A WINNER.**

**01. Winning Cards.** A winning card is a card upon which the numbers drawn by the caller cover the previously designated arrangement of winning squares. (3-20-20)T

**02. Player's Responsibility.** It is the player's responsibility to notify the game operator or caller that the player has a winning card by yelling "bingo" loud enough for the caller to hear the player. (3-20-20)T

**03. Game Stops to Verify Winner.** When a player announces a winning card, the game must stop for winner verification before the next number is selected. The game must be secured so that it can be continued if the declaration of a winning bingo card is incorrect. If a player mistakenly announces a winning card and the card is not a winner, the game proceeds until a winner is declared. (3-20-20)T

**04. Verification of Winning Card.** To verify a winning card a bingo operator's employee or volunteer must call back the combination of numbers in the assigned pattern and the color of the paper card. The caller must verify the numbers called back. Electronic verifying devices may be used by entering the serial number of the winning card. A monitor must reveal the card and the winning pattern to verify its status as a valid bingo or an invalid bingo. Once a winner is declared the caller must announce "one (1) good winner" or "two (2)" or more if it applies to the game. (3-20-20)T

**05. Prizes For Multiple Winners.** If more than one (1) winner is declared, cash prizes must be divided equally, and merchandise prizes of equal value awarded. (3-20-20)T

**310. MISCELLANEOUS RULES FOR GAMES USING NON-ELECTRONIC BINGO CARDS.**

**01. Hard Cards.** Unlicensed charitable or nonprofit organizations with an annual gross bingo revenue of ten thousand dollars (\$10,000) or less may use hard cards. A licensed organization may request a special one (1)

time use of hard cards for community fund-raising projects that it is sponsoring. No hard cards are allowed to be reserved for any players, with the exception of Braille cards. (3-20-20)T

- 02. Braille Cards.** Braille cards are allowed in any bingo game for use by individuals who need them. (3-20-20)T
- 03. Two Part Disposable Cards.** Two (2) part disposable cards may be used in “U-Pick-Em” games, if: (3-20-20)T
- a. Original and Duplicate Copies.** The cards are printed on two (2) part, self-duplicating paper that provides for an original and duplicate copy; (3-20-20)T
- b. Operating Controls.** Players mark their numbers on each card in a distinct, clear and legible manner before separation of the duplicate and original card, and operators establish and set forth in plain view house rules setting out any conditions by which an entry may be added, deleted or changed before separation, and changes are verified by a worker authorized by the bingo manager; and (3-20-20)T
- c. Retention and Play of Duplicate Copy.** The player retains and plays the duplicate copy, and all winning cards and their duplicate copies are retained by the operator as part of the operator’s daily bingo records. (3-20-20)T
- 04. Card-Minding Devices.** Card-minding devices are prohibited unless they meet the requirement for allowable electronic bingo devices set forth in Section 67-7702(7)(a)(i) through 67-7702(7)(a)(iv), Idaho Code. (3-20-20)T
- 05. Autodaubing Features.** Autodaubing features are prohibited. (3-20-20)T
- 06. Use of Nonreusable Cards.** With the exception of Braille bingo cards authorized for use pursuant to Subsection 310.02 of these rules, every organization that uses nonreusable paper bingo cards must use only nonreusable colored bingo paper or electronic bingo paper so that all sales can be tracked. Nonreusable colored bingo paper must have a series and serial number on each card. After each bingo session, an organization using nonreusable bingo paper must track its bingo sales for that session by recording the series and serial numbers of all paper sold, damaged, donated, used for promotion, or omitted by the manufacturer or distributor. See Section 67-7709(3), Idaho Code. (3-20-20)T

**311. BINGO OPERATIONS USING ELECTRONIC BINGO MACHINES.**

- 01. Electronic Bingo Machines Defined.** Electronic bingo cards, electronic bingo devices, host systems, or site systems are individually and collectively called electronic bingo machines in these rules. (3-20-20)T
- 02. Use of Approved Hardware and Software.** All organizations that offer or use any electronic bingo machines during play must use hardware or software, or both, approved by the Commission, provided that printers used in connection with site systems may be obtained from any source. See Sections 67-7716 and 67-7719(1), Idaho Code. (3-20-20)T
- 03. List of Approved Hardware and Software.** The Director will maintain a list of approved hardware and software for electronic bingo machines and promptly update the list after any changes. (3-20-20)T
- 04. Requirements For Approved Site Systems.** All site systems licensed by the Commission must have the ability to track, either with or without input from the bingo game’s operators, the number of games played that are connected to the site system, revenue from the games played that are connected to the site system, the number of winners who are connected to the site system, and the distribution of cash and merchandise prizes to winners connected to the site system for each session played using the site system. (3-20-20)T
- 05. Inspection and Testing.** All electronic bingo machines used by bingo game operators and all records that the electronic bingo machines generate must be available to be inspected or tested, or both, to determine whether the electronic bingo machines are properly functioning. Any agency or officer listed in Section 67-7709(5),



Idaho Code, or their representative, is authorized to conduct an inspection and testing. See Sections 67-7717(8) and 67-7717(9), Idaho Code. (3-20-20)T

**06. Pre-Game Testing.** The Director or Lottery Security Division may by letter or other written communication prescribe appropriate pre-game testing procedures for electronic bingo machines as in their judgment are necessary for the particular hardware and software used. (3-20-20)T

### **312. REQUIREMENTS FOR BINGO GAME OPERATIONS USING ELECTRONIC BINGO MACHINES.**

**01. Maximum Number of Faces.** Electronic bingo devices are hereby prohibited from monitoring more than fifty-four (54) faces (electronic bingo cards) per game. All electronic bingo devices are required to be restricted by their hardware or software so that they can monitor no more than fifty-four (54) faces per game. See Section 67-7717(1), Idaho Code. (3-20-20)T

**02. Identification Number.** Every electronic bingo device that requires a site system to download electronic bingo cards to the device must comply with the requirements of Section 67-7717(2), Idaho Code, concerning identification numbers. (3-20-20)T

**03. Erasing Numbers.** Every electronic bingo device must be programmed to erase electronic bingo cards and bingo card face numbers after a session has been completed, as required by Section 67-7717(3), Idaho Code. (3-20-20)T

**04. Players Cannot Choose Numbers.** No electronic bingo device that allows bingo players to design their own bingo cards by choosing, rearranging, or placing numbers on a card is permitted. See Section 67-7717(4), Idaho Code. (3-20-20)T

**05. Connections to Site System.** Site systems are prohibited from engaging in sales, voids, or reload transactions for an electronic bingo device unless the device is connected to and communicating with the site system. See Section 67-7717(5), Idaho Code. (3-20-20)T

**06. Printouts.** Site systems must be electronically connected to an on-site printer that upon request is capable of printing a transaction log for each player that shows the device identification number and all bingo cards and face numbers loaded into the device. The site system must be able to record and print on-site a receipt showing the device identification number, the date of the bingo session, the number of electronic bingo cards purchased or loaded, and the total amount charged for each of the electronic bingos cards. This receipt must be given to the player on request or as required by any agency or officer listed in Section 67-7709(5), Idaho Code, or their representative. See Section 67-7717(6), Idaho Code. The site system must be connected to an on-site printer that can print the winning game combinations on demand for the entire bingo session. See Section 67-7717(7). (3-20-20)T

#### **07. Malfunctioning Electronic Bingo Machines. (3-20-20)T**

**a.** Whenever the Lottery or any agency or officer listed in Section 67-7709(5), Idaho Code, or their representative, detects or discovers a malfunction or other problem with an electronic bingo machine that could affect the security or integrity of a bingo game or of an electronic bingo machine, every bingo operator using such a malfunctioning electronic bingo machine must discontinue its use as directed by a representative of the Lottery or correct the malfunction or other problem as directed by a representative of the Lottery. Failure to take the directed action may result in confiscation or seizure of the electronic bingo machine that is malfunctioning or has other problems. See Section 67-7717(8), Idaho Code. (3-20-20)T

**b.** Whenever a manufacturer, a distributor, a licensed bingo operation, a player, or any other person detects or discovers a malfunction or other problem with an electronic bingo machine that could affect the security or integrity of a bingo game or of an electronic bingo machine, every bingo operator using such a malfunctioning electronic bingo machine must discontinue the use of that electronic bingo machine and notify the Commission by telephone no later than the next working day of the action taken and the nature of the malfunction or other problem. The Commission may request further written explanation as necessary. See Section 67-7717(9), Idaho Code. For purposes of this paragraph, notification to an officer or employee of the Lottery Security Division will be considered

notification to the Commission. (3-20-20)T

**08. Receipts.** The cash register or the site system must provide a receipt for the sale of all bingo cards used in conjunction with an electronic bingo device. Additional paper bingo cards must be separately receipted. The cash register receipt and the player's receipt must identify and show the sale of disposable paper bingo cards separately from receipts for electronic bingo cards. See Section 67-7719(12), Idaho Code. (3-20-20)T

### **313. PLAY USING ELECTRONIC BINGO MACHINES.**

**01. No Player-Owned Devices.** Use of player-owned electronic bingo devices is prohibited. See Section 67-7719(2), Idaho Code. (3-20-20)T

**02. Provision of Devices.** Only the bingo game operator can provide electronic bingo devices. The operator may charge for the use of an electronic bingo device. If there is a charge for use of an electronic bingo device, the fee must be separately stated on the cash register and the bingo player's receipt and be included in the gross revenues. See Section 67-7719(3) and (11), Idaho Code. (3-20-20)T

**03. Use of Devices On Premises.** A player using an electronic bingo device must be on the premises during play to be eligible to play bingo or to win a prize. See Section 67-7719(3), Idaho Code. (3-20-20)T

**04. Available Devices.** Electronic bingo devices must be made available on a first-come, first-served basis, and no device can be reserved for any player, except a device may be reserved for players with a disability (within the meaning of the Americans with Disabilities Act) if the disability would restrict or impair the player's ability to mark bingo cards. A bingo game operator may provide and reserve electronic bingo devices exclusively for persons with disabilities and forbid their use by all other persons. See Section 67-7719(5), Idaho Code. (3-20-20)T

**05. One Device Per Player.** It is prohibited for any player to use more than one (1) electronic bingo device at a time. See Section 67-7719(6), Idaho Code. No electronic bingo device can be used to monitor hard bingo or shutter cards. See Section 67-7719(7), Idaho Code. (3-20-20)T

**06. Reserve Devices.** Every bingo game operator using electronic bingo devices must keep at least one (1) electronic bingo device in reserve as a backup in case a device in use malfunctions. See Section 67-7719(4), Idaho Code. A reserve device is not considered an available device under Subsection 302.04 of this rule. If a reserve device is put in use to replace a malfunctioning electronic bingo device, and if there are no more unused electronic bingo devices available to serve as a reserve device, the operator is not required to take an electronic bingo device from a player that is then using the device in order to maintain a reserve device, and the operator may continue to offer bingo games without a reserve device throughout the remainder of the session, unless one (1) or more electronic bingo devices are turned in before the session ends, in which case a device that was turned in will then become the reserve device. (3-20-20)T

**07. Loading Electronic Bingo Devices.** A bingo operator using an electronic bingo device is prohibited from downloading electronic bingo cards into an electronic bingo device before payment by the player. The player must be on the bingo operator's premises when the device is downloaded with electronic bingo cards. The device can only be downloaded with electronic bingo cards during the session. See Section 67-7719(10), Idaho Code. Players are prohibited from choosing or rejecting individual electronic bingo cards loaded into an electronic bingo device. See Section 67-7719(8), Idaho Code. (3-20-20)T

**08. Additional Paper Cards.** When a player who has purchased fifty-four (54) bingo cards per game is using an electronic bingo device to monitor up to fifty-four (54) cards, a bingo operator may allow the player to purchase additional disposable paper bingo cards to play using a manual daubing or marking method. See Section 67-7719(9), Idaho Code. (3-20-20)T

**09. Other Requirements.** The Director or the Director of Lottery Security, or his designee may by letter or other written communication prescribe appropriate procedures for play and determination of winners and other matters generally covered by Sections 307 through 309 of these rules for paper bingo cards whenever it is necessary to do so in conjunction with the use or playing characteristics or other attributes of a given hardware or software. These letters are public records within the meaning of Title 74, Chapter 1, Idaho Code. (3-20-20)T

**314. MAXIMUM PRIZES.**

Maximum prizes are defined in Section 67-7708, Idaho Code.

(3-20-20)T

**315. (RESERVED)**

**316. LIMITS ON BINGO OPERATION'S PRIZE PAYOUT RATIOS AND ADMINISTRATIVE EXPENSES.**

**01. Applicability.** All organizations conducting bingo games, whether licensed or unlicensed, must adhere to the required limits of statute and of this rule in dedicating their gross revenues from bingo operations. These limits or percentages, or both, pertain to annual gross revenues during a twelve (12) month license year. See Section 67-7708, Idaho Code. (3-20-20)T

**02. Donated Merchandise.** Donated merchandise offered as prizes is not included in the prize amounts paid out when calculating the prize payout ratio. The organization conducting the bingo game must document the value of the donated items, describe the donated items, and list the donated items on the daily reports as prizes. (3-20-20)T

**03. Donated Cash Funds Prohibited.** Donated cash may not be offered as prizes in bingo games nor deposited into the separate bingo account. (3-20-20)T

**317. PAYMENT OF EXPENSES, WINNINGS, AND CHARITABLE CONTRIBUTIONS.**

All payments for expenses and donations for charitable purposes must be paid by check from the Separate Bank Account and recorded in the bingo operation's general ledger. See Section 67-7709, Idaho Code. (3-20-20)T

**318. MINIMUM CHARITABLE OR NONPROFIT DONATION.**

A minimum of twenty percent (20%) of annual gross revenues of a bingo operation must be paid to a charitable or nonprofit organization to be used for charitable purposes. The licensed bingo operation must maintain records showing the charitable activities to which the proceeds are applied. See Section 67-7709, Idaho Code. Organizations are permitted and encouraged to donate more than twenty percent (20%) of their gross revenues from bingo operations to charitable or nonprofit organizations to be used for charitable purposes. No part of this twenty percent (20%) can be used, whether directly or indirectly, for any bingo expense. (3-20-20)T

**319. MAXIMUM PRIZES.**

By this rule the Commission exercises its authority over maximum prizes are set forth in Section 67-7708, Idaho Code. (3-20-20)T

**01. Maximum Prize For One Game.** The maximum prize in cash and merchandise that may be offered for any one (1) bingo game is three thousand dollars (\$3,000). (3-20-20)T

**02. Maximum Prizes For One Session.** The total of the maximum prizes in cash and merchandise that may be offered at any one (1) bingo session is twenty-five thousand dollars (\$25,000). (3-20-20)T

**320. (RESERVED)**

**321. ACCOUNTING AND REPORTING REQUIRED.**

Every organization conducting bingo games, whether licensed or unlicensed, must comply with the accounting requirements of Sections 121 through 126 of these rules. (3-20-20)T

**322. SEPARATE BANK ACCOUNT AND LIMITATIONS ON USE.**

**01. Establishment of Account.** All net proceeds received in connection with a bingo game required to be licensed under Title 67, Chapter 77, Idaho Code, and by these rules must be placed in a Separate Bank Account. See Section 67-7709(1), Idaho Code. Only bingo funds generated from bingo games may be distributed as prizes, administrative expenses, or charitable/nonprofit donations. (3-20-20)T

**02. Disbursements Use of Funds.** All disbursements must be documented as defined in Section 67-7709(1), Idaho Code, and by these rules. (3-20-20)T

**323. GENERAL LEDGER.**

**01. Establishment of General Ledger.** A general ledger must be established to account separately for the bingo operation and track all transactions for the funds generated from bingo. (3-20-20)T

**02. Documentation.** The accounting of revenues from sales of bingo cards or other entry fees and all disbursements must be documented. The accounting should include, but not be limited to, total prize payouts per session, and bingo related expenses per session, charitable contributions per session, wages, date and purpose or payee for each entry. (3-20-20)T

**03. Annual Report.** Copies of general ledgers must accompany the Annual Bingo Report filed with the Lottery. Copies of the Charitable Contribution Acknowledgement Report Forms and Charitable Donation Reporting Form shall also accompany the Annual Bingo Report. All disbursements shall be recorded in the general ledger. (3-20-20)T

**04. Retention of Records.** An accounting of all gross revenues and disbursements required by statute and these rules must be retained in records with the organization for a period of five (5) years, including the date and amount of each transaction, as well as the name and address of each payee for all prize payments exceeding one hundred dollars (\$100). A copy of each CCARF and the Charitable Donation Reporting Form shall be retained in permanent records of the organization. (3-20-20)T

**324. ANNUAL REPORT.**

**01. When Due.** Every licensed charitable or nonprofit organization conducting bingo games shall prepare an annual report within thirty (30) days after the close of its license year and file the annual report with the Lottery. See Section 67-7709(2), Idaho Code. (3-20-20)T

**02. Information Required By Forms.** The nightly reports, receipts, winner records, and payouts must be documented and kept with the organization's records for five (5) years along with any further information required by the forms prescribed by the Lottery pursuant to statute and rule. (3-20-20)T

**03. Independent Audit.** Organizations that exceed two hundred thousand dollars (\$200,000) in annual gross revenue from bingo games, raffle events, or bingo games and raffles combined must submit an independent audit performed by a certified public accountant licensed in Idaho and who meets peer review requirements set forth by the Idaho State Board of Accountancy. This independent audit must be submitted within ninety (90) days of the end of the licensed organization's license year. (3-20-20)T

**325. RECORDS OF PRIZE DISBURSEMENTS.**

Organizations conducting bingo games must record names and addresses of winners for prize disbursements exceeding one hundred dollars (\$100). Any prizes exceeding one thousand one hundred ninety-nine dollars (\$1,199) must have a W2-G on file for a gaming income for these amounts as required by the Internal Revenue Service. See 26 U.S.C. Section 6041 and 26 CFR 7.6041-1 and 35a.9999-3 (question and answer 19). (3-20-20)T

**326. ACCOUNTING OF REVENUES AND EXPENSES.**

**01. Deposit of Receipts.** Bingo funds received in check form must be payable to the organization. All funds must be deposited in a Separate Bank Account. (3-20-20)T

**02. Ledger Entries and Receipts For Expenses.** All ledger entries must track disbursements of cash and checks with expenses documented with receipts. The receipts shall include the payee's name and address, date, and an authorized signature from the licensed organization. (3-20-20)T

**03. Recording of Wages.** Wages paid must be recorded on expense records as gross amounts before withholding of taxes or other withholding and net amount paid, with each item of withholding shown. Wages paid

must be documented with copies of pay stubs, or other records showing gross wages and withholding. (3-20-20)T

**04. Submission With Annual Report.** Copies of ledgers containing the documentation of all transactions must be submitted with the Annual Bingo Report. Inventory tracking of sequentially numbered paper must be retained in records for a period of five (5) years and kept available for examination. All documents must be legible and compiled in an orderly manner. (3-20-20)T

**327. INSPECTION OF FINANCIAL RECORDS AND DOCUMENTS.**

All financial records and documents of an organization shall be kept as required by these rules and be open to inspection by the county sheriff of the county where the bingo games were held, the chief of police of the city where the bingo games were held, the prosecuting attorney of the county where the bingo games were held, the Attorney General or the Lottery, or any of their agents, at reasonable times and during reasonable hours. All records must be kept for five (5) years. (3-20-20)T

**328. -- 399. (RESERVED)**

**SUB AREA: CONDUCT OF RAFFLES**

**400. REQUIREMENTS FOR ORGANIZATIONS CONDUCTING RAFFLES.**

All organizations conducting raffles, whether licensed or unlicensed, must abide by these rules. It is unlawful to conduct raffles in violation of Title 67, Chapter 77, Idaho Code, or in violation of these rules, and persons doing so may be subject to administrative, civil or criminal penalties. See Section 67-7710, Idaho Code. (3-20-20)T

**401. LIMITATION ON ANNUAL NUMBER OF RAFFLES.**

Charitable or non-profit organizations are limited to conducting twelve (12) raffle events per year, provided that this limitation shall not apply to public or private elementary or secondary schools located in the state. See Section 67-7710(2), Idaho Code. (3-20-20)T

**402. OWNERSHIP OF PRIZES.**

Organizations must be able to substantiate ownership of all prizes or other legally enforceable rights to obtain the prizes to be offered in a raffle prior to advertising or selling tickets for such prizes. Proof of ownership of prizes or other legally enforceable rights to obtain prizes must be provided to the Lottery upon request. (3-20-20)T

**403. MAXIMUM PRIZES.**

The maximum aggregate value of cash prizes that may be offered or paid for any single raffle event, which is not a duck race, is one thousand dollars (\$1,000). There is no limit on the maximum value of merchandise that may be offered as raffle prizes if the merchandise is not redeemable for cash. There is no limit on the maximum amount of the aggregate cash prizes for a duck race if the cash prize is underwritten by insurance, otherwise the maximum aggregate cash prize for a duck race is one thousand dollars (\$1,000). There is no limit on the maximum value for the merchandise used as prizes for a duck race if the merchandise is not redeemable for cash. See Section 67-7710(2), Idaho Code. (3-20-20)T

**404. REQUIREMENTS FOR DONATION TO CHARITY -- LIMITATION ON EXPENSES.**

At least eighty percent (80%) of the net proceeds from sales of raffle tickets or chances and duck races must be donated to a charitable or nonprofit organization to be used for a charitable purpose. (Net proceeds are defined in Subsection 301.30 of these rules.) The name and address of the charitable or nonprofit organizations awarded these funds must be listed on the annual raffle report submitted to the Lottery. The annual raffle report must also include the charitable purpose for which the charitable donation was used by the charitable organization or non-profit organization. A maximum of twenty percent (20%) of net proceeds is allowed for expenses. See Section 67-7710(3), Idaho Code. (3-20-20)T

**405. GENERAL LEDGER AND RECORDKEEPING.**

Every organization conducting a raffle event must establish a general ledger for the raffle. The organization must keep records that show the total number of tickets or chances sold, the revenues from tickets or chances sold, the expenses of conducting the raffle, and the prizes for each raffle. (3-20-20)T

**406. ANNUAL RAFFLE REPORT.**

Every licensed organization conducting a raffle shall prepare an annual raffle report and Charitable Donation Report and submit both reports to the Lottery within thirty (30) days after the close of its license year. See Section 67-7710, Idaho Code. (3-20-20)T

**407. INDEPENDENT AUDIT OF LARGE RAFFLES.**

Every charitable or non-profit organization whose gross annual revenues exceed two hundred thousand dollars (\$200,000) from the operation of raffles shall provide the Commission with a copy of an annual report of raffle events. The audit shall be performed by a certified public accountant licensed in Idaho and who meets the peer review requirements set forth by the Idaho State Board of Accountancy. The audit must be submitted within ninety (90) days after the end of the organizations license year. (3-20-20)T

**408. -- 499. (RESERVED)**

**SUB AREA: LICENSING AND LICENSE FEES FOR ORGANIZATIONS  
CONDUCTING BINGO GAMES OR RAFFLES**

**500. APPLICATION.**

All persons required by statute and by these rules to obtain a license before operating a bingo game or conducting a raffle must pay the license fees and apply for and receive a license under the rules in this sub area. See Section 67-7711(1), Idaho Code. (3-20-20)T

**501. LICENSE FEES.**

Each organization that applies to the Lottery for a license under these rules shall pay annually to the Lottery a nonrefundable license fee that is due upon submission of the application. An application approved by the Lottery, complete with all required information, must be submitted along with the appropriate fee to the Lottery Security Division. See Section 67-7712(1), Idaho Code. These non-refundable fees are based on flat initial fee for applicants without a license and a fee based on annual gross revenues from bingo sessions or raffle events for applicants with a license as follows:

\$100 fee - initial application
\$100 fee - up to \$25,000 annual gross revenues
\$200 fee - up to \$75,000 annual gross revenues
\$300 fee - over \$75,000 annual gross revenues

(3-20-20)T

**502. INFORMATION TO BE PROVIDED IN APPLICATION.**

**01. Background Check of Applicants.** The application for an initial license and for a renewal license to operate a bingo game or to conduct a raffle will be reviewed and relevant background investigations will be conducted on all persons listed on the application as officers, directors or members of the charitable or nonprofit organization. The signature from the organization's representative on the application gives the Lottery authority to conduct the required investigations. The persons listed on the application must be officers or directors of the organization applying for a license and the application must be signed by an officer of the organization. (3-20-20)T

**02. Proper Identification.** The application must list the name, address, date of birth, driver's license number and social security or tax identification number of the applicant, if applicable. If the applicant is a corporation, association or similar legal entity, the application must also list the full name, current home address and phone number, date of birth, social security number, driver's license number and state of issuance, of each listed officer and director in order to conduct background investigations. See Section 67-7711(2)(a) and (b), Idaho Code. (3-20-20)T

**03. Charitable Organizations.** The application of a charitable organization must include a copy of the application for recognition of exemptions and a determination letter from the Internal Revenue Service that indicates that the organization is a charitable organization and that states the section of the tax code under which the exemption is granted, except that if the organization is a state or local branch, lodge, post of chapter or a national organization, a

copy of the determination letter of the national organization will satisfy this requirement. See Section 67-7711(2)(c)(i), Idaho Code. The applicant must also provide verifiable documentation to prove charitable function, purpose and activities. Acceptable documentation includes, but is not limited to, meeting minutes, donation documentation, and membership list. (3-20-20)T

**04. Incorporated Nonprofit Organizations.** The application of an incorporated nonprofit organization must include a copy of the certificate of existence issued by the secretary of state pursuant to Title 30, Chapter 3, Idaho Code, establishing the organization's good corporate standing in the state. See Section 67-7711(2)(c)(ii), Idaho Code. The applicant must also provide verifiable documentation to prove charitable function, purpose and activities. Acceptable documentation includes, but is not limited to, meeting minutes, donation documentation, and membership list. (3-20-20)T

**05. Locations.** The application must list the location or locations at which the applicant will conduct bingo games or bingo sessions or drawings for raffles. See Section 67-7711(2)(d), Idaho Code. (3-20-20)T

**06. Raffle Drawings.** Raffle drawings must be held in Idaho and conducted within the license year for licensed organizations or within twelve (12) months from the date the first ticket was sold for unlicensed organizations. (3-20-20)T

**07. License Year and Fiscal Year.** An organization may apply for a license to coincide with the organization's fiscal year. See Section 67-7711(5), Idaho Code. (3-20-20)T

**08. Failure to Provide Information.** Failure to provide all information required for an application may result in a delay in considering an application or denial or dismissal of an application for a bingo/raffle license. See Section 67-7711(1), Idaho Code. (3-20-20)T

**503. MULTIPLE CHAPTERS LICENSED TOGETHER.**

Different chapters of an organization may apply for and share one (1) raffle license so long as the information required in Subsections 502.01 through 502.06 of these rules is provided to the Lottery before the issuance of the license. See Section 67-7711(4), Idaho Code. When two (2) or more chapters share a license, in aggregate they are subject to the limitations of a single organization with a license; multiple chapters sharing a license are not entitled to multiples of the event or prize limits for a license. (3-20-20)T

**504. COMPENSATION OF CERTAIN PERSONS AND CONTRACTS WITH CERTAIN PERSONS PROHIBITED.**

Persons listed on the application as officers or directors and their relatives and members of their household are prohibited from being compensated for their participation in the organizations bingo operation. No organization shall contract with any person not employed by, or a volunteer for, the organization for the purpose of conducting a bingo game or raffle on the organizations behalf. See Section 67-7711(3), Idaho Code. (3-20-20)T

**505. ACTION ON LICENSES.**

**01. Applications For Licenses.** An application for a license will be approved, denied or dismissed in writing within fifteen (15) days of receipt of the written application and all other required documentation, except as provided in Section 67-7712(2)(j), Idaho Code, when a criminal prosecution of an applicant is pending or an appeal from a criminal prosecution of an applicant is pending. The application will be denied if the applicant does not meet the requirements of statute and of these rules. If an application is not received thirty (30) days in advance of a proposed event, it is possible that a license may not be granted before the event, and the event will not be allowed to proceed without a license. See Section 67-7711(1), Idaho Code. (3-20-20)T

**02. Issuance of Licenses.** A license will be issued when an application for a license is approved. A license expires one (1) year after its issuance. See Section 67-7711(1), Idaho Code. (3-20-20)T

**03. Notice of Intended Actions.** If the Lottery intends to deny an application for a license or the renewal of a license or intends to revoke, cancel, rescind or suspend a license, it will provide fifteen (15) days' written notice to the applicant or to the licensee of the general basis for its intended action. If the applicant or licensee does not agree to the Lottery's intended action, the applicant or licensee must in writing request a hearing within the

fifteen (15) day notice period. If a timely written request for a hearing is made, the hearing will be conducted in the same manner as a contested case hearing under Title 67, Chapter 52, Idaho Code. If a timely written request for a hearing is not made, the intended action is final and not subject to appeal. See Section 67-7712(3), Idaho Code.

(3-20-20)T

**506. SUSPENSION OR REVOCATION OF LICENSE -- CIVIL AND CRIMINAL PENALTIES.**

Violation of the bingo and raffle statutes or of these bingo/raffle rules or of any conditions of a license may be grounds for administrative, civil or criminal actions, including, but not limited to, placement on probationary status, suspension of operations, license revocation, penalties, or fines. See Section 67-7707, Idaho Code. See also Sections 500 through 504 of these rules.

(3-20-20)T

**507. EXEMPTION FROM LICENSING AND LICENSING FEES.**

Section 67-7713, Idaho Code, exempts charitable and non-profit organizations operating certain low-stakes bingo or raffle games from licensing.

(3-20-20)T

**01. Low-Stakes Bingo.** A charitable or nonprofit organization conducting a bingo game does not need to obtain a license if its gross annual bingo sales (gross revenues from bingo operations) are less than ten thousand dollars (\$10,000).

(3-20-20)T

**02. Low-Stakes Raffle.** A charitable or nonprofit organization does not need to obtain a license to conduct a raffle if the maximum aggregate value of merchandise awarded as prizes for the raffle does not exceed five thousand dollars (\$5,000).

(3-20-20)T

**03. Exemption From Licensing Not Exemption From Rules.** Organizations exempt from licensing under this rule must still comply with applicable requirements of statute and bingo/raffle rules. This information is available by contacting the Lottery.

(3-20-20)T

**508. RULES AND FORMS.**

The Lottery will provide forms and reports necessary in regulating the charitable or nonprofit bingo and raffle events. The Commission is authorized to promulgate rules consistent with and in compliance with Title 67, Chapter 52, Idaho Code.

(3-20-20)T

**509. -- 599. (RESERVED)**

**SUB AREA: VENDORS AND VENDORS' LICENSES AND FEES – APPROVED GAMING DEVICES**

**600. VENDOR'S LICENSE REQUIRED.**

All businesses or persons who manufacture, sell, distribute, furnish, or supply to any person or organization any gaming devices, equipment, or materials in this state shall first obtain a vendor's license from the Lottery. See Section 67-7715, Idaho Code. Vendors must file an application and submit all required forms for background investigations.

(3-20-20)T

**601. LICENSE FEES.**

Each initial application for a vendor's license must be accompanied by a five hundred dollar (\$500) non-refundable annual license fee that is due upon submission of the application. An application form approved by the Lottery, completed with all required information, must be submitted with the appropriate fee to the Director of Lottery Security, or his designee. See Section 67-7715(3)-(5), Idaho Code.

(3-20-20)T

**602. INFORMATION TO BE PROVIDED IN APPLICATION.**

**01. Identification of Applicants.** The application for initial license and for renewal of a license must list:

(3-20-20)T

**a.** The name, address, date of birth, driver's license number and social security number of the applicant, and if the applicant is a corporation, proprietorship, association, partnership or other similar legal entity, the name, home address, date of birth, driver's license number and social security number of each of the officers of the corporation and their spouses, as well as the name and address of the directors and their spouses, or other persons



similarly situated and the financial information required to complete the application form. See Section 67-7715(3)(a), Idaho Code. (3-20-20)T

**b.** The locations from which or persons with which the applicant will provide any gaming devices, equipment or material in this state or for use in this state. See Section 67-7715(3)(b), Idaho Code. (3-20-20)T

**02. Incomplete Applications.** Financial reports submitted with the license application will be reviewed as part of the background investigation. All requested data must be included on the application to avoid any delay. The application may be dismissed if it is incomplete. (3-20-20)T

**603. APPROVAL, DENIAL OR DISMISSAL OF APPLICATION FOR ISSUANCE OF LICENSE.**  
The Lottery will approve, deny or dismiss an application for a vendor's license, within fifteen (15) days. At the applicant's request the Lottery may defer decision for a longer time. The application will be approved, denied or dismissed in writing. The Lottery will issue vendor licenses to successful applicants. See Section 67-7715, Idaho Code. (3-20-20)T

**604. SUSPENSION OR REVOCATION OF LICENSE.**  
Any licensed vendor in violation of statute or of these rules or of any conditions of its license may face suspension or revocation of its vendor's license. (3-20-20)T

**605. -- 609. (RESERVED)**

**610. GAMING DEVICES, EQUIPMENT OR MATERIALS.**  
Gaming devices, equipment, and materials include but are not limited to: (3-20-20)T

**01. Number Selectors and Related Equipment.** Number selection machines, manual mixing drums, or computerized random selectors, site systems, host systems or other electronic bingo machines used to select numbers for bingo or raffles are gaming devices, equipment or materials. (3-20-20)T

**02. Bingo Cards.** Numbered paper bingo cards and hard bingo cards as described in Paragraphs 310.03.a. and 301.19 of these rules, including Bonanza cards, "U-Pick-Ems," and electronic bingo cards, are gaming devices, equipment or materials. (3-20-20)T

**03. Miscellaneous.** Daubers, raffle tickets, record keeping materials, electronic bingo devices and other items used in the operation of bingo or raffles are gaming devices, equipment or materials. (3-20-20)T

**611. PAPER BINGO CARD MANUFACTURERS STANDARDS.**  
Card manufacturers must follow these standards for paper cards: (3-20-20)T

**01. Quality of Paper.** The paper must be of sufficient weight and quality to allow for clearly readable numbers and to prevent ink from spreading or bleeding through a packet and obscuring other numbers or cards. (3-20-20)T

**02. Random Assignment of Numbers.** Numbers printed on the card must be randomly assigned. (3-20-20)T

**03. Serial Numbers.** Each set of cards must be comprised of cards bearing the same serial number. No serial number may be duplicated by a manufacturer in a given calendar year. (3-20-20)T

**04. Packet Assembly.** Cards assembled in books or packets must be glued, not stapled. (3-20-20)T

**05. Labeling.** A label must be placed on the exterior of each carton of bingo paper listing the type of product, number of packets or loose sheets, serial numbers, per (series) numbers, number of cases, cut of paper, and color of paper. (3-20-20)T

**06. Packing Slips.** A packing slip inside each case must list the same information as listed on the label. (3-20-20)T

**07. Invoice.** All orders must be accompanied by an invoice which lists the type of product, number of packets or loose sheets, serial numbers of all packets or loose sheets, per (series) numbers, number of cases, cut of paper, color of paper and pricing by item. The invoice must also include the supplier (vendor) name, and the name and address of the organization purchasing the paper. (3-20-20)T

**612. NUMBER SELECTORS.**

All number selectors for bingo operations must be approved by the Commission after review and advice by the Bingo-Raffle Advisory Board. Electronic random selectors must interact with players. Auto daubing systems for paper bingo cards are prohibited. (3-20-20)T

**613. DISTRIBUTION AND USE OF ELECTRONIC BINGO MACHINES.**

**01. Approved Sources.** A licensed distributor of electronic bingo machines must purchase, rent, lease or otherwise provide electronic bingo machines only from a licensed manufacturer and purchase, lease, rent, or otherwise provide only electronic bingo machines that have been approved by the Commission. See Section 67-7718(1), Idaho Code. (3-20-20)T

**02. Approved Users.** A licensed distributor of electronic bingo machines is permitted to sell, rent, lease or otherwise provide electronic bingo machines only to licensed bingo operators. See Section 67-7718(2), Idaho Code. (3-20-20)T

**03. Initial Use.** The licensed distributor of electronic bingo machines must notify the Commission in writing of the sale, rental, lease, provision or installation of any electronic bingo machines before a licensed bingo operator's first use of the machines as follows: (3-20-20)T

- a.** The complete name and address of the licensed bingo operator and their license number. (3-20-20)T
- b.** The type of equipment and the serial numbers of equipment that was sold, rented, leased, provided or installed. (3-20-20)T
- c.** The expected date upon which the licensed bingo operator will begin to use the equipment. (3-20-20)T
- d.** A copy of any and all agreements or contracts between the licensed distributor and the licensed bingo operator regarding use of the equipment. (3-20-20)T

**04. Installation, Maintenance, Service and Repair.** The licensed distributor must be the initial contact for installation, service, maintenance or repair of electronic bingo machines and for ordering electronic bingo cards. The distributor may enlist the manufacturer's assistance for installation, service, maintenance or repair of electronic bingo machines. With the Commission's approval, a licensed manufacturer may authorize or subcontract with others for service, repair or maintenance of electronic bingo machines, but the licensed manufacturer retains ultimate responsibility and liability for service, maintenance and repair. See Section 67-7718(4), Idaho Code. (3-20-20)T

**05. Invoices and Payments.** The licensed distributor of electronic bingo machines must be the person who invoices for and collects payments for a licensed bingo operator's use of electronic bingo machines. The manufacturer may generate the invoice. All payments must be to the distributor and not the manufacturer. The invoice must contain the licensed distributor's name, complete address and license number of the licensed bingo operator. See Section 67-7718(5), Idaho Code. (3-20-20)T

**06. Transportation Of Electronic Bingo Devices.** A licensed distributor may transport electronic bingo devices from one (1) location to another for use by one (1) or more licensed bingo operator after the distributor has notified the Commission in writing of its schedule for rotating the electronic bingo devices from one (1) location to another. The notification must list the locations at which the devices will be used and name the licensed bingo operators that will be using the devices at each location. See Section 67-7718(6), Idaho Code. (3-20-20)T

**07. Site Systems and Transportation of Site Systems.** Each licensed bingo operator that uses a site system must have its own site system. A licensed bingo operator that uses a site system cannot transport its site system from one (1) location to another or allow another bingo operator to use its site system without prior written approval from the Commission. See Section 67-7718(6), Idaho Code. (3-20-20)T

**614. -- 699. (RESERVED)**

**SUB AREA: SUSPENSION, REVOCATION, OR DENIAL OF A LICENSE**

**700. SUSPENSION, REVOCATION OR DENIAL OF LICENSE.**

Any licensee or applicant for a license found by a court of competent jurisdiction or by the Lottery pursuant to the procedures of Section 67-7712, Idaho Code, to be in violation of any statutes or rules governing operating, supplying of equipment for, participating in, or establishing of gaming in the state of Idaho may be subject to suspension, revocation or denial of its license. See Sections 67-7712 and 67-7715, Idaho Code. (3-20-20)T

**701. GROUNDS FOR SUSPENSION, REVOCATION OR DENIAL OF LICENSE.**

The Lottery may suspend, revoke or deny a license if it finds that the licensee or applicant for a license has violated any provision of Title 67, Chapter 77, Idaho Code, any of these rules, or any county ordinance adopted pursuant to Title 67, Chapter 77, Idaho Code, (See Section 67-7712(2), Idaho Code). (3-20-20)T

**702. COMPLAINT AGAINST AND INVESTIGATION OF LICENSEES.**

The Lottery may, upon its own motion, or upon a written verified complaint of any other person, investigate the operation of any gaming purportedly authorized by Title 67, Chapter 77, Idaho Code, or by these rules, whether the gaming is conducted by a licensed or an exempt operation, and whether gaming equipment or supplies comply with the requirements of Title 67, Chapter 77, Idaho Code. If the Lottery has reasonable cause to believe that any gaming described in Title 67, Chapter 77, Idaho Code, or in these rules, violates the provisions of the Idaho Code or of these rules, in its discretion it may under the procedures set forth in Section 67-7712(3), Idaho Code, and as provided by these rules propose to revoke, cancel, rescind or suspend any license for a period not to exceed one (1) year, or refuse to grant a renewal of the license, or take other action as may be appropriate under Idaho Code or these rules. See Section 67-7712(3), Idaho Code. (3-20-20)T

**703. PROCEDURE UPON FINDING OF REASONABLE CAUSE.**

If the Lottery refuses to grant a license or refuse to grant a renewal of a license or revoke, cancel, rescind or suspend a license, it shall give the applicant or licensee fifteen (15) calendar days' written notice of its intended action stating generally the basis for its action. Within the fifteen (15) calendar days' notice period, the applicant or licensee shall indicate its acceptance of the decision of the Lottery or request a hearing to be held in the same manner as hearings in contested cases pursuant to Title 67, Chapter 52, Idaho Code. See Section 67-7712(3), Idaho Code. (3-20-20)T

**704. CONDUCT OF HEARING IN CONTESTED CASE.**

The hearing in a contested case shall be conducted within twenty-one (21) days of the request. The applicant or licensee may appeal the decisions of the Lottery after the hearing pursuant to Title 67, Chapter 52, Idaho Code. Failure to make the request for hearing as provided in these rules shall render the decision of the Lottery final and not subject to further appeal. See Section 67-7712(3), Idaho Code. (3-20-20)T

**705. -- 999. (RESERVED)**

**IDAPA 53 – IDAHO BARLEY COMMISSION**  
**DOCKET NO. 53-0101-2000F (FEE RULE)**  
**NOTICE OF OMNIBUS RULEMAKING – ADOPTION OF TEMPORARY RULE**

**EFFECTIVE DATE:** The effective date of the temporary rule being adopted through this omnibus rulemaking is the adjournment date of the second regular session of the 65th Idaho State Legislature - March 20, 2020.

**AUTHORITY:** In compliance with Sections 67-5226, Idaho Code, notice is hereby given this agency has adopted a temporary rule. The action is authorized pursuant to Section 22-4009, Idaho Code.

**DESCRIPTIVE SUMMARY:** The following is the required finding and concise statement of its supporting reasons for adopting a temporary rule:

This temporary rule adopts the following chapter under IDAPA 53:

**IDAPA 53**

- IDAPA 53.01.01, *Rules of the Idaho Barley Commission*

**TEMPORARY RULE JUSTIFICATION:** Pursuant to Sections 67-5226(1) and 67-5226(2), Idaho Code, the Governor has found that temporary adoption of the rule is appropriate for the following reasons:

These temporary rules are necessary to protect the public health, safety, and welfare of the citizens of Idaho and confer a benefit on its citizens. These temporary rules implement the duly enacted laws of the state of Idaho, provide citizens with the detailed rules and standards for complying with those laws, and assist in the orderly execution and enforcement of those laws. The expiration of these rules without due consideration and processes would undermine the public health, safety, and welfare of the citizens of Idaho and deprive them of the benefit intended by these rules.

**FEE SUMMARY:** Pursuant to Section 67-5226(2), the Governor has found that the fee(s) or charge(s) being imposed or increased is justified and necessary to avoid immediate danger and the fee(s) is described herein:

The fees or charges, authorized in Section 22-4015, Idaho Code, are part of the agency's 2021 budget that relies upon the existence of these fees or charges to meet the state's obligations and provide necessary state services. Failing to reauthorize these temporary rules would create immediate danger to the state budget, immediate danger to necessary state functions and services, and immediate danger of a violation of Idaho's constitutional requirement that it balance its budget.

The following is a specific description of the fees or charges:

Idaho barley growers pay a Barley Tax that is currently three cents (\$.03) per hundredweight of barley marketed, which is collected at point of first purchase and remitted to the Idaho Barley Commission. Section 22-4015, Idaho Code, allows for the Barley Tax of up to four cents (\$.04) per hundredweight.

**ASSISTANCE ON TECHNICAL QUESTIONS:** For assistance on technical questions concerning the temporary rule, contact Laura Wilder at 208-334-2090 or [lwilder@barley.idaho.gov](mailto:lwilder@barley.idaho.gov).

DATED this 21th day of February, 2020.

Laura Wilder, Executive Director  
Idaho Barley Commission  
821 W. State Street  
Boise, ID 83706  
Tel: 208-334-2090 (office)  
Tel: 208-608-4519 (mobile)  
Email: [lwilder@barley.idaho.gov](mailto:lwilder@barley.idaho.gov)

# IDAPA 53 – IDAHO BARLEY COMMISSION

## 53.01.01 – RULES OF THE IDAHO BARLEY COMMISSION

### 000. LEGAL AUTHORITY.

In accordance with Section 22-4009, Idaho Code, the Idaho Barley Commission has promulgated rules implementing the provisions of Chapter 40, Title 22, Idaho Code. (3-20-20)T

### 001. TITLE AND SCOPE.

These rules are titled IDAPA 53.01.01, “Rules of the Idaho Barley Commission,” IDAPA 53, Title 01, Chapter 01. These rules provide the means for the protection, promotion, study, research, analysis and development of markets concerning the growing and marketing of Idaho barley. (3-20-20)T

### 002. -- 009. (RESERVED)

### 010. DEFINITIONS.

The definitions set forth in Section 22-4003, Idaho Code, apply to this chapter (3-20-20)T

### 011. -- 099. (RESERVED)

### 100. FIRST PURCHASER RULES.

In accordance with Section 22-4015(1), Idaho Code, the Commission will designate the quarters (three (3) month periods) for the purpose of collecting the tax imposed on all barley grown, delivered into, or stored within the state of Idaho and sold or contracted in the state. (3-20-20)T

**01. Designated Quarters.** The quarters designated by the Commission for payment of tax are: (3-20-20)T

**a.** The Commission’s first quarter will begin on the first day of July and end the thirtieth day of September. The first quarter barley tax is due on or before the fifteenth day of October. (3-20-20)T

**b.** The Commission’s second quarter will begin on the first day of October and end the thirty-first day of December. The second quarter barley tax is due on or before the fifteenth day of January. (3-20-20)T

**c.** The Commission’s third quarter will begin on the first day of January and end the thirty-first day of March. The third quarter barley tax is due on or before the fifteenth day of April. (3-20-20)T

**d.** The Commission’s fourth quarter will begin on the first day of April and end the thirtieth day of June. The fourth quarter barley tax is due on or before the fifteenth day of July. (3-20-20)T

**02. Barley Tax Return (Form Number 1).** The first purchaser of barley is required to complete and send the Barley Tax Return (Form Number 1) to the commission office each and every quarter on or before the dates specified in these rules. The Barley Tax Return (Form Number 1) shall be provided to the first purchaser by the Commission and, at a minimum, require the following legible information: (3-20-20)T

**a.** The tax reporting period. (3-20-20)T

**b.** The name and address of the barley purchaser. (3-20-20)T

**c.** The net weight of the barley purchased (if any) in pounds or hundredweights. (3-20-20)T

**d.** The total amount of tax deducted (if any) from sellers by the purchaser. (3-20-20)T

**e.** The tax withheld by Commodity Credit Corporation loans. (3-20-20)T

**f.** The total amount of tax due the Commission (if any). (3-20-20)T

**03. Delivery of Documents to Commission (Form Number 2).** The first purchaser of barley shall complete and return the Report of Tax on Barley (Form Number 2), or equivalent, to the commission office each and every quarter on or before the dates specified in these rules. The Commission shall provide blank copies of Form Number 2 to the first purchaser. Form Number 2, or equivalent, will, at a minimum, require the following legible

- information: (3-20-20)T
- a. The name and address of the purchaser. (3-20-20)T
  - b. The quarter the barley was purchased. (3-20-20)T
  - c. The name or names and address or addresses of the grower and seller. (3-20-20)T
  - d. The number of pounds of barley purchased. (3-20-20)T
  - e. The total barley tax withheld from each purchase. (3-20-20)T
- 04. Deduction of Tax on Net Weight of Barley.** The first purchaser shall deduct the barley tax on the NET weight of the barley after deduction of dockage. (3-20-20)T
- 05. Late Payment Penalty** (As specified in Section 22-4018 (2), Idaho Code). Any person or firm who makes payment to the Commission at a date later than prescribed in Section 22-4015, Idaho Code, shall be subject to a late payment penalty of fifteen percent (15%) per annum on the amount due. (3-20-20)T

**101. -- 199. (RESERVED)**

**200. EXEMPTIONS.**

In accordance with Section 22-4015, Idaho Code, the barley assessment shall be imposed on all barley grown, delivered into or stored within, and sold or contracted in Idaho. If a barley assessment that serves a comparable purpose to the Idaho assessment was previously paid in a jurisdiction outside Idaho, the seller of the barley is exempt from payment of the Idaho barley assessment. The Commission will determine jurisdictions outside of Idaho that collect an assessment that serves a comparable purpose, which includes, as a minimum, funding for research and market development programs. In order to qualify for the exemption, the seller must demonstrate to the first purchaser in the state of Idaho that an assessment has been previously paid to such a jurisdiction. (3-20-20)T

**201. -- 999. (RESERVED)**

# **IDAPA 57 – SEXUAL OFFENDER MANAGEMENT BOARD**

## **DOCKET NO. 57-0101-2000F (FEE RULE)**

### **NOTICE OF OMNIBUS RULEMAKING – ADOPTION OF TEMPORARY RULE**

**EFFECTIVE DATE:** The effective date of the temporary rule being adopted through this omnibus rulemaking is the adjournment date of the second regular session of the 65th Idaho State Legislature - March 20, 2020.

**AUTHORITY:** In compliance with Sections 67-5226, Idaho Code, notice is hereby given this agency has adopted a temporary rule. The action is authorized pursuant to Section 18-8314, Idaho Code.

**DESCRIPTIVE SUMMARY:** The following is the required finding and concise statement of its supporting reasons for adopting a temporary rule:

This temporary rule adopts the following chapter under IDAPA 57:

#### **IDAPA 57**

- 57.01.01, *Rules Governing the Sexual Offender Management Board*

**TEMPORARY RULE JUSTIFICATION:** Pursuant to Sections 67-5226(1) and 67-5226(2), Idaho Code, the Governor has found that temporary adoption of the rule is appropriate for the following reasons:

These temporary rules are necessary to protect the public health, safety, and welfare of the citizens of Idaho and confer a benefit on its citizens. These temporary rules implement the duly enacted laws of the state of Idaho, provide citizens with the detailed rules and standards for complying with those laws, and assist in the orderly execution and enforcement of those laws. The expiration of these rules without due consideration and processes would undermine the public health, safety, and welfare of the citizens of Idaho and deprive them of the benefit intended by these rules.

**FEE SUMMARY:** Pursuant to Section 67-5226(2), the Governor has found that the fee(s) or charge(s) being imposed or increased is justified and necessary to avoid immediate danger and the fee(s) is described herein:

The fees or charges, authorized in Section 18-8314, Idaho Code, are part of the agency's 2021 budget that relies upon the existence of these fees or charges to meet the state's obligations and provide necessary state services. Failing to reauthorize these temporary rules would create immediate danger to the state budget, immediate danger to necessary state functions and services, and immediate danger of a violation of Idaho's constitutional requirement that it balance its budget.

The following is a specific description of the fees or charges:

Seventy-five dollars (\$75) for initial certification applications and fifty dollars (\$50) for biennial certification renewal applications for: senior/approved level psychosexual evaluators, associate/supervised level sexual offender treatment provider, and associate/supervised level post-conviction sexual offender polygraph examiners.

Fifty dollars (\$50) for initial certification application and thirty dollars (\$30) for annual certification renewal applications for entry-level provisional/supervised psychosexual evaluators and provisional/supervised sexual offender treatment providers.

There is an option for certificate holders to seek a 60-day extension to submit proof of completing continuing education requirements upon renewal of certification. There is a \$25 fee for this 60-day extension.

**ASSISTANCE ON TECHNICAL QUESTIONS:** For assistance on technical questions concerning the temporary rule, contact Nancy Volle at (208) 658-2002.

DATED this 14th day of February, 2020.

Nancy Volle  
SOMB Program Manager  
Sexual Offender Management Board

1299 N. Orchard St., Ste #110  
Boise, ID 83706  
Phone: (208) 658-2002; Fax: (208) 287-3322

## IDAPA 57 – SEXUAL OFFENDER MANAGEMENT BOARD

### 57.01.01 – RULES OF THE SEXUAL OFFENDER MANAGEMENT BOARD

#### 000. LEGAL AUTHORITY.

This chapter is adopted under the legal authority of Section 18-8314(3), Idaho Code, to implement the provisions of Sections 18-8312 through 18-8316, Idaho Code. (3-20-20)T

#### 001. TITLE AND SCOPE.

**01. Title.** These rules are titled IDAPA 57.01.01, “Rules of the Sexual Offender Management Board.” (3-20-20)T

**02. Scope.** These rules provide procedures for the Sexual Offender Management Board to: (3-20-20)T

**a.** Establish certified evaluator, sexual offender treatment provider and post conviction sexual offender polygraph examiner qualifications; (3-20-20)T

**b.** Establish standards for psychosexual evaluations and sexual offender treatment programs based on current and evolving best practices; (3-20-20)T

**c.** Approve, issue, renew, deny, suspend, revoke, restrict or otherwise monitor a certification; (3-20-20)T

**d.** Establish fees for initial and renewal certification; (3-20-20)T

**e.** Establish procedures for standards and qualification quality assurance; and (3-20-20)T

**f.** Establish standard protocols for sexual offender management, assessment and classification. (3-20-20)T

**03. Relationship to the Department of Correction.** The Board is created within the Idaho Department of Correction, and relies upon the department for fiscal and administrative support. The governor appoints the Board members. The powers and duties of the Board are separate from the Department of Correction, and are set forth in Section 18-8314, Idaho Code. (3-20-20)T

#### 002. ADMINISTRATIVE APPEALS.

The “Idaho Rules of Administrative Procedure of the Attorney General,” IDAPA 04.11.01, Sections 000 through 799 apply to contested cases of the Board. (3-20-20)T

#### 003. INCORPORATION BY REFERENCE.

The following documents are incorporated by reference into these rules: (3-20-20)T

**01. “Bylaws and Constitution of the American Association of Police Polygraphists,”** effective May, 2010, is herein incorporated by reference and is available from the American Association of Police Polygraphists, PO Box 657, Waynesville, Ohio 45068, website <http://www.policepolygraph.org/>. (3-20-20)T

**02. “Bylaws of the American Polygraph Association,”** effective March 2018, is herein incorporated by reference and is available from the American Polygraph Association, PO Box 8037, Chattanooga, Tennessee 37414, website <http://www.polygraph.org/>. (3-20-20)T

**03. “Idaho Sexual Offender Management Board Standards and Guidelines for Adult Sexual Offender Management Practices,”** December 2019 revision, is herein incorporated by reference and is available from the Board’s office and on the Board website, <http://somb.idaho.gov/>. (3-20-20)T

**04. “Idaho Sexual Offender Management Board Standards and Guidelines for Practitioners, Evaluations and Treatment of Juvenile Sexual Offenders,”** December 2019 revision, is herein incorporated by reference and is available from the Board's office and on the Board's website, <http://somb.idaho.gov/>. (3-20-20)T

**05. The Sexual Offender Management Board's “Required Format for Juvenile Psychosexual Evaluation Reports,”** December 2019 revision, is herein incorporated by reference and is available from the Board's



office and on the Board's website, <http://somb.idaho.gov/>. (3-20-20)T

**06. The Sexual Offender Management Board's "Required Format for Adult Psychosexual Evaluation Reports,"** December 2019 revision, is herein incorporated by reference and is available from the Board's office and on the Board's website, <http://somb.idaho.gov/>. (3-20-20)T

**005. PUBLIC RECORDS ACT COMPLIANCE.**

**01. Administrative Rules.** The rules contained herein are promulgated pursuant to Title 67, Chapter 52, Idaho Code, and are public records. (3-20-20)T

**02. Public Records Requests.** Requests for public information are processed in compliance with the Idaho Public Records Act, Title 74, Chapter 1, Idaho Code. (3-20-20)T

**006. -- 009. (RESERVED)**

**010. DEFINITIONS.**

**01. Board.** The Sexual Offender Management Board described in Section 18-8312, Idaho Code. (3-20-20)T

**02. Central Roster.** A roster of evaluators, treatment providers and polygraph examiners, who meet the qualifications and are certified by the Board to conduct psychosexual evaluations, provide sexual offender treatment or conduct post-conviction sexual offender polygraphs. (3-20-20)T

**03. Certificate Holder.** A person who has been approved by the Board and certified as meeting qualifications to conduct or assist in the conduct of psychosexual evaluations, provide sexual offender treatment or conduct post conviction sexual offender polygraphs. (3-20-20)T

**04. Certified Evaluator.** Either a psychiatrist licensed by this state pursuant to Title 54, Chapter 18, Idaho Code, or a master's or doctoral level mental health professional licensed by this state pursuant to Title 54, Chapters 23, 32, or 34, Idaho Code. The evaluator shall have by education, experience, and training, expertise in the assessment and treatment of sexual offenders, meet the qualifications, and be approved by the Board to perform psychosexual evaluations in this state, as described in Section 18-8314, Idaho Code. A person meeting this definition may be certified by the Board as either a senior/approved certified evaluator or an associate/supervised certified evaluator. (3-20-20)T

**05. Certified Post Conviction Sex Offender Polygraph Examiner.** A polygraph examiner who has received specialized post conviction sexual offender testing training, and who is certified by the Board to conduct post conviction sexual offender polygraph examinations as ordered or required by the court, Idaho Department of Correction, or Idaho Commission for Pardons and Parole. A person meeting this definition may be certified by the Board as either a senior/approved post conviction sexual offender polygraph examiner or an associate/supervised post conviction sexual offender polygraph examiner. (3-20-20)T

**06. Certified Treatment Provider.** A person who has been certified by the Board as meeting qualifications to provide sexual offender treatment as ordered by the court, Idaho Department of Correction, Idaho Commission for Pardons and Parole, or Idaho Department of Juvenile Corrections. Such person shall be licensed by this state or another state or jurisdiction as a psychiatrist, or a master's or doctoral level mental health professional, and who has by education, experience and training, expertise in the treatment of sexual offenders. A person meeting this definition may be certified by the Board as either a senior/approved sex offender treatment provider or an associate/supervised sex offender treatment provider. (3-20-20)T

**07. Client.** An adult or juvenile receiving services from a person certified by the Board pursuant to Section 18-8314, Idaho Code. (3-20-20)T

**08. Established Standards.** The "Idaho Sexual Offender Management Board Standards and Guidelines for Adult Sexual Offender Management Practices" and the "Idaho Sexual Offender Management Board

Standards and Guidelines for Practitioners, Evaluations and Treatment of Juvenile Sexual Offenders” as referenced in Section 004 of these rules and established pursuant to Section 18-8314, Idaho Code. (3-20-20)T

**09. Provisional/Supervised Psychosexual Evaluator.** A person with limited clinical experience and specialized training, who may be licensed or is working toward licensure as a psychiatrist or master’s or doctoral level mental health professional, who is authorized by the Board to assist with the conduct of psychosexual evaluations under the clinical supervision of a senior/approved psychosexual evaluator. A person with a provisional/supervised psychosexual evaluator certificate is not considered to be a certified evaluator as defined in Section 18-8303, Idaho Code or for the purposes of conducting a psychosexual evaluation in accordance with Section 18-8316, Idaho Code. Certification approval is specific to adult or juvenile clients. (3-20-20)T

**10. Provisional/Supervised Sex Offender Treatment Provider.** A person with limited clinical experience and specialized training, who may be licensed or is working toward licensure as a psychiatrist or master’s or doctoral level mental health professional, who is authorized by the Board to provide sexual offender treatment under the clinical supervision of a senior/approved sex offender treatment provider. Certification approval is specific to adult or juvenile clients. (3-20-20)T

**11. Psychosexual Evaluation.** A comprehensive evaluation and assessment specifically addressing a person’s sexual development, sexual deviancy, sexual history and risk of re-offense. A psychosexual evaluation for the purpose of these rules is conducted post conviction, as ordered by the court pursuant to Section 18-8316, Idaho Code, or Title 20, Chapter 5, Idaho Code, by a person who has been certified by the Board. (3-20-20)T

**12. Quality Assurance.** Processes established by the Board to review psychosexual evaluations and sexual offender treatment procedures to assure minimum standards and certificate holder qualifications are met. All quality assurance reviews will be conducted under the direction of the Board. (3-20-20)T

**13. Sexual Offender.** A person adjudicated or convicted of an offense as listed in Section 18-8304, Idaho Code, or a substantially equivalent offense under the laws of another state, territory, commonwealth, or other jurisdiction of the United States including tribal courts and military courts; or who has been adjudicated or convicted of a sexual offense-related crime. (3-20-20)T

**14. Sexual Offender Classification Board.** A board in effect from 1998 to 2011 that determined whether a sexual offender should be designated as a violent sexual predator; set certified evaluator qualifications and standards; and administered an evaluator certification process. (3-20-20)T

**15. Supervision.** (3-20-20)T

**a.** For purposes of clinical practice supervision for associate/supervised psychosexual evaluator or associate/supervised sex offender treatment provider certification, supervision is generally considered as face-to-face direct contact, documented teleconferencing, or interactive video conferencing with a Board-approved supervisor using a ratio of one (1) hour of clinical supervision for every twenty (20) hours of direct service provided; or (3-20-20)T

**b.** For purposes of clinical practice supervision for provisional/supervised psychosexual evaluator or provisional/supervised treatment provider certification, supervision is considered as continual face-to-face direct contact with a Board-approved supervisor for the first two hundred fifty (250) hours of direct service provided followed by face-to-face direct contact with a Board-approved supervisor using a ratio of one (1) hour of clinical supervision for every fifteen (15) hours of direct service provided; or (3-20-20)T

**c.** For purposes of supervision for associate/supervised post conviction sexual offender polygraph examiners, supervision is generally considered as face-to-face direct contact with a Board-approved supervisor during conduct of the supervisee’s first five (5) PCSOT polygraphs followed by review by a Board-approved supervisor of one (1) PCSOT polygraph for every five (5) PCSOT polygraphs conducted by the supervisee. Such review shall include chart and report review. (3-20-20)T

**16. Treatment.** For purposes of certification eligibility the provision of face-to-face individual, group, or family therapy with a person who has been investigated by law enforcement or child protective services for

commission of a sexual offense, or who has been adjudicated or convicted of a sexual offense or sexual offense-related crime. Treatment must be directly relevant to the client’s sexually offending behavior. (3-20-20)T

**17. Violent Sexual Predator.** A person who was designated as a violent sexual predator by the Sexual Offender Classification Board where such designation has not been removed by judicial action or otherwise. (3-20-20)T

**011. ABBREVIATIONS.**

**01. APA.** The American Polygraph Association. (3-20-20)T

**02. PCSOT.** “Post conviction sexual offender testing” is specialized instruction beyond the basic polygraph training for the purpose of specific polygraph testing of post convicted sexual offenders. (3-20-20)T

**03. SOCB.** The Sexual Offender Classification Board. (3-20-20)T

**04. SOMB.** The Sexual Offender Management Board. (3-20-20)T

**012. -- 019. (RESERVED)**

**020. RECORDKEEPING.**

**01. Certificate Holders.** Records on all applicants and certifications issued, renewed, denied, suspended, revoked, or otherwise monitored shall be maintained for a period not less than five (5) years. (3-20-20)T

**02. Violent Sexual Predators.** The file on a sexual offender who was designated as a violent sexual predator by the SOCB is maintained by the Board and is considered the official file for all purposes. (3-20-20)T

**021. BOARD MEETINGS.**

**01. Meetings.** The Board meets at least quarterly and may meet more frequently. All business of the Board is conducted in compliance with the open meeting law, pursuant to Title 67, Chapter 23, Idaho Code, and Section 18-8315, Idaho Code. (3-20-20)T

**02. Agenda.** An agenda for each regularly scheduled meeting is posted in compliance with Section 67-2343, Idaho Code. (3-20-20)T

**022. -- 039. (RESERVED)**

**040. CERTIFIED EVALUATOR QUALIFICATIONS.**

**01. Certified Evaluators.** Each evaluator who conducts or assists with the conduct of a psychosexual evaluation pursuant to Section 18-8316, Idaho Code, must meet the qualifications as set forth in the established standards issued by the Board and be certified by the Board. (3-20-20)T

**a.** Certification approval is specific to adult or juvenile clients. (3-20-20)T

**b.** A certificate holder may be separately approved to provide services to both adult and juvenile clients. (3-20-20)T

**02. Certification Requirements.** Minimum requirements for certification as a psychosexual evaluator include criteria, requirements, and expectations in the following categories: (3-20-20)T

**a.** Formal educational requirements; (3-20-20)T

**b.** Professional licensure requirements; (3-20-20)T

- c. Clinical experience requirements; (3-20-20)T
- d. Specialized training requirements; and (3-20-20)T
- e. Continuing education and professional development requirements. (3-20-20)T

**041. LEVELS OF PSYCHOSEXUAL EVALUATOR CERTIFICATION.**

The Board issues certificates within three (3) levels reflective of a person's training and experience specific to the population to be served: (3-20-20)T

**01. Senior/Approved Psychosexual Evaluator. (3-20-20)T**

a. Possesses a valid Idaho license to practice as a psychiatrist or master's or doctoral level psychologist, social worker, professional counselor, or marriage and family therapist. (3-20-20)T

b. Has engaged in a combination of direct, face-to-face clinical practice with sexual offenders and received specialized training for a minimum of one thousand five hundred (1,500) hours. Of this requirement, a minimum of five hundred (500) combined hours shall have been accumulated within the three (3) years immediately preceding an initial application for certification at this level, as set forth in the established standards issued by the Board; and (3-20-20)T

c. Has conducted a minimum of nine (9) psychosexual evaluations within the three (3) years preceding an initial application for certification at this level. (3-20-20)T

**02. Associate/Supervised Psychosexual Evaluator. (3-20-20)T**

a. Possesses a valid Idaho license to practice as a psychiatrist or master's or doctoral level psychologist, social worker, professional counselor, or marriage and family therapist. (3-20-20)T

b. Has engaged in a combination of supervised direct, face-to-face clinical practice with sexual offenders and received specialized training for a minimum of five hundred (500) hours. Of this requirement, a minimum of three hundred (300) combined hours shall have been accumulated within the three (3) years immediately preceding an initial application for certification at this level, as set forth in the established standards issued by the Board; (3-20-20)T

c. Has conducted a minimum of six (6) psychosexual evaluations within the three (3) years preceding an initial application for certification at this level; and (3-20-20)T

d. Shall only conduct psychosexual evaluations under the clinical practice supervision of a Board-approved supervisor as defined in Paragraph 010.15.a. of these rules, and under the terms of a formal clinical supervision agreement. (3-20-20)T

**03. Provisional/Supervised Psychosexual Evaluator. (3-20-20)T**

a. Possesses or is currently enrolled in a graduate program of study toward the attainment of a master's or doctoral degree, preferably with an emphasis on the application of forensic clinical practice; (3-20-20)T

b. Possesses or is pursuing a valid license to practice as a psychiatrist or master's or doctoral level psychologist, social worker, professional counselor, or marriage and family therapist; (3-20-20)T

c. May assist with the conduct of psychosexual evaluations only under the clinical supervision of a Board-approved supervisor as defined in Paragraph 010.15.b. of these rules, and under the terms of a formal clinical supervision agreement. Face-to-face supervision is required when providing direct clinical services to sex offenders. (3-20-20)T

**042. -- 079. (RESERVED)**

**080. SEXUAL OFFENDER TREATMENT PROVIDER QUALIFICATIONS.**

**01. Certified Sexual Offender Treatment Provider.** Each person who provides treatment to sexual offenders as ordered or required by the court, Idaho Department of Correction, Idaho Commission for Pardons and Parole, or the Idaho Department of Juvenile Corrections, in accordance with Section 18-8314, Idaho Code, must meet the qualifications as set forth in the established standards issued by the Board. (3-20-20)T

- a. Certification approval is specific to adult or juvenile clients. (3-20-20)T
- b. A certificate holder may be separately approved to provide services to both adult and juvenile clients. (3-20-20)T

**02. Certification Requirements.** Minimum requirements for certification as a sexual offender treatment provider include criteria, requirements, and expectations in the following categories: (3-20-20)T

- a. Formal educational requirements; (3-20-20)T
- b. Professional licensure requirements; (3-20-20)T
- c. Clinical experience requirements; (3-20-20)T
- d. Specialized training requirements; and (3-20-20)T
- e. Continuing education and professional development requirements. (3-20-20)T

**081. LEVELS OF SEXUAL OFFENDER TREATMENT PROVIDER CERTIFICATION.**

The Board issues certificates within three (3) levels reflective of a person's training and experience specific to the population to be served: (3-20-20)T

**01. Senior/Approved Sexual Offender Treatment Provider.** (3-20-20)T

- a. Possesses a valid license to practice in this state or another state or jurisdiction as a psychiatrist or master's or doctoral level psychologist, social worker, professional counselor, or marriage and family therapist; and (3-20-20)T
- b. Has engaged in a combination of direct, face-to-face clinical practice with sexual offenders and received specialized training for a minimum of one thousand five hundred (1,500) hours. Of this requirement, a minimum of five hundred (500) combined hours shall have been accumulated within the three (3) years immediately preceding an initial application for certification at this level, as set forth in the established standards issued by the Board. (3-20-20)T

**02. Associate/Supervised Sexual Offender Treatment Provider.** (3-20-20)T

- a. Possesses a valid license to practice in this state or another state or jurisdiction as a psychiatrist or master's or doctoral level psychologist, social worker, professional counselor, or marriage and family therapist. (3-20-20)T
- b. Has engaged in a combination of supervised direct, face-to-face clinical practice with sexual offenders and received specialized training for a minimum of five hundred (500) hours. Of this requirement, a minimum of three hundred (300) combined hours shall have been accumulated within the three (3) years immediately preceding an initial application for certification at this level, as set forth in the established standards issued by the Board; and (3-20-20)T
- c. Shall only provide treatment services under the clinical practice supervision of a Board-approved supervisor as defined in Paragraph 010.15.a. of these rules, and under the terms of a formal clinical supervision agreement. (3-20-20)T

**03. Provisional/Supervised Sexual Offender Treatment Provider. (3-20-20)T**

**a.** Possesses or is currently enrolled in a graduate program of study toward the attainment of a master's or doctoral degree, preferably with an emphasis on the application of forensic clinical practice; and (3-20-20)T

**b.** Possesses or is pursuing a valid license to practice as a psychiatrist or master's or doctoral level psychologist, social worker, professional counselor, or marriage and family therapist. (3-20-20)T

**c.** Shall only provide treatment services under the clinical supervision of a Board-approved supervisor as defined in Paragraph 010.15.b. of these rules, and under the terms of a formal clinical supervision agreement. Face-to-face supervision is required when providing direct clinical services to sex offenders. (3-20-20)T

**082. -- 099. (RESERVED)**

**100. SPECIALIZED TRAINING FOR PSYCHOSEXUAL EVALUATORS AND SEXUAL OFFENDER TREATMENT PROVIDERS.**

For initial certification as a psychosexual evaluator or sexual offender treatment provider, an applicant must have participated in specialized training in the field of sexual abuse, as set forth in the established standards issued by the Board. Sources for such training may be formal conferences, symposia, seminars and workshops in areas such as: (3-20-20)T

**01. Sexually Abusive Behavior.** Contemporary research regarding the etiology of sexually abusive behavior; (3-20-20)T

**02. Offending Behavior.** Research-identified risk factors for the development and continuation of sexually abusive/offending behavior; (3-20-20)T

**03. Assessment, Treatment, and Management of Adult or Juvenile Sex Offenders.** Contemporary research and practice in the areas of assessment, treatment, and management of adult or juvenile sex offenders; (3-20-20)T

**04. Specific Risk Assessment Tools.** Research-supported, sex offender-specific risk assessment tools; and (3-20-20)T

**05. Deviant Sexual Arousal and/or Interests.** Physiological assessment of deviant sexual arousal and/or interests. (3-20-20)T

**101. CONTINUING EDUCATION FOR PSYCHOSEXUAL EVALUATORS AND SEXUAL OFFENDER TREATMENT PROVIDERS.**

To maintain certification as a psychosexual evaluator or sexual offender treatment provider, a certificate holder must receive continuing education in the field of sexual abuse. (3-20-20)T

**01. Senior/Approved and Associate/Supervised Certification Levels.** A psychosexual evaluator or sexual offender treatment provider who is certified at a senior/approved or an associate/supervised level must receive a minimum of forty (40) hours of specialized continuing education in the form of formal conferences, symposia, seminars, workshops or on-line training over the course of the two-year period prior to each renewal period as set forth in the established standards issued by the Board. A certificate holder not meeting the continuing education requirements may formally petition the SOMB for a sixty-day extension to submit proof of meeting continuing education requirements. (3-20-20)T

**02. Provisional/Supervised Certification Level.** A provisional/supervised psychosexual evaluator or sexual offender treatment provider must receive a minimum of twenty (20) hours of specialized continuing education in the form of formal conferences, symposia, seminars, workshops or on-line training annually as set forth in the established standards issued by the Board. A certificate holder not meeting the continuing education requirements may formally petition the SOMB for a sixty-day extension to submit proof of meeting continuing education

requirements. (3-20-20)T

**102. -- 149. (RESERVED)**

**150. REQUEST FOR CONDITIONAL WAIVER.**

**01. Conditional Waiver.** The Board may consider an initial applicant's request for a time limited conditional waiver for deficiencies in experience and specialized training qualifications as set forth in the established standards issued by the Board. (3-20-20)T

**02. Duration.** A conditional waiver is limited to a period of two (2) years. Conditional waivers may not be extended or renewed after the third year. (3-20-20)T

**03. Frequency.** A conditional waiver request shall only be considered one (1) time for an initial certification application for psychosexual evaluator and sexual offender treatment provider applicants at the senior/approved or associate/supervised level. (3-20-20)T

**151. (RESERVED)**

**152. RECIPROCITY.**

The Board may consider reciprocity for any applicant who has been licensed or certified to conduct psychosexual evaluations or sexual offender treatment in another state or jurisdiction as set forth in the established standards issued by the Board. (3-20-20)T

**153. EXCLUSION.**

Each mental health employee of the Idaho Department of Correction or Idaho Department of Juvenile Corrections who conducts psychosexual evaluations or provides sexual offender treatment is exempt from the certification process. This exemption shall only apply while the employee is acting within the course and scope of his employment with the applicable agency. (3-20-20)T

**154. REQUEST FOR CHANGE IN CERTIFICATION LEVEL.**

**01. Request to Advance in Level of Certification.** A certificate holder may apply at any time during an effective certification to advance to the next higher level of certification provided that he meets the established qualifications and requirements as set forth in the established standards issued by the Board. (3-20-20)T

**02. Request to Change to a Less Independent Level of Certification.** A certificate holder may apply at any time during an effective certification for a reduction in his level of certification in the event that he no longer meets the established qualifications and requirements for his current level of certification as set forth in the established standards issued by the Board. (3-20-20)T

**155. APPLICATION FOR CHANGE IN CERTIFICATION LEVEL.**

Application for change in certification level shall be on a form provided by the Board and submitted with the required supporting documentation and applicable renewal application processing fee: (3-20-20)T

**01. Advance to Senior/Approved Level of Certification Application Fee.** A non-refundable renewal application fee payable to the Board in the amount of fifty dollars (\$50) provided that the application is submitted three hundred sixty-five (365) days or more after the most recent effective certification date. The application fee shall be waived if submission is within three hundred sixty-five (365) days from the most recent effective certification date. (3-20-20)T

**02. Advance to Associate/Supervised Level of Certification Application Fee.** A non-refundable renewal application fee payable to the Board in the amount of thirty dollars (\$30) provided that the application is submitted three hundred sixty-five (365) days or more after the most recent effective certification date. The application fee shall be waived if submission is within three hundred sixty-five (365) days from the most recent effective certification date. (3-20-20)T

**03. Change to a Less Independent Level of Certification Application Fee.** A non-refundable renewal application fee payable to the Board in the amount of fifty dollars (\$50) provided that the application is submitted three hundred sixty-five (365) days or more after the most recent effective certification date. The application fee shall be waived if submission is within three hundred sixty-five (365) days from the most recent effective certification date. (3-20-20)T

**156. -- 199. (RESERVED)**

**200. POST CONVICTION SEXUAL OFFENDER POLYGRAPH EXAMINER QUALIFICATIONS.**

**01. Certified Examiner.** Each person who conducts post conviction sexual offender polygraphs as ordered or required by the court, Idaho Department of Correction, or Idaho Commission for Pardons and Parole, in accordance with Section 18-8314, Idaho Code, must meet the qualifications as set forth in the established standards issued by the Board and be certified by the Board. There shall not be a separate certification specific to adult or juvenile clients. (3-20-20)T

**02. Certification Requirements.** Minimum requirements for certification as a sexual offender treatment provider include criteria and requirements in the following categories: (3-20-20)T

- a.** Educational requirements; (3-20-20)T
- b.** Experience requirements; (3-20-20)T
- c.** Specialized training requirements; and (3-20-20)T
- d.** Continuing education and professional development requirements. (3-20-20)T

**201. LEVELS OF POST CONVICTION SEXUAL OFFENDER POLYGRAPH EXAMINER CERTIFICATION.**

The Board issues certificates within two (2) levels reflective of a person's experience in conducting post conviction sexual offender polygraphs. (3-20-20)T

**01. Senior/Approved Post Conviction Sexual Offender Polygraph Examiner.** (3-20-20)T

- a.** Has graduated from an APA-accredited polygraph school; (3-20-20)T
- b.** Has successfully completed a minimum of forty (40) hours of formal post conviction sexual offender polygraph testing beyond the basic polygraph training course requirements from an APA-accredited program or school; and (3-20-20)T
- c.** Has successfully completed a minimum of one hundred (100) polygraph examinations. Of this requirement, a minimum of ten (10) sexual history polygraph examinations and a minimum of ten (10) PCSOT maintenance polygraph examinations shall have been conducted within the three (3) years immediately preceding an initial application for certification at this level, as set forth in the established standards issued by the Board; (3-20-20)T

**02. Associate/Supervised Post Conviction Sexual Offender Polygraph Examiner.** (3-20-20)T

- a.** Has graduated from an APA-accredited polygraph school; (3-20-20)T
- b.** Has successfully completed a minimum of forty (40) hours of formal post conviction sexual offender polygraph testing beyond the basic polygraph training course requirements from an APA-accredited program or school; and (3-20-20)T
- c.** Shall only conduct polygraphs under the supervision of a Board-approved supervisor as defined in Paragraph 010.15.c. of these rules, and under the terms of a formal supervision agreement. (3-20-20)T



202. -- 230. (RESERVED)

**231. CONTINUING EDUCATION FOR POST CONVICTION SEXUAL OFFENDER POLYGRAPH EXAMINERS.**

To maintain certification as a post conviction sexual offender polygraph examiner, a certificate holder must receive a minimum of thirty (30) hours of continuing education related to the field of polygraphy in the form of formal conferences, symposia, seminars, or workshops over the course of the two-year period prior to each renewal period as set forth in the established standards issued by the Board. A certificate holder not meeting the continuing education requirements may formally petition the SOMB for a sixty-day extension to submit proof of meeting continuing education requirements. (3-20-20)T

232. -- 299. (RESERVED)

**300. STANDARDS FOR PROFESSIONAL CONDUCT AND CLIENT RELATIONS.**

**01. General Considerations for Certified Evaluators and Certified Treatment Providers.** Each person who is certified by the Board to conduct or assist with the conduct of psychosexual evaluations or provide sexual offender treatment shall: (3-20-20)T

**a.** Adhere to the ethical principles and codes, and all practice standards and guidelines for the person's respective discipline and area of professional licensure; (3-20-20)T

**b.** Be knowledgeable of statutes and scientific data relevant to specialized sexual offender evaluation and sexual offender treatment; (3-20-20)T

**c.** Be familiar with the statutory requirements for assessments and reports for the courts, pursuant to Section 18-8316, Idaho Code; (3-20-20)T

**d.** Be committed to community protection and safety; (3-20-20)T

**e.** Provide services in a manner that ensures humane and ethical treatment of clients; (3-20-20)T

**f.** Conduct testing in accordance with the person's licensing body, qualifications and experience, and in a manner that ensures the integrity of testing data; (3-20-20)T

**g.** Avoid relationships with clients that may constitute a conflict of interest, impair professional judgment and risk exploitation; and (3-20-20)T

**h.** Have no sexual relationships with any client. (3-20-20)T

**02. General Considerations for Certified Post Conviction Sexual Offender Polygraph Examiners.** Each person who is certified by the Board to conduct post conviction sexual offender polygraph examinations shall: (3-20-20)T

**a.** Adhere to the ethical principles and codes, and all practice standards and guidelines for the person's discipline, area of professional practice, or licensure as promulgated by any applicable regulatory board or licensing authority; (3-20-20)T

**b.** Adhere to the standards and guidelines specific to post conviction sexual offender testing as promulgated by the APA; (3-20-20)T

**c.** Adhere to the ethical principles and codes, and all practice standards and guidelines for the administration of polygraph examinations generally, as promulgated by the APA or the American Association of Police Polygraphists, as referenced in Section 004 of these rules; (3-20-20)T

**d.** Avoid relationships with clients that may constitute a conflict of interest, impair professional judgment and risk exploitation; (3-20-20)T

- e. Have no sexual relationships with any client; (3-20-20)T
- f. Take factors such as age, mental capacity and co-occurring mental health concerns into consideration when utilizing polygraphy with juvenile offenders; (3-20-20)T
- g. Be committed to community protection and safety; and (3-20-20)T
- h. Provide services in a manner that ensures humane and ethical treatment of clients. (3-20-20)T

**301. -- 329. (RESERVED)**

**330. INITIAL CERTIFICATION APPLICATION.**

An applicant seeking certification by the Board must submit a completed application on forms provided by the Board for the applicant's area of practice and client population, if applicable, accompanied by documentation as outlined in the established standards issued by the Board and an initial certification application fee made payable to the Board. (3-20-20)T

**331. EXPIRATION AND RENEWAL OF CERTIFICATION.**

No certification shall be renewed, except as follows: (3-20-20)T

**01. Renewal.** At least thirty (30) days prior to the expiration of a certification, a certificate holder shall apply for renewal of the certification on forms provided by the Board for the applicant's area of practice and client population, if applicable, accompanied by documentation as outlined in the established standards issued by the Board and a renewal certification application fee made payable to the Board. (3-20-20)T

**02. Removal from the Roster.** A certificate holder who has not renewed his certification shall be removed from the central roster. (3-20-20)T

**03. Renewal After Certification Expiration.** A certificate holder whose certification has expired may reapply at any time for certification as follows: (3-20-20)T

**a.** A certificate holder whose certification has been expired for less than three hundred sixty-five (365) days may reapply following the certification renewal process as referenced in Subsection 331.01 of these rules. (3-20-20)T

**b.** A certificate holder whose certification has been expired for three hundred sixty-five (365) days or longer may reapply for certification following the initial certification process as referenced in Section 330 of these rules. (3-20-20)T

**332. FEES.**

The following non-refundable application processing fees are established by the Board: (3-20-20)T

**01. Initial Certification.** Application processing fees for initial certification are: (3-20-20)T

**a.** Senior/Approved Psychosexual Evaluator, Treatment Provider, or Post Conviction Sexual Offender Polygraph Examiner – Seventy-five dollars (\$75). (3-20-20)T

**b.** Associate/Supervised Psychosexual Evaluator, Treatment Provide, or Post Conviction Sexual Offender Polygraph Examiner – Seventy-five dollars (\$75). (3-20-20)T

**c.** Provisional/Supervised Psychosexual Evaluator or Treatment Provider – Fifty dollars (\$50). (3-20-20)T

**02. Renewal Certification.** Application processing fees for renewal certification are: (3-20-20)T

**a.** Senior/Approved Psychosexual Evaluator, Treatment Provider, or Post Conviction Sexual Offender

Polygraph Examiner – Fifty dollars (\$50). (3-20-20)T

**b.** Associate/Supervised Psychosexual Evaluator, Treatment Provider, or Post Conviction Sexual Offender Polygraph Examiner – Fifty dollars (\$50). (3-20-20)T

**c.** Provisional/Supervised Psychosexual Evaluator or Treatment Provider – Thirty dollars (\$30). (3-20-20)T

**03. Change in Certification Level.** Application processing fees for a change in certification level are as referenced in Section 155 of these rules. (3-20-20)T

**04. Continuing Education Extension.** Application processing fee for a request for an extension of time to complete continuing education requirements is twenty-five dollars (\$25). (3-20-20)T

**333. CERTIFICATION PERIOD.**

Provided that the certificate holder continues to meet the criteria for certification and such certification has not been suspended, revoked, otherwise restricted or placed on voluntary inactive status, the effective period for certification is as follows: (3-20-20)T

**01. Senior/Approved Psychosexual Evaluator or Treatment Provider.** Certification shall remain in effect for two (2) years. Certification renewal shall typically occur during the certificate holder's month of birth two (2) years following initial certification and every two (2) years thereafter. (3-20-20)T

**02. Associate/Supervised Psychosexual Evaluator or Treatment Provider.** Certification shall remain in effect for two (2) years. Certification renewal shall typically occur during the certificate holder's month of birth two (2) years following initial certification and every two (2) years thereafter. (3-20-20)T

**03. Provisional/Supervised Psychosexual Evaluator or Treatment Provider.** Certification shall remain in effect for one (1) year. Certification renewal shall typically occur during the certificate holder's month of birth one (1) year following initial certification and annually thereafter. Certification at the provisional/supervised level is limited to a period of three (3) years, at which time the certificate holder must meet minimum requirements for upgrade to the associate/supervised level to be eligible for certification renewal. (3-20-20)T

**04. Senior/Approved Post Conviction Sexual Offender Polygraph Examiner.** Certification shall remain in effect for two (2) years. Certification renewal shall typically occur during the certificate holder's month of birth two (2) years following initial certification and every two (2) years. (3-20-20)T

**05. Associate/Supervised Post Conviction Sexual Offender Polygraph Examiner.** Certification shall remain in effect for two (2) years from the certificate holder's month of birth following initial certification. Thereafter, the certificate holder must meet minimum requirements for upgrade to the senior/approved level to be eligible for certification renewal. (3-20-20)T

**334. APPLICABILITY AND NOTIFICATION OF CHANGES.**

Certification shall only apply to the person named therein and is not transferable. The Board must be notified in writing within thirty (30) days of any change in the certificate holder's name, business address or phone number. (3-20-20)T

**335. REQUEST FOR PLACEMENT ON INACTIVE STATUS.**

Any certificate holder may request placement on inactive status by submitting a written request to the SOMB specifying the reasons for the request and indicating the inactive status effective date. A certificate holder who is placed on inactive status shall be removed from the central roster of certified evaluators, treatment providers and post conviction sexual offender polygraph examiners. A person who has been placed on inactive status may reapply for certification in accordance with the established standards issued by the Board. (3-20-20)T

**336. -- 349. (RESERVED)**

**350. CENTRAL ROSTER OF PSYCHOSEXUAL EVALUATORS, SEXUAL OFFENDER TREATMENT PROVIDERS AND POST CONVICTION SEXUAL OFFENDER POLYGRAPH EXAMINERS.**

**01. Identification.** The Board shall publish a central roster of psychosexual evaluators, sexual offender treatment providers and post conviction sexual offender polygraph examiners pursuant to Sections 18-8312 through 18-8316, Idaho Code. The central roster shall indicate: (3-20-20)T

- a. The certificate holder's name; (3-20-20)T
  - b. The certificate holder's business address and telephone number; (3-20-20)T
  - c. Whether the certificate holder is certified or approved by conditional waiver; (3-20-20)T
  - d. The category and applicable level of certification; (3-20-20)T
  - e. The expiration date of the certification or conditional waiver; (3-20-20)T
  - f. Whether the certificate holder is approved to provide services to adult or juvenile clients, or both; (3-20-20)T
- and
- g. Current formal disciplinary action imposed on a certificate holder by the Board. (3-20-20)T

**02. Availability.** A copy of the central roster may be obtained from the Board, and shall be posted on the Board's website. (3-20-20)T

**351. -- 379. (RESERVED)**

**380. DENIAL AND GROUNDS FOR DISCIPLINE.**

**01. Cause.** The Board may deny, suspend, revoke, restrict or otherwise monitor certification of an applicant or certificate holder for the following reasons: (3-20-20)T

- a. Failure to meet or maintain the minimum eligibility criteria and qualifications for certification; (3-20-20)T
- b. Falsification of any information or documentation, or concealing a material fact in the application for certification, or during any investigation or quality assurance review; (3-20-20)T
- c. Misrepresentation of current level or designation of certification, or practicing outside the scope or current level or designation of certification; (3-20-20)T
- d. Failure to comply with Section 18-8316, Idaho Code, any portion of this chapter, or the established standards issued by the Board; (3-20-20)T
- e. Failure to demonstrate an understanding of counter-transference issues and a broad knowledge of sexuality in the general populations, and basic theories and typologies of sexual offenders and sexual assault victims; (3-20-20)T
- f. Failure or refusal to comply with the quality assurance review process or to cooperate during any investigation concerning certification, including failure or refusal to provide data, information or records as requested by the Board or designee; (3-20-20)T
- g. Failure to comply with any informal disciplinary measures, remedial steps, corrective action or final order issued by the Board as a condition of continued certification, including practicing on a suspended or restricted certification; (3-20-20)T

- h.** Engaging in conduct that departs from the established standards issued by the Board; (3-20-20)T
- i.** Revocation, suspension, limitation, reprimand, voluntary surrender or any other disciplinary action or proceeding, including investigation against a license, certificate or privilege to practice by a professional licensing board; (3-20-20)T
- j.** Conviction of, or entry of a withheld judgment or plea of nolo contendere to conduct constituting a felony or crime of moral turpitude; or (3-20-20)T
- k.** Failure to notify the Board in writing of any circumstances that affect a certificate holder's eligibility for certification, including any disciplinary action taken by a respective professional licensing board or conviction of any felony or crime of moral turpitude. (3-20-20)T

**02. Mirroring Orders.** If a state licensing board with authority over a certificate holder's professional license takes action against the professional license which suspends, restricts, limits, or affects the certificate holder's ability to provide services pursuant to their SOMB certification, the SOMB is authorized to issue an order suspending, restricting, limiting, or otherwise affecting the certificate holder's SOMB certification in the same fashion as the professional licensing board's action. (3-20-20)T

**03. Emergency Suspension.** Pursuant to Section 67-5247, Idaho Code, if the Board finds that public health, safety or welfare requires immediate emergency action the Board may take such action necessary to prevent or avoid the immediate danger as outlined in the established standards issued by the Board. (3-20-20)T

**381. REAPPLICATION FOLLOWING CERTIFICATION DENIAL OR DISCIPLINARY ACTION.**

**01. Denial.** An applicant whose certification was denied may reapply when evidence is available confirming that he meets the required qualifications for the respective area of practice as referenced in Sections 040, 080 or 200 of these rules; (3-20-20)T

**02. Suspension.** A person whose certification has been suspended may apply for reinstatement after the suspension period has expired and following completion of any remedial steps or corrective action ordered by the Board, as outlined in the established standards issued by the Board; (3-20-20)T

**03. Restriction.** A person whose certification has been restricted or otherwise monitored may request removal of the restrictions after the restriction period has expired. If no period of restriction was established, the request may be made following completion of any remedial steps or corrective action ordered by the Board, as outlined in the established standards issued by the Board; (3-20-20)T

**04. Revocation.** A person whose certification has been revoked may request reinstatement after the revocation period has expired, as outlined in the established standards issued by the Board. The Board shall have discretion to impose any monitoring conditions upon a certificate holder whose certification has been reinstated following revocation; (3-20-20)T

**05. Withheld Discipline and Probation.** A certificate holder whose formal discipline was withheld and placed on probationary status may request reinstatement after the probationary period has expired and any conditions imposed have been met, as outlined in the established standards issued by the Board. (3-20-20)T

**382. LEVELS OF DISCIPLINE.**

The levels of disciplinary action utilized by the Board against a certificate holder may generally include formal discipline, informal discipline or withholding formal discipline and probation. (3-20-20)T

**383. FORMAL DISCIPLINE.**

Formal disciplinary action consists of suspension, revocation or other restrictions. Formal disciplinary actions restrict or otherwise impede a certificate holder's ability to perform sexual offender services consistent with their certification level. (3-20-20)T

**384. INFORMAL DISCIPLINE.**

Informal disciplinary action consists of monitoring a certificate holder or issuing letters of informal reprimand or counseling. Informal disciplinary actions do not restrict or otherwise impede a certificate holder's ability to perform sexual offender services consistent with their certification level. (3-20-20)T

**385. WITHHOLDING FORMAL DISCIPLINE AND PROBATION.**

The Board may withhold the imposition of formal discipline and place the certificate holder on a period of probation not to exceed two (2) years. The Board may impose any conditions of probation as deemed necessary to ensure compliance with the established standards issued by the Board. Such probationary conditions may include attendance at specialized training, review of the certificate holder's work product by the Board or its designee, or supervised practice by a senior level certificate holder. Failure to comply with a probationary condition imposed by the Board may result in the imposition of any suspended disciplinary action. (3-20-20)T

**386. COMPLAINTS.**

Any individual may file against a certificate holder by submitting a written complaint to the Board, as outlined in the established standards issued by the Board. (3-20-20)T

**01. Initial Review.** The Board's designee shall conduct an initial review of any complaint or information received to determine if the Board has jurisdiction. (3-20-20)T

**02. Investigation.** The Board's designee shall conduct an investigation upon a determination that the Board has jurisdiction and a possible violation may exist. Investigative findings shall be presented to the Board as outlined in the established standards issued by the Board. (3-20-20)T

**387. DISCIPLINARY PROCESS.**

The disciplinary process may be initiated as a result of a complaint received by the Board or a quality assurance review, or be based upon a review of information submitted to the Board during the certification process, monitoring process or while under formal probation. (3-20-20)T

**388. -- 399. (RESERVED)**

**400. QUALITY ASSURANCE.**

Policies for technical review and quality assurance of psychosexual evaluation reports and sexual offender treatment services and polygraph examinations are outlined in the established standards issued by the Board. (3-20-20)T

**401. -- 449. (RESERVED)**

**450. PSYCHOSEXUAL EVALUATIONS.**

**01. Adult Psychosexual Evaluations.** Pre-sentence psychosexual evaluations on adult sexual offenders shall be conducted pursuant to the established standards issued by the Board and written utilizing the "Required Format for Psychosexual Evaluation Reports," as referenced in Section 004 of these rules. (3-20-20)T

**02. Juvenile Psychosexual Evaluations.** Psychosexual evaluations on juveniles adjudicated for sexual offenses shall be conducted in accordance with the established standards issued by the Board and written utilizing the "Required Format for Juvenile Psychosexual Evaluation Reports," incorporated by reference in Section 004 of these rules. (3-20-20)T

**03. Testing.** The evaluator shall utilize testing instrumentation and assessment measures as outlined in the established standards issued by the Board. (3-20-20)T

**04. Client Participation.** The client being evaluated may refuse or decline to participate in any testing, assessment measure, or physiological measure used for the pre-sentence psychosexual evaluation. The evaluator shall document the client's refusal or declination in the psychosexual evaluation report. (3-20-20)T

**451. -- 479. (RESERVED)**

**480. POLYGRAPH EXAMINATIONS.**

Post conviction sexual offender polygraph examinations performed pursuant to an order or requirement by the court

or requested by the Idaho Department of Correction or Idaho Commission for Pardons and Parole shall be conducted by a person certified by the Board to conduct such examinations and shall follow the established standards issued by the Board. (3-20-20)T

**481. -- 499. (RESERVED)**

**500. SEXUAL OFFENDER TREATMENT.**

Specialized sexual offender treatment conducted pursuant to an order or requirement by the court, the Idaho Department of Correction, the Idaho Commission for Pardons and Parole or the Idaho Department of Juvenile Corrections shall be conducted by a person certified by the Board to conduct such treatment and shall follow the established standards issued by the Board. (3-20-20)T

**501. -- 999. (RESERVED)**

## IDAPA 58 – DEPARTMENT OF ENVIRONMENTAL QUALITY

### DOCKET NO. 58-0000-2000F (FEE RULE)

#### NOTICE OF OMNIBUS RULEMAKING – ADOPTION OF TEMPORARY RULE

**EFFECTIVE DATE:** The effective date of the temporary rules being adopted through this omnibus rulemaking is the adjournment date of the Second Regular Session of the 65th Idaho Legislature - March 20, 2020.

**AUTHORITY:** In compliance with Sections 67-5226, Idaho Code, notice is hereby given that the Idaho Board of Environmental Quality (Board) has adopted temporary fee rules. The action is authorized pursuant to the following Idaho Code provisions. Citations to any federal statutes that provide the basis of authority or requirement for the rulemaking are also included.

- IDAPA 58.01.01 – Sections 39-105, 39-107, 39-114(4), 39-115(3), and 39-116B, Idaho Code; Clean Air Act, 42 U.S.C. § 7401 *et seq.*
- IDAPA 58.01.05 – Chapters 44 and 58, Title 39, Idaho Code; Solid Waste Disposal Act, 42 U.S.C. § 6901 *et seq.*
- IDAPA 58.01.06 – Sections 39-105, 39-107, and 39-7408C, Idaho Code; Solid Waste Disposal Act, 42 U.S.C. § 6901 *et seq.*
- IDAPA 58.01.07 – Chapters 1 and 88, Title 39, Idaho Code; Solid Waste Disposal Act, 42 U.S.C. §§ 6991 – 6991m
- IDAPA 58.01.08 – Chapter 1, Title 39, Idaho Code; Chapter 21, Title 37, Idaho Code; Safe Drinking Water Act, 42 U.S.C. § 300f *et seq.*
- IDAPA 58.01.09 – Sections 39-104A, 39-105, and 39-107, Idaho Code
- IDAPA 58.01.11 – Sections 39-105, 39-107, 39-120, and 39-126, Idaho Code
- IDAPA 58.01.12 – Chapters 1 and 36, Title 39, Idaho Code; Clean Water Act, 33 U.S.C. § 1251 *et seq.*
- IDAPA 58.01.13 – Chapter 1, Title 39, Idaho Code
- IDAPA 58.01.14 – Sections 39-105, 39-107, and 39-119, Idaho Code
- IDAPA 58.01.18 – Sections 39-105, 39-107, 39-4405, and 39-7210, Idaho Code
- IDAPA 58.01.20 – Chapters 1 and 76, Title 39, Idaho Code; Safe Drinking Water Act, 42 U.S.C. § 300f *et seq.*
- IDAPA 58.01.25 – Chapter 1, Title 39, Idaho Code; Clean Water Act, 33 U.S.C. §§ 1342 and 1345

**DESCRIPTIVE SUMMARY:** The following is the required finding and concise statement of its supporting reasons for adopting temporary rules:

On February 13, 2020, the Board adopted as temporary fee rules the IDAPA 58 rule chapters as they were presented in the pending rule dockets adopted by the Board in 2019 and submitted to the Second Regular Session of the 65th Idaho Legislature for review (2019 pending rule dockets). The 2019 pending rule dockets are posted in the [2020 Legislative Rules Review Books](#). The IDAPA 58 fee rule chapters and the 2019 pending rule dockets are listed below. More information regarding this rule docket is available at <http://www.deq.idaho.gov/laws-rules-etc/deq-rulemakings/58-0000-2000f/>.

- IDAPA 58.01.01, *Rules for the Control of Air Pollution in Idaho*
  - Docket No. 58-0101-1903
  - Docket No. 58-0101-1904
  - Docket No. 58-0101-1905
- IDAPA 58.01.05, *Rules and Standards for Hazardous Waste*
  - Docket No. 58-0000-1900F
  - Docket No. 58-0105-1901
- IDAPA 58.01.06, *Solid Waste Management Rules*
  - Docket No. 58-0000-1900F



- IDAPA 58.01.07, *Rules Regulating Underground Storage Tank Systems*
  - Docket No. 58-0000-1900F
- IDAPA 58.01.08, *Idaho Rules for Public Drinking Water Systems*
  - Docket No. 58-0000-1900F
- IDAPA 58.01.09, *Rules Regulating Swine Facilities*
  - Docket No. 58-0109-1901
- IDAPA 58.01.11, *Ground Water Quality Rule*
  - Docket No. 58-0111-1901
- IDAPA 58.01.12, *Rules for Administration of Water Pollution Control Loans*
  - Docket No. 58-0000-1900F
- IDAPA 58.01.13, *Rules for Ore Processing by Cyanidation*
  - Docket No. 58-0000-1900F
- IDAPA 58.01.14, *Rules Governing Fees for Environmental Operating Permits, Licenses, and Inspection Services*
  - Docket No. 58-0000-1900F
- IDAPA 58.01.18, *Idaho Land Remediation Rules*
  - Docket No. 58-0000-1900F
- IDAPA 58.01.20, *Rules for Administration of Drinking Water Loan Program*
  - Docket No. 58-0000-1900F
- IDAPA 58.01.25, *Rules Regulating the Idaho Pollutant Discharge Elimination System Program*
  - Docket No. 58-0000-1900F

**TEMPORARY RULE JUSTIFICATION:** Pursuant to Sections 67-5226(1) and 67-5226(2), Idaho Code, the Governor has found that temporary adoption of the rule is appropriate for the following reasons:

These temporary rules are necessary to protect the public health, safety, and welfare of the citizens of Idaho and confer a benefit on its citizens. These temporary rules implement the duly enacted laws of the state of Idaho, provide citizens with the detailed rules and standards for complying with those laws, and assist in the orderly execution and enforcement of those laws. The expiration of these rules without due consideration and processes would undermine the public health, safety, and welfare of the citizens of Idaho and deprive them of the benefit intended by these rules. DEQ would not be able to fulfill its statutory obligations without these rules. The state of Idaho would lose primacy over federal environmental laws without these rules. These rules are central to DEQ's mission to protect human health and the quality of Idaho's air, land, and water.

**FEE SUMMARY:** Pursuant to Section 67-5226(2), Idaho Code, the Governor has found that the fees or charges being imposed are justified and necessary to avoid immediate danger and the fees are described below. This rulemaking does not impose a fee or charge beyond what was previously approved and codified.

The fees authorized in the Idaho Code sections listed below are part of the agency's 2021 budget that relies upon the existence of these fees or charges to meet the state's obligations and provide necessary state services. Failing to reauthorize these temporary rules would create immediate danger to the state budget, immediate danger to necessary state functions and services, and immediate danger of a violation of Idaho's constitutional requirement that it balance its budget. Temporary adoption of these rules is necessary to ensure that (1) the state of Idaho maintains primacy over federal programs; (2) DEQ is able to continue to offer services such as permit and license issuance; and (3) DEQ is able to continue to administer programs such as voluntary remediation, and the wastewater and drinking water loan programs.

Listed below are the DEQ fee rule chapters, fee categories, and the statutory authority for imposition of the fees.

- IDAPA 58.01.01, *Rules for the Control of Air Pollution in Idaho* – Idaho Code § 39-114(4), crop residue burn fee; Idaho Code § 39-115(3), application fee for industrial or commercial air pollution source permits; Idaho Code § 39-116B, motor vehicle inspection fee;
- IDAPA 58.01.05, *Rules and Standards for Hazardous Waste* – Idaho Code § 39-5813(3), hazardous waste siting license fee;
- IDAPA 58.01.06, *Solid Waste Management Rules* – Idaho Code § 39-7408(C), commercial solid waste siting license fee;
- IDAPA 58.01.07, *Rules Regulating Underground Storage Tank Systems* – Idaho Code §§ 39-119, 39-8802(d), annual UST fee;
- IDAPA 58.01.08, *Idaho Rules for Public Drinking Water Systems* – Idaho Code § 39-119, annual drinking water system fee;
- IDAPA 58.01.09, *Rules Regulating Swine Facilities* – Idaho Code § 39-119, permit application fee;
- IDAPA 58.01.11, *Ground Water Quality Rule* – Idaho Code § 39-119, point of compliance application fee;
- IDAPA 58.01.12, *Rules for Administration of Water Pollution Control Loans* – Idaho Code §§ 39-119, 39-3627(4), loan fee to offset costs of administering loan program;
- IDAPA 58.01.13, *Rules for Ore Processing by Cyanidation* – Idaho Code § 39-118A(2)(c), permit application fee;
- IDAPA 58.01.14, *Rules Governing Fees for Environmental Operating Permits, Licenses, and Inspection Services* – Idaho Code § 39-119, fees for environmental operating permits, licenses, inspection services and waiver application processing;
- IDAPA 58.01.18, *Idaho Land Remediation Rules* – Idaho Code § 39-7210(5), voluntary remediation program application fee;
- IDAPA 58.01.20, *Rules for Administration of Drinking Water Loan Program* – Idaho Code §§ 39-119, 39-3627(4), loan fee to offset costs of administering loan program;
- IDAPA 58.01.25, *Rules Regulating the Idaho Pollutant Discharge Elimination System Program* – Idaho Code § 39-175C.

**ASSISTANCE ON TECHNICAL QUESTIONS:** For assistance on technical questions concerning the temporary fee rules, contact the undersigned.

DATED this 13th day of February, 2020

Paula J. Wilson  
Department of Environmental Quality  
1410 N. Hilton Street  
Boise, Idaho 83706  
Phone: (208) 373-0418  
Fax No.: (208) 373-0481  
[paula.wilson@deq.idaho.gov](mailto:paula.wilson@deq.idaho.gov)

# IDAPA 58 – DEPARTMENT OF ENVIRONMENTAL QUALITY

## 58.01.01 – RULES FOR THE CONTROL OF AIR POLLUTION IN IDAHO

### 000. LEGAL AUTHORITY.

The Board of Environmental Quality is authorized to promulgate rules for the Department of Environmental Quality governing air pollution pursuant to Sections 39-105 and 39-107, Idaho Code. (3-20-20)T

### 001. TITLE AND SCOPE.

These rules are titled IDAPA 58.01.01, Rules of the Department of Environmental Quality, IDAPA 58.01.01, “Rules for the Control of Air Pollution in Idaho.” These rules provide for the control of air pollution in Idaho. (3-20-20)T

### 002. WRITTEN INTERPRETATIONS.

The Department of Environmental Quality has written statements which pertain to the interpretation of the rules of this chapter, or to the documentation of compliance with the rules of this chapter. The written statements are available for public inspection and copying at cost at the Department of Environmental Quality, 1410 N. Hilton, Boise, Idaho 83706-1255 at (208) 373-0502. (3-20-20)T

### 003. ADMINISTRATIVE APPEALS.

Persons may be entitled to appeal agency actions authorized under this chapter pursuant to IDAPA 58.01.23, “Rules of Administrative Procedure Before the Board of Environmental Quality.” (3-20-20)T

### 004. (RESERVED)

### 005. DEFINITIONS.

The purpose of Sections 005 through 008 is to assemble definitions used throughout this chapter. (3-20-20)T

### 006. GENERAL DEFINITIONS.

**01. Accountable.** Any SIP emission trading program must account for the aggregate effect of the emissions trades in the demonstration of reasonable further progress, attainment, or maintenance. (3-20-20)T

**02. Act.** The Environmental Protection and Health Act of 1972 as amended (Sections 39-101 through 39-130, Idaho Code). (3-20-20)T

**03. Actual Emissions.** The actual rate of emissions of a pollutant from an emissions unit as determined in accordance with the following: (3-20-20)T

**a.** In general, actual emissions as of a particular date shall equal the average rate, in tons per year, at which the unit actually emitted the pollutant during a two-year period which precedes the particular date and which is representative of normal source operation. The Department shall allow the use of a different time period upon a determination that it is more representative of normal source operation. Actual emissions shall be calculated using the unit’s actual operating hours, production rates, and types of materials processed, stored, or combusted during the selected time period. (3-20-20)T

**b.** The Department may presume that the source-specific allowable emissions for the unit are equivalent to actual emissions of the unit. (3-20-20)T

**c.** For any emissions unit (other than an electric utility steam generating unit as specified below) which has not yet begun normal operations on the particular date, actual emissions shall equal the potential to emit of the unit on that date. (3-20-20)T

**d.** For an electric utility steam generating unit (other than a new unit or the replacement of an existing unit) actual emissions of the unit following the physical or operational change shall equal the representative actual annual emissions of the unit, provided the source owner or operator maintains and submits to the Department, on an annual basis for a period of five (5) years from the date the unit resumes regular operation, information demonstrating that the physical or operational change did not result in an emissions increase. A longer period, not to exceed ten (10) years may be required by the Department if it determines such a period to be more representative of normal source post-change operations. (3-20-20)T

**04. Adverse Impact on Visibility.** Visibility impairment which interferes with the management,

protection, preservation, or enjoyment of the visitor's visual experience of the Federal Class I Area. This determination must be made on a case-by-case basis taking into account the geographic extent, intensity, duration, frequency, and time of visibility impairments, and how these factors correlate with: (3-20-20)T

- a. Times of visitor use of the Federal Class I Area; and (3-20-20)T
- b. The frequency and timing of natural conditions that reduce visibility. (3-20-20)T
- c. This term does not include affects on integral vistas when applied to 40 CFR 51.307. (3-20-20)T

**05. Air Pollutant/Air Contaminant.** Any substance, including but not limited to, dust, fume, gas, mist, odor, smoke, vapor, pollen, soot, carbon or particulate matter or any combination thereof. (3-20-20)T

**06. Air Pollution.** The presence in the outdoor atmosphere of any air pollutant or combination thereof in such quantity of such nature and duration and under such conditions as would be injurious to human health or welfare, to animal or plant life, or to property, or to interfere unreasonably with the enjoyment of life or property. (3-20-20)T

**07. Air Quality.** The specific measurement in the ambient air of a particular air pollutant at any given time. (3-20-20)T

**08. Air Quality Criterion.** The information used as guidelines for decisions when establishing air quality goals and air quality standards. (3-20-20)T

**09. Allowable Emissions.** The allowable emissions rate of a stationary source or facility calculated using the maximum rated capacity of the source or facility (unless the source or facility is subject to federally enforceable limits which restrict the operating rate, or hours of operation, or both) and the most stringent of the following: (3-20-20)T

- a. The applicable standards set forth in 40 CFR part 60 and 61; (3-20-20)T
- b. Any applicable State Implementation Plan emissions limitation including those with a future compliance date; or (3-20-20)T
- c. The emissions rate specified as a federally enforceable permit condition, including those with a future compliance date. (3-20-20)T

**10. Ambient Air.** That portion of the atmosphere, external to buildings, to which the general public has access. (3-20-20)T

**11. Ambient Air Quality Violation.** Any ambient concentration that causes or contributes to an exceedance of a national ambient air quality standard as determined by 40 CFR Part 50. (3-20-20)T

**12. Atmospheric Stagnation Advisory.** An air pollution alert declared by the Department when air pollutant impacts have been observed and/or meteorological conditions are conducive to additional air pollutant buildup. (3-20-20)T

**13. Attainment Area.** Any area which is designated, pursuant to 42 U.S.C. Section 7407(d), as having ambient concentrations equal to or less than national primary or secondary ambient air quality standards for a particular air pollutant or air pollutants. (3-20-20)T

**14. BART-Eligible Source.** Any of the following stationary sources of air pollutants, including any reconstructed source, which was not in operation prior to August 7, 1962, and was in existence on August 7, 1977, and has the potential to emit two hundred fifty (250) tons per year or more of any air pollutant. In determining potential to emit, fugitive emissions, to the extent quantifiable, must be counted. (3-20-20)T

- a. Fossil-fuel fired steam electric plants of more than two hundred fifty (250) million BTU's per hour

heat input;		(3-20-20)T
<b>b.</b>	Coal cleaning plants (thermal dryers);	(3-20-20)T
<b>c.</b>	Kraft pulp mills;	(3-20-20)T
<b>d.</b>	Portland cement plants;	(3-20-20)T
<b>e.</b>	Primary zinc smelters;	(3-20-20)T
<b>f.</b>	Iron and steel mill plants;	(3-20-20)T
<b>g.</b>	Primary aluminum ore reduction plants;	(3-20-20)T
<b>h.</b>	Primary copper smelters;	(3-20-20)T
day;	<b>i.</b> Municipal incinerators capable of charging more than two hundred fifty (250) tons of refuse per	(3-20-20)T
	<b>j.</b> Hydrofluoric, sulfuric, and nitric acid plants;	(3-20-20)T
	<b>k.</b> Petroleum refineries;	(3-20-20)T
	<b>l.</b> Lime plants;	(3-20-20)T
	<b>m.</b> Phosphate rock processing plants;	(3-20-20)T
	<b>n.</b> Coke oven batteries;	(3-20-20)T
	<b>o.</b> Sulfur recovery plants;	(3-20-20)T
	<b>p.</b> Carbon black plants (furnace process);	(3-20-20)T
	<b>q.</b> Primary lead smelters;	(3-20-20)T
	<b>r.</b> Fuel conversion plants;	(3-20-20)T
	<b>s.</b> Sintering plants;	(3-20-20)T
	<b>t.</b> Secondary metal production facilities;	(3-20-20)T
	<b>u.</b> Chemical process plants;	(3-20-20)T
	<b>v.</b> Fossil-fuel boilers of more than two hundred fifty (250) million BTU's per hour heat input;	(3-20-20)T
(300,000) barrels;	<b>w.</b> Petroleum storage and transfer facilities with a capacity exceeding three hundred thousand	(3-20-20)T
	<b>x.</b> Taconite ore processing facilities;	(3-20-20)T
	<b>y.</b> Glass fiber processing plants; and	(3-20-20)T
	<b>z.</b> Charcoal production facilities.	(3-20-20)T
	<b>15. Baseline (Area, Concentration, Date).</b> See Section 579.	(3-20-20)T

- 16. Best Available Retrofit Technology (BART).** Means an emission limitation based on the degree of reduction achievable through the application of the best system of continuous emission reduction for each pollutant which is emitted by an existing stationary facility. The emission limitation must be established, on a case-by-case basis, taking into consideration the technology available, the costs of compliance, the energy and non-air quality environmental impacts of compliance, any pollution control equipment in use or in existence at the source, the remaining useful life of the source, and the degree of improvement in visibility which may reasonably be anticipated to result from the use of such technology. (3-20-20)T
- 17. Board.** Idaho Board of Environmental Quality. (3-20-20)T
- 18. Breakdown.** An unplanned failure of any equipment or emissions unit which may cause excess emissions. (3-20-20)T
- 19. BTU.** British thermal unit. (3-20-20)T
- 20. Clean Air Act.** The federal Clean Air Act, 42 U.S.C. Sections 7401 through 7671q. (3-20-20)T
- 21. Collection Efficiency.** The overall performance of the air cleaning device in terms of ratio of materials collected to total input to the collector unless specific size fractions of the contaminant are stated or required. (3-20-20)T
- 22. Commence Construction or Modification.** In general, this means initiation of physical on-site construction activities on an emissions unit which are of a permanent nature. Such activities include, but are not limited to, installation of building supports and foundations, laying of underground pipework, and construction of permanent storage structures. With respect to a change in method of operation, this term refers to those on-site activities, other than preparatory activities, which mark the initiation of the change. (3-20-20)T
- 23. Complete.** A determination made by the Department that all information needed to process a permit application has been submitted for review. (3-20-20)T
- 24. Construction.** Fabrication, erection, installation, or modification of a stationary source or facility. (3-20-20)T
- 25. Control Equipment.** Any method, process or equipment which removes, reduces or renders less noxious, air pollutants discharged into the atmosphere. (3-20-20)T
- 26. Controlled Emission.** An emission which has been treated by control equipment to remove all or part of an air pollutant before release to the atmosphere. (3-20-20)T
- 27. Criteria Air Pollutant.** Any of the following: PM<sub>10</sub>; PM<sub>2.5</sub>; sulfur oxides; ozone, nitrogen dioxide; carbon monoxide; lead. (3-20-20)T
- 28. Deciview.** A measurement of visibility impairment. A deciview is a haze index derived from calculated light extinction, such that uniform changes in haziness correspond to uniform incremental changes in perception across the entire range of conditions, from pristine to highly impaired. The deciview haze index is calculated based on the following equation (for the purposes of calculating deciview, the atmospheric light extinction coefficient must be calculated from aerosol measurements): Deciview Haze Index =  $10 \ln_e (b_{\text{ext}}/10\text{Mm}^{-1})$  where  $b_{\text{ext}}$  = the atmospheric light extinction coefficient, expressed in inverse megameters ( $\text{Mm}^{-1}$ ). (3-20-20)T
- 29. Department.** The Department of Environmental Quality. (3-20-20)T
- 30. Designated Facility.** Any of the following facilities: (3-20-20)T
- a.** Fossil-fuel fired steam electric plants of more than two hundred fifty (250) million BTU's per hour heat input; (3-20-20)T
- b.** Coal cleaning plants (thermal dryers); (3-20-20)T

- c. Kraft pulp mills; (3-20-20)T
- d. Portland cement plants; (3-20-20)T
- e. Primary zinc smelters; (3-20-20)T
- f. Iron and steel mill plants; (3-20-20)T
- g. Primary aluminum ore reduction plants; (3-20-20)T
- h. Primary copper smelters; (3-20-20)T
- i. Municipal incinerators capable of charging more than two hundred and fifty (250) tons of refuse per day; (3-20-20)T
- j. Hydrofluoric, sulfuric, and nitric acid plants; (3-20-20)T
- k. Petroleum refineries; (3-20-20)T
- l. Lime plants; (3-20-20)T
- m. Phosphate rock processing plants; (3-20-20)T
- n. Coke oven batteries; (3-20-20)T
- o. Sulfur recovery plants; (3-20-20)T
- p. Carbon black plants (furnace process); (3-20-20)T
- q. Primary lead smelters; (3-20-20)T
- r. Fuel conversion plants; (3-20-20)T
- s. Sintering plants; (3-20-20)T
- t. Secondary metal production facilities; (3-20-20)T
- u. Chemical process plants; (3-20-20)T
- v. Fossil-fuel boilers (or combination thereof) of more than two hundred and fifty (250) million BTU's per hour heat input; (3-20-20)T
- w. Petroleum storage and transfer facilities with a capacity exceeding three hundred thousand (300,000) barrels; (3-20-20)T
- x. Taconite ore processing facilities; (3-20-20)T
- y. Glass fiber processing plants; and (3-20-20)T
- z. Charcoal production facilities. (3-20-20)T
- 31. **Director.** The Director of the Department of Environmental Quality or his designee. (3-20-20)T
- 32. **Effective Dose Equivalent.** The sum of the products of absorbed dose and appropriate factors to account for differences in biological effectiveness due to the quality of radiation and its distribution in the body of reference man. The unit of the effective dose equivalent is the rem. It is generally calculated as an annual dose. (3-20-20)T
- 33. **Emission.** Any controlled or uncontrolled release or discharge into the outdoor atmosphere of any

air pollutants or combination thereof. Emission also includes any release or discharge of any air pollutant from a stack, vent, or other means into the outdoor atmosphere that originates from an emission unit. (3-20-20)T

**34. Emission Standard.** A permit or regulatory requirement established by the Department or EPA which limits the quantity, rate, or concentration of emissions of air pollutants on a continuous basis, including any requirements which limit the level of opacity, prescribe equipment, set fuel specifications, or prescribe operation or maintenance procedures for a source to assure continuous emission reduction. (3-20-20)T

**35. Emissions Unit.** An identifiable piece of process equipment or other part of a facility which emits or may emit any air pollutant. This definition does not alter or affect the term “unit” for the purposes of 42 U.S.C. Sections 7651 through 7651o. (3-20-20)T

**36. EPA.** The United States Environmental Protection Agency and its Administrator or designee. (3-20-20)T

**37. Environmental Remediation Source.** A stationary source that functions to remediate or recover any release, spill, leak, discharge or disposal of any petroleum product or petroleum substance, any hazardous waste or hazardous substance from any soil, ground water or surface water, and shall have an operational life no greater than five (5) years from the inception of any operations to the cessation of actual operations. Nothing in this definition shall be construed so as to actually limit remediation projects to five (5) years or less of total operation. (3-20-20)T

**38. Excess Emissions.** Emissions that exceed an applicable emissions standard established for any facility, source or emissions unit by statute, regulation, rule, permit, or order. (3-20-20)T

**39. Existing Stationary Source or Facility.** Any stationary source or facility that exists, is installed, or is under construction on the original effective date of any applicable provision of this chapter. (3-20-20)T

**40. Facility.** All of the pollutant-emitting activities which belong to the same industrial grouping, are located on one (1) or more contiguous or adjacent properties, and are under the control of the same person (or persons under common control). Pollutant-emitting activities shall be considered as part of the same industrial grouping if they belong to the same Major Group (i.e. which have the same two-digit code) as described in the Standard Industrial Classification Manual. The fugitive emissions shall not be considered in determining whether a permit is required unless required by federal law. (3-20-20)T

**41. Federal Class I Area.** Any federal land that is classified or reclassified “Class I.” (3-20-20)T

**42. Federal Land Manager.** The Secretary of the department with authority over the Federal Class I Area (or the Secretary's designee). (3-20-20)T

**43. Federally Enforceable.** All limitations and conditions which are enforceable by EPA and the Department under the Clean Air Act, including those requirements developed pursuant to 40 CFR Parts 60 and 61 requirements within any applicable State Implementation Plan, and any permit requirements established pursuant to 40 CFR 52.21 or under regulations approved pursuant to 40 CFR Parts 51, 52, 60, or 63. (3-20-20)T

**44. Fire Hazard.** The presence or accumulation of combustible material of such nature and in sufficient quantity that its continued existence constitutes an imminent and substantial danger to life, property, public welfare or adjacent lands. (3-20-20)T

**45. Fuel-Burning Equipment.** Any furnace, boiler, apparatus, stack and all appurtenances thereto, used in the process of burning fuel for the primary purpose of producing heat or power by indirect heat transfer. (3-20-20)T

**46. Fugitive Dust.** Fugitive emissions composed of particulate matter. (3-20-20)T

**47. Fugitive Emissions.** Those emissions which could not reasonably pass through a stack, chimney, vent, or other functionally equivalent opening. (3-20-20)T



- 48. Garbage.** Any waste consisting of putrescible animal and vegetable materials resulting from the handling, preparation, cooking and consumption of food including, but not limited to, waste materials from households, markets, storage facilities, handling and sale of produce and other food products. (3-20-20)T
- 49. Gasoline.** Any mixture of volatile hydrocarbons suitable as a fuel for the propulsion of motor vehicles or motor boats. Gasoline also means aircraft engine fuels when used for the operation or propulsion of motor vehicles or motor boats and includes gasohol, but does not include special fuels. (3-20-20)T
- 50. Gasoline Cargo Tank.** Any tank or trailer used for the transport of gasoline from sources of supply to underground gasoline storage tanks. (3-20-20)T
- 51. Gasoline Dispensing Facility (GDF).** Any facility with underground gasoline storage tanks used for dispensing gasoline. (3-20-20)T
- 52. Grain Elevator.** Any plant or installation at which grain is unloaded, handled, cleaned, dried, stored, or loaded. (3-20-20)T
- 53. Grain Storage Elevator.** Any grain elevator located at any wheat flour mill, wet corn mill, dry corn mill (human consumption), rice mill, or soybean extraction plant which has a permanent grain storage capacity of thirty five thousand two hundred (35,200) cubic meters (ca. 1 million bushels). (3-20-20)T
- 54. Grain Terminal Elevator.** Any grain elevator which has a permanent storage capacity of more than eighty-eight thousand one hundred (88,100) cubic meters (ca. 2.5 million bushels), except those located at animal food manufacturers, pet food manufacturers, cereal manufacturers, breweries, and livestock feedlots. (3-20-20)T
- 55. Hazardous Air Pollutant (HAP).** Any air pollutant listed pursuant to Section 112(b) of the Clean Air Act. Hazardous Air Pollutants are regulated air pollutants. (3-20-20)T
- 56. Hazardous Waste.** Any waste or combination of wastes of a solid, liquid, semisolid, or contained gaseous form which, because of its quantity, concentration or characteristics (physical, chemical or biological) may:
- a.** Cause or significantly contribute to an increase in deaths or an increase in serious, irreversible, or incapacitating reversible illnesses; or (3-20-20)T
  - b.** Pose a substantial threat to human health or to the environment if improperly treated, stored, disposed of, or managed. Such wastes include, but are not limited to, materials which are toxic, corrosive, ignitable, or reactive, or materials which may have mutagenic, teratogenic, or carcinogenic properties; provided that such wastes do not include solid or dissolved material in domestic sewage, or solid or dissolved materials in irrigation return flows or industrial discharges which are allowed under a national pollution discharge elimination system permit, or source, special nuclear, or by-product material as defined by 42 U.S.C. Sections 2014(e),(z) or (aa). (3-20-20)T
- 57. Hot-Mix Asphalt Plant.** Those facilities conveying proportioned quantities or batch loading of cold aggregate to a drier, and heating, drying, screening, classifying, measuring and mixing the aggregate and asphalt for the purpose of paving, construction, industrial, residential or commercial use. (3-20-20)T
- 58. Incinerator.** Any source consisting of a furnace and all appurtenances thereto designed for the destruction of refuse by burning. "Open Burning" is not considered incineration. For purposes of these rules, the destruction of any combustible liquid or gaseous material by burning in a flare stack shall be considered incineration. (3-20-20)T
- 59. Indian Governing Body.** The governing body of any tribe, band, or group of Indians subject to the jurisdiction of the United States and recognized by the United States as possessing power of self-government. (3-20-20)T

- 60. Integral Vista.** A view perceived from within the mandatory Class I Federal Area of a specific landmark or panorama located outside the boundary of the mandatory Class I Federal Area. (3-20-20)T
- 61. Kraft Pulping.** Any pulping process which uses, for a cooking liquor, an alkaline sulfide solution containing sodium hydroxide and sodium sulfide. (3-20-20)T
- 62. Least Impaired Days.** The average visibility impairment (measured in deciviews) for the twenty percent (20%) of monitored days in a calendar year with the lowest amount of visibility impairment. (3-20-20)T
- 63. Lowest Achievable Emission Rate (LAER).** For any source, the more stringent rate of emissions based on the following: (3-20-20)T
- a.** The most stringent emissions limitation which is contained in any State Implementation Plan for such class or category of facility, unless the owner or operator of the proposed facility demonstrates that such limitations are not achievable; or (3-20-20)T
  - b.** The most stringent emissions limitation which is achieved in practice by such class or category of facilities. This limitation, when applied to a modification, means the lowest achievable emissions rate for the new or modified emissions units within the facility. In no event shall the application of the term permit a proposed new or modified facility to emit any pollutant in excess of the amount allowable under an applicable new source standard of performance. (3-20-20)T
- 64. Mandatory Class I Federal Area.** Any area identified in 40 CFR 81.400 through 81.437. (3-20-20)T
- 65. Member of the Public.** For purposes of Subsection 006.108.a.xvi., a person located at any off-site point where there is a residence, school, business or office. (3-20-20)T
- 66. Mercury.** Total mercury including elemental mercury and mercury compounds. (3-20-20)T
- 67. Mercury Best Available Control Technology (MBACT).** An emission standard for mercury based on the maximum degree of reduction practically achievable as specified by the Department on an individual case-by-case basis taking into account energy, economic and environmental impacts, and other relevant impacts specific to the source. A Department approved MBACT shall be valid until the source subject to the MBACT is modified. If the proposed modification to the source subject to MBACT occurs within ten (10) years of the MBACT determination, a new MBACT review shall not be triggered as long as the source can meet the existing MBACT requirements. If the proposed modification occurs more than ten (10) years after the MBACT determination, then the proposed modification shall be subject to a new MBACT review. (3-20-20)T
- 68. Modification.** (3-20-20)T
- a.** Any physical change in, or change in the method of operation of, a stationary source or facility which results in an emission increase as defined in Section 007 or which results in the emission of any regulated air pollutant not previously emitted. (3-20-20)T
  - b.** Any physical change in, or change in the method of operation of, a stationary source or facility which results in an increase in the emissions rate of any state only toxic air pollutant, or emissions of any state only toxic air pollutant not previously emitted. (3-20-20)T
  - c.** Fugitive emissions shall not be considered in determining whether a permit is required for a modification unless required by federal law. (3-20-20)T
  - d.** For purposes of this definition of modification, routine maintenance, repair and replacement shall not be considered physical changes and the following shall not be considered a change in the method of operation: (3-20-20)T

- i. An increase in the production rate if such increase does not exceed the operating design capacity of the affected stationary source, and if a more restrictive production rate is not specified in a permit; (3-20-20)T
- ii. An increase in hours of operation if more restrictive hours of operation are not specified in a permit; and (3-20-20)T
- iii. Use of an alternative fuel or raw material if the stationary source is specifically designed to accommodate such fuel or raw material before January 6, 1975 and use of such fuel or raw material is not specifically prohibited in a permit. (3-20-20)T

**69. Monitoring.** Sampling and analysis, in a continuous or noncontinuous sequence, using techniques which will adequately measure emission levels and/or ambient air concentrations of air pollutants. (3-20-20)T

**70. Most Impaired Days.** The average visibility impairment (measured in deciviews) for the twenty percent (20%) of monitored days in a calendar year with the highest amount of visibility impairment. (3-20-20)T

**71. Multiple Chamber Incinerator.** Any article, machine, equipment, contrivance, structure or part of a structure used to dispose of combustible refuse by burning, consisting of three (3) or more refractory lined combustion furnaces in series physically separated by refractory walls, interconnected by gas passage ports or ducts and employing adequate parameters necessary for maximum combustion of the material to be burned. (3-20-20)T

**72. Natural Conditions.** Includes naturally occurring phenomena that reduce visibility as measured in terms of light extinction, visual range, contrast, or coloration. (3-20-20)T

**73. New Stationary Source or Facility.** (3-20-20)T

**a.** Any stationary source or facility, the construction or modification of which is commenced after the original effective date of any applicable provision of this chapter; or (3-20-20)T

**b.** The restart of a nonoperating facility shall be considered a new stationary source or facility if: (3-20-20)T

i. The restart involves a modification to the facility; or (3-20-20)T

ii. After the facility has been in a nonoperating status for a period of two (2) years, and the Department receives an application for a Permit to Construct in the area affected by the existing nonoperating facility, the Department will, within five (5) working days of receipt of the application notify the nonoperating facility of receipt of the application for a Permit to Construct. Upon receipt of this Departmental notification, the nonoperating facility will comply with the following restart schedule or be considered a new stationary source or facility when it does restart: Within thirty (30) working days after receipt of the Department's notification of the application for a Permit to Construct, the nonoperating facility shall provide the Department with a schedule detailing the restart of the facility. The restart must begin within sixty (60) days of the date the Department receives the restart schedule. (3-20-20)T

**74. Nonattainment Area.** Any area which is designated, pursuant to 42 U.S.C. Section 7407(d), as not meeting (or contributes to ambient air quality in a nearby area that does not meet) the national primary or secondary ambient air quality standard for the pollutant. (3-20-20)T

**75. Noncondensibles.** Gases and vapors from processes that are not condensed at standard temperature and pressure unless otherwise specified. (3-20-20)T

**76. Odor.** The sensation resulting from stimulation of the human sense of smell. (3-20-20)T

**77. Opacity.** A state which renders material partially or wholly impervious to rays of light and causes obstruction of an observer's view, expressed as percent. (3-20-20)T

**78. Open Burning.** The burning of any matter in such a manner that the products of combustion

resulting from the burning are emitted directly into the ambient air without passing through a stack, duct or chimney. (3-20-20)T

**79. Operating Permit.** A permit issued by the Director pursuant to Sections 300 through 386 and/or 400 through 461. (3-20-20)T

**80. Particulate Matter.** Any material, except water in uncombined form, that exists as a liquid or a solid at standard conditions. (3-20-20)T

**81. Particulate Matter Emissions.** All particulate matter emitted to the ambient air as measured by an applicable reference method, or any equivalent or alternative method in accordance with Section 157. (3-20-20)T

**82. Permit to Construct.** A permit issued by the Director pursuant to Sections 200 through 228. (3-20-20)T

**83. Person.** Any individual, association, corporation, firm, partnership or any federal, state or local governmental entity. (3-20-20)T

**84. PM<sub>10</sub>.** All particulate matter in the ambient air with an aerodynamic diameter less than or equal to a nominal ten (10) micrometers as measured by a reference method based on Appendix J of 40 CFR Part 50 and designated in accordance with 40 CFR Part 53 or by an equivalent method designated in accordance with 40 CFR Part 53. (3-20-20)T

**85. PM<sub>10</sub> Emissions.** All particulate matter, including condensible particulates, with an aerodynamic diameter less than or equal to a nominal ten (10) micrometers emitted to the ambient air as measured by an applicable reference method, or an equivalent or alternative method in accordance with Section 157. (3-20-20)T

**86. PM<sub>2.5</sub>.** All particulate matter in the ambient air with an aerodynamic diameter less than or equal to a nominal two point five (2.5) micrometers measured by a reference method based on Appendix L of 40 CFR Part 50 and designated in accordance with 40 CFR Part 53 or by an equivalent method designated in accordance with 40 CFR Part 53. (3-20-20)T

**87. PM<sub>2.5</sub> Emissions.** All particulate matter, including condensible particulates, with an aerodynamic diameter less than or equal to a nominal two point five (2.5) micrometers emitted to the ambient air as measured by an applicable reference method, or an equivalent or alternative method in accordance with Section 157. (3-20-20)T

**88. Potential to Emit/Potential Emissions.** The maximum capacity of a facility or stationary source to emit an air pollutant under its physical and operational design. Any physical or operational limitation on the capacity of the facility or source to emit an air pollutant, including air pollution control equipment and restrictions on hours of operation or on the type or amount of material combusted, stored or processed, shall be treated as part of its design if the limitation or the effect it would have on emissions is state or federally enforceable. Secondary emissions do not count in determining the potential to emit of a facility or stationary source. (3-20-20)T

**89. Portable Equipment.** Equipment which is designed to be dismantled and transported from one (1) job site to another job site. (3-20-20)T

**90. PPM (parts per million).** Parts of a gaseous contaminant per million parts of gas by volume. (3-20-20)T

**91. Prescribed Fire Management Burning.** The controlled application of fire to wildland fuels in either their natural or modified state under such conditions of weather, fuel moisture, soil moisture, etc., as will allow the fire to be confined to a predetermined area and at the same time produce the intensity of heat and rate of spread required to accomplish planned objectives, including: (3-20-20)T

**a.** Fire hazard reduction; (3-20-20)T

**b.** The control of pests, insects, or diseases; (3-20-20)T

- c. The promotion of range forage improvements; (3-20-20)T
- d. The perpetuation of natural ecosystems; (3-20-20)T
- e. The disposal of woody debris resulting from a logging operation, the clearing of rights of way, a land clearing operation, or a driftwood collection system; (3-20-20)T
- f. The preparation of planting and seeding sites for forest regeneration; and (3-20-20)T
- g. Other accepted natural resource management purposes. (3-20-20)T
- 92. Primary Ambient Air Quality Standard.** That ambient air quality which, allowing an adequate margin of safety, is requisite to protect the public health. (3-20-20)T
- 93. Process or Process Equipment.** Any equipment, device or contrivance for changing any materials whatever or for storage or handling of any materials, and all appurtenances thereto, including ducts, stack, etc., the use of which may cause any discharge of an air pollutant into the ambient air but not including that equipment specifically defined as fuel-burning equipment or refuse-burning equipment. (3-20-20)T
- 94. Process Weight.** The total weight of all materials introduced into any source operation which may cause any emissions of particulate matter. Process weight includes solid fuels charged, but does not include liquid and gaseous fuels charged or combustion air. Water which occurs naturally in the feed material shall be considered part of the process weight. (3-20-20)T
- 95. Process Weight Rate.** The rate established as follows: (3-20-20)T
- a. For continuous or long-run steady-state source operations, the total process weight for the entire period of continuous operation or for a typical portion thereof, divided by the number of hours of such period or portion thereof; (3-20-20)T
- b. For cyclical or batch source operations, the total process weight for a period that covers a complete cycle of operation or an integral number of cycles, divided by the hours of actual process operation during such a period. Where the nature of any process or operation or the design of any equipment is such as to permit more than one (1) interpretation of this definition, the interpretation that results in the minimum value for allowable emission shall apply. (3-20-20)T
- 96. Quantifiable.** The Department must be able to determine the emissions impact of any SIP trading programs requirement(s) or emission limit(s). (3-20-20)T
- 97. Radionuclide.** A type of atom which spontaneously undergoes radioactive decay. (3-20-20)T
- 98. Regional Haze.** Visibility impairment that is caused by the emission of air pollutants from numerous sources located over a wide geographic area. Such sources include, but are not limited to, major and minor stationary sources, mobile sources, and area sources. (3-20-20)T
- 99. Regulated Air Pollutant.** (3-20-20)T
- a. For purposes of determining applicability of major source permit to operate requirements, issuing, and modifying permits pursuant to Sections 300 through 397, and in accordance with Title V of the federal Clean Air Act amendments of 1990, 42 U.S.C. Section 7661 et seq., "regulated air pollutant" shall have the same meaning as in Title V of the federal Clean Air Act amendments of 1990, and any applicable federal regulations promulgated pursuant to Title V of the federal Clean Air Act amendments of 1990, 40 CFR Part 70; (3-20-20)T
- b. For purposes of determining applicability of any other operating permit requirements, issuing, and modifying permits pursuant to Sections 400 through 410, the federal definition of "regulated air pollutant" as defined in Subsection 006.99.a. shall also apply; (3-20-20)T

**c.** For purposes of determining applicability of permit to construct requirements, issuing, and modifying permits pursuant to Sections 200 through 228, except Section 214, and in accordance with Part D of Subchapter I of the federal Clean Air Act, 42 U.S.C. Section 7501 et seq., “regulated air pollutant” shall mean those air contaminants that are regulated in non-attainment areas pursuant to Part D of Subchapter I of the federal Clean Air Act and applicable federal regulations promulgated pursuant to Part D of Subchapter I of the federal Clean Air Act, 40 CFR 51.165; and (3-20-20)T

**d.** For purposes of determining applicability of any other major or minor permit to construct requirements, issuing, and modifying permits pursuant to 200 through 228, except Section 214, “regulated air pollutant” shall mean those air contaminants that are regulated in attainment and unclassifiable areas pursuant to Part C of Subchapter I of the federal Clean Air Act, 40 CFR 52.21, and any applicable federal regulations promulgated pursuant to Part C of Subchapter I of the federal Clean Air Act, 42 U.S.C. Section 7470 et seq. (3-20-20)T

**100. Replicable.** Any SIP procedures for applying emission trading shall be structured so that two (2) independent entities would obtain the same result when determining compliance with the emission trading provisions. (3-20-20)T

**101. Responsible Official.** One (1) of the following: (3-20-20)T

**a.** For a corporation: a president, secretary, treasurer, or vice-president of the corporation in charge of a principal business function, or any other person who performs similar policy or decision-making functions for the corporation, or a duly authorized representative of such person if the representative is responsible for the overall operation of one (1) or more manufacturing, production, or operating facilities applying for or subject to a permit and either: (3-20-20)T

**i.** The facilities employ more than two hundred fifty (250) persons or have gross annual sales or expenditures exceeding twenty-five million dollars (\$25,000,000) (in second quarter 1980 dollars); or (3-20-20)T

**ii.** The delegation of authority to such representative is approved in advance by the Department. (3-20-20)T

**b.** For a partnership or sole proprietorship: a general partner or the proprietor, respectively. (3-20-20)T

**c.** For a municipality, State, Federal, or other public agency: either a principal executive officer or ranking elected official. For the purposes of Section 123, a principal executive officer of a Federal agency includes the chief executive officer having responsibility for the overall operations of a principal geographic unit of the agency (e.g., a Regional Administrator of EPA). (3-20-20)T

**d.** For Phase II sources: (3-20-20)T

**i.** The designated representative in so far as actions, standards, requirements, or prohibitions under 42 U.S.C. Sections 7651 through 7651o or the regulations promulgated thereunder are concerned; and (3-20-20)T

**ii.** The designated representative for any other purposes under 40 CFR Part 70. (3-20-20)T

**102. Safety Measure.** Any shutdown (and related startup) or bypass of equipment or processes undertaken to prevent imminent injury or death or severe damage to equipment or property which may cause excess emissions. (3-20-20)T

**103. Salvage Operation.** Any source consisting of any business, trade or industry engaged in whole or in part in salvaging or reclaiming any product or material, such as, but not limited to, reprocessing of used motor oils, metals, chemicals, shipping containers, or drums, and specifically including automobile graveyards and junkyards. (3-20-20)T

**104. Scheduled Maintenance.** Planned upkeep, repair activities and preventative maintenance on any

air pollution control equipment or emissions unit, including process equipment, and including shutdown and startup of such equipment. (3-20-20)T

**105. Secondary Ambient Air Quality Standard.** That ambient air quality which is requisite to protect the public welfare from any known or anticipated adverse effects associated with the presence of air pollutants in the ambient air. (3-20-20)T

**106. Secondary Emissions.** Emissions which would occur as a result of the construction, modification, or operation of a stationary source or facility, but do not come from the stationary source or facility itself. Secondary emissions must be specific, well defined, quantifiable, and affect the same general area as the stationary source, facility, or modification which causes the secondary emissions. Secondary emissions include emissions from any offsite support facility which would not be constructed or increase its emissions except as a result of the construction or operation of the primary stationary source, facility or modification. Secondary emissions do not include any emissions which come directly from a mobile source regulated under 42 U.S.C. Sections 7521 through 7590. (3-20-20)T

**107. Shutdown.** The normal and customary time period required to cease operations of air pollution control equipment or an emissions unit beginning with the initiation of procedures to terminate normal operation and continuing until the termination is completed. (3-20-20)T

**108. Significant.** In reference to a net emissions increase or the potential of a source to emit any of the following pollutants, a rate of emissions that would equal or exceed any of the following: (3-20-20)T

- a. Pollutant and emissions rate: (3-20-20)T
  - i. Carbon monoxide, one hundred (100) tons per year; (3-20-20)T
  - ii. Nitrogen oxides, forty (40) tons per year; (3-20-20)T
  - iii. Sulfur dioxide, forty (40) tons per year; (3-20-20)T
  - iv. Particulate matter: (3-20-20)T
    - (1) Twenty-five (25) tons per year of particulate matter emissions; (3-20-20)T
    - (2) Fifteen (15) tons per year of PM<sub>10</sub> emissions; or (3-20-20)T
    - (3) Ten (10) tons per year of direct PM<sub>2.5</sub> emissions; or forty (40) tons per year of sulfur dioxide emissions; or forty (40) tons per year of nitrogen oxide emissions; (3-20-20)T
  - v. Ozone, forty (40) tons per year of volatile organic compounds; (3-20-20)T
  - vi. Lead, six-tenths (0.6) of a ton per year; (3-20-20)T
  - vii. Fluorides, three (3) tons per year; (3-20-20)T
  - viii. Sulfuric acid mist, seven (7) tons per year; (3-20-20)T
  - ix. Hydrogen sulfide (H<sub>2</sub>S), ten (10) tons per year; (3-20-20)T
  - x. Total reduced sulfur (including H<sub>2</sub>S), ten (10) tons per year; (3-20-20)T
  - xi. Reduced sulfur compounds (including H<sub>2</sub>S), ten (10) tons per year; (3-20-20)T
  - xii. Municipal waste combustor organics (measured as total tetra- through octa-chlorinated dibenzo-p-dioxins and dibenzofurans), thirty-five ten-millionths (0.0000035) tons per year; (3-20-20)T
  - xiii. Municipal waste combustor metals (measured as particulate matter), fifteen (15) tons per year;

- (3-20-20)T
- xiv. Municipal waste combustor acid gases (measured as sulfur dioxide and hydrogen chloride), forty (40) tons per year; or (3-20-20)T
- xv. Municipal solid waste landfill emissions (measured as nonmethane organic compounds), fifty (50) tons per year. (3-20-20)T
- b.** In reference to a net emissions increase or the potential of a source or facility to emit a regulated air pollutant not listed in Subsection 006.108.a. above and not a toxic air pollutant, any emission rate; or (3-20-20)T
- c.** For a major facility or major modification which would be constructed within ten (10) kilometers of a Class I area, the emissions rate which would increase the ambient concentration of an emitted regulated air pollutant in the Class I area by one (1) microgram per cubic meter, twenty-four (24) hour average, or more. (3-20-20)T
- 109. Significant Contribution.** Any increase in ambient concentrations which would exceed the following: (3-20-20)T
- a.** Sulfur dioxide: (3-20-20)T
- i. One (1.0) microgram per cubic meter, annual average; (3-20-20)T
- ii. Five (5) micrograms per cubic meter, twenty-four (24) hour average; (3-20-20)T
- iii. Twenty-five (25) micrograms per cubic meter, three (3) hour average; (3-20-20)T
- b.** Nitrogen dioxide, one (1.0) microgram per cubic meter, annual average; (3-20-20)T
- c.** Carbon monoxide: (3-20-20)T
- i. One-half (0.5) milligrams per cubic meter, eight (8) hour average; (3-20-20)T
- ii. Two (2) milligrams per cubic meter, one (1) hour average; (3-20-20)T
- d.** PM<sub>10</sub>: (3-20-20)T
- i. One (1.0) microgram per cubic meter, annual average; (3-20-20)T
- ii. Five (5.0) micrograms per cubic meter, twenty-four (24) hour average; (3-20-20)T
- e.** PM<sub>2,5</sub>: (3-20-20)T
- i. Three-tenths (0.3) microgram per cubic meter, annual average; (3-20-20)T
- ii. One point two (1.2) micrograms per cubic meter, twenty-four (24) hour average. (3-20-20)T
- 110. Small Fire.** A fire in which the material to be burned is not more than four (4) feet in diameter nor more than three (3) feet high. (3-20-20)T
- 111. Smoke.** Small gas-borne particles resulting from incomplete combustion, consisting predominantly, but not exclusively, of carbon and other combustible material. (3-20-20)T
- 112. Smoke Management Plan.** A document issued by the Director to implement Sections 606 through 616, Categories of Allowable Burning. (3-20-20)T
- 113. Smoke Management Program.** A program whereby meteorological information, fuel conditions,



fire behavior, smoke movement and atmospheric dispersal conditions are used as a basis for scheduling the location, amount and timing of open burning operations so as to minimize the impact of such burning on identified smoke sensitive areas. (3-20-20)T

- 114. Source.** A stationary source. (3-20-20)T
- 115. Source Operation.** The last operation preceding the emission of air pollutants, when this operation:
- a.** Results in the separation of the air pollutants from the process materials or in the conversion of the process materials into air pollutants, as in the case of fuel combustion; and (3-20-20)T
  - b.** Is not an air cleaning device. (3-20-20)T
- 116. Special Fuels.** All fuel suitable as fuel for diesel engines; a compressed or liquefied gas obtained as a by-product in petroleum refining or natural gasoline manufacture, such as butane, isobutane, propane, propylene, butylenes, and their mixtures; and natural gas, either liquid or gas, and hydrogen, used for the generation of power for the operation or propulsion of motor vehicles. (3-20-20)T
- 117. Stack.** Any point in a source arranged to conduct emissions to the ambient air, including a chimney, flue, conduit, or duct but not including flares. (3-20-20)T
- 118. Stage 1 Vapor Collection.** Used during the refueling of underground gasoline storage tanks to reduce hydrocarbon emissions. Vapors in the tank, which are displaced by the incoming gasoline, are routed through a hose into the gasoline cargo tank and returned to the terminal for processing. Two (2) types of Stage 1 systems exist: coaxial and dual point. (3-20-20)T
- a.** Coaxial System. A Stage 1 vapor collection system that requires only one (1) tank opening. The tank opening is usually four (4) inches in diameter with a three (3) inch diameter product fill tube inserted into the opening. Fuel flows through the inner tube while vapors are displaced through the annular space between the inner and outer tubes. (3-20-20)T
  - b.** Dual Point System. A Stage 1 vapor collection system that consists of two (2) separate tank openings, one (1) for delivery of the product and the other for the recovery of vapors. (3-20-20)T
- 119. Standard Conditions.** Except as specified in Subsection 576.02 for ambient air quality standards, a dry gas temperature of twenty degrees Celsius (20C) sixty-eight degrees Fahrenheit (68F) and a gas pressure of seven hundred sixty (760) millimeters of mercury (14.7 pounds per square inch) absolute. (3-20-20)T
- 120. Startup.** The normal and customary time period required to bring air pollution control equipment or an emissions unit, including process equipment, from a nonoperational status into normal operation. (3-20-20)T
- 121. Stationary Source.** Any building, structure, facility, emissions unit, or installation which emits or may emit any air pollutant. The fugitive emissions shall not be considered in determining whether a permit is required unless required by federal law. (3-20-20)T
- 122. Tier I Source.** Any of the following: (3-20-20)T
- a.** Any source located at any major facility as defined in Section 008; (3-20-20)T
  - b.** Any source, including an area source, subject to a standard, limitation, or other requirement under 42 U.S.C. Section 7411 or 40 CFR Part 60, and required by EPA to obtain a Part 70 permit; (3-20-20)T
  - c.** Any source, including an area source, subject to a standard or other requirement under 42 U.S.C. Section 7412, 40 CFR Part 61 or 40 CFR Part 63, and required by EPA to obtain a Part 70 permit, except that a source is not required to obtain a permit solely because it is subject to requirements under 42 U.S.C. Section 7412(r); (3-20-20)T

- d. Any Phase II source; and (3-20-20)T
- e. Any source in a source category designated by the Department. (3-20-20)T
- 123. Total Suspended Particulates.** Particulate matter as measured by the method described in 40 CFR 50 Appendix B. (3-20-20)T
- 124. Toxic Air Pollutant.** An air pollutant that has been determined by the Department to be by its nature, toxic to human or animal life or vegetation and listed in Section 585 or 586. (3-20-20)T
- 125. Toxic Air Pollutant Carcinogenic Increments.** Those ambient air quality increments based on the probability of developing excess cancers over a seventy (70) year lifetime exposure to one (1) microgram per cubic meter (1 ug/m<sup>3</sup>) of a given carcinogen and expressed in terms of a screening emission level or an acceptable ambient concentration for a carcinogenic toxic air pollutant. They are listed in Section 586. (3-20-20)T
- 126. Toxic Air Pollutant Non-carcinogenic Increments.** Those ambient air quality increments based on occupational exposure limits for airborne toxic chemicals expressed in terms of a screening emission level or an acceptable ambient concentration for a non-carcinogenic toxic air pollutant. They are listed in Section 585. (3-20-20)T
- 127. Toxic Substance.** Any air pollutant that is determined by the Department to be by its nature, toxic to human or animal life or vegetation. (3-20-20)T
- 128. Trade Waste.** Any solid, liquid or gaseous material resulting from the construction or demolition of any structure, or the operation of any business, trade or industry including, but not limited to, wood product industry waste such as sawdust, bark, peelings, chips, shavings and cull wood. (3-20-20)T
- 129. TRS (Total Reduced Sulfur).** Hydrogen sulfide, mercaptans, dimethyl sulfide, dimethyl disulfide and any other organic sulfide present. (3-20-20)T
- 130. Unclassifiable Area.** An area which, because of a lack of adequate data, is unable to be classified pursuant to 42 U.S.C. Section 7407(d) as either an attainment or a nonattainment area. (3-20-20)T
- 131. Uncontrolled Emission.** An emission which has not been treated by control equipment. (3-20-20)T
- 132. Upset.** An unplanned disruption in the normal operations of any equipment or emissions unit which may cause excess emissions. (3-20-20)T
- 133. Visibility Impairment.** Any humanly perceptible change in visibility (light extinction, visual range, contrast, coloration) from that which would have existed under natural conditions. (3-20-20)T
- 134. Visibility in Any Mandatory Class I Federal Area.** Includes any integral vista associated with that area. (3-20-20)T
- 135. Wigwam Burner.** Wood waste burning devices commonly called teepee burners, silos, truncated cones, and other such burners commonly used by the wood product industry for the disposal by burning of wood wastes. (3-20-20)T
- 136. Wood Stove Curtailment Advisory.** An air pollution alert issued through local authorities and/or the Department to limit wood stove emissions during air pollution episodes. (3-20-20)T
- 007. DEFINITIONS FOR THE PURPOSES OF SECTIONS 200 THROUGH 228 AND 400 THROUGH 461.**
- 01. Agricultural Activities and Services.** For the purposes of Subsection 222.02.f., the usual and

customary activities of cultivating the soil, producing crops and raising livestock for use and consumption. Agricultural activities and services do not include manufacturing, bulk storage, handling for resale or the formulation of any agricultural chemical listed in Sections 585 or 586. (3-20-20)T

**02. Baseline Actual Emissions.** The rate of emissions, in tons per year, of a regulated air pollutant as determined by the following provisions: (3-20-20)T

**a.** For any existing electric utility steam generating unit, baseline actual emissions means the average rate, in tons per year, at which the unit actually emitted the regulated air pollutant during any consecutive twenty-four (24) month period selected by the owner or operator within the five (5) year period immediately preceding when the owner or operator begins actual construction of the project. The Director shall allow the use of a different time period upon a determination that it is more representative of normal source operation. (3-20-20)T

i. The average rate shall include fugitive emissions to the extent quantifiable, and emissions associated with startups, shutdowns, and malfunctions. (3-20-20)T

ii. The average rate shall be adjusted downward to exclude any non-compliant emissions that occurred while the source was operating above any emission limitation that was legally enforceable during the consecutive twenty-four (24) month period. (3-20-20)T

iii. For a regulated air pollutant, when a project involves multiple emissions units, only one (1) consecutive twenty-four (24) month period must be used to determine the baseline actual emissions for all the emissions units being changed. A different consecutive twenty-four (24) month period can be used for each regulated air pollutant. (3-20-20)T

iv. The average rate shall not be based on any consecutive twenty-four (24) month period for which there is inadequate information for determining annual emissions, in tons per year, and for adjusting this amount if required by Subsection 007.02.a.ii. (3-20-20)T

**b.** For an existing emissions unit (other than an electric utility steam generating unit), baseline actual emissions means the average rate, in tons per year, at which the emissions unit actually emitted the regulated air pollutant during any consecutive twenty-four (24) month period selected by the owner or operator within the ten (10) year period immediately preceding either the date the owner or operator begins actual construction of the project, or the date a complete permit application is received by the Director for a permit required under these rules, whichever is earlier, except that the ten (10) year period shall not include any period earlier than November 15, 1990. (3-20-20)T

i. The average rate shall include fugitive emissions to the extent quantifiable, and emissions associated with startups, shutdowns, and malfunctions. (3-20-20)T

ii. The average rate shall be adjusted downward to exclude any non-compliant emissions that occurred while the source was operating above an emission limitation that was legally enforceable during the consecutive twenty-four (24) month period. (3-20-20)T

iii. The average rate shall be adjusted downward to exclude any emission limitation with which the source must currently comply, had such source been required to comply with such limitations during the consecutive twenty-four (24) month period; however, if an emission limitation is part of a standard or other requirement under 40 CFR Part 63, the baseline actual emissions need only be adjusted if the Department has taken credit for such emissions reductions in an attainment demonstration or maintenance plan. (3-20-20)T

iv. For a regulated air pollutant, when a project involves multiple emissions units, only one (1) consecutive twenty-four (24) month period must be used to determine the baseline actual emissions for all the emissions units being changed. A different consecutive twenty-four (24) month period can be used for each regulated air pollutant. (3-20-20)T

v. The average rate shall not be based on any consecutive twenty-four (24) month period for which there is inadequate information for determining annual emissions, in tons per year, and for adjusting this amount if

required by Subsections 007.02.b.ii. and 007.02.b.iii. (3-20-20)T

**c.** For a new emissions unit, the baseline actual emissions for purposes of determining the emissions increase that will result from the initial construction and operation of such unit shall equal zero (0); and, thereafter, for all other purposes, shall equal the unit's potential to emit. (3-20-20)T

**d.** For a plantwide applicability limit (PAL) for a stationary source, the baseline actual emissions shall be calculated for existing electric utility steam generating units in accordance with the procedures contained in Subsection 007.02.a, for other existing emissions units in accordance with the procedures contained in Subsection 007.02.b, and for a new emissions unit in accordance with the procedures contained in Subsection 007.02.c. (3-20-20)T

**03. Begin Actual Construction.** Commence construction. (3-20-20)T

**04. Emissions Increase.** The amount by which projected actual emissions exceed baseline actual emissions of an emissions unit. (3-20-20)T

**05. Innovative Control Technology.** Any system of air pollution control that has not been adequately demonstrated in practice, but would have a substantial likelihood of achieving greater continuous emissions reduction than any control system in current practice, or of achieving at least comparable reductions at lower cost in terms of energy, economics, or non-air quality environmental effects. (3-20-20)T

**06. Net Emissions Increase.** For purposes of Sections 204 and 205, a net emissions increase shall be defined by the federal regulations incorporated by reference. For purposes of Section 210, a net emissions increase shall be an emissions increase from a particular modification plus any other increases and decreases in actual emissions at the facility that are creditable and contemporaneous with the particular modification, where: (3-20-20)T

**a.** A creditable increase or decrease in actual emissions is contemporaneous with a particular modification if it occurs between the date five (5) years before the commencement of construction or modification on the particular change and the date that the increase from the particular modification occurs. Any replacement unit that requires shakedown becomes operational only after a reasonable shakedown period, not to exceed one hundred and eighty (180) days; (3-20-20)T

**b.** A decrease in actual emissions is creditable only if it satisfies the requirements for emission reduction credits (Section 460) and has approximately the same qualitative significance for public health and welfare as that attributed to the increase from the particular modification, and is federally enforceable at and after the time that construction of the modification commences. (3-20-20)T

**c.** The increase in toxic air pollutant emissions from an already operating or permitted source is not included in the calculation of the net emissions increase for a proposed new source or modification if: (3-20-20)T

**i.** The already operating or permitted source commenced construction or modification prior to July 1, 1995; or (3-20-20)T

**ii.** The uncontrolled emission rate from the already operating or permitted source is ten per cent (10%) or less of the applicable screening emissions level listed in Section 585 or 586; or (3-20-20)T

**iii.** The already operating or permitted source is an environmental remediation source subject to or regulated by the Resource Conservation and Recovery Act (42 U.S.C. Sections 6901-6992k) and IDAPA 58.01.05, "Idaho Rules and Standards for Hazardous Waste," (IDAPA 58.01.05.000 et seq.) or the Comprehensive Environmental Response, Compensation and Liability Act (42 U.S.C. 6901-6992k) or a consent order. (3-20-20)T

**07. Pilot Plant.** A stationary source located at least one quarter (1/4) mile from any sensitive receptor that functions to test processing, mechanical, or pollution control equipment to determine full-scale feasibility and which does not produce products that are offered for sale except in developmental quantities. (3-20-20)T

**08. Projected Actual Emissions.** (3-20-20)T

a. The maximum annual rate, in tons per year, at which an existing emissions unit is projected to emit a regulated air pollutant in any one (1) of the five (5) years (twelve (12) month period) following the date the unit resumes regular operation after the project, or in any one (1) of the ten (10) years following that date, if the project involves increasing the emissions unit's design capacity or its potential to emit that regulated air pollutant and full utilization of the unit would result in a significant emissions increase or a significant net emissions increase at an existing major stationary source. (3-20-20)T

b. In determining the projected actual emissions, the owner or operator of the stationary source: (3-20-20)T

i. Shall consider all relevant information including, but not limited to, historical operational data, the company's own representations, the company's expected business activity and the company's highest projections of business activity, the company's filings with state or federal regulatory authorities, and compliance plans under the approved state implementation plan; and (3-20-20)T

ii. Shall include fugitive emissions to the extent quantifiable and emissions associated with startups, shutdowns, and malfunctions; and (3-20-20)T

iii. Shall exclude, in calculating any increase in emissions that results from the particular project, that portion of the unit's emissions following the project that an existing unit could have accommodated during the consecutive twenty-four (24) month period used to establish the baseline actual emissions and that are also unrelated to the particular project, including any increased utilization due to product demand growth; or (3-20-20)T

iv. In lieu of using the method set out in Subsections 007.08.b.i. through 007.08.b.iii., may elect to use the emissions unit's potential to emit, in tons per year. (3-20-20)T

**09. Reasonable Further Progress (RFP).** Annual incremental reductions in emissions of the applicable air pollutant as identified in the SIP which are sufficient to provide for attainment of the applicable ambient air quality standard by the required date. (3-20-20)T

**10. Sensitive Receptor.** Any residence, building or location occupied or frequented by persons who, due to age, infirmity or other health based criteria, may be more susceptible to the deleterious effects of a toxic air pollutant than the general population including, but not limited to, elementary and secondary schools, day care centers, playgrounds and parks, hospitals, clinics and nursing homes. (3-20-20)T

**11. Short Term Source.** Any new stationary source or modification to an existing source, with an operational life no greater than five (5) years from the inception of any operations to the cessation of actual operations. (3-20-20)T

**12. Toxic Air Pollutant Reasonably Available Control Technology (T-RACT).** An emission standard based on the lowest emission of toxic air pollutants that a particular source is capable of meeting by the application of control technology that is reasonably available, as determined by the Department, considering technological and economic feasibility. If control technology is not feasible, the emission standard may be based on the application of a design, equipment, work practice or operational requirement, or combination thereof. (3-20-20)T

**008. DEFINITIONS FOR THE PURPOSES OF SECTIONS 300 THROUGH 386.**

**01. Affected States.** All States: (3-20-20)T

a. Whose air quality may be affected by the emissions of the Tier I source and that are contiguous to Idaho; or (3-20-20)T

b. That are within fifty (50) miles of the Tier I source. (3-20-20)T

**02. Allowance.** An authorization allocated to a Phase II source by the EPA to emit during or after a specified calendar year, one (1) ton of sulfur dioxide. (3-20-20)T

**03. Applicable Requirement.** All of the following if approved or promulgated by EPA as they apply to emissions units in a Tier I source (including requirements that have been promulgated through rulemaking at the time of permit issuance but which have future-effective compliance dates): (3-20-20)T

**a.** Any standard or other requirement provided for in the applicable state implementation plan, including any revisions to that plan that are specified in 40 CFR Parts 52.670 through 52.690. (3-20-20)T

**b.** Any term or condition of any permits to construct issued by the Department pursuant to Sections 200 through 223 or by EPA pursuant to 42 U.S.C. Sections 7401 through 7515; provided that terms or conditions relevant only to toxic air pollutants are not applicable requirements. (3-20-20)T

**c.** Any standard or other requirement under 42 U.S.C. Section 7411 including 40 CFR Part 60; (3-20-20)T

**d.** Any standard or other requirement under 42 U.S.C. Section 7412 including 40 CFR Part 61 and 40 CFR Part 63; (3-20-20)T

**e.** Any standard or other requirement of the acid rain program under 42 U.S.C. Sections 7651 through 7651o; (3-20-20)T

**f.** Any requirements established pursuant to 42 U.S.C. Section 7414(a)(3), 42 U.S.C. Section 7661c(b) or Sections 120 through 128 of these rules; (3-20-20)T

**g.** Any standard or other requirement governing solid waste incineration, under 42 U.S.C. Section 7429; (3-20-20)T

**h.** Any standard or other requirement for consumer and commercial products and tank vessels, under 42 U.S.C. Sections 7511b(e) and (f); and (3-20-20)T

**i.** Any standard or other requirement under 42 U.S.C. Sections 7671 through 7671q including 40 CFR Part 82. (3-20-20)T

**j.** Any ambient air quality standard or increment or visibility requirement provided in 42 U.S.C. Sections 7470 through 7492, but only as applied to temporary sources receiving Tier I operating permits under Section 324. (3-20-20)T

**04. Designated Representative.** A responsible person or official authorized by the owner or operator of a Phase II unit to represent the owner or operator in matters pertaining to the holding, transfer, or disposition of allowances allocated to a Phase II unit, and the submission of and compliance with permits, permit applications, and compliance plans for the Phase II unit. (3-20-20)T

**05. Draft Permit.** The version of a Tier I operating permit that is made available by the Department for public participation and affected State review. (3-20-20)T

**06. Emergency.** For the purposes of Section 332, an emergency is any situation arising from sudden and reasonably unforeseeable events beyond the control of the owner or operator, including acts of God, which situation requires immediate corrective action to restore normal operation and that causes the Tier I source to exceed a technology-based emission limitation under the Tier I operating permit due to unavoidable increases in emissions attributable to the emergency. An emergency shall not include noncompliance to the extent caused by improperly designed equipment, lack of preventative maintenance, careless or improper operation, or operator error. (3-20-20)T

**07. Final Permit.** The version of a Tier I permit issued by the Department that has completed all review procedures required in Sections 364 and 366. (3-20-20)T

**08. General Permit.** A Tier I permit issued pursuant to Section 335. (3-20-20)T

317. **09. Insignificant Activity.** Those activities that qualify as insignificant in accordance with Section 006 through 008, the definitions in 40 CFR Part 60 shall have the meaning given in that Part, except that the term “Administrator” shall mean “Department.” (3-20-20)T

**10. Major Facility.** A facility (as defined in Section 006) is major if the facility meets any of the following criteria: (3-20-20)T

**a.** For hazardous air pollutants: (3-20-20)T

i. The facility emits or has the potential to emit ten (10) tons per year (tpy) or more of any hazardous air pollutant, other than radionuclides, which has been listed pursuant to 42 U.S.C. Section 7412(b); provided that emissions from any oil or gas exploration or production well (with its associated equipment) and emissions from any oil or gas pipeline compressor or pump station shall not be aggregated with emissions from other similar emission units within the facility. (3-20-20)T

ii. The facility emits or has the potential to emit twenty-five (25) tpy or more of any combination of any hazardous air pollutants, other than radionuclides, which have been listed pursuant to 42 U.S.C. 7412(b); provided that emissions from any oil or gas exploration or production well (with its associated equipment) and emissions from any oil or gas pipeline compressor or pump station shall not be aggregated with emissions from other similar emission units within the facility. (3-20-20)T

**b.** For non-attainment areas: (3-20-20)T

i. The facility is located in a “serious” particulate matter (PM-10) nonattainment area and the facility has the potential to emit seventy (70) tpy or more of PM-10. (3-20-20)T

ii. The facility is located in a “serious” carbon monoxide nonattainment area in which stationary sources are significant contributors to carbon monoxide levels and the facility has the potential to emit fifty (50) tpy or more of carbon monoxide. (3-20-20)T

iii. The facility is located in an ozone transport region established pursuant to 42 U.S.C. Section 7511c and the facility has the potential to emit fifty (50) tpy or more of volatile organic compounds. (3-20-20)T

iv. The facility is located in an ozone nonattainment area and, depending upon the classification of the nonattainment area, the facility has the potential to emit the following amounts of volatile organic compounds or oxides of nitrogen; provided that oxides of nitrogen shall not be included if the facility has been identified in accordance with 42 U.S.C. Section 7411a(f)(1) or (2) if the area is “marginal” or “moderate,” one hundred (100) tpy or more, if the area is “serious,” fifty (50) tpy or more, if the area is “severe,” twenty-five (25) tpy or more, and if the area is “extreme,” ten (10) tpy or more. (3-20-20)T

**c.** The facility emits or has the potential to emit one hundred (100) tons per year or more of any regulated air pollutant. The fugitive emissions shall not be considered in determining whether the facility is major unless the facility belongs to one (1) of the following categories: (3-20-20)T

i. Designated facilities. (3-20-20)T

ii. All other source categories regulated by 40 CFR Part 60, 40 CFR Part 61 or 40 CFR Part 63, but only with respect to those air pollutants that have been regulated for that category and only if determined by rule by the Administrator of EPA pursuant to Section 302(j) of the Clean Air Act. (3-20-20)T

**009. DEFINITIONS FOR THE PURPOSES OF 40 CFR PART 60.**  
Notwithstanding the definitions listed in Sections 006 through 008, the definitions in 40 CFR Part 60 shall have the meaning given in that Part, except that the term “Administrator” shall mean “Department.” (3-20-20)T

**010. DEFINITIONS FOR THE PURPOSES OF 40 CFR PART 61 AND 40 CFR PART 63.**  
Notwithstanding the definitions listed in Sections 006 through 008, the definitions in 40 CFR Part 61 and 40 CFR Part 63 shall have the meaning given in those Parts, except that the term “Administrator” shall mean “Department.” (3-20-20)T

**011. DEFINITIONS FOR THE PURPOSES OF SECTIONS 790 THROUGH 799.**

**01. Best Management Practice.** The best management practice (BMP) employed within an industry to control fugitive emissions. (3-20-20)T

**02. Control Strategy Trigger.** An event or condition that indicates that a control action is needed to prevent violation of a standard or a provision of the rule. (3-20-20)T

**03. Nonmetallic Mineral Processing Plant.** Any combination of equipment that is used to crush or grind any nonmetallic mineral or rock wherever it may be located, including equipment located at lime plants, power plants, steel mills, asphalt concrete plants, Portland cement plants, or any other facility or location processing nonmetallic minerals. (3-20-20)T

**04. NSPS Regulated Facility or Plant.** A facility or processing plant that is subject to a standard, limitation, or other requirement of 40 CFR 60, Standards for the Performance of New Stationary Sources. (3-20-20)T

**05. Permit by Rule.** A provision of the rules under which a facility or source registers with the Department and meets the specific requirements for that type of source. The source is then deemed to have a permit, thereby authorizing construction and operation without first obtaining a "Permit to Construct" as required in Section 201. Operating in accordance with a "Permit by Rule" (PBR) does not relieve the owner or operator from complying with all applicable federal, state, and local rules and regulations. (3-20-20)T

**06. Progressive Control Strategy.** A sequence of control actions that when progressively employed can reduce the potential for violation of a standard or a provision of the rules. Control actions, beginning with those early in the sequence, shall be progressively applied until an adequate level of control is achieved. (3-20-20)T

**07. Site of Operations.** The specific operating location of a nonmetallic mineral processing plant. (3-20-20)T

**012. -- 105. (RESERVED)**

**106. ABBREVIATIONS.**

**01. AAC.** Acceptable Ambient Concentration. (3-20-20)T

**02. AACC.** Acceptable Ambient Concentration for a Carcinogen. (3-20-20)T

**03. ACGIH.** American Conference of Government Industrial Hygienists. (3-20-20)T

**04. CAS.** Chemical Abstract Service. (3-20-20)T

**05. CL.** Derived from ACGIH ceiling Limit UF = 10. (3-20-20)T

**06. EL.** Emissions Screening Level. (3-20-20)T

**07. ID.** Idaho Division of Environmental Quality. Not OEL based. (3-20-20)T

**08. LA.** From LA Dept. of Environmental Quality. Not OEL based eight (8) hour TWA. (3-20-20)T

**09. MA.** From MA Dept. of Environmental Protection, Div. of Air Quality Control. Not OEL based, annual averaging time, no uf. (3-20-20)T

**10. MI.** From MI Dept. of Natural Resources, Air Quality Div. Based on toxicological data, annual av. time, no uf. (3-20-20)T

**11. NY.** From New York Dept. of Conservation, Div. of Air Quality. Not OEL based, one (1) yr. Av.



- time no uncertainty factor (uf). (3-20-20)T
- 12. OEL. Reference Occupational Exposure Level. (3-20-20)T
  - 13. PL. From Phil. Dept. of Air Management Services. Not OEL based, one (1) yr. averaging time no uf. (3-20-20)T
  - 14. PL1. From Phil. Dept. of Air Management Services. Unspecified OEL based, one (1) yr. averaging time, uf=10. (3-20-20)T
  - 15. PL2. From Phil. Dept. of Air Management Services. Not OEL based one (1) yr. Av. time, uf=10. (3-20-20)T
  - 16. PL3. From Phil. Dept. of Air Management Services. Not OEL based, one (1) yr. av. time, uf=1000. (3-20-20)T
  - 17. TWA. Time Weighted Average. (3-20-20)T
  - 18. UF. Uncertainty Factor. (3-20-20)T
  - 19. URF. Unit Risk Factor from the US Environmental Protection Agency. (3-20-20)T
  - 20. WA. From Washington Dept. of Ecology, Air Programs. Acceptable Source Impact Level based. (3-20-20)T

**107. INCORPORATIONS BY REFERENCE.**

**01. General.** Unless expressly provided otherwise, any reference in these rules to any document identified in Subsection 107.03 constitutes the full incorporation into these rules of that document for the purposes of the reference, including any notes and appendices therein. The term “documents” includes codes, standards or rules which have been adopted by an agency of the state or of the United States or by any nationally recognized organization or association. (3-20-20)T

**02. Availability of Referenced Material.** Copies of the documents incorporated by reference into these rules are available at the following locations: (3-20-20)T

- and;
- a. All federal publications: U.S. Government Printing Office at <http://www.ecfr.gov/cgi-bin/ECFR;> (3-20-20)T
  - b. Statutes of the state of Idaho: <http://legislature.idaho.gov/idstat/TOC/IDStatutesTOC.htm>; and (3-20-20)T
  - c. All documents herein incorporated by reference: (3-20-20)T
  - i. Department of Environmental Quality, 1410 N. Hilton, Boise, Idaho 83706-1255 at (208) 373-0502. (3-20-20)T
  - ii. State Law Library, 451 W. State Street, P.O. Box 83720, Boise, Idaho 83720-0051, (208) 334-3316. (3-20-20)T

**03. Documents Incorporated by Reference.** The following documents are incorporated by reference into these rules: (3-20-20)T

- a. Requirements for Preparation, Adoption, and Submittal of Implementation Plans, [40 CFR Part 51](#) revised as of July 1, 2019. The following portions of 40 CFR Part 51 are expressly excluded from any incorporation by reference into these rules: (3-20-20)T

- i. All sections included in 40 CFR Part 51, Subpart P, Protection of Visibility, except that 40 CFR 51.301, 51.304(a), 51.307, and 51.308 are incorporated by reference into these rules; and (3-20-20)T
- ii. Appendix Y to Part 51, Guidelines for BART Determinations Under the Regional Haze Rule. (3-20-20)T
- b. National Primary and Secondary Ambient Air Quality Standards, 40 CFR Part 50, revised as of July 1, 2019. (3-20-20)T
- c. Approval and Promulgation of Implementation Plans, 40 CFR Part 52, Subparts A and N and Appendices D and E, revised as of July 1, 2019. (3-20-20)T
- d. Ambient Air Monitoring Reference and Equivalent Methods, 40 CFR Part 53, revised as of July 1, 2019. (3-20-20)T
- e. Ambient Air Quality Surveillance, 40 CFR Part 58, revised as of July 1, 2019. (3-20-20)T
- f. Standards of Performance for New Stationary Sources, 40 CFR Part 60, revised as of July 1, 2019. (3-20-20)T
- g. National Emission Standards for Hazardous Air Pollutants, 40 CFR Part 61, revised as of July 1, 2019. (3-20-20)T
- h. Federal Plan Requirements for Hospital/Medical/Infectious Waste Incinerators Constructed on or Before December 1, 2008, 40 CFR Part 62, Subpart HHH, revised as of July 1, 2019. (3-20-20)T
- i. National Emission Standards for Hazardous Air Pollutants for Source Categories, 40 CFR Part 63, revised as of July 1, 2019. (3-20-20)T
- j. Compliance Assurance Monitoring, 40 CFR Part 64, revised as of July 1, 2019. (3-20-20)T
- k. State Operating Permit Programs, 40 CFR Part 70, revised as of July 1, 2019. (3-20-20)T
- l. Permits, 40 CFR Part 72, revised as of July 1, 2019. (3-20-20)T
- m. Sulfur Dioxide Allowance System, 40 CFR Part 73, revised as of July 1, 2019. (3-20-20)T
- n. Protection of Stratospheric Ozone, 40 CFR Part 82, revised as of July 1, 2019. (3-20-20)T
- o. Clean Air Act, 42 U.S.C. Sections 7401 through 7671g (1997). (3-20-20)T
- p. Medical Waste Combustors, Section 39-128, Idaho Code (1992). (3-20-20)T

**108. -- 120. (RESERVED)**

**121. COMPLIANCE REQUIREMENTS BY DEPARTMENT.**

Any person engaged in an activity which may violate the air quality provisions of the Act, violate an air quality order issued or entered in accordance with the Act or these rules, or violate any of these rules, may be required by the Department to do any of the following: (3-20-20)T

- 01. Schedule.** Prepare a proposed schedule whereby the unlawful activity will be brought into compliance over a specified period of time. (3-20-20)T
- 02. Report.** Submit periodic reports to the Department indicating progress in achieving compliance. (3-20-20)T
- 03. Records.** Submit, keep and maintain appropriate records. (3-20-20)T

**04. Monitoring.** Monitor air pollutants at the source, in the ambient air, or in vegetation to demonstrate compliance. (3-20-20)T

**05. Episode Plans.** Develop emergency episode plans to help prevent ambient air pollution concentrations from reaching levels which would cause substantial endangerment to health or the environment. (3-20-20)T

**122. INFORMATION ORDERS BY THE DEPARTMENT.**

The Department may issue information orders as follows: (3-20-20)T

**01. Purpose.** For the purpose of: (3-20-20)T

**a.** Developing or assisting in the development of any implementation plan, any standard of performance, any emission standard or any rule; (3-20-20)T

**b.** Determining whether any person is in violation of any standard of performance, any emission standard, any implementation plan or any rule; or (3-20-20)T

**c.** Carrying out any air quality provisions of the Act, any air quality order issued or entered in accordance with the Act or rules, or any of these rules. (3-20-20)T

**02. Persons.** The Department may issue an information order to any person who: (3-20-20)T

**a.** Owns or operates any emission source; (3-20-20)T

**b.** Manufactures emission control equipment; (3-20-20)T

**c.** The Department believes may have information necessary to meet the intent of these rules; or (3-20-20)T

**d.** Is subject to any requirement of these rules. (3-20-20)T

**03. Requirements.** The information order may require the person to perform the following on a one-time, periodic or continuous basis: (3-20-20)T

**a.** Establish, maintain and submit records; (3-20-20)T

**b.** Make reports; (3-20-20)T

**c.** Install, use, and maintain monitoring equipment, and use audit procedures or methods; (3-20-20)T

**d.** Sample emissions in accordance with procedures or methods, at such locations, at such intervals, during such periods and in such manner as the Department shall prescribe; (3-20-20)T

**e.** Keep records on control equipment parameters, production variables or other indirect data when the Department determines that direct monitoring of emissions is impractical; (3-20-20)T

**f.** Submit compliance certifications including: (3-20-20)T

**i.** Identification of the applicable requirement that is the basis of the certification; (3-20-20)T

**ii.** The method(s) or other means used by the owner or operator for determining the compliance status for each applicable requirement, and whether such methods or other means provide continuous or intermittent data; and (3-20-20)T

**iii.** The status of compliance with each applicable requirement, based on the method or means

designated in Subsection 122.03.f.ii. The certification shall identify each deviation and take it into account in the compliance certification. The certification shall also identify as possible exceptions to compliance any periods during which compliance is required and in which an excursion or exceedance as defined under 40 CFR Part 64 occurred; and (3-20-20)T

- g.** Provide such other information as the Department may require. (3-20-20)T

**123. CERTIFICATION OF DOCUMENTS.**

All documents, including but not limited to, application forms for permits to construct, application forms for operating permits, progress reports, records, monitoring data, supporting information, requests for confidential treatment, testing reports or compliance certifications submitted to the Department shall contain a certification by a responsible official. The certification shall state that, based on information and belief formed after reasonable inquiry, the statements and information in the document are true, accurate, and complete. (3-20-20)T

**124. TRUTH, ACCURACY AND COMPLETENESS OF DOCUMENTS.**

All documents submitted to the Department shall be truthful, accurate and complete. (3-20-20)T

**125. FALSE STATEMENTS.**

No person shall knowingly make any false statement, representation, or certification in any form, notice, or report required under any permit, or any applicable rule or order in force pursuant thereto. (3-20-20)T

**126. TAMPERING.**

No person shall knowingly render inaccurate any monitoring device or method required under any permit, or any applicable rule or order in force pursuant thereto. (3-20-20)T

**127. FORMAT OF RESPONSES.**

All responses and information submitted to the Department shall be provided in a format approved by the Department. (3-20-20)T

**128. CONFIDENTIAL INFORMATION.**

Information obtained by the Department under these rules is subject to public disclosure pursuant to the provisions of Chapter 1, Title 74, Idaho Code and Section 39-111, Idaho Code. Information submitted under a trade secret claim may be entitled to confidential treatment by the Department as provided in Section 74-114, Idaho Code, and IDAPA 58.01.21, "Rules Governing the Protection and Disclosure of Records in the Possession of the Department of Environmental Quality." If the information for which the person is requesting confidential treatment is submitted to the Department under Sections 300 through 386 or the terms or conditions of a Tier I operating permit, the person shall also submit the same information directly to the EPA. (3-20-20)T

**129. (RESERVED)**

**130. STARTUP, SHUTDOWN, SCHEDULED MAINTENANCE, SAFETY MEASURES, UPSET AND BREAKDOWN.**

The purpose of Sections 130 through 136 is to establish procedures and requirements to be implemented in all excess emissions events and to establish criteria to be applied by the Department in determining whether to take enforcement action to impose penalties for an excess emissions event where the excess emissions are caused by startup, shutdown, scheduled maintenance, upset, or breakdown of any emissions unit or which occur as a direct result of the implementation of any safety measure. (3-20-20)T

**131. EXCESS EMISSIONS.**

**01. Applicability.** The owner or operator of a facility or emissions unit generating excess emissions shall comply with Sections 131, 132, 133.01, 134.01, 134.02, 134.03, 135, and 136, as applicable. If the owner or operator anticipates requesting consideration under Subsection 131.02, then the owner or operator shall also comply with the applicable provisions of Subsections 133.02, 133.03, 134.04, and 134.05. (3-20-20)T

**02. Enforcement Action Criteria.** Where an excess emissions event occurs as a direct result of startup, shutdown, or scheduled maintenance, or an unavoidable upset or unavoidable breakdown, or the

implementation of a safety measure, the Department shall consider the sufficiency of the information submitted and the following criteria to determine if an enforcement action to impose penalties is warranted: (3-20-20)T

**a.** Whether prior to the excess emissions event, the owner or operator submitted and implemented procedures pursuant to Subsections 133.02 and 133.03 or Subsections 134.04 and 134.05, as applicable; (3-20-20)T

**b.** Whether the owner or operator complied with all relevant portions of Subsections 131, 132, 133.01, 134.01, 134.02, 134.03, 135, and 136; (3-20-20)T

**c.** Whether the excess emissions event was part of a recurring pattern of excess emissions events indicative of inadequate design, operation or maintenance of the facility or emissions unit; and (3-20-20)T

**d.** Where appropriate, whether the excess emissions event was caused by an activity necessary to prevent loss of life, personal injury or severe property damage. (3-20-20)T

**03. Effect of Determination.** Any decision by the Department under Subsection 131.02 shall not excuse the owner or operator from compliance with the relevant emission standard and shall not preclude the Department from taking an enforcement action to enjoin the activity causing the excess emissions. Any decision made by the Department under Subsection 131.02 shall not preclude the Department from taking an enforcement action for future or other excess emission events. The affirmative defense for emergencies under Section 332 of these Rules may be applied in addition to the provisions of Sections 130 through 136. (3-20-20)T

**132. CORRECTION OF CONDITION.**

The person responsible for, or in charge of a facility during, an excess emissions event shall, with all practicable speed, initiate and complete appropriate and reasonable action to correct the conditions causing such excess emissions event; to reduce the frequency of occurrence of such events; to minimize the amount by which the emission standard is exceeded; and shall, as provided below or upon request of the Department, submit a full report of such occurrence, including a statement of all known causes, and of the scheduling and nature of the actions to be taken. (3-20-20)T

**133. STARTUP, SHUTDOWN AND SCHEDULED MAINTENANCE REQUIREMENTS.**

The requirements in Subsection 133.01 shall apply in all cases where startup, shutdown, or scheduled maintenance of any equipment or emissions unit is expected to result or results in an excess emissions event. The owner or operator of the facility or emissions unit generating the excess emissions shall demonstrate compliance with all of the requirements of Subsection 133.01, as well as the development and implementation of procedures pursuant to Subsections 133.02 and 133.03 as a prerequisite to any consideration under Subsection 131.02. (3-20-20)T

**01. General Provisions.** The following shall pertain to all startup, shutdown, and scheduled maintenance activities expected to result or resulting in excess emissions: (3-20-20)T

**a.** No scheduled startup, shutdown, or maintenance resulting in excess emissions shall occur during any period in which an Atmospheric Stagnation Advisory and/or a Wood Stove Curtailment Advisory has been declared by the Department within an area designated by the Department as a PM-10 nonattainment area, unless the permittee demonstrates that such is reasonably necessary to facility operations and cannot be reasonably avoided and the Department approves such activity in advance, to the extent advance approval by the Department is feasible. This prohibition on scheduled startup, shutdown or maintenance activities during Advisories does not apply to situations where shutdown is necessitated by urgent situations, such as imminent equipment failure, power curtailment, worker safety concerns or similar situations. (3-20-20)T

**b.** The owner or operator of a source of excess emissions shall notify the Department of any startup, shutdown, or scheduled maintenance event that is expected to cause an excess emissions event. Such notification shall identify the time of the excess emissions, specific location, equipment involved, and type of excess emissions event (i.e. startup, shutdown, or scheduled maintenance). The notification shall be given as soon as reasonably possible, but no later than two (2) hours prior to the start of the excess emissions event unless the owner or operator demonstrates to the Department's satisfaction that a shorter advanced notice was necessary. The Department may prohibit or postpone any scheduled startup, shutdown, or maintenance activity upon consideration of the factors listed in Subsection 134.03. (3-20-20)T

c. The owner or operator of a source of excess emissions shall report and record the information required pursuant to Sections 135 and 136 for each excess emissions event due to startup, shutdown, or scheduled maintenance. (3-20-20)T

d. The owner or operator of a source of excess emissions must make the maximum reasonable effort, including off-shift labor where practicable to accomplish maintenance during periods of nonoperation of any related source operations or equipment. (3-20-20)T

**02. Excess Emissions Procedures.** For all equipment or emissions unit from which excess emissions may occur during startup, shutdown, or scheduled maintenance, the facility owner or operator shall prepare, implement and file with the Department specific procedures which will be used to minimize excess emissions during such events. Specific information for each of the types of excess emissions events (i.e. startup, shutdown and scheduled maintenance) shall be established or documented for each piece of equipment or emissions unit and shall include all of the following (which may be based upon the facility owner or operator's knowledge of the process or emissions where measured data is unavailable): (3-20-20)T

a. Identification of the specific equipment or emissions unit and the type of event anticipated. (3-20-20)T

b. Identification of the specific emissions in excess of applicable emission standards during the startup, shutdown, or scheduled maintenance period. (3-20-20)T

c. The estimated amount of excess emissions expected to be released during each event. (3-20-20)T

d. The expected duration of each excess emissions event. (3-20-20)T

e. An explanation of why the excess emissions are reasonably unavoidable for each of the types of excess emissions events (i.e. startup, shutdown, and scheduled maintenance). (3-20-20)T

f. Specification of the frequency at which each of the types of excess emissions events (i.e. startup, shutdown, and scheduled maintenance) are expected to occur. (3-20-20)T

g. For scheduled maintenance, the owner or operator shall also document detailed explanations of: (3-20-20)T

i. Why the maintenance is needed. (3-20-20)T

ii. Why it is impractical to reduce or cease operation of the equipment or emissions unit during the scheduled maintenance period. (3-20-20)T

iii. Why the excess emissions are not reasonably avoidable through better scheduling of the maintenance or through better operation and maintenance practices. (3-20-20)T

iv. Why, where applicable, it is necessary to by-pass, take off line, or operate equipment or emissions unit at reduced efficiency while the maintenance is being performed. (3-20-20)T

h. Justification to explain why the piece of equipment or emissions unit cannot be modified or redesigned to eliminate or reduce the excess emissions which occur during startup, shutdown, and scheduled maintenance. (3-20-20)T

i. Detailed specification of the procedures to be followed by the owner or operator which will minimize excess emissions at all times during startup, shutdown, and scheduled maintenance. These procedures may include such measures as preheating or otherwise conditioning the emissions unit prior to its use or the application of auxiliary equipment or emissions unit to reduce the excess emissions. (3-20-20)T

**03. Amendments to Procedures.** The owner or operator shall amend, and the Department may require

amendments to, the procedures established pursuant to Section 133 from time to time and as deemed reasonably necessary to ensure that the procedures are and remain consistent with good pollution control practices. (3-20-20)T

**04. Filing of Excess Emissions Procedures.** (3-20-20)T

**a.** Unless otherwise required by the Department, the failure to prepare or file procedures pursuant to Subsection 133.02 shall not be a violation of these Rules in and of itself. (3-20-20)T

**b.** To the extent procedures or plans for excess emissions resulting from startup, shutdown, or scheduled maintenance are required to be or are otherwise submitted to the Department with any permit application, such submission, if deemed adequate by the Department, shall fulfill the requirement under this Section to file plans and procedures with the Department. (3-20-20)T

**134. UPSET, BREAKDOWN AND SAFETY REQUIREMENTS.**

The requirements in Subsections 134.01, 134.02, and 134.03 shall apply in all cases where upset or breakdown of equipment or an emissions unit, or the initiation of safety measures, result or may result in an excess emissions event. The owner or operator of the facility or emissions unit generating the excess emissions shall demonstrate compliance with all of the requirements of Subsections 134.01, 134.02 and 134.03 as well as the development and implementation of procedures pursuant to Subsections 134.04 and 134.05 as a prerequisite to any consideration under Subsection 131.02. Where the owner or operator demonstrates that because of the unforeseeable nature of the excess emissions event it is impractical to develop procedures pursuant to Subsection 134.04, the Department shall exercise its enforcement discretion on a case by case basis. (3-20-20)T

**01. Routine Maintenance and Repairs.** For all equipment or emissions units from which excess emissions may occur during upset conditions or breakdowns or implementation of safety measures, the facility owner or operator shall: (3-20-20)T

**a.** Implement routine preventative maintenance and operating procedures consistent with good pollution control practices for minimizing upsets and breakdowns or events requiring implementation of safety measures, and (3-20-20)T

**b.** Make routine repairs in an expeditious fashion when the owner or operator knew or should have known that an excess emissions event was likely to occur. Off-shift labor and overtime shall be utilized, to the extent practicable, to ensure that such repairs are made expeditiously. (3-20-20)T

**02. Excess Emissions Minimization and Notification.** For all equipment or emissions units from which excess emissions result during upset or breakdown conditions, or for other situations that may necessitate the implementation of safety measures which cause excess emissions, the facility owner or operator shall comply with the following: (3-20-20)T

**a.** The owner or operator shall immediately undertake all appropriate measures to reduce and, to the extent possible, eliminate excess emissions resulting from the event and to minimize the impact of such excess emissions on the ambient air quality and public health. (3-20-20)T

**b.** The owner or operator shall notify the Department of any upset/breakdown/safety event that results in excess emissions. Such notification shall identify the time, specific location, equipment or emissions unit involved, and (to the extent known) the cause(s) of the occurrence. The notification shall be given as soon as reasonably possible, but no later than twenty-four (24) hours after the event, unless the owner or operator demonstrates to the Department's satisfaction that the longer reporting period was necessary. (3-20-20)T

**c.** The owner or operator shall report and record the information required pursuant to Sections 135 and 136 for each excess emissions event caused by an upset, breakdown, or safety measure. (3-20-20)T

**03. Discretionary Reduction or Cessation Provisions.** During any period of excess emissions caused by upset, breakdown, or operation under facility safety measures, the Department may require the owner or operator to immediately reduce or cease operation of the equipment or emissions unit causing the excess emissions until such time as the condition causing the excess emissions has been corrected or brought under control. Such action by the

Department shall be taken upon consideration of the following factors and after consultation with the facility owner or operator: (3-20-20)T

- a. Potential risk to the public or the environment. (3-20-20)T
- b. Whether ceasing operations could result in physical damage to the equipment, emissions unit or facility, or cause injury to employees. (3-20-20)T
- c. Whether continued excess emissions were reasonably unavoidable as determined by the Department. (3-20-20)T
- d. The effect of the increase in pollution resulting from the shutdown and subsequent restart of the equipment or emissions unit or facility. (3-20-20)T
- e. The owner or operator shall not be required to reduce or cease operations at the entire facility if reducing or ceasing operations at a portion of the facility eliminates or adequately reduces the excess emissions. (3-20-20)T

**04. Excess Emissions Procedures.** For equipment or emissions units and process upsets and breakdowns and situations that require implementation of safety measures, which events can reasonably be anticipated to occur periodically but which cannot be reasonably avoided or predicted with certainty, the owner or operator shall prepare, implement, and file with the Department specific procedures which will be used to minimize such events and excess emissions during such events. To the extent possible and reasonably practicable (and based upon knowledge of the process or emissions where measured data is not available), specify the following information for each type of anticipated upset/ breakdown/safety event: (3-20-20)T

- a. The specific air pollution control equipment or emissions unit and the type of event anticipated. (3-20-20)T
- b. The specific emissions in excess of applicable emission standards during the event. (3-20-20)T
- c. The estimated amount of excess emissions expected to be released during each event. (3-20-20)T
- d. The expected duration of each excess emissions event. (3-20-20)T
- e. An explanation of why the excess emissions are reasonably unavoidable. (3-20-20)T
- f. The frequency of the type of event, based on historic occurrences. (3-20-20)T
- g. Justification to explain why the piece of control equipment or emissions unit cannot be modified or redesigned to eliminate or reduce the particular type of event. (3-20-20)T
- h. Detailed specification of the procedures to be followed by the owner or operator which will minimize excess emissions at all times during such events, including without limitation those procedures listed under Subsection 134.05. (3-20-20)T

**05. Amendments to Procedures.** The owner or operator shall amend, and the Department may require amendments to, the procedures established pursuant to Section 134 from time to time and as deemed reasonably necessary to ensure that the procedures are and remain consistent with good pollution control practices. (3-20-20)T

**06. Filing of Excess Emissions Procedures.** (3-20-20)T

- a. Failure to follow procedures filed with the Department shall not preclude the Department from making a determination under Subsection 131.02 if the owner or operator demonstrates to the Department's satisfaction that alternate and equivalent procedures were used and were necessitated by the exigency of the circumstances. (3-20-20)T



**b.** Unless otherwise required by the Department, the failure to prepare or file procedures pursuant to Subsection 134.04 shall not be a violation of these Rules in and of itself. (3-20-20)T

**c.** To the extent procedures or plans for excess emissions resulting from upsets, breakdowns or safety measures are required to be or are otherwise submitted to the Department with any permit application, such submission, if deemed adequate by the Department, shall fulfill the requirement under this Section to file plans and procedures with the Department. (3-20-20)T

**135. EXCESS EMISSIONS REPORTS.**

**01. Deadline for Excess Emissions Reports.** A written report for each excess emissions event shall be submitted to the Department by the owner or operator no later than fifteen (15) days after the beginning of each such event. (3-20-20)T

**02. Contents of Excess Emissions Reports.** Each report shall contain the following information: (3-20-20)T

**a.** The time period during which the excess emissions occurred; (3-20-20)T

**b.** Identification of the specific equipment or emissions unit which caused the excess emissions; (3-20-20)T

**c.** An explanation of the cause, or causes, of the excess emissions and whether the excess emissions occurred as a result of startup, shutdown, scheduled maintenance, upset, breakdown or a safety measure; (3-20-20)T

**d.** An estimate of the emissions in excess of any applicable emission standard (based on knowledge of the process and facility where emissions data is unavailable); (3-20-20)T

**e.** A description of the activities carried out to eliminate the excess emissions; and (3-20-20)T

**f.** Certify compliance status with the requirements of Sections 131, 132, 133.01, 134.01 through 134.03, 135, and 136. (3-20-20)T

**g.** If requesting consideration under Subsection 131.02, certify compliance status with Sections 131, 132, 133.01 through 133.03, 134.01 through 134.05, 135, and 136. (3-20-20)T

**136. EXCESS EMISSIONS RECORDS.**

**01. Maintenance of Excess Emissions Records.** The owner or operator shall maintain excess emissions records at the facility for the most recent five (5) calendar year period. (3-20-20)T

**02. Availability of Excess Emissions Records.** The excess emissions records shall be made available to the Department upon request. (3-20-20)T

**03. Contents of Excess Emissions Records.** The excess emissions records shall include the following: (3-20-20)T

**a.** An excess emissions log book for each emissions unit or piece of equipment containing copies of all reports that have been submitted to the Department pursuant to Section 135 for the particular emissions unit or equipment; and (3-20-20)T

**b.** Copies of all startup, shutdown, and scheduled maintenance procedures and upset/breakdown/safety preventative maintenance plans which have been developed by the owner or operator in accordance with Sections 133 and 134, and facility records as necessary to demonstrate compliance with such procedures and plans. (3-20-20)T

**04. Protections Under Section 128.** The protections under Section 128 for confidential information

shall be available for excess emissions reports and records upon proper request of the owner or operator in accordance with Section 128. (3-20-20)T

**137. -- 139. (RESERVED)**

**140. VARIANCES.**

The purpose of Sections 140 through 149 is to establish procedures for obtaining variances. (3-20-20)T

**141. PETITION.**

A variance proceeding shall be commenced by filing three (3) copies of a petition for variance with the Department. The complaint may be accompanied by such affidavits or other proof as the petitioner may submit in order to make it possible for the Department, if it so desires, to dispose of the matter without a hearing. The petition shall contain the following: (3-20-20)T

**01. Statement of Facts.** A concise statement of the facts upon which the variance is requested, including a description of the business or activity in question; the quantity and type of raw materials processed; an estimate of the quantity and type of contaminants discharged; a description of existing and proposed equipment for the control of discharges; and a time schedule for bringing the activity into compliance. (3-20-20)T

**02. Statement of Reasons.** A concise statement of why the petitioner believes that compliance with the provision from which variance is sought would impose an arbitrary or unreasonable hardship, including a description of the costs that compliance would impose on the petitioner and others, and of the injury that the grant of the variance would impose on the public. (3-20-20)T

**03. Requested Relief.** A clear statement of the precise extent of the relief sought. (3-20-20)T

**142. NOTICE.**

The Department shall give notice of all variance petitions as required by law. (3-20-20)T

**143. INVESTIGATION AND RECOMMENDATION.**

After investigating the variance petition and considering the views of persons who might be adversely affected by the grant of the variance, the Department staff shall, within twenty-one (21) days after the filing of the petition, make a recommendation to the Department as to the disposition of the petition. The recommendation, a copy of which shall be served on the petitioner, shall include: (3-20-20)T

**01. Efforts.** A description of the efforts made by the staff to investigate the facts as alleged and to ascertain the views of persons who might be affected, and a summary of the views so ascertained. (3-20-20)T

**02. Disputed Facts.** A statement of the degree to which, if at all, the staff disagrees with the facts as alleged in the petition. (3-20-20)T

**03. Other Facts.** Allegations of any other facts the staff believes relevant to the disposition of the petition. (3-20-20)T

**04. Costs.** The staff's assessment of the costs that compliance would impose on the petitioner and on others and of the injury that the grant of the variance would impose on the public. (3-20-20)T

**05. Recommendations.** The staff's reasoned recommendations as to what disposition should be made of the petition. (3-20-20)T

**144. OBJECTIONS TO PETITION.**

Any person may file with the Department, within twenty-one (21) days after the filing of the petition, a written objection to the grant of the variance. A copy of such objection shall be provided by the Department to the petitioner. (3-20-20)T

**145. AUTHORIZATION OF HEARING.**

**01. No Objection.** If no objection is made by the staff or by any other person to the grant of the variance within twenty-one (21) days after the filing of the petition, the Department shall authorize a hearing unless it determines either: (3-20-20)T

**a.** That even if all the facts alleged in the petition are true, the petitioner is not entitled to variance; or (3-20-20)T

**b.** That the petitioner has shown from affidavits or other proof that compliance with the provision from which variance is sought would impose an arbitrary or unreasonable hardship. (3-20-20)T

**02. No Hearing.** If the Department decides not to hold a hearing, it shall pass upon the petition and shall prepare an opinion stating its reasons both for the grant or denial of the petition and for its decision not to hold a hearing. (3-20-20)T

**03. Early Hearing.** The Department may authorize a hearing without waiting for the expiration of the twenty-one (21) days during which objections may be filed; provided that if a hearing is not held the Department shall not rule upon the petition until the twenty-one (21) days have elapsed. (3-20-20)T

**146. NOTICE OF HEARING.**

The Hearing Officer, after appropriate consultation with the parties, shall set a time and place for hearing and give notice to the petitioner, the EPA, and anyone who has filed an objection to the petition at least twenty-one (21) days prior to the date of the hearing. The hearing shall be set for a date no later than sixty (60) days after the filing of the petition. Any request by the petitioner for a continuance shall constitute a waiver of the right to a decision within ninety (90) days for the period of the continuance. (3-20-20)T

**147. DECISION.**

The Department shall render a final decision upon the petition within ninety (90) days after the filing of the petition, except that time included in a continuance granted at the request of the petitioner shall not be counted. When exigencies of time require, the Department may delay the filing of an opinion until not more than thirty (30) days after the filing of its final order. (3-20-20)T

**148. PROOF OF HARDSHIP.**

No variance shall be granted, with or without hearing, without adequate proof by the petitioner that compliance would impose an arbitrary or unreasonable hardship. (3-20-20)T

**149. VARIANCE FROM NEW RULE.**

If any person files a petition for variance from a rule within twenty (20) days after the original effective date of such a rule, the operation of such rule shall be stayed as to such person, pending the disposition of the petition. The Department may hold a hearing upon said petition within five (5) days from the notice of such hearing, but in all other respects, the rules in Sections 140 through 149 shall apply to the extent they are consistent with the hearing date set by the hearing officer. (3-20-20)T

**150. -- 154. (RESERVED)**

**155. CIRCUMVENTION.**

No person shall willfully cause or permit the installation or use of any device or use of any means that conceals emissions of pollutants that would otherwise violate the provisions of this chapter without resulting in a reduction in the total amount of emissions. (3-20-20)T

**156. TOTAL COMPLIANCE.**

Where more than one (1) section of these rules applies to a particular situation, all such rules must be met for total compliance, unless otherwise provided for in these rules. (3-20-20)T

**157. TEST METHODS AND PROCEDURES.**

The purpose of this Section is to establish procedures and requirements for test methods and results. Unless otherwise specified in these rules, permit, order, consent decree, or prior written approval by the Department: (3-20-20)T

**01. General Requirements.** If a source test is performed to satisfy a performance test requirement or a compliance test requirement imposed by state or federal regulation, rule, permit, order or consent decree, then the test methods and procedures shall be conducted in accordance with the requirements of Section 157. (3-20-20)T

**a.** Prior to conducting any emission test, owners or operators are strongly encouraged to submit to the Department in writing, at least thirty (30) days in advance, the following for approval: (3-20-20)T

i. The type of method to be used; (3-20-20)T

ii. Any extenuating or unusual circumstances regarding the proposed test; and (3-20-20)T

iii. The proposed schedule for conducting and reporting the test. (3-20-20)T

**b.** Without prior Department approval, any alternative testing is conducted solely at the owner's or operator's risk. If the owner or operator fails to obtain prior written approval by the Department for any testing deviations, the Department may determine the test does not satisfy the testing requirements. (3-20-20)T

**02. Test Requirements.** Tests shall be conducted in accordance with the following requirements. (3-20-20)T

**a.** The test must be conducted under operational conditions specified in the applicable state or federal regulation, rule, permit, order, consent decree or by Department approval. If the operational requirements are not specified, the source should test at worst-case normal operating conditions. Worst-case normal conditions are those conditions of fuel type, and moisture, process material makeup and moisture and process procedures which are changeable or which could reasonably be expected to be encountered during the operation of the facility and which would result in the highest pollutant emissions from the facility. (3-20-20)T

**b.** The Department may impose operational limitations or require additional testing in a permit, order or consent decree if the test is conducted under conditions other than worst-case normal. (3-20-20)T

**c.** The Department will accept the methods approved for the applicable pollutants, source type and operating conditions found in 40 CFR Parts 51, 60, 61, and 63 in determining the appropriate test method for an emission limit where one is not otherwise specified. (3-20-20)T

**d.** The following requirements apply to owners or operators requesting minor changes in the test method. As stated in Subsection 157.01 above, without prior Department approval, other changes may result in rejection of the test results by the Department. (3-20-20)T

i. For federal emission standards codified at 40 CFR Parts 60, 61, and 63, the Department will accept those minor changes which have received written approval of the U.S. EPA Administrator so long as the Department determines they are appropriate for the specific application. (3-20-20)T

ii. For all other emission standards in these rules or for permit requirements, the Department will accept those minor changes that the Department determines are appropriate for the specific application. (3-20-20)T

**e.** An owner or operator proposing to use an alternative test method not considered a minor change in Subsection 157.02.d. above, must: (3-20-20)T

i. Demonstrate to the Department by comparative testing or sufficient analysis, that the alternative method is comparable and equivalent to the designated test method. (3-20-20)T

ii. Submit the request for approval to use an alternative test method to the Department at least thirty (30) days in advance of a scheduled test. (3-20-20)T

iii. Obtain, and submit to the Department, EPA approval for use of the alternative test method for emission standards in these rules (except for state only toxic air pollutant standards) or for federal emission standards codified at 40 CFR Parts 60, 61, and 63. (3-20-20)T

iv. Obtain verification that any prior approval of an alternative test method by the Department continues to be acceptable. Alternative methods may cease to be acceptable if new or different information indicates that the alternative test method is less accurate, less reliable, or not comparable with any current state or federal regulation, rule order, permit, or consent decree. (3-20-20)T

f. Prior approval by the Department may not constitute Department approval for subsequent tests if new or different information indicates that a previously Department approved test method is less accurate, less reliable or not comparable with any current state or federal regulation, rule, order, permit or consent decree. (3-20-20)T

**03. Observation of Tests by Department Staff.** The owner or operator shall provide notice of intent to test to the Department at least fifteen (15) days prior to the scheduled test, or shorter time period as provided in a permit, order, consent decree or by Department approval. The Department may, at its option, have an observer present at any emissions tests conducted on a source. (3-20-20)T

**04. Reporting Requirements.** If the source test is performed to satisfy a performance test requirement imposed by state or federal regulation, rule, permit, order, or consent decree, a written report shall be submitted to the Department within sixty (60) days of the completion of the test. The written report shall: (3-20-20)T

a. Meet the format and content requirements specified by the Department in any applicable rule, regulation, guidance, permit, order, or consent decree. Any deviations from the format and contents specified require prior written approval from the Department. Failure to obtain such approval may result in the rejection of the test results. (3-20-20)T

b. Include all data required to be noted or recorded in any referenced test method. (3-20-20)T

**05. Test Results Review Criteria.** The Department will make every effort to review test results within a reasonable time. The Department may reject tests as invalid for: (3-20-20)T

a. Failure to adhere to the approved/required method; (3-20-20)T

b. Using a method inappropriate for the source type or operating conditions; (3-20-20)T

c. An incomplete written report; (3-20-20)T

d. Computational or data entry errors; (3-20-20)T

e. Clearly unreasonable results; (3-20-20)T

f. Failure to comply with the certification requirements of Section 123 of these rules; or (3-20-20)T

g. Failure of the source to conform to operational requirements in orders, permits, or consent decrees at the time of the test. (3-20-20)T

**158. -- 159. (RESERVED)**

**160. PROVISIONS GOVERNING SPECIFIC ACTIVITIES AND CONDITIONS.**

Sections 160 through 164 establish provisions governing specific activities and conditions. Test methods and procedures shall comply with Section 157. (3-20-20)T

**161. TOXIC SUBSTANCES.**

Any contaminant which is by its nature toxic to human or animal life or vegetation shall not be emitted in such quantities or concentrations as to alone, or in combination with other contaminants, injure or unreasonably affect human or animal life or vegetation. (3-20-20)T

**162. MODIFYING PHYSICAL CONDITIONS.**

When physical conditions such as tall adjacent buildings, valley and mountain terrain, etc., are such as to limit the normal dispersion of air pollutants, the Board may set more restrictive emission limitations on those sources affected by the unusual conditions when air quality standards would reasonably be expected to be exceeded. (3-20-20)T

**163. SOURCE DENSITY.**

Should areas develop where each individual source is meeting the requirements of this chapter, yet the ambient air quality standards are being exceeded or might reasonably be expected to be exceeded, the Board may set more restrictive emission limits than are contained in this chapter. (3-20-20)T

**164. POLYCHLORINATED BIPHENYLS (PCBS).**

**01. Prohibition on Burning.** Burning any material containing greater than five (5) parts per million of polychlorinated biphenyls (PCBs) is prohibited, except for incineration for the purpose of disposal. Incineration for disposal shall comply with the following provisions: (3-20-20)T

**a.** No person shall commence construction or modification of a PCB incinerator without a permit issued according to Sections 200 through 225. (3-20-20)T

**b.** The Department must provide opportunity for public comments prior to a final decision for a permit to construct or modify a new PCB incinerator. (3-20-20)T

**c.** A permit issued according to Sections 200 through 225 for construction or modification of a PCB incinerator shall require, as a minimum, best available control technology and monitoring instrumentation. (3-20-20)T

**d.** No permit to operate, construct or modify a PCB incinerator shall be processed or issued prior to March 16, 1987, or such earlier date as shall be determined by the State Board of Environmental Quality. (3-20-20)T

**02. Prohibition on Sales.** No person shall sell, distribute or provide any materials containing greater than five (5) parts per million PCBs for home or commercial heating equipment. (3-20-20)T

**165. -- 174. (RESERVED)**

**175. PROCEDURES AND REQUIREMENTS FOR PERMITS ESTABLISHING A FACILITY EMISSIONS CAP.**

The purpose of Sections 176 through 181 is to establish uniform procedures to obtain a Facility Emissions Cap (FEC) for stationary sources or facilities (hereinafter referred to as facility or facilities). A permit establishing a FEC will be issued pursuant to Sections 200 through 228 or Sections 400 through 410. (3-20-20)T

**176. FACILITY EMISSIONS CAP.**

**01. Optional Facility Emissions Cap.** An owner or operator of a facility may request a FEC to establish an enforceable facility-wide emission limitation. (3-20-20)T

**02. Applicability.** (3-20-20)T

**a.** The owner or operator of any facility, which is not a major facility as defined in Sections 204 or 205, may apply to the Department for a permit to establish a FEC. (3-20-20)T

**b.** FECs are available for new and existing facilities that are not major as defined in Section 204 or 205 or existing facilities undergoing a modification that does not make the facility a major facility as defined in Section 204 or 205. (3-20-20)T

**c.** Facilities that become major facilities as defined in Section 204 or 205 are no longer eligible for a FEC under Section 176. (3-20-20)T

**03. Definitions.** For the purposes of Sections 175 through 181, the following terms shall be defined as

- below. (3-20-20)T
- a. Baseline actual emissions. As defined in Section 007. (3-20-20)T
  - b. Design concentration. The ambient concentration used in establishing the FEC. (3-20-20)T
  - c. Facility emissions cap (FEC). A facility-wide emission limitation expressed in tons per year, for any criteria pollutant or hazardous air pollutant established in accordance with Sections 176 through 181. A FEC is calculated using baseline actual emissions plus an operational variability component and a growth component. A FEC, which is defined in tons per year on a twelve (12) month rolling basis, must be set below major facility thresholds as defined in Sections 204 and 205. (3-20-20)T
  - d. FEC pollutant. The pollutant for which a FEC is established. (3-20-20)T
  - e. Growth component. The level of emissions requested by the applicant and approved by the Department to allow for potential future business growth or facility changes that may increase emissions above baseline actual emissions plus the operational variability component. (3-20-20)T
  - f. Operational variability component. The level of emissions up to the significant emission rate (SER) minus one (1) ton per year but no more than the facility's potential to emit (PTE). If the proposed FEC pollutant does not have a SER listed in Section 006 or has a SER less than or equal to ten (10) tons per year, the operational variability component is the level of emissions requested by the applicant and approved by the Department. The operational variability component cannot be more than the facility's PTE. (3-20-20)T

**177. APPLICATION PROCEDURES.**

In addition to the information required pursuant to Sections 202 or 402, whichever is applicable, applications requesting a FEC must include the information required under Sections 176 through 181 and Subsections 177.01 through 177.03. (3-20-20)T

- 01. Estimates of Emissions.** A proposed FEC for each pollutant requested by the facility, including the basis for calculating the FEC. (3-20-20)T
- 02. Estimates of Ambient Concentrations.** (3-20-20)T
  - a. Estimates of ambient concentrations will be determined as described in Subsection 202.02. (3-20-20)T
  - b. Estimates of ambient concentrations may include projections of alternative future changes within the proposed FEC. (3-20-20)T
  - c. For a new, existing, or modified facility, a demonstration that for each FEC pollutant, the FEC will not cause or significantly contribute to a violation of any ambient air quality standard. (3-20-20)T
  - d. For renewal of terms and conditions establishing a FEC, it is presumed that the previous permitting analysis is satisfactory, unless the Department determines otherwise. (3-20-20)T
- 03. Monitoring and Recordkeeping.** The application must include proposed means for the facility to determine facility emissions on a rolling twelve (12) month consecutive basis. (3-20-20)T

**178. STANDARD CONTENTS OF PERMITS ESTABLISHING A FACILITY EMISSIONS CAP.**

In addition to the elements required by Sections 203 and 211 or Sections 403 and 405, whichever is applicable, the Department shall have the authority to impose, implement and enforce the terms in Subsections 178.01 through 178.05 and conditions establishing a FEC. (3-20-20)T

- 01. Emission Limitations and Standards.** All permits establishing use of a FEC shall contain annual facility wide emissions limitations for each FEC pollutant. (3-20-20)T

- 02. Monitoring.** All permits establishing a FEC shall contain sufficient monitoring to ensure compliance with the FEC on a rolling twelve (12) month consecutive basis. (3-20-20)T
- 03. Recordkeeping.** All permits establishing a FEC shall include the following: (3-20-20)T
- a.** Sufficient recordkeeping to assure compliance with the FEC. (3-20-20)T
  - b.** Retention of required monitoring records and support information for a period of at least five (5) years from the date of the monitoring sample, measurement, report or application. Supporting information includes, but is not limited to, calibration and maintenance records and original strip-chart recordings for continuous monitoring instrumentation and copies of all reports required by the permit. (3-20-20)T
- 04. Reporting.** All permits establishing a FEC shall include the following: (3-20-20)T
- a.** Sufficient reporting to assure compliance with the permit establishing the FEC. (3-20-20)T
  - b.** Submittal of an annual report each year on or before the anniversary date of permit issuance. All required reports must be certified in accordance with Section 123. (3-20-20)T
- 05. Duration.** Each permit establishing a FEC shall state that the terms and conditions establishing the FEC are effective for a fixed term of five (5) years. (3-20-20)T

**179. PROCEDURES FOR ISSUING PERMITS ESTABLISHING A FACILITY EMISSIONS CAP.**

- 01. General Procedures.** Procedures for issuing permits establishing a FEC will follow Sections 209 or 404, whichever is applicable. (3-20-20)T
- 02. Renewal.** The renewal of the terms and conditions establishing a FEC are subject to the same procedural requirements for issuing permits (Subsection 179.01) and Subsections 179.02.a. through 179.02.d.: (3-20-20)T
- a.** The permittee shall submit a complete application to the Department for a renewal of the terms and conditions establishing the FEC at least six (6) months before, but no earlier than eighteen (18) months before, the expiration date of the existing permit. To ensure that the term of the permit does not expire before the terms and conditions are renewed, the permittee is encouraged to submit the application nine (9) months prior to expiration. (3-20-20)T
  - b.** If a timely and complete application for a renewal of the terms and conditions establishing the FEC is submitted, but the Department fails to issue or deny the renewal permit before the end of the term of the previous permit, then all the terms and conditions of the previous permit shall remain in effect until the renewal permit has been issued or denied. (3-20-20)T
  - c.** Expiration of the terms and conditions establishing a FEC may be grounds to terminate the facility's right to operate pursuant to Sections 176 through 181, unless a timely and complete renewal application has been submitted. (3-20-20)T
  - d.** On renewal, the Department may adjust a FEC with an unused growth component in accordance with the Idaho Environmental Protection and Health Act, Chapter 1, Title 39, Idaho Code, and these rules. (3-20-20)T
- 03. Reopening the FEC.** The Department may reopen a FEC to: (3-20-20)T
- a.** Reduce the FEC to reflect newly applicable federal requirements (for example, NSPS) with compliance dates after the issuance of the permit establishing the FEC. (3-20-20)T
  - b.** Reduce the FEC consistent with any other requirement that is enforceable as a practical matter, and that the state may impose on the facility under the Idaho Environmental Protection and Health Act, Chapter 1, Title



39, Idaho Code, and these rules. (3-20-20)T

**04. FEC Termination.** The Director may approve a revision of a permit establishing a FEC to terminate the FEC, provided the permittee complies with Subsections 209.04 or 404.04, as applicable, and Subsections 179.04.a. through 179.04.c.: (3-20-20)T

**a.** The permittee may request a revision of the permit establishing the FEC to terminate the FEC at anytime prior to the expiration of the permit. The permittee is encouraged to submit an application for a permit to construct or Tier I operating permit, as applicable, six (6) months prior to the time the permittee wishes to terminate the FEC. (3-20-20)T

**b.** The FEC established in the permit shall remain in effect until the Department issues a new permit to construct or Tier I operating permit, as applicable. (3-20-20)T

**c.** Nothing in Section 179 prohibits a permittee from requesting a permit revision to terminate the FEC during the permit renewal process. (3-20-20)T

**180. REVISIONS TO PERMITS ESTABLISHING A FACILITY EMISSIONS CAP.**

Section 180 requires revisions to terms and conditions establishing a FEC. The permittee is exempt from Sections 200 through 228 unless the permittee chooses to use those rules to process any change to the permit, except as provided in Subsection 180.02. (3-20-20)T

**01. Criteria.** A permit revision is required for the following: (3-20-20)T

**a.** A change to existing monitoring, reporting or recordkeeping requirements in the permit establishing the FEC; (3-20-20)T

**b.** A change to the FEC; or (3-20-20)T

**c.** A change to the facility that would impose new requirements not included in the permit establishing the FEC. (3-20-20)T

**02. Permit Revision Application Procedures.** A permittee may initiate a permit revision by submitting a permit revision application to the Department or by complying with other applicable sections (Sections 200 or 400). For revision of terms and conditions establishing the FEC, it is presumed that the previous permitting analysis is satisfactory unless the Department determines otherwise. A permit revision application shall: (3-20-20)T

**a.** Meet the standard application requirements of Section 177; (3-20-20)T

**b.** Describe the proposed permit revision; (3-20-20)T

**c.** Describe and quantify the change in emissions above the FEC permit limit; and (3-20-20)T

**d.** Identify new requirements resulting from the change. (3-20-20)T

**03. Permit Revisions.** The Department will process permit revisions pursuant to Section 209 or Section 404. (3-20-20)T

**181. NOTICE AND RECORD-KEEPING OF ESTIMATES OF AMBIENT CONCENTRATIONS.**

Section 181 authorizes facility changes that comply with the terms and conditions establishing the FEC, but that are not included in the estimate of ambient concentration analysis approved for the permit establishing the FEC. No permit revision shall be required for facility changes implemented in accordance with Section 181. (3-20-20)T

**01. Notice.** For facility changes that comply with the terms and conditions establishing the FEC, but are not included in the estimate of ambient concentration analysis approved for the permit establishing the FEC, the permittee shall review the estimate of ambient concentration analysis. (3-20-20)T

**a.** In the event that the facility change would result in a significant contribution above the design concentration determined by the estimate of ambient concentration analysis approved for the permit establishing the FEC, but does not cause or significantly contribute to a violation to any ambient air quality standard, the permittee shall provide notice to the Department in accordance with Subsection 181.01.b. (3-20-20)T

**b.** Notice procedures. The permittee may make a facility change under Section 181 if the permittee provides written notification to the Department so that the notification is received at least seven (7) days in advance of the proposed change or, in the event of an emergency, the permittee provides the notification so that it is received at least twenty-four (24) hours in advance of the proposed change. For each such change, the written notification shall: (3-20-20)T

i. Describe the proposed change; (3-20-20)T

ii. Describe and quantify expected emissions; and (3-20-20)T

iii. Provide the estimated ambient concentration analysis. (3-20-20)T

**02. Recordkeeping.** For facility changes that comply with the terms and conditions establishing the FEC, but are not included in the estimate of ambient concentration analysis approved for the permit establishing the FEC, the permittee shall review the estimate of ambient concentration analysis. In the event the facility change would not result in a significant contribution above the design concentration determined by the estimate of ambient concentration analysis approved for the permit establishing the FEC, the permittee shall record and maintain documentation on-site of the review. (3-20-20)T

**03. Estimates of Ambient Concentrations.** Estimates of ambient concentrations shall be determined during the term of this permit using the same model and model parameters as used with the estimate of ambient concentration analysis approved for the permit establishing the FEC. The permittee shall include any changes to the facility that are not included in the originally approved estimate of ambient concentration analysis. (3-20-20)T

**182. -- 199. (RESERVED)**

**200. PROCEDURES AND REQUIREMENTS FOR PERMITS TO CONSTRUCT.**

The purposes of Sections 200 through 228 is to establish uniform procedures and requirements for the issuance of "Permits to Construct." As used throughout Sections 200 through 228 and 578 through 581, major facility shall be defined as major stationary source in 40 CFR 52.21(b) and 40 CFR 51.165, incorporated by reference into these rules at Section 107, and major modification shall be defined as in 40 CFR 52.21(b) and 40 CFR 51.165, incorporated by reference into these rules at Section 107. These CFR sections have been codified in the electronic CFR which is available at [www.ecfr.gov](http://www.ecfr.gov). (3-20-20)T

**201. PERMIT TO CONSTRUCT REQUIRED.**

No owner or operator may commence construction or modification of any stationary source, facility, major facility, or major modification without first obtaining a permit to construct from the Department which satisfies the requirements of Sections 200 through 228 unless the source is exempted in any of Sections 220 through 223, or the owner or operator complies with Section 213 and obtains the required permit to construct, or the owner or operator complies with Sections 175 through 181, or the source operates in accordance with all of the applicable provisions of a permit by rule. (3-20-20)T

**202. APPLICATION PROCEDURES.**

Application for a permit to construct must be made using forms furnished by the Department, or by other means prescribed by the Department. The application shall be certified by the responsible official in accordance with Section 123 and shall be accompanied by all information necessary to perform any analysis or make any determination required under Sections 200 through 228. (3-20-20)T

**01. Required Information.** Depending upon the proposed size and location of the new or modified stationary source or facility, the application for a permit to construct shall include all of the information required by one or more of the following provisions: (3-20-20)T

- a.** For any new or modified stationary source or facility: (3-20-20)T
- i. Site information, plans, descriptions, specifications, and drawings showing the design of the stationary source, facility, or modification, the nature and amount of emissions (including secondary emissions), and the manner in which it will be operated and controlled. (3-20-20)T
  - ii. A schedule for construction of the stationary source, facility, or modification. (3-20-20)T
- b.** For any new major facility or major modification in a nonattainment area which would be major for the nonattainment regulated air pollutant(s): (3-20-20)T
- i. A description of the system of continuous emission control proposed for the new major facility or major modification, emission estimates, and other information as necessary to determine that the lowest achievable emission rate would be applied. (3-20-20)T
  - ii. A description of the emission offsets proposed for the new major facility or major modification, including information on the stationary sources, mobile sources, or facilities providing the offsets, emission estimates, and other information necessary to determine that a net air quality benefit would result. (3-20-20)T
  - iii. Certification that all other facilities in Idaho, owned or operated by (or under common ownership of) the proposed new major facility or major modification, are in compliance with all local, state or federal requirements or are on a schedule for compliance with such. (3-20-20)T
  - iv. An analysis of alternative sites, sizes, production processes, and environmental control techniques which demonstrates that the benefits of the proposed major facility or major modification significantly outweigh the environmental and social costs imposed as a result of its location, construction, or modification. (3-20-20)T
  - v. An analysis of the impairment to visibility of any federal Class I area, Class I area designated by the Department, or integral vista of any mandatory federal Class I area that the new major facility or major modification would impact (including the monitoring of visibility in any Class I area near the new major facility or major modification, if requested by the Department). (3-20-20)T
- c.** For any new major facility or major modification in an attainment or unclassifiable area for any regulated air pollutant. (3-20-20)T
- i. A description of the system of continuous emission control proposed for the new major facility or major modification, emission estimates, and other information as necessary to determine that the best available control technology would be applied. (3-20-20)T
  - ii. An analysis of the effect on air quality by the new major facility or major modification, including meteorological and topographical data necessary to estimate such effects. (3-20-20)T
  - iii. An analysis of the effect on air quality projected for the area as a result of general commercial, residential, industrial, and other growth associated with the new major facility or major modification. (3-20-20)T
  - iv. A description of the nature, extent, and air quality effects of any or all general commercial, residential, industrial, and other growth which has occurred since August 7, 1977, in the area the new major facility or major modification would affect. (3-20-20)T
  - v. An analysis of the impairment to visibility, soils, and vegetation that would occur as a result of the new major facility or major modification and general commercial, residential, industrial, and other growth associated with establishment of the new major facility or major modification. The owner or operator need not provide an analysis of the impact on vegetation or soils having no significant commercial or recreational value. (3-20-20)T
  - vi. An analysis of the impairment to visibility of any federal Class I area, Class I area designated by the Department, or integral vista of any mandatory federal Class I area that the new major facility or major

modification would affect. (3-20-20)T

vii. An analysis of the existing ambient air quality in the area that the new major facility or major modification would affect for each regulated air pollutant that a new major facility would emit in significant amounts or for which a major modification would result in a significant net emissions increase. (3-20-20)T

viii. Ambient analyses as specified in Subsections 202.01c.vii., 202.01c.ix., 202.01c.x., and 202.01c.xii., may not be required if the projected increases in ambient concentrations or existing ambient concentrations of a particular regulated air pollutant in any area that the new major facility or major modification would affect are less than the amounts listed under 40 CFR 52.21(i)(5)(i), or the regulated air pollutant is not listed therein. (3-20-20)T

ix. For any regulated air pollutant which has an ambient air quality standard, the analysis shall include continuous air monitoring data, gathered over the year preceding the submittal of the application, unless the Department determines that a complete and adequate analysis can be accomplished with monitoring data gathered over a period shorter than one (1) year, but not less than four (4) months, which is adequate for determining whether the emissions of that regulated air pollutant would cause or contribute to a violation of the ambient air quality standard or any prevention of significant deterioration (PSD) increment. (3-20-20)T

x. For any regulated air pollutant which does not have an ambient air quality standard, the analysis shall contain such air quality monitoring data that the Department determines is necessary to assess ambient air quality for that air pollutant in any area that the emissions of that air pollutant would affect. (3-20-20)T

xi. If requested by the Department, monitoring of visibility in any Class I area the proposed new major facility or major modification would affect. (3-20-20)T

xii. Operation of monitoring stations shall meet the requirements of Appendix B to 40 CFR Part 58 or such other requirements as extensive as those set forth in Appendix B as may be approved by the Department. (3-20-20)T

**02. Estimates of Ambient Concentrations.** All estimates of ambient concentrations shall be based on the applicable air quality models, data bases, and other requirements specified in 40 CFR 51, Appendix W (Guideline on Air Quality Models). (3-20-20)T

**a.** Where an air quality model specified in the "Guideline on Air Quality Models," is inappropriate, the model may be modified or another model substituted, subject to written approval of the Administrator of the U.S. Environmental Protection Agency and public comment pursuant to Subsection 209.01.c.; provided that modifications and substitutions of models used for toxic air pollutants will be reviewed by the Department. (3-20-20)T

**b.** Methods like those outlined in the U.S. Environmental Protection Agency's "Interim Procedures for Evaluating Air Quality Models (Revised)" (September 1984) should be used to determine the comparability of air quality models. (3-20-20)T

**03. Additional Information.** Any additional information, plans, specifications, evidence or documents that the Department may require to make the determinations required under Sections 200 through 225 shall be furnished upon request. (3-20-20)T

**203. PERMIT REQUIREMENTS FOR NEW AND MODIFIED STATIONARY SOURCES.**  
No permit to construct shall be granted for a new or modified stationary source unless the applicant shows to the satisfaction of the Department all of the following: (3-20-20)T

**01. Emission Standards.** The stationary source or modification would comply with all applicable local, state or federal emission standards. (3-20-20)T

**02. NAAQS.** The stationary source or modification would not cause or significantly contribute to a violation of any ambient air quality standard. (3-20-20)T

**03. Toxic Air Pollutants.** Using the methods provided in Section 210, the emissions of toxic air pollutants from the stationary source or modification would not injure or unreasonably affect human or animal life or vegetation as required by Section 161. Compliance with all applicable toxic air pollutant carcinogenic increments and toxic air pollutant non-carcinogenic increments will also demonstrate preconstruction compliance with Section 161 with regards to the pollutants listed in Sections 585 and 586. (3-20-20)T

**204. PERMIT REQUIREMENTS FOR NEW MAJOR FACILITIES OR MAJOR MODIFICATIONS IN NONATTAINMENT AREAS.**

New major facilities or major modifications proposed for location in a nonattainment area and which would be major for the nonattainment regulated air pollutant are considered nonattainment new source review (NSR) actions and are subject to the requirements in Section 204. Section 202 contains application requirements and Section 209 contains processing requirements for nonattainment NSR permitting actions. The intent of Section 204 is to incorporate the federal nonattainment NSR rule requirements. (3-20-20)T

**01. Incorporated Federal Program Requirements.** Requirements contained in the following subparts of 40 CFR 51.165 are incorporated by reference into these rules at Section 107. Requirements contained in the following subparts of 40 CFR 52.21, are incorporated by reference at Section 107 of these rules. These CFR sections have been codified in the electronic CFR at [www.ecfr.gov](http://www.ecfr.gov).

<b>40 CFR Reference</b>	<b>40 CFR Reference Title</b>
40 CFR 51.165(a)(1)	Definitions
40 CFR 51.165(a)(2)(ii) - 51.165(a)(3)	Applicability Provisions
40 CFR 51.165(a)(6)(i) - (v)	Applicability Provisions
40 CFR 52.21(aa)	Actual PALs

(3-20-20)T

**02. Additional Requirements.** The applicant must demonstrate to the satisfaction of the Department the following: (3-20-20)T

**a.** LAER. Except as otherwise provided in Section 204, the new major facility or major modification would be operated at the lowest achievable emission rate (LAER) for the nonattainment regulated air pollutant, specifically: (3-20-20)T

i. A new major facility would meet the lowest achievable emission rate at each new emissions unit which emits the nonattainment regulated air pollutant; and (3-20-20)T

ii. A major modification would meet the lowest achievable emission rate at each new or modified emissions unit which has a net emissions increase of the nonattainment regulated air pollutant. (3-20-20)T

**b.** Required offsets. Allowable emissions from the new major facility or major modification are offset by reductions in actual emissions from stationary sources, facilities, and/or mobile sources in the nonattainment area so as to represent reasonable further progress. All offsetting emission reductions must satisfy the requirements for emission reduction credits (Section 460) and provide for a net air quality benefit which satisfies the requirements of Section 208. If the offsets are provided by other stationary sources or facilities, a permit to construct shall not be issued for the new major facility or major modification until the offsetting reductions are made enforceable through the issuance of operating permits. The new major facility or major modification may not commence operation, and an operating permit for the new major facility or major modification shall not be effective before the date the offsetting reductions are achieved. (3-20-20)T

**c.** Compliance status. All other sources in the State owned or operated by the applicant, or by any entity controlling, controlled by or under common control with such person, are in compliance with all applicable emission limitations and standards or subject to an enforceable compliance schedule. (3-20-20)T

**d.** Effect on visibility. The effect on visibility of any federal Class I area, Class I area designated by the Department, or integral vista of a mandatory Class I Federal Area, by the new major facility or major modification, is consistent with making reasonable progress toward the national visibility goal referred to in 40 CFR 51.300(a). The Department may take into account the costs of compliance, the time necessary for compliance, the energy and non-air quality environmental impacts of compliance and the useful life of the source. Any integral vista which the Federal Land Manager has not identified at least six (6) months prior to the submittal of a complete application, or which the Department determines was not identified in accordance with the criteria adopted pursuant to 40 CFR 51.304(a), may be exempted from Section 204 by the Department. (3-20-20)T

**03. Nonmajor Requirements.** If the proposed action meets the requirements of an exemption or exclusion under the provisions of 40 CFR 51.165 or 40 CFR 52.21 incorporated in Section 204, the nonmajor facility or stationary source permitting requirements of Sections 200 through 228 apply, including the exemptions in Sections 220 through 223. (3-20-20)T

**205. PERMIT REQUIREMENTS FOR NEW MAJOR FACILITIES OR MAJOR MODIFICATIONS IN ATTAINMENT OR UNCLASSIFIABLE AREAS.**

The prevention of significant deterioration (PSD) program is a construction permitting program for new major facilities and major modifications to existing major facilities located in areas in attainment or in areas that are unclassifiable for any criteria air pollutant. Section 202 contains application requirements and Section 209 contains processing requirements for PSD permit actions. The intent of Section 205 is to incorporate the federal PSD rule requirements. (3-20-20)T

**01. Incorporated Federal Program Requirements.** Requirements contained in the following subparts of 40 CFR 52.21 are incorporated by reference into these rules at Section 107. These CFR sections have been codified in the electronic CFR which is available at [www.ecfr.gov](http://www.ecfr.gov).

<b>40 CFR Reference</b>	<b>40 CFR Reference Title</b>
40 CFR 52.21(a)(2)	Applicability Procedures
40 CFR 52.21(b)	Definitions
40 CFR 52.21(i)	Review of Major Stationary Sources and Major Modifications - Source Applicability and Exempting
40 CFR 52.21(j)	Control Technology Review
40 CFR 52.21(k)	Source Impact Analysis
40 CFR 52.21(r)	Source Obligation
40 CFR 52.21(v)	Innovative Control Technology
40 CFR 52.21(w)	Permit Rescission
40 CFR 52.21(aa)	Actual PALS

(3-20-20)T

**02. Effect on Visibility.** The applicant must demonstrate that the effect on visibility of any federal Class I area, Class I area designated by the Department, or integral vista of a mandatory Class I Federal Area, by the new major facility or major modification, is consistent with making reasonable progress toward the national visibility goal referred to in 40 CFR 51.300(a). The Department may take into account the costs of compliance, the time necessary for compliance, the energy and non-air quality environmental impacts of compliance and the useful life of the source. Any integral vista which the Federal Land Manager has not identified at least six (6) months prior to the submittal of a complete application, or which the Department determines was not identified in accordance with the criteria adopted pursuant to 40 CFR 51.304(a), may be exempted from this requirement by the Department. (3-20-20)T

**03. Exception to Incorporation by Reference of 40 CFR 52.21.** Every use of the word Administrator in 40 CFR 52.21 means the Department except for the following: (3-20-20)T

**a.** In 40 CFR 52.21(b)(17), the definition of federally enforceable, Administrator means the EPA Administrator. (3-20-20)T

**b.** In 40 CFR 52.21(l)(2), air quality models, Administrator means the EPA Administrator. (3-20-20)T

**c.** In 40 CFR 52.21(b)(43), permit program approved by the Administrator, Administrator means the EPA Administrator. (3-20-20)T

**d.** In 40 CFR 52.21(b)(48)(ii)(c), MACT standard that is proposed or promulgated by the Administrator, Administrator means the EPA Administrator. (3-20-20)T

**e.** In 40 CFR 52.21(b)(50)(i), regulated NSR pollutant as defined by Administrator, Administrator means the EPA Administrator. (3-20-20)T

**04. Nonmajor Requirements.** If the proposed action meets the requirements of an exemption or exclusion under the provisions of 40 CFR 52.21 incorporated in Section 205, the nonmajor facility or stationary source permitting requirements of Sections 200 through 228 apply, including the exemptions in Sections 220 through 223. (3-20-20)T

**206. OPTIONAL OFFSETS FOR PERMITS TO CONSTRUCT.**

The owner or operator of any proposed new or modified stationary source, new major facility, or major modification, which cannot meet the requirements of Subsections 202.01.c.vi., 203.02, 203.03, 204.02.d., 205.01 (40 CFR 52.21(k)), and 209.02.b.vi., may propose the use of an emission offset in order to meet those requirements and thereby obtain a permit to construct. Any proposed emission offset must satisfy the requirements for emission reduction credits, Section 460, and demonstrate, through appropriate dispersion modeling, that the offset will reduce ambient concentrations sufficiently to meet the requirements at all modeled receptors which could not otherwise have met the requirements. (3-20-20)T

**207. REQUIREMENTS FOR EMISSION REDUCTION CREDIT.**

In order to be credited in a permit to construct, any emission reduction credit must satisfy the requirements of Section 460. (3-20-20)T

**208. DEMONSTRATION OF NET AIR QUALITY BENEFIT.**

The demonstration of net air quality benefit shall: (3-20-20)T

**01. VOCs.** For trades involving volatile organic compounds, show that total emissions are reduced for the air basin in which the stationary source or facility is located; (3-20-20)T

**02. Other Regulated Air Pollutants.** For trades involving any other regulated air pollutant, show through appropriate dispersion modeling that the trade will not cause an increase in ambient concentrations at any modeled receptor; (3-20-20)T

**03. Mobile Sources.** For trades involving mobile sources, show a reduction in the ambient impact of emissions upon air quality by obtaining sufficient emission reductions to, at a minimum, compensate for adverse ambient impact where the major facility or major modification would otherwise cause or significantly contribute to a violation of any national ambient air quality standard. (3-20-20)T

**209. PROCEDURE FOR ISSUING PERMITS.**

**01. General Procedures.** General procedures for permits to construct. (3-20-20)T

**a.** Within thirty (30) days after receipt of the application for a permit to construct, the Department shall determine whether the application is complete or whether more information must be submitted and shall notify the applicant of its findings in writing. (3-20-20)T

- b.** Within sixty (60) days after the application is determined to be complete the Department shall: (3-20-20)T
- i.** Upon written request of the applicant, provide a draft permit for applicant review. Agency action on the permit under this Section may be delayed if deemed necessary to respond to applicant comments. (3-20-20)T
- ii.** Notify the applicant in writing of the approval, conditional approval, or denial of the application if an opportunity for public comment is not required pursuant to Subsection 209.01.c. The Department shall set forth reasons for any denial; or (3-20-20)T
- iii.** Issue a proposed approval, proposed conditional approval, or proposed denial. (3-20-20)T
- c.** An opportunity for public comment will be provided on all applications requiring a permit to construct. Public comment shall be provided on an application for any new major facility or major modification, any new facility or modification which would affect any Class I area, any application which uses fluid modeling or a field study to establish a good engineering practice stack height pursuant to Sections 510 through 516, any application which uses an interpollutant trade pursuant to Subsection 210.17, any application which the Director determines an opportunity for public comment should be provided, and any application upon which the applicant so requests. (3-20-20)T
- i.** The Department's proposed action, together with the information submitted by the applicant and the Department's analysis of the information, shall be made available to the public in at least one (1) location in the region in which the stationary source or facility is to be located. (3-20-20)T
- ii.** The availability of such materials shall be made known by notice published in a newspaper of general circulation in the county(ies) in which the stationary source or facility is to be located. (3-20-20)T
- iii.** A copy of such notice shall be sent to the applicant and to appropriate federal, state and local agencies. (3-20-20)T
- iv.** There shall be a thirty (30) day period after initial publication for comment on the Department's proposed action, such comment to be made in writing to the Department. (3-20-20)T
- v.** After consideration of comments and any additional information submitted during the comment period, and within forty-five (45) days after initial publication of the notice, or notice of public hearing if one is requested under Subsections 209.02.b.iv. or 209.02.a.ii., unless the Director deems that additional time is required to evaluate comments and information received, the Department shall notify the applicant in writing of approval, conditional approval, or denial of the permit. The Department shall set forth the reasons for any denial. (3-20-20)T
- vi.** All comments and additional information received during the comment period, together with the Department's final determination, shall be made available to the public at the same location as the preliminary determination. (3-20-20)T
- d.** A copy of each permit will be sent to the U.S. Environmental Protection Agency. (3-20-20)T
- 02. Additional Procedures for Specified Sources.** (3-20-20)T
- a.** For any new major facility or major modification in an attainment or unclassifiable area for any regulated air pollutant. (3-20-20)T
- i.** The public notice issued pursuant to Subsection 209.01.c.ii. shall indicate the degree of increment consumption that is expected from the new major facility or major modification; and (3-20-20)T
- ii.** The public notice issued pursuant to Subsection 209.01.c.ii. shall indicate the opportunity for a public hearing for interested persons to appear and submit written or oral comments on the air quality effects of the new major facility or major modification, alternatives to it, the control technology required, and other appropriate



considerations. All requests for public hearings during a comment period with an opportunity for a hearing must be requested in writing by interested persons within fourteen (14) days of the publication of the legal notice of the proposed permit to construct or within fourteen (14) days prior to the end of the comment period, whichever is later.

(3-20-20)T

**b.** For any new major facility or major modification which would affect a federal Class I area or an integral vista of a mandatory federal Class I area. (3-20-20)T

**i.** If the Department is notified of the intent to apply for a permit to construct, it shall notify the appropriate Federal Land Manager within thirty (30) days; (3-20-20)T

**ii.** A copy of the permit application and all relevant information, including an analysis of the anticipated effects on visibility in any federal Class I area, shall be sent to the Administrator of the U.S. Environmental Protection Agency and the Federal Land Manager within thirty (30) days of receipt of a complete application and at least sixty (60) days prior to any public hearing on the application; (3-20-20)T

**iii.** Notice of every action related to the consideration of the permit shall be sent to the Administrator of the U.S. Environmental Protection Agency; (3-20-20)T

**iv.** The public notice issued pursuant to Subsection 209.01.c.ii. shall indicate the opportunity for a public hearing for interested persons to appear and submit written or oral comments on the air quality effect of the new major facility or major modification, alternatives to it, the control technology required, and other appropriate considerations. All requests for public hearings during a comment period with an opportunity for a hearing must be requested in writing by interested persons within fourteen (14) days of the publication of the legal notice of the proposed permit to construct or within fourteen (14) days prior to the end of the comment period, whichever is later. (3-20-20)T

**v.** The notice of public hearing, if required, shall explain any differences between the Department's preliminary determination and any visibility analysis performed by the Federal Land Manager and provided to the Department within thirty (30) days of the notification pursuant to Subsection 209.02.b.ii. (3-20-20)T

**vi.** Upon a sufficient showing by the Federal Land Manager that a proposed new major facility or major modification will have an adverse impact upon the air quality related values (including visibility) of any federal mandatory Class I area, the Director may deny the application notwithstanding the fact that the concentrations of regulated air pollutants would not exceed the maximum allowable increases for a Class I area. (3-20-20)T

**03. Establishing a Good Engineering Stack Height.** The Department will notify the public of the availability of any fluid model or field study used to establish a good engineering practice stack height and provide an opportunity for a public hearing before issuing a permit or setting an emission standard based thereon. (3-20-20)T

**04. Revisions of Permits to Construct.** The Director may approve a revision of any permit to construct provided the stationary source or facility continues to meet all applicable requirements of Sections 200 through 228. Revised permits will be issued pursuant to procedures for issuing permits (Section 209), except that the requirements of Subsections 209.01.c., 209.02.a., and 209.02.b., shall only apply if the permit revision results in an increase in emissions authorized by the permit or if deemed appropriate by the Director. (3-20-20)T

**05. Permit to Construct Procedures for Tier I Sources.** For Tier I sources that require a permit to construct, the owner or operator shall either: (3-20-20)T

**a.** Submit only the information required by Sections 200 through 219 for a permit to construct, in which case: (3-20-20)T

**i.** A permit to construct or denial will be issued in accordance with Subsections 209.01.a. and 209.01.b. (3-20-20)T

**ii.** The owner or operator may construct the source after permit to construct issuance or in accordance with Subsection 213.02.c. (3-20-20)T

- iii. The owner or operator may operate the source after permit to construct issuance so long as it does not violate any terms or conditions of the existing Tier I operating permit and complies with Subsection 380.02. (3-20-20)T
- iv. Unless a different time is prescribed by these rules, the applicable requirements contained in a permit to construct will be incorporated into the Tier I operating permit during renewal (Section 369). Where an existing Tier I permit would prohibit such construction or change in operation, the source must obtain a permit revision before commencing operation. Tier I sources required to meet the requirements under Section 112(g) of the Clean Air Act (Section 214), or to have a permit under the preconstruction review program approved into the applicable implementation plan under Part C (Section 205) or Part D (Section 204) of Title I of the Clean Air Act, shall file a complete application to obtain a Tier I permit revision within twelve (12) months after commencing operation. (3-20-20)T
- v. The application or minor or significant permit modification request shall be processed in accordance with timelines: Section 361 and Subsections 367.02 through 367.05. (3-20-20)T
- vi. The final Tier I operating permit action shall incorporate the relevant terms and conditions from the permit to construct; or (3-20-20)T
- b.** Submit all information required by Sections 200 through 219 for a permit to construct and Sections 300 through 386 for a Tier I operating permit, or Tier I operating permit modification, in which case: (3-20-20)T
- i. Completeness of the application shall be determined within thirty (30) days. (3-20-20)T
- ii. The Department shall prepare a proposed permit to construct or denial in accordance with Sections 200 through 219 and a draft Tier I operating permit or Tier I operating permit modification in accordance with Sections 300 through 386 within sixty (60) days. (3-20-20)T
- iii. The Department shall provide for public comment and affected state review in accordance with Sections 209, 364 and 365 on the proposed permit to construct or denial and draft Tier I operating permit or Tier I operating permit modification. (3-20-20)T
- iv. Except as otherwise provided by these rules, the Department shall prepare and issue to the owner or operator a final permit to construct or denial within fifteen (15) days of the close of the public comment period. The owner or operator may construct the source after permit to construct issuance or in accordance with Subsection 213.02.c. (3-20-20)T
- v. The final permit to construct will be sent to EPA, along with the proposed Tier I operating permit or modification. The proposed Tier I operating permit or modification shall be sent for review in accordance with Section 366. (3-20-20)T
- vi. The Tier I operating permit, or Tier I operating permit modification, will be issued in accordance with Section 367. The owner or operator may operate the source after permit to construct issuance so long as it does not violate any terms or conditions of the existing Tier I operating permit and complies with Subsection 380.02; or (3-20-20)T
- c.** Submit all information required by Sections 200 through 219 for a permit to construct and Sections 300 through 381 for a Tier I operating permit, or Tier I operating permit modification, in which case: (3-20-20)T
- i. Completeness of the application shall be determined within thirty (30) days. (3-20-20)T
- ii. The Department shall prepare a draft permit to construct or denial in accordance with Sections 200 through 219 and that also meets the requirements of Sections 300 through 381 within sixty (60) days. (3-20-20)T
- iii. The Department shall provide for public comment and affected state review in accordance with Sections 209, 364, and 365 on the draft permit to construct or denial. (3-20-20)T

iv. The Department shall prepare and send a proposed permit to construct or denial to EPA for review in accordance with Section 366. EPA review of the proposed permit to construct or denial in accordance with Section 366 can occur concurrently with public comment and affected state review of the draft permit, as provided in Subsection 209.05.c.iii. above, except that if the draft permit or denial is revised in response to public comment or affected state review, the Department must send the revised proposed permit to construct or denial to EPA for review in accordance with Section 366. (3-20-20)T

v. Except as otherwise provided by these rules, the Department shall prepare and issue to the owner or operator a final permit to construct or denial in accordance with Section 367. The owner or operator may construct the source after permit to construct issuance or in accordance with Subsection 213.02.c. (3-20-20)T

vi. The permittee may, at any time after issuance, request that the permit to construct requirements be incorporated into the Tier I operating permit through an administrative amendment in accordance with Section 381. The owner or operator may operate the source or modification upon submittal of the request for an administrative amendment. (3-20-20)T

**06. Transfer of Permits to Construct.** (3-20-20)T

a. Transfers by Revision. A permit to construct may be transferred to a new owner or operator in accordance with Subsection 209.04. (3-20-20)T

b. Automatic Transfers. Any permit to construct, with or without transfer prohibition language, may be automatically transferred if: (3-20-20)T

i. The current permittee notifies the Department at least thirty (30) days in advance of the proposed transfer date; (3-20-20)T

ii. The notice provides written documentation signed by the current and proposed permittees containing a date for transfer of permit responsibility, designation of the proposed permittee's responsible official, and certification that the proposed permittee has reviewed and intends to operate in accordance with the permit terms and conditions; and (3-20-20)T

iii. The Department does not notify the current permittee and the proposed permittee within thirty (30) days of receipt of the notice of the Department's determination that the permit must be revised pursuant to Subsection 209.04. If the Department does not issue such notice, the transfer is effective on the date provided in the notice described in Subsection 209.06.b.ii. (3-20-20)T

**210. DEMONSTRATION OF PRECONSTRUCTION COMPLIANCE WITH TOXIC STANDARDS.**

In accordance with Subsection 203.03, the applicant shall demonstrate preconstruction compliance with Section 161 to the satisfaction of the Department. The accuracy, completeness, execution and results of the demonstration are all subject to review and approval by the Department. (3-20-20)T

**01. Identification of Toxic Air Pollutants.** The applicant may use process knowledge, raw materials inputs, EPA and Department references and commonly available references approved by EPA or the Department to identify the toxic air pollutants emitted by the stationary source or modification. (3-20-20)T

**02. Quantification of Emission Rates.** (3-20-20)T

a. The applicant may use standard scientific and engineering principles and practices to estimate the emission rate of any toxic air pollutant at the point(s) of emission. (3-20-20)T

i. Screening engineering analyses use unrefined conservative data. (3-20-20)T

ii. Refined engineering analyses utilize refined and less conservative data including, but not limited to, emission factors requiring detailed input and actual emissions testing at a comparable emissions unit using EPA or Department approved methods. (3-20-20)T

**b.** The uncontrolled emissions rate of a toxic air pollutant from a source or modification is calculated using the maximum capacity of the source or modification under its physical and operational design without the effect of any physical or operational limitations. (3-20-20)T

**i.** Examples of physical and operational design include but are not limited to: the amount of time equipment operates during batch operations and the quantity of raw materials utilized in a batch process. (3-20-20)T

**ii.** Examples of physical or operational limitations include but are not limited to: shortened hours of operation, use of control equipment, and restrictions on production which are less than design capacity. (3-20-20)T

**c.** The controlled emissions rate of a toxic air pollutant from a source or modification is calculated using the maximum capacity of the source or modification under its physical and operational design with the effect of any physical or operational limitation that has been specifically described in a written and certified submission to the Department. (3-20-20)T

**d.** The T-RACT emissions rate of a toxic air pollutant from a source or modification is calculated using the maximum capacity of the source or modification under its physical and operational design with the effect of: (3-20-20)T

**i.** Any physical or operational limitation other than control equipment that has been specifically described in a written and certified submission to the Department; and (3-20-20)T

**ii.** An emission standard that is T-RACT. (3-20-20)T

**03. Quantification of Ambient Concentrations.** (3-20-20)T

**a.** The applicant may use the modeling methods provided in Subsection 202.02 to estimate the ambient concentrations at specified receptor sites for any toxic air pollutant emitted from the point(s) of emission. (3-20-20)T

**b.** The point of compliance is the receptor site that is estimated to have the highest ambient concentration of the toxic air pollutant of all the receptor sites that are located either at or beyond the facility property boundary or at a point of public access; provided that, if the toxic air pollutant is listed in Section 586, the receptor site is not considered to be at a point of public access if the receptor site is located on or within a road, highway or other transportation corridor transecting the facility. (3-20-20)T

**c.** The uncontrolled ambient concentration of the source or modification is estimated by modeling the uncontrolled emission rate. (3-20-20)T

**d.** The controlled ambient concentration of the source or modification is estimated by modeling the controlled emission rate. (3-20-20)T

**e.** The approved net ambient concentration from a modification for a toxic air pollutant at each receptor is calculated by subtracting the estimated decreases in ambient concentrations for all sources at the facility contributing an approved creditable decrease at the receptor site from the estimated ambient concentration from the modification at the receptor. (3-20-20)T

**f.** The approved offset ambient concentration from a source or modification for a toxic air pollutant at each receptor is calculated by subtracting the estimated decreases in ambient concentrations for all sources contributing an approved offset at the receptor from the estimated ambient concentration for the source or modification at the receptor. (3-20-20)T

**g.** The T-RACT ambient concentration of the source or modification is estimated by using refined modeling and the T-RACT emission rate. (3-20-20)T

**h.** The approved interpollutant ambient concentration from a source or modification for a toxic air

pollutant at each receptor is calculated as follows: (3-20-20)T

i. Step 1: Calculate the estimated decrease in ambient concentrations for each toxic air pollutant from each source contributing an approved interpollutant trade at the receptor by multiplying the approved interpollutant ratio by the overall decrease in the ambient concentration of the toxic air pollutant at the receptor site. (3-20-20)T

ii. Step 2: Calculate the total estimated decrease at the receptor by summing all of the individual estimated decreases calculated in Subsection 210.03.h.i. for that receptor. (3-20-20)T

iii. Step 3: Calculate the approved interpollutant ambient concentration by subtracting the total estimated decrease at the receptor from the estimated ambient concentration for the source or modification at the receptor. (3-20-20)T

**04. Preconstruction Compliance Demonstration.** The applicant may use any of the Department approved standard methods described in Subsections 210.05 through 210.08, and may use any applicable specialized method described in Subsections 210.09 through 210.12 to demonstrate preconstruction compliance for each identified toxic air pollutant. (3-20-20)T

**05. Uncontrolled Emissions.** (3-20-20)T

a. Compare the source's or modification's uncontrolled emissions rate for the toxic air pollutant to the applicable screening emission level listed in Sections 585 or 586. (3-20-20)T

b. If the source's or modification's uncontrolled emission rate is less than or equal to the applicable screening emission level, no further procedures for demonstrating preconstruction compliance will be required for that toxic air pollutant as part of the application process. (3-20-20)T

**06. Uncontrolled Ambient Concentration.** (3-20-20)T

a. Compare the source's or modification's uncontrolled ambient concentration at the point of compliance for the toxic air pollutant to the applicable acceptable ambient concentration listed in Sections 585 or 586. (3-20-20)T

b. If the source's or modification's uncontrolled ambient concentration at the point of compliance is less than or equal to the applicable acceptable ambient concentration, no further procedures for demonstrating preconstruction compliance will be required for that toxic air pollutant as part of the application process. (3-20-20)T

**07. Controlled Emissions.** (3-20-20)T

a. Compare the source's or modification's controlled emissions rate for the toxic air pollutant to the applicable screening emission level listed in Sections 585 or 586. (3-20-20)T

b. If the source's or modification's controlled emission rate is less than or equal to the applicable screening emission level, no further procedure for demonstrating preconstruction compliance is required for that toxic air pollutant as part of the application process. (3-20-20)T

**08. Controlled Ambient Concentration.** (3-20-20)T

a. Compare the source's or modification's controlled ambient concentration at the point of compliance for the toxic air pollutant to the applicable acceptable ambient concentration listed in Sections 585 or 586. (3-20-20)T

b. If the source's or modification's controlled ambient concentration at the point of compliance is less than or equal to the applicable acceptable ambient concentration, no further procedures for demonstrating preconstruction compliance will be required for that toxic air pollutant as part of the application process. (3-20-20)T

c. The Department shall include an emission limit for the toxic air pollutant in the permit to construct

that is equal to or, if requested by the applicant, less than the emission rate that was used in the modeling. (3-20-20)T

**09. Net Emissions.** (3-20-20)T

**a.** As provided in Section 007 (definition of net emissions increase) and Sections 460 and 461, the owner or operator may net emissions to demonstrate preconstruction compliance. (3-20-20)T

**b.** Compare the modification's approved net emissions increase (expressed as an emission rate) for the toxic air pollutant to the applicable screening emission level listed in Sections 585 or 586. (3-20-20)T

**c.** If the modification's approved net emissions increase is less than or equal to the applicable screening emission level, no further procedures for demonstrating preconstruction compliance will be required for that toxic air pollutant as part of the application process. (3-20-20)T

**d.** The Department shall include emission limits and other permit terms for the toxic air pollutant in the permit to construct that assure that the facility will be operated in the manner described in the preconstruction compliance demonstration. (3-20-20)T

**10. Net Ambient Concentration.** (3-20-20)T

**a.** As provided in Section 007 (definition of net emission increase) and Sections 460 and 461, the owner or operator may net ambient concentrations to demonstrate preconstruction compliance. (3-20-20)T

**b.** Compare the modification's approved net ambient concentration at the point of compliance for the toxic air pollutant to the applicable acceptable ambient concentration listed in Sections 585 or 586. (3-20-20)T

**c.** If the modification's approved net ambient concentration at the point of compliance is less than or equal to the applicable acceptable ambient concentration, no further procedures for demonstrating preconstruction compliance will be required for that toxic air pollutant as part of the application process. (3-20-20)T

**d.** The Department shall include emission limits and other permit terms for the toxic air pollutant in the permit to construct that assure that the facility will be operated in the manner described in the preconstruction compliance demonstration. (3-20-20)T

**11. Toxic Air Pollutant Offset Ambient Concentration.** (3-20-20)T

**a.** As provided in Sections 206 and 460, the owner or operator may use offsets to demonstrate preconstruction compliance. (3-20-20)T

**b.** Compare the source's or modification's approved offset ambient concentration at the point of compliance for the toxic air pollutant to the applicable acceptable ambient concentration listed in Sections 585 or 586. (3-20-20)T

**c.** If the source's or modification's approved offset ambient concentration at the point of compliance is less than or equal to the applicable acceptable ambient concentration, no further procedures for demonstrating preconstruction compliance will be required for that toxic air pollutant as part of the application process. (3-20-20)T

**d.** The Department shall include emission limits and other permit terms for the toxic air pollutant in the permit to construct that assure that the facility will be operated in the manner described in the preconstruction compliance demonstration. (3-20-20)T

**12. T-RACT Ambient Concentration for Carcinogens.** (3-20-20)T

**a.** As provided in Subsections 210.12 and 210.13, the owner or operator may use T-RACT to demonstrate preconstruction compliance for toxic air pollutants listed in Section 586. (3-20-20)T

**i.** This method may be used in conjunction with netting (Subsection 210.09), and offsets (Subsection

210.11). (3-20-20)T

ii. This method is not to be used to demonstrate preconstruction compliance for toxic air pollutants listed in Section 585. (3-20-20)T

b. Compare the source's or modification's approved T-RACT ambient concentration at the point of compliance for the toxic air pollutant to the amount of the toxic air pollutant that would contribute an ambient air cancer risk probability of less than one to one hundred thousand (1:100,000) (which amount is equivalent to ten (10) times the applicable acceptable ambient concentration listed in Section 586). (3-20-20)T

c. If the source's or modification's approved T-RACT ambient concentration at the point of compliance is less than or equal to the amount of the toxic air pollutant that would contribute an ambient air cancer risk probability of less than one to one hundred thousand (1:100,000), no further procedures for demonstrating preconstruction compliance will be required for that toxic air pollutant as part of the application process. (3-20-20)T

d. The Department shall include emission limits and other permit terms for the toxic air pollutant in the permit to construct that assure that the facility will be operated in the manner described in the preconstruction compliance demonstration. (3-20-20)T

**13. T-RACT Determination Processing.** (3-20-20)T

a. The applicant may submit all information necessary to the demonstration at the time the applicant submits the complete initial application or the applicant may request the Department to review a complete initial application to determine if Subsection 210.12 may be applicable to the source or modification. (3-20-20)T

b. Notwithstanding Subsections 209.01.a. and 209.01.b., if the applicant requests the Department to review a complete initial application and Subsection 210.12 is determined to be applicable, the completeness determination for the initial application will be revoked until a supplemental application is submitted and determined complete. When the supplemental application is determined complete, the timeline for agency action shall be reinitiated. (3-20-20)T

**14. T-RACT Determination.** T-RACT shall be determined on a case-by-case basis by the Department as follows: (3-20-20)T

a. The applicant shall submit information to the Department identifying and documenting which control technologies or other requirements the applicant believes to be T-RACT. (3-20-20)T

b. The Department shall review the information submitted by the applicant and determine whether the applicant has proposed T-RACT. (3-20-20)T

c. The technological feasibility of a control technology or other requirements for a particular source shall be determined considering several factors including, but not limited to: (3-20-20)T

i. Process and operating procedures, raw materials and physical plant layout. (3-20-20)T

ii. The environmental impacts caused by the control technology that cannot be mitigated, including, but not limited to, water pollution and the production of solid wastes. (3-20-20)T

iii. The energy requirements of the control technology. (3-20-20)T

d. The economic feasibility of a control technology or other requirement, including the costs of necessary mitigation measures, for a particular source shall be determined considering several factors including, but not limited to: (3-20-20)T

i. Capital costs. (3-20-20)T

ii. Cost effectiveness, which is the annualized cost of the control technology divided by the amount of emission reduction. (3-20-20)T

iii. The difference in costs between the particular source and other similar sources, if any, that have implemented emissions reductions. (3-20-20)T

e. If the Department determines that the applicant has proposed T-RACT, the Department shall determine which of the options, or combination of options, will result in the lowest emission of toxic air pollutants, develop the emission standards constituting T-RACT and incorporate the emission standards into the permit to construct. (3-20-20)T

f. If the Department determines that the applicant has not proposed T-RACT, the Department shall disapprove the submittal. If the submittal is disapproved, the applicant may supplement its submittal or demonstrate preconstruction compliance through a different method provided in Section 210. If the applicant does not supplement its submittal or demonstrate preconstruction compliance through a different method provided in Section 210, the Department shall deny the permit. (3-20-20)T

**15. Short Term Source Factor.** For short term sources, the applicant may utilize a short term adjustment factor of ten (10). For a carcinogen, multiply either the applicable acceptable ambient concentration (AACC) or the screening emission rate, but not both, by ten (10), to demonstrate preconstruction compliance. This method may be used for TAPs listed in Section 586 only and may be utilized in conjunction with standard methods for quantification of emission rates (Subsections 210.05 through 210.08). (3-20-20)T

**16. Environmental Remediation Source.** (3-20-20)T

a. For Remediation sources subject to or regulated by the Resource Conservation and Recovery Act (42 U.S.C. Sections 6901-6992k) and the "Idaho Rules and Standards for Hazardous Waste," (IDAPA 58.01.05.000 et seq.) or the Comprehensive Environmental Response, Compensation and Liability Act (42 U.S.C. 6901-6992k) or a consent order, if the estimated ambient concentration at the point of impact is greater than the acceptable ambient impacts listed in Sections 585 and 586, Best Available Control Technology shall be applied and operated until the estimated uncontrolled emissions from the remediation source are below the acceptable ambient concentration. (3-20-20)T

b. For Remediation sources not subject to or regulated by the Resource Conservation and Recovery Act (42 U.S.C. Sections 6901-6992k) and the "Idaho Rules and Standards for Hazardous Waste," (IDAPA 58.01.05.000 et seq.) or the Comprehensive Environmental Response, Compensation and Liability Act (42 U.S.C. 6901-6992k) or a consent order, shall, for the purposes of these rules, be considered the same as any other new or modified source of toxic air pollution. (3-20-20)T

c. For an environmental remediation source that functions to remediate or recover any release, spill, leak, discharge or disposal of any petroleum product or petroleum substance, the Department may waive the requirements of Section 513 of these rules. (3-20-20)T

**17. Interpollutant Trading Ambient Concentration.** (3-20-20)T

a. As provided in Subsections 209.01.c., 210.17 through 210.19, the owner or operator may use interpollutant trading to demonstrate preconstruction compliance. This method may be used in conjunction with netting (Subsection 210.10), and offsets (Subsection 210.11) (3-20-20)T

b. Compare the source's or modification's approved interpollutant ambient concentration at the point of compliance for the toxic air pollutant emitted by the source or modification to the applicable acceptable ambient concentration listed in Sections 585 or 586. (3-20-20)T

c. If the source's or modification's approved interpollutant ambient concentration at the point of compliance is less than or equal to the applicable acceptable ambient concentration listed in Sections 585 or 586, no further procedures for demonstrating preconstruction compliance will be required for that toxic air pollutant as part of the application process. (3-20-20)T

d. The Department shall include emission limits for all of the toxic air pollutants involved in the trade



in the permit to construct. The Department shall also include other permit terms in the permit to construct that assure that the facility will be operated in the manner described in the preconstruction compliance demonstration. (3-20-20)T

**18. Interpollutant Trading Determination Processing.** (3-20-20)T

**a.** The applicant may submit all information necessary to the demonstration at the time the applicant submits the complete initial application or the applicant may request the Department to review a complete initial application to determine if Subsection 210.17 may be applicable to the source or modification. (3-20-20)T

**b.** Notwithstanding Subsections 209.01.a. and 209.01.b., if the applicant requests the Department to review a complete initial application and Subsection 210.17 is determined to be applicable, the completeness determination for the initial application will be revoked until a supplemental application is submitted and determined complete. When the supplemental application is determined complete, the timeline for agency action shall be reinitiated. (3-20-20)T

**19. Interpollutant Determination.** (3-20-20)T

**a.** The applicant may request an interpollutant trade if the Department determines that: (3-20-20)T

**i.** The facility complies with an emission standard at least as stringent as best available control technology (BACT); and (3-20-20)T

**ii.** The owner or operator has instituted all known and available methods of pollution prevention at the facility to reduce, avoid or eliminate toxic air pollution prior to its generation including, but not limited to, recycling, chemical substitution, and process modification provided that such pollution prevention methods are compatible with each other and the product or service being produced; and (3-20-20)T

**iii.** The owner or operator has taken all available offsets; and (3-20-20)T

**iv.** The owner or operator has identified all geographical areas and populations that may be impacted by the proposed interpollutant trade. (3-20-20)T

**b.** Interpollutant trades shall be approved or denied on a case-by-case basis by the Department. Denials shall be within the discretion of the Department. Approvals shall be granted only if: (3-20-20)T

**i.** The Department of Health and Welfare's Division of Health approves the interpollutant trade; and (3-20-20)T

**ii.** The Department of Environmental Quality determines that the interpollutant trade will result in a overall benefit to the environment; and (3-20-20)T

**iii.** An EPA approved database or other EPA approved reference provides relative potency factors, or comparable factors, or other data that is sufficient to allow for adequate review and approval of the proposed trade by the Department and the Department of Health and Welfare's Division of Health is submitted for all of the toxic air pollutants being traded; and (3-20-20)T

**iv.** The reductions occur at the same facility where the proposed source or modification will be constructed; and (3-20-20)T

**v.** The interpollutant trade will not cause an increase in sum of the ambient concentrations of the carcinogenic toxic air pollutants involved in the particular interpollutant trade at any receptor site; and (3-20-20)T

**vi.** The total cancer risk with the interpollutant trade will be less than the total cancer risk without the interpollutant trade; and (3-20-20)T

**vii.** The total non-cancer health risk with the interpollutant trade will be less than the total non-cancer

health risk without the interpollutant trade. (3-20-20)T

**20. NSPS and NESHAP Sources.** No demonstration of compliance with the toxic air pollutant provisions is required to obtain a permit to construct or to demonstrate permit to construct exemption criteria for a new source or for modification of an existing source if the toxic air pollutant is also a listed hazardous air pollutant from: (3-20-20)T

**a.** The equipment or activity covered by a NSPS or NESHAP; or (3-20-20)T

**b.** The source category of equipment or activity addressed by a NSPS or NESHAP even if the equipment or activity is not subject to compliance requirements under the federal rule. (3-20-20)T

**21. Permit Compliance Demonstration.** Additional procedures and requirements to demonstrate and ensure actual and continuing compliance may be required by the Department in the permit to construct. (3-20-20)T

**22. Interpretation and Implementation of Other Sections.** Except as specifically provided in other sections of these rules, the provisions of Section 210 are not to be utilized in the interpretation or implementation of any other section of these rules. (3-20-20)T

## **211. CONDITIONS FOR PERMITS TO CONSTRUCT.**

**01. Reasonable Conditions.** The Department may impose any reasonable conditions upon an approval, including conditions requiring the stationary source or facility to be provided with: (3-20-20)T

**a.** Sampling ports of a size, number, and location as the Department may require; (3-20-20)T

**b.** Safe access to each port; (3-20-20)T

**c.** Instrumentation to monitor and record emissions data; (3-20-20)T

**d.** Instrumentation for ambient monitoring to determine the effect emissions from the stationary source or facility may have, or are having, on the air quality in any area affected by the stationary source or facility; and (3-20-20)T

**e.** Any other sampling and testing facilities as may be deemed reasonably necessary. (3-20-20)T

**02. Cancellation.** The Department may cancel a permit to construct if the construction is not begun within two (2) years from the date of issuance, or if during the construction, work is suspended for one (1) year. (3-20-20)T

**03. Notification to The Department.** Any owner or operator of a stationary source or facility subject to a permit to construct shall furnish the Department written notifications as follows: (3-20-20)T

**a.** A notification of the anticipated date of initial start-up of the stationary source or facility not more than sixty (60) days or less than thirty (30) days prior to such date; and (3-20-20)T

**b.** A notification of the actual date of initial start-up of the stationary source or facility within fifteen (15) days after such date. (3-20-20)T

**04. Performance Test.** Within sixty (60) days after achieving the maximum production rate at which the stationary source or facility will be operated but not later than one hundred eighty (180) days after initial start-up of such stationary source or facility, the owner or operator of such stationary source or facility may be required to conduct a performance test in accordance with methods and under operating conditions approved by the Department and furnish the Department a written report of the results of such performance test. (3-20-20)T

**a.** Such test shall be at the expense of the owner or operator. (3-20-20)T

- b. The Department may monitor such test and may also conduct performance tests. (3-20-20)T
- c. The owner or operator of a stationary source or facility shall provide the Department fifteen (15) days prior notice of the performance test to afford the Department the opportunity to have an observer present. (3-20-20)T

**212. OBLIGATION TO COMPLY.**

**01. Responsibility to Comply with All Requirements.** Receiving a permit to construct shall not relieve any owner or operator of the responsibility to comply with all applicable local, state and federal statutes, rules and regulations. (3-20-20)T

**02. Relaxation of Standards or Restrictions.** At such time that a particular facility or modification becomes a major facility or major modification solely by virtue of a relaxation in any enforceable emission standard or restriction on the operating rate, hours of operation or on the type or amount of material combusted, stored or processed, which was used to exempt the facility or modification from certain requirements for a permit to construct, the requirements for new major facilities or major modifications shall apply to the facility or modification as though construction had not yet commenced. (3-20-20)T

**213. PRE-PERMIT CONSTRUCTION.**

This section describes how owners or operators may commence construction or modification of certain stationary sources before obtaining the required permit to construct. (3-20-20)T

**01. Pre-Permit Construction Eligibility.** Pre-permit construction approval is available for non-major sources and non-major modifications and for new sources or modifications proposed in accordance with Subsection 213.01.d. Pre-permit construction is not available for any new source or modification that: uses emissions netting to stay below major source levels; uses optional offsets pursuant to Section 206; or would have an adverse impact on the air quality related values of any Class I area. Owners or operators may ask the Department for the ability to commence construction or modification of qualifying sources under Section 213 before receiving the required permit to construct. To obtain the Department's pre-permit construction approval, the owner or operator shall satisfy the following requirements: (3-20-20)T

a. The owner or operator shall apply for a permit to construct in accordance with Subsections 202.01.a., 202.02, and 202.03 of this chapter. (3-20-20)T

b. The owner or operator shall consult with Department representatives prior to submitting a pre-permit construction approval application. (3-20-20)T

c. The owner or operator shall submit a pre-permit construction approval application which must contain, but not be limited to: a letter requesting the ability to construct before obtaining the required permit to construct, a copy of the notice referenced in Subsection 213.02; proof of eligibility; process description(s); equipment list(s); proposed emission limits and modeled ambient concentrations for all regulated air pollutants and toxic air pollutants, such that they demonstrate compliance with all applicable air quality rules and regulations. The models shall be conducted in accordance with Subsection 202.02 and with written Department approved protocol and submitted with sufficient detail so that modeling can be duplicated by the Department. (3-20-20)T

d. Owners or operators seeking limitations on a source's potential to emit such that permitted emissions will be either below major source levels or below a significant increase must describe in detail in the pre-permit construction application the proposed restrictions and certify in accordance with Section 123 that they will comply with the restrictions, including any applicable monitoring and reporting requirements. (3-20-20)T

**02. Permit to Construct Procedures for Pre-Permit Construction.** (3-20-20)T

a. Within ten (10) days after the submittal of the pre-permit construction approval application, the owner or operator shall hold an informational meeting in at least one (1) location in the region in which the stationary source or facility is to be located. The informational meeting shall be made known by notice published at least ten (10) days before the meeting in a newspaper of general circulation in the county(ies) in which the stationary source or

facility is to be located. A copy of such notice shall be included in the application. (3-20-20)T

**b.** Within fifteen (15) days after the receipt of the pre-permit construction approval application, the Department shall notify the owner or operator in writing of pre-permit construction approval or denial. The Department may deny the pre-permit construction approval application for any reason it deems valid. (3-20-20)T

**c.** Upon receipt of the pre-permit construction approval letter issued by the Department, the owner or operator may begin construction at their own risk as identified in Subsection 213.02.d. Upon issuance of the pre-permit construction approval letter, any and all potential to emit limitations addressed in the pre-permit construction application pursuant to Subsection 213.01.d. shall become enforceable. The owner or operator shall not operate those emissions units subject to permit to construct requirements in accordance with Section 200 unless and until issued a permit pursuant to Section 209. (3-20-20)T

**d.** If the pre-permit construction approval application is determined incomplete or the permit to construct is denied, the Department shall issue an incompleteness or denial letter pursuant to Section 209. If the Department denies the permit to construct, then the owner or operator shall have violated Section 201 on the date it commenced construction as defined in Section 006. The owner or operator shall not contest the final permit to construct decision based on the fact that they have already begun construction. (3-20-20)T

#### **214. DEMONSTRATION OF PRECONSTRUCTION COMPLIANCE FOR NEW AND RECONSTRUCTED MAJOR SOURCES OF HAZARDOUS AIR POLLUTANTS.**

**01. Permitting Authority.** For purposes of this section, Sections 112(g) and (j) of the Clean Air Act, and 40 CFR Part 63, the permitting authority shall be the Department. (3-20-20)T

**02. Definitions.** Unless specifically provided otherwise, the definitions for terms set forth in this section shall be the definitions set forth in Section 112 of the Clean Air Act and 40 CFR Part 63 as incorporated by reference into these rules at Section 107. For purposes of determining if a source is a major source of hazardous air pollutants, the definition of potential to emit at Section 006 of these rules shall apply. (3-20-20)T

**03. Compliance with Federal MACT.** All owners or operators of major sources of hazardous air pollutants which are subject to an applicable Maximum Available Control Technology (MACT) standard promulgated by EPA pursuant to Section 112 of the Clean Air Act and 40 CFR Part 63 shall comply with the applicable MACT standard and such owners or operators are not subject to Subsections 214.04 and 214.05. (3-20-20)T

**04. Requirement to Obtain Preconstruction MACT Determination from the Director.** No owner or operator may construct or reconstruct a major source of hazardous air pollutants unless such owner or operator has obtained a MACT standard determination from the Director. The Director shall make the MACT standard determination on a case by case basis and in accordance with Section 112(g)(2)(B) of the Clean Air Act and 40 CFR 63.40 through 63.44 as incorporated by reference into these rules at Section 107. (3-20-20)T

**05. Development of MACT by the Director After EPA Deadline.** In the event that EPA fails to promulgate a MACT standard for a category or subcategory of major sources of hazardous air pollutants identified by the EPA under the Clean Air Act by the date established under Section 112(e) of the Clean Air Act, the owner or operator of any major source of hazardous air pollutants in such category or subcategory shall submit an application to the Director for a MACT standard determination. The Director shall make the MACT standard determination on a case by case basis and in accordance with Section 112(j) of the Clean Air Act and 40 CFR 63.50 through 63.56 as incorporated by reference into these rules at Section 107. (3-20-20)T

#### **215. MERCURY EMISSION STANDARD FOR NEW OR MODIFIED SOURCES.**

No owner or operator may commence construction or modification of a stationary source or facility that results in an increase in annual potential emissions of mercury of twenty-five (25) pounds or more unless the owner or operator has obtained a permit to construct under Sections 200 through 228 of these rules. The permit to construct application shall include an MBACT analysis for the new or modified source or sources for review and approval by the Department. A determination of applicability under Section 215 shall be based upon the best available information. Fugitive emissions shall not be included in a determination of applicability under Section 215. (3-20-20)T

**01. Exemptions.** New or modified stationary sources within a source category subject to 40 CFR Part 63 are exempt from the requirements of Section 215. (3-20-20)T

**02. Applicability.** Except as provided in Subsection 215.01, Section 215 applies to all new or modified sources for which an application for a permit to construct was submitted to the Department on or after July 1, 2011. (3-20-20)T

**216. -- 219. (RESERVED)**

**220. GENERAL EXEMPTION CRITERIA FOR PERMIT TO CONSTRUCT EXEMPTIONS.**

**01. General Exemption Criteria.** Sections 220 through 223 may be used by owners or operators to exempt certain sources from the requirement to obtain a permit to construct. Nothing in these sections shall preclude an owner or operator from choosing to obtain a permit to construct. For purposes of Sections 220 through 223, the term source means the equipment or activity being exempted. For purposes of Sections 220 through 223, fugitive emissions shall not be considered in determining whether a source meets the applicable exemption criteria unless required by federal law. No permit to construct is required for a source that satisfies all of the following criteria, in addition to the criteria set forth at Sections 221 and 223 or 222 and 223 (as required): (3-20-20)T

**a.** The maximum capacity of a source to emit an air pollutant under its physical and operational design without consideration of limitations on emission such as air pollution control equipment, restrictions on hours of operation and restrictions on the type and amount of material combusted, stored or processed would not: (3-20-20)T

i. Equal or exceed one hundred (100) tons per year of any regulated air pollutant. (3-20-20)T

ii. Cause an increase in the emissions of a major facility that equals or exceeds the significant emissions rates set out in the definition of significant at Section 006. (3-20-20)T

**b.** Combination. The source is not part of a proposed new major facility or part of a proposed major modification. (3-20-20)T

**02. Record Retention.** Unless the source is subject to and the owner or operator complies with Section 385, the owner or operator of the source, except for those sources listed in Subsections 222.02.a. through 222.02.g., shall maintain documentation on site which shall identify the exemption determined to apply to the source and verify that the source qualifies for the identified exemption. The records and documentation shall be kept for a period of time not less than five (5) years from the date the exemption determination has been made or for the life of the source for which the exemption has been determined to apply, which ever is greater, or until such time as a permit to construct or an operating permit is issued which covers the operation of the source. The owner or operator shall submit the documentation to the Department upon request. (3-20-20)T

**221. CATEGORY I EXEMPTION.**

No permit to construct is required for a source that satisfies the criteria set forth in Section 220 and the following: (3-20-20)T

**01. Below Regulatory Concern.** The maximum capacity of a source to emit an air pollutant under its physical and operational design considering limitations on emissions such as air pollution control equipment, restrictions on hours of operation and restrictions on the type and amount of material combusted, stored or processed shall be less than ten percent (10%) of the significant emission rates set out in the definition of significant at Section 006. (3-20-20)T

**02. Radionuclides.** The source is not required to obtain approval to construct in accordance with the applicable radionuclides standard in 40 CFR Part 61, Subpart H. (3-20-20)T

**03. Toxic Air Pollutants.** The source shall comply with Section 223. (3-20-20)T

**04. Mercury.** The source shall have potential emissions that are less than twenty-five (25) pounds per year of mercury. Fugitive emissions shall not be included in the calculation of potential mercury emissions. (3-20-20)T

**222. CATEGORY II EXEMPTION.**  
No permit to construct is required for the following sources. (3-20-20)T

**01. Exempt Source.** A source that satisfies the criteria set forth in Section 220 and that is specified below: (3-20-20)T

**a.** Laboratory equipment used exclusively for chemical and physical analyses, research or education, including, but not limited to, ventilating and exhaust systems for laboratory hoods. To qualify for this exemption, the source shall: (3-20-20)T

i. Comply with Section 223. (3-20-20)T

ii. Not be required to obtain approval to construct in accordance with the applicable radionuclides standard in 40 CFR Part 61, Subpart H. (3-20-20)T

**b.** Environmental characterization activities including emplacement and operation of field instruments, drilling of sampling and monitoring wells, sampling activities, and environmental characterization activities. (3-20-20)T

**c.** Stationary internal combustion engines of less than or equal to six hundred (600) horsepower and which are fueled by natural gas, propane gas, liquefied petroleum gas, distillate fuel oils, residual fuel oils, and diesel fuel; waste oil, gasoline, or refined gasoline shall not be used. To qualify for this exemption, the source must be operated in accordance with the following: (3-20-20)T

i. One hundred (100) horsepower or less -- unlimited hours of operation. (3-20-20)T

ii. One hundred one (101) to two hundred (200) horsepower -- less than four hundred fifty (450) hours per month. (3-20-20)T

iii. Two hundred one (201) to four hundred (400) horsepower -- less than two hundred twenty-five (225) hours per month. (3-20-20)T

iv. Four hundred one (401) to six hundred (600) horsepower -- less than one hundred fifty (150) hours per month. (3-20-20)T

**d.** Stationary internal combustion engines used exclusively for emergency purposes which are operated less than five hundred (500) hours per year and are fueled by natural gas, propane gas, liquefied petroleum gas, distillate fuel oils, residual fuel oils, and diesel fuel; waste oil, gasoline, or refined gasoline shall not be used. (3-20-20)T

**e.** A pilot plant that uses a slip stream from an existing process stream not to exceed ten percent (10%) of that existing process stream and which satisfies the following: (3-20-20)T

i. The source shall comply with Section 223. For carcinogen emissions, the owner or operator may utilize a short term adjustment factor of ten (10) by multiplying either the acceptable ambient concentration or the screening emissions level, but not both, by ten (10). (3-20-20)T

ii. The source is not required to obtain approval to construct in accordance with the applicable radionuclides standard in 40 CFR Part 61, Subpart H. (3-20-20)T

iii. The exemption for a pilot plant shall terminate one (1) year after the commencement of operations and shall not be renewed. (3-20-20)T

**02. Other Exempt Sources.** A source that satisfies the criteria set forth in Section 220 and that is specified below: (3-20-20)T

**a.** Air conditioning or ventilating equipment not designed to remove air pollutants generated by or released from equipment. (3-20-20)T

**b.** Air pollutant detectors or recorders, combustion controllers, or combustion shutoffs. (3-20-20)T

**c.** Fuel burning equipment for indirect heating and for heating and reheating furnaces using natural gas, propane gas, liquefied petroleum gas, or biogas (gas produced by the anaerobic decomposition of organic material through a controlled process) with hydrogen sulfide concentrations less than two hundred (200) ppmv exclusively with a capacity of less than fifty (50) million btu's per hour input. (3-20-20)T

**d.** Other fuel burning equipment for indirect heating with a capacity of less than one million (1,000,000) btu's per hour input. (3-20-20)T

**e.** Mobile internal combustion engines, marine installations and locomotives. (3-20-20)T

**f.** Agricultural activities and services. (3-20-20)T

**g.** Retail gasoline, natural gas, propane gas, liquefied petroleum gas, distillate fuel oils and diesel fuel sales. (3-20-20)T

**h.** Used Oil Fired Space Heaters which comply with all the following requirements: (3-20-20)T

**i.** The used oil fired space heater burns only used oil that the owner or operator generates on site, that is derived from households, such as used oil generated by individuals maintaining their personal vehicles, or on-specification used oil that is derived from commercial generators provided that the generator, transporter and owner or operator burning the oil for energy recovery comply fully with IDAPA 58.01.05.015, "Rules and Standards for Hazardous Waste"; (3-20-20)T

(1) For the purposes of Subsection 222.02.h., "used oil" refers to any oil that has been refined from crude oil or any synthetic oil that has been used and, as a result of such use, is contaminated by physical or chemical impurities. (3-20-20)T

(2) For the purposes of Subsection 222.02.h., "used oil fired space heater" refers to any furnace or apparatus and all appurtenances thereto, designed, constructed and used for combusting used oil for energy recovery to directly heat an enclosed space. (3-20-20)T

**ii.** Any used oil burned is not contaminated by added toxic substances such as solvents, antifreeze or other household and industrial chemicals; (3-20-20)T

**iii.** The used oil fired space heater is designed to have a maximum capacity of not more than one half (0.5) million BTU per hour; (3-20-20)T

**iv.** The combustion gases from the used oil fired space heater are vented to the ambient air through a stack equivalent to the type and design specified by the manufacturer of the heater and installed to minimize down wash and maximize dispersion; and (3-20-20)T

**v.** The used oil fired space heater is of modern commercial design and manufacture, except that a homemade used oil fired space heater may be used if, prior to the operation of the homemade unit, the owner or operator submits documentation to the Department demonstrating, to the satisfaction of the Department, that emissions from the homemade unit are no greater than those from modern commercially available units. (3-20-20)T

**i.** Multiple chamber crematory retorts used to cremate human or animal remains using natural gas exclusively with a maximum average charge capacity of two hundred (200) pounds of remains per hour and a minimum secondary combustion chamber temperature of one thousand five hundred (1500) degrees Fahrenheit while

operating. (3-20-20)T

**j.** Petroleum environmental remediation source by vapor extraction with an operation life not to exceed five (5) years (except for landfills). The short-term adjustment factor in Subsection 210.15 cannot be used if the remediation is within five hundred (500) feet of a sensitive receptor. Forms are available at the DEQ website at <http://www.deq.idaho.gov>, to help assist sources in this exemption determination. (3-20-20)T

**k.** Dry cleaning facilities that are not major under, but subject to, 40 CFR Part 63, Subpart M. (3-20-20)T

**223. EXEMPTION CRITERIA AND REPORTING REQUIREMENTS FOR TOXIC AIR POLLUTANT EMISSIONS.**

No permit to construct for toxic air pollutants is required for a source that satisfies any of the exemption criteria below, the recordkeeping requirements at Subsection 220.02, and reporting requirements as follows: (3-20-20)T

**01. Below Regulatory Concern (BRC) Exemption.** The source qualifies for a BRC exemption if the uncontrolled emission rate (refer to Section 210) for all toxic air pollutants emitted by the source is less than or equal to ten percent (10%) of all applicable screening emission levels listed in Sections 585 and 586. (3-20-20)T

**02. Level I Exemption.** To obtain a Level I exemption, the source shall satisfy the following criteria: (3-20-20)T

**a.** The uncontrolled emission rate (refer to Section 210) for all toxic air pollutants shall be less than or equal to all applicable screening emission levels listed in Sections 585 and 586; or (3-20-20)T

**b.** The uncontrolled ambient concentration (refer to Section 210) for all toxic air pollutants at the point of compliance shall be less than or equal to all applicable acceptable ambient concentrations listed in Sections 585 and 586. (3-20-20)T

**03. Level II Exemption.** To obtain a Level II exemption, the maximum capacity of a source to emit a toxic air pollutant under its physical and operational design considering limitations on emissions such as air pollution control equipment, restrictions on hours of operation and restrictions on the type and amount of material combusted, stored or processed at the point of compliance is less than or equal to ten percent (10%) of all applicable screening emission levels listed in Sections 585 and 586. (3-20-20)T

**04. Annual Report for Toxic Air Pollutant Exemption.** The owner or operator of a source claiming a Level I or II exemption shall submit a certified report, on or before May 1 for the previous calendar year, to the Department for each Level I or II exemption determination. The owner or operator is not required to annually submit a certified report for a Level I or II exemption determination previously claimed and reported. The report shall be labeled "Toxic Air Pollutant Exemption Report" and shall state the date construction has or will commence and shall include copies of all exemption determinations completed by the owner or operator for each Level I and II exemption. (3-20-20)T

**224. PERMIT TO CONSTRUCT APPLICATION FEE.**

All applicants for a permit to construct shall submit a permit to construct application fee of one thousand dollars (\$1,000) to the Department at the time of the original submission of the application. The permit to construct application fee is not required to be submitted for: (3-20-20)T

**01. Exemption Applicability Determinations.** Exemption applicability determinations set forth in Sections 220 through 223; (3-20-20)T

**02. Typographical Errors.** Changes to correct typographical errors; or (3-20-20)T

**03. Name or Ownership Change.** A change in the name or ownership of the holder of a permit to construct when the Department determines no other review or analysis is required. (3-20-20)T

**225. PERMIT TO CONSTRUCT PROCESSING FEE.**



A permit to construct processing fee, calculated by the Department pursuant to the categories provided in the following table, shall be paid to the Department by the person receiving the permit. The applicable processing fee category shall be determined by adding together the amount of increases of regulated pollutant emissions and subtracting any decreases of regulated pollutant emissions as identified in the permit to construct. The fee calculation shall not include fugitive emissions.

PERMIT TO CONSTRUCT CATEGORY	FEE
General permit, no facility-specific requirements (Defined as a source category specific permit for which the Department has developed standard emission limitations, operating requirements, monitoring and recordkeeping requirements, and that require minimal engineering analysis. General permit facilities may include portable concrete batch plants, portable hot-mix asphalt plants and portable rock crushing plants.)	\$500
New source or modification to existing source with increase of emissions of less than one (1) ton per year	\$1,000
New source or modification to existing source with increase of emissions of one (1) to less than ten (10) tons per year	\$2,500
New source or modification to existing source with increase of emissions of ten (10) to less than one hundred (100) tons per year	\$5,000
Nonmajor new source or modification to existing source with increase of emissions of one hundred (100) tons per year or more	\$7,500
New major facility or major modification	\$10,000
Permit modifications where no engineering analysis is required	\$250
Application submittals for exemption applicability determinations, typographical errors, and name and ownership changes as described in Subsections 224.01, 224.02, 224.03	\$0.00

(3-20-20)T

**226. PAYMENT OF FEES FOR PERMITS TO CONSTRUCT.**

**01. Fee Submittal.** The permit to construct application fee shall be submitted with the application. The permit to construct processing fee shall be payable upon receipt of an assessment sent to the person receiving a permit by the Department. The permit to construct application and processing fees shall be sent to:

Air Quality Permit to Construct Fees  
 Fiscal Office,  
 Idaho Department of Environmental Quality  
 1410 N. Hilton, Boise, ID 83706-1255

(3-20-20)T

**02. Delinquency.** No application for a permit to construct shall be processed by the Department unless accompanied by a permit to construct application fee. No permit to construct shall be issued by the Department until the Department has received the permit to construct processing fee.

(3-20-20)T

**227. RECEIPT AND USAGE OF FEES.**

Permit to construct application and processing fee receipts shall be deposited by the Department into a stationary source permit account. Monies from this account shall be used solely toward technical, legal and administrative support of the Department's permit to Construct and Tier II permit programs and shall not be used for those activities supported by the fund created for implementing the operating permit program required under Title V of the federal Clean Air Act amendments of 1990. The permit to construct application fee payable under Section 227 shall be retained by the Department regardless of whether a permit to construct is issued by the Department in response to an application. The Department will review the fee schedule at least every two (2) years.

(3-20-20)T

**228. APPEALS.**

A person may be able to file an appeal within thirty-five (35) days of the date the person receives an assessment from the Department under Section 225, in accordance with IDAPA 58.01.23, "Rules of Administrative Procedure Before the Board of Environmental Quality." (3-20-20)T

**229. -- 299. (RESERVED)**

**300. PROCEDURES AND REQUIREMENTS FOR TIER I OPERATING PERMITS.**

The purposes of Sections 300 through 399 are to establish requirements and procedures for the issuance of Tier I operating permits. (3-20-20)T

**301. REQUIREMENT TO OBTAIN TIER I OPERATING PERMIT.**

**01. Prohibition.** No owner or operator shall operate, or allow or tolerate the operation of, any Tier I source without an effective Tier I operating permit. (3-20-20)T

**02. Exceptions.** (3-20-20)T

**a.** No Tier I operating permit is required if the owner or operator is in compliance with Sections 311 through 315 and the Department has not taken final action on the application. (3-20-20)T

**b.** Tier I sources not located at major facilities do not require a Tier I operating permit until: (3-20-20)T

i. December 31, 1997 for Phase II sulfur dioxide sources; (3-20-20)T

ii. January 1, 1999 for Phase II nitrogen oxides sources; (3-20-20)T

iii. January 1, 2000 for solid waste incineration units required to obtain a permit pursuant to 42 U.S.C. Section 7429(e); and (3-20-20)T

iv. The source becomes a Tier I source under Section 006 of this chapter. (3-20-20)T

**c.** No Tier I operating permit is required for the following Tier I sources: (3-20-20)T

i. All sources and source categories that would be required to obtain a permit solely because they are subject to 40 CFR Part 60, Subpart AAA; and (3-20-20)T

ii. All sources and source categories that would be required to obtain a permit solely because they are subject to 40 CFR Part 61.145. (3-20-20)T

**302. OPTIONAL TIER I OPERATING PERMIT.**

Any facility listed in Section 301 not required to obtain a Tier I operating permit may opt to apply for a Tier I operating permit. (3-20-20)T

**303. -- 310. (RESERVED)**

**311. STANDARD PERMIT APPLICATIONS.**

The purpose of Sections 311 through 315 is to establish standard Tier I operating permit application procedures. (3-20-20)T

**312. DUTY TO APPLY.**

For each Tier I source, the owner or operator shall submit a timely and complete permit application in accordance with Sections 311 through 315. (3-20-20)T

**313. TIMELY APPLICATION.**

- 01. Original Tier I Operating Permits.** (3-20-20)T
- a.** For Tier I sources existing on May 1, 1994, the owner or operator of the Tier I source shall submit to the Department a complete application for an original Tier I operating permit by no later than June 1, 1996, or within twelve (12) months of EPA approval of the Tier I operating program, whichever is earlier, unless: (3-20-20)T
- i. The Department provides written notification of an earlier date to the owner or operator. (3-20-20)T
- ii. The Tier I source is identified in Subsections 301.02.b. or 301.02.c. (3-20-20)T
- b.** For sources that become Tier I sources after May 1, 1994, that are located at a facility not previously authorized by a Tier I operating permit, the owner or operator of the Tier I source shall submit to the Department a complete application for an original Tier I operating permit within twelve (12) months after becoming a Tier I source or commencing operation, unless: (3-20-20)T
- i. The Department provides written notification of an earlier date to the owner or operator. (3-20-20)T
- ii. The Tier I source is identified in Subsections 301.02.b. or 301.02.c. (3-20-20)T
- c.** For initial phase II acid rain sources identified in Subsections 301.02.b.i. or 301.02.b.ii., the owner or operator of the initial Phase II acid rain source shall submit to the Department a complete application for an original Tier I operating permit by January 1, 1996 for sulfur dioxide, and by January 1, 1998 for nitrogen oxides. (3-20-20)T
- d.** For Tier I sources identified in Subsection 301.02.b.iii.: (3-20-20)T
- i. Existing on July 1, 1998, the owner or operator of the Tier I source shall submit to the Department a complete application for an original Tier I operating permit by no later than January 1, 1999, unless the Department provides written notification of an earlier date to the owner or operator. (3-20-20)T
- ii. That become Tier I sources after July 1, 1998, located at a facility not previously authorized by a Tier I operating permit, the owner or operator of the Tier I source shall submit to the Department a complete application for an original Tier I operating permit within twelve (12) months after becoming a Tier I source or commencing operation, unless the Department provides written notification of an earlier date to the owner or operator. (3-20-20)T
- 02. Earlier Dates During Initial Period.** Except as otherwise provided in these rules, during the initial period which begins May 1, 1994 and ends three (3) years after EPA approval of the Tier I operating program, the Department may designate Tier I sources for processing as follows: (3-20-20)T
- a.** The Department may develop a general estimate of the total work load and benefits associated with the Tier I operating permit applications that are predicted to be submitted during the initial period including, but not limited to, original permit applications and significant permit modification applications. (3-20-20)T
- b.** Considering the complexity of the applications, air quality benefits of permitting and requests for early actions from owners and operators, the Department may divide the applications into three (3) groups each representing approximately one-third (1/3) of the total work load and benefits. (3-20-20)T
- c.** The Department may prioritize the three (3) groups and the Tier I sources within each group for processing, establish early application deadlines and notify the owners or operators of the Tier I sources in the group in writing of a required submittal date earlier than the general deadlines provided in Subsection 313.01. (3-20-20)T
- 03. Renewals of Tier I Operating Permits.** The owner or operator of the Tier I source shall submit a complete application to the Department for a renewal of the Tier I operating permit at least six (6) months before, but no earlier than eighteen (18) months before, the expiration date of the existing Tier I operating permit. To ensure that

the term of the operating permit does not expire before the permit is renewed, the owner or operator is encouraged to submit the application nine (9) months prior to expiration. (3-20-20)T

**04. Changes to Tier I Operating Permits.** Sections 380 through 386 provide the requirements and procedures for changes at Tier I sources and to Tier I operating permits. (3-20-20)T

**314. REQUIRED STANDARD APPLICATION FORM AND REQUIRED INFORMATION.**

**01. General Requirements.** (3-20-20)T

**a.** Applications shall be submitted on a form or forms provided by the Department or by other means prescribed by these rules or the Department. The application shall be certified by the responsible official in accordance with Section 123. (3-20-20)T

**i.** If the Tier I source is regulated under 42 U.S.C. Sections 7651 through 7651o, the owner or operator shall also submit nationally-standardized acid rain forms provided by EPA. (3-20-20)T

**b.** All information shall be in sufficient detail so that the Department may efficiently and effectively determine the applicability of requirements and make all other necessary evaluations and determinations. (3-20-20)T

**02. General Information for the Facility.** (3-20-20)T

**a.** Provide identifying information, including the name, address and telephone number of: (3-20-20)T

**i.** The owner; (3-20-20)T

**ii.** The operator; (3-20-20)T

**iii.** The facility where the Tier I source is located; (3-20-20)T

**iv.** The registered agent of the owner, if any; (3-20-20)T

**v.** The registered agent of the operator, if any; (3-20-20)T

**vi.** The responsible official, if other than the owner or operator; and (3-20-20)T

**vii.** The contact person. (3-20-20)T

**b.** Provide a general description of the processes used and products produced by the facility where the Tier I source is located, including any associated with each requested alternative operating scenario and trading scenario. The description shall include narrative and applicable SIC codes. (3-20-20)T

**c.** Provide a general description of each process line affecting a Tier I source. (3-20-20)T

**03. Specific Information for Each Emissions Unit.** The owner or operator shall provide, in an itemized format, all of the information identified in Subsections 314.04 through 314.11 for each emissions unit, unless the emissions unit is an insignificant activity. (3-20-20)T

**04. Emissions.** (3-20-20)T

**a.** Identify and describe all emissions of pollutants for which the source is major and all emissions of regulated air pollutants from each emissions unit. Fugitive emissions shall be included in the application in the same manner as stack emissions, regardless of whether the source category is included in the list of sources contained in the definition of major facility (Section 008). (3-20-20)T

**b.** Emissions rates shall be quantified in tons per year (tpy) or for radionuclides the effective dose equivalent (EDE) in millirem per year and in such additional terms as are necessary to determine compliance

- consistent with the applicable test method. (3-20-20)T
- c.** Identify and describe all points of emissions in sufficient detail to establish the basis for fees and applicability of requirements of the Clean Air Act. (3-20-20)T
  - d.** To the extent it is needed to determine or regulate emissions, identify and quantify all fuels, fuel use, raw materials, production rates, and operating schedules. (3-20-20)T
  - e.** Identify and describe all air pollution control equipment and compliance monitoring devices or activities. (3-20-20)T
  - f.** Identify and describe all limitations on source operation or any work practice standards affecting emissions. (3-20-20)T
  - g.** Provide the calculations on which the information provided under Subsections 314.04.a. through 314.04.e. is based. (3-20-20)T
- 05. Applicable Requirements.** (3-20-20)T
- a.** Cite and describe all applicable requirements affecting the emissions unit; and (3-20-20)T
  - b.** Describe or reference all methods required by each applicable requirement for determining the compliance status of the emissions unit with the applicable requirement, including any applicable monitoring, recordkeeping and reporting requirements or test methods. (3-20-20)T
- 06. Other Requirements.** Other specific information that may be necessary to determine the applicability of, implement or enforce any requirement of the Act, these rules, 42 U.S.C. Sections 7401 through 7671q or federal regulations. (3-20-20)T
- 07. Proposed Determinations of Nonapplicability.** Identify requirements for which the applicant seeks a determination of nonapplicability and provide an explanation of why the requirement is not applicable to the Tier I source. (3-20-20)T
- 08. Alternative Operating Scenarios.** (3-20-20)T
- a.** Identify all requested alternative operating scenarios. (3-20-20)T
  - b.** Provide a detailed description of all requested alternative operating scenarios. Include all the information required by Section 314 that is relevant to the alternative operating scenario. (3-20-20)T
- 09. Compliance Certifications.** (3-20-20)T
- a.** Provide a compliance certification regarding the compliance status of each emissions unit at the time the application is submitted to the Department that: (3-20-20)T

    - i.** Identifies all applicable requirements affecting each emissions unit. (3-20-20)T
    - ii.** Certifies the compliance status of each emissions unit with each of the applicable requirements. (3-20-20)T
    - iii.** Provides a detailed description of the method(s) used for determining the compliance status of each emissions unit with each applicable requirement, including a description of any monitoring, recordkeeping, reporting and test methods that were used. Also provide a detailed description of the method(s) required for determining compliance. (3-20-20)T
    - iv.** Certifies the compliance status of the emissions unit with any applicable enhanced monitoring requirements. (3-20-20)T

- v. Certifies the compliance status of the emissions unit with any applicable enhanced compliance certification requirements. (3-20-20)T
- vi. Provides all other information necessary to determining the compliance status of the emissions unit. (3-20-20)T
- b.** Provide a schedule for submission of compliance certifications during the term of the Tier I operating permit. The schedule shall require compliance certifications to be submitted no less frequently than annually, or more frequently if specified by the underlying applicable requirement or by the Department. (3-20-20)T
- 10. Compliance Plans.** (3-20-20)T
- a.** Provide a compliance description as follows: (3-20-20)T
- i. For each applicable requirement with which the emissions unit is in compliance, state that the emissions unit will continue to comply with the applicable requirement. (3-20-20)T
- ii. For each applicable requirement that will become effective during the term of the Tier I operating permit that does not contain a more detailed schedule, state that the emissions unit will meet the applicable requirement on a timely basis. (3-20-20)T
- iii. For each applicable requirement that will become effective during the term of the Tier I operating permit that contains a more detailed schedule, state that the emissions unit will comply with the applicable requirement on the schedule provided in the applicable requirement. (3-20-20)T
- iv. For each applicable requirement with which the emission unit is not in compliance, state that the emissions unit will be in compliance with the applicable requirement by the time the Tier I operating permit is issued or provide a compliance schedule in accordance with Subsection 314.10.b. (3-20-20)T
- b.** All compliance schedules shall: (3-20-20)T
- i. Include a schedule of remedial measures leading to compliance, including an enforceable sequence of actions and specific dates for achieving milestones and achieving compliance. (3-20-20)T
- ii. Incorporate the terms and conditions of any applicable consent order, judicial order, judicial consent decree, administrative order, settlement agreement or judgment. (3-20-20)T
- iii. Be supplemental to, and shall not sanction noncompliance with, the applicable requirements on which it is based. (3-20-20)T
- c.** Provide a schedule for submission to the Department of periodic progress reports no less frequently than every six (6) months or at a more frequent period if one (1) is specified in the underlying applicable requirement or by the Department. (3-20-20)T
- 11. Trading Scenarios.** (3-20-20)T
- a.** Identify all requested trading scenarios, including alternative emissions limits (bubbles) authorized by Section 440. (3-20-20)T
- b.** Provide a detailed description of all requested trading scenarios. Include all the information required by Section 314 that is relevant to the trading scenario and all the information required by Section 440, if applicable. Emissions trades must comply with all applicable requirements. (3-20-20)T
- c.** Provide proposed replicable procedures and permit terms that ensure the emissions trades are quantifiable and enforceable. Emissions trades involving emissions units for which the emissions are not quantifiable or for which there are no replicable procedures to enforce the emissions trade shall not be approved. (3-20-20)T

**12. Additional Information.** Provide all additional information that the Department determines is necessary for the Department to efficiently and effectively perform its functions. Such functions include, but are not limited to, determining the applicability of requirements for all regulated air pollutants, determining compliance with applicable requirements, developing or defining Tier I operating permit terms and conditions, defining all approved alternative operating scenarios, evaluating excess emissions procedures or making all necessary evaluations and determinations. (3-20-20)T

**315. DUTY TO SUPPLEMENT OR CORRECT APPLICATION.**

**01. Failure to Submit.** Any applicant who fails to submit any relevant facts or who has submitted incorrect information in a permit application shall, upon becoming aware of such failure or incorrect submittal, promptly submit such supplementary facts or corrected information. (3-20-20)T

**02. Necessary Additional Information.** If, while processing an application that has been determined or deemed to be complete, the Department determines that additional information is necessary to evaluate or take final action on that application, the Department may request such information in writing and set a deadline for a response. The applicant shall submit the requested information on or before the deadline set by the Department. (3-20-20)T

**03. Additional Information After Completeness.** The applicant shall promptly provide additional information as necessary to address any requirements that become applicable to the Tier I source after the date a complete application was filed but prior to release of a proposed action. (3-20-20)T

**316. EFFECT OF INACCURATE INFORMATION IN APPLICATIONS OR FAILURE TO SUBMIT RELEVANT INFORMATION.**

Notwithstanding the shield provisions of Section 325, the owner or operator shall be subject to enforcement action for operation of the Tier I source without a Tier I operating permit if the owner or operator submitted an incomplete or inaccurate application or the Tier I source is later determined not to qualify for coverage under the conditions and terms of the Tier I operating permit. (3-20-20)T

**317. INSIGNIFICANT ACTIVITIES.**

**01. Applicability Criteria.** This Section contains the criteria for identifying insignificant activities for the purposes of the Tier I operating permit program. Notwithstanding any other provision of this rule, no emission unit or activity subject to an applicable requirement shall qualify as an insignificant emission unit or activity. Applicants may not exclude from Tier I operating permit applications information that is needed to determine whether the facility is major or whether the facility is in compliance with applicable requirements. (3-20-20)T

- a.** Presumptively insignificant emission units. (3-20-20)T
  - i.** Except as provided above, the activities listed in this section may be omitted from the permit application. (3-20-20)T
    - (1) Blacksmith forges. (3-20-20)T
    - (2) Mobile transport tanks on vehicles except for those containing asphalt and not including loading and unloading operations. (3-20-20)T
    - (3) Natural gas pressure regulator vents, excluding venting at oil and gas production facilities. (3-20-20)T
    - (4) Storage tanks, reservoirs and pumping and handling equipment of any size, limited to soaps, lubricants, lubricating oil, treater oil, hydraulic fluid, vegetable oil, grease, animal fat, aqueous salt solutions or other materials and processes using appropriate lids and covers where there is no generation of objectionable odor or airborne particulate matter. (3-20-20)T

- (5) Pressurized storage of oxygen, nitrogen, carbon dioxide, air, or inert gases. (3-20-20)T
- (6) Storage of solid material, dust-free handling. (3-20-20)T
- (7) Boiler water treatment operations, not including cooling towers. (3-20-20)T
- (8) Vents from continuous emission monitors and other analyzers. (3-20-20)T
- (9) Vents from rooms, buildings and enclosures that contain permitted emissions units or activities from which local ventilation, controls, and separate exhaust are provided. (3-20-20)T
- (10) Internal combustion engines for propelling or powering a vehicle. (3-20-20)T
- (11) Recreational fireplaces including the use of barbecues, campfires and ceremonial fires. (3-20-20)T
- (12) Brazing, soldering, and welding equipment and cutting torches for use in cutting metal wherein components of the metal do not generate hazardous air pollutants or hazardous air pollutant precursors. (3-20-20)T
- (13) Atmospheric generators used in connection with metal heat treating processes using non-hazardous air pollutant metals as the primary raw material. (3-20-20)T
- (14) Non-hazardous air pollutant metal finishing or cleaning using tumblers. (3-20-20)T
- (15) Drop hammers or hydraulic presses for forging or metalworking. (3-20-20)T
- (16) Electrolytic deposition, used to deposit brass, bronze, copper, iron, tin, zinc, precious and other metals not listed as the parents of hazardous air pollutants. (3-20-20)T
- (17) Equipment used for surface coating, painting, dipping or spraying operations, except those that will emit volatile organic compound or hazardous air pollutant. (3-20-20)T
- (18) Process water filtration systems. (3-20-20)T
- (19) Portable electrical generators that can be moved by hand from one (1) location to another. Moved by hand means that it can be moved without the assistance of any motorized or non-motorized vehicle, conveyance, or device. (3-20-20)T
- (20) Plastic and resin curing equipment, excluding FRP and provided these activities are not related to the source's primary business activity. (3-20-20)T
- (21) Extrusion equipment, metals, minerals, plastics, grain or wood used without solvents containing hazardous air pollutant. (3-20-20)T
- (22) Presses and vacuum forming, for curing rubber and plastic products or for laminating plastics without solvents containing hazardous air pollutants present. (3-20-20)T
- (23) Roller mills and calendars for use with rubber and plastics without solvents containing hazardous air pollutants. (3-20-20)T
- (24) Conveying and storage of plastic pellets. (3-20-20)T
- (25) Plastic compression, injection, and transfer molding and extrusion, rotocasting, pultrusion, blowmolding, excluding acrylics, PVC, polystyrene and related copolymers and the use of plasticizer. Only oxygen, carbon dioxide, nitrogen, air or inert gas allowed as blowing agent. (3-20-20)T
- (26) Plastic pipe welding. (3-20-20)T



- (27) Wax application in either a molten state or aqueous suspension. (3-20-20)T
- (28) Plant maintenance and upkeep including routine housekeeping, janitorial activities, cleaning and preservation of equipment, preparation for and painting of structures or equipment, retarring roofs, applying insulation to buildings in accordance with applicable environmental and health and safety requirements and lawn, landscaping and groundskeeping activities. Provided these activities are not conducted as part of a manufacturing process, are not related to the source's primary business activity, and not otherwise triggering a permit modification. (3-20-20)T
- (29) Agricultural activities on a facility's property that are not subject to registration or new source review by the permitting authority. (3-20-20)T
- (30) Maintenance of paved streets and parking lots including paving, stripping, salting, sanding, cleaning and sweeping of streets and paved surfaces. Provided these activities are not related to the source's primary business activity, do not otherwise trigger a permit modification, and fugitive emissions are reasonably controlled as required in Section 808. (3-20-20)T
- (31) Ultraviolet curing processes. (3-20-20)T
- (32) Hot melt adhesive application with no volatile organic compounds or hazardous air pollutants in the adhesive formula. (3-20-20)T
- (33) Laundering, dryers, extractors, tumblers for fabrics, using water solutions of bleach and/or detergents except for boilers. (3-20-20)T
- (34) Steam cleaning operations. (3-20-20)T
- (35) Steam sterilizers. (3-20-20)T
- (36) Food service activities including cafeterias, kitchen facilities and barbecues located at a source for providing food service on premises. (3-20-20)T
- (37) Portable drums and totes. (3-20-20)T
- (38) Fluorescent light tube and aerosol can crushing in units designed to reduce emissions from these activities. (3-20-20)T
- (39) Flares used to indicate danger to the public. (3-20-20)T
- (40) General vehicle maintenance including vehicle exhaust from repair facilities provided these activities are not related to the source's primary business activity and do not have applicable requirements under title VI of the Clean Air Act. (3-20-20)T
- (41) Comfort air conditioning or air cooling systems, not used to remove air contaminants from specific equipment. (3-20-20)T
- (42) Natural draft hoods, natural draft stacks, or natural draft ventilators for sanitary and storm drains, safety valves, and storage tanks subject to size and service limitations expressed elsewhere in this section. (3-20-20)T
- (43) Natural and forced air vents for bathroom/toilet facilities. (3-20-20)T
- (44) Office activities. (3-20-20)T
- (45) Equipment used for quality control/assurance or inspection purposes, including sampling equipment used exclusively to withdraw materials for laboratory analyses and testing. (3-20-20)T
- (46) Fire suppression systems and similar safety equipment and equipment used to train firefighters

- including fire drill pits. (3-20-20)T
- (47) Materials and equipment used by, and activity related to operation of infirmary; infirmary is not the source's business activity except equipment affected by the radionuclide NESHAP. (3-20-20)T
- (48) Satellite Accumulation Areas (SAAs) and Temporary Accumulation Areas (TAAs) managed in compliance with RCRA. (3-20-20)T
- (49) Equipment for carving, cutting, routing, turning, drilling, machining, sawing, surface grinding, sanding, planing, buffing, shot blasting, sintering, or polishing: Ceramics, glass, leather, metals, plastics, rubber, concrete, paper stock, or wood provided that these activities are not conducted as part of a manufacturing process. (3-20-20)T
- (50) Oxygen, nitrogen, or rare gas extraction and liquefaction equipment subject to other exemption limitation, e.g., internal and external combustion equipment. (3-20-20)T
- (51) Slaughterhouses, such as rendering cookers, boilers, heating plants, incinerators, and electrical power generating equipment. (3-20-20)T
- (52) Ozonation equipment. (3-20-20)T
- (53) Temporary construction activities at a facility provided that the installation or modification of emissions units must comply with all applicable federal, state, and local rules and regulations. (3-20-20)T
- (54) Batch loading and unloading of solid phase catalysts. (3-20-20)T
- (55) Pulse capacitors. (3-20-20)T
- (56) Gas cabinets using only gases that are not regulated air pollutants. (3-20-20)T
- (57) CO<sub>2</sub> lasers, used only on metals and other materials which do not emit hazardous air pollutants in the process. (3-20-20)T
- (58) Structural changes not having air contaminant emissions. (3-20-20)T
- (59) Equipment used to mix, package, store and handle soaps, lubricants, vegetable oil, grease, animal fat, and non-volatile aqueous salt solutions, provided appropriate lids and covers are utilized. (3-20-20)T
- (60) Photographic process equipment by which an image is reproduced upon material sensitized to radiant energy, e.g., blueprint activity, photocopiers, mimeograph, telefax, photographic developing, and microfiche provided these activities are not related to the source's primary business activity. (3-20-20)T
- (61) Pharmaceutical and cosmetics packaging equipment. (3-20-20)T
- (62) Paper trimmers/binders provided these activities are not related to the source's primary business activity. (3-20-20)T
- (63) Bench-scale laboratory equipment and laboratory equipment used exclusively for physical or chemical analysis, including associated vacuum producing devices but excluding research and development facilities. (3-20-20)T
- (64) Repair and maintenance shop activities not related to the source's primary business activity. (3-20-20)T
- (65) Handling equipment and associated activities for glass and aluminum which is destined for recycling, provided these activities are not related to the source's primary business activity. (3-20-20)T

(66)	Hydraulic and hydrostatic testing equipment.	(3-20-20)T
(67)	Batteries and battery charging stations, except at battery manufacturing plants.	(3-20-20)T
(68)	Porcelain and vitreous enameling equipment.	(3-20-20)T
(69)	Solid waste containers.	(3-20-20)T
(70)	Salt baths using nonvolatile salts that do not result in emissions of any regulated air pollutants.	(3-20-20)T
(71)	Shock chambers.	(3-20-20)T
(72)	Wire strippers.	(3-20-20)T
(73)	Humidity chambers.	(3-20-20)T
(74)	Solar simulators.	(3-20-20)T
(75)	Environmental chambers not using hazardous air pollutant gases.	(3-20-20)T
(76)	Totally enclosed conveyors not including transfer points.	(3-20-20)T
(77)	Steam vents and safety relief valves.	(3-20-20)T
(78)	Air compressors, pneumatically operated equipment, systems, and hand tools.	(3-20-20)T
(79)	Steam leaks.	(3-20-20)T
(80)	Boiler blow-down tank.	(3-20-20)T
(81)	Salt cake mix tanks at pulp mills.	(3-20-20)T
(82)	Digester chip feeders at pulp mills.	(3-20-20)T
(83)	Weak liquor and filter tanks at pulp mills.	(3-20-20)T
(84)	Process water and white water storage tanks at pulp mills.	(3-20-20)T
(85)	Demineralizer water tanks, demineralization, demineralizer vents, and oxygen scavenging (deaeration) of water.	(3-20-20)T
(86)	Clean condensate tanks.	(3-20-20)T
(87)	Alum tanks.	(3-20-20)T
(88)	Broke beaters, repulpers, pulp and repulping tanks, stock chests and pulp handling.	(3-20-20)T
(89)	Lime and mud filtrate tanks.	(3-20-20)T
(90)	Hydrogen peroxide tanks.	(3-20-20)T
(91)	Lime mud washer.	(3-20-20)T
(92)	Lime mud filter.	(3-20-20)T
(93)	Hydro and liquor clarifiers or filters and storage tanks and associated pumping, piping, and	

- handling. (3-20-20)T
- (94) Lime grits washers, filters, and handling. (3-20-20)T
  - (95) Lime silos and feed bins. (3-20-20)T
  - (96) Paper forming. (3-20-20)T
  - (97) Starch cooking. (3-20-20)T
  - (98) Pulp stock cleaning and screening. (3-20-20)T
  - (99) Paper winders or other paper converting equipment. (3-20-20)T
  - (100) Sludge dewatering and wet sludge handling. (3-20-20)T
  - (101) Screw press vents. (3-20-20)T
  - (102) Pond dredging. (3-20-20)T
  - (103) Polymer tanks and storage devices and associated pumping and handling equipment, used for solids dewatering and flocculation. (3-20-20)T
  - (104) Non-PCB oil filled circuit breakers, oil filled transformers and other equipment that is analogous to, but not considered to be, a tank. (3-20-20)T
  - (105) Lab-scale electric or steam-heated drying ovens and autoclaves. (3-20-20)T
- systems.
- (106) Sewer manholes, junction boxes, sumps and lift stations associated with waste water treatment (3-20-20)T
  - (107) Water cooling towers processing exclusively noncontact cooling water. (3-20-20)T
  - (108) Paper coating and sizing. (3-20-20)T
  - (109) Process waste water and ponds. (3-20-20)T
  - (110) Outdoor firearms practice ranges. (3-20-20)T
- b.** Insignificant activities on the basis of size or production rate. (3-20-20)T
- i.** This section contains lists of units or activities that are insignificant on the basis of size or production rate. Units and activities listed in this section must be listed in the permit application. The following units and activities are determined to be insignificant based on their size or production rate: (3-20-20)T
    - (1) Operation, loading and unloading of storage tanks and storage vessels, with lids or other appropriate closure and less than two hundred sixty (260) gallon capacity thirty five cubic feet (35cft), heated only to the minimum extend to avoid solidification if necessary. (3-20-20)T
    - (2) Operation, loading and unloading of storage tanks, not greater than one thousand one hundred (1,100) gallon capacity, with lids or other appropriate closure, not for use with hazardous air pollutants, maximum (max.) vp five-hundred fifty (550) mm Hg. (3-20-20)T
    - (3) Operation, loading and unloading of volatile organic compound storage tanks, ten thousand (10,000) gallons capacity or less, with lids or other appropriate closure, vp not greater than eighty (80) mm Hg at twenty-one (21) degrees C. Operation, loading and unloading of gasoline storage tanks, ten thousand (10,000) gallons capacity or less, with lids or other appropriate closure. (3-20-20)T

- (4) Operation, loading and unloading storage of butane, propane, or liquefied petroleum gas (LPG), storage tanks, vessel capacity under forty thousand (40,000) gallons. (3-20-20)T
- (5) Combustion source, less than five million (5,000,000) Btu/hr, exclusively using natural gas, butane, propane, and/or LPG. (3-20-20)T
- (6) Combustion source, less than five hundred thousand (500,000) Btu/hr, using any commercial fuel containing less than four-tenths percent (.4%) by weight sulfur for coal or less than one percent (1%) by weight sulfur for other fuels. (3-20-20)T
- (7) Combustion source, of less than one million (1,000,000) Btu/hr, if using kerosene, No. 1 or No. 2 fuel oil. (3-20-20)T
- (8) Combustion source, not greater than five hundred thousand (500,000) Btu/hr, if burning waste wood, wood waste or waste paper. (3-20-20)T
- (9) Welding using not more than one (1) ton per day of welding rod. (3-20-20)T
- (10) Foundry sand molds, unheated and using binders with less than twenty-five hundredths percent (.25%) free phenol by sand weight. (3-20-20)T
- (11) "Parylene" coaters using less than five hundred (500) gallons of coating per year. (3-20-20)T
- (12) Printing and silkscreening, using less than two (2) gallon/day of any combination of the following: Inks, coatings, adhesives, fountain solutions, thinners, retarders, or nonaqueous cleaning solutions. (3-20-20)T
- (13) Water cooling towers and ponds, not using chromium-based corrosion inhibitors, not used with barometric jets or condensers, not greater than ten thousand (10,000) gpm, not in direct contact with gaseous or liquid process streams containing regulated air pollutants. (3-20-20)T
- (14) Combustion turbines, of less than five hundred (500) HP. (3-20-20)T
- (15) Batch solvent distillation, not greater than fifty-five (55) gallons batch capacity. (3-20-20)T
- (16) Municipal and industrial water chlorination facilities of not greater than twenty million (20,000,000) gallons per day capacity. The exemption does not apply to waste water treatment. (3-20-20)T
- (17) Surface coating, using less than two (2) gallons per day. (3-20-20)T
- (18) Space heaters and hot water heaters using natural gas, propane or kerosene and generating less than five million (5,000,000) Btu/hr. (3-20-20)T
- (19) Tanks, vessels, and pumping equipment, with lids or other appropriate closure for storage or dispensing of aqueous solutions of inorganic salts, bases and acids excluding: (3-20-20)T
- (a) Ninety-nine percent (99%) or greater H<sub>2</sub>SO<sub>4</sub> or H<sub>3</sub>PO<sub>4</sub>. (3-20-20)T
- (b) Seventy percent (70%) or greater HNO<sub>3</sub>. (3-20-20)T
- (c) Thirty percent (30%) or greater HCl. (3-20-20)T
- (d) More than one (1) liquid phase where the top phase is more than one percent (1%) volatile organic compounds. (3-20-20)T
- (20) Equipment used exclusively to pump, load, unload, or store high boiling point organic material, material with initial boiling point (IBP) not less than one hundred fifty (150) degrees C or vapor pressure (vp) not

- more than five (5) mm Hg at twenty-one (21) degrees C with lids or other appropriate closure. (3-20-20)T
- (21) Smokehouses under twenty (20) square feet. (3-20-20)T
- (22) Milling and grinding activities, using paste-form compounds with less than one percent (1%) volatile organic compounds. (3-20-20)T
- (23) Rolling, forging, drawing, stamping, shearing, or spinning hot or cold metals. (3-20-20)T
- (24) Dip-coating operations, using materials with less than one percent (1%) volatile organic compounds. (3-20-20)T
- (25) Surface coating, aqueous solution or suspension containing less than one percent (1%) volatile organic compounds. (3-20-20)T
- (26) Cleaning and stripping activities and equipment, using solutions having less than one percent (1%) volatile organic compounds by weight. On metallic substrates, acid solutions are not considered for listing as insignificant. (3-20-20)T
- (27) Storage and handling of water based lubricants for metal working where the organic content of the lubricant is less than ten percent (10%). (3-20-20)T
- (28) Municipal and industrial waste water chlorination facilities of not greater than one million (1,000,000) gallons per day capacity. (3-20-20)T
- (29) Domestic sewage treatment ponds with average flowrates less than four hundred (400) gpm or treating waste from less than three thousand (3000) people from non-residential sources. (3-20-20)T
- (30) An emission unit or activity with potential emissions less than or equal to the significant emission rate as defined in Section 006 and actual emissions less than or equal to ten percent (10%) of the levels contained in Section 006 of the definition of significant and no more than one (1) ton per year of any hazardous air pollutant. (3-20-20)T

**318. -- 320. (RESERVED)**

**321. TIER I OPERATING PERMIT CONTENT.**

The purpose of Sections 321 through 336 is to mandate and authorize the contents of Tier I operating permits. (3-20-20)T

**322. STANDARD CONTENTS OF TIER I OPERATING PERMITS.**

All Tier I operating permits shall contain and the Department shall have the authority to impose, implement and enforce, the following elements for all permitted operating scenarios and emissions trading scenarios. Fugitive emissions shall be included in the Tier I operating permit in the same manner as stack emissions. (3-20-20)T

**01. Emission Limitations and Standards.** All Tier I operating permits shall contain emission limitations and standards, including, but not limited to, those operational requirements and limitations that assure compliance with the applicable requirements identified in the application, or determined by the Department to be applicable to the source. (3-20-20)T

**02. Authority for and Form of Terms and Conditions.** All Tier I operating permits shall specify and reference the origin of and authority for each term or condition, and identify any difference in form as compared to the applicable requirement upon which the term or condition is based. (3-20-20)T

**03. Terms or Conditions for Applicable Requirements.** All Tier I operating permits shall contain at least one (1) permit term or condition for every applicable requirement specifically identified in the application or determined by the Department to be applicable to the source. (3-20-20)T

**04. Alternative Operating Scenarios.** All Tier I operating permits shall contain terms and conditions to ensure compliance with all applicable requirements for each alternative operating scenario that was requested by the applicant and approved by the Department, including, but not limited to, a requirement that the owner or operator of the source, contemporaneously with making a change from one (1) operating scenario to another, record the change in an operating scenario log located and retained at the permitted facility. (3-20-20)T

**05. Trading Scenarios.** (3-20-20)T

**a.** All Tier I operating permits shall contain terms and conditions for each trading scenario that was requested by the applicant and approved by the Department including, but not limited to, terms and conditions which ensure that any emission trade is quantifiable, accountable, enforceable and based on replicable procedures. (3-20-20)T

**b.** The Tier I operating permit shall state that no permit revision shall be required under approved economic incentives, marketable permits, emissions trading, and other similar programs or processes for changes that are provided for in the permit. (3-20-20)T

**c.** The Tier I operating permit shall, at a minimum, include a requirement that the owner or operator of the source, contemporaneously with making a change from one (1) trading scenario to another, record the change in a trading scenario log located and retained at the permitted facility and provide notice to the Department in accordance with Section 383. (3-20-20)T

**06. Monitoring.** All Tier I operating permits shall contain the following with respect to monitoring: (3-20-20)T

**a.** Sufficient monitoring to ensure compliance with all of the terms and conditions of the Tier I operating permit; (3-20-20)T

**b.** All emissions monitoring and analysis procedures or test methods required under the applicable requirements; (3-20-20)T

**c.** If the applicable requirement does not require specific periodic testing or monitoring, terms and conditions requiring periodic monitoring, recordkeeping, or both, that is sufficient to yield reliable data for the relevant time periods that are representative of the emissions unit's compliance with the Tier I operating permit, as reported pursuant to Subsection 322.08, and ensuring the use of terms, test methods, units, averaging periods, and other statistical conventions consistent with the applicable requirement; and (3-20-20)T

**d.** Requirements that the Department determines are necessary, concerning the use, maintenance and installation of monitoring equipment or methods. (3-20-20)T

**07. Recordkeeping.** All Tier I operating permits shall incorporate by reference all applicable requirements regarding recordkeeping and require all of the following: (3-20-20)T

**a.** Sufficient recordkeeping to assure compliance with all of the terms and conditions of the Tier I operating permit. (3-20-20)T

**b.** Recording of monitoring information including but not limited to the following: (3-20-20)T

**i.** The date, place (as defined in the Tier I operating permit) and time of sampling or measurements; (3-20-20)T

**ii.** The date(s) analyses were performed; (3-20-20)T

**iii.** The company or entity that performed the analyses; (3-20-20)T

**iv.** The analytical techniques or methods used; (3-20-20)T

- v. The results of such analyses; and (3-20-20)T
- vi. The operating conditions existing at the time of sampling or measurement. (3-20-20)T
- c. Retention of all monitoring records and support information for a period of at least five (5) years from the date of the monitoring sample, measurement, report or application. Supporting information includes but is not limited to all calibration and maintenance records and all original strip-chart recordings for continuous monitoring instrumentation and copies of all reports required by the Tier I operating permit. (3-20-20)T
- 08. Reporting.** All Tier I operating permits shall incorporate by reference all applicable requirements regarding reporting and require all of the following: (3-20-20)T
- a. Sufficient reporting to assure compliance with all of the terms and conditions of the Tier I operating permit. (3-20-20)T
- b. Prompt reporting of deviations from permit requirements including, but not limited to, those attributable to excess emissions. If the deviation is an excess emission, the report shall be submitted in accordance with the requirements of Sections 130 through 136. For all other deviations, the report shall be submitted in accordance with Subsection 322.08.c. unless the permit specifies another time frame. The reports shall describe the probable cause of such deviations and any corrective actions or preventative measures taken. (3-20-20)T
- c. Submittal of reports for any required monitoring at least every six (6) months. All instances of deviations from Tier I operating permit requirements, which include monitoring, recordkeeping, and reporting, must be clearly identified in such reports. All required reports must be certified in accordance with Section 123. (3-20-20)T
- 09. Testing.** All Tier I operating permits shall contain terms and conditions requiring sufficient testing to assure compliance with all of the terms and conditions of the Tier I operating permit. (3-20-20)T
- 10. Compliance Schedule and Progress Reports.** All Tier I operating permits shall contain terms and conditions regarding the compliance plan submitted in the application in accordance with Subsection 314.10 including all of the following: (3-20-20)T
- a. For each applicable requirement for which the source is not in compliance at the time of the permit issuance, terms and conditions consistent with the compliance schedule submitted by the applicant including all of the following: (3-20-20)T
- i. A schedule of remedial measures leading to compliance including an enforceable sequence of actions and specific dates for achieving the milestones and achieving compliance. (3-20-20)T
- ii. A requirement that the permittee submit periodic progress reports to the Department no less frequently than every six (6) months or at a more frequent period if one is specified in the underlying applicable requirement or by the Department. (3-20-20)T
- iii. A requirement that any progress report shall include a statement of when the milestones and compliance were or will be achieved, an explanation of why any dates in the compliance schedule submitted by the applicant or in the terms or conditions of the Tier I operating permit were not or will not be met and a detailed description of any preventative or corrective measures undertaken by the permittee. (3-20-20)T
- iv. All terms and conditions of any applicable consent order, judicial order, judicial consent decree, administrative order, settlement agreement or judgment. (3-20-20)T
- v. A statement that the terms and conditions regarding the compliance schedule are supplemental to, and do not sanction noncompliance with, the underlying applicable requirement. (3-20-20)T
- b. For each applicable requirement that will become effective during the term of the Tier I operating permit and that requires a detailed compliance schedule, the permit shall include such compliance schedule.



(3-20-20)T

c. For each applicable requirement that will become effective during the term of the Tier I operating permit that does not require a detailed compliance schedule, the permit shall include a statement that the permittee shall meet, on a timely basis, all such applicable requirements. (3-20-20)T

**11. Periodic Compliance Certifications.** Each Tier I operating permit shall require submittal of compliance certifications during the term of the permit for each emissions unit to the Department and the EPA as follows: (3-20-20)T

a. Compliance certifications for all emissions units shall be submitted no less frequently than annually, or more frequently if specified by the underlying applicable requirement or by the Department. (3-20-20)T

b. The compliance certification for each emissions unit shall address all of the terms and conditions contained in the Tier I operating permit that are applicable to such emissions unit including emissions limitations, standards and work practices. (3-20-20)T

c. The compliance certification shall be in an itemized format providing the following information: (3-20-20)T

i. The identification of each term or condition of the Tier I operating permit that is the basis of the certification; (3-20-20)T

ii. The identification of the method(s) or other means used by the owner or operator for determining the compliance status with each term and condition during the certification period. Such methods and other means shall include, at a minimum, the methods and means required under Subsections 322.06, 322.07, and 322.08; (3-20-20)T

iii. The status of compliance with the terms and conditions of the Tier I operating permit for the period covered by the certification, including whether compliance during the period was continuous or intermittent. The certification shall be based on the method or means designated in Subsection 322.11.c.ii. above. The certification shall identify each deviation and take it into account in the compliance certification. The certification shall also identify as possible exceptions to compliance any periods during which compliance is required and in which an excursion or exceedance as defined under 40 CFR Part 64 occurred; and (3-20-20)T

iv. Such information as the Department may require to determine the compliance status of the emissions unit. (3-20-20)T

d. All original compliance certifications shall be submitted to the Department and a copy of all compliance certifications shall be submitted to the EPA; (3-20-20)T

**12. Permit Conditions Regarding Acid Rain Allowances.** (3-20-20)T

a. A permit condition prohibiting emissions exceeding any allowances that the source lawfully holds. (3-20-20)T

b. No limit shall be placed on the number of allowances held by the source and no permit revisions shall be required for increases in emissions that are authorized by allowances acquired pursuant to the acid rain program, provided that such increases do not require a permit revision under any other applicable requirement. (3-20-20)T

c. The source may not, however, use allowances as a defense to noncompliance with any other applicable requirement. (3-20-20)T

d. Any such allowance shall be accounted for according to the procedures established in 40 CFR Part 72 and 40 CFR Part 73. (3-20-20)T

**13. Permit Duration.** Each Tier I operating permit shall state that it is effective for a fixed term of five (5) years; except that during the first four (4) years after EPA approval of the Tier I operating permit program, the permit may be issued with an initial term of three (3) years to five (5) years unless the Tier I source is also a Phase II source. (3-20-20)T

**14. Other Specific Requirements.** Any terms or conditions determined by the Department to be necessary for approval of the Tier I operating permit. (3-20-20)T

**15. General Requirements.** Each Tier I operating permit shall contain provisions stating the following: (3-20-20)T

**a.** The permittee shall comply with all conditions of this permit. Any permit noncompliance constitutes a violation and is grounds for enforcement action; for permit revocation, termination, revocation and reissuance, or revision; or for denial of a permit renewal application. (3-20-20)T

**b.** It shall not be a defense in an enforcement action that it would have been necessary to halt or reduce any activity in order to maintain compliance with the terms and conditions of this permit. (3-20-20)T

**c.** This permit may be revised, revoked, reopened and reissued, or terminated for cause. (3-20-20)T

**d.** The filing of a request by the permittee for a permit revision, revocation and reissuance, or termination, or of a notification of planned changes or anticipated noncompliance does not stay any permit condition. (3-20-20)T

**e.** This permit does not convey any property rights of any sort, or any exclusive privilege. (3-20-20)T

**f.** The permittee shall furnish all information requested by the Department, within a reasonable time, that the Department may request in writing to determine whether cause exists for modifying, revoking and reissuing or terminating the permit or to determine compliance with the permit. (3-20-20)T

**g.** Upon request, the permittee shall furnish to the Department copies of records required to be kept by this permit. (3-20-20)T

**h.** The provisions of this permit are severable, and if any provision of this permit to any circumstance is held invalid, the application of such provision to other circumstances, and the remainder of this permit shall not be affected thereby. (3-20-20)T

**i.** The permittee shall comply with Sections 380 through 386 as applicable. (3-20-20)T

**j.** Unless specifically identified as a "State Only" provision, all terms and conditions in the this permit, including any terms and conditions designed to limit a source's potential to emit, are enforceable: (3-20-20)T

**i.** By the Department in accordance with State law; and (3-20-20)T

**ii.** By the United States or any other person in accordance with Federal law. (3-20-20)T

**k.** Provisions specifically identified as a "State Only" provision are enforceable only in accordance with State law. "State Only" provisions are those that are not required under the Federal Clean Air Act or under any of its applicable requirements or those provisions adopted by the State prior to federal approval. (3-20-20)T

**l.** Upon presentation of credentials, the permittee shall allow the Department or an authorized representative of the Department to do the following: (3-20-20)T

**i.** Enter upon the permittee's premises where a Tier I source is located or emissions-related activity is conducted, or where records are kept under the conditions of this permit; (3-20-20)T

**ii.** Have access to and copy, at reasonable times, any records that are kept under the conditions of this

- permit; (3-20-20)T
- iii. Inspect at reasonable times any facilities, equipment (including monitoring and air pollution control equipment), practices, or operations regulated or required under this permit; and (3-20-20)T
  - iv. Sample or monitor at reasonable times substances or parameters for the purpose of determining or ensuring compliance with this permit or applicable requirements. (3-20-20)T
- m.** Nothing in this permit shall alter or affect the following: (3-20-20)T
- i. Any administrative authority or judicial remedy available to prevent or terminate emergencies or imminent and substantial dangers; (3-20-20)T
  - ii. The liability of an owner or operator of a source for any violation of applicable requirements prior to or at the time of permit issuance; (3-20-20)T
  - iii. The applicable requirements of the acid rain program, consistent with 42 U.S.C. Section 7651g(a); (3-20-20)T
  - iv. The owner or operator's duty to provide information. (3-20-20)T
- n.** The owner or operator of a Tier I source shall pay registration fees to the Department in accordance with Sections 387 through 399, which are hereby incorporated by reference. (3-20-20)T
- o.** All documents submitted to the Department shall be certified in accordance with Section 123 and comply with Section 124. (3-20-20)T
- p.** If a timely and complete application for a Tier I operating permit renewal is submitted, but the Department fails to issue or deny the renewal permit before the end of the term of the previous permit, then all the terms and conditions of the previous permit including any permit shield that may have been granted pursuant to Section 325 shall remain in effect until the renewal permit has been issued or denied. (3-20-20)T
- q.** The permittee shall promptly report deviations from permit requirements including, but not limited to, those attributable to excess emissions. If the deviation is an excess emission, the report shall be submitted in accordance with the requirements of Sections 130 through 136. For all other deviations, the report shall be submitted in accordance with Subsection 322.08.c. unless the permit specifies another time frame. The reports shall describe the probable cause of such deviations and any corrective actions or preventative measures taken. (3-20-20)T

**323. -- 324. (RESERVED)**

**325. ADDITIONAL CONTENTS OF TIER I OPERATING PERMITS -- PERMIT SHIELD.**

Each Tier I operating permit shall include provisions stating: (3-20-20)T

**01. General Permit Shield.** Compliance with the terms and conditions of the Tier I operating permit, including those applicable to all alternative operating scenarios and trading scenarios, shall be deemed compliance with all of the following: (3-20-20)T

**a.** Applicable requirements as of the date of permit issuance that are specifically identified in the Tier I operating permit and have a corresponding term or condition in the Tier I operating permit. (3-20-20)T

**b.** Non-applicable requirements. For a requirement to be a non-applicable requirement, all of the following criteria must be met: (3-20-20)T

i. The permittee must have provided the information required by Subsection 314.08.b. in the application. (3-20-20)T

ii. The requirement must be specifically identified in the Tier I operating permit as a non-applicable

requirement. (3-20-20)T

iii. The requirement must have been determined by the Department, in writing and in acting on the permit application or revision, to not be applicable to the Tier I source. (3-20-20)T

iv. Tier I operating permit must include the Department's determination or a concise summary thereof. (3-20-20)T

**02. Limitation on Permit Shield.** Permit revisions and other actions authorized by Sections 300 through 386 may eliminate, modify or suspend the permit shield. (3-20-20)T

**326. -- 331. (RESERVED)**

**332. EMERGENCY AS AN AFFIRMATIVE DEFENSE REGARDING EXCESS EMISSIONS.**

**01. General.** An emergency, as defined in Section 008, constitutes an affirmative defense to an action brought for noncompliance with such technology-based emission limitation if the conditions of Subsection 332.02 are met. (3-20-20)T

**02. Demonstration of Emergency.** The affirmative defense of emergency shall be demonstrated through properly signed, contemporaneous operating logs, or other relevant evidence that: (3-20-20)T

a. An emergency occurred and that the permittee can identify the cause(s) of the emergency; (3-20-20)T

b. The permitted facility was at the time being properly operated; (3-20-20)T

c. During the period of the emergency, the permittee took all reasonable steps, as determined by the Department, to minimize levels of emissions that exceeded the emission standards, or other requirements in the permit; and (3-20-20)T

d. The permittee submitted written notice of the emergency to the Department within two (2) working days of the time when emission limitations were exceeded due to the emergency. This notice must contain a description of the emergency, any steps taken to mitigate emissions, and corrective actions taken. Compliance with this section satisfies the written reporting requirements under Section 135 and Subsection 322.15.q. (3-20-20)T

**03. Burden of Proof.** In any enforcement proceeding, the permittee seeking to establish the occurrence of an emergency has the burden of proof. (3-20-20)T

**04. Applicability.** Section 332 is in addition to any emergency or upset provision contained in any applicable requirement. (3-20-20)T

**333. -- 334. (RESERVED)**

**335. GENERAL TIER I OPERATING PERMITS AND AUTHORIZATIONS TO OPERATE.**

**01. Issuance of General Tier I Operating Permits.** The Department may, after notice and opportunity for public participation provided in accordance with Section 364, issue a general Tier I operating permit covering numerous similar sources. (3-20-20)T

**02. Contents of General Tier I Operating Permits.** Each general Tier I operating permit: (3-20-20)T

a. Shall include all terms and conditions identified in Sections 322 and 325. (3-20-20)T

b. Shall include specific criteria by which sources may qualify for coverage under the general Tier I operating permit; and (3-20-20)T

c. May provide for applications which deviate from the requirements of Sections 311 through 315, provided that such applications meet all other requirements of 42 U.S.C. 7661 through 7661f and include all information necessary to determine qualification for, and to ensure compliance with, the general Tier I operating permit. (3-20-20)T

**03. Applications for Authorizations to Operate.** The owner or operator of a Tier I source may apply for an authorization to operate under the terms and conditions of a general Tier I operating permit by: (3-20-20)T

a. Stating in the application submitted pursuant to Sections 311 through 315 that the owner or operator has determined that the Tier I source qualifies for coverage under a specifically identified general Tier I operating permit and that the owner or operator requests that operations of the Tier I source be authorized under a specifically identified general Tier I operating permit; or (3-20-20)T

b. Complying with the specific application requirements, if any, provided in the general Tier I operating permit. (3-20-20)T

**04. Procedures for Issuing Authorizations to Operate.** Without repeating the public participation procedures required under Section 364, the Department shall issue an authorization to operate a Tier I source under a specifically identified general Tier I operating permit if the Department determines that the Tier I source qualifies for coverage. (3-20-20)T

**05. Review of Authorizations to Operate.** The issuance of an authorization to operate shall be a final agency action for purposes of administrative and judicial review of the authorization. The general Tier I operating permit shall not be subject to administrative or judicial review upon the issuance of an authorization to operate. (3-20-20)T

**06. Phase II Sources.** General Tier I operating permits shall not be authorized for Phase II sources under the acid rain program unless otherwise provided in 40 CFR Part 72. (3-20-20)T

**336. TIER I OPERATING PERMITS FOR TIER I PORTABLE SOURCES.**

**01. Issuance of Tier I Operating Permits for Portable Tier I Sources.** (3-20-20)T

a. The Department may issue a single Tier I operating permit authorizing emissions from similar operations of a portable Tier I source by the owner or operator at multiple temporary locations. (3-20-20)T

b. The operation must be temporary and involve at least one (1) change of location for the portable Tier I source during the term of the Tier I operating permit. (3-20-20)T

**02. Phase II Sources.** No Phase II source shall be permitted as a portable Tier I source. (3-20-20)T

**03. Contents of Tier I Operating Permits for Portable Tier I Sources.** Tier I operating permits for portable Tier I sources shall include the following: (3-20-20)T

a. Terms and conditions that will ensure compliance with all applicable requirements at all authorized locations; (3-20-20)T

b. Requirements that the owner or operator notify the Department at least ten (10) days in advance of each change in location in accordance with Section 500; and (3-20-20)T

c. All terms and conditions identified in Sections 322 and 325 through 332. (3-20-20)T

**337. -- 359. (RESERVED)**

**360. STANDARD PROCESSING OF TIER I OPERATING PERMIT APPLICATIONS.**

The purposes of Sections 360 through 369 is to establish standard procedures and requirements for processing Tier I operating permits. (3-20-20)T

**361. COMPLETENESS OF APPLICATIONS.**

**01. Criteria for Completeness.** Except as otherwise provided by these rules, the application must comply with Section 314 including that the information must be in sufficient detail. (3-20-20)T

**02. Timelines for Determinations of Completeness.** The Department shall send written notice to the applicant of whether the application is complete within sixty (60) days of receiving the application. If the Department fails to send the written notice to the applicant within sixty (60) days of receipt, the application shall be deemed complete. (3-20-20)T

**03. Effects of Completeness Determination.** (3-20-20)T

**a.** The submittal of a complete application activates the application shield provided by Subsection 361.02. (3-20-20)T

**b.** The submittal of a complete Tier I operating permit application shall not affect the permit to construct requirements of Sections 200 through 225 or 42 U.S.C. Sections 7401 through 7515. (3-20-20)T

**c.** The timelines for final agency action provided in Subsections 367.02 and 367.03 begin on the date of the completeness determination. (3-20-20)T

**362. TECHNICAL MEMORANDUMS FOR TIER I OPERATING PERMITS.**

**01. Memorandum for Draft Permit.** As part of its review of the Tier I operating permit application, the Department shall prepare a technical memorandum that sets forth the legal and factual basis for the draft Tier I operating permit terms and conditions (including references to the applicable statutory or regulatory provisions) or the draft denial. (3-20-20)T

**02. Revised Memorandum for Proposed Permit.** If the Department revises its analysis, its conclusions or the terms or conditions of the Tier I operating permit in response to public comment, the Department may revise the technical memorandum for the proposed permit or the proposed denial. (3-20-20)T

**03. Release of Memorandum.** The technical memorandum(s) shall be made available to the public in accordance with Section 364 and sent to the EPA with the proposed Tier I operating permit or proposed denial. (3-20-20)T

**363. PREPARATION OF DRAFT PERMIT OR DRAFT DENIAL.**

Except as otherwise provided in these rules, the Department shall prepare a draft permit or draft denial as promptly as practicable or one hundred twenty (120) days before the deadline for final action, whichever is earlier. (3-20-20)T

**364. PUBLIC NOTICES, COMMENTS AND HEARINGS.**

**01. Generally.** Except as otherwise provided in these rules, all Tier I operating permit proceedings shall provide for public notice and public comment, including offering an opportunity for a hearing, on a draft permit or on a draft denial. (3-20-20)T

**02. Public Comment Package.** A public comment package including the draft permit or draft denial, the technical memorandum and the application shall be prepared and distributed to appropriate public locations, the applicant and affected States. (3-20-20)T

**03. Giving Notice.** Notice shall be given: by publication in a newspaper of general circulation in the area where the Tier I source is located or in a State publication designed to give general public notice; by mailing the notice to persons on a mailing list developed by the Department, including those who request in writing to be on the list; by mailing the notice to all affected States; and by other means if necessary to ensure adequate notice to the affected public. (3-20-20)T

**04. Content of the Notice.** The notice shall identify the affected facility; provide the name and address of the permittee; provide the name and address of the Department processing the application; identify the draft permit action; identify the emissions change if the permit action is a permit revision or reopening; provide the locations where the public may locate a copy of the public comment package; provide the name, address, and telephone number of a person from whom interested persons may obtain additional information that is relevant to the permit decision by filing a written public documents request and paying any costs; provide a brief description of the comment procedures, including the deadline for comments and the name and address of the person to whom written comments must be delivered; and state the time and place of any hearing that has been scheduled or provide information regarding how a person may request a hearing. (3-20-20)T

**05. Public Comment Procedures.** (3-20-20)T

- a.** The Department shall provide at least thirty (30) days for public comment. (3-20-20)T
- b.** The Department may designate the person to receive written comments. (3-20-20)T
- c.** The Department shall give notice of any public hearing at least thirty (30) days in advance of the hearing. (3-20-20)T
- d.** The public hearing, if any, shall be an informal meeting, conducted by a hearing officer designated by the Department and transcribed. Written comments or supporting documents may be submitted during the hearing. (3-20-20)T
- e.** The public comments and additional information received during the comment period shall be available to the public upon the filing of a written public documents request and the payment of any costs. (3-20-20)T

**365. PREPARATION OF PROPOSED PERMIT OR PROPOSED DENIAL.**

**01. Timeline.** Except as otherwise provided by these rules, the Department shall prepare a proposed permit or proposed denial within thirty (30) days after the close of the public comment period, unless the Department determines that additional time is required to evaluate comments and information received. (3-20-20)T

**02. Availability.** The proposed permit or proposed denial shall be available to the public upon the filing a written public documents request and the payment of any costs. (3-20-20)T

**03. Notice to Affected States.** If the Department refuses to accept all recommendations that an affected State submitted during the public comment period, the Department shall send a copy of the notice sent to EPA in accordance with Subsection 366.01.d. to the affected State that submitted the recommendation. (3-20-20)T

**366. EPA REVIEW PROCEDURES.**

**01. Submittal of Proposal to EPA.** Except as otherwise provided in these rules and unless EPA waives its opportunity to review a proposed permit, the Department will transmit the following to EPA: (3-20-20)T

- a.** The proposed permit or proposed denial. (3-20-20)T
- b.** The technical memorandum, as revised if appropriate. (3-20-20)T
- c.** The application including all supplements and corrections submitted by the applicant, unless the applicant has submitted the information under a claim of confidentiality or unless the Department has entered an agreement with EPA to submit only a summary form and relevant portions of the permit application. (3-20-20)T
- d.** Notice of any refusal by the Department to accept all recommendations for the proposal that any affected State submitted during the public comment period. The notice shall include the Department's reasons for not accepting any such recommendation. The Department is not required to accept recommendations that are not based on applicable requirements. (3-20-20)T

**02. Opportunity for EPA Objection.** (3-20-20)T

**a.** EPA may submit to the Department a written objection to the proposal within forty-five (45) days of receipt of the transmittal identified in Subsection 366.01. (3-20-20)T

**b.** The written objection shall state the EPA's reasons for the objection and provide the terms and conditions that the Tier I operating permit must include to respond to the objection or state that the permit must be denied. (3-20-20)T

**c.** EPA shall provide a copy of the written objection to the applicant. (3-20-20)T

**03. Response to EPA Objections.** Within ninety (90) days of receiving a written objection from EPA, the Department shall prepare a revised proposal and submit it to EPA in accordance with Subsection 366.01. If EPA determines that the revised proposal is objectionable, the Department will review the permit action taken by EPA and take a comparable final permit action in accordance with Section 367. (3-20-20)T

**04. Public Petitions to EPA.** (3-20-20)T

**a.** If the EPA does not object in writing under Subsection 366.02, any person may petition the EPA within sixty (60) days after the expiration of the EPA's forty-five (45) day review period to make such objection. (3-20-20)T

**b.** Any such petition shall be based only on objections to the draft permit or draft denial that were raised with specificity during the public comment period provided for in Section 364 unless the petitioner demonstrates that it was impracticable to raise such objections within such period, or unless the grounds for such objection arose after such period. (3-20-20)T

**c.** If the EPA objects to the proposal in accordance with Subsection 366.02 as a result of a petition filed under Subsections 366.04.a. and 366.04.b., the Department shall: (3-20-20)T

**i.** Not issue a permit action until EPA's objection has been resolved, except that a petition for review does not stay the effectiveness of a Tier I operating permit or its requirements pending EPA's review of the petition and Department review of the objection if the Tier I operating permit was issued by the Department after the end of the forty-five (45) day review period and prior to an EPA objection initiated by a petition. (3-20-20)T

**ii.** Process the objection in accordance with Subsection 366.03. (3-20-20)T

**367. ACTION ON APPLICATION.**

**01. Issuance Conditions.** Except as otherwise provided by these rules, a Tier I operating permit, or any portion thereof, may be issued only if all of the following conditions have been met: (3-20-20)T

**a.** The owner or operator has submitted a complete application in accordance with Section 361. (3-20-20)T

**b.** The public has been provided notice and opportunities for comment and a hearing in accordance with Section 364. (3-20-20)T

**c.** Affected States have been provided notice in accordance with Section 364 and Subsection 365.03. (3-20-20)T

**d.** The terms and conditions of the Tier I operating permit comply with Sections 321 through 336 including providing for compliance with all applicable requirements. (3-20-20)T

**e.** The EPA has been provided with the proposal and an opportunity to object and the Department has responded as required by Section 366. (3-20-20)T



**02. Deadlines for Final Actions During Initial Period.** Except as otherwise provided in these rules, during the initial period beginning May 1, 1994 and ending three (3) years after EPA approval of the Tier I operating program, the Department will prioritize all of the applications predicted to be submitted during the initial period considering the groups established in accordance with Subsection 313.02, if any. The prioritization will result in the Department taking final action on one-third (1/3) of all such permit applications during each of the one (1) year periods following EPA approval of the program. (3-20-20)T

**03. Deadlines for Final Actions After Initial Period.** Except as otherwise provided in these rules, during the period beginning three (3) years after EPA approval of the Tier I operating program, the Department shall take final action on complete applications within eighteen (18) months. (3-20-20)T

**04. Deadline for Tier I Operating Permits with Early Reductions.** The Department shall take final action on any complete Tier I operating permit application containing an early reduction demonstration under 42 U.S.C. Section 7412 (i)(5) within nine (9) months of receipt of the complete application. (3-20-20)T

**05. Deadline for Tier I Operating Permits for Phase II Sources.** The permitting of phase II sources shall occur in accordance with the deadlines in 42 U.S.C. Section 7651 through 7651o. (3-20-20)T

**06. Copy to EPA.** The Department shall send a copy of the final Tier I operating permit to EPA. (3-20-20)T

**07. Original to Permittee.** The Department shall send the original Tier I operating permit to the permittee. (3-20-20)T

**368. EXPIRATION OF PRECEDING PERMITS.**

If a timely and complete Tier I permit application is received by the Department and is not acted upon in a timely manner as prescribed by these rules, the permit to construct, Tier I operating permit or Tier II operating permit, if any, that has been previously issued to the owner or operator of the Tier I source by the Department or EPA shall continue in full force until the Department has completed action of the permit application. No Tier I operating permit will be considered to have expired due solely to the Department's inaction on a timely Tier I operating permit application. (3-20-20)T

**369. TIER I OPERATING PERMIT RENEWAL.**

**01. Renewal Procedures.** Tier I operating permits being renewed are subject to the same procedural requirements, including those for public participation, including affected State review, and EPA review, that apply to initial Tier I operating permit issuance. (3-20-20)T

**02. Expiration and Renewal Application Shield.** Tier I operating permit expiration terminates the source's right to operate unless a timely and complete renewal application has been submitted. (3-20-20)T

**370. -- 379. (RESERVED)**

**380. CHANGES TO TIER I OPERATING PERMITS.**

**01. Applicability.** Sections 380 through 399 establish procedures and requirements for permit revisions and changes requiring notice. These provisions do not alter the requirements for permits to construct set forth at Sections 200 through 228. (3-20-20)T

**02. Changes Requiring Permit Revisions.** Sections 381 through 383 establish procedures and requirements for Tier I operating permit revisions. A permit revision is required for changes that are not addressed or prohibited by the Tier I operating permit if such changes are subject to any requirements under Title IV of the Clean Air Act or are modifications under any provision of Title I of the Clean Air Act. (3-20-20)T

**03. Changes Requiring Notice.** Sections 384 and 385 establish procedures and requirements for providing notice by the permittee to the Department and EPA of certain emission trades and changes that contravene

a permit term (Section 384), or certain changes that are not addressed or prohibited by the permit (Section 385). (3-20-20)T

**04. Reopening.** Section 386 establishes procedures for reopening the permit for cause by the Department, EPA, or the permittee. (3-20-20)T

**05. Acid Rain.** Changes regulated under Title IV of the Clean Air Act, 42 U.S.C. Sections 7651 through 7651o, shall be governed by regulations promulgated under Title IV of the Act. (3-20-20)T

**381. ADMINISTRATIVE PERMIT AMENDMENTS.**

**01. Criteria.** An administrative permit amendment is a permit revision that: (3-20-20)T

**a.** Corrects typographical errors; (3-20-20)T

**b.** Identifies a change in the name, address, or phone number of any person identified in the Tier I operating permit, or provides a similar minor administrative change at the Tier I source; (3-20-20)T

**c.** Requires more frequent monitoring or reporting by the permittee; (3-20-20)T

**d.** Allows for a change in ownership or operational control of a Tier I source where the Department determines that no other change in the Tier I operating permit is necessary, provided that a written agreement containing a specific date for transfer of permit responsibility, coverage, and liability between the current and new permittee has been submitted to the Department; (3-20-20)T

**e.** Incorporates into the Tier I operating permit the requirements from a permit to construct that was issued by the Department in accordance with Subsection 209.05.c.; or (3-20-20)T

**f.** Is any other type of change that EPA and the Department have determined as part of the Part 70 program to be similar to those in Subsections 381.01.a. through 381.01.d. (3-20-20)T

**02. Administrative Permit Amendment Application Procedures.** (3-20-20)T

**a.** If initiated by the permittee, the permittee shall submit a request to the Department. The request shall: (3-20-20)T

**i.** State at the beginning of the request that it is a "REQUEST FOR ADMINISTRATIVE PERMIT AMENDMENT." (3-20-20)T

**ii.** Describe the proposed administrative permit amendment including any permit to construct to be incorporated; (3-20-20)T

**iii.** State the date on which the proposed administrative amendment will occur at the facility; (3-20-20)T

**iv.** Identify any Tier I operating permit term or condition that is no longer applicable as a result of the change; and (3-20-20)T

**v.** Identify any applicable requirement that would apply to the Tier I source as a result of the change. (3-20-20)T

**b.** If initiated by the Department, the Department shall notify the permittee that the Department is initiating an administrative permit amendment and provide a brief summary of the proposed administrative permit amendment including all of the information required by Subsection 381.02.a.i. through 381.02.a.v. (3-20-20)T

**c.** The Department shall, within sixty (60) days of the receipt of a request for an administrative permit amendment, take final action on the request and may incorporate such changes without providing notice to the public

or affected States provided that the Department designates any such administrative permit amendment as having been made pursuant to Section 381. The Department shall submit a copy of the revised permit, or an addendum, to the EPA and send the original to the permittee. (3-20-20)T

**03. Implementation Procedures.** (3-20-20)T

**a.** The permittee may implement the changes addressed in the request for an administrative permit amendment under Subsections 381.01.a. through 381.01.f. immediately upon submittal of the request. (3-20-20)T

**b.** If the permittee obtains a permit to construct under Subsection 209.05.c., then so long as the change does not violate any terms or conditions of the existing Tier I operating permit, the permittee may operate the source described in the permit to construct immediately upon submittal of the request for an administrative permit amendment. (3-20-20)T

**04. Permit Shield.** Upon final action by the Department, the permit shield described in Section 325 shall extend only to administrative permit amendments identified in Subsection 381.01.e. (3-20-20)T

**382. SIGNIFICANT PERMIT MODIFICATION.**

**01. Criteria.** Significant modification procedures shall be used for applications requesting permit revisions that do not qualify as minor permit modifications or as administrative amendments. Nothing herein shall be construed to preclude the permittee from making changes consistent with this chapter that would render existing permit compliance terms and conditions irrelevant. A significant permit modification is a permit revision for changes that: (3-20-20)T

**a.** Violate an existing Tier I permit term or condition derived from an applicable requirement; (3-20-20)T

**b.** Involve significant changes to existing monitoring, reporting or recordkeeping requirements in the permit. Every significant change in existing monitoring terms or conditions (except more frequent monitoring or reporting under Subsection 381.01.c.) and every relaxation of reporting or recordkeeping terms or conditions shall be considered significant; (3-20-20)T

**c.** Require or change a case-by-case determination of an emission limitation or other standard; a source-specific determination for temporary sources of ambient impacts; or a visibility or increment analysis; (3-20-20)T

**d.** Seek to establish or change a permit term or condition for which there is no corresponding underlying applicable requirement and that the source has assumed to avoid an applicable requirement to which the source would otherwise be subject. Such terms and conditions include, but are not limited to, an enforceable emissions cap assumed to avoid classification as a modification under any provision of Title I of the Clean Air Act or an alternative emissions limit for an early reduction of hazardous air pollutants that was approved pursuant to regulations promulgated under 42 U.S.C. Section 7412(i)(5) of the Clean Air Act; (3-20-20)T

**e.** Constitute a modification under any provision of Title I of the Clean Air Act; or (3-20-20)T

**f.** Could be processed as an administrative amendment or as a minor modification, except the permittee has requested the change be processed as a significant modification, including incorporating the requirements of a permit to construct that was issued by the Department in accordance with Subsection 209.05.a. (3-20-20)T

**02. Significant Permit Modification Application Procedures.** A permittee may initiate a significant permit modification by submitting a complete significant permit modification application to the Department. The application shall: (3-20-20)T

**a.** Request the use of significant permit modification procedures and state at the beginning of the request that it is a "REQUEST FOR SIGNIFICANT PERMIT MODIFICATION"; (3-20-20)T

- b. Meet the standard application requirements of Sections 314 and 315; (3-20-20)T
- c. Provide a summary sheet; (3-20-20)T
  - i. Describing the proposed significant permit modification; (3-20-20)T
  - ii. Describing and quantifying any change in emissions resulting from the significant permit modification including, but not limited to, an identification of any new regulated air pollutant(s) that will be emitted; (3-20-20)T
  - iii. Identifying any Tier I operating permit term or condition that will no longer be applicable as a result of the significant permit modification; and (3-20-20)T
  - iv. Identifying new applicable requirement resulting from the change. (3-20-20)T
- d. Significant permit modifications shall be issued in accordance with all procedural requirements as they apply to Tier I operating permit issuance and renewal, including those for applications (Sections 314 and 315), public participation (Section 364), review by affected States (Sections 364 and 365), and review by EPA (Section 366). (3-20-20)T
- e. The Department will process the majority of significant permit modifications within nine (9) months of receiving a complete application. The Department shall determine which significant permit modification applications will be processed within nine (9) months. (3-20-20)T

**03. Implementation Procedures.** The permittee shall comply with Sections 200 through 223 as applicable, including Subsection 209.05 governing permit to construct procedures for Tier I sources. (3-20-20)T

**04. Permit Shield.** Upon final action by the Department, the permit shield described in Section 325 shall extend to significant permit modifications. (3-20-20)T

**383. MINOR PERMIT MODIFICATION.**

**01. Criteria.** (3-20-20)T

a. Minor permit modification procedures may be used for permit modifications involving economic incentives, marketable permits, emissions trading, and other similar approaches explicitly provided for in the SIP or applicable requirements promulgated by EPA. A permittee may not use minor modification procedures for changes described in Subsections 382.01.a. through 382.01.e. (3-20-20)T

b. Any other permit modification that is not required to be processed as a significant permit modification under Section 382. (3-20-20)T

c. Groups of a permittee's applications eligible for processing as minor permit modifications may be processed under minor permit modification procedures if collectively, the changes proposed in the minor modification applications do not exceed the lesser of: (3-20-20)T

- i. Ten percent (10%) of the emissions allowed by the existing Tier I operating permit for the emissions unit for which the change is requested; (3-20-20)T
- ii. Twenty percent (20%) of the major facility criteria in Section 008; or (3-20-20)T
- iii. Five (5) tons per year. (3-20-20)T

**02. Minor Permit Modification Application Procedures.** A permittee may initiate a minor permit modification by submitting a complete standard application described in Section 314 to the Department. The application shall: (3-20-20)T

- a.** Request the use of minor permit modification procedures and state at the beginning of the request that it is a “REQUEST FOR MINOR PERMIT MODIFICATION,” designate either “INDIVIDUAL” or “GROUP” processing, and provide a summary sheet; (3-20-20)T
- i.** Describing the proposed minor permit modification; (3-20-20)T
- ii.** Stating the date on which the proposed minor permit modification will occur at the facility; (3-20-20)T
- iii.** Describing and quantifying any change in emissions resulting from the minor permit modification including, but not limited to, an identification of any new regulated air pollutant(s) that will be emitted; (3-20-20)T
- iv.** Identifying any Tier I operating permit term or condition that will no longer be applicable as a result of the minor permit modification; (3-20-20)T
- v.** Identifying any new applicable requirement that is applicable to the Tier I source as a result of the minor permit modification; (3-20-20)T
- vi.** Certifying by a responsible official under Section 123 that the proposed permit modification meets the criteria for a minor permit modification and, if applicable, the use of group processing procedures; and (3-20-20)T
- vii.** Listing the permittee’s other pending applications awaiting group processing and a determination of whether the requested modification, aggregated with the other applications, equals or exceeds the thresholds under Subsection 383.01.c. above. (3-20-20)T
- b.** Include completed forms for the Department to use to notify the EPA and affected States as required under Sections 364 and 366. (3-20-20)T
- c.** Include the applicant’s suggested draft Tier I permit with the minor permit modification. (3-20-20)T
- 03. EPA and Affected State Notification Procedures.** (3-20-20)T
- a.** Within five (5) working days of receipt of a complete minor permit modification application, the Department shall notify EPA and the affected States of the requested permit modification and forward the forms completed by the applicant and other required information, if any, to the EPA and affected States. Affected States and EPA review shall occur simultaneously. (3-20-20)T
- b.** On a quarterly basis or within five (5) working days of receiving an application demonstrating that the aggregate of a permittee’s pending applications equals or exceeds the threshold level established in Subsection 383.01.c. above, whichever is earlier, the Department shall notify EPA and the affected States of the requested permit modification and forward the forms completed by the applicant and other required information, if any, to the EPA and affected States. Affected States and EPA review shall occur simultaneously. (3-20-20)T
- c.** The Department shall promptly notify EPA and any affected States in writing including its reasons for not accepting any such recommendation if the Department refuses to accept all the timely recommendations submitted by affected States. (3-20-20)T
- d.** Timetable for Issuance. The Department may not issue a final permit modification until after EPA’s forty-five (45) day review period or until EPA has notified the Department that EPA will not object to issuance of the permit modification, whichever is first; although the Department can approve the permit modification prior to that time. (3-20-20)T
- e.** Within ninety (90) days of the Department’s receipt of a complete minor permit modification application or within fifteen (15) days after the end EPA’s forty-five (45) day review period, whichever is later, the

Department shall take one (1) of the following actions: (3-20-20)T

- i. Issue the minor permit modification as proposed; (3-20-20)T
- ii. Deny the minor permit modification application; (3-20-20)T
- iii. Determine that the requested minor permit modification does not meet the minor permit modification criteria and should be reviewed under the significant modification procedures; or (3-20-20)T
- iv. Revise the proposed minor permit modification, transmit the revised proposal to the EPA in accordance with Section 366, and notify the permittee. (3-20-20)T

**f.** Within one hundred and eighty (180) days of the Department's receipt of a complete application for modifications eligible for group processing or within fifteen (15) days after the end of EPA's forty-five (45) day review period, whichever is later, the Department shall take one (1) of the actions specified in Subsections 383.03.e.i., 383.03.e.ii., 383.03.e.iii., or 383.03.e.iv. (3-20-20)T

**04. Implementation Procedures.** (3-20-20)T

**a.** The permittee may make the change proposed in its minor permit modification immediately upon submittal of a complete application to the Department before final action by the Department. (3-20-20)T

**b.** After the source makes the allowed change and until the Department takes any of the actions specified in Subsections 383.03.e.i., 383.03.e.ii., or 383.03.e.iii., the permittee must comply with both the applicable requirements governing the change and the proposed terms and conditions. (3-20-20)T

**c.** During this time period, the permittee need not comply with the existing permit terms and conditions it seeks to modify; provided that, if the source fails to comply with the applicable requirements governing the change and the proposed revisions, the existing permit terms and conditions it seeks to modify may be enforced against it. (3-20-20)T

**05. Permit Shield.** The permit shield described in Section 325 shall not apply to any minor permit modification. (3-20-20)T

**384. SECTION 502(B)(10) CHANGES AND CERTAIN EMISSION TRADES.**

**01. Criteria.** This section authorizes emission changes within a permitted facility without requiring a permit revision, if the changes are not modifications under any provision of the Title I of the Clean Air Act and the changes do not exceed the emissions allowable under the permit (whether expressed therein as a rate of emissions or total emissions). (3-20-20)T

**a.** Changes authorized are changes that: (3-20-20)T

- i. Are Section 502(b)(10) changes; (3-20-20)T
- ii. Are changes involving trades of increases and decreases of emissions within the permitted facility where the State Implementation Plan provides for such emissions trades without requiring a permit revision. SIP trades are allowed in compliance with this Section even if the Tier I operating permit does not already provide for such emission trading; or (3-20-20)T

iii. Are changes made under the terms and conditions of the Tier I permit that authorize the trading of emissions increases and decreases within the permitted facility for the purpose of complying with a federally-enforceable emissions cap that is established by the Department in the Tier I operating permit independent of otherwise applicable requirements. (3-20-20)T

**b.** Changes constituting a modification under Title I of the Clean Air Act or subject to a requirement under Title IV of the Clean Air Act are not authorized by this Section. (3-20-20)T

**02. Notice Procedures.** The permittee may make a change under this Section if the permittee provides written notification to the Department and EPA so that the notification is received at least seven (7) days in advance of the proposed change; or, in the event of an emergency, the permittee provides the notification so that it is received at least twenty-four (24) hours in advance of the proposed change. The permittee, the Department, and EPA shall attach the notification to their copy of the Tier I operating permit. (3-20-20)T

- a.** For each such change, the written notification shall: (3-20-20)T
    - i.** State at the beginning of the notification “NOTIFICATION OF SECTION 502(b)(10) CHANGE” or “NOTIFICATION OF EMISSION TRADE”; (3-20-20)T
    - ii.** Describe the proposed change; (3-20-20)T
    - iii.** Provide the date on which the proposed change will occur; (3-20-20)T
    - iv.** Describe and quantify any expected change in emissions including identification of any new regulated air pollutant(s) that will be emitted; (3-20-20)T
    - v.** Identify any permit term or condition that is no longer applicable as a result of the change; (3-20-20)T
    - vi.** Specifically identify and describe the emergency, if any; and (3-20-20)T
    - vii.** Identify any new applicable requirement that would apply to the Tier I source as a result of the change. (3-20-20)T
  - b.** For changes described in Subsection 384.01.a.ii., the written notification shall also include: (3-20-20)T
    - i.** Identification of the provisions in the SIP that provide for the emissions trade; (3-20-20)T
    - ii.** All of the information required by the provision in the SIP authorizing the emissions trade; (3-20-20)T
    - iii.** Specific identification of the provisions in the SIP with which the permittee will comply; and (3-20-20)T
    - iv.** The pollutants subject to the trade. (3-20-20)T
  - c.** For changes described in Subsection 384.01.a.iii., the written notification shall also describe how the change will comply with the terms and conditions of the permit. (3-20-20)T
- 03. Permit Shield.** The permit shield described in Section 325 shall only extend to changes made in accordance with Subsection 384.01.a.iii. (3-20-20)T

**385. OFF-PERMIT CHANGES AND NOTICE.**

**01. Criteria.** This section authorizes changes that are neither addressed nor prohibited by the Tier I operating permit to be made without a permit revision if each such change meets all applicable requirements and does not violate any existing permit terms or conditions. Changes constituting a modification under Title I of the Clean Air Act, or subject to a requirement under Title IV of the Clean Air Act are not off-permit changes. (3-20-20)T

**02. Notice Procedure.** Sources must provide written notice to the Department and EPA of each such change except changes that qualify as insignificant under Section 317, within seven (7) days of making the off-permit change. (3-20-20)T

- a. The written notification provided to the Department and EPA shall: (3-20-20)T
- i. State at the beginning of the notification “NOTIFICATION OF OFF-PERMIT CHANGE”; (3-20-20)T
- ii. Describe the off-permit change; (3-20-20)T
- iii. State the date on which the off-permit change will occur or has occurred; (3-20-20)T
- iv. Describe and quantify any change in emissions resulting from the off-permit change including, but not limited to, an identification of any new regulated air pollutant(s) that will be emitted; and (3-20-20)T
- v. Identify any new applicable requirement that is applicable to the Tier I source as a result of the off-permit change. (3-20-20)T

**b.** The permittee shall keep a record at the facility describing all off-permit changes made at the Tier I source that result in emissions of a regulated air pollutant subject to an applicable requirement, but not otherwise regulated under the permit, and identifying the emissions resulting from those changes. (3-20-20)T

**03. Permit Shield Applicability.** The permit shield described in Section 325 shall not apply to any off-permit change. (3-20-20)T

**386. REOPENING FOR CAUSE.**

The Department shall reopen a Tier I permit if cause exists. (3-20-20)T

**01. Criteria.** Cause for reopening exists under any of the following circumstances: (3-20-20)T

**a.** Additional applicable requirements become applicable to a major Tier I source with a remaining permit term of three (3) or more years; provided that no such reopening is required if the original effective date of the applicable requirement is later than the date on which the Tier I operating permit is due to expire and the original Tier I operating permit or any of its terms and conditions has not been extended pursuant to Section 368; provided further that the permittee must comply with the additional applicable requirement no later than the effective date; (3-20-20)T

**b.** Whenever additional applicable requirements become applicable to an affected source, as defined for the purposes of the acid rain program; (3-20-20)T

**c.** The Department or EPA determines that the Tier I operating permit contains a material mistake or inaccurate statements were used or considered in establishing the emissions standards or other terms or conditions of the Tier I operating permit; or (3-20-20)T

**d.** The Department or EPA determines that the Tier I operating permit does not ensure compliance with the applicable requirements. (3-20-20)T

**02. Procedures for Reopenings.** (3-20-20)T

**a.** The Department shall follow the same procedures for reopening as they apply to initial permit issuance and shall affect only those parts of the permit for which cause to reopen exists. Reopenings shall be made as expeditiously as practicable in accordance with Sections 360 through 379. (3-20-20)T

**b.** The Department shall notify the permittee in writing of reopening and provide a brief summary of the reason for the reopening at least thirty (30) days prior to the reopening. (3-20-20)T

**c.** The EPA may initiate reopenings for circumstances listed in Subsections 386.01.a. through 386.01.d. by providing written notification to the Department and the permittee. (3-20-20)T

**i.** The Department shall within ninety (90) days after receipt of notification from EPA, forward to EPA a proposed determination of termination, revocation, revision, or revocation and reissuance, as appropriate. The



Administrator may extend the ninety (90) day period for an additional ninety (90) days if EPA finds that a new or revised permit application is necessary or that the Department must require the permittee to submit additional information. (3-20-20)T

ii. The EPA will review the proposed determination from the Department within ninety (90) days of receipt. (3-20-20)T

iii. The Department shall have ninety (90) days from receipt of an EPA objection to resolve any EPA objection and to terminate, modify, or revoke and reissue the permit. (3-20-20)T

iv. If the Department fails to submit a proposed determination or fails to resolve any EPA objection, the EPA may terminate, modify, revoke and reissue the permit after taking the following actions: (3-20-20)T

(1) Providing at least thirty (30) days' notice to the permittee in writing of the reason for such action, and (3-20-20)T

(2) Providing the permittee an opportunity for comment on the EPA's proposed action and an opportunity for a hearing. (3-20-20)T

**387. REGISTRATION AND REGISTRATION FEES.**

The purpose of Sections 387 through 397 is to set forth the requirements for the annual registration of Tier I sources, and the annual assessment and payment of fees to support the Tier I permitting program. (3-20-20)T

**388. APPLICABILITY.**

**01. Applicability.** Sections 387 through 397 shall apply to all major facilities, as defined in Section 008, including facilities that obtained air quality permits that limited potential emissions below major facility levels during the previous year. Facilities, sources and emissions exempt under Section 301 are not required to register or pay fees. (3-20-20)T

**02. Deferred Sources.** Certain sources may qualify for and request deferral from the Tier 1 operating permit program under Subsection 301.02.b.iv. and thereby not pay Tier I fees. On or before such time as those deferred sources are required to submit a Tier 1 operating permit application, the Department shall reconsider Sections 387 through 397 to determine whether an alternative basis upon which those sources shall register and be assessed and pay fees should be developed. (3-20-20)T

**389. REGISTRATION INFORMATION.**

Any person owning or operating a facility or source during the previous calendar year or any portion of the previous calendar year for which Sections 387 through 397 apply shall, by April 1 of each year, register with the Department and submit the following information (submittal forms are located at the DEQ website at <http://www.deq.idaho.gov>): (3-20-20)T

**01. Facility Information.** The name, address, telephone number and location of the facility; (3-20-20)T

**02. Owner/Operator Information.** The name, address and telephone numbers of the owners and operators; (3-20-20)T

**03. Facility Emission Units.** The number and type of emission units present at the facility or the Tier I permit number for the facility; and (3-20-20)T

**04. Pollutant Registration.** The actual emissions from the previous calendar year for oxides of sulfur (SO<sub>x</sub>), oxides of nitrogen (NO<sub>x</sub>), particulate matter (PM<sub>10</sub>), and volatile organic compounds (VOC) calculated using methods to include, but not limited to, continuous emissions monitoring (CEMS), certified source tests, material balances (mass-balance), state/industry emission factors, or AP-42 emission factors applied to throughput, actual operating hours, production rates, in-place control equipment, or the types of materials processed, stored, or combusted. (3-20-20)T

**05. Radionuclide Registration.** The amount of radionuclides from facilities regulated under 40 CFR Part 61, Subpart H, for which the registrant wishes to be registered to emit from each source in curies per year except that no amount in excess of or less than an existing permit, consent order, or judicial order will be allowed. (3-20-20)T

**390. REGISTRATION FEE.**

This registration fee structure shall be reviewed at least every two (2) years to assure the funds meet the presumptive minimum as defined by EPA. The annual registration fee as determined in Section 390 shall be paid as provided in Section 393. (3-20-20)T

**01. Tier I Annual Fee.** The Tier I annual fee schedule shall be as follows: (3-20-20)T

**a.** A fixed annual fee for Tier I major sources emitting regulated air pollutants listed in Subsection 389.04 as follows: (3-20-20)T

i. Seven thousand (7,000) tons per year and above shall pay seventy-one thousand five hundred dollars (\$71,500); (3-20-20)T

ii. Four thousand five hundred (4,500) tons per year and above shall pay forty-two thousand nine hundred dollars (\$42,900); (3-20-20)T

iii. Three thousand (3,000) tons per year and above shall pay twenty-eight thousand six hundred dollars (\$28,600); (3-20-20)T

iv. One thousand (1,000) tons per year and above shall pay twenty-two thousand seven hundred fifty dollars (\$22,750); (3-20-20)T

v. Five hundred (500) tons per year and above shall pay eleven thousand fifty dollars (\$11,050); (3-20-20)T

vi. Two hundred (200) tons per year and above shall pay seven thousand one hundred fifty dollars (\$7,150); and (3-20-20)T

vii. Less than two hundred (200) tons per year shall pay three thousand five hundred seventy-five dollars (\$3,575); plus (3-20-20)T

**b.** A per ton annual fee of thirty-nine dollars and forty-eight cents (\$39.48) per ton for all regulated air pollutant emissions listed in Subsection 389.04 as follows: (3-20-20)T

i. Greater than or equal to four thousand five hundred (4,500) tons per year not to exceed one hundred forty-three thousand dollars (\$143,000); (3-20-20)T

ii. Greater than or equal to three thousand (3,000) but less than four thousand five hundred (4,500) tons per year not to exceed seventy-one thousand five hundred dollars (\$71,500); (3-20-20)T

iii. Greater than or equal to one thousand (1,000) but less than three thousand (3,000) tons per year not to exceed thirty-five thousand one hundred dollars (\$35,100); (3-20-20)T

iv. Greater than or equal to five hundred (500) but less than one thousand (1,000) tons per year not to exceed twenty-five thousand twenty-five dollars (\$25,025); (3-20-20)T

v. Greater than or equal to two hundred (200) but less than five hundred (500) tons per year not to exceed ten thousand seven hundred twenty-five dollars (\$10,725); and (3-20-20)T

vi. Less than two hundred (200) tons per year not to exceed three thousand five hundred seventy-five dollars (\$3,575). (3-20-20)T

**02. Fee-for-Service.** The fee-for-service shall be as follows: Sources requesting Section 300 permit modifications or renewals, or receiving program maintenance services, including but not limited to site visits, response to public inquiries, modeling, responses to site questions and opacity readings by the Department shall be assessed a fee for actual time expended and expenses incurred by the Department in the previous calendar year in an amount not to exceed twenty thousand dollars (\$20,000) per facility per year as a fee-for-service. Service shall be conducted by qualified Department staff or contractors. (3-20-20)T

**03. Radionuclide Registration Fee.** (3-20-20)T

**a.** A registration fee of five dollars per curie per year (\$5/curie/year) shall be paid by facilities regulated under 40 CFR Part 61, Subpart H. (3-20-20)T

**b.** The registration fee may be paid as provided in Section 397. (3-20-20)T

**391. REQUEST FOR INFORMATION.**

Any additional information, plans, specifications, evidence or documents that the Department may require to make the determinations required under Sections 387 through 397 shall be furnished on request. (3-20-20)T

**392. REGISTRATION FEE ASSESSMENT.**

All facilities to which Sections 387 through 397 apply shall pay to the Department an annual registration fee as required by Section 390. The Department shall determine the fee based on the information supplied by the registrant and the Department's analysis of information available. In the event of a failure of a facility to submit pertinent registration information, the Department may calculate the fee and shall assess the facility the fee and the costs of calculating the fee. No later than May 15 of each year, or within fifteen (15) days following the adjournment of the regular session of the Idaho State Legislature, whichever is later, the Department shall send to each registrant, to which Sections 387 through 397 apply, by certified mail, an assessment of the annual fee payable by the registrant. (3-20-20)T

**393. PAYMENT OF TIER I REGISTRATION FEE.**

**01. Fee Payment Date.** The registration fee shall be paid to and received by the Department no later than July 1 of each year, or within forty-five (45) days following the receipt of the registration fee assessment in Section 392, whichever is later. Checks should be made payable to "Department of Environmental Quality." (3-20-20)T

**02. Fee Payments Mailing Address.** All fee payments should be sent to:

Air Quality Tier I Registration Fees  
Idaho Department of Environmental Quality  
1410 N. Hilton, Boise, Idaho 83706-1255

(3-20-20)T

**394. EFFECT OF DELINQUENCY ON APPLICATIONS.**

No permit to construct or operate, other than those issued at the discretion of the Director, shall be accepted for processing, processed, or issued by the Department for any facility or to any person having Tier I operating permit fees delinquent in full or in part. (3-20-20)T

**395. APPEALS.**

Persons may file an appeal within thirty-five (35) days of the date the person received an assessment issued under Section 392. The appeal shall be filed in accordance with IDAPA 58.01.23, "Rules of Administrative Procedure Before the Board of Environmental Quality." (3-20-20)T

**396. EXEMPTIONS.**

**01. Registration Fees.** The following facilities or sources are exempt from paying registration fees under Sections 387 through 397: (3-20-20)T

**a.** Facilities and sources specified by the Department, after public notice, as exempt from the payment of registration fees; and (3-20-20)T

**b.** Country grain elevators. (3-20-20)T

**02. Registering and Paying Fees.** The following facilities or sources are exempt from registering and paying registration fees under Sections 387 through 397: (3-20-20)T

**a.** Facilities and sources specified by the Department, after public notice, as exempt from registration and the payment of registration fees; (3-20-20)T

**b.** Confined animal feeding operations; and (3-20-20)T

**c.** Insignificant activities identified in Subsection 317.01. (3-20-20)T

**03. Paying Fees.** The following emissions are exempt from registering and paying registration fees under Sections 387 through 397: (3-20-20)T

**a.** Fugitive emissions from wood products. (3-20-20)T

**b.** Fugitive dust emissions, except facilities listed in Subsections 008.10.c.i. and 008.10.c.ii. Facilities listed in that section shall not be required to pay fees for fugitive dust emission in excess of one hundred (100) tons. (3-20-20)T

### **397. LUMP SUM PAYMENTS OF REGISTRATION FEES.**

**01. Agreement.** The Department may, in its discretion, enter an agreement with any person for the lump sum payment of all, or any addition to, the registration fees required by Section 390. (3-20-20)T

**02. Minimum Amount.** The minimum amount for any lump sum agreement shall be three hundred thousand dollars (\$300,000). (3-20-20)T

**03. Payment Waiver.** Upon the execution and full performance of the agreement by the person, the Department shall waive the payment requirements of Section 390. All other provisions of Sections 387 through 397 shall remain applicable to the person. (3-20-20)T

### **398. -- 399. (RESERVED)**

### **400. PROCEDURES AND REQUIREMENTS FOR TIER II OPERATING PERMITS.**

The purpose of Sections 400 through 410 is to establish uniform procedures for the issuance of "Tier II Operating Permits." (3-20-20)T

### **401. TIER II OPERATING PERMIT.**

**01. Optional Tier II Operating Permits.** The owner or operator of any stationary source or facility which is not subject to (or wishes to accept limitations on the facility's potential to emit so as to not be subject to) Sections 300 through 399 may apply to the Department for an operating permit to: (3-20-20)T

**a.** Authorize the use of alternative emission limits (bubbles) pursuant to Section 440; (3-20-20)T

**b.** Authorize the use of an emission offset pursuant to Sections 204.02.b. or 206; (3-20-20)T

**c.** Authorize the use of a potential to emit limitation, an emission reduction or netting transaction to exempt a facility or modification from certain requirements for a permit to construct; (3-20-20)T

**d.** Authorize the use of a potential to emit limitation to exempt the facility from Tier I permitting requirements. (3-20-20)T

- e. Bank an emission reduction credit pursuant to Section 461; (3-20-20)T
- 02. Required Tier II Operating Permits.** (3-20-20)T
- a. A Tier II operating permit is required for any stationary source or facility which: (3-20-20)T
- i. Is not subject to Sections 300 through 399 with a permit to construct which establishes any emission standard different from those in these rules. (3-20-20)T
- ii. Has annual actual mercury emissions in excess of sixty-two (62) pounds. Fugitive emissions shall not be included in a determination of the actual mercury emissions. The owner or operator of the stationary source or facility shall submit a Tier II permit application for review and approval by the Department, no later than twelve (12) months after becoming subject to Subsection 401.02.a.ii., that includes an MBACT analysis for all sources that emit mercury. A determination of applicability under Subsection 401.02 shall be based upon best available information. An MBACT analysis for review and approval by the Department shall be included in a Tier II renewal application for any mercury emitting source not otherwise subject to MBACT. (3-20-20)T
- b. Stationary sources within a source category subject to 40 CFR Part 63 are exempt from the requirements of Subsection 401.02.a.ii. (3-20-20)T
- 03. Tier II Operating Permits Required by the Department.** The Director may require or revise a Tier II operating permit for any stationary source or facility whenever the Department determines that: (3-20-20)T
- a. Emission rate reductions are necessary to attain or maintain any ambient air quality standard or applicable prevention of significant deterioration (PSD) increment; or (3-20-20)T
- b. Specific emission standards, or requirements on operation or maintenance are necessary to ensure compliance with any applicable emission standard or rule. (3-20-20)T
- 04. Multiple Tier II Operating Permits.** Subject to approval by EPA, the Director may issue one (1) or more Tier II operating permits to a facility which allow any specific stationary source or emissions unit within that facility a future compliance date of up to three (3) years beyond the compliance date of any provision of these rules, provided the Director has reasonable cause to believe such a future compliance date is warranted. (3-20-20)T
- 05. Tier II Operating Permits Establishing a Facility Emissions Cap.** The owner or operator of any stationary source or facility may request a Tier II operating permit establishing a Facility Emissions Cap (FEC) pursuant to Sections 175 through 181. (3-20-20)T
- 402. APPLICATION PROCEDURES.**  
Application for a Tier II operating permit must be made using forms furnished by the Department, or by other means prescribed by the Department. The application shall be certified by the responsible official and shall be accompanied by all information necessary to perform any analysis or make any determination required under Sections 400 through 410. (3-20-20)T
- 01. Required Information.** Site information, plans, description, specifications, and drawings showing the design of the stationary source, facility, or modification, the nature and amount of emissions (including secondary emissions), and the manner in which it will be operated and controlled. (3-20-20)T
- 02. Additional Specific Information.** (3-20-20)T
- a. For emission reduction credits, a description of the emission reduction credits proposed for use, including descriptions of the stationary sources or facilities providing the reductions, a description of the system of continuous emission control which provides the emission reduction credits, emission estimates, and other information necessary to determine that the emission reductions satisfy the requirements for emission reduction credits (Section 460); and (3-20-20)T
- b. For alternative emission limits (bubbles) or emission offsets, information on the air quality impacts

of the traded emissions as necessary to determine the change in ambient air quality that would occur. (3-20-20)T

**c.** For restrictions on potential to emit, a description of the proposed potential to emit limitations including the proposed monitoring and recordkeeping requirements that will be used to verify compliance with the limitations. (3-20-20)T

**03. Estimates of Ambient Concentrations.** All estimates of ambient concentrations shall be based on the applicable air quality models, data bases, and other requirements specified in 40 CFR 51 Appendix W (Guideline on Air Quality Models). (3-20-20)T

**a.** Where an air quality model specified in the “Guideline on Air Quality Models” is inappropriate, the model may be modified or another model substituted, subject to written approval of the Administrator of the U.S. Environmental Protection Agency and public comment pursuant to Subsection 404.01.c. (3-20-20)T

**b.** Methods like those outlined in the U.S. Environmental Protection Agency’s “Interim Procedures for Evaluating Air Quality Models (revised)” (1984) should be used to determine the comparability of air quality models. (3-20-20)T

**04. Additional Information.** Any additional information, plans, specifications, evidence or documents that the Department may require to make the determinations required under Sections 400 through 410 shall be furnished upon request. (3-20-20)T

**403. PERMIT REQUIREMENTS FOR TIER II SOURCES.**

No Tier II operating permit shall be granted unless the applicant shows to the satisfaction of the Department that: (3-20-20)T

**01. Emission Standards.** The stationary source would comply with all applicable local, state or federal emission standards. (3-20-20)T

**02. NAAQS.** The stationary source would not cause or significantly contribute to a violation of any ambient air quality standard. (3-20-20)T

**404. PROCEDURE FOR ISSUING PERMITS.**

**01. General Procedures.** General procedures for Tier II operating permits. (3-20-20)T

**a.** Within thirty (30) days after receipt of the application for a Tier II operating permit, the Department shall determine whether the application is complete or whether more information must be submitted and shall notify the applicant of its findings in writing. (3-20-20)T

**b.** Within sixty (60) days after the application is determined to be complete the Department shall: (3-20-20)T

**i.** Notify the applicant in writing of the approval, conditional approval, or denial of the application if an opportunity for public comment is not required pursuant to Subsection 404.01.c. The Department shall set forth reasons for any denial; or (3-20-20)T

**ii.** Issue a proposed approval, proposed conditional approval, or proposed denial. (3-20-20)T

**c.** An opportunity for public comment shall be provided on an application for any Tier II operating permit pursuant to Subsection 401.01, any application which uses fluid modeling or a field study to establish a good engineering practice stack height pursuant to Sections 510 through 516 and any other application which the Director determines an opportunity for public comment should be provided. (3-20-20)T

**i.** The Department's proposed action, together with the information submitted by the applicant and the Department's analysis of the information, shall be made available to the public in at least one (1) location in the region in which the stationary source or facility is to be located. (3-20-20)T

ii. The availability of such materials shall be made known by notice published in a newspaper of general circulation in the county(ies) in which the stationary source or facility is to be located. (3-20-20)T

iii. A copy of such notice shall be sent to the applicant and to appropriate federal, state and local agencies. (3-20-20)T

iv. There shall be a thirty (30) day period after initial publication for comment on the Department's proposed action, such comment to be made in writing to the Department. (3-20-20)T

v. After consideration of comments and any additional information submitted during the comment period, and within forty-five (45) days after initial publication of the notice, unless the Director deems that additional time is required to evaluate comments and information received, the Department shall notify the applicant in writing of approval, conditional approval, or denial of the permit. The Department shall set forth the reasons for any denial. (3-20-20)T

vi. All comments and additional information received during the comment period, together with the Department's final determination, shall be made available to the public at the same location as the preliminary determination. (3-20-20)T

d. A copy of each proposed and final permit will be sent to the U.S. Environmental Protection Agency. (3-20-20)T

**02. Specific Procedures.** Procedures for Tier II operating permits required by the Department under Subsection 401.03. (3-20-20)T

a. The Director shall send a notification to the proposed permittee by registered mail of his intention to issue a Tier II operating permit for the facility concerned. The notification shall contain a copy of the proposed permit in draft form stating the proposed emission standards and any required action, with corresponding dates, which must be taken by the proposed permittee in order to achieve or maintain compliance with the proposed Tier II operating permit. (3-20-20)T

b. The Department's proposed Tier II operating permit shall be made available to the public in at least one (1) location in the region in which the facility is located. The availability of such materials shall be made known by notice published in a newspaper of general circulation in the county(ies) in which the facility is located. A copy of such notice shall be sent to the applicant. There shall be a thirty (30) day period after publication for comment on the Department's proposed Tier II operating permit. Such comment shall be made in writing to the Department. (3-20-20)T

c. A public hearing will be scheduled to consider the standards and limitations contained in the proposed Tier II operating permit if the proposed permittee files a request therefor with the Department within ten (10) days of receipt of the notification, or if the Director determines that there is good cause to hold a hearing. (3-20-20)T

d. After consideration of comments and any additional information submitted during the comment period or at any public hearing, the Director shall render a final decision upon the proposed Tier II operating permit within thirty (30) days of the close of the comment period or hearing. At this time the Director may adopt the entire Tier II operating permit as originally proposed or any part or modification thereof. (3-20-20)T

e. All comments and additional information received during the comment period, together with the Department's final permit, shall be made available to the public at the same location as the proposed Tier II operating permit. (3-20-20)T

**03. Availability of Fluid Models and Field Studies.** The Department will notify the public of the availability of any fluid model or field study used to establish a good engineering practice stack height and provide an opportunity for a public hearing before issuing a permit or setting an emission standard based thereon. (3-20-20)T

**04. Permit Revision or Renewal.** The Director may approve a revision of any Tier II operating permit or renewal of any Tier II operating permit provided the stationary source or facility continues to meet all applicable requirements of Sections 400 through 410. Revised permits will be issued pursuant to procedures for issuing permits (Section 404), except that the requirements of Subsection 404.01.c. shall only apply if the permit revision results in an increase in allowable emissions or if deemed appropriate by the Director. Renewed Tier II operating permits will be issued pursuant to procedures for issuing permits (Section 404), except that the requirements of Subsections 404.01.c., and 404.02.b. through 404.02.e. shall only apply if the permit revision results in an increase in allowable emissions or if deemed appropriate by the Director. The expiration of a permit will not affect the operation of a stationary source or a facility during the administrative procedure period associated with the permit renewal process. The permittee shall submit a complete application to the Department for a renewal of the terms and conditions establishing the Tier II operating permit at least six (6) months before, but no earlier than eighteen (18) months before, the expiration date of the existing permit. To ensure that the term of the permit does not expire before the terms and conditions are renewed, the permittee is encouraged to submit the application nine (9) months prior to expiration. (3-20-20)T

**05. Transfer of Tier II Permit.** (3-20-20)T

**a. Transfers by Revision.** A Tier II permit may be transferred to a new owner or operator in accordance with Subsection 404.04. (3-20-20)T

**b. Automatic Transfers.** Any Tier II permit, with or without transfer prohibition language, may be automatically transferred if: (3-20-20)T

**i.** The current permittee notifies the Department at least thirty (30) days in advance of the proposed transfer date; (3-20-20)T

**ii.** The notice provides written documentation signed by the current and proposed permittees containing a date for transfer of permit responsibility, designation of the proposed permittee's responsible official, and certification that the proposed permittee has reviewed and intends to operate in accordance with the permit terms and conditions; and (3-20-20)T

**iii.** The Department does not notify the current permittee and the proposed permittee within thirty (30) days of receipt of the notice of the Department's determination that the permit must be revised pursuant to Subsection 404.04. If the Department does not issue such notice, the transfer is effective on the date provided in the notice described in Subsection 404.05.b.ii. (3-20-20)T

**405. CONDITIONS FOR TIER II OPERATING PERMITS.**

**01. Reasonable Conditions.** The Department may impose any reasonable conditions upon an approval, including conditions requiring the stationary source or facility to be provided with: (3-20-20)T

**a.** Sampling ports of a size, number, and location as the Department may require; (3-20-20)T

**b.** Safe access to each port; (3-20-20)T

**c.** Instrumentation to monitor and record emissions data; (3-20-20)T

**d.** Instrumentation for ambient monitoring to determine the effect emissions from the stationary source or facility may have, or are having, on the air quality in any area affected by the stationary source or facility; and (3-20-20)T

**e.** Any other sampling and testing facilities as may be deemed reasonably necessary. (3-20-20)T

**02. Performance Tests.** Any performance tests required by the permit shall be performed in accordance with methods and under operating conditions approved by the Department. The owner or operator shall furnish to the Department a written report of the results of such performance test. (3-20-20)T

**a.** Such test shall be at the expense of the owner or operator. (3-20-20)T



b. The Department may monitor such test and may also conduct performance tests. (3-20-20)T

c. The owner or operator of a stationary source or facility shall provide the Department fifteen (15) days prior notice of the performance test to afford the Department the opportunity to have an observer present. (3-20-20)T

**03. Permit Term.** Tier II operating permits shall be issued for a period not to exceed five (5) years. This five (5) year operating permit restriction does not apply to the provisions contained in Section 461.02 (banked emission reduction credits). (3-20-20)T

**04. Single Tier II Operating Permit.** When a facility includes more than one (1) stationary source or emissions unit, a single Tier II operating permit may be issued including all stationary sources and emissions units located at that facility. Such Tier II operating permit shall separately identify each stationary source and emissions unit to which the Tier II operating permit applies. When a single stationary source or facility is subject to permit modification, suspension or revocation, such action by the Director shall only affect that individual stationary source or emissions unit without thereby affecting any other stationary source or emissions unit subject to that Tier II operating permit. (3-20-20)T

**406. OBLIGATION TO COMPLY.** Receiving a Tier II operating permit shall not relieve any owner or operator of the responsibility to comply with all applicable local, state and federal rules and regulations. (3-20-20)T

**407. TIER II OPERATING PERMIT PROCESSING FEE.**

**01. Tier II Operating Permit Processing Fee.** A Tier II operating permit processing fee, calculated by the Department pursuant to the categories provided in the following table, shall be paid to the Department by the person receiving a Tier II permit or permit renewal. The fee calculation shall not include fugitive emissions.

TIER II OPERATING PERMIT CATEGORY	FEE
General permit, no facility specific requirements (Defined as a source category specific permit for which the Department has developed standard emission limitations, operating requirements, monitoring and recordkeeping requirements, and that require minimal engineering analysis.)	\$500
Stationary sources or facilities with permitted emissions of less than one (1) ton per year	\$1,250
Stationary sources or facilities with permitted emissions of one (1) to less than ten (10) tons per year	\$2,500
Stationary sources or facilities with permitted emissions of ten (10) to less than one hundred (100) tons per year	\$5,000
Stationary sources or facilities with permitted emissions of one hundred (100) tons or more per year	\$10,000
Synthetic minor stationary sources with permitted emissions below a major threshold level	\$10,000

(3-20-20)T

**02. Tier II Operating Permit Processing Fee Not Required.** So long as the Department determines no other review or analysis is required, the Tier II operating permit processing fee is not required to be submitted when:

a. A permit to construct issued within the last five (5) years is rolled into a Tier II permit; (3-20-20)T

b. A change to correct typographical errors is requested; (3-20-20)T

c. A change in the name or ownership of the holder of a Tier II operating permit is requested; or (3-20-20)T

d. A synthetic minor permit is issued and the Department's processing costs can be charged against fees collected from the person receiving the permit under Title V of the federal Clean Air Act amendments of 1990. (3-20-20)T

**408. PAYMENT OF TIER II OPERATING PERMIT PROCESSING FEE.**

**01. Fee Submittal.** The Tier II operating permit processing fee shall be payable upon receipt of an assessment sent, along with the final permit or permit renewal, to the person receiving a permit or permit renewal by the Department. The Tier II operating permit fee should be sent to:

Air Quality Tier II Fees  
Fiscal Office  
Idaho Department of Environmental Quality  
1410 N. Hilton, Boise, ID 83706-1255 (3-20-20)T

**02. Delinquency.** Failure to submit a Tier II operating permit processing fee within forty-five (45) days of receipt of an assessment by the Department will result in a monthly accrual of interest in the amount of twelve percent (12%) per annum on the outstanding balance until the fee is paid in full. (3-20-20)T

**409. RECEIPT AND USAGE OF FEES.**

Tier II operating permit processing fee and delinquency interest receipts shall be deposited by the Department into a stationary source permit account. Monies from this account shall be used solely toward technical, legal and administrative support of the Department's Permit to Construct and Tier II permit programs and shall not be used for those activities supported by the fund created for implementing the operating permit program required under Title V of the federal Clean Air Act amendments of 1990. The Department will review the Tier II fee schedule at least every two (2) years. (3-20-20)T

**410. APPEALS.**

A person may be able to file an appeal within thirty-five (35) days of the date the person receives an assessment under Section 407, in accordance with IDAPA 58.01.23, "Rules of Administrative Procedure Before the Board of Environmental Quality." (3-20-20)T

**411. -- 439. (RESERVED)**

**440. REQUIREMENTS FOR ALTERNATIVE EMISSION LIMITS (BUBBLES).**

The owner or operator of any facility may apply to the Department for a Tier I or Tier II operating permit (or a revision thereto) to authorize an alternative emission limit for any stationary source or emissions unit within the facility. The Department may issue or revise a Tier II operating permit or issue a significant modification to a Tier I operating permit which authorizes an alternative emission limit provided that all of the following are met: (3-20-20)T

**01. Actual Emissions.** There is no increase in actual emissions of the applicable air pollutant at the facility. (3-20-20)T

**02. Emission Reductions.** All emission reductions satisfy the requirements for emission reduction credits (Section 460). (3-20-20)T

**03. Trade Requirements.** All trades involve the same air pollutant and demonstrate ambient equivalence as specified in Subsection 441.02. (3-20-20)T

**04. Applicable Requirement Prohibition.** No applicable Section of 40 CFR Part 60, 40 CFR Part 61, or 40 CFR Part 63, best available control technology requirement, lowest achievable emission rate requirement, or visual emission standard is exceeded. (3-20-20)T

**05. Actual HAP/TAP Emissions.** The actual emissions of any hazardous air pollutant or any toxic air

pollutant are not increased. (3-20-20)T

**06. Fugitive Dust Trades.** Where the trade involves fugitive dust, the owner or operator shall undertake an adequate post-approval monitoring program to evaluate the ambient results of the controls. If the monitoring data indicate that the air quality effects are not equivalent, then: (3-20-20)T

a. Further reductions must be proposed by the owner or operator; and/or (3-20-20)T

b. The applicable emission standards in the operating permit will be adjusted by the Department; (3-20-20)T

**07. Compliance Schedule Extension.** Any compliance schedule extension for a facility in a nonattainment area is consistent with reasonable further progress. (3-20-20)T

**08. EPA Approval.** Approval of the U.S. Environmental Protection Agency, and where necessary the appropriate court, has been obtained for any individual stationary source or facility which is the subject of a federal enforcement action or outstanding enforcement order. (3-20-20)T

**441. DEMONSTRATION OF AMBIENT EQUIVALENCE.**  
The demonstration of ambient equivalence shall: (3-20-20)T

**01. VOC Trades.** For trades involving volatile organic compounds, show that total emissions are not increased for the air basin in which the stationary source or facility is located. (3-20-20)T

**02. Other Trades.** For trades involving any other air pollutant, show through appropriate dispersion modeling that the trade will not cause a significant contribution at any modeled receptor. (3-20-20)T

**442. -- 459. (RESERVED)**

**460. REQUIREMENTS FOR EMISSION REDUCTION CREDIT.**  
In order to be credited in a permit to construct, Tier I operating permit or Tier II operating permit any emission reduction must satisfy the following: (3-20-20)T

**01. Allowable Emissions.** The proposed level of allowable emissions must be less than the actual emissions of the stationary source(s) or emission unit(s) providing the emission reduction credit. No emission reduction(s) can be credited for actual emissions which exceed the allowable emissions of the stationary source(s) or emission unit(s). (3-20-20)T

**02. Timing of Emission Reduction.** In an attainment or unclassifiable area any emission reduction which occurs prior to the minor source baseline date must have been banked with the Department prior to the minor source baseline date in order to be credited; in a nonattainment area the emission reduction must occur after the base year of any control strategy for the particular air pollutant. (3-20-20)T

**03. Emission Rate Calculation.** The emission rate before and after the reduction must be calculated using the same method and averaging time and the characteristics necessary to evaluate any future use of the emission reduction credit must be described. (3-20-20)T

**04. Permit Issuance.** A permit to construct, Tier I operating permit or Tier II operating permit shall be issued which establishes a new emission standard for the facility, or restricts the operating rate, hours of operation, or the type or amount of material combusted, stored or processed for the stationary source(s) or emission unit(s) providing the emission reductions. (3-20-20)T

**05. Imposed Reductions.** Emission reductions imposed by local, state or federal regulations or permits shall not be allowed for emission reduction credits. (3-20-20)T

**06. Mobile Sources.** The proposed level of allowable emissions must be less than the actual emissions of the mobile sources or stationary sources providing the emission reduction credit. Mobile source emission reduction

credits shall be made state or federally enforceable by SIP revision. The form of the SIP revision may be a state or local regulation, operating permit condition, consent or enforcement order, or any mechanism available to the state that is enforceable. (3-20-20)T

**461. REQUIREMENTS FOR BANKING EMISSION REDUCTION CREDITS (ERC'S).**

**01. Application to Bank an ERC.** The owner or operator of any facility may apply to the Department for a Tier I or Tier II operating permit (or a revision thereto) to bank an emission reduction credit. An application to bank an emission reduction credit must be received by the Department no later than one (1) year after the reduction occurs. The Department may issue or revise such a Tier I or Tier II operating permit and a "Certificate of Ownership" for an emission reduction credit, provided that all emission reductions satisfy the requirements for emission reduction credits (Section 460). (3-20-20)T

**02. Banking Period.** Emission reduction credits may be banked with the Department. The banked emission reduction credits may be used for offsets, netting in accordance with the definition of net emissions increase at Section 007, or alternative emission limits (bubbles), or sold to other facilities. The use of banked emission reduction credits must satisfy the applicable requirements of the program in which they are proposed for use, including approval of a permit to construct or a Tier I or Tier II operating permit. (3-20-20)T

**03. Certificate of Ownership.** Upon issuing or revising a Tier I or Tier II operating permit for an emission reduction credit, the Department will issue a "Certificate of Ownership" which will identify the owner of the credits, quantify the credited emission reduction and describe the characteristics of the emissions which were reduced and emissions unit(s) which previously emitted them. (3-20-20)T

**04. Adjustment by Department.** If at any time the Department, or the owner or operator of a facility which has produced an emission reduction credit, finds that the actual reduction in emissions differs from that in the certificate of ownership, the Department will adjust the amount of banked emission reduction credits to reflect the actual emission reduction and issue a revised certificate of ownership. (3-20-20)T

**05. Proportional Discounts.** If at any time the Department finds that additional emission reductions are necessary to attain and maintain any ambient air quality standard or applicable prevention of significant deterioration (PSD) increment, banked emission reduction credits at facilities in the affected area may be proportionally discounted by an amount which will not exceed the percentage of emission reduction required for that area. (3-20-20)T

**06. Transfer of Ownership.** Whenever the holder of a certificate of ownership for banked emission reduction credits, sells or otherwise transfers ownership of all or part of the banked credits, the holder shall submit the certificate of ownership to the Department. The Department will issue a revised certificate(s) of ownership which reflects the old and new holder(s) and amount(s) of banked emission reduction credits. (3-20-20)T

**07. Public Registry.** The Department will maintain a public registry of all banked emissions reduction credits, indicating the current holder of each certificate of ownership and the amount and type of credited emissions. (3-20-20)T

**462. -- 499. (RESERVED)**

**500. REGISTRATION PROCEDURES AND REQUIREMENTS FOR PORTABLE EQUIPMENT.**

**01. Registration Requirements.** All existing portable equipment shall be registered within ninety (90) days after the original effective date of this Section 500 and at least ten (10) days prior to relocating, using forms provided by the Department, except that no registration is required for mobile internal combustion engines, marine installations and locomotives. (3-20-20)T

**02. Compliance with Rules and Regulations.** Possessing a "Certificate of Registration" does not relieve any owner or operator of the responsibility to comply with all applicable local, state and federal rules and regulations. (3-20-20)T

501. -- 509. (RESERVED)

**510. STACK HEIGHTS AND DISPERSION TECHNIQUES.**

The purpose of Sections 510 through 516 is to establish criteria for good engineering practice for stack heights and dispersion techniques. (3-20-20)T

**511. APPLICABILITY.**

The provisions of Sections 510 through 516 shall apply to existing, new, and modified stationary sources and facilities. The provisions of Sections 510 through 516 do not apply to stack heights in existence, or dispersion techniques implemented, on or before December 31, 1970, except where regulated or toxic air pollutant(s) are being emitted from such stacks or using such dispersion techniques by sources which were constructed, or reconstructed, or for which major modifications were carried out, after December 31, 1970. (3-20-20)T

**512. DEFINITIONS.**

For the purpose of Sections 500 through 516: (3-20-20)T

**01. Dispersion Technique.** Any technique which attempts to affect the concentration of a regulated or toxic air pollutant in the ambient air by: (3-20-20)T

- a. Using that portion of a stack which exceeds good engineering practice stack height; (3-20-20)T
- b. Varying the rate of emission of a regulated or toxic air pollutant according to atmospheric conditions or ambient concentrations of that pollutant; or (3-20-20)T

c. Increasing final exhaust gas plume rise by manipulating source process parameters, exhaust gas parameters, stack parameters, or combining exhaust gases from several existing stacks into one (1) stack, or other selective handling of exhaust gas streams so as to increase the exhaust gas plume rise. This does not include the reheating of a gas stream, following use of a pollution control system, for the purpose of returning the gas to the temperature at which it was originally discharged from the facility generating the gas stream; smoke management in agricultural or silvicultural prescribed burning programs; episodic restrictions on residential woodburning and open burning; techniques which increase final exhaust gas plume rise where the resulting allowable emissions of sulfur dioxide from the facility do not exceed five thousand (5,000) tons per year; or the merging of exhaust gas streams where: (3-20-20)T

i. The source owner or operator demonstrates that the facility was originally designed and constructed with such merged gas streams; (3-20-20)T

ii. After July 8, 1985, such merging is part of a change in operation at the facility that includes the installation of pollution controls and is accompanied by a net reduction in the allowable emissions of a regulated or toxic air pollutant. This exclusion from the definition of "dispersion techniques" shall apply only to the emission limitation for the regulated or toxic air pollutant affected by such change in operation; or (3-20-20)T

iii. Before July 8, 1985, such merging was part of a change in operation at the facility that included the installation of emissions control equipment or was carried out for sound economic or engineering reasons. Where there was an increase in the emission limitation or, in the event that no emission limitation was in existence prior to the merging, the reviewing agency shall presume that merging was significantly motivated by an intent to gain emissions credit for greater dispersion. Absent a demonstration by the source owner or operator that merging was not significantly motivated by such intent, the reviewing agency shall deny credit for the effects of such merging in calculating the allowable emissions for the source. (3-20-20)T

**02. Excessive Concentration.** For the purpose of determining good engineering practice stack height in a fluid modeling evaluation or field study as provided for in Subsection 512.03.c. "Excessive Concentration" means: (3-20-20)T

- a. For sources seeking credit for stack height exceeding that established under Subsection 512.03.b., a maximum ground level concentration due to emissions from a stack due in whole or in part to downwash, wakes, or eddy effects produced by nearby structures or nearby terrain features which individually is at least forty percent

(40%) in excess of the maximum concentration experienced in the absence of such effects, and which contributes to a total concentration due to emissions from all sources that is greater than an ambient air quality standard. For sources subject to the prevention of significant deterioration program, an excessive concentration alternatively means a maximum ground-level concentration due to emissions from a stack due in whole or in part to downwash, wakes, or eddy effects produced by nearby structures or nearby terrain features which individually is at least forty percent (40%) in excess of the maximum concentration experienced in the absence of the maximum concentration deterioration increment. The allowable emission rate to be used in making demonstrations under Subsection 512.02.a., shall be prescribed by the new source performance standard that is applicable to the source category unless the owner or operator demonstrates that this emission rate is infeasible. Where such demonstrations are approved by the Department, an alternative emission rate shall be established in consultation with the source owner or operator.

(3-20-20)T

**b.** For sources seeking credit after October 1, 1983, for increases in existing stack heights up to the heights established under Subsection 512.03.b., either:

(3-20-20)T

**i.** A maximum ground-level concentration due in whole or in part to downwash, wakes or eddy effects as provided in Subsection 512.02.a., except that the emission rate specified by any applicable SIP or, in the absence of such a limit, the actual emission rate shall be used; or

(3-20-20)T

**ii.** The actual presence of a local nuisance caused by the existing stack as determined by the authority administering the Department.

(3-20-20)T

**c.** For sources seeking credit after January 12, 1979, for a stack height determined under Subsection 512.03.b., where the Department requires the use of a field study or fluid model to verify GEP stack height, for sources seeking stack height credit after November 9, 1984, based on the aerodynamic influence of cooling towers, and for sources seeking stack height credit after December 31, 1970, based on the aerodynamic influence of structures not adequately represented by the equations in Subsection 512.03.b., a maximum ground-level concentration due in whole or in part to downwash, wakes or eddy effects that is at least forty percent (40%) in excess of the maximum concentration experienced in the absence of such downwash, wakes, or eddy effects.

(3-20-20)T

**03. Good Engineering Practice (GEP) Stack Height.** The greater of:

(3-20-20)T

**a.** Sixty-five (65) meters, measured from the ground-level elevation at the base of the stack;

(3-20-20)T

**b.** For stacks in existence on January 12, 1979, and for which the owner or operator had obtained all applicable preconstruction permits or approvals required,

$$H = 2.5S$$

provided the owner or operator produces evidence that this equation was actually relied on in establishing an emission limitation. For all other stacks provided that the Department may require the use of a field study or fluid model to verify GEP stack height for the source,

$$H = S + 1.5L$$

where:

(3-20-20)T

**i.** H = good engineering practice stack height measured from the ground-level elevation at the base of the stack.

(3-20-20)T

**ii.** S = height of nearby structure(s) measured from the ground-level elevation at the base of the stack.

(3-20-20)T

**iii.** L = lesser dimension, height or projected width, of nearby structure(s).

(3-20-20)T

**c.** The height demonstrated by a fluid model or a field study approved by the Department which ensures that the emissions from a stack do not result in excessive concentrations of any regulated or toxic air pollutant as a result of atmospheric downwash, wakes, or eddy effects created by the source itself, structures, or terrain features.

(3-20-20)T

**04. Nearby Structures or Terrain Features.** “Nearby” as applied to a specific structure or terrain feature under the definition of “good engineering practice stack height”; and (3-20-20)T

**a.** For purposes of applying the formulae provided under Subsection 512.03.b., means that distance up to five (5) times the lesser of the height or the width dimension of a structure, but not greater than one-half (1/2) mile (0.8 km); and (3-20-20)T

**b.** For conducting demonstrations under Subsection 512.03.c., means not greater than one-half (0.5) mile (0.8 km), except that the portion of a terrain feature may be considered to be nearby which falls within a distance of up to ten (10) times the maximum height of the feature, not to exceed two (2) miles if such feature achieves a height one-half (0.5) mile (0.8 km) from the stack that is at least forty percent (40%) of the GEP stack height determined by the formulae provided in Subsection 512.03.b., or twenty-six (26) meters, whichever is greater, as measured from the ground-level elevation at the base of the stack. The height of the structure or terrain feature is measured from the ground-level elevation at the base of the stack. (3-20-20)T

**05. Stack in Existence.** The owner or operator had: (3-20-20)T

**a.** Begun, or caused to begin, a continuous program of physical on-site construction of the stack; or (3-20-20)T

**b.** Entered into binding agreements or contractual obligations which could not be cancelled or modified without substantial loss to the owner or operator, to undertake a program of construction of the stack to be completed in a reasonable time. (3-20-20)T

**513. REQUIREMENTS.**

The required degree of emission control of any regulated or toxic air pollutant shall not be affected by the amount of any stack height that exceeds good engineering practice (GEP) or by any other dispersion technique. (3-20-20)T

**514. OPPORTUNITY FOR PUBLIC HEARING.**

Whenever a new or revised emission limitation is to be based on a good engineering practice stack height that exceeds the height allowed by the formulae in Subsections 512.03.a. and 512.03.b., the Department will notify the public of the availability of the demonstration study submitted under Subsection 512.03.c., and will provide an opportunity for public hearing on the demonstration study. (3-20-20)T

**515. APPROVAL OF FIELD STUDIES AND FLUID MODELS.**

Any field study or fluid model used to demonstrate GEP stack height under Subsection 512.03.b. or 512.03.c., and any determination of “excessive concentration” under Subsection 512.02 must be approved by the EPA prior to an emission limit being established. The construction of any new stack, or any increase to the height of any existing stack to the height determined by the formulae in Subsection 512.03.b., without completing a fluid model and a field study must be approved by the EPA. (3-20-20)T

**516. NO RESTRICTION ON ACTUAL STACK HEIGHT.**

The provisions of Sections 510 through 516 do not restrict, in any manner, the actual stack height of any stationary source or facility. (3-20-20)T

**517. MOTOR VEHICLE INSPECTION AND MAINTENANCE PROGRAM.**

**01. Purpose.** The purpose of Sections 517 through 527 is to set forth the minimum standards for a motor vehicle inspection and maintenance program, established pursuant to Section 39-116B, Idaho Code, for registered motor vehicles as defined in Section 49-123, Idaho Code. This program is designed to follow the basic inspection and maintenance program defined in 40 CFR 51.352. (3-20-20)T

**02. Applicability.** Sections 517 through 527 apply only to the counties of Ada and Canyon and the cities of Boise, Eagle, Garden City, Meridian, Kuna, Star, Caldwell, Greenleaf, Melba, Middleton, Nampa, Notus, Parma, and Wilder. (3-20-20)T

- 03. Options.** (3-20-20)T
- a.** Section 39-116B, Idaho Code, provides the counties and cities listed in Subsection 517.02 with the following implementation options. The counties and cities may: (3-20-20)T
- i.** Enter into a joint exercise of powers agreement with the Director to implement a motor vehicle inspection and maintenance program; or (3-20-20)T
- ii.** Obtain Department approval to implement an alternative motor vehicle emissions control strategy that will result in emissions reductions equivalent to that of a motor vehicle inspection and maintenance program. (3-20-20)T
- b.** If neither of the options listed in Subsection 517.03.a. are selected, the Department shall implement the motor vehicle inspection and maintenance program. (3-20-20)T
- 04. Governing Authority.** For the purpose of Sections 517 through 527, governing authority means the governing entity responsible for the development and implementation of the motor vehicle inspection and maintenance program. The governing entity may be the counties and cities listed in Subsection 517.02 or the Department. The governing authority shall adopt Sections 517 through 527 of these rules. (3-20-20)T
- 05. Exemptions.** Sections 517 through 527 do not apply to the following: (3-20-20)T
- a.** Electric or hybrid motor vehicles; (3-20-20)T
- b.** Motor vehicles with a model year less than five (5) years old; (3-20-20)T
- c.** Motor vehicles with a model year older than 1981; (3-20-20)T
- d.** Classic automobiles as defined by Section 49-406A, Idaho Code; (3-20-20)T
- e.** Motor vehicles with a maximum vehicle gross weight of less than fifteen hundred (1500) pounds; (3-20-20)T
- f.** Motor vehicles registered as motor homes as defined by Section 49-114, Idaho Code; (3-20-20)T
- g.** Motorized farm equipment; and (3-20-20)T
- h.** Registered motor vehicles engaged solely in the business of agriculture. (3-20-20)T
- 518. REQUIREMENTS FOR LICENSING AUTHORIZED INSPECTION STATIONS OR RETEST STATIONS.**
- 01. General.** (3-20-20)T
- a.** No person or enterprise shall in any manner represent any place as an inspection station or retest station unless such station is operated under a valid license issued by the governing authority. (3-20-20)T
- b.** No license for any inspection station or retest station may be assigned, transferred or used by other than the original applicant for that specific station. (3-20-20)T
- 02. Applications for License.** Applications for license as an inspection station or retest station shall be made on the forms provided by the governing authority. No license shall be issued unless the governing authority finds that the facilities, tools and equipment of the applicant comply with the requirements set forth in Subsections 518.03 or 518.04. (3-20-20)T
- 03. Requirements for Licensed Inspection Stations.** In order to qualify for issuance and continuance of an inspection station license, an establishment must meet the following requirements: (3-20-20)T



- a. Must have a permanent location; (3-20-20)T
  - b. Must ensure that at least one employee, who has been issued an emissions technician license by the governing authority, is on duty at all times of station operation; (3-20-20)T
  - c. Must demonstrate the ability to perform the emissions test and comply with reporting and recordkeeping requirements established by the governing authority; (3-20-20)T
  - d. Must obtain and maintain in force appropriate business liability insurance; and (3-20-20)T
  - e. Must have the tools, equipment and supplies, as required by the governing authority, available for performance of the emissions test. (3-20-20)T
- 04. Requirements for Licensed Retest Stations.** In order to qualify for issuance and continuance of a retest station license, an establishment must meet the requirements listed in Subsection 518.03. (3-20-20)T
- 05. Approval Procedure.** (3-20-20)T
- a. Applications received by the governing authority will be reviewed for completeness and an inspection of the facility will be performed. An inspection report will be prepared for the governing authority's review. (3-20-20)T
  - b. Stations which meet the requirements of Subsections 518.01 through 518.04 will be granted an inspection station license or retest station license and issued a station sign. The station sign and license shall be posted in a conspicuous place, readily visible to the public. The station sign and license shall remain the property of the governing authority. (3-20-20)T
- 06. Revocation of Inspection Station or Retest Station License.** The governing authority has the authority to issue warnings and suspend or revoke a station license upon a showing that emission tests are not being performed in accordance with these rules and any other specifications or procedures enacted by the governing authority. (3-20-20)T

**519. REQUIREMENTS FOR LICENSING AUTHORIZED EMISSIONS TECHNICIANS.**

- 01. Applications for License.** Application for a license as an emissions technician shall be filed with the governing authority. Applications for the emissions technician license shall be completed on forms provided by the governing authority. (3-20-20)T
- 02. Requirements for Issuance of an Emissions Technician License.** An applicant must demonstrate the knowledge and skill necessary to perform an emissions test of motor vehicle engines. The governing authority shall require the minimum standards set forth in 40 CFR 51.367, incorporated by reference into these rules at Section 107. (3-20-20)T
- 03. Revocation of Emissions Technician License.** The governing authority has the authority to issue warnings and suspend or revoke an emissions technician license upon a showing that emission tests are not being performed in accordance with these rules or any other specifications or procedures enacted by the governing authority. (3-20-20)T

**520. INSPECTION FREQUENCY.**

The inspections shall occur no more than once every two (2) years. If the owner of the motor vehicle obtains a waiver pursuant to Section 526, the motor vehicle must be inspected the following year. (3-20-20)T

**521. TEST PROCEDURE REQUIREMENTS.**

The governing authority shall require the minimum standards set forth in 40 CFR 51.357(a), incorporated by reference into these rules at Section 107. (3-20-20)T

**522. TEST STANDARDS.**

The governing authority shall require the minimum standards set forth in 40 CFR 51.357(b), incorporated by reference into these rules at Section 107. (3-20-20)T

**523. TEST EQUIPMENT.**

The governing authority shall require the minimum standards set forth in 40 CFR 51.358, incorporated by reference in to these rules at Section 107. (3-20-20)T

**524. INSPECTION FEE.**

The fee for a motor vehicle inspection, as established in Section 39-116B(2)(g), Idaho Code, shall not exceed twenty dollars (\$20) per vehicle. This fee is necessary to carry out the provisions of Sections 517 through 527 and to fund an air quality public awareness and outreach program. (3-20-20)T

**525. PUBLIC OUTREACH.**

The governing authority shall issue a pamphlet for distribution to owners of motor vehicles. The pamphlet shall include, but not be limited to, the reasons for and the methods of the inspection. The governing authority may also establish and operate an informational hotline, website, or any other means of outreach that is deemed to be efficient and effective by the governing authority. (3-20-20)T

**526. WAIVERS.**

The governing authority shall require the minimum standards set forth in 40 CFR 51.360(a), incorporated by reference into these rules at Section 107. If the owner of the motor vehicle obtains a waiver, the motor vehicle must be inspected the following year. (3-20-20)T

**01. Financial Hardship.** If repairs required under Section 526 pose a financial hardship on the owner of the motor vehicle, the governing authority shall have the authority to issue a waiver without requiring expenditure of the amounts listed in 40 CFR 51.360(a). Such determination of hardship shall be made on a case-by-case basis by the governing authority. (3-20-20)T

**02. Public Service Vehicles Operating Less than 1,000 Miles Per Year.** For public service vehicles owned by a governmental entity and operated less than one thousand (1,000) miles per year, the governing authority shall have the authority to issue a waiver without requiring expenditure of the amounts listed in 40 CFR 51.360(a). (3-20-20)T

**527. EXTENSIONS.**

The governing authority shall have the authority to grant extensions for vehicles or vehicle owners temporarily located outside of a testing area that cannot easily be returned to an area for testing. The extension shall not exceed one (1) year. For active duty military personnel and their families stationed outside the applicable testing area specified in Subsection 517.02, a time extension not to exceed the testing period is available. Military extensions shall be renewed with current military orders. (3-20-20)T

**528. -- 549. (RESERVED)**

**550. AIR POLLUTION EMERGENCY RULE.**

The purpose of Sections 550 through 562 is to define criteria for an air pollution emergency, to formulate a plan for preventing or alleviating such an emergency, and to specify rules for carrying out the plan. The procedures for implementing Sections 550 through 562 are delineated in Chapter VI of the SIP. (3-20-20)T

**551. EPISODE CRITERIA.**

The purpose of Sections 551 through 556 is to establish criteria for stages of atmospheric stagnation and/or degraded air quality. (3-20-20)T

**552. STAGES.**

The Department has defined four (4) stages of atmospheric stagnation and/or degraded air quality. (3-20-20)T

**01. Stage 1 -- Air Pollution Forecast and Caution.** An internal watch by the Department shall be actuated by a National Weather Service report that an Atmospheric Stagnation Advisory has been issued, or the

equivalent local forecast of stagnant atmospheric conditions. (3-20-20)T

**02. Stage 2 -- Alert.** This is the first stage at which air pollution control actions by industrial sources are to begin. (3-20-20)T

**03. Stage 3 -- Warning.** The warning stage indicates that air quality is further degraded and that control actions are necessary to maintain or improve air quality. (3-20-20)T

**04. Stage 4 -- Emergency.** The emergency stage indicates that air quality has degraded to a level that will substantially endanger the public health and that the most stringent control actions are necessary. (3-20-20)T

**553. EFFECT OF STAGES.**

Once an episode stage is reached or the Department determines that reaching a particular stage is imminent, emergency action corresponding to that stage will remain in effect until air quality measurements indicate that another stage (either lower or higher) has been attained or the Department determines that reaching another stage (either lower or higher) is imminent. At such time, actions corresponding to the next stage will go into effect. This procedure will continue until the episode is terminated. The air quality criteria used to define each of the episode stages for carbon monoxide, nitrogen dioxide, ozone, particulate matter, and sulfur dioxide are specified in Section 556. The levels will be determined by the Department through its analysis of meteorological and ambient air quality monitoring data. (3-20-20)T

**554. -- 555. (RESERVED)**

**556. CRITERIA FOR DEFINING LEVELS WITHIN STAGES.**

The air quality criteria defining each of these levels for carbon monoxide (CO), nitrogen dioxide (NO<sub>2</sub>), ozone (O<sub>3</sub>), particles with an aerodynamic diameter less than or equal to a nominal ten (10) micrometers (PM-10), particles with an aerodynamic diameter less than or equal to a nominal two point five (2.5) micrometers (PM-2.5), and sulfur dioxide (SO<sub>2</sub>) are: (3-20-20)T

**01. Stage 1 -- Forecast and Caution.** A Stage 1 Forecast and Caution shall be declared by the Department when particulate concentrations reach, or are forecasted to reach, and persist, at or above the levels listed below. The Department may call a Stage 1 Forecast and Caution, if it determines, after evaluating the pertinent meteorology, weather conditions and air quality conditions such as visibility, and source parameters such as source type, strength, location and projected duration, that a Stage 1 Forecast and Caution is required to protect the public health.

CO	NA
NO <sub>2</sub>	NA
O <sub>3</sub>	NA
SO <sub>2</sub>	NA
PM-2.5	80 ug/m <sup>3</sup> 1 hour average
PM-2.5	50 ug/m <sup>3</sup> 24 hour average
PM-10	385 ug/m <sup>3</sup> 1 hour average
PM-10	150 mg/m <sup>3</sup> 24 hour average

(3-20-20)T

**02. Stage 2 -- Alert.**

CO - 17 mg/m <sup>3</sup> (15 ppm)	8-hour average
NO <sub>2</sub> - 1130 ug/m <sup>3</sup> (0.6 ppm)	1-hour average
- 282 ug/m <sup>3</sup> (0.15 ppm)	24-hour average

O <sub>3</sub> - 400 ug/m3 (0.2 ppm)	1-hour average
PM-10 - 350 ug/m3	24-hour average
SO <sub>2</sub> - 800 ug/m3 (0.3 ppm)	24-hour average

(3-20-20)T

**03. Stage 3 -- Warning.**

CO - 34 mg/m3 (30 ppm)	8-hour average
NO <sub>2</sub> - 2260 ug/m3 (1.2 ppm),	1-hour average
- 565 ug/m3 (0.3 ppm)	24-hour average
O <sub>3</sub> - 800 ug/m3 (0.4 ppm)	1-hour average
PM-10 - 420 ug/m3	24-hour average
SO <sub>2</sub> - 1600 ug/m3 (0.6 ppm)	24-hour average

(3-20-20)T

**04. Stage 4 -- Emergency.**

CO - 46 mg/m3 (40 ppm)	8-hour average
NO <sub>2</sub> - 3000 ug/m3 (1.6 ppm)	1-hour average
- 750 ug/m3 (0.4 ppm)	24-hour average
O <sub>3</sub> - 1000 ug/m3 (0.5 ppm)	1-hour average
PM-10 - 500 ug/m3	24-hour average
SO <sub>2</sub> - 2100 ug/m3 (0.8 ppm)	24-hour average

(3-20-20)T

**557. PUBLIC NOTIFICATION.**

The purpose of Sections 557 through 560 is to establish requirements for public notification regarding atmospheric stagnation and/or degraded air quality. (3-20-20)T

**558. INFORMATION TO BE GIVEN.**

**01. Information to Be Given.** On the basis of degrading air quality as determined by the Director, and the criteria for emergency episode stages as shown in Section 556, the Director will utilize appropriate media and techniques including, but not limited to, print, electronic and internet, to insure that the following information is announced to the public, affected government, and commercial, industrial institutional and agricultural entities as practicable: (3-20-20)T

- a. Definition of the extent of the problem; (3-20-20)T
- b. Indication of the action taken by the Director; (3-20-20)T
- c. Air pollution forecast for next few days; (3-20-20)T
- d. Notice of when the next statement from the Department will be issued; (3-20-20)T
- e. Listing of all general procedures which the public, commercial, institutional and industrial sectors are required to follow; (3-20-20)T

f. Specific warnings and advice to those persons who because of acute or chronic health problems, may be most susceptible to the effects of the episode. (3-20-20)T

g. Location and description of the affected area. (3-20-20)T

**559. MANNER AND FREQUENCY OF NOTIFICATION.**

Such announcements will be made by the news media during regularly scheduled television and radio news broadcasts and in all editions of specified newspapers. In addition, when the stage 4 emergency level is reached, television and radio stations designated by the Department will repeat these announcements at one (1) hour intervals during normal broadcasting hours. (3-20-20)T

**560. NOTIFICATION TO SOURCES.**

The Department will assure that all significant sources of the applicable air pollutant(s) are notified of the emergency stage by telephone or other appropriate means. (3-20-20)T

**561. GENERAL RULES.**

All persons in the designated stricken area shall be governed by the following rules for each emergency episode stage. The Director may waive one (1) or more of the required measures at each episode stage if, on the basis of information available to him, he judges that a measure is an inappropriate response to the specific episode conditions which then exist. (3-20-20)T

**01. Stage 1 -- Air Pollution Forecast and Caution.** There shall be no new ignition of open burning of any kind. The Director may require, if practicable, or in an emergency situation, the cessation of any open burning. (3-20-20)T

**02. Stage 2 -- Alert.** (3-20-20)T

a. There shall be no open burning of any kind. (3-20-20)T

b. The use of burners and incinerators for the disposal of any form of solid waste shall be prohibited. (3-20-20)T

c. Persons operating fuel-burning equipment which requires boiler lancing or soot blowing shall perform such operations only between the hours of 12:00 pm (noon) and 4:00 p.m. (3-20-20)T

d. Commercial, industrial and institutional facilities utilizing coal or residual fuel oil are required to switch to natural gas or distillate oil if available. (3-20-20)T

**03. Stage 3 -- Warning.** (3-20-20)T

a. There shall be no open burning of any kind. (3-20-20)T

b. The use of burners and incinerators for the disposal of any form of solid waste or liquid waste shall be prohibited. (3-20-20)T

c. Persons operating fuel-burning equipment which requires boiler lancing or soot blowing shall perform such operations only between the hours of 12:00 pm (noon) and 4:00 p.m. (3-20-20)T

d. Commercial, industrial and institutional facilities utilizing coal or residual fuel are required to either: (3-20-20)T

i. Switch completely to natural gas or distillate oil; or (3-20-20)T

ii. If these low sulfur fuels are not available, curtail the use of existing fuels to the extent possible without causing injury to persons or damage to equipment. (3-20-20)T

- 04. Stage 4 -- Emergency.** This will be called only with specific concurrence of Governor. (3-20-20)T
- a.** There shall be no open burning of any kind. (3-20-20)T
- b.** The use of burners and incinerators for the disposal of any form of solid or liquid waste shall be prohibited. (3-20-20)T
- c.** All places of employment described below shall immediately cease operations: (3-20-20)T
- i.** All mining and quarrying operations; (3-20-20)T
- ii.** All construction work except that which must proceed to avoid injury to persons; (3-20-20)T
- iii.** All manufacturing establishments except those required to have in force an air pollution emergency plan; (3-20-20)T
- iv.** All wholesale trade establishments, i.e. places of business primarily engaged in selling merchandise to retailers or industrial, commercial, institutional or professional users, or to other wholesalers, or acting as agents in buying merchandise for or selling merchandise to such persons or companies except those engaged in the distribution of drugs, surgical supplies and food; (3-20-20)T
- v.** All offices of local, county and State government including authorities, joint meetings, and other public bodies excepting such agencies which are determined by the chief administrative officer of local, county, or State government authorities, joint meetings and other public bodies to be vital for public safety and welfare and the enforcement of the provisions of this order; (3-20-20)T
- vi.** All retail trade establishments except pharmacies, surgical supply distributors, and stores primarily engaged in the sale of food; (3-20-20)T
- vii.** Banks, credit agencies other than banks, securities and commodities brokers, dealers, exchanges and services; offices of insurance carriers, agents and brokers, real estate offices; (3-20-20)T
- viii.** Wholesale and retail laundries, laundry services and cleaning and dyeing establishments; photographic studios; beauty shops, barber shops, shoe repair shops; (3-20-20)T
- ix.** Advertising offices, consumer credit reporting, adjustment and collection agencies; duplicating, addressing, blueprinting; photocopying, mailing, mailing list and stenographic services; equipment rental services, commercial testing laboratories; (3-20-20)T
- x.** Automobile repair, automobile services, garages except those located adjacent to state or interstate highways; (3-20-20)T
- xi.** Establishments rendering amusement and recreational services including motion picture theaters; (3-20-20)T
- xii.** Elementary and secondary schools, colleges, universities, professional schools, junior colleges, vocational schools, and public and private libraries. (3-20-20)T
- d.** All commercial and manufacturing establishments not included in this order will institute such actions as will result in maximum reduction of the applicable air pollutant(s) from their operation by ceasing, curtailing, or postponing operations which emit the applicable air pollutants to the extent possible without causing injury to persons or damage to equipment. These actions include limiting boiler lancing or soot blowing operations for fuel burning equipment to between the hours of 12:00 pm (noon) and 4:00 p.m. (3-20-20)T
- e.** When the emergency episode is declared for carbon monoxide, the use of motor vehicles is prohibited except in emergencies or with the approval of local or state police or the Department. (3-20-20)T

**562. SPECIFIC EMERGENCY EPISODE ABATEMENT PLANS FOR POINT SOURCES.**

In addition to the general rules presented in Section 561, the Department shall require that specific point sources adopt and implement their own Emergency Episode Abatement Plans in accordance with the criteria set forth in Sections 551 through 556. An individual plan can be revised periodically by the Department after consultation between the Department and the owners and/or operators of the source. (3-20-20)T

**563. TRANSPORTATION CONFORMITY.**

The purpose of Sections 563 through 574 is to adopt and implement Section 176(c) of the Clean Air Act (CAA), as amended [42 U.S.C. 7401 et seq.], and the related requirements of 23 U.S.C. 109(j), with respect to the conformity of transportation plans, programs, and projects developed, funded, or approved by the United States Department of Transportation (USDOT), and by metropolitan planning organizations (MPOs) or other recipients of funds under Title 23 U.S.C. or the Federal Transit Laws (49 U.S.C. Chapter 53). These sections set forth policy, criteria, and procedures for demonstrating and assuring conformity of such activities to an applicable implementation plan developed pursuant to Section 110 and Part D of the CAA. The publications referred to in Sections 563 through 574 are available from the IDEQ. (3-20-20)T

**564. (RESERVED)**

**565. ABBREVIATIONS.**

- |            |   |            |
|------------|---|------------|
| <b>01.</b> | <b>CAA.</b> Clean Air Act, as amended.  | (3-20-20)T |
| <b>02.</b> | <b>CFR.</b> Code of Federal Regulations.  | (3-20-20)T |
| <b>03.</b> | <b>CO.</b> Carbon Monoxide.   | (3-20-20)T |
| <b>04.</b> | <b>EPA.</b> Environmental Protection Agency.  | (3-20-20)T |
| <b>05.</b> | <b>FHWA.</b> Federal Highway Administration of USDOT.   | (3-20-20)T |
| <b>06.</b> | <b>FTA.</b> Federal Transit Administration of USDOT.  | (3-20-20)T |
| <b>07.</b> | <b>HPMS.</b> Highway Performance Monitoring System.   | (3-20-20)T |
| <b>08.</b> | <b>ICC.</b> Interagency Consultation Committee.   | (3-20-20)T |
| <b>09.</b> | <b>IDEQ.</b> Idaho Department of Environmental Quality.   | (3-20-20)T |
| <b>10.</b> | <b>ITD.</b> Idaho Transportation Department.  | (3-20-20)T |
| <b>11.</b> | <b>LHTAC</b> Local Highway Technical Assistance Council.  | (3-20-20)T |
| <b>12.</b> | <b>LRTP.</b> Long Range Transportation Plan.  | (3-20-20)T |
| <b>13.</b> | <b>MPO.</b> Metropolitan Planning Organization.   | (3-20-20)T |
| <b>14.</b> | <b>NAAQS.</b> National Ambient Air Quality Standards.   | (3-20-20)T |
| <b>15.</b> | <b>NEPA.</b> National Environmental Policy Act, as amended.   | (3-20-20)T |
| <b>16.</b> | <b>O3.</b> Ozone.   | (3-20-20)T |
| <b>17.</b> | <b>PM.</b> Particulate matter.  | (3-20-20)T |
| <b>18.</b> | <b>PM<sub>x</sub>.</b> Particles with an aerodynamic diameter less than or equal to a nominal X micrometers, where X denotes any size fraction number regulated by the NAAQs (e.g.: 10, 2.5). | (3-20-20)T |

- |     |   |            |
|-----|---|------------|
| 19. | STIP. Statewide Transportation Improvement Program. | (3-20-20)T |
| 20. | TCM. Transportation Control Measure.                | (3-20-20)T |
| 21. | TIP. Transportation Improvement Program.            | (3-20-20)T |
| 22. | USDOT. United States Department of Transportation.  | (3-20-20)T |
| 23. | VMT. Vehicle Miles Traveled.                        | (3-20-20)T |

**566. DEFINITIONS FOR THE PURPOSE OF SECTIONS 563 THROUGH 574 AND 582.**

Terms used but not defined in Sections 563 through 574 and 582 shall have the meaning given them by the CAA, Titles 23 and 49 U.S.C., other Environmental Protection Agency (EPA) regulations, or other USDOT regulations, in that order of priority. For the purpose of Sections 563 through 574 and 582: (3-20-20)T

**01. Applicable Implementation Plan.** Applicable Implementation Plan is defined in Section 302(q) of the CAA and means the portion (or portions) of the implementation plan, or most recent revision thereof, which has been approved under Section 110 of the CAA, or promulgated under Section 110(c) of the CAA, or promulgated or approved pursuant to regulations promulgated under Section 301(d) of the CAA and which implements the relevant requirements of the CAA. (3-20-20)T

**02. Consult or Consultation.** The lead agency confers with other ICC members and persons on the distribution list and considers their views prior to taking actions relating to transportation conformity. The lead agency shall distribute all appropriate information necessary to make a conformity determination and, prior to making a conformity determination, shall consider the views of such parties and shall provide a timely, written response to those views. Such views and written responses shall be included in the record of decision or action. Consultation shall not occur with respect to a transportation plan or transportation improvement program (TIP) revision that merely adds or exempts projects listed in 40 CFR 93.126. (3-20-20)T

**03. Distribute.** Make available relevant documents and information by electronic and manual means, whichever is more appropriate, to all ICC members and persons on the distribution list. Electronic distribution may include existing and future technological applications, such as electronic mail, internet web-site posting including downloadable files, or the use of an electronic mail reply system based on the distribution list. Manual distribution may include the United States Postal Service, the state internal mail system, a facsimile machine, or any commercially available mail service provider. (3-20-20)T

**04. Distribution List.** A list containing the names and addresses of ICC members and any person(s) expressing an interest in receiving information and material pertaining to ICC meetings. To express interest, a person may contact the lead agency by postal mail, electronic mail, telephone or in person, and inform the ICC member of their interest in being on the distribution list for information and material pertaining to ICC meetings. (3-20-20)T

**05. Exempt Projects.** Projects exempt from conformity requirements based on the general criteria of safety, mass transit, and other factors, as described in 40 CFR 93.126. (3-20-20)T

**06. Lead Agency.** The transportation or air quality agency responsible for conducting the consultation process, as identified in Subsections 568.01 through 568.03. (3-20-20)T

**07. Lead Air Quality Agency.** An agency designated pursuant to Section 174 of the CAA as responsible for developing an applicable implementation plan, or alternatively the agency designated by the Governor as the lead air quality agency for a county, region, or any jurisdiction. (3-20-20)T

**08. Local Highway Jurisdiction.** A county with jurisdiction over a highway system, a city with jurisdiction over a highway system, or a highway district, as defined by Section 40-113(3), Idaho Code. (3-20-20)T

**09. Local Highway Technical Assistance Council (LHTAC).** The public agency created in Chapter 24, Title 40, Idaho Code. (3-20-20)T



- 10. Maximum Priority.** (3-20-20)T
- a.** All possible actions must be taken to shorten the time periods necessary to complete essential steps in TCM implementation - for example, by increasing the funding rate - even though timing of other projects may be affected. It is not permissible to have prospective discrepancies with the applicable implementation plan's TCM implementation schedule due to: (3-20-20)T
- i.** Lack of funding in the TIP; (3-20-20)T
  - ii.** Lack of commitment to the project by the sponsoring agency; (3-20-20)T
  - iii.** Unreasonably long periods to complete future work due to lack of staff or other agency resources; (3-20-20)T
  - iv.** Lack of approval or consent by local governmental bodies; or (3-20-20)T
  - v.** Failure to have applied for a permit where necessary work preliminary to such application has been completed. (3-20-20)T
- b.** Where statewide and metropolitan funding resources, planning, and management capabilities are fully consumed within the flexibility of the Transportation Equity Act of 1998 (TEA-21), Pub. L. No. 105-178, 112 Stat 107, as amended by Pub. L. No. 105-206, 112 Stat 685, or future federal omnibus transportation funding bills, with responding to damage from natural disasters, civil unrest, or terrorist acts, TCM implementation can be determined to be timely without regard to the above, provided reasonable efforts are being made. (3-20-20)T
- 11. Metropolitan Planning Organization (MPO).** The organization designated as being responsible, together with the State, for conducting the continuing cooperative and comprehensive transportation planning process under 23 U.S.C. 134 and 49 U.S.C. 5303 and 23 CFR 450. It is the forum for cooperative transportation decision-making. (3-20-20)T
- 12. Public Notice.** Distribution of the meeting times, location, duration and agenda, to all the ICC members and persons on the distribution list. (3-20-20)T
- 13. Recipient of Funds Designated Under Title 23 U.S.C. or the Federal Transit Laws.** Any agency at any level of state, county, city, or regional government that routinely receives Title 23 U.S.C. or Federal Transit Laws funds to construct FHWA/FTA projects, operate FHWA/FTA projects or equipment, purchase equipment, or undertake other services or operations via contracts or agreements. This definition does not include private landowners, developers, contractors, or entities that are only paid for services or products created by their own employees. (3-20-20)T
- 14. Regionally Significant Project.** A transportation project, other than an exempt project, that is on a facility which serves regional transportation needs (such as access to and from the area outside the region, major activity centers in the region, major planned developments such as new retail malls, sports complexes, etc., or transportation terminals as well as most terminals themselves) and would normally be included in the modeling of a metropolitan area's transportation network, including, at a minimum: (3-20-20)T
- a.** All principal arterial highways; (3-20-20)T
  - b.** All fixed guideway transit facilities that offer an alternative to regional highway travel; and (3-20-20)T
  - c.** Any other facilities determined to be regionally significant through Section 570, interagency consultation. (3-20-20)T
- 15. Transportation Agency.** The public agency responsible for one (1) or more of the following transportation modes: (3-20-20)T

- a. Air; (3-20-20)T
- b. Rail; (3-20-20)T
- c. Water; (3-20-20)T
- d. Highway; (3-20-20)T
- e. Bicycle and pedestrian paths; and (3-20-20)T
- f. Transit. (3-20-20)T

**16. Transit Agency.** Any agency involved in providing mass transportation services by bus, rail, or other conveyance providing general or special service to the public on a regular and continuing basis. The term "Transit Agency" does not include school buses or charter or sightseeing services. (3-20-20)T

**567. AGENCIES AFFECTED BY CONSULTATION.**

This Section identifies those agencies and other entities (federal, tribal, state and local) involved in the consultation process and those general actions requiring consultation. (3-20-20)T

**01. Interagency Consultation Committee.** A committee of representatives shall be formed in each nonattainment or maintenance area of the state, to convene on conformity determinations, as necessary, and shall be called the Interagency Consultation Committee (ICC) for that nonattainment or maintenance area. The ICC shall undertake consultation procedures, as applicable, in preparing for and before making conformity determinations in developing long-range transportation plans (LRTP), transportation improvement programs (TIP), and applicable implementation plans. (3-20-20)T

**02. ICC Members.** The ICC shall consist of the following agencies or entities, as applicable: (3-20-20)T

- a. A Metropolitan Planning Organization (MPO) where one exists; (3-20-20)T
- b. The Idaho Transportation Department (ITD); (3-20-20)T
- c. The Federal Highway Administration (FHWA) and the Federal Transit Administration (FTA) divisional office; (3-20-20)T
- d. The Idaho Department of Environmental Quality (IDEQ); (3-20-20)T
- e. Affected Local Highway Jurisdictions involved in transportation, (3-20-20)T
- f. Affected Transit agency(ies); (3-20-20)T
- g. The Local Highway Technical Assistance Council (LHTAC); (3-20-20)T
- h. Indian Tribal governments with transportation planning responsibilities; and (3-20-20)T
- i. The United States Environmental Protection Agency (EPA). (3-20-20)T

**03. Agencies Entitled to Participate.** Agencies which may be affected by the consultation process and which are entitled to participate in the consultation process include: (3-20-20)T

- a. Any local transit agency or provider, local highway jurisdiction, and any city or county transportation or air quality board or agency where the nonattainment or maintenance area is located; and (3-20-20)T
- b. Any other state or federal or tribal organization in the state responsible under state or federal law for developing, submitting or implementing transportation related provisions of an implementation plan. (3-20-20)T

**04. More Than One Pollutant.** Areas that are nonattainment for more than one (1) pollutant may conduct consultation, as specified in this section, through a single committee for all pollutants. (3-20-20)T

**05. Open to the Public.** All meetings of the ICC shall be open to the public. (3-20-20)T

**06. Delegation.** An ICC member may delegate its role or responsibility in the consultation process to another entity pursuant to applicable state law. An ICC member making such delegation shall notify all other ICC members in writing when the delegation occurs. The written notice shall provide the name, address, and telephone number of one (1) or more contact persons representing the entity accepting the delegated role or responsibility. (3-20-20)T

**07. General Actions Requiring Consultation.** The ICC shall undertake the consultation process prior to the development of the following: (3-20-20)T

**a.** The implementation plan(s), including the emission budget and list of TCMs in the applicable implementation plan(s), prepared by the lead air quality agency in a nonattainment or maintenance area; (3-20-20)T

**b.** All other conformity determinations for transportation plans, projects, and programs; and (3-20-20)T

**c.** Revisions to the preceding documents which may directly or indirectly affect conformity determinations. (3-20-20)T

**568. ICC MEMBER ROLES IN CONSULTATION.**

The lead agency as identified in this section is the ICC member responsible for initiating the consultation process, preparing the initial and final drafts of the document or decision, and assuring the adequacy of the consultation process for all conformity processes and procedures. (3-20-20)T

**01. Designated Lead Air Quality Agency.** IDEQ or the MPO, as the designated lead air quality agency, shall be the lead agency for the development of the implementation plan, the associated emission budgets, and the list of Transportation Control Measures (TCMs) in the plan. The concurrence of IDEQ on each applicable implementation plan is required before IDEQ adopts the plan and submits it to EPA for inclusion in the applicable implementation plan. (3-20-20)T

**02. Areas with an MPO.** For areas in which an MPO has been established, the designated MPO shall be the lead agency responsible for conformity determinations, development of the LRTP, development of the TIP, and project level documentation under 23 CFR 450. (3-20-20)T

**03. Areas Without an MPO.** For areas in which an MPO has not been established, ITD shall be the lead agency for preparing the final document on conformity determinations, the development of the statewide transportation plan, the development of the STIP, and project level documentation under 23 CFR 450. (3-20-20)T

**569. ICC MEMBER RESPONSIBILITIES IN CONSULTATION.**

This Section identifies the specific responsibilities of ICC members. (3-20-20)T

**01. Designated Lead Air Quality Agency Responsibilities.** The designated lead air quality agency shall be responsible for developing or providing and distributing draft and final documentation, data and analyses for: (3-20-20)T

**a.** Air emission inventories; (3-20-20)T

**b.** Emission budgets; (3-20-20)T

**c.** Attainment and maintenance demonstrations; (3-20-20)T

**d.** Control strategy implementation plan revisions; (3-20-20)T

- e. Updated motor vehicle emission factors; (3-20-20)T
- f. Proposal and evaluation of TCMs; and (3-20-20)T
- g. Public outreach on draft air quality plans pursuant to 40 CFR Part 51. (3-20-20)T
- 02. Designated MPO Responsibilities.** The designated MPO shall be responsible for: (3-20-20)T
  - a. Conformity determinations corresponding to LRTPs and TIPs; (3-20-20)T
  - b. Making conformity determinations for the entire nonattainment or maintenance area, including areas beyond the boundaries of the MPO, where no agreement is in effect as required by 23 CFR 450.310(f); (3-20-20)T
  - c. Identify regionally significant projects through the consultation process; (3-20-20)T
  - d. Implementing TCMs in air quality nonattainment and/or maintenance areas, as applicable; (3-20-20)T
  - e. Providing technical and policy input on emissions budgets; (3-20-20)T
  - f. Performing transportation modeling, regional emissions analyses, and project level analysis, as necessary; (3-20-20)T
  - g. Documenting timely implementation of TCMs, as required, for determining conformity; and (3-20-20)T
  - h. Distributing relevant draft and final project environmental documents to ICC members and persons on the distribution list per the schedule in Subsection 570.01.c. (3-20-20)T
- 03. Non-MPO Area Responsibilities.** In areas without an established MPO, ITD shall be responsible for: (3-20-20)T
  - a. Conformity determinations corresponding to STIPs and project-level analyses; (3-20-20)T
  - b. Providing technical and policy input on proposed revisions to motor vehicle emissions factors and to emission budgets; (3-20-20)T
  - c. Distributing relevant draft and final project environmental documentation prepared by, or for ITD, to ICC members and persons on the distribution list per the schedule in Subsection 570.01.c.; (3-20-20)T
  - d. Convening air quality technical review meetings on specific projects when requested by other ICC members, or as needed; (3-20-20)T
  - e. Convening interagency consultation meetings required for purposes of making conformity determinations in nonattainment or maintenance areas, outside of MPO boundaries, as necessary; (3-20-20)T
  - f. Making conformity determinations in nonattainment or maintenance areas, outside of MPO boundaries, as necessary; and (3-20-20)T
  - g. Implementing TCMs in air quality nonattainment and/or maintenance areas, as applicable. (3-20-20)T
- 04. FHWA and FTA Responsibilities.** FHWA and FTA shall be responsible for: (3-20-20)T
  - a. Assuring timely action on final findings of conformity for transportation plans, TIPs, and federally

funded projects, including the basis for those findings after consultation with other agencies as provided in Section 569 and 40 CFR 93.105; and (3-20-20)T

**b.** Providing guidance on conformity and the transportation planning process to ICC members. FHWA and FTA may rely solely on the consultation process initiated by ITD or the MPO, where one exists, and shall not be required to duplicate that process. (3-20-20)T

**05. EPA Responsibilities.** EPA shall be responsible for providing policy and technical guidance on conformity criteria to ICC members. (3-20-20)T

**06. Responsibility to Disclose Potentially Regionally Significant Projects.** ITD, the local highway jurisdiction, transit agency, or transportation project sponsor shall be responsible for disclosing potentially regionally significant projects within air quality nonattainment and maintenance areas to the ICC in a timely manner. (3-20-20)T

**a.** Local Highway Jurisdictions shall disclose of potentially regionally significant projects upon written request of ITD within fourteen (14) days of such request, or when annual local and MPO project lists are due to ITD District Offices as part of the annual STIP development process; (3-20-20)T

**b.** In an MPO area, to help assure timely disclosure, the sponsor of any potentially regionally significant project shall disclose such projects to the MPO annually on or before March 1 of that calendar year; and (3-20-20)T

**c.** In MPO nonattainment and maintenance areas, the TIP and associated conformity demonstration shall be deemed to be incomplete if any regionally significant project has not been disclosed to the ICC in a timely manner. Therefore, such a TIP shall be considered to be non-conforming to applicable implementation plan(s). (3-20-20)T

**570. GENERAL CONSULTATION PROCESS.**

Section 570 provides the general procedures for interagency consultation (federal, tribal, state, and local) and public participation for transportation conformity determinations in air quality nonattainment and maintenance areas in the state of Idaho. (3-20-20)T

**01. Lead Agency in Consultation.** The following are the responsibilities of the lead agency at each stage of the consultation process: (3-20-20)T

**a.** Initiating the consultation process by notifying other ICC members of the document or decision that must undergo the consultation process and by scheduling and convening consultation meetings and agendas; (3-20-20)T

**b.** Developing and maintaining a distribution list of all ICC members and any other persons expressing an interest in receiving information and materials pertaining to ICC meetings; (3-20-20)T

**c.** Distributing an agenda and all supporting material, including minutes of ICC meetings, to ICC members and persons on the distribution list as follows: (3-20-20)T

**i.** Fourteen (14) days in advance of an ICC meeting if there are non-technical issues to be resolved by the ICC; (3-20-20)T

**ii.** Thirty (30) days in advance of an ICC meeting if there are technical issues to be resolved by the ICC; or (3-20-20)T

**iii.** If distribution of technical material pursuant to Subsection 570.01.c.ii. is not feasible thirty (30) days prior to an ICC meeting, then the lead agency shall notify the ICC members and persons on the distribution list in writing at least thirty (30) days prior to the ICC meeting. Together with the notification, the lead agency shall distribute and disclose all available material and documentation to the ICC members and persons on the distribution list, informing them of the nature, purpose, and details of possible program changes that are expected to occur from

earlier analyses of the actions. All technical material and documentation shall be distributed at a minimum of fourteen (14) days prior to the ICC meeting. (3-20-20)T

**d.** Conferring with other agencies and persons not on the distribution list that have expressed an interest in the document or decision to be developed; (3-20-20)T

**e.** Providing ICC members and persons on the distribution list access to all information needed for meaningful input; (3-20-20)T

**f.** Soliciting early and continuing input from other ICC members and persons on the distribution list; (3-20-20)T

**g.** Following the public consultation procedures outlined in Section 574; (3-20-20)T

**h.** Providing an opportunity for informal question and answer on the draft document or proposed decision; (3-20-20)T

**i.** Considering the views of ICC members and persons on the distribution list and responding in writing to significant comments in a timely and substantive manner prior to finalizing or taking any final action on those documents or determinations enumerated in Section 567.07.a. through 567.07.c.; and (3-20-20)T

**j.** Assuring all comments and written responses of ICC members and persons on the distribution list are made part of the record of any action. (3-20-20)T

**02. Public Comment Period to Satisfy Thirty Day Document Distribution Requirement.** A lead agency may use all or any part of another public comment period established for public outreach procedures pursuant to 23 CFR 450 for a transportation plan, program, or project to satisfy the thirty (30) day advance distribution requirement for technical issues, and shall notify all ICC members and other persons on the distribution list when so doing fourteen (14) days prior to commencement of the public comment period. (3-20-20)T

**03. Separate Times or in Combination.** The above actions may be conducted at separate times or in combination, as required, to enhance the efficiency of the process. (3-20-20)T

**04. Final Document Distribution.** A lead agency, upon completion of a final document subject to the consultation process under Sections 563 through 574 of these rules (including any federal agency), shall distribute each final document to all other ICC members and persons on the distribution list within thirty (30) days of adopting or approving such document or making such determination. (3-20-20)T

**05. Use of Checklist for Distribution of Material.** The lead agency may supply a checklist of available supporting information to ICC members and persons on the distribution list to be used to request all or part of the supporting information, in lieu of generally distributing all supporting information. (3-20-20)T

**06. Use of Other Meetings for Consultation.** A meeting that is scheduled or required for another purpose may be used for the purposes of consultation only if the public notice for the meeting identifies consultation as an agenda item. (3-20-20)T

#### **571. CONSULTATION PROCEDURES.**

The consultation process among ICC members and persons on the distribution list shall be undertaken for the following specific major activities (federal, tribal, state, and local), specific routine activities and specific air quality related activities, in accordance with the procedures in Section 570. Participating agencies shall be all ICC members unless otherwise specified in Subsections 571.01 through 571.04. (3-20-20)T

**01. Specific Major Activities.** The consultation process shall be undertaken for the following specific major activities. The lead agency for each activity shall be the designated MPO or ITD in the absence of an MPO. (3-20-20)T

**a.** Evaluating and choosing each air quality model and associated methods and assumptions to be used

in hot-spot analyses and regional emissions analyses including vehicle miles traveled forecasting. The hot-spot analyses shall be performed consistent with procedures described in 40 CFR 93.116 and 40 CFR 93.123 and regional emissions analysis shall be performed using procedures outlined on 40 CFR 93.122. (3-20-20)T

**b.** Determining which minor arterials and other transportation projects should be considered “regionally significant” for the purposes of regional emissions analysis, in addition to those functionally classified as principal arterial or higher or fixed guideway transit systems or extensions that offer an alternative to regional highway travel. (3-20-20)T

**c.** Evaluating whether projects otherwise exempted from meeting the requirements of Sections 563 through 574 of these rules should be treated as non-exempt in cases where potential adverse emissions impacts may exist for any reason per 40 CFR 93.126 and 127. (3-20-20)T

**d.** Making a determination as to whether past obstacles to implementation of TCMs which are behind the schedule established in the applicable implementation plan have been identified and are being overcome, and whether state and local agencies with influence over approvals or funding for TCMs are giving maximum priority to approval or funding for TCMs. This consultation procedure shall also consider whether delays in TCM implementation necessitate revisions to the applicable implementation plan to remove TCMs or substitute TCMs with other emission reduction measures. (3-20-20)T

**e.** Identifying projects located at sites in PM nonattainment or maintenance areas which have vehicle and roadway emission and dispersion characteristics which are essentially identical to those at sites which have violations verified by monitoring, and therefore require quantitative PM hot-spot analysis. In case a method for quantitative hot-spot analysis has not been formally adopted by EPA, a sound qualitative analysis developed in conjunction with FHWA may be used for the same. (3-20-20)T

**f.** Making a determination whether the project is included in the regional emissions analysis supporting the currently conforming TIP's conformity determination, and whether the project's design concept and scope have changed significantly from those which were included in the regional emissions analysis, or in a manner which would significantly impact use of the facility. (3-20-20)T

**g.** For areas in the state with no MPOs, making a determination whether a project has undergone project-level analysis and whether the project's design concept and scope have changed significantly from those which were included in the project-level analysis, or in a manner which would significantly impact use of the facility. (3-20-20)T

**h.** Establishing appropriate public participation opportunities for project-level conformity determinations, as applicable, in the manner specified by Section 574, to be initiated by the recipient of the funds designated under 23 U.S.C. or the Federal Transit Act. (3-20-20)T

**i.** Choosing conformity tests and methodologies for isolated and rural nonattainment and maintenance areas as required by 40 CFR 93.109(g)(2)(iii). (3-20-20)T

**02. Specific Routine Activities.** The consultation process shall be undertaken for the following specific routine activities. The lead agency shall be the MPO or ITD in the absence of an MPO. (3-20-20)T

**a.** Evaluating events that will trigger new conformity determinations in addition to those triggering events established in 40 CFR 93.104. Participating agencies shall be the MPO and state, tribal, regional, and local air quality planning agencies. (3-20-20)T

**b.** Consulting on emissions analysis for transportation activities that cross the borders of MPOs or nonattainment or maintenance areas. Participating agencies shall be the MPO and state, tribal, regional, and local air quality planning agencies. (3-20-20)T

**c.** Determining whether the project sponsor or MPO has demonstrated that the requirements are satisfied without a particular mitigation, such as emissions offsets or other control measures, or determining that a conforming project approved with mitigation no longer requires mitigation. (3-20-20)T

**d.** Assuring that plans for construction of regionally significant projects that are not FHWA/FTA projects, including projects for which alternative locations, design concept and scope, or the no-build option are still being considered, are disclosed to the MPO or ITD in the absence of an MPO on a regular basis, and assuring that any changes to those plans are immediately disclosed. (3-20-20)T

**e.** Determining whether a project, which was previously found to conform, has or will have a significant change in design concept and scope since the project plan and TIP conformity determination. (3-20-20)T

**f.** Designing, scheduling, and funding of research and data collection effort pertaining to transportation or air quality planning with implications for transportation conformity. (3-20-20)T

**g.** Reviewing and recommending regional transportation model development by the MPO (e.g., household/travel transportation surveys). (3-20-20)T

**h.** Development of transportation improvement programs. (3-20-20)T

**i.** Development of regional transportation plans. (3-20-20)T

**j.** Consulting when the metropolitan planning area does not include the entire nonattainment area or maintenance area, for planning requirements which may fall under the jurisdiction of more than one (1) MPO or the MPO and ITD. (3-20-20)T

**03. Specific Air Quality Related Activities.** The consultation process shall be undertaken when preparing an applicable implementation plan that includes the revision or addition of a motor vehicle emissions inventory and budget activities in accordance with the procedures in Section 570. Consultation is not required for administrative amendments that do not affect conformity. The lead agency for each activity shall be IDEQ or the MPO. In addition to the Section 570 consultation process, the lead agency shall undertake the following: (3-20-20)T

**a.** Scheduling consultation meetings early in the process of decision on the applicable implementation plan, and prior to making a final recommendation to their management, committees, boards or commissions, for a final decision on such documents; (3-20-20)T

**b.** Arranging for technical committees or teams to assist ICC members in reviewing documents provided by the lead agency. The lead agency may convene technical meetings as necessary; and (3-20-20)T

**c.** Scheduling and conducting meetings of the ICC at regularly scheduled intervals, no less frequently than quarterly. (3-20-20)T

**d.** The ICC may appoint subcommittees to address specific issues pertaining to applicable implementation plan development. Any recommendations of a subcommittee shall be considered by the ICC. (3-20-20)T

**04. Notification Process.** The designated MPO, or ITD in the absence of an MPO, shall notify ICC members and persons on the distribution list of a transportation plan or TIP revisions that merely add or delete exempt projects listed in 40 CFR 93.126 early in the process of decision, and by supplying all relevant documents and information to the same. (3-20-20)T

**572. FINAL CONFORMITY DETERMINATIONS BY USDOT.**

Section 572 establishes the process USDOT shall follow when making final determinations on proposed or anticipated transportation actions subject to transportation conformity. (3-20-20)T

**01. Final Conformity Determination Process.** USDOT will make making final determinations on proposed or anticipated STIP or transportation plan or project conformity by: (3-20-20)T

**a.** Distributing a draft conformity determination to EPA for review and comment. USDOT shall allow a maximum of thirty (30) days for EPA to respond; and (3-20-20)T



**b.** USDOT shall respond in writing to any significant comments raised by EPA within fourteen (14) days of receipt in writing before making a final decision. (3-20-20)T

**02. New or Revised Information.** If USDOT requests any new or revised information to support a STIP, TIP or transportation plan or project conformity determination, then USDOT shall either return the conformity determination for additional consultation pursuant to Section 570, or USDOT shall distribute the new information to the ICC members and persons on the distribution list for review and comment; (3-20-20)T

**a.** When USDOT distributes such new or additional information to ICC members and persons on the distribution list, USDOT shall allow for a maximum of thirty (30) days for the lead agency to respond to any new or revised supporting information; and (3-20-20)T

**b.** USDOT shall distribute a written response within fourteen (14) days of receipt to any significant comments raised by the ICC members and persons on the distribution list on the new or revised supporting information before making a final decision. (3-20-20)T

**573. RESOLVING CONFLICTS.**

Conflicts between state agencies or between state agencies and the MPO regarding a determination of conformity, applicable implementation plan submittal, or other policy decision under Sections 563 through 574, shall be resolved in the following manner. (3-20-20)T

**01. Conflict Resolution at the Level of IDEQ Regions and ITD Districts.** Every effort shall be made to resolve any conflicts among state agencies or between state agencies and an MPO at the regional level. The regional administrator of IDEQ, the District Engineer of ITD and the other agency managers at the regional level of the affected jurisdictions, or their designated representatives shall be involved in conflict resolution at the regional level. (3-20-20)T

**02. Conflict Resolution at the Level of IDEQ and ITD Headquarters.** If conflict(s) are not resolved at the regional level, the issue shall be raised to the level of agency directors for resolution. (3-20-20)T

**03. Conflict Resolution at the Governor's Level.** If conflict(s) are not resolved through Subsection 569.02, then IDEQ shall raise the conflict to the Governor, as follows: (3-20-20)T

**a.** The IDEQ administrator shall request in writing that ITD or the MPO provide IDEQ with written notification of resolution of IDEQ's comments. ITD or the MPO shall provide IDEQ with the requested written notification within fourteen (14) days of receipt of IDEQ's written request. (3-20-20)T

**b.** Within fourteen (14) days of its receipt of the requested written notification, IDEQ may appeal the conformity determination in writing to the Governor. If IDEQ appeals to the Governor, then the final conformity determination must have the concurrence of the Governor. If IDEQ does not appeal in writing to the Governor within fourteen (14) days of its receipt of written notification of resolution of its comments, then the lead transportation agency may proceed with the final conformity determination. (3-20-20)T

**c.** The fourteen (14) days shall start on the date when the IDEQ administrator receives notification of the written resolution of his comments regarding a determination of conformity, applicable implementation plan submittal, or other decision under Sections 563 through 574. (3-20-20)T

**04. Process for Conflict Resolution at the Governor's Level.** The Governor may delegate to another independent official or agency within the state his or her role in this process. The Governor may not delegate his or her role to the head or staff of the state air quality agency or any local air quality agency, ITD, a state transportation commission or board, any agency that has responsibility for any one (1) of these functions, or an MPO. (3-20-20)T

**574. PUBLIC CONSULTATION PROCEDURES.**

Affected agencies making conformity determinations on transportation plans, programs, and projects shall establish a proactive public involvement process which provides opportunity for public review and comment by, at a minimum, providing at the beginning of the public comment period and prior to taking formal action on a conformity

determination for all transportation plans and TIPs, reasonable public access to technical and policy information considered by the agency, and consistent with these requirements and those of 23 CFR 450. Any charges imposed for public inspection and copying should be consistent with the fee schedule contained in 49 CFR 7.95. In addition, these agencies must specifically address, in writing, all public comments relating to known plans for a regionally significant project, which is not receiving FHWA or FTA funding, or approval. This is especially important if the project's emissions have not been properly reflected in the emissions analysis supporting a proposed conformity finding for a transportation plan or TIP. These agencies shall also provide opportunity for public involvement in conformity determinations for projects where otherwise required by law. (3-20-20)T

**575. AIR QUALITY STANDARDS AND AREA CLASSIFICATION.**

Ambient Air Quality Standards. The purpose of Sections 575 through 587 is to establish air quality standards for the state of Idaho which define acceptable ambient concentrations consistent with established air quality criteria. (3-20-20)T

**576. GENERAL PROVISIONS FOR AMBIENT AIR QUALITY STANDARDS.**

**01. Applicability.** The ambient air quality standards established herein shall apply to all of the state. (3-20-20)T

**02. Standard Conditions.** Where applicable, air quality measurements shall be corrected to a reference temperature of twenty-five degrees Celsius (25C) and to a reference pressure of seven hundred and sixty (760) millimeters of mercury absolute. (3-20-20)T

**03. Revisions.** As pertinent air quality criteria information becomes available, such information shall be considered and new or revised air quality standards promulgated as appropriate. (3-20-20)T

**04. Control of Unregulated Contaminants.** The absence of an air quality standard for a specific contaminant shall not preclude action by the Department to control such contaminants to assure the health, welfare and comfort of the people of the State. (3-20-20)T

**05. Methods.** All measurement techniques for determining compliance with 40 CFR Part 50 shall be consistent with those specified in 40 CFR Parts 50 and 53. (3-20-20)T

**577. AMBIENT AIR QUALITY STANDARDS FOR FLUORIDES.**

Primary and secondary air quality standards are those concentrations in the ambient air which result in a total fluoride content in vegetation used for feed and forage of no more than: (3-20-20)T

**01. Annual Standard.** Forty (40) ppm, dry basis -- annual arithmetic mean. (3-20-20)T

**02. Bimonthly Standard.** Sixty (60) ppm, dry basis -- monthly concentration for two (2) consecutive months. (3-20-20)T

**03. Monthly Standard.** Eighty (80) ppm, dry basis -- monthly concentration never to be exceeded. (3-20-20)T

**578. DESIGNATION OF ATTAINMENT, UNCLASSIFIABLE, AND NONATTAINMENT AREAS.**

**01. Annual Review.** The Department shall annually review the available ambient air quality data and when appropriate, redesignate areas as attainment, unclassifiable or nonattainment with the standards in 40 CFR Part 50. (3-20-20)T

**02. Boundaries.** Boundaries for such areas will be based, as much as possible, on actual ambient concentrations and shall take into account such things as the location of air pollutant sources, modeled air quality concentrations, terrain, geographical boundaries and political jurisdictions. (3-20-20)T

**03. Area Designation.** Designation of attainment and unclassifiable areas shall generally be made on a county basis. Redesignation of attainment or unclassifiable areas cannot intersect or be smaller than the area of

impact of any major facility or major modification which establishes the baseline date or is subject to a PSD permit. (3-20-20)T

**04. Redesignations.** Redesignations shall be adopted by the Department after public notice and opportunity for a public hearing and will be submitted by the Governor (or if delegated, the Director) to the U.S. Environmental Protection Agency. (3-20-20)T

**579. BASELINES FOR PREVENTION OF SIGNIFICANT DETERIORATION.**

**01. Baseline Date(s).** (3-20-20)T

**a.** Major Source Baseline Date. (3-20-20)T

i. In the case of PM<sub>10</sub> and sulfur dioxide, January 6, 1975; (3-20-20)T

ii. In the case of nitrogen dioxide, February 8, 1988; and (3-20-20)T

iii. In the case of PM<sub>2.5</sub>, October 20, 2010. (3-20-20)T

**b.** Minor Source Baseline Date. The earliest date after the trigger date on which a major stationary source or a major modification subject to prevention of significant deterioration (PSD) submits a complete application. The trigger date is: (3-20-20)T

i. In the case of PM<sub>10</sub> and sulfur dioxide, August 7, 1977; and (3-20-20)T

ii. In the case of nitrogen dioxide, February 8, 1988. (3-20-20)T

iii. In the case of PM<sub>2.5</sub>, October 20, 2011. (3-20-20)T

**c.** The baseline date is established for each pollutant for which increments or other equivalent measures have been established if: (3-20-20)T

i. The area in which the proposed source or modification would construct is designated as attainment or unclassifiable under Section 107(d) of the Clean Air Act for the pollutant on the date of its complete prevention of significant deterioration (PSD) application; and (3-20-20)T

ii. In the case of a major stationary source, the pollutant would be emitted in significant amounts, or, in the case of a major modification, there would be a significant net emissions increase of the pollutant. (3-20-20)T

**d.** Any minor source baseline date established originally for the TSP increments shall remain in effect and shall apply for purposes of determining the amount of available PM<sub>10</sub> increments, except that the Department may rescind any such minor source baseline date where it can be shown, to the satisfaction of the Department, that the emissions increase from the major stationary source, or the net emissions increase from the major modification, responsible for triggering that date did not result in a significant amount of PM<sub>10</sub> emissions. (3-20-20)T

**02. Baseline Area.** Any intrastate area designated as attainment or unclassifiable under 42 U.S.C. Section 7407(d), in which the major facility or major modification establishing the minor source baseline date would construct or would have an air quality impact for the pollutant for which the baseline date is established, as follows: Equal to or greater than 1 µg/m<sup>3</sup> (annual average) for SO<sub>2</sub>, NO<sub>2</sub>, or PM<sub>10</sub>; or equal or greater than 0.3 µg/m<sup>3</sup> (annual average) for PM<sub>2.5</sub>. (3-20-20)T

**03. Baseline Concentration.** The ambient concentration for a particular regulated air pollutant which exists in the applicable baseline area on the applicable minor source baseline date. (3-20-20)T

**a.** The baseline concentration shall represent: (3-20-20)T

i. The actual emissions from sources in existence on the applicable minor source baseline date; and

(3-20-20)T

ii. The allowable emissions of major facilities and major modifications which commenced construction before the applicable major source baseline date, but were not in operation by the applicable minor source baseline date. (3-20-20)T

b. The baseline concentration shall not include the actual emissions of new major facilities and major modifications which commenced construction on or after the applicable major source baseline date. (3-20-20)T

**580. CLASSIFICATION OF PREVENTION OF SIGNIFICANT DETERIORATION AREAS.**

**01. Restrictions On Area Classification.** (3-20-20)T

a. All of the following areas which were in existence on August 7, 1977, are Class I and may not be redesignated: (3-20-20)T

i. International parks; (3-20-20)T

ii. National wilderness areas which exceed five thousand (5,000) acres; (3-20-20)T

iii. National memorial parks which exceed five thousand (5,000) acres; (3-20-20)T

iv. National parks which exceed six thousand (6,000) acres. (3-20-20)T

b. The following areas are Class II and may be redesignated only as Class I or II: (3-20-20)T

i. National monuments, national primitive areas, national preserves, national recreational areas, national wild and scenic rivers, national wildlife refuges, and national lakeshores or seashores which exceed ten thousand (10,000) acres; or (3-20-20)T

ii. National parks or national wilderness areas established after August 7, 1977, which exceed ten thousand (10,000) acres. (3-20-20)T

c. All other areas in the State are Class II and may be redesignated Class I, II or III. (3-20-20)T

**02. Procedures for Redesignation of Prevention of Significant Deterioration (PSD) Areas.** The Governor may submit to the U.S. Environmental Protection Agency a proposal to redesignate areas as a revision to the SIP. In preparing any such proposal the Department shall: (3-20-20)T

a. Consult with the elected leadership of local and other substate general purpose governments in the area covered by the proposed redesignation; (3-20-20)T

b. Prepare a discussion of the reasons for the proposed redesignation, including a satisfactory description and analysis of the health, environmental, economic, social and energy effects of the proposal. This document will be made available for public inspection at least thirty (30) days prior to the public hearing on the proposed redesignation and the notice announcing the hearing will include notification of the availability of the document; (3-20-20)T

c. Provide written notice to the appropriate Federal Land Manager of any federal lands proposed for redesignation and provide at least thirty (30) days for the Federal Land Manager to confer with the Department and to submit written comments and recommendations. If written comments and recommendations are submitted, the Department shall publish a list of any inconsistency between the proposed redesignation and the comments and recommendations, including the reasons for making a redesignation against the recommendation of the Federal Land Manager; (3-20-20)T

d. Notify other states, Indian governing bodies, and federal land managers whose land may be affected by the proposed redesignation at least thirty (30) days prior to the public hearing; (3-20-20)T

e. For a redesignation to Class III: After consulting with the appropriate committees of the legislature, if it is in session, or the leadership of the legislature, if it is not in session, obtain specific approval by the Governor and by all general purpose units of local government representing a majority of the residents of the area to be redesignated; demonstrate that the redesignation would not cause, or contribute to, violations of any ambient air quality standard, or violations of PSD increments in any other area; and make available, for public inspection prior to the public hearing, any permit application and accompanying material for any major facility or major modification which could only be permitted if the area were designated as Class III; and (3-20-20)T

f. Hold at least one (1) public hearing on the proposed redesignation. (3-20-20)T

**581. PREVENTION OF SIGNIFICANT DETERIORATION (PSD) INCREMENTS.**

The purpose of Section 581 is to establish the allowable degree of deterioration for the areas within the State which have air quality better than the ambient standards. (3-20-20)T

**01. Incorporated Federal Program Requirements - Class I, II and III Areas.** Class I, II, and III area PSD increment requirements contained in 40 CFR 52.21(c) are incorporated by reference into these rules at Section 107. These CFR sections have been codified in the electronic CFR at [www.ecfr.gov](http://www.ecfr.gov). (3-20-20)T

**02. Exceedances.** For any period other than an annual period, the applicable maximum allowable increase may be exceeded during one (1) such period per year at any one (1) location. (3-20-20)T

**03. Exclusions.** The following concentrations shall be excluded in determining compliance with the maximum allowable increases: (3-20-20)T

a. Concentrations attributable to the increase in emissions from facilities which have converted from the use of petroleum products, natural gas, or both by reason of an order in effect under the Energy Supply and Environmental Coordination Act of 1974 (or any superseding legislation) or by reason of a natural gas curtailment plan in effect pursuant to the Federal Power Act, over the emissions from such facilities before the effective date of such order or plan; this shall not apply more than five (5) years after the effective date of such order or plan; (3-20-20)T

b. Concentrations of PM-10 attributable to the increase in emissions from construction or other temporary emission-related activities of new or modified facilities; (3-20-20)T

c. The increase in concentrations attributable to new facilities outside the United States over the concentrations attributable to existing facilities which are included in the baseline concentration; and (3-20-20)T

d. Concentrations attributable to the temporary increase in emissions of sulfur dioxide, nitrogen dioxide, or particulate matter from facilities which are affected by a revision to the SIP approved by the U.S. Environmental Protection Agency; this exclusion shall not exceed two (2) years unless a longer time is approved by the U.S. Environmental Protection Agency, is not renewable, and applies only to revisions which: (3-20-20)T

i. Would not affect the applicable pollutant concentrations in a Class I area or an area where an applicable increment is known to be violated and would not cause or contribute to a violation of an ambient air quality standard; and (3-20-20)T

ii. Require limitations to be in effect at the end of the approved time period which would ensure that the emissions from facilities affected by the revision would not exceed those concentrations occurring before the revision was approved. (3-20-20)T

**582. -- 584. (RESERVED)**

**585. TOXIC AIR POLLUTANTS NON-CARCINOGENIC INCREMENTS.**

The screening emissions levels (EL) and acceptable ambient concentrations (AAC) for non-carcinogens are as provided in the following table. The AAC in this section are twenty-four (24) hour averages. (3-20-20)T

CAS NUMBER	SUBSTANCE	OEL (mg/m3)	EL (lb/hr)	AAC (mg/m3)
60-35-5	Acetamide (NY)	--	0.002	0.0003
64-19-7	Acetic acid	25	1.67	1.25
108-24-7	Acetic anhydride	20	1.33	1
67-64-1	Acetone	1780	119	89
75-05-8	Acetonitrile	67	4.47	3.35
540-59-0	Acetylene dichloride, See 1,2-Dichloroethylene			
79-27-6	Acetylene tetrabromide	15	1	.75
107-02-8	Acrolein	0.25	0.017	0.0125
79-10-7	Acrylic acid	30	2	1.5
107-18-6	Allyl alcohol	5	0.333	.25
106-92-3	Allyl glycidyl ether	22	1.47	1.1
2179-59-1	Allyl propyl disulfide	12	0.8	0.6
7429-90-5	Aluminum Including:			
NA	Metal & Oxide	10	0.667	0.5
NA	Pyro powders	5	0.333	0.25
NA	Soluble salts	2	0.133	0.10
NA	Alkyls not otherwise classified	2	0.133	0.10
141-43-5	2-Aminoethanol, See Ethanolamine			
504-29-0	2-Aminopyridine	2	0.133	0.10
7664-41-7	Ammonia	18	1.2	0.9
12125-02-9	Ammonium chloride fume	10	0.667	0.5
3825-26-1	Ammonium perfluoro-octanoate	0.1	0.007	0.05
7773-06-0	Ammonium sulfamate	10	0.667	0.5
628-63-7	n-Amyl acetate	530	35.3	26.5
626-38-0	Sec-Amyl acetate	665	44.3	33.25
7440-36-0	Antimony & compounds, as Sb (handling & use)	0.5	0.033	0.025
86-88-4	ANTU	0.3	0.02	0.015
7784-42-1	Arsine	0.2	0.013	0.01
86-50-0	Azinphos-methyl	0.2	0.013	0.01
7440-39-3	Barium, soluble compounds, as Ba	0.5	0.033	0.025
17804-35-2	Benomyl	10	0.67	0.5
7106-51-4	p-Benzoquinone, See Quinone			

CAS NUMBER	SUBSTANCE	OEL (mg/m <sup>3</sup> )	EL (lb/hr)	AAC (mg/m <sup>3</sup> )
94-36-0	Benzoyl peroxide	5	0.333	0.25
92-52-4	Biphenyl	1.5	0.1	0.075
1304-82-1	Bismuth telluride undoped	10	0.667	0.05
NA	Bismuth telluride if selenium doped	5	0.333	0.25
1303-96-4	Borates, tetra odium salts - Including:			
NA	Anhydrous	1	0.067	0.05
NA	Decahydrate	5	0.333	0.25
NA	Pentahydrate	1	0.067	0.05
1303-86-2	Boron oxide	10	0.667	0.5
10294-33-4	Boron tribromide	10	0.667	0.5
7637-07-2	Boron trifluoride	3	0.2	0.25
314-40-9	Bromacil	10	0.667	0.5
7726-95-6	Bromine	0.7	0.047	0.035
7789-30-2	Bromine penta-fluoride	0.7	0.047	0.035
75-25-2	Bromoform	5	0.333	0.25
109-79-5	Butanethiol, see Butyl mercaptan			
78-93-3	2-Butanone, see Methyl ethyl ketone			
112-07-2	2-butoxyethyl acetate	---	8.33	1.25
111-76-2	2-Butoxyethanol (EGBG)	120	8	6
123-86-4	n-Butyl acetate	710	47.3	35.5
105-46-4	sec-Butyl acetate	950	63.3	47.5
540-88-5	tert-Butyl acetate	950	63.3	47.5
141-32-2	Butyl acrylate	55	3.67	2.75
71-36-3	n-Butyl alcohol	150	10	7.5
78-92-2	Sec-Butyl alcohol	305	20.3	15.25
75-65-0	tert-Butyl alcohol	300	20	15
109-73-9	Butylamine	15	1	.75
124-17-4	Butyl carbitol acetate (ID)	---	0.846	.625
1189-85-1	tert-Butyl chromate, as CrO <sub>3</sub>	0.1	0.007	.005
2426-08-6	n-Butyl glycidyl ether	135	9	6.75
138-22-7	n-Butyl lactate	25	1.67	1.25
109-79-5	Butyl mercaptan	1.8	0.12	0.09
89-72-5	o-sec-Butylphenol	30	2	1.5
98-51-1	p-tert-Butyltoluene	60	4	3

CAS NUMBER	SUBSTANCE	OEL (mg/m3)	EL (lb/hr)	AAC (mg/m3)
1317-65-3	Calcium carbonate	10	0.667	0.5
156-62-7	Calcium cyanamide	0.5	0.033	0.025
1305-62-0	Calcium hydroxide	5	0.333	0.25
1305-78-8	Calcium oxide	2	0.133	0.1
1344-95-2	Calcium silicate (synthetic)	10	0.667	0.5
13397-24-5	Calcium sulfate	10	0.667	0.5
76-22-2	Camphor, synthetic	12	0.8	0.6
105-60-2	Caprolactam - Including:			
	Dust	1	0.067	0.05
	Vapor	20	1.33	1.0
1333-86-4	Carbon black	3.5	0.23	0.175
2425-06-1	Captafol	0.1	0.007	0.005
133-06-2	Captan	5	0.333	0.25
463-58-1	Carbonyl sulfide	0.4	0.027	0.02
63-25-2	Carbaryl	5	0.333	0.25
1563-66-2	Carbofuran	0.1	0.007	0.005
75-15-0	Carbon disulfide	30	2	1.5
558-13-4	Carbon tetrabromide	1.4	0.093	0.07
75-44-5	Carbonyl chloride, See Phosgene			
353-50-4	Carbonyl fluoride	5	0.333	0.25
120-80-9	Catechol	20	1.33	1.0
21351-79-1	Cesium hydroxide	2	0.133	0.10
133-90-4	Chloramben (PL)	---	887	133
8001-35-2	Chlorinated camphene	0.5	0.0333	0.025
31242-93-0	Chlorinated diphenyl oxide	0.5	0.033	0.025
7782-50-5	Chlorine	3	0.2	0.15
10049-04-4	Chlorine dioxide	0.3	0.02	0.015
7790-91-2	Chlorine trifluoride (CL)	0.38	0.025	0.002
107-20-0	Chloroacetaldehyde	0.32	0.021	0.015
78-95-5	Chloroacetone	0.38	0.0253	0.019
532-27-4	a-Chloroacetophenone	0.32	0.021	0.016
79-04-9	Chloroacetyl chloride	0.2	0.013	0.01
108-90-7	Chlorobenzene	350	23.3	17.5
510-15-6	Chlorobenzilate (PL1)	---	0.047	0.035



CAS NUMBER	SUBSTANCE	OEL (mg/m3)	EL (lb/hr)	AAC (mg/m3)
2698-41-1	O-Chlorobenzylidene malononitrile (CL)	0.4	0.0027	0.03
126-99-8	2-Chloro-1,3-butadiene, see B-Chloroprene			
107-07-3	2-Chloroethanol, see Ethylene chlorohydrin			
600-25-9	1-Chloro-1-nitro propane	10	0.667	0.5
95-57-8	2-Chlorophenol (and all isomers) (ID)	---	0.033	0.025
76-06-2	Chloropicrin	0.7	0.047	0.037
126-99-8	B-chloroprene	36	2.4	1.8
2039-87-4	o-Chlorostyrene	285	19	14.25
95-49-8	o-Chlorotoluene	250	16.7	12.5
1929-82-4	2-Chloro-6-(tri-chloromethyl) pyridine, see Nitrapyrin			
2921-88-2	Chlorpyrifos	0.2	0.013	0.01
7440-47-3	Chromium metal - Including:	0.5	0.033	0.025
7440-47-3	Chromium (II) compounds, as Cr	0.5	0.033	0.025
16065-83-1	Chromium (III) compounds, as Cr	0.5	0.033	0.025
2971-90-6	Clopidol	10	0.667	0.5
NA	Coal dust (<5% silica)	2	0.133	0.1
10210-68-1	Cobalt carbonyl as Co	0.1	0.007	0.005
16842-03-8	Cobalt hydrocarbonyl as Co	0.1	0.007	0.005
7440-48-4	Cobalt metal, dust, and fume	0.05	0.0033	0.0025
7440-50-8	Copper:			
7440-50-8	Fume	0.2	0.013	0.01
7440-50-8	Dusts & mists, as Cu	1	0.067	0.05
95-48-7	o-Cresol	22	1.47	1.1
108-39-4	m-Cresol	22	1.47	1.1
106-44-5	p-Cresol	22	1.47	1.1
1319-77-3	Cresols/Cresylic Acid (isomers and mixtures)	22	1.47	1.1
123-73-9	Crotonaldehyde	5.7	0.38	0.285
299-86-5	Cruformate	5	0.333	0.25
98-82-8	Cumene	245	16.3	12.25
420-04-2	Cyanamide	2	0.133	0.1
592-01-8	Cyanide and compounds as CN	5	0.333	0.25
110-82-7	Cyclohexane	1050	70	52.5
108-93-0	Cyclohexanol	200	13.3	10
108-94-1	Cyclohexanone	100	6.67	5

CAS NUMBER	SUBSTANCE	OEL (mg/m3)	EL (lb/hr)	AAC (mg/m3)
110-83-8	Cyclohexene	1015	67.7	50.75
108-91-8	Cyclohexylamine	41	2.73	2.05
121-82-4	Cyclonite	1.5	0.1	0.075
542-92-7	Cyclopentadiene	200	13.3	10
287-92-3	Cyclopentane	1720	114.667	86
94-75-7	2,4-D	10	0.667	0.5
17702-41-9	Decaborane	0.3	0.02	0.015
8065-48-3	Demeton	0.1	0.007	0.005
123-42-2	Diacetone alcohol	240	16	12
39393-37-8	Dialkyl phthalate (ID)	---	16.4	2.46
107-15-3	1,2-Diaminoethane, See Ethylenediamine			
333-41-5	Diazinon	0.1	0.007	0.005
334-88-3	Diazomethane	0.34	0.023	0.017
19287-45-7	Diborane	0.1	0.007	0.005
102-81-8	2-N-Dibutylamino ethanol	14	0.933	0.7
2528-36-1	Dibutyl phenyl phosphate	3.5	0.233	0.175
107-66-4	Dibutyl phosphate	8.6	0.573	0.43
84-74-2	Dibutyl phthalate	5	0.333	0.25
7572-29-4	Dichloroacetylene	0.39	0.0026	0.0195
95-50-1	o-Dichlorobenzene	300	20	15
106-46-7	1,4-Dichlorobenzene	450	30	22.5
118-52-5	1,3-Dichloro-5, 5-dimethyl hydantoin	0.2	0.013	0.025
75-34-3	Dichloroethane	405	27	20.25
540-59-0	1,2-Dichloroethylene	790	52.7	39.5
111-44-4	Dichloroethyl ether	30	2	1.5
75-43-4	Dichlorofluoromethane	40	2.67	2
594-72-9	1, 1-Dichloro-1-nitroethane	10	0.667	0.5
78-87-5	1,2-Dichloropropane, see Propylene dichloride			
75-99-0	2,2-Dichloropropionic acid	6	0.4	0.3
62-73-7	Dichlorvos	1	0.067	0.05
141-66-2	Dicrotophos	0.25	0.017	0.125
77-73-6	Dicyclopentadiene	30	2	1.5
102-54-5	Dicyclopentadienyl iron	10	0.667	0.5
111-42-2	Diethanolamine	15	1	0.75

CAS NUMBER	SUBSTANCE	OEL (mg/m3)	EL (lb/hr)	AAC (mg/m3)
109-89-7	Diethylamine	30	2	1.5
100-37-8	2-Diethylamino-ethanol	50	3.33	2.5
111-40-0	Diethylene triamine	4	0.267	0.2
60-29-7	Diethyl ether	1200	80	60
96-22-0	Diethyl Ketone	705	47	35.25
84-66-2	Diethyl phthalate	5	0.333	0.25
2238-07-5	Diglycidyl ether (DGE)	0.53	0.035	0.0265
123-31-9	Dihydroxybenzene, see Hydroquinone			
108-83-8	Diisobutyl ketone	145	9.67	7.25
108-18-9	Diisopropylamine	20	1.33	1
127-19-5	Dimethyl acetamide	35	2.33	1.75
124-40-3	Dimethylamine	9.2	0.613	0.46
60-11-7	Dimethyl aminoazo-benzene (NY)	---	0.002	0.0003
1300-73-8	Dimethylamino-benzene, see Xylidine			
121-69-7	Dimethylaniline (N,N-Dimethylaniline)	25	1.67	1.25
1330-20-7	Dimethylbenzene, see Xylene			
300-76-5	Dimethyl-1,2-dibromo-2-dichloroethyl phosphate, see Naled			
68-12-2	Dimethylformamide	30	2	1.5
108-83-8	2,6-Dimethyl-4-heptanone, see Diisobutyl ketone			
131-11-3	Dimethylphthalate	5	0.333	0.25
148-01-6	Dinitolmide	5	0.333	0.25
528-29-0	Dinitrobenzene	1	0.067	0.05
99-65-0	m (or) 1,3-Dinitrobenzene	1	0.067	0.05
100-25-4	p (or) 1,4-Dinitrobenzene	1	0.067	0.05
534-52-1	Dinitro-o-cresol	0.2	0.013	0.01
148-01-6	3,5-Dinitro-o-toluamide, see Dinitolmide			
117-84-0	N-Dioctyl Phthalate	5	0.333	0.25
78-34-2	Dioxathion	0.2	0.013	0.01
92-52-4	Diphenyl, see Biphenyl			
122-39-4	Diphenylamine	10	0.667	0.5
	Diphenyl methane diisocyanate, see Methylenediphenyl diisocyanate			
34590-94-8	Dipropylene glycol methyl ether	600	40	30

CAS NUMBER	SUBSTANCE	OEL (mg/m3)	EL (lb/hr)	AAC (mg/m3)
123-19-3	Dipropyl ketone	235	15.7	11.75
85-00-7	Diquat	0.5	0.033	0.01
97-77-8	Disulfiram	2	0.133	0.1
298-04-4	Disulfoton	0.1	0.007	0.005
128-37-0	2,6-Ditert. butyl-p-cresol	10	0.667	0.5
330-54-1	Diuron	10	0.667	0.5
108-57-6	Divinyl benzene	50	3.33	2.5
1302-74-5	Emery (corundum) total dust (> 1% silica)	10	0.667	0.5
115-29-7	Endosulfan	0.1	0.007	0.005
72-20-8	Endrin	0.1	0.007	0.005
13838-16-9	Enflurane	566	37.7	28.3
1395-21-7	Enzymes, see Subtilisins			
2104-64-5	EPN (Ethoxy-4-Nitro-phenoxy phenylphosphine)	0.5	0.033	0.025
106-88-7	1,2-Epoxybutane (MI)	---	0.8	0.6
75-56-9	1,2-Epoxypropane, see Propylene oxide			
556-52-5	2,3-Epoxy-1-propanol, see Glycidol			
75-08-1	Ethanethiol, see Ethyl mercaptan			
141-43-5	Ethanolamine	8	0.533	0.4
563-12-2	Ethion	0.4	0.027	0.02
110-80-5	2-Ethoxyethanol	19	1.27	0.95
111-15-9	2-Ethoxyethyl acetate (EGEEA)	27	1.8	1.35
141-78-6	Ethyl acetate	1400	93.3	70
64-17-5	Ethyl alcohol	1880	125	94
75-04-7	Ethylamine	18	1.2	0.9
541-85-5	Ethyl amyl ketone	130	8.67	6.5
100-41-4	Ethyl benzene	435	29	21.75
74-96-4	Ethyl bromide	22	1.47	1.1
106-35-4	Ethyl butyl ketone	230	15.3	11.5
51-79-6	Ethyl carbamate (Urethane) (WA)	---	0.002	0.0015
75-00-3	Ethyl chloride	2640	176	132
107-07-3	Ethylene chlorohydrin	3	0.2	0.15
107-15-3	Ethylenediamine	25	1.67	1.25
107-06-2	Ethylene dichloride	40	2.667	2
107-21-1	Ethylene glycol vapor (CL)	127	0.846	6.35

CAS NUMBER	SUBSTANCE	OEL (mg/m3)	EL (lb/hr)	AAC (mg/m3)
628-96-6	Ethylene glycol denigrate	0.31	0.021	0.016
110-49-6	Ethylene glycol methyl ether acetate, see 2-Methoxyethyl acetate			
96-45-7	Ethylene thiourea (PL2)	---	0.047	0.035
109-94-4	Ethyl formate	300	20	15
16219-75-3	Ethylidene norbornene (CL)	25	0.167	1.25
75-08-1	Ethyl mercaptan	1	0.067	0.05
100-74-3	N-Ethylmorpholine	23	1.53	1.15
78-10-4	Ethyl silicate	85	5.67	4.25
22224-92-6	Fenamiphos	0.1	0.007	0.005
115-90-2	Fensulfothion	0.1	0.007	0.005
55-38-9	Fenthion	0.2	0.013	0.01
14484-64-1	Ferbam	10	0.667	0.5
12604-58-9	Ferrovandium dust	1	0.067	0.05
NA	Fibrous glass dust	10	0.667	0.5
NA	Fine Mineral Fibers - Including: mineral fiber emissions from facilities manufacturing or processing glass, rock, or slag fibers (or other mineral derived fibers) of average diameter 1 micrometer or less. (ID)	--	0.661	0.5
NA	Fluorides, as F	2.5	0.167	0.125
7782-41-4	Fluorine	2	0.133	0.1
944-22-9	Fonofos	0.1	0.007	0.005
75-12-7	Formamide	30	2	1.5
64-18-6	Formic acid	9.4	0.627	0.47
98-01-1	Furfural	8	0.533	0.4
98-00-0	Furfuryl alcohol	40	2.67	2
7782-65-2	Germanium tetrahydride	0.6	0.04	0.03
NA	Glass, Fibrous or dust, see Fibrous glass dust			
111-30-8	Glutaraldehyde (CL)	0.82	0.0047	0.041
556-52-5	Glycidol	75	5	3.75
110-80-5	Glycol monoethyl ether, see 2-Ethoxyethanol			
7440-58-6	Hafnium	0.5	0.033	0.025
110-43-0	2-Heptanone, see Methyl n-amyl ketone			
106-35-4	3-Heptanone, see Ethyl butyl ketone			
151-67-7	Halothane	404	26.9	20.2

CAS NUMBER	SUBSTANCE	OEL (mg/m3)	EL (lb/hr)	AAC (mg/m3)
142-82-5	Heptane (n-Heptane)	1640	109	82
77-47-4	Hexachlorocyclopentadiene	0.1	0.007	0.005
1335-87-1	Hexachloronaphthalene	0.2	0.013	0.010
684-16-2	Hexafluoroacetone	0.7	0.047	0.035
822-06-0	Hexamethylene diisocyanate	0.03	0.002	0.0015
680-31-9	Hexamethylphosphoramide (WA)	---	0.002	0.0015
110-54-3	Hexane (n-Hexane)	180	12	9
591-78-6	2-Hexanone, see Methyl n-butyl ketone			
108-10-1	Hexone, see Methyl isobutyl ketone			
108-84-9	sec-Hexyl acetate	300	20	15
107-41-5	Hexylene glycol (CL)	121	0.806	6.05
37275-59-5	Hydrogenated terphenyls	5	0.333	0.25
10035-10-6	Hydrogen bromide (CL)	10	0.0667	0.5
7647-01-0	Hydrogen chloride (CL)	7.5	0.05	0.375
7722-84-1	Hydrogen peroxide	1.5	0.1	0.075
7783-06-4	Hydrogen sulfide	14	0.933	0.7
123-31-9	Hydroquinone	2	0.133	0.1
123-42-2	4-Hydroxy-4-Methyl-2-pentanone, see Diacetone alcohol			
999-61-1	2 -Hydroxypropyl acrylate	3	0.2	0.15
95-13-6	Indene	45	3	2.25
7440-74-6	Indium & compounds as In	0.1	0.007	0.005
7553-56-2	Iodine (CL)	0.1	0.0067	0.005
75-47-8	Iodoform	10	0.667	0.5
1309-37-1	Iron oxide fume (Fe <sub>2</sub> O <sub>3</sub> ) as Fe	5	0.333	0.25
13463-40-6	Iron pentacarbonyl as Fe	0.8	0.053	0.04
7439-89-6	Iron salts, soluble, as Fe	1	0.067	0.05
123-92-2	Isoamyl acetate	525	35	26.25
123-51-3	Isoamyl alcohol	360	24	18
110-19-0	Isobutyl acetate	700	46.7	35
78-83-1	Isobutyl alcohol	150	10	6
26952-21-6	Isooctyl alcohol	270	18	13.5
78-59-1	Isophorone	28	1.867	1.4
4098-71-9	Isophorone diisocyanate	0.09	0.006	0.0045
109-59-1	Isopropoxyethanol	105	7	5.25

CAS NUMBER	SUBSTANCE	OEL (mg/m3)	EL (lb/hr)	AAC (mg/m3)
108-21-4	Isopropyl Acetate	1040	69.3	52
67-63-0	Isopropyl alcohol	980	65.3	49
75-31-0	Isopropylamine	12	0.8	0.6
643-28-7	N-Isopropylaniline	10	0.667	0.5
108-20-3	Isopropyl ether	1040	69.3	52
4016-14-2	Isopropyl glycidyl ether (IGE)	240	16	12
1332-58-7	Kaolin (respirable dust)	2	0.133	0.1
463-51-4	Ketene	0.9	0.06	0.045
7580-67-8	Lithium hydride	0.025	0.002	0.00125
546-93-0	Magnesite	10	0.667	0.5
1309-48-4	Magnesium oxide fume	10	0.667	0.5
121-75-5	Malathion	10	0.667	0.5
108-31-6	Maleic anhydride	1	0.067	0.05
7439-96-5	Manganese as Mn Including:			
7439-96-5	Dust & compounds	5	0.333	0.25
7439-96-5	Fume	1	0.067	0.05
101-68-8	MDI, see Methylene diphenyl isocyanate			
NA	Mercaptans not otherwise listed (ID)	---	0.033	0.025
141-79-7	Mesityl oxide	60	4	3
79-41-4	Methacrylic acid	70	4.67	3.5
74-93-1	Methanethiol, see Methyl mercaptan			
67-56-1	Methanol	260	17.3	13
16752-77-5	Methomyl	2.5	0.17	0.125
72-43-5	Methoxychlor	10	0.667	0.5
109-86-4	2-Methoxyethanol	16	1.07	0.8
110-49-6	2-Methoxyethyl acetate	24	1.6	1.2
150-76-5	4-Methoxyphenol	5	0.333	0.25
108-65-6	1-methoxy-2-proanol acetate (ID)	n/a	24	3.6
79-20-9	Methyl acetate	610	40.7	30.5
74-99-7	Methyl acetylene	1640	109	82
NA	Methyl acetylene-propadiene mix (MAPP)	1640	109	82
96-33-3	Methyl acrylate	35	2.33	1.75
126-98-7	Methylacrylonitrile	3	0.2	0.15
74-89-5	Methylamine	12	0.8	0.6

CAS NUMBER	SUBSTANCE	OEL (mg/m3)	EL (lb/hr)	AAC (mg/m3)
108-11-2	Methyl emyl alcohol, see Methyl isobutyl carbinol			
110-43-0	Methyl n-amyl ketone	235	15.7	11.75
100-61-8	N-Methyl aniline	2	0.133	0.1
74-83-9	Methyl bromide	19	1.27	0.95
591-78-6	Methyl n-butyl ketone	20	1.33	1
74-87-3	Methyl chloride	103	6.867	5.15
71-55-6	Methyl chloroform	1910	127	95.5
137-05-3	Methyl 2-cyano-acrylate	8	0.533	0.4
25639-42-3	Methylcyclohexanol	235	15.7	11.75
583-60-8	o-Methylcyclohexanone	230	15.3	11.5
8022-00-2	Methyl demeton	0.5	0.033	0.01
101-68-8	Methylenediphenyl diisocyanate (MDI)	0.05	0.003	0.0025
5124-30-1	Methylene bis (4-cyclohexyl isocyanate)	0.11	0.007	0.0055
78-93-3	Methyl ethyl ketone (MEK)	590	39.3	29.5
1338-23-4	Methyl ethyl ketone peroxide (CL)	1.5	0.01	0.0075
107-31-3	Methyl formate	246	16.4	12.3
541-85-5	5-Methyl-3-heptanone, see Ethyl amyl ketone			
110-12-3	Methyl isoamyl ketone	240	16	12
108-11-2	Methyl isobutyl carbinol	104	6.93	5.2
108-10-1	Methyl isobutyl ketone	205	13.7	10.25
624-83-9	Methyl isocyanate	0.05	0.003	0.0025
563-80-4	Methyl isopropyl ketone	705	47	35.25
74-93-1	Methyl mercaptan	0.5	0.033	0.025
80-62-6	Methyl methacrylate	410	27.3	20.5
298-00-0	Methyl parathion	0.2	0.013	0.01
107-87-9	Methyl propyl ketone	700	46.7	35
681-84-5	Methyl silicate	6	0.4	0.3
98-83-9	a-Methyl styrene	240	16	10.20
109-87-5	Methylal (dimethoxymethane)	3110	207	155.5
108-87-2	Methylcyclohexane	1610	107	80.5
21087-64-9	Metribuzin	5	0.333	0.25
7786-34-7	Mevinphos	0.1	0.007	0.005
12001-26-2	Mica (Respirable dust)	3	0.2	0.15
NA	Mineral Wool Fiber (no asbestos)	10	0.667	0.5



CAS NUMBER	SUBSTANCE	OEL (mg/m3)	EL (lb/hr)	AAC (mg/m3)
7439-98-7	Molybdenum as Mo - Including:			
NA	Soluble compounds	5	0.333	0.25
NA	Insoluble compounds	10	0.667	0.5
108-90-7	Monochlorobenzene, see Chlorobenzene			
6923-22-4	Monocrotophos	0.25	0.017	0.0125
110-91-8	Morpholine	70	4.67	0.35
300-76-5	Naled	3	0.2	0.15
91-20-3	Naphthalene	50	3.33	2.5
54-11-5	Nicotine	0.5	0.033	0.025
1929-82-4	Nitrapyrin	10	0.667	0.5
7697-37-2	Nitric acid	5	0.333	0.25
100-01-6	p-Nitroaniline	3	0.2	0.15
98-95-3	Nitrobenzene	5	0.333	0.25
100-00-5	p-Nitrochlorobenzene	3	0.2	0.15
79-24-3	Nitroethane	310	20.7	15.5
7783-54-2	Nitrogen trifluoride	29	1.93	1.45
55-63-0	Nitroglycerin	0.46	0.031	0.023
75-52-5	Nitromethane	50	3.333	2.5
108-03-2	1-Nitropropane	90	6	4.5
99-08-1	m (or) 3-Nitrotoluene	11	0.733	0.55
88-72-2	o (or) 2-Nitrotoluene	11	0.733	0.55
99-99-0	p (or) 4-Nitrotoluene	11	0.733	0.55
76-06-2	Nitrotrichloromethane, see Chloropicrin			
10024-97-2	Nitrous oxide	90	6	4.5
111-84-2	Nonane	1050	70	52.5
2234-13-1	Octachloronaphthalene	0.1	0.007	0.005
111-65-9	Octane	1400	93.3	70
NA	Oil mist, mineral	5	0.333	0.25
20816-12-0	Osmium tetroxide as Os	0.002	0.0001	0.0001
144-62-7	Oxalic acid	1	0.067	0.05
7783-41-7	Oxygen difluoride (CL)	0.11	0.0007	0.0005
8002-74-2	Paraffin wax fume	2	0.133	0.1
4685-14-7	Paraquat	0.1	0.007	0.007
NA	Paraquat, all Compounds	0.1	0.007	0.005

CAS NUMBER	SUBSTANCE	OEL (mg/m3)	EL (lb/hr)	AAC (mg/m3)
56-38-2	Parathion	0.1	0.007	0.005
19624-22-7	Pentaborane	0.01	0.001	0.0005
1321-64-8	Pentachloronaphthalene	0.5	0.033	0.025
82-68-8	Pentachloronitrobenzene	0.5	0.0333	0.025
87-86-5	Pentachlorophenol	0.5	0.033	0.025
109-66-0	Pentane	1770	118	88.5
107-87-9	2-Pentanone, see Methyl propyl ketone			
594-42-3	Perchloromethyl mercaptan	0.8	0.053	0.04
7616-94-6	Perchloryl Fluoride	13	0.867	0.65
93763-70-3	Perlite	10	0.667	0.5
532-27-4	Phenacyl chloride, see a-Chloroacetophenone			
108-95-2	Phenol	19	1.27	0.95
92-84-2	Phenothiazine	5	0.333	0.25
108-45-2	m-Phenylenediamine	0.1	0.0067	0.005
106-50-3	p-Phenylenediamine	0.1	0.007	0.005
101-84-8	Phenyl ether, vapor	7	0.467	0.035
122-60-1	Phenyl glycidyl ether (PGE)	6	0.4	0.3
108-98-5	Phenyl mercaptan	2	0.133	0.1
638-21-1	Phenylphosphine (CL)	0.25	0.0017	0.00125
298-02-2	Phorate	0.05	0.003	0.001
7786-34-7	Phosdrin, see Mevinphos			
75-44-5	Phosgene	0.4	0.027	0.02
7803-51-2	Phosphine	0.4	0.027	0.02
7664-38-2	Phosphoric acid	1	0.067	0.05
7723-14-0	Phosphorus	0.1	0.007	0.005
10025-87-3	Phosphorus oxychloride	0.6	0.04	0.030
10026-13-8	Phosphorus penta-chloride	1	0.067	0.05
1313-80-3	Phosphorus penta-sulfide	1	0.067	0.05
1314-56-3	Phosphorus pentoxide (ID)	--	0.067	0.05
7719-12-2	Phosphorus trichloride	1.5	0.1	0.075
85-44-9	Phthalic anhydride	6	0.4	0.3
626-17-5	m-Phthalodinitrile	5	0.333	0.25
1918-02-1	Picloram	10	0.667	0.5
88-89-1	Picric acid	0.1	0.006	0.005

CAS NUMBER	SUBSTANCE	OEL (mg/m <sup>3</sup> )	EL (lb/hr)	AAC (mg/m <sup>3</sup> )
83-26-1	Pindone	0.1	0.007	0.005
142-64-3	Piperazine dihydro-chloride	5	0.333	0.25
83-26-1	2-Pivaloyl-1,3-indandione, see Pindone			
7440-06-4	Platinum - Including:			
7440-06-4	Metal	1	0.067	0.05
NA	Soluble salts, as Pt	0.002	0.0001	0.0001
65997-15-1	Portland cement	10	0.667	0.5
1310-58-3	Potassium hydroxide	2	0.133	0.1
107-19-7	Propargyl alcohol	2.3	0.153	0.115
123-38-6	Propionaldehyde (LA)	0.43	0.0287	0.0215
79-09-4	Propionic acid	30	2	1.5
114-26-1	Propoxur (Baygon)	0.5	0.033	0.025
109-60-4	n-Propyl acetate	840	56	42
71-23-8	Propyl alcohol	500	33.3	25
78-87-5	Propylene dichloride	347	23.133	17.35
6423-43-4	Propylene glycol dinitrate	0.34	0.023	0.017
107-98-2	Propylene glycol monomethyl ether	360	24	18
75-56-9	Propylene oxide	48	3.2	2.4
627-13-4	n-Propyl nitrate	105	7	5.25
8003-34-7	Pyrethrum	5	0.333	0.25
110-86-1	Pyridine	15	1	0.75
120-80-9	Pyrocatechol, see Catechol			
106-51-4	Quinone	0.4	0.027	0.02
121-84-4	RDX, see Cyclonite			
NA	Refractory Ceramic Fibers (see entry for specific content of emissions, ex: silica)			
108-46-3	Resorcinol	45	3	2.25
7440-16-6	Rhodium - Including:			
7440-16-6	Metal	1	0.067	0.05
NA	Insoluble compounds, as Rh	1	0.067	0.05
NA	Soluble compounds, as Rh	0.01	0.001	0.0005
299-84-3	Ronnel	10	0.667	0.5
83-79-4	Rotenone (commercial)	5	0.333	0.25

CAS NUMBER	SUBSTANCE	OEL (mg/m3)	EL (lb/hr)	AAC (mg/m3)
8030-30-6	Rubber solvent (Naphtha)	1590	106	79.5
14167-18-1	Salcoine as CO	0.1	0.007	0.005
7782-49-2	Selenium	0.2	0.013	0.010
NA	Selenium and compounds as Se	0.2	0.013	0.01
136-78-7	Sesone	10	0.667	0.5
7803-62-5	Silane, see silicon tectrahydride			
NA	Silica - amorphous - Including:			
61790-53-2	Diatomaceous earth (uncalcined)	10	0.667	0.5
112926-00-8	Precipitated silica	10	0.667	0.5
112926-00-8	Silica gel	10	0.667	0.5
NA	Silica, crystalline - Including:			
14464-46-1	Cristobalite	0.05	0.0033	0.0025
14808-60-7	quartz	0.1	0.0067	0.005
60676-86-0	silica, fused	0.1	0.0067	0.005
15468-32-3	tridymite	0.05	0.0033	0.0025
1317-95-9	Tripoli	0.1	0.0067	0.005
7440-21-3	Silicon	10	0.667	0.5
409-21-2	Silicon carbide	10	0.667	0.5
7803-62-5	Silicon tetrahydride	7	0.467	0.35
7440-22-4	Silver - Including			
7440-22-4	Metal	0.1	0.007	0.005
7440-22-4	Soluble compounds, as Ag	0.01	0.001	0.005
26628-22-8	Sodium azide (CL)	0.3	0.002	0.0015
7631-90-5	Sodium bisulfite	5	0.333	0.25
136-78-7	Sodium 2,4-dichloro-phenoxyethyl sulfate, see Sesone			
62-74-8	Sodium fluoroacetate	0.05	0.003	0.0025
1310-73-2	Sodium hydroxide	2	0.133	0.1
7681-57-4	Sodium metabisulfite	5	0.333	0.25
NA	Stearates (not including toxic metals)	10	0.667	0.5
7803-52-3	Stibine	0.5	0.033	0.025
8052-41-3	Stoddard solvent	525	35	26.25
57-24-9	Strychnine	0.15	0.01	0.0075
60-41-3	Strychnine sulfate as strichnine	0.15	0.01	0.01
100-42-5	Styrene monomer (ID)	--	6.67	1

CAS NUMBER	SUBSTANCE	OEL (mg/m3)	EL (lb/hr)	AAC (mg/m3)
1395-21-7	Subtilisins (Proteolytic enzymes as 100% pure crystalline enzyme)	0.00006	4.0E-07	3.0E-7
3689-24-5	Sulfotep	0.2	0.013	0.01
7664-93-9	Sulfuric acid	1	0.067	0.05
10025-67-9	Sulfur monochloride (CL)	6	0.04	0.03
5714-22-7	Sulfur pentafluoride (CL)	0.1	0.0007	0.0005
7783-60-0	Sulfur tetrafluoride (CL)	0.4	0.0027	0.002
2699-79-8	Sulfuryl fluoride	20	1.33	1
35400-43-2	Sulprofos	1	0.067	0.05
8065-48-3	Systox, see Demeton			
93-76-5	2,4,5-Trichlorophen-oxyacetic acid (2,4,5,-T)	10	0.667	0.05
7440-25-7	Tantalum	5	0.333	0.25
3689-24-5	TEDP, see Sulfotep			
13494-80-9	Tellurium & Compounds as Te	0.1	0.007	0.005
7783-80-4	Tellurium hexafluoride as Te	0.2	0.013	0.01
3383-96-8	Temephos	10	0.667	0.5
107-49-3	TEPP (Tetraethyl-pyrophosphate)	0.05	0.003	0.0025
26140-60-3	Terphenyls	4.7	0.313	0.235
1335-88-2	Tetrachloronaphthalene	2	0.133	0.10
78-00-2	Tetraethyl Lead	0.1	0.007	0.005
597-64-8	Tetraethyltin as organic tin	0.1	0.007	0.005
109-99-9	Tetrahydrofuran	590	39.3	29.5
75-74-1	Tetramethyl lead, as Pb	0.15	0.01	0.0075
3333-52-6	Tetramethyl succinonitrile	3	0.2	0.15
509-14-8	Tetranitromethane	8	0.533	0.4
7722-88-5	Tetrasodium pyrophosphate	5	0.333	0.25
479-45-8	Tetryl	1.5	0.1	0.075
7440-28-0	Thallium, soluble Compounds, as Tl	0.1	0.007	0.005
96-69-5	4,4-Thiobis (6 tert, butyl-m-cresol)	10	0.667	0.5
68-11-1	Thioglycolic acid	4	0.267	0.2
7719-09-7	Thionyl chloride (CL)	4.9	0.0327	0.245
137-26-8	Thiram	5	0.333	0.25
7440-31-5	Tin - Including:			
7440-31-5	Metal	2	0.133	0.1

CAS NUMBER	SUBSTANCE	OEL (mg/m3)	EL (lb/hr)	AAC (mg/m3)
NA	Oxide & inorganic compounds, except SnH4, as Sn	2	0.133	0.1
NA	Organic compounds as Sn	0.1	0.007	0.005
108-88-3	Toluene (toluol)	375	25	18.75
584-84-9	Toluene-2,4-di-isocyanate (TDI)	0.04	0.003	0.002
10-41-54	p-Toluenesulfonic acid (ID)	n/a	0.067	0.05
126-73-8	Tributyl phosphate	2.2	0.147	0.11
76-03-9	Trichloroacetic acid	7	0.467	0.35
120-82-1	1,2,4-Trichlorobenzene (CL)	37	2.47	1.85
79-01-6	Trichloroethylene	269	17.93	13.45
1321-65-9	Trichloronaphthalene	5	0.333	0.25
76-06-2	Trichloronitromethane, See Chloropicrin			
95-95-4	2,4,5-Trichlorophenol (MA)	---	---	0.0016
96-18-4	1,2,3-Trichloropropane	60	4	3
121-44-8	Triethylamine	4.1	0.27	0.2
1582-09-8	Trifluralin (PL3)	---	7.7	1.15
552-30-7	Trimellitic anhydride	0.04	0.003	0.002
75-50-3	Trimethylamine	12	0.8	0.6
25551-13-7	Trimethyl benzene (mixed and individual isomers)	123	8.2	6.15
540-84-1	2,2,4-Trimethyl-pentane	350	23.3	17.5
121-45-9	Trimethyl phosphite	10	0.667	0.5
479-45-8	2,4,6-Trinitrophenyl-methylnitramine, see Tetryl			
78-30-8	Triorthocresyl phosphate	0.1	0.007	0.005
603-34-9	Triphenyl amine	5	0.333	0.25
115-86-6	Triphenyl phosphate	3	0.2	0.15
7440-33-7	Tungsten - Including:			
NA	Insoluble compounds	5	0.333	0.25
NA	Soluble compounds	1	0.067	0.05
8006-64-2	Turpentine	560	37.3	28
7440-61-1	Uranium (natural) Soluble & insoluble compounds as U	0.2	0.013	0.01
110-62-3	n-Valeraldehyde	175	11.7	8.75
1314-62-1	Vanadium, as V2O5 Respirable Dust & fume	0.05	0.003	0.0025
108-05-4	Vinyl acetate	35	2.3	1.75
25013-15-4	Vinyl toluene	240	16	12

CAS NUMBER	SUBSTANCE	OEL (mg/m <sup>3</sup> )	EL (lb/hr)	AAC (mg/m <sup>3</sup> )
8032-32-4	VM & P Naphtha	1370	91.3	68.5
81-81-2	Warfarin	0.1	0.007	0.005
1330-20-7	Xylene (o-, m-, p-isomers)	435	29	21.75
1477-55-0	m-Xylene a, a-diamine (CL)	0.1	0.0007	0.0005
1300-73-8	Xylidine	2.5	1.67	0.125
7440-65-5	Yttrium (Metal and compounds as Y)	1	0.067	0.05
7440-66-6	Zinc metal (ID)	--	0.667	0.5
7646-85-7	Zinc chloride fume	1	0.067	0.05
1314-13-2	Zinc oxide fume	5	0.333	0.05
1314-13-2	Zinc oxide dust	10	0.667	0.5
7440-67-7	Zirconium compounds as Zr	5	0.333	0.25

(3-20-20)T

**586. TOXIC AIR POLLUTANTS CARCINOGENIC INCREMENTS.**

The screening emissions levels (EL) and acceptable ambient concentrations (AACC) for carcinogens are as provided in the following table. The AACC in this section are annual averages.

CAS NUMBER	SUBSTANCE	URF	EL lb/hr	AACC ug/m <sup>3</sup>
75-07-0	Acetaldehyde	2.2E-06	3.0E-03	4.5E-01
79-06-1	Acrylamide	1.3E-03	5.1E-06	7.7E-04
107-13-1	Acrylonitrile	6.8E-05	9.8E-05	1.5E-02
309-00-2	Aldrin	4.9E-03	1.3E-06	2.0E-04
62-53-3	Aniline	7.4E-06	9.0E-04	1.4E-01
140-57-8	Aramite	7.1E-06	9.3E-04	1.4E-01
NA	Aroclor, all (PCB) (ID)	---	6.6E-05	1.0E-02
7440-38-2	Arsenic compounds	4.3E-03	1.5E-06	2.3E-04
1332-21-4	Asbestos (Fibers /M.L.)	2.3E-01	N/A	4.0E-06
71-43-2	Benzene	8.3E-06	8.0E-04	1.2E-01
92-87-5	Benzidine	6.7E-02	9.9E-08	1.5E-05
50-32-8	Benzo(a)pyrene	3.3E-03	2.0E-06	3.0E-04
7440-41-7	Beryllium & compounds	2.4E-04	2.8E-05	4.2E-03
106-99-0	1,3-Butadiene	2.8E-04	2.4E-05	3.6E-03
111-44-4	Bis (2-chloroethyl) ether	3.3E-04	2.0E-05	3.0E-03
542-88-1	Bis (chloromethyl) ether	6.2E-02	1.0E-07	1.6E-05

CAS NUMBER	SUBSTANCE	URF	EL lb/hr	AACC ug/m3
108-60-1	Bis (2-chloro-1-methyl- ethyl) ether	2.0E-05	3.3E-04	5.0E-02
117-81-7	Bis (2-ethylhexyl) phthalate	2.4E-07	2.8E-02	4.2E+00
7440-43-9	Cadmium and compounds	1.8E-03	3.7E-06	5.6E-04
56-23-5	Carbon tetrachloride	1.5E-05	4.4E-04	6.7E-02
57-74-9	Chlordane	3.7E-04	1.8E-04	2.7E-03
67-66-3	Chloroform	2.3E-05	2.8E-04	4.3E-02
18540-29-9	Chromium (VI) & compounds as Cr+6	1.2E-02	5.6E-07	8.3E-05
NA	Coal Tar Volitiles as benzene			
NA	Coke oven emissions	6.2E-04	1.1E-05	1.6E-03
8001-58-9	Creosote (ID) See coal tar volatiles as benzene extractables			
50-29-3	DDT (Dichlorodi phenyltrichloroethane)	9.7E-05	6.8E-05	1.0E-02
96-12-8	1,2-Dibromo-3-chloropropane	6.3E-03	1.0E-06	1.6E-04
75-34-3	1,1 dichloroethane	2.6E-05	2.5E-04	3.8E-02
107-06-2	1,2 dichloroethane	2.6E-05	2.5E-04	3.8E-02
75-35-4	1,1 dichloroethylene	5.0E-05	1.3E-04	2.0E-02
75-09-2	Dichloromethane (Methylenechloride)	4.1E-06	1.6E-03	2.4E-01
542-75-6	1,3 dichloropropene	4.0E-06	1.7E-03	2.5E-01
764-41-0	1,4-Dichloro-2-butene	2.6E-03	2.5E-06	3.8E-04
60-57-1	Dieldrin	4.6E-03	1.4E-06	2.1E-04
56-53-1	Diethylstilbestrol	1.4E-01	4.7E-08	7.1E-06
123-91-1	1,4 dioxane	1.4E-06	4.8E-03	7.1E-01
	Dioxin and Furans (2,3,7,8,TCDD & mixtures) Dioxin and Furan emissions shall be considered as one TAP and expressed as an equivalent emission of 2,3,7,8, TCDD based on the relative potency of the isomers in accordance with US EPA guidelines. U.S. EPA (Environmental Protection Agency), (2010) Recommended Toxicity Equivalence Factors (TEFs) for Human Health Risk Assessments of 2,3,7,8-Tetrachlorodibenzo-p-dioxin and Dioxin-Like Compounds. Risk Assessment Forum, Washington, DC. EPA/600/R-10/005.			
122-66-7	1,2-Diphenylhydrazine	2.2E-04	3.0E-05	4.5E-03
106-89-8	Epichlorohydrin	1.2E-06	5.6E-03	8.3E-01
106-93-4	Ethylene dibromide	2.2E-04	3.0E-05	4.5E-03
75-21-8	Ethylene oxide	1.0E-04	6.7E-05	1.0E-02
50-00-0	Formaldehyde	1.3E-05	5.1E-04	7.7E-02
76-44-8	Heptachlor	1.3E-03	5.1E-06	7.7E-04
1024-57-3	Heptachlor Epoxide	2.6E-03	2.5E-06	3.5E-04



CAS NUMBER	SUBSTANCE	URF	EL lb/hr	AACC ug/m3
118-74-1	Hexachlorobenzene	4.9E-04	1.3E-05	2.0E-03
87-68-3	Hexachlorobutadiene	2.0E-05	3.3E-04	5.0E-02
	Hexachlorocyclo-hexane, Technical	5.1E-04	1.3E-05	1.9E-03
319-84-6	Hexachlorocyclohexane (Lindane) Alpha (BHC)	1.8E-03	3.7E-06	5.6E-04
319-85-7	Hexachlorocyclohexane (Lindane) Beta (BHC)	5.3E-04	1.3E-05	1.8E-03
58-89-9	Hexachlorocyclohexane (Lindane) Gamma (BHC)	3.8E-04	1.7E-05	2.6E-03
67-72-1	Hexachloroethane	4.0E-06	1.7E-03	2.5E-01
302-01-2	Hydrazine	2.9E-03	2.3E-06	3.4E-04
10034-93-2	Hydrazine Sulfate	2.9E-03	2.2E-06	3.5E-04
56-49-5	3-methylcholanthrene	2.7E-03	2.5E-06	3.7E-04
75-09-2	Methylene Chloride	4.1E-06	1.6E-03	2.4E-01
74-87-3	Methyl chloride	3.6E-06	1.9E-03	2.8E-01
101-14-4	4,4-Methylene bis(2-Chloroaniline)	4.7E-05	1.4E-04	2.1E-02
60-34-4	Methyl hydrazine	3.1E-04	2.2E-05	3.2E-03
7440-02-0	Nickel	2.4E-04	2.7E-05	4.2E-03
12035-72-2	Nickel Subsulfide	4.8E-04	1.4E-05	2.1E-02
7440-02-0	Nickel Refinery Dust	2.4E-04	2.8E-05	4.2E-02
79-46-9	2-Nitropropane	2.7E-02	2.5E-07	3.7E-05
55-18-5	N-Nitrosodiethylamine (diethylnitrosoamine) (DEN)	4.3E-02	1.5E-07	2.3E-05
62-75-9	N-Nitrosodimethylamine	1.4E-02	4.8E-07	7.1E-05
924-16-3	N-Nitrosodi-n-butylamine	1.6E-03	4.1E-06	6.3E-04
930-55-2	N-Nitrosopyrrolidine	6.1E-04	1.1E-05	1.6E-03
684-93-5	N-Nitroso-N-methylurea (NMU)	3.5E-01	1.9E-08	2.9E-06
82-68-8	Pentachloronitrobenzene	7.3E-05	9.1E-05	1.4E-02
127-18-4	Perchloroethylene (see tetrachloroethylene)			
NA	Polyaromatic Hydrocarbons (except 7-PAH group)	7.3E-05	9.1E-05	1.4E-02
	(Polycyclic Organic Matter or 7-PAH group) For emissions of the 7-PAH group, the following PAHs shall be considered together as one TAP, equivalent in potency to benzo(a)pyrene: benzo(a)anthracene, benzo(b)fluoranthene, benzo(k)fluoranthene, dibenzo(a,h)anthracene, chrysene, indeno(1,2,3-cd)pyrene, benzo(a)pyrene. (WA)			
23950-58-5	Promanide	4.6E-06	1.5E-03	2.2E-01
50-55-5	Reserpine	3.0E-03	2.2E-06	3.3E-04
1746-01-6	2,3,7,8,-Tetrachlorodibenzo-p-dioxin (2,3,7,8, -TCDD)	4.5.E+01	1.5E-10	2.2E-08

CAS NUMBER	SUBSTANCE	URF	EL lb/hr	AACC ug/m3
NA	Soots and Tars (ID) See coal tar volatiles as benzene extractables.			
79-34-5	1,1,2,2-Tetrachloro-ethane	5.8E-05	1.1E-05	1.7E-02
127-18-4	Tetrachloroethylene	4.8E-07	1.3E-02	2.1E+00
79-00-5	1,1,2 - trichloroethane	1.6E-05	4.2E-04	6.2E-02
62-56-6	Thiourea	5.5E-04	1.2E-05	1.8E-03
8001-35-2	Toxaphene	3.2E-04	2.0E-05	3.0E-03
79-01-6	Trichloroethylene	1.3E-06	5.1E-04	7.7E-01
88-06-2	2,4,6 - Trichlorophenol	5.7E-06	1.2E-03	1.8E-01
75-01-4	Vinyl chloride	7.1E-06	9.4E-04	1.4E-01

(3-20-20)T

**587. LISTING OR DELISTING TOXIC AIR POLLUTANT INCREMENTS.**

Persons may request the listing of any toxic substance or delisting of any toxic air pollutant in Sections 585 or 586 by filing a petition for adoption of rules in accordance with IDAPA 58.01.23, "Rules of Administrative Procedure Before the Board of Environmental Quality."

(3-20-20)T

**588. -- 591. (RESERVED)**

**592. STAGE 1 VAPOR COLLECTION.**

The purpose of Sections 592 through 598 is to set forth requirements for Stage 1 vapor collection systems. Section 599 sets forth the requirements for gasoline cargo tanks that deliver gasoline to those required to install and operate Stage 1 vapor collection systems. These sections apply to gasoline dispensing facilities (GDF) and gasoline cargo tanks in Ada and Canyon Counties only. Nothing in these rules is intended to supersede or render inapplicable any federal, state, or local laws, including, but not limited to, the National Emission Standards for Hazardous Air Pollutants for Source Category: Gasoline Dispensing Facilities, 40 CFR Part 63, Subpart CCCCCC, of the federal Clean Air Act.

(3-20-20)T

**593. AFFECTED EQUIPMENT OR PROCESSES.**

**01. Applicability.** Sections 592 through 598 apply to transfers of gasoline to underground storage tanks with a tank capacity of ten thousand (10,000) gallons and not otherwise subject to 40 CFR 63.11118. The emission sources include the underground gasoline storage tanks and associated equipment components in vapor or liquid gasoline service at new, reconstructed, or existing GDFs. Pressure/vacuum vents on underground gasoline storage tanks and the equipment necessary to unload product from cargo tanks into the storage tanks at GDFs are covered emission sources.

(3-20-20)T

**02. New Sources.** A source is a new source if construction commenced on the source after April 1, 2009.

(3-20-20)T

**03. Reconstructed Sources.** A source is reconstructed if meeting the criteria for reconstruction as defined in 40 CFR 63.2, incorporated by reference into these rules at Section 107.

(3-20-20)T

**04. Existing Sources.** A source is an existing source if it is not new or reconstructed. (3-20-20)T

**594. COMPLIANCE DATES.**

**01. New or Reconstructed Sources.** For a new or reconstructed source, the owner or operator must

comply with the standards in Sections 595 and 596 no later than April 1, 2009 or upon startup, whichever is later. Owners or operators of new sources shall install dual point systems. (3-20-20)T

**02. Existing Sources.** For an existing source, the owner or operator must comply with the standards in Sections 595 and 596 upon installation of the Stage 1 vapor collection system, or by May 1, 2010, whichever is earlier. (3-20-20)T

**595. SUBMERGED FILL REQUIREMENTS.**

The owner or operator must only load gasoline into underground storage tanks at the facility by utilizing submerged filling. (3-20-20)T

**01. Installed On or Before November 9, 2006.** Submerged fill pipes installed on or before November 9, 2006 must be no more than twelve (12) inches from the bottom of the storage tank. (3-20-20)T

**02. Installed After November 9, 2006.** Submerged fill pipes installed after November 9, 2006 must be no more than six (6) inches from the bottom of the storage tank. (3-20-20)T

**596. VAPOR BALANCE REQUIREMENTS.**

The owner or operator of a GDF must comply with the following requirements on and after the applicable compliance date in Section 594: (3-20-20)T

**01. Loading.** When loading an underground gasoline storage tank equipped with a vapor balance system, connect and ensure the proper operation of the vapor balance system whenever gasoline is being loaded. (3-20-20)T

**02. Maintenance.** Maintain all equipment associated with the vapor balance system to be vapor tight and in good working order. (3-20-20)T

**03. Inspection.** In order to ensure that the vapor balance equipment is maintained to be vapor tight and in good working order, inspect the vapor balance equipment on an annual basis to discover potential or actual equipment failures. A log form is available on the Department's website at <http://www.deq.idaho.gov>. (3-20-20)T

**04. Repair.** Replace, repair or modify any worn or ineffective component or design element within twenty-four (24) hours to ensure the vapor-tight integrity and efficiency of the vapor balance system. If repair parts must be ordered, either a written or verbal order for those parts must be initiated within two (2) working days of detecting such a leak. Such repair parts must be installed within five (5) working days after receipt. (3-20-20)T

**597. TESTING AND MONITORING REQUIREMENTS.**

The owner or operator of a GDF must comply with the following requirements within ninety (90) days of registration under Section 598 and every three (3) years thereafter. (3-20-20)T

**01. Testing.** (3-20-20)T

**a.** The owner or operator must demonstrate compliance with the leak rate and cracking pressure requirements, specified in item 1(g) of Table 1 to 40 CFR Part 63, Subpart CCCCCC, incorporated by reference into these rules at Section 107, for pressure-vacuum vent valves installed on underground gasoline storage tanks using the test methods identified in Subsection 597.01.a.i. or 597.01.a.ii. (3-20-20)T

**i.** California Air Resources Board Vapor Recovery Test Procedure TP-201.1E,--Leak Rate and Cracking Pressure of Pressure/Vacuum Vent Valves, adopted October 8, 2003 (see 40 CFR 63.14, incorporated by reference into these rules at Section 107). (3-20-20)T

**ii.** Use alternative test methods and procedures in accordance with the alternative test method requirements in 40 CFR 63.7(f), incorporated by reference into these rules at Section 107. (3-20-20)T

**b.** The owner or operator must demonstrate compliance with the static pressure performance requirement, specified in item 1(h) of Table 1 to 40 CFR Part 63, Subpart CCCCCC, for the vapor balance system by

conducting a static pressure test on the underground gasoline storage tanks using the test methods identified in paragraph 597.01.b.i. or 597.01.b.ii. (3-20-20)T

i. California Air Resources Board Vapor Recovery Test Procedure TP-201.3,--Determination of 2-Inch WC Static Pressure Performance of Vapor Recovery Systems of Dispensing Facilities, adopted April 12, 1996, and amended March 17, 1999 (see 40 CFR 63.14, incorporated by reference into these rules at Section 107). (3-20-20)T

ii. Use alternative test methods and procedures in accordance with the alternative test method requirements in 40 CFR 63.7(f), incorporated by reference into these rules at Section 107. (3-20-20)T

**02. Alternative Testing.** The owner or operator of a GDF, choosing, under the provisions of 40 CFR 63.6(g), to use a vapor balance system other than that described in Table 1 to 40 CFR Part 63, Subpart CCCCCC, must demonstrate to the Department the equivalency of their vapor balance system to that described in Table 1 to 40 CFR Part 63, Subpart CCCCCC, using the procedures specified in Subsections 597.02.a. and 597.02.b. (3-20-20)T

a. The owner or operator must demonstrate compliance by conducting a performance test on the vapor balance system to demonstrate that the vapor balance system achieves 95 percent reduction using the California Air Resources Board Vapor Recovery Test Procedure TP-201.1,--Volumetric Efficiency for Phase I Vapor Recovery Systems, adopted April 12, 1996, and amended February 1, 2001, and October 8, 2003, (see 40 CFR 63.14, incorporated by reference into these rules at Section 107). (3-20-20)T

b. The owner or operator must, during the performance test required under Subsection 597.02.a., determine and document alternative acceptable values for the leak rate and cracking pressure requirements specified in item 1(g) of Table 1 to 40 CFR Part 63, Subpart CCCCCC, and for the static pressure performance requirement in item 1(h) of Table 1 to 40 CFR Part 63, Subpart CCCCCC. (3-20-20)T

**598. REGISTRATION, RECORDKEEPING, AND REPORTING REQUIREMENTS.**

**01. Registration.** (3-20-20)T

a. Any GDF subject to these rules shall: (3-20-20)T

i. Within thirty (30) days of installation of the Stage 1 vapor collection system, the owner or operator of the GDF shall submit to the Department a registration which provides, at a minimum, the operation name and address, signature of the owner or operator in accordance with Section 123 of these rules, the location of records and reports required by Subsections 598.02 and 598.03 (including contact person's name, address and telephone number), the number of underground gasoline storage tanks, the number of gasoline tank pipe vents, and the date of completion of installation of the Stage 1 vapor collection system and pressure/vacuum relief valve; and (3-20-20)T

ii. The registration certification shall be displayed at the GDF. (3-20-20)T

b. Upon modification of an existing Stage 1 vapor collection system or pressure/vacuum relief valve, the owner or operator of the GDF shall submit to the Department a registration that details the changes to the information provided in the previous registration and which includes the signature of the owner or operator. The registration must be submitted to the Department within thirty (30) days after completion of such modification. (3-20-20)T

c. A new registration must be submitted to the Department within thirty (30) days after any change in ownership of the GDF. (3-20-20)T

**02. Recordkeeping Requirements.** (3-20-20)T

a. Each owner or operator must keep the following records: (3-20-20)T

i. Records of all tests performed under Section 597; (3-20-20)T

ii. Records related to the operation and maintenance of vapor balance equipment required under Section 596. Any vapor balance component defect must be logged and tracked by station personnel on a monthly basis using forms provided by the Department or a reasonable facsimile; and (3-20-20)T

iii. Records of permanent changes made at the GDF and vapor balance equipment which may affect emissions. (3-20-20)T

b. Records required under 598.02.a. must be kept for a period of five (5) years and must be made available for inspection by the Department upon request. (3-20-20)T

**03. Reporting Requirements.** Each owner or operator subject to the management practices in Section 596 must report to the Department the results of all volumetric efficiency tests required under Section 597. Reports submitted under these rules must be submitted within thirty (30) days of the completion of the performance testing. (3-20-20)T

**599. GASOLINE CARGO TANKS.**

**01. Prohibitions.** After May 1, 2010, or if a Stage 1 vapor collection system is installed and operating, whichever is earlier, owners or operators of gasoline cargo tanks that unload gasoline into an underground gasoline storage tank with a capacity of ten thousand (10,000) gallons or more, in Ada or Canyon Counties, shall comply with Table 2 to 40 CFR Part 63, Subpart CCCCCC, incorporated by reference into these rules at Section 107. Table 2 requires that the following conditions are met prior to unloading the gasoline: (3-20-20)T

a. All hoses in the vapor balance system are properly connected; (3-20-20)T  
b. The adapters or couplers that attach to the vapor line on the storage tank have closures that seal upon disconnect; (3-20-20)T

c. All vapor return hoses, couplers, and adapters used in the gasoline delivery are vapor-tight; (3-20-20)T

d. All tank truck vapor return equipment is compatible in size and forms a vapor-tight connection with the vapor balance equipment on the GDF storage tank; and (3-20-20)T

e. All hatches on the tank truck are closed and securely fastened. (3-20-20)T

f. The filling of storage tanks at GDF shall be limited to unloading by vapor-tight gasoline cargo tanks. Documentation that the cargo tank has met the specifications of EPA Method 27 (40 CFR Part 60, Appendix A-8, incorporated by reference into these rules at Section 107), shall be carried on the cargo tank. (3-20-20)T

**02. Compliance.** The owner or operator of a gasoline cargo tank subject to Section 599 shall ensure compliance with Table 2 to 40 CFR Part 63, Subpart CCCCCC, by visually inspecting the requirements set out in Subsections 599.01.a., 599.01.b., 599.01.d., and 599.01.e. and by successfully completing the testing requirements set out in Subsections 599.01.c. and 599.01.f. (3-20-20)T

**03. Recordkeeping and Reporting.** (3-20-20)T

a. The owner or operator of the gasoline cargo tank subject to Section 599 shall maintain records of all certification testing and repairs. The records must identify the gasoline cargo tank; the date of the test or repair; and if applicable, the type of repair and the date of retest. The records must be maintained in a legible, readily available condition for at least two (2) years after the date of testing or repair was completed and must be available for inspection by the Department upon request. (3-20-20)T

b. Copies of all tests required under Subsection 599.01 shall be submitted to the Department within thirty (30) days of certification testing. (3-20-20)T

**600. RULES FOR CONTROL OF OPEN BURNING.**

The purpose of Sections 600 through 624 is to reduce the amount of emissions and minimize the impact of open

burning to protect human health and the environment from air pollutants resulting from open burning as well as to reduce the visibility impairment in mandatory Class I Federal Areas in accordance with the regional haze long-term strategy referenced at Section 667. (3-20-20)T

**601. FIRE PERMITS, HAZARDOUS MATERIALS, AND LIABILITY.**

Compliance with the provisions of Sections 600 through 623 does not exempt or excuse any person from complying with applicable laws and ordinances of other jurisdictions responsible for fire control or hazardous material disposal or from liability for damages or injuries which may result from open burning. (3-20-20)T

**602. NONPREEMPTION OF OTHER JURISDICTIONS.**

The provisions of Sections 600 through 623 are not intended to interfere with the rights of any city, county or other governmental entities or agencies to provide equal or more stringent control of open burning within their respective jurisdictions. (3-20-20)T

**603. GENERAL RESTRICTIONS.**

**01. Categories and Materials.** No person shall allow, suffer, cause or permit any open burning operation unless it is a category of open burning set forth in Sections 600 through 623 and the materials burned do not include any of the following: (3-20-20)T

- a. Garbage, as defined in Section 006. (3-20-20)T
- b. Dead animals, animal parts, or animal wastes (feces, feathers, litter, etc.) except as provided in Section 616. (3-20-20)T
- c. Motor vehicles, parts, or any materials resulting from a salvage operation. (3-20-20)T
- d. Tires or other rubber materials or products. (3-20-20)T
- e. Plastics. (3-20-20)T
- f. Asphalt or composition roofing or any other asphaltic material or product. (3-20-20)T
- g. Tar, tar paper, waste or heavy petroleum products, or paints. (3-20-20)T
- h. Lumber or timbers treated with preservatives. (3-20-20)T
- i. Trade waste, as defined in Section 006, except as specifically allowed under Sections 600 through 623. (3-20-20)T
- j. Insulated wire. (3-20-20)T
- k. Pathogenic wastes. (3-20-20)T
- l. Hazardous wastes. (3-20-20)T

**02. Air Pollution Episodes.** No person shall allow, suffer, cause or permit any open burning to be initiated during any stage of an air pollution episode declared by the Department in accordance with Sections 550, through 562. (3-20-20)T

**03. Emergency Authority.** In accordance with Title 39, Chapter 1, Idaho Code, the Department has the authority to require immediate abatement of any open burning in cases of emergency requiring immediate action to protect human health or safety. (3-20-20)T

**604. -- 605. (RESERVED)**

**606. CATEGORIES OF ALLOWABLE BURNING.**

The purpose of Sections 606 through 623 is to establish categories of open burning that are allowed when done according to prescribed conditions. Unless specifically exempted each category in Sections 606 through 623 is subject to all of the provisions of Sections 600 through 605. (3-20-20)T

**607. RECREATIONAL AND WARMING FIRES.**

Fires used for the preparation of food or for recreational purposes (e.g. campfires, ceremonial fires, and barbecues), or small fires set for handwarming purposes, are allowable forms of open burning. (3-20-20)T

**608. WEED CONTROL FIRES.**

Open outdoor fires used for the purpose of weed abatement such as along fence lines, canal banks, and ditch banks is an allowable forms of open burning. (3-20-20)T

**609. TRAINING FIRES.**

Fires used by qualified personnel to train firefighters in the methods of fire suppression and fire fighting techniques, or to display certain fire ecology or fire behavior effects are allowable forms of open burning. Training facilities shall notify the Department prior to igniting any training fires. Training fires shall not be allowed to smolder after the training session has terminated. Training fires are exempt from Subsections 603.01.c. and 603.01.e. through 603.01.j. (3-20-20)T

**610. INDUSTRIAL FLARES.**

Industrial flares, used for the combustion of flammable gases are allowable forms of open burning. Industrial flares are subject to permitting requirements in Sections 200 through 223. (3-20-20)T

**611. RESIDENTIAL SOLID WASTE DISPOSAL FIRES.**

**01. Fires Allowed.** Open outdoor fires used to dispose of solid waste (e.g. rubbish, tree leaves, yard trimmings, gardening waste, etc.) excluding garbage produced by the operation of a domestic household is an allowable form of open burning when the following provisions are met: (3-20-20)T

a. No scheduled house to house solid waste collection service is available; and (3-20-20)T

b. The burning is conducted on the property where the solid waste was generated. (3-20-20)T

**02. Fires Exempt.** Open outdoor fires used to dispose of tree leaves, gardening waste or yard trimmings are exempt from Subsection 611.01.a. when conducted in accordance with local governmental ordinances or rules which allow for the open burning of tree leaves, gardening waste or yard trimming during certain periods of the year. (3-20-20)T

**612. LANDFILL DISPOSAL SITE FIRES.**

The use of fires for the disposal of solid waste at any solid waste landfill disposal site or facility is an allowable form of open burning only if conducted in accordance with IDAPA 58.01.06, "Solid Waste Management Rules and Standards" or the Solid Waste Facilities Act, Chapter 74, Title 39, Idaho Code. (3-20-20)T

**613. ORCHARD FIRES.**

The use of heating devices to protect orchard crops from frost damage and the use of fires to dispose of orchard clippings are allowable forms of open burning when the following provisions are met: (3-20-20)T

**01. Open-Pot Heaters.** The use of stackless open-pot heaters is prohibited. (3-20-20)T

**02. Heating Device Opacity.** Orchard heating device with visible emissions exceeding forty percent (40%) opacity at normal operating conditions shall not be used. Opacity shall be determined by the procedures contained in Section 625. (3-20-20)T

**03. Heating Device Emissions.** All heaters purchased after September 21, 1970, shall emit no more than one (1.0) gram per minute of solid carbonaceous matter at normal operating conditions as certified by the manufacturer. At the time of purchase, the seller shall certify in writing to the purchaser that all new equipment is in compliance with Section 613. (3-20-20)T

**04. Orchard Clippings.** The open burning of orchard clippings shall be conducted on the property where the clippings were generated. (3-20-20)T

**614. PRESCRIBED BURNING.**

The use of open outdoor fires to obtain the objectives of prescribed fire management burning is an allowable form of open burning when the provisions of Section 614 are met. (3-20-20)T

**01. Burning Permits or Prescribed Fire Plans.** (3-20-20)T

**a.** Whenever a burning permit or prescribed fire plan is required by the Department of Lands, U.S.D.A. Forest Service, or any other state or federal agency responsible for land management, any person who conducts or allows prescribed burning shall meet all permit and/or plan conditions and terms which control smoke. (3-20-20)T

**b.** The Department will seek interagency agreements to assure permits or plans issued by agencies referred to in Subsection 614.01.a. provide adequate consideration for controlling smoke from prescribed burning. (3-20-20)T

**02. Smoke Management Plans for Prescribed Burning.** (3-20-20)T

**a.** Whenever a permit or plan is not required by the Department of Lands, U.S.D.A. Forest Service, or any other state or federal agency responsible for land management, any person who conducts or allows prescribed burning shall meet all conditions set forth in a Smoke Management Plan for Prescribed Burning. (3-20-20)T

**b.** The Department will develop and put into effect a Smoke Management Plan for Prescribed Burning consistent with the purpose of Sections 600 through 616. (3-20-20)T

**03. Rights-of-Way Fires.** The open burning of woody debris generated during the clearing of rights of way shall be open burned according to Sections 38-101 and 38-401, Idaho Code, IDAPA 20 Title 16 and Sections 606 through 616 of these rules. (3-20-20)T

**615. DANGEROUS MATERIAL FIRES.**

Fires used or permitted by a public or military fire chief to dispose of materials (including military ordnance) which present a danger to life, valuable property or the public welfare, or for the purpose of prevention of a fire hazard when no practical alternative method of disposal or removal is available are allowable forms of open burning. (3-20-20)T

**616. INFECTIOUS WASTE BURNING.**

Upon the order of a public health officer, fires used to dispose of diseased animals or infested material are an allowable form of open burning and exempt from Subsection 603.01.k. (3-20-20)T

**617. CROP RESIDUE DISPOSAL.**

The open burning of crop residue on fields where the crops were grown is an allowable form of open burning if conducted in accordance with Section 39-114, Idaho Code, and Sections 618 through 624 of these rules. (3-20-20)T

**618. PERMIT BY RULE.**

**01. General Requirements.** All persons shall be deemed to have a permit by rule if they comply with all the provisions of Sections 618 through 624. No person shall conduct an open burn of crop residue without obtaining the applicable permit by rule. Those persons applying for a spot burn, baled agricultural residue burn, or propane flaming permit shall comply with the provisions in Section 624. The permit by rule does not relieve the applicant from obtaining all other required permits and approvals required by other state and local fire agencies or permitting authorities. (3-20-20)T

**02. Forms.** The Department shall provide the appropriate forms to complete the permit by rule. Forms may be available at the Department offices or on the Department website <http://www.deq.idaho.gov>. (3-20-20)T



**619. REGISTRATION FOR PERMIT BY RULE.**

Any person applying to burn crop residue shall annually provide the following registration information to the Department at least thirty (30) days prior to the date the applicant proposes to burn: (3-20-20)T

**01. Location of Property.** Street address of the property upon which the proposed burning of crop residue will occur or, if there is no street address of the property, the legal description of the property using longitude and latitude coordinates or township, range and section for the Idaho meridian; (3-20-20)T

**02. Applicant Information.** Name, mailing address, and telephone number of the applicant, and the person who will be responsible for conducting the proposed burning of crop residue and the portable form of communication referenced in Subsection 622.01.c. of this rule; (3-20-20)T

**03. Plot Plan.** A plot plan showing the location of each proposed crop residue burning area in relation to the property lines and indicating the distances and directions of the nearest residential, public, and commercial properties, and roads; (3-20-20)T

**04. Type, Acreage and Fuel Characteristics of Crop Residue Proposed to be Burned.** The crop type, area over which burning will be conducted (acres), and other fuel characteristics; (3-20-20)T

**05. Preventive Measures.** A description of the measures that will be taken to prevent escaped burns or withhold additional material such that the fire burns down, including but not limited to, the availability of water and plowed firebreaks; and (3-20-20)T

**06. Date of Burning.** The requested date(s) when the proposed crop residue burning would be conducted or the proposed date the field will be available to be burned. (3-20-20)T

**620. BURN FEE.**

**01. Burn Fee.** The burn fee in Section 39-114, Idaho Code, shall be paid in its entirety within thirty (30) days following the receipt of the annual burn fee invoice. See also Subsection 624.02.a. for registration and fee requirements for burning under a spot and baled agricultural residue burn permit. The burn fee should be sent to:

Crop Residue Burn Fee  
Fiscal Office  
Idaho Department of Environmental Quality  
1410 N. Hilton, Boise, ID 83706-1255

(3-20-20)T

**02. Effect of Delinquent Fee Payment.** The Department shall not accept or process a registration for a permit by rule to burn for any person having burn fees delinquent, in full or in part. (3-20-20)T

**621. BURN DETERMINATION.**

**01. Burn Approval Criteria.** The Department shall develop a Crop Residue Operating Guide to use in assisting in the determination of burn approvals. The permittee shall obtain initial approval from the Department for the proposed burn at least twelve (12) hours in advance of the burn. The permittee shall confirm, with the Department, the approval the morning of the proposed burn. The Department may shorten this time frame if meteorological or other applicable conditions change that will impact the air quality during the proposed burn period. To approve a permittee's request to burn, the Department must determine that ambient air quality levels do not exceed ninety percent (90%) of the ozone national ambient air quality standard (NAAQS) and seventy-five percent (75%) of the level of any other NAAQS on any day and are not projected to exceed such level over the next twenty-four (24) hours, and ambient air quality levels have not reached, and are not forecasted to reach and persist at, eighty percent (80%) of the one (1) hour action criteria for particulate matter under Section 556 of these rules. In making this determination, the Department shall consider the following: (3-20-20)T

- a.** Expected Emissions. Expected emissions from all burns proposed for the same dates; (3-20-20)T
- b.** Proximity of Other Burns. The proximity of other burns and other potential emission sources within

- the area to be affected by the proposed burn; (3-20-20)T
- c.** Moisture Content. Moisture content of the material to be burned; (3-20-20)T
  - d.** Acreage, Crop Type, and Fuel Characteristics. Acreage, crop type, and fuel characteristics to be burned; (3-20-20)T
  - e.** Meteorological Conditions. Meteorological conditions; (3-20-20)T
  - f.** Proximity to Institutions with Sensitive Populations. The proximity of the burn to institutions with sensitive populations, including public schools while in session; hospitals; residential health care facilities for children, the elderly or infirm; and other institutions with sensitive populations as approved by the Department. The Department shall not authorize a burn if conditions are such that institutions with sensitive populations will be adversely impacted or when the plume is predicted to impact such institutions; (3-20-20)T
  - g.** Proximity to Public Roadways. Proximity to public roadways; (3-20-20)T
  - h.** Proximity to Airports. Proximity to airports; and (3-20-20)T
  - i.** Other Relevant Factors. Any other factors relevant to preventing exceedances of the air quality concentrations of Section 621. (3-20-20)T

**02. Notification of Approval.** If the Department approves the burn, then it will post on its website written notification of the approval and any specific conditions under which the burn is approved. Special conditions may include, but are not limited to: (3-20-20)T

- a.** Conditions for burns near institutions with sensitive populations; (3-20-20)T
- b.** The requirement to withhold additional material such that the fire burns down if the Department determines pollutant concentrations reach the levels in Subsection 621.01 of this rule; (3-20-20)T
- c.** Conditions to ensure the burn does not create a hazard for travel on a public roadway; and (3-20-20)T
- d.** The requirement to consult with the Department to determine actions to be taken if conditions at the burn site fail to satisfy the conditions specified in the notice of approval to burn. (3-20-20)T

**622. GENERAL PROVISIONS.**

**01. Burn Provisions.** All persons in Idaho intending to dispose of crop residue through burning shall abide by the following provisions: (3-20-20)T

- a.** Burning Prohibitions. Burning of crop residue shall not be conducted on weekends, federal or state holidays, or after sunset or before sunrise; (3-20-20)T
- b.** Designated Burn Day. Burning of crop residue shall not be conducted unless the Department has designated that day a burn day and the permittee has received individual approval specifying the conditions under which the burn may be conducted; (3-20-20)T
- c.** Portable Form of Communication. The person conducting the burning must have on their possession a portable form of communication such as a cellular phone or radio of compatible frequency with the Department in order to receive burn approval information or information that might require measures to withhold additional material such that the fire burns down; (3-20-20)T
- d.** Location of Field Burning. Open burning of crop residue shall be conducted in the field where it was generated; (3-20-20)T

**e.** Limitations on Burning. When required by the conditions of the notice of approval to burn, the permittee burning in proximity to institutions with sensitive populations shall immediately extinguish the fire or withhold additional material such that the fire burns down, unless the Department determines that the burn will not have an adverse impact on such institutions; (3-20-20)T

**f.** Training Session. All persons intending to burn crop residue shall attend a crop residue burning training session provided by the Idaho Department of Environmental Quality or the Idaho State Department of Agriculture and shall attend a crop residue disposal refresher training session every five (5) years; (3-20-20)T

**g.** Air Stagnation or Degraded Air Quality. All field burning shall be prohibited when the Department issues an air quality forecast and caution, alert, warning or emergency as identified in Section 552 of these rules; (3-20-20)T

**h.** Allowable Forms of Open Burning. The use of reburn machines, propane flammers, or other portable devices to ignite or reignite a field for the purposes of crop residue burning shall be considered an allowable form of open burning. Tires and other restricted material described in Subsection 603.01, of this rule, are not allowed for ignition of fields; (3-20-20)T

**i.** Additional Burn Permits. All persons intending to burn crop residue shall obtain any additional applicable permits from federal, state or local fire control authorities prior to receiving approval from the Department to burn crop residue; and (3-20-20)T

**j.** Reporting to the Department. All persons burning crop residue shall report to the Department the date burning was conducted, the actual number and location of acres burned, and other information as required by the Department. The Department may restrict further burning by a permittee until completed burns are reported. (3-20-20)T

**k.** Specific Conditions. The open burning of crop residue shall be conducted in accordance with the specific conditions in the permittee's permit by rule. (3-20-20)T

**02. Annual Report.** The Department shall develop an annual report that shall include, at a minimum, an analysis of the causes of each exceedance of a limitation in Section 621 of this rule, if any, and an assessment of the circumstances associated with any reported endangerment to human health associated with a burn. The report shall include any proposed revisions to these rules or the Crop Residue Operating Guide deemed necessary to prevent future exceedances. (3-20-20)T

**03. Advisory Committee.** The Department will assemble an advisory committee consisting of representatives from environmental organizations, farming organizations, health organizations, tribal organizations, the Idaho State Department of Agriculture, the Idaho Department of Environmental Quality, and others to discuss open burning of crop residue issues. (3-20-20)T

**623. PUBLIC NOTIFICATION.**

**01. Designation of Burn Days.** The Director or his designee shall designate for a given county or airshed within a county burn or no-burn days. (3-20-20)T

**02. Posting on Website.** The Department shall post daily on its website ([www.deq.idaho.gov](http://www.deq.idaho.gov)): (3-20-20)T

**a.** Whether a given day is a burn or no-burn day; (3-20-20)T

**b.** The location and number of acres permitted to be burned; (3-20-20)T

**c.** Meteorological conditions and any real time ambient air quality monitoring data; and (3-20-20)T

**d.** A toll-free number to receive requests for information (1-800-345-1007). (3-20-20)T

**03. E-Mail Update Service.** The Department shall provide an opportunity for interested persons to sign up to receive automatic e-mail updates for information regarding the open burning of crop residue. (3-20-20)T

**624. SPOT BURN, BALED AGRICULTURAL RESIDUE BURN, AND PROPANE FLAMING PERMITS.**

**01. Applicability.** (3-20-20)T

**a. Spot Burn.** A spot burn includes no more than one (1) acre of evenly distributed crop residue or two (2) tons of piled crop residue. The open burning of weed patches, spots of heavy residue, equipment plugs and dumps, pivot corners of fields, and pastures may constitute a spot burn. Spot burn does not include the open burning of wind rows. (3-20-20)T

**b. Baled Agricultural Residue Burn.** An open burn used to dispose of broken, mildewed, diseased, or otherwise pest-ridden bales still in the field where they were generated. (3-20-20)T

**c. Propane Flaming.** The use of flame-generating equipment to briefly apply flame and/or heat to the topsoil of a cultivated field of pre-emerged or plowed-under crop residue with less than five hundred fifty (550) pounds of burnable, non-green residue per acre in order to control diseases, insects, pests, and weed emergence. (3-20-20)T

**02. Spot and Baled Agricultural Residue Burn Permit.** (3-20-20)T

**a. Registration and Fee Requirements.** Any person applying for a spot and baled agricultural residue burn permit under Section 624 shall provide the registration information listed in Subsections 619.01 and 619.02 and pay a nonrefundable fee of twenty dollars (\$20) to the Department (see Section 620) at least fourteen (14) days prior to the date the applicant proposes to conduct the first burn of the calendar year. (3-20-20)T

**b. Term and Acreage.** A spot and baled agricultural residue burn permit is valid for the calendar year in which it is issued and is good for a cumulative total of no more than ten (10) acres of spots and/or equivalent piled or baled agricultural residue during the year and no more than one (1) acre of spots and/or equivalent piled or baled agricultural residue per day. Two (2) tons of piled or baled agricultural residue is assumed to be equivalent to one (1) acre. (3-20-20)T

**03. Propane Flaming Permit.** Persons conducting propane flaming as defined under Subsection 624.01.c. shall be deemed to have a permit by rule if they comply with the applicable provisions in Subsections 624.04 and 624.05. (3-20-20)T

**04. General Provisions.** All persons intending to burn under Section 624 shall comply with the provisions of Subsections 622.01.c., 622.01.d., 622.01.f., through 622.01.i., and 622.01.k. in addition to the following: (3-20-20)T

**a.** The permittee is responsible to ensure that adequate measures are taken so the burn does not create a hazard for travel on a public roadway. (3-20-20)T

**b.** Burning is not allowed if the proposed burn location is within three (3) miles of an institution with a sensitive population and the surface wind speed is greater than twelve (12) miles per hour or if the smoke is adversely impacting or is expected to adversely impact an institution with a sensitive population. (3-20-20)T

**c. Designated Burn Day.** Burning shall not be conducted unless the Department has designated that day a burn day, which for purposes of Section 624 may include weekends and holidays, and the permittee burns within the burn window provided on the Department's website at [www.deq.idaho.gov](http://www.deq.idaho.gov). Spot and baled agriculture residue burns shall not smolder and create smoke outside of the designated time period burning is allowed. (3-20-20)T

**05. Recordkeeping.** Permittees shall record the date, time frame, type of burn, type of crop, and

amount burned on the date of the burn. Records of such burns shall be retained for two (2) years and made available to the Department upon request. (3-20-20)T

**625. VISIBLE EMISSIONS.**

A person shall not discharge any air pollutant into the atmosphere from any point of emission for a period or periods aggregating more than three (3) minutes in any sixty (60) minute period which is greater than twenty percent (20%) opacity as determined by this section. (3-20-20)T

- 01. Exemptions.** The provisions of this section shall not apply to: (3-20-20)T
  - a.** Kraft Process Lime Kilns, if operating prior to January 24, 1969; or (3-20-20)T
  - b.** Carbon Monoxide Flare Pits on Elemental Phosphorous Furnaces, if operating prior to January 24, 1969; or (3-20-20)T
  - c.** Liquid Phosphorous Loading Operations, if operating prior to January 24, 1969; or (3-20-20)T
  - d.** Wigwam Burners; or (3-20-20)T
  - e.** Kraft Process Recovery Furnaces. (3-20-20)T
  - f.** Calcining Operations Utilizing an Electrostatic Precipitator to Control Emissions, if operating prior to January 24, 1969. (3-20-20)T

**02. Standards for Exempted Sources.** Except as provided in Section 626, for sources exempted from the provisions of this section, a person shall not discharge into the atmosphere from any point of emission, for any air pollutant for a period or periods aggregating more than three (3) minutes in any sixty (60) minute period which is greater than forty percent (40%) opacity as determined by this section. (3-20-20)T

**03. Exception.** The provisions of this section shall not apply when the presence of uncombined water, nitrogen oxides and/or chlorine gas are the only reason(s) for the failure of the emission to comply with the requirements of this rule. (3-20-20)T

**04. Test Methods and Procedures.** The appropriate test method under this section shall be EPA Method 9 (contained in 40 CFR Part 60) with the method of calculating opacity exceedances altered as follows: (3-20-20)T

- a.** Opacity evaluations shall be conducted using forms available from the Department or similar forms approved by the Department. (3-20-20)T
- b.** Opacity shall be determined by counting the number of readings in excess of the percent opacity limitation, dividing this number by four (4) (each reading is deemed to represent fifteen (15) seconds) to find the number of minutes in excess of the percent opacity limitation. This method is described in the Procedures Manual for Air Pollution Control, Section II (Evaluation of Visible Emissions Manual), September 1986. (3-20-20)T
- c.** Sources subject to New Source Performance Standards must calculate opacity as detailed above and as specified in 40 CFR Part 60. (3-20-20)T

**05. Applicability.** Section 625 shall not apply to the open burning of crop residue. (3-20-20)T

**626. GENERAL RESTRICTIONS ON VISIBLE EMISSIONS FROM WIGWAM BURNERS.**

Except for a period of one (1) hour following start up a person shall not discharge into the atmosphere from any wigwam burner any air pollutant for a period or periods aggregating more than three (3) minutes in any sixty (60) minute period which is greater than twenty percent (20%) opacity as determined by the procedures contained in Section 625. (3-20-20)T

**627. -- 649. (RESERVED)**

**650. RULES FOR CONTROL OF FUGITIVE DUST.**

The purpose of Sections 650 through 652 is to require that all reasonable precautions be taken to prevent the generation of fugitive dust. (3-20-20)T

**651. GENERAL RULES.**

All reasonable precautions shall be taken to prevent particulate matter from becoming airborne. In determining what is reasonable, consideration will be given to factors such as the proximity of dust emitting operations to human habitations and/or activities, the proximity to mandatory Class I Federal Areas and atmospheric conditions which might affect the movement of particulate matter. Some of the reasonable precautions may include, but are not limited to, the following: (3-20-20)T

**01. Use of Water or Chemicals.** Use, where practical, of water or chemicals for control of dust in the demolition of existing buildings or structures, construction operations, the grading of roads, or the clearing of land. (3-20-20)T

**02. Application of Dust Suppressants.** Application, where practical, of asphalt, oil, water or suitable chemicals to, or covering of dirt roads, material stockpiles, and other surfaces which can create dust. (3-20-20)T

**03. Use of Control Equipment.** Installation and use, where practical, of hoods, fans and fabric filters or equivalent systems to enclose and vent the handling of dusty materials. Adequate containment methods should be employed during sandblasting or other operations. (3-20-20)T

**04. Covering of Trucks.** Covering, when practical, open bodied trucks transporting materials likely to give rise to airborne dusts. (3-20-20)T

**05. Paving.** Paving of roadways and their maintenance in a clean condition, where practical. (3-20-20)T

**06. Removal of Materials.** Prompt removal of earth or other stored material from streets, where practical. (3-20-20)T

**652. AGRICULTURAL ACTIVITIES.**

For agricultural activity purposes, operating in conformance with generally recognized agricultural practices constitutes reasonable control of fugitive dust. For the purpose of Section 652: (3-20-20)T

**01. Agricultural Activity.** An “agricultural activity” means any activity that is exempt from the requirement to obtain a permit to construct under Subsection 222.02.f., wherein “agricultural activities and services” is defined in Section 007, that occurs in connection with the production of agricultural products for food, fiber, fuel, feed and other lawful purposes, and including, but not limited to: (3-20-20)T

**a.** Preparing land for agricultural production; (3-20-20)T

**b.** Applying or handling pesticides herbicides, or other chemicals, compounds or substances labeled for insects, pests, crops, weeds, water or soil; (3-20-20)T

**c.** Planting, irrigating, growing, fertilizing, harvesting or producing agricultural, horticultural, floricultural and viticulture crops, fruits and vegetable products, field grains, seeds, hay, sod and nursery stock, and other plant products, plant by-products, plant waste and animal compost; (3-20-20)T

**d.** Breeding, hatching, raising, producing, feeding and keeping livestock, dairy animals, swine, fur-bearing animals, poultry, eggs, fish and other aquatic species, and other animals, animal products and animal by-products, animal waste, animal compost, and bees, bee products and bee by-products; (3-20-20)T

**e.** Transporting agricultural products to or from an agricultural facility; (3-20-20)T

**f.** Grinding, chopping, cubing, or any other means of preparing or converting a commodity for animal

feed; and (3-20-20)T

- g.** Piling, stacking or other means of storing commodities outdoors. (3-20-20)T

**02. Generally Recognized Agricultural Practices.** “Generally recognized agricultural practices” means economically feasible practices that are customary among or appropriate to farms and ranches of a similar nature in the local area. In determining whether an agricultural activity is consistent with generally recognized agricultural practices, the Idaho Department of Environmental Quality shall consult with the Idaho Department of Agriculture. (3-20-20)T

**653. -- 664. (RESERVED)**

**665. REGIONAL HAZE RULES.**

The purpose of Sections 665 through 668 is to address regional haze visibility impairment in mandatory Class I Federal Areas. The intent of Sections 665 through 668 is to set forth the requirements to implement the federal programs for visibility protection and regional haze. (3-20-20)T

**666. REASONABLE PROGRESS GOALS.**

The Department will establish reasonable progress goals, expressed in deciviews for each mandatory Class I Federal Area located within Idaho. These goals will provide for reasonable progress toward achieving natural visibility conditions. The reasonable progress goals must provide for an improvement in visibility for the most impaired days over the period of the implementation plan and ensure no degradation in visibility for the least impaired days over the same period. The reasonable progress goals are not directly enforceable, but will be implemented through enforceable strategies in the long-term strategy. (3-20-20)T

**01. Process for Setting Reasonable Progress Goals.** In establishing a reasonable progress goal for any mandatory Class I Federal Area within Idaho, the Department shall: (3-20-20)T

**a.** Consider the costs of compliance, the time necessary for compliance, the energy and non-air quality environmental impacts of compliance, and the remaining useful life of any potentially affected sources, and include a demonstration showing how these factors were taken into consideration in selecting the goal. (3-20-20)T

**b.** Analyze and determine the rate of progress needed to attain natural visibility conditions by the year 2064. To calculate this rate of progress, the Department will compare baseline visibility conditions to natural visibility conditions in the mandatory Class I Federal Area and determine the uniform rate of visibility improvement (measured in deciviews) that would need to be maintained during each implementation period in order to attain natural visibility conditions by 2064. In establishing the reasonable progress, the Department will consider the uniform rate of improvement in visibility and the emission reduction measures needed to achieve it for the period covered by the implementation plan. (3-20-20)T

**c.** Consult with those states which may reasonably be anticipated to cause or contribute to visibility impairment in the mandatory Class I Federal Area. (3-20-20)T

**02. Justification for Reasonable Progress Goals.** If the Department establishes a reasonable progress goal that provides for a slower rate of improvement in visibility than the rate that would be needed to attain natural conditions by 2064, the Department will demonstrate, based on the factors in Subsection 666.01.a., that the rate of progress for the implementation plan to attain natural conditions by 2064 is not reasonable; and that the progress goal adopted by the Department is reasonable. The Department will provide to the public for review, as part of its implementation plan, an assessment of the number of years it would take to attain natural conditions if visibility improvement continues at the rate of progress selected by the Department as reasonable. (3-20-20)T

**667. LONG-TERM STRATEGY FOR REGIONAL HAZE.**

The purpose of Section 667 is to develop a long-term strategy for making reasonable progress toward the national goal of preventing any future and remedying any existing impairment of visibility in mandatory Class I Federal Areas in which impairment results from man-made air pollution. (3-20-20)T

- 01. Submittal of Long-Term Strategy.** The Department will submit to EPA a long-term strategy that

addresses regional haze visibility impairment for each mandatory Class I Federal Area within the state and for each mandatory Class I Federal Area located outside the state which may be affected by emissions from the state. (3-20-20)T

**02. Enforceable Emission Limitations.** The long-term strategy must include enforceable emissions limitations, compliance schedules, and other measures as necessary to achieve the reasonable progress goals established by the Department. (3-20-20)T

**03. Requirements for Long-Term Strategy.** In establishing long-term strategy for regional haze, the Department will meet the following requirements: (3-20-20)T

**a.** The Department will document the technical basis, including modeling, monitoring and emissions information, on which the state is relying to determine its apportionment of emission reduction obligations necessary for achieving reasonable progress in each mandatory Class I Federal Area it affects. The Department may meet this requirement by relying on technical analyses developed by the regional planning organization and approved by all state participants. The Department will identify the baseline emission inventory on which its strategies are based. The baseline emissions inventory year is presumed to be the most recent year of the consolidated periodic emissions inventory. (3-20-20)T

**b.** The Department will identify all anthropogenic sources of visibility impairment considered by the Department in developing its long-term strategy. The Department should consider major and minor stationary sources, mobile sources, and area sources. (3-20-20)T

**c.** The Department will consider, at a minimum, the following factors in developing its long-term strategy: (3-20-20)T

**i.** Emission reductions due to ongoing air pollution control programs, including measures to address reasonably attributable visibility impairment; (3-20-20)T

**ii.** Measures to mitigate the impacts of construction activities; (3-20-20)T

**iii.** Emissions limitations and schedules for compliance to achieve the reasonable progress goal; (3-20-20)T

**iv.** Source retirement replacement schedules; (3-20-20)T

**v.** Smoke management techniques for agricultural and forestry management purposes including plans as currently exist with the state for these purposes; (3-20-20)T

**vi.** Enforceability of emissions limitations and control measures; and (3-20-20)T

**vii.** The anticipated net effect on visibility due to projected changes in point, area, and mobile source emissions over the period addressed by the long-term strategy. (3-20-20)T

**04. Interstate Consultation.** The Department will undertake the following process in developing the long-term strategy where interstate consultation is required. (3-20-20)T

**a.** Where Idaho has emissions that are reasonably anticipated to contribute to visibility impairment in any mandatory Class I Federal Area located in another state or states, the Department will consult with the other state(s) in order to develop coordinated emission management strategies. (3-20-20)T

**b.** The Department will consult with any other state having emissions that are reasonably anticipated to contribute to visibility impairment in any mandatory Class I Federal Area within Idaho. (3-20-20)T

**c.** Where other states cause or contribute to impairment in a mandatory Class I Federal Area, the Department must demonstrate that the state has included in its implementation plan all measures necessary to obtain its share of the emission reductions needed to meet the progress goal for the area. If the state of Idaho has participated



in a regional planning process, the Department must ensure the state has included all measures needed to achieve its apportionment of emission reduction obligations agreed upon through that process. (3-20-20)T

**668. BART REQUIREMENT FOR REGIONAL HAZE.**

The purpose of Section 668 is to implement the BART requirements in 40 CFR 51.308(e). The following analysis and documentation is required for each BART-eligible source: (3-20-20)T

**01. BART-Eligible Sources.** The Department shall identify a list of all BART-eligible sources within the state. (3-20-20)T

**02. BART Determination.** The Department shall complete a determination of BART for each BART-eligible source in the state that emits any air pollutant which may reasonably be anticipated to cause or contribute to any impairment of visibility in any mandatory Class 1 Federal Area. All such sources are subject to BART. (3-20-20)T

**a.** A single source that is responsible for a one (1.0) deciview change or more in any mandatory Class I Federal Area is considered to “cause” visibility impairment. (3-20-20)T

**b.** A single source that is responsible for a one-half (0.5) deciview change or more in any mandatory Class I Federal Area is considered to “contribute” to visibility impairment. (3-20-20)T

**c.** The determination of BART must be based on an analysis of the best system of continuous emission control technology available and associated emission reductions achievable for each BART-eligible source that is subject to BART within the state. In this analysis, the following must be taken into consideration: (3-20-20)T

i. Costs of compliance; (3-20-20)T

ii. Energy and non-air quality environmental impacts of compliance; (3-20-20)T

iii. Any pollution control equipment in use at the source; (3-20-20)T

iv. The remaining useful life of the source; and (3-20-20)T

v. The degree of improvement in visibility which may reasonably be anticipated to result from the use of such technology. (3-20-20)T

**d.** The Department may determine that a BART determination is not required: (3-20-20)T

i. For sulfur dioxide (SO<sub>2</sub>) or for nitrogen oxides (NO<sub>x</sub>) if a BART-eligible source has the potential to emit less than forty (40) tons per year of such pollutant(s); or (3-20-20)T

ii. For PM<sub>10</sub> if a BART-eligible source emits less than fifteen (15) tons per year of such pollutant. (3-20-20)T

**03. Alternative to Infeasible Emission Standards.** If the Department determines in establishing BART that technological or economic limitations on the applicability of measurement methodology to a particular source would make the imposition of an emission standard infeasible, it may instead prescribe a design, equipment, work practice, or other operational standard, or combination thereof, to require the application of BART. Such standard, to the degree possible, is to set forth the emission reduction to be achieved by implementation of such design, equipment, work practice, or operation and must provide for compliance by means which achieve equivalent results. (3-20-20)T

**04. BART Installation and Operation Due Date.** Each source subject to BART is required to install and operate BART as expeditiously as practicable, but in no event later than five (5) years after approval of the implementation plan. (3-20-20)T

**05. Maintenance of BART Equipment.** Each source subject to BART is required to maintain the

control equipment required by the Department and establish procedures to ensure such equipment is properly operated and maintained. (3-20-20)T

**06. BART Alternative.** As an alternative to the installation of BART for a source or sources, the Department may approve a BART alternative. If the Department approves source grouping as a BART alternative, only sources (including BART-eligible and non-BART eligible sources) causing or contributing to visibility impairment to the same mandatory Class I Federal Area may be grouped together. (3-20-20)T

**a.** If a source(s) proposes a BART alternative, the resultant emissions reduction and visibility impacts must be compared with those that would result from the BART options evaluated for the source(s). (3-20-20)T

**b.** Source(s) proposing a BART alternative must demonstrate that this BART alternative will achieve greater reasonable progress than would be achieved through the installation and operation of BART. (3-20-20)T

**c.** Source(s) proposing a BART alternative shall include in the BART analysis an analysis and justification of the averaging period and method of evaluating compliance with the proposed emission limitation. (3-20-20)T

**07. Reasonable Progress Goal Requirements for BART-Eligible Sources.** Once the Department has met the requirements for BART or BART alternative, as identified in Subsection 668.06, BART-eligible sources will be subject to the requirements of reasonable progress goals, as defined in 40 CFR 51.308(d), in the same manner as other sources. (3-20-20)T

**669. -- 674. (RESERVED)**

**675. FUEL BURNING EQUIPMENT -- PARTICULATE MATTER.**

The purpose of Sections 675 through 681 is to establish particulate matter emission standards for fuel burning equipment. (3-20-20)T

**676. STANDARDS FOR NEW SOURCES.**

A person shall not discharge into the atmosphere from any fuel burning equipment with a maximum rated input of ten (10) million BTU's per hour or more, and commencing operation on or after October 1, 1979, particulate matter in excess of the concentrations shown in the following table:

FUEL TYPE	ALLOWABLE PARTICULATE gr/dscf	EMISSIONS Oxygen
Gas	.015	3%
Liquid	.050	3%
Coal	.050	8%
Wood Product	.080	8%

The effluent gas volume shall be corrected to the oxygen concentration shown. (3-20-20)T

**677. STANDARDS FOR MINOR AND EXISTING SOURCES.**

A person shall not discharge into the atmosphere from any fuel burning equipment in operation prior to October 1, 1979, or with a maximum rated input of less than ten (10) million BTU per hour, particulate matter in excess of the concentrations shown in the following table:

FUEL TYPE	ALLOWABLE PARTICULATE gr/dscf	EMISSIONS Oxygen
Gas	.015	3%
Liquid	.050	3%
Coal	.100	8%

FUEL TYPE	ALLOWABLE PARTICULATE gr/dscf	EMISSIONS Oxygen
Wood Product	.200	8%

The effluent gas volume shall be corrected to the oxygen concentration shown. (3-20-20)T

**678. COMBINATIONS OF FUELS.**

When two (2) or more types of fuel are burned concurrently, the allowable emission shall be determined by proportioning the gross heat input and emission standards for each fuel. (3-20-20)T

**679. AVERAGING PERIOD.**

For purposes of Sections 675 through 680, emissions shall be averaged according to the following, whichever is the lesser period of time: (3-20-20)T

**01. One Cycle.** One (1) complete cycle of operation; or (3-20-20)T

**02. One Hour.** One (1) hour of operation representing worst-case conditions for the emission of particulate matter. (3-20-20)T

**680. ALTITUDE CORRECTION.**

For purposes of Sections 675 through 680, standard conditions shall be adjusted for the altitude of the source by subtracting one-tenth (0.10) of an inch of mercury for each one hundred (100) feet above sea level from the standard atmospheric pressure at sea level of twenty-nine and ninety-two one hundredths (29.92) inches of mercury. (3-20-20)T

**681. TEST METHODS AND PROCEDURES.**

The appropriate test method under Sections 675 through 680 shall be EPA Method 5 contained in 40 CFR Part 60 or such comparable and equivalent method approved in accordance with Subsection 157.02.d. Test methods and procedures shall also comply with Section 157. (3-20-20)T

**682. -- 699. (RESERVED)**

**700. PARTICULATE MATTER -- PROCESS WEIGHT LIMITATIONS.**

**01. Particulate Matter Emission Limitations.** The purpose of Sections 700 through 703 is to establish particulate matter emission limitations for process equipment. (3-20-20)T

**02. Minimum Allowable Emission.** Notwithstanding the provisions of Sections 701 and 702, no source shall be required to meet an emission limit of less than one (1) pound per hour. (3-20-20)T

**03. Averaging Period.** For the purposes of Sections 701 through 703, emissions shall be averaged according to the following, whichever is the lesser period of time: (3-20-20)T

**a.** One (1) complete cycle of operation; or (3-20-20)T

**b.** One (1) hour of operation representing worst-case conditions for the emissions of particulate matter. (3-20-20)T

**04. Test Methods and Procedures.** The appropriate test method under Sections 700 through 703 shall be EPA Method 5 contained in 40 CFR Part 60 or such comparable and equivalent methods approved in accordance with Subsection 157.02.d. Test methods and procedures shall comply with Section 157. (3-20-20)T

**701. PARTICULATE MATTER -- NEW EQUIPMENT PROCESS WEIGHT LIMITATIONS.**

**01. General Restrictions.** No person shall emit into the atmosphere from any process or process equipment commencing operation on or after October 1, 1979, particulate matter in excess of the amount shown by the following equations, where E is the allowable emission from the entire source in pounds per hour, and PW is the

process weight in pounds per hour. (3-20-20)T

a. If PW is less than 9,250 pounds per hour,  
 $E = 0.045(PW)^{0.60}$  (3-20-20)T

b. If PW is equal to or greater than 9,250 pounds per hour,  
 $E = 1.10(PW)^{0.25}$  (3-20-20)T

**02. Exemption.** The provisions of Section 701 shall not apply to fuel burning equipment. (3-20-20)T

**03. Emission Standards -- Table.** The following table illustrates the emission standards set forth in Section 701.

PROCESS WEIGHT	ALLOWABLE EMISSIONS FROM ENTIRE SOURCE	PROCESS WEIGHT	EMISSIONS FROM ENTIRE SOURCE
lb/hr	lb/hr	lb/hr	lb/hr
175 or less	1	20,000	13.08
200	1.08	40,000	15.56
400	1.64	60,000	17.22
600	2.09	80,000	18.50
800	2.40	100,000	19.56
1,000	2.84	200,000	23.26
2,000	4.30	400,000	27.66
4,000	6.52	600,000	30.61
6,000	8.32	800,000	32.90
8,000	9.89	1,000,000	34.79
10,000	11.00	2,000,000	41.37

(3-20-20)T

**702. PARTICULATE MATTER -- EXISTING EQUIPMENT PROCESS WEIGHT LIMITATIONS.**

The provisions of Section 702 shall become effective on January 1, 1981. (3-20-20)T

**01. General Restrictions.** No person shall emit into the atmosphere from any process or process equipment operating prior to October 1, 1979, particulate matter in excess of the amount shown by the following equations, where E is the allowable emission from the entire source in pounds per hour, and PW is the process weight in pounds per hour: (3-20-20)T

a. If PW is less than 17,000 pounds per hour,  
 $E = 0.045 (PW)^{0.60}$  (3-20-20)T

b. If PW is equal to or greater than 17,000 pounds per hour,  
 $E = 1.12 (PW)^{0.27}$ . (3-20-20)T

**02. Exemptions.** The provisions of Section 702 shall not apply to: (3-20-20)T

a. Fuel burning equipment; or (3-20-20)T

- b. Equipment used exclusively to dehydrate sugar beet pulp or alfalfa. (3-20-20)T

03. Emission Standards -- Table. The following table illustrates the emission standards set forth in Section 702.

PROCESS WEIGHT	EMISSIONS FROM ENTIRE SOURCE	PROCESS WEIGHT	EMISSIONS FROM ENTIRE SOURCE
lb/hr	lb/hr	lb/hr	lb/hr
175 or less	1	20,000	16.24
200	1.08	40,000	19.58
400	1.64	60,000	21.84
600	2.09	80,000	23.61
800	2.48	100,000	25.07
1,000	2.84	200,000	30.23
2,000	4.30	400,000	36.46
4,000	6.52	600,000	40.67
6,000	8.32	800,000	43.96
8,000	9.89	1,000,000	46.69
10,000	11.30	2,000,000	56.30

(3-20-20)T

703. PARTICULATE MATTER -- OTHER PROCESSES.

01. Other Processes. No person with processes exempt under Subsection 702.02.b. shall emit particulate matter to the atmosphere from any process or process equipment in excess of the amount shown in the following equations, where E is the total rate of emission from all emission points from the source in pounds per hour and P is the process weight rate in pounds per hour. (3-20-20)T

- a. If P is less than sixty thousand (60,000) pounds per hour,  
 $E = 0.02518(P)^{0.67}$  (3-20-20)T

- b. If P is greater than or equal to sixty thousand (60,000) pounds per hour,  
 $E = 23.84(P)^{0.11} - 40$  (3-20-20)T

02. Emission Standards -- Table. The following table illustrates the emission standards set forth in Section 703.

ALLOWABLE RATE OF EMISSION BASED ON PROCESS WEIGHT RATE			
Process Weight Rate	Rate of Emission	Process Weight Rate	Rate of Emission
Lb/Hr	Lb/Hr	Lb/Hr	Lb/Hr
100	0.551	16,000	16.5
200	0.877	18,000	17.9

ALLOWABLE RATE OF EMISSION BASED ON PROCESS WEIGHT RATE			
Process Weight Rate	Rate of Emission	Process Weight Rate	Rate of Emission
Lb/Hr	Lb/Hr	Lb/Hr	Lb/Hr
400	1.40	20,000	19.2
600	1.83	30,000	25.2
800	2.22	40,000	30.5
1,000	2.58	50,000	35.4
1,500	3.38	60,000	40.0
2,000	4.10	70,000	41.3
2,500	4.76	80,000	42.5
3,000	5.38	90,000	43.6
3,500	5.96	100,000	44.6
4,000	6.52	120,000	46.3
5,000	7.58	140,000	47.8
6,000	8.56	160,000	49.0
7,000	9.49	200,000	51.2
8,000	10.4	1,000,000	69.0
9,000	11.2	2,000,000	77.6
10,000	12.0	6,000,000	92.7
12,000	13.6		

(3-20-20)T

**704. -- 724. (RESERVED)**

**725. RULES FOR SULFUR CONTENT OF FUELS.**

This section applies to fuel burning sources in Idaho. Its purpose is to prevent excessive ground level concentrations of sulfur dioxide. The reference test method for measuring fuel sulfur content shall be ASTM method, D129-95 Standard Test for Sulfur in Petroleum Products (General Bomb Method) or such comparable and equivalent method approved in accordance with Subsection 157.02.d. Test methods and procedures shall comply with Section 157.

(3-20-20)T

**01. Definitions.** (3-20-20)T

**a. ASTM.** American Society for Testing and Materials. (3-20-20)T

**b. Distillate Fuel Oil.** Any oil meeting the specifications of ASTM Grade 1 or Grade 2 fuel oils. (3-20-20)T

**c. Residual Fuel Oil.** Any oil meeting the specifications of ASTM Grade 4, Grade 5 and Grade 6 fuel oils. (3-20-20)T

**02. Residual Fuel Oils.** No person shall sell, distribute, use or make available for use, any residual fuel

oil containing more than one and three-fourths percent (1.75%) sulfur by weight. (3-20-20)T

**03. Distillate Fuel Oil.** No person shall sell, distribute, use or make available for use, any distillate fuel oil containing more than the following percentages of sulfur: (3-20-20)T

**a. ASTM Grade 1.** ASTM Grade 1 fuel oil - zero point three percent (0.3%) by weight. (3-20-20)T

**b. ASTM Grade 2.** ASTM Grade 2 fuel oil - zero point five percent (0.5%) by weight. (3-20-20)T

**04. Coal.** No person shall sell, distribute, use or make available for use, any coal containing greater than one percent (1.0%) sulfur by weight. (3-20-20)T

**05. Alternative.** The Department may approve in a permit issued in accordance with these rules an alternative fuel sulfur content if the applicant demonstrates that, through control measures or other means, sulfur dioxide emissions (based on a one (1) hour averaging period) are equal to or less than those resulting from the combustion of fuels complying with the limitations of Subsections 725.01 through 725.04. (3-20-20)T

**726. -- 749. (RESERVED)**

**750. RULES FOR CONTROL OF FLUORIDE EMISSIONS.**

The purpose of Sections 750 through 751 is to prevent the emission of fluorides such that the accumulation of fluorine in feed and forage for livestock does not exceed the safe limits specified below. (3-20-20)T

**751. GENERAL RULES.**

Any owner or operator of a facility subject to Sections 750 and 751 shall demonstrate compliance with Section 751 by January 1, 1982, in accordance with a compliance schedule, listing increments of progress, which shall be submitted to the Department on or before August 1, 1980. (3-20-20)T

**01. Emission Limitations -- Phosphate Fertilizer Plants.** No person shall allow, suffer, cause or permit the discharge into the atmosphere of total fluoride emissions in gaseous and in particulate form, expressed as fluoride (F-), from the phosphate fertilizer plant sources listed in Subsection 751.03 in excess of thirty hundredths (0.30) pounds of fluoride per ton of P<sub>2</sub>O<sub>5</sub> input to the calciner operation, calculated at maximum rated capacity. (3-20-20)T

**02. Monitoring, Testing, and Reporting Requirements.** Compliance with Subsection 751.01 will be adjudged upon the results of the continuing program of fluoride sampling of potential grazing areas and alfalfa growing areas conducted by the Department. Sampling conducted by any person subject to Section 751 may be accepted for determining compliance with Subsection 751.01 if such sampling is conducted at sites approved by the Department in advance of sampling, using analytical procedures appearing in the Procedures Manual for Air Pollution Control, Section I (Source Test Methods) or equivalent methods approved by the Department in advance of sampling. Compliance with Subsection 751.01 shall be demonstrated by testing methods approved in advance by the Department. When approved by the Director in advance of sampling, engineering calculations may be submitted in lieu of emission data. Monitoring and reporting requirements shall be included in operating permits granted to each facility. (3-20-20)T

**03. Source Specific Permits.** To assure compliance with Subsection 751.01, the Director shall specify methods for calculating total allowable emissions and shall issue source specific permits containing emission limitations for the following sources within phosphate fertilizer plants: (3-20-20)T

**a.** Calciner operation; and (3-20-20)T

**b.** Wet phosphoric acid plants; and (3-20-20)T

**c.** Super phosphoric acid production; and (3-20-20)T

**d.** Diammonium phosphate plants; and (3-20-20)T

- e. Monoammonium phosphate production; and (3-20-20)T
- f. Triple super phosphate (mono calcium phosphate) production. (3-20-20)T

**04. Exemptions.** The provisions of Subsections 751.01, 751.02, and 751.03 shall not apply to any phosphate fertilizer facility which produces mono ammonium phosphate exclusively if no animal feed is grown or if no animal grazing occurs or if the animal feed and forage meets the ambient air quality standards for fluorides specified in Section 577 within a three (3) mile radius of such facility. This exemption shall only apply if the owner or operator of the facility, on an annual basis: (3-20-20)T

- a. Conducts a fluoride sampling program of potential grazing areas at locations approved in advance of sampling by the Department, using analytical techniques appearing in the Procedures Manual for Air Pollution Control, Section I (Source Test Methods); and (3-20-20)T
- b. Submits the results of such sampling program to the Department as soon as they become available. (3-20-20)T

**752. -- 759. (RESERVED)**

**760. RULES FOR THE CONTROL OF AMMONIA FROM DAIRY FARMS.**

The purpose of Sections 760 through 764 is to set forth the requirements for the control of ammonia through best management practices (BMPs) for certain size dairy farms licensed by the Idaho State Department of Agriculture to sell raw milk for human consumption. Compliance with these sections does not relieve the owner or operator of a dairy farm from the responsibility of complying with all other federal, state and local applicable laws, regulations, and requirements, including, but not limited to, Sections 161, 650 and 651 of these rules. Registration forms and guidance documents relating to these rules are located at [www.deq.idaho.gov](http://www.deq.idaho.gov). (3-20-20)T

**761. GENERAL APPLICABILITY.**

The requirements of Sections 760 through 764 apply to the following size dairy farms:

**SUMMARY: Animal Unit (AU) or mature cow threshold to produce 100 ton NH<sub>3</sub>/year**

Animal Unit (AU) Basis	Drylot	Free Stall/Scrape	Free Stall/Flush
AU (100 t NH <sub>3</sub> ) Threshold			
No land app	7089	3893	2293
27% volatilization 1	6842	3827	
80% volatilization 2	6397	3700	
Total Cows (100 t NH <sub>3</sub> ) Threshold			
Cow Basis (1400 lbs)	Drylot	Free Stall/Scrape	Free Stall/Flush
No land app	5063	2781	1638
27% volatilization 1	4887	2733	
80% volatilization 2	4569	2643	
1 Assumes: Expected level of N->NH <sub>3</sub> volatilization for: drop-hose or ground level liquid manure application			
2 Assumes: Expected level of N->NH <sub>3</sub> volatilization for: center pivot or other conventional sprinkler irrigation liquid manure application			

(3-20-20)T



**762. PERMIT BY RULE.**

**01. General Requirement.** Owners and operators of dairy farms shall be deemed to have a permit by rule if they comply with all of the applicable provisions of Sections 760 through 764. Owners and operators of dairy farms subject to Sections 760 through 764 shall not operate without obtaining the applicable permit by rule within the time frame specified. (3-20-20)T

**02. Optional Permit by Rule.** Nothing in Sections 760 through 764 shall preclude any owner or operator of a dairy farm from requesting and obtaining an air quality permit pursuant to Section 200, nor shall Sections 760 through 764 preclude an owner or operator of a dairy farm below the threshold size in Section 761 from complying with Sections 760 through 764 and thereby obtaining a permit by rule. (3-20-20)T

**03. Exemption.** If a dairy farm not subject to Sections 760 through 764 otherwise would become subject to those sections as a result of an emergency, the dairy farm shall notify the Director in writing within fourteen (14) days of the emergency. The notification shall include an explanation of the emergency circumstances. The dairy farm shall be exempt from the requirements of Sections 760 through 764 as long as the consequences of the emergency continue (but in no case for more than one (1) year) unless for good cause the Director determines it is appropriate to limit, condition or revoke the exemption. For the purpose of this rule “emergency” shall be defined as a serious situation or occurrence that happens unexpectedly and demands immediate action. (3-20-20)T

**763. REGISTRATION FOR PERMIT BY RULE.**

**01. Registration Process.** Any owner or operator of a new dairy farm subject to sections 760 through 764, or an existing dairy farm that becomes subject to these sections due to change in size or type of operation, shall register prior to fifteen (15) days of triggering the threshold for which a permit is required. (3-20-20)T

**02. Registration Due Date.** Any owner or operator of an existing dairy farm subject to Sections 760 through 764 shall register within fifteen (15) days of the effective date of Sections 760 through 764. (3-20-20)T

**03. Registration Information.** The following information shall be provided by the registrant to the Department of Environmental Quality and the Department of Agriculture: (3-20-20)T

- a.** Name, address, location of dairy farm, and telephone number. (3-20-20)T
- b.** Information sufficient to establish that the dairy farm is of the size and type described in Section 761. (3-20-20)T
- c.** Information describing what BMPs, as described in Section 764, are employed to total twenty-seven (27) points. (3-20-20)T

**04. Exemption from Registration Fee.** Dairy farms subject to Sections 760 through 764 are exempt from paying the permit by rule registration fee set forth in Section 800. (3-20-20)T

**05. Inspection.** Within thirty (30) days of receipt of the registration information, the state of Idaho shall conduct a qualifying inspection to ensure the requisite point total of BMPs are employed. (3-20-20)T

**764. DAIRY FARM BEST MANAGEMENT PRACTICES.**

**01. BMPs.** Each dairy farm subject to Sections 760 through 764, or that otherwise obtains a permit by rule under these sections, shall employ BMPs for the control of ammonia to total twenty-seven (27) points. Points may be obtained through third party export with sufficient documentation. The table located at Subsection 764.02. lists available BMPs and the associated point value. As new information becomes available or upon request, the Director may determine a practice not listed in the table constitutes a BMP and assign a point value. (3-20-20)T

**02. Table - Ammonia Control Practices for Idaho Dairies.**

		Ammonia Control Effectiveness <sup>1</sup>			Compliance Method <sup>3</sup>
System	Component	Open Lot	Freestall Scrape	Freestall Flush	
Waste Storage and Treatment Systems	Synthetic Lagoon Cover	15	20	20	1
	GeoteXtile Covers	10	13	13	1
	Solids Separation	3	3	3	3, 4
	Composting	4	4	4	1
	Separate Slurry and Liquid Manure Basins	6	10	-	1
	In-House Separation	0	12	0	1
	Direct Utilization of Collected Slurry	6	10	-	1, 3, 4
	Direct Utilization of Parlor Wastewater	10	10	10	1
	Direct Utilization of Flush Water	8	0	13	3, 4
	Anaerobic Digester	-	-	-	-
	Anaerobic Lagoon	-	-	-	-
	Aerated Lagoon	10	12	15	2
	Sequencing-Batch Reactor	15	20	20	2
	Lagoon Nitrification/Denitrification Systems	15	20	20	2
	Fixed-Media Aeration Systems	15	20	20	2
Zeolite Treatment of Liquid Manure 1lb/cow/day	4	5	5	2	
Zeolite Treatment of Liquid Manure 2lb/cow/day	8	10	10	2	
General Practices	Vegetative or Wooded Buffers (established)	7	7	7	1
	Vegetative or Wooded Buffers (establishing)	2	2	2	1
	Alternatives to Copper Sulfate	-	-	-	-
Freestall Barns	Scrape Built Up Manure	-	3	3	1
	Frequent Manure Removal	UD	UD	UD	-
	Tunnel Ventilation	-	-	-	-

		Ammonia Control Effectiveness <sup>1</sup>			
System	Component	Open Lot	Freestall Scrape	Freestall Flush	Compliance Method <sup>3</sup>
		Tunnel Ventilation w/Biofilters	-	10	
	Tunnel Ventilation w/Washing Wall	-	10	10	3, 4
Open Lots and Corrals	Rapid Manure Removal	4	2	2	1, 2
	Corral Harrowing	4	2	2	1
	Surface Amendments	10	5	5	2
	In-Corral Composting / Stockpiling	4	2	2	1
	Summertime Deep Bedding	10	5	5	1
Animal Nutrition	Manage Dietary Protein	2	2	2	2
Composting Practices	Alum Incorporation	12	8	6	2
	Carbon:Nitrogen Ratio (C:N) Ratio Manipulation	10	7.5	5	2
	Composting with Windrows	-	-	-	-
	Composting Static Pile	6	4.5	3	1
	Forced Aeration Composting	10	7.5	5	1
	Forced Aeration Composting with Biofilter	12	8	6	1
	Zeolite Incorporation	12	8	6	2
Land Application <sup>2</sup>	Soil Injection - Slurry	10	15	7.5	2
	Incorporation of Manure within 24 hrs	10	10	10	2
	Incorporation of Manure within 48 hrs	5	5	5	2
	Nitrification of Lagoon Effluent	10	10	15	3, 4
	Low Energy/Pressure Application Systems	7	7	10	1
	Freshwater Dilution	5	8	8	1, 2
	Pivot Drag Hoses	8	8	10	1
	Subsurface Drip Irrigation	10	10	12	1

System	Component	Ammonia Control Effectiveness <sup>1</sup>			Compliance Method <sup>3</sup>
		Open Lot	Freestall Scrape	Freestall Flush	
Notes:					
1. The ammonia emission reduction effectiveness of each practice is rated numerically based on practical year-round implementation. Variations due to seasonal practices and expected weather conditions have been factored into these ratings. Not implementing a BMP when it is not practicable to do so, does not reduce the point value assigned to the BMP, nor does it constitute failure to perform the BMP. UD indicates that the practice is still under development.					
2. Land application practices assume practice is conducted on all manure; points will be pro-rated to reflect actual waste treatment; points can be obtained on exported material with sufficient documentation.					
3. Method used by inspector to determine compliance 1=Observation by Inspector 2=On-Site Recordkeeping Required 3, 4=Deviation Reporting Required. Equipment upsets and/or breakdowns shall be recorded in a deviation log and if repaired in a reasonable timeframe does not constitute non-compliance with this rule.					

(3-20-20)T

**765. -- 774. (RESERVED)**

**775. RULES FOR CONTROL OF ODORS.**

The purpose of Sections 775 through 776 is to control odorous emissions from all sources for which no gaseous emission control rules apply. (3-20-20)T

**776. GENERAL RULES.**

**01. General Restrictions.** No person shall allow, suffer, cause or permit the emission of odorous gases, liquids or solids into the atmosphere in such quantities as to cause air pollution. (3-20-20)T

**02. Restrictions on Rendering Plants.** No person shall allow, suffer, cause or permit any plant engaged in the processing of animal, mineral, or vegetable matter or chemical processes utilizing animal, mineral or vegetable matter to be operated without employing reasonable measures for the control of odorous emissions including wet scrubbers, incinerators, chemicals or such other measures as may be approved by the Department. (3-20-20)T

**777. -- 784. (RESERVED)**

**785. RULES FOR CONTROL OF INCINERATORS.**

The purpose of Sections 785 through 788 is to prevent excessive emissions of particulate matter from incinerators. (3-20-20)T

**786. EMISSION LIMITS.**

**01. General Restrictions.** No person shall allow, suffer, cause or permit any incinerator to discharge more than two-tenths (0.2) pounds of particulates per one hundred (100) pounds of refuse burned. (3-20-20)T

**02. Averaging Period.** For the purposes of Section 786, emissions shall be averaged according to the following, whichever is the lesser period of time: (3-20-20)T

- a. One (1) complete cycle of operation; or (3-20-20)T

**b.** One (1) hour of operation representing worst-case conditions for the emissions of particulate matter. (3-20-20)T

**03. Test Methods and Procedures.** The appropriate test method under Sections 785 through 788 shall be EPA Method 5 contained in 40 CFR Part 60 or such comparable and equivalent methods approved in accordance with Subsection 157.02.d. Test methods and procedures shall comply with Section 157. (3-20-20)T

**787. EXCEPTIONS.**  
Sections 785 and 786 do not apply to wigwam burners. (3-20-20)T

**788. -- 789. (RESERVED)**

**790. RULES FOR THE CONTROL OF NONMETALLIC MINERAL PROCESSING PLANTS.**  
The purpose of Sections 790 through 799 is to set forth the requirements for nonmetallic mineral processing plants, frequently referred to as rock crushers. Definitions specific to nonmetallic mineral processing permits are located in Section 011 while other general terms may be defined in Sections 006 through 008. Compliance with Section 790 does not relieve the owner or operator of a nonmetallic mineral processing plant from the responsibility of complying with other federal, state, and local applicable laws, regulations, and requirements. (3-20-20)T

**791. GENERAL CONTROL REQUIREMENTS.**

**01. Prohibition.** No owner or operator of a nonmetallic mineral processing plant shall allow, suffer, or cause the emissions of any air pollutant to the atmosphere in such quantity of such nature and duration and under such conditions as would be injurious to human health or welfare, to animal or plant life, or to property, or to interfere unreasonably with the enjoyment of life or property. (3-20-20)T

**02. Control of Fugitive Dust.** In accordance with Sections 650 and 651, owners and operators of nonmetallic mineral processing plants shall take all reasonable precautions to prevent the generation of fugitive dust. In determining what is reasonable, consideration will be given to factors such as the proximity to human habitations and/or activities and atmospheric conditions which might affect the movement of particulate matter. (3-20-20)T

**792. EMISSIONS STANDARDS FOR NONMETALLIC MINERAL PROCESSING PLANTS SUBJECT TO 40 CFR 60, SUBPART OOO.**

**01. Applicability and Designation of Affected Facilities.** The provisions of 40 CFR 60.670(a)(1) are applicable to the following affected facilities in fixed or portable nonmetallic mineral processing plants that commence construction, modification, or reconstruction after August 31, 1983: each crusher, grinding mill, screening operation, bucket elevator, belt conveyor, bagging operation, storage bin, and enclosed truck or railcar loading station. Also, crushers and grinding mills at hot mix asphalt facilities that reduce the size of nonmetallic minerals embedded in recycled asphalt pavement and subsequent affected facilities up to, but not including the first storage silo or bin, are subject to the provisions of 40 CFR 60.670(a)(1). (3-20-20)T

**02. Facilities Not Applicable to 40 CFR 60.670(a)(2), (b), and (c).** The provisions of 40 CFR 60.670(a)(2), (b), and (c) do not apply to the following operations: all facilities located in underground mines, plants without crushers or grinding mills above ground, and wet processing operations (as defined in 40 CFR 60.671). (3-20-20)T

**a.** An affected facility that is subject to the provisions of 40 CFR 60, Subpart F (Standards of Performance for Portland Cement Plants) or Subpart I (Standards of Performance for Hot Mix Asphalt Plants) or that follows the in plant process any facility subject to the provisions of 40 CFR 60, Subparts F or I, is not subject to the provisions of 40 CFR 60, Subpart OOO. (3-20-20)T

**b.** Facilities at the following plants are not subject to the provisions of 40 CFR 60, Subpart OOO: (3-20-20)T

**i.** Fixed sand and gravel plants and crushed stone plants with capacities, as defined in 40 CFR 60.671, of twenty-three (23) megagrams per hour (twenty-five (25) tons per hour) or less; (3-20-20)T

ii. Portable sand and gravel plants and crushed stone plants with capacities, as defined in 40 CFR 60.671, of one hundred thirty-six (136) megagrams per hour (one hundred fifty (150) tons per hour) or less; and (3-20-20)T

iii. Common clay plants and pumice plants with capacities, as defined in 40 CFR 60.671, of nine (9) megagrams per hour (ten (10) tons per hour) or less. (3-20-20)T

**03. Standards of Performance for Nonmetallic Mineral Processing Plants.** Affected facilities subject to 40 CFR 60, Subpart OOO, shall comply with all applicable emissions standards, monitoring requirements, test methods and procedures, and reporting and recordkeeping requirements. (3-20-20)T

**793. EMISSIONS STANDARDS FOR NONMETALLIC MINERAL PROCESSING PLANTS NOT SUBJECT TO 40 CFR 60, SUBPART OOO.**

Owners and operators of nonmetallic mineral processing plants that are not subject to a NSPS requirement shall comply with the emissions standards set forth in Section 793. (3-20-20)T

**01. Processing Plants Not Regulated by NSPS.** Fixed or portable plants that commenced construction, reconstruction, or modification before August 31, 1983 are not subject to 40 CFR 60, Subpart OOO. (3-20-20)T

**02. Emissions Standards for Fugitive Emissions.** No owner or operator shall cause to be discharged into the atmosphere emissions which exhibit greater than twenty percent (20%) opacity from any crusher, grinding mill, screening operation, bucket elevator, belt conveyor, conveying system, transfer point, vent, capture system, storage bin, stockpile, truck dumping operation, vehicle traffic on an affected paved public roadway, vehicle traffic on or wind erosion of an unpaved haul road, or other source of fugitive emissions. Opacity shall be determined using the test methods and procedures in Section 625. The plant is not required to have a certified opacity reader. (3-20-20)T

**794. PERMIT REQUIREMENTS.**

No owner or operator may commence construction, reconstruction, modification or operation of any nonmetallic mineral processing plant regardless of whether or not the source is an affected facility pursuant to 40 CFR 60.670(e) without first obtaining a permit or complying with Sections 795 through 799. The owner or operator shall comply with the permitting requirements of Subsection 794.02 or Subsection 794.03 and the applicable portions of Subsection 794.04 and/or Subsection 794.05. (3-20-20)T

**01. Permit by Rule Eligibility.** New major facilities or major modifications subject to Sections 204 and 205 are not eligible for a Permit by Rule. (3-20-20)T

**02. Permit by Rule.** Owners and operators of nonmetallic mineral processing plants that meet all of the applicable requirements set forth in Sections 795 through 799 shall be deemed to have a permit by rule (PBR) and shall not be required to obtain a permit to construct under Sections 200 through 228. (3-20-20)T

**03. Permit to Construct.** Owners and operators of nonmetallic mineral processing plants that do not meet all of the requirements set forth in Sections 795 through 799, or that operate or intend to operate a nonmetallic mineral processing plant at a single site of operations for more than twelve (12) consecutive months, or that choose to construct and operate under specific permit requirements rather than the provisions of the permit by rule shall obtain a permit to construct pursuant to Sections 200 through 228. An existing permit to construct shall be considered valid until the permit is modified, incorporated into a Tier II operating permit, or terminated by the Department. Existing permits to construct may be terminated by the Department by registering the source under the permit by rule provisions in accordance with Section 797 after June 15, 2001. (3-20-20)T

**04. Tier I Operating Permits.** Owners and operators of nonmetallic mineral processing plants that are affected facilities subject to a requirement of the New Source Performance Standards (NSPS) in 40 CFR 60 are Tier I sources as defined in Section 006. Tier I sources must comply with the applicable permitting requirements of Sections 300 through 399. (3-20-20)T

**05. Tier II Operating Permits.** Owners and operators of nonmetallic mineral processing plants that

are required by the Department or choose to obtain a Tier II operating permit pursuant to Sections 400 through 410 shall operate in accordance with the specific provisions of the Tier II operating permit until such time as the operating permit is terminated in writing by the Department. The Department may require owners and operators of nonmetallic mineral processing plants to obtain a Tier II operating permit whenever the Department determines that: (3-20-20)T

**a.** Emission rate reductions are necessary to attain or maintain any ambient air quality standard or applicable prevention of significant deterioration (PSD) increment; or (3-20-20)T

**b.** Specific emissions standards, or requirements on operation or maintenance are necessary to ensure compliance with any applicable emission standard or rule. (3-20-20)T

**795. PERMIT BY RULE REQUIREMENTS.**

The purpose of Sections 795 through 799 is to establish the requirements for a permit by rule for nonmetallic mineral processing plants. (3-20-20)T

**796. APPLICABILITY.**

**01. Permit by Rule.** Owners and operators of nonmetallic mineral processing plants shall be deemed to have a permit by rule if they comply with all of the applicable provisions of Sections 795 through 799. Nothing in Sections 795 through 799 shall preclude any owner or operator from obtaining a permit. Portable sources that operate or may be operated at a single location or site of operations for more than twelve (12) consecutive months must obtain a permit to construct or a Tier II operating permit. (3-20-20)T

**02. Permit Option.** Owners and operators of nonmetallic mineral processing plants that hold a valid permit to construct or a Tier II operating permit must comply with the terms and conditions of the permit and are not subject to the requirements of the permit by rule in Sections 795 through 799. (3-20-20)T

**797. REGISTRATION FOR PERMIT BY RULE.**

**01. Registration Process.** Any owner or operator of a nonmetallic mineral processing plant that opts to operate under the permit by rule shall register in the following manner: (3-20-20)T

**a.** Any new or modified processing plant shall register fifteen (15) days prior to commencing operation or modification. The Department shall acknowledge registration in writing within fifteen (15) days. (3-20-20)T

**b.** Any permitted processing plant shall register with the Department and request termination of the current permit to construct or Tier II operating permit. The Department shall normally act on the request within fifteen (15) days and notify the registrant in writing. (3-20-20)T

Registration for permit by rule does not relieve the owner or operator of portable equipment from the registration and relocation requirements of Section 500. (3-20-20)T

**02. Registration Information.** The following information shall be provided by the registrant to the Department: (3-20-20)T

**a.** For all crushers and grinding mills, the registrant shall supply information on the manufacturer, crusher type (such as jaw, cone), serial number, date of manufacture, and maximum throughput capacity; (3-20-20)T

**b.** For all screen decks, the registrant shall supply manufacturer name, physical size of screen, number of decks, serial number, and date of manufacture; and (3-20-20)T

**c.** For all electrical generators, the registrant shall supply manufacturer name, rated output, and fuel. (3-20-20)T

**798. ELECTRICAL GENERATORS.**

The following requirements apply to all electrical generators used to provide electrical power to any nonmetallic

mineral processing plant. The requirements apply to each site of operations. (3-20-20)T

**01. Fuel Type.** Only ASTM (American Society of Testing and Materials) Grade 1 or 2 fuel oil shall be used. The sulfur content of the fuel used shall not exceed the percentages of sulfur given in Section 725. (3-20-20)T

**02. Generator Operating Requirements.** For the purposes of Sections 790 through 799, the following apply to all electrical generators.

Rated Output Capacities (kW)	Allowable Operating Hours (hr/day)		Allowable Operating Hours (hr/yr)	
	Attainment Unclassifiable Areas	PM-10 Nonattainment Areas	Attainment Unclassifiable Areas	PM-10 Nonattainment Areas
0 - 454	24	8	8760	2880
455 - 1000	24	24	8760	8760
1001 - 2000	24	24	5200	5200

kW = kilowatts  
 hr/day = hours per day  
 hr/yr = hours per year

(3-20-20)T

**03. Generator Opacity Limit.** Visible emissions from any generator stack, vent, or other functionally equivalent opening shall not exceed twenty percent (20%) opacity for a period or periods aggregating more than three (3) minutes in any sixty (60) minute period. Opacity shall be determined using the test methods and procedures contained in Section 625. (3-20-20)T

**04. Monitoring and Recordkeeping Requirements.** (3-20-20)T

**a.** The owner or operator shall monitor and record the following information. (3-20-20)T

**i.** The rated output capacity, in kilowatts (kW), of the electrical generator(s) used; (3-20-20)T

**ii.** Operating hours on a monthly and annual basis so compliance can be continuously determined for the previous twelve (12) month period; and (3-20-20)T

**iii.** Vendor receipts of the fuel oil purchased clearly identifying the ASTM Grade. (3-20-20)T

**b.** Records of monitoring and recordkeeping requirements for current operations shall be maintained at the site of operations for the duration of operations at that location and shall be available to Department representatives upon request. Records for previous sites of operation shall be kept for the most recent two (2) year period at a location where they can be reasonably accessed and shall be made available to the Department upon request. (3-20-20)T

**799. NONMETALLIC MINERAL PROCESSING PLANT FUGITIVE DUST BEST MANAGEMENT PRACTICE.**

The owner or operator of a nonmetallic mineral processing plant shall use the Best Management Practices (BMP) contained in Section 799 to control the emissions of fugitive dust. Fugitive dust emissions shall be reasonably controlled as required by Sections 650 and 651. It shall be the responsibility of the owner or operator to reasonably control fugitive emissions at each site of operations but only for the duration of operations at each site under the control of the owner or operator. (3-20-20)T

**01. Generally Applicable Requirements.** All reasonable precautions shall be taken to prevent particulate matter from becoming airborne. The following requirements apply generally to this Fugitive Dust BMP.



(3-20-20)T

**a.** Control strategy triggers. The owner or operator of a nonmetallic mineral processing plant shall at all times be observant of all sources of fugitive dust emissions and monitor control strategies at least once per day when operating. When fugitive dust emissions are observed at any time to be exceeding any control strategy trigger specified in Subsections 799.02 through 799.06, that event shall trigger initiation of the prescribed control strategy or control strategies to control the fugitive dust emissions. (3-20-20)T

**b.** Control strategies. A progressive control strategy shall be used to reasonably control the emissions of fugitive dust. Progressive control strategy means that if the initial control strategy or strategies chosen do not adequately control fugitive dust emissions, the owner or operator shall employ successive control strategies as listed until fugitive dust control is achieved. Fugitive dust control shall be applied on a frequency such that visible emissions do not exceed any emission standard specified in Sections 790 through 799. (3-20-20)T

**c.** Monitoring and recordkeeping. The owner or operator shall maintain a record of each event where a control strategy is triggered. The trigger shall be recorded with a summary of the control strategy employed. If the trigger is a citizen complaint, the owner or operator shall record the complaint, an evaluation of whether the complaint has merit, and a summary of the corrective action taken. The record shall be maintained on forms provided by the Department or other forms that contain similar information. Records for current operations shall be maintained at the site of operations for the duration of operations at that location and shall be available to Department representatives upon request. Records for previous sites of operation shall be kept for the most recent two (2) year period at a location where they can be reasonably accessed and shall be made available to the Department upon request. (3-20-20)T

**02. Requirements for Paved Public Roadways.** (3-20-20)T

**a.** Definitions. (3-20-20)T

**i.** Paved public roadway. A paved public roadway means a roadway accessible to the general public having a surface of asphalt or concrete. (3-20-20)T

**ii.** Track-out. Track-out means the deposition of mud, dirt, or similar debris onto the surface of a paved public roadway from the tires and/or undercarriage of any vehicle associated with the operation of a nonmetallic mineral processing plant. (3-20-20)T

**b.** Control strategy triggers. Triggers that require initiation of a strategy or strategies to control fugitive dust emissions from track-out include, but are not limited to: (3-20-20)T

**i.** Visible deposition of mud, dirt, or similar debris on the surface of a paved public roadway. (3-20-20)T

**ii.** Visible fugitive emissions from vehicle traffic on an affected paved public roadway that approach twenty percent (20%) opacity for a period or periods aggregating more than one (1) minute in any sixty (60) minute period. (3-20-20)T

**iii.** Citizen complaints of failure to reasonably control fugitive dust shall be expeditiously evaluated by the owner or operator for merit. If the owner or operator determines the complaint has merit, the progressive strategy shall be expeditiously employed to reasonably control fugitive dust. The Department may review the complaint records and investigate citizen complaints as appropriate. If the Department finds that a complaint has merit, it may determine additional control measures are required. (3-20-20)T

**c.** Control strategies. The following are control strategies for track-out. (3-20-20)T

**i.** Prompt removal of mud, dirt, or similar debris from the affected surface of a paved public roadway. (3-20-20)T

**ii.** Water flush, and/or water flush and vacuum sweep, the affected surface of the paved public

roadway. Runoff shall be controlled so it does not saturate the surface of the adjacent unpaved haul road such that track-out is enhanced. If runoff is not, or cannot be controlled, gravel shall be applied to the surface of the adjacent unpaved haul road over an area sufficient to control track-out. (3-20-20)T

iii. Apply gravel to the surface of the adjacent unpaved haul road. The area of application shall be sufficient to control track-out. (3-20-20)T

iv. Apply an environmentally safe chemical soil stabilizer or chemical dust suppressant to the surface of the adjacent unpaved haul road. The area of application shall be sufficient to control track-out. (3-20-20)T

v. Other control strategy or strategies as approved by the Department. (3-20-20)T

**03. Requirements for Unpaved Haul Roads.** (3-20-20)T

a. Definition of “unpaved haul roads.” Any unsurfaced roadway within the physical boundary of a nonmetallic mineral processing facility that is used as a haul road, access road, or similar. (3-20-20)T

b. Control strategy triggers. Triggers that require initiation of a strategy or strategies to control fugitive dust emissions from unpaved haul roads include, but are not limited to: (3-20-20)T

i. Visible fugitive emissions from vehicle traffic on an affected paved public roadway that approach twenty percent (20%) opacity for a period or periods aggregating more than one (1) minute in any sixty (60) minute period. (3-20-20)T

ii. Citizen complaints of failure to reasonably control fugitive dust shall be expeditiously evaluated by the owner or operator for merit. If the owner or operator determines the complaint has merit, the progressive strategy shall be expeditiously employed to reasonably control fugitive dust. The Department may review the complaint records and investigate citizen complaints as appropriate. If the Department finds that a complaint has merit, it may determine additional control measures are required. (3-20-20)T

c. Control strategies. The following are control strategies for fugitive dust emissions from unpaved haul roads. (3-20-20)T

i. Limit vehicle traffic on unpaved haul roads. (3-20-20)T

ii. Limit vehicle speeds on unpaved haul roads. If a speed limit is imposed, signs shall be posted along the haul road route and clearly indicate the speed limit. Signs shall be placed so they are visible to vehicles entering and leaving the site of operations. (3-20-20)T

iii. Apply water to the surface of the unpaved haul road. Runoff shall be controlled so it does not saturate the surface of the unpaved haul road such that it causes track-out. If runoff is not, or cannot be controlled, gravel shall be applied to the surface of the unpaved haul road over an area sufficient to control track-out. (3-20-20)T

iv. Apply gravel to the surface of the unpaved haul road. (3-20-20)T

v. Apply an environmentally safe chemical soil stabilizer or chemical dust suppressant to the surface of the unpaved haul road. (3-20-20)T

vi. Other control strategy or strategies as approved by the Department. (3-20-20)T

**04. Requirements for Transfer Points, Screening Operations, and Stacks and Vents.** (3-20-20)T

a. Definitions. (3-20-20)T

i. Transfer point. Transfer point means a point in a conveying operation where the nonmetallic mineral is transferred to or from a belt conveyor except where the nonmetallic mineral is being transferred to a stockpile. (3-20-20)T

- ii. Belt conveyor. Belt conveyor means a conveying device that transports material from one (1) location to another by means of an endless belt that is carried on a series of idlers and routed around a pulley at each end. (3-20-20)T
- iii. Conveying system. Conveying system means a device for transporting materials from one (1) piece of equipment or location to another location within a plant. Conveying systems include but are not limited to the following: feeders, belt conveyors, bucket elevators and pneumatic systems. (3-20-20)T
- iv. Bucket elevator. Bucket elevator means a conveying device of nonmetallic minerals consisting of a head and foot assembly which supports and drives an endless single or double strand chain or belt to which buckets are attached. (3-20-20)T
- v. Screening operation. Screening operation means a device for separating material according to size by passing undersize material through one (1) or more mesh surfaces (screens) in series, and retaining oversize material on the mesh surfaces (screens). (3-20-20)T
- vi. Capture system. Capture system means the equipment (including enclosures, hoods, ducts, fans, dampers, etc.) used to capture and transport particulate matter generated by one (1) or more process operations to a control device. (3-20-20)T
- vii. Control device. Control device means the air pollution control equipment used to reduce particulate matter emissions released to the atmosphere from one (1) or more process operations at a nonmetallic mineral processing plant. (3-20-20)T
- viii. Vent. Vent means an opening through which there is mechanically induced air flow for the purpose of exhausting from a building air carrying particulate matter emissions from one (1) or more affected facilities. (3-20-20)T
- b.** Control strategy triggers. Triggers that require initiation of a strategy or strategies to control fugitive dust emissions from transfer points, belt conveyors, bucket elevators, screening operations, conveying systems, capture systems, and building vents include, but are not limited to, the following: (3-20-20)T
- i. NSPS regulated processing plants. (3-20-20)T
- (1) Opacity greater than ten percent (10%) from any transfer point on a belt conveyor, conveying system, bucket elevator, or screening operation. (3-20-20)T
- (2) For any transfer point on a belt conveyor, conveying system, bucket elevator, or screening operation located within a building, opacity greater than seven percent (7%) from any building vent. (3-20-20)T
- (3) Opacity greater than seven percent (7%) from any capture system stack. (3-20-20)T
- (4) Citizen complaints of failure to reasonably control fugitive dust shall be expeditiously evaluated by the owner or operator for merit. If the owner or operator determines the complaint has merit, the progressive strategy shall be expeditiously employed to reasonably control fugitive dust. The Department may review the complaint records and investigate citizen complaints as appropriate. If the Department finds that a complaint has merit, it may determine additional control measures are required. (3-20-20)T
- ii. Processing plants not regulated by NSPS. (3-20-20)T
- (1) Opacity greater than twenty percent (20%) from any transfer point on a belt conveyor, conveying system, bucket elevator, or screening operation. (3-20-20)T
- (2) For any transfer point on a belt conveyor, conveying system, bucket elevator, or screening operation located within a building, opacity greater than twenty percent (20%) from any building vent. (3-20-20)T

- (3) Opacity greater than twenty percent (20%) from any capture system stack. (3-20-20)T
- (4) Citizen complaints of failure to reasonably control fugitive dust shall be expeditiously evaluated by the owner or operator for merit. If the owner or operator determines the complaint has merit, the progressive strategy shall be expeditiously employed to reasonably control fugitive dust. The Department may review the complaint records and investigate citizen complaints as appropriate. If the Department finds that a complaint has merit, it may determine additional control measures are required. (3-20-20)T
- c. Control Strategies.** The following are control strategies for transfer points, belt conveyors, bucket elevators, screening operations, conveying systems, capture systems, and building vents. Controls shall be applied on a frequency such that visible fugitive emissions do not exceed any applicable opacity limit. (3-20-20)T
- i. Limit drop heights of materials such that there is a homogeneous flow of material. (3-20-20)T
- ii. Install, operate, and maintain water spray bars to control fugitive dust emissions at transfer points on belt conveyors, conveying systems, bucket elevators, and screening operations as necessary. (3-20-20)T
- iii. Other control strategy or strategies as approved by the Department. (3-20-20)T
- 05. Requirements for Crushers and Grinding Mills.** (3-20-20)T
- a. Definitions.** (3-20-20)T
- i. **Crusher.** Crusher means a machine used to crush any nonmetallic mineral, and includes, but is not limited to, the following types: jaw, gyratory, cone, roll, rod mill, hammermill, and impactor. (3-20-20)T
- ii. **Grinding mill.** Grinding mill means a machine used for the wet or dry fine crushing of any nonmetallic mineral. Grinding mills include, but are not limited to, the following types: hammer, roller, rod, pebble and ball, and fluid energy. The grinding mill includes the air conveying system, air separator, or air classifier, where such systems are used. (3-20-20)T
- iii. **Initial crusher.** Initial crusher means any crusher into which nonmetallic minerals can be fed without prior crushing in the plant. (3-20-20)T
- b. Control strategy triggers.** Triggers that require initiation of a strategy or strategies to control fugitive dust emissions from any crusher, grinding mill, building vent, or capture system stack include, but are not limited to, the following. (3-20-20)T
- i. NSPS regulated processing plants. (3-20-20)T
- (1) Opacity greater than fifteen percent (15%) from any crusher or grinding mill at which capture system is not used. (3-20-20)T
- (2) For any crusher or grinding mill located within a building, opacity greater than seven percent (7%) from any building vent. (3-20-20)T
- (3) Opacity greater than seven percent (7%) from any capture system stack. (3-20-20)T
- (4) Citizen complaints of failure to reasonably control fugitive dust shall be expeditiously evaluated by the owner or operator for merit. If the owner or operator determines the complaint has merit, the progressive strategy shall be expeditiously employed to reasonably control fugitive dust. The Department may review the complaint records and investigate citizen complaints as appropriate. If the Department finds that a complaint has merit, it may determine additional control measures are required. (3-20-20)T
- ii. Processing plants not regulated by NSPS. (3-20-20)T
- (1) Opacity greater than twenty percent (20%) from any crusher or grinding mill at which capture

system is not used. (3-20-20)T

(2) For any crusher or grinding mill located within a building, opacity greater than twenty percent (20%) from any building vent. (3-20-20)T

(3) Opacity greater than twenty percent (20%) from any capture system stack. (3-20-20)T

(4) Citizen complaints of failure to reasonably control fugitive dust shall be expeditiously evaluated by the owner or operator for merit. If the owner or operator determines the complaint has merit, the progressive strategy shall be expeditiously employed to reasonably control fugitive dust. The Department may review the complaint records and investigate citizen complaints as appropriate. If the Department finds that a complaint has merit, it may determine additional control measures are required. (3-20-20)T

**c.** Control strategies. The following are control strategies for any crusher, grinding mill, building vent, or capture system stack. Controls shall be applied on a frequency such that visible fugitive emissions do not exceed any applicable opacity limit. (3-20-20)T

i. Limit drop heights of materials such that there is a homogeneous flow of material. (3-20-20)T

ii. Install, operate, and maintain water spray bars to control fugitive dust emissions at crusher drop points as necessary. (3-20-20)T

iii. Other control strategy or strategies as approved by the Department. (3-20-20)T

**06. Requirements for Stockpiles.** (3-20-20)T

**a.** Definitions. (3-20-20)T

i. Stockpile. Stockpile means any nonmetallic mineral storage pile, reserve supply, or similar. Nonmetallic minerals shall have the meaning given in 40 CFR Part 60, Subpart OOO. Nonmetallic minerals may be stockpiled by belt conveyor, truck dumping, or similar. (3-20-20)T

ii. Truck dumping. Truck dumping means the unloading of nonmetallic minerals from movable vehicles designed to transport nonmetallic minerals from one (1) location to another. Movable vehicles include but are not limited to: trucks, front-end loaders, skip hoists, and railcars. (3-20-20)T

**b.** Control strategy triggers. Triggers that require immediate initiation of a strategy or strategies to control fugitive dust emissions from stockpiles include, but are not limited to: (3-20-20)T

i. Visible fugitive emissions from wind erosion of any stockpile that approaches twenty percent (20%) opacity for a period or periods aggregating more than one (1) minute in any sixty (60) minute period. (3-20-20)T

ii. Citizen complaints of failure to reasonably control fugitive dust shall be expeditiously evaluated by the owner or operator for merit. If the owner or operator determines the complaint has merit, the progressive strategy shall be expeditiously employed to reasonably control fugitive dust. The Department may review the complaint records and investigate citizen complaints as appropriate. If the Department finds that a complaint has merit, it may determine additional control measures are required. (3-20-20)T

**c.** Control strategies. The following are control strategies for stockpiles. (3-20-20)T

i. Limit the height of the stockpiles. (3-20-20)T

ii. Limit the disturbance of the stockpiles. (3-20-20)T

iii. Apply water onto the surface of the stockpile. (3-20-20)T

- iv. Other control strategy or strategies as approved by the Department. (3-20-20)T

**800. REGISTRATION FEE FOR PERMIT BY RULE.**

A registration fee of two hundred fifty dollars (\$250) shall be submitted to the Department with each permit by rule registration. (3-20-20)T

**801. PAYMENT OF FEES FOR PERMITS BY RULE REGISTRATION.**

The permit by rule registration fee shall be paid in its entirety at the time the required registration form is submitted to the Department. The permit by rule registration form and fee should be sent to:

Permit by Rule Registration Fees  
Fiscal Office  
Idaho Department of Environmental Quality  
1410 N. Hilton, Boise, ID 83706-1255

(3-20-20)T

**802. RECEIPT AND USAGE OF FEES.**

Permit by rule registration fee receipts shall be deposited by the Department into a stationary source permit account. Monies from this account shall be used solely toward technical, legal and administrative support of the Department's Permit to Construct and Tier II permit programs and shall not be used for those activities supported by the fund created for implementing the operating permit program required under Title V of the federal Clean Air Act amendments of 1990. Fees payable under Section 800 shall be retained by the Department regardless of whether a permit by rule registration is accepted by the Department in response to a registration request. (3-20-20)T

**803. -- 804. (RESERVED)**

**805. RULES FOR CONTROL OF HOT-MIX ASPHALT PLANTS.**

The purpose of Sections 805 through 808 is to establish for hot-mix asphalt plants restrictions on the emission of particulate matter. (3-20-20)T

**806. EMISSION LIMITS.**

No person shall cause, allow or permit a hot-mix asphalt plant to have particulate emissions which exceed the limits specified in Sections 700 through 703. (3-20-20)T

**807. MULTIPLE STACKS.**

In the case of more than one (1) stack to a hot-mix asphalt plant, the emission limitation will be based on the total emission from all stacks. (3-20-20)T

**808. FUGITIVE DUST CONTROL.**

**01. Fugitive Emission Controls.** No person shall cause, allow or permit a plant to operate that is not equipped with an efficient fugitive dust control system. The system shall be operated and maintained in such a manner as to satisfactorily control the emission of particulate material from any point other than the stack outlet. (3-20-20)T

**02. Plant Property Dust Controls.** The owner or operator of the plant shall maintain fugitive dust control of the plant premises and plant owned, leased or controlled access roads by paving, oil treatment or other suitable measures. Good operating practices, including water spraying or other suitable measures, shall be employed to prevent dust generation and atmospheric entrainment during operations such as stockpiling, screen changing and general maintenance. (3-20-20)T

**809. -- 814. (RESERVED)**

**815. RULES FOR CONTROL OF KRAFT PULP MILLS.**

The purpose of Sections 815 through 818 is to establish emission standards for recovery furnaces and notification and reporting requirements for low volume high concentration (LVHC) and high volume low concentration (HVLC) gas venting at kraft pulp mills. (3-20-20)T

**816. RECOVERY FURNACE TRS STANDARD.**

The average daily emissions of total reduced sulfur (TRS) from each recovery furnace shall not exceed fifteen (15) ppm expressed as hydrogen sulfide on a dry basis. Recovery furnaces at kraft pulp mills subject to 40 CFR Part 60 TRS standards are exempt from the requirements of Section 816. (3-20-20)T

**817. RECOVERY FURNACE TRS MONITORING AND RECORDKEEPING.**

Owners and operators of each recovery furnace subject to the TRS emission standard in Section 816 shall maintain and operate equipment to continuously monitor and record the daily average TRS concentrations. (3-20-20)T

**818. KRAFT PULP MILL LVHC AND HVLC GAS VENTING NOTIFICATION AND REPORTING.**

Section 818 is applicable to kraft pulp mill LVHC and HVLC gas venting from sources required to be controlled pursuant to 40 CFR 63, Subpart S. For purposes of Sections 130 through 136, an excess emission is defined as a continuous uncontrolled gas venting in excess of five (5) minutes. Excess emissions notification and reporting shall be conducted pursuant to the requirements contained in Sections 130 through 136 and the permit issued to the kraft pulp mill. (3-20-20)T

**819. -- 834. (RESERVED)**

**835. RULES FOR CONTROL OF RENDERING PLANTS.**

The purpose of Sections 835 through 839 is to establish for rendering plants limitations on the emission of odors. (3-20-20)T

**836. CONTROL OF COOKERS.**

No person shall allow, suffer, cause, or permit the operation or use of any device, machine, equipment, or other contrivance to cook inedible animal or marine matter unless all gases, vapors, and gas entrained effluents from these processes are passed through condensers to remove all steam and other condensable materials. All noncondensibles passing through the condensers must then be incinerated at one thousand two hundred degrees Fahrenheit (1,200) for a minimum of three-tenths (0.3) seconds, or treated in an equally effective manner. (3-20-20)T

**837. CONTROL OF EXPELLERS.**

No person shall allow, suffer, cause, or permit the installation or operation of an expeller unless it is properly hooded and all exhaust gases are ducted to odor control equipment. (3-20-20)T

**838. CONTROL OF PLANT AIR.**

No person shall allow, suffer, cause, or permit the installation or operation of a rendering plant unless plant ventilation air is collected and ducted to odor control equipment. (3-20-20)T

**839. EXCEPTIONS.**

Section 838 shall not apply when it can be demonstrated that without ducting plant ventilation air to the odor control equipment no noticeable odors from the plant can be detected at the property line. (3-20-20)T

**840. -- 859. (RESERVED)**

**860. EMISSION GUIDELINES FOR MUNICIPAL SOLID WASTE LANDFILLS THAT COMMENCED CONSTRUCTION, RECONSTRUCTION OR MODIFICATION BEFORE MAY 30, 1991.**

**01. Applicability.** All owners or operators of any small or large municipal solid waste landfills in the following categories are subject to Section 860: (3-20-20)T

- a. Landfills that have accepted waste since November 8, 1987; (3-20-20)T
- b. Landfills with no modifications after May 30, 1991; or (3-20-20)T
- c. Landfills that closed after November 8, 1987 with no modifications after May 30, 1991. (3-20-20)T

**02. Definitions.** Unless specifically provided otherwise immediately below, the definitions for all terms set forth in Section 860 shall be the definitions set forth in 40 CFR Part 60. The following definitions apply to

Section 860: (3-20-20)T

**a.** “Closed municipal solid waste landfill” (closed landfill) means a landfill in which solid waste is no longer being placed, and in which no additional solid wastes will be placed without first filing a notification of modification as prescribed under 40 CFR 60.7(a)(4). Once a notification of modification has been filed, and additional solid waste is placed in the landfill, the landfill is no longer closed. A landfill is considered closed after meeting the criteria of 40 CFR 258.60. (3-20-20)T

**b.** “Effective date” means July 2, 1999. (3-20-20)T

**c.** “Existing municipal solid waste landfill” (existing landfill) means a municipal solid waste landfill that began construction, reconstruction or modification before May 30, 1991 and has accepted waste at any time since November 8, 1987 or has additional design capacity available for future waste deposition. (3-20-20)T

**d.** “Large municipal solid waste landfill” (large landfill) means a municipal solid waste landfill with a design capacity greater than or equal to two point five (2.5) million megagrams or two point five (2.5) million cubic meters. (3-20-20)T

**e.** “Modification” means an action that results in an increase in the permitted volume design capacity of the landfill by either horizontal or vertical expansion based on its permitted design capacity as of May 30, 1991. Modification does not occur until the owner or operator commences construction on the horizontal or vertical expansion. (3-20-20)T

**f.** “Municipal solid waste landfill” (landfill) means an entire disposal facility in a contiguous geographical space where household waste is placed in or on land. A municipal solid waste landfill may also receive other types of RCRA Subtitle D wastes such as commercial solid waste, nonhazardous sludge, conditionally exempt small quantity generator waste, and industrial solid waste. Portions of a municipal solid waste landfill may be separated by access roads and may be publicly or privately owned. A municipal solid waste landfill may be a new municipal solid waste landfill, an existing municipal solid waste landfill, or a lateral expansion (modification). (3-20-20)T

**g.** “New municipal solid waste landfill” (new landfill) means a municipal solid waste landfill that began construction, reconstruction or modification or began accepting waste on or after May 30, 1991. (3-20-20)T

**h.** “Small municipal solid waste landfill” (small landfill) means a municipal solid waste landfill with a design capacity less than two point five (2.5) million megagrams or two point five (2.5) million cubic meters. (3-20-20)T

**03. General Requirements.** All owners or operators of landfills subject to Section 860 must comply with, 40 CFR Section 60.30c through 60.36c and 40 CFR Section 60.751 through 60.759 as amended by 63 Fed. Reg. 32,743-53 (June 16, 1998) and 64 Fed. Reg. 9,257-62 (February 24, 1999) and incorporated by reference into these rules at Section 107. Where “Administrator” or “EPA” appears in 40 CFR Part 60, “Department” shall be substituted, except in any section of 40 CFR Part 60 for which a federal rule or delegation specifically indicates that authority will not be delegated to the state. (3-20-20)T

**04. Permitting Requirements.** All owners or operators of landfills subject to Section 860 must comply with Federal Operating Permit Requirements (Title V) as specified in Sections 300 through 399 of these rules: (3-20-20)T

**a.** All owners or operators of existing large landfills must submit a complete Federal Operating Permit application one (1) year after EPA approves the Clean Air Act Section 111(d) State Plan associated with Section 860. (3-20-20)T

**b.** All owners or operators of existing small landfills that are major sources must submit a complete Federal Operating Permit application within one (1) year of becoming a major source. (3-20-20)T

**05. Reporting Requirements.** All owners or operators of landfills subject to Section 860 shall comply



with the following: (3-20-20)T

- a. All owners or operators of large landfills must: (3-20-20)T
  - i. Submit an Initial Design Capacity Report and an Initial Nonmethane Organic Compound Report within ninety (90) days of the effective date of Section 860 and; (3-20-20)T
  - ii. Submit an annual Nonmethane Organic Compound Report until nonmethane emissions are less than fifty (50) Mg/yr. (3-20-20)T
- b. All owners or operators of small landfills must submit an Initial Design Capacity Report and an Initial Nonmethane Organic Compound Report within ninety (90) days of the effective date of Section 860. (3-20-20)T

**06. Compliance Schedules and Increments of Progress.** All owners or operators of landfills subject to Section 860 that have a nonmethane organic compound emission rate fifty (50) Mg/yr or greater as specified in 40 CFR Section 60.752(b)(2) shall comply with the following schedule: (3-20-20)T

- a. The owner or operator of an existing large landfill must submit their first Annual Emission Rate Report with the design capacity report no later than July 31, 2000. (3-20-20)T
- b. The owner or operator of an existing landfill shall submit a collection and control system design plan within one (1) year of the date of the first Annual Emission Rate Report showing that the nonmethane organic compound emission rate is fifty (50) Mg/yr or greater as specified in 40 CFR Section 60.752(b)(2). (3-20-20)T
- c. The owner or operator of an existing landfill shall award contracts for construction of collection and control systems or orders for purchase of components no later than January 31, 2002. (3-20-20)T
- d. The owner or operator of an existing landfill shall initiate on-site construction or installation of the collection and control systems no later than April 30, 2002. (3-20-20)T
- e. The owner or operator of an existing landfill shall complete, no later than September 30, 2002, on-site construction or installation of collection and control systems capable of meeting the requirements of Section 860. (3-20-20)T
- f. The owner or operator of an existing landfill shall comply with Section 860 no later than September 30, 2002. (3-20-20)T

**07. Compliance Schedules and Increments of Progress for Municipal Solid Waste Landfills That Have Nonmethane Organic Compound Emission Rates Less Than 50 Mg/yr.** All owners or operators of landfills subject to Section 860 that have nonmethane organic compound emission rates less than fifty (50) Mg/yr on or after November 19, 1999 shall install collection and control systems within thirty (30) months after the date the first annual nonmethane organic compound emission rate equals or exceeds fifty (50) Mg/yr as specified in 40 CFR Section 60.36c(b). (3-20-20)T

**861. -- 999. (RESERVED)**

## 58.01.05 – RULES AND STANDARDS FOR HAZARDOUS WASTE

### 000. LEGAL AUTHORITY.

These rules are adopted pursuant to the authority vested in the Board of Environmental Quality by the Hazardous Waste Management Act of 1983, as amended (HWMA), Sections 39-4401 et seq., Idaho Code, and the authority vested in the Director of the Department of Environmental Quality by the Hazardous Waste Facility Siting Act of 1985, as amended, Sections 39-5801 et seq., Idaho Code. (3-20-20)T

### 001. TITLE.

These rules are titled IDAPA 58.01.05, “Rules and Standards for Hazardous Waste.” (3-20-20)T

### 002. INCORPORATION BY REFERENCE OF FEDERAL REGULATIONS.

Any reference in these rules to requirements, procedures, or specific forms contained in the Code of Federal Regulations (CFR), Title 40, Parts 124, 260 - 268, 270, 273, 278, and 279 shall constitute the full adoption by reference of that part and Subparts as they appear in 40 CFR, revised as of July 1, 2019, including any notes and appendices therein, unless expressly provided otherwise in these rules. (3-20-20)T

**01. Exceptions.** Nothing in 40 CFR Parts 260 - 268, 270, 273, 278, 279 or Part 124 as pertains to permits for Underground Injection Control (U.I.C.) under the Safe Drinking Water Act, the Dredge or Fill Program under Section 404 of the Clean Water Act, the National Pollution Discharge Elimination System (NPDES) under the Clean Water Act or Prevention of Significant Deterioration Program (PSD) under the Clean Air Act is adopted or included by reference herein. (3-20-20)T

**02. Availability of Referenced Material.** The federal regulations adopted by reference throughout these rules are maintained at the following locations: (3-20-20)T

- a. U.S. Government Printing Office, <http://www.ecfr.gov/cgi-bin/ECFR>; and (3-20-20)T
- b. State Law Library, 451 W. State Street, P.O. Box 83720, Boise, ID 83720-0051, (208) 334-3316; and (3-20-20)T
- c. Department of Environmental Quality, 1410 N. Hilton, Boise, ID 83706-1255, (208) 373-0502. (3-20-20)T

### 003. DEFINITIONS.

For the purpose of these rules and any materials incorporated herein by reference, the following definitions apply unless their application would be inconsistent with the Hazardous Waste Management Act, or unless these rules expressly provide for different definitions. (3-20-20)T

**01. Board.** The Idaho Board of Environmental Quality. (3-20-20)T

**02. CFR.** The United States Code of Federal Regulations. (3-20-20)T

**03. Department.** The Idaho Department of Environmental Quality. (3-20-20)T

**04. Director.** When used in the context of 40 CFR, the definition shall be the Director of the Idaho Department of Environmental Quality, or his designee, as the context requires. When used in the context of these rules, the definition shall be the U. S. Environmental Protection Agency Region 10 Regional Administrator. (3-20-20)T

**05. Environmental Appeals Board.** When used in the context of 40 CFR, the definition shall be the Idaho Board of Environmental Quality except as set forth in Section 39-4413(2), Idaho Code, or except where noted in these rules. When used in the context of these rules, the definition shall be the U.S. Environmental Appeals Board. (3-20-20)T

**06. U.S. Environmental Protection Agency or EPA, EPA Headquarters, or EPA.** When used in the context of 40 CFR, the definition shall be the Idaho Department of Environmental Quality, except when used to refer to an EPA Identification number, EPA hazardous waste number, EPA forms, publications or guidance, and EPA Acknowledgment of Consent, and where noted in these rules. Under the latter circumstances, the definition shall be the U.S. Environmental Protection Agency and the Headquarters of the U.S. Environmental Protection Agency as appropriate. When used in the context of these rules, the definition shall be the U.S. Environmental Protection Agency. (3-20-20)T

- 07. HWFSA.** The Hazardous Waste Facility Siting Act of 1985, Sections 39-5801 et seq., Idaho Code. (3-20-20)T
- 08. HWMA.** The Hazardous Waste Management Act of 1983, Sections 39-4401 et seq., Idaho Code. (3-20-20)T
- 09. IDAPA.** The Idaho Administrative Procedures Act, Title 67, Chapter 52, Idaho Code. (3-20-20)T
- 10. RCRA.** When used in the context of 40 CFR, the definition shall be the comparable sections of the Hazardous Waste Management Act of 1983, Sections 39-4401 et seq., Idaho Code. When used in the context of these rules, the definition shall be The Resource Conservation and Recovery Act, 42 U.S. Code, Sections 6901 et seq. (3-20-20)T
- 11. Regional Administrator or Administrator.** When used in the context of 40 CFR, the definition shall be the Director of the Idaho Department of Environmental Quality, or his designee, except where noted in these rules. When used in the context of these rules, the definition shall be the U.S. Environmental Protection Agency Administrator or Region 10 Regional Administrator as appropriate. (3-20-20)T
- 12. TSD.** Treatment, storage or disposal. (3-20-20)T
- 13. United States or U.S.** When used in the context of 40 CFR, the definition shall be the state of Idaho, except where noted in these rules. When used in the context of these rules, the definition shall be the United States. (3-20-20)T
- 004. HAZARDOUS WASTE MANAGEMENT SYSTEM.**  
40 CFR Part 260 and all Subparts, except 40 CFR 260.2, are herein incorporated by reference as provided in 40 CFR, revised as of July 1, 2019. For the purposes of 40 CFR 260.4(a)(4) and 260.5(b)(2), “EPA” is defined as the U.S. Environmental Protection Agency. For the purposes of 40 CFR 260.10 in the definition of electronic manifest and electronic manifest system, “EPA” is defined as the U.S. Environmental Protection Agency. For purposes of 40 CFR 260.10, in the definition of hazardous waste constituent, “Administrator” is defined as the U.S. Environmental Protection Agency Administrator. For purposes of 40 CFR 260.20, “Federal Register” is defined as the Idaho Administrative Bulletin. (3-20-20)T
- 005. IDENTIFICATION AND LISTING OF HAZARDOUS WASTE.**  
40 CFR Part 261 and all Subparts (excluding 261.4(b)(17)), except the language “in the Region where the sample is collected” in 40 CFR 261.4(e)(3)(iii), are herein incorporated by reference as provided in 40 CFR, revised as of July 1, 2019. For purposes of 40 CFR 261.10 and 40 CFR 261.11, “Administrator” is defined as the U.S. Environmental Protection Agency Administrator. For purposes of 40 CFR 261.4(b)(11)(ii), 40 CFR 261.39(a)(5), 40 CFR 261.41, and 40 CFR 261 Appendix IX, “EPA” is defined as the U.S. Environmental Protection Agency. Copies of annual reports and advance notifications under these sections shall also be sent to the Director. (3-20-20)T
- 01. Hazardous Secondary Materials Managers Emergency Notification.** In addition to the emergency notification required by 40 CFR 261.411(d)(3) and 261.420(f)(4)(ii), the emergency coordinator must also immediately notify the Idaho Office of Emergency Management by telephone, 1-800-632-8000, to file an identical report. (3-20-20)T
- 02. Excluded Wastes.** Chemically Stabilized Electric Arc Furnace Dust (CSEAFD) generated by EnviroSAFE Services of Idaho, Inc. (ESII) at ESII’s facility in Grand View, Idaho using the Super Detox(R) treatment process as modified by ESII and that is disposed of in a Subtitle D or Subtitle C landfill is excluded from the lists of hazardous waste provided ESII implements a program that meets the following conditions: (3-20-20)T
- a. Verification Testing Requirements.** Sample Collection and analyses, including quality control procedures, conducted pursuant to Subsections 005.02.b. and 005.02.c., must be performed according to SW-846 methodologies and the RCRA Part B permit, including future revisions. (3-20-20)T
- b. Initial Verification Testing.** (3-20-20)T

i. For purposes of Subsections 005.02.b., “new source” means any generator of Electric Arc Furnace Dust (EAFD), EPA and Idaho Department of Environmental Quality Hazardous Waste No. KO61, whose waste has not previously been processed by ESII using the Super Detox(R) treatment process resulting in processed EAFD which has been subjected to initial verification testing and has demonstrated compliance with the delisting levels specified in Subsection 005.02.d. (3-20-20)T

ii. Prior to the initial treatment of any new source of EAFD, ESII must notify the Department in writing. The written notification includes: (3-20-20)T

(1) The waste profile information; and (3-20-20)T

(2) The name and address of the generator. (3-20-20)T

iii. The first four (4) consecutive batches treated must be sampled in accordance with Subsection 005.02.a. Each of the four (4) samples shall be analyzed to determine if the CSEAFD generated meets the delisting levels specified in Subsection 005.02.d. (3-20-20)T

iv. If the initial verification testing demonstrates that the CSEAFD samples meet the delisting levels specified in Subsection 005.02.d., ESII shall submit the operational and analytical test data, including quality control information, to the Department, in accordance with Subsection 005.02.f. Subsequent to such data submittal, the CSEAFD generated from EAFD originating from the new source shall be considered delisted. (3-20-20)T

v. CSEAFD generated by ESII from EAFD originating from a new source shall be managed as hazardous waste in accordance with Subtitle C of RCRA until: (3-20-20)T

(1) Initial verification testing demonstrates that the CSEAFD meets the delisting levels specified in Subsection 005.02.d.; and (3-20-20)T

(2) The operational and analytical test data is submitted to the Department pursuant to Subsection 005.02.b.iv. (3-20-20)T

vi. For purposes of Subsections 005.02.b. and 005.02.c., “batch” means the CSEAFD that results from a single treatment episode in a full scale mixing vessel. (3-20-20)T

c. Subsequent Verification Testing. (3-20-20)T

i. Subsequent to initial verification testing, ESII shall collect a representative sample, in accordance with Subsection 005.02.a., from each batch of CSEAFD generated by ESII. ESII may, at its discretion, conduct subsequent verification testing on composite samples. In no event shall a composite sample consist of representative samples from more than twenty (20) batches of CSEAFD. (3-20-20)T

ii. The samples shall be analyzed prior to disposal of each batch of CSEAFD to determine if the CSEAFD meets the delisting levels specified in Subsection 005.02.d. (3-20-20)T

iii. Each batch of CSEAFD generated by ESII shall be subjected to subsequent verification testing no later than thirty (30) days after it is generated by ESII. (3-20-20)T

iv. If the levels of constituents measured in a sample, or composite sample, of CSEAFD do not exceed the levels set forth in Subsection 005.02.d., then any batch of CSEAFD which contributed to the sample that does not exceed the levels set forth in Subsection 005.02.d. is non-hazardous and may be managed and/or disposed of in a Subtitle D or Subtitle C landfill. (3-20-20)T

v. If the constituent levels in a sample, or composite sample, exceed any of the delisting levels set forth in Subsection 005.02.d., then ESII must submit written notification of the results of the analysis to the Department within fifteen (15) days from receiving the final analytical results, and any CSEAFD which contributed to the sample must be: (3-20-20)T

- (1) Retested, and retreated if necessary, until it meets the levels set forth in Subsection 005.02.d.; or (3-20-20)T
- (2) Managed and disposed of in accordance with Subtitle C of RCRA. (3-20-20)T
- vi. Each batch of CSEAFD shall be managed as hazardous waste in accordance with Subtitle C of RCRA until subsequent verification testing demonstrates that the CSEAFD meets the delisting levels specified in Subsection 005.02.d. (3-20-20)T

**d. Delisting Levels. (3-20-20)T**

i. All leachable concentrations for these metals must not exceed the following levels (mg/l):

antimony	0.06	mercury	0.009
arsenic	0.50	nickel	1
barium	7.60	selenium	0.16
beryllium	0.010	silver	0.30
cadmium	0.050	thallium	0.020
chromium	0.33	vanadium	2
lead	0.15	zinc	70

(3-20-20)T

ii. Metal concentrations must be measured in the waste leachate by the method specified in 40 CFR Part 261.24. (3-20-20)T

**e. Modification of Treatment Process. (3-20-20)T**

i. If ESII makes a decision to modify the Super Detox(R) treatment process from the description of the process as set forth in ESII's Petition for Delisting Treated K061 Dust by the Super Detox(R) Process submitted to the Department on July 14, 1995, ESII shall notify the Department in writing prior to implementing the modification. (3-20-20)T

ii. After ESII's receipt of written approval from the Department, and subject to any conditions included with the approval, ESII may implement the proposed modification. (3-20-20)T

iii. If ESII modifies its treatment process without first receiving written approval from the Department, this exclusion of waste will be void from the time the process was modified. (3-20-20)T

iv. ESII's Petition for Delisting Treated K061 Dust by the Super Detox(R) Process submitted to the Department on July 14, 1995 is available at the Department of Environmental Quality, Waste Management and Remediation Division, 1410 N. Hilton, Boise, Idaho 83706. (3-20-20)T

**f. Records and Data Retention and Submittal. (3-20-20)T**

i. Records of disposal site, operating conditions and analytical data from verification testing must be compiled, summarized, and maintained at ESII's Grand View facility for a minimum of five (5) years from the date the records or data are generated. (3-20-20)T

ii. The records and data maintained by ESII must be furnished upon request to the Department or EPA. (3-20-20)T

iii. Failure to submit requested records or data within ten (10) business days of receipt of a written request or failure to maintain the required records and data on site for the specified time, will be considered by the Department, at its discretion, sufficient basis to revoke the exclusion to the extent directed by the Department.

(3-20-20)T

iv. All records or data submitted to the Department must be accompanied by a signed copy of the following certification statement to attest to the truth and accuracy of the records or data submitted: "Under civil and/or criminal penalty of law for the making or submission of false or fraudulent statements or representations, I certify that the information contained in or accompanying this document is true, accurate, and complete. As to any identified sections of this document for which I cannot personally verify the truth and accuracy, I certify as the ESII official having supervisory responsibility for the persons who, acting under my direct instructions, made the verification that this information is true, accurate, and complete. In the event that any of this information is determined by the Department in its sole discretion to be false, inaccurate, or incomplete, and upon conveyance of this fact to ESII, I recognize and agree that this exclusion of waste will be void as if it never had effect or to the extent directed by the Department and that ESII will be liable for any actions taken in contravention of ESII's RCRA and CERCLA obligations premised upon ESII's reliance on the void exclusion."

(3-20-20)T

g. Facility Merger and Name Change. On May 4, 2001, the Department was notified of a stock transfer that resulted in ESII's facility merging with American Ecology. This created a name change from EnviroSAFE Services of Idaho, Inc. (ESII) to US Ecology Idaho, Inc. effective May 1, 2001. All references to EnviroSAFE Services of Idaho, Inc. or ESII now refer to US Ecology Idaho, Inc.

(3-20-20)T

#### **006. STANDARDS APPLICABLE TO GENERATORS OF HAZARDOUS WASTE.**

**01. Incorporation by Reference.** 40 CFR Part 262 and all Subparts, except for the language "for the Region in which the generator is located" in 40 CFR 262.42(a)(2) and 40 CFR 262.42(b), are herein incorporated by reference as provided in 40 CFR, revised as of July 1, 2019. For purposes of 40 CFR 262.82, 262.83, and 262.84, "EPA" is defined as the U.S. Environmental Protection Agency. Copies of advance notification, annual reports, and exception reports, required under those sections, shall also be provided to the Director. For purposes of 40 CFR 262.20, 262.21, 262.24, 262.25, and 262.39, EPA or Environmental Protection Agency is defined as the U.S. Environmental Protection Agency. For purposes of 40 CFR Part 262, Subpart H, "United States or U.S." is defined as the United States.

(3-20-20)T

**02. Generator Emergency Notification.** In addition to the emergency notification required by 40 CFR 262.16(b)(9)(iv)(C) and 262.265(d)(2), (see 40 CFR 262.17(a)(6), 263.30(c)(1), 264.56(d)(2), and 265.56(d)(2)) the emergency coordinator must also immediately notify the Idaho Office of Emergency Management by telephone, 1-800-632-8000, to file an identical report.

(3-20-20)T

#### **007. STANDARDS APPLICABLE TO TRANSPORTERS OF HAZARDOUS WASTE.**

40 CFR Part 263 and all Subparts are herein incorporated by reference as provided in 40 CFR, revised as of July 1, 2019. For purposes of 40 CFR 263.20(g), 263.20(g)(1), 263.20(g)(4), 263.21(a)(4), and 263.22(d), "United States" is defined as the United States. For the purposes of 40 CFR 263.20(a), "EPA" is defined as U.S. Environmental Protection Agency.

(3-20-20)T

#### **008. STANDARDS FOR OWNERS AND OPERATORS OF HAZARDOUS WASTE TREATMENT, STORAGE AND DISPOSAL FACILITIES.**

40 CFR Part 264 and all Subparts (excluding 40 CFR 264.1(f), 264.1(g)(12), 264.149, 264.150, 264.301(l), 264.1030(d), 264.1050(g), 264.1080(e), 264.1080(f) and 264.1080(g)) are herein incorporated by reference as provided in 40 CFR, revised as of July 1, 2019. For purposes of 40 CFR Subsection 264.12(a), "Regional Administrator" is defined as the U.S. Environmental Protection Agency Region 10 Regional Administrator. For purposes of 40 CFR 264.71 and 264.1082(c)(4)(ii), "EPA" is defined as the U.S. Environmental Protection Agency.

(3-20-20)T

#### **009. INTERIM STATUS STANDARDS FOR OWNERS AND OPERATORS OF HAZARDOUS WASTE TREATMENT, STORAGE AND DISPOSAL FACILITIES.**

40 CFR Part 265, and all Subparts (excluding Subpart R, 40 CFR 265.1(c)(4), 265.1(c)(15), 265.149, 265.150, 265.1030(c), 265.1050(f), 265.1080(e), 265.1080(f), and 265.1080(g)), except the language contained in 40 CFR

265.340(b)(2) as replaced with: “The following requirements continue to apply even when the owner or operator has demonstrated compliance with the MACT requirements of part 63, subpart EEE of this chapter: 40 CFR 265.351 (closure) and the applicable requirements of Subparts A through H, BB and CC of this part,” are herein incorporated by reference as provided in 40 CFR, revised as of July 1, 2019. For purposes of 40 CFR Subsection 265.12(a), “Regional Administrator” is defined as the U.S. Environmental Protection Agency Region 10 Regional Administrator. For purposes of 40 CFR 265.71 and 265.1083(c)(4)(ii), “EPA” is defined as the U.S. Environmental Protection Agency. (3-20-20)T

**010. STANDARDS FOR THE MANAGEMENT OF SPECIFIC HAZARDOUS WASTES AND SPECIFIC TYPES OF HAZARDOUS WASTE FACILITIES.**

40 CFR Part 266 and all Subparts are herein incorporated by reference as provided in 40 CFR, revised as of July 1, 2019. (3-20-20)T

**011. LAND DISPOSAL RESTRICTIONS.**

40 CFR Part 268 and all Subparts are herein incorporated by reference as provided in 40 CFR, revised as of July 1, 2019, except for 40 CFR 268.1(e)(3), 268.5, 268.6, 268.13, 268.42(b), and 268.44(a) through (g). The authority for implementing the provisions of these excluded sections remains with the EPA. However, the requirements of Sections 39-4403(17) and 39-4423, Idaho Code, shall be applied in all cases where these requirements are more stringent than the federal standards. If the Administrator of the EPA grants a case-by-case variance pursuant to 40 CFR 268.5, that variance will simultaneously create the same case-by-case variance to the equivalent requirement of these rules. For purposes of 40 CFR 268.2(j) “EPA” is defined as the U.S. Environmental Protection Agency. For purposes of 40 CFR 268.40(b), “Administrator” is defined as U.S. Environmental Protection Agency Administrator. In 40 CFR 268.7(a)(9)(iii), “D009” is excluded, (from lab packs as noted in 40 CFR Part 268 Appendix IV.) (3-20-20)T

**012. HAZARDOUS WASTE PERMIT PROGRAM.**

40 CFR Part 270 and all Subparts, except 40 CFR 270.1(c)(2)(ix), 270.12(a) and 40 CFR 270.14(b)(18), are herein incorporated by reference as provided in 40 CFR, revised as of July 1, 2019. For purposes of 40 CFR 270.2, 270.5, 270.10(e)(2), 270.10(e)(3), 270.10(f)(2), 270.10(f)(3), 270.10(g), 270.11(a)(3), 270.32(a), 270.32(b)(2), 270.32(c), 270.51, 270.72(a)(5), and 270.72(b)(5), “EPA” and “Administrator” or “Regional Administrator” is defined as the U.S. Environmental Protection Agency and the U.S. Environmental Protection Agency Region 10 Regional Administrator respectively. (3-20-20)T

**013. PROCEDURES FOR DECISION-MAKING (STATE PROCEDURES FOR RCRA OR HWMA PERMIT APPLICATIONS).**

40 CFR Part 124, Subparts A, B and G are herein incorporated by reference as provided in 40 CFR, revised as of July 1, 2019, except that the last sentence of 40 CFR 124.10(b)(1), 40 CFR 124.15(b)(2), 40 CFR 124.19, the fourth sentence of 40 CFR 124.31(a), the third sentence of 40 CFR 124.32(a), and the second sentence of 40 CFR 124.33(a) are expressly omitted from the incorporation by reference of each of those subsections. For purposes of 40 CFR 124.6(e), 124.10(b), and 124.10(c)(1)(ii) “EPA” and “Administrator” or “Regional Administrator” is defined as the U.S. Environmental Protection Agency and the U.S. Environmental Protection Agency Region 10 Regional Administrator, respectively. (3-20-20)T

**014. (RESERVED)**

**015. STANDARDS FOR THE MANAGEMENT OF USED OIL.**

**01. Incorporation by Reference.** 40 CFR Part 279 and all Subparts are herein incorporated by reference as provided in 40 CFR, revised as of July 1, 2019. For purposes of 40 CFR 279.43(c)(3)(ii) “Director” is defined as the Director, U.S.DOT Office of Hazardous Materials Regulation. (3-20-20)T

**02. Used Oil as a Dust Suppressant.** 40 CFR Part 279 contains a prohibition on the use of used oil as a dust suppressant at 279.82(a), however, States may petition EPA to allow the use of used oil as a dust suppressant. Members of the public may petition the State to make this application to EPA. This petition to the State must: (3-20-20)T

**a.** Be submitted to the Idaho Department of Environmental Quality, 1410 North Hilton, Boise, Idaho 83706-1255; and (3-20-20)T

- b. Demonstrate how the requirements of 40 CFR 279.82(b) will be met. (3-20-20)T

**016. STANDARDS FOR UNIVERSAL WASTE MANAGEMENT.**

40 CFR Part 273 and all Subparts are herein incorporated by reference as provided in 40 CFR, revised as of July 1, 2019. For purposes of 40 CFR 273.32(a)(3), "EPA" is defined as the U.S. Environmental Protection Agency. (3-20-20)T

**017. CRITERIA FOR THE MANAGEMENT OF GRANULAR MINE TAILINGS (CHAT) IN ASPHALT CONCRETE AND PORTLAND CEMENT CONCRETE IN TRANSPORTATION CONSTRUCTION PROJECTS FUNDED IN WHOLE OR IN PART BY FEDERAL FUNDS.**

40 CFR Part 278 and all Subparts are herein incorporated by reference as provided in 40 CFR, revised as of July 1, 2019. (3-20-20)T

**018. STANDARDS FOR OWNERS AND OPERATORS OF HAZARDOUS WASTE FACILITIES OPERATING UNDER A STANDARDIZED PERMIT.**

40 CFR Part 267 and all Subparts, except 40 CFR 267.150, are herein incorporated by reference as provided in 40 CFR, revised as of July 1, 2019. (3-20-20)T

**019. -- 354. (RESERVED)**

**355. HAZARDOUS WASTE FACILITY SITING LICENSE FEE.**

An application for a siting license required by HWFSA shall be accompanied by a siting license fee in an amount established by these rules. The license fee shall not exceed seven thousand five hundred dollars (\$7,500) and shall be submitted with the siting license application. (3-20-20)T

**01. License Fee Criteria.** The siting license fee required by HWFSA and these rules shall be based on the costs to the Department of reviewing the siting license application and the characteristics of the proposed hazardous waste facility, including the projected site size, projected waste volume, and the hydrogeological characteristics surrounding the site. (3-20-20)T

a. "Projected Waste Volume" means the total actual or potential hazardous waste volume, in gallons or an equivalent measurement, proposed for the hazardous waste facility. (3-20-20)T

b. "Site Size" means the sum in acres of all proposed "Hazardous Waste Management Unit(s)" as defined in Section 004 (40 CFR 260.10). (3-20-20)T

**02. License Fee Scale.** Except as provided in Subsection 355.03, the siting license fee required by HWFSA and these rules shall be determined using the table below.

LICENSE FEE SCALE - PROJECTED HAZARDOUS WASTE VOLUME (gallons)			
Site Size	Up to 10,000	10,000 - 20,000	More Than 20,000
1 acre or greater	\$3,000	\$4,000	\$7,500
Equal to or greater than 1/2 acre, but less than 1 acre	\$4,000	\$5,000	\$7,500
Less than 1/2 acre	\$5,000	\$6,000	\$7,500

(3-20-20)T

**03. License Fee for Facilities Required to Submit Engineering or Hydrogeological Information.** For any proposed commercial hazardous waste disposal, treatment or storage facility or any on-site land disposal facility for wastes listed pursuant to Section 201(d)(2) and (e), as modified by Section 209 of the Federal Hazardous and Solid Waste Amendments of 1984, which must submit engineering or hydrogeological information to indicate compliance with technical criteria as adopted in the Hazardous Waste Management Plan, the siting license fee shall be seven thousand five hundred dollars (\$7,500). (3-20-20)T



**04. Expansion, Enlargement or Alteration of a Commercial Hazardous Waste Disposal, Treatment or Storage Facility or Any On-Site Land Disposal Facility for Wastes Listed Pursuant to Section 201(D)(2) and (E), as Modified by Section 209 of the Hazardous and Solid Waste Amendments of 1984.** The significant expansion, enlargement or alteration of a hazardous waste treatment, storage or disposal facility in existence on July 1, 1985, constitutes a new proposal for which a siting license is required and for which a siting license fee must be paid. (3-20-20)T

**05. Siting License Fee Nonrefundable.** The siting license fee required by these rules shall be nonrefundable and may not be applied toward any subsequent application should the siting license application be cancelled or withdrawn, or denied. (3-20-20)T

**356. VARIANCE APPLICATIONS FOR TSD FACILITIES OR SITES.**

**01. Application Contents and Standard of Review.** Applications for variances shall be submitted in triplicate and shall contain such detailed plans, specifications, and information regarding objectives, procedures, controls, and other pertinent data as the Director may require. A variance shall not exceed one (1) year in duration. The Director may grant a variance only if the applicant demonstrates to the Director's satisfaction that construction and operation of the TSD facility or site in the manner allowed by the variance and any term or condition imposed as part of the variance: (3-20-20)T

- a. Is required to avert unnecessary and significant hardship; (3-20-20)T
- b. Is not inconsistent with EPA requirements; and (3-20-20)T
- c. Will not create a nuisance or a hazard to the public health, safety or the environment. (3-20-20)T

**02. Public Hearings.** The Director may hold a public hearing on an initial application for a variance and shall hold a public hearing on any application to renew or extend a variance. The public hearing shall be held at a location in the county where the operations that are the subject of the application for the variance are conducted unless the Director determines that a different location would be more appropriate and convenient for interested members of the public. The Director shall give at least twenty (20) days' notice of the hearing to the applicant by certified mail and shall cause at least one (1) publication of notice in a newspaper with general circulation in either the county where the operation is conducted or the county where the hearing is to be held. The Director shall cause to be made a complete record of the testimony and the evidence submitted at the hearing. (3-20-20)T

**03. Public Information.** All information submitted as part of a variance application shall be treated as public information and shall not be subject to any claim of confidentiality. The Director shall make the application available for public inspection at the Department's state office and appropriate regional office. The Director shall make available for public inspection at the Department's state office and all regional offices a current list of pending applications for variances and a current schedule of pending variance hearings. (3-20-20)T

**04. Director's Decision.** No variance shall be issued or denied until the Director has considered the relative interests of the applicant, other persons and property affected by the variance and the public. Any variance granted pursuant to this section shall be for a period specified by the Director but not more than one (1) year. No variance shall be issued or denied without a written order stating the findings upon which the decision is based. (3-20-20)T

**05. Applicant to Bear Costs.** The cost of public notice, recording and transcribing of testimony and hearing facilities shall be borne by the applicant, regardless of whether or not a variance is issued. (3-20-20)T

**357. -- 499. (RESERVED)**

**500. ROUTING OF HAZARDOUS WASTE SHIPMENTS.**

**01. Transporting.** Any person transporting a quantity of hazardous waste which requires a manifest shall, to the extent possible: (3-20-20)T

- a. Use state, United States and interstate highways; and (3-20-20)T
- b. Avoid municipalities and population centers, even when doing so may add miles to the distance traveled. (3-20-20)T

**02. Director's Conditions.** The Director may, upon a finding that a shipment or shipments of hazardous waste constitutes a greater than normal risk to the public health, safety or environment, prescribe by order particular conditions for that shipment or shipments including but not limited to special placarding, pilot vehicles, routing restrictions, parking restrictions and timing restrictions. (3-20-20)T

**501. -- 799. (RESERVED)**

**800. INSPECTION PLAN -- FREQUENCY LEVELS.**

The Department may, as time and resources permit, conduct regular inspections of persons or entities subject to these rules, their records, and property at approximately the following frequency levels based upon potential risk to the public health or environment. (3-20-20)T

**01. Commercial TSD Facilities.** Commercial TSD facilities or sites or offsite generator TSD facilities or sites, up to every day. (3-20-20)T

**02. Generator On-Site TSD Facilities.** Generator on-site TSD facilities or sites -- up to twenty (20) times per year. (3-20-20)T

**03. Transport Vehicles.** Transport vehicles as necessary. (3-20-20)T

**04. Transport Facilities.** Transport facilities or sites -- up to twelve (12) times per year. (3-20-20)T

**05. Generators.** Generators -- up to twelve (12) times per year. (3-20-20)T

**06. Conduct Inspections.** Nothing in the preceding schedule of frequency levels may be construed as limiting the Department's authority to conduct inspections when there is reasonable cause to suspect a violation of HWMA or these rules. The Director may by policy guidance memorandum modify the inspection frequency levels as necessary for the effective or efficient enforcement of HWMA and these rules. (3-20-20)T

**801. -- 849. (RESERVED)**

**850. ILLEGAL ACTIONS.**

**01. False Statements or Representations.** Any person who makes a false statement or representation in any application, label, manifest, record, report, permit or other document filed, maintained or used for the purpose of complying with these rules or HWMA thereby commits a violation. Each false statement or representation constitutes a separate and distinct violation for which civil penalties may be imposed. Any person who knowingly makes a false statement or representation of the type described above is, in addition to civil penalties, subject to criminal prosecution for the commission of a misdemeanor for each statement or representation. (3-20-20)T

**02. Failure to Comply with These Rules, the HWMA, or Other Requirements.** Any person who violates these rules, HWMA, or any permit, standard, condition, requirement, compliance agreement or order issued pursuant to these rules or HWMA thereby commits a violation. Civil penalties may be imposed for each separate violation and for each day of continuing violation. Any person who knowingly commits a violation of the type described above is, in addition to civil penalties, subject to criminal prosecution for the commission of a misdemeanor for each separate violation and for each day of a continuing violation. (3-20-20)T

**851. -- 899. (RESERVED)**

**900. EXPENDITURES FROM HAZARDOUS WASTE EMERGENCY ACCOUNT.**

The Director may declare a hazardous waste emergency if the public health, safety or the environment are threatened

by a release or threat of release of a hazardous waste or a substance which has become a hazardous waste. Following a hazardous waste emergency declaration, the Department may spend or obligate to be spent up to two hundred thousand dollars (\$200,000) from the Hazardous Waste Emergency Account to obtain equipment and materials, conduct investigations, test samples, and employ personnel as necessary or eliminate or mitigate the immediate threat and stabilize the situation. The Director may authorize the expenditure or obligation of more than two hundred thousand dollars (\$200,000) from this account in any given situation upon a finding by the Board that a greater expenditure or obligation is prudent and necessary to protect the public health, safety or environment. (3-20-20)T

**901. -- 995. (RESERVED)**

**996. ADMINISTRATIVE PROVISIONS.**

Administrative appeals of agency actions shall be governed by IDAPA 58.01.23, "Rules of Administrative Procedure Before the Board of Environmental Quality." (3-20-20)T

**997. CONFIDENTIALITY OF RECORDS.**

Information obtained by the Department under these rules shall be disclosed to the public in accordance with Chapter 1, Title 74, Idaho Code. Information submitted under a trade secret claim may be entitled to confidential treatment by the Department as provided in Section 74-114, Idaho Code, and IDAPA 58.01.21, "Rules Governing the Protection and Disclosure of Records in the Possession of the Idaho Department of Environmental Quality." (3-20-20)T

**998. -- 999. (RESERVED)**

## 58.01.06 – SOLID WASTE MANAGEMENT RULES

### 000. LEGAL AUTHORITY.

Sections 39-105 and 39-107, Idaho Code, authorize the Board of Environmental Quality to adopt rules and administer programs to protect surface water quality, ground water quality and air quality, and to regulate solid waste treatment or disposal and the licensure and certification requirements pertinent thereto. Section 39-7408C, Idaho Code, authorizes the Board of Environmental Quality to establish by rule municipal solid waste commercial siting license fees. (3-20-20)T

### 001. TITLE AND SCOPE.

- 01. Title.** These rules are titled IDAPA 58.01.06, “Solid Waste Management Rules.” (3-20-20)T
- 02. Scope.** These rules establish requirements applicable to all solid waste and solid waste management facilities in Idaho, except as specifically provided in Subsections 001.03 and 001.04. (3-20-20)T
- 03. Wastes Not Regulated Under These Rules.** (3-20-20)T
- a.** These rules do not apply to the following solid wastes: (3-20-20)T
- i.** Liquid wastes when the discharge or potential discharge of the liquid waste is regulated under a federal, state or local water pollution discharge or wastewater land application permit, including management of any solids if management of the solids are addressed in a permit term or condition; (3-20-20)T
- ii.** Hazardous wastes regulated by the Hazardous Waste Management Act, Chapter 44, Title 39, Idaho Code, and the rules adopted thereunder; (3-20-20)T
- iii.** Polychlorinated biphenyl (PCB) waste regulated under the Toxic Substance Control Act, 15 U.S.C. 2601, et seq., with the exception that the PCB Waste Disposal Act, Chapter 62, Title 39, Idaho Code, and these rules shall apply to PCB waste authorized by federal law to be disposed of at a nonhazardous waste landfill that is permitted, licensed or registered under Idaho Law; (3-20-20)T
- iv.** Slash or slashing areas resulting from the harvesting of timber and the disposal of which is managed pursuant to Chapter 1, Title 38, Idaho Code or log landings or sorting sites; (3-20-20)T
- v.** Wastes used, managed, stored and disposed in accordance with The Wood and Mill Yard Debris Technical Guidance Manual, as amended, published by the Department and developed pursuant to Sections 39-171 through 39-174, Idaho Code; (3-20-20)T
- vi.** Clean soils and clean dredge spoils as regulated under Section 404 of the federal Clean Water Act provided that they are not hazardous wastes regulated by the Hazardous Waste Management Act, Chapter 44, Title 39, Idaho Code and the rules adopted thereunder; (3-20-20)T
- vii.** Septage taken to a sewage treatment plant permitted by either the U.S. Environmental Protection Agency or the Department pursuant to IDAPA 58.01.15, “Rules Governing the Cleaning of Septic Tanks”; (3-20-20)T
- viii.** All radioactive waste and radioactive materials regulated pursuant to Section 39-4405(9), Idaho Code and rules adopted thereunder and radioactive waste and materials regulated under the authority of the Atomic Energy Act of 1954, as amended.; (3-20-20)T
- ix.** Petroleum Contaminated Soils (PCS) from a leaking petroleum storage tank system managed as a one (1) time remediation pursuant to IDAPA 58.01.02, “Water Quality Standards”; or (3-20-20)T
- x.** Asbestos as regulated by the Toxic Substances Control Act, as amended, 15 U.S.C. Sections 2601, et seq., or asbestos as regulated by the Clean Air Act, as amended, 42 U.S.C. Section 7412. (3-20-20)T
- xi.** Nonhazardous wastes disposed in a permitted hazardous waste treatment, storage and disposal unit regulated by the Hazardous Waste Management Act, Chapter 44, Title 39, Idaho Code, and rules adopted thereunder; (3-20-20)T
- xii.** Waste otherwise regulated under Department authorities. (3-20-20)T

- b.** These rules do not apply to the following solid waste unless these wastes are mixed with more than incidental quantities of regulated waste; (3-20-20)T
- i.** Inert wastes; (3-20-20)T
  - ii.** Manures and crop (plant) residues ultimately returned to the soils at agronomic rates; (3-20-20)T
  - iii.** Any agricultural solid waste which is managed and regulated pursuant to rules adopted by the Idaho Department of Agriculture. The Department reserves the right to use existing authorities to regulate agricultural waste that impacts human health or the environment; (3-20-20)T
  - iv.** Overburden, waste dumps, low-grade stockpiles, tailings and other materials uniquely associated with mineral extraction, beneficiation or processing operations; (3-20-20)T
  - v.** Slag from the production of elemental phosphorus; (3-20-20)T
  - vi.** Phospho-gypsum from the production of phosphate fertilizers, which includes the production of phosphoric acid; and (3-20-20)T
  - vii.** Wood waste used for ornamental, animal bedding, mulch and plant bedding, or road building purposes. (3-20-20)T

**04. Solid Waste Management Facilities Not Regulated Under These Rules.** These Rules do not apply to the following solid waste management facilities: (3-20-20)T

- a.** Solid waste management facilities accepting only solid waste excluded by Subsection 001.03; (3-20-20)T
- b.** Recycling centers; or (3-20-20)T
- c.** Backyard composting sites. (3-20-20)T
- d.** Facilities which cease accepting solid waste prior to April 26, 2002 shall be required to only comply with applicable cover, seeding, grading and closure requirements of the former Solid Waste Management Rules and Standards, as follows: (3-20-20)T
  - i.** Grading. The entire site, including the landfill surfaces, shall be graded and provided with drainage facilities to minimize runoff onto and into the sanitary landfill to prevent erosion or washing and to prevent the collection of standing water. The grading of the final surface of the fill area must provide a slope of not less than one percent (1%), but not exceeding fifteen percent (15%), except as approved by the Department or as required in Section 39-7415(3), Idaho Code. (3-20-20)T
  - ii.** Seeding. Seeding to promote stabilization of the final soil cover shall be done as soon as weather permits seed bed preparation and planting operations and when seasonal conditions are suitable for the type of vegetation to be used. Re-seeding is mandatory until adequate vegetative cover is established to prevent erosion. (3-20-20)T
  - iii.** Site Closure. An inspection of the entire site of the completed sanitary landfill, or other solid waste management site that is to be vacated, shall be made by a representative of the District before earth moving equipment or other equipment vital to disposal of solid waste is removed from the site or used on other projects. Any necessary corrective work shall be performed before the operation is accepted as completed. (3-20-20)T
    - (1) An official notice of closure of the site shall be sent to the District at the time the site is closed. (3-20-20)T
    - (2) Arrangements shall be made for the repair of all cracked, eroded, and uneven areas in the final cover during the year following completion of fill operations. (3-20-20)T

**002. WRITTEN INTERPRETATIONS.**

The Department of Environmental Quality may have written statements that pertain to the interpretation of the rules in this chapter. Any such written statements are available for review at the Department of Environmental Quality, 1410 N. Hilton, Boise, ID 83706-1255. (3-20-20)T

**003. ADMINISTRATIVE APPEALS.**

Persons may be entitled to appeal agency actions authorized under this chapter pursuant to IDAPA 58.01.23, "Rules of Administrative Procedure Before the Board of Environmental Quality." (3-20-20)T

**004. APPLICABILITY.**

These rules apply to all solid waste unless excluded by Subsection 001.03 and to all existing, new or modified solid waste management sites in Idaho identified in Subsection 004.01 and 004.02, unless excluded by Subsection 001.04. Compliance with these rules shall not relieve owners and operators from the obligation to comply with other applicable state or federal laws, including but not limited to the IDAPA 58.01.02, "Water Quality Standards," IDAPA 58.01.11, "Ground Water Quality Rule," and IDAPA 58.01.01, "Rules for the Control of Air Pollution in Idaho." (3-20-20)T

**01. Solid Waste Facility Other Than Municipal Solid Waste Landfills (MSWLF) Applicability.**

Sections 000 through 060 and Section 999 apply to all solid waste facilities other than MSWLF, as specified therein. (3-20-20)T

**02. Municipal Solid Waste Landfill Applicability.** Sections 000 through 007, and Sections 994 through 999 apply to all MSWLFs, as specified therein. (3-20-20)T

**005. DEFINITIONS.**

**01. Active Portion.** That part of a new or existing facility or unit where waste had been, or may be, disposed of, treated, or otherwise managed, and that has not been closed in accordance with applicable rules. (3-20-20)T

**02. Backyard Composting.** Composting operations used only by the owner or person in control of a residential dwelling unit to process garbage and yard waste generated at that dwelling unit. (3-20-20)T

**03. Beneficial Use.** Various uses of ground water in Idaho including, but not limited to, domestic water supplies, industrial water supplies, industrial water supplies and agricultural water supplies. A beneficial use is defined as actual current and projected future uses of ground water. (3-20-20)T

**04. Commercial Solid Waste Facility.** A MSWLF owned and operated as an enterprise conducted with the intent of making a profit by any individual, association, firm, or partnership for the disposal of solid waste, but excluding a MSWLF owned or operated by a political subdivision, state or federal agency or, municipality or a MSWLF owned or operated by any individual, association, firm, or partnership exclusively for the disposal of solid waste generated by such individual, association, firm, or partnership. (3-20-20)T

**05. Composting Facility.** See definition of Processing Facility. (3-20-20)T

**06. Conditionally Exempt Small Quantity Generator (CESQG) Hazardous Waste.** As defined in 40 CFR Part 261.5. (3-20-20)T

**07. Conditionally Exempt Small Quantity Generator (CESQG) Management Facility.** A facility or portion thereof where household hazardous waste or CESQG wastes are transferred from a vehicle or container and subsequently transported to another facility. A CESQG management facility does not include temporary drop off locations or other facilities where individuals or businesses are authorized to store waste for ultimate collection and disposal. (3-20-20)T

**08. Contamination.** The introduction of a substance into the surface or ground water causing: (3-20-20)T

- a.** At or beyond the point of compliance, the concentration of that substance in ground water to result in significant degradation, as determined pursuant to Section 400.02.b of the Idaho Ground Water Rule, or in an exceedance of the maximum contamination level (MCL) specified in the Idaho Ground Water Rule; (3-20-20)T
- b.** The concentration of that substance in surface water exceeds a numerical criteria or fails to protect designated beneficial uses specified in the Idaho Water Quality Standards, IDAPA 58.01.02; (3-20-20)T
- c.** A statistically significant increase in the concentration of that substance in the ground water at or beyond the point of compliance, or in surface water, where the existing concentration of that substance exceeds the contamination level specified in Subsections 005.08.a. or 005.08.b. of this rule; or (3-20-20)T
- d.** A statistically significant increase in the concentration of that substance in ground water at the point of compliance, or in surface water, above background of a substance which; (3-20-20)T
- i.** Is not specified in Subsections 005.08.a. or 005.08.b. of this rule; and (3-20-20)T
- ii.** Is a result of the disposal of solid waste; and (3-20-20)T
- iii.** Has been determined by the department to present a substantial risk to human health or the environment in the concentrations found in the ground water at the point of compliance, or in surface water. (3-20-20)T
- 09. Degradation.** The lowering of ground water quality as measured in a statistically significant and reproducible manner. (3-20-20)T
- 10. Department.** The Idaho Department of Environmental Quality. (3-20-20)T
- 11. Director.** The Director of the Idaho Department of Environmental Quality. (3-20-20)T
- 12. Disposal.** Discharge, deposit, injection, dumping, spilling, leaking, leaching, migration or placing of any solid waste into or on any land or water so that such solid waste or any constituent thereof may enter the environment or be emitted into the air or discharged into any waters, including ground water. (3-20-20)T
- 13. Existing Facility.** A facility operating and receiving solid waste on or before April 26, 2002. (3-20-20)T
- 14. Facility.** Any area used for any solid waste management activity, including but not limited to: (3-20-20)T
- a.** Storage; (3-20-20)T
- b.** Transfer; (3-20-20)T
- c.** Processing; (3-20-20)T
- d.** Separation; (3-20-20)T
- e.** Incineration; (3-20-20)T
- f.** Treatment; (3-20-20)T
- g.** Salvaging; or (3-20-20)T
- h.** Disposal of solid waste. (3-20-20)T
- 15. Garbage.** Any waste consisting of putrescible animal and vegetable materials resulting from the

handling, preparation, cooking and consumption of food, including wastes materials from households, markets, storage facilities, handling and sale of produce and other food products. (3-20-20)T

**16. Ground Water.** Any water of the state that occurs beneath the surface of the earth in a saturated geological formation of rock or soil. (3-20-20)T

**17. Household Waste.** Any solid waste, including kitchen wastes, trash and sanitary waste in septic tanks, derived from households, including single and multiple residences, hotels and motels, bunkhouses, ranger stations, crew quarters, campgrounds, picnic grounds and day use recreation areas. (3-20-20)T

**18. Incinerator.** Any source consisting of a furnace and all appurtenances thereto designed for the destruction of solid waste by burning. "Open Burning" is not considered incineration. (3-20-20)T

**19. Inert Waste.** Noncombustible, nonhazardous, and non-putrescible solid wastes that are likely to retain their physical and chemical structure and have a de minimis potential to generate leachate under expected conditions of disposal, which includes resistance to biological attack. "Inert waste" includes, but is not limited to, rock, concrete, cured asphaltic concrete, masonry block, brick, gravel, dirt, inert coal combustion by-products, inert precipitated calcium carbonate and inert component mixture of wood or mill yard debris. (3-20-20)T

**20. Landfill.** An area of land or an excavation in which wastes are placed for permanent disposal, and that is not a land application unit, surface impoundment, injection well or waste pile, as those terms are defined under 40 CFR 257.2. (3-20-20)T

**21. Leachate.** A liquid that has passed through or emerged from waste and contains soluble, suspended, or miscible materials removed from such waste. (3-20-20)T

**22. Lift.** A vertical rise of compacted solid waste that is complete when it is no longer practical to add additional height without the addition of a cover layer to provide structural stability. (3-20-20)T

**23. Modification.** Any change in the physical characteristics, waste types managed, method of operation, or lateral expansion beyond the boundaries of a site. The following shall not be considered a modification: (3-20-20)T

- a. Repair and replacement of existing equipment; (3-20-20)T
- b. Increase in production rate that does not exceed the Tier level criteria or approved facility capacity; (3-20-20)T
- c. An increase in hours of operation if more restrictive hours of operation are not specified in an approved operating plan; and (3-20-20)T
- d. Acquisition of property that is not to be used for the processing or disposal of solid waste. (3-20-20)T

**24. Municipal Solid Waste Landfill Unit (MSWLF).** As regulated under Chapter 74, Title 39, Idaho Code, a discrete area of land or an excavation that receives household waste, and that is not a land application unit, surface impoundment, injection well, or waste pile, as those terms are defined under 40 CFR 257.2. A MSWLF unit also may receive other types of RCRA subtitle D wastes, such as commercial solid waste, nonhazardous sludge, conditionally exempt small quantity generator waste and industrial solid waste. Such a landfill may be publicly or privately owned. A MSWLF unit may be a new MSWLF unit, an existing MSWLF unit or a lateral expansion. (3-20-20)T

**25. Non-Municipal Solid Waste (NMSW).** A solid waste that is: (3-20-20)T

- a. Not mixed with household waste; or (3-20-20)T
- b. Not excluded from these rules by Subsection 001.03. (3-20-20)T



26. **Non-Municipal Solid Waste Landfill (NMSWLF).** A landfill that accepts only non-municipal solid waste. (3-20-20)T
27. **Open Burning.** The combustion of solid waste without: (3-20-20)T
- a. Control of combustion air to maintain adequate temperature for efficient combustion; (3-20-20)T
- b. Containment of the combustion reaction in an enclosed device so as to provide sufficient residence time and mixing for complete combustion; and (3-20-20)T
- c. Control of the emission of the combustion products. (3-20-20)T
28. **Operator.** The person(s) responsible for the overall operation of all or part of a site or facility. (3-20-20)T
29. **Owner.** The person(s) who owns land or a portion of the land on which a site or facility is located. (3-20-20)T
30. **Person.** Any individual, association, partnership, firm, joint stock company, trust, political subdivision, public or private corporation, state or federal government department, agency, or instrumentality, municipality, industry, or any other legal entity which is recognized by law as the subject of rights and duties. (3-20-20)T
31. **Point of Compliance.** A vertical surface located no more than one hundred fifty (150) yards hydraulically down gradient from the active portion of a facility or site, located at the facility boundary down gradient of the land area, or located at the point of diversion of an identified beneficial use within the site, whichever is the smallest distance from the active portion. (3-20-20)T
32. **Processing Facility.** A facility that uses biological or chemical decomposition to prepare solid waste for reuse, excluding waste handling at transfer stations or recycling centers. (3-20-20)T
33. **Projected Waste Volume.** The total actual or potential solid waste volume measured in tons per day, cubic yards per day, or an equivalent measurement, proposed to be received or processed at a solid waste facility. (3-20-20)T
34. **Pumpable Waste.** Wastes, including non-domestic septage, sludge, wastewater and non-municipal solid wastes, which are pumped from a holding area or container into a watertight tank truck or equivalent and transported for processing or disposal. (3-20-20)T
35. **Qualified Professional.** Qualified professional means a licensed professional geologist or licensed professional engineer, as appropriate, holding current professional registration in good standing and in compliance with applicable provisions of Chapter 12, Title 54, Idaho Code. (3-20-20)T
36. **Recyclables.** Used, end, or waste products with useful properties that can be reused. (3-20-20)T
37. **Recycling.** The reclamation of solid waste and its subsequent introduction into an industrial process by which the materials are transformed into a new product in such a manner that the original identity as a product is lost. (3-20-20)T
38. **Recycling Center.** A materials recovery facility that receives recyclables, then sorts, bales, loads, or physically alters the material and transports the commodities to markets. (3-20-20)T
39. **Salvage.** The reclamation of solid waste at a disposal site. (3-20-20)T
40. **Scavenge.** The unauthorized removal of materials from a facility. (3-20-20)T

- 41. Septage.** A semisolid consisting of settled sewage solids combined with varying amounts of water and dissolved materials generated from a septic tank system. (3-20-20)T
- 42. Site.** Any contiguous geographic area with one (1) or more facilities owned or operated by the same person for any of the following activities: (3-20-20)T
- a.** Storage; (3-20-20)T
  - b.** Transfer; (3-20-20)T
  - c.** Processing; (3-20-20)T
  - d.** Separation; (3-20-20)T
  - e.** Incineration; (3-20-20)T
  - f.** Treatment; (3-20-20)T
  - g.** Salvaging; or (3-20-20)T
  - h.** Disposal of solid waste. (3-20-20)T
- 43. Site Size.** The sum in acres of all proposed or existing facilities. (3-20-20)T
- 44. Solid Waste.** Any garbage or refuse, sludge from a waste water treatment plant, water supply treatment plant, or air pollution control facility and other discarded material including solid, liquid, semi-solid, or contained gaseous material resulting from industrial, commercial, mining, and agricultural operations and from community activities, but does not include solid or dissolved materials in domestic sewage, or solid or dissolved material in irrigation return flows or industrial discharges which are point sources subject to permits under Section 402 of the Federal Water Pollution Control Act, as amended (86 Stat. 880), or source, special nuclear, or by-product material as defined by the Atomic Energy Act of 1954, as amended (68 Stat. 923). (3-20-20)T
- 45. Speculative Accumulation.** Stock piles of materials or recyclables to be processed for reuse or disposal when fifty percent (50%) of the material is not reused or disposed by the end of the following calendar year after the date of first receipt by the facility, and which may create a nuisance or public health impact. (3-20-20)T
- 46. Storm Water.** Accumulation of water from natural precipitation, including snow melt. (3-20-20)T
- 47. Surface Water.** All surface accumulations of water, natural or artificial, public or private, or parts thereof which are wholly or partially within, which flow through or border upon the state, unless such waters are an integral part of the facility's operation for storm water control and or leachate management. (3-20-20)T
- 48. Tipping Floor.** An area at a transfer station, processing facility, CESQG management facility or incinerator that receives and contains all waste materials. (3-20-20)T
- 49. Toxic Leachate or Gas.** Concentrations of leachate or gas that will cause contamination, as defined by these rules, or that will exceed standards in the IDAPA 58.01.01, "Rules for the Control of Air Pollution in Idaho." (3-20-20)T
- 50. Transfer Station.** A facility or portion thereof where solid wastes are transferred from a vehicle or container and subsequently transported off-site to another facility. A transfer station does not include an authorized rural drop-box or other facilities where persons are authorized to store individual waste for ultimate collection and disposal, or any other facility that stores solid waste generated at the facility for collection and disposal off-site. A transfer station shall include waste tire collection sites as defined in Section 39-6501, Idaho Code. (3-20-20)T
- 51. Wood or Mill Yard Debris Facility.** A facility that manages exclusively, solid wood, bark, or wood fiber generated from the process of manufacturing wood products that may include ash from the burning of

wood waste in amounts and in conformity with the requirements of the Wood & Mill Yard Technical Guidance Manual, components of soil, rock, or moisture. (3-20-20)T

**52. Yard Waste.** Weeds, straw, leaves, grass clippings, brush, wood, and other natural, organic, materials typically derived from general landscape maintenance activities. (3-20-20)T

**006. ABBREVIATIONS.**

- 01. BRC.** Below Regulatory Concern. (3-20-20)T
- 02. CFR.** Code of Federal Regulations. (3-20-20)T
- 03. EPA.** Environmental Protection Agency. (3-20-20)T
- 04. ISWFA.** Idaho Solid Waste Facilities Act, Chapter 74, Title 39, Idaho Code. (3-20-20)T
- 05. MSWLF.** Municipal Solid Waste Land Fill. (3-20-20)T
- 06. NMSW.** Non-Municipal Solid Waste. (3-20-20)T
- 07. NMSWLF.** Non-Municipal Solid Waste Land Fill. (3-20-20)T
- 08. PCS.** Petroleum Contaminated Soils. (3-20-20)T
- 09. RCRA.** Resource Conservation and Recovery Act. (3-20-20)T
- 10. U.S.C.** United States Code. (3-20-20)T

**007. INCORPORATION BY REFERENCE.**

**01. General.** Unless expressly provided otherwise, any reference in these rules to any document identified in Subsection 007.02 shall constitute the full adoption by reference, including any notes and appendices therein. The term “documents” includes codes, standards or rules which have been adopted by an agency of the state or of the United States or by any nationally recognized organization or association. (3-20-20)T

**02. Documents Incorporated by Reference.** The following documents are incorporated by reference into these rules: (3-20-20)T

- a.** [40 CFR 257.24\(a\)](#), revised as of July 1, 2001. (3-20-20)T
- b.** [40 CFR 257.9](#), revised as of July 1, 2001. (3-20-20)T

**03. Availability of Referenced Material.** Copies of the documents incorporated by reference into these rules are available at the following locations: (3-20-20)T

- a.** Department of Environmental Quality, 1410 N. Hilton, Boise ID 83706-1255. (3-20-20)T
- b.** Idaho State Law Library, 451 W. State Street, P.O. Box 83720, Boise ID 83720-0051. (3-20-20)T
- c.** U.S. Government Printing Office, Superintendent of Documents, Washington, D.C. 20402, or U.S. Government Bookstore, Room 194 Federal Bldg., 915 Second Ave., Seattle, WA 98174, [www.ecfr.gov](http://www.ecfr.gov). (3-20-20)T

**008. OFFICE – OFFICE HOURS – MAILING ADDRESS AND STREET ADDRESS.**

The state office of the Department of Environmental Quality and the office of the Board of Environmental Quality are located at 1410 N. Hilton, Boise, Idaho 83706-1255, telephone number (208) 373-0502. The office hours are 8:00 a.m. to 5:00 p.m. Monday through Friday. (3-20-20)T

**009. SOLID WASTE MANAGEMENT FACILITY CLASSIFICATION.**

**01. BRC Facilities.** A facility is below regulatory concern (BRC) provided it is a processing facility that does not manage PCS or pumpable waste, and the cumulative volume of solid waste at the facility at any one (1) time is less than or equal to three hundred (300) cubic yards. (3-20-20)T

**02. Tier I Facilities.** Tier I facilities shall comply with the requirements identified in Section 011. A facility shall be classified as a Tier I facility if the Department determines the facility is: (3-20-20)T

**a.** A landfill that only accepts for disposal materials that are not likely to produce leachate including, but not limited to, glass, plastic, cardboard, wood, composition roofing material, roofing paper, or ceramics, and which has a total disposal capacity of less than or equal to two thousand (2000) cubic yards. (3-20-20)T

**b.** A processing facility that only processes wastes including, but not limited to, untreated or unpainted wood, yard waste, sheet rock, clean paper products, animal manures, plant or crop residues, or garbage without meats or animal fats, and the cumulative volume of wastes at the facility at any one time is less than or equal to six hundred (600) cubic yards. (3-20-20)T

**c.** A processing facility that only manages PCS not excluded under Subsection 001.03.a.ix. or pumpable wastes and the cumulative volume of material at the facility at any one (1) time is less than or equal to two hundred (200) cubic yards; or (3-20-20)T

**d.** An emergency solid waste management facility that only accepts debris resulting from a natural disaster. (3-20-20)T

**03. Tier II Facility.** Tier II facilities shall comply with the Tier II general siting, operational and closure requirements and any applicable Tier II facility specific requirements. Tier II facilities are not required to install ground water monitoring wells, leachate collection systems or liners. Facilities shall be classified as a Tier II facility if the Department determines the facility is not: (1) landfilling or disposing of CESQG hazardous waste; (2) landfilling or disposing of materials with a high human pathogenic potential; (3) managing solid waste in a manner or volume that will form toxic leachate or gas; or (4) managing solid waste in a manner or volume that is likely to pose a substantial risk to human health or the environment. A Tier II facility is one that meets the four (4) above criteria and is identified below: (3-20-20)T

**a.** A NMSW landfill which has a total disposal capacity greater than two thousand (2000) cubic yards; or (3-20-20)T

**b.** A processing facility or incinerator that has a cumulative volume of wastes at the facility at any one time that is greater than six hundred (600) cubic yards; or (3-20-20)T

**c.** A processing facility that only manages PCS not excluded under Subsection 001.03.a.ix. or pumpable wastes and the cumulative volume of material at the facility at any one (1) time is greater than two hundred (200) cubic yards; or (3-20-20)T

**d.** A transfer station or CESQG waste management facility. (3-20-20)T

**04. Tier III Facility.** Tier III facilities shall comply with the Tier III general siting, operating and closure requirements, ground water monitoring requirements, install leachate collection systems, liners, air contaminant control systems and any applicable Tier III facility specific requirements. Facilities shall be classified as a Tier III facility if the Department determines the facility is: (1) a facility landfilling or disposing of CESQG hazardous waste; (2) a facility landfilling or disposing of materials with a high human pathogenic potential; (3) a facility managing solid waste in a manner or volume that will form toxic leachate or gas; or (4) a facility managing solid waste in a manner or volume that is likely to pose a substantial risk to human health or the environment. (3-20-20)T

**05. Wood or Mill Yard Debris Facilities.** For the period of one (1) year after April 1, 2003, all Wood or Mill Yard Debris Facilities that are not exempt from these Rules as provided in Section 001.03 shall be regulated as

Tier I Facilities. Thereafter, all Wood and Mill Yard Debris Facilities that are not exempt from these Rules as provided in Section 001.03 shall be regulated as Tier I Facilities unless, based on site-specific criteria including but not limited to site geology, site soils, groundwater characteristics, distance to surface waters, and site climatic data, the Department determines the facility is more appropriately regulated under a different tier classification. Facilities not regulated as a Tier I Facility shall be regulated as a Tier II Facility unless the Department determines the facility manages waste in a manner that will form toxic leachate or gas. (3-20-20)T

**06. Site Specific Classification.** An owner or operator of a facility classified as a Tier I, Tier II or Tier III facility may request to be regulated pursuant to the requirements of a lower classification. An owner or operator requesting site specific classification must submit information demonstrating to the Department that, when in compliance with the requirements of a lower classification, the facility would not cause contamination, toxic leachate or gas, or concentrations of a substance that exceed standards in the IDAPA 58.01.01 "Rules for the Control of Air Pollution in Idaho." The information included in any request under this subsection shall include: (3-20-20)T

- a. Characterization of waste and expected quantities of waste; (3-20-20)T
- b. Site characterization including; (3-20-20)T
  - i. Site geology report; (3-20-20)T
  - ii. Site soils report; (3-20-20)T
  - iii. Ground water report; (3-20-20)T
  - iv. Site climatic data; (3-20-20)T
- c. Facility Design Plan; (3-20-20)T
- d. Operating Plan; and (3-20-20)T
- e. Closure Plan. (3-20-20)T

**07. General and Site Specific Classification Process.** The Department's review of a request for a site specific classification shall be conducted pursuant to the process set forth in Section 032. (3-20-20)T

**010. BELOW REGULATORY CONCERN FACILITIES.**

**01. Applicable Requirements.** The owner and operator of a new BRC facility shall comply with the following requirements prior to accepting waste. The owner and operator of an existing BRC facility shall comply with the following requirements within two (2) years from April 26, 2002. During the two-year period from April 26, 2002, existing facilities shall operate in compliance with their approved operating plan and 40 CFR 257.1 through 257.3: (3-20-20)T

- a. Prohibited Activities. The following activities are prohibited: (3-20-20)T
  - i. Disposal in a landfill of regulated waste from any business that provides health care, support to health care businesses, or medical diagnostic services that has not been decontaminated. "Regulated waste" and "decontaminated" for the purpose of Section 010 shall have the same meaning as defined at 29 CFR 1910.1030; (3-20-20)T
  - ii. Speculative accumulation, unless otherwise approved by the Department in writing; and (3-20-20)T
  - iii. Disposal of radioactive waste except in a facility regulated pursuant to Section 39-4405(9), Idaho Code, and rules adopted thereunder or a facility regulated under the authority of The Atomic Energy Act of 1954, as amended. (3-20-20)T

- b.** Nuisance Control. The owner and operator shall control nuisances, including but not limited to: (3-20-20)T
- i.** Disease or discomfort. Operations at any facility shall not provide sustenance to rodents or insects that cause human disease or discomfort; (3-20-20)T
  - ii.** Vector. Vector control procedures shall prevent or control vectors that may cause health hazards or nuisances; (3-20-20)T
  - iii.** Odor. The facility shall be operated to control malodorous gases; and (3-20-20)T
  - iv.** Litter. Effective measures shall be taken to minimize the loss of debris from the facility. Debris blown from or within the facility shall be collected and properly disposed to prevent objectionable accumulations. (3-20-20)T
- c.** Bird Hazards to Aircraft. No facility may handle putrescible wastes in such a manner that may attract birds and increase the likelihood of bird/aircraft collisions. Facilities that are located within ten thousand (10,000) feet of any airport runway used by turbojet aircraft, or within five thousand (5,000) feet of any airport used by only piston-type aircraft shall operate the facility in such a manner that birds are not a hazard to aircraft; and (3-20-20)T
- d.** Open Burning and Fires. Open burning is prohibited at facilities except as authorized by these rules and IDAPA 58.01.01, "Rules for the Control of Air Pollution in Idaho." (3-20-20)T
- i.** No open burning shall be conducted during an air pollution episode, declared in accordance with IDAPA 58.01.01, "Rules for the Control of Air Pollution in Idaho." (3-20-20)T
  - ii.** Open burning is authorized only if it is infrequent and the materials are agricultural wastes, silviculture wastes, land clearing debris, diseased trees, or debris from emergency cleanup operations. Materials burned shall not include garbage, dead animals, asphalt, petroleum products, paints, tires or other rubber products, plastics, paper (other than that necessary to start the fire), cardboard, treated wood, construction debris, metal, pathogenic wastes, hazardous wastes, or any other substance (other than natural vegetation) that when burned releases toxic emissions, dense smoke or strong odors. (3-20-20)T
  - iii.** Open burning shall be conducted pursuant to conditions set forth by the Department or local fire authority. The owner and operator of the facility shall contact the Department and the local fire authority prior to conducting open burning to report its nature and location. (3-20-20)T

**02. Application Content, Review and Approval Requirements.** The owner and operator of a BRC facility are not required to submit an application. (3-20-20)T

**03. Documentation Requirements.** The owner and operator shall maintain on site documentation, such as a daily log of the quantity and type of waste received or managed, that verifies the facility's BRC status. (3-20-20)T

**011. APPLICABLE REQUIREMENTS FOR TIER I FACILITIES.**

**01. Applicable Requirements.** The owner and operator of a new Tier I facility shall comply with the following requirements prior to accepting waste. The owner and operator of an existing Tier I facility shall comply with the following requirements within two (2) years from April 26, 2002. During the two-year period from April 26, 2002, existing facilities shall operate in compliance with their approved operating plan, if any, and 40 CFR 257.1 through 257.3: (3-20-20)T

- a.** Prohibited Activities. The following activities are prohibited: (3-20-20)T
- i.** Disposal in a landfill of regulated waste from any business that provides health care, support to health care businesses, or medical diagnostic services that has not been decontaminated. "Regulated waste" and

- “decontaminated” for the purpose of Section 011 shall have the same meaning as defined at 29 CFR 1910.1030; (3-20-20)T
- ii. Speculative accumulation, unless otherwise approved by the Department in writing; and (3-20-20)T
  - iii. Disposal of radioactive waste except in a facility regulated pursuant to Section 39-4405(9), Idaho Code, and rules adopted thereunder or a facility regulated under the authority of The Atomic Energy Act of 1954, as amended. (3-20-20)T
- b.** Signs. Facilities open to the general public shall clearly post visible and legible signs at each entrance to the facility. The signs shall specify at a minimum the name of the facility, the hours of operation, the waste accepted at the facility and an emergency phone number. (3-20-20)T
- c.** Nuisance Control. The owner and operator shall control nuisances, including but not limited to: (3-20-20)T
- i. Disease or Discomfort. Operations at any facility shall not provide sustenance to rodents or insects that cause human disease or discomfort; (3-20-20)T
  - ii. Vector. Vector control procedures shall prevent or control vectors that may cause health hazards or nuisances; (3-20-20)T
  - iii. Odor. The facility shall be operated to control malodorous gases; and (3-20-20)T
  - iv. Litter. Effective measures shall be taken to minimize the loss of debris from the facility. Debris blown from or within the facility shall be collected and properly disposed to prevent objectionable accumulations. (3-20-20)T
- d.** Facility Access. Unauthorized vehicles and persons shall be prohibited access to the facility. A facility open to the public shall accept waste only when an attendant is on duty. The facility shall be fenced or otherwise blocked to access when an attendant is not on duty. The owner and operator shall maintain the fencing or other access controls for a period of ten (10) years after closure, or another timeframe approved in writing by the Department. (3-20-20)T
- e.** Bird Hazards to Aircraft. No facility may handle putrescible wastes in such a manner that may attract birds and increase the likelihood of bird/aircraft collisions. Facilities that are located within ten thousand (10,000) feet of any airport runway used by turbojet aircraft, or within five thousand (5,000) feet of any airport used by only piston-type aircraft shall operate the facility in such a manner that birds are not a hazard to aircraft. (3-20-20)T
- f.** Open Burning and Fires. Open burning is prohibited at facilities except as authorized by these rules and IDAPA 58.01.01, “Rules for the Control of Air Pollution in Idaho.” (3-20-20)T
- i. No open burning shall be conducted during an air pollution episode, declared in accordance with IDAPA 58.01.01, “Rules for the Control of Air Pollution in Idaho.” (3-20-20)T
  - ii. Open burning is authorized only if it is infrequent and the materials are agricultural wastes, silviculture wastes, land clearing debris, diseased trees, or debris from emergency cleanup operations. Materials burned shall not include garbage, dead animals, asphalt, petroleum products, paints, tires or other rubber products, plastics, paper (other than that necessary to start the fire), cardboard, treated wood, construction debris, metal, pathogenic wastes, hazardous wastes, or any other substance (other than natural vegetation) that when burned releases toxic emissions, dense smoke or strong odors. (3-20-20)T
  - iii. Open burning shall be conducted pursuant to conditions set forth by the Department or local fire authority. The owner and operator of the facility shall contact the Department and the local fire authority prior to conducting open burning to report its nature and location. (3-20-20)T

**g.** Storm Water Run-On/Run-Off Controls. Implement sufficient storm water management provisions, which may incorporate a NPDES storm water pollution prevention plan, to prevent contamination of surface or ground water and prevent the spread and impact of contamination beyond the boundary of the facility. (3-20-20)T

**h.** Variance Request. An owner and operator may submit a written variance request for a variance from the requirements listed in Section 011. The owner and operator must demonstrate to the Department that the variance is at least as protective of human health and the environment as the requirements listed in Section 011. (3-20-20)T

**02. Application Content, Review and Approval Requirements.** The owner and operator of a Tier I facility shall submit notification to the Department prior to operating. The notice shall include; the owners name, operators name, physical location of site, mailing address, facility phone number and type of solid waste management facility. (3-20-20)T

**03. Documentation Requirements.** The owner and operator shall maintain on site documentation, such as a daily log of the quantity and type of waste received, that verifies the facility's Tier I status. (3-20-20)T

**012. APPLICABLE REQUIREMENTS FOR TIER II FACILITIES.**

The owner and operator of a new Tier II facility shall establish compliance with the requirements of Section 012 by obtaining Department approval of the applications required in Subsection 012.02 before beginning construction and Subsection 012.04 prior to accepting waste. The owner and operator of an existing Tier II facility shall establish compliance with the requirements of Section 012 by obtaining Department approval of the applications required in Subsection 012.04 within two (2) years from April 26, 2002, and Subsection 012.02 within five (5) years from April 26, 2002. During the two (2) year period from April 26, 2002, existing facilities shall operate in compliance with their approved operating plan, if any, and 40 CFR 257.1 through 257.3. In lieu of submitting an application, the owner and operator of existing facilities may demonstrate to the Department, compliance with Section 012 by submitting copies of existing permits and other approvals that establish compliance with the applicable siting, design, operating, closure, and post-closure requirements of Section 012 and Subsection 032.01. The owner and operator of a Tier II facility shall meet the requirements of Subsection 012.05 prior to facility closure; except that owners and operators closing Tier II facilities within eighteen (18) months from April 26, 2002 shall comply with applicable cover, seeding, grading and closure requirements of the former Solid Waste Management Rules and Standards, as enumerated in Subsection 001.04.d. of these rules. (3-20-20)T

**01. General Siting Requirements.** The owner and operator of a Tier II facility shall comply with the following siting requirements: (3-20-20)T

**a.** Flood Plain Restriction. A facility shall not be located within a one hundred (100) year flood plain if the facility will restrict the flow of the one hundred (100) year flood, reduce the temporary water storage capacity of the flood plain, or result in a washout of solid waste so as to pose a hazard to human health and the environment. (3-20-20)T

**b.** Endangered or Threatened Species Restriction. The facility shall not cause or contribute to the taking of any endangered or threatened species of plants, fish, or wildlife or result in the destruction or adverse modification of the critical habitat of endangered or threatened species as identified in 50 CFR Part 17. (3-20-20)T

**c.** Surface Water Restriction. The active portion of a facility shall be located such that the facility shall not cause contamination of surface waters, unless such surface waters are an integral part of the non-municipal solid waste management facility's operation for storm water and/or leachate management. (3-20-20)T

**d.** Park, Scenic or Natural Use Restriction. The active portion of a facility shall not be located closer than one thousand (1,000) feet from the boundary of any state or national park, or land reserved or withdrawn for scenic or natural use including, but not limited to, wild and scenic areas, national monuments, wilderness areas, historic sites, recreation areas, preserves and scenic trails. (3-20-20)T

**e.** Variance from Siting Requirement. An owner or operator of an existing or planned facility that cannot meet the siting requirements of Section 012 may apply for a variance from the Department. The Department



shall approve a written request for a variance provided the owner and operator demonstrate to the Department that the variance is at least as protective of public health and the environment as the siting requirements in Section 012.

(3-20-20)T

**02. Siting Application.** Documentation shall be submitted to the Department demonstrating compliance with the siting requirements and restrictions specified in Subsection 012.01 within the time frames specified in Section 012. If the documentation has been certified by a qualified professional, the Director shall approve the siting application unless the Director finds the evidence supports a contrary opinion. A map indicating the following shall also be submitted to the Department as part of a Siting Application:

(3-20-20)T

- a. Highways, roads, and adjacent communities; (3-20-20)T
- b. Property boundaries; (3-20-20)T
- c. Total acreage of the site; (3-20-20)T
- d. Off-site and on-site access roads and service roads; (3-20-20)T
- e. Type(s) of land use adjacent to the facility and a description of all facilities on the site; (3-20-20)T
- f. All water courses, ponds, lakes, reservoirs, canals, irrigation systems, and existing water supplies, within one-quarter (1/4) mile of the proposed facility property lines; (3-20-20)T
- g. High tension power line rights-of-way, fuel transmission pipeline rights-of-way, and proposed and existing utilities; (3-20-20)T
- h. Proposed or existing fencing; (3-20-20)T
- i. Proposed and existing structures at the facility and within five hundred (500) feet of the facility boundary. This shall include location of employee buildings, and scales (if provided); and (3-20-20)T
- j. Direction of prevailing winds. (3-20-20)T

**03. General Operating Requirements.** The owner and operator of a Tier II facility shall comply with the following operating requirements:

(3-20-20)T

- a. Prohibited Activities. The following activities are prohibited: (3-20-20)T
  - i. Disposal in a landfill of regulated waste from any business that provides health care, support to health care businesses, or medical diagnostic services that has not been decontaminated. “Regulated waste” and “decontaminated” for the purpose of Section 012 has the same meaning as defined at 29 CFR 1910.1030; (3-20-20)T
  - ii. Speculative accumulation, unless otherwise approved in an operating plan; and (3-20-20)T
  - iii. Disposal of radioactive waste except in a facility regulated pursuant to Section 39-4405(9), Idaho Code, and rules adopted thereunder or a facility regulated under the authority of The Atomic Energy Act of 1954, as amended. (3-20-20)T
- b. Signs. Facilities open to the general public shall clearly post visible and legible signs at each entrance to the facility specifying, at a minimum, the name of the facility, the hours of operation, the waste accepted at the facility and an emergency phone number. (3-20-20)T
- c. Waste Types. Only the solid waste types listed in the approved operating plan may be accepted for disposal or processing. (3-20-20)T
- d. Waste Monitoring and Measurement. Provisions shall be made for monitoring or measuring all solid waste delivered to a facility. The waste monitoring program shall include: (3-20-20)T

- i. A daily written log listing the types and quantities of wastes received; (3-20-20)T
- ii. A plan for monitoring and handling receipt of unauthorized wastes; (3-20-20)T
- iii. Routine characterization of the wastes received; and (3-20-20)T
- iv. Other measures included in an approved Operating Plan. (3-20-20)T
- e. Communication. Communication devices shall be available or reasonably accessible at the site. (3-20-20)T
- f. Fire Prevention and Control. Adequate provisions shall be made for controlling or managing fires at the site. (3-20-20)T
- g. Facility Access. Unauthorized vehicles and persons shall be prohibited access to the facility. A facility open to the public shall accept waste only when an attendant is on duty. The facility shall be fenced or otherwise blocked to access when an attendant is not on duty. (3-20-20)T
- h. Scavenging and Salvaging. Scavenging by the public at a facility is prohibited; however, salvaging may be conducted in accordance with a written operations plan and only by the owner, operator or an authorized agent. (3-20-20)T
- i. Nuisance Control. The owner and operator shall control nuisances, including but not limited to:
  - i. Disease or Discomfort. Operations at any facility shall not provide sustenance to rodents or insects that cause human disease or discomfort; (3-20-20)T
  - ii. Vector. Vector control procedures shall prevent or control vectors that may cause health hazards or nuisances; (3-20-20)T
  - iii. Odor. The facility shall be operated to control malodorous gases; and (3-20-20)T
  - iv. Litter. Effective measures shall be taken to minimize the loss of debris from the facility. Debris blown from or within the facility shall be collected and properly disposed to prevent objectionable accumulations. (3-20-20)T
- j. Bird Hazards to Aircraft. No facility may handle putrescible wastes in such a manner that may attract birds and increase the likelihood of bird/aircraft collisions. Facilities that are located within ten thousand (10,000) feet of any airport runway used by turbojet aircraft, or within five thousand (5,000) feet of any airport used by only piston-type aircraft shall operate the facility in such a manner that birds are not a hazard to aircraft. (3-20-20)T
- k. Open Burning and Fires. Open burning is prohibited at facilities except as authorized by these rules and IDAPA 58.01.01, "Rules for the Control of Air Pollution in Idaho." (3-20-20)T
  - i. No open burning shall be conducted during an air pollution episode, declared in accordance with IDAPA 58.01.01, "Rules for the Control of Air Pollution in Idaho." (3-20-20)T
  - ii. Open burning is authorized only if it is infrequent and the materials are agricultural wastes, silviculture wastes, land clearing debris, diseased trees, or debris from emergency cleanup operations. Materials burned shall not include garbage, dead animals, asphalt, petroleum products, paints, tires or other rubber products, plastics, paper (other than that necessary to start the fire), cardboard, treated wood, construction debris, metal, pathogenic wastes, hazardous wastes, or any other substance (other than natural vegetation) that when burned releases toxic emissions, dense smoke or strong odors. (3-20-20)T

iii. Open burning shall be conducted pursuant to conditions set forth by the Department or local fire authority. The owner and operator of the facility shall contact the Department and the local fire authority prior to conducting open burning to report its nature and location. (3-20-20)T

**l.** Storm Water Run-On/Run-Off Controls. The operating plan shall include sufficient storm water management provisions, which may incorporate a NPDES storm water pollution prevention plan, to prevent contamination of surface and ground water and prevent the spread and impact of contamination beyond the boundary of the facility. (3-20-20)T

**m.** Variance Request. An owner and operator of an existing or planned facility may submit to the Department a written variance request for a variance from the operating requirements listed in Section 012. The Department shall approve a written request for a variance provided the owner and operator demonstrate to the Department that the variance is at least as protective of human health and the environment as the requirements listed in Section 012. (3-20-20)T

**04. Operating Plan.** The owner and operator of a Tier II facility shall submit to the Department an Operating Plan containing that information required by Subsection 012.03, within the time frames stated in Section 012. An Operating Plan shall include a description of the wastes to be accepted, the methods for maintaining compliance with each of the applicable general operating requirements of Subsection 012.03, and complies with any applicable facility specific requirements found in Subsections 012.09 through 012.11. (3-20-20)T

**05. Closure Requirement.** The owner and operator of a Tier II facility shall comply with the following closure and post-closure care requirements: (3-20-20)T

**a.** Public Notice. For a facility open to the public the owner and operator shall provide public notice of the facility's closure by publishing a notice in the local newspaper and posting signs at the facility's entrance. This notice shall be published and the signs posted; (3-20-20)T

i. At least thirty (30) days and no more than ninety (90) days prior to the date of last receipt of waste for a facility that has reached disposal capacity; or (3-20-20)T

ii. If the facility has remaining capacity and there is a reasonable likelihood that the facility will receive additional waste, a notice shall be published and signs posted at least thirty (30) days and no more than ninety (90) days prior to closure. (3-20-20)T

**b.** Facility Closure. Unless the Department establishes an alternate closure time period, the owner and operator shall close the facility within six (6) months of the Department's approval of the Closure Plan. The facility shall be closed in accordance with the approved Closure Plan. (3-20-20)T

**c.** Clean Site/Access Control. The owner and operator shall close the facility by managing or removing all solid waste to prevent impact to human health or the environment and installing a gate or other device to prevent public access after the last receipt of waste; and (3-20-20)T

**d.** Drainage and Erosion Control. The owner and operator shall install appropriate measures to control erosion and install appropriate measures to control the run-on and runoff from a twenty-five (25) year, twenty-four (24) hour storm event and to provide for the diversion of other surface waters from the closed facility. (3-20-20)T

**e.** Closure Plan Certification. Within thirty (30) days of closure, the owner and operator shall notify the Department in writing that the facility was closed in accordance with the approved Closure Plan. If closure of the facility is different from the approved Closure Plan, the owner and operator shall submit for Department review and approval documents, such as "as-built" plans, showing the final conditions of the facility. (3-20-20)T

**06. Closure Plan Application.** Except as specified in Subsection 012.10, the owner and operator of a Tier II facility shall submit to the Department a Closure Plan Application containing the following information no later than ninety (90) days before the date on which the facility receives the known final receipt of wastes or, if the facility has remaining capacity and there is a reasonable likelihood that the facility will receive additional wastes, no later than one (1) year after the most recent receipt of wastes: (3-20-20)T

- a. A complete and accurate legal description of the facility; (3-20-20)T
- b. A map of the facility, showing pertinent facility features, including: (3-20-20)T
  - i. Facility boundaries, drainage patterns, location of fill areas, and location of access control measures; (3-20-20)T
  - ii. All water courses, ponds, lakes, reservoirs, canals, irrigation systems, and existing water supplies, within one-quarter (1/4) mile of the facility boundary; (3-20-20)T
  - iii. Location of disposal trenches and description of waste disposed; and (3-20-20)T
  - iv. Proposed final contours of the closed facility, drawn to a reasonable scale with five (5) foot intervals for the operational area, and ten (10) foot intervals for the remainder of the facility; (3-20-20)T
- c. Estimated date of last receipt of waste; (3-20-20)T
- d. A description of how public access to the closed facility will be controlled; (3-20-20)T
- e. Estimated total cubic yards, or tons, of waste in place; (3-20-20)T
- f. Total acreage of the facility and acres containing waste; (3-20-20)T
- g. Closure equipment and procedures to be used; (3-20-20)T
- h. Texture, depth and permeability of final cover material; (3-20-20)T
- i. Design and construction plan for any necessary final cover; (3-20-20)T
- j. Placement, design, and management of run-on and run-off storm water controls; (3-20-20)T
- k. Types of vegetation and planting procedures to be used for establishing vegetative cover; (3-20-20)T
- l. Other closure information the Department determines is necessary to protect human health and the environment. (3-20-20)T

**07. Documentation Requirements.** The owner and operator of a Tier II facility shall maintain on site a copy of each Department-approved Application and Plan required by Section 012. (3-20-20)T

**08. Modification Application.** The owner and operator shall submit to the Department for review and approval a Modification Application describing any proposed modification. The owner and operator of a Tier II facility shall not implement the modification prior to Department approval. If a proposed modification alters the classification of a facility, the owner and operator shall comply with the application content, review and approval requirements for the new classification. (3-20-20)T

**09. Tier II Processing Facilities.** In addition to the requirements in Subsections 012.01 through 012.08, the owner and operator of a Tier II processing facility shall also comply with the following requirements: (3-20-20)T

- a. Siting Requirements: (3-20-20)T
  - i. Ground Water. The active portion of a facility shall be located, designed and constructed such that the facility shall not cause contamination to a drinking water source or cause contamination of the ground water. (3-20-20)T
  - ii. Geologic Restrictions. No facility may be located on land that would threaten the integrity of the

design. (3-20-20)T

iii. Property Line Restriction. The active portion of a facility shall not be located closer than one hundred (100) feet to the property line. (3-20-20)T

b. Siting Application. The owner and operator shall provide in the Siting Application documentation that demonstrates compliance with the siting requirements specified in Subsection 012.01 and 012.09.a. (3-20-20)T

c. Operating Requirements: (3-20-20)T

i. Odor Management Plan. The owner and operator of a Tier II processing facility shall implement a Department approved Odor Management Plan designed to minimize malodorous gases. An Odor Management Plan shall include specific operating criteria for oxygen, moisture and temperature levels appropriate for the wastes to be processed and processing technologies to be employed, methods used to maintain the specific operating criteria and a monitoring strategy that includes the frequency and parameters for monitoring the specific operating criteria. (3-20-20)T

ii. Documentation requirement. The owner and operator of a processing facility shall maintain documentation of compliance with Section 012, including an operational log of the methods used to maintain the operating criteria and sampling results. (3-20-20)T

d. Operating Plan. The operating plan required in Subsection 012.04 shall identify methods used for maintaining compliance with each applicable operating requirement of Subsection 012.03 and Subsection 012.09.c. (3-20-20)T

**10. Tier II Incinerators, CESQG Management Facility and Transfer Stations.** In addition to the requirements in Subsections 012.01 through 012.04 and Subsections 012.07 and 012.08, the owner and operator of a Tier II incinerator, CESQG management facility or transfer station shall comply with the following requirements: (3-20-20)T

a. Design Requirements. The owner and operator shall comply with the following design requirements; (3-20-20)T

i. A tipping floor design constructed of impermeable and durable material and designed to contain, collect, and convey any liquids to a storage or leachate management system. Any transfer station that accepts only waste tires will not be required to construct a tipping floor; (3-20-20)T

ii. A leachate storage or management system. (3-20-20)T

b. Design Application. The following information shall be submitted to the Department in a Design Application: (3-20-20)T

i. A description of the tipping floor design; (3-20-20)T

ii. A description of the storage or leachate management system design; (3-20-20)T

iii. Building and construction design blueprints; (3-20-20)T

iv. A map illustrating a storm water run-on/run-off system designed to prevent contamination of surface and ground water, and prevent the spread and impact of contamination beyond the boundary of the facility; and (3-20-20)T

v. Operational design and capacity information including a description of the waste types and projected daily and annual waste volumes. (3-20-20)T

c. Operating Requirements. The owner and operator of a Tier II facility shall comply with the following operating requirements: (3-20-20)T

- i. Implement cleaning procedures and waste residency times to maintain sanitary conditions on the surface of the tipping floor; and (3-20-20)T
- ii. Implement and operate a leachate storage or management system. (3-20-20)T
- d.** Waste Tire Collection Site Requirements. Individual tire piles shall not exceed five thousand (5000) square feet of continuous area, nor fifty thousand (50,000) cubic feet in volume or ten (10) feet in height. (3-20-20)T
- e.** Closure Requirement. The owner and operator of a Tier II facility shall comply with the following closure and post-closure care requirements: (3-20-20)T
  - i. Public Notice. For a facility open to the public the owner and operator shall provide public notice of the facility's closure by publishing a notice in the local newspaper and posting signs at the facility's entrance. This notice shall be published and the signs posted at least thirty (30) days prior to closure. (3-20-20)T
  - ii. Facility Closure. The owner and operator shall close the facility by removing all solid waste to prevent impact to human health or the environment and installing a gate or other device to prevent public access after the last receipt of waste; and (3-20-20)T
  - iii. Closure Time Period. Unless the Department establishes an alternate closure time period, the owner and operator shall close the facility within two (2) months of the Department's approval of the Closure Plan. The facility shall be closed in accordance with the approved Closure Plan. (3-20-20)T
  - iv. Closure Plan Certification. Within thirty (30) days of closure, the owner and operator shall notify the Department in writing that the facility was closed in accordance with the approved Closure Plan. If closure of the facility is different from the approved Closure Plan, the owner and operator shall submit for Department review and approval documents, such as "as-built" plans, showing the final conditions of the facility. (3-20-20)T
  - f.** Closure Plan Application. The owner and operator shall submit to the Department a Closure Plan Application containing the following information no later than ninety (90) days before the date on which the facility receives the known final receipt of wastes: (3-20-20)T
    - i. A complete and accurate legal description of the facility; (3-20-20)T
    - ii. A map of the facility, showing pertinent facility features, including facility boundaries, drainage patterns, and location of access control measures; (3-20-20)T
    - iii. Estimated date of last receipt of waste; (3-20-20)T
    - iv. A description of how public access to the closed facility will be controlled; (3-20-20)T
    - v. Closure equipment and procedures to be used; (3-20-20)T
    - vi. Anticipated future uses for the facility; (3-20-20)T
    - vii. Other closure information the Department determines is necessary to protect human health and the environment. (3-20-20)T
- 11.** Tier II NMSWLF. In addition to the requirements in Subsections 012.01 through 012.08, the owner and operator of a Tier II NMSWLF shall also comply with the following requirements: (3-20-20)T
  - a.** Siting Requirements: (3-20-20)T
    - i. Wetlands. A facility shall not be located in wetlands, except as provided in 40 CFR 257.9. (3-20-20)T

- ii. Ground Water. The active portion of a facility shall be located, designed and constructed such that the facility shall not cause contamination to a drinking water source or cause contamination of the ground water. (3-20-20)T
- iii. Geologic Restrictions. No facility may be located on land that would threaten the integrity of the design. (3-20-20)T
- iv. Property Line Restriction. The active portion of a facility shall not be located closer than one hundred (100) feet to the property line. (3-20-20)T
- b. Siting Application. The owner and operator shall provide in the Siting Application documentation that demonstrates compliance with the siting requirements specified in Subsections 012.01 and 012.11.a.; (3-20-20)T
- c. Design Application. The owner and operator shall provide the following information for design approval: (3-20-20)T
  - i. A facility map illustrating: (3-20-20)T
    - (1) Surface water and erosion control systems; (3-20-20)T
    - (2) Proposed fill area, including the location of waste disposal trenches or cells, noting the locations of trenches used for separated wastes such as animal carcasses, tree trunks, stumps, bulky wastes, car bodies, asbestos, and petroleum contaminated soils; (3-20-20)T
    - (3) Location of borrow areas; (3-20-20)T
    - (4) Design elevation grade of final cover; (3-20-20)T
    - (5) Soil and water table test boring holes, wells, or excavations; (3-20-20)T
    - (6) Proposed receiving, storage, and processing areas; (3-20-20)T
    - (7) Proposed trench layout and development; and (3-20-20)T
    - (8) Contour lines at five (5) foot intervals within the operating area and ten (10) foot intervals to the facility boundary. (3-20-20)T
  - d. Operating Requirements: The owner and operator of a NMSWLF shall comply with the following operating requirements: (3-20-20)T
    - i. Compaction and placement of waste in locations consistent with the approved operating plan; (3-20-20)T
    - ii. Provision for storage of waste during periods when the NMSWLF is inaccessible; (3-20-20)T
    - iii. Application of a six (6) inch compacted soil cover layer on exposed waste as necessary to prevent nuisance and vector conditions at periods consistent with the approved operating plan. An owner and operator may request that the Department approve an alternate cover that addresses vectors, litter, fire, odor, and scavenging concerns; (3-20-20)T
    - iv. Placement of an interim cover layer of twelve (12) inches of compacted soil between lifts to provide erosion control and structural stability. An owner and operator may request that the Department approve an alternate interim cover that addresses erosion, and stability for subsequent lifts; (3-20-20)T
    - v. Preservation of existing vegetation where attainable. (3-20-20)T
  - e. Operating Plan. The operating plan required in Subsection 012.04 shall identify the methods used

for maintaining compliance with each applicable operating requirement of Subsection 012.03 and Subsection 012.11.d.; (3-20-20)T

**f.** Closure Requirements. The owner and operator of a Tier II NMSWLF shall comply with the following closure requirements: (3-20-20)T

i. Final Cover. Within seven (7) days of the date of last receipt of waste, a cover layer shall be applied to prevent nuisances and vector conditions. Within one hundred and twenty (120) days of the date of last receipt of waste, a final cover layer of eighteen (18) inches of compacted soil with an approved in-place permeability designed to minimize infiltration, or its functional equivalent, and, a six (6) inch soil layer that minimizes erosion and sustains plant growth shall be constructed; (3-20-20)T

ii. Facility Stabilization. All disturbed portions of the facility shall be stabilized. Stabilization practices may include but are not limited to: establishment of vegetation, mulching, geotextiles, and sod stabilization; (3-20-20)T

iii. Slope Stability. Finished grade shall be at a minimum of two percent (2%) and a maximum of thirty- three percent (33%) slope on the final surface of the completed fill area, after settlement; and (3-20-20)T

iv. Drainage Control. The completed landfill shall be graded to prevent surface water ponding and erosion, and to conform to the local topography. (3-20-20)T

**g.** Closure Plan. The owner and operator shall provide in the Closure Plan documentation that demonstrates compliance with closure requirements specified in Subsections 012.05 and 012.11.f. (3-20-20)T

**h.** Deed Notation: (3-20-20)T

i. After completion and certification of closure of a NMSWLF, the owner and operator shall record a notation on the deed to the landfill facility property, or some other recorded instrument that is normally examined during title search and is commonly recorded in the County where the landfill facility property is located, to provide notice to any potential purchaser that the property has been used as a solid waste processing or disposal facility and its future use may be restricted in accordance with a post-closure care plan. A copy of the notated deed, or other recorded instrument shall be sent to the Department after recording with the county clerk; (3-20-20)T

ii. The owner may request permission from the Department to remove the notation from the deed, or to remove the other recorded instrument, if all wastes are removed from the facility; (3-20-20)T

iii. Federal agencies with responsibility for management of landfills on federal property shall make a notation in the federal property records for the affected property. If the subject property is ever sold or transferred by the federal government, a notation on the deed or patent shall be made. (3-20-20)T

**i.** Post-Closure Care Plan. Owners and operators of a NMSWLF shall submit, in accordance with the time frames specified in Subsection 012.06, to the Department for review and approval a Post-Closure Care Plan, shall obtain Department approval of the Plan, and shall conduct post-closure care in accordance with the Plan. The Post-Closure Care Plan shall typically contain: (3-20-20)T

i. The name and address of an agent authorized to accept communications or service during the post-closure period. The name may be changed during the post-closure period by providing the Department with twenty (20) days advance written notice of the change; (3-20-20)T

ii. Provisions to maintain the integrity and effectiveness of the final cover; (3-20-20)T

iii. Provisions to continue to maintain and operate the systems required in the operating plan including run-on/run-off control systems; (3-20-20)T

iv. Provisions to maintain appropriate security of the closed facility; (3-20-20)T



- v. Provisions for routine facility inspections by the owner and operator to insure compliance with the Post-Closure Care Plan; and (3-20-20)T
- vi. A description of the planned use(s) of the property during the post-closure care period: (3-20-20)T
- j. Post-closure care for the NMSWLF shall be conducted for a period of five (5) years, unless the Department establishes in writing an alternate facility-specific post-closure care period. (3-20-20)T
- k. Post-Closure Standards and Inspection. Post-closure use or operation of the site shall not disturb any final cover or storm water control systems in a manner that will increase the potential to threaten human health or the environment. (3-20-20)T
- l. The approved Post-Closure Care Plan shall be maintained and available for review on request by the Department. (3-20-20)T

**013. APPLICABLE REQUIREMENTS FOR TIER III FACILITIES.**

The owner and operator of a new Tier III facility shall establish compliance with the requirements of Section 013 by obtaining Department approval of the applications required in Subsection 013.02 before beginning construction and Subsection 013.04 prior to accepting waste. The owner and operator of an existing Tier III facility shall establish compliance with the requirements of Section 013 by obtaining Department approval of the applications required in Subsection 013.04 within two (2) years from April 26, 2002, and Subsection 013.02 within five (5) years from April 26, 2002. During the two (2) year period from April 26, 2002, existing facilities shall operate in compliance with their approved operating plan and 40 CFR 257.1 through 257.3. In lieu of submitting an application, the owner and operator of existing facilities may demonstrate to the Department, compliance with Section 013 by submitting copies of existing permits and other approvals that establish compliance with the applicable siting, design, operating, closure, and post-closure requirements of Section 013 and Subsection 032.01. The owner and operator of a Tier III facility shall meet the requirements of Subsection 012.07 prior to facility closure; except that owners and operators closing Tier III facilities within eighteen (18) months from April 26, 2002 shall comply with applicable cover, seeding, grading and closure requirements of the former Solid Waste Management Rules and Standards, as enumerated in Subsection 001.04.d. of these rules. (3-20-20)T

**01. General Siting Requirements.** The owner and operator of a Tier III facility shall comply with the following siting requirements: (3-20-20)T

- a. Flood Plain Restriction. A facility shall not be located within a one hundred (100) year flood plain if the facility will restrict the flow of the one hundred (100) year flood, reduce the temporary water storage capacity of the flood plain, or result in a washout of solid waste so as to pose a hazard to human health and the environment. (3-20-20)T
- b. Endangered or Threatened Species Restriction. The facility shall not cause or contribute to the taking of any endangered or threatened species of plants, fish, or wildlife or result in the destruction or adverse modification of the critical habitat of endangered or threatened species as identified in 50 CFR Part 17. (3-20-20)T
- c. Surface Water Restriction. The active portion of a facility shall be located such that the facility shall not cause contamination of surface waters, unless such surface waters are an integral part of the non-municipal solid waste management facility's operation for storm water and/or leachate management. (3-20-20)T
- d. Ground Water. The active portion of the facility shall be located, designed and constructed such that the facility shall not cause contamination to a drinking water source or cause contamination of ground water. (3-20-20)T
- e. Geologic Restrictions. No facility may be located on land that would threaten the integrity of the design. (3-20-20)T
- f. Property Line Restriction. The active portion of a facility shall not be located closer than one hundred (100) feet to the property line. (3-20-20)T

**g.** Park, Scenic or Natural Use Restriction. The active portion of a facility shall not be located closer than one thousand (1,000) feet from the boundary of any state or national park, or land reserved or withdrawn for scenic or natural use including, but not limited to, wild and scenic areas, national monuments, wilderness areas, historic sites, recreation areas, preserves and scenic trails. (3-20-20)T

**h.** Variance from Siting Requirement. Any existing or planned facility that does not meet the siting requirements of Section 013 may apply for a variance from the Department. The Department may approve a written request for a variance provided the owner and operator demonstrate to the Department that the variance is at least as protective of public health and the environment as the siting requirements in Section 013. (3-20-20)T

**02. Siting Application.** Documentation shall be submitted to the Department demonstrating compliance with the siting requirements and restrictions specified in Subsection 013.01 within the time frames specified in Section 013. If the documentation has been certified by a qualified professional, the Director shall approve the siting application unless the Director finds the evidence supports a contrary opinion. A map indicating the following shall also be submitted to the Department as part of a Siting Application: (3-20-20)T

- a.** Highways, roads, and adjacent communities; (3-20-20)T
- b.** Property boundaries; (3-20-20)T
- c.** Total acreage of the site; (3-20-20)T
- d.** Off-site and on-site access roads and service roads; (3-20-20)T
- e.** Type(s) of land use adjacent to the facility and a description of all facilities on the site; (3-20-20)T
- f.** All water courses, ponds, lakes, reservoirs, canals, irrigation systems, and existing water supplies, within one-quarter (1/4) mile of the proposed facility property lines; (3-20-20)T
- g.** High tension power line rights-of-way, fuel transmission pipeline rights-of-way, and proposed and existing utilities; (3-20-20)T
- h.** Proposed or existing fencing; (3-20-20)T
- i.** Proposed and existing structures at the facility and within five hundred (500) feet of the facility boundary. This shall include location of employee buildings, and scales (if provided); and (3-20-20)T
- j.** Direction of prevailing winds. (3-20-20)T

**03. General Operating Requirements.** The owner and operator of a Tier III facility shall comply with the following operating requirements: (3-20-20)T

- a.** Prohibited Activities. The following activities are prohibited: (3-20-20)T
  - i.** Disposal in a landfill of regulated waste from any business that provides health care, support to health care businesses, or medical diagnostic services that has not been decontaminated. "Regulated waste" and "decontaminated" for the purpose of Section 013 has the same meaning as defined at 29 CFR 1910.1030; (3-20-20)T
  - ii.** Speculative accumulation, unless otherwise approved in an operating plan; and (3-20-20)T
  - iii.** Disposal of radioactive waste except in a facility regulated pursuant to Section 39-4405(9), Idaho Code and rules adopted thereunder or a facility regulated under the authority of The Atomic Energy Act of 1954, as amended. (3-20-20)T
- b.** Signs. Facilities open to the general public shall clearly post visible and legible signs at each entrance to the facility specifying, at a minimum, the name of the facility, the hours of operation, the waste accepted at the facility and an emergency phone number. (3-20-20)T

- c.** Waste Types. Only the solid waste types listed in the approved operating plan may be accepted for disposal or processing. (3-20-20)T
- d.** Waste Monitoring and Measurement. Provisions shall be made for monitoring or measuring all solid waste delivered to a facility. The waste monitoring program shall include: (3-20-20)T
- i.** A daily written log listing the types and quantities of wastes received; (3-20-20)T
  - ii.** A plan for monitoring and handling receipt of unauthorized wastes; (3-20-20)T
  - iii.** Routine characterization of the wastes received; and (3-20-20)T
  - iv.** Other measures included in an approved Operating Plan. (3-20-20)T
- e.** Communication. Communication devices shall be available or reasonably accessible at the site. (3-20-20)T
- f.** Fire Prevention and Control. Adequate provisions shall be made for controlling or managing fires at the site. (3-20-20)T
- g.** Facility Access. Unauthorized vehicles and persons shall be prohibited access to the facility. A facility open to the public shall accept waste only when an attendant is on duty. The facility shall be fenced or otherwise blocked to access when an attendant is not on duty. (3-20-20)T
- h.** Scavenging and Salvaging. Scavenging by the public at a facility is prohibited; however, salvaging may be conducted in accordance with a written operating plan and only by the owner, operator or an authorized agent. (3-20-20)T
- i.** Nuisance Control. The owner and operator shall control nuisances, including but not limited to: (3-20-20)T
- i.** Disease or Discomfort. Operations at any facility shall not provide sustenance to rodents or insects that cause human disease or discomfort; (3-20-20)T
  - ii.** Vector. Vector control procedures shall prevent or control vectors that may cause health hazards or nuisances; (3-20-20)T
  - iii.** Odor. The facility shall be operated to control malodorous gases; and (3-20-20)T
  - iv.** Litter. Effective measures shall be taken to minimize the loss of debris from the facility. Debris blown from or within the facility shall be collected and properly disposed to prevent objectionable accumulations. (3-20-20)T
- j.** Bird Hazards to Aircraft. No facility may handle putrescible wastes in such a manner that may attract birds and increase the likelihood of bird/aircraft collisions. Facilities that are located within ten thousand (10,000) feet of any airport runway used by turbojet aircraft, or within five thousand (5,000) feet of any airport used by only piston-type aircraft shall operate the facility in such a manner that birds are not a hazard to aircraft. (3-20-20)T
- k.** Open Burning and Fires. Open burning is prohibited at facilities except as authorized by these rules and IDAPA 58.01.01, "Rules for the Control of Air Pollution in Idaho." (3-20-20)T
- i.** No open burning shall be conducted during an air pollution episode, declared in accordance with IDAPA 58.01.01, "Rules for the Control of Air Pollution in Idaho." (3-20-20)T
  - ii.** Open burning is authorized only if it is infrequent and the materials are agricultural wastes,

silviculture wastes, land clearing debris, diseased trees, or debris from emergency cleanup operations. Materials burned shall not include garbage, dead animals, asphalt, petroleum products, paints, tires or other rubber products, plastics, paper (other than that necessary to start the fire), cardboard, treated wood, construction debris, metal, pathogenic wastes, hazardous wastes, or any other substance (other than natural vegetation) that when burned releases toxic emissions, dense smoke or strong odors. (3-20-20)T

iii. Open burning shall be conducted pursuant to conditions set forth by the Department or local fire authority. The owner and operator of the facility shall contact the Department and the local fire authority prior to conducting open burning to report its nature and location. (3-20-20)T

l. Storm Water Run-On/Run-Off Controls. The operating plan shall include sufficient storm water management provisions, which may incorporate a NPDES storm water pollution prevention plan, to prevent contamination of ground or surface water and prevent the spread and impact of contamination beyond the boundary of the facility. (3-20-20)T

m. Variance Request. An owner and operator may submit to the Department a written variance request for a variance from the operating requirements listed in Section 013. The Department shall approve a written request for a variance provided the owner and operator demonstrate to the Department that the variance is at least as protective of human health and the environment as the requirements listed in Section 013. (3-20-20)T

**04. Operating Plan.** The owner and operator of a Tier III facility shall submit to the Department an Operating Plan containing that information required by Subsection 013.03, within the time frames stated in Section 013. An Operating Plan shall included a description of the wastes to be accepted, the methods for maintaining compliance with each of the applicable general operating requirements of Subsection 013.03, and complies with any applicable facility specific requirements found in Subsections 013.11 through 013.13. (3-20-20)T

**05. Ground Water Monitoring Requirements.** The owner and operator of a new Tier III facility shall comply with the following ground water monitoring requirements: (3-20-20)T

a. Install and maintain ground water monitoring wells at the point of compliance as approved by the Department; (3-20-20)T

b. Within thirty (30) days of completion of each well, submit a copy of the geologic log and record of well construction to the Department; (3-20-20)T

c. Monitor the ground water quarterly, unless otherwise directed by the Department. Constituents to be monitored shall be those listed in 40 CFR Part 257.24 unless otherwise authorized by the Department; and (3-20-20)T

d. The owner and operator of any facility required to monitor ground water pursuant to Section 013 shall continue the approved monitoring schedule for five (5) years following facility closure, unless otherwise approved by the Department upon request of the owner and operator for a modified monitoring schedule. (3-20-20)T

**06. Ground Water Monitoring Application.** The following information shall be submitted to the Department in a Ground Water Monitoring Application: (3-20-20)T

a. A map showing soil types, depth to ground water, ground water flow direction and locations of proposed ground water monitoring wells; and (3-20-20)T

b. A monitoring schedule indicating sample frequency and constituents to be analyzed. (3-20-20)T

**07. Closure Requirement.** The owner and operator of a Tier III facility shall comply with the following closure requirements: (3-20-20)T

a. Public Notice. For a facility open to the public the owner and operator shall provide public notice of the facility's closure by publishing a notice in the local newspaper and posting signs at the facility's entrance. This notice shall be published and the signs posted; (3-20-20)T

i. At least thirty (30) days and no more than ninety (90) days prior to the date of last receipt of waste for a facility that has reached disposal capacity; or (3-20-20)T

ii. If the facility has remaining capacity and there is a reasonable likelihood that the facility will receive additional waste, a notice shall be published and signs posted at least thirty (30) days and no more than ninety (90) days prior to closure. (3-20-20)T

**b. Facility Closure.** Unless the Department establishes an alternate closure time period, the owner and operator shall close the facility within six (6) months of the Department's approval of the Closure Plan. The facility shall be closed in accordance with the approved Closure Plan. (3-20-20)T

**c. Clean Site/Access Control.** The owner and operator shall close the facility by managing or removing all solid waste to prevent impact to human health or the environment and shall install a gate or other device to prevent public access after the last receipt of waste; (3-20-20)T

**d. Drainage and Erosion Control.** The owner and operator shall install appropriate measures to control erosion and install appropriate measures to control the run-on and runoff from a twenty-five (25) year, twenty-four (24) hour storm event and to provide for the diversion of other surface waters from the closed facility; and (3-20-20)T

**e. Closure Plan Certification.** Within thirty (30) days of closure, the owner and operator shall notify the department in writing that the facility was closed in accordance with the approved Closure Plan. If closure of the facility is different from the approved Closure Plan, the owner and operator shall submit for Department review and approval documents, such as "as-built" plans, showing the final conditions of the facility. (3-20-20)T

**08. Closure Plan Application.** The owner and operator of a Tier III facility shall submit to the Department a Closure Plan Application containing the information no later than ninety (90) days before the date on which the facility receives the known final receipt of wastes or, if the facility has remaining capacity and there is a reasonable likelihood that the facility will receive additional wastes, no later than one (1) year after the most recent receipt of wastes. The following information shall be submitted to the Department in a Closure Application: (3-20-20)T

**a.** A complete and accurate legal description of the facility; (3-20-20)T

**b.** A map of the facility, showing pertinent facility features, including: (3-20-20)T

i. Facility boundaries, drainage patterns, location of fill areas, and location of access control measures; (3-20-20)T

ii. All water courses, ponds, lakes, reservoirs, canals, irrigation systems, and existing water supplies, within one-quarter (1/4) mile of the facility boundary; (3-20-20)T

iii. Location of disposal trenches and description of waste disposed; and (3-20-20)T

iv. Proposed final contours of the closed facility, drawn to a reasonable scale with five (5) foot intervals for the operational area, and ten (10) foot intervals for the remainder of the facility; (3-20-20)T

**c.** Estimated date of last receipt of waste; (3-20-20)T

**d.** A description of how public access to the closed facility will be controlled; (3-20-20)T

**e.** Estimated total cubic yards, or tons, of waste in place; (3-20-20)T

**f.** Total acreage of the facility and acres containing waste; (3-20-20)T

**g.** Closure equipment and procedures to be used; (3-20-20)T

- h.** Texture, depth and permeability of final cover material; (3-20-20)T
  - i.** Design and construction plan for any necessary final cover; (3-20-20)T
  - j.** Placement, design, and management of run-on and run-off storm water controls; (3-20-20)T
  - k.** Types of vegetation and planting procedures to be used for establishing vegetative cover; (3-20-20)T
  - l.** Details of any proposed changes to any existing groundwater monitoring system; (3-20-20)T
  - m.** Details of any proposed changes to any existing landfill gas control system; (3-20-20)T
  - n.** Details of any proposed changes to any existing leachate collection system; and (3-20-20)T
  - o.** Other closure information the Department determines is necessary to protect human health and the environment. (3-20-20)T
- 09. Documentation Requirements.** The owner and operator of a Tier III facility shall maintain on site each Department-approved application required by Section 013. (3-20-20)T
- 10. Modification Application.** The owner and operator shall submit to the Department a Modification Application describing the proposed modification no less than sixty (60) days prior to the proposed modification of the facility. The owner and operator of a Tier III facility shall not implement the modification prior to Department approval. If a proposed modification alters the classification of a facility, the owner and operator shall comply with the application content, review and approval requirements for the new classification. (3-20-20)T
- 11. Tier III Processing Facilities.** In addition to the requirements in Subsections 013.01 through 013.10, the owner and operator of a Tier III processing facility shall comply with the following requirements: (3-20-20)T
- a.** Odor Management Plan. The owner and operator of a Tier III processing facility shall implement a Department approved Odor Management Plan designed to minimize malodorous gases. An Odor Management Plan shall include specific operating criteria for oxygen, moisture and temperature levels appropriate for the wastes to be processed and processing technologies to be employed; methods used to maintain the specific operating criteria and a monitoring strategy that includes the frequency and parameters for monitoring the specific operating criteria; (3-20-20)T
  - b.** Additional Requirements for PCS. Owners and operators of Tier III PCS processing facilities shall comply with the following applicable requirements: (3-20-20)T

    - i.** Leachate collection and control system to prevent contamination of ground and surface waters; (3-20-20)T
    - ii.** Liner designed to prevent ground and surface water contamination. The liner design shall account for the types of wastes handled and the potential for migration of liquids and gaseous contaminants to ground water; and (3-20-20)T
    - iii.** Air emission control system to prevent discharges of air pollutants. (3-20-20)T
    - iv.** An owner and operator of a PCS processing facility may submit a written request for a variance from the leachate control and liner requirements. The owner and operator must demonstrate that the variance is at least as protective of surface and ground water as the leachate collection system and liner. (3-20-20)T
  - c.** Design Application. The following information shall be submitted to the Department in a Design Application: (3-20-20)T

- i. Building and construction design blueprints; (3-20-20)T
  - ii. A map illustrating a storm water run-on/run-off system designed to prevent contamination of ground or surface water or and prevent contamination beyond the boundary of the facility; (3-20-20)T
  - iii. Operational design and capacity information including a description of the waste types and projected daily and annual waste volumes; and (3-20-20)T
  - iv. Design and Construction Requirements. The owner and operator of a Tier III PCS processing facility shall submit for Department review and approval the following information as part of the Design Application: (3-20-20)T
    - (1) A hydrogeologic evaluation, including the potential for migration of contamination to ground or surface water; (3-20-20)T
    - (2) A detailed description of treatment methods to be used; (3-20-20)T
    - (3) Design plans for a leachate collection and control system to prevent ground and surface water contamination from the leachate control system; (3-20-20)T
    - (4) Design plans for an air emissions control system to prevent discharges of air pollutants; and (3-20-20)T
    - (5) Design plans for a liner designed to prevent ground or surface water contamination. The liner design shall account for the types of wastes handled and the potential for migration of liquid and gaseous contaminants to ground water. (3-20-20)T
  - d. Operating Plan. The owner and operator of a PCS processing facility shall submit for Department review and approval the following information as part of the Subsection 013.04, Operating Plan: (3-20-20)T
    - i. A sampling plan that describes the methods and frequency that the owner and operator will use to sample and analyze the wastes when received, during processing, and on final testing of processed material; and (3-20-20)T
    - ii. A description of how the owner and operator will maintain and operate the liner, leachate collection and control system, and air emission control system consistent with the approved design application. (3-20-20)T
  - e. Documentation Requirement. The owner and operator of a processing facility shall maintain documentation of compliance with Section 013, including an operational log of the methods used to maintain the operating criteria and sampling results. (3-20-20)T
- 12. Tier III Incinerators.** In addition to the requirements in Subsections 013.01 through 013.04 and Subsections 013.09 and 013.10, the owner and operator of a Tier III incinerator shall comply with the following requirements: (3-20-20)T
- a. Design Requirements. The owner and operator of an incinerator comply with the following design requirements: (3-20-20)T
    - i. A tipping floor constructed of impermeable and durable material and designed to contain, collect, and convey any liquids to a storage or leachate management system. Any facility that accepts only waste tires will not be required to construct a tipping floor. (3-20-20)T
    - ii. A storage or leachate management system. (3-20-20)T
  - b. Design Application. The following information shall be submitted to the Department in a Design Application: (3-20-20)T

- i. A description of the tipping floor design; (3-20-20)T
- ii. A description of the storage or leachate management system design; (3-20-20)T
- iii. Building and construction design blueprints; (3-20-20)T
- iv. A map illustrating a storm water run-on/run-off system designed to prevent ground or surface water contamination, or contamination from the facility beyond the boundary of the facility; (3-20-20)T
- v. Operational design and capacity information including a description of the waste types and projected daily and annual waste volumes; and (3-20-20)T
- vi. Any facility specific design elements required by these rules. (3-20-20)T
- c. Operating Requirements.** The owner and operator of an incinerator shall comply with the following operating requirements: (3-20-20)T
  - i. Maintain and operate the tipping floor to control odors, insects, and rodents; (3-20-20)T
  - ii. Implement cleaning procedures and waste residency times used to maintain sanitary conditions on the surface of the tipping floor; and (3-20-20)T
  - iii. Implement a storage or leachate management system operation. (3-20-20)T
- d. Waste Tire Collection Site Requirements.** Individual tire piles shall not exceed five thousand (5000) square feet of continuous area, nor fifty thousand (50,000) cubic feet in volume or ten (10) feet in height. (3-20-20)T
- e.** If it is determined that the tipping floor or leachate management system integrity has been breached, or waste has been handled or stored outside of the containment of the tipping floor, unless allowed in the facility Operating Plan, the owner and operator of the Tier III incinerator shall comply with Subsections 013.05 through 013.08. (3-20-20)T
- 13. Tier III NMSWLFs.** In addition to the requirements in Subsection 013.01 through 013.10, the owner and operator of a Tier III NMSWLF shall comply with the following requirements: (3-20-20)T
  - a.** Siting Requirements: A facility shall not be located in wetlands, except as provided in 40 CFR 257.9; (3-20-20)T
  - b.** Siting Application. The owner and operator shall include in the Siting Application documentation demonstrating compliance with the requirement specified in Subsection 013.13.a.; (3-20-20)T
  - c.** Design and Construction Requirements: The owner and operator of a new NMSWLF shall comply with the following design and construction requirements: (3-20-20)T
    - i. Leachate Collection and Control System. A leachate collection and control system shall be constructed to prevent ground and surface water contamination; (3-20-20)T
    - ii. Liner. A liner designed to prevent ground or surface water contamination shall be installed. The liner design shall account for the types of wastes handled and the potential for migration of liquid and gaseous contamination to ground or surface water; (3-20-20)T
    - iii. Landfill Emission Control System. Appropriate toxic and flammable gas monitoring devices shall be installed where the location, geophysical condition, and waste characteristics indicate that there is a reasonable probability that the facility will generate toxic and flammable gas: exceeding twenty-five (25) percent of the lower explosive limit for gases in facility structures (excluding gas control or gas recovery system components); exceeding the lower explosive limit at the property boundary; or otherwise presenting a potential threat to public health or the



environment; and (3-20-20)T

iv. An owner or operator may submit a written request for a variance from the leachate collection and control system, liner, or emission control system requirements. The Department may approve the variance upon demonstration by the owner or operator that the variance is at least as protective of human health and the environment as the leachate collection and control system, liner, or emission control system. (3-20-20)T

**d.** Design Application. The following information shall be submitted to the Department in a Design Application: (3-20-20)T

i. Design plans shall address the need for and include as required a leachate collection and control system, liner, and emission control systems in Subsection 013.13.c.; (3-20-20)T

ii. A facility map illustrating: (3-20-20)T

(1) Surface water and erosion control systems; (3-20-20)T

(2) Proposed fill area, including the location of waste disposal trenches or cells, noting the locations of trenches used for separated wastes such as animal carcasses, tree trunks, stumps, bulky wastes, car bodies, asbestos, and petroleum contaminated soils; (3-20-20)T

(3) Location of borrow areas; (3-20-20)T

(4) Design elevation grade of final cover; (3-20-20)T

(5) Soil and water table test boring holes, wells, or excavations; (3-20-20)T

(6) Proposed receiving, storage, and processing areas; (3-20-20)T

(7) Proposed trench layout and development; and (3-20-20)T

(8) Contour lines at five (5) foot intervals within the operating area and ten (10) foot intervals to the facility boundary. (3-20-20)T

(9) Building and construction design blueprints; (3-20-20)T

(10) Operational design and capacity information including a description of the waste types and projected daily and annual waste volumes; and (3-20-20)T

**e.** Operating Requirements: The owner and operator of a NMSWLF shall comply with the following operating requirements: (3-20-20)T

i. Compaction and placement of waste in locations consistent with the approved operations plan; (3-20-20)T

ii. Provision for storage of waste during periods when the NMSWLF is inaccessible; (3-20-20)T

iii. Application of a six (6) inch compacted soil cover layer on exposed waste as necessary to prevent nuisance and vector conditions at periods consistent with the approved operations plan. An owner and operator may request that the Department approve an alternate cover that addresses vectors, litter, fire, odor, and scavenging concerns; (3-20-20)T

iv. Placement of an interim cover layer of twelve (12) inches of compacted soil between lifts to provide erosion control and structural stability. An owner and operator may request that the Department approve an alternate interim cover that addresses erosion, and stability for subsequent lifts; (3-20-20)T

v. Maintenance and operation of a leachate collection and control system and air emission control

- system consistent with the approved design application; and (3-20-20)T
- vi. Preservation of existing vegetation where attainable. (3-20-20)T
- f. Operating Plan. The operating plan required in Section 013 shall identify the methods used for maintaining compliance with each applicable operating requirement of Subsection 013.03. and Subsection 013.13.e. including but not limited to the type, the method of compaction and the frequency of application of respective cover materials; (3-20-20)T
- g. Closure Requirements. The owner and operator of a NMSWLF shall comply with the following closure requirements: (3-20-20)T
- i. Final Cover. Within seven (7) days of the date of last receipt of waste, a cover layer shall be applied to prevent nuisances and vector conditions. Within one hundred and twenty (120) days of the date of last receipt of waste, a final cover layer of eighteen (18) inches of compacted soil with an approved in-place permeability designed to minimize infiltration, or its functional equivalent, and, a six (6) inch soil layer that minimizes erosion and sustains plant growth shall be constructed; (3-20-20)T
- ii. Facility Stabilization. All disturbed portions of the facility shall be stabilized. Stabilization practices may include but are not limited to: establishment of vegetation, mulching, geotextiles, and sod stabilization; (3-20-20)T
- iii. Slope Stability. Finished grade shall be at a minimum of two percent (2%) and a maximum of thirty- three percent (33%) slope on the final surface of the completed fill area, after settlement; and (3-20-20)T
- iv. Drainage Control. The completed landfill shall be graded to prevent surface water ponding and erosion, and to conform to the local topography. (3-20-20)T
- h. Deed Notation: (3-20-20)T
- i. After completion and certification of closure of a NMSWLF, the owner and operator shall record a notation on the deed to the landfill facility property, or some other recorded instrument that is normally examined during title search and is commonly recorded in the County where the landfill facility property is located, to provide notice to any potential purchaser that the property has been used as a solid waste processing or disposal facility and its future use may be restricted in accordance with a post-closure care plan. A copy of the notated deed, or other recorded instrument, shall be sent to the Department after recording with the county clerk. (3-20-20)T
- ii. The owner may request permission from the Department to remove the notation from the deed, or the other recorded instrument, if all wastes are removed from the facility. (3-20-20)T
- iii. Federal agencies with responsibility for management of landfills on federal property shall make a notation in the federal property records for the affected property. If the subject property is ever sold or transferred by the federal government, a notation on the deed or patent shall be made. (3-20-20)T
- i. Closure Plan. The owner and operator shall provide in the Closure Plan documentation that demonstrates compliance with closure requirements specified in Subsections 013.07 and 013.13.g. (3-20-20)T
- j. Post-Closure Care Plan. Owners and operators of a NMSWLF shall submit, in accordance with the time frames specified in Subsection 013.08, to the Department for review and approval a Post-Closure Care Plan, shall obtain Department approval of the Plan, and shall conduct post-closure care in accordance with the Plan: (3-20-20)T
- i. Unless the Department determines otherwise, the Post-Closure Care Plan shall contain: (3-20-20)T
- (1) The name and address of an agent authorized to accept communications or service during the post-closure period. The name may be changed during the post-closure period by providing the Department with twenty (20) days advance written notice of the change; (3-20-20)T

- (2) Provisions to maintain the integrity and effectiveness of the final cover; (3-20-20)T
- (3) Provisions to continue to maintain and operate the systems required in the operating plan, including: run-on/run-off control systems, leachate collection and control systems, groundwater monitoring systems, and gas monitoring systems; (3-20-20)T
- (4) Provisions to maintain appropriate security of the closed facility; (3-20-20)T
- (5) Provisions for routine facility inspections by the owner and operator to insure compliance with the Post-Closure Care Plan; and (3-20-20)T
- (6) A description of the planned use(s) of the property during the post-closure care period. (3-20-20)T
  - ii. Post-closure care for the NMSWLF shall be conducted for a minimum of five (5) years, but not more than thirty (30) years, as necessary to protect human health and the environment. (3-20-20)T
  - iii. Post-Closure Standards and Inspection. Post-closure use or operation of the site shall not disturb any final cover, liner or other component of the containment system in a manner that will increase the potential to threaten human health or the environment. (3-20-20)T
  - iv. The approved Post-Closure Care Plan shall be maintained and available for review on request by the Department. (3-20-20)T
  - v. The requirements in Subsection 013.07 shall apply to owners and operators and their successors and assigns. (3-20-20)T

**014. -- 031. (RESERVED)**

**032. TIER II AND TIER III APPLICATION AND PLAN REVIEW AND APPROVAL.**

**01. Application Submittal.** The owner and operator shall submit three (3) copies of each required application to the Department. The owner and operator may submit applications for siting, design, operation, or ground water monitoring approval sequentially or concurrently. (3-20-20)T

**02. Preapplication Conference.** The owner or operator may request that the Department convene a preapplication conference with any interested federal, state and local entities to discuss the approval procedures, application content, time tables for application processing, siting and design requirements. (3-20-20)T

**03. Application Review.** (3-20-20)T

**a.** On receipt of an application the Department shall, within thirty (30) days, notify the owner and operator in writing whether the submission is complete and whether the application identifies an appropriate Tier level. The notice shall identify any deficiencies in the application, and the information relied upon in making the determination, and shall state that an applicant may submit additional information in the form of an amended application, withdraw the application or request a conference to discuss the Department's determination. (3-20-20)T

**b.** Upon receipt of the Department's determination that a siting application is complete, the owner and operator shall publish a notice in a newspaper of general circulation as determined in Section 31-819, Idaho Code, in the county and the immediate vicinity of the proposed facility and shall also provide notice to local government. The notice shall include the name and location of the proposed facility, a general description of the proposed operations, the location where the application may be reviewed, and instructions directing the public to submit comments to the Department within thirty (30) days of the date of publication. The owner and operator shall provide a copy of the published notice and notice to local government to the Department within five (5) business days of publication. (3-20-20)T

**c.** The Department shall approve, deny, or approve with conditions each application. Failure to issue a

decision within the stated time shall be deemed approval. Approval conditions shall relate to protection of human health and the environment as required in these rules. (3-20-20)T

i. For a siting application, the Department shall notify the owner and operator in writing of the Department's decision within thirty (30) days of the date of the close of the public comment period. The Department and the owner and operator may agree, in writing to a longer period of time for the Department's determination. Design, Operating and Ground Water Monitoring Applications shall not be reviewed until the Siting Application is approved. (3-20-20)T

ii. For the Design, Operating and Ground Water Monitoring applications, the Department shall notify the owner and operator in writing of the Department's decision within sixty (60) days from the date the application is determined to be complete. (3-20-20)T

d. If the Department denies an application, the written decision shall state the basis for the denial, and the information relied upon in making the determination. (3-20-20)T

**04. Application Valid for Two Years.** Unless otherwise stated in the Department's approval of the facility's application, the Department's approval shall become invalid if the owner and operator fail to begin construction within two (2) years from the date of approval, or if after construction has begun, work is suspended for more than two (2) years. Owners and operators may apply for an extension provided that the written request is received by the Department no less than one (1) month prior to expiration of the approval. Within fifteen (15) days from Department receipt of extension request, the Department shall approve the extension request or deny the extension request and state the basis for denial. (3-20-20)T

**033. -- 059. (RESERVED)**

**060. VIOLATIONS.**

**01. Failure to Comply.** Failure by any person to comply with the provisions of these rules shall be deemed a violation of these rules. (3-20-20)T

**02. Falsification of Statements and Records.** It shall be a violation of these rules for any person to knowingly make a false statement, representation, or certification in any application, document, or record developed, maintained, or submitted pursuant to these rules or the conditions of an approval. (3-20-20)T

**03. Penalties.** Any person violating any provision of these rules or any approved conditions or order issued thereunder shall be liable for civil penalty in accordance with Title 39, Chapter 1, Idaho Code. (3-20-20)T

**061. -- 993. (RESERVED)**

**994. COMMERCIAL SOLID WASTE SITING LICENSE FEE.**

An application for a commercial solid waste siting license required by the Idaho Solid Waste Facilities Act shall be accompanied by a siting license fee in an amount established by these rules. The license fee shall not exceed seven thousand five hundred dollars (\$7,500) and shall be submitted with the siting license application. (3-20-20)T

**01. Commercial Solid Waste Siting License Fee Criteria.** The commercial solid waste siting license fee required by the Idaho Solid Waste Facilities Act and these rules shall apply to commercial MSWLFs only and shall be based on the cost of the Department's review and the characteristics of the proposed commercial solid waste facility, including the projected site size, projected waste volume, and the hydrogeological and atmospheric characteristics surrounding the site. (3-20-20)T

**02. Commercial Solid Waste Siting License Fee Scale.** The commercial solid waste siting license fee required by the Idaho Solid Waste Facilities Act and these rules shall be determined using the table below. The fee determined using the table below may then be adjusted by the Department if necessary to reflect the cost of the Department's review, taking into account the hydrogeological and atmospheric characteristics surrounding the site.

COMMERCIAL SOLID WASTE SITING LICENSE FEE SCALE PROJECTED SOLID WASTE VOLUME Tons per day (TPD)			
Site Size	Up to 20 TPD	20 to 100 TPD	More than 100 TPD
5 acres or less	\$3,500	\$4,500	\$5,500
5 to 50 acres	\$4,500	\$5,500	\$6,500
more than 50 acres	\$5,500	\$6,500	\$7,500

(3-20-20)T

**03. Notification of Adjustment of Fee.** Within thirty (30) days of receipt of the application and fee, the Department shall notify the applicant if the fee has been adjusted and the date by which any additional fee must be paid by the applicant. (3-20-20)T

**04. Expansion or Enlargement of a Commercial Solid Waste Facility.** The expansion or enlargement of a commercial solid waste facility constitutes a new proposal for which a commercial solid waste siting license is required and for which a siting license fee must be paid. All commercial solid waste facilities not in operation on March 20, 1996 must submit a commercial solid waste license application and fee. (3-20-20)T

**05. Commercial Solid Waste Siting License Fee Not Refundable.** The commercial solid waste siting license fee required by the Idaho Solid Waste Facilities Act and by these rules shall not be refundable and may not be applied toward any subsequent application should the commercial solid waste siting license application be canceled, withdrawn or denied. (3-20-20)T

**995. COMMERCIAL SOLID WASTE SITING LICENSE APPLICATION.**

In addition to the contents of a Siting License Application as required in the Idaho Solid Waste Facilities Act, these rules require the applicant to include in the application the following items: (3-20-20)T

**01. Location.** A map indicating the location of the proposed commercial solid waste facility; (3-20-20)T

**02. Copies of Application.** Ten (10) copies of the completed application; and (3-20-20)T

**03. Application Format.** A copy of the application in a format prepared for photocopying. (3-20-20)T

**996. -- 998. (RESERVED)**

**999. CONFIDENTIALITY OF RECORDS.**

Information obtained by the Department under these rules is subject to public disclosure pursuant to the provisions of Chapter 1, Title 74, Idaho Code. Information submitted under a trade secret claim may be entitled to confidential treatment by the Department as provided in Section 74-114, Idaho Code, and IDAPA 58.01.21, "Rules Governing the Protection and Disclosure of Records in the Possession of the Department of Environmental Quality." (3-20-20)T

## 58.01.07 – RULES REGULATING UNDERGROUND STORAGE TANK SYSTEMS

### 000. LEGAL AUTHORITY.

Chapters 1 and 88, Title 39, Idaho Code, grant authority to the Board of Environmental Quality to promulgate rules for the regulation of underground storage tank systems within the state of Idaho. (3-20-20)T

### 001. TITLE AND SCOPE.

**01. Title.** These rules are titled IDAPA 58.01.07, “Rules Regulating Underground Storage Tank Systems.” (3-20-20)T

**02. Scope.** These rules establish standards and procedures necessary for the regulation of underground storage tank systems. Compliance with these rules shall not relieve persons from the obligation to comply with other applicable state or federal laws. (3-20-20)T

### 002. WRITTEN INTERPRETATIONS.

As described in Section 67-5201(19)(b)(iv), Idaho Code, the Department of Environmental Quality may have written statements which pertain to the interpretation of these rules. If available, such written statements can be inspected and copied at cost at the Department of Environmental Quality, 1410 N. Hilton, Boise, Idaho 83706-1255. (3-20-20)T

### 003. ADMINISTRATIVE PROVISIONS.

Persons may be entitled to appeal agency actions authorized under these rules pursuant to IDAPA 58.01.23, “Rules of Administrative Procedure Before the Board of Environmental Quality.” (3-20-20)T

### 004. INCORPORATION BY REFERENCE.

Any reference to any document identified in Subsection 004.01 shall constitute the full adoption by reference into IDAPA 58.01.07. (3-20-20)T

**01. Documents Incorporated by Reference.** Technical Standards and Corrective Action Requirements for Owners and Operators of Underground Storage Tanks, [40 CFR Part 280](#), revised as of July 1, 2017 with the following exceptions: (3-20-20)T

- a. 40 CFR 280.12, the definition of “Replaced” is excluded; (3-20-20)T
- b. 40 CFR 280.12, the definition of “Under-dispenser containment or UDC” is excluded; (3-20-20)T
- c. 40 CFR 280.20, the introductory paragraph sentence, “In addition, except for suction piping that meets the requirements of Section 280.41(b)(1)(ii)(A) through (E), tanks and piping installed or replaced after April 11, 2016 must be secondarily contained and use interstitial monitoring in accordance with Section 280.43(g),” is excluded; (3-20-20)T
- d. 40 CFR 280.20(f), is excluded; (3-20-20)T
- e. 40 CFR 280.34(b)(9), the citation to Section 280.245 is excluded; (3-20-20)T
- f. 40 CFR 280.41(a)(1), “installed on or before April 11, 2016...” is excluded; (3-20-20)T
- g. 40 CFR 280.41(a)(2), is excluded; (3-20-20)T
- h. 40 CFR 280.41(b)(1), “installed on or before April 11, 2016...” is excluded; (3-20-20)T
- i. 40 CFR 280.41(b)(2), is excluded; (3-20-20)T
- j. 40 CFR 280.42, Note to paragraph (a), “for tank installed on or before October 13, 2015.” is excluded; (3-20-20)T
- k. 40 CFR 280.42(e), “installed on or before October 13, 2015...” is excluded; and (3-20-20)T
- l. 40 CFR Part 280 Subpart J is excluded. (3-20-20)T

**02. Hazardous Substance Underground Storage Tank Systems.** (3-20-20)T

a. The following items only apply to hazardous substance underground storage tank systems and do

not apply to petroleum underground storage tank systems: (3-20-20)T

i. The definition of “Hazardous substance UST system” in 40 CFR 280.12 and use of this term or regulations regarding hazardous substance in [40 CFR Part 280](#); and (3-20-20)T

ii. 40 CFR 280.42 and any reference to 40 CFR 280.42 in [40 CFR Part 280](#). (3-20-20)T

b. All other provisions of 40 CFR Part 280 and all provisions of IDAPA 58.01.07 shall apply to hazardous substance underground storage tank systems. (3-20-20)T

**03. Consistency.** In the event of conflict or inconsistency between the language in IDAPA 58.01.07 and that found in [40 CFR Part 280](#), IDAPA 58.01.07 shall prevail. (3-20-20)T

**04. Stringency.** IDAPA 58.01.07 shall be no more stringent than federal law or regulations governing underground storage tank systems. (3-20-20)T

**05. Availability of Referenced Material.** The federal regulations adopted by reference can be obtained at the following locations: (3-20-20)T

a. U.S. Government Printing Office, [www.ecfr.gov](http://www.ecfr.gov); and (3-20-20)T

b. Department of Environmental Quality, Hearing Coordinator, 1410 N. Hilton, Boise, ID 83706-1255, (208)373-0502. (3-20-20)T

**005. OFFICE HOURS – MAILING ADDRESS AND STREET ADDRESS.**

The state office of the Department of Environmental Quality and the office of the Board of Environmental Quality are located at 1410 N. Hilton, Boise, Idaho 83706-1255, (208) 373-0502, [www.deq.idaho.gov](http://www.deq.idaho.gov). The office hours are 8 a.m. to 5 p.m. Monday through Friday. (3-20-20)T

**006. CONFIDENTIALITY OF RECORDS.**

Information obtained by the Department under these rules is subject to public disclosure pursuant to the provisions of Title 74, Chapter 1, Idaho Code, and IDAPA 58.01.21, “Rules Governing the Protection and Disclosure of Records in the Possession of the Idaho Department of Environmental Quality.” (3-20-20)T

**007. -- 009. (RESERVED)**

**010. DEFINITIONS.**

For the purpose of the rules contained in IDAPA 58.01.07, “Rules Regulating Underground Storage Tank Systems,” the following definitions apply: (3-20-20)T

**01. Board.** The Idaho Board of Environmental Quality. (3-20-20)T

**02. Community Water System.** A public water system that serves at least fifteen (15) service connections used by year-round residents of the area served by the system or regularly serves at least twenty-five (25) year-round residents. (3-20-20)T

**03. Department.** The Idaho Department of Environmental Quality. (3-20-20)T

**04. Director.** The Director of the Idaho Department of Environmental Quality or his authorized agent. (3-20-20)T

**05. Existing.** Solely for purposes of determining when secondary containment is required, existing is when a petroleum underground storage tank, piping, motor fuel dispensing system, facility, public water system or potable drinking water well is in place when a new installation or replacement of a tank, piping, or motor fuel dispensing system begins. (3-20-20)T

**06. EPA.** The United States Environmental Protection Agency. (3-20-20)T

**07. Installation of a New Motor Fuel Dispenser System.** The installation of a new motor fuel dispenser and the equipment necessary to connect the dispenser to the petroleum underground storage tank system. This equipment may include flexible connectors, risers, or other transitional components that are beneath the dispenser, below the shear valve, and connect the dispenser to the piping. It does not mean the installation of a motor fuel dispenser installed separately from the equipment needed to connect the dispenser to the petroleum underground storage tank system. (3-20-20)T

**08. Installer.** Any person who installs a new or replacement petroleum underground storage tank system. (3-20-20)T

**09. New Underground Storage Tank.** Has the same meaning as “underground storage tank or UST” in 40 CFR 280.12, except that such term includes tanks that have been previously used and meet the requirements of 40 CFR 280.20(a). (3-20-20)T

**10. Non-Community Water System.** A public water system that is not a community water system. A non-community water system is either a transient non-community water system or a non-transient non-community water system. (3-20-20)T

**11. Piping.** A hollow cylinder or a tubular conduit constructed of non-earthen materials that routinely contains and conveys regulated petroleum substances from the petroleum underground storage tank(s) to the dispenser(s) or other end-use equipment. It does not mean vent, vapor recovery, or fill lines that do not routinely contain regulated petroleum substances. (3-20-20)T

**12. Potable Drinking Water Well.** Any hole (dug, driven, drilled, or bored) that extends into the earth until it meets ground water which supplies water for a non-community public water system or otherwise supplies water for household use (consisting of drinking, bathing, and cooking, or other similar uses). Such wells may provide water to entities such as a single-family residence, group of residences, businesses, schools, parks, campgrounds, and other permanent or seasonal communities. (3-20-20)T

**13. Product Deliverer.** Any person who delivers or deposits product into a petroleum underground storage tank. This term may include major oil companies, jobbers, petroleum transportation companies, or other product delivery entities. (3-20-20)T

**14. Public Water System.** A system for the provision to the public of water for human consumption through pipes or, after August 5, 1998, other constructed conveyances, if such system has at least fifteen (15) service connections or regularly serves an average of at least twenty-five (25) individuals daily at least sixty (60) days out of the year. Such term includes: any collection, treatment, storage, and distribution facilities under control of the operator of such system and used primarily in connection with such system; and, any collection or pretreatment storage facilities not under such control which are used primarily in connection with such system. Such term does not include any “special irrigation district.” A public water system is either a “community water system” or a “non-community water system.” (3-20-20)T

**15. Red Tag.** A tamper-resistant tag, device, or mechanism attached to the tank’s fill pipes that clearly identifies a petroleum underground storage tank as ineligible for product delivery. The tag or device shall be visible to the product deliverer and clearly state that it is unlawful to deliver to, deposit into, or accept product into the ineligible petroleum underground storage tank. (3-20-20)T

**16. Replace.** As it applies to petroleum underground storage tanks and piping, replace is defined as follows: (3-20-20)T

**a. Petroleum Underground Storage Tank.** Replace means to remove an existing tank and install a new tank. (3-20-20)T

**b. Piping.** Replace means to remove and put back in one hundred (100) percent of the piping, excluding connectors, connected to a single petroleum underground storage tank system. This definition does not alter the requirement in 40 CFR 280.33(c) to replace metal pipe sections and fittings that have released product as a



result of corrosion or other damage. A replacement of metal pipe section and fittings pursuant to 40 CFR 280.33(c) shall be considered a replacement under this definition only if one hundred (100) percent of the metal piping, excluding connectors, is replaced. (3-20-20)T

**17. Under-Dispenser Spill Containment.** Containment underneath a dispenser that will prevent leaks from the dispenser from reaching soil or ground water. Such containment must: (3-20-20)T

- a.** At installation or modification, be liquid-tight on its sides, bottom, and at any penetrations; and (3-20-20)T
- b.** Be compatible with the substance conveyed by the piping; and either (3-20-20)T
- c.** Allow for visual inspection and access to the components in the containment system; or (3-20-20)T
- d.** Be monitored for releases using a release detection method that meets the requirements of 40 CFR 280.43(g). (3-20-20)T

**011. – 099. (RESERVED)**

**100. ADDITIONAL MEASURES TO PROTECT GROUND WATER FROM CONTAMINATION.**

**01. Notification.** An owner, operator or designee must: (3-20-20)T

**a.** Provide written notice to the Department thirty (30) days prior to the installation of a new piping system or a new or replacement petroleum underground storage tank. (3-20-20)T

**b.** Provide notice to the Department twenty-four (24) hours prior to the installation of a replacement piping system. (3-20-20)T

**02. Notification Forms.** The written notice required in Subsection 100.01.a. shall be made upon forms provided by the Department. (3-20-20)T

**03. Requirements for Petroleum UST Systems.** Owners, operators, and installers of a new or replacement petroleum underground storage tank or piping system shall comply with the following requirements. (3-20-20)T

**a.** Each new petroleum underground storage tank, or piping connected to any such new tank, installed after February 23, 2007, or any existing petroleum underground storage tank, or existing piping connected to such existing tank, that is replaced after February 23, 2007, shall have secondary containment and be monitored for leaks if the new or replaced petroleum underground storage tank or piping is within one thousand (1,000) feet of any existing public water system or any existing potable drinking water well. At a minimum, secondary containment systems must be designed, constructed, and installed to contain regulated substances released from the tank system until they are detected and removed, prevent the release of regulated substances to the environment at any time during the operational life of the petroleum underground storage tank system, and be checked for evidence of a release at least every thirty (30) days. The following conditions are excluded: (3-20-20)T

- i.** Suction piping that meets the requirements of 40 CFR 280.41(b)(1)(ii)(A) through (E); (3-20-20)T
- ii.** Piping that manifolds two (2) or more petroleum underground storage tanks together; (3-20-20)T
- iii.** Existing piping to which new piping is connected to install a dispenser; and (3-20-20)T
- iv.** Tanks identified in 40 CFR 280.10(b). (3-20-20)T

**b.** If the owner installs, within one (1) year, a potable drinking water well at the new facility that is within one thousand (1,000) feet of the petroleum underground tanks, piping, or motor fuel dispenser system as part of the new underground storage tank facility installation, secondary containment and under-dispenser containment

are required, regardless of whether the well is installed before or after the petroleum underground tanks, piping, and motor fuel dispenser system are installed. (3-20-20)T

**c.** The notice required in Subsection 100.01 shall indicate whether the new or replacement installation is within one thousand (1,000) feet of an existing public water system or any existing potable drinking water well. If the owner and installer certify that the installation is not within one thousand (1,000) feet of an existing public water system or any existing potable drinking water well, the owner, operator or designee shall provide and maintain documentation showing that a reasonable investigation of water systems and drinking water wells was undertaken. A reasonable investigation includes, but is not limited to, a search of the records of: (3-20-20)T

- i. The public or private water service provider in the area which the new or replacement installation is located (if any); (3-20-20)T
- ii. The city or county in which the new or replacement installation is located; (3-20-20)T
- iii. The Idaho Department of Water Resources; and (3-20-20)T
- iv. The Idaho Department of Environmental Quality. (3-20-20)T

**d.** In the case of a replacement of an existing petroleum underground storage tank or existing piping connected to the petroleum underground storage tank, Section 100 shall apply only to the specific petroleum underground storage tank or piping being replaced, not to other petroleum underground storage tanks and connected pipes comprising such system. (3-20-20)T

**e.** Each installation of a new motor fuel dispenser system shall include under-dispenser spill containment if the new dispenser is within one thousand (1,000) feet of any existing public water system or any existing potable drinking water well. (3-20-20)T

**04. Requirements for Hazardous Substance UST Systems.** Owners, operators, and installers of a new or replacement hazardous substance underground storage tank or piping system shall have secondary containment as required in 40 CFR 280.42. (3-20-20)T

**05. Certification.** Owners and operators shall also comply with the certification requirements of 40 CFR 280.22(f) as incorporated by reference into these rules. (3-20-20)T

**101. ALTERNATIVE PERIODIC TESTING OF CONTAINMENT SUMPS USED FOR INTERSTITIAL MONITORING OF PIPING.**

**01. Applicability.** (3-20-20)T

**a.** The alternative test method in Subsection 101.02 shall only be used for containment sumps that are performing continuous interstitial monitoring as a piping release detection method where an electronic sump sensor is installed and connected to an electronic monitoring device, such as an automatic tank gauge, or where the piping within a containment sump is continuous to a containment sump which has an electronic sump sensor installed and connected to an electronic monitoring device, such as an automatic tank gauge. (3-20-20)T

i. The sump sensor in Subsection 101.01.a. must be positioned in the containment sump according to manufacturer instructions and at the lowest possible point in the containment sump. (3-20-20)T

ii. The sump sensor in Subsection 101.01.a. must be wired and programmed appropriately to shut down power to the submersible turbine pump (positive shutdown) when the sensor is in contact with liquid in any containment sump. (3-20-20)T

iii. If new dispensers are added and Subsection 101.01.a.ii. cannot be achieved (no electrical conduit, not enough sensor ports, etc.), an electronic stand-alone dispenser containment sump sensor may be used if it is wired appropriately to shut down power to the dispenser when the sensor is in contact with liquid in the dispenser containment sump. (3-20-20)T

**b.** The Department may not allow the alternative test method in Subsection 101.02 if it determines the containment sump, penetration fittings, or containment sump sensors are not constructed or positioned in a manner that will accommodate the alternative testing or prevent releases to the environment (i.e., penetration fittings are too close to the containment sump bottom). (3-20-20)T

**02. Alternative Test Method Allowed.** (3-20-20)T

**a.** As an alternative to the allowable test method in 40 CFR 280.35(a)(1)(ii)(A)-(C), containment sumps used for interstitial monitoring of piping may be tested as follows: (3-20-20)T

**i.** Temporarily remove any interstitial monitoring containment sump sensors before conducting the test; (3-20-20)T

**ii.** Add water to the containment sump up to a point directly beneath the first containment sump penetration fitting from the bottom of the containment sump. The water must be allowed to settle for at least fifteen (15) minutes; (3-20-20)T

**iii.** Place a measuring stick that has one sixteenth (1/16th) inch increments into the lowest point in the containment sump and extending above the water level in the sump; and (3-20-20)T

**iv.** Document the initial water level measurement as measured from the bottom of the containment sump. After one (1) hour, document the ending water level measurement. If the water level changes less than one eighth (1/8th) inch, the containment sump passes the integrity test. If the water level changes one eighth (1/8th) inch or greater, the containment sump fails the integrity test. (3-20-20)T

**b.** Upon completion of the test, remove all water and properly dispose of it. Reinstall any interstitial monitoring sensors. Reinstall all containment sump lids, gaskets, and covers. (3-20-20)T

**102. -- 199. (RESERVED)**

**200. RELEASE REPORTING REQUIREMENTS.**

**01. Information to be Reported.** (3-20-20)T

**a.** In addition to the requirements in IDAPA 58.01.02, "Water Quality Standards," Subsection 851.01, owners or operators shall report the following information regarding confirmed petroleum underground storage tank releases to the Department on forms provided by the Department: (3-20-20)T

**i.** The release source; and (3-20-20)T

**ii.** The release cause. (3-20-20)T

**b.** Releases less than twenty-five (25) gallons that are cleaned up within twenty-four (24) hours, and which do not cause a sheen on nearby surface water, do not need to be reported. (3-20-20)T

**02. Release Sources.** Release sources may include, but are not limited to the following: (3-20-20)T

**a.** Petroleum Underground Storage Tanks; (3-20-20)T

**b.** Piping; (3-20-20)T

**c.** Dispensers, which include the dispenser and equipment used to connect the dispenser to the piping. A release from a suction pump or components located above the shear valve would be an example of a release from the dispenser; (3-20-20)T

**d.** Submersible turbine pump area, which includes the submersible turbine pump head (typically

located in the tank sump), the line leak detector, and the piping that connects the submersible turbine pump to the petroleum underground storage tank; and (3-20-20)T

**e.** Delivery problem, which identifies releases that occurred during product delivery to the petroleum underground storage tank. Typical causes associated with this source are spills and overfills. (3-20-20)T

**03. Release Causes.** Release causes may include, but are not limited to the following: (3-20-20)T

**a.** Spills which may occur when the delivery hose is disconnected from the fill pipe of the petroleum underground storage tank or when the nozzle is removed from the vehicle at the dispenser; (3-20-20)T

**b.** Overfills which may occur from the fill pipe at the petroleum underground storage tank or when the nozzle fails to shut off at the dispenser; (3-20-20)T

**c.** Physical or mechanical damage of all types except corrosion. Examples include a puncture of the petroleum underground storage tank or piping, loose fittings, broken components, and components that have changed dimension like elongation or swelling; (3-20-20)T

**d.** Corrosion of a metal tank, piping, flex connector, or other component; and (3-20-20)T

**e.** Installation problem that occurs specifically because the underground storage tank system was not installed properly. (3-20-20)T

**04. Requirements.** The reporting required in Section 200 shall be reported to the Department within ninety (90) days of a confirmed release. The reporting requirement in Section 200 shall not relieve owners or operators from the obligation to comply with 40 CFR Part 280 Subpart E “Release Reporting, Investigation, and Confirmation,” IDAPA 58.01.02, “Water Quality Standards,” Section 851, “Petroleum Release Reporting, Investigation, and Confirmation,” and IDAPA 58.01.02, “Water Quality Standards,” Section 852, “Petroleum Release Response and Corrective Action.” (3-20-20)T

**201. -- 299. (RESERVED)**

**300. TRAINING REQUIREMENTS.**

**01. Requirements.** The Department shall adopt a training program to help owners and operators comply with the requirements of these rules. The training program requirements shall: (3-20-20)T

**a.** Be consistent with 42 U.S.C. 6991i(a), as amended by the Underground Storage Tank Compliance Act, (Pub.L. 109-58, title XV, sec. 1524(a), Aug. 8, 2005); (3-20-20)T

**b.** Be developed in cooperation with petroleum underground storage tank owners and tank operators; (3-20-20)T

**c.** Take into consideration training programs implemented by petroleum underground storage tank owners and operators as of August 8, 2005; (3-20-20)T

**d.** Provide for training to be conducted on site or at another mutually convenient location; and (3-20-20)T

**e.** Be appropriately communicated to petroleum underground storage tank owners and operators. (3-20-20)T

**02. Operator Designation.** For each petroleum underground storage tank system regulated under these rules, the owner or operator shall: (3-20-20)T

**a.** Designate: (3-20-20)T

i. The class A operator, who is the individual(s) having primary responsibility for on-site operation and maintenance of the petroleum underground storage tank system. This does not require that the class A operator be on site; (3-20-20)T

ii. The class B operator, who is the individual(s) having daily on-site responsibility for the operation and maintenance of the petroleum underground storage tank system. This does not require that the class B operator be on site at all times; and (3-20-20)T

iii. The class C operator, who is the daily, on-site individual(s) having primary responsibility for addressing emergencies presented by a spill or release from the petroleum underground storage tank system. The class C operator can be designated by the class A or B operator. (3-20-20)T

**b.** Maintain a record at the facility where the petroleum underground storage tank is located listing each person designated in Subsections 300.02.a.i., 300.02.a.ii., and 300.02.a.iii. (3-20-20)T

**c.** Notify the Department in writing of the individual(s) designated in Subsections 300.02.a.i. and 300.02.a.ii. within thirty (30) days of the designation. (3-20-20)T

**03. Training.** The owner or operator of each petroleum underground storage tank system regulated under these rules shall ensure that the individual(s) identified in Subsections 300.02.a.i. and 300.02.a.ii. participate in the training conducted by the Department or a state of Idaho approved third party. (3-20-20)T

**a.** The individual(s) identified in Subsections 300.02.a.i. or 300.02.a.ii. shall provide training to the persons identified in Subsection 300.02.a.iii. (3-20-20)T

**b.** The individual(s) identified in Subsection 300.02.a.iii. must be trained before assuming responsibility for responding to emergencies. (3-20-20)T

**c.** The individual(s) identified in Subsections 300.02.a.i. and 300.02.a.ii. shall repeat the training within thirty (30) days if the petroleum underground storage tank system for which they have responsibility is determined to be out of compliance with these rules. (3-20-20)T

**d.** The individual(s) identified in Subsections 300.02.a.i. and 300.02.a.ii. shall be trained within thirty (30) days of assuming operation and maintenance duties. (3-20-20)T

**04. Unattended Sites.** In the case of unattended sites, a sign must be posted in a location visible from the dispensers indicating emergency shut-off procedures and emergency contact phone numbers. (3-20-20)T

**301. -- 399. (RESERVED)**

**400. INSPECTIONS.**

**01. Department Authority.** In order to fulfill the statutory requirements of Chapter 88, Title 39, Idaho Code, officers, employees or representatives of the Department, or third-party inspectors as described in Subsection 400.02, are authorized to inspect petroleum underground storage tanks, contents of the tanks, and associated equipment and records relating to such tanks, contents, and associated equipment. (3-20-20)T

**02. Third-Party Inspections.** (3-20-20)T

**a.** Third-party inspectors must be certified, licensed, or registered by an approved state program to perform on-site inspections. At a minimum, third-party inspectors must meet the requirements listed in Subsections 400.02.a.i. through 400.02.a.v.: (3-20-20)T

i. Be trained in the state-specific inspection protocols and procedures, and perform inspections pursuant to such protocols and procedures; (3-20-20)T

ii. Successfully complete the state's required training program. The training program for third-party

inspectors must be comparable to the training program for Department inspectors; (3-20-20)T

iii. Not be the owner or operator of the petroleum underground storage tank, an employee of the owner or operator of the petroleum underground storage tank, or a person having daily on-site responsibility for the operation and maintenance of the petroleum underground storage tank; (3-20-20)T

iv. Use an inspection report form developed by the Department. Review of applicable records and other activities that can be accomplished off-site may be combined with activities conducted at the site to fulfill the on-site inspection requirement; and (3-20-20)T

v. Complete and submit the inspection report to the Department in the manner and time frame established by the Department. All third-party inspection reports must be submitted electronically to the Department for review and for the Department to make a compliance determination for each site. If requested by the Department, third-party inspectors shall provide all supporting documentation for its inspection reports. (3-20-20)T

b. Third-party inspection procedures must contain an audit program, developed by the Department, to monitor third-party inspectors on a routine basis. The audit program must include a sufficient number of on-site inspections to effectively assess inspector performance. (3-20-20)T

c. If a third-party inspector fails to demonstrate to the approved state program adequate competence and proficiency to perform petroleum underground storage tank inspections, or the approved state program otherwise determines it is not appropriate for the third-party inspector to conduct on-site inspections as part of a third-party inspection program, the approved state program must take appropriate action against the third-party inspector as provided by law. (3-20-20)T

**03. Inspections.** All inspections shall be done in accordance with the provisions of Section 39-108, Idaho Code. At a minimum, an on-site inspection must assess compliance with the provisions of these rules and 40 CFR Part 280. (3-20-20)T

**401. -- 499. (RESERVED)**

**500. DELIVERY PROHIBITION.**

**01. Prohibition.** Effective August 8, 2007, it shall be unlawful for any person to deliver to, deposit into, or accept a regulated petroleum substance into a petroleum underground storage tank at a facility which has been identified by the Department to be ineligible for such delivery, deposit, or acceptance. (3-20-20)T

**02. Classification as Ineligible.** The Department shall classify a petroleum underground storage tank as ineligible for delivery, deposit, or acceptance of a regulated petroleum substance as soon as practicable after the Department determines one or more of the following conditions exists: (3-20-20)T

a. Required spill prevention equipment is not installed; (3-20-20)T

b. Required overfill protection equipment is not installed; (3-20-20)T

c. Required leak detection equipment is not installed; or (3-20-20)T

d. Required corrosion protection equipment is not installed. (3-20-20)T

**03. Warning of Violations.** The Department may classify a petroleum underground storage tank as ineligible for delivery, deposit, or acceptance of a regulated petroleum substance if the owner or operator of the tank has been issued a written warning for any of the following violations, and the owner or operator fails to initiate corrective action within thirty (30) days of the issuance of the written warning, unless the deadline is extended by the Department: (3-20-20)T

a. Failure to properly operate or maintain leak detection equipment; (3-20-20)T

- b. Failure to properly operate or maintain spill, overfill, or corrosion protection equipment; or (3-20-20)T
- c. Failure to maintain financial responsibility. (3-20-20)T
- 04. Service of Notice.** If the Department classifies a petroleum underground storage tank as ineligible for delivery, deposit, or acceptance of a regulated petroleum substance pursuant to Subsections 500.02 or 500.03, the Department shall provide a written notice of the determination to the owner or operator prior to prohibiting the delivery, deposit, or acceptance of a regulated petroleum substance. Notice is considered properly served by the Department in any of the following ways: (3-20-20)T
- a. The notice is personally delivered to the owner or operator; or (3-20-20)T
- b. The notice is clearly posted at a public entrance to the facility where the petroleum underground storage tank is located and a copy of the notice is also sent by certified mail to the last known address of the owner or operator. (3-20-20)T
- 05. Red-Tagging.** Once service of the written notice of the ineligible determination is complete, the Department shall then attach a red tag to each fill pipe of the ineligible petroleum underground storage tank clearly identifying the tank as ineligible. The Department shall also maintain a list of all petroleum underground storage tanks that are classified as ineligible for delivery, deposit, or acceptance of a regulated petroleum substance. The Department shall make the list available to the public by posting the list on the Department’s website at [www.deq.idaho.gov](http://www.deq.idaho.gov). (3-20-20)T
- 06. Written Notice.** The written notice required by Subsection 500.04 must include: (3-20-20)T
- a. The specific reasons or violations that led to the ineligible classification; (3-20-20)T
- b. A statement notifying the owner and operator that the petroleum underground storage tank is ineligible for delivery and it is unlawful for any person to deliver to, deposit into, or accept a regulated petroleum substance into the petroleum underground storage tank; (3-20-20)T
- c. The effective date the petroleum underground storage tank is deemed ineligible for delivery; (3-20-20)T
- d. The name and address of the department representative to whom a written request for re-inspection can be made, if a re-inspection is necessary; (3-20-20)T
- e. A statement regarding the right to appeal the Department’s action regarding ineligible classification pursuant to IDAPA 58.01.23, “Rules of Administrative Procedure Before the Board of Environmental Quality”; and (3-20-20)T
- f. The option to request a compliance conference pursuant to Subsection 500.07. (3-20-20)T
- 07. Compliance Conference.** The owner or operator may request a compliance conference with the Department within fifteen (15) days of receipt of the notice. A compliance conference shall be scheduled within twenty (20) days and conducted in an informal manner by the Department. At the compliance conference, the owner or operator may explain why he believes the petroleum underground storage tank should not be classified as ineligible. During the compliance conference, the owner or operator and the Department will identify and establish appropriate acts and a time schedule for compliance as necessary. (3-20-20)T
- 08. Duration of Ineligible Classification.** The classification of a petroleum underground storage tank as ineligible shall remain in effect until the conditions cited in the notice no longer exist. If the Department determines that an ineligible storage tank has returned to compliance and is now eligible for delivery, deposit, or acceptance of a regulated petroleum substance, the Department or an authorized designee shall, as soon as practicable, remove the red tag from the petroleum underground storage tank and also remove the petroleum underground storage tank from the ineligible list posted on its website. The Department will also send a written notice

to the owner and operator that an ineligible storage tank has returned to compliance and is now eligible for delivery, deposit, or acceptance of a regulated petroleum substance. (3-20-20)T

**09. Declining Classification.** The Director may decline to classify a petroleum underground storage tank as ineligible if the Director decides that classifying the petroleum underground storage tank as ineligible for delivery, deposit, or acceptance is not in the best interest of the public. (3-20-20)T

**a.** The Director may only defer application of delivery prohibition for up to one hundred eighty (180) days after determining a petroleum underground storage tank is ineligible for delivery, deposit, or acceptance of a regulated petroleum substance. (3-20-20)T

**b.** The Director may authorize the delivery, deposit, or acceptance of product into an ineligible petroleum underground storage tank if such activity is necessary to test or calibrate the underground storage tank or dispenser system. (3-20-20)T

**10. Department Authority.** Nothing in Section 500 shall affect or preempt the authority of the Department to prohibit the delivery, deposit, or acceptance of a regulated petroleum substance to a petroleum underground storage tank under other existing authorities. (3-20-20)T

**11. Proper Notice.** A person shall not be in violation of Subsection 500.01 if the Department fails to provide the notice required by Subsections 500.04 and 500.05. (3-20-20)T

**12. Unlawful to Tamper with Red Tag.** It shall be unlawful for any person to tamper with and/or remove the red tag without the Department's approval. (3-20-20)T

**501. -- 599. (RESERVED)**

**600. PETROLEUM UNDERGROUND STORAGE TANK DATABASE.**

**01. Maintenance.** The Department shall maintain a database which provides details on the status of all petroleum underground storage tanks in the state of Idaho which are subject to regulation. The database shall be updated no less than the end of each calendar quarter. (3-20-20)T

**02. Identification.** The database shall identify any tanks subject to delivery prohibition. (3-20-20)T

**03. Petition.** Petroleum underground storage tank owners or operators may petition the Department to correct any inaccurate information for their tanks and the Department shall correct any such inaccurate information within thirty (30) days after verification. (3-20-20)T

**04. Availability.** The database shall be available to the public on the Department's website at [www.deq.idaho.gov](http://www.deq.idaho.gov). (3-20-20)T

**601. FEE SCHEDULE FOR UNDERGROUND STORAGE TANKS.**

All regulated underground storage tanks shall pay an annual underground storage tank fee provided in Section 39-119, Idaho Code. The fee shall be assessed to regulated underground storage tanks as provided in Section 601. (3-20-20)T

**01. Fee Criteria.** (3-20-20)T

**a.** Compartment and siphon-manifolded underground storage tanks shall be treated as separate underground storage tanks. (3-20-20)T

**b.** Temporarily out of use tanks are included in Section 601. (3-20-20)T

**02. Fee Amount and Schedule.** (3-20-20)T

**a.** Annual fees shall be paid for each fee year beginning January 2, 2018, and continuing for each



succeeding year. (3-20-20)T

**b.** The annual fee per underground storage tank is one hundred dollars (\$100). The annual fee shall not exceed one hundred dollars (\$100) and will be re-calculated each year if the fee balance exceeds thirty-five thousand dollars (\$35,000). Any fee balance above thirty-five thousand dollars (\$35,000) will be used to reduce the following year's fee. (3-20-20)T

**c.** New underground storage tanks installed after January 2 will not pay a fee until the following January. (3-20-20)T

**03. Billing.** (3-20-20)T

**a.** An annual fee invoice will be generated and mailed in November for each owner listed in the Department's Underground Storage Tank Database. (3-20-20)T

**b.** Owners will have one (1) month to notify the Department in writing if the number of underground storage tanks is incorrect. (3-20-20)T

**04. Payment.** Payment of the annual fee shall be due on January 2, unless it is a Saturday, a Sunday, or a legal holiday, in which event the payment shall be due on the successive business day. Fees paid by check or money order shall be made payable to the Idaho Department of Environmental Quality and sent to 1410 North Hilton Street, Boise, ID 83706-1255. (3-20-20)T

**05. Delinquent Unpaid Fees.** An owner will be delinquent in payment if the annual fee has not been received by the Department by March 1. (3-20-20)T

**06. Enforcement.** Failure to comply with Section 601 shall be subject to enforcement and penalties pursuant to the enforcement provisions of Section 39-108, Idaho Code, (Idaho Environmental Protection and Health Act), and Section 39-8811(2), Idaho Code, (Idaho Underground Storage Tank Act). (3-20-20)T

**07. Nonrefundable.** The annual fee required by these rules shall be nonrefundable. (3-20-20)T

**08. Fee Report.** Prior to February 1 of each year, the Director shall report to the Governor and the Idaho Legislature on the use of fees collected the previous year. At a minimum, the report shall include: (3-20-20)T

**a.** A list of all tanks subject to inspection; (3-20-20)T

**b.** The type of inspection and regulatory authority or guidance used; and (3-20-20)T

**c.** A detailed accounting of how fee funds were spent. (3-20-20)T

**602. -- 999. (RESERVED)**

## 58.01.08 – IDAHO RULES FOR PUBLIC DRINKING WATER SYSTEMS

### 000. LEGAL AUTHORITY.

The Idaho Legislature has given the Idaho Board of Environmental Quality the authority to promulgate rules governing quality and safety of drinking water, pursuant to Title 37, Chapter 21 and Title 39, Chapter 1, Idaho Code. (3-20-20)T

### 001. TITLE AND SCOPE.

**01. Title.** These rules are titled IDAPA 58.01.08, “Idaho Rules for Public Drinking Water Systems.” (3-20-20)T

**02. Scope.** The purpose of these rules is to control and regulate the design, construction, operation, maintenance, and quality control of public drinking water systems to provide a degree of assurance that such systems are protected from contamination and maintained free from contaminants which may injure the health of the consumer. (3-20-20)T

### 002. INCORPORATION BY REFERENCE AND AVAILABILITY OF REFERENCED MATERIALS.

**01. Incorporation by Reference.** The following documents are incorporated by reference into these rules. (3-20-20)T

**a.** [40 CFR Part 141](#), revised as of July 1, 2015 (excluding annual monitoring provisions in 40 CFR 141.854(a)(4),(d),(e),(f) and (h), and the Aircraft Drinking Water Rule in Subsection X), and [40 CFR Part 143](#), revised as of July 1, 2011. Any reference in these rules to requirements, procedures, or specific forms contained in any section or subsection of 40 CFR Parts 141 and 143 shall constitute the full adoption by reference of that section or subsection, including any notes and appendices therein, unless expressly provided otherwise in these rules. (3-20-20)T

**b.** American Water Works Association (AWWA) Standards, effective December 2009, available for a fee from the AWWA, 6666 West Quincy Avenue, Denver, Colorado 80235, Telephone (800) 926-7337, <http://apps.awwa.org/ebusmain/OnlineStore.aspx>. (3-20-20)T

**02. Availability of Specific Referenced Material.** Copies of specific documents referenced within these rules are available at the following locations: (3-20-20)T

**a.** All federal regulations: Superintendent of Documents, U.S. Government Printing Office, Washington, D.C. 20402, Telephone (202)783-3238; U.S. Government Bookstore, Room 194, Federal Bldg., 915 Second Ave., Seattle, WA 98174, (206) 553-4270; or [Online at http://www.gpoaccess.gov/ecfr/index.html](http://www.gpoaccess.gov/ecfr/index.html). (3-20-20)T

**b.** All documents incorporated by reference are available for review at the Department of Environmental Quality, 1410 N. Hilton, Boise, ID 83706-1255, (208) 373-0502. (3-20-20)T

**c.** Recommended Standards for Water Works: a report of the Water Supply Committee of the Great Lakes -- Upper Mississippi River Board of State and Provincial Public Health and Environmental Managers, published by Health Education Services, P.O. Box 7126, Albany, New York 12224, Telephone (518) 439-7286. (3-20-20)T

**d.** Manual of Individual and Non-Public Water Supply Systems (EPA 570/9-91-004), published by the U.S. Environmental Protection Agency, available from the Superintendent of Documents, U.S. Government Printing Office, Washington, D.C.20402, Telephone (202) 782-3238. (3-20-20)T

**e.** U.S. Department of Commerce, National Bureau of Standards Handbook, No. 69, “Maximum Permissible Concentrations of Radionuclides in Air and in Water for Occupational Exposure” as amended in 1963, NCRP Publications, P.O. Box 20175, Washington, D.C. 20014. (3-20-20)T

**f.** Rules of the Idaho Water Resources Board are available [at http://www.adminrules.idaho.gov/rules/37/37index.htm](http://www.adminrules.idaho.gov/rules/37/37index.htm), or the Idaho Department of Water Resources, Idaho Water Center, 322 E. Front St., P.O. Box 83720, Boise, Idaho 83720-0098, Telephone (208) 287-4800. (3-20-20)T

**g.** ANSI/NSF Standard 44-2002e -- 2004, Residential Cation Exchange Water Softeners, available from the National Sanitation Foundation, 789 N. Dixboro Road, Ann Arbor, Michigan 48105, Telephone (734) 769-

8010. (3-20-20)T
- h.** ANSI/NSF Standard 53-2002e -- 2003, Drinking Water Treatment Units -- Health Effects, available from the National Sanitation Foundation, 789 N. Dixboro Road, Ann Arbor, Michigan 48105, Telephone (734) 769-8010. (3-20-20)T
  - i.** ANSI/NSF Standard 55-2002 -- 2002, Ultraviolet Microbiological Water Treatment Systems, available from the National Sanitation Foundation, 789 N. Dixboro Road, Ann Arbor, Michigan 48105, Telephone (734) 769-8010. (3-20-20)T
  - j.** ANSI/NSF Standard 58-2003 -- 2004, Reverse Osmosis Drinking Water Treatment Systems, available from the National Sanitation Foundation, 789 N. Dixboro Road, Ann Arbor, Michigan 48105, Telephone (734) 769-8010. (3-20-20)T
  - k.** ANSI/NSF Standard 60-2000a -- 2000, Drinking Water Treatment Chemicals -- Health Effects, available from the National Sanitation Foundation, 789 N. Dixboro Road, Ann Arbor, Michigan 48105, Telephone (734) 769-8010. (3-20-20)T
  - l.** ANSI/NSF Standard 61-2000a -- 2000, Drinking Water System Components -- Health Effects, available from the National Sanitation Foundation, 789 N. Dixboro Road, Ann Arbor, Michigan 48105, Telephone (734) 769-8010. (3-20-20)T
  - m.** American Water Works Association (AWWA) Standards, available from the AWWA, 6666 West Quincy Avenue, Denver, Colorado 80235, (800) 926-7337, [www.awwa.org](http://www.awwa.org). (3-20-20)T
  - n.** Cross Connection Control Manual, available from Pacific Northwest Section of the American Water Works Association, P.O. Box 19581, Portland, OR, 97280-0581, Telephone (503) 246-5845. (3-20-20)T
  - o.** Manual of Cross-Connection Control, Foundation for Cross-Connection Control and Hydraulic Research, University of Southern California, KAP-200 University Park MC-2531, Los Angeles, CA 90089-2531, (866)545-6340, [www.usc.edu/dept/fccchr/](http://www.usc.edu/dept/fccchr/). (3-20-20)T
  - p.** Manual on Slow Sand Filtration (1991), published by AWWA Research Foundation 6666 West Quincy Avenue, Denver, CO 80235, (800)926-7337, [www.awwa.org](http://www.awwa.org). (3-20-20)T
  - q.** Slow Sand Filtration (1991), published by the American Society of Civil Engineers American Society of Civil Engineers, 1801 Alexander Bell Drive, Reston, VA 20191, (800)548-2723, [www.asce.org](http://www.asce.org). (3-20-20)T
  - r.** Slow Sand Filtration and Diatomaceous Earth Filtration for Small Water Systems, DOH Pub #331-204 (4/03), Washington State Department of Health, Division of Environmental Health, Office of Drinking Water, PO Box 47828, Olympia WA 98504-7828, (360)236-3100 or (800)521-0323, [http://www.doh.wa.gov/ehp/dw/Programs/water\\_sys\\_design.htm](http://www.doh.wa.gov/ehp/dw/Programs/water_sys_design.htm). (3-20-20)T
  - s.** Water System Design Manual, DOH Pub #331-123 (Rev. 8/01), Washington State Department of Health, Division of Environmental Health, Office of Drinking Water, PO Box 47828, Olympia WA 98504-7828, (360)236-3100 or (800)521-0323, [http://www.doh.wa.gov/ehp/dw/Programs/water\\_sys\\_design.htm](http://www.doh.wa.gov/ehp/dw/Programs/water_sys_design.htm). (3-20-20)T
  - t.** Submersible Motors: Application, Installation, Maintenance (Franklin Electric AIM manual), Franklin Electric, Bluffton, Indiana 46714, (800)348-2420, <http://www.franklin-electric.com/aim-manual.aspx>. (3-20-20)T
  - u.** Guidance Manual for Compliance with the Filtration and Disinfection Requirements for Public Water Systems Using Surface Water Sources (March 1991 Edition), U.S. Environmental Protection Agency, <http://water.epa.gov/lawsregs/rulesregs/sdwa/swtr/upload/guidsws.pdf>. (3-20-20)T
  - v.** Standard Methods for the Examination of Water and Wastewater, a joint publication of the American Public Health Association, the Water Environment Federation, and the American Water Works

Association, 6666 West Quincy Avenue, Denver, CO 80235, 800-926-7337, [www.standardmethods.org](http://www.standardmethods.org) (3-20-20)T

**w.** F480-02 Standard Specification for Thermoplastic Well Casing Pipe and Couplings Made in Standard Dimension ratios (SDR), SCH 40 and SCH 80, American Society for Testing and Materials (ASTM Standard F480-02). (3-20-20)T

**x.** “Idaho Standards for Public Works Construction,” Local Highway Technical Assistance Council, 3330 Grace Street, Boise, ID 83605, (208)344-0565. (3-20-20)T

**y.** Memorandum of Understanding between the Idaho Department of Environmental Quality and the Idaho Division of Building Safety Plumbing Bureau, Idaho Department of Environmental Quality, 1410 North Hilton, Boise, Idaho 83706, [www.deq.idaho.gov](http://www.deq.idaho.gov). (3-20-20)T

**z.** Idaho General Safety and Health Standards (IGSHS), available from the Idaho Division of Building Safety, 1090 E. Watertower St., Meridian, Idaho 83642, (208)334-3950, <http://dbs.idaho.gov/>. (3-20-20)T

**aa.** Implementation Guidance for the Long Term 2 Enhanced Surface Water Treatment Rule, Idaho Department of Environmental Quality, 1410 North Hilton, Boise, Idaho 83706, [www.deq.idaho.gov](http://www.deq.idaho.gov). (3-20-20)T

**bb.** Implementation Guidance for the Stage 2 Disinfectants and Disinfection Byproducts Rule, Idaho Department of Environmental Quality, 1410 North Hilton, Boise, Idaho 83706, [www.deq.idaho.gov](http://www.deq.idaho.gov). (3-20-20)T

**cc.** Implementation Guidance for the Ground Water Rule, Idaho Department of Environmental Quality, 1410 North Hilton, Boise, Idaho 83706, [www.deq.idaho.gov](http://www.deq.idaho.gov). (3-20-20)T

**dd.** AWWA Recommended Practice for Backflow Prevention and Cross-Connection Control (M14), available from the AWWA, 6666 West Quincy Avenue, Denver, Colorado 80235, Telephone (800) 926-7337. (3-20-20)T

**ee.** Membrane Filtration Guidance Manual (EPA 815-R-06-009) published by the U.S. Environmental Protection Agency, available from the Superintendent of Documents, U.S. Government Printing Office, Washington, D.C. 20402, Telephone (202) 782-3238, [http://www.epa.gov/ogwdw/disinfection/lt2/pdfs/guide\\_lt2\\_membranefiltration\\_final.pdf](http://www.epa.gov/ogwdw/disinfection/lt2/pdfs/guide_lt2_membranefiltration_final.pdf). (3-20-20)T

**ff.** Ultraviolet Disinfection Guidance Manual for the Final Long Term 2 Enhanced Surface water Treatment Rule (EPA 815-R-06-007) published by the U.S. Environmental Protection Agency, available from the Superintendent of Documents, U.S. Government Printing Office, Washington, D.C.20402, Telephone (202) 782-3238, [www.epa.gov/safewater/disinfection/lt2/pdfs/guide\\_lt2\\_uvguidance.pdf](http://www.epa.gov/safewater/disinfection/lt2/pdfs/guide_lt2_uvguidance.pdf). (3-20-20)T

**gg.** Improving Clearwell Design for CT Compliance, Report #90756, available from the Water Research Foundation, [http://waterrf.org/ProjectsReports/PublicReportLibrary/RFR90756\\_2000\\_271.pdf](http://waterrf.org/ProjectsReports/PublicReportLibrary/RFR90756_2000_271.pdf). (3-20-20)T

**hh.** Surface Water Treatment Rule Compliance Guidance, dated January 10, 1996, Idaho Department of Environmental Quality, [www.deq.idaho.gov](http://www.deq.idaho.gov). (3-20-20)T

**ii.** Uniform Plumbing Code, available at Division of Building Safety, 1090 E. Watertower St., Meridian, Idaho 83642; and at the Division of Building Safety, 1250 Ironwood Dr., Ste. 220, Coeur d’Alene, Idaho 83814, <http://dbs.idaho.gov>. (3-20-20)T

**03. Precedence.** In the event of conflict or inconsistency between the language in these rules and that found in any document incorporated by reference, these rules shall prevail. (3-20-20)T

**003. DEFINITIONS.**

The definitions set forth in 40 CFR 141.2 are herein incorporated by reference except for the definition of the terms “action level,” “disinfection,” “noncommunity water system,” and “person.” (3-20-20)T

**01. Action Level.** The concentration of lead or copper in water that determines, in some cases, whether

a water system must install corrosion control treatment, monitor source water, replace lead service lines, or undertake a public education program. (3-20-20)T

- 02. Administrator.** The Administrator of the United States Environmental Protection Agency. (3-20-20)T
- 03. Annual Samples.** Samples that are required once per calendar year. (3-20-20)T
- 04. Annular Opening.** As used in well construction, this term refers to the nominal inside diameter of the borehole minus the outside diameter of the casing divided by two (2). (3-20-20)T
- 05. Aquifer.** A geological formation of permeable saturated material, such as rock, sand, gravel, etc., capable of yielding an economic quantity of water to wells and springs. (3-20-20)T
- 06. Average Day Demand.** The volume of water used by a system on an average day based on a one (1) year period. See also the definition of Water Demand in these rules. (3-20-20)T
- 07. Backflow.** The reverse from normal flow direction in a plumbing system or water system caused by back pressure or back siphonage. (3-20-20)T
- 08. Bag Filters.** Pressure-driven separation devices that remove particulate matter larger than one (1) micrometer using an engineered porous filtration media. They are typically constructed of a non-rigid, fabric filtration media housed in a pressure vessel in which the direction of flow is from the inside of the bag to the outside. (3-20-20)T
- 09. Bank Filtration.** A water treatment process that uses a well to recover surface water that has naturally infiltrated into ground water through a river bed or bank(s). Infiltration is typically enhanced by the hydraulic gradient imposed by a nearby pumping water supply or other well(s). (3-20-20)T
- 10. Board.** The Idaho Board of Environmental Quality. (3-20-20)T
- 11. Capacity.** The capabilities required of a public drinking water system in order to achieve and maintain compliance with these rules and the requirements of the federal Safe Drinking Water Act. It is divided into three (3) main elements: (3-20-20)T

  - a.** Technical capacity means the system has the physical infrastructure to consistently meet drinking water quality standards and treatment requirements and is able to meet the requirements of routine and emergency operations. It further means the ability of system personnel to adequately operate and maintain the system and to otherwise implement technical knowledge. Training of operator(s) is required, as appropriate, for the system size and complexity. (3-20-20)T
  - b.** Financial capacity means the financial resources of the water system, including an appropriate budget; rate structure; cash reserves sufficient for current operation and maintenance, future needs and emergency situations; and adequate fiscal controls. (3-20-20)T
  - c.** Managerial capacity means that the management structure of the water system embodies the aspects of water system operations, including, but not limited to; (3-20-20)T

    - i. Short and long range planning; (3-20-20)T
    - ii. Personnel management; (3-20-20)T
    - iii. Fiduciary responsibility; (3-20-20)T
    - iv. Emergency response; (3-20-20)T
    - v. Customer responsiveness; (3-20-20)T

- vi. Source water protection; (3-20-20)T
- vii. Administrative functions such as billing and consumer awareness; and (3-20-20)T
- viii. Ability to meet the intent of the federal Safe Drinking Water Act. (3-20-20)T

**12. Cartridge Filters.** Pressure-driven separation devices that remove particulate matter larger than one (1) micrometer using an engineered porous filtration media. They are typically constructed as rigid or semi-rigid, self-supporting filter elements housed in pressure vessels in which flow is from the outside of the cartridge to the inside. (3-20-20)T

**13. Clean Compliance History.** For the purposes of the Revised Total Coliform Rule in Subsection 100.01, clean compliance history means a record of no maximum contaminant level violations under Subsection 050.05, no monitoring violations under Subsection 100.01, and no coliform treatment technique trigger exceedances or treatment technique violations under Subsection 100.01. (3-20-20)T

**14. Combined Distribution System.** The interconnected distribution system consisting of the distribution systems of wholesale systems and of the consecutive systems that receive finished water. (3-20-20)T

**15. Community Water System.** A public water system which serves at least fifteen (15) service connections used by year-round residents or regularly serves at least twenty-five (25) year-round residents. See also the definition of a Public Drinking Water System in these rules. (3-20-20)T

**16. Components of Finished Water Storage.** Storage is available to serve the system if the storage structure or facility is elevated sufficiently or is equipped with sufficient booster pumping capability to pressurize the system. Components of finished water storage are further defined as: (3-20-20)T

**a. Dead Storage.** Storage that is either not available for use in the system or can provide only substandard flows and pressures. (3-20-20)T

**b. Effective Storage.** Effective storage is all storage other than dead storage and is made up of the additive components described in Paragraphs c. through f. of this Subsection. (3-20-20)T

**c. Operational Storage.** Operational storage supplies water when, under normal conditions, the sources are off. This component is the larger of; (3-20-20)T

i. The volume required to prevent excess pump cycling and ensure that the following volume components are full and ready for use when needed; or (3-20-20)T

ii. The volume needed to compensate for the sensitivity of the water level sensors. (3-20-20)T

**d. Equalization Storage.** Storage of finished water in sufficient quantity to compensate for the difference between a water system's maximum pumping capacity and peak hour demand. (3-20-20)T

**e. Fire Suppression Storage.** The water needed to support fire flow in those systems that provide it. (3-20-20)T

**f. Standby Storage.** Standby storage provides a measure of reliability or safety factor should sources fail or when unusual conditions impose higher than anticipated demands. Normally used for emergency operation, if standby power is not provided, to provide water for eight (8) hours of operation at average day demand. (3-20-20)T

**17. Composite Correction Program (CCP).** A systematic approach to identifying opportunities for improving the performance of water treatment and implementing changes that will capitalize on these opportunities. The CCP consists of two (2) elements: (3-20-20)T

**a. Comprehensive Performance Evaluation (CPE).** A thorough review and analysis of a treatment

plant's performance-based capabilities and associated administrative, operation, and maintenance practices. It is conducted to identify factors that may be adversely impacting a plant's capability to achieve compliance and emphasizes approaches that can be implemented without significant capital improvements. The CPE must consist of at least the following components: assessment of plant performance; evaluation of major unit processes; identification and prioritization of performance limiting factors; assessment of the applicability of comprehensive technical assistance; and preparation of a CPE report. (3-20-20)T

**b.** Comprehensive Technical Assistance (CTA). The implementation phase that is carried out if the CPE results indicate improved performance potential. During the CTA phase, the system must identify and systematically address plant-specific factors. The CTA consists of follow-up to the CPE results, implementation of process control priority setting techniques, and maintaining long term involvement to systematically train staff and administrators. (3-20-20)T

**18. Compositing of Samples.** The mixing of up to five (5) samples by the laboratory. (3-20-20)T

**19. Confining Layer.** A nearly impermeable subsurface stratum which is located adjacent to one (1) or more aquifers and does not yield a significant quantity of water to a well. (3-20-20)T

**20. Confirmation Sample.** A sample of water taken from the same point in the system as the original sample and at a time as soon as possible after the original sample was taken. (3-20-20)T

**21. Connection.** Each structure, facility, or premises which is connected to a water system, and which is or could be used for domestic purposes, is considered a single connection. A single family residence is considered to be a premises. Multi-family dwellings and apartment, condominium, and office complexes are considered single connections unless individual units are billed separately for water by the water system, in which case each such unit shall be considered a single connection. (3-20-20)T

**22. Consecutive System.** A public water system that receives some or all of its finished water from one (1) or more wholesale systems. Delivery may be through a direct connection or through the distribution system of one (1) or more consecutive systems. (3-20-20)T

**23. Consumer.** Any person served by a public water system. (3-20-20)T

**24. Consumer Confidence Report (CCR).** An annual report that community water systems must deliver to their customers. The reports must contain information on the quality of the water delivered by the systems and characterize the risks (if any) from exposure to contaminants detected in the drinking water in an accurate and understandable manner. (3-20-20)T

**25. Contaminant.** Any physical, chemical, biological, or radiological substance or matter in water. (3-20-20)T

**26. Cross Connection.** Any actual or potential connection or piping arrangement between a public or a consumer's potable water system and any other source or system through which it is possible to introduce into any part of the potable water system used water, water from any source other than an approved public water system, industrial fluid, gas or substance other than the intended potable water with which the system is supplied. Cross connections include bypass arrangements, jumper connections, removable sections, swivel or change-over devices and other temporary or permanent devices which, or because of which "backflow" can or may occur. (3-20-20)T

**27. Dead End Main.** A distribution main of any diameter and length that does not loop back into the distribution system. (3-20-20)T

**28. Dead Storage.** Storage that is either not available for use in the system or can provide only substandard flows and pressures. See also the definition of Components of Finished Water Storage in these rules. (3-20-20)T

**29. Department.** The Idaho Department of Environmental Quality. (3-20-20)T

- 30. Director.** The Director of the Department of Environmental Quality or his designee. (3-20-20)T
- 31. Direct Integrity Test (DIT).** A physical test applied to a microfiltration or ultrafiltration membrane unit in order to identify integrity breaches. (3-20-20)T
- 32. Disinfection.** Introduction of chlorine, other agents, or processes that are approved by the Department (such as ultraviolet light) in sufficient concentration, dosage, or application, and for the time required to kill or inactivate pathogenic and indicator organisms. (3-20-20)T
- 33. Disinfection Profile.** A summary of daily *Giardia lamblia* inactivation through the drinking water treatment plant. The procedure for developing a disinfection profile is contained in 40 CFR 141.172 and 40 CFR 141.530-141.536. (3-20-20)T
- 34. Distribution System.** Any combination of pipes, tanks, pumps, and other equipment which delivers water from the source(s), treatment facility(ies), or a combination of source(s) and treatment facility(ies) to the consumer. Chlorination may be considered as a function of a distribution system. (3-20-20)T
- 35. Drinking Water.** Means “water for human consumption.” (3-20-20)T
- 36. Drinking Water System.** All mains, pipes, and structures through which water is obtained and distributed, including wells and well structures, intakes and cribs, pumping stations, treatment plants, reservoirs, storage tanks and appurtenances, collectively or severally, actually used or intended for use for the purpose of furnishing water for drinking or general domestic use. (3-20-20)T
- 37. Dual Sample Set.** A set of two (2) samples collected at the same time and same location, with one (1) sample analyzed for TTHM and the other sample analyzed for HAA5. Dual sample sets are collected for the purposes of conducting an Initial Distribution System Evaluation (40 CFR Part 141, Subpart U) and for determining compliance with the TTHM and HAA5 MCLs under the Stage 2 Disinfection Byproducts Requirements (40 CFR Part 141, Subpart V). (3-20-20)T
- 38. Effective Contact Time.** For the purpose of these rules, effective contact time means the time in minutes that it takes for water to move from the point of completely mixed chemical application to the point where residual concentration is measured. It is the “T” in contact time (CT) calculations and is either “demonstrated” or “calculated.” It is the contact time sufficient to achieve the inactivation of target pathogens under the expected range of raw water pH and temperature variation and must be demonstrated through tracer studies or other evaluations or calculations acceptable to the Department. “Improving Clearwell Design for CT Compliance,” referenced in Subsection 002.02, contains information that may be used as guidance for these calculations. (3-20-20)T
- 39. Effective Storage.** Effective storage is all storage other than dead storage and is made up of the additive components described in Paragraphs c. through f. of the definition of Components of Finished Water Storage in these rules. (3-20-20)T
- 40. Enhanced Coagulation.** The addition of sufficient coagulant for improved removal of disinfection byproduct precursors by conventional filtration treatment. Conventional filtration treatment is defined in 40 CFR 141.2. (3-20-20)T
- 41. Enhanced Softening.** The improved removal of disinfection byproduct precursors by precipitative softening. (3-20-20)T
- 42. Equalization Storage.** Storage of finished water in sufficient quantity to compensate for the difference between a water system’s maximum pumping capacity and peak hour demand. See also the definition of Components of Finished Water Storage in these rules. (3-20-20)T
- 43. Equivalent Dwelling Unit (EDU).** A unit of measure that standardizes all land use types (housing, retail, office, etc.) to the level of demand created by a single-family detached housing unit within a water system. The demand for one (1) equivalent dwelling unit is equivalent to the amount of water provided to the average single-family detached housing unit within a water system. For example, a business designed to use three (3) times as much



water as an average single-family detached housing unit would have a demand of three (3) equivalent dwelling units. (3-20-20)T

**44. Exemption.** A temporary deferment of compliance with a maximum contaminant level or treatment technique requirement which may be granted only if the system demonstrates to the satisfaction of the Department that the system cannot comply due to compelling factors and the deferment does not cause an unreasonable risk to public health. (3-20-20)T

**45. Facility Plan.** The facility plan for a public drinking water system describes the overall system, including sources of water, treatment processes and facilities, pumping stations and distribution piping, finished water storage, and waste disposal. It is a comprehensive planning document for infrastructure and includes a plan for the future of the system/facility, including upgrades and additions. It is usually updated on a regular basis due to anticipated or unanticipated growth patterns, regulatory requirements, or other infrastructure needs. A facility plan is sometimes referred to as a master plan or facilities planning study. In general, a facility plan is an overall system-wide plan as opposed to a project specific plan. (3-20-20)T

**46. Facility Standards and Design Standards.** Facility standards and design standards are described in Sections 500 through 552 of these rules. Facility and design standards found in Sections 500 through 552 of these rules must be followed in the planning, design, construction, and review of public drinking water facilities. (3-20-20)T

**47. Fee Assessment.** A charge assessed on public drinking water systems based on a rate structure calculated by system size. (3-20-20)T

**48. Filter Profile.** A graphical representation of individual filter performance, based on continuous turbidity measurements or total particle counts versus time for an entire filter run, from startup to backwash inclusively, that includes an assessment of filter performance while another filter is being backwashed. (3-20-20)T

**49. Filtrate.** As the term relates to microfiltration and ultrafiltration, the product water or the portion of the feed stream that has passed through the membrane. (3-20-20)T

**50. Finished Water.** Water that is introduced into the distribution system of a public water system and is intended for distribution and consumption without further treatment, except as necessary to maintain water quality in the distribution system (e.g., booster disinfection, addition of corrosion control chemicals). (3-20-20)T

**51. Finished Water Storage Structures or Facilities.** Finished water storage structures or facilities are defined as: (3-20-20)T

**a.** Above-ground storage structure or facility. A finished water storage structure or facility with a bottom elevation above normal ground surface. (3-20-20)T

**b.** Ground-level storage structure or facility. A finished water storage structure or facility with a bottom elevation at normal ground surface. (3-20-20)T

**c.** Partially buried storage structure or facility. A finished water storage structure or facility with a bottom elevation below normal ground surface and any portion of the structure or facility above normal ground surface. (3-20-20)T

**d.** Below-ground storage structure or facility. A finished water storage structure or facility with a bottom elevation and top elevation below normal ground surface. (3-20-20)T

**52. Fire Flow Capacity.** The water system capacity, in addition to maximum day demand, that is available for fire fighting purposes within the water system or distribution system pressure zone. Adequacy of the water system fire flow capacity is determined by the local fire authority or through a hydraulic analysis performed by a licensed professional engineer to establish required fire flows in accordance with the International Fire Code as adopted by the State Fire Marshal. (3-20-20)T

- 53. Fire Suppression Storage.** The water needed to support fire flow in those systems that provide it. See also the definition of Components of Finished Water Storage in these rules. (3-20-20)T
- 54. Fixture Protection.** The practice of installing backflow prevention assemblies or devices to isolate one (1) or more cross connections within a customer's facility. (3-20-20)T
- 55. Flowing Stream.** As used in the Long Term 2 Enhanced Surface Water Treatment Rule (40 CFR Part 141, Subpart W), this term means a course of running water flowing in a definite channel. (3-20-20)T
- 56. Flux.** The throughput of a pressure-driven membrane filtration process expressed as flow per unit of membrane area, usually in gallons per square foot per day or liters per hour per square meter. (3-20-20)T
- 57. Ground Water System.** A public water system which is supplied exclusively by a ground water source or sources. (3-20-20)T
- 58. Ground Water Under the Direct Influence of Surface Water (GWUDI).** Any water beneath the surface of the ground with significant occurrence of insects or other macroorganisms, algae, or large diameter pathogens such as *Giardia lamblia* or *Cryptosporidium*, or significant and relatively rapid shifts in water characteristics such as turbidity, temperature, conductivity, or pH which closely correlate to climatological or surface water conditions. Direct influence shall be determined by the Department for individual sources. The determination of direct influence may be based on site-specific measurements of water quality, documentation of well construction characteristics and geology with field evaluation, a combination of water quality and documentation, or other information required by the Department. (3-20-20)T
- 59. Haloacetic Acids (Five) (HAA5).** The sum of the concentrations in milligrams per liter of the haloacetic acid compounds (monochloroacetic acid, dichloroacetic acid, trichloroacetic acid, monobromoacetic acid, and dibromoacetic acid) rounded to two (2) significant figures after addition. (3-20-20)T
- 60. Health Hazards.** Any condition which creates, or may create, a danger to the consumer's health. Health hazards may consist of, but are not limited to, design, construction, operational, structural, collection, storage, distribution, monitoring, treatment or water quality elements of a public water system. See also the definition of Significant Deficiency, which refers to a health hazard identified during a sanitary survey. (3-20-20)T
- 61. Indirect Integrity Monitoring.** Monitoring some aspect of filtrate water quality that is indicative of the removal of particulate matter. (3-20-20)T
- 62. Inorganic.** Generally refers to compounds that do not contain carbon and hydrogen. (3-20-20)T
- 63. Internal or In-Plant Isolation.** The practice of installing backflow prevention assemblies to protect an area within a water customer's structure, facility, or premises from contaminating another part of the structure, facility, or premises. (3-20-20)T
- 64. Lake/Reservoir.** As used in the Long Term 2 Enhanced Surface Water Treatment Rule (40 CFR Part 141, Subpart W), this term means a natural or man-made basin or hollow on the Earth's surface in which water collects or is stored that may or may not have a current or single direction of flow. (3-20-20)T
- 65. Level 1 Assessment.** A Level 1 Assessment is an evaluation to identify the possible presence of sanitary defects, defects in distribution system coliform monitoring practices, and (when possible) the likely reason that the system triggered the assessment. It is conducted by the system operator or owner. Minimum elements include review and identification of atypical events that could affect distributed water quality or indicate that distributed water quality was impaired; changes in distribution system maintenance and operation that could affect distributed water quality (including water storage); source and treatment considerations that bear on distributed water quality, where appropriate (e.g., whether a ground water system is disinfected); existing water quality monitoring data; and inadequacies in sample sites, sampling protocol, and sample processing. The system must conduct the assessment consistent with any Department directives that tailor specific assessment elements with respect to the size and type of the system and the size, type, and characteristics of the distribution system. (3-20-20)T

**66. Level 2 Assessment.** A Level 2 Assessment is an evaluation to identify the possible presence of sanitary defects, defects in distribution system coliform monitoring practices, and (when possible) the likely reason that the system triggered the assessment. A Level 2 assessment provides a more detailed examination of the system (including the system's monitoring and operational practices) than does a Level 1 assessment through the use of more comprehensive investigation and review of available information, additional internal and external resources, and other relevant practices. It is conducted by an individual approved by the Department in accordance with Subsection 305.03, which may include the system operator. Minimum elements include review and identification of atypical events that could affect distributed water quality or indicate that distributed water quality was impaired; changes in distribution system maintenance and operation that could affect distributed water quality (including water storage); source and treatment considerations that bear on distributed water quality, where appropriate (e.g., whether a ground water system is disinfected); existing water quality monitoring data; and inadequacies in sample sites, sampling protocol, and sample processing. (3-20-20)T

**67. License.** A physical document issued by the Idaho Division of Occupational and Professional Licenses certifying that an individual has met the appropriate qualifications and has been granted the authority to practice in Idaho under the provisions of Chapter 24, Title 54, Idaho Code. (3-20-20)T

**68. Locational Running Annual Average (LRAA).** The average of sample analytical results for samples taken at a particular monitoring location during the previous four (4) calendar quarters, as set forth in the Stage 2 Disinfection Byproducts Requirements (40 CFR Part 141, Subpart V). (3-20-20)T

**69. Log.** Logarithm to the base ten (10). In the context of these rules, it is used in the determination of removal or inactivation efficiencies. It is expressed as the logarithm to the base ten (10) or "log" of the concentration of the feed or raw water minus the log of the concentration in the filtrate or product water. For example, if the incoming feed or raw water concentration is one hundred (100), and the outgoing filtrate or product water concentration is ten (10), a 10-fold reduction was attained; or 1-log removal. 1-log removal also equates to ninety percent (90%) removal, as ninety (90) of the original feed concentration counts had been removed, leaving ten (10) in the filtrate. Similarly, 2-log equates to ninety-nine percent (99%) removal. (3-20-20)T

**70. Log Removal Value (LRV).** LRV is a measure of filtration removal efficiency for a target organism, particulate, or surrogate expressed as Logarithm to the base ten (10). (3-20-20)T

**71. Material Deviation.** A change from the design plans that significantly alters the type or location of facilities, requires engineering judgment to design, or impacts the public safety or welfare. (3-20-20)T

**72. Material Modification.** Those modifications of an existing public water system that are intended to increase system capacity or alter the methods or processes employed. Any project that adds source water to a system, increases the pumping capacity of a system, increases the potential population served by the system or the number of service connections within the system, adds new or alters existing drinking water system components, or affects the water demand of the system is considered to be increasing system capacity or altering the methods or processes employed. Maintenance and repair performed on the system and the replacement of valves, pumps, or other similar items with new items of the same size and type are not considered a material modification. (3-20-20)T

**73. Maximum Contaminant Level (MCL).** The maximum permissible level of a contaminant in water which is delivered to any user of a public water system. (3-20-20)T

**74. Maximum Day Demand.** The average rate of consumption for the twenty-four (24) hour period in which total consumption is the largest for the design year. See also the definition of Water Demand in these rules. (3-20-20)T

**75. Maximum Pumping Capacity.** The pumping capacity with the largest source or pump out of service. (3-20-20)T

**76. Maximum Residual Disinfectant Level (MRDL).** A level of a disinfectant added for water treatment that may not be exceeded at the consumer's tap without an unacceptable possibility of adverse health effects. For chlorine and chloramines, a public water system is in compliance with the MRDL, when the running annual average of monthly averages of samples taken in the distribution system, computed quarterly, is less than or

equal to the MRDL. For chlorine dioxide, a public water system is in compliance with the MRDL when daily samples are taken at the entrance to the distribution system and no two (2) consecutive daily samples exceed the MRDL. MRDLs are enforceable in the same manner as maximum contaminant levels under Section 1412 of the Safe Drinking Water Act. There is convincing evidence that addition of a disinfectant is necessary for control of waterborne microbial contaminants. Notwithstanding the MRDLs listed in 40 CFR 141.65, operators may increase residual disinfectant levels of chlorine or chloramines (but not chlorine dioxide) in the distribution system to a level and for a time necessary to protect public health to address specific microbiological contamination problems caused by circumstances such as distribution line breaks, storm runoff events, source water contamination, or cross-connections. (3-20-20)T

**77. Maximum Residual Disinfectant Level Goal (MRDLG).** The maximum level of a disinfectant added for water treatment at which no known or anticipated adverse effect on the health of persons would occur, and which allows an adequate margin of safety. MRDLGs are nonenforceable health goals and do not reflect the benefit of the addition of the chemical for control of waterborne microbial contaminants. (3-20-20)T

**78. Membrane Filtration.** A pressure or vacuum driven separation process in which particulate matter larger than one (1) micrometer ( $\mu\text{m}$ ) is rejected by an engineered barrier, primarily through a size-exclusion mechanism. This definition includes the common membrane technologies of microfiltration, ultrafiltration, nanofiltration, and reverse osmosis. (3-20-20)T

**79. Membrane Unit.** A group of treatment systems or membrane modules that usually share common control and valving so that the group can be isolated for testing or cleaning. (3-20-20)T

**80. Method Detection Limit (MDL).** The lowest concentration which can be determined to be greater than zero with ninety-nine percent (99%) confidence, for a particular analytical method. (3-20-20)T

**81. Microfiltration (MF).** A low pressure membrane filtration process with pore diameter normally in the range of 0.1 to 0.5  $\mu\text{m}$ . (3-20-20)T

**82. Module.** As the term relates to membrane filtration, it is the smallest component of a membrane unit in which a specific membrane surface area is housed. The component is typically equipped with a feedwater inlet, a filtrate outlet, and concentrate or backwash outlet structure. (3-20-20)T

**83. Nanofiltration (NF).** A membrane filtration process that removes dissolved constituents from water. Nanofiltration is similar to reverse osmosis but allows a higher percentage of certain ions to pass through the membrane. These systems typically operate under higher pressure than microfiltration and ultrafiltration. (3-20-20)T

**84. New System.** Any water system that meets, for the first time, the definition of a public water system provided in Section 1401 of the federal Safe Drinking Water Act (42 U.S.C. Section 300f). This includes systems that are entirely new construction and previously unregulated systems that are expanding. (3-20-20)T

**85. Noncommunity Water System.** A public water system that is not a community water system. A non-community water system is either a transient noncommunity water system or a non-transient noncommunity water system. See also the definition of a Public Drinking Water System in these rules. (3-20-20)T

**86. Non-Potable Fluids.** Any fluids that do not meet the definition of potable water. This definition also includes any gases that are heavier than air such as propane. (3-20-20)T

**87. Non-Potable Mains.** Pipelines that collect, deliver, or otherwise convey non-potable fluids. (3-20-20)T

**88. Non-Potable Services or Lines.** Pipelines that collect, deliver, or otherwise convey non-potable fluids to or from a non-potable main. These pipelines connect individual facilities to the non-potable main. This term also refers to pipelines that convey non-potable fluids from a pressurized irrigation system, reclaimed wastewater system, and other non-potable systems to individual consumers. (3-20-20)T

**89. Nontransient Noncommunity Water System.** A public water system that is not a community

water system and that regularly serves at least twenty-five (25) of the same persons over six (6) months per year. See also the definition of a Public Drinking Water System in these rules. (3-20-20)T

**90. Operating Shift.** That period of time during which water system operator decisions that affect public health are necessary for proper operation of the system. (3-20-20)T

**91. Operational Storage.** Operational storage supplies water when, under normal conditions, the sources are off. This component is the larger of the volume required to prevent excess pump cycling and ensure that the following volume components are full and ready for use when needed or the volume needed to compensate for the sensitivity of the water level sensors. See also the definition of Components of Finished Water Storage in these rules. (3-20-20)T

**92. Operation and Maintenance Manual.** An operation and maintenance manual typically covers three main subjects: a water system specific operations plan (see definition of Operations Plan); maintenance information and checklists; and manufacturer's product information (including trouble shooting information, a parts list and parts order form, special tools, spare parts list, etc.). An operation and maintenance manual may cover every aspect of the water system or any part of the water system, including but not limited to the following: treatment, pump stations, storage reservoirs, distribution system, pressure reducing valve stations, etc. (3-20-20)T

**93. Operations Plan.** The operations plan is part of an operation and maintenance manual. Depending on which facilities of the water system are being addressed, the operations plan may cover many types of information including but not limited to the following: daily, weekly, monthly, and yearly operating instructions; information specific to a particular type of treatment; location of valves and other key distribution system features; pertinent telephone and address contact information including the responsible charge water system operator and water system owner; operator safety procedures; alarm system; emergency procedures; trouble-shooting advice; water quality testing; depressurization events; customer service; and response to customer complaints. (3-20-20)T

**94. Owner/Purveyor of Water/Supplier of Water.** The person, company, corporation, association, or other organizational entity which holds legal title to the public water system, who provides, or intends to provide, drinking water to the customers, and who is ultimately responsible for the public water system operation. (3-20-20)T

**95. Peak Hour Demand.** The highest hourly flow, excluding fire flow, that a water system or distribution system pressure zone is likely to experience in the design year. See also the definition of Water Demand in these rules. (3-20-20)T

**96. Person.** A human being, municipality, or other governmental or political subdivision or other public agency, or public or private corporation, any partnership, firm, association, or other organization, any receiver, trustee, assignee, agent or other legal representative of the foregoing or other legal entity. (3-20-20)T

**97. Pesticides.** Substances which meet the criteria for regulation pursuant to the Federal Insecticide, Fungicide, and Rodenticide Act (FIFRA), as amended, and any regulations adopted pursuant to FIFRA. For example, pesticides include, but are not limited to insecticides, fungicides, rodenticides, herbicides, and algacides. (3-20-20)T

**98. Plant Design Capacity.** The maximum design flow through treatment units. The minimum plant design capacity could be equal to peak hour demand but could also be equal to the maximum day demand if equalization storage is provided. (3-20-20)T

**99. Plant.** A physical facility where drinking water or wastewater is treated or processed. (3-20-20)T

**100. Point of Use (POU) Treatment Device.** A treatment device applied to a single tap used for the purpose of reducing contaminants in drinking water at that one tap. (3-20-20)T

**101. Point of Use (POU) Treatment System.** A collection of POU treatment devices. (3-20-20)T

**102. Potable Mains.** Pipelines that deliver potable water to multiple service connections. (3-20-20)T

**103. Potable Services.** Pipelines that convey potable water from a connection to the potable water main (3-20-20)T

to individual consumers. (3-20-20)T

**104. Potable Water.** Water for human consumption. See the definition of Water for Human Consumption in Section 003. (3-20-20)T

**105. Preliminary Engineering Report.** The preliminary engineering report for a public drinking water system facility is a report that addresses specific portions of the system or facility for which modifications are being designed. Modifications may include, but are not limited to, significant changes to existing processes or facilities, system expansion, addition of treatment, or installation of other processes and facilities. This report addresses specific purpose and scope, design requirements, alternative solutions, costs, operation and maintenance requirements, and other requirements as described in Section 503. Preliminary engineering reports are generally project specific as opposed to an overall system-wide plan, such as a facility plan. (3-20-20)T

**106. Premises Isolation or Containment.** The practice of separating the customer's structure, facility, or premises from the purveyor's system by means of a backflow prevention assembly installed on the service line before any distribution takes place. (3-20-20)T

**107. Presedimentation.** A preliminary treatment process used to remove gravel, sand, and other particulate material from the source water through settling before the water enters the primary clarification and filtration processes in a treatment plant. (3-20-20)T

**108. Protected Water Source.** For the purposes of the Revised Total Coliform Rule (40 CFR Part 141, Subpart Y), a protected water source is a ground water well that is not susceptible to contamination on the basis of well construction, hydrologic data, or contamination history. (3-20-20)T

**109. Public Notice.** The notification of public water system consumers of information pertaining to that water system including information regarding water quality or compliance status of the water system. (3-20-20)T

**110. Public Drinking Water System.** A system for the provision to the public of water for human consumption through pipes or, after August 5, 1998, other constructed conveyances, if such system has at least fifteen (15) service connections, regardless of the number of water sources or configuration of the distribution system, or regularly serves an average of at least twenty-five (25) individuals daily at least sixty (60) days out of the year. Such term includes: any collection, treatment, storage, and distribution facilities under the control of the operator of such system and used primarily in connection with such system; and any collection or pretreatment storage facilities not under such control which are used primarily in connection with such system. Such term does not include any "special irrigation district." A public water system is either a "community water system" or a "noncommunity water system" as further defined as: (3-20-20)T

**a. Community water system.** A public water system which serves at least fifteen (15) service connections used by year-round residents or regularly serves at least twenty-five (25) year-round residents. (3-20-20)T

**b. Noncommunity water system.** A public water system that is not a community water system. A noncommunity water system is either a transient noncommunity water system or a non-transient noncommunity water system. (3-20-20)T

**c. Nontransient noncommunity water system.** A public water system that is not a community water system and that regularly serves at least twenty-five (25) of the same persons over six (6) months per year. (3-20-20)T

**d. Transient noncommunity public water system.** A noncommunity water system which does not regularly serve at least twenty-five (25) of the same persons over six (6) months per year. (3-20-20)T

**111. Public Water System/Water System/System.** Means "public drinking water system." (3-20-20)T

**112. Pump House.** A structure containing important water system components, such as a well, hydropneumatic tank, booster pump, pump controls, flow meter, well discharge line, or a treatment unit. Pump houses

are often called well houses in common usage, even though in modern construction these structures may not contain either a well or a pump. These terms are used interchangeably in national standards and trade publications.

(3-20-20)T

**113. Qualified Licensed Professional Engineer (QLPE).** A professional engineer licensed by the state of Idaho; qualified by education or experience in the specific technical fields involved in these rules; and retained or employed by a city, county, quasi-municipal corporation, or regulated public utility for the purposes of plan and specification review.

(3-20-20)T

**114. Quasi-Municipal Corporation.** A public entity, other than community government, created or authorized by the legislature to aid the state in, or to take charge of, some public or state work for the general welfare. For the purpose of these rules, this term refers to drinking water districts.

(3-20-20)T

**115. Raw Water.** Raw water is any ground water, spring water, or surface water utilized as source water prior to treatment for the purpose of producing potable water.

(3-20-20)T

**116. Redundancy.** The installation of duplicate components or backup systems that are designed to maintain minimum pressure and capacity of the system should any component fail or otherwise be out of service for maintenance or repair.

(3-20-20)T

**117. Regulated Public Utility.** For the purpose of these rules, any public water system that falls under the jurisdiction of the Idaho Public Utilities Commission and is subject to the rules thereof.

(3-20-20)T

**118. Reverse Osmosis (RO).** A membrane filtration process that removes dissolved constituents from water. Reverse osmosis is similar to nanofiltration but allows a lower percentage of certain ions to pass through the membrane. These systems typically operate under higher pressure than microfiltration and ultrafiltration.

(3-20-20)T

**119. Repeat Compliance Period.** Any subsequent compliance period after the initial compliance period.

(3-20-20)T

**120. Resolution.** As the term relates to membrane treatment, it is the size of the smallest integrity breach that contributes to a response from a direct integrity test when testing low pressure membranes.

(3-20-20)T

**121. Responsible Charge (RC).** Responsible Charge means active, daily on-site or on-call responsibility for the performance of operations or active, on-going, on-site, or on-call direction of employees and assistants.

(3-20-20)T

**122. Responsible Charge Operator.** An operator of a public drinking water system, designated by the system owner, who holds a valid license at a class equal to or greater than the drinking water system classification, who is in responsible charge of the public drinking water system.

(3-20-20)T

**123. Reviewing Authority.** For those projects requiring preconstruction approval by the Department, the Department is the reviewing authority. For those projects allowing for preconstruction approval by others, pursuant to Subsection 504.03.b. of these rules, the qualified Idaho licensed professional engineer (QLPE) is also the reviewing authority.

(3-20-20)T

**124. Sampling Point.** The location in a public water system from which a sample is drawn.

(3-20-20)T

**125. Sanitary Defect.** A defect that could provide a pathway of entry for microbial contamination into the distribution system or that is indicative of a failure or imminent failure in a barrier that is already in place. Examples of sanitary defects include but are not limited to: cross connections, inadequate distribution system pressures, inadequate or missing sanitary seal, improperly screened storage tank vents, inadequate protection from contamination during flooding, history of treatment failures, deterioration of system components, and water main leaks or breaks.

(3-20-20)T

**126. Sanitary Survey.** An onsite review of the water source, facilities, equipment, operation and maintenance of a public water system for the purpose of evaluating the adequacy of such source, facilities,

equipment, operation and maintenance for producing and distributing safe drinking water. The sanitary survey will include, but is not limited to the following elements: (3-20-20)T

- a. Source; (3-20-20)T
- b. Treatment; (3-20-20)T
- c. Distribution system; (3-20-20)T
- d. Finished water storage; (3-20-20)T
- e. Pumps, pump facilities, and controls; (3-20-20)T
- f. Monitoring and reporting and data verification; (3-20-20)T
- g. System management and operation; and (3-20-20)T
- h. Operator compliance with state requirements. (3-20-20)T

**127. SDWIS-State.** An acronym that stands for “Safe Drinking Water Information System-State Version.” It is a software package developed under contract to the U.S. Environmental Protection Agency and used by a majority of U.S. states to collect, maintain, and report data about regulated public water systems. (3-20-20)T

**128. Seasonal System.** A noncommunity water system that is not operated as a public water system on a year-round basis and starts up and shuts down at the beginning and end of each operating season. (3-20-20)T

**129. Sensitivity.** As the term relates to membrane treatment, it is the maximum log removal value (LRV) for a specific resolution that can be reliably verified by the direct integrity test associated with a given low pressure membrane filtration system. (3-20-20)T

**130. Sewage.** The water-carried human or animal waste from residences, buildings, industrial establishments or other places, together with such ground water infiltration and surface water as may be present. (3-20-20)T

**131. Significant Deficiency.** As identified during a sanitary survey, any defect in a system’s design, operation, maintenance, or administration, as well as any failure or malfunction of any system component, that the Department or its agent determines to cause, or have potential to cause, risk to health or safety, or that could affect the reliable delivery of safe drinking water. See also the definition of Health Hazards. (3-20-20)T

**132. Simple Water Main Extension.** New or replacement water main(s) that require plan and specification review by a qualified licensed professional engineer (QLPE) or by the Department per these rules and that is connected to existing water main facilities and does not require the addition of system components designed to control quantity or pressure, including, but not limited to, booster stations, new sources, pressure reducing valve stations, or reservoirs; and continues to provide the pressure and quantity requirements of Subsection 552.01. (3-20-20)T

**133. Special Irrigation District.** An irrigation district in existence prior to May 18, 1994 that provides primarily agricultural service through a piped water system with only incidental residential or similar use where the system or the residential or similar users of the system comply with the exclusion provisions in Section 1401(4)(B)(i)(II) or (III) of the Safe Drinking Water Act. (3-20-20)T

**134. Spring.** A source of water which flows from a laterally percolating water table's intersection with the surface or from a geological fault that allows the flow of water from an artesian aquifer. (3-20-20)T

**135. Standby Storage.** Standby storage provides a measure of reliability or safety factor should sources fail or when unusual conditions impose higher than anticipated demands. See also the definition of Components of Finished Water Storage in these rules. (3-20-20)T



**136. Substantially Modified.** The Department shall consider a public water system to be substantially modified when, as the result of one (1) or more projects, there is a combined increase of twenty-five percent (25%) or more above the system's existing configuration in the population served or number of service connections, the total length of transmission and distribution water mains, and the peak or average water demand. (3-20-20)T

**137. Substitute Responsible Charge Operator.** An operator of a public drinking water system who holds a valid license at a class equal to or greater than the drinking water system classification, designated by the system owner to replace and to perform the duties of the responsible charge operator when the responsible charge operator is not available or accessible. (3-20-20)T

**138. Surface Water System.** A public water system which is supplied by one (1) or more surface water sources or ground water sources under the direct influence of surface water. Also called subpart H systems in applicable sections of 40 CFR Part 141. (3-20-20)T

**139. Total Organic Carbon (TOC).** Total organic carbon in mg/l measured using heat, oxygen, ultraviolet irradiation, chemical oxidants, or combinations of these oxidants that convert organic carbon to carbon dioxide, rounded to two (2) significant figures. (3-20-20)T

**140. Total Trihalomethanes (TTHM).** The sum of the concentration in milligrams per liter of the trihalomethane compounds (trichloromethane [chloroform], dibromochloromethane, bromodichloromethane and tribromomethane [bromoform]), rounded to two (2) significant figures. (3-20-20)T

**141. Transient Noncommunity Public Water System.** A noncommunity water system which does not regularly serve at least twenty-five (25) of the same persons over six (6) months per year. See also the definition of a Public Drinking Water System in these rules. (3-20-20)T

**142. Treatment Facility.** Any place(s) where a public drinking water system or nontransient noncommunity water system alters the physical or chemical characteristics of the drinking water. Chlorination may be considered as a function of a distribution system. (3-20-20)T

**143. Turbidity.** A measure of the interference of light passage through water, or visual depth restriction due to the presence of suspended matter such as clay, silt, nonliving organic particulates, plankton and other microscopic organisms. Operationally, turbidity measurements are expressions of certain light scattering and absorbing properties of a water sample. Turbidity is measured by the Nephelometric method. (3-20-20)T

**144. Ultrafiltration (UF).** A low pressure membrane filtration process with pore diameter normally in the range of five thousandths to one tenth micrometer (0.005 to 0.1  $\mu$ m). (3-20-20)T

**145. Ultraviolet (UV) Light Technology.** A physical disinfection process that has proven effective against common pathogens in drinking water. (3-20-20)T

**146. UV Transmittance (UVT).** A measure of the fraction of incident light transmitted through a material (e.g., water sample or quartz). The UVT is usually reported for a wavelength of two hundred fifty-four (254) nm and a pathlength of one (1) cm. It is often represented as a percentage. (3-20-20)T

**147. Unregulated Contaminant.** Any substance that may affect the quality of water but for which a maximum contaminant level or treatment technique has not been established. (3-20-20)T

**148. Use Assessment.** For the purpose of obtaining a waiver from certain monitoring requirements, a use assessment is an evaluation as to whether synthetic organic contaminants are being or have been used, manufactured, transported, stored, or disposed of in the watershed for surface water or the zone of influence for ground water. (3-20-20)T

**149. Variance.** A temporary deferment of compliance with a maximum contaminant level or treatment technique requirement which may be granted only when the system demonstrates to the satisfaction of the Department that the raw water characteristics prevent compliance with the MCL or requirement after installation of

the best available technology or treatment technique and the deterrent does not cause an unreasonable risk to public health. (3-20-20)T

**150. Very Small Public Drinking Water System.** A Community or Nontransient Noncommunity Public Water System that serves five hundred (500) persons or less and has no treatment other than disinfection or has only treatment which does not require any chemical treatment, process adjustment, backwashing or media regeneration by an operator (e.g. calcium carbonate filters, granular activated carbon filters, cartridge filters, ion exchangers). (3-20-20)T

**151. Volatile Organic Chemicals (VOCs).** VOCs are lightweight organic compounds that vaporize or evaporate easily. (3-20-20)T

**152. Vulnerability Assessment.** A determination of the risk of future contamination of a public drinking water supply. (3-20-20)T

**153. Waiver.** (3-20-20)T

**a.** For the purposes of these rules, except Sections 500 through 552, “waiver” means the Department approval of a temporary reduction in sampling requirements for a particular contaminant. (3-20-20)T

**b.** For purposes of Sections 500 through 552, “waiver” means a dismissal of any requirement of compliance. (3-20-20)T

**c.** For the purposes of Section 010, “waiver” means the deferral of a fee assessment for a public drinking water system. (3-20-20)T

**154. Wastewater.** Any combination of liquid or water and pollutants from activities and processes occurring in dwellings, commercial buildings, industrial plants, institutions and other establishments, together with any ground water, surface water, and storm water that may be present; liquid or water that is chemically, biologically, physically or rationally identifiable as containing blackwater, gray water or commercial or industrial pollutants; and sewage. See IDAPA 58.01.16, “Wastewater Rules,” for additional information. (3-20-20)T

**155. Water for Human Consumption.** Water that is used by humans for drinking, bathing for purposes of personal hygiene (including hand-washing), showering, cooking, dishwashing, and maintaining oral hygiene. In common usage, the terms “culinary water,” “drinking water,” and “potable water” are frequently used as synonyms. (3-20-20)T

**156. Water Demand.** The volume of water requested by system users to satisfy their needs. Water demand can be further categorized as: (3-20-20)T

**a.** Average day demand. The volume of water used by a system on an average day based on a one (1) year period. (3-20-20)T

**b.** Maximum day demand. The average rate of consumption for the twenty-four (24) hour period in which total consumption is the largest for the design year. (3-20-20)T

**c.** Peak hour demand. The highest hourly flow, excluding fire flow, that a water system or distribution system pressure zone is likely to experience in the design year. (3-20-20)T

**157. Water Main.** A pipe within a public water system which is under the control of the system operator and conveys water to two (2) or more service connections or conveys water to a fire hydrant. The collection of water mains within a given water supply is called the distribution system. (3-20-20)T

**158. Watershed.** The land area from which water flows into a stream or other body of water which drains the area. (3-20-20)T

**159. Wholesale System.** A public water system that treats source water as necessary to produce finished

water and then delivers some or all of that finished water to another public water system. Delivery may be through a direct connection or through the distribution system of one (1) or more consecutive systems. (3-20-20)T

**004. COVERAGE.**  
40 CFR 141.3 is herein incorporated by reference. (3-20-20)T

**005. GENERAL PROVISIONS FOR WAIVERS, VARIANCES, AND EXEMPTIONS.**  
40 CFR 141.4 is herein incorporated by reference. (3-20-20)T

**01. Waivers.** (3-20-20)T

**a.** The Department may waive any requirement of Sections 500 through 552 that is not explicitly imposed by Idaho Statute, if it can be shown to the satisfaction of the Department that the requirement is not necessary for the protection of public health, protection from contamination, and satisfactory operation and maintenance of a public water system. (3-20-20)T

**b.** The Department may at its discretion waive the requirements outlined in Section 010. (3-20-20)T

**c.** Waiver of monitoring requirements is addressed in Subsection 100.07. (3-20-20)T

**02. Variances.** (3-20-20)T

**a.** General Variances. A variance may be granted by the Department if a public water system submits an application and demonstrates to the satisfaction of the Department that the following minimum requirements as required by 42 USC Section 1415(a) (The Safe Drinking Water Act) are met. These include but are not limited to: (3-20-20)T

**i.** The system has installed the best available technology, treatment techniques, or other means to comply with the maximum contaminant level; and (3-20-20)T

**ii.** Alternative sources of water are not reasonably available to the system. (3-20-20)T

**iii.** For provisions of a national primary drinking water regulation which requires the use of a specific treatment technique with respect to a contaminant, the system must demonstrate that the technique is not necessary to protect the health of the system's customers. (3-20-20)T

**b.** Small System Variances. A small system variance for a maximum contaminant level or treatment technique may be granted by the Department if a public water system submits an application and demonstrates to the satisfaction of the Department that the following minimum requirements as required by 42 USC Section 1415(e) are met. These include, but are not limited to: (3-20-20)T

**i.** The system serves three thousand three hundred (3,300) or fewer persons; (3-20-20)T

**ii.** If the system serves more than three thousand three hundred (3,300) persons but fewer than ten thousand (10,000) persons, the application shall be approved by the U.S. Environmental Protection Agency; (3-20-20)T

**iii.** The U.S. Environmental Protection Agency has identified a variance technology that is applicable to the size and source water quality conditions of the public water system; (3-20-20)T

**iv.** The system installs, operates and maintains such treatment technology, treatment technique, or other means; and (3-20-20)T

**v.** The system cannot afford to comply with a national primary drinking water regulation in accordance with affordability criteria established by the Department, including compliance through treatment, alternative source of water supply, restructuring or consolidation. (3-20-20)T

**03. Exemptions.** An exemption may be granted by the Department if a public water system submits an application and demonstrates to the satisfaction of the Department that the following minimum requirements as required by 42 USC Section 1416(a) are met. These include but are not limited to: (3-20-20)T

**a.** The system is unable to comply with a maximum contaminant level or treatment technique due to compelling factors, which may include economic factors; (3-20-20)T

**b.** The system was in operation by the effective date of such contaminant level or treatment technique and no reasonable source of water is available to the system; or (3-20-20)T

**c.** If the system was not in operation by the effective date of such contaminant level or treatment technique, then no reasonable alternative source of water is available to the system; and (3-20-20)T

**d.** The granting of an exemption will not result in an unreasonable risk to health; (3-20-20)T

**e.** Management or restructuring changes cannot reasonably be made to comply with the contaminant level or treatment technique to improve the quality of the drinking water; (3-20-20)T

**f.** The system cannot meet the standard without capital improvements which cannot be completed prior to the date established pursuant to 42 USC Section 1412b(10); (3-20-20)T

**g.** If the system needs financial assistance, the system has entered into an agreement to obtain such financial assistance; or (3-20-20)T

**h.** The system has entered into an enforceable agreement to become a part of a regional public water system and is taking all practical steps to meet the standard. (3-20-20)T

**04. Conditions.** A waiver, exemption or variance may be granted upon any conditions that the Department, in its discretion, determines are appropriate. Failure by the public water system to comply with any condition voids the waiver, variance or exemption. (3-20-20)T

**05. Public Hearing.** The Department shall provide public notice and an opportunity for public hearing in the area served by the public water system before any exemption or variance under Section 005 is granted by the Department. At the conclusion of the hearing, the Department shall record the findings and issue a decision approving, denying, modifying, or conditioning the application. (3-20-20)T

**06. Exceptions.** Any person aggrieved by the Department's decision on a request for a waiver, variance or exemption may file a petition for a contested case with the Board. Such petitions shall be filed with the Board, as prescribed in, IDAPA 58.01.23, "Rules of Administrative Procedure Before the Board of Environmental Quality." (3-20-20)T

**07. Surface Water Variances.** Variances from the requirements of Sections 300 through 303 are not allowed. (3-20-20)T

**08. Surface Water Exemptions.** Exemptions from 40 CFR 141.72(a)(3) and 40 CFR 141.72(b)(2) are not allowed. (3-20-20)T

**006. SITING REQUIREMENTS.** 40 CFR 141.5 is herein incorporated by reference. (3-20-20)T

**007. DISAPPROVAL DESIGNATION.** The Department or its agent may assign a disapproved designation to a public water system when: (3-20-20)T

**01. Defects.** There are design or construction defects, or some combination of design and construction defects; or (3-20-20)T

**02. Operating Procedures.** Operating procedures constitute a health hazard; or (3-20-20)T

**03. Quality.** Physical, chemical, microbiological or radiological quality does not meet the requirements of these rules; or (3-20-20)T

**04. Monitoring.** The required monitoring as specified in these rules has not been conducted; or (3-20-20)T

**05. Unapproved Source.** An unapproved source of drinking water is used or the system is interconnected with a disapproved water system. (3-20-20)T

**06. Non-Payment of Annual Fee Assessment.** The annual drinking water system fee assessment is not paid as set forth in Section 010. (3-20-20)T

**07. Public Notification.** The Department may require the owner of a water system that has been given a disapproval designation to notify the public. The manner, content, and timing of this notification will be determined by the Department. This requirement is in addition to any public notification requirements set forth in Section 150 that may also apply to the disapproved system. (3-20-20)T

**008. HEALTH HAZARDS.**

**01. Prohibited.** (3-20-20)T

**a.** No public water system, or portion of a public water system, shall constitute a health hazard, as determined by the Department and defined in Section 003 of these rules. (3-20-20)T

**b.** No public water system, or portion of a public water system, shall create a condition which prevents, or may prevent, the detection of a health hazard, as determined by the Department. (3-20-20)T

**02. Schedule.** Health hazards and conditions which prevent, or may prevent, the detection of a health hazard must be mitigated as required by the Department and terminated within a time schedule established by the Department. (3-20-20)T

**03. Standards.** Design and construction revisions necessary to correct a health hazard or conditions which prevent, or may prevent, the detection of a health hazard, must be reviewed and approved by the Department, and comply with Sections 501 through 552, unless otherwise specified by the Department. (3-20-20)T

**009. MONITORING.**

The Department may, in its discretion, alter the monitoring or sampling requirements for any contaminant otherwise specified in these rules if the Department determines that such alteration is necessary to adequately assess the level of such contamination. (3-20-20)T

**010. FEE SCHEDULE FOR PUBLIC DRINKING WATER SYSTEMS.**

All regulated public drinking water systems shall pay an annual drinking water system fee. The fee shall be assessed to regulated public drinking water systems as provided in this section. (3-20-20)T

**01. Effective Date.** Annual fees shall be paid for each fee year beginning October 1, 1993, and continuing for each succeeding year. (3-20-20)T

**02. Fee Schedule.** (3-20-20)T

**a.** Community and Nontransient noncommunity public drinking water systems shall pay an annual fee according to the following fee schedule:

Number of Connections	Fee
1 to 20	\$100

Number of Connections	Fee
21 to 184	\$5 per connection, not to exceed a total of \$735 per system
185 to 3,663	\$4 per connection, not to exceed a total of \$10,988 per system
3,664 or more	\$3 per connection

(3-20-20)T

**b.** The annual fee for transient public drinking water systems is twenty-five dollars (\$25). (3-20-20)T

**c.** New public drinking water systems formed after October 1 will not pay a fee until the following October. (3-20-20)T

**03. Fee Assessment.** (3-20-20)T

**a.** An annual fee assessment will be generated for each community and nontransient noncommunity public drinking water system listed in the Department's Safe Drinking Water Information System (SDWIS). (3-20-20)T

**b.** Community and nontransient noncommunity public drinking water systems will be notified each year of the official number of connections listed in SDWIS. Systems will have at least one (1) month to notify the Department if the number of connections listed in SDWIS is not in agreement with the system's records. (3-20-20)T

**c.** The official number of connections listed in SDWIS following each yearly update, as required in Subsection 010.03.b., will be used to calculate the annual fee for community and nontransient noncommunity public drinking water systems for the next fee year of October 1 through September 30. (3-20-20)T

**04. Billing.** An annual fee shall be assessed and a statement will be mailed to all community, nontransient noncommunity, and transient public drinking water systems listed in SDWIS by the Department on or before September 1 of each year. (3-20-20)T

**05. Payment.** (3-20-20)T

**a.** Payment of the annual fee shall be due on October 1, unless it is a Saturday, a Sunday, or a legal holiday, in which event the payment shall be due on the successive business day. Fees paid by check or money order shall be made payable to the Idaho Department of Environmental Quality and sent to 1410 North Hilton Street, Boise, ID 83706-1255. (3-20-20)T

**b.** If a public water system consists of two hundred fifty (250) connections or more, the system may request to divide its annual fee payment into equal monthly or quarterly installments by submitting a request to the Department on the proper request form provided with the initial billing statement. (3-20-20)T

**c.** The Department will notify applicable systems, in writing, of approval or denial of a requested monthly or quarterly installment plan within ten (10) business days of the Department receiving such a request. (3-20-20)T

**d.** If a public water system has been approved to pay monthly installments then each installment shall be due by the first day of each month, unless it is a Saturday, a Sunday, or a legal holiday, in which event the installment shall be due on the successive business day. (3-20-20)T

**e.** If a public water system has been approved to pay quarterly installments then each installment shall be due by the first day of the month of each quarter (October 1, January 1, April 1, and July 1), unless it is a Saturday, a Sunday, or a legal holiday, in which event the installment shall be due on the first successive business day. (3-20-20)T

**06. Delinquent Unpaid Fees.** A public water system will be delinquent in payment if its annual fee

assessment has not been received by the Department by November 1; or if having first opted to pay monthly or quarterly installments, its monthly or quarterly installment has not been received by the Department by the last day of the month in which the monthly or quarterly payment is due. (3-20-20)T

**07. Suspension of Services and Disapproval Designation.** (3-20-20)T

**a.** For any system delinquent in payment of fee assessed under Subsections 010.02 and 010.06, in excess of ninety (90) days, technical services provided by the Department may be suspended except for the following: (3-20-20)T

- i. Issuance of monitoring waivers; (3-20-20)T
- ii. Review and processing of engineering reports; and (3-20-20)T
- iii. Review of plans and specifications for design and construction as set forth in Sections 501 through 552. (3-20-20)T

**b.** For any system delinquent in payment of fee assessed under Subsections 010.02 and 010.06, in excess of one hundred and eighty (180) days, the Department may suspend all technical services provided by the Department including any of the following: (3-20-20)T

- i. Review and processing of engineering reports; (3-20-20)T
- ii. Review of plans and specifications for design and construction as set forth in Sections 501 through 552; (3-20-20)T
- iii. Renewal of monitoring waivers; or (3-20-20)T
- iv. Granting of new monitoring waivers. (3-20-20)T

**c.** For any system delinquent in payment of fee assessed under Subsections 010.02 and 010.06, in excess of one hundred and eighty (180) days, the Department may disapprove the public water system pursuant to Subsection 007.06. (3-20-20)T

**08. Reinstatement of Suspended Services and Approval Status.** For any public water system for which delinquency of fee payment, pursuant to Subsection 010.07, has resulted in the suspension of technical services, the disapproval of a public water system, or both, continuation of technical services, reinstatement of public water system approval, or both, will occur upon payment of delinquent annual fee assessments. (3-20-20)T

**09. Enforcement Action.** Nothing in Section 010 waives the Department's right to undertake an enforcement action at any time, including seeking penalties, as provided in Section 39-108, Idaho Code. (3-20-20)T

**10. Responsibility to Comply.** Subsection 010.07 shall in no way relieve any system from its obligation to comply with all applicable state and federal drinking water statutes, rules, regulations, or orders. (3-20-20)T

**011. CONTINUITY OF SERVICE.**

**01. Transfer of Ownership.** No owner shall transfer system ownership without providing written notice to the Department and all customers. Notification shall include a schedule for transferring responsibilities and identification of the new owner. (3-20-20)T

**02. Maintenance of Standards.** The system transferring ownership shall ensure that all health related standards are met during transfer and shall ensure that water rights, operation and maintenance manuals, and all other pertinent documentation is transferred to the new owner. (3-20-20)T

**012. WRITTEN INTERPRETATIONS.**

The Department of Environmental Quality may have written statements in the form of guidance and policy documents that pertain to the interpretation of the rules of this chapter. Such written statements may be inspected and copies obtained at the Department of Environmental Quality, 1410 North Hilton, Boise, Idaho 83706-1255.

(3-20-20)T

**013. USE OF GUIDANCE.**

Guidance documents referenced in these rules are to be used to assist both designers and reviewers in determining a reasonable way to achieve compliance with the rules. Nothing in these rules makes the use of a particular guidance or guidance document mandatory. If the plans and specifications comply with applicable facility and design standards as set out in these rules, Section 39-118, Idaho Code, requires that the Department not substitute its judgment for that of the design engineer concerning the manner of compliance. If the design engineer needs assistance as to how to comply with a particular rule, the design engineer may use the referenced guidance documents for that assistance. However, the design engineer may also use other guidance or provide documentation to substantiate his or her own professional judgment.

(3-20-20)T

**014. ADMINISTRATIVE PROVISIONS.**

Persons may be entitled to appeal agency actions authorized under these rules pursuant to IDAPA 58.01.23, "Rules of Administrative Procedure Before the Board of Environmental Quality."

(3-20-20)T

**015. CONFIDENTIALITY OF RECORDS.**

Information obtained by the Department under these rules is subject to public disclosure pursuant to the provisions of Chapter 1, Title 74, Idaho Code. Information submitted under a trade secret claim may be entitled to confidential treatment by the Department as provided in Section 74-114, Idaho Code, and IDAPA 58.01.21, "Rules Governing the Protection and Disclosure of Records in the Possession of the Department of Environmental Quality."

(3-20-20)T

**016. OFFICE HOURS -- MAILING ADDRESS AND STREET ADDRESS.**

The state office of the Department of Environmental Quality and the office of the Board of Environmental Quality are located at 1410 N. Hilton, Boise, Idaho 83706-1255, telephone number (208) 373-0502. The office hours are 8 a.m. to 5 p.m. Monday through Friday.

(3-20-20)T

**017. -- 049. (RESERVED)**

**050. MAXIMUM CONTAMINANT LEVELS AND MAXIMUM RESIDUAL DISINFECTANT LEVELS.**

**01. Maximum Contaminant Levels for Inorganic Contaminants.** (3-20-20)T

**a.** 40 CFR 141.11 is herein incorporated by reference. (3-20-20)T

**b.** 40 CFR 141.62 is herein incorporated by reference. (3-20-20)T

**c.** The maximum contaminant level for cyanide is two-tenths milligram per liter (0.2 mg/l). (3-20-20)T

**02. Maximum Contaminant Levels for Organic Contaminants.** 40 CFR 141.61 is herein incorporated by reference, except that the best available technology (BAT) treatment listed in 40 CFR 141.61(b) shall be changed to reflect that packed tower aeration will not be listed for toxaphene but will be listed for toluene.

(3-20-20)T

**03. Maximum Contaminant Levels for Turbidity.** 40 CFR 141.13 is herein incorporated by reference. (3-20-20)T

**04. Maximum Contaminant Levels for Radionuclides.** 40 CFR 141.66 is herein incorporated by reference. (3-20-20)T

**05. Maximum Contaminant Levels for Microbiological Contaminants.** 40 CFR 141.63 is herein incorporated by reference. (3-20-20)T



**06. Maximum Contaminant Levels for Disinfection Byproducts.** 40 CFR 141.64 is herein incorporated by reference. (3-20-20)T

**07. Maximum Residual Disinfectant Levels.** 40 CFR 141.65 is herein incorporated by reference. (3-20-20)T

**08. Effective Dates.** Effective date information provided in 40 CFR 141.6 and 40 CFR 141.60 is applicable. (3-20-20)T

**051. -- 099. (RESERVED)**

**100. MONITORING AND ANALYTICAL REQUIREMENTS.**

**01. Total Coliform Sampling and Analytical Requirements.** The Total Coliform Rule, 40 CFR 141.21, is herein incorporated by reference. The Revised Total Coliform Rule, 40 CFR Part 141, Subpart Y, is herein incorporated by reference, excluding the annual monitoring provisions in 40 CFR 141.854 (a)(4), (d), (e), (f) and (h). (3-20-20)T

**a.** Routine monitoring requirements for public water systems serving more than one thousand (1,000) people. 40 CFR 141.857 is herein incorporated by reference. (3-20-20)T

**b.** Routine monitoring requirements for community water systems serving one thousand (1,000) or fewer people using only ground water. 40 CFR 141.855 is herein incorporated by reference. (3-20-20)T

**c.** Routine monitoring requirements for subpart H public water system serving one thousand (1,000) or fewer people. 40 CFR 141.856 is herein incorporated by reference. (3-20-20)T

**d.** Routine monitoring requirements for non-community water system serving one thousand (1,000) or fewer people using only ground water. 40 CFR 141.854 is herein incorporated by reference, excluding the annual monitoring provisions in 40 CFR 141.854 (a)(4), (d), (e), (f), and (h). (3-20-20)T

**02. Turbidity Sampling and Analytical Requirements.** 40 CFR 141.22 is herein incorporated by reference. (3-20-20)T

**03. Inorganic Chemical Sampling and Analytical Requirements.** 40 CFR 141.23 is herein incorporated by reference. (3-20-20)T

**04. Organic Chemicals, Sampling and Analytical Requirements.** 40 CFR 141.24 is herein incorporated by reference. (3-20-20)T

**05. Analytical Methods for Radioactivity.** 40 CFR 141.25 is herein incorporated by reference. (3-20-20)T

**06. Monitoring Frequency and Compliance Requirements for Radioactivity in Community Water Systems.** 40CFR 141.26 is herein incorporated by reference. (3-20-20)T

**07. Monitoring Waivers.** 40 CFR 141.23(b) 141.23(c), 141.24(f), 141.24(h) are herein incorporated by reference. (3-20-20)T

**a.** Waivers from sampling requirements in Subsections 100.03, 100.04, 200.01, and 503.03.e.v. may be available to all systems for all contaminants except nitrate, nitrite, and disinfection byproducts and are based upon a vulnerability assessment, use assessment, the analytical results of previous sampling, or some combination of vulnerability assessment, use assessment, and analytical results. (3-20-20)T

**b.** There are two (2) general types of monitoring waivers: (3-20-20)T

**i.** Waivers based exclusively upon previous analytical data (3-20-20)T

- ii. Waivers based on a use or vulnerability assessment. (3-20-20)T
  - c. Waivers are to be made by the Department on a contaminant specific basis and must be in writing. (3-20-20)T
  - d. Vulnerability assessments may be conducted by the Department, the water system, or a third party organization. The Department shall approve or disapprove all vulnerability assessments in writing. (3-20-20)T
  - e. Water systems which do not receive waivers shall sample at the required initial and repeat monitoring frequencies. (3-20-20)T
  - f. If a system elects to request a waiver from monitoring, it shall do so in writing at least sixty (60) days prior to the required monitoring deadline date. (3-20-20)T
- 08. Initial Monitoring Schedule.** In addition to the requirements specified in 40 CFR 141.23, 40 CFR 141.24, and 40 CFR 141.40, initial monitoring must be completed according to the following schedule unless otherwise specified by the Department: (3-20-20)T
- a. Public water systems serving more than one hundred (100) people must conduct initial monitoring before January 1, 1995 except that: (3-20-20)T
    - i. Initial monitoring for nitrate and nitrite must be completed before January 1, 1994 for all surface water sources serving transient noncommunity public water systems and for all ground water sources serving any public water system. (3-20-20)T
    - ii. Initial monitoring for nitrate and nitrite must be completed before April 1, 1993 for all surface water sources serving community or nontransient noncommunity public water systems. (3-20-20)T
    - iii. Initial monitoring required under 40 CFR 141.23(c) must be completed before January 1, 1994 for all surface water sources serving community or nontransient noncommunity public water systems. (3-20-20)T
  - b. Public water systems serving one hundred (100) or less people must conduct initial monitoring before January 1, 1996 except that: (3-20-20)T
    - i. Initial monitoring for nitrate and nitrite must be completed before January 1, 1994 for all surface water sources serving transient noncommunity public water systems and for all ground water sources serving a public water system. (3-20-20)T
    - ii. Initial monitoring for nitrate and nitrite must be completed before April 1, 1993 for all surface water sources serving community or nontransient noncommunity public water systems. (3-20-20)T
    - iii. Initial monitoring required under 40 CFR 141.23(c) must be completed before January 1, 1994 for all surface water sources serving community or nontransient noncommunity public water systems. (3-20-20)T
- 09. Alternate Analytical Techniques.** 40 CFR 141.27 is herein incorporated by reference. (3-20-20)T
- 10. Approved Laboratories.** 40 CFR 141.28 and 40 CFR 141.852(b) are herein incorporated by reference. All analyses conducted pursuant to these rules, except those listed below, shall be performed in laboratories certified or granted reciprocity by the Idaho Department of Health and Welfare, Bureau of Laboratories, as provided in IDAPA 16.02.13, "Rules Governing Certification of Idaho Water Quality Laboratories." The following analyses may be performed by any person acceptable to the Department of Environmental Quality: (3-20-20)T
- a. pH; (3-20-20)T
  - b. Turbidity (Nephelometric method only); (3-20-20)T

- c. Daily analysis for fluoride; (3-20-20)T
- d. Temperature; (3-20-20)T
- e. Disinfectant residuals, except ozone, which shall be analyzed using the Indigo Method or an acceptable automated method pursuant to Subsection 300.05.d.; (3-20-20)T
- f. Alkalinity; (3-20-20)T
- g. Calcium; (3-20-20)T
- h. Conductivity; (3-20-20)T
- i. Silica; and (3-20-20)T
- j. Orthophosphate. (3-20-20)T
- 11. **Monitoring of Consecutive Water Systems.** 40 CFR 141.29 is herein incorporated by reference. (3-20-20)T
- 12. **Disinfection Residuals, Disinfection Byproducts, and Disinfection Byproduct Precursors.** 40 CFR Part 141, Subpart L is herein incorporated by reference. (3-20-20)T
- 101. -- 149. (RESERVED)
- 150. **REPORTING, PUBLIC NOTIFICATION, RECORDKEEPING.**
  - 01. **Reporting Requirements.** 40 CFR 141.31 is herein incorporated by reference. (3-20-20)T
  - 02. **Public Notification of Drinking Water Violations.** 40 CFR Part 141, Subpart Q is herein incorporated by reference. (3-20-20)T
  - 03. **Record Maintenance.** 40 CFR 141.33 is herein incorporated by reference. (3-20-20)T
  - 04. **Reporting for Unregulated Contaminant Monitoring Results.** 40 CFR 141.35 is herein incorporated by reference. (3-20-20)T
  - 05. **Reporting and Record Keeping Requirements for the Interim Enhanced Surface Water Treatment Rule.** 40 CFR 141.175 is herein incorporated by reference. (3-20-20)T
  - 06. **Reporting and Record Keeping Requirements for the Disinfectants and Disinfectant Byproducts Rule.** 40 CFR 141.134 is herein incorporated by reference. (3-20-20)T
  - 07. **Reporting and Record Keeping Requirements for the Revised Total Coliform Rule.** 40 CFR 141.861 is herein incorporated by reference. (3-20-20)T
- 151. **CONSUMER CONFIDENCE REPORTS.**
  - 40 CFR Part 141, Subpart O is herein incorporated by reference. (3-20-20)T
- 152. -- 199. (RESERVED)
- 200. **SPECIAL REGULATIONS.**
  - 01. **Monitoring Requirements for Unregulated Contaminants.** 40 CFR 141.40 is herein incorporated by reference. (3-20-20)T
  - 02. **Special Monitoring for Sodium.** 40 CFR 141.41 is herein incorporated by reference. (3-20-20)T

03. **Special Monitoring for Corrosively Characteristics.** 40 CFR 141.42 is herein incorporated by reference. (3-20-20)T

04. **Prohibition on Use of Lead Pipes, Solder, and Flux.** 40 CFR 141.43 is herein incorporated by reference. (3-20-20)T

201. -- 249. (RESERVED)

**250. MAXIMUM CONTAMINANT LEVEL GOALS AND MAXIMUM RESIDUAL DISINFECTION LEVEL GOALS.**

01. **Maximum Contaminant Level Goals for Organic Contaminants.** 40 CFR 141.50 is herein incorporated by reference. (3-20-20)T

02. **Maximum Contaminant Level Goals for Inorganic Contaminants.** 40 CFR 141.51 is herein incorporated by reference. (3-20-20)T

03. **Maximum Contaminant Level Goals for Microbiological Contaminants.** 40 CFR 141.52 is herein incorporated by reference. (3-20-20)T

04. **Maximum Contaminant Level Goals for Disinfection Byproducts.** 40 CFR 141.53 is herein incorporated by reference. (3-20-20)T

05. **Maximum Residual Disinfectant Level Goals for Disinfectants.** 40 CFR 141.54 is herein incorporated by reference. (3-20-20)T

06. **Maximum Contaminant Level Goals for Radionuclides.** 40 CFR 141.55 is herein incorporated by reference. (3-20-20)T

251. -- 299. (RESERVED)

**300. FILTRATION AND DISINFECTION.**

01. **General Requirements.** 40 CFR 141.70 is herein incorporated by reference. Each public water system using a surface water source or ground water source directly influenced by surface water shall be operated by personnel, as specified in Sections 553 and 554, who have met state requirements for licensing of water system operators. (3-20-20)T

02. **Filtration.** 40 CFR 141.73 is herein incorporated by reference. (3-20-20)T

a. Each system which provides filtration treatment shall submit engineering evaluations, other documentation, or some combination of engineering evaluations and other documentation as required by the Department to demonstrate ongoing compliance with these rules. (3-20-20)T

b. The Department will establish filtration removal credit on a system-by-system basis. Unless otherwise demonstrated to the satisfaction of the Department, the maximum log removal credit allowed for filtration is as follows:

Maximum Log Removal			
Filtration Type	Giardia lamblia	Viruses	Cryptosporidium
Conventional	2.5	2.0	2.5
Direct	2.0	1.0	2.0

Maximum Log Removal			
Filtration Type	Giardia lamblia	Viruses	Cryptosporidium
Slow sand	2.0	2.0	2.0
Diatomaceous earth	2.0	1.0	2.0
Microfiltration	3.0	0.5	3.0
Ultrafiltration	3.5	2.0	3.5
Nanofiltration	4.0	3.0	4.0
Reverse Osmosis	4.0	3.0	4.0
Alternate technology	2.0	0	2.0

(3-20-20)T

- c. Filtration removal credit shall be granted for filtration treatment provided the system is: (3-20-20)T
- i. Operated in accordance with the Operations Plan specified in Subsection 552.03.a.; and (3-20-20)T
  - ii. The system is in compliance with the turbidity performance criteria specified under 40 CFR 141.73; and (3-20-20)T
  - iii. Coagulant chemicals must be added and coagulation and flocculation unit process must be used at all times during which conventional and direct filtration treatment plants are in operation; and (3-20-20)T
  - iv. Slow sand filters are operated at rates not to exceed one-tenth (0.1) gallons per minute per square foot or as approved by the Department; and (3-20-20)T
  - v. Diatomaceous earth filters are operated at a rate not to exceed one point five (1.5) gallons per minute per square foot. (3-20-20)T
- 03. Criteria for Avoiding Filtration.** 40 CFR 141.71 is herein incorporated by reference. (3-20-20)T
- 04. Disinfection.** 40 CFR 141.72 is herein incorporated by reference. (3-20-20)T
- a. In addition to the disinfection requirements in 40 CFR 141.72, each system with a surface water source or ground water source directly influenced by surface water shall maintain a minimum of at least two-tenths (0.2) parts per million of chlorine in the treated water after an effective contact time of at least thirty (30) minutes at peak hour demand before delivery to the first customer. Effective contact time is either demonstrated or calculated. (3-20-20)T
- i. Demonstrated effective contact time is generally determined by tracer studies on a completed contact basin. Prior to conducting a tracer study, a testing plan shall be submitted to the Department for review and approval. The tracer chemical shall not be reactive with anything in the water or be consumed in the process. (3-20-20)T
  - ii. Calculated effective contact time for tank type contact basins is based on tank baffling and inlet/outlet configurations for the maximum hourly flow rate through that contact basin. Calculated effective contact time in a “pipeline type contact basin” (often called a pipeline contactor) is calculated by dividing the internal volume of the pipe by the maximum hourly flow rate through that pipeline contactor. (3-20-20)T
- b. The Department may allow a system to utilize automatic shut-off of water to the distribution system whenever total disinfectant residual is less than two-tenths (0.2) mg/l rather than provide redundant

disinfection components and auxiliary power as required in 40 CFR 141.72(a)(2). An automatic water shut-off may be used if the system demonstrates to the satisfaction of the Department that, at all times, a minimum of twenty (20) psi pressure and adequate fire flow can be maintained in the distribution system when water delivery is shut-off to the distribution system and, at all times, minimum *Giardia lamblia* and virus inactivation removal rates can be achieved prior to the first customer. (3-20-20)T

c. Each system which is required to provide filtration must provide disinfection treatment such that filtration plus disinfection provide at least 3-Log or ninety-nine and nine tenths percent (99.9%) inactivation/removal of *Giardia lamblia* cysts and at least 4-Log or ninety-nine and ninety-nine hundredths percent (99.99%) inactivation/removal of viruses as specified in 40 CFR 141.72 and Section 300, and at least 2-Log or ninety-nine percent (99%) removal of *Cryptosporidium* as required by 40 CFR Part 141, Subpart P or Subpart T. However, in all cases the disinfection portion of the treatment train shall be designed to provide not less than five tenths (0.5) log *Giardia lamblia* inactivation, irrespective of the *Giardia lamblia* removal credit awarded to the filtration portion of the treatment train. (3-20-20)T

**05. Analytical and Monitoring Requirements.** 40 CFR 141.74 is herein incorporated by reference. (3-20-20)T

a. Each public water system which is required to provide disinfection shall monitor as follows: (3-20-20)T

i. Each day the system is in operation, the purveyor shall determine the total level of inactivation of *Giardia lamblia* cysts and viruses achieved through disinfection based on CT99.9 values provided in 40 CFR 141.74(b)(3) (Tables 1.1 through 1.6, 2.1 and 3.1). (3-20-20)T

ii. At least once per day, the system shall monitor the following parameters to determine the total inactivation ratio achieved through disinfection: (3-20-20)T

(1) Temperature of the disinfected water at each residual disinfectant concentration sampling point; and (3-20-20)T

(2) If using chlorine, the pH of the disinfected water at each chlorine residual sampling point. (3-20-20)T

(3) The effective contact time, "T," must be determined each day during peak hour demand. Disinfectant contact time, "T," in pipelines used for *Giardia lamblia* and virus inactivation shall be calculated by dividing the internal volume of the pipe by the peak hour flow rate through that pipe. Effective contact time, "T," for all other system components used for *Giardia lamblia* and virus inactivation shall be determined by tracer studies or other evaluations or calculations acceptable to the Department. (3-20-20)T

(4) The residual disinfectant concentrations at each residual disinfectant sampling point at or before the first customer, must be determined each day during peak hour demand, or at other times approved by the Department. (3-20-20)T

iii. The purveyor may demonstrate to the Department, based on a Department approved on-site disinfection challenge study protocol, that the system is achieving disinfection requirements specified in Subsection 300.04 utilizing CT99.9 values other than those specified in 40 CFR 141.74(b)(3) (Tables 2.1 and 3.1) for ozone, chlorine dioxide, and chloramine. (3-20-20)T

iv. The total inactivation ratio shall be calculated as follows: (3-20-20)T

(1) If the system applies disinfectant at only one (1) point, the system shall determine the total inactivation ratio by either of the two (2) following methods: (3-20-20)T

(a) One inactivation ratio (CT<sub>calc</sub>/CT<sub>99.9</sub>) is determined at/or before the first customer during peak hour demand; or (3-20-20)T

(b) Sequential inactivation ratios are calculated between the point of disinfectant application and a point at or before the first customer during peak hour demand. The following method must be used to calculate the total inactivation ratio: (3-20-20)T

- (i) Step 1: Determine (CT<sub>calc</sub>/CT<sub>99.9</sub>) for each sequence. (3-20-20)T
- (ii) Step 2: Add the (CT<sub>calc</sub>/CT<sub>99.9</sub>) values for all sequences. The result is the total inactivation ratio. (3-20-20)T

(2) If the system uses more than one point of disinfectant application at or before the first customer, the system must determine the CT value of each disinfection sequence immediately prior to the next point of disinfectant application during peak hour demand. The sum of the (CT<sub>calc</sub>/CT<sub>99.9</sub>) values from all sequences is the total inactivation ratio. (CT<sub>calc</sub>/CT<sub>99.9</sub>) must be determined by the methods described in 40 CFR 141.74(b)(4)(i)(B). (3-20-20)T

v. Log removal credit for disinfection shall be determined by multiplying the total inactivation ratio by three (3). (3-20-20)T

vi. The Department may reduce the CT monitoring requirements specified under Section 300, for any system which demonstrates that the required inactivation levels are consistently exceeded. Reduced CT monitoring shall be allowed only where the reduction in monitoring will not endanger the health of consumers served by the water system. (3-20-20)T

b. Residual disinfectant concentrations for ozone must be measured using the Indigo Method, or automated methods may be used if approved by the Department as provided for in 40 CFR 141.74(a)(2). (3-20-20)T

c. Unfiltered Subpart H systems. 40 CFR 141.857(c) is herein incorporated by reference. (3-20-20)T

d. As provided for in 40 CFR 141.74(b), the Department may specify interim monitoring requirements for unfiltered systems notified by the Department or U.S. Environmental Protection Agency that filtration treatment must be installed. Until filtration is installed, systems shall conduct monitoring for turbidity and disinfectant residuals as follows unless otherwise specified by the Department. (3-20-20)T

i. Disinfectant residual concentrations entering the distribution system shall be measured at the following minimum frequencies, and samples must be taken at evenly spaced intervals throughout the workday.

Minimum Frequencies	
Population	Samples/day
Less than 500	1
501 - 1000	2
1,001 - 2,500	3
Greater than 2501	4

(3-20-20)T

ii. Turbidity shall be measured at least once per day at the entry point to the distribution system. (3-20-20)T

iii. The Department may, at its discretion, reduce the turbidity monitoring frequency for any noncommunity system which demonstrates to the satisfaction of the Department: (3-20-20)T

(1) A free chlorine residual of two-tenths (0.2) part per million is maintained throughout the distribution system; (3-20-20)T

- (2) The water source is well protected; (3-20-20)T
- (3) The total coliform MCL is not exceeded or a Level 1 or Level 2 Assessment has not been triggered in accordance with 40 CFR 141.859; and (3-20-20)T
- (4) No significant health risk is present. (3-20-20)T

**e.** The Department may allow systems with surface water sources or ground water sources under the direct influence of surface water, to substitute continuous turbidity monitoring for grab sample monitoring as specified in 40 CFR 141.74(b)(2) and 40 CFR 141.74(c)(1) and Subsection 300.05. The Department may allow continuous turbidity monitoring provided the continuous turbidimeter is operated, maintained, standardized and calibrated per the manufacturer's recommendations. For purposes of determining compliance with turbidity performance criteria, discrete values must be recorded every four (4) hours water is supplied to the distribution system. (3-20-20)T

**f.** The Department may allow systems using both a surface water source(s), or ground water source(s) under the direct influence of surface water, and one (1) or more ground water sources, to measure disinfectant residual at points other than the total coliform sampling points, as specified in 40 CFR 141.74(b)(6)(i) and 40 CFR 141.74(c)(3)(i) and Subsection 300.05. The Department may allow alternate sampling points provided the system submits an alternate monitoring plan to the Department for approval in advance of the monitoring requirement that demonstrates the alternative points are more representative of treated (disinfected) water quality within the distribution system. Heterotrophic bacteria, measured as heterotrophic plate count (HPC) as specified in 40 CFR 141.74(a)(1), may be measured in lieu of residual disinfectant concentration as outlined in 40 CFR 141.74(b)(6)(i). (3-20-20)T

**g.** The Department may allow a reduced turbidity monitoring frequency for systems using slow sand filtration or technology other than conventional, direct, or diatomaceous earth filtration, as specified in 40 CFR 141.74(c)(1) and Subsection 300.05. To be considered for a reduced turbidity monitoring frequency, a system must submit a written request to the Department in advance of the monitoring requirement. (3-20-20)T

**06. Reporting and Recordkeeping Requirements.** 40 CFR 141.75 is herein incorporated by reference. (3-20-20)T

**a.** As provided in 40 CFR 141.75(a) and Section 300, the Department may establish interim reporting requirements for systems notified by the Department or U.S. Environmental Protection Agency that filtration treatment must be installed as specified in 40 CFR 141.75(a) and as referred to in Subsection 300.06. Until filtration treatment is installed, systems required to install filtration treatment shall report as follows: (3-20-20)T

**i.** The purveyor shall immediately report to the Department via telephone or other equally rapid means, but no later than the end of the next business day, the following information: (3-20-20)T

- (1) The occurrence of a waterborne disease outbreak potentially attributable to that water system; (3-20-20)T
- (2) Any turbidity measurement which exceeds five (5) NTU; and (3-20-20)T
- (3) Any result indicating that the disinfectant residual concentration entering the distribution system is below two-tenths (0.2) mg/l free chlorine. (3-20-20)T

**ii.** The purveyor shall report to the Department within ten (10) days after the end of each month the system serves water to the public the following monitoring information using a Department-approved form: (3-20-20)T

- (1) Turbidity monitoring information; and (3-20-20)T
- (2) Disinfectant residual concentrations entering the distribution system. (3-20-20)T



iii. Personnel qualified under Subsection 300.01 shall complete and sign the monthly report forms submitted to the Department as required in Subsection 300.06. (3-20-20)T

b. In addition to the reporting requirements in 40 CFR 141.75(b) pertaining to systems with filtration treatment, each public water system which provides filtration treatment must report the level of *Giardia lamblia* and virus inactivation/removal achieved each day by filtration and disinfection. (3-20-20)T

**07. Recycle Provisions.** 40 CFR 141.76 is herein incorporated by reference. (3-20-20)T

a. The Department shall evaluate recycling records kept by water systems pursuant to 40 CFR 141.76 during sanitary surveys, comprehensive performance evaluations, or other inspections. (3-20-20)T

b. The Department may require a system to modify recycling practices if it can be shown that these practices adversely affect the ability of the system to meet surface water treatment requirements. (3-20-20)T

**301. ENHANCED FILTRATION AND DISINFECTION - SYSTEMS SERVING TEN THOUSAND OR MORE PEOPLE.**

This Section incorporates, 40 CFR Part 141, Subpart P, of the National Primary Drinking Water Regulations, known as the Interim Enhanced Surface Water Treatment Rule. (3-20-20)T

**01. General Requirements.** 40 CFR 141.170 is herein incorporated by reference. (3-20-20)T

**02. Criteria for Avoiding Filtration.** 40 CFR 141.171 is herein incorporated by reference. (3-20-20)T

**03. Disinfection Profiling and Benchmarking.** 40 CFR 141.172 is herein incorporated by reference. (3-20-20)T

**04. Filtration.** 40 CFR 141.173 is herein incorporated by reference. (3-20-20)T

**05. Filtration Sampling Requirements.** 40 CFR 141.174 is herein incorporated by reference. (3-20-20)T

**302. SANITARY SURVEYS FOR SYSTEMS USING SURFACE WATER OR GROUND WATER UNDER THE DIRECT INFLUENCE OF SURFACE WATER.**

The Department shall conduct a sanitary survey of all public water systems which use surface water or ground water under the direct influence of surface water. (3-20-20)T

**01. Frequency.** For noncommunity water systems, a sanitary survey shall be conducted every five (5) years. For community water systems, a sanitary survey shall be conducted every three (3) years, except that a community water system that has been determined to have outstanding performance, according to criteria established by the Department, may have a sanitary survey conducted every five (5) years. (3-20-20)T

**02. Report.** A report describing the results of the sanitary survey will be provided to the water system. (3-20-20)T

a. As part of the sanitary survey report or as an independent action, the Department shall provide written notice to the water system describing any significant deficiency within thirty (30) days after the Department identifies the significant deficiency. The notice may specify corrective actions and deadlines for completion of corrective actions. (3-20-20)T

b. The Department may, at its discretion, provide this written notice at the time of the sanitary survey. (3-20-20)T

**03. Response Required.** The owner of a public water system must respond in writing, describing how and on what schedule the system will address all significant deficiencies, not later than forty-five (45) days after receiving notification from the Department. (3-20-20)T

**04. Consultation with the Department.** Public water systems shall consult with the Department prior to taking specific corrective actions in response to significant deficiencies identified during a sanitary survey, unless such corrective actions are specified in detail by the Department in its written notification under Subsection 302.02. (3-20-20)T

**05. Violation.** Failure to address significant deficiencies identified in a sanitary survey that are within the control of the public water system and its governing body shall constitute a violation of these rules. (3-20-20)T

**303. SANITARY SURVEYS FOR PUBLIC WATER SYSTEMS USING GROUND WATER.**  
The Department shall conduct a sanitary survey of all public water systems that use ground water. 40 CFR Part 141, Subpart S, is herein incorporated by reference. (3-20-20)T

**01. Frequency.** For non-community water systems, a sanitary survey shall be conducted every five (5) years. For community water systems, a sanitary survey shall be conducted every three (3) years, except as provided below. (3-20-20)T

**a.** A community water system may have a sanitary survey conducted every five (5) years if the system provides at least a four (4)-log treatment of viruses (using inactivation, removal, or a Department approved combination of 4-log inactivation and removal) before or at the first customer for all of its ground water sources. (3-20-20)T

**b.** A community water system may have a sanitary survey conducted every five (5) years if it has an outstanding performance record, as determined by the Department and documented in previous sanitary surveys, and has no history of Total Coliform Rule or Revised Total Coliform Rule MCL or monitoring violations under Subsection 100.01 since the last sanitary survey. (3-20-20)T

**02. Report.** A report describing the results of the sanitary survey shall be provided to the water system. (3-20-20)T

**a.** As part of the sanitary survey report or as an independent action, the Department shall provide written notice to the water system describing any significant deficiency within thirty (30) days after the Department identifies the significant deficiency. The notice may specify corrective actions and deadlines for completion of corrective actions. (3-20-20)T

**b.** The Department may, at its discretion, provide this written notice at the time of the sanitary survey. (3-20-20)T

**03. Significant Deficiencies.** For each of the eight (8) elements of a sanitary survey of a ground water system, the following deficiencies shall in all cases be considered significant for the purposes of the notice required in Subsection 303.02. Decisions about the significance of other deficiencies identified during the sanitary survey shall be at the Department's discretion, as indicated in the Department's sanitary survey protocol. (3-20-20)T

**a.** Source: Lack of a sanitary well cap as specified in Subsection 511.06.b. (3-20-20)T

**b.** Treatment: (3-20-20)T

**i.** Chemical addition lacks emergency shut-off as specified in Subsection 531.02.b.ii. (3-20-20)T

**ii.** Chemical addition is not flow proportioned where the rate of flow or chemical demand is not reasonably constant, as specified in Subsection 531.02.b.ii. (3-20-20)T

**c.** Distribution system: No means for flushing dead end water mains, as specified in Subsection 542.09. (3-20-20)T

**d.** Finished water storage: Roof leaking, as specified in Subsections 544.09 and 544.09.c. (3-20-20)T

**e.** Pumps, pump facilities, and controls: No accessible check valve between pump and shut-off valve,

as specified in Subsection 511.04. (3-20-20)T

**f.** Monitoring, reporting, and data verification: Repeated failure to collect the required number and type of Total Coliform Rule or the Revised Total Coliform Rule samples during the most recent two (2) year period, as specified in Subsection 100.01. (3-20-20)T

**g.** System management and operation: History of frequent depressurization in the distribution system in violation of Subsection 552.01. (3-20-20)T

**h.** Operator compliance with state licensing requirements: Responsible charge operator is not licensed as required in Subsection 554.02. (3-20-20)T

**04. Response Required.** The owner of a public water system must respond in writing, describing how and on what schedule the system will address all significant deficiencies, not later than thirty (30) days after receiving notification from the Department. (3-20-20)T

**05. Consultation with the Department.** Public water systems shall consult with the Department prior to taking specific corrective actions in response to significant deficiencies identified during a sanitary survey unless such corrective actions are specified in detail by the Department in its written notification under Subsection 303.02. (3-20-20)T

**06. Violation.** Failure to address significant deficiencies identified in a sanitary survey that are within the control of the public water system and its governing body shall constitute a violation of these rules. (3-20-20)T

**304. COMPOSITE CORRECTION PROGRAM (CCP).**

In accordance with 40 CFR 142.16(g)(1), the Department may require a public water system to conduct a composite correction program, as defined in Section 003 of these rules, for the purpose of identifying and correcting deficiencies in water treatment and distribution. Composite Correction Programs consist of a Comprehensive Performance Evaluation (CPE) and Comprehensive Technical Assistance (CTA). Failure to implement any Department-required performance improvement factors identified through the CCP constitutes a violation of these rules. (3-20-20)T

**01. Comprehensive Performance Evaluation (CPE).** If required, the CPE must be conducted to identify factors that may be adversely impacting a plant's capability to achieve compliance. It must emphasize approaches that can be implemented without significant capital improvements and must consist of at least the following components: assessment of plant performance; evaluation of major unit processes; identification and prioritization of performance limiting factors; assessment of the applicability of comprehensive technical assistance; and preparation of a CPE report. (3-20-20)T

**02. Comprehensive Technical Assistance (CTA).** During the CTA phase, the system must identify and systematically address plant-specific factors. The CTA consists of follow-up to the CPE results, implementation of process control priority setting techniques, and maintaining long term involvement to systematically train staff and administrators. (3-20-20)T

**305. COLIFORM TREATMENT TECHNIQUE TRIGGERS AND ASSESSMENT REQUIREMENTS FOR PROTECTION AGAINST POTENTIAL FECAL CONTAMINATION.**

40 CFR 141.859, excluding 40 CFR 141.859(a)(2)(iii), is herein incorporated by reference. (3-20-20)T

**01. Treatment Technique Triggers.** Systems owners and operators must ensure that assessments are conducted in accordance with Subsection 305.02 after exceeding treatment technique triggers in this subsection. (3-20-20)T

**a.** Level 1 treatment technique triggers: (3-20-20)T

**i.** For systems taking forty (40) or more samples per month, the system exceeds five percent (5.0%) total coliform-positive samples for the month. (3-20-20)T

**ii.** For systems taking fewer than forty (40) samples per month, the system has two (2) or more total

coliform positive samples in the same month. (3-20-20)T

iii. The system owner or operator fails to take every required repeat sample after any single total coliform-positive sample. (3-20-20)T

b. Level 2 treatment technique triggers: (3-20-20)T

i. An E.coli MCL violation, as specified in Subsection 050.05 and Subsection 100.01 of these rules; or (3-20-20)T

ii. A second or any additional Level 1 triggers as defined in Subsection 305.01.a. within a rolling 12-month period, unless the Department has determined a likely reason that the samples that caused the first Level 1 treatment technique trigger were total coliform-positive and has established that the system has corrected the problem. (3-20-20)T

**02. Requirements For Assessments.** (3-20-20)T

a. System owners and operators must ensure that Level 1 and 2 assessments are conducted in order to identify the possible presence of sanitary defects and defects in distribution system coliform monitoring practices. The assessment must be conducted consistent with any Department directives that tailor specific assessment elements with respect to the size and type of the system and the size, type, and characteristics of the distribution system. (3-20-20)T

b. When conducting assessments, owners and operators must ensure that the assessor evaluates minimum elements that include review and identification of inadequacies in sample sites; sampling protocol; sample processing; atypical events that could affect distributed water quality or indicate that distributed water quality was impaired; changes in distribution system maintenance and operation that could affect distributed water quality (including water storage); source and treatment considerations that bear on distributed water quality, where appropriate (e.g., small ground water systems); and existing water quality monitoring data. The system owner or operator must ensure the assessments are consistent with the elements in the Department provided forms for Level 1 and Level 2 assessments. (3-20-20)T

c. Level 1 Assessments. A system owner or operator must conduct a Level 1 assessment if the system exceeds one of the treatment technique triggers in Subsection 305.01.a. as soon as practical after any trigger level is identified and submit a completed Level 1 assessment report or form to the Department within thirty (30) days after the system learns that it has exceeded a trigger. (3-20-20)T

i. The completed assessment report or form must describe sanitary defects detected, corrective actions completed, and a proposed timetable for any corrective actions not already completed. The assessment report or form may also note that no sanitary defects were identified. (3-20-20)T

ii. If the Department reviews the completed Level 1 report or form and determines that the assessment is not sufficient (including any proposed timetable for any corrective actions not already completed), the Department will consult with the owner or operator of the system. If the Department requires revisions after consultation, the system owner or operator must submit a revised assessment report or form to the Department on an agreed-upon schedule not to exceed thirty (30) days from the date of consultation. (3-20-20)T

iii. Upon completion and submission of the assessment report or form by the system owner or operator, the Department will determine if the system has identified a likely cause for the Level 1 trigger and, if so, establish that the system has corrected the problem, or has included a schedule acceptable to the Department for correcting the problem. (3-20-20)T

d. Level 2 Assessments. A system owner or operator must ensure that a Level 2 assessment is conducted if the system exceeds one of the treatment technique triggers in Subsection 305.01.b. The owner or operator must comply with any expedited actions or additional action required by the Department in the case of an E.coli MCL violation. (3-20-20)T

i. The system owner or operator must ensure that a Level 2 assessment is conducted by the Department or a party approved by the Department as described in Subsection 305.03 as soon as practical after any trigger in Subsection 305.01.b. and must submit a completed Level 2 assessment report or form to the Department within 30 (thirty) days after the system learns that it has exceeded a trigger if the assessment was conducted by a party other than the Department. (3-20-20)T

ii. The Department will schedule and conduct Level 2 assessments for an E.coli treatment technique trigger in Subsection 305.01.b.i. unless the Department approves another party to conduct the assessment as outlined in Subsection 305.03. (3-20-20)T

iii. A second or any additional triggered Level 2 Assessment within a rolling twelve-month period must be conducted by a Department approved third party even if the public water system has staff or management approved under Subsection 305.03. (3-20-20)T

iv. The completed assessment report or form must describe sanitary defects detected, corrective actions completed, and a proposed timetable for any corrective actions not already completed. The assessment report or form may also note that no sanitary defects were identified. (3-20-20)T

v. If the Department reviews the completed Level 2 report or form and determines that the assessment is not sufficient (including any proposed timetable for any corrective actions not already completed), the Department will consult with the owner or operator of the system. If the Department requires revisions after consultation, the system owner or operator must submit a revised assessment report or form to the Department on an agreed-upon schedule not to exceed 30 (thirty) days from the date of consultation. (3-20-20)T

vi. Upon completion and submission of the assessment report or form by the system owner or operator, the Department will determine if the system has identified a likely cause for the Level 2 trigger and, if so, establish that the system has corrected the problem, or has included a schedule acceptable to Department for correcting the problem. (3-20-20)T

e. Corrective action. Systems must correct sanitary defects found through either Level 1 or Level 2 assessments conducted under this section. For corrections not completed by the time of submission of the assessment report or form, the system must complete the corrective action(s) in compliance with a timetable approved by the Department in consultation with the system. The system must notify the Department when each scheduled corrective action is completed. (3-20-20)T

f. Consultation. At any time during the assessment or corrective action phase, either the water system or the Department may request a consultation with the other party to determine the appropriate actions to be taken. The system may consult with the Department on all relevant information that may impact its ability to comply with a requirement of this Section, including the method of accomplishment, an appropriate timeframe, and other relevant information. (3-20-20)T

**03. Approved Parties for Level 2 Assessments.** The system may conduct a Level 2 assessment if the system has staff or management with the certification or qualifications outlined in this Subsection or if the system hires parties that meet the qualifications in this Subsection. The following parties are approved by the Department to conduct Level 2 assessments: (3-20-20)T

a. The Department or persons contracted with the Department who are trained to conduct sanitary surveys; (3-20-20)T

b. Currently licensed operators in good standing that are licensed through the Idaho Division of Occupational and Professional Licenses with a drinking water classification of Distribution I through IV or Treatment I through IV and that are licensed at least to the classification level of the public water system requiring the Level 2 assessment; or (3-20-20)T

c. Licensed professional engineers licensed by the state of Idaho and qualified by education and experience in the specific technical fields involved in these rules. (3-20-20)T

**306. -- 309. (RESERVED)**

**310. ENHANCED FILTRATION AND DISINFECTION - SYSTEMS SERVING FEWER THAN TEN THOUSAND PEOPLE.**

40 CFR 141, Subpart T is herein incorporated by reference. (3-20-20)T

**311. ENHANCED TREATMENT FOR CRYPTOSPORIDIUM -- LONG TERM 2 ENHANCED SURFACE WATER TREATMENT RULE.**

40 CFR Part 141, subpart W is herein incorporated by reference. (3-20-20)T

**01. Cryptosporidium Treatment Credit for Approved Watershed Control Program.** The Department shall award 0.5 (zero point five) logs cryptosporidium removal credit to systems that have a Department approved Watershed Control Program. Requirements for a watershed control program are set forth in 40 CFR 141, Subpart W. Guidance on how to develop a watershed control program and obtain Department approval is provided in "Implementation Guidance for the Long Term 2 Enhanced Surface Water Treatment Rule," as referenced in Section 002. (3-20-20)T

**02. Assessment of Significant Changes in the Watershed.** As part of the sanitary survey process set forth in Section 302, the Department, or an agent approved by the Department, shall assess significant changes in the watershed of a surface water system that have occurred since the system conducted source water monitoring. If changes in the watershed have the potential to significantly increase contamination of the source water with cryptosporidium, the Department shall consult with the water system owner on follow-up actions that may be required under 40 CFR 141, Subpart W, including, but not limited to, source water monitoring and/or additional treatment requirements. "Implementation Guidance for the Long Term 2 Enhanced Surface Water Treatment Rule," as referenced in Section 002, provides a description of factors that will be considered by the Department when making an assessment of changes in the watershed. These factors include, but are not limited to the following: (3-20-20)T

**a.** New NPDES permits or changes in existing NPDES permits that involve increased loading of contaminants. (3-20-20)T

**b.** Changes in land use patterns. (3-20-20)T

**c.** Changes in agricultural cropping, chemical application, or irrigation practices. (3-20-20)T

**d.** Changes in other non-point discharge source activities (such as grazing, manure application, commercial or residential development). (3-20-20)T

**e.** Stream or riverbed modifications. (3-20-20)T

**f.** NPDES permit violations at wastewater treatment plants and confined animal feedlot operations. (3-20-20)T

**g.** Dramatic natural events such as floods, forest fires, earthquakes, and landslides that may transport or expose contaminants. (3-20-20)T

**h.** Prolonged drought conditions that may warrant special preparatory measures to minimize impacts from waste accumulations that are washed into source waters when precipitation returns. (3-20-20)T

**i.** Status of the water system's emergency response plan. (3-20-20)T

**j.** Accidental or illegal waste discharges and spills. (3-20-20)T

**312. -- 319. (RESERVED)**

**320. DISINFECTANT RESIDUALS, DISINFECTION BYPRODUCTS, AND DISINFECTION BYPRODUCT PRECURSORS.**

This Section incorporates 40 CFR Part 141, Subpart L, of the National Primary Drinking Water Regulations, known as the Disinfectants and Disinfection Byproducts Rule. (3-20-20)T

- 01. General Requirements.** 40 CFR 141.130 is herein incorporated by reference. (3-20-20)T
- 02. Analytical Requirements.** 40 CFR 141.131 is herein incorporated by reference. DPD colorimetric test kits may be used to measure residual disinfectant concentrations for chlorine, chloramines, and chlorine dioxide. (3-20-20)T
- 03. Monitoring Requirements.** 40 CFR 141.132 is herein incorporated by reference. (3-20-20)T
- 04. Compliance Requirements.** 40 CFR 141.133 is herein incorporated by reference. (3-20-20)T
- 05. Treatment Techniques for Control of Disinfection Byproduct (DBP) Precursors.** 40 CFR 141.135 is herein incorporated by reference. (3-20-20)T

**321. INITIAL DISTRIBUTION SYSTEM EVALUATIONS.**

40 CFR Part 141, Subpart U is herein incorporated by reference. "Implementation Guidance for the Stage 2 Disinfectants and Disinfection Byproducts Rule," as referenced in Section 002, provides assistance to public water system owners and operators in understanding and achieving compliance with the requirements of 40 CFR 141, Subpart U. (3-20-20)T

**322. STAGE 2 DISINFECTION BYPRODUCTS REQUIREMENTS.**

40 CFR Part 141, Subpart V is herein incorporated by reference. "Implementation Guidance for the Stage 2 Disinfectants and Disinfection Byproducts Rule," as referenced in Section 002, provides assistance to public water system owners and operators in understanding and achieving compliance with the requirements of 40 CFR 141, Subpart V. (3-20-20)T

**323. GROUND WATER RULE.**

40 CFR 141, Subpart S is herein incorporated by reference. "Implementation Guidance for the Ground Water Rule," as referenced in Section 002, provides assistance to public water system owners and operators in understanding and achieving compliance with the requirements of 40 CFR 141, Subpart S. (3-20-20)T

**01. Discontinuation of Treatment.** Systems that wish to discontinue four (4)-log virus treatment at a ground water source must meet the following criteria. Ground water sources on which treatment has been discontinued shall be subject to the triggered source water monitoring requirements of 40 CFR 141, Subpart S. (3-20-20)T

- a.** Demonstration that any known source of contamination has been removed. (3-20-20)T
- b.** Demonstration that structural deficiencies of the well have been rehabilitated and no longer exist. (3-20-20)T
- c.** Provide evidence that the well is drawing from a protected or confined aquifer. (3-20-20)T
- d.** Submit results of one (1) year of monthly monitoring for a fecal indicator organism during which no positive results occurred. (3-20-20)T

**02. Chlorine Purging Prior to Triggered Source Sampling.** 40 CFR 141.402(e) requires that ground water source samples be collected at a location prior to any treatment. Pursuant to this requirement, systems that add chlorine to a source, either in the well bore or near enough to the wellhead that chlorinated water could backflow into the well, shall ensure that all chlorine residual has been purged prior to taking a triggered source water sample. This shall be accomplished by measuring chlorine residual in the source water until a reading of zero is obtained and be recorded in the space provided for chlorine residual on the sample submittal form. (3-20-20)T

**324. -- 349. (RESERVED)**

**350. CONTROL OF LEAD AND COPPER.**

- 01. General Requirements.** 40 CFR 141.80, revised as of July 1, 2008, is herein incorporated by reference. (3-20-20)T
- 02. Applicability of Corrosion Control Treatment Steps to Small, Medium-Size, and Large Water Systems.** 40 CFR 141.81, revised as of July 1, 2008, is herein incorporated by reference. (3-20-20)T
- 03. Description of Corrosion Control Treatment Requirements.** (3-20-20)T
- a.** 40 CFR 141.82, revised as of July 1, 2008, is herein incorporated by reference. (3-20-20)T
- b.** The Department may modify its determination of the optimal corrosion control treatment or optimal water quality control parameters where it concludes that such changes are necessary to optimize corrosion control treatment as specified in 40 CFR 141.82(h) and as referred to in Subsection 350.03. The Department may also modify its determination of the optimal corrosion control treatment or water quality control parameters where it finds such changes will provide equivalent or improved treatment in a manner which is simpler or less costly to operate. (3-20-20)T
- 04. Source Water Treatment Requirements.** 40 CFR 141.83, revised as of July 1, 2008, is herein incorporated by reference. The Department may modify its determination of optimal source treatment or maximum permissible lead and copper concentrations where it concludes that such changes are necessary as specified in 40 CFR 141.83(b)(6). (3-20-20)T
- 05. Lead Service Line Replacement Requirements.** 40 CFR 141.84, revised as of July 1, 2008, is herein incorporated by reference. (3-20-20)T
- 06. Public Education and Supplemental Monitoring Requirements.** 40 CFR 141.85, revised as of July 1, 2008, is herein incorporated by reference. (3-20-20)T
- 07. Monitoring Requirements for Lead and Copper in Tap Water.** 40 CFR 141.86, revised as of July 1, 2008, is herein incorporated by reference. (3-20-20)T
- 08. Monitoring Requirements for Water Quality Parameters.** 40 CFR 141.87, revised as of July 1, 2008, is herein incorporated by reference. (3-20-20)T
- 09. Monitoring Requirements for Lead and Copper in Source Water.** 40 CFR 141.88, revised as of July 1, 2008, is herein incorporated by reference. (3-20-20)T
- 10. Analytical Methods.** 40 CFR 141.89, revised as of July 1, 2008, is herein incorporated by reference. (3-20-20)T
- 11. Reporting Requirements.** 40 CFR 141.90, revised as of July 1, 2008, is herein incorporated by reference. (3-20-20)T
- 12. Recordkeeping Requirements.** 40 CFR 141.91, revised as of July 1, 2008, is herein incorporated by reference. (3-20-20)T
- 351. -- 399. (RESERVED)**
- 400. SECONDARY MCLS.**
- 01. Purpose.** 40 CFR 143.1, revised as of July 1, 2003, is herein incorporated by reference. (3-20-20)T
- 02. Definitions.** 40 CFR 143.2, revised as of July 1, 2003, is herein incorporated by reference. (3-20-20)T
- 03. Secondary Maximum Contaminant Levels.** 40 CFR 143.3, revised as of July 1, 2003, is herein



incorporated by reference. (3-20-20)T

- 04. Monitoring.** 40 CFR 143.4, revised as of July 1, 2010, is herein incorporated by reference. (3-20-20)T

**401. -- 449. (RESERVED)**

**450. USE OF NON-CENTRALIZED TREATMENT DEVICES.**

**01. Criteria and Procedures for Public Water Systems Using Point of Entry Devices.** 40 CFR 141.100 is herein incorporated by reference. (3-20-20)T

**02. Point of Use (POU) Treatment Devices.** (3-20-20)T

**a.** A public water system may use point of use (POU) treatment in order to achieve compliance with certain maximum contaminant levels (MCL) or treatment techniques, in accordance with Subsection 450.02.b., when the following conditions are met: (3-20-20)T

i. A program for long-term operation, maintenance, and monitoring of the POU treatment system is approved by the Department, pursuant to Section 450.02.d. (3-20-20)T

ii. The public water system or a vendor of POU treatment devices under contract with the public water system shall own, control, and maintain the POU treatment system to ensure proper operation and maintenance and compliance with the MCL or treatment technique. (3-20-20)T

iii. Each POU treatment device is equipped with a mechanical warning mechanism to ensure that customers are automatically notified of operational problems. (3-20-20)T

iv. The POU treatment device must be certified by an accredited American National Standards Institute (ANSI) certification body to meet applicable ANSI/National Sanitation Foundation (NSF) Standards. (3-20-20)T

**b.** POU treatment devices shall not be used to achieve compliance with a MCL or treatment technique requirement for a microbial contaminant or an indicator of a microbial contaminant. Community water systems may not use POU treatment devices to achieve compliance with a nitrate MCL. (3-20-20)T

**c.** The Department will waive the plan and specification requirements of Section 504 relating to material modifications for the following systems only to the extent that the material modification proposed is limited to the installation or use of a POU treatment device(s): (3-20-20)T

i. Community water systems serving two hundred (200) or fewer service connections. (3-20-20)T

ii. Non-transient non-community water systems. (3-20-20)T

iii. Transient non-community water systems. (3-20-20)T

iv. Community water systems serving more than two hundred (200) service connections if approved by the Department through the waiver process outlined in Subsection 005.01.a. (3-20-20)T

**d.** A public water system must obtain written approval by the Department before installation of a POU treatment device for the purpose of achieving compliance with a MCL or treatment technique. The public water system shall submit the following documentation for approval to the Department: (3-20-20)T

i. Information identifying the public water system name and number, total number of service connections, contaminant(s) to be treated, type of POU treatment device to be installed, manufacturer and model number of the POU treatment device, type and function of the mechanical warning mechanism (performance indicator) on the POU treatment device, certification verification for ANSI/NSF, installer qualifications, and a

- proposed date for installation of the POU treatment device(s). (3-20-20)T
- ii. The manufacturer's specifications for the POU treatment device including demonstration that the POU treatment device is suited for the water chemistry of the public water system and contaminant(s) of concern and is of sufficient design and capacity for the particular application. (3-20-20)T
- iii. Information relating to how other drinking water dispensing units, such as instant hot water dispensers and refrigerator water and ice dispensers, whose primary function is to provide drinking water, will be provided with treated water. If water is transported from a POU treatment device to another drinking water dispensing unit, the conducting tube shall be of non-reactive material. (3-20-20)T
- iv. For non-transient non-community water systems and transient non-community water systems, demonstration that the drinking water dispensing units are located in areas adequate to protect public health. (3-20-20)T
- v. Demonstration that all POU treatment devices are owned, controlled, and maintained by the public water system or by a vendor of POU treatment devices under contract with the public water system. (3-20-20)T
- vi. A sampling plan identifying the location of all service connections and demonstrating how the system will ensure that all POU treatment devices are sampled for compliance with the contaminant(s) being treated during every compliance period or at a frequency designated by the Department. (3-20-20)T
- vii. Documentation that a customer at each service connection has agreed to installation and use of a POU treatment device and has granted access for installation, maintenance, and sampling. (3-20-20)T
- viii. A plan that describes how the public water system will address any non-compliance with Subsection 450.02.d.vii. (3-20-20)T
- ix. A maintenance plan that demonstrates how on-going maintenance activities will be performed and on what frequency, including: frequency of treatment media replacements, frequency of POU treatment device replacements, periodic verification that the mechanical warning device is functional, schedule of planned maintenance activities, plan of how the system will address unscheduled maintenance problems, and a plan and method of waste disposal. (3-20-20)T
- x. Documentation that the system meets the current requirements for a certified operator pursuant to Section 554. (3-20-20)T
- xi. A plan for on-going education and outreach to the customers of the public water system, including rental customers, on POU treatment and health effects of the contaminant(s) of concern. (3-20-20)T
- xii. A plan for how the system will ensure real estate disclosures for the POU treatment system. (3-20-20)T
- xiii. A statement of recognition that failure to maintain compliance with the MCL, or the failure to operate and maintain compliance with a POU treatment system as approved by the Department, may necessitate installation of centralized treatment. (3-20-20)T
- e. Within thirty (30) days of installing the approved POU treatment system, the public water system shall notify the Department in writing that the POU treatment system was installed as approved by the Department. (3-20-20)T
- f. Within thirty (30) days of installing the approved POU treatment system, the public water system shall submit samples from each POU treatment device to a certified laboratory for the contaminant(s) being treated by the POU treatment device. The samples shall be used to demonstrate initial compliance with the MCL. (3-20-20)T
- g. The water system owner or operator must maintain records for a POU treatment system. Records shall be submitted to the Department at a frequency and in a format specified by the Department. Records to maintain

- shall include: (3-20-20)T
- i. Requirements of Subsection 450.02.d.; (3-20-20)T
  - ii. All sampling performed on the POU treatment devices; (3-20-20)T
  - iii. Maintenance logs and schedules; (3-20-20)T
  - iv. Log of installed units; and (3-20-20)T
  - v. Contracts, lease agreements, or other legal documents with vendors and consumers. (3-20-20)T
- 03. Use of Bottled Water.** 40 CFR 141.101 is herein incorporated by reference. (3-20-20)T

**451. TREATMENT TECHNIQUES.**

- 01. General Requirements.** 40 CFR 141.110 is herein incorporated by reference. (3-20-20)T
- 02. Treatment Techniques for Acrylamide and Epichlorohydrin.** 40 CFR 141.111 is herein incorporated by reference. (3-20-20)T

**452. -- 499. (RESERVED)**

**500. FACILITY AND DESIGN STANDARDS: DEMONSTRATION OF TECHNICAL, FINANCIAL, AND MANAGERIAL CAPACITY OF PUBLIC DRINKING WATER SYSTEMS.**

No person shall proceed, or cause to proceed, with construction of a new or substantially modified community or nontransient, noncommunity drinking water system until it has been demonstrated to the Department that the water system will have adequate technical, financial, and managerial capacity, as defined in Section 003 of these rules. With the exception of water sources, demonstration of capacity shall be submitted to the Department prior to or concurrent with the submittal of plans and specifications, as required in Section 39-118, Idaho Code, and Subsection 504.03 of these rules. Plans and specifications for water sources may be submitted to the Department prior to demonstration of capacity for the water system. The Department shall issue its approval of the new system capacity demonstration in writing. (3-20-20)T

- 01. Technical Capacity.** In order to meet this requirement, the public water system shall submit documentation to demonstrate the following: (3-20-20)T
- a. The system meets the relevant design, construction, and operating requirements of these rules; (3-20-20)T
  - b. The system has an adequate and consistent source of water; (3-20-20)T
  - c. A plan is in place to protect the water source and deal with emergencies; (3-20-20)T
  - d. A plan exists for replacement or improvement of infrastructure as necessary; and (3-20-20)T
  - e. The system has trained personnel with an understanding of the technical and operational characteristics of the system. (3-20-20)T

- 02. Financial Capacity.** A demonstration of financial capacity must include but is not limited to the following information: (3-20-20)T

a. Documentation that organizational and financial arrangements are adequate to construct and operate the public water system in accordance with these rules. This information can be provided by submitting estimated construction, operation, and maintenance costs, letters of credit, or other access to financial capital through public or private sources and, if available, a certified financial statement; (3-20-20)T

**b.** Demonstration of revenue sufficiency, that includes but is not limited to billing and collection procedures; a proposed rate structure which demonstrates the availability of operating funds, revenues for depreciation and reserves, and the ability to accrue a capital replacement fund. A preliminary operating budget shall be provided; and (3-20-20)T

**c.** Adequate fiscal controls must be demonstrated. (3-20-20)T

**03. Managerial Capacity.** In order to demonstrate adequate managerial capacity, the owner or operator of a new drinking water system shall submit at least the following information to the Department: (3-20-20)T

**a.** Clear documentation of legal ownership and any plans that may exist for transfer of that ownership upon completion of construction or after a period of operation; (3-20-20)T

**b.** The name, address, and telephone number of the person who will be accountable for ensuring that the water system is in compliance with these rules; (3-20-20)T

**c.** The name, address, and telephone number of the responsible charge operator; (3-20-20)T

**d.** A description of the manner in which the water system will be managed. Information such as by-laws, restrictive covenants, articles of incorporation, or procedures and policy manuals which describe the management organizational structure shall be provided; (3-20-20)T

**e.** A recommendation of staff qualifications, including training, experience, certification or licensing, and continuing education; (3-20-20)T

**f.** An explanation of how the water system will establish and maintain effective communications and relationships between the water system management, its customers, professional service providers, and any applicable regulatory agencies; and (3-20-20)T

**g.** Evidence of planning for future growth, equipment repair and maintenance, and long term replacement of system components. (3-20-20)T

**04. Submittal Form.** The Department shall provide a standard form to be used in preparing a new system capacity demonstration. The submittal form and general guidance on how to prepare a new system capacity document is provided in, "How to Demonstrate Financial, Technical, and Managerial Capacity in New Public Water Systems." This document may be requested from the Department and is available on the DEQ website at <http://www.deq.idaho.gov>. (3-20-20)T

**05. Expanding Systems.** A public water system which comes into existence as a result of growth in population or number of service connections within a previously unregulated system will be considered a new system under these rules and is subject to all design, construction and operating requirements herein. (3-20-20)T

**06. Consolidation.** In demonstrating new system capacity, the owner of the proposed new system must investigate the feasibility of obtaining water service from an established public water system. If such service is available, but the owner elects to proceed with an independent system, the owner must explain why this choice is in the public interest in terms of environmental protection, affordability to water users, and protection of public health. (3-20-20)T

**07. Exclusion.** New public water systems which are public utilities as defined in Sections 61-104 (Corporation), 61-124 (Water System), 61-125 (Water Corporation), and 61-129 (Public Utility), Idaho Code, must meet the regulatory requirements of the Idaho Public Utilities Commission (IPUC) in Chapter 1, Title 61, Idaho Code, Public Utilities Law, and IDAPA 31.01.01, "Rules of Procedure of the Idaho Public Utilities Commission." Such water systems will not be required to meet any requirements of this Section which are in conflict with the provisions and requirements of the IPUC. (3-20-20)T

**501. FACILITY AND DESIGN STANDARDS: GENERAL DESIGN REQUIREMENTS FOR PUBLIC DRINKING WATER SYSTEMS.**

Unless otherwise specified by the Department, the design of new drinking water systems, or modifications to existing, public drinking water systems, shall be in conformance with the facility and design standards set forth in Sections 006 and 500 through 552 of these rules. The following general design requirements shall apply as applicable for the type of water system and the treatment or other processes employed. (3-20-20)T

**01. Materials Used in Construction.** Products that are used to construct public drinking water systems and have water contact surfaces shall conform to applicable AWWA standards and be certified by an accredited ANSI certification body to meet applicable ANSI/NSF standards, where products meeting such AWWA and ANSI/NSF standards exist. In the absence of such products, products meeting applicable product standards and acceptable to the reviewing authority may be selected. Corrosion control shall be taken into account during all aspects of public water system design. (3-20-20)T

**02. Additives Used in Operation.** No chemical or other substance shall be added to drinking water, nor shall any process be utilized to treat drinking water, unless specifically approved by the Department. All chemicals shall conform to applicable AWWA standards and be certified by an accredited ANSI certification body to meet ANSI/NSF Standard 60, referenced in Subsection 002.02. (3-20-20)T

**03. Design Basis.** The system, including the water source and treatment facilities, shall be designed to provide either peak hour demand of the system or maximum day demand plus equalization storage at the design year. (3-20-20)T

**04. Design of Treatment Facilities.** Design of treatment facilities shall address: (3-20-20)T

**a.** Functional aspects of facility layout and provisions for future facility expansion; (3-20-20)T

**b.** Provision for expansion of waste treatment and disposal facilities (see Section 540); (3-20-20)T

**c.** Roads constructed to provide year-round access by vehicles and equipment needed for repair and maintenance; (3-20-20)T

**d.** Site grading and drainage; and (3-20-20)T

**e.** Chemical Feed or Injection. Unless otherwise approved by the Department based on documentation provided by the design engineer, all chemical feed or injection systems must be designed to ensure complete mixing through rapid mix devices or other measures. (3-20-20)T

**f.** Redundancy. Unless otherwise approved by the Department or as specified in other sections of these rules, to ensure that minimum quality, quantity, and pressure requirements of these rules are continuously met during maintenance, breakdowns, structural failures, emergencies, or other periods when components must be out of service, water system treatment, filtration, and disinfection components for all new or substantially modified community or nontransient, noncommunity drinking water systems shall be designed such that plant design capacity can be maintained with any component out of service. Raw water intake structures are excluded from the general redundancy requirement but shall be designed to ensure that plant design capacity will be maintained. (3-20-20)T

**05. Design of Buildings.** The design of buildings that are a part of public drinking water systems shall provide for: (3-20-20)T

**a.** Adequate ventilation, lighting, heating, and air conditioning; (3-20-20)T

**b.** Adequate drainage; (3-20-20)T

**c.** Dehumidification equipment, if necessary; (3-20-20)T

**d.** Accessibility of equipment for operation, servicing, and removal; (3-20-20)T

- e. Flexibility and convenience of operation and safety of operators; and (3-20-20)T
  - f. Separate room(s) for chemical storage and feed equipment that may be required based on type of chemicals and associated hazards. (3-20-20)T
- 06. Electrical.** Main switch gear electrical controls shall be located above grade, in areas not subject to flooding. All electrical work shall conform to the requirements of the National Electrical Code or to relevant state/local codes. The National Electrical Code is available from the National Fire Protection Association, 1 Batterymarch Park, Quincy, Massachusetts 02169-7471, (617)770-3000, <http://www.nfpa.org>. (3-20-20)T
- 07. Reliability and Emergency Operation.** New community water systems constructed after April 15, 2007 are required to have sufficient dedicated on-site standby power, with automatic switch-over capability, or standby storage so that water may be treated and supplied to pressurize the entire distribution system during power outages. During a power outage, the water system shall be able to meet the operating pressure requirements of Subsection 552.01.b. for a minimum of eight (8) hours at average day demand plus fire flow where provided. A minimum of eight (8) hours of fuel storage shall be located on site unless an equivalent plan is authorized by the Department. Standby power provided in a public drinking water system shall be coordinated with the standby power that is provided in the wastewater collection and treatment system. (3-20-20)T
- a. The Department may require the installation of standby power or storage facilities in existing systems if the frequency and duration of power outages a system experiences constitute a health hazard. (3-20-20)T
  - b. Existing community public water systems that are substantially modified after April 15, 2007 shall meet the requirements of Subsection 501.07. in those portions of the system affected by the modifications. (3-20-20)T
  - c. New sources and booster pumps intended to increase system capacity shall be provided with standby power or equivalent unless, during a power outage, the public water system or distribution system pressure zone can already meet the minimum operating capacity and pressure requirements in Subsection 501.07 for a minimum of eight (8) hours at average day demand plus fire flow where provided for each pressure zone. (3-20-20)T
  - d. For both new and existing public water systems, the Department may reduce the requirements of Subsection 501.07 if the system can demonstrate the capacity to adequately protect public health during a power outage. Any decision by the Department will be based on, but not limited to, the following considerations: (3-20-20)T
    - i. An adequate emergency response and operation plan and the capacity to implement that plan. (3-20-20)T
    - ii. The adequacy of the system's cross connection control program and the capacity to protect public health in the event of a system wide depressurization. (3-20-20)T
    - iii. Demonstration of historical and projected reliability of the electrical power supplied to the water system. (3-20-20)T
    - iv. A strategy for providing information to the public during power outages, including instructions to stop irrigation, boil water, etc., until notified otherwise. (3-20-20)T
    - v. The level of reliability acceptable to consumers. This can be accomplished with either a vote of the majority of consumers for privately owned and operated systems or a decision by the governing body for publicly governed systems. (3-20-20)T
    - vi. Other considerations that may be pertinent, including connections to other public water systems, agreements to provide water in emergency situations, and the availability of dedicated portable auxiliary power. (3-20-20)T
- 08. On-Site Analysis and Testing Capabilities.** Each public water system shall have equipment and

facilities for routine testing necessary to ensure proper operation. Equipment selection shall be based on the characteristics of the raw water source and the complexity of the treatment process involved. (3-20-20)T

**09. Sample Taps.** Sample taps shall be provided so that water samples can be obtained from each water source and from appropriate locations in each unit operation of treatment, and from the finished water. Taps shall be consistent with sampling needs and shall not be of the petcock type. Taps owned by the water system and used for obtaining samples for bacteriological analysis shall be of the smooth-nosed type without interior or exterior threads, shall not be of the mixing type, and shall not have a screen, aerator, or other such appurtenance. (3-20-20)T

**10. Facility Potable Water Supply.** The facility water supply service line and the plant finished water sample tap shall be supplied from a source of finished water at a point where all chemicals have been thoroughly mixed, and the required disinfectant contact time, if applicable, has been achieved. There shall be no cross connections between the facility water supply service line and any piping, troughs, tanks, or other treatment units containing wastewater, treatment chemicals, raw or partially treated water. (3-20-20)T

**11. Meters.** All water supplies shall have an acceptable means of measuring the flow from each source, the wash water, the recycled water, any blended water of different quality, and the finished water. (3-20-20)T

**12. Operation and Maintenance Manual.** A new or updated operation and maintenance manual that addresses all water system facilities shall be submitted to the Department for review and approval prior to start-up of the new or materially modified public water system unless the same system components are already covered in an existing operation and maintenance manual. For existing systems with continual operational problems as determined by the Department, the Department may require that an operation and maintenance manual be submitted to the Department for review and approval. The operator shall ensure that the system is operated in accordance with the approved operation and maintenance manual. (3-20-20)T

**13. Start-Up Training.** Provisions shall be made for operator instruction at the start-up of a new plant or pumping station. (3-20-20)T

**14. Safety.** Consideration shall be given to the protection of maintenance personnel and visitors from typical and foreseeable hazards in accordance with the engineering standards of care. The design shall comply with all applicable safety codes and regulations that may include the Uniform Building Code, International Fire Code, National Fire Protection Association Standards, and state and federal OSHA standards. Items to be considered include, but are not limited to, noise arresters, noise protection, confined space entry, protective equipment and clothing, gas masks, safety showers and eye washes, handrails and guards, warning signs, smoke detectors, toxic gas detectors and fire extinguishers. (3-20-20)T

**15. Security.** Appropriate design measures to help ensure the security of water system facilities shall be incorporated. Such measures, at a minimum, shall include means to lock all exterior doorways, windows, gates and other entrances to source, treatment, pumping stations, and water storage facilities. (3-20-20)T

**16. Other Regulations.** Consideration must be given to the design requirements of other federal, state, and local regulatory agencies for items such as safety requirements, special designs for the handicapped, plumbing and electrical codes, and construction in the flood plain. (3-20-20)T

**17. Ground Water Source Redundancy.** New community water systems served by ground water shall have a minimum of two (2) sources if they are intended to serve more than twenty-five (25) connections or equivalent dwelling units (EDUs). Under normal operating conditions, with any source out of service, the remaining source(s) shall be capable of providing either the peak hour demand of the system or a minimum of the maximum day demand plus equalization storage. See Subsection 501.18 for general design and redundancy requirements concerning fire flow capacity. (3-20-20)T

**18. Redundant Fire Flow Capacity.** (3-20-20)T

**a.** Public water systems that provide fire flow shall be designed to provide maximum day demand plus fire flow. Fire flow requirements and system adequacy shall be determined by the local fire authority or by a hydraulic analysis by a licensed professional engineer to establish required fire flows in accordance with the

International Fire Code as adopted by the State Fire Marshal. Pumping systems supporting fire flow capacity must be designed so that fire flow may be provided with any pump out of service. (3-20-20)T

**b.** The requirement for redundant pumping capacity specified in Subsection 501.18.a. may be reduced to the extent that fire suppression storage is provided in sufficient quantity to meet some or all of fire flow demands. Where fire suppression storage is not provided, the requirement for fire flow pumping redundancy may be reduced or eliminated if the following conditions are met: (3-20-20)T

**i.** The local fire authority justifies that the fire flow capacity of the system is acceptable and is compatible with the water demand of existing and planned fire-fighting equipment and fire-fighting practices in the area served by the system. (3-20-20)T

**ii.** In a manner appropriate to the system type and situation, notification is provided to customers that describes the design of the system's fire-fighting capability and explains how it differs from the requirements of Subsection 501.18.a. (3-20-20)T

**19. Pilot Studies.** Unless otherwise approved by the Department based on documentation provided by the design engineer, pilot studies are required for treatment processes other than chlorine disinfection or point of use installations. Pilot studies may be performed in the field using the proposed source water or in conjunction with bench scale testing in the lab using the proposed source water. The system shall obtain the Department's approval of a pilot study plan before the pilot study is implemented. A pilot study shall be conducted for a period that shall be determined by the design engineer and approved by the Department. A final pilot study report with results shall be submitted to the Department for review and approval. Upon completion of the pilot study, final approval of equipment and treatment processes is subject to the applicable requirements of Sections 500 through 552. (3-20-20)T

**a.** Pilot Study Plan. A pilot study plan shall include the following and any other items required by the Department: (3-20-20)T

**i.** Introduction and Background. The plan shall discuss general information about the project including the existing system, the reason for conducting the pilot study, and anticipated results of a successful pilot study. (3-20-20)T

**ii.** Alternative Processes. Provide a brief description of alternative processes that could be used if the proposed process is shown to be ineffective from the study. (3-20-20)T

**iii.** Procedures and Methods. The procedures and methods section shall discuss how the pilot study will be conducted, the time frame of the study, source water quality, how source water may be altered to mimic various source water quality conditions, and the water quality parameters that are monitored and evaluated to determine if the treatment process was effective. (3-20-20)T

**b.** Pilot Study Report. The pilot study report shall include the following and any other items required by the Department: (3-20-20)T

**i.** Introduction and Background. (3-20-20)T

**ii.** Results. A discussion of the overall pilot study progress, including any issues or problems and a general discussion of results of the study and what the results indicate. This discussion should determine parameters necessary for full scale implementation. (3-20-20)T

**iii.** Conclusions. Conclusions and recommendation to proceed with the treatment process if the results of the study proved successful. (3-20-20)T

**c.** Additional specific pilot study requirements in Sections 500 through 552 shall be included in pilot study plans and reports. (3-20-20)T

**d.** Engineer's Seal Required. Pilot study plans and pilot study reports submitted to the Department shall bear the imprint of an Idaho licensed professional engineer's seal that is both signed and dated by the engineer.



(3-20-20)T

**502. FACILITY AND DESIGN STANDARDS: FACILITY PLANS.**

See the definition of Facility Plan in Section 003.

(3-20-20)T

**01. Facility Plans Required.** All new public drinking water systems, and existing public drinking water systems undergoing material modification or expansion, are required to have a current facility plan that shall address all applicable issues specifically required in Sections 500 through 552 of these rules including, but not limited to, hydraulic capacity, treatment capacity, standby power, redundancy, fire flows, project financing, and operation and maintenance considerations sufficiently to determine the effects of the project on the overall infrastructure. Facility plans must address the entire potential service area of the project. Facility plans may not be required for simple water main extension projects as detailed in Subsections 502.01.a. and 502.01.b. (3-20-20)T

**a.** Department-reviewed simple water main extension projects. A facility plan is not required if the Department is provided documentation supporting the ability of the purveyor to provide service for the simple water main extension without adding system components designed to control quantity or pressure to the system and while continuing to provide the pressure and quantity requirements of Subsection 552.01. Documentation may be in the form of: (3-20-20)T

i. Hydraulic modeling; (3-20-20)T

ii. Usage data and flow calculations; (3-20-20)T

iii. Declining balance reports that demonstrate the system has the capacity to supply the service area of the system served by the extension; or (3-20-20)T

iv. Other documentation acceptable to the Department. (3-20-20)T

**b.** Qualified Licensed Professional Engineer (QLPE)-reviewed Simple Water Main Extension Projects. A Department-approved facility plan is not required to be in place prior to the QLPE approving a simple water main extension pursuant to Subsection 504.03.b., provided that the service area of the system served by the extension is in compliance with the facility and design standards in Sections 500 through 552 of these rules. If the Department has not approved a facility plan for the system which includes the proposed simple water main extension, then the system purveyor or the QLPE shall provide with the transmittal letter documentation supporting the ability of the purveyor to provide service for the simple water main extension without adding system components designed to control quantity or pressure to the system and while continuing to provide the pressure and quantity requirements of Subsection 552.01. The purveyor shall provide this documentation to the QLPE as necessary. Documentation may be in the form of: (3-20-20)T

i. Hydraulic modeling; (3-20-20)T

ii. Usage data and flow calculations; (3-20-20)T

iii. Declining balance reports that demonstrate the system has the capacity to supply the service area of the system served by the extension; or (3-20-20)T

iv. Other documentation acceptable to the Department. (3-20-20)T

**02. Submittal to the Department.** When required, facility plans shall be submitted to the Department for review and approval prior to the submission of plans and specifications for a project related to the facility plan. (3-20-20)T

**03. Engineer's Seal Required.** Facility plans submitted to the Department shall bear the imprint of an Idaho licensed professional engineer's seal that is both signed and dated by the engineer. (3-20-20)T

**04. Facility Plan Contents.** The facility plan shall include basic information, criteria and assumptions, and alternative solutions with preliminary layouts and cost estimates as applicable. The facility plan is intended to

address system wide growth, to identify system deficiencies, and to lay out a plan for system upgrades and expansion. (3-20-20)T

**a.** New public water system facility plan. The minimum requirements for a facility plan for a new public water system are listed in Subsections 502.04.a.i. through 502.04.a.viii. If specific items listed in Subsections 502.04.a.i. through 502.04.a.viii. are not applicable to a particular system, then the submitting engineer shall state this in the facility plan and state the reason why the requirement is not applicable. The facility plan must also include sufficient detail to support applicable requirements of Sections 501 through 552. (3-20-20)T

- i. Location. A general description and location of the system. (3-20-20)T
- ii. Population. The estimated design population of the system including the number of connections and the number of EDUs proposed. (3-20-20)T
- iii. Sources of Water. Adequacy, quality, and availability of sources of water for potable use and a description of the non-potable irrigation system. (3-20-20)T
- iv. Treatment. Identify and describe any anticipated treatment. (3-20-20)T
- v. Water Quantity. Design data for domestic, irrigation, fire fighting, commercial, or industrial water uses, including peak hour, maximum day, and average day demands. (3-20-20)T
- vi. Storage. Include the size and location of any anticipated storage structures. (3-20-20)T
- vii. Operating Pressure. Pressure ranges for all flow conditions prescribed by these rules. (3-20-20)T
- viii. Sewage. Describe the sewage collection system and sewage treatment works, with reference to their relationship to existing or proposed water works structures which may affect the operation of the water supply system, or which may affect the quality of the supply. (3-20-20)T

**b.** Existing public water system facility plan. The minimum requirements for a facility plan for an existing public water system must include Subsections 502.04.b.i. through 502.04.b.vii. as well as Subsections 502.04.a.i. through 502.04.a.viii. If specific items listed in Subsections 502.04.b.i. through 502.04.b.vii. or Subsections 502.04.a.i. through 502.04.a.viii. are not applicable to a particular facility plan, then the submitting engineer shall state this in the facility plan and state the reason why the requirement is not applicable. The facility plan must also include sufficient detail to support applicable requirements of Sections 501 through 552. (3-20-20)T

- i. Hydraulic analysis. A computer analysis of the hydraulics of the distribution system if requested by the Department; any analysis of an existing distribution system shall be properly calibrated. The type or sophistication of analysis shall be dependent on the type of system. (3-20-20)T
- ii. Identify and evaluate problems related to the drinking water system. (3-20-20)T
- iii. Describe financing methods. (3-20-20)T
- iv. Set forth anticipated charges for users. (3-20-20)T
- v. Review organizational and staffing requirements. (3-20-20)T
- vi. Offer a project(s) recommendation for client consideration. (3-20-20)T
- vii. Outline official actions and procedures to implement the project. (3-20-20)T

**c. Public Water System Facility Plan funded by the State Revolving Fund.** If the project is funded by the state revolving fund or a state grant, the facility plan must meet the requirements of Subsections 502.04.a. and 502.04.b., and other requirements that may also apply. See IDAPA 58.01.20, "Rules for Administration of Drinking Water Loan Program," and IDAPA 58.01.22, "Rules for Administration of Planning Grants for Public Drinking Water

Facilities.” (3-20-20)T

**d.** Facility Plan Guidance. A checklist, which can be used as guidance, can be found on the DEQ website at <http://www.deq.idaho.gov>. The guidance document is for Department grant and loan projects, but may be used in part or in whole as a guide to assist in the development of any facility plan. (3-20-20)T

**503. FACILITY AND DESIGN STANDARDS: PRELIMINARY ENGINEERING REPORTS.**

See the definition of Preliminary Engineering Report in Section 003. Preliminary engineering reports are required for all new water systems or material modifications to existing water systems that require plan and specification review and approval pursuant to Subsection 504.03. The preliminary engineering report shall be in conformance with the approved facility plan or shall describe any modifications to the facility plan. Preliminary engineering reports must be completed for all major water system projects including, but not limited to, source, pump station, pressure control, storage, and treatment projects. Preliminary engineering reports are not required for simple water main extensions that are approved in accordance with Subsections 502.01.a. or 502.01.b. (3-20-20)T

**01. Submittal to Reviewing Authority.** Preliminary engineering reports shall be submitted to the Department for review and must be approved by the Department prior to the submission of plans and specifications. The Department may allow well construction plans and specifications to be submitted concurrently with a preliminary engineering report for these projects. (3-20-20)T

**02. Seal Required.** Preliminary engineering reports submitted to the Department shall bear the imprint of an Idaho licensed professional engineer's seal that is both signed and dated by the engineer. The Department will accept the seal and signature of an Idaho licensed professional geologist on preliminary reports for well source, spring source, or infiltration gallery site reports, and for well construction. (3-20-20)T

**03. Preliminary Engineering Report Contents.** The preliminary engineering report must include sufficient detail to demonstrate that the proposed project meets applicable criteria. The items included in Subsections 503.03.a. through 503.03.e., and all applicable issues and items specifically required in Sections 500 through 552, shall be addressed in detail. As required, a preliminary engineering report shall also identify and evaluate drinking water related problems, assemble basic information, present criteria and assumptions, examine alternative solutions with preliminary layouts and cost estimates, offer a conclusion with a proposed project, and outline official actions and procedures to implement the project. If specific items in Subsections 503.03.a. through 503.03.e. are not applicable to a particular design, then the designer shall state this in the preliminary engineering report and state the reason why it is not applicable. Items adequately addressed in the facility plan under which the project is being designed may be addressed by reference for purposes of the preliminary engineering report. (3-20-20)T

**a.** All preliminary engineering reports shall include items in Subsection 503.03.a. and the applicable items from Subsections 503.03.b. through 503.03.e. (3-20-20)T

**i.** General information. The preliminary engineering report general information shall include, but is not limited to: (3-20-20)T

(1) Project description. A detailed description of the proposed project; (3-20-20)T

(2) Site selection. A general description of the location of the project and justification of the site selection; (3-20-20)T

(3) Access and utilities. A general discussion of adequacy of local roadways and availability of power or other utilities; (3-20-20)T

(4) Surrounding land use. A general discussion of surrounding land use, including any potential sources of contamination; and (3-20-20)T

(5) Security. A general discussion of planned security features such as fencing, lighting, alarm systems, etc. (3-20-20)T

**ii.** Coordination with facility plan. The preliminary engineering report shall discuss or reference items

- provided in the Department-approved facility plan. These items include, but are not limited to: (3-20-20)T
- (1) Existing System. A general description of the existing system and how the project fits into the overall system and facility plan; (3-20-20)T
  - (2) Size. The estimated system size based on number of persons, number of connections, or number of EDUs served or impacted by the project; (3-20-20)T
  - (3) Water Quantity. Design data for domestic, irrigation, fire fighting, commercial and industrial water uses, including peak hour, maximum day, and average day demands; (3-20-20)T
  - (4) Storage. How the project will affect various storage requirements. See definition of Components of Finished Water Storage in Section 003; (3-20-20)T
  - (5) Operating Pressure. Pressure ranges for all flow conditions prescribed by these rules; (3-20-20)T
  - (6) Hydraulic Analysis. A computer analysis of the hydraulics of the distribution system if requested by the Department; any analysis of an existing distribution system shall be properly calibrated. The type and sophistication of analysis shall be dependent on the type of system; (3-20-20)T
  - (7) Sources of Water. A general discussion of the adequacy, quality and availability of source of water. A water system that is to be served by a separate non-potable irrigation system must provide documentation to demonstrate the actual availability of water in sufficient quantity to ensure that the irrigation system will not compete with or in any way diminish the source of water for the potable water system; (3-20-20)T
  - (8) Sewage. Describe the sewage collection system and sewage treatment works, with special reference to their relationship to existing or proposed water works structures which may affect the operation of the water supply system, or which may affect the quality of the supply; (3-20-20)T
  - (9) Treatment wastes. Assesses and characterize all anticipated waste discharges generated by the project and any activities that could impact the water supply. The location of each waste handling area or discharge point shall be shown on a scale map; (3-20-20)T
  - (10) Financing methods. Provide brief discussion of financing options investigated or planned; and (3-20-20)T
  - (11) Flooding. Discuss mechanisms for protection of the system from flooding. (3-20-20)T
- iii. Code provisions. The preliminary engineering report shall include a summary of applicable codes and standards that apply to the proposed project. (3-20-20)T
  - iv. Cost estimate. The preliminary engineering report shall provide, as applicable, estimated construction costs for public works projects or projects funded through public monies. (3-20-20)T
  - v. Construction schedule. The preliminary engineering report shall include the proposed construction schedule. (3-20-20)T
  - vi. Potential sources of contamination. Identify sources of contamination and describe how the drinking water sources will be protected. (3-20-20)T
  - vii. Soils and ground water levels. Generally discuss soil, ground water conditions, and potential building foundation problems, including a description of: (3-20-20)T
    - (1) The character of the soil through which water mains are to be laid; (3-20-20)T
    - (2) Characteristics of the soil, water table, and geological substrate that may affect the design and construction of the foundations of proposed structures; and (3-20-20)T

- (3) The approximate elevation of ground water in relation to subsurface structures. (3-20-20)T
- b.** Drinking water wells and spring construction projects. In addition to items listed in Subsection 503.03.a., a preliminary engineering report for source water construction projects shall include all items listed in Subsection 503.03.b., applicable items in Sections 510 through 514, and Sections 500 to 552 should be evaluated for their relevance to the project. (3-20-20)T
- i. Anticipated geology and hydrogeology. Include geological data and existing well logs. (3-20-20)T
- ii. Drilling methodology. Describe the anticipated drilling method and well construction. (3-20-20)T
- iii. Water quality. Anticipated potability and water quality including monitoring results required for new sources by these rules. (3-20-20)T
- iv. Water rights. Provide the appropriate documentation for the water rights for the drinking water source. (3-20-20)T
- v. Dimensions of the well lot and location of source. Include geographical coordinates of the source location. (3-20-20)T
- vi. Evaluation of surface water influence. For all new ground water sources, including but not limited to wells, springs, and infiltration galleries, systems shall supply information as required by the Department to determine if these sources are under the direct influence of surface water. (3-20-20)T
- vii. Provide a site evaluation report as required by Section 510 for wells and 514 for springs. (3-20-20)T
- c.** Well and pump house construction projects. In addition to items listed in Subsection 503.03.a., preliminary engineering reports for well and pump house construction projects shall include all items listed in Subsection 503.03.c., applicable items in Sections 511, 541, 547, and Sections 500 to 552 should be evaluated for their relevance to the project. (3-20-20)T
- i. Well house. Include information on the anticipated construction and well house equipment such as heating, ventilation, interior lighting, and drain(s). (3-20-20)T
- ii. Water Level. Provide a brief description of the means for measuring the water level in the well. (3-20-20)T
- iii. Well pump. Include information on the proposed or planned pump, including the pump curve. (3-20-20)T
- iv. Controls. Describe the equipment and controls for the well and pump house. This includes but is not limited to system control and data acquisition, variable frequency drive, and other manual or automated controls within the well house. (3-20-20)T
- v. Piping and appurtenances including but not limited to sample taps, discharge piping, flow meters, check valves, and pressure gauges. Describe the receiving system for the pump to waste volume of water including an evaluation of the capacity of the receiving system and, if applicable, provide documentation that the system owner will accept the estimated volume of water and any limitations the owner places upon that acceptance. (3-20-20)T
- vi. Well vent. Describe the well vent if applicable. (3-20-20)T
- vii. Casings and well caps. Describe the anticipated casing and well cap type and materials. (3-20-20)T
- viii. Pitless adapters and units. Describe the anticipated pitless adapter for the well. (3-20-20)T

ix. Soil and water conditions. Describe the soil and ground water conditions that may affect the design and construction of proposed structure(s). (3-20-20)T

d. Reservoir and storage construction projects. In addition to items listed in Subsection 503.03.a., preliminary engineering reports for reservoir and storage construction projects shall include all items listed in Subsection 503.03.d., applicable items in Sections 544, and Sections 500 to 552 should be evaluated for their relevance to the project. (3-20-20)T

i. Sizing. Describe the required storage capacity and the related components of finished water storage. (3-20-20)T

ii. Overflow. Describe the anticipated overflow system for the water storage project and where the overflow will discharge. (3-20-20)T

iii. Vents. Describe the venting system used for the water storage project if applicable. (3-20-20)T

iv. Construction materials. Describe the construction materials used for the storage project. (3-20-20)T

v. Protection from freezing. Describe the protection of storage facility features from freezing especially riser pipes, overflows, and vents. (3-20-20)T

vi. Grading. Describe any site work or grading that may be necessary. (3-20-20)T

vii. Corrosion prevention. Provide a discussion on methods to prevent corrosion such as coatings, cathodic protection, corrosion resistant materials, and encasement. (3-20-20)T

viii. Disinfection. Describe the methods to be used to disinfect the storage facility and the testing to check for proper disinfection. (3-20-20)T

e. Surface water and ground water under the direct influence of surface water (GWUDI) treatment construction projects. In addition to items listed in Subsection 503.03.a., preliminary engineering reports for surface water treatment and GWUDI construction projects shall include all items listed in Sections 503.03.e., applicable items in Sections 515 through 540, and Sections 500 to 552 should be evaluated for their relevance to the project. (3-20-20)T

i. Intake structures. Describe the intake structures that will be used. (3-20-20)T

ii. Off-stream raw water storage. If applicable, describe the proposed off-stream raw water storage. (3-20-20)T

iii. Treatment methods. Describe the treatment methods and potential alternatives including the removal of pathogens, disinfection, enhanced disinfection, water quality monitoring, and redundancy provisions. (3-20-20)T

iv. Treatment Wastes. Characterize the various wastes from the water treatment processes and, if applicable, their volumes, constituents, and proposed treatment and disposal. If discharging to a sanitary sewage system, verify that the system is capable of handling the flow to the treatment works and that the treatment works is capable and willing to accept the additional loading. (3-20-20)T

v. Monitoring Results. Provide applicable raw water monitoring results as required by these rules including anticipated turbidity ranges, microbiological, physical, chemical, radiological, and other parameters as determined by the Department. (3-20-20)T

vi. Potential contamination. An assessment of the degree of hazard to the supply by agricultural, industrial, recreational, and residential activities in the watershed, and by accidental spillage of materials that may be toxic, harmful or detrimental to treatment processes. (3-20-20)T

- vii. Waste discharge. Assess all waste discharges and activities that could impact the water supply. The location of each waste discharge shall be shown on a scale map. (3-20-20)T
- viii. Hydrological and historical stream flow data. Provide any available records and data. (3-20-20)T
- ix. Water rights and water quantity. A copy of the appropriate permit(s) or application(s) from the Idaho Department of Water Resources regarding authorization to appropriate public waters of the state of Idaho in sufficient quantity to meet the design requirements of the system. (3-20-20)T
- x. Turbidity. Anticipated turbidity range. (3-20-20)T
- xi. Watershed. Assessment of the degree of control the water system will be able to exercise over the watershed. (3-20-20)T
- xii. Projected future uses of impoundments or reservoirs within the watershed. (3-20-20)T
- xiii. Water quality. Submit source water sample data over a sufficient period of time to assess the microbiological, physical, chemical and radiological characteristics of the water. (3-20-20)T
- xiv. Stream characteristics. Provide consideration of currents, wind and ice conditions, and the effect of confluent streams. (3-20-20)T

**504. FACILITY AND DESIGN STANDARDS: REVIEW OF PLANS AND SPECIFICATIONS.**

The facility and design standards set forth in these rules shall be applied in the review of plans and specifications for public water system facilities. If design issues are not addressed by the facility and design standards set out in these rules, then guidance documents, some of which are listed in Subsection 002.02, shall be used as guidance in the design and review of plans and specifications for public drinking water facilities. See also Section 013. (3-20-20)T

**01. Ownership.** Documentation of the ownership and responsibility for operating the proposed system shall be made available to the Department prior to or concurrent with the submittal of plans and specifications as required in Subsection 504.03. The documentation must show organization and financial arrangements adequate to assure construction, operation and maintenance of the system according to these rules. Documentation shall also include the name of the water system, the name, address, and phone number of the supplier of water, the system size, and the name, address, and phone number of the system operator. (3-20-20)T

**02. Connection to an Existing System.** If the proposed project is to be connected to an existing public water system, a letter from the purveyor must be submitted to the Department stating that the purveyor will be able to provide services to the proposed project. The Department may require documentation supporting the ability of the purveyor to provide service to the new system without diminishing quality of service to existing customers. This letter must be submitted prior to or concurrent with the submittal of plans and specifications as required in Subsection 504.03. (3-20-20)T

**03. Plans and Specifications Required.** (3-20-20)T

**a.** Prior to construction of new public drinking water systems, new drinking water systems designed to serve fifteen (15) or more service connections, or material modifications of existing public water systems, plans and specifications must be submitted to the Department for review and approval. Construction should commence as soon as practical after approval, and if construction is not completed within twelve (12) months of the Department's final approval, an extension or re-approval must be obtained from the Department. The Department may require re-submittal of all or part of the plans and specifications prior to issuing an extension or re-approving the plans and specifications. (3-20-20)T

**b.** Plans and specifications for simple water main extensions shall not require pre-construction approval by the Department when such extensions will be owned and operated by a city, county, quasi-municipal corporation or regulated public utility, provided that such plans and specifications are reviewed and approved by a QLPE who was not involved in the preparation of the plans and specifications being reviewed to verify compliance with the requirements of these rules prior to initiation of construction. Any plans and specifications approved

pursuant to Subsection 504.03.b. shall be transmitted to the Department at the time construction is authorized and shall be marked or stamped as "Approved for Construction." Along with the plans and specifications, the transmittal must include the items listed in Subsections 504.03.b.i. through 504.03.b.vii. The plans and specifications must bear the imprint of an Idaho licensed professional engineer's seal that is both signed and dated by the engineer, and the approval or transmittal letter must be sealed, signed, and dated by the QLPE that is approving the plans and specifications. (3-20-20)T

i. A statement that the author of the transmittal letter is the QLPE representing the city, county, quasi-municipal corporation or regulated public entity. (3-20-20)T

ii. A statement that the extension project complies with the current facility plan or preliminary engineering report, or a statement that the water system has adequate capacity. Please see Subsection 502.01.b. for further information. (3-20-20)T

iii. A statement from the city, county, quasi-municipal corporation or regulated public entity or its authorized agent that the water system purveyor will serve the project. (3-20-20)T

iv. A statement from the city, county, quasi-municipal corporation or regulated public entity or its authorized agent that the water system purveyor will own and operate the project after construction is complete. (3-20-20)T

v. A statement by the QLPE that the plans and specifications are approved for construction. (3-20-20)T

vi. A statement by the QLPE that the plans and specifications comply with the facility standards within these rules. (3-20-20)T

vii. A statement recommending whether sanitary restrictions can be released or should remain in force. (3-20-20)T

c. Subsections 504.03.c.i. through 504.03.c.vi. outline the projects which QLPEs may approve and which QLPEs may not approve. (3-20-20)T

i. A QLPE may approve plans and specifications for simple water main extensions that are able to connect to an existing water system owned by a city, county, quasi-municipal corporation, or regulated public utility at the time the extension is approved for construction by the QLPE. (3-20-20)T

ii. A QLPE may approve plans for simple water main extensions which will connect to an existing water system, but are unable to connect to the system at the time the extension is approved for construction by the QLPE, provided sanitary restrictions remain in force for the proposed extension. (3-20-20)T

iii. A QLPE may not approve plans and specifications which include mechanical systems such as booster stations. (3-20-20)T

iv. A QLPE may not approve plans and specifications for projects which the QLPE was the design engineer or otherwise involved in the design. (3-20-20)T

v. A QLPE employed by a city, county, quasi-municipal corporation, or regulated public utility may approve a design that was prepared by a subordinate engineer or an engineer from a separate design group within the city, county, quasi-municipal corporation, or regulated public utility. (3-20-20)T

vi. A QLPE who is not employed by a city, county, quasi-municipal corporation, or regulated public utility, but is retained by a city, county, quasi-municipal corporation, or regulated public utility for the purpose of plan and specification review may not approve projects designed by the company with which the QLPE is employed. (3-20-20)T

d. At the discretion of the city, county, quasi-municipal corporation or regulated public utility, the



plans addressed by Subsection 504.03.b. may be referred to the Department for review and approval prior to initiation of construction. (3-20-20)T

**04. Criteria for Review.** The Department shall review plans and specifications to determine compliance with these rules and engineering standards of care. If the plans and specifications comply with these rules and engineering standards of care, the Department shall not substitute its judgment for that of the owner's design engineer concerning the manner of compliance with the rule. (3-20-20)T

**05. Schedule for Review.** The Department shall review plans and specifications and endeavor to resolve design issues within forty-two (42) calendar days of submittal such that approval can be granted. If the Department and applicant have not resolved design issues within forty-two (42) calendar days or at any time thereafter, the applicant may file a written demand to the Department for a decision. Upon receipt of such written demand, the Department shall deliver a written decision to the applicant within no more than seven (7) calendar days explaining any reasons for disapproval. The Department shall maintain records of all written demands for decision made pursuant to Subsection 504.05 with such records including the final decision rendered and the timeliness thereof. (3-20-20)T

**06. Engineer's Seal Required.** Plans and specifications submitted to the Department shall bear the imprint of an Idaho licensed professional engineer's seal; except that the Department will accept the seal of an Idaho licensed professional geologist on the following: (3-20-20)T

**a.** Well source, spring source, or infiltration gallery site evaluation reports, as specified in Subsections 510 and 514. (3-20-20)T

**b.** Plans and specifications for well construction and results of field inspection and testing, as specified in Section 510. (3-20-20)T

**07. Contents of Plans and Specifications.** Plans and specifications shall, where pertinent, provide the following: (3-20-20)T

**a.** General layout, including: (3-20-20)T

i. Suitable title. (3-20-20)T

ii. Name of municipality or other entity or person responsible for the water supply. (3-20-20)T

iii. Area or institution to be served. (3-20-20)T

iv. Scale of drawings. (3-20-20)T

v. North arrow. (3-20-20)T

vi. Datum used. (3-20-20)T

vii. General boundaries of municipality or area to be served. (3-20-20)T

viii. Date, name, and address of the designing engineer. (3-20-20)T

ix. Legible prints suitable for reproduction. (3-20-20)T

x. Location and size of existing water mains, if applicable. (3-20-20)T

xi. For systems undergoing material modification, location and nature of existing water works structures and appurtenances affecting the proposed improvements. (3-20-20)T

**b.** Detailed plans, including: (3-20-20)T

- i. Stream crossings, providing profiles with elevations of the stream bed and the estimated normal and extreme high and, where appropriate, low water levels. (3-20-20)T
- ii. Location and size of the property to be used for the development with respect to known references such as roads, streams, section lines, or streets. (3-20-20)T
- iii. Topography and arrangement of present or planned wells or structures. (3-20-20)T
- iv. Elevations of the one hundred (100) year flood level in relation to the floor of structures, upper termination of protective casings, and grade surrounding facilities. (3-20-20)T
- v. Details of well construction, including diameter and depth of drill holes, casing and liner diameters and depths, grouting depths, elevations, and designation of geological formations, water levels and other data as specified in Section 510. (3-20-20)T
- vi. Location of all known existing and potential sources of pollution within five hundred (500) feet of water sources or underground treated storage facilities. (3-20-20)T
- vii. Size, length, and materials of proposed water mains. (3-20-20)T
- viii. Location of existing or proposed streets; water sources, ponds, lakes, and drains; storm sanitary, combined and house sewers; septic tanks, disposal fields and cesspools. (3-20-20)T
- ix. Schematic flow diagrams and hydraulic profiles showing the flow through various plant units. (3-20-20)T
- x. Piping in sufficient detail to show flow through the plant including waste lines. (3-20-20)T
- xi. Locations of all chemical storage areas, chemical feeding equipment, and points of chemical application. (3-20-20)T
- xii. All appurtenances, specific structures, equipment, water treatment plant waste disposal units and points of discharge having any relationship to the plans for water mains or water works structures. (3-20-20)T
- xiii. Locations of sanitary or other facilities, such as lavatories, showers, toilets, and lockers, when applicable or required by the Department. (3-20-20)T
- xiv. Locations, dimensions, and elevations of all proposed plant facilities. (3-20-20)T
- xv. Locations of all sampling taps owned by the water system. (3-20-20)T
- xvi. Adequate description of any significant features not otherwise covered by the specifications that may impact public safety or welfare. (3-20-20)T
- c. Complete, detailed technical specifications shall be supplied for the proposed project, including: (3-20-20)T
  - i. A program for keeping existing water works facilities in operation during construction of additional facilities so as to minimize interruption of service. (3-20-20)T
  - ii. Laboratory facilities and equipment. (3-20-20)T
  - iii. Description of chemical feeding equipment. (3-20-20)T
  - iv. Procedures for flushing, disinfection and testing, as needed, prior to placing the project in service. All wells, pipes, tanks, and equipment which can convey or store potable water shall be disinfected in accordance with AWWA Standards, incorporated into these rules at Subsection 002.01. Plans or specifications shall outline the

procedure and include the disinfectant dosage, contact time, and method of testing the results of this procedure. (3-20-20)T

v. Materials or proprietary equipment for sanitary or other facilities, including any necessary backflow or back-siphonage protection. (3-20-20)T

d. Complete design criteria, as set forth in these rules. (3-20-20)T

e. The Department may require additional information which is not part of the construction drawings, including, but not limited to, head loss calculations, proprietary technical data, and copies of contracts. (3-20-20)T

**08. Notification of Material Deviations.** As set forth in Subsection 504.03, during construction or modification, the reviewing authority must be notified of any material deviation from the approved plans. The reviewing authority's prior written approval is required before any material deviation is allowed. (3-20-20)T

**09. Record Plans and Specifications Required.** (3-20-20)T

a. Within thirty (30) calendar days of the completion of construction of facilities for which plans are required to be reviewed pursuant to Subsection 504.03, record plans and specifications based on information provided by the construction contractor and field observations made by the engineer or the engineer's designee depicting the actual construction of facilities performed, must be submitted to the Department by the engineer representing the city, county, quasi-municipal corporation or regulated public utility that owns the project, or by the design engineer or owner-designated substitute engineer if the facilities will not be owned and operated by a city, county, quasi-municipal corporation or regulated public utility. Such submittal by the professional engineer must confirm material compliance with the approved plans and specifications or disclose any material deviations therefrom. If the construction does not materially deviate from the approved plans and specifications, the owner may have a statement to that effect prepared by an Idaho licensed professional engineer and filed with the Department in lieu of submitting a complete and accurate set of record drawings. (3-20-20)T

b. Record plans and specifications, or a statement submitted in lieu of record plans and specifications, must bear the imprint of an Idaho licensed professional engineer's seal that is both signed and dated by the engineer. (3-20-20)T

c. The Department will accept the seal and signature of an Idaho licensed professional geologist on record plans and specifications, or a statement bearing the seal and signature of an Idaho licensed professional geologist in lieu of record plans and specifications, for record plans and specifications for well construction and results of field inspection and testing, as specified in Section 510. (3-20-20)T

**10. Exception.** The Department may waive the plan and specification approval required of any particular facility or category of facilities when doing so will have no significant impact on public health or the environment. (3-20-20)T

**11. Requirement to Have Approved Plans and Specifications and Approval Letter On-Site During Construction.** It is the responsibility of the owner to maintain one (1) copy of the approved plans and specifications and the approval letter from the reviewing authority on-site during construction at all times. (3-20-20)T

**12. Construction.** Except as provided in Subsection 504.03.b., no construction shall commence until all of the necessary approvals have been received from the Department. The owner shall provide for the inspection of the construction of a public drinking water system facility by an Idaho licensed professional engineer to the extent required to confirm material compliance with the approved plans and to produce accurate record documents as required by Subsection 504.09. (3-20-20)T

**505. -- 509. (RESERVED)**

**510. FACILITY AND DESIGN STANDARDS: SITING AND CONSTRUCTION OF WELLS.** Written approval by the Department is required before water from any new or reconstructed well may be served to the

public. Any supplier of water for a public water system served by one (1) or more wells shall ensure that the following requirements are met: (3-20-20)T

**01. Site Approval.** Prior to drilling, the site of a public water system well must be approved in writing by the Department. The Department shall require the supplier of water to submit a well site evaluation report that takes into account the proposed size, depth, and location of the well. The evaluation may include, but is not limited to the following types of information: (3-20-20)T

- a. An evaluation of the quality of anticipated ground water. (3-20-20)T
- b. Identification of the known aquifers and the extent of each aquifer, based on the stratigraphy, sedimentation, and geologic structure beneath the proposed well site. (3-20-20)T
- c. An estimate of hydrologic and geologic properties of each aquifer and confining layers. (3-20-20)T
- d. Prediction of the sources of water to be extracted by the well and the drawdown of existing wells, springs, and surface water bodies that may be caused by pumping the proposed well. This prediction may be based on analytical or numerical models as determined by the Idaho Department of Water Resources permitting process. (3-20-20)T
- e. Demonstration of the extent of the capture zone of the well, based on the well's design discharge and on aquifer geology, using estimates of hydraulic conductivity and storativity. (3-20-20)T
- f. Description of potential sources of contamination within five hundred (500) feet of the well site. (3-20-20)T

**02. Location.** Each well shall be staked by the design engineer or licensed professional geologist prior to drilling, be located a minimum of fifty (50) feet from the nearest property line, be located a minimum of fifty (50) feet from any potential source of contamination, and be no closer to specified sources of contamination than set forth in Subsection 900.01. In vulnerable settings, the Department may require engineering or hydrologic analysis to determine if the required setback distance is adequate to prevent contamination. (3-20-20)T

**03. Construction Standards.** In addition to meeting the requirements of these rules, all wells shall be constructed in accordance with IDAPA 37.03.09, "Well Construction Standards Rules," and related rules and laws administered by the Idaho Department of Water Resources. All wells shall comply with the drilling permit requirements of Section 42-235, Idaho Code. (3-20-20)T

- a. Casing that meets the requirements set forth in Subsection 900.02 (Table 2). The use of plastic well casing for public water system wells may be considered on a case-by-case basis. Plastic casing shall meet or exceed ASTM Standard F480-02 and ANSI/NSF Standard 61. (3-20-20)T
- b. Public water system wells shall have no less than fifty-eight (58) feet of annular seal of not less than one and one-half (1 ½) inches thickness as measured from land surface to the bottom of the seal unless: (3-20-20)T
  - i. It can be demonstrated to the Department's satisfaction that there is a confining layer at lesser depth that is capable of preventing unwanted water from reaching the intake zone of the well; or (3-20-20)T
  - ii. The best and most practical aquifer at a particular site is less than fifty-eight (58) feet deep; or; (3-20-20)T
  - iii. The Department specifies a different annular seal depth based on local hydrologic conditions. (3-20-20)T
  - iv. More stringent standards are required by applicable Rules of the Idaho Water Resources Board, referenced in Subsection 002.02. (3-20-20)T

c. Specifications shall include allowable tolerances for plumbness and alignment in accordance with AWWA Standards, incorporated by reference into these rules at Subsection 002.01, or as otherwise approved by the Department. If the well fails to meet these requirements, it may be accepted by the Department if it does not interfere with the installation or operation of the pump or uniform placement of grout. (3-20-20)T

d. Geological data shall be collected at each pronounced change in formation and shall be recorded in the driller's log. Supplemental data includes, but is not limited to, accurate geographical location such as latitude and longitude or GIS coordinates, and other information on accurate records of drillhole diameters and depths, assembled order of size and length of casing, screens and liners, grouting depths, formations penetrated, and water levels. (3-20-20)T

e. The owner of each well shall retain all records pertaining to each well until the well has been properly abandoned. (3-20-20)T

f. Wells with intake screens shall: (3-20-20)T

i. Be constructed of materials resistant to damage by chemical action of ground water or cleaning operations. (3-20-20)T

ii. Have openings based on sieve analysis of formation or gravel pack materials. (3-20-20)T

iii. Have sufficient length and diameter to provide adequate specific capacity and aperture entrance velocity not to exceed point three (0.3) feet per second, or as otherwise approved by the Department. (3-20-20)T

iv. Be installed so that the pumping water level remains above the screen under all operating conditions, or otherwise approved by the Department. Where a bottom plate or sump is utilized, it shall be of the same material as the screen, or as otherwise approved by the Department. Where a washdown assembly, tailpipe or sump is used below the screen, it may be made of a different material than the screen. (3-20-20)T

g. Permanent well casing shall be surrounded by a minimum of one and one-half (1 ½) inches of grout to the depth required by Subsection 510.03.b. of these rules, or by the Rules of the Idaho Water Resources Board referenced in Subsection 002.02, whichever is greater. All casing identified in plans and specifications as temporary casing shall be removed prior to well completion. (3-20-20)T

i. Neat cement grout consisting of cement that conforms to AWWA Standard A-100, and water, with not more than six (6) gallons of water per ninety-four (94) pounds of cement, shall be used for one and one-half (1 ½) inch openings. Additives may be used to enhance effectiveness and are subject to approval by the reviewing authority and the Idaho Department of Water Resources on a case-by-case basis. (3-20-20)T

ii. Bentonite grout shall have a solids content not less than twenty-five (25) percent by weight when mixed with water and be specifically manufactured for use in sealing of well casing. Bentonite grout shall not contain weighting agents to increase solids content. Bentonite grout shall not be used above the water table. All bentonite grout shall be installed by positive displacement from the bottom up through a tremmie or float shoe. (3-20-20)T

iii. Where a dry annular space is to be sealed, a minimum of two (2) inches on all sides of the casing shall be required to place bentonite to depths not greater than one hundred (100) feet, using #8 mesh granular bentonite. All dry pour granular bentonite shall be tagged at appropriate intervals to verify placement. If a bridge occurs, a tremmie pipe shall be washed or jetted through the bridge to allow for pumping of grout. Bentonite chips shall be of sufficient size to accommodate proper placement for the existing subsurface conditions. (3-20-20)T

iv. Dry granular bentonite used in wells where a dry annular space is to be sealed with depths greater than one hundred (100) feet shall require an annulus of at least three (3) inches on all sides of the casing, or as approved by the reviewing authority and the Idaho Department of Water Resources. If a bridge occurs, a tremmie pipe shall be washed or jetted through the bridge to allow for pumping of grout. Bentonite chips shall be of sufficient size to accommodate proper placement for the existing subsurface conditions. (3-20-20)T

v. All chip bentonite seals installed through water shall only be used in annular spaces of at least four

(4) inches on all sides of the casing. If a bridge occurs, a tremmie pipe shall be washed or jetted through the bridge to allow for pumping of grout. Bentonite chips shall be of sufficient size to accommodate proper placement for the existing subsurface conditions. Chip bentonite seals installed through water shall be: (3-20-20)T

- (1) Installed in accordance with manufacturer's specifications; or (3-20-20)T
- (2) Installed by pouring chips over a one-quarter (1/4) inch mesh screen for three-eighths (3/8) inch chips to remove fines to prevent bridging at the water table; or (3-20-20)T
- (3) Installed using coated pellets to retard hydration if approved by the reviewing authority and the Idaho Department of Water Resources. (3-20-20)T

vi. Concrete may be approved on a case-by-case basis by the reviewing authority and the Idaho Department of Water Resources. Upon such approval, the approved method shall use a six (6) sack minus one-half (1/2) inch Portland cement concrete and shall be installed by positive displacement from the bottom up through a tremmie pipe. (3-20-20)T

**04. Disinfection.** All tools, bits, pipe, and other materials to be inserted in the borehole shall be cleaned and disinfected in accordance with the Well Construction Standards and permitting requirements of the Idaho Water Resources Board, referenced in Subsection 002.02 This applies to new well construction and repair of existing wells. (3-20-20)T

**05. Well Completion Report Required.** Upon completion of a well, and prior to its use as a drinking water source, the following information and data must be submitted by the water system to the Department. The well completion report must be submitted to the Department prior to or concurrent with the submittal of the preliminary engineering report for well house construction/modification. The well completion report shall bear the imprint of an Idaho licensed professional engineer's or an Idaho licensed professional geologist's seal that is both signed and dated by the engineer or geologist: (3-20-20)T

- a. A copy of all well logs; (3-20-20)T
- b. Results of test pumping, as specified in Subsection 510.06; (3-20-20)T
- c. As constructed plans showing at least the following: (3-20-20)T
  - i. Annular seal, including depth and sealant material used and method of application; (3-20-20)T
  - ii. Casing perforations, results of sieve analysis used in designing screens installed in sand or gravel aquifers, gravel packs; and (3-20-20)T
  - iii. Recommended pump location. (3-20-20)T
- d. Other information as may be specified by the Department. (3-20-20)T
- e. Sampling results for iron, manganese, corrosivity, and other secondary contaminants specified by the Department. Other monitoring requirements are specified in Subsections 510.05.e.i. through 510.05.e.iii. (3-20-20)T
  - i. Community Systems. Results of analysis for total coliform, inorganic chemical contaminants, organic chemicals, and radionuclide contaminants set forth in Subsections 050.01, 050.02, 050.05, 100.01, 100.03, 100.04, 100.05, and 100.06, unless analysis is waived pursuant to Subsection 100.07. (3-20-20)T
  - ii. Nontransient Noncommunity Systems. Results of analysis for total coliform and inorganic and organic chemical contaminants listed in Subsections 050.01, 050.02, 100.01, 100.03, 100.04, unless analysis is waived pursuant to Subsection 100.07. (3-20-20)T
  - iii. Transient Noncommunity Systems. Results of a total coliform, nitrite, and nitrate analysis listed in

Subsections 050.01, 100.01 and 100.03. (3-20-20)T

**06. Test Pumping.** Upon completion of a ground water source, test pumping shall be conducted in accordance with the following procedures to meet the specified requirements: (3-20-20)T

**a.** The well shall be test pumped at the desired yield (design capacity) of the well for at least twenty-four (24) consecutive hours after the drawdown trend has stabilized, as determined by the supervising engineer or geologist. Alternatively, the well may be pumped at a rate of one hundred fifty percent (150%) of the desired yield for at least six (6) continuous hours after the drawdown trend has stabilized, as determined by the supervising engineer or geologist. The field pumping equipment must be capable of maintaining a constant rate of discharge during the test. Discharge water must be piped an adequate distance to prevent recharge of the well during the test. If the well fails the test protocol, design of the water system shall be re-evaluated and submitted to the Department for approval. (3-20-20)T

**b.** Upon completion of well development, the well shall be tested for sand production. Fifteen (15) minutes after the start of the test pumping (at or above the design production rate), the sand content of a new well shall not be more than five (5) parts per million. Sand production shall be measured by a centrifugal sand sampler or other means acceptable to the Department. If sand production exceeds five (5) ppm, the well shall be screened gravel packed, or re-developed. (3-20-20)T

**c.** The following data shall be provided: (3-20-20)T

i. Static water level in the well prior to test pumping; (3-20-20)T

ii. Well yield in gpm and duration of the pump test, including a discussion of any discrepancy between the desired yield and the yield observed during the test; (3-20-20)T

iii. Water level in the well recorded at regular intervals during pumping; (3-20-20)T

iv. Profile of water level recovery from the pumping level projected to the original static water level. (3-20-20)T

v. Depth at which the test pump was positioned in the well; (3-20-20)T

vi. Test pump capacity and head characteristics; (3-20-20)T

vii. Sand production data. (3-20-20)T

viii. Results of analysis based on the drawdown and recovery test pertaining to aquifer properties, long term sustained yield, and boundary conditions affecting drawdown. (3-20-20)T

**d.** The Department may allow the use of other pump test protocols that are generally accepted by engineering firms with specialized experience in well construction, by the well drilling industry, or as described in national standards (such as ANSI/AWWA A100-97), as long as the minimum data specified in Subsection 510.06.c. are provided. The Department welcomes more extensive data about the well, such as step-drawdown evaluations used in determining well capacity for test pumping purposes, zone of influence calculations, and any other information that may be of use in source protection activities or in routine water system operations. (3-20-20)T

**e.** Where aquifer yield, sustainability, or water quality are questionable, the Department, at its discretion, may require additional site specific investigations that could include test well construction, long-term pumping tests, or other means to demonstrate that the aquifer yield is sufficient to meet the long-term water requirements of the project. (3-20-20)T

**07. Conversion of Non-Public Water System Wells for Public Water System Use.** Any existing well constructed for use other than as a public water system source may be considered for use as a public water system source on a case-by-case basis. The owner of such a well must demonstrate to the Department's satisfaction that the well site conforms to the requirements of Subsections 510.01, 510.02, and Section 512, the well is

constructed in a manner that is protective of public health and that both the quantity and quality of water produced by the well meet public water system standards set forth in these rules. (3-20-20)T

**08. Observation Wells.** If observation wells are used and are intended to remain in service after completion of the water supply well, the observation wells shall be constructed in accordance with the requirements for permanent wells and be protected at the upper terminal to preclude entrance of foreign materials. See Rules of the Idaho Water Resources Board referenced in Subsection 002.02. (3-20-20)T

**09. Well Abandonment.** Any water supply well that will no longer be used must be abandoned by sealing the borehole carefully to prevent pollution of the ground water, eliminate any physical hazard, conserve aquifer yield, maintain confined head conditions in artesian wells, and prevent mixing of waters from different aquifers. The objective of proper well abandonment procedures is to restore, as far as possible, the original hydrogeologic conditions. The services of a licensed well driller are required. Instructions for abandoning various types of wells may be obtained from the Idaho Department of Water Resources. See Rules of the Idaho Water Resources Board referenced in Subsection 002.02. (3-20-20)T

**511. FACILITY AND DESIGN STANDARDS: WELL PUMPS, DISCHARGE PIPING, AND APPURTENANCES.**

**01. Sample Tap Required.** A sample tap suitable for collecting bacteriological samples shall be provided on the discharge piping from every well at a point where pressure is maintained but prior to any treatment. This sample tap shall be of the smooth-nosed type without interior or exterior threads, shall not be of the mixing or petcock type, and shall not have a screen, aerator, or other such appurtenance. The sample tap for collecting bacteriological samples may be used for other sampling purposes. In addition, threaded hose bib taps may also be used for collecting samples, other than bacteriological samples, if equipped with an appropriate backflow prevention device as may be necessary to protect the public water system from contamination. (3-20-20)T

**02. Discharge Piping.** The discharge line shall be equipped with the necessary valves and appurtenances to allow a well to be pumped to waste at the design capacity of the well via an approved air gap through an approved non-corrodible screen at a location prior to the first service connection, and shall meet the following requirements: (3-20-20)T

- a.** Be designed to minimize friction loss. (3-20-20)T
- b.** Have control valves and appurtenances located above the pump house floor when an above-ground discharge is provided. (3-20-20)T
- c.** Be protected against contamination. (3-20-20)T
- d.** Vertical turbine pumps shall be equipped with an air release-vacuum relief valve, or equivalent, located upstream from the check valve, with exhaust/relief piping terminating in a down-turned position at least eighteen (18) inches above the floor and covered with a twenty-four (24) mesh corrosion resistant screen. (3-20-20)T
- e.** Have all exposed piping, valves and appurtenances protected against physical damage and freezing. (3-20-20)T
- f.** Be properly anchored to prevent movement, and protected against surge or water hammer. (3-20-20)T
- g.** The pump to waste discharge piping shall be valved to ensure that other system components that could be negatively affected by the quality of the discharged water are not pressurized by the water that is being pumped to waste. (3-20-20)T
- h.** Where two (2) or more wells are connected to a common well house, the discharge piping shall be designed to ensure that each well can be pumped to waste independently without affecting the ability of the other well or wells to pressurize the system. (3-20-20)T



- 03. Pressure Gauge Required.** A pressure gauge shall be provided on all discharge piping. (3-20-20)T
- 04. Flow Meter and Check Valve.** Unless otherwise approved by the Department based on documentation provided by the design engineer, an instantaneous and totalizing flow meter equipped with nonvolatile memory shall be installed on the discharge line of each well in accordance with the manufacturer's specifications. Meters installed on systems with variable frequency drives shall be capable of accurately reading the full range of flow rates. An accessible check valve, which is not located in the pump column, shall be installed in the discharge line of each well between the pump and the shut-off valve. Additional check valves shall be located in the pump column as necessary. (3-20-20)T
- 05. Well Vent.** All wells shall be vented, unless it can be demonstrated that the drawdown under maximum pumping conditions will not exceed ten (10) feet. (3-20-20)T
- a.** For wells not in a pump house, the open end of the vent shall be screened with a twenty-four (24) mesh or similar non-corrodible screen and terminated downward at least eighteen (18) inches above the final ground surface. (3-20-20)T
- b.** If the well is in a pump house, the open end of the vent shall be screened with a twenty-four (24) mesh or similar non-corrodible screen and must terminate at least twelve (12) inches above the pump house floor. (3-20-20)T
- c.** Artesian wells equipped with pumps may need venting or an air valve as determined by the Department. (3-20-20)T
- 06. Casings and Sanitary Well Caps.** The following requirements apply to well casings and sanitary caps: (3-20-20)T
- a.** Casings shall extend at least eighteen (18) inches above the final ground surface. If the well is located within a pump house, casings shall extend least twelve (12) inches above the pump house floor. For a well located in an area subject to flooding, the Department may require an extension of the casing above the one hundred (100) year or highest known flood level, whichever is higher. (3-20-20)T
- b.** Wells shall be cased and provided with an approved cap in such a manner that surface water cannot enter the well. (3-20-20)T
- c.** For community water systems, a permanent means for measuring water level within the casing must be provided. For other water systems, a temporary means to measure water levels should be made available. All equipment required for conducting water level measurements shall be purchased and made available to the water system operator at the time the well is put into service. Where pneumatic or electronic water level measuring equipment is used, it shall be made using corrosion resistant materials attached firmly to the drop pipe or pump column and in such a manner as to prevent entrance of foreign materials. (3-20-20)T
- 07. Well Houses.** For regulatory purposes, a well house is considered a pump house as defined in Section 003. Well houses must meet the requirements for pump houses as set forth in Section 541. All above ground discharge piping shall be contained in a well house or otherwise protected from freezing. (3-20-20)T
- 08. Pitless Adapters and Units.** Pitless adapters or pitless units: (3-20-20)T
- a.** Shall be of the type marked approved by the National Sanitation Foundation or Pitless Adapter Division of the Water Systems Council. (3-20-20)T
- b.** Shall be designed, constructed and installed to be watertight including the cap, cover, casing extension and other attachments. (3-20-20)T
- c.** Shall be field tested for leaks before being put into service. The procedure outlined in "Manual of Individual and Non-Public Water Supply Systems," referenced in Subsection 002.02, or other procedure approved by the Department shall be followed. (3-20-20)T

**d.** Pitless adapters with a two (2) inch or smaller discharge line shall be provided with a swing joint outside the pitless adapter unit to reduce strain, deformation, and possible leakage of the pitless seal caused by settling soils in the trench. The orientation of swing joints shall be such that any settling that occurs will tighten the threads. The hole in the casing shall be cut with a saw rather than a torch with an opening large enough to allow seating of gaskets. (3-20-20)T

**e.** Shall be provided with a contamination-proof entrance connection for electrical cable. (3-20-20)T

**f.** In the case of pitless adapters: (3-20-20)T

**i.** Threaded adapters shall be installed by drilling a hole not more than one quarter (1/4) inch larger than the outer diameter of the pitless shank. No torch-cut holes shall be accepted. The orientation of swing joints shall be such that any settling that occurs will tighten the threads. (3-20-20)T

**ii.** The only field welding permitted will be that needed to connect a pitless adapter to the casing. (3-20-20)T

**g.** In the case of pitless units: (3-20-20)T

**i.** Shall be shop-fabricated from the point of connection with the well casing to the unit cap or cover. (3-20-20)T

**ii.** Shall be constructed of materials and weight at least equivalent to and compatible with the well casing. (3-20-20)T

**iii.** Shall be threaded or welded to the well casing. Threaded units shall be installed by drilling a hole not more than one quarter (1/4) inch larger than the outer diameter of the pitless shank. No torch-cut holes shall be accepted. If the connection to the casing is by field weld, the shop-assembled unit must be designed specifically for field welding to the casing. (3-20-20)T

**iv.** Shall terminate at least eighteen (18) inches above final ground elevation or three (3) feet above the 100-year flood level or the highest known flood elevation, whichever is higher, or as otherwise approved by the Department. (3-20-20)T

**v.** Shall be provided with access to disinfect the well. (3-20-20)T

**vi.** Shall have field connection to the lateral discharge from the pitless unit of threaded, flanged, or mechanical joint connection. (3-20-20)T

**h.** After installation of a pitless adapter or unit, the disturbed well seal shall be repaired or replaced to meet original seal specifications unless otherwise proposed by the design engineer and approved by the Department. The engineering proposal shall ensure that the material surrounding the final seal is moisture controlled and compacted such that it equals or exceeds the characteristics of the native soil prior to being disturbed. (3-20-20)T

**09. Wells Not Allowed in Pits.** Wells shall not be located in pits. Exceptions to this requirement will be granted by the Department if the well was constructed prior to November 5, 1964, and the installation is constructed or reconstructed in accordance with the requirements of the Department to provide watertight construction of pit walls and floors, floor drains and acceptable pit covers. (3-20-20)T

**10. Discharge Pumps.** Discharge pumps shall be subject to the following requirements: (3-20-20)T

**a.** Line shaft pumps shall. (3-20-20)T

**i.** Have the casing firmly connected to the pump structure or have the casing inserted into a recess extending at least one-half (1/2) inch into the pump base. (3-20-20)T

- ii. Have the pump foundation and base designed to prevent water from coming into contact with the joint. (3-20-20)T
- iii. Use lubricants that meet ANSI/NSF Standard 61. (3-20-20)T
- b. When a submersible pump is used: (3-20-20)T
  - i. The top of the casing shall be effectively sealed against the entrance of water under all conditions of vibration or movement of conductors or cables. (3-20-20)T
  - ii. The electrical cable shall be firmly attached to the drop pipe at twenty-one (21) foot intervals or less, or at each coupling or joint. (3-20-20)T

**512. FACILITY AND DESIGN STANDARDS: WELL LOT.**

A well lot shall be provided for wells constructed after November 1, 1977. The well lot shall be owned in fee simple by the supplier of water or controlled by lease or easement with a term of not less than the useful life of the well and be large enough to provide a minimum distance of fifty (50) feet between the well and the nearest property line. (3-20-20)T

**01. Use of Chemicals on the Well Lot.** No pesticides, herbicides, or fertilizers shall be applied to a well lot without prior approval from the Department. (3-20-20)T

**02. Storage of Hazardous Materials on the Well Lot.** No pesticides, herbicides, fertilizers, portable containers of petroleum products, or other materials known to be toxic or hazardous shall be stored on a well lot, except that: (3-20-20)T

a. An internal combustion engine to drive either a generator for emergency standby power or a pump to provide fire flows, and an associated fuel tank, may be placed on the well lot. (3-20-20)T

b. A propane or natural gas powered generator is preferable to reduce risk of fuel spillage. (3-20-20)T

c. If a diesel or gasoline-fueled engine is used, the fuel tank and connecting piping must be approved by the Underwriter's Laboratory, Inc., double-walled, meet the requirements of the local fire jurisdiction, and include both spill prevention and overfill protection features. The tank must be above ground and may be contained within the structural base of the generator unit. A licensed water system operator shall be present during filling of the tank following a period of usage, or during periodic extraction and replacement of outdated fuel. (3-20-20)T

d. Should the internal combustion engine be located within the pump house, the floor of the pump house shall be constructed so as to contain all petroleum drips and spills so that they will not be able to reach the floor drain(s). Engine exhaust shall be directly discharged outside the pump house. (3-20-20)T

e. A spill containment structure shall surround all fuel tanks and be sized to contain at least one hundred ten percent (110%) of the fuel tank volume. The Department may require additional containment capacity in settings where accumulation of snow, ice, or rain water could be expected to diminish the usable capacity of the structure. (3-20-20)T

**03. Location of Hydrants.** Hydrants of the frost free type shall be placed in the buried piping system at a minimum of five (5) feet away from the well casing to prevent drain water from accumulating and compromising the grout seal surrounding the well casing. (3-20-20)T

**04. Parking Lots and Vehicle Storage.** No public parking or vehicle storage shall be allowed on the well lot, except that operation/maintenance vehicles may be temporary parked on the well lot during the normal course of business. (3-20-20)T

**513. FACILITY AND DESIGN STANDARDS: NUMBER OF GROUND WATER SOURCES REQUIRED – EXISTING SYSTEMS.**

Existing community water systems served by ground water and intending to serve more than twenty-five (25)

connections or equivalent dwelling units are subject to the following requirements for the number of ground water sources required. (3-20-20)T

**01. Existing System with All Sources Constructed Prior to July 1, 1985.** A community water system served by ground water and with all existing sources constructed prior to July 1, 1985 will be required to comply with Subsection 501.17 upon substantially modifying the system after July 2002. (3-20-20)T

**02. Existing System with Any Sources Constructed After July 1, 1985.** A community water system served by ground water with any sources constructed after July 1, 1985 is required to comply with Subsection 501.17 when a modification is made to the system which increases the population served or number of service connections, increases the length of transmission and distribution water mains, or increases the peak or average water demand. (3-20-20)T

**514. FACILITY AND DESIGN STANDARDS: SPRING SOURCES.**

Written approval by the Department is required before water from any new or reconstructed spring source may be served to the public. For new spring sources, the Department shall require a site evaluation report containing applicable required information listed in Subsection 510.01. This information includes, but is not limited to, the following: an evaluation of the potability and quality of anticipated spring water; an estimate of hydrologic and geologic properties of the aquifer; and a description of potential sources of contamination within five hundred (500) feet of the spring. Any supplier of water for a public water system served by one (1) or more springs shall ensure that the following requirements are met: (3-20-20)T

**01. Protection of the Spring.** Springs shall be housed in a permanent structure and protected from contamination including the entry of surface water, animals, and dust. (3-20-20)T

**02. Spring Box or Combined Spring Box/Finished Water Storage Design.** To facilitate efficient design and review of spring box or combined spring box/finished water storage designs, these site-specific designs should be coordinated in advance with the Department. Specific issues to be addressed are: (3-20-20)T

**a.** The inlet shall be screened as determined by the Department and located above the floor of the collection chamber. (3-20-20)T

**b.** Unless otherwise approved by the Department based on documentation provided by the design engineer, the spring box or combined spring box/finished water storage tank shall meet the applicable design requirements of Section 544 - Facility and Design Standards: General Design of Finished Water Storage. (3-20-20)T

**03. Sample Tap Required.** A sample tap suitable for collecting bacteriological samples shall be provided. This sample tap shall be of the smooth-nosed type without interior or exterior threads, shall not be of the mixing or petcock type, and shall not have a screen, aerator, or other such appurtenance. The sample tap for collecting bacteriological samples may be used for other sampling purposes. In addition, threaded hose bib taps may also be used for collecting samples, other than bacteriological samples, if equipped with an appropriate backflow prevention device as may be necessary to protect the public water system from contamination. (3-20-20)T

**04. Flow Measurement.** A flow meter or other flow measuring device shall be provided. (3-20-20)T

**05. Protected Area.** The entire area within a one hundred (100) foot radius of the spring box shall be owned by the supplier of water or controlled by a long term lease, fenced to prevent trespass of livestock and void of buildings, dwellings and sources of contamination. Surface water shall be diverted from this area. (3-20-20)T

**515. FACILITY AND DESIGN STANDARDS: SURFACE SOURCES AND GROUND WATER SOURCES UNDER THE DIRECT INFLUENCE OF SURFACE WATER.**

Written approval by the Department is required before water from any new surface source or ground water source that is under the direct influence of surface water may be served to the public. Infiltration collection lines or galleries are considered ground water under the direct influence of surface water unless demonstrated otherwise. Infiltration galleries that are not directly influenced by surface water shall meet the requirements of Section 514. The area around infiltration lines shall be under the control of the water purveyor for a distance acceptable to the Department. (3-20-20)T

- 01. Intake Structures.** Design of intake structures shall provide for: (3-20-20)T
- a.** Withdrawal of water from more than one (1) level if quality varies with depth. (3-20-20)T
  - b.** Separate facilities for release of less desirable water held in storage. (3-20-20)T
  - c.** Where frazil ice may be a problem, holding the velocity of flow into the intake structure to a minimum, generally not to exceed point five (0.5) feet per second. Frazil ice is made up of randomly distributed ice crystals that are formed in flowing water that has cooled below thirty-two (32) degrees Fahrenheit and is prevented from forming into ice sheets by the movement of the water. (3-20-20)T
  - d.** Inspection manholes every one thousand (1000) feet for pipe sizes large enough to permit visual inspection. (3-20-20)T
  - e.** Cleaning the intake line as needed. (3-20-20)T
  - f.** Adequate protection against rupture by dragging anchors, ice, or other hazards. (3-20-20)T
  - g.** Ports located above the bottom of the stream, lake or impoundment, but at sufficient depth to be kept submerged at low water levels. (3-20-20)T
  - h.** Where shore wells are not provided, a diversion device capable of keeping large quantities of fish or debris from entering an intake structure. (3-20-20)T
  - i.** If necessary, provisions shall be made in the intake structure to control the influx of nuisance aquatic organisms. Specific control methods must be approved by the reviewing authority. (3-20-20)T
  - j.** When buried surface water collectors are used, sufficient intake opening area must be provided to minimize inlet headloss. Particular attention shall be given to the selection of backfill material in relation to the collector pipe slot size and gradation of the native material over the collector system. (3-20-20)T
- 02. Raw Water Pumps.** Raw water pumping wells shall: (3-20-20)T
- a.** Have motors and electrical controls located above grade (except for submersible pumps), and protected from flooding as required by the reviewing authority. (3-20-20)T
  - b.** Be accessible and designed to prevent flotation. (3-20-20)T
  - c.** Be equipped with removable or traveling screens before the pump suction well. (3-20-20)T
  - d.** Provide for introduction of chlorine or other chemicals in the raw water transmission main if necessary for quality control. (3-20-20)T
  - e.** Where practical, have intake valves and provisions for back flushing or cleaning by a mechanical device and testing for leaks. (3-20-20)T
  - f.** Have provisions for withstanding surges where necessary. (3-20-20)T
- 03. Offstream Raw Water Storage.** An off-stream raw water storage reservoir is a facility into which water is pumped during periods of good quality and high stream flow for future release to treatment facilities. These off-stream raw water storage reservoirs shall be constructed to assure that: (3-20-20)T
- a.** Water quality is protected by controlling runoff into the reservoir. (3-20-20)T
  - b.** Dikes are structurally sound and protected against wave action and erosion. (3-20-20)T

- c. Intake structures and devices meet requirements of Subsection 515.01. (3-20-20)T
- d. Point of influent flow is separated from the point of withdrawal. (3-20-20)T
- e. Separate pipes are provided for influent to and effluent from the reservoir. (3-20-20)T
- 04. Reservoirs.** Impoundments and reservoirs shall provide, where applicable: (3-20-20)T
  - a. Removal of brush and trees to high water elevation. (3-20-20)T
  - b. Protection from floods during construction. (3-20-20)T
  - c. Abandonment of all wells which will be inundated, in accordance with requirements of the Idaho Department of Water Resources. See Rules of the Idaho Water Resources Board referenced in Subsection 002.02. (3-20-20)T

**516. -- 517. (RESERVED)**

**518. FACILITY AND DESIGN STANDARDS: ADDITIONAL DESIGN CRITERIA FOR SURFACE WATER TREATMENT.**

Performance criteria for surface water treatment facilities are specified in National Primary Drinking Water Regulations, as set forth in Sections 300, 301, and 310 of these rules. Surface water treatment systems must comply with applicable general design requirements in Section 503. In addition, the following design requirements apply specifically to surface water treatment facilities: (3-20-20)T

**01. Engineering Design Requirements.** The system shall ensure that filtration and disinfection facilities for surface water or ground water directly influenced by surface water sources are designed, constructed and operated in accordance with all applicable engineering practices designated by the Department. The design of the water treatment plant must consider the worst raw water quality conditions that are likely to occur during the life of the facility. (3-20-20)T

**02. Removal of Pathogens.** Filtration facilities (excluding disinfection) shall be designed, constructed and operated to achieve at least two (2) log removal of *Giardia lamblia* cysts, two (2) log removal of *Cryptosporidium* oocysts, and one (1) log removal of viruses, except as allowed under Subsection 518.09.b. (3-20-20)T

**03. Disinfection.** Disinfection facilities shall be designed, constructed and operated so as to achieve at least point five zero (0.50) log inactivation of *Giardia lamblia* cysts; and (3-20-20)T

- a. Two (2) log inactivation of viruses if using conventional and slow sand filtration technology; or (3-20-20)T
- b. Three (3) log inactivation of viruses if using direct and diatomaceous earth filtration technology; or (3-20-20)T
- c. Four (4) log inactivation of viruses if using alternate filtration technology. (3-20-20)T
- d. Four (4) log inactivation of viruses if filtration treatment is not used. (3-20-20)T

**04. Enhanced Disinfection.** Higher levels of disinfection than specified under Subsection 518.03 may be required by the Department in order to provide adequate protection against *Giardia lamblia* and viruses. (3-20-20)T

**05. Filter to Waste.** For plants constructed after December 31, 1992, each filter unit must be capable of filter to waste. For plants constructed prior to December 31, 1992, each filter unit must be capable of filter to waste unless the system demonstrates through continuous turbidity monitoring or other means acceptable to the Department that water quality is not adversely affected following filter backwashing, cleaning or media replacement. (3-20-20)T

**06. Continuous Turbidity Monitoring.** For conventional, direct, membrane, and diatomaceous earth

filtration technology, equipment must be provided to continuously measure the turbidity of each filter unit. (3-20-20)T

**07. Continuous Monitoring of Disinfectant.** Equipment must be provided and operated for continuous measurement of disinfectant residual prior to entry to the distribution system, unless the system serves fewer than three thousand three hundred (3,300) people. (3-20-20)T

**08. Continuous Operation Required.** Diatomaceous earth filtration facilities shall include an alternate power source with automatic startup and alarm, or be designed in a manner to ensure continuous operation. (3-20-20)T

**09. Acceptable Technology.** The purveyor shall select a filtration technology acceptable to the Department. (3-20-20)T

**a.** Conventional, direct, membrane, slow sand, diatomaceous earth, and membrane filtration technologies are generally acceptable to the Department on a case-by-case basis. (3-20-20)T

**b.** Alternate filtration technologies may be acceptable if the purveyor demonstrates all of the following to the satisfaction of the Department: (3-20-20)T

**i.** That the filtration technology: (3-20-20)T

(1) Is certified and listed by the National Sanitation Foundation (NSF) under Standard 53, Drinking Water Treatment Units - Health Effects, as achieving the NSF criteria for cyst reduction; or (3-20-20)T

(2) Removes at least ninety-nine percent (99%) (two (2) logs) of *Cryptosporidium* oocysts or surrogate particles and removes or inactivates at least ninety-nine percent (99%) (two (2) logs) of *Giardia lamblia* cysts or *Giardia lamblia* cyst surrogate particles in a challenge study acceptable to the Department. (3-20-20)T

**ii.** Based on field studies or other means acceptable to the Department, it must be demonstrated that the filtration technology has the following capabilities: (3-20-20)T

(1) In combination with disinfection treatment, consistently achieves at least ninety-nine percent (99%) (two (2) logs) removal of *Cryptosporidium* oocysts or surrogate particles and at least ninety-nine and nine tenths percent (99.9%) (three (3) logs) removal or inactivation of *Giardia lamblia* cysts and ninety-nine and ninety-nine hundredths percent (99.99%) (four (4) logs) removal or inactivation of viruses; and (3-20-20)T

(2) Meets the turbidity performance requirements of 40 CFR 141.73 (b). (3-20-20)T

**10. Pilot Studies.** The system shall conduct pilot studies in accordance with the following requirements and in accordance with Subsection 501.19 for all proposed filtration facilities and structural modifications to existing filtration facilities, unless the Department modifies the requirements in writing: (3-20-20)T

**a.** The system shall obtain the Department's approval of the pilot study plan before the pilot filter is constructed and before the pilot study is undertaken. (3-20-20)T

**b.** The design and operation of the pilot study shall be overseen by an Idaho licensed professional engineer. (3-20-20)T

**c.** The system's pilot study plan shall identify at a minimum: (3-20-20)T

**i.** The objectives of the pilot study; (3-20-20)T

**ii.** Pilot filter design; (3-20-20)T

**iii.** Water quality and operational parameters to monitor; (3-20-20)T

- iv. Amount of data to collect; and (3-20-20)T
- v. Qualifications of the pilot plant operator. (3-20-20)T
- d.** The system shall ensure that the pilot study is: (3-20-20)T
  - i. Conducted to simulate conditions of the proposed full-scale design; (3-20-20)T
  - ii. Conducted for at least twelve (12) consecutive months or for a shorter period upon approval by the Department; (3-20-20)T
  - iii. Conducted to evaluate the reliability of the treatment system to achieve applicable water quality treatment criteria specified for filtration systems in 40 CFR 141.72 and 40 CFR 141.73; and (3-20-20)T
  - iv. Designed and operated in accordance with good engineering practices documented in references acceptable to the Department. (3-20-20)T

**11. Redundant Disinfection.** Surface water systems constructed after July 1, 1985, are required to install redundant disinfection components or maintain a backup unit on site as required to maintain constant application of disinfectant whenever water is being delivered to the distribution system. (3-20-20)T

**519. FACILITY AND DESIGN STANDARDS: SURFACE WATER TREATMENT; DESIGN STANDARDS FOR MICROSCREENING.**

A microscreen may be used to reduce nuisance organisms and organic loadings. It shall not be used in place of filtration or coagulation in the preparation of water for filtration. (3-20-20)T

- 01. Design Considerations.** The following shall be taken into account during design: (3-20-20)T
  - a. The nature of the suspended matter to be removed. (3-20-20)T
  - b. The corrosiveness of the water. (3-20-20)T
  - c. The effect of chlorination, when required as pre-treatment. (3-20-20)T
  - d. The duplication of units for continuous operation during equipment maintenance. (3-20-20)T
  - e. Automated backflushing operation when used in conjunction with microfiltration treatment. (3-20-20)T
- 02. Design Requirements.** Design shall provide the following: (3-20-20)T
  - a. A durable, corrosion-resistant screen. (3-20-20)T
  - b. A by-pass arrangement. (3-20-20)T
  - c. Protection against back-siphonage when potable water is used for washing. (3-20-20)T
  - d. Proper disposal of water used to wash the microscreen. (3-20-20)T

**520. FACILITY AND DESIGN STANDARDS: SURFACE WATER TREATMENT: CLARIFICATION PROCESSES.**

Treatment facilities designed to include clarification for processing surface water shall meet the following requirements: (3-20-20)T

**01. Two Units Required.** A minimum of two (2) units for redundancy shall be provided for flocculation and sedimentation such that plant design capacity can be maintained with any component out of service for maintenance or repairs. (3-20-20)T



**02. Parallel or Serial Operation.** The units shall be capable of being operated either in series or parallel where softening is performed. (3-20-20)T

**03. Independent Units.** The units shall be constructed in such a way that each can be taken out of service without disrupting operation, and with drains or pumps sized to allow dewatering in a reasonable period of time. (3-20-20)T

**04. Manual Start-Up.** The units shall be started manually following shutdown. (3-20-20)T

**05. Pre-Treatment.** Waters exhibiting high turbidity may require pretreatment, usually sedimentation with or without the addition of coagulation chemicals. When presedimentation is provided, the following requirements must be met: (3-20-20)T

**a.** Incoming water shall be dispersed across the full width of the line of travel as quickly as possible. Short circuiting must be prevented. (3-20-20)T

**b.** Provisions for bypassing pre-sedimentation basins shall be included. (3-20-20)T

**c.** The need for redundant pretreatment components shall be evaluated according to the type and necessity of the pretreatment. (3-20-20)T

**06. Rapid Mix.** Unless otherwise approved by the Department based on documentation provided by the design engineer, a rapid mix device or chamber is required prior to flocculation, clarification, sedimentation, and settler units. The need for redundant rapid mix components shall be evaluated. Rapid mix shall mean the rapid dispersion of chemicals throughout the water to be treated, usually by violent agitation. The engineer shall submit the design basis for the velocity gradient (G value) selected, considering the chemicals to be added and water temperature, color and other related water quality parameters. Basins or mixing chambers shall be equipped with devices capable of providing adequate mixing for all treatment flow rates. (3-20-20)T

**07. Flocculation.** Flocculation shall mean the gathering together of fine particles in water by gentle mixing after the addition of coagulant chemicals to form larger particles. (3-20-20)T

**a.** Basin inlet and outlet design shall minimize short-circuiting and destruction of floc. A drain, pumps, or a combination of both drain and pumps shall be provided to accomplish dewatering and sludge removal. (3-20-20)T

**b.** The flow-through velocity shall not be less than one-half (0.5) nor greater than one and one-half (1.5) feet per minute with a detention time for floc formation of at least thirty (30) minutes unless otherwise approved by the Department. (3-20-20)T

**c.** Agitators shall be driven by variable speed drives. (3-20-20)T

**d.** Flocculation and sedimentation basins shall be as close together as possible. The velocity of flocculated water through pipes or conduits to settling basins shall be not less than one-half (0.5) nor greater than one and one-half (1.5) feet per second. Allowances must be made to minimize turbulence at bends and changes in direction. (3-20-20)T

**08. Small Systems May Use Baffling.** Baffling may be used to provide for flocculation in small plants upon approval by the Department. (3-20-20)T

**09. Sedimentation Units.** The following criteria apply to conventional sedimentation units: (3-20-20)T

**a.** A minimum of two (2) hours of settling time shall be provided following flocculation unless adequate settling in less time can be demonstrated. (3-20-20)T

- b. Inlets shall be designed to distribute the water equally and at uniform velocities. (3-20-20)T
- c. Outlet weirs or submerged orifices shall maintain velocities suitable for settling in the basin and minimize short-circuiting. Outlet weirs shall be designed so that the rate of flow over the outlet weirs or through the submerged orifices shall not exceed twenty-thousand (20,000) gallons per day per foot of the outlet launder. The entrance velocity through the submerged orifices shall not exceed one-half (0.5) feet per second. (3-20-20)T
- d. The velocity through settling basins shall not exceed one-half (0.5) feet per minute. The basins must be designed to minimize short-circuiting. Fixed or adjustable baffles must be provided as necessary to achieve the maximum potential for clarification. (3-20-20)T
- e. When an overflow weir or pipe is provided the overflow shall discharge by gravity with a free fall at a location where the discharge will be noted. (3-20-20)T
- f. Adequate sludge collection equipment that ensures proper basin coverage shall be provided and basins must be provided with a means for dewatering. (3-20-20)T
- g. Flushing lines or hydrants shall be provided and must be equipped with backflow prevention devices acceptable to the Department. (3-20-20)T
- h. Sludge removal design shall provide that sludge pipes are not less than three (3) inches in diameter and arranged so as to facilitate cleaning. Entrance to sludge withdrawal piping shall be designed to prevent clogging. Provision shall be made for the operator to observe and sample sludge being withdrawn from the unit. (3-20-20)T
- i. Sludge shall be disposed of in accordance with applicable regulations, as set forth in Section 540. (3-20-20)T
- 10. Solids Contact Clarifiers.** Solids contact clarifiers are generally acceptable for combined softening and clarification where water characteristics, especially temperature, do not fluctuate rapidly, flow rates are uniform and operation is continuous. A minimum of two (2) units are required for surface water treatment as required in Subsection 520.01. (3-20-20)T
- a. Chemicals shall be applied at such points and by such means as to ensure satisfactory mixing of the chemicals with the water. (3-20-20)T
- b. Unless otherwise approved by the Department based on documentation provided by the design engineer, a rapid mix device or chamber ahead of the solids contact clarifier is required to assure proper mixing of the chemicals applied. Mixing devices employed shall be constructed so as to provide good mixing of the raw water with previously formed sludge particles and prevent deposition of solids in the mixing zone. (3-20-20)T
- c. Flocculation equipment shall be adjustable as to speed, pitch, or a combination of speed and pitch and must provide for coagulation in a separate chamber or baffled zone within the unit. (3-20-20)T
- d. Sludge removal design shall provide that sludge pipes are not less than three (3) inches in diameter and arranged so as to facilitate cleaning. Entrance to sludge withdrawal piping shall be designed to prevent clogging. Provision shall be made for the operator to observe and sample sludge being withdrawn from the unit. (3-20-20)T
- e. Blow-off outlets and drains must terminate and discharge at places acceptable to the Department in regard to control of potential cross connections. Cross connection control must be included for the potable water lines used to backflush sludge lines. (3-20-20)T
- f. The detention time shall be established on the basis of the raw water characteristics and other local conditions that affect the operation of the unit. The Department may request data to support decisions made with respect to detention times. The Department may alter detention time requirements. (3-20-20)T
- g. Controls for sludge withdrawal which minimize water losses shall be provided. (3-20-20)T

**h.** Unless otherwise approved by the Department based on documentation provided by the design engineer, weirs shall be adjustable and at least equivalent in length to the perimeter of the tank. Weir loading shall not exceed ten (10) gallons per minute per foot of weir length for units used as clarifiers or twenty (20) gallons per minute per foot of weir length for units used for softening. Where orifices are used, the loading rates per foot of launder rates shall be equivalent to weir loadings. Either shall produce uniform rising rates over the entire area of the tank. (3-20-20)T

**i.** Upflow rates shall not exceed one (1) gallon per minute per square foot of area at the sludge separation line for units used as clarifiers or one and three-quarters (1.75) gallons per minute per foot of area at the slurry separation line for units used as softeners. The Department may consider higher rates if supporting data is provided. (3-20-20)T

**11. Settler Units.** Settler units consisting of variously shaped tubes or plates installed in multiple layers and at an angle to the flow may be used for sedimentation following flocculation. (3-20-20)T

**a.** Inlets and outlets shall be designed to maintain velocities suitable for settling in the basin and to minimize short-circuiting. Plate units shall be designed to minimize unequal distribution across the units. (3-20-20)T

**b.** Drain piping from the settler units must be sized to facilitate a quick flush of the settler units and to prevent flooding other portions of the plant. (3-20-20)T

**c.** Although most units will be located within a plant, outdoor installations must provide sufficient freeboard above the top of settlers to prevent freezing in the units. (3-20-20)T

**d.** Water shall be applied to tube settlers at a maximum rate of two (2) gallons per minute per square foot of cross-sectional area for tube settlers, unless higher rates are justified through pilot plant or in-plant demonstration studies. See Subsection 501.19 for general information on conducting pilot studies. (3-20-20)T

**e.** Water shall be applied to plate settlers at a maximum plate loading rate of one-half (0.5) gallons per minute per square foot, based on eighty (80) percent of the projected horizontal plate area. (3-20-20)T

**f.** Flushing lines shall be provided to facilitate maintenance and must be properly protected against backflow or back siphonage. (3-20-20)T

**12. High Rate Clarification.** High rate clarification processes may be approved upon demonstrating satisfactory performance under on-site pilot plant conditions or documentation of full scale plant operation with similar raw water quality conditions. Reductions in detention times and/or increases in weir loading rates shall be justified. See Subsection 501.19 for general information on conducting pilot studies. Examples of such processes include dissolved air flotation, ballasted flocculation, contact flocculation/clarification, and helical upflow. (3-20-20)T

**521. FACILITY AND DESIGN STANDARDS: SURFACE WATER TREATMENT: FILTRATION USING RAPID RATE GRAVITY FILTERS.**

**01. Pretreatment.** The use of rapid rate gravity filters shall require pretreatment in the form of coagulation, flocculation, and sedimentation. (3-20-20)T

**02. Rate of Filtration.** The filter rate must be proposed and justified by the design engineer to the satisfaction of the Department prior to the preparation of final plans and specifications. (3-20-20)T

**03. Number of Units.** A minimum of two (2) units for redundancy shall be provided for filtration such that plant design capacity can be maintained with any component out of service for maintenance or repairs. Where declining rate filtration is provided, the variable aspect of filtration rates, and the number of filters must be considered when determining the design capacity for the filters. (3-20-20)T

**04. Structure and Hydraulics.** The filter structure shall be designed to provide for: (3-20-20)T

- a. Vertical walls within the filter. There shall be no protrusion of the filter walls into the filter media. (3-20-20)T
  - b. Cover by superstructure with sufficient headroom to permit normal inspection and operation. (3-20-20)T
  - c. Minimum depth of filter box of eight and one-half (8.5) feet. (3-20-20)T
  - d. Minimum water depth over the surface of the filter media of three (3) feet. (3-20-20)T
  - e. Trapped effluent to prevent backflow of air to the bottom of the filters. (3-20-20)T
  - f. Prevention of floor drainage to the filter with a minimum four (4) inch curb around the filters. (3-20-20)T
  - g. Prevention of flooding by providing overflow. (3-20-20)T
  - h. Maximum velocity of treated water entering the filters of two (2) feet per second. (3-20-20)T
  - i. Cleanouts and straight alignment for influent pipes or conduits where solids loading is heavy, or following lime-soda softening. (3-20-20)T
  - j. Washwater drain capacity to carry maximum flow. (3-20-20)T
  - k. Walkways around filters to be not less than twenty-four (24) inches wide and equipped with safety handrails or walls. (3-20-20)T
  - l. Construction so as to prevent cross connections and common walls between potable water and non-potable fluids. (3-20-20)T
- 05. Washwater Troughs.** Washwater troughs shall be constructed to have: (3-20-20)T
- a. The bottom elevation above the maximum level of expanded media during washing. (3-20-20)T
  - b. A two (2) inch freeboard at the maximum rate of wash. (3-20-20)T
  - c. The top edge level and all at the same elevation. (3-20-20)T
  - d. Spacing so that each trough serves the same number of square feet of filter area. (3-20-20)T
  - e. Maximum horizontal travel of suspended particles to reach the trough not to exceed three (3) feet. (3-20-20)T
- 06. Filter Material.** The media shall be clean silica sand or other natural or synthetic media free from detrimental chemical or bacterial contaminants, approved by the Department, and having the following characteristics: (3-20-20)T
- a. A total depth of not less than twenty-four (24) inches and generally not more than thirty (30) inches. (3-20-20)T
  - b. An effective size range of the smallest material no greater than forty-five hundredths (0.45) of a millimeter to fifty-five hundredths (0.55) of a millimeter. (3-20-20)T
  - c. A uniformity coefficient of the smallest material not greater than one and sixty-five hundredths (1.65). (3-20-20)T
  - d. A minimum of twelve (12) inches of media with an effective size range no greater than forty-five hundredths (0.45) of a millimeter to fifty-five hundredths (0.55) of a millimeter and a specific gravity greater than

- other filtering materials within the filter. (3-20-20)T
- e. Types of filter media are as follows: (3-20-20)T
    - i. Clean, crushed anthracite or a combination of anthracite and other media may be considered on the basis of experimental data specific to the project. The anthracite shall have the following characteristics: (3-20-20)T
      - (1) Effective size of forty-five hundredths (0.45) of a millimeter to fifty-five hundredths (0.55) of a millimeter with uniformity coefficient not greater than sixty-five hundredths (1.65) when used alone. (3-20-20)T
      - (2) Effective size of eight tenths (0.8) of a millimeter to one and two-tenths (1.2) millimeters with a uniformity coefficient not greater than one and eighty-five hundredths (1.85) when used as a cap. (3-20-20)T
      - (3) Effective size for anthracite used as a single media on potable ground water for iron and manganese removal only shall be a maximum of eight tenths (0.8) of a millimeter (effective sizes greater than this may be approved based upon onsite pilot plant studies or other demonstration acceptable to the Department). See Subsection 501.19 for general information on conducting pilot studies. (3-20-20)T
    - ii. Sand media shall have the following characteristics: (3-20-20)T
      - (1) Effective size of forty-five hundredths (0.45) of a millimeter to fifty-five hundredths (0.55) of a millimeter. (3-20-20)T
      - (2) Uniformity coefficient of not greater than one and sixty-five hundredths (1.65). (3-20-20)T
      - (3) Larger size sand media may be allowed by the Department where full-scale tests have demonstrated that treatment goals can be met under all conditions. (3-20-20)T
    - iii. Granular activated carbon (GAC) as a single media may be considered for filtration only after pilot or full-scale testing and with prior approval of the Department. See Subsection 501.19 for general information on conducting pilot studies. The design shall include the following: (3-20-20)T
      - (1) The media must meet the basic specifications for filter media as given in Subsections 521.06.a. through d., except that larger size media may be allowed where full scale tests have demonstrated that treatment goals can be met under all conditions. (3-20-20)T
      - (2) There must be a means for periodic treatment of filter material for control of bacterial and other growth. (3-20-20)T
      - (3) Provisions must be made for frequent replacement or regeneration. (3-20-20)T
    - iv. Other media will be considered based on experimental data and operating experience. (3-20-20)T
    - v. A three (3) inch layer of torpedo sand shall be used as a supporting media for filter sand where supporting gravel is used, and shall have an effective size of eight-tenths (0.8) millimeters to two (2.0) millimeters, and a uniformity coefficient not greater than one and seven-tenths (1.7). (3-20-20)T
    - vi. Gravel, when used as the supporting media, shall consist of cleaned and washed, hard, durable, rounded silica particles and shall not include flat or elongated particles. The coarsest gravel shall be two and one-half (2.5) inches in size when the gravel rests directly on a lateral system and must extend above the top of the perforated laterals. Not less than four (4) layers of gravel shall be provided in accordance with the size and depth distribution specified in the table below. Reduction of gravel depths and other size gradations may be considered upon justification to the reviewing authority for slow sand filtration or when proprietary filter bottoms are specified.

Size of Gravel	Depth
2 ½ to 1 ½ inches	5 to 8 inches

Size of Gravel	Depth
1 ½ to ¾ inches	3 to 5 inches
¾ to ½ inches	3 to 5 inches
½ to 3/16 inches	2 to 3 inches
3/16 to 3/32 inches	2 to 3 inches

(3-20-20)T

**07. Filter Bottoms and Strainer Systems.** Departure from the standards set out in Subsection 521.07 may be acceptable for high rate filters and for proprietary bottoms. Porous plate bottoms shall not be used where iron or manganese may clog them or with waters softened by lime. The design of manifold-type collection systems shall:

(3-20-20)T

- a. Minimize loss of head in the manifold and laterals. (3-20-20)T
- b. Ensure even distribution of wash water and even rate of filtration over the entire area of the filter. (3-20-20)T
- c. Provide the ratio of the area of the final openings of the strainer systems to the area of the filter at about three-thousandths (0.003), (3-20-20)T
- d. Provide the total cross-sectional area of the laterals at about twice the total area of the final openings. (3-20-20)T
- e. Provide the cross-sectional area of the manifold at one and one-half (1.5) to two (2) times the total area of the laterals. (3-20-20)T
- f. Lateral perforations without strainers shall be directed downward. (3-20-20)T

**08. Surface or Subsurface Wash.** Surface or subsurface wash facilities are required except for filters used exclusively for iron or manganese removal, and may be accomplished by a system of fixed nozzles or a revolving-type apparatus. All devices shall be designed with:

(3-20-20)T

- a. Provision for water pressures of at least forty-five (45) pounds per square inch. (3-20-20)T
- b. A properly installed vacuum breaker or other approved device to prevent back siphonage if connected to the treated water system. (3-20-20)T
- c. Rate of flow of two (2.0) gallons per minute per square foot of filter area with fixed nozzles or one-half (0.5) gallon per minute per square foot with revolving arms. (3-20-20)T
- d. Air wash can be considered based on experimental data and operating experiences. (3-20-20)T

**09. Air Scouring.** Air scouring can be considered in place of surface wash provided the following conditions are met:

(3-20-20)T

- a. Air flow for air scouring the filter must be three (3) to five (5) standard cubic feet per minute square foot of filter area when the air is introduced in the underdrain; a lower air rate must be used when the air scour distribution system is placed above the underdrains. (3-20-20)T
- b. A method for avoiding excessive loss of the filter media during backwashing must be provided. (3-20-20)T
- c. Air scouring must be followed by a fluidization wash sufficient to re-stratify the media. (3-20-20)T

- d.** Air must be free from contamination. (3-20-20)T
- e.** Air scour distribution systems shall be placed below the media and supporting bed interface with the following exception: if placed at the interface the air scour nozzles shall be designed to prevent media from clogging the nozzles or entering the air distribution system. (3-20-20)T
- f.** Piping for the air distribution system shall not be flexible hose which will collapse when not under air pressure and shall not be a relatively soft material which may erode at the orifice opening with the passage of air at high velocity. (3-20-20)T
- g.** Air delivery piping shall not pass down through the filter media nor shall there be any arrangement in the filter design which would allow short circuiting between the applied unfiltered water and the filtered water. (3-20-20)T
- h.** The backwash water delivery system must be capable of fifteen (15) gallons per minute per square foot of filter surface area (37 m/hr); however, when air scour is provided the backwash water rate must be variable and should not exceed eight (8) gallons per minute per square foot (20 m/hr) unless operating experience shows that a higher rate is necessary to remove scoured particles from filter media surfaces. (3-20-20)T
- i.** The filter underdrains shall be designed to accommodate air scour piping when the piping is installed in the underdrain. (3-20-20)T
- 10. Filter Appurtenances.** The following shall be provided for every filter: (3-20-20)T
- a.** Influent and effluent sampling taps. (3-20-20)T
- b.** A gauge capable of indicating loss of head. (3-20-20)T
- c.** A meter indicating rate-of flow. A modified rate controller which limits the rate of filtration to a maximum rate may be used. However, equipment that simply maintains a constant water level on the filters is not acceptable, unless the rate of flow onto the filter is properly controlled. A pump or a flow meter in each filter effluent line may be used as the limiting device for the rate of filtration only if approved by the Department on a site-specific basis. (3-20-20)T
- 11. Backwash.** Provisions shall be made for washing filters as follows: (3-20-20)T
- a.** A minimum backwash rate such that a fifty (50) percent expansion of the filter bed is achieved. (3-20-20)T
- b.** Filtered water provided at the required rate by wash water tanks, a wash water pump, from the high service main, or a combination of these. (3-20-20)T
- c.** Wash water pumps in duplicate unless an alternate means of obtaining wash water is available. (3-20-20)T
- d.** Not less than fifteen (15) minutes wash of one filter at the design rate of wash. (3-20-20)T
- e.** A wash water regulator or valve on the main wash water line to obtain the desired rate of filter wash with the wash water valves on the individual filters open wide. (3-20-20)T
- f.** A rate-of-flow indicator, preferably with a totalizer, on the main wash water line, located so that it can be easily read by the operator during the washing process. (3-20-20)T
- g.** Design to prevent rapid changes in backwash water flow. Backwash shall be operator initiated. Automated systems shall be operator adjustable. (3-20-20)T

**12. Roof Drainage.** Roof drains shall not discharge into the filters or basins and conduits preceding the filters. (3-20-20)T

**522. FACILITY AND DESIGN STANDARDS: SURFACE WATER TREATMENT: FILTRATION USING DIATOMACEOUS EARTH.**

The use of these filters may be considered for application to surface waters with low turbidity and low bacterial contamination, and may be used for iron removal for ground waters providing the removal is effective and the water is of satisfactory sanitary quality before treatment. (3-20-20)T

**01. Conditions of Use.** Diatomaceous earth filters are expressly excluded from consideration for the following conditions: (3-20-20)T

- a.** Bacteria removal; (3-20-20)T
- b.** Color removal; (3-20-20)T
- c.** Turbidity removal where either the gross quantity of turbidity is high or the turbidity exhibits poor filterability characteristics; or (3-20-20)T
- d.** Filtration of waters with high algae counts. (3-20-20)T

**02. Treated Water Storage.** Treated water storage capacity in excess of normal requirements shall be provided to allow operation of the filters at a uniform rate during all conditions of system demand at or below the approved filtration rate, and guarantee continuity of service during adverse raw water conditions without by-passing the system. (3-20-20)T

**03. Number of Units.** A minimum of two (2) units for redundancy shall be provided for filtration such that plant design capacity can be maintained with any component out of service for maintenance or repairs. (3-20-20)T

**04. Precoat.** A uniform precoat shall be applied hydraulically to each septum by introducing a slurry to the tank influent line and employing a filter-to-waste recirculation system. (3-20-20)T

**05. Body Feed.** A body feed system to apply additional amounts of diatomaceous earth slurry during the filter run is required to avoid short filter runs or excessive head losses. (3-20-20)T

- a.** The rate of body feed is dependent on raw water quality and characteristics and must be determined in the pilot plant study. See Subsection 501.19 for general information on conducting pilot studies. (3-20-20)T
- b.** Continuous mixing of the body feed slurry is required. (3-20-20)T

**06. Filtration Requirements.** (3-20-20)T

- a.** Rate of filtration shall be controlled by a positive means. (3-20-20)T
- b.** Head loss shall not exceed thirty (30) psi for pressure diatomaceous earth filters, or a vacuum of fifteen (15) inches of mercury for a vacuum system. (3-20-20)T
- c.** A recirculation or holding pump shall be employed to maintain differential pressure across the filter when the unit is not in operation in order to prevent the filter cake from dropping off the filter elements. A minimum recirculation rate of one-tenth (0.1) gallon per minute per square foot of filter area shall be provided. (3-20-20)T
- d.** The septum or filter elements shall be structurally capable of withstanding maximum pressure and velocity variations during filtration and backwash cycles, and shall be spaced such that no less than one (1) inch is provided between elements or between any element and a wall. (3-20-20)T
- e.** The filter influent shall be designed to prevent scour of the diatomaceous earth from the filter



- element. (3-20-20)T
- 07. Backwash.** A satisfactory method to thoroughly remove and dispose of spent filter cake shall be provided. (3-20-20)T
- 08. Appurtenances.** The following shall be provided for every filter: (3-20-20)T
- a.** Sampling taps for raw and filtered water. (3-20-20)T
  - b.** Loss of head or differential pressure gauge. (3-20-20)T
  - c.** Rate-of-flow indicator. (3-20-20)T
  - d.** A throttling valve used to reduce rates below normal during adverse raw water conditions. (3-20-20)T
  - e.** Evaluation of the need for body feed, recirculation, and any other pumps. (3-20-20)T
  - f.** Provisions for filtering to waste with appropriate measures for backflow prevention. (3-20-20)T
- 09. Monitoring.** A continuous monitoring turbidimeter with recorder is required on each filter effluent for plants treating surface water. (3-20-20)T

**523. FACILITY AND DESIGN STANDARDS: SURFACE WATER TREATMENT: SLOW SAND FILTRATION.**

The use of these filters shall require prior engineering studies to demonstrate the adequacy and suitability of this method of filtration for the specific water supply. Slow Sand Filtration and Diatomaceous Earth Filtration for Small Water Systems, Manual on Slow Sand Filtration, and Slow Sand Filtration referenced in Subsection 002.02, may be used as guidance in design of slow sand filtration facilities. (3-20-20)T

**01. Quality of Raw Water.** Slow rate gravity filtration shall be limited to waters having maximum turbidities of ten (10) nephelometric units and maximum color of fifteen (15) units; such turbidity must not be attributable to colloidal clay. Raw water quality data must include examinations for algae. For source water having variable turbidity, the potential use of a roughing filter or other pretreatment technology should be evaluated. The Department may allow the use of a pretreatment technology on raw waters that exceed the normal limits for turbidity and color, if it can be demonstrated to the Department's satisfaction that pretreatment will enable slow sand filtration to properly operate and comply with these Rules. (3-20-20)T

**02. Number of Units.** A minimum of two (2) units for redundancy shall be provided for filtration such that plant design capacity can be maintained with any component out of service for maintenance or repairs. The Department may allow a single bed filter if it can be demonstrated to the Department's satisfaction that an alternative water source is available such that the water system can provide plant design capacity with the filter taken out of service for maintenance and repairs. (3-20-20)T

**03. Structural Details and Hydraulics.** Slow rate gravity filters shall be so designed as to provide a cover, unless otherwise approved by the Department based on documentation provided by the design engineer, headroom to permit normal movement by operating personnel for scraping and sand removal operations, adequate access hatches and access ports for handling of sand and for ventilation, filtration to waste, an overflow at the maximum filter water level, and protection from freezing. A permanent means of determining sand depth shall be provided. (3-20-20)T

**04. Underdrains.** Each filter unit shall be equipped with a main drain and an adequate number of lateral underdrains to collect the filtered water. The underdrains shall be so spaced that the maximum velocity of the water flow in the underdrain will not exceed three-fourths (0.75) feet per second. The maximum spacing of laterals shall not exceed three (3) feet if pipe laterals are used. (3-20-20)T

**05. Filter Material.** The following requirements apply: (3-20-20)T

- a. A minimum depth of thirty (30) inches of filter sand shall be placed on graded gravel layers. (3-20-20)T
- b. The effective size shall be between fifteen hundredths (0.15) of a millimeter and thirty-five hundredths (0.35) of a millimeter. Larger sizes may be considered by the Department based on the results of a pilot study. See Subsection 501.19 for general information on conducting pilot studies. (3-20-20)T
- c. The uniformity coefficient shall not exceed three point zero (3.0). (3-20-20)T
- d. The sand shall be cleaned and washed free from foreign matter. (3-20-20)T
- e. The sand shall be rebedded to the original minimum depth of thirty (30) inches when scraping has reduced the bed depth to no less than twenty-four (24) inches. Where sand is to be reused in order to provide biological seeding and shortening of the ripening process, rebedding shall utilize a "throw over" technique whereby new sand is placed on the support gravel and existing sand is replaced on top of the new sand. The maximum filtration rate shall not exceed zero point one (0.1) gallon per minute per square foot for each individual bed. (3-20-20)T

**06. Filter Sand Support.** (3-20-20)T

- a. A three (3)-inch layer of sand shall be used as a supporting media for filter sand. The supporting sand shall have an effective size of zero point eight (0.8) millimeters to two point zero (2.0) millimeters and a uniformity coefficient not greater than one point seven (1.7). (3-20-20)T
- b. Gravel shall consist of cleaned and washed, hard, durable, rounded rock particles and shall not include flat or elongated particles. The coarsest gravel shall be two and one-half (2.5) inches in size when the gravel rests directly on a lateral system and must extend above the top of the perforated laterals. Not less than four (4) layers of gravel shall be provided in accordance with the size and depth distribution specified in the table below. Reduction of gravel depths and other size gradations may be considered upon justification to the Department.

Size of Gravel	Depth
2 1/2 to 1 1/2 inches	5 to 8 inches
1 1/2 to 3/4 inches	3 to 5 inches
3/4 to 1/2 inches	3 to 5 inches
1/2 to 3/16 inches	2 to 3 inches
3/16 to 3/32 inches	2 to 3 inches

(3-20-20)T

**07. Depth of Water Over Filter Beds.** The design shall provide a depth of at least three (3) to six (6) feet of water over the sand. Influent water shall not scour the sand surface. (3-20-20)T

**08. Control Appurtenances.** Each filter shall be equipped with a loss of head gauge, an orifice, Venturi meter, or other suitable means of discharge measurement installed on each filter to control the rate of filtration, and an effluent pipe designed to maintain the water level above the top of the filter sand. The effluent piping must not be directly interconnected with the other filter beds. A sample tap shall be provided for each filter bed. (3-20-20)T

**09. Ripening.** Slow sand filters must be filtered-to-waste until they are biologically mature before being put into service following construction, scraping, re-sanding, or reopening after extended shutdown. The period of filter-to-waste shall be as follows: (3-20-20)T

- a. Filters shall be filtered-to-waste after scraping or cleaning until the effluent turbidity falls

consistently below the pre-cleaning level, unless otherwise approved by the Department based on documentation provided by the design engineer. (3-20-20)T

**b.** Filters shall be filtered-to-waste following construction, re-sanding, or extended shutdown based on project specific protocols that have been approved by the Department and then incorporated into a Department approved operation and maintenance manual. These protocols may be based on factors from standard literature such as those listed in Subsection 002.02 but typically include factors such as minimum filter-to-waste time periods, bacteriological testing, and effluent turbidity. Sampling results from the filter-to-waste period shall be provided to the Department for review and the Department must provide authorization prior to restarting service to the public. (3-20-20)T

**10. Supernatant Drain Required.** Filter beds shall be equipped with a supernatant drain to allow for quick removal of water standing over sand that has become impermeable because it requires scraping or rebedding. (3-20-20)T

**11. Filter Bed Control and Minimum Rate of Flow.** Each filter bed shall be controlled separately and filters must be operated at a constant filtration rate with any changes made gradually. The minimum rate of filtration shall be at least two hundredths (0.02) gallons per minute per square foot. (3-20-20)T

**524. FACILITY AND DESIGN STANDARDS: SURFACE WATER TREATMENT: DIRECT FILTRATION.**

Direct filtration, as used herein, refers to the filtration of a surface water following chemical coagulation and possibly flocculation but without prior settling. The nature of the treatment process will depend upon the raw water quality. A full scale direct filtration plant shall not be constructed without prior pilot studies which are acceptable to the reviewing authority. In-plant demonstration studies are required where conventional treatment plants are converted to direct filtration. Where direct filtration is proposed, an engineering report shall be submitted prior to conducting pilot plant or in-plant demonstration studies. See Subsection 501.19 for general information on conducting pilot studies. (3-20-20)T

**01. Filtration Requirements.** (3-20-20)T

**a.** Filters shall be rapid rate gravity filters with dual or mixed media. The final filter design shall be based on the pilot plant or in-plant demonstration studies, and all portions of Section 518 apply. Pressure filters or single media sand filters shall not be used. (3-20-20)T

**b.** A continuous recording turbidimeter shall be installed on each filter effluent line and on the composite filter effluent line. (3-20-20)T

**c.** Additional continuous monitoring equipment such as particle counting or streaming current metering to assist in control of coagulant dose may be required by the reviewing authority. (3-20-20)T

**02. Siting Requirements.** The plant design and land ownership surrounding the plant shall allow for modifications of the plant. (3-20-20)T

**03. Redundancy.** A minimum of two (2) units shall be provided for filtration such that plant capacity can be maintained with any component out of service for maintenance or repairs. (3-20-20)T

**525. FACILITY AND DESIGN STANDARDS: LOW PRESSURE MEMBRANE FILTRATION.**

Low pressure filtration, as used herein, refers to microfiltration or ultrafiltration processes. Low pressure membrane systems can provide greater than 3-log removal of *Giardia lamblia* and *Cryptosporidium*, and ultrafiltration systems can also provide up to 2-log virus removal. The Department will determine maximum available removal credits for the specific membrane under consideration. The actual log removal credit that a low pressure membrane filtration system will receive is the lower of the values determined by the following: the removal efficiency demonstrated during challenge testing, or the maximum log removal that can be verified by direct integrity testing required during the course of normal operation. Membrane systems shall contain sufficient design to allow for offline direct integrity testing of all units or modules at the required interval while retaining the capability to supply maximum day demand to the water system. Membrane systems shall have at least two (2) units unless it can be demonstrated to the

satisfaction of the Department that a secondary source or treatment component can supply the required minimum plant design capacity. (3-20-20)T

**01. Membrane Selection and Design Considerations.** (3-20-20)T

**a. Challenge Testing.** Challenge testing involves seeding feed water with an organism or particulate and measuring the log reduction of the organism or particulate between the feed and filtrate. It is a one-time product-specific test event performed by an approved third party designed to demonstrate the removal ability of the membrane. Challenge testing shall be conducted by the third party entity in general conformance with the USEPA Membrane Filtration Guidance Manual referenced in Subsection 002.02 (Membrane Filtration Guidance Manual). The challenge test report shall be submitted to the Department along with the preliminary engineering report for the project. The Department may accept another state's challenge test report approval. (3-20-20)T

**b. Water Quality Considerations for Design.** A review of historical source water data shall be conducted to determine the degree of pretreatment needed if any, the feasibility of membrane filtration, and an estimated cost of the system. At a minimum, the following parameters shall be investigated: Seasonal temperature and turbidity profiles, total organic loading, occurrence of algae, microbial activity, iron, manganese, and hardness levels, and any other inorganic or physical parameters determined to be necessary by the Department. The data shall be used to determine anticipated fouling and scaling, backwash and cleaning cycles and regimens, acceptable trans-membrane pressure differentials, and design flux, especially during lowest anticipated water temperature. (3-20-20)T

**c. Pilot Study.** A pilot study shall be conducted for a period that shall be determined by the design engineer and approved by the Department. The duration should include the season of lowest water temperatures and the season including the highest anticipated turbidity, algal bloom, TOC, and iron/manganese event or otherwise cover four seasons of source water quality conditions. The Department may approve a shorter duration proof pilot to verify design criteria that affect the reliable production capacity of the membrane system. The Department may approve the use of a full scale pilot study where the full scale facility will act as the pilot study. The Department may also waive the pilot study requirement. Proof pilot studies, full scale pilot studies, and the waiving of the pilot study requirement will only be approved in circumstances where source water conditions and fouling characteristics are already well understood. Such source waters include but are not limited to ground water under the influence of surface water, waters with existing membrane plants, waters where sufficient pilot test data has already been generated, and extensively used or tested membrane products where production or test data on similar waters is available (i.e., same lake, reservoir, or same reach for stream sources). In addition to the requirements in Subsection 501.19, the pilot study shall include: (3-20-20)T

- i. A means to identify the best membrane to use for the anticipated water quality; (3-20-20)T
- ii. Analysis of any need for pretreatment; (3-20-20)T
- iii. Range of anticipated flux rates; (3-20-20)T
- iv. Operating and transmembrane pressure; (3-20-20)T
- v. Fouling and scaling potential; (3-20-20)T
- vi. Backwash and recovery cleaning, cleaning processes, and intervals; (3-20-20)T
- vii. Efficiency and process mass balance; (3-20-20)T
- viii. Waste stream volume, characterization, and disposal method; (3-20-20)T
- ix. Turbidity; and (3-20-20)T
- x. Integrity testing results and procedures. (3-20-20)T

**02. Monitoring and Compliance Requirements for Membranes.** Public drinking water systems that use low pressure membrane filtration must comply with the following requirements. (3-20-20)T

- a. Initial Start-Up. (3-20-20)T
  - i. The Department shall be notified at least one (1) week in advance of the planned start-up date. (3-20-20)T
  - ii. The design engineer shall oversee start-up procedures. (3-20-20)T
  - iii. All monitoring equipment shall be calibrated prior to start-up. (3-20-20)T
  - iv. The system shall pass direct integrity testing prior to going on-line and producing water for distribution. (3-20-20)T
  - v. A method for the disposal of start-up water shall be approved by the Department prior to start-up. (3-20-20)T
- b. Direct Integrity Testing. (3-20-20)T
  - i. Scale of Testing. Testing must be conducted on each membrane skid in service at least daily for the first year of operation. (3-20-20)T
  - ii. Resolution. The test method used must have a resolution of three (3)  $\mu\text{m}$  or less for Cryptosporidium and Giardia lamblia removal credit. (3-20-20)T
  - iii. Sensitivity. The test method used must have sensitivity sufficient to verify the ability of the membrane filtration system to remove the constituent at a level commensurate with the credit awarded by the Department. (3-20-20)T
    - (1) Formulae for sensitivity calculation for pressure-based tests are available in the Membrane Filtration Guidance Manual referenced in Subsection 002.02. The volumetric concentration factor used in the calculation may be either calculated or determined experimentally. (3-20-20)T
    - (2) Formulae for sensitivity calculation for marker-based tests are available in the Membrane Filtration Guidance Manual referenced in Subsection 002.02. (3-20-20)T
  - iv. Control Limit. A control limit must be established within the sensitivity limits of the direct integrity test that is indicative of an integral membrane unit capable of achieving the log removal credit awarded by the Department. (3-20-20)T
    - (1) If the direct integrity test results exceed the control limit for any membrane unit, that unit must be removed from service. (3-20-20)T
    - (2) Any unit taken out of service for exceeding a direct integrity test control limit cannot be returned to service until repairs are confirmed by subsequent direct integrity test results that are within the control limit. (3-20-20)T
  - v. Frequency. Direct integrity testing must be conducted on each membrane unit at a frequency of at least once per day that the unit is in operation. The Department may extend testing frequency up to a duration of once per week after one (1) year of daily testing showing a less than five percent (5%) testing failure rate for the previous year. During weekly testing, if at any time the system fails more than two (2) direct integrity tests within a three (3) month period, the system shall return to daily testing. (3-20-20)T
- c. Indirect Integrity Monitoring. (3-20-20)T
  - i. Scale of Testing. Testing must be conducted on each membrane unit in service. (3-20-20)T
  - ii. Monitoring Method. Continuous indirect integrity monitoring must be conducted using turbidity

monitoring unless the Department approves an alternative method. (3-20-20)T

iii. Frequency. Continuous indirect integrity monitoring must be conducted at a frequency of at least one (1) reading every fifteen (15) minutes. The Department may allow a time delay in reporting compliance turbidity measurements if it can be demonstrated that elevated turbidity readings above fifteen hundredths (0.15) NTU immediately following direct integrity testing or maintenance are the result of factors related to entrained air or membrane wettability and are not related to membrane integrity. (3-20-20)T

iv. Control Limit. If the continuous indirect integrity monitoring results exceed the specified control limit for any membrane unit for a period greater than fifteen (15) minutes (i.e., two (2) consecutive readings at fifteen (15) minute intervals), direct integrity testing must be immediately conducted on that unit. (3-20-20)T

(1) The control limit for turbidity monitoring is fifteen hundredths (0.15) NTU. (3-20-20)T

(2) Control limits for Department approved alternative methods shall be established by the Department. (3-20-20)T

d. Operations Plan. A project specific operation and maintenance manual shall be provided as required in Subsection 501.12. See definition of Operation and Maintenance Manual in Section 003 for the typical contents of an operation and maintenance manual and the included operations plan. The operations plan in the operation and maintenance manual for membrane systems shall include, but is not limited to the following information: (3-20-20)T

i. Filtration: (3-20-20)T

(1) Control of feed flow to the membrane system; (3-20-20)T

(2) Measurement of inlet/outlet pressures and filtrate flows; (3-20-20)T

(3) Measurement of transmembrane pressure changes during filter run; and (3-20-20)T

(4) Feed flow control in response to temperature changes. (3-20-20)T

ii. Membrane backwashing: (3-20-20)T

(1) Programming automated frequency; (3-20-20)T

(2) Proper backwash venting and disposal; see Section 540; (3-20-20)T

(3) Appropriate backwash rate; and (3-20-20)T

(4) Monitoring during return of filter to service. (3-20-20)T

iii. Chemical cleaning: (3-20-20)T

(1) Selection of proper chemical washing sequence; (3-20-20)T

(2) Proper procedures for dilution of chemicals; (3-20-20)T

(3) Monitoring of pH through chemical cleaning cycle; (3-20-20)T

(4) Rinsing of membrane system following chemical clean; and (3-20-20)T

(5) Return of filter to service. (3-20-20)T

iv. Chemical feeders (in the case that chemical pretreatment is applied): (3-20-20)T

- (1) Calibration check; (3-20-20)T
- (2) Settings and adjustments (how they should be made); and (3-20-20)T
- (3) Dilution of chemicals and polymers (proper procedures). (3-20-20)T
- v. Monitoring and observing operation: (3-20-20)T
  - (1) Observation of feed water or pretreated water turbidity; (3-20-20)T
  - (2) Observation of trans-membrane pressure increase between backwashes; (3-20-20)T
  - (3) Filtered water turbidity; (3-20-20)T
  - (4) Procedures to follow if turbidity breakthrough occurs. (3-20-20)T
- vi. Troubleshooting. A troubleshooting checklist or guide shall be included. Suggested troubleshooting items include but are not limited to the following: (3-20-20)T
  - (1) No raw water (feed water) flow to plant; (3-20-20)T
  - (2) Can't control rate of flow of water through equipment; (3-20-20)T
  - (3) Valving configuration for direct flow and cross-flow operation modes; (3-20-20)T
  - (4) Poor raw water quality (raw water quality falls outside the performance range of the equipment); (3-20-20)T
  - (5) Poor filtrate quality; (3-20-20)T
  - (6) Failed membrane integrity test; (3-20-20)T
  - (7) Low pump feed pressure; (3-20-20)T
  - (8) Automatic operation (if provided) not functioning; (3-20-20)T
  - (9) Filtered water turbidity too high; (3-20-20)T
  - (10) Head loss builds up excessively rapidly; (3-20-20)T
  - (11) Reduced flux; (3-20-20)T
  - (12) Machine will not start and "Power On" indicator off; (3-20-20)T
  - (13) Machine will not start and "Power On" indicator on; (3-20-20)T
  - (14) Pump cavitation; (3-20-20)T
  - (15) Valve stuck or won't operate; and (3-20-20)T
  - (16) No electric power. (3-20-20)T
- e. Reporting. The sensitivity, resolution, and frequency of the direct integrity test proposed for use with the full-scale facility must be reported to the Department prior to initial operation. The following shall be reported to the Department on a monthly basis: (3-20-20)T
  - i. Any direct integrity test results exceeding the control limit, as well as the corrective action taken in

response, must be reported to the Department within ten (10) days of the end of the monthly monitoring cycle on a Department reporting form. The form is available at [www.deq.idaho.gov](http://www.deq.idaho.gov); (3-20-20)T

ii. Any continuous indirect integrity monitoring results triggering direct integrity testing, as well as any corrective action taken in response, must be reported to the Department within ten (10) days of the end of the monthly monitoring cycle on a Department reporting form. The form is available at [www.deq.idaho.gov](http://www.deq.idaho.gov); (3-20-20)T

iii. Any additional information considered necessary by the Department on a case-specific basis to verify proper operation and maintenance of the membrane filtration process; and (3-20-20)T

iv. All direct integrity test results and continuous indirect integrity monitoring results must be retained for a minimum of three (3) years. (3-20-20)T

**526. -- 528. (RESERVED)**

**529. FACILITY AND DESIGN STANDARDS: DISINFECTION OF DRINKING WATER, ULTRAVIOLET LIGHT.**

**01. General.** (3-20-20)T

a. Ultraviolet (UV) light technology is a primary disinfectant typically used for *Cryptosporidium*, *Giardia lamblia*, and virus inactivation of both surface water and ground water supplies. Reactor performance in terms of inactivation of any particular organism is a function of the delivered dose which is determined by validation testing. (3-20-20)T

b. UV disinfection credit will be awarded for filtered systems and unfiltered systems if the system meets the requirements for unfiltered systems in 40 CFR 141.71. Systems will receive *Cryptosporidium*, *Giardia lamblia*, and virus treatment credits by achieving the corresponding UV dose values for the appropriate target pathogen and log reduction shown in Subsection 529.03, calculated to take into account the validation factor and reduction equivalent dose. The target pathogen and the target log inactivation shall be used to identify the corresponding required UV dose. (3-20-20)T

c. For water systems using UV light to meet microbial treatment requirements, at least ninety-five percent (95%) of the water delivered to the public every month must be treated by UV reactors operating within validated conditions for the required UV dose. (3-20-20)T

d. When reviewing proposed UV disinfection projects, the Department will use the USEPA UV Disinfection Guidance Manual for the Final Long Term 2 Enhanced Surface Water Treatment Rule referenced in Subsection 002.02 (UV Disinfection Guidance Manual) for guidance. (3-20-20)T

**02. Pilot Studies and Validation.** (3-20-20)T

a. The Department may allow on-site pilot studies on a case by case basis. Pilot studies are usually used to determine how much fouling occurs on site, to evaluate UV system reliability (e.g. UV sensors, UV transmittance (UVT) monitors, ballast reliability) and to provide operators experience running a UV system. They may also be used to assess lamp aging or impacts of power quality. See Subsection 501.19 for general information on conducting pilot studies. (3-20-20)T

b. Validation testing determines the operating conditions and monitoring algorithms that the UV system will use to define how much UV dose is being delivered by the reactor during operation. The validated dose as determined through validation testing is compared to the required dose in the UV Dose Table (Subsection 529.03) to determine inactivation credit. The validated dose is calculated by dividing the determined reduction equivalent dose by a validation factor to account for biases and experimental uncertainty. UV light treatment reactors shall be validated by a third party entity approved by the Department. At a minimum, validation testing must account for the following: UV absorbance of the water; lamp fouling and aging; measurement uncertainty of on-line UV sensors; UV dose distributions arising from the velocity profiles through the reactor; failure of UV lamps and other critical system components; inlet and outlet piping configuration of the UV reactor; lamp and UV sensor locations; and other



parameters required by the Department. The Department may allow alternative test microbes such as MS2 phage where the UV dose response better matches that of Cryptosporidium and Giardia lamblia to provide more accurate and efficient UV dose monitoring. Additional guidance is available in the UV Disinfection Guidance Manual, referenced in Subsection 002.02, or another validation standard as approved by the Department. (3-20-20)T

**c.** Validation testing shall be conducted on full scale testing of a reactor that conforms uniformly to the UV reactors used by the system and inactivation of a test microorganism whose dose response characteristics have been quantified with a low pressure mercury vapor lamp. (3-20-20)T

**d.** Validation testing must determine and establish validated operating conditions under which the reactor delivers the required UV dose in Subsection 529.03. Validated operating conditions include: (3-20-20)T

i. Flow rate; (3-20-20)T

ii. UV Intensity as measured by a UV sensor; (3-20-20)T

iii. UV lamp operating status. (3-20-20)T

**e.** The department may approve an alternative approach to validation testing. (3-20-20)T

**03. UV Dose Table.** The treatment credits listed in the dose table are based on UV light at a wavelength of two hundred fifty-four (254) nm as produced by a low pressure mercury vapor lamp. To receive treatment credit for other lamp types, the system shall demonstrate an equivalent germicidal dose through validation testing.

UV Dose Table (millijoules per square centimeter)			
Log	Cryptosporidium	Giardia lamblia	Virus
0.5	1.6	1.5	39
1.0	2.5	2.1	58
1.5	3.9	3.0	79
2.0	5.8	5.2	100
2.5	8.5	7.7	121
3.0	12	11	143
3.5	15	15	163
4.0	22	22	186

(3-20-20)T

**04. Reactor Design.** Inlet and outlet conditions shall ensure that UV dose delivery at the plant is equal to or exceeds that utilized during validation. At a minimum, design criteria shall address target pathogen(s), required log inactivation and UV dose, flow rate, UVT, and lamp aging and fouling factors. UVT and flow rate shall be selected to account for seasonal changes in UVT. Lamp aging and fouling factors shall be supported by documentation or pilot study data. Recommended approaches of the UV Disinfection Guidance Manual, referenced in Subsection 002.02, shall be used in meeting this requirement. (3-20-20)T

**a.** The reactor systems must be designed to monitor and record parameters to verify the operation within the validated operating conditions approved by the Department. The system must be equipped with facilities to monitor and record UV intensity as measured by a UV sensor, flow rate, lamp status, UVT, and other parameters designated by the Department. (3-20-20)T

**b.** The ultraviolet treatment device shall be designed to provide a UV light dose equal to or greater

than that specified in the UV Dose Table for the required log reduction. The UV Disinfection Guidance Manual, referenced in Subsection 002.02, shall be utilized in evaluating the appropriate dose required for the target microbe. The reactor shall also deliver the target dose while operating within the validated operating conditions for that particular unit. (3-20-20)T

**c.** The ultraviolet treatment assemblies shall be designed to allow for cleaning and replacement of the lamp, lamp sleeves, and sensor window or lens. (3-20-20)T

**d.** All ultraviolet treatment device designs shall evaluate lamp fouling and aging issues and manufacturer's recommendations regarding fouling, aging, and replacement shall be discussed in the Operation and Maintenance Manual. (3-20-20)T

**e.** For in-situ cleaning of the lamp sleeve, the design shall protect the potable water from cleaning solutions. (3-20-20)T

**f.** When off-line chemical cleaning systems are used, the UV enclosure shall be removed from service, drained, flushed with an NSF/ANSI Standard 60 certified solution, drained, and rinsed before being placed back in service. (3-20-20)T

**g.** On-line systems that use wipers or brushes may use chemical solutions provided they are NSF/ANSI Standard 60 certified. (3-20-20)T

**h.** An automatic shutdown valve shall be installed in the water supply line from the ultraviolet treatment device such that if power is not provided to the reactor or valve, the valve shall be in the closed position. (3-20-20)T

**i.** The design of the inlet and outlet piping configuration and the locations of expansions, bends, tees and valves shall assure that the UV dose delivery is equal to or greater than the required UV dose. Approach length prior to each reactor included in the credited dose calculations, downstream length following each reactor, and locations of any cleaning device/mechanism shall be based on validation testing. (3-20-20)T

**j.** For parallel trains, the flow to each reactor shall be equally distributed and metered or otherwise account for uneven flows in the design to ensure that the required UV dose is delivered to each train under varying flow conditions. (3-20-20)T

**k.** Valves shall be provided to allow isolating and removing from service each UV reactor. (3-20-20)T

**l.** Reactors shall be provided with air relief and pressure control valves per manufacturer requirements. (3-20-20)T

**m.** UVT analyzers shall be provided if UVT is part of the dose monitoring strategy. It is recommended that UVT be monitored on a regular basis for all systems to assess UVT variability. (3-20-20)T

**n.** A single train with a standby reactor or a sufficient number of parallel ultraviolet treatment devices shall be installed to ensure that adequate disinfection is provided when one unit is out of service. The Department may approve an alternate method that provides adequate disinfection such as standby chlorination. Any system that produces water on an irregular schedule may provide documentation for the Department's review and approval that a single reactor would be an acceptable design by demonstrating there would be adequate for time for maintenance and cleaning during operation shutdowns. (3-20-20)T

**o.** No bypass of the ultraviolet treatment process may be installed unless an alternate method of providing adequate disinfection is provided. (3-20-20)T

**05. Controls.** (3-20-20)T

**a.** A delay mechanism shall be installed to provide sufficient lamp warm-up prior to allowing water to flow from the ultraviolet treatment unit. (3-20-20)T

**b.** An automatic shutdown shall be designed to activate the shutdown valve in cases where the ultraviolet light dose falls below the approved design dose or outside of the validated specifications. (3-20-20)T

**06. Reliability.** The system must be capable of producing the plant design capacity at all times. (3-20-20)T

**a.** Standby equipment. Unless otherwise approved by the Department based on documentation provided by the design engineer and in accordance with Subsection 529.04.n., a minimum of two (2) reactors is required to maintain disinfection when one unit is taken out of service. Each reactor must be sized to deliver the required UV dose under the operating conditions of flow and UVT that occur at the plant. The conditions shall fall within the validated range of the reactor as determined during validation testing. (3-20-20)T

**b.** Power supply. The quality and reliability of the power supply shall be analyzed and back-up power supplies shall be discussed in the contingency plan. (3-20-20)T

**c.** Validated operating conditions. If UVT is above the validated range of UVT, the UV dose monitoring algorithm shall default to the maximum of the validated range. If UVT is below the validated range, the UV system operation shall be recorded as outside of the validated operating conditions. When UVT falls outside of ranges identified in the validated operating conditions, the contingency plan shall be enacted if UVT is part of the dose monitoring strategy. (3-20-20)T

**d.** Contingency plan. A contingency plan for total UV disinfection failure, loss of power, or in the event that water quality changes produce water quality unsuitable for UV disinfection shall be described in the preliminary engineering report. (3-20-20)T

**07. Monitoring.** Water systems using UV light must monitor for the parameters necessary to demonstrate operation within the validated conditions of the required UV dose. PWSs must check the calibration of UV sensors and online UVT monitors and recalibrate in accordance with a protocol approved by the Department. At a minimum, the following parameters must be monitored: (3-20-20)T

**a.** Flow rate. If the flow rate is below the validated range, then the UV dose monitoring algorithm shall default to the validated range. If the flow rate is above the validated range, then the UV system operation shall be recorded as outside of the validated operating conditions; (3-20-20)T

**b.** UV intensity as measured by UV sensors; (3-20-20)T

**c.** UVT if UVT is part of the dose monitoring strategy; and (3-20-20)T

**d.** Lamp status. (3-20-20)T

**08. Alarms.** The settings or predetermined set points for the alarms shall be specified in the preliminary engineering report. The report shall also specify the alarms that shall activate the contingency plan response. At a minimum, the following alarms are required: (3-20-20)T

**a.** Low UV intensity; (3-20-20)T

**b.** High turbidity if required by the Department; (3-20-20)T

**c.** Low UVT; (3-20-20)T

**d.** Low UV dose; (3-20-20)T

**e.** Lamp failure; (3-20-20)T

**f.** UVT monitor failure; (3-20-20)T

**g.** UV sensor failure; (3-20-20)T

- h.** Low water level; and (3-20-20)T
  - i.** High flow rate. (3-20-20)T
  - 09. Initial Startup.** The following items shall be tested and verified before UV disinfected water is distributed: (3-20-20)T

    - a.** Electrical components; (3-20-20)T
    - b.** Water level; (3-20-20)T
    - c.** Flow split between reactor trains if applicable; (3-20-20)T
    - d.** Controls and alarms; and (3-20-20)T
    - e.** Instrument calibration. (3-20-20)T
  - 10. Operation and Maintenance Manual.** A project specific operation and maintenance manual shall be provided as required in Subsection 501.12. See definition of Operation and Maintenance Manual in Section 003 for the typical contents of an operation and maintenance manual and the included operations plan. The operations plan in the operation and maintenance manual shall include, but is not limited to the following information: (3-20-20)T

    - a.** Lamp aging and replacement intervals. Lamp replacement intervals may be based on the degree of lamp aging as indicated by the UV sensors; (3-20-20)T
    - b.** Lamp fouling analysis and cleaning procedures; (3-20-20)T
    - c.** Lamp replacement; and (3-20-20)T
    - d.** Lamp breakage. (3-20-20)T
- 530. FACILITY AND DESIGN STANDARDS: DISINFECTION OF DRINKING WATER, DISINFECTING AGENTS.**
- Disinfection may be accomplished with gas and liquid chlorine, calcium or sodium hypochlorites, chlorine dioxide, ozone, or ultraviolet light. Other disinfecting agents will be considered, providing reliable application equipment is available and testing procedures for a residual are recognized in “Standard Methods for the Examination of Water and Wastewater,” referenced in Subsection 002.02, or an equivalent means of measuring effectiveness exists. The required amount of primary disinfection needed shall be specified by the Department. Consideration must be given to the formation of disinfection by-products (DBP) when selecting the disinfectant. See Section 531, Facility Design Standards - Design Standards for Chemical Application. For public water systems using only ground water and that voluntarily chlorinate, see Subsection 552.04. (3-20-20)T
- 01. Chlorination.** (3-20-20)T

    - a.** In addition to the requirements of Section 531, chlorination equipment shall meet the following requirements: (3-20-20)T

      - i.** Solution-feed gas chlorinators or hypochlorite feeders of the positive displacement type must be provided. (3-20-20)T
      - ii.** Standby or backup equipment of sufficient capacity shall be available to replace the largest unit. Spare parts shall be on hand to replace parts subject to wear and breakage. (3-20-20)T
      - iii.** Automatic proportioning chlorinators are required where the rate of flow or chlorine demand is not reasonably constant. (3-20-20)T

- iv. Each eductor (submerged jet pump) must be selected for the point of application with particular attention given to the quantity of chlorine to be added, the maximum injector waterflow, the total discharge back pressure, the injector operating pressure, and the size of the chlorine solution line. (3-20-20)T
- v. The chlorine solution injector/diffuser must be compatible with the point of application to provide a rapid and thorough mix with all the water being treated. (3-20-20)T
- vi. Automatic switch-over of chlorination treatment units shall be provided, where necessary, to assure continuous disinfection. (3-20-20)T
- b.** Effective contact time and point of application requirements are as follows: (3-20-20)T
- i. Effective contact time sufficient to achieve the inactivation of target pathogens under the expected range of raw water pH and temperature variation must be demonstrated through tracer studies or other evaluations or calculations acceptable to the Department. Improving Clearwell Design for CT Compliance, referenced in Section 002.02, contains information that may be used as guidance for these calculations. Additional baffling can be added to new or existing basins to minimize short circuiting and increase contact time. (3-20-20)T
- ii. At least two (2) contactors shall be provided which are each capable of providing the required effective contact time at one-half (1/2) of the plant design capacity. Alternatively, a single contactor that can provide effective contact time at plant design capacity may be designed with separate sections and bypass piping to allow sections to be cleaned or maintained individually during low flow conditions. Any system that produces water on an irregular schedule may provide documentation for the Department's review and approval that a single contactor would be an acceptable design by demonstrating there would be adequate time for maintenance and cleaning during operation shutdowns. (3-20-20)T
- iii. At plants treating surface water, except slow sand filtration systems: (3-20-20)T
- (1) Unless otherwise approved by the Department, in addition to the injection point prior to the disinfection contact tank, injection points shall also be provided for applying the disinfectant to the raw water, settled water, and water entering the distribution system. (3-20-20)T
- (2) Unless otherwise approved by the Department, chemical piping or tubing shall be installed from the disinfectant feed system to each injection system during the initial construction. (3-20-20)T
- iv. For pipeline contactors, provision shall be made to drain accumulated sediment from the bottom of the contactor if the discharge from the contactor is not located at the bottom. (3-20-20)T
- c.** Chlorine residual test equipment recognized in the "Standard Methods for the Examination of Water and Wastewater," referenced in Subsection 002.02, shall be provided for use by the operator. All surface water treatment plants that serve a population greater than three thousand three hundred (3,300) must have equipment to measure chlorine residuals continuously entering the distribution system. A sample tap shall be provided to measure chlorine residual and shall be located at a point after receiving the required contact time and at or prior to the first service connection. (3-20-20)T
- d.** Chlorinator piping requirements: (3-20-20)T
- i. Cross connection protection: The chlorinator water supply piping shall be designed to prevent contamination of the treated water supply by sources of questionable quality. At all facilities treating surface water, pre- and post-chlorination systems must be independent to prevent possible siphoning of partially treated water into the clear well. The water supply to each eductor shall have a separate shut-off valve. No master shut-off valve will be allowed. (3-20-20)T
- ii. The pipes carrying elemental liquid or dry gaseous chlorine under pressure must be Schedule 80 seamless steel tubing or other materials recommended by the Chlorine Institute (never use PVC). Rubber, PVC, polyethylene, or other materials recommended by the Chlorine Institute must be used for chlorine solution piping and

fittings. Nylon products are not acceptable for any part of the chlorine solution piping system. (3-20-20)T

**02. Disinfection with Ozone.** Systems that are required to maintain a disinfectant residual in the distribution system shall supplement ozone disinfection with a chemical disinfectant. (3-20-20)T

**a.** The following are requirements for feed gas preparation: (3-20-20)T

**i.** Feed gas can be air, oxygen enriched air, or high purity oxygen. Sources of high purity oxygen include purchased liquid oxygen conforming with AWWA Standard B-304; on site generation using cryogenic air separation; or temperature, pressure or vacuum swing (adsorptive separation) technology. In all cases, the design engineer must ensure that the maximum dew point of -76°F (-60°C) will not be exceeded at any time. (3-20-20)T

**ii.** Air compression: (3-20-20)T

(1) Air compressors shall be of the liquid-ring or rotary lobe, oil-less, positive displacement type for smaller systems or dry rotary screw compressors for larger systems. (3-20-20)T

(2) The air compressors shall have the capacity to simultaneously provide for maximum ozone demand, provide the air flow required for purging the desiccant dryers (where required) and allow for standby capacity. (3-20-20)T

(3) Air feed for the compressor shall be drawn from a point protected from rain, condensation, mist, fog and contaminated air sources to minimize moisture and hydrocarbon content of the air supply. (3-20-20)T

(4) A compressed air after-cooler, entrainment separator, or a combination of the two (2) with automatic drain shall be provided prior to the dryers to reduce the water vapor. (3-20-20)T

(5) A back-up air compressor must be provided so that ozone generation is not interrupted in the event of a break-down. (3-20-20)T

**iii.** Air drying: (3-20-20)T

(1) Dry, dust-free and oil-free feed gas must be provided to the ozone generator. Dry gas is essential to prevent formation of nitric acid, to increase the efficiency of ozone generation and to prevent damage to the generator dielectrics. Sufficient drying to a maximum dew point of -76°F (-60°C) must be provided at the end of the drying cycle. (3-20-20)T

(2) Drying for high pressure systems may be accomplished using heatless desiccant dryers only. For low pressure systems, a refrigeration air dryer in series with heat-reactivated desiccant dryers shall be used. (3-20-20)T

(3) A refrigeration dryer capable of reducing inlet air temperature to 40°F (4°C) shall be provided for low pressure air preparation systems. The dryer can be of the compressed refrigerant type or chilled water type. (3-20-20)T

(4) For heat-reactivated desiccant dryers, the unit shall contain two (2) desiccant filled towers complete with pressure relief valves, two (2) four-way valves and a heater. In addition, external type dryers shall have a cooler unit and blowers. The size of the unit shall be such that the specified dew point will be achieved during a minimum adsorption cycle time of sixteen (16) hours while operating at the maximum expected moisture loading conditions. (3-20-20)T

(5) Multiple air dryers shall be provided so that the ozone generation is not interrupted in the event of dryer breakdown. (3-20-20)T

(6) Each dryer shall be capable of venting "dry" gas to the atmosphere, prior to the ozone generator, to allow start-up when other dryers are "on-line." (3-20-20)T

- iv. Air filters: (3-20-20)T
- (1) Air filters shall be provided on the suction side of the air compressors, between the air compressors and the dryers and between the dryers and the ozone generators. (3-20-20)T
- (2) The filter before the desiccant dryers shall be of the coalescing type and be capable of removing aerosol and particulates larger than 0.3 microns in diameter. The filter after the desiccant dryer shall be of the particulate type and be capable of removing all particulates greater than 0.1 microns in diameter, or smaller if specified by the generator manufacturer. (3-20-20)T
- v. Piping in the air preparation system can be common grade steel, seamless copper, stainless steel or galvanized steel. The piping must be designed to withstand the maximum pressures in the air preparation system. (3-20-20)T
- b. The following requirements apply to the ozone generator: (3-20-20)T
- i. Capacity. (3-20-20)T
- (1) The production rating of the ozone generators shall be stated in pounds per day and kWhr per pound at a maximum cooling water temperature and maximum ozone concentration. (3-20-20)T
- (2) The design shall ensure that the minimum concentration of ozone in the generator exit gas will not be less than one (1) percent (by weight). (3-20-20)T
- (3) Generators shall be sized to have sufficient reserve capacity so that the system does not operate at peak capacity for extended periods of time resulting in premature breakdown of the dielectrics. (3-20-20)T
- (4) The production rate of ozone generators will decrease as the temperature of the coolant increases. If there is to be a variation in the supply temperature of the coolant throughout the year, then pertinent data shall be used to determine production changes due to the temperature change of the supplied coolant. The design shall ensure that the generators can produce the required ozone at maximum coolant temperature. (3-20-20)T
- (5) Appropriate ozone generator backup equipment must be provided. (3-20-20)T
- ii. Electrical. The generators can be low, medium or high frequency type. Specifications shall require that the transformers, electronic circuitry and other electrical hardware be proven, high quality components designed for ozone service. (3-20-20)T
- iii. Cooling. Adequate cooling shall be provided. The cooling water must be properly treated to minimize corrosion, scaling and microbiological fouling of the water side of the tubes. Where cooling water is treated, cross connection control shall be provided to prevent contamination of the potable water supply. (3-20-20)T
- iv. Materials. To prevent corrosion, the ozone generator shell and tubes shall be constructed of Type 316L stainless steel. (3-20-20)T
- c. The following requirements apply to ozone contactors: (3-20-20)T
- i. Bubble diffusers. (3-20-20)T
- (1) Where disinfection is the primary application, a minimum of two (2) contact chambers, each equipped with baffles to prevent short circuiting and induce countercurrent flow, shall be provided. Ozone shall be applied using porous-tube or dome diffusers. (3-20-20)T
- (2) The minimum contact time shall be ten (10) minutes. A shorter contact time (CT) may be approved by the Department if justified by appropriate design and "CT" considerations. (3-20-20)T
- (3) Where taste and odor control is of concern, multiple application points and contactors shall be

considered. (3-20-20)T

(4) Contactors shall be separate closed vessels that have no common walls with adjacent rooms. The contactor must be kept under negative pressure and sufficient ozone monitors shall be provided to protect worker safety. (3-20-20)T

(5) Contact vessels can be made of reinforced concrete, stainless steel, fiberglass or other material which will be stable in the presence of residual ozone and ozone in the gas phase above the water level. If contact vessels are made of reinforced concrete, all reinforcement bars shall be covered with a minimum of one and one-half (1.5) inches of concrete. (3-20-20)T

(6) Where necessary, a system shall be provided between the contactor and the off-gas destruct unit to remove froth from the air and return the other to the contactor or other location acceptable to the reviewing authority. If foaming is expected to be excessive, then a potable water spray system shall be placed in the contactor head space. (3-20-20)T

(7) All openings into the contactor for pipe connections, hatchways, etc. shall be properly sealed using welds or ozone resistant gaskets such as Teflon or Hypalon. (3-20-20)T

(8) Multiple sampling ports shall be provided to enable sampling of each compartment's effluent water and to confirm "CT" calculations. (3-20-20)T

(9) A pressure/vacuum relief valve shall be provided in the contactor and piped to a location where there will be no damage to the destruction unit. (3-20-20)T

(10) The depth of water in bubble diffuser contactors shall be a minimum of eighteen (18) feet. The contactor shall also have a minimum of three (3) feet of freeboard to allow for foaming. (3-20-20)T

(11) All contactors shall have provisions for cleaning, maintenance and drainage of the contactor. Each contactor compartment shall also be equipped with an access hatchway. (3-20-20)T

(12) Aeration diffusers shall be fully serviceable by either cleaning or replacement. (3-20-20)T

ii. Other contactors, such as the venturi or aspirating turbine mixer contactor, may be approved by the Department provided adequate ozone transfer is achieved and the required contact times and residuals can be met and verified. (3-20-20)T

d. The following requirements apply to ozone destruction units: (3-20-20)T

i. A system for treating the final off-gas from each contactor must be provided in order to meet safety and air quality standards. Acceptable systems include thermal destruction and thermal/catalytic destruction units. (3-20-20)T

ii. The maximum allowable ozone concentration in the discharge is 0.1 ppm (by volume). (3-20-20)T

iii. At least two (2) units shall be provided which are each capable of handling the entire gas flow. (3-20-20)T

iv. Exhaust blowers shall be provided in order to draw off-gas from the contactor into the destruct unit. (3-20-20)T

v. Catalysts must be protected from froth, moisture and other impurities which may harm the catalyst. (3-20-20)T

vi. The catalyst and heating elements shall be located where they can easily be reached for maintenance. (3-20-20)T



- e. Piping materials: Only low carbon 304L and 316L stainless steels shall be used for ozone service with 316L preferred. (3-20-20)T
- f. The following requirements apply to joints and connections: (3-20-20)T
- i. Connections on piping used for ozone service are to be welded where possible. (3-20-20)T
- ii. Connections with meters, valves or other equipment are to be made with flanged joints with ozone resistant gaskets, such as Teflon or Hypalon. Screwed fittings shall not be used because of their tendency to leak. (3-20-20)T
- iii. A positive closing plug or butterfly valve plus a leak-proof check valve shall be provided in the piping between the generator and the contactor to prevent moisture reaching the generator. (3-20-20)T
- g. The following requirements apply to instrumentation: (3-20-20)T
- i. Pressure gauges shall be provided at the discharge from the air compressor, at the inlet to the refrigeration dryers, at the inlet and outlet of the desiccant dryers, at the inlet to the ozone generators and contactors, and at the inlet to the ozone destruction unit. (3-20-20)T
- ii. Each generator shall have a trip which shuts down the generator when the wattage exceeds a certain preset level. (3-20-20)T
- iii. Dew point monitors shall be provided for measuring the moisture of the feed gas from the desiccant dryers. Where there is potential for moisture entering the ozone generator from downstream of the unit or where moisture accumulation can occur in the generator during shutdown, post-generator dew point monitors shall be used. (3-20-20)T
- iv. Air flow meters shall be provided for measuring air flow from the desiccant dryers to each of the other ozone generators, air flow to each contactor, and purge air flow to the desiccant dryers. (3-20-20)T
- v. Temperature gauges shall be provided for the inlet and outlet of the ozone cooling water and the inlet and outlet of the ozone generator feed gas and, if necessary, for the inlet and outlet of the ozone power supply cooling water. (3-20-20)T
- vi. Water flow meters shall be installed to monitor the flow of cooling water to the ozone generators and, if necessary, to the ozone power supply. (3-20-20)T
- vii. Ozone monitors shall be installed to measure ozone concentration in both the feed-gas and off-gas from the contactor and in the off-gas from the destruct unit. For disinfection systems, monitors shall also be provided for monitoring ozone residuals in the water. The number and location of ozone residual monitors shall be such that the amount of time that the water is in contact with the ozone residual can be determined. (3-20-20)T
- viii. A minimum of one ambient ozone monitor shall be installed in the vicinity of the contactor and a minimum of one shall be installed in the vicinity of the generator. Ozone monitors shall also be installed in any areas where ozone gas may accumulate. (3-20-20)T
- h. Safety requirements are as follows: (3-20-20)T
- i. The maximum allowable ozone concentration in the air to which workers may be exposed must not exceed one-tenth part per million (0.1 ppm) by volume. (3-20-20)T
- ii. Noise levels resulting from the operating equipment of the ozonation system shall be controlled to within acceptable limits by special room construction and equipment isolation. (3-20-20)T
- iii. Emergency exhaust fans must be provided in the rooms containing the ozone generators to remove ozone gas if leakage occurs. (3-20-20)T

iv. A sign shall be posted indicating “No smoking, oxygen in use” at all entrances to the treatment plant. In addition, no flammable or combustible materials shall be stored within the oxygen generator areas. (3-20-20)T

**03. Disinfection with Chlorine Dioxide.** Chlorine dioxide may be considered as a primary and residual disinfectant, a pre-oxidant to control tastes and odors, to oxidize iron and manganese, and to control hydrogen sulfide and phenolic compounds. When choosing chlorine dioxide, consideration must be given to formation of the regulated by-products, chlorite and chlorate. (3-20-20)T

a. Chlorine dioxide generation equipment shall be factory assembled pre-engineered units with a minimum efficiency of ninety-five (95) percent. The excess free chlorine shall not exceed three (3) percent of the theoretical stoichiometric concentration required. (3-20-20)T

b. Other design requirements include: (3-20-20)T

i. The design shall comply with all applicable portions of Subsections 530.01.a. through 530.01.d. (3-20-20)T

ii. The maximum residual disinfectant level allowed shall be zero point eight (0.8) milligrams per liter (mg/l), even for short term exposures. (3-20-20)T

iii. Notification of a change in disinfection practices and the schedule for the changes shall be made known to the public; particularly to hospitals, kidney dialysis facilities and fish breeders, as chlorine dioxide and its by-products may have effects similar to chloramines. (3-20-20)T

**04. Other Disinfecting Agents.** Proposals for use of disinfecting agents other than those listed shall be submitted to the Department for approval prior to preparation of final plans and specifications. (3-20-20)T

**531. FACILITY AND DESIGN STANDARDS: DESIGN STANDARDS FOR CHEMICAL APPLICATION.**

**01. General Equipment Design.** General equipment design shall be such that: (3-20-20)T

a. Feeders will be able to supply, at all times, the necessary amounts of chemicals at an accurate rate, throughout the range of feed. (3-20-20)T

b. Chemical-contact materials and surfaces are resistant to the aggressiveness of the chemical solution. (3-20-20)T

c. Corrosive chemicals are introduced in such a manner as to minimize potential for corrosion. (3-20-20)T

d. Chemicals that are incompatible are not stored or handled together. At facilities where more than one (1) chemical is stored or handled, tanks and pipelines shall be clearly labeled to identify the chemical they contain. (3-20-20)T

e. All chemicals are conducted from the feeder to the point of application in separate conduits. (3-20-20)T

f. Chemical feeders are as near as practical to the feed point. (3-20-20)T

g. Chemical feeders and pumps shall operate at no lower than twenty percent (20%) of the feed range unless two fully independent adjustment mechanisms such as pump pulse rate and stroke length are fitted when the pump shall operate at no lower than ten percent (10%) of the rated maximum. (3-20-20)T

h. Spare parts shall be on hand for parts of feeders that are subject to frequent wear and damage.

(3-20-20)T

i. Redundant chemical feeders with automatic switchover shall be provided when necessary to ensure adequate treatment. If the water treatment system includes at least two (2) process trains of equipment so that the plant design capacity can be maintained with any component out of service, redundant chemical feeders are not required on each process train. (3-20-20)T

**02. Facility Design.** (3-20-20)T

a. Where chemical feed is necessary for the protection of the supply, such as disinfection, coagulation or other essential processes, a minimum of two feeders shall be provided and a separate feeder shall be used for each chemical applied. (3-20-20)T

b. Chemical application control systems shall meet the following requirements: (3-20-20)T

i. Feeders may be manually or automatically controlled, with automatic controls being designed so as to allow override by manual controls. (3-20-20)T

ii. Chemical feeders shall be controlled by a flow sensing device so that injection of the chemicals will not continue when the flow of water stops. (3-20-20)T

iii. Automatic proportioning chlorinators are required where the rate of flow or chlorine demand is not reasonably constant. (3-20-20)T

iv. A means to measure water flow must be provided in order to determine chemical feed rates. (3-20-20)T

v. Provisions shall be made for measuring the quantities of chemicals used. (3-20-20)T

vi. Weighing scales shall be provided for weighing cylinders at all plants utilizing chlorine gas, fluoride solution feed. (3-20-20)T

vii. Weighing scales shall be capable of providing reasonable precision in relation to average daily dose. (3-20-20)T

viii. Where conditions warrant, for example with rapidly fluctuating intake turbidity, coagulant and coagulant aid addition may be made according to turbidity, streaming current or other sensed parameter. (3-20-20)T

c. Dry chemical feeders shall measure chemicals volumetrically or gravimetrically, provide adequate solution water and agitation of the chemical in the solution pot, and completely enclose chemicals to prevent emission of dust to the operating room. (3-20-20)T

d. Positive displacement type solution feed pumps must be capable of operating at the required maximum head conditions found at the point of injection. (3-20-20)T

e. Liquid chemical feeders shall be such that chemical solutions cannot be siphoned or overfed into the water supply, by assuring discharge at a point of positive pressure, or providing vacuum relief, or providing a suitable air gap, or providing other suitable means or combinations as necessary. (3-20-20)T

f. Cross connection control must be provided to assure that the following requirements are satisfied. (3-20-20)T

i. The service water lines discharging to solution tanks shall be properly protected from backflow. (3-20-20)T

ii. No direct connection exists between any sewer and a drain or overflow from the feeder, solution chamber or tank by providing that all drains terminate at least six (6) inches or two pipe diameters, whichever is

- greater, above the overflow rim of a receiving sump, conduit or waste receptacle. (3-20-20)T
- g.** Chemical feed equipment shall be readily accessible for servicing, repair, and observation of operation. (3-20-20)T
  - h.** In-plant water supply for chemical mixing shall be: (3-20-20)T

    - i.** Ample in quantity and adequate in pressure. (3-20-20)T
    - ii.** Provided with means for measurement when preparing specific solution concentrations by dilution. (3-20-20)T
    - iii.** Properly treated for hardness, when necessary. (3-20-20)T
    - iv.** Properly protected against backflow. (3-20-20)T
    - v.** Obtained from a location sufficiently downstream of any chemical feed point to assure adequate mixing. (3-20-20)T
  - i.** Chemical storage facilities shall satisfy the following requirements: (3-20-20)T

    - i.** Storage tanks and pipelines for liquid chemicals shall be specified for use with individual chemicals and not used for different chemicals. Off-loading areas must be clearly labeled to prevent accidental cross-contamination. (3-20-20)T
    - ii.** Chemicals shall be stored in covered or unopened shipping containers, unless the chemical is transferred into an approved storage unit. (3-20-20)T
  - j.** Bulk liquid storage tanks shall comply with the following requirements: (3-20-20)T

    - i.** A means which is consistent with the nature of the chemical solution shall be provided in a solution tank to maintain a uniform strength of solution. Continuous agitation shall be provided to maintain slurries in suspension. (3-20-20)T
    - ii.** Means shall be provided to measure the liquid level in the tank. (3-20-20)T
    - iii.** Bulk liquid storage tanks shall be kept covered. Bulk liquid storage tanks with access openings shall have such openings curbed and fitted with overhanging covers. (3-20-20)T
    - iv.** Subsurface locations for bulk liquid storage tanks shall be free from sources of possible contamination, and assure positive drainage for ground waters, accumulated water, chemical spills and overflows. (3-20-20)T
    - v.** Bulk liquid storage tanks shall be vented, but shall not vent through vents common with day tanks. Acid storage tanks must be vented to the outside atmosphere, but not through vents in common with day tanks. (3-20-20)T
    - vi.** Each bulk liquid storage tank shall be provided with a valved drain, protected against backflow. (3-20-20)T
    - vii.** Bulk liquid storage tanks shall have an overflow that is turned downward with the end screened with a twenty-four (24) mesh or similar non-corrodible screen, have a free fall discharge, and be located where noticeable. (3-20-20)T
    - viii.** Bulk liquid storage tanks shall be provided with secondary containment so that chemicals from equipment failure, spillage, or accidental drainage shall be fully contained. A common receiving basin may be provided for each group of compatible chemicals. The bulk liquid storage tank basin or the common receiving basin

shall provide a secondary containment volume sufficient to hold one hundred ten percent (110%) of the volume of the largest storage tank. Piping shall be designed to minimize or contain chemical spills in the event of pipe ruptures. (3-20-20)T

ix. Where chemical feed is necessary for the protection of the supply, a means to assure continuity of chemical supply while servicing a bulk liquid storage tank shall be provided. (3-20-20)T

k. Day tanks are subject to the requirements in Subsections 531.02.k.i. through 531.02.k.iv. For the purposes of Section 531, day tanks are defined as liquid chemical tanks holding no more than a thirty (30) hour chemical supply. (3-20-20)T

i. Day tanks shall be provided where bulk storage of liquid chemicals are provided. The Department may allow chemicals to be fed directly from shipping containers no larger than fifty-five (55) gallons. (3-20-20)T

ii. Day tanks shall meet all the requirements of Subsection 531.02.j., with the exception of Subsection 531.02.j.viii. Shipping containers do not require overflow pipes or drains as required by Subsection 531.02.j. and are not subject to the requirements of Subsection 531.02.j.viii. (3-20-20)T

iii. Where feasible, secondary containment shall be provided so that chemicals from equipment failure, spillage, or accidental drainage of day tanks shall be fully contained. A common receiving basin may be provided for each group of compatible chemicals. The common receiving basin shall provide a secondary containment volume sufficient to hold the volume of the largest storage tank. If secondary containment is not feasible, day tanks shall be located and protective curbing provided so that chemicals from equipment failure, spillage, or accidental drainage of day tanks shall not enter the water in conduits, treatment, or storage basins. Secondary containment is not required for a day tank if an Idaho licensed professional engineer demonstrates to the Department that the chemical concentration and volume, if spilled, will not be a safety hazard to employees, will not be hazardous to the public health, and will not harm the environment. (3-20-20)T

iv. Day tanks and the tank refilling line entry points shall be clearly labeled with the name of the chemical contained. (3-20-20)T

l. Provisions shall be made for measuring quantities of chemicals used to prepare feed solutions. (3-20-20)T

m. Vents from feeders, storage facilities and equipment exhaust shall discharge to the outside atmosphere above grade and remote from air intakes. (3-20-20)T

**03. Chemicals.** Chemical shipping containers shall be fully labeled to include chemical name, purity and concentration, supplier name and address, and evidence of ANSI/NSF certification where applicable. (3-20-20)T

**04. Safety Requirements for Chemical Facilities.** (3-20-20)T

a. The following requirements apply to chlorine gas feed and storage rooms: (3-20-20)T

i. Each storage room shall be enclosed and separated from other operating areas. They shall be constructed in such a manner that all openings between the chlorine room and the remainder of the plant are sealed, and provided with doors equipped with panic hardware, assuring ready means of exit and opening outward only to the building exterior. (3-20-20)T

ii. Each room shall be provided with a shatter resistant inspection window installed in an interior wall. (3-20-20)T

iii. Each room shall have a ventilating fan with a capacity which provides one (1) complete air change per minute when the room is occupied. Where this is not appropriate due to the size of the room, a lesser rate may be allowed by the Department on a site specific basis. (3-20-20)T

iv. The ventilating fan shall take suction near the floor as far as practical from the door and air inlet,

with the point of discharge so located as not to contaminate air inlets to any rooms or structures. Air inlets shall be through louvers near the ceiling. (3-20-20)T

- v. Louvers for chlorine room air intake and exhaust shall facilitate airtight closure. (3-20-20)T
  - vi. Separate switches for the fan and lights shall be located outside of the chlorine room and at the inspection window. Outside switches shall be protected from vandalism. A signal light indicating fan operation shall be provided at each entrance when the fan can be controlled from more than one (1) point. (3-20-20)T
  - vii. Vents from feeders and storage shall discharge to the outside atmosphere, above grade. (3-20-20)T
  - viii. Where provided, floor drains shall discharge to the outside of the building and shall not be connected to any internal drainage systems or external drainage systems unless the external drainage systems drain to an approved discharge point. (3-20-20)T
  - ix. Chlorinator rooms shall be heated to sixty degrees Fahrenheit (60°F) and be protected from excessive heat. Cylinders and gas lines shall be protected from temperatures above that of the feed equipment. (3-20-20)T
  - x. Pressurized chlorine feed lines shall not carry chlorine gas beyond the chlorinator room. (3-20-20)T
  - xi. Critical isolation valves shall be conspicuously marked and access kept unobstructed. (3-20-20)T
  - xii. All chlorine rooms, buildings, and areas shall be posted with a prominent danger sign warning of the presence of chlorine. (3-20-20)T
  - xiii. Full and empty cylinders of chlorine gas shall be isolated from operating areas and stored in definitely assigned places away from elevators, stairs, or gangways. They shall be restrained in position to prevent being knocked over or damaged by passing or falling objects. In addition, they shall be stored in rooms separate from ammonia storage, out of direct sunlight, and at least twenty (20) feet from highly combustible materials. Cylinders shall not be kept in unventilated enclosures such as lockers and cupboards. (3-20-20)T
- b.** Where acids and caustics are used, they shall be kept in closed corrosion-resistant shipping containers or storage units. Acids and caustics shall not be handled in open vessels, but shall be pumped in undiluted form from original containers through suitable hose to the point of treatment or to a covered day tank. (3-20-20)T
- c.** Sodium chlorite for chlorine dioxide generation. Proposals for the storage and use of sodium chlorite shall be approved by the Department prior to the preparation of final plans and specifications. Provisions shall be made for proper storage and handling of sodium chlorite to eliminate any danger of fire or explosion associated with its oxidizing nature. (3-20-20)T
- i. Chlorite (sodium chlorite) shall be stored by itself in a separate room. It must be stored away from organic materials. The storage structure shall be constructed of noncombustible materials. If the storage structure must be located in an area where a fire may occur, water must be available to keep the sodium chlorite area cool enough to prevent heat-induced explosive decomposition of the chlorite. (3-20-20)T
  - ii. Care shall be taken to prevent spillage. An emergency plan of operation shall be available for the clean up of any spillage. Storage drums shall be thoroughly flushed prior to recycling or disposal. (3-20-20)T
- d.** Where ammonium hydroxide is used, an exhaust fan shall be installed to withdraw air from high points in the room and makeup air shall be allowed to enter at a low point. The feed pump, regulators, and lines shall be fitted with pressure relief vents discharging outside the building away from any air intake and with water purge lines leading back to the headspace of the bulk storage tank. (3-20-20)T
- e.** Where anhydrous ammonia is used, the storage and feed systems (including heaters where required) shall be enclosed and separated from other work areas and constructed of corrosion resistant materials.

- (3-20-20)T
- i. Pressurized ammonia feed lines shall be restricted to the ammonia room. (3-20-20)T
  - ii. An emergency air exhaust system, as described in Subsection 531.04.a., but with an elevated intake, shall be provided in the ammonia storage room. (3-20-20)T
  - iii. Leak detection systems shall be fitted in all areas through which ammonia is piped. (3-20-20)T
  - iv. Special vacuum breaker/regulator provisions must be made to avoid potentially violent results of backflow of water into cylinders or storage tanks. (3-20-20)T
  - v. Consideration shall be given to the provision of an emergency gas scrubber capable of absorbing the entire contents of the largest ammonia storage unit whenever there is a risk to the public as a result of potential ammonia leaks. (3-20-20)T

**05. Operator Safety.** The Idaho General Safety and Health Standards, referenced in Subsection 002.02, may be used as guidance in designing facilities to ensure the safety of operators. The following requirements are in addition to the requirements of Subsection 501.12. (3-20-20)T

**a.** Respiratory protection equipment, meeting the requirements of the National Institute for Occupational Safety and Health (NIOSH) shall be available where chlorine gas is handled, and shall be stored at a convenient heated location, but not inside any room where chlorine is used or stored. The units shall use compressed air, have at least a thirty (30) minute capacity, and be compatible with or exactly the same as units used by the fire department responsible for the plant. (3-20-20)T

**b.** Chlorine leak detection. A bottle of concentrated ammonium hydroxide (fifty-six (56) per cent ammonia solution) shall be available for chlorine leak detection. Where ton containers are used, a leak repair kit approved by the Chlorine Institute shall be provided. (3-20-20)T

**c.** Protective equipment. (3-20-20)T

i. At least one pair of rubber gloves, a dust respirator of a type certified by NIOSH for toxic dusts, an apron or other protective clothing, and goggles or face mask shall be provided for each operator. (3-20-20)T

ii. A deluge shower and eyewashing device shall be installed where strong acids and alkalis are used or stored. A water holding tank that will allow water to come to room temperature shall be installed in the water line feeding the deluge shower and eyewashing device. Other methods of water tempering will be considered on an individual basis. (3-20-20)T

iii. For chemicals other than strong acids and alkalis, an appropriate eye washing device or station shall be provided. (3-20-20)T

iv. Other protective equipment shall be provided as necessary. (3-20-20)T

**06. Design Requirements for Specific Applications.** In addition to Subsection 531.01 through 531.03, the following design requirements apply for the specific applications within Subsection 531.06 of this rule. (3-20-20)T

**a.** Sodium chlorite for chlorine dioxide generation. Positive displacement feeders shall be provided. Tubing for conveying sodium chlorite or chlorine dioxide solutions shall be Type 1 PVC, polyethylene or materials recommended by the manufacturer. Chemical feeders may be installed in chlorine rooms if sufficient space is provided. Otherwise, facilities meeting the requirements of chlorine rooms shall be provided. Feed lines shall be installed in a manner to prevent formation of gas pockets and shall terminate at a point of positive pressure. Check valves shall be provided to prevent the backflow of chlorine into the sodium chlorite line. (3-20-20)T

**b.** Hypochlorite facilities shall meet the following requirements: (3-20-20)T

- i. Hypochlorite shall be stored in the original shipping containers or in hypochlorite compatible containers. Storage containers or tanks shall be sited out of the sunlight in a cool and ventilated area. (3-20-20)T
  - ii. Stored hypochlorite shall be pumped undiluted to the point of addition. Where dilution is unavoidable, deionized or softened water shall be used. (3-20-20)T
  - iii. Storage areas, tanks, and pipe work shall be designed to avoid the possibility of uncontrolled discharges and a sufficient amount of appropriately selected spill absorbent shall be stored on-site. (3-20-20)T
  - iv. Hypochlorite feeders shall be positive displacement pumps with compatible materials for wetted surfaces. (3-20-20)T
  - v. To avoid air locking in smaller installations, small diameter suction lines shall be used with foot valves and degassing pump heads. In larger installations flooded suction shall be used with pipe work arranged to ease escape of gas bubbles. Calibration tubes or mass flow monitors which allow for direct physical checking of actual feed rates shall be fitted. (3-20-20)T
  - vi. Injectors shall be made removable for regular cleaning where hard water is to be treated. (3-20-20)T
- c.** When ammonium sulfate is used, the tank and dosing equipment contact surfaces shall be made of corrosion resistant non-metallic materials. Provision shall be made for removal of the agitator after dissolving the solid. The tank shall be fitted with a lid and vented outdoors. Injection of the solution should take place in the center of treated water flow at a location where there is high velocity movement. (3-20-20)T
- d.** When aqua ammonia (ammonium hydroxide) is used, the feed pumps and storage shall be enclosed and separated from other operating areas. The aqua ammonia room shall be equipped as required for chlorinator rooms with the following changes: (3-20-20)T
- i. A corrosion resistant, closed, unpressurized tank shall be used for bulk storage, vented through an inert liquid trap to a high point outside and an incompatible connector, or lockout provisions shall be made to prevent accidental addition of other chemicals to the storage tank. (3-20-20)T
  - ii. The storage tank shall be designed to avoid conditions where temperature increases cause the ammonia vapor pressure over the aqua ammonia to exceed atmospheric pressure. This capability can be provided by cooling/refrigeration or diluting or mixing the contents with water without opening the system. (3-20-20)T
  - iii. The aqua ammonia shall be conveyed direct from storage to the treated water stream injector without the use of a carrier water stream unless the carrier stream is softened. (3-20-20)T
  - iv. The point of delivery to the main water stream shall be placed in a region of turbulent water flow. (3-20-20)T
  - v. Provisions shall be made for easy access for removal of calcium scale deposits from the injector. (3-20-20)T

**532. FACILITY AND DESIGN STANDARDS: DESIGN STANDARDS FOR SOFTENING.**

The softening process selected must be based upon the mineral qualities of the raw water and the desired finished water quality in conjunction with requirements for disposal of sludge or brine waste (see Section 540), cost of plant, cost of chemicals, and plant location. Applicability of the process chosen shall be demonstrated. (3-20-20)T

**01. Lime or Lime-Soda Process.** Rapid mix, flocculation, and sedimentation processes shall meet the requirements of Section 520. In addition the following requirements must be met: (3-20-20)T

- a.** When split treatment is used, an accurate means of measuring and splitting the flow must be provided. (3-20-20)T



- b.** Rapid mix basins must provide not more than thirty (30) seconds detention time with adequate velocity gradients to keep the lime particles dispersed. (3-20-20)T
- c.** Equipment for stabilization of water softened by the lime or lime-soda process is required, see Section 537. (3-20-20)T
- d.** Mechanical sludge removal equipment shall be provided in the sedimentation basin. (3-20-20)T
- e.** Provisions must be included for proper disposal of softening sludges; see Section 540. (3-20-20)T
- f.** The plant processes must be manually started following shut-down. (3-20-20)T
- 02. Cation Exchange Process.** (3-20-20)T
- a.** Pre-treatment is required when the content of iron, manganese, or a combination of the two, is one milligram per liter (1 mg/l) or more. (3-20-20)T
- b.** The units may be of pressure or gravity type, of either an upflow or downflow design. Automatic regeneration based on volume of water softened shall be used unless manual regeneration is justified and is approved by the Department. A manual override shall be provided on all automatic controls. (3-20-20)T
- c.** Rate-of-flow controllers or the equivalent shall be used to control the hydraulic loading of cation exchange units. (3-20-20)T
- d.** The bottoms, strainer systems and support for the exchange resin shall conform to the criteria provided for rapid rate gravity filters in Section 521. (3-20-20)T
- e.** Cross Connection Control. Backwash, rinse and air relief discharge pipes shall be installed in such a manner as to prevent any possibility of back-siphonage. (3-20-20)T
- f.** A bypass must be provided around softening units to produce a blended water of desirable hardness. Totalizing meters must be installed on the bypass line and on each softener unit. The bypass line must have a shutoff valve. (3-20-20)T
- g.** When the applied water contains a chlorine residual, the cation exchange resin shall be a type that is not damaged by residual chlorine. (3-20-20)T
- h.** Smooth-nose sampling taps must be provided for the collection of representative samples. The taps shall be located to provide for sampling of the softener influent, effluent, blended water, and on the brine tank discharge piping. The sampling taps for the blended water shall be at least twenty (20) feet downstream from the point of blending. Petcocks are not acceptable as sampling taps. (3-20-20)T
- i.** Brine and salt storage tanks shall meet the following requirements: (3-20-20)T
- i.** Salt dissolving or brine tanks and wet salt storage tanks must be covered and must be corrosion-resistant. (3-20-20)T
- ii.** The make-up water inlet must be protected from back-siphonage. (3-20-20)T
- iii.** Wet salt storage basins must be equipped with manholes or hatchways for access and for direct dumping of salt from truck or railcar. Openings must be provided with raised curbs and watertight covers having overlapping edges similar to those required for finished water reservoirs. (3-20-20)T
- iv.** Overflows, where provided, must be protected with twenty-four (24) mesh or similar non-corrodible screens, and must terminate with either a turned down bend having a proper free fall discharge or a self-closing flap valve. (3-20-20)T

- v. The salt shall be supported on graduated layers of gravel placed over a brine collection system. (3-20-20)T
- vi. Alternative designs which are conducive to frequent cleaning of the wet salt storage tank may be considered. (3-20-20)T
- vii. An eductor may be used to transfer brine from the brine tank to the softeners. If a pump is used, a brine measuring tank or means of metering shall be provided to obtain the proper dilution. (3-20-20)T
- j. Suitable disposal must be provided for brine waste; see Section 540. Where the volume of spent brine must be reduced, consideration may be given to using a part of the spent liquid concentrate for a subsequent regeneration. (3-20-20)T
- k. Pipes and contact materials must be resistant to the aggressiveness of salt. Plastic and red brass are acceptable piping materials. Steel and concrete must be coated with a non-leaching protective coating which is compatible with salt and brine. (3-20-20)T
- l. Bagged salt and dry bulk salt storage shall be enclosed and separated from other operating areas in order to prevent damage to equipment. (3-20-20)T

**533. FACILITY AND DESIGN STANDARDS: DESIGN STANDARDS FOR TASTE AND ODOR CONTROL.**

Provision shall be made for the control of taste and odor. Chemicals shall be added sufficiently ahead of other treatment processes to assure adequate contact time for an effective and economical use of the chemicals. Where severe taste and odor problems are encountered, in-plant studies, pilot plant studies, or both in-plant and pilot plant studies may be required. See Subsection 501.19 for general information on conducting pilot studies. (3-20-20)T

- 01. Chlorination.** When using chlorination as a method of taste and odor control adequate contact time must be provided to complete the chemical reactions involved. (3-20-20)T
- 02. Chlorine Dioxide.** Provisions shall be made for proper storing and handling of the sodium chlorite, so as to eliminate any danger of explosion. (3-20-20)T
- 03. Powdered Activated Carbon.** (3-20-20)T
  - a. The carbon can be added as a pre-mixed slurry or by means of a dry-feed machine as long as the carbon is properly wetted. (3-20-20)T
  - b. Continuous agitation or resuspension equipment is necessary to keep the carbon from depositing in the slurry storage tank. (3-20-20)T
  - c. Provision shall be made for adequate dust control. (3-20-20)T
  - d. Powdered activated carbon shall be handled as a potentially combustible material. (3-20-20)T
- 04. Granular Activated Carbon.** Replacement of anthracite with GAC may be considered as a control measure for geosmin and methyl isoborneol (MIB) taste and odors from algae blooms in surface water applications. Demonstration studies are required by the Department. (3-20-20)T
- 05. Copper Sulfate and Other Copper Compounds.** Continuous or periodic treatment of surface water with copper compounds to kill algae or other growths shall be controlled to prevent copper in excess of one point zero (1.0) milligrams per liter as copper in the plant effluent or distribution system. Care shall be taken to assure an even distribution of the chemical within the treatment area. (3-20-20)T
- 06. Potassium Permanganate.** Application of potassium permanganate may be considered, providing the treatment shall be designed so that the products of the reaction are not visible in the finished water. (3-20-20)T

**07. Ozone.** Ozonation may be used as a means of taste and odor control. Adequate contact time must be provided to complete the chemical reactions involved. (3-20-20)T

**08. Other Methods.** Other methods of taste and odor control shall be made only after pilot plant tests and approval of the Department. (3-20-20)T

**534. FACILITY AND DESIGN STANDARDS: AERATION PROCESSES.**

Public water systems that install aeration treatment are subject to the Rules of the Department of Environmental Quality, IDAPA 58.01.01, "Rules for the Control of Air Pollution in Idaho." The system owner or the design engineer shall contact one of the Department's regional offices for information on obtaining a permit or an exemption for the emissions resulting from the aeration process. General information may be found on the DEQ website <http://www.deq.idaho.gov>. (3-20-20)T

- 01. Natural Draft Aeration.** Design shall provide: (3-20-20)T
  - a.** Perforations in the distribution pan three sixteenths to one-half ( $3/16 - 1/2$ ) inches in diameter, spaced one to three (1-3) inches on centers to maintain a six (6) inch water depth. (3-20-20)T
  - b.** For distribution of water uniformly over the top tray. (3-20-20)T
  - c.** Discharge through a series of three (3) or more trays with separation of trays not less than twelve (12) inches. (3-20-20)T
  - d.** Loading at a rate of one to five (1-5) gallons per minute for each square foot of total tray area. (3-20-20)T
  - e.** Trays with slotted, heavy wire (1/2 inch openings) mesh or perforated bottoms. (3-20-20)T
  - f.** Construction of durable material resistant to aggressiveness of the water and dissolved gases. (3-20-20)T
  - g.** Protection from insects by twenty-four (24) mesh or similar non-corrodible screen. (3-20-20)T
- 02. Forced or Induced Draft Aeration.** Devices shall be designed to: (3-20-20)T
  - a.** Include a blower with a weatherproof motor in a tight housing and screened enclosure. (3-20-20)T
  - b.** Ensure adequate counter current of air through the enclosed aerator column. (3-20-20)T
  - c.** Exhaust air directly to the outside atmosphere. (3-20-20)T
  - d.** Include a down-turned and twenty-four (24) mesh or similar non-corrodible screened air outlet and inlet. (3-20-20)T
  - e.** Be such that air introduced in the column shall be as free from obnoxious fumes, dust, and dirt as possible. (3-20-20)T
  - f.** Be such that sections of the aerator can be easily reached or removed for maintenance of the interior or installed in a separate aerator room. (3-20-20)T
  - g.** Provide loading at a rate of one to five (1-5) gallons per minute for each square foot of total tray area. (3-20-20)T
  - h.** Ensure that the water outlet is adequately sealed to prevent unwarranted loss of air. (3-20-20)T
  - i.** Discharge through a series of five (5) or more trays with separation of trays not less than six (6)

- inches or as approved by the Department. (3-20-20)T
- j. Provide distribution of water uniformly over the top tray. (3-20-20)T
  - k. Be of durable material resistant to the aggressiveness of the water and dissolved gases. (3-20-20)T
- 03. Spray Aeration.** Design shall provide: (3-20-20)T
- a. A hydraulic head of between five (5) and twenty-five (25) feet. (3-20-20)T
  - b. Nozzles, with the size, number, and spacing of the nozzles being dependent on the flowrate, space, and the amount of head available. (3-20-20)T
  - c. Nozzle diameters in the range of one (1) to one and one-half (1.5) inches to minimize clogging. (3-20-20)T
  - d. An enclosed basin to contain the spray. Any openings for ventilation must be protected with a twenty-four (24) mesh or similar non-corrodible screen. (3-20-20)T
- 04. Pressure Aeration.** Pressure aeration may be used for oxidation purposes only if the pilot plant study indicates the method is applicable; it is not acceptable for removal of dissolved gases. See Subsection 501.19 for general information on conducting pilot studies. Filters following pressure aeration must have adequate exhaust devices for release of air. Pressure aeration devices shall be designed to give thorough mixing of compressed air with water being treated and provide twenty-four (24) mesh or similar non-corrodible screened and filtered air, free of obnoxious fumes, dust, dirt and other contaminants. (3-20-20)T
- 05. Packed Tower Aeration.** Packed tower aeration may be used for the removal of volatile organic chemicals, trihalomethanes, carbon dioxide, and radon. Final design shall be based on the results of pilot studies and be approved by the Department. (3-20-20)T
- a. Process design criteria. (3-20-20)T

    - i. Justification for the design parameters selected (i.e., height and diameter of unit, air to water ratio, packing depth, surface loading rate, etc.) shall be provided to the Department for review. The pilot study shall evaluate a variety of loading rates and air to water ratios at the peak contaminant concentration. Special consideration shall be given to removal efficiencies when multiple contaminations occur. Where there is considerable past performance data on the contaminant to be treated and there is a concentration level similar to previous projects, the Department may approve the process design based on use of appropriate calculations without a pilot study. (3-20-20)T
    - ii. The tower shall be designed to reduce contaminants to below the maximum contaminant level and to the lowest practical level. (3-20-20)T
    - iii. The type and size of the packing used in the full scale unit shall be the same as that used in the pilot study. (3-20-20)T
    - iv. The maximum air to water ratio for which credit will be given is 80:1. (3-20-20)T
    - v. The design shall consider potential fouling problems from calcium carbonate and iron precipitation and from bacterial growth. It may be necessary to provide pretreatment. Disinfection capability shall be provided prior to and after packed tower aeration. (3-20-20)T
    - vi. The effects of temperature shall be considered. (3-20-20)T
    - vii. Redundant packed tower aeration capacity at the design flowrate shall be provided. (3-20-20)T
  - b. The tower may be constructed of stainless steel, concrete, aluminum, fiberglass or plastic.

Uncoated carbon steel is not allowed. Towers constructed of light-weight materials shall be provided with adequate support to prevent damage from wind. Packing materials shall be resistant to the aggressiveness of the water, dissolved gases and cleaning materials and shall be suitable for contact with potable water. (3-20-20)T

- c.** Water flow system. (3-20-20)T

  - i. Water shall be distributed uniformly at the top of the tower using spray nozzles or orifice-type distributor trays that prevent short circuiting. (3-20-20)T
  - ii. A mist eliminator shall be provided above the water distributor system. (3-20-20)T
  - iii. A side wiper redistribution ring shall be provided at least every ten (10) feet in order to prevent water channeling along the tower wall and short circuiting. (3-20-20)T
  - iv. Sample taps shall be provided in the influent and effluent piping. The sample taps shall satisfy the requirements of Subsection 501.09. (3-20-20)T
  - v. The effluent sump, if provided, shall have easy access for cleaning purposes and be equipped with a drain valve. The drain shall not be connected directly to any storm or sanitary sewer. (3-20-20)T
  - vi. The design shall prevent freezing of the influent riser and effluent piping when the unit is not operating. (3-20-20)T
  - vii. The water flow to each tower shall be metered. (3-20-20)T
  - viii. An overflow line shall be provided which discharges twelve (12) to fourteen (14) inches above a splash pad or drainage inlet. Proper drainage shall be provided to prevent flooding of the area. (3-20-20)T
  - ix. Means shall be provided to prevent flooding of the air blower. (3-20-20)T
- d.** Air flow system. (3-20-20)T

  - i. The air inlet to the blower and the tower discharge vent shall be down-turned and protected with a non-corrodible twenty-four (24) mesh screen to prevent contamination from extraneous matter. (3-20-20)T
  - ii. The air inlet shall be in a protected location. (3-20-20)T
  - iii. An air flow meter shall be provided on the influent air line or an alternative method to determine the air flow shall be provided. (3-20-20)T
  - iv. A positive air flow sensing device and a pressure gauge must be installed on the air influent line. The positive air flow sensing device must be a part of an automatic control system which will turn off the influent water if positive air flow is not detected. The pressure gauge will serve as an indicator of fouling buildup. (3-20-20)T
  - v. A backup motor for the air blower must be readily available. (3-20-20)T
- e.** Other features that shall be provided: (3-20-20)T

  - i. A sufficient number of access ports with a minimum diameter of twenty-four (24) inches to facilitate inspection, media replacement, media cleaning and maintenance of the interior. (3-20-20)T
  - ii. A method of cleaning the packing material when iron, manganese, or calcium carbonate fouling may occur. (3-20-20)T
  - iii. Tower effluent collection and pumping wells constructed to clearwell standards. (3-20-20)T
  - iv. Provisions for extending the tower height without major reconstruction. (3-20-20)T

- v. No bypass shall be provided unless specifically approved by the Department. (3-20-20)T
- vi. Disinfection and adequate contact time after the water has passed through the tower and prior to the distribution system. (3-20-20)T
- vii. Adequate packing support to allow free flow of water and to prevent deformation with deep packing heights. (3-20-20)T
- viii. Operation of the blower and disinfectant feeder equipment during power failures. (3-20-20)T
- ix. Adequate foundation to support the tower and lateral support to prevent overturning due to wind loading. (3-20-20)T
- x. Fencing and locking gate to prevent vandalism. (3-20-20)T
- xi. An access ladder with safety cage for inspection of the aerator including the exhaust port and demister. (3-20-20)T
- xii. Electrical interconnection between blower, disinfectant feeder and supply pump. (3-20-20)T

**06. Other Methods of Aeration.** Other methods of aeration may be used if applicable to the treatment needs. Such methods include but are not restricted to spraying, diffused air, cascades and mechanical aeration. The treatment processes are subject to the approval of the Department. (3-20-20)T

**07. Protection of Aerators.** All aerators except those discharging to lime softening or clarification plants shall be protected from contamination by birds, insects, wind borne debris, rainfall and water draining off the exterior of the aerator. (3-20-20)T

**08. Disinfection.** Ground water supplies exposed to the atmosphere by aeration must receive disinfection as described in Section 530 as the minimum additional treatment. (3-20-20)T

**535. FACILITY AND DESIGN STANDARDS: DESIGN STANDARDS FOR IRON AND MANGANESE CONTROL SYSTEMS.**

Iron and manganese control, as used herein, refers solely to treatment processes designed specifically for this purpose. The treatment process used will depend upon the character of the raw water. The selection of one (1) or more treatment processes must meet specific local conditions as determined by engineering investigations, including chemical analyses of representative samples of water to be treated, and receive the approval of the Department. The Department may require a pilot plant study in order to gather all information pertinent to the design. See Subsection 501.19 for general information on conducting pilot studies. (3-20-20)T

**01. Removal by Oxidation, Detention and Filtration.** (3-20-20)T

**a.** Oxidation may be by aeration or by chemical oxidation with chlorine, potassium permanganate, ozone or chlorine dioxide. (3-20-20)T

**b.** Detention time: (3-20-20)T

**i.** A minimum detention time of thirty (30) minutes shall be provided following aeration to ensure that the oxidation reactions are as complete as possible. This minimum detention may be omitted only where a pilot plant study indicates no need for detention. The detention basin may be designed as a holding tank without provisions for sludge collection but with sufficient baffling to prevent short circuiting. (3-20-20)T

**ii.** Sedimentation basins shall be provided when treating water with high iron or manganese content, or where chemical coagulation is used to reduce the load on the filters. Provisions for sludge removal shall be made. (3-20-20)T

**c.** Filtration. Rapid rate pressure filters are normally used for iron and manganese removal. Pressure filters shall not be used in the filtration of surface or other polluted waters or following lime-soda softening. (3-20-20)T

**i.** The rate of filtration shall not exceed three (3) gallons per minute per square foot of filter area except where in-plant testing as approved by the Department has demonstrated satisfactory results at higher rates. (3-20-20)T

**ii.** The filters shall be designed to provide for: (3-20-20)T

(1) Loss of head gauges on the inlet and outlet pipes of each battery of filters. (3-20-20)T

(2) An easily readable meter or flow indicator on each battery of filters. (3-20-20)T

(3) Filtration and backwashing of each filter individually with an arrangement of piping as simple as possible to accomplish these purposes. (3-20-20)T

(4) Minimum side wall shell height of five (5) feet. A corresponding reduction in side wall height is acceptable where proprietary bottoms permit reduction of the gravel depth. (3-20-20)T

(5) The top of the wash water collectors to be at least eighteen (18) inches above the surface of the media, (3-20-20)T

(6) The underdrain system to efficiently collect the filtered water and to uniformly distribute the backwash water at a rate not less than fifteen (15) gallons per minute per square foot of filter area. (3-20-20)T

(7) Backwash flow indicators and controls that are easily readable while operating the control valves. (3-20-20)T

(8) An air release valve on the highest point of each filter. (3-20-20)T

(9) An accessible manhole to facilitate inspection and repairs for filters thirty-six (36) inches or more in diameter. Sufficient handholds shall be provided for filters less than thirty-six (36) inches in diameter. (3-20-20)T

(10) A means to observe the wastewater during backwashing and construction to prevent cross connection. (3-20-20)T

**02. Removal by Manganese Coated Media Filtration.** This process consists of a continuous or batch feed of potassium permanganate to the influent of a manganese coated media filter. (3-20-20)T

**a.** Other oxidizing agents or processes such as chlorination or aeration may be used prior to the permanganate feed to reduce the cost of the chemical. (3-20-20)T

**b.** An anthracite media cap of at least six (6) inches or more as required by the Department shall be provided over manganese coated media. (3-20-20)T

**c.** Normal filtration rate shall be three (3) gallons per minute per square foot. (3-20-20)T

**d.** Normal wash rate shall be eight (8) to ten (10) gallons per minute per square foot with manganese greensand and fifteen (15) to twenty (20) gallons per minute with manganese coated media. (3-20-20)T

**e.** Sample taps shall be provided prior to application of permanganate, immediately ahead of filtration, at points between the anthracite media, and at the filter effluent. The sample taps shall satisfy the requirements of Subsection 501.09. (3-20-20)T

**03. Removal by Ion Exchange.** This process is not acceptable where either the raw water or wash water contains dissolved oxygen or other oxidants. (3-20-20)T

**04. Biological Removal.** Biofiltration to remove manganese, iron, or a combination of manganese and iron requires on-site piloting testing to establish effectiveness. The final filter design shall be based on the on-site pilot plant studies. (3-20-20)T

**05. Sequestration by Polyphosphates.** This process shall not be used when iron, manganese or a combination thereof exceeds one point zero (1.0) mg/l. The total phosphate applied shall not exceed ten (10) mg/l as PO<sub>4</sub>. Where phosphate treatment is used, satisfactory chlorine residuals shall be maintained in the distribution system. Possible adverse affects on corrosion must be addressed when phosphate addition is proposed for iron sequestering. (3-20-20)T

**a.** Stock phosphate solution must be kept covered and disinfected by carrying approximately ten (10) mg/l free chlorine residual unless it is demonstrated to the satisfaction of the Department that the phosphate solution is not able to support bacterial growth and the phosphate solution is being fed from the covered shipping container or an approved disinfected tank. Phosphate solutions having a pH of two point zero (2.0) or less may also be exempted from this requirement by the Department. (3-20-20)T

**b.** Polyphosphates shall not be applied ahead of iron and manganese removal treatment. The point of application shall be prior to any aeration, oxidation or disinfection if no iron or manganese removal treatment is provided. (3-20-20)T

**06. Sequestration by Sodium Silicates.** Sodium silicate sequestration of iron and manganese is allowed only for ground water supplies prior to air contact. On-site pilot studies are required to determine the suitability of sodium silicate for the particular water and the minimum feed needed. Rapid oxidation of the metal ions such as by chlorine or chlorine dioxide must accompany or closely precede the sodium silicate addition. (3-20-20)T

**a.** Sodium silicate addition is applicable to waters containing up to two (2) mg/l of iron, manganese or combination thereof. (3-20-20)T

**b.** Chlorine residuals shall be maintained throughout the distribution system to prevent biological breakdown of the sequestered iron. (3-20-20)T

**c.** The amount of silicate added shall be limited to twenty (20) mg/l as SiO<sub>2</sub>, but the amount of added and naturally occurring silicate shall not exceed sixty (60) mg/l as SiO<sub>2</sub>. (3-20-20)T

**d.** Sodium silicate shall not be applied ahead of iron or manganese removal treatment. (3-20-20)T

**07. Sampling Taps.** Smooth-nosed sampling taps shall be provided for control purposes. Taps shall be located on each raw water source, each treatment unit influent and each treatment unit effluent. The sample taps shall satisfy the requirements of Subsection 501.09. (3-20-20)T

**536. FACILITY AND DESIGN STANDARDS: DESIGN STANDARDS FOR FLUORIDATION.**

**01. Chemical Feed Equipment and Methods.** In addition to the requirements in Section 531, fluoride feed equipment shall meet the following requirements: (3-20-20)T

**a.** Scales, loss-of-weight recorders or liquid level indicators, as appropriate, accurate to within five (5) percent of the average daily change in reading shall be provided for chemical feeds. (3-20-20)T

**b.** The accuracy of chemical feeders used for fluoridation shall be plus or minus five (5) percent of the intended dose. (3-20-20)T

**c.** Unsealed storage units for fluorosilicic acid shall be vented to the atmosphere at a point outside any building. (3-20-20)T

**d.** Fluoride compound shall not be added before lime-soda softening or ion exchange softening. (3-20-20)T



- e. The point of application of fluorosilicic acid, if into a horizontal pipe, shall be in the lower half of the pipe. (3-20-20)T
  - f. A fluoride solution shall be applied by a positive displacement pump having a stroke rate not less than twenty (20) strokes per minute, and at a feed rate not less than twenty (20) percent of the rated capacity of the feed pump. (3-20-20)T
  - g. A spring opposed diaphragm type anti-siphon device shall be provided for all fluoride feed lines and dilution water lines. (3-20-20)T
  - h. Except for constant flow systems, a device to measure the flow of water to be treated is required. (3-20-20)T
  - i. The dilution water pipe shall terminate at least two (2) pipe diameters above the solution tank. (3-20-20)T
  - j. Water used for sodium fluoride dissolution shall be softened if hardness exceeds seventy-five (75) mg/l as calcium carbonate. (3-20-20)T
  - k. Fluoride solutions shall be injected at a point of continuous positive pressure or a suitable air gap provided. (3-20-20)T
  - l. The electrical outlet used for the fluoride feed pump shall be interconnected with the well or service pump. (3-20-20)T
  - m. Consideration shall be given to providing a separate room for fluorosilicic acid storage and feed. (3-20-20)T
- 02. Secondary Controls.** Secondary control systems for fluoride chemical feed devices shall be provided as a means of reducing the possibility for overfeed; these may include flow or pressure switches or other devices. (3-20-20)T
- 03. Dust Control.** Provision must be made for the transfer of dry fluoride compounds from shipping containers to storage bins or hoppers in such a way as to minimize the quantity of fluoride dust which may enter the room in which the equipment is installed. The enclosure shall be provided with an exhaust fan and dust filter which places the hopper under a negative pressure. Air exhausted from fluoride handling equipment shall discharge through a dust filter to the outside atmosphere of the building. (3-20-20)T

**537. FACILITY AND DESIGN STANDARDS: DESIGN STANDARDS FOR STABILIZATION.**

Water that is unstable due either to natural causes or to subsequent treatment shall be stabilized. The expected treated water quality shall be evaluated to determine what, if any, treatment is necessary. (3-20-20)T

- 01. Carbon Dioxide Addition.** (3-20-20)T
  - a. Recarbonation basin design shall provide the following: (3-20-20)T
    - i. A total detention time of twenty (20) minutes. (3-20-20)T
    - ii. A mixing compartment having a detention time of at least three (3) minutes. (3-20-20)T
    - iii. A reaction compartment. (3-20-20)T
    - iv. The mixing and reaction compartments shall have a depth sufficient to provide a diffuser submergence of not less than seven and one-half (7.5) feet and no greater than the manufacturer's recommendation. (3-20-20)T

**b.** Where liquid carbon dioxide is used, adequate precautions must be taken to prevent carbon dioxide from entering the plant from the recarbonation process. (3-20-20)T

**c.** Recarbonation tanks shall be located outside or be sealed and vented to the outside with adequate seals and adequate purge flow of air to ensure workers safety. (3-20-20)T

**d.** Provisions shall be made for draining the recarbonation basin and removing sludge. (3-20-20)T

**02. Phosphates.** The feeding of phosphates may be used for sequestering calcium, for corrosion control, and in conjunction with alkali feed following ion exchange softening. (3-20-20)T

**a.** Stock phosphate solution must be kept covered and disinfected by carrying approximately ten (10) mg/l free chlorine residual unless the phosphate is not able to support bacterial growth and the phosphate is being fed from the covered shipping container. Phosphate solutions having a pH of two point zero (2.0) or less are exempted from this requirement. (3-20-20)T

**b.** Satisfactory chlorine residuals shall be maintained in the distribution system when phosphates are used. (3-20-20)T

**03. Split Treatment.** Raw water may be blended with lime-softened water to partially stabilize the water prior to secondary clarification and filtration. Treatment plants designed to utilize split treatment shall also contain facilities for further stabilization by other methods. (3-20-20)T

**04. Water Unstable Due to Biochemical Action in Distribution System.** Unstable water resulting from the bacterial decomposition of organic matter in water (especially in dead end mains), the biochemical action within tubercles, and the reduction of sulfates to sulfides shall be prevented by the maintenance of a free or combined chlorine residual throughout the distribution system. (3-20-20)T

**538. – 539. (RESERVED)**

**540. FACILITY AND DESIGN STANDARDS: DESIGN STANDARDS FOR TREATMENT AND DISPOSAL OF TREATMENT PLANT WASTE RESIDUALS.**

Provisions must be made for proper disposal of water treatment plant waste such as sanitary, laboratory, clarification sludge, softening sludge, iron sludge, filter backwash water, and liquid concentrates. In locating waste disposal facilities, due consideration shall be given to preventing potential contamination of the water supply. (3-20-20)T

**01. Sanitary Waste.** The sanitary waste from water treatment plants, pumping stations, and other waterworks installations must receive treatment. Waste from these facilities shall be discharged directly to a sanitary sewer system, when available and feasible, or to an adequate on-site waste treatment facility approved under the provisions of IDAPA 58.01.03, "Individual/Subsurface Sewage Disposal Rules." (3-20-20)T

**02. Liquid Concentrates.** (3-20-20)T

**a.** Waste from ion exchange plants, demineralization plants, reverse osmosis, on-site chlorine generators, or other plants which produce liquid concentrates may be disposed of by the following methods: (3-20-20)T

**i.** Liquid concentrates that contain radionuclides must be further treated to remove the radioactive constituents as sludge. See Subsection 540.03.e. for disposal requirements for sludge that contains radionuclides. The residual liquids from which radionuclides have been removed may be disposed of in accordance with Subsections 540.02.a.ii. through 540.02.a.iv. (3-20-20)T

**ii.** Controlled discharge to a stream or other receiving water body if adequate dilution is available. Such discharge will require a National Pollution Elimination System Permit from the U.S. Environmental Protection Agency, Region 10, 1200 Sixth Avenue, Seattle, WA 98101, Telephone (206) 553-1200. (3-20-20)T

**iii.** Liquid concentrates may be discharged to a sanitary sewer, if available and feasible. Acceptance of

such waste must be approved by the sewer authority. (3-20-20)T

iv. Subsurface disposal or land application of liquid concentrates may be permitted, but only if such discharge meets the requirements of IDAPA 58.01.03, "Individual/Subsurface Sewage Disposal Rules" for subsurface disposal or the requirements of IDAPA 58.01.17, "Recycled Water Rules" for land application. (3-20-20)T

b. Should the nature of the liquid concentrate cause it to be ineligible for permitted discharge as described in Subsection 540.02.a., further onsite treatment of the liquid concentrate may be required in order to produce sludge and liquid waste that will meet the permit criteria for one (1) or more of the disposal options. (3-20-20)T

**03. Sludge Waste.** Sludge is the solid waste resulting from coagulation, precipitation, or passive settling of liquid concentrates. Depending on composition, liquids remaining after sludge removal may be disposed of by methods described in Subsection 540.02, recycled through the treatment plant, or may be pure enough to be unregulated. The following methods of treatment and disposal apply to sludge: (3-20-20)T

a. Precipitative Softening Sludge. (3-20-20)T

i. At least two (2) temporary storage lagoons must be provided in order to give flexibility in operation. Provisions must be made for convenient cleaning. An acceptable means of final sludge disposal must be provided. (3-20-20)T

ii. Liquid or dewatered precipitative softening sludge may be applied to farm land if heavy metals or other contaminants do not exceed the requirements of IDAPA 58.01.02, "Water Quality Standards." (3-20-20)T

iii. Dewatered precipitative softening sludge may be disposed of in a sanitary landfill in accordance with the requirements of IDAPA 58.01.06, "Solid Waste Management Rules." Acceptance of such waste is at the discretion of the landfill authority. (3-20-20)T

b. Alum or Ferric Sludge. (3-20-20)T

i. Temporary storage lagoons must contain at least two (2) compartments to facilitate independent filling and dewatering operations. Mechanical concentration may be considered. If mechanical dewatering is used, it shall be preceded by sludge concentration and chemical pre-treatment. A pilot plant study is required before the design of a mechanical dewatering installation. See Subsection 501.19 for general information on conducting pilot studies. (3-20-20)T

ii. Alum or ferric sludge may be discharged to a sanitary sewer if available and feasible. Acceptance of such waste must be approved by the sewer authority. (3-20-20)T

iii. Dewatered alum or ferric sludge may be disposed of in a sanitary landfill in accordance with the requirements of IDAPA 58.01.06, "Solid Waste Management Rules." Acceptance of such waste is at the discretion of the landfill authority. (3-20-20)T

iv. Alum or ferric sludge may be disposed of by land application if the permitting requirements of IDAPA 58.01.02, "Water Quality Standards," and IDAPA 58.01.17, "Recycled Water Rules," are met. (3-20-20)T

v. Water removed from alum or ferric sludge may be disposed of in the same manner as liquid concentrates, as described in Subsection 540.02. (3-20-20)T

c. Red Water. Red water is the waste filter wash water from iron and manganese removal plants. (3-20-20)T

i. If sand filters are used they shall have the following features: (3-20-20)T

(1) Total filter area shall be sufficient to adequately dewater applied solids. Unless the filter is small

enough to be cleaned and returned to service in one (1) day, two (2) or more cells are required. (3-20-20)T

(2) The “red water” filter shall have sufficient capacity to contain, above the level of the sand, the entire volume of wash water produced by washing all of the production filters in the plant, unless the production filters are washed on a rotating schedule and the flow through the production filters is regulated by true rate of flow controllers. Then sufficient volume shall be provided to properly dispose of the wash water involved. (3-20-20)T

(3) Where freezing is a problem, provisions should be made for covering the filters during the winter months. (3-20-20)T

(4) “Red water” filters shall not have common walls with finished water. (3-20-20)T

ii. Subsurface infiltration lagoons may be permitted, but only if such discharge meets the requirements of IDAPA 58.01.03, “Individual/Subsurface Sewage Disposal Rules.” (3-20-20)T

iii. “Red water” may be discharged to a sanitary sewer if available and feasible. Acceptance of such waste must be approved by the sewer authority. Design shall prevent cross connections and there shall be no common walls between potable and non-potable fluid. (3-20-20)T

**d. Filter Backwash Water.** (3-20-20)T

i. Recycling is permitted if the backwash waters are returned to the head of the treatment plant or another entry point if supported by engineering studies. Backwash water shall be held for a sufficient time prior to recycling to allow solids to settle out. (3-20-20)T

ii. Dewatered sludge from backwash water clarification processes may be disposed of in a sanitary landfill in accordance with the requirements of IDAPA 58.01.06, “Solid Waste Management Rules.” Acceptance of such waste must be approved by the landfill authority. (3-20-20)T

**e. Radioactive Sludge.** Waste residuals containing radioactive substances, including, but not limited to granular activated carbon used for radon removal or ion-exchange regeneration waste from uranium removal, must be disposed of in accordance with IDAPA 58.01.10, “Rules Regulating the Disposal of Radioactive Materials Not Regulated Under The Atomic Energy Act of 1954, As Amended.” (3-20-20)T

i. The buildup of radioactive materials such as uranium or radon and its decay products shall be considered and adequate shielding and safeguards shall be provided for operators and visitors. (3-20-20)T

ii. Waste residuals containing naturally occurring radioactive materials that have been concentrated by human activities must be disposed of in an approved hazardous waste landfill (Class D), in accordance with the IDAPA 58.01.10, “Rules Regulating the Disposal of Radioactive Materials not Regulated Under the Atomic Energy Act of 1954, as Amended,” and IDAPA 58.01.06, “Solid Waste Management Rules.” (3-20-20)T

iii. Waste residuals containing greater than point zero five (.05) percent by weight of uranium are subject to licensing and disposal under the regulations of the U.S. Nuclear Regulatory Commission, Region IV, 611 Ryan Plaza Drive, Suite 400, Arlington, TX 76011, Phone 817-860-8299. (3-20-20)T

**f. Arsenic Sludge.** Solid waste residuals containing arsenic at a concentration less than five (5) mg/l may be disposed of at a sanitary landfill if permitted under IDAPA 58.01.06, “Solid Waste Management Rules.” Solid waste containing arsenic at a concentration greater than five (5) mg/l must be disposed of at an approved hazardous waste landfill. Liquid wastes generated by arsenic treatment processes are subject to the handling and disposal requirements for liquid concentrates, as discussed under Subsection 540.02. (3-20-20)T

**04. Spent Media.** Exhausted ion exchange media, adsorption media, disposable filters, and other components of treatment processes that contain concentrated contaminants shall be disposed of in accordance with IDAPA 58.01.06, “Solid Waste Management Rules,” and/or IDAPA 58.01.10, “Rules Regulating the Disposal of Radioactive Materials not Regulated Under the Atomic Energy Act of 1954, as Amended.” (3-20-20)T

**541. FACILITY AND DESIGN STANDARDS: PUMPING FACILITIES.**

Pumping facilities shall be designed to maintain the sanitary quality of pumped water. (3-20-20)T

**01. Pump Houses.** Unless otherwise approved by the Department based on documentation provided by the design engineer, pump house components shall be located above-grade. The following requirements apply to pump houses as defined in Section 003 unless it can be shown that some or all of these requirements are not needed to protect the combination of system components in a given structure: (3-20-20)T

**a.** Pump houses shall be readily accessible for operation, maintenance, and repair at all times and under all weather conditions unless permitted to be out of service for a period of inaccessibility. (3-20-20)T

**b.** Pump houses shall be protected from flooding and shall be adequately drained. The ground surface shall be graded so as to lead surface drainage away from the pump house. Unless otherwise approved by the Department based on documentation provided by the design engineer, the floor surface shall be at least six (6) inches above the final ground surface and pump house components shall be located at least six (6) inches above the floor surface. (3-20-20)T

**c.** Pump houses shall be of durable construction, fire and weather resistant, and with outward-opening doors. All underground structures shall be waterproofed. (3-20-20)T

**d.** Provisions shall be made for adequate heating for the comfort of the operator and the safe and efficient operation of the equipment. In pump houses not occupied by personnel, only enough heat need be provided to prevent freezing of equipment or treatment processes. (3-20-20)T

**e.** Ventilation shall conform to existing local and/or state codes. Adequate ventilation shall be provided for all pumping stations for operator comfort and dissipation of excess heat and moisture from the equipment. In all cases, measures must be taken to minimize corrosion of metallic and electrical components. (3-20-20)T

**f.** Pump houses shall be provided with a locking door or access to prohibit unauthorized entrance and shall be protected to prevent vandalism and entrance by animals. Plans and specifications for pump houses must provide enough detail to enable the reviewing engineer to determine that the facility is secure, safe, accessible, and that it conforms to electrical and plumbing codes. (3-20-20)T

**g.** Pump houses shall be kept clean and in good repair and shall not be used to store toxic or hazardous materials other than those materials required for treatment processes. (3-20-20)T

**h.** A suitable outlet shall be provided for drainage from pump glands without discharging onto the floor. (3-20-20)T

**i.** Floor drains shall not be connected to sewers, storm drains, chlorination room drains, or any other source of contamination unless otherwise approved by the Department based on documentation provided by the design engineer. Gas chlorination room drains shall not be connected to any other drainage system and should terminate in a properly located below ground sump. Sumps for pump house floor drains shall not be closer than thirty (30) feet from any well. (3-20-20)T

**j.** Adequate space shall be provided for the installation of potential additional units and for the safe and efficient servicing of all equipment. (3-20-20)T

**k.** Suction basins shall be watertight, have floors sloped to permit removal of water and settled solids, be covered or otherwise protected against contamination, and have two (2) pumping compartments or other means to allow the suction basin to be taken out of service for inspection maintenance or repair. (3-20-20)T

**l.** Pump houses shall be designed to allow efficient equipment servicing. Crain-ways, hoist beams, eyebolts, or other adequate facilities for servicing or removal of pumps, motors or other heavy equipment shall be provided. Openings in floors, roofs or wherever else shall be provided as needed for removal of heavy or bulky equipment. (3-20-20)T

**m.** All remote controlled stations shall be electrically operated and controlled and shall have signaling apparatus of proven performance. Signaling apparatus shall report automatically when the station is out of service. (3-20-20)T

**n.** Any threaded hose bib installed in the pump house must be equipped with an appropriate backflow prevention device. (3-20-20)T

**02. Pumping Units.** At least two (2) pumping units shall be provided for raw water and surface source pumps. Pumps using seals containing mercury shall not be used in public drinking water system facilities. With any pump out of service, the remaining pump or pumps shall be capable of providing the peak hour demand of the system or a minimum of the maximum day demand plus equalization storage. See Subsection 501.18 for general design requirements concerning fire flow capacity and Subsection 501.07 regarding reliability and emergency operation. The pumping units shall meet the following requirements: (3-20-20)T

**a.** The pumps shall have ample capacity to supply the maximum demand against the required pressure without dangerous overloading. (3-20-20)T

**b.** The pumps shall be driven by prime movers able to meet the maximum horsepower condition of the pumps. (3-20-20)T

**c.** The pumps shall be provided with readily available spare parts and tools. (3-20-20)T

**d.** The pumps shall be served by control equipment that has proper heater and overload protection for air temperature encountered. (3-20-20)T

**e.** Suction lift shall be avoided if possible. When suction lift is used, it shall be within the limits allowed by the manufacturer of the pumps, and provision shall be made for priming the pumps. (3-20-20)T

**f.** Prime water must not be of lesser sanitary quality than that of the water being pumped. Means shall be provided to prevent either backpressure or backsiphonage backflow. When an air-operated ejector is used, the twenty-four (24) mesh or similar non-corrodible screened intake shall draw clean air from a point at least ten (10) feet above the ground or other source of possible contamination, unless the air is filtered by an apparatus approved by the reviewing authority. Vacuum priming may be used. (3-20-20)T

**03. Appurtenances.** The following appurtenances shall be provided for all water pumps. Additional requirements specific to well pumps are provided in Section 511. (3-20-20)T

**a.** Pumps shall be protected against freezing and valved to permit satisfactory operation, maintenance, and repair of the equipment. If foot valves are necessary, they shall have a net valve area of at least two and one-half (2.5) times the area of the suction pipe and they shall be screened. Each pump shall have an accessible check valve on the discharge side between the pump and the shut-off valve or a combination valve that performs both control valve and check valve functions. Surge relief measures shall be designed to minimize hydraulic transients. (3-20-20)T

**b.** In general, piping shall be designed so that it will have watertight joints, be protected against surge or water hammer, be provided with suitable restraints where necessary, be designed so that friction losses will be minimized, and not be subject to contamination. Each pump shall have an individual suction line or the suction lines shall be manifolded such that they will ensure similar hydraulic and operating conditions. (3-20-20)T

**c.** Each pump station shall have a standard pressure gauge on its discharge line and suction line. (3-20-20)T

**d.** Water seals shall not be supplied with water of a lesser sanitary quality than that of the water being pumped. Where pumps are sealed with potable water and are pumping water of lesser sanitary quality, the seal shall: (3-20-20)T

**i.** Be provided with either an approved reduced pressure principle backflow preventer or a break tank

open to atmospheric pressure, (3-20-20)T

ii. Where a break tank is provided, have an air gap of at least six (6) inches or two (2) pipe diameters, whichever is greater, between the feeder line and the flood rim of the tank. (3-20-20)T

e. Pumps, their prime movers, and accessories shall be controlled in such a manner that they will operate at rated capacity without dangerous overload. Where two (2) or more pumps are installed, provision shall be made for alternation. Provision shall be made to prevent energizing the motor in the event of a backspin cycle. Equipment shall be provided or other arrangements made to prevent surge pressures from activating controls which switch on pumps or activate other equipment outside the normal design cycle of operation. (3-20-20)T

**04. Booster Pumps.** In addition to other applicable requirements in Section 541, booster pumps must comply with the following: (3-20-20)T

a. In-line booster pumps shall maintain an operating pressure that is consistent with the requirements specified in Subsection 552.01, and shall be supplied with an automatic cutoff when intake pressure is less than or equal to five (5) psi. (3-20-20)T

b. Booster pumps with a suction line directly connected to any storage reservoirs shall be protected by an automatic cutoff to prevent pump damage and avoid excessive reservoir drawdown. (3-20-20)T

c. Each booster pumping station shall contain not less than two (2) pumps with capacities such that peak hour demand, or a minimum of the maximum day demand plus equalization storage, can be satisfied with any pump out of service. See Subsection 501.18 for general design requirements concerning fire flow capacity. (3-20-20)T

#### **542. FACILITY AND DESIGN STANDARDS - DISTRIBUTION SYSTEM.**

**01. Protection from Contamination.** The distribution system shall be protected from contamination and be designed to prevent contamination by steam condensate or cooling water from engine jackets or other heat exchange devices. (3-20-20)T

**02. Installation of Water Mains.** Division 400 of "Idaho Standards for Public Works Construction," referenced in Subsection 002.02, may be used as guidance for installation of water mains. In addition, the following provisions shall apply: (3-20-20)T

a. Installed pipe shall be pressure tested and leakage tested in accordance with the applicable AWWA Standards, incorporated by reference into these rules at Subsection 002.01. (3-20-20)T

b. New, cleaned, and repaired water mains shall be disinfected in accordance with AWWA Standard C651, incorporated by reference into these rules at Subsection 002.01. The specifications shall include detailed procedures for the adequate flushing, disinfection, and microbiological testing of all water mains. (3-20-20)T

c. In areas where aggressive soil conditions are suspected or known to exist, analyses shall be performed to determine the actual aggressiveness of the soil. If soils are found to be aggressive, action shall be taken to protect metallic joint restraints and the water main, such as encasement in polyethylene, provision of cathodic protection, or use of corrosion resistant materials. (3-20-20)T

d. The Department must approve any interconnection between potable water supplies, taking into account differences in water quality between the two systems. (3-20-20)T

e. A continuous and uniform bedding shall be provided in the trench for all buried pipe. Backfill material shall be tamped in layers around the pipe and to a sufficient height above the pipe to adequately support and protect the pipe. Stones found in the trench shall be removed for a depth of at least six (6) inches below the bottom of the pipe. (3-20-20)T

f. Water mains shall be covered with sufficient earth or other insulation to prevent freezing.

(3-20-20)T

**g.** All tees, bends, plugs and hydrants shall be provided with reaction blocking, tie rods or joints designed to prevent movement. (3-20-20)T

**03. Pressure Relief Valves.** All pumps connected directly to the distribution system shall be designed in conjunction with a water pressure relief valve of type, size, and material approved by the Department unless the Department approves another method that will prevent excessive pressure development. (3-20-20)T

**04. Flow Meter Required.** Unless otherwise approved by the Department based on documentation provided by the design engineer, all source pumps and booster pumps connected directly to the distribution system shall have an instantaneous and totalizing flow meter, equipped with nonvolatile memory, installed in accordance with manufacture's specifications. (3-20-20)T

**05. Pipe and Jointing Materials.** Pipe and jointing materials comply with the standards set forth in Subsection 501.01. Pipe shall be manufactured of materials resistant internally and externally to corrosion and not imparting tastes, odors, color, or any contaminant into the system. Where distribution systems are installed in areas of ground water contaminated by organic compounds: (3-20-20)T

**a.** Pipe and joint materials which do not allow permeation of the organic compounds shall be used; and (3-20-20)T

**b.** Non-permeable materials shall be used for all portions of the system including pipe, joint materials, hydrant leads, and service connections. (3-20-20)T

**06. Size of Water Mains.** When fire hydrants are provided, they shall not be connected to water mains smaller than six (6) inches in diameter, and fire hydrants shall not be installed unless fireflow volumes are available. If fire flow is not provided, water mains shall be no less than three (3) inches in diameter. Any departure from this minimum standard shall be supported by hydraulic analysis and detailed projections of water use. (3-20-20)T

**07. Separation of Potable, Non-Potable, and Raw Water Pipelines.** The requirements for the protection of potable mains from contamination by non-potable pipelines are described in Subsections 542.07.a. through 542.07.c. For the purposes of Subsection 542.07, the term "pipeline" applies to both mains and services. The Department will use the Memorandum of Understanding with the Plumbing Bureau as guidance in determining the relative responsibilities for reviewing service lines. The conditions of Subsections 542.07.a. and 542.07.b. shall apply to all potable services constructed or reconstructed after April 15, 2007 and where the Department or the QLPE is the reviewing authority. Raw water pipelines must be protected from contamination from non-potable pipelines, and must not contaminate potable pipelines. They shall therefore meet equivalent separation distances shown below from either potable or non-potable pipelines. (3-20-20)T

**a.** Parallel installation requirements. (3-20-20)T

**i.** Potable mains in relation to non-potable mains. (3-20-20)T

(1) Greater than ten (10) feet separation: no additional requirements. (3-20-20)T

(2) Ten (10) feet to six (6) feet separation: separate trenches, with the bottom of the potable main above the top of the non-potable main, and non-potable main constructed with potable water class pipe. (3-20-20)T

(3) Less than six (6) feet separation: design engineer to submit data to the Department for review and approval showing that this installation will protect public health and the environment, non-potable main to be constructed of potable water class pipe, and with the bottom of the potable main above the top of the non-potable main. (3-20-20)T

(4) Non-potable mains are prohibited from being located in the same trench as potable mains. (3-20-20)T



(5) Pressure wastewater mains or other pressurized mains or lines containing non-potable fluids shall be no closer horizontally than ten (10) feet from potable mains. (3-20-20)T

ii. New potable services in relation to non-potable services, new potable services in relation to non-potable mains, and new non-potable services in relation to potable mains. (3-20-20)T

(1) Greater than six (6) feet separation: no additional requirements based on separation distance. (3-20-20)T

(2) Less than six (6) feet separation: design engineer to submit data that this installation will protect public health and the environment and non-potable service constructed with potable water class pipe. (3-20-20)T

(3) New potable services are prohibited from being located in the same trench as non-potable mains or non-potable services. (3-20-20)T

**b.** Requirements for potable water mains or services crossing non-potable water mains or services. (3-20-20)T

i. If there is eighteen (18) inches or more vertical separation with the potable water pipeline above the non-potable pipeline, then the potable pipeline joints must be as far as possible from the non-potable water pipeline. (3-20-20)T

ii. If there is eighteen (18) inches or more vertical separation with the potable water pipeline below the non-potable pipeline, then the potable pipeline joints must be as far as possible from the non-potable pipeline, and the non-potable pipeline must be supported through the crossing to prevent settling. (3-20-20)T

iii. Less than eighteen (18) inches vertical separation: (3-20-20)T

(1) Potable pipeline joint to be as far as possible from the non-potable pipeline; and either: (3-20-20)T

(a) Non-potable pipeline constructed with potable water class pipe for a minimum of ten (10) feet either side of potable pipeline with a single twenty (20) foot section of potable water class pipe centered on the crossing; or (3-20-20)T

(b) Sleeve non-potable or potable pipeline with potable water class pipe for ten (10) feet either side of crossing. Use of hydraulic cementitious materials such as concrete, controlled density fill, and concrete slurry encasement is not allowed as a substitute for sleeving. (3-20-20)T

(2) If potable pipeline is below non-potable pipeline, the non-potable pipeline must also be supported through the crossing to prevent settling. (3-20-20)T

iv. Pressure wastewater mains or other pressurized mains or lines containing non-potable fluids shall be no closer vertically than eighteen (18) inches from potable mains. (3-20-20)T

**c.** Existing potable services in relation to new non-potable mains, existing non-potable services in relation to new potable mains, and existing potable services in relation to new non-potable services shall meet the requirements of Subsection 542.07.b., where practical, based on cost, construction factors, and public health significance. If the Department determines that there are significant health concerns with these services, such as where a large existing service serves an apartment building or a shopping center, then the design shall conform with Subsection 542.07.b. (3-20-20)T

**08. Separation from Subsurface Wastewater Systems and Other Sources of Contamination.** A minimum horizontal distance of twenty-five (25) feet shall be maintained between any potable water pipe and a septic tank or subsurface wastewater disposal system. Guidance on separation from other potential sources of contamination, such as stormwater facilities, may be found on the DEQ website <http://www.deq.idaho.gov>. (3-20-20)T

**09. Dead End Mains.** All dead end water mains shall be equipped with a means of flushing and shall be flushed at least semiannually at a water velocity of two and one-half (2.5) feet per second. (3-20-20)T

**a.** Dead ends shall be minimized by making appropriate tie-ins whenever practical in order to provide increased reliability of service and reduce head loss. (3-20-20)T

**b.** Flushing shall be performed in such a way as to minimize any erosion of unprotected areas and, if applicable, shall be coordinated with the owner of the receiving system. No water main flushing device shall be directly connected to any sewer. (3-20-20)T

**c.** Stub outs for future main connections shall meet all requirements for dead end mains listed in Subsection 542.09 as determined by the Department. Flushing devices may be temporary in nature. (3-20-20)T

**10. Repair of Leaks.** Leaking water mains shall be repaired or replaced upon discovery and disinfected in accordance with American Water Works Association (AWWA) Standards, incorporated by reference into these rules at Subsection 002.01. (3-20-20)T

**11. Separation from Structures.** Water mains shall be separated by at least five (5) feet from buildings, industrial facilities, and other permanent structures. (3-20-20)T

**12. Meter Vault Required.** All new public water systems shall include a meter vault at each service connection. A lockable shut-off valve shall be installed in the meter vault. This requirement shall also apply to extensions of the distribution system of existing public water systems. (3-20-20)T

**13. Minimum Pressure at Building Sites.** Any public water system constructed or undergoing material modification where topographical relief may affect water pressure at the customers' premises shall provide the Department with an analysis which demonstrates that the pressure at each designated building site will be at least forty (40) psi, based on dynamic pressure in the main, as set forth in Subsections 552.01.b.i. and 552.01.b.v., plus a static compensation from the elevation of the main to the elevation of each building site. (3-20-20)T

**a.** If forty (40) psi cannot be provided at each designated building site, the Department may require that reasonable effort be made to provide notification to existing and potential customers of the expected pressure. (3-20-20)T

**b.** The Department will not authorize a service connection at any designated building site where analysis indicates that pressure will be less than twenty (20) psi static pressure (or twenty-six point five (26.5) psi for two (2) story buildings). (3-20-20)T

**14. Isolation Valves.** A sufficient number of valves shall be provided on water mains to minimize inconvenience and sanitary hazards during repairs. (3-20-20)T

**15. Air Valves.** At high points in water mains where air can accumulate, provisions shall be made to remove the air by means of air release and vacuum relief valves or combination air release/vacuum relief valves. Air release valves, vacuum relief valves, or combination air release/vacuum relief valves may not be required if vacuum relief and air release functions in the pipeline can be adequately handled by approved appurtenances such as fire hydrants. (3-20-20)T

**a.** The open end of an air valve shall be extended to at least one (1) foot above grade and provided with a twenty-four (24) mesh or similar non-corrodible screened, downward-facing elbow. When the air vent on an air relief valve cannot be practically installed above ground, the vent may be below grade provided that the valve is manually operated and the air vent is extended to the top of the valve vault and provided with a twenty-four (24) mesh or similar non-corrodible screened, downward-facing elbow. In addition, for below ground vents, the valve vault must be rated for appropriate traffic loading in traffic areas and the vault drained to daylight or provided with adequate drainage to prevent flooding of the vault. (3-20-20)T

**b.** Discharge piping from air valves or combination air release/vacuum relief valves shall not connect directly to any storm drain, storm sewer, or sanitary sewer. (3-20-20)T

**16. Backflow Protection.** Automatic air relief valves shall be equipped with a means of backflow protection. (3-20-20)T

**17. Surface Water Crossings.** For the purposes of Subsection 542.17, surface water is defined as all surface accumulations of water, natural or artificial, public or private, or parts thereof which are wholly or partially within, which flow through or border upon the state. This includes, but is not limited to, rivers, streams, canals, ditches, lakes, and ponds. Surface water crossings, whether over or under water, shall be constructed as follows: (3-20-20)T

**a.** Above water crossings: the pipe shall be adequately supported and anchored, protected from damage and freezing, and shall be accessible for repair or replacement. (3-20-20)T

**b.** Under water crossings: A minimum cover of two (2) feet shall be provided over the pipe. When crossing a water course that is greater than fifteen (15) feet in width, the following shall be provided: (3-20-20)T

**i.** The pipe shall be of special construction, having flexible, restrained, or welded water-tight joints; and (3-20-20)T

**ii.** Valves shall be provided at both ends of water crossings so that the section can be isolated for testing or repair; the valves shall be easily accessible and not subject to flooding; and (3-20-20)T

**iii.** Permanent taps or other provisions to allow insertion of a small meter to determine leakage and obtain water samples shall be made on each side of the valve closest to the supply source. (3-20-20)T

**543. FACILITY AND DESIGN STANDARDS: CROSS CONNECTION CONTROL.**

There shall be no connection between the distribution system and any pipes, pumps, hydrants, water loading stations, or tanks whereby unsafe water or other contaminating materials may be discharged or drawn into a public water system. The water purveyor is responsible through its cross connection control program to take reasonable and prudent measures to protect the water system against contamination and pollution from cross connections through premises isolation or containment, internal or in-plant isolation, fixture protection, or some combination of premises isolation, internal isolation, and fixture protection. (3-20-20)T

**01. Testable Assemblies.** All double check valve backflow prevention assemblies, reduced pressure principle backflow prevention assemblies, spill resistant vacuum breakers, and pressure vacuum breakers used must pass a performance test conducted by the University of Southern California Foundation for Cross-Connection Control and Hydraulic Research (USC Foundation) and be included on the USC Foundation "List of Approved Assemblies." (3-20-20)T

**02. Atmospheric Vacuum Breakers.** All atmospheric vacuum breakers used shall be marked approved either by the International Association of Plumbing and Mechanical Officials (IAPMO) or by the American Society of Sanitation Engineers (ASSE). (3-20-20)T

**03. Replacement Parts and Components.** All replacement parts and components, including resilient seated shutoff valves, shall meet original manufacturer's specifications or otherwise be approved by the USC Foundation as replacement parts or components for use on double check valve backflow prevention assemblies, reduced pressure principle backflow prevention assemblies, pressure vacuum breakers, and spill resistant pressure vacuum breakers. The design, material, or operational characteristics of any assembly must not be altered during maintenance or repair. (3-20-20)T

**04. Assembly Selection.** Appropriate and adequate backflow prevention assembly types for various facilities, fixtures, equipment, and uses of water should be selected from the AWWA Pacific Northwest Section Cross Connection Control Manual, the Uniform Plumbing Code, the AWWA Recommended Practice for Backflow Prevention and Cross Connection Control (M14), the USC Foundation Manual of Cross Connection Control, or other sources deemed acceptable by the Department. The selected assembly manufacturer model number must be included on the USC Foundation "List of Approved Assemblies" and must comply with local ordinances. (3-20-20)T

**544. FACILITY AND DESIGN STANDARDS: GENERAL DESIGN OF FINISHED WATER STORAGE.**

The materials and designs used for finished water storage structures shall provide stability and durability as well as protect the quality of the stored water. Finished water storage structures shall be designed to maintain water circulation and prevent water stagnation. Steel structures and facilities such as steel tanks, standpipes, reservoirs, and elevated tanks shall be designed and constructed in accordance with applicable AWWA Standards, incorporated by reference into these rules at Subsection 002.01. Other materials of construction are acceptable when properly designed to meet the requirements of Section 544. (3-20-20)T

**01. Sizing and Isolation Requirements.** (3-20-20)T

**a.** Storage facilities shall have sufficient capacity, as determined from engineering studies that consider peak flows, fire flow capacity, and analysis of the need for various components of finished storage as defined under the term “Components of Finished Water Storage” in Section 003. The requirement for storage may be reduced when the source and treatment facilities have sufficient capacity with standby power to supply peak demands of the system. (3-20-20)T

**b.** All storage structures which provide pressure directly to the distribution system, such as elevated storage structures or ground level storage structures with associated pumping systems, shall be designed so they can be isolated and drained for cleaning or maintenance without causing a loss of pressure in the distribution system. (3-20-20)T

**02. Location.** Storage facilities shall be located in a manner that protects against contamination, ensures structural stability, protects against flooding, and provides year-round access by vehicles and equipment needed for repair and maintenance. (3-20-20)T

**a.** If the bottom elevation of a storage reservoir must be below normal ground surface, it shall be placed above the seasonal high ground water table. (3-20-20)T

**b.** Non-potable mains and services, standing water, and similar sources of possible contamination must be kept at least fifty (50) feet from any partially buried or below-ground storage structure or facility, except that non-potable mains and services constructed of potable water class pipe are allowed as close as twenty (20) feet from a partially buried or below-ground storage structure or facility. Partially buried or below-ground storage structures or facilities shall be located a minimum of fifty (50) feet from the nearest property line. (3-20-20)T

**c.** No public water supply storage tank shall be located within five hundred (500) feet of any municipal or industrial wastewater treatment plant or any land which is spray irrigated with wastewater or used for sludge disposal. (3-20-20)T

**d.** The top of a partially buried storage structure shall not be less than two (2) feet above normal ground surface. (3-20-20)T

**e.** Ground-level or above-ground storage structures or facilities shall be located a minimum of twenty (20) feet from the nearest property line and a minimum of twenty (20) feet from any potential source of contamination. (3-20-20)T

**03. Protection from Contamination.** All finished water storage structures shall have suitable watertight roofs which exclude birds, animals, insects, and excessive dust. The installation of appurtenances, such as antennas, shall be done in a manner that ensures no damage to the tank, coatings or water quality, or corrects any damage that occurred. (3-20-20)T

**04. Protection from Trespassers.** Fencing, locks on access manholes, and other necessary precautions shall be provided to prevent trespassing, vandalism, and sabotage. (3-20-20)T

**05. Drains.** No drain on a water storage structure may have a direct connection to a sewer or storm drain. The design shall allow draining the storage facility for cleaning or maintenance without causing loss of pressure in the distribution system. (3-20-20)T

**06. Overflow.** Overflow pipes of any storage structure or facility shall discharge to daylight in a way that will preclude the possibility of backflow to the reservoir and, where practical, be provided with an expanded metal screen installed within the pipe that will exclude rodents and deter vandalism. The overflow pipe shall be of sufficient diameter to permit waste of water in excess of the filling rate. The overflow shall discharge over a drainage inlet structure or a splash plate and, when practical, discharge at an elevation between twelve (12) and twenty-four (24) inches above the receiving surface. (3-20-20)T

**a.** When an internal overflow pipe is used on above-ground tanks, it shall be located in the access tube. (3-20-20)T

**b.** The overflow for ground-level, partially buried, or below-ground storage structures or facilities shall have a vertical section of pipe at least two (2) pipe diameters in length and either: (3-20-20)T

**i.** Be screened with a twenty-four (24) mesh non-corrodible screen installed within the pipe when practical or an expanded metal screen installed within the pipe plus a weighted flapper valve or check; or (3-20-20)T

**ii.** Be an equivalent system acceptable to the Department. (3-20-20)T

**07. Access.** Finished water storage structures shall be designed with reasonably convenient access to the interior for cleaning and maintenance. At least two (2) manholes shall be provided above the waterline at each water compartment where space permits, as determined by the Department. One (1) manhole may be allowed on smaller tanks on a case-by-case basis. (3-20-20)T

**a.** The following access requirements apply to above-ground and ground-level storage structures. Each access manhole shall be framed a minimum of four (4) inches above the surface of the roof at the opening. The actual height above the surface of the roof must be sufficient to prevent incidental contamination from snow accumulation, storm water runoff or accumulation, irrigation water, or other potential sources of contamination. (3-20-20)T

**b.** The following access requirements apply to, partially buried or below-ground storage structures. Each access manhole shall be elevated a minimum of twenty-four (24) inches above the surface of the roof or the ground level, whichever is higher. The actual height above the surface of the roof or the ground level must be sufficient to prevent incidental contamination from snow accumulation, storm water runoff or accumulation, irrigation water, or other potential sources of contamination. (3-20-20)T

**c.** Each manhole shall be fitted with a solid water tight cover designed to prevent the entrance of contaminants. Each cover shall be hinged only on one (1) side and shall have a locking device. Unless otherwise approved by the Department based on documentation provided by the design engineer, each cover shall have a framed opening with the lid extending down around the frame at least two (2) inches, and the frame shall be at least four (4) inches high. (3-20-20)T

**08. Vents.** Finished water storage structures shall be vented. The overflow pipe shall not be considered a vent. Open construction between the sidewall and roof is not permissible. Vents shall: (3-20-20)T

**a.** Prevent the entrance of surface water and rainwater and extend twelve (12) inches above the roof. (3-20-20)T

**b.** Exclude birds and animals. (3-20-20)T

**c.** Exclude insects and dust, as much as this function can be made compatible with effective venting. (3-20-20)T

**d.** On ground-level, partially buried, or below-ground structures, open downward with the opening at least twenty-four (24) inches above the roof or the ground level and covered with twenty-four (24) mesh non-corrodible screen. The screen shall be installed within the pipe at a location least susceptible to vandalism. (3-20-20)T

e. On above-ground tanks and standpipes, open downward, and be fitted with twenty-four (24) mesh or similar non-corrodible screen. (3-20-20)T

**09. Roof and Sidewall.** The roof and sidewalls of all water storage structures must be watertight with no openings except properly constructed vents, manholes, overflows, risers, drains, pump mountings, control ports, or piping for inflow and outflow. Particular attention shall be given to the sealing of roof structures which are not integral to the tank body. (3-20-20)T

a. Any pipes running through the roof or sidewall of a metal storage structure must be welded, or properly gasketed. In concrete tanks, these pipes shall be connected to standard wall castings which were poured in place during the forming of the concrete. (3-20-20)T

b. Openings in the roof of a storage structure designed to accommodate control apparatus or pump columns shall be curbed and sleeved with proper additional shielding to prevent contamination from surface or floor drainage. (3-20-20)T

c. The roof of the storage structure shall be sloped to facilitate drainage. Downspout pipes shall not enter or pass through the reservoir. Parapets, or similar construction which would tend to hold water and snow on the roof, will not be approved unless adequate waterproofing and drainage are provided. (3-20-20)T

d. Reservoirs with pre-cast concrete roof structures must be made watertight with the use of a waterproof membrane or similar product. (3-20-20)T

**10. Construction Materials.** Materials used in storage facility construction shall meet the requirements for water contact surfaces set forth in Subsection 501.01. Porous materials such as wood or concrete block are not acceptable for use in storage construction. (3-20-20)T

**11. Protection from Freezing.** Finished water storage structures and their appurtenances, especially the riser pipes, overflows, and vents, shall be designed to prevent freezing which will interfere with proper functioning. (3-20-20)T

**12. Internal Catwalk.** Every catwalk over finished water in a storage structure shall have a solid floor with sealed raised edges, designed to prevent contamination from shoe scrapings and dirt. (3-20-20)T

**13. Silt Stops.** Removable silt stops shall be provided to prevent sediment from entering the reservoir discharge pipe. (3-20-20)T

**14. Grading.** The area surrounding a ground-level, partially buried, or below-ground structures shall be graded in a manner that will prevent surface water from standing within fifty (50) feet of it. (3-20-20)T

**15. Coatings and Cathodic Protection.** Proper protection shall be given to metal surfaces by paints or other protective coatings, by cathodic protective devices, or by both. (3-20-20)T

**16. Disinfection.** Storage facilities shall be disinfected in accordance with AWWA Standard C652, incorporated by reference into these rules at Subsection 002.01. Two (2) or more successive sets of samples, taken at twenty-four (24) hour intervals, shall indicate microbiologically satisfactory water before the facility is placed into operation. (3-20-20)T

**17. Abandonment.** All unused subsurface storage tanks shall be removed and backfilled, or abandoned by extracting residual fluids and filling the structure with sand or fine gravel. (3-20-20)T

**545. FACILITY AND DESIGN STANDARDS: TREATMENT PLANT STORAGE FACILITIES.**  
The design standards of Section 544 shall apply to treatment plant storage. (3-20-20)T

**01. Filter Wash Water.** Filter wash water tanks shall be sized, in conjunction with available pump units and finished water storage, to provide the backwash water required by Section 521. Consideration must be given to the backwashing of several filters in rapid succession. (3-20-20)T

**02. Clearwell.** When finished water storage is used to provide disinfectant contact time special attention must be given to tank size and baffling. An overflow and vent shall be provided. A minimum of two (2) clearwell compartments shall be provided to allow for cleaning or maintenance. Clearwells constructed under filters may be exempt from the requirements set out in Subsection 544.02.d. when the design provides adequate protection from contamination. (3-20-20)T

**03. Adjacent Storage.** Finished or treated water must not be stored or conveyed in a compartment adjacent to untreated or partially treated water when the two (2) compartments are separated by a single wall, unless approved by the reviewing authority. (3-20-20)T

**04. Other Treatment Plant Storage Tanks.** Unless otherwise allowed by the reviewing authority, other treatment plant storage tanks/basins such as detention basins, backwash reclaim tanks, receiving basins, and pump wet-wells for finished water shall be designed as finished water storage structures. In addition, these tanks/basins shall be designed to allow for cleaning or maintenance through temporary tanks, standby pumping capabilities, or other means approved by the Department. (3-20-20)T

**546. FACILITY AND DESIGN STANDARDS: DISTRIBUTION SYSTEM STORAGE FACILITIES.**

**01. Design.** The applicable design standards of Section 544 shall be followed for distribution system storage. (3-20-20)T

**02. Isolation.** Finished water storage structures which provide pressure directly to the distribution system shall be designed so they can be isolated from the distribution system and drained for cleaning or maintenance without causing a loss of pressure in the distribution system. This requirement may be met through available temporary tanks, redundant pumping capabilities, or other temporary means approved by the Department. If the finished water storage structure provides fire flow for the water system, the water system owner shall provide the local fire authority advance notification of cleaning or maintenance events which isolate the structure from the distribution system and reduce available fire flow to less than the minimum required by the local fire authority. (3-20-20)T

**03. Drain.** Drains shall discharge to daylight in a way that will preclude the possibility of backflow to the reservoir and, where practical, be provided with an expanded metal screen installed within the pipe that will exclude rodents and deter vandalism. The drain shall, when practical, discharge at an elevation between twelve (12) and twenty-four (24) inches above the receiving surface, and discharge over a drainage inlet structure or a splash plate. (3-20-20)T

**04. Level Controls.** Adequate controls shall be provided to maintain levels in distribution system storage structures. Level indicating devices shall be provided at a central location. (3-20-20)T

**547. FACILITY AND DESIGN STANDARDS: HYDROPNEUMATIC TANK SYSTEMS.**

Hydropneumatic tanks use compressed air to regulate pump cycling and to absorb pressure surges (water hammer). These tanks do not provide true storage. Systems serving more than one-hundred-fifty (150) homes are generally better served by providing reservoir storage, as set forth in Sections 544, 545 and 546. (3-20-20)T

**01. General Design of Hydropneumatic Systems.** (3-20-20)T

**a.** Tanks shall be located above normal ground surface and be completely housed. (3-20-20)T

**b.** Tanks shall have bypass piping to permit operation of the system while the tank is being repaired or painted. Exterior surfaces and accessible interior surfaces shall be provided with protective coatings and shall be maintained in good condition. Supports beneath tanks shall be structurally sound. (3-20-20)T

**c.** Tanks shall be sized to limit pump cycles to not more than six (6) per hour unless a pump manufacturer's warranty specifically supports more frequent cycling. The number of pump cycles may be increased in systems with multiple pumps if a means to automatically alternate pumps is provided. The Franklin Electric AIM manual, referenced in Subsection 002.02, Chapter 11 of the Washington State Department of Health Water System

Design Manual, referenced in Subsection 002.02, or manufacturer's recommendations may be used as guidance in calculating the size of hydropneumatic tanks. (3-20-20)T

**d.** Tanks of greater than one-hundred twenty (120) gallons volume shall conform with the American Society of Mechanical Engineers (ASME) specifications code for unfired pressure vessels. Tanks of less than one hundred twenty (120) gallons volume shall meet the ASME code or be certified by a nationally recognized testing agency to be capable of withstanding twice the maximum allowable working pressure. (3-20-20)T

**02. Requirements Specific to Conventional Hydropneumatic Tanks.** Conventional tanks are those that have a direct air to water interface and require periodic air recharge to compensate for absorption of air into the water. (3-20-20)T

**a.** Each tank shall have an access manhole, a drain, and control equipment consisting of a pressure gauge, water sight glass, automatic or manual air blow-off, means for adding air that is filtered or otherwise protected from contamination, and pressure operated start-stop controls for the pumps. If tank size allows, the access manhole shall be at least twenty-four (24) inches in diameter. (3-20-20)T

**b.** The gross volume of tanks in systems served by variable speed pumps may be less than that required for systems served by constant speed pumps. Design volumes shall be approved by the Department on a site-specific basis. (3-20-20)T

**03. Requirements Specific to Bladder Tanks.** Bladder tanks have a membrane that separates air and water inside the tank. (3-20-20)T

**a.** Bladder tanks must be pre-charged with air to a pressure of five (5) psi below the setting at which the pump turns on (the low operating pressure for the system). (3-20-20)T

**b.** Each manifold assembly shall have a pressure gauge and pressure operated start-stop controls for the pumps. (3-20-20)T

**c.** The procedure for sizing bladder tanks is to determine the number of a selected size of tanks that are needed to provide pump protection. Reduced tank volume in systems served by variable speed pumps shall be approved by the Department on a site specific basis. (3-20-20)T

**548. FACILITY AND DESIGN STANDARDS: DISINFECTION OF FACILITIES PRIOR TO USE.** Any supplier of water for a public water system shall ensure that new construction or modifications to an existing system shall be flushed and disinfected in accordance with American Water Works Association (AWWA) Standards, incorporated by reference into these rules at Subsection 002.01, prior to being placed into service. (3-20-20)T

**549. -- 551. (RESERVED)**

**552. OPERATING CRITERIA FOR PUBLIC WATER SYSTEMS.**

**01. Quantity and Pressure Requirements.** Design requirements regarding pressure analysis are found in Section 542.13. (3-20-20)T

**a.** Minimum Capacity. The capacity of a public drinking water system shall be at least eight hundred (800) gallons per day per residence. (3-20-20)T

**i.** The minimum capacity of eight hundred (800) gallons per day shall be the design maximum day demand rate exclusive of irrigation and fire flow requirements. (3-20-20)T

**ii.** The minimum capacity of eight hundred (800) gallons per day is only acceptable if the public drinking water system has equalization storage of finished water in sufficient quantity to compensate for the difference between a water system's maximum pumping capacity and peak hour demand. (3-20-20)T

**iii.** The design capacity of a public drinking water system for material modifications may be less than



eight hundred (800) gallons per day per residence if the water system owner provides information that demonstrates to the Department's satisfaction the maximum day demand for the system, exclusive of irrigation and fire flows, is less than eight hundred (800) gallons per day per residence. (3-20-20)T

b. Pressure. All public water systems shall meet the following requirements: (3-20-20)T

i. Any public water system shall be capable of providing sufficient water during maximum day demand conditions, including fire flow where provided, to maintain a minimum pressure of twenty (20) psi throughout the distribution system, at ground level, as measured at the service connection or along the property line adjacent to the consumer's premises. (3-20-20)T

ii. Public Notification. (3-20-20)T

(1) During unplanned or emergency situations, when water pressure within the system is known to have fallen below twenty (20) psi, the water supplier must notify the Department, provide public notice to the affected customers within twenty-four (24) hours, and disinfect or flush the system as appropriate. When sampling and corrective procedures have been conducted and after determination by the Department that the water is safe, the water supplier may re-notify the affected customers that the water is safe for consumption. The water supplier shall notify the affected customers if the water is not safe for consumption. (3-20-20)T

(2) During planned maintenance or repair situations, when water pressure within the system is expected to fall below twenty (20) psi, the water supplier must provide public notice to the affected customers prior to the planned maintenance or repair activity and shall ensure that the water is safe for consumption. (3-20-20)T

iii. If an initial investigation by the water supplier fails to discover the causes of inadequate or excessive pressure, the Department may require the water supplier to conduct a local pressure monitoring study to diagnose and correct pressure problems. Compliance with these requirements by water systems that do not have a meter vault or other point of access at the service connection or along the property line adjacent to the consumer's premises where pressure in the distribution system can be reliably measured shall be determined by measurements within the consumer's premises, or at another representative location acceptable to the Department. (3-20-20)T

iv. Copies of pressure monitoring study reports required under Subsection 552.01.b.iii. detailing study results and any resulting corrective actions planned or performed by the public water system shall be submitted to the Department in accordance with these rules. (3-20-20)T

v. The following public water systems or service areas of public water systems shall maintain a minimum pressure of forty (40) psi throughout the distribution system, during peak hour demand conditions, excluding fire flow, measured at the service connection or along the property line adjacent to the consumer's premises. (3-20-20)T

(1) Any public water system constructed or substantially modified after July 1, 1985. (3-20-20)T

(2) Any new service areas. (3-20-20)T

(3) Any public water system that is undergoing material modification where it is feasible to meet the pressure requirements as part of the material modification. (3-20-20)T

vi. Any public water system shall keep static pressure within the distribution system below one hundred (100) psi and should ordinarily keep static pressure below eighty (80) psi. Pressures above one hundred (100) psi shall be controlled by pressure reducing valve stations installed in the distribution main. In areas where failure of installed pressure reducing valve stations would result in extremely high pressure, pressure relief valves may be required. The Department may approve the use of pressure reducing devices at individual service connections on a case by case basis, if it can be demonstrated that higher pressures in portions of the distribution system are required for efficient system operation. If system modification will cause pressure to routinely exceed eighty (80) psi, or if a check valve or an individual pressure reducing device is added to the service line, the water system owner shall notify affected customers. Notification may include reasons for the elevated pressure, problems or damage that elevated pressure can inflict on appliances or plumbing systems, and suggested procedures or mitigation efforts

affected property owners may initiate to minimize problems or damage. (3-20-20)T

vii. The Department may allow the installation of booster pump systems at individual service connections on a case by case basis. However, such an installation may only occur with the full knowledge and agreement of the public water system, including assurance by the water system that the individual booster pump will cause no adverse effects on system operation. (3-20-20)T

viii. For elevated storage tanks, pressure calculations during peak hour demand shall be based on the lowest water level after both operational storage and equalization storage have been exhausted. Pressure calculations during fire flow demands shall be based on the lowest water level after operational storage, equalization storage, and fire suppression storage have been exhausted. (3-20-20)T

ix. For hydropneumatic tanks, pressure calculations shall be based on the lowest pressure of the pressure cycle and this requirement shall be noted in the operation and maintenance manual. (3-20-20)T

**c.** Fire Flows. Any public water system designed to provide fire flows shall ensure that such flows are compatible with the water demand of existing and planned fire-fighting equipment and fire fighting practices in the area served by the system. (3-20-20)T

**d.** Irrigation Flows. (3-20-20)T

i. Any public water system constructed after November 1, 1977, shall be capable of providing water for uncontrolled, simultaneous foreseeable irrigation demand, which shall include all acreage that the system is designed to irrigate. (3-20-20)T

(1) The Department must concur with assumptions regarding the acreage to be irrigated. In general, an assumption that no outside watering will occur is considered unsound and is unlikely to be approved. (3-20-20)T

(2) An assumption of minimal outside watering, as in recreational subdivisions, may be acceptable if design flows are adequate for maintenance of "green zones" for protection against wildland fire. (3-20-20)T

ii. The requirement of Subsection 552.01.d.i. may be modified by the Department if: (3-20-20)T

(1) A separate irrigation system is provided; or (3-20-20)T

(2) The supplier of water can regulate the rate of irrigation through its police powers, and the water system is designed to accommodate a regulated rate of irrigation flow. The Department may require the water system to submit a legal opinion addressing the enforceability of such police powers. (3-20-20)T

iii. If a separate non-potable irrigation system is provided for the consumers, all mains, hydrants and appurtenances shall be easily identified as non-potable. The Department must concur with a plan to ensure that each new potable water service is not cross-connected with the irrigation system. (3-20-20)T

**02. Ground Water.** (3-20-20)T

**a.** Public water systems constructed after July 1, 1985, and supplied by ground water, shall treat water within the system by disinfection if the ground water source is not protected from contamination. (3-20-20)T

**b.** The Department may, in its discretion, require disinfection for any existing public water system supplied by ground water if the system has repeated coliform present samples or E.coli MCL exceedances, and if the system does not appear adequately protected from contamination. Adequate protection will be determined based upon at least the following factors: (3-20-20)T

i. Location of possible sources of contamination; (3-20-20)T

ii. Size of the well lot; (3-20-20)T

- iii. Depth of the source of water; (3-20-20)T
  - iv. Bacteriological quality of the aquifer; (3-20-20)T
  - v. Geological characteristics of the area; and (3-20-20)T
  - vi. Adequacy of development of the source. (3-20-20)T
- 03. Operating Criteria.** The operating criteria for systems that provide filtration shall be as follows: (3-20-20)T
- a.** A project specific operation and maintenance manual shall be provided as required in Subsection 501.12. See definition of Operation and Maintenance Manual in Section 003 for the typical contents of an operation and maintenance manual and the included operations plan. For the operations plan in the operation and maintenance manual, additional guidance for several types of filtration systems can be found in the Department's SWTR Compliance Guidance referenced in Subsection 002.02. (3-20-20)T
  - b.** The system shall conduct monitoring specified by the Department before serving water to the public in order to protect the health of consumers served by the system. (3-20-20)T
  - c.** New treatment facilities shall be operated in accordance with Subsection 552.03.a., and the system shall conduct monitoring specified by the Department for a trial period specified by the Department before serving water to the public in order to protect the health of consumers served by the system. (3-20-20)T
- 04. Chlorination.** Systems that regularly add chlorine to their water are subject to the provisions of Section 320. Systems using surface water or ground water under the direct influence of surface water, are subject to the disinfection requirements of Sections 300 and 518. (3-20-20)T
- a.** Systems using only ground water that add chlorine for the purpose of disinfection, as defined in Section 003, are subject to the following requirements: (3-20-20)T
    - i. Chlorinator and chlorine contact tank capacity shall be such that the system is able to demonstrate that it is routinely achieving four (4) logs (ninety-nine point ninety-nine percent) (99.99%) inactivation/removal of viruses. The required effective contact time will be specified by the Department. This condition must be attainable even when the plant design capacity coincides with anticipated maximum chlorine demands. (3-20-20)T
    - ii. A detectable chlorine residual shall be maintained throughout the distribution system. (3-20-20)T
    - iii. Automatic proportioning chlorinators are required where the rate of flow or chlorine demand is not reasonably constant. (3-20-20)T
    - iv. Analysis for free chlorine residual shall be conducted at a location at or prior to the first service connection at least daily and records of these analyses shall be kept by the supplier of water for at least one (1) year. A report of all daily chlorine residual measurements for each calendar month shall be submitted to the Department no later than the tenth day of the following month. The frequency of measuring free chlorine residuals shall be sufficient to detect variations in chlorine demand or changes in water flow. (3-20-20)T
    - v. If gas chlorination equipment is provided, a separate and ventilated room is required. (3-20-20)T
    - vi. The Department may, in its discretion, require a treatment rate higher than that specified in Subsection 552.04.a.i. (3-20-20)T
    - vii. When chlorine gas is used, chlorine leak detection devices and safety equipment shall be provided and equipped with both an audible alarm and a warning light. (3-20-20)T
    - viii. The Department may require redundant chlorine pumping capabilities with automatic switchover for systems with documented source water contamination problems and that lack adequate storage to supply the

system during a pump failure. (3-20-20)T

**b.** Systems using only ground water that add chlorine for the purpose of maintaining a disinfectant residual in the distribution system, when the source(s) is not at risk of microbial contamination, are subject to the following requirements: (3-20-20)T

**i.** Automatic proportioning chlorinators are required where the rate of flow or chlorine demand is not reasonably constant. (3-20-20)T

**ii.** Analysis for free chlorine residual shall be made at a frequency that is sufficient to detect variations in chlorine demand or changes in water flow. (3-20-20)T

**c.** Systems using only ground water that add chlorine for other purposes, such as oxidation of metals or taste and odor control, when the source(s) is known to be free of microbial contamination, must ensure that chlorine residual entering the distribution system after treatment is less than four (4.0) mg/L. The requirements in Subsection 552.04.b.ii. also apply if the system maintains a chlorine residual in the distribution system. (3-20-20)T

**05. Fluoridation.** (3-20-20)T

**a.** Commercial sodium fluoride, sodium silico fluoride and hydrofluosilicic acid which conform to the applicable American Water Works Association (AWWA) Standards, incorporated by reference into these rules at Subsection 002.01, are acceptable. Use of other chemicals shall be specifically approved by the Department. (3-20-20)T

**b.** Fluoride compounds shall be stored in covered or unopened shipping containers. (3-20-20)T

**c.** Provisions shall be made to minimize the quantity of fluoride dust. Empty bags, drums, or barrels shall be disposed of in a manner that will minimize exposure to fluoride dusts. (3-20-20)T

**d.** Daily records of flow and amounts of fluoride added shall be kept. An analysis for fluoride in finished water shall be made at least weekly. Records of these analyses shall be kept by the supplier of water for five (5) years. (3-20-20)T

**06. Cross Connection Control Program - Community Water Systems.** The water purveyor is responsible through its cross connection control program to take reasonable and prudent measures to protect the water system against contamination and pollution from cross connections through premises isolation, internal or in-plant isolation, fixture protection, or some combination of premises isolation, internal isolation, and fixture protection. Pursuant to Section 543, all suppliers of water for community water systems shall implement a cross connection control program to prevent the entrance to the system of materials known to be toxic or hazardous. The water purveyor is responsible to enforce the system's cross connection control program. The program will at a minimum include: (3-20-20)T

**a.** An inspection program to locate cross connections and determine required suitable protection. For new connections, suitable protection must be installed prior to providing water service. (3-20-20)T

**b.** Required installation and operation of adequate backflow prevention assemblies. Appropriate and adequate backflow prevention assembly types for various facilities, fixtures, equipment, and uses of water should be selected from the AWWA Pacific Northwest Section Cross Connection Control Manual, the Uniform Plumbing Code, the AWWA Recommended Practice for Backflow Prevention and Cross Connection Control (M14), the USC Foundation Manual of Cross Connection Control, or other sources deemed acceptable by the Department. The assemblies must meet the requirements of Section 543 and comply with local ordinances. (3-20-20)T

**c.** Annual inspections and testing of all installed backflow prevention assemblies by a tester licensed by a licensing authority recognized by the Department. Testing shall be done in accordance with the test procedures published by the University of Southern California Foundation for Cross-Connection Control and Hydraulic Research. See the USC Foundation Manual of Cross-Connection Control referenced in Subsection 002.02. (3-20-20)T

**d.** Discontinuance of service to any structure, facility, or premises where suitable backflow protection has not been provided for a cross connection. (3-20-20)T

**e.** Assemblies that cannot pass annual tests or those found to be defective shall be repaired, replaced, or isolated within ten (10) business days. If the failed assembly cannot be repaired, replaced, or isolated within ten (10) business days, water service to the failed assembly shall be discontinued. (3-20-20)T

**07. Cross Connection Control - Non-Community Water Systems.** All suppliers of water for non-community water systems shall ensure that cross connections do not exist or are isolated from the potable water system by an approved backflow prevention assembly. Backflow prevention assemblies shall be inspected and tested annually for functionality by an Idaho licensed tester, as specified in Subsections 552.06.c. and 552.06.e. (3-20-20)T

**08. Start-up Procedures For Seasonal Systems Subject To Subsections 100.01.a., c., and d.** (3-20-20)T

**a.** All seasonal system owners and operators must demonstrate completion of a Department approved start-up procedure, including start-up sampling, prior to serving water to the public. The system owner or operator must submit information on a Department provided or approved form that includes a statement certifying that the system owner or operator followed proper start-up procedures. The form shall be submitted to the Department within 30 (thirty) days following the system's start-up date. (3-20-20)T

**b.** The Department may exempt any seasonal system from Subsection 552.08.a. if the entire distribution system remains pressurized during the entire period that the system is not operating, except that the systems that monitor less frequently than monthly must still monitor during the vulnerable period designated by the Department. The Department may exempt a seasonal system from Subsection 552.08.a. if the owner or operator of the system meets all of the following conditions: (3-20-20)T

- i.** Requests an exemption in writing to the Department for approval; (3-20-20)T
- ii.** Demonstrates a clean compliance history as defined in Section 003 for a minimum of five (5) years; (3-20-20)T
- iii.** Has no uncorrected significant deficiencies from the most recent sanitary survey; and (3-20-20)T
- iv.** Total coliform samples submitted to a certified laboratory within 30 (thirty) days prior to serving water to the public demonstrate the absence of total coliform. (3-20-20)T

**553. CLASSIFICATION OF WATER SYSTEMS.**

**01. System Classification Required.** The Department shall classify community, nontransient noncommunity, and surface water systems based on indicators of potential health risks. (3-20-20)T

**a.** The owner or designee of every community and nontransient noncommunity public water system shall submit proof of the current conditions related to the classification of the system every five (5) years or more frequently if required by the Department. (3-20-20)T

**b.** The owner or designee of all surface water systems shall submit proof of the current conditions related to the classification of the system every five (5) years or more frequently if required by the Department. (3-20-20)T

**02. Classification Criteria.** Systems shall be classified under a system that uses the following criteria: (3-20-20)T

- a.** Complexity, size, and type of source water for treatment facilities. (3-20-20)T
- b.** Complexity and size of distribution systems. (3-20-20)T

- c. Other criteria deemed necessary to completely classify systems. (3-20-20)T
- d. The Department shall develop guidelines for applying the criteria set forth in Section 553. (3-20-20)T

**554. LICENSE REQUIREMENTS.**

**01. Licensed Operator Required.** (3-20-20)T

a. Owners of all community and nontransient noncommunity public drinking water systems must place the direct supervision of their drinking water system, including each treatment facility and distribution system, under the responsible charge of a properly licensed operator. (3-20-20)T

b. Owners of all surface water systems must place the direct supervision of their public drinking water system under the responsible charge of a properly licensed operator. (3-20-20)T

**02. Responsible Charge Operator License Requirement.** An operator in responsible charge of a public drinking water system must hold a valid license equal to or greater than the classification of the public water system where the responsible charge operator is in responsible charge. Responsible charge means active, daily on-site or on-call responsibility for the performance of operations or active, on-going, on-site, or on-call direction of employees and assistants. (3-20-20)T

**03. Substitute Responsible Charge Operator License Requirement.** At such times as the responsible charge operator is not available, a substitute responsible charge operator shall be designated to replace the responsible charge operator. A substitute responsible charge operator of a public water system must hold a valid license equal to or greater than the classification of the public water system where the substitute responsible charge operator is in responsible charge. (3-20-20)T

**04. Shift Operator Requirement.** Any public drinking water system subject to these requirements with multiple operating shifts must have a designated properly licensed operator available for each operating shift. An on-duty designated shift operator does not replace the requirements in Subsections 554.01 and 554.03 for responsible charge operator coverage during all operating shifts. (3-20-20)T

**05. Water Operator License Requirement.** All operating personnel at public drinking water systems subject to these requirements making process control/ system integrity decisions about water quality or quantity that affect public health must hold a valid and current license. (3-20-20)T

**555. -- 559. (RESERVED)**

**560. CONTRACTING FOR SERVICES.**

Public water systems may contract with persons to provide responsible charge operators and substitute responsible charge operators. Proof of such contract shall be submitted to the Department prior to the contracted person performing any services at the public water system. (3-20-20)T

**561. -- 562. (RESERVED)**

**563. ADVISORY GROUP.**

Stakeholder Involvement. Ongoing stakeholder involvement will be provided through the existing drinking water advisory committee at the Department. (3-20-20)T

**564. -- 899. (RESERVED)**

**900. TABLES.**

- 01. Table 1 -- Minimum Distances From a Public Water System Well.**

Minimum Distances from a Public Water System Well	
Gravity wastewater line	50 feet
Any potential source of contamination	50 feet
Pressure wastewater line	100 feet
Class A Municipal Reclaimed Wastewater Pressure distribution line	50 feet
Individual home septic tank	100 feet
Individual home disposal field	100 feet
Individual home seepage pit	100 feet
Privies	100 feet
Livestock	50 feet
Drainfield - standard subsurface disposal module	100 feet
Absorption module - large soil absorption system	150 - 300 feet, see IDAPA 58.01.03
Canals, streams, ditches, lakes, ponds and tanks used to store non-potable substances	50 feet
Storm water facilities disposing storm water originating off the well lot	50 feet
Municipal or industrial wastewater treatment plant	500 feet
Reclamation and reuse of municipal and industrial wastewater sites	See IDAPA 58.01.17
Biosolids application site	1,000 feet

(3-20-20)T

02. Table 2 - Well Casing Standards for Public Water System Wells.

STEEL PIPE					
				WEIGHT PER FOOT (pounds)	
DIAMETER (inches)			THICKNESS (inches)	Plain Ends	With Threads and Couplings
SIZE	External	Internal		(calculated)	(nominal)
6 (id) *	6.625	6.065	0.280	18.97	19.18
8	8.625	7.981	0.322	28.55	29.35
10	10.750	10.020	0.365	40.48	41.85
12	12.750	12.000	0.375	49.56	51.15

STEEL PIPE					
14 (od) *	14.000	13.250	0.375	54.57	57.00
16	16.000	15.250	0.375	62.58	
18	18.000	17.250	0.375	70.59	
20	20.000	19.250	0.375	78.60	
22	22.000	21.000	0.500	114.81	
24	24.000	23.000	0.500	125.49	
26	26.000	25.000	0.500	136.17	
28	28.000	27.000	0.500	146.85	
30	30.000	29.000	0.500	157.53	
32	32.000	31.000	0.500	168.21	
34	34.000	33.000	0.500	178.89	
36	36.000	35.000	0.500	189.57	

\* id = inside diameter  
od = outside diameter

(3-20-20)T

**901. -- 999. (RESERVED)**



## 58.01.09 – RULES REGULATING SWINE FACILITIES

### 000. LEGAL AUTHORITY.

The Idaho Legislature has given the Idaho Board of Environmental Quality the authority to promulgate Rules Regulating Swine Facilities pursuant to Sections 39-104A, 39-105, and 39-107, Idaho Code. (3-20-20)T

### 001. TITLE AND SCOPE.

01. **Title.** These rules are titled IDAPA 58.01.09, “Rules Regulating Swine Facilities.” (3-20-20)T

02. **Scope.** These rules establish the procedures and requirements for the issuance of a permit to construct, operate, close or expand swine facilities of a defined capacity. The intent of these rules is to ensure animal waste from swine facilities are properly controlled so as not to adversely affect public health or the environment. (3-20-20)T

### 002. WRITTEN INTERPRETATIONS.

As described in Section 67-5201(19)(b)(iv), Idaho Code, the Department of Environmental Quality may have written statements which pertain to the interpretation of these rules. If available, such written statements can be inspected and copied at cost at the Department of Environmental Quality, 1410 N. Hilton, Boise, Idaho 83706-1255. (3-20-20)T

### 003. ADMINISTRATIVE APPEALS.

Persons may be entitled to appeal agency actions authorized under these rules pursuant to IDAPA 58.01.23, “Rules of Administrative Procedure Before the Board of Environmental Quality.” (3-20-20)T

### 004. -- 009. (RESERVED)

### 010. DEFINITIONS.

01. **Animal Unit.** An animal unit equals two and a half (2.5) swine, each weighing over twenty-five (25) kilograms (approximately fifty-five (55) pounds), or ten (10) weaned swine, each weighing under twenty-five (25) kilograms. Total animal units are calculated by adding the number of swine weighing over twenty-five (25) kilograms multiplied by four-tenths (.4) plus the number of weaned swine weighing under twenty-five (25) kilograms multiplied by one-tenth (.1). (3-20-20)T

02. **Animal Waste.** Animal excrement, feed wastes, process wastewater or any other waste associated with the confinement of swine. (3-20-20)T

03. **Animal Waste Management System.** Any structure or system that provides for the collection, treatment, disposal, distribution, or storage of animal waste. (3-20-20)T

04. **Certified Planner.** A person who has completed the nutrient management certification in accordance with the Nutrient Management Standard. (3-20-20)T

05. **Department.** The Idaho Department of Environmental Quality. (3-20-20)T

06. **Director.** The Director of the Department of Environmental Quality or his designee. (3-20-20)T

07. **Existing Facility.** A facility built and in operation one (1) year or more prior to the original effective date of these rules. (3-20-20)T

08. **Expanding Facility.** A swine facility of less than two thousand (2,000) animal units that increases its one-time animal unit capacity to two thousand (2,000) or more animal units or an existing facility that increases its one-time animal unit capacity by ten percent (10%). (3-20-20)T

09. **Facility or Swine Facility.** Any place, site or location or part thereof where swine are kept, handled, housed, or otherwise maintained and includes but is not limited to buildings, lots, pens, and animal waste management system, and which has the one-time animal unit capacity of two thousand (2000) or more animal units. (3-20-20)T

10. **Land Application.** The spreading on or incorporation of animal waste into the soil mantle primarily for beneficial purposes. (3-20-20)T

11. **Nutrient Management Plan.** A plan prepared in compliance with the Nutrient Management

Standard or other equally protective standard approved by the Director for managing the amount, source, placement, form, and timing of the land application of nutrients and soil amendments for plant production and to minimize the potential for environmental degradation, particularly impairment of water quality. (3-20-20)T

**12. Nutrient Management Standard.** The United States Department of Agriculture-Natural Resource Conservation Service Code 590 or the Idaho Agricultural Pollution Abatement Plan-Nutrient Management Standard Component Practice. (3-20-20)T

**13. One-Time Animal Unit Capacity.** The maximum number of animal units that a facility is capable of housing at any given point in time. (3-20-20)T

**14. Operate.** Confine, feed, propagate, house, or otherwise sustain swine. (3-20-20)T

**15. Permit.** A written authorization by the Director to construct, operate, or expand a swine facility. (3-20-20)T

**16. Permittee.** The person in whose name a permit is issued. (3-20-20)T

**17. Person.** Any individual, association, partnership, firm, joint stock company, joint venture, trust, political subdivision, public or private corporation, state or federal governmental department, agency or instrumentality, or any legal entity which is recognized by law as the subject of rights and duties. (3-20-20)T

**18. Process Wastewater.** Any water used in the facility that comes into contact with any manure, litter, bedding, raw, intermediate, or final material or product used in or resulting from the production of swine and any products directly or indirectly used in the operation of a facility, such as spillage or overflow from animal watering systems; washing, cleaning, or flushing pens, barns, manure pits, or spray cooling of animals; and dust control and any precipitation which comes into contact with animals or animal waste. (3-20-20)T

**19. Unauthorized Discharge.** A release of animal waste to the environment or waters of the state that is not authorized by the permit or the terms of an NPDES permit issued by the federal EPA. (3-20-20)T

**20. Waters of the State.** All the accumulations of water, surface and underground, natural and artificial, public and private, or parts thereof which are wholly or partially within, which flow through or border upon the state. (3-20-20)T

**011. -- 099. (RESERVED)**

**100. APPLICABILITY.**

**01. Permit Required.** No person shall construct, operate, or expand a regulated swine facility without first obtaining a permit issued by the Director as provided in these rules. (3-20-20)T

**02. Regulated Facilities.** New swine facilities having a one-time animal unit capacity of two thousand (2,000) or more animal units and expanding facilities are required to be permitted as provided in these rules. (3-20-20)T

**03. Common Control.** Two (2) or more swine facilities under common control of the same person may be considered, for purposes of permitting, to be a single facility, even though separately their capacity is less than two thousand (2,000) animal units, if they use a common animal waste management system or land application site. (3-20-20)T

**04. Existing Swine Facilities.** Those swine facilities built and in operation one (1) year or more prior to the original effective date of these rules are exempt from the requirements of these rules except as provided in Section 210. (3-20-20)T

**101. -- 199. (RESERVED)**

**200. PERMIT APPLICATION.**

**01. Permit Application.** Every person requiring a permit under these rules shall submit a permit application to the Department. A permit application will be used to determine if the construction, operation, and closure of a swine facility will be in conformance with these and other applicable rules. (3-20-20)T

**02. Preapplication Conference.** Prospective applicants are encouraged to meet with the Department to discuss application requirements and procedures. (3-20-20)T

**03. Contents of Application.** Each application shall include, in the format set forth by the Director and when determined applicable by the Director, the following information in Subsections 200.04 through 200.08 in sufficient detail to allow the Director to make necessary application review decisions concerning design, environmental protection and public health. (3-20-20)T

**04. Relevant Information.** (3-20-20)T

**a.** Name, mailing address and phone number of the facility owner. (3-20-20)T

**b.** Name, mailing address and phone number of the facility operator. (3-20-20)T

**c.** Name and mailing address of the facility. (3-20-20)T

**d.** Legal description of the facility location. (3-20-20)T

**e.** The legal structure of the entity owning the facility, including the names and addresses of all directors, officers, registered agents and partners. (3-20-20)T

**f.** The names and locations of all swine facilities owned and/or operated by the applicant within the last ten (10) years. (3-20-20)T

**g.** The one-time animal unit capacity of the facility. (3-20-20)T

**h.** The type of animals to be confined at the facility. (3-20-20)T

**i.** Evidence that a valid water right exists to supply adequate water for the proposed facility or a copy of either an application for permit to appropriate water or an application to change the point of diversion, place, period and nature of use of an existing water right that has been filed with the Idaho Department of Water Resources which, if approved, will supply adequate water for the proposed operation. (3-20-20)T

**j.** Proof of financial capability to perform remedial actions and to meet the conditions of an approved closure plan for a facility. The mechanism used to demonstrate financial capability must be legally valid, binding and enforceable under applicable law and must insure that the funds necessary to meet the costs of remediation and closure will be available whenever they are needed in accordance with Section 205. The mechanisms include, but are not limited to, trust funds, surety bonds, letters of credit, insurance and corporate guarantees. (3-20-20)T

**k.** The facility's biosecurity and sanitary standards. (3-20-20)T

**l.** A statement of estimated annual income and operating expenses that demonstrate, to the satisfaction of the Department, financial capability to operate the facility. (3-20-20)T

**05. Construction Plan.** Plans and specifications for the facility's animal waste management system that include the following information: (3-20-20)T

**a.** Vicinity map(s) prepared on one (1) or more seven and one-half minute (7.5') USGS topographic quadrangle maps or a high quality reproduction(s) that includes the following: (3-20-20)T

**i.** Layout of the facility, including buildings and animal waste management system; (3-20-20)T

- ii. The one hundred (100) year FEMA flood zones or other appropriate flood data for the facility site and land application sites owned or leased by the applicant; (3-20-20)T
  - iii. The location of occupied dwellings, public and private gathering places, such as schools, churches and parks, and incorporated municipalities which are within a two (2) mile radius of the facility; and (3-20-20)T
  - iv. Private and community domestic water wells, irrigation wells, irrigation conveyance and drainage structures, monitoring wells, wetlands, streams, springs, and reservoirs which are within a one (1) mile radius of the facility. (3-20-20)T
- b.** Facility construction specifications including: (3-20-20)T
- i. A site plan showing: (3-20-20)T
    - (1) Building locations; (3-20-20)T
    - (2) Waste facilities; (3-20-20)T
    - (3) All waste conveyance systems; and (3-20-20)T
    - (4) All irrigation systems used for land application, including details of approved water supply protection devices. (3-20-20)T
  - ii. Building plans showing: (3-20-20)T
    - (1) All wastewater collection systems in housed units; (3-20-20)T
    - (2) All freshwater supply systems, including details of approved water supply protection devices; (3-20-20)T
    - (3) Detailed drawings of wastewater collection and conveyance systems and containment construction; and (3-20-20)T
    - (4) Detailed construction and installation procedures. (3-20-20)T
- 06. Site Characterization.** A characterization of the facility and any land application site(s) owned or operated by the applicant, prepared by a registered professional geologist, a registered professional engineer or a qualified ground water hydrologist, that includes the following information: (3-20-20)T
- a.** A description of monitoring methods, frequency, and reporting components related to either leak detection systems and/or ground water monitoring wells; (3-20-20)T
  - b.** The climatic, hydrogeologic, and soil characteristics; (3-20-20)T
  - c.** The depth to water and a potentiometric map for the uppermost and regional aquifer; (3-20-20)T
  - d.** The vertical and horizontal conductivity, gradient, and ground water flow direction and velocity; (3-20-20)T
  - e.** Estimates of recharge to the uppermost aquifer; (3-20-20)T
  - f.** Information which characterizes the relationship between the ground water and adjacent surface waters; and (3-20-20)T
  - g.** A summary of local ground water quality data. (3-20-20)T

**07. Nutrient Management Plan.** A plan prepared by a Certified Planner demonstrating compliance with the Nutrient Management Standard for land application. (3-20-20)T

**08. Closure Plan.** A plan describing the procedures for final closure of a facility that ensures no adverse impacts to the environment and waters of the state and that includes: (3-20-20)T

**a.** The estimated length of operation of the facility; and (3-20-20)T

**b.** A description of the procedures, methods, and schedule to be implemented at the facility for final disposal, handling, management and/or treatment of all animal waste. (3-20-20)T

**09. Other Information.** An applicant shall provide any other information relative to Subsections 200.04 through 200.08 deemed necessary by the Director to assess protection of human health and the environment (3-20-20)T

**10. Application Fee.** A fee shall be submitted with each permit application as follows: (3-20-20)T

**a.** Three thousand dollars (\$3,000) for facilities that have a one-time animal unit capacity of less than five-thousand (5,000) animal units; (3-20-20)T

**b.** Five thousand dollars (\$5,000) for facilities that have a one-time animal unit capacity of five thousand to ten thousand (5,000-10,000) animal units; and (3-20-20)T

**c.** Ten thousand dollars (\$10,000) for facilities that have a one-time animal unit capacity over ten thousand (10,000) animal units. (3-20-20)T

**201. -- 204. (RESERVED)**

**205. FINANCIAL ASSURANCE REQUIREMENTS.**

**01. Written Estimate of Costs.** The owner of a swine facility shall submit, as part of the permit application, a detailed written estimate, in current dollars, of the cost of hiring a third party to: (3-20-20)T

**a.** Remediate potential contamination caused by the operation of the facility or of any potential spill or breach, including, without limitation, remediation pursuant to the facility's Spill Contingency Plan; and (3-20-20)T

**b.** Close the facility in accordance with an approved closure plan. (3-20-20)T

**c.** The Department must approve the cost estimate as reasonable prior to the issuance of a permit. (3-20-20)T

**02. Financial Assurance Mechanisms.** The owner shall submit as part of the permit application evidence of financial assurance to cover the approved remediation and closure cost estimates. However, if the Department has determined, prior to October 19, 2000, that a complete application has been submitted, the owner shall submit the remediation and closure cost estimates and financial assurance mechanism to the Department for approval prior to the issuance of a permit. The mechanism used to demonstrate financial assurance shall be submitted to the Department for approval and shall ensure that the funds necessary to meet the approved costs of remediation and closure will be available whenever they are needed. The financial assurance mechanisms allowed for swine facilities shall include any mechanism or a combination of mechanisms meeting the criteria set forth below or other mechanism approved by the Department. (3-20-20)T

**a.** Trust Fund. (3-20-20)T

**i.** An owner may satisfy the requirements of Subsection 205.02 by establishing a trust fund and submitting an originally signed duplicate of the trust agreement to the Department. The trustee must be an entity which has the authority to act as a trustee and whose trust operations are regulated and examined by a federal or state

agency. (3-20-20)T

ii. After the trust fund is established, whenever the current remediation and closure cost estimates change, the owner must compare the new estimates with the trustee's most recent annual valuation of the trust fund. If the value of the fund is less than the amount of the new estimate, the owner, within sixty (60) days after the change in the cost estimate, must either deposit an amount equal into the fund so that its value after this deposit at least equals the amount of the current remediation or closure cost estimate, or obtain other financial assurance as specified in Subsection 205.02 to cover the difference. (3-20-20)T

iii. If the value of the trust fund is greater than the total amount of the current remediation or closure cost estimate, the owner may submit a written request to the Department for release of the amount in excess of the current remediation or closure cost estimate. (3-20-20)T

iv. If an owner substitutes other financial assurance as specified in Subsection 205.02 for all or part of the trust fund, he may submit a written request to the Department for release of the amount in excess of the current remediation or closure cost estimate covered by the trust fund. (3-20-20)T

**b. Surety Bond.** (3-20-20)T

i. An owner may satisfy the requirements of Subsection 205.02 by obtaining a payment or performance surety bond and submitting a certified copy of the bond to the Department. The surety company issuing the bond must, at a minimum, be among those listed as acceptable sureties on federal bonds in Circular 570 of the U.S. Department of the Treasury. (3-20-20)T

ii. The penal sum of the bond must be in an amount at least equal to the current remediation and closure cost estimates. (3-20-20)T

iii. Under the terms of the bond, the surety will become liable on the bond obligation when: (3-20-20)T

(1) The owner fails to perform as guaranteed by the bond; or (3-20-20)T

(2) The Department notifies the owner that he has failed to meet requirements of these rules. (3-20-20)T

iv. Under the terms of the bond, the surety may cancel the bond by sending notice of cancellation by certified mail to the owner and the Department one hundred twenty (120) days in advance of cancellation. Cancellation may not occur, however, during the one hundred twenty (120) days beginning with the date of receipt of the notice by the Department, as evidenced by the return receipt. The surety shall remain liable on the bond for costs of remediation and closure unless the owner obtains a replacement financial assurance mechanism, approved by the Department in accordance with Subsection 205.02.f., that covers both the existing and future costs of remediation and closure. (3-20-20)T

**c. Letter of Credit.** (3-20-20)T

i. An owner may satisfy the requirements of Subsection 205.02 by obtaining an irrevocable standby letter of credit and submitting a certified copy of the letter to the Department. The issuing institution must be an entity which has the authority to issue letters of credit and whose letter-of-credit operations are regulated and examined by a federal or state agency. (3-20-20)T

ii. The letter of credit must be accompanied by a letter from the owner referring to the letter of credit by number, issuing institution, and date, and providing the following information: the type of facility, name and address of the facility, and the amount of funds assured for remediation and closure of the facility by the letter of credit. (3-20-20)T

iii. The letter of credit must be irrevocable and issued for a period of at least one (1) year. The letter of credit must provide that the expiration date will be automatically extended for a period of at least one (1) year unless,

at least one hundred twenty (120) days before the current expiration date, the issuing institution notifies both the owner and the Department by certified mail of a decision not to extend the expiration date. Cancellation may not occur, however, during the one hundred twenty (120) days beginning with the date of receipt of the notice by the Department, as evidenced by the return receipt. The issuing institution shall remain liable on the letter of credit for costs of remediation and closure unless the owner obtains a replacement financial assurance mechanism, approved by the Department in accordance with Subsection 205.02.f., that covers both the existing and future costs of remediation and closure. (3-20-20)T

iv. The letter of credit must be issued in an amount at least equal to the current remediation and closure cost estimates. (3-20-20)T

**d.** Insurance. (3-20-20)T

i. An owner may satisfy the requirements of Subsection 205.02 by obtaining remediation and closure insurance and submitting a certificate of such insurance to the Department. At a minimum, the insurer must be licensed to transact the business of insurance, or eligible to provide insurance as an excess or surplus lines insurer, in one (1) or more states. (3-20-20)T

ii. The insurance policy must be issued for a face amount at least equal to the current remediation and closure cost estimates. The term “face amount” means the total amount the insurer is obligated to pay under the policy. Actual payments by the insurer will not change the face amount, although the insurer’s future liability will be lowered by the amount of the payments. (3-20-20)T

iii. Each insurance policy must contain a provision allowing assignment of the policy to a successor. Such assignment may be conditional upon consent of the insurer, provided such consent is not unreasonably refused. (3-20-20)T

iv. The automatic renewal of the policy must, at a minimum, provide the insured with the option of renewal at the face amount of the expiring policy. The insurer may cancel the policy by sending notice by certified mail to the owner and the Department one hundred twenty (120) days in advance. Cancellation may not occur, however, during the one hundred twenty (120) days beginning with the date of receipt of the notice by the Department, as evidenced by the return receipt. The insurer shall remain liable on the policy for costs of remediation and closure unless the owner obtains a replacement financial assurance mechanism, approved by the Department in accordance with Subsection 205.02.f., that covers both the existing and future costs of remediation and closure. (3-20-20)T

**e.** Corporate Guarantee. (3-20-20)T

i. An owner may satisfy the requirements of Subsection 205.02 by obtaining a written guarantee and submitting a certified copy of the guarantee and appropriate letter from the guarantor. The guarantor must be the direct or higher-tier parent corporation of the owner, a firm whose parent corporation is also the parent corporation of the owner, or a firm with a “substantial business relationship” with the owner. (3-20-20)T

ii. If the guarantor’s parent company is also the parent corporation of the owner, a letter from the guarantor’s chief financial officer must describe the value received in consideration of the guarantee. (3-20-20)T

iii. If the guarantor is a firm with a “substantial business relationship” with the owner, the letter must describe the “substantial business relationship” and the value received in consideration of the guarantee. (3-20-20)T

iv. The terms of the guarantee shall provide that if the owner fails to perform remediation or closure of a facility covered by the guarantee, the guarantor will: (3-20-20)T

(1) Perform, or pay a third party to perform, remediation and closure as required (performance guarantee); or (3-20-20)T

(2) Establish a fully funded trust fund as specified in Subsection 205.02.a. in the name of the owner (payment guarantee). (3-20-20)T

v. The guarantee shall remain in force for as long as the owner must comply with the applicable financial assurance requirements of Subsection 205.02 unless the guarantor sends notice of cancellation by certified mail to the owner and to the Department one hundred twenty (120) days in advance. Cancellation may not occur, however, during the one hundred twenty (120) days beginning on the date of receipt of the notice by the Department, as evidenced by the return receipt. The guarantor shall remain liable on the guarantee for costs of remediation and closure unless the owner obtains a replacement financial assurance mechanism, approved by the Department in accordance with Subsection 205.02.f., that covers both the existing and future costs of remediation and closure.

(3-20-20)T

f. If a financial assurance mechanism is cancelled by the issuing entity, the owner shall obtain alternate financial assurance, within sixty (60) days of receipt of notice of cancellation by the Department, which shall be submitted to the Department for approval. The alternate financial assurance must become effective not later than the effective date of cancellation or termination of the existing financial assurance. An owner may only cancel a financial assurance mechanism after first obtaining an alternative mechanism approved by the Department.

(3-20-20)T

**03. Continuous Coverage.** The owner shall provide continuous coverage for remediation and closure until released from financial assurance requirements by the Department.

(3-20-20)T

**04. Adjustment of Financial Assurance Amounts.** The following provisions apply to the adjustment of the amount of financial assurance:

(3-20-20)T

a. The owner shall increase the remediation and closure cost estimates and the amount of financial assurance if changes to the closure plan or facility conditions or operations increase the cost estimates at any time during the active life of the facility. The cost estimates and financial assurance shall also be adjusted to reflect inflation. Increased cost estimates and financial assurance shall be submitted to the Department for approval.

(3-20-20)T

b. The owner may reduce the remediation and closure cost estimates and the amount of financial assurance if the cost estimates exceed the maximum cost of remediation or closure at any time during the active life of the facility. The owner shall first notify the Department and obtain its approval of the justification for the reduction of the remediation and closure cost estimates.

(3-20-20)T

**05. Release from Financial Assurance Requirements.** When remediation and closure conditions required by a permit are complete, financial assurance shall be released by the Department as follows:

(3-20-20)T

a. When the Department determines that initial closure activities have been completed, financial assurance, less identified retainages, shall be released.

(3-20-20)T

b. A sufficient amount of financial assurance shall be retained by the Department, up to five (5) years after closure, to ensure proper remediation and closure of a facility.

(3-20-20)T

c. Release of any amount of financial assurance shall not release the owner from any responsibility for meeting remediation or closure requirements.

(3-20-20)T

**06. Owner Liability.** Nothing in these rules shall relieve the owner of liability for remediation and closure costs. The use of all financial assurance shall not relieve the owner from responsibility and liability for remediation and closure costs.

(3-20-20)T

**206. -- 209. (RESERVED)**

**210. EXISTING FACILITIES.**

**01. Registration Requirement.** Existing facility owners shall register with the Department within three (3) months after the original effective date of these rules. Registration shall include the information in Subsection 200.04 except for Subsection 200.04.j. Nothing in Section 210 shall be construed to deny an existing



facility the opportunity to apply for, and receive, a permit under these rules. (3-20-20)T

**02. Plan Requirement.** Existing facilities shall submit a nutrient management plan and closure plan to the Director for approval within two (2) years of the original effective date of these rules in accordance with Subsections 200.07 and 200.08. An application fee shall not be required unless the facility is expanding. (3-20-20)T

**03. Expanding Facility.** The owner of an existing facility shall not increase the one-time animal unit capacity of the facility by ten percent (10%) or more without first obtaining a permit for the expansion as required by these rules. The ten percent (10%) increase is measured cumulatively from the original effective date of these rules. (3-20-20)T

**211. -- 249. (RESERVED)**

**250. REQUIREMENTS FOR WATER QUALITY PROTECTION.**

The following minimum design and performance standards are intended as a baseline for protection of public health and the waters of the state. These standards shall apply to all facilities and be reflected in the permit unless the Director approves, based on an applicant's site specific information, that compliance with a specific standard is not required to protect water quality and the public health. Other conditions, as determined by the Director to be necessary to protect water quality, may be included in a permit. (3-20-20)T

**01. Animal Waste Management System Design Criteria.** A facility's animal waste management system shall be designed and constructed in accordance with the NRCS and the American Society of Agricultural Engineers standards, whichever is most stringent and shall: (3-20-20)T

**a.** Contain the maximum expected operating water balance and the twenty-five (25) year twenty-four (24) hour rainfall event and the one (1) in five (5) year winter runoff. (3-20-20)T

**b.** Provide capacity to store the peak volume of process wastewater that will be generated during a six (6) month period. (3-20-20)T

**c.** Provide a one (1) foot freeboard in addition to the storage requirements, specified in Subsections 250.01.a. and 250.01.b. (3-20-20)T

**d.** Impoundments, other than for emergency runoff, containing or designed to contain process wastewater shall be designed for efficient leak detection and shall not be located in the one-hundred (100) year floodplain. (3-20-20)T

**e.** Seepage rates for impoundments shall be no greater than  $1 \times 10^{-7}$  cm/sec. (3-20-20)T

**02. Water Quality Monitoring.** Ground water and/or leak detection monitoring shall be conducted for every facility with a liquid storage impoundment and shall be designed to give the earliest possible detection of an unauthorized discharge to ground water. (3-20-20)T

**03. Discharges.** Facilities shall be constructed, operated and maintained to not cause unauthorized discharges. (3-20-20)T

**04. Spill Contingency Plan.** Facilities shall prepare a discharge response strategy that describes procedures and methods to be implemented for the abatement and cleanup of any pollutant. (3-20-20)T

**05. Stockpile Areas.** Animal waste stockpile areas, including compost areas, shall be constructed to ensure that all water and precipitation, which comes into contact with the stockpiles, does not enter waters of the state. (3-20-20)T

**251. -- 299. (RESERVED)**

**300. APPLICATION PROCESSING PROCEDURE.**

**01. Application Completeness.** Within thirty (30) days of receipt of an application, the Director shall provide written notice to the applicant as to whether the application meets all the requirements of Section 200. The Department shall provide public notice of the receipt of a complete application. An application which does not, on its face, meet all the requirements of Section 200 of these rules shall be returned to the applicant by the Director with a written list of the deficiencies. The Director will not process an application until it is determined to be complete in accordance with these rules. (3-20-20)T

**02. Notice of Environmental Suitability of Facility Location.** Within thirty (30) days of the Director's notice that the application is complete, the Director shall determine whether the facility is environmentally suitable for the selected location. In making this decision, the Director shall review the location of the facility relative to flood zones, dwellings, wells, surface and ground water and those other items the applicant must identify on the vicinity map. Written notice of the Director's determination will be sent to the applicant, with a copy sent to the appropriate county and city officials for the selected location, along with a Department analysis that includes the following: (3-20-20)T

- a.** A brief description of the proposed facility, its animal waste management system and its nutrient management plan; (3-20-20)T
- b.** A brief summary of the basis for the determination on environmental suitability including references to applicable requirements and supporting materials; (3-20-20)T
- c.** A description of the schedule for issuing a permit; and (3-20-20)T
- d.** The name and phone number of the Department staff to contact for additional information. (3-20-20)T

**03. Draft Permit.** Within sixty (60) days of the Director's determination that a facility is environmentally suitable for its proposed location, the Director shall either issue a draft permit or a notice of denial of a permit to the applicant. The draft permit shall be in the same form as a final permit and shall specify conditions of construction, operation and closure. (3-20-20)T

**04. Public Comments.** The Department shall provide notice to the public of its issuance of a draft permit. The public may provide written comments for a time period and in a manner specified in the Department's notice. The Department may, in its discretion, provide an opportunity for the public to provide oral comments. (3-20-20)T

**05. Permit Denial.** The Director may deny a permit if: (3-20-20)T

- a.** The owner of a facility is not in substantial compliance with a final agency order or any final order or judgement of a court secured by any state or federal agency relating to the operation of a swine facility; (3-20-20)T
- b.** The application is inaccurate; (3-20-20)T
- c.** The facility as proposed cannot meet the requirements set forth in these rules or cannot be constructed, operated and closed in a manner that protects human health and the environment; or (3-20-20)T
- d.** The appropriate county or city does not approve the location of the facility. (3-20-20)T

**06. Final Permit.** Within sixty (60) days of the issuance of a draft permit, the Director shall issue a final permit to the applicant, however, a permit shall not be issued by the Director until the applicant has received final approval from the appropriate county or city for the location of the facility and has received approval for a water right from the Department of Water Resources. The permit shall be effective for a fixed term of not more than five (5) years, and may be reissued upon receipt of an updated application and demonstration of compliance with the rules and permit requirements existing at the time of reissuance. (3-20-20)T

**07. Additional Information.** At any time during the application process an applicant shall provide the

Director with additional information the Director deems necessary to process a permit, within thirty (30) days of the Director's request. The time period within which the Director must act with regard to the permit shall be stayed until the information requested is provided. If an applicant fails to provide the information within this time period, unless a longer time period is allowed by the Director, the Director may cease the application process and require the applicant to submit a new application. (3-20-20)T

**301. -- 399. (RESERVED)**

**400. PERMIT CONDITIONS.**

The following conditions shall apply to all permittees. (3-20-20)T

**01. Compliance Required.** The permittee shall comply with all conditions of the permit. The permit shall not relieve the permittee of the responsibility to comply with all other applicable local, state, and federal laws. (3-20-20)T

**02. Financial Capability.** Permittees shall have the financial capability to perform remedial actions and to meet the conditions of an approved closure plan for a facility. (3-20-20)T

**03. Construction and Operation of Facility.** The permittee shall ensure that construction, operation and maintenance of the facility proceed according to the construction plans and specifications and the approved monitoring, nutrient management and closure plans, and comply with the following: (3-20-20)T

**a.** Within thirty (30) days of completion of construction, submit as built plans. (3-20-20)T

**b.** Apply appropriate management practices as approved by the Director. (3-20-20)T

**c.** The facility or operations associated with the facility shall not create a public health hazard or nuisance conditions including odors. (3-20-20)T

**d.** The facility shall not dispose of any material not approved for disposal under the permit into the animal waste management system including, but not limited to, human waste. (3-20-20)T

**e.** The removal of animal waste from an impoundment or storage structure shall be performed in a manner to not damage the integrity of the liner. (3-20-20)T

**f.** Dead animals shall be removed from the facility for rendering, cremation, burial, composting or other disposal in accordance with IDAPA 02.04.17, "Rules Governing Dead Animal Movement and Disposal." (3-20-20)T

**g.** Nutrient management plans shall be amended if modifications to the facility operation, as outlined in the Nutrient Management Standard or other conditions, warrant the amendment. (3-20-20)T

**h.** Soil tests shall be conducted on all land application sites owned or leased by the permittee every year to determine compliance with the nutrient management plan and Nutrient Management Standard. The Director may require more frequent soil tests if deemed necessary. (3-20-20)T

**04. Provide Information.** The permittee shall furnish to the Director within a reasonable time, any information including copies of records required by the permit or other applicable rules, which the Director may reasonably require to determine whether cause exists for modifying or revoking the permit or to determine compliance with the permit or other applicable rules. (3-20-20)T

**05. Entry and Access.** The permittee shall allow the Director, consistent with Title 39, Chapter 1, Idaho Code, and in compliance with the biosecurity and sanitary standards of a facility, so long as the standards and requirements do not inhibit reasonable access, to: (3-20-20)T

**a.** Enter at reasonable times upon the premises of a permitted facility or where records are kept; (3-20-20)T

- b. Have access to and copy at reasonable times any records that must be kept under conditions of the permit; (3-20-20)T
- c. Inspect any facility or land application site; and (3-20-20)T
- d. Sample or monitor at reasonable times, substances or parameters directly related to compliance with the permit or these rules. (3-20-20)T

**06. Reporting.** The permittee shall report to the Director under the circumstances and in the manner specified in Section 400: (3-20-20)T

a. Orally, no later than twenty-four (24) hours from the time the permittee knows or should reasonably know of any noncompliance which may endanger the public health or the environment; and (3-20-20)T

b. In writing, within five (5) working days from the time a permittee knows or should reasonably know of any event which has resulted or which may result in noncompliance with these rules. The report shall contain: (3-20-20)T

i. A description of the event and its cause or if the cause is not known, steps taken to investigate and determine the cause; (3-20-20)T

ii. The period of the event including, to the extent possible, times and dates; (3-20-20)T

iii. Measures taken to mitigate the event or eliminate the event and protect the public health; and (3-20-20)T

iv. Steps taken to prevent recurrence of the event. (3-20-20)T

c. In writing, when the permittee knows or should reasonably know of material relevant facts not submitted or incorrect information submitted in a permit application or any report or notice to the Director. (3-20-20)T

**07. Begin Construction.** If a permittee fails to begin construction or expansion of a facility within two (2) years of the effective date of a permit, the Director may void the permit and require a new application. (3-20-20)T

**08. Permit Renewal.** If a permittee intends to continue operation of the permitted facility after expiration of an existing permit, the permittee shall apply for a new permit at least one hundred eighty (180) days prior to the expiration of any permit issued pursuant to these rules. (3-20-20)T

**401. -- 449. (RESERVED)**

**450. SPECIFIC PERMIT CONDITIONS.**

**01. Basis for Specific Permit Conditions.** Conditions necessary for the protection of the environment and the public health may differ from facility to facility because of varying environmental conditions and animal waste compositions. The Director may establish, on a case-by-case basis, specific permit conditions. Specific conditions shall be established in consideration of characteristics specific to a facility and inherent hazards of those characteristics. Such characteristics include, but are not limited to, the following: (3-20-20)T

a. Chemical, biological, physical and volumetric characteristics of the process wastewater; (3-20-20)T

b. Geological and climatic nature of the facility site; (3-20-20)T

c. Size of the site and its proximity to population centers and to ground and surface water; (3-20-20)T

- d. Legal considerations relative to land use and water rights; (3-20-20)T
- e. Techniques used in process wastewater distribution and the disposition of that vegetation exposed to process wastewaters; and (3-20-20)T
- f. The need for monitoring and record keeping to determine if the facility is being operated in conformance with its design and if its design is adequate to protect the environment and the public health. (3-20-20)T
- 02. Limitations to Operation.** Conditions of the permit may specify or limit: (3-20-20)T
  - a. Process wastewater composition; (3-20-20)T
  - b. Method, manner and frequency of process wastewater treatment; (3-20-20)T
  - c. Physical, chemical and biological characteristics of a facility; (3-20-20)T
  - d. An odor management plan; and (3-20-20)T
  - e. Any other condition the Director finds necessary to protect public health or the environment. (3-20-20)T
- 03. Compliance Schedules.** The Director may establish a compliance schedule for facilities as part of the permit conditions including: (3-20-20)T
  - a. Specific steps or actions to be taken by the permittee to achieve compliance with applicable requirements or permit conditions; and (3-20-20)T
  - b. Dates by which those steps or actions are to be taken. (3-20-20)T
- 04. Monitoring Requirements.** Any facility may be subject to monitoring requirements including, but not limited to, the following: (3-20-20)T
  - a. The type, installation, use and maintenance of monitoring equipment; (3-20-20)T
  - b. Monitoring or sampling methodology, frequency and locations; (3-20-20)T
  - c. Monitored substances or parameters; (3-20-20)T
  - d. Testing and analytical procedures; and (3-20-20)T
  - e. Reporting requirements including both frequency and form. (3-20-20)T
- 451. -- 499. (RESERVED)**
- 500. PERMIT MODIFICATION.**
  - 01. Minor Modifications.** Minor modifications are those which do not have a potential affect to the environment or the public health. Such modifications shall be made by the Director. Minor modifications are generally limited to: (3-20-20)T
    - a. The correction of typographical errors; (3-20-20)T
    - b. Transfer of ownership or operational control in accordance with Section 550; or (3-20-20)T
    - c. Certain minor changes in monitoring or operational conditions. (3-20-20)T
  - 02. Major Modifications.** All modifications not considered minor shall be considered major

modifications. The procedure for making major modifications shall be the same as that used for a new permit under these rules. (3-20-20)T

**501. -- 549. (RESERVED)**

**550. TRANSFER OF PERMITS.**

**01. Transfer Application.** A new owner or operator of a facility shall submit a transfer application to the Director that includes at least the following: (3-20-20)T

**a.** The relevant information required by Subsection 200.04; and (3-20-20)T

**b.** Any change of conditions at the facility resulting from the transfer of ownership or operation. (3-20-20)T

**c.** The Director shall review the transfer application and within sixty (60) days of its receipt either approve or deny the transfer. (3-20-20)T

**02. Transfer Approval.** An approved permit transfer shall be a minor modification in accordance with Subsection 500.01 as long as there are no major changes of conditions at the facility. Major changes of conditions at a facility will be subject to the provisions of Subsection 500.02. (3-20-20)T

**03. Transfer Denial.** A notification of a permit denial shall set forth the reasons for the denial, steps necessary to meet the requirements for a permit transfer and the opportunity for the applicant to request a hearing. (3-20-20)T

**04. Permit Obligations.** The new permittee assumes all rights and responsibilities of the transferred permit. (3-20-20)T

**551. -- 599. (RESERVED)**

**600. VIOLATIONS.**

**01. Failure to Comply.** Failure by a permittee to comply with the provisions of these rules or with any permit condition shall be deemed a violation of these rules. (3-20-20)T

**02. Falsification of Statements and Records.** It shall be a violation of these rules for any person to knowingly make a false statement, representation, or certification in any application report, document, or record developed, maintained, or submitted pursuant to these rules or the conditions of a permit. (3-20-20)T

**03. Discharges.** Any unauthorized discharge from a facility shall be a violation of these rules. (3-20-20)T

**04. Penalties.** Any person violating any provision of these rules or any permit or order issued thereunder shall be liable for a civil or criminal penalty in accordance with Title 39, Chapter 1, Idaho Code. (3-20-20)T

**05. Permit Revocation.** The Director may revoke a permit for: (3-20-20)T

**a.** A material violation of any condition of a permit; or (3-20-20)T

**b.** If the permit was obtained by misrepresentation or failure to disclose all relevant facts. (3-20-20)T

**06. Revocation Hearing.** Prior to revoking a permit, the Director shall issue a notice of intent which shall become final unless the permittee timely requests an administrative hearing in writing. Such hearing shall be conducted in accordance with Section 003 of these rules. (3-20-20)T

**601. -- 998. (RESERVED)**

**999. CONFIDENTIALITY OF RECORDS.**

Information obtained by the Department under these rules is subject to public disclosure pursuant to the provisions of Chapter 1, Title 74, Idaho Code. Information submitted under a trade secret claim may be entitled to confidential treatment by the Department as provided in Section 74-114, Idaho Code, and IDAPA 58.01.21, "Rules Governing the Protection and Disclosure of Records in the Possession of the Idaho Department of Environmental Quality."

(3-20-20)T

## 58.01.11 – GROUND WATER QUALITY RULE

### 000. LEGAL AUTHORITY.

The Idaho Legislature has given the Board of Environmental Quality authority to promulgate the Ground Water Quality Rule pursuant to Sections 39-105, 39-107, 39-120, and 39-126, Idaho Code. The authority to formulate and adopt rules as are necessary and feasible to protect the environment and health of the citizens of the state is vested in the Director and Board pursuant to Sections 39-105 and 39-107, Idaho Code. Under Section 39-120, Idaho Code, the Board is authorized to adopt, by rule, ambient ground water quality standards. Under Section 39-126, Idaho Code, all state agencies shall incorporate the Ground Water Quality Plan, adopted by the legislature, in the administration of their programs and are granted authority to promulgate rules to protect ground water quality as necessary to administer such programs. (3-20-20)T

### 001. TITLE AND SCOPE.

**01. Title.** This rule is titled IDAPA 58.01.11, Rules of the Department of Environmental Quality, IDAPA 58.01.11, “Ground Water Quality Rule.” (3-20-20)T

**02. Scope.** Under Section 39-120, Idaho Code, the Department of Environmental Quality is designated as the primary agency to coordinate and administer ground water quality protection programs for the state. This rule establishes minimum requirements for protection of ground water quality through standards and an aquifer categorization process. The requirements of this rule shall serve as a basis for the administration of programs which address ground water quality. This rule does not in and of itself create a permit program. (3-20-20)T

### 002. ADMINISTRATIVE APPEALS.

Persons may be entitled to appeal agency actions authorized under this chapter pursuant to IDAPA 58.01.23, “Rules of Administrative Procedure Before the Board of Environmental Quality.” (3-20-20)T

### 003. WRITTEN INTERPRETATIONS.

The Department of Environmental Quality may have written statements which pertain to the interpretation of the rules of this chapter. If available, such written statements can be inspected and copied, at cost, at the Department of Environmental Quality, 1410 North Hilton, Boise, ID 83706-1255. (3-20-20)T

### 004. -- 005. (RESERVED)

### 006. POLICIES.

It is the intent of the Department to implement, through this rule, the following policies from the Protection and Prevention Sections of the Idaho Ground Water Quality Plan, adopted by the legislature, 1992 Session Law, Chapter 310, Page 922. These policies are: (3-20-20)T

**01. Ground Water Quality Protection.** It is the policy of the state of Idaho to maintain and protect the existing high quality of the state’s ground water. (3-20-20)T

**02. Existing and Projected Future Beneficial Uses.** The policy of the state of Idaho is that existing and projected future beneficial uses of ground water shall be maintained and protected, and degradation that would impair existing and projected future beneficial uses of ground water and interconnected surface water shall not be allowed. (3-20-20)T

**03. Categorization of Ground Water.** The policy of the state of Idaho is to provide differential protection for the state’s ground water resources. A ground water categorization system should be established for aquifers or portions of aquifers. The categorization system should be based on vulnerability of the ground water, existing and projected future beneficial uses of the ground water, existing quality of the ground water, and social and economic considerations. (3-20-20)T

**04. Ground Water Quality Standards.** The policy of the state of Idaho is to establish ground water quality standards for biological, radiological, and chemical constituents. (3-20-20)T

**05. Prevention of Ground Water Contamination.** The policy of the state of Idaho is to prevent contamination of ground water from all regulated and nonregulated sources of contamination to the maximum extent practical. (3-20-20)T

**06. Mining.** The policy of the state of Idaho is to protect ground water and allow for the extraction of minerals above and within ground water. (3-20-20)T



**007. DEFINITIONS.**

- 01. Agricultural Chemical.** Any pesticide, nutrient or fertilizer used for the benefit of agricultural production or pest management. (3-20-20)T
- 02. Aquifer.** A geological unit of permeable saturated material capable of yielding economically significant quantities of water to wells and springs. (3-20-20)T
- 03. Beneficial Uses.** Various uses of ground water in Idaho including, but not limited to, domestic water supplies, industrial water supplies, agricultural water supplies, aquacultural water supplies, and mining. A beneficial use is defined as actual current or projected future uses of ground water. (3-20-20)T
- 04. Best Available Method.** Any system, process, or method which is available to the public for commercial or private use to minimize the impact of point or nonpoint sources of contamination on ground water quality. (3-20-20)T
- 05. Best Management Practice.** A practice or combination of practices determined to be the most effective and practical means of preventing or reducing contamination to ground water and interconnected surface water from nonpoint and point sources to achieve water quality goals and protect the beneficial uses of the water. (3-20-20)T
- 06. Best Practical Method.** Any system, process, or method that is established and in routine use which could be used to minimize the impact of point or nonpoint sources of contamination on ground water quality. (3-20-20)T
- 07. Board.** The Idaho Board of Environmental Quality. (3-20-20)T
- 08. Cleanup.** The removal, treatment or isolation of a contaminant from ground water through the directed efforts of humans or the removal or treatment of a contaminant in ground water through management practice or the construction of barriers, trenches and other similar facilities for prevention of contamination, as well as the use of natural processes such as ground water recharge, natural decay and chemical or biological decomposition. (3-20-20)T
- 09. Constituent.** Any chemical, ion, radionuclide, synthetic organic compound, microorganism, waste or other substance occurring in ground water. (3-20-20)T
- 10. Contaminant.** Any chemical, ion, radionuclide, synthetic organic compound, microorganism, waste or other substance which does not occur naturally in ground water or which naturally occurs at a lower concentration. (3-20-20)T
- 11. Contamination.** The direct or indirect introduction into ground water of any contaminant caused in whole or in part by human activities. (3-20-20)T
- 12. Crop Root Zone.** The zone that extends from the surface of the soil to the depth of the deepest crop root and is specific to a species of plant, group of plants, or crop. (3-20-20)T
- 13. Degradation.** The lowering of ground water quality as measured in a statistically significant and reproducible manner. (3-20-20)T
- 14. Department.** The Department of Environmental Quality. (3-20-20)T
- 15. Extraction.** Physical removal of ore or waste rock from mineral-bearing deposits. Extraction does not include processing, which is the removal of target minerals from ores by physical or chemical methods. (3-20-20)T
- 16. Ground Water.** Any water of the state which occurs beneath the surface of the earth in a saturated geological formation of rock or soil. (3-20-20)T

17. **Ground Water Quality Standard.** Values, either numeric or narrative, assigned to any constituent for the purpose of establishing minimum levels of protection. (3-20-20)T
18. **Highly Vulnerable Ground Water.** Ground water characterized by a relatively high potential for contaminants to enter and/or be transported within the flow system. Determinations of ground water vulnerability will include consideration of land use practices and aquifer characteristics. (3-20-20)T
19. **Irreplaceable Source.** A ground water source serving a beneficial use(s) where the reliable delivery of comparable quality and quantity of water from an alternative source in the region would be economically infeasible or precluded by institutional constraints. (3-20-20)T
20. **Mine Operator.** Any person authorized to engage in mining activities, including without limitation those authorized by law, lease, contract, permit, or plan of operation. It does not include a governmental agency that grants mineral leases or similar contracts or permits unless the agency is engaged in mining activities. (3-20-20)T
21. **Mining Activity.** Recovery of a mineral from mineral-bearing deposits, which includes reclamation, extraction, excavation, overburden placement, disposal of tailings resulting from processing, and disposal of mineral extraction wastes, including tailings that are the result of extraction, waste rock, and other extraction wastes uniquely associated with mining. (3-20-20)T
22. **Mining Area.** The area on or within which one (1) or more mining activities occur. The Department shall determine the boundaries of the mining area as provided in Section 401. Distinct mining activities may constitute separate mining areas. (3-20-20)T
23. **Natural Background Level.** The level of any constituent in the ground water within a specified area as determined by representative measurements of the ground water quality unaffected by human activities. (3-20-20)T
24. **Person.** Any individual, association, partnership, firm, joint stock company, joint venture, trust, estate, political subdivision, public or private corporation, state or federal governmental department, agency or instrumentality, or any legal entity which is recognized by law as the subject of rights and duties. (3-20-20)T
25. **Point of Compliance.** The vertical surface where the Department determines compliance with ground water quality standards as provided in Subsection 400.05 and Section 401. (3-20-20)T
26. **Practical Quantitation Level.** The lowest concentration of a constituent that can be reliably quantified among laboratories within specified limits of precision and accuracy during routine laboratory operating conditions. Specified limits of precision and accuracy are the criteria listed in the calibration specifications or quality control specifications of an analytical method. (3-20-20)T
27. **Projected Future Beneficial Uses.** Various uses of ground water, such as drinking water, aquaculture, industrial, mining or agriculture, that are practical and achievable in the future based on hydrogeologic conditions, water quality, future land use activities and social/economic considerations. (3-20-20)T
28. **Recharge Area.** An area in which water infiltrates into the soil or geological formation from, including but not limited to precipitation, irrigation practices and seepage from creeks, streams, and lakes, and percolates to one (1) or more aquifers. (3-20-20)T
29. **Reclamation.** The process of restoring an area affected by a mining activity to its original or another beneficial use, considering previous uses, possible future uses, and surrounding topography. The objective is to re-establish a diverse, self-perpetuating plant community, and to minimize erosion, remove hazards, and maintain water quality. (3-20-20)T
30. **Remediation.** Any action taken (1) to control the source of contamination, (2) to reduce the level of contamination, (3) to mitigate the effects of contaminants, and/or (4) to minimize contaminant movement. Remediation includes providing alternate drinking water sources when needed. (3-20-20)T

**31. Site Background Level.** The ground water quality at the hydraulically upgradient site boundary. (3-20-20)T

**008. -- 010. (RESERVED)**

**011. INCORPORATION BY REFERENCE.**

Codes, standards and regulations may be incorporated by reference in this rule pursuant to Section 67-5229, Idaho Code. Such incorporation by reference shall constitute full adoption by reference, including any notes or appendices therein, unless expressly provided otherwise in this rule. Codes, standards or regulations adopted by reference throughout this rule are available in the following locations: (3-20-20)T

**01. Department of Environmental Quality.** Department of Environmental Quality, 1410 N. Hilton, Boise, ID 83706-1255. (3-20-20)T

**02. Law Library.** State Law Library, 451 W. State Street, P.O. Box 83720, Boise, ID 83720-0051. (3-20-20)T

**03. U.S. Government Printing Office.** U.S. Government Printing Office, Superintendent of Documents, Washington, D.C. 20402, or U.S. Government Bookstore, Room 194 Federal Bldg., 915 Second Ave., Seattle, WA 98174. (3-20-20)T

**012. -- 149. (RESERVED)**

**150. IMPLEMENTATION.**

This rule establishes minimum requirements to maintain and protect ground water quality. This rule applies to all activities with the potential to degrade ground water quality. (3-20-20)T

**01. Ground Water Quality Standards.** The numerical and narrative standards in Sections 200 and 301 identify minimum levels of protection for ground water quality and shall be used as a basis for: (3-20-20)T

**a.** Evaluating or comparing ground water quality when developing or modifying best available methods, best management practices, or best practical methods; (3-20-20)T

**b.** Identifying permit conditions; (3-20-20)T

**c.** Establishing cleanup levels; and (3-20-20)T

**d.** Determining appropriate actions when ground water quality standards are exceeded. (3-20-20)T

**02. Aquifer Categorization.** Aquifers of the state shall be categorized based on vulnerability of the ground water, existing and projected future beneficial uses of the ground water, existing water quality, and social and economic considerations. There shall be three aquifer categories, Sensitive Resource, General Resource, and Other Resource, to provide different levels of protection. The level of protection required for each category and application of standards to these categories are shown in Table I.

<b>Table 1. Level of Protection and Application of Standards to Aquifer Categories</b>		
<b>Category</b>	<b>Level of Protection</b>	<b>Application of Standards</b>
Sensitive Resource	Apply best management practices and best available methods. This category provides the highest level of ground water protection.	May apply stricter standards than in Section 200.
General Resource	Apply best management practices and best practical methods to the maximum extent practical.	Apply numerical and narrative standards in Section 200.

Table 1. Level of Protection and Application of Standards to Aquifer Categories		
Category	Level of Protection	Application of Standards
Other Resource	Apply best management practices and best practical methods to the maximum extent practical.	May apply less strict standards than in Section 200.

(3-20-20)T

a. All aquifers where there are activities with the potential to degrade ground water quality are categorized in Section 300. Those aquifers where no activities with the potential to degrade ground water quality are occurring will remain uncategorized until such activities are commenced. If no action is taken to categorize an aquifer when an activity(ies) with the potential to degrade ground water quality is initiated, the aquifer will automatically be categorized as General Resource.

(3-20-20)T

b. Categorization should be considered when an activity with the potential to degrade ground water quality is proposed over an aquifer or portion of an aquifer which presently has no such activities and, based on the criteria in Section 350, the aquifer may be most appropriately categorized as Sensitive Resource or Other Resource.

(3-20-20)T

c. Recategorization should be considered when information on vulnerability of the ground water, existing and projected future beneficial uses of the ground water, existing quality of the ground water, and social and economic considerations, in conjunction with one or more of the criteria in Section 350, demonstrates that the aquifer or portion of an aquifer may be more appropriate in another category.

(3-20-20)T

**03. Ground Water-Surface Water Interconnection.** The beneficial uses of interconnected surface water shall be recognized when evaluating ground water quality protection. The implementation of water quality programs shall ensure that the quality of ground water that discharges to surface water does not impair the identified beneficial uses of the surface water and that surface water infiltration does not impair beneficial uses of ground water.

(3-20-20)T

**04. Interagency Coordination.** The Department will coordinate with other federal, state, and local agencies to pursue interagency agreements when necessary to ensure implementation of this rule for activities which have the potential to degrade ground water quality.

(3-20-20)T

**151. -- 199. (RESERVED)**

**200. GROUND WATER QUALITY STANDARDS.**

The following numerical and narrative standards apply to all ground water of the state and shall not be exceeded unless otherwise allowed in this rule.

(3-20-20)T

**01. Numerical Ground Water Quality Standards.**

(3-20-20)T

a. The Primary Constituent Standards are based on protection of human health and are identified in Table II.

Table II - Primary Constituent Standards		
Chemical Abstract Service Number	Constituent	Standard (mg/l unless otherwise specified)
7440-36-0	Antimony	0.006
7440-38-2	Arsenic	0.05

Table II - Primary Constituent Standards		
Chemical Abstract Service Number	Constituent	Standard (mg/l unless otherwise specified)
1332-21-4	Asbestos	7 million fibers/l longer than 10 um
7440-39-3	Barium	2
7440-41-7	Beryllium	0.004
7440-43-9	Cadmium	0.005
7440-47-3	Chromium	0.1
7440-50-8	Copper	1.3
57-12-5	Cyanide	0.2
16984-48-8	Fluoride	4
7439-92-1	Lead	0.015
7439-97-6	Mercury	0.002
*1	Nitrate (as N)	10
*1	Nitrite (as N)	1
*1	Nitrate and Nitrite (both as N)	10
7782-49-2	Selenium	0.05
7440-28-0	Thallium	0.002
15972-60-8	Alachlor	0.002
1912-24-9	Atrazine	0.003
71-43-2	Benzene	0.005
50-32-8	Benzo(a)pyrene (PAH)	0.0002
75-27-4	Bromodichloromethane (THM)	0.1
75-25-2	Bromoform (THM)	0.1
1563-66-2	Carbofuran	0.04
56-23-5	Carbon Tetrachloride	0.005
57-74-9	Chlordane	0.002
124-48-1	Chlorodibromomethane (THM)	0.1
67-66-3	Chloroform(THM)	0.002
94-75-7	2,4-D	0.07
75-99-0	Dalapon	0.2
103-23-1	Di(2-ethylhexyl) adipate	0.4
96-12-8	Dibromochloropropane	0.0002
541-73-1	Dichlorobenzene m-	0.6

Table II - Primary Constituent Standards		
Chemical Abstract Service Number	Constituent	Standard (mg/l unless otherwise specified)
95-50-1	Dichlorobenzene o-	0.6
106-46-7	1,4(para)-Dichlorobenzene or Dichlorobenzene p-	0.075
107-06-2	1,2-Dichloroethane	0.005
75-35-4	1,1-Dichloroethylene	0.007
156-59-2	cis-1, 2-Dichloroethylene	0.07
156-60-5	trans-1, 2-Dichloroethylene	0.1
75-09-2	Dichloromethane	0.005
78-87-5	1,2-Dichloropropane	0.005
117-81-7	Di(2-ethylhexyl)phthalate	0.006
88-85-7	Dinoseb	0.007
85-00-7	Diquat	0.02
145-73-3	Endothall	0.1
72-20-8	Endrin	0.002
100-41-4	Ethylbenzene	0.7
106-93-4	Ethylene dibromide	0.00005
1071-83-6	Glyphosate	0.7
76-44-8	Heptachlor	0.0004
1024-57-3	Heptachlor epoxide	0.0002
118-74-1	Hexachlorobenzene	0.001
77-47-4	Hexachlorocyclopentadiene	0.05
58-89-9	Lindane	0.0002
72-43-5	Methoxychlor	0.04
108-90-7	Monochlorobenzene	0.1
23135-22-0	Oxamyl (Vydate)	0.2
87-86-5	Pentachlorophenol	0.001
1918-02-1	Picloram	0.5
1336-36-3	Polychlorinated biphenyls (PCBs)	0.0005
122-34-9	Simazine	0.004
100-42-5	Styrene	0.1
1746-01-6	2,3,7,8-TCDD (Dioxin)	3.0 x 10 <sup>-8</sup>
127-18-4	Tetrachloroethylene	0.005

Table II - Primary Constituent Standards		
Chemical Abstract Service Number	Constituent	Standard (mg/l unless otherwise specified)
108-88-3	Toluene	1
*1	Total Trihalomethanes [the sum of the concentrations of bromodichloromethane, dibromochloromethane, tribromomethane (bromoform), and trichloromethane (chloroform)]	0.1
8001-35-2	Toxaphene	0.003
93-72-1	2,4,5-TP (Silvex)	0.05
120-82-1	1,2,4-Trichlorobenzene	0.07
71-55-6	1,1,1-Trichloroethane	0.2
79-00-5	1,1,2-Trichloroethane	0.005
79-01-6	Trichloroethylene	0.005
75-01-4	Vinyl Chloride	0.002
1330-20-7	Xylenes (total)	10
*1	Gross alpha particle activity (including radium -226, but excluding radon and uranium)	15 pCi/l
*1	Combined beta/photon emitters	4 millirems/year effective dose equivalent
*1	Combined Radium - 226 and radium 228	5 pCi/l
*1	Strontium 90	8 pCi/l
*1	Tritium	20,000 pCi/l
*1	Total Coliform <sup>2</sup>	1 colony forming unit/100 ml
	Escherichia coliform (E. coli)	Less than 1 viable colony or colony forming unit/100 ml using any EPA approved method
	Fecal coliform	Less than 1 viable colony or colony forming unit/100 ml using any EPA approved method
Table Footnotes		
*1 No Chemical Abstract Service Number exists for this constituent.		
<sup>2</sup> An exceedance of the primary ground water quality standard for total coliform is not a violation of these rules. If the primary ground water quality standard for total coliform is exceeded, additional analysis for fecal coliform or E. coli will be conducted. An exceedance of the primary ground water quality standards for either fecal coliform or E. coli is a violation of these rules.		

(3-20-20)T

- b. The Secondary Constituent Standards are generally based on aesthetic qualities and are identified

in Table III.

TABLE III - SECONDARY CONSTITUENT STANDARDS	
Constituent	Standard (mg/l unless otherwise specified)
Aluminum	0.2
Chloride	250
Color	15 Color Units
Foaming Agents	0.5
Iron	0.3
Manganese	0.05
Odor	3.0 Threshold Odor Number
pH	6.5 to 8.5 (no units apply)
Silver	0.1
Sulfate	250
Total Dissolved Solids	500
Zinc	5

(3-20-20)T

c. Sample preservation and analytical procedures to determine compliance with the standards identified in Subsection 200.01 shall be in accordance with the following, except that cyanide shall be analyzed as weak acid dissociable cyanide using a method approved by the Department: (3-20-20)T

i. Environmental Protection Agency, Code of Federal Regulations, Title 40, Parts 141 and 143, revised as of July 2001; or (3-20-20)T

ii. Another method approved by the Department. (3-20-20)T

**02. Narrative Ground Water Quality Standards.** Contaminant concentrations, alone or in combination with other contaminants or properties, shall not cause the ground water to be hazardous, deleterious, carcinogenic, mutagenic, teratogenic, or toxic. Determinations of specific numerical levels when applying this standard shall be based on: (3-20-20)T

a. Best scientific information currently available on adverse effects of the contaminant(s); (3-20-20)T

b. Protection of a beneficial use; or (3-20-20)T

c. Practical quantitation levels for the contaminant(s), if they exceed the levels identified in Subsection 200.02.a. or 200.02.b. (3-20-20)T

**03. Natural Background Level.** If the natural background level of a constituent exceeds the standard in this section, the natural background level shall be used as the standard. (3-20-20)T

201. -- 299. (RESERVED)



**300. CATEGORIZED AQUIFERS OF THE STATE.**

Aquifers or portions of aquifers in the state are categorized as follows: (3-20-20)T

**01. Sensitive Resource.** (3-20-20)T

**a. Spokane Valley -- Rathdrum Prairie Aquifer.** (3-20-20)T

**i.** In addition to the ground water quality standards in Section 200, the following narrative standard applies: the aquifer shall not be degraded, as it relates to beneficial uses, as a result of point source or nonpoint source activity unless it is demonstrated by the person proposing the activity that such change is justifiable as a result of necessary economic or social development. (3-20-20)T

**02. General Resource.** All aquifers or portions of aquifers where there are activities with the potential to degrade ground water quality of the aquifer, unless otherwise listed in Subsection 300.01 or 300.03. Once an activity with the potential to degrade the ground water quality of an uncategorized aquifer or portion of an aquifer is initiated, the uncategorized aquifer shall automatically become General Resource unless petitioned into the Sensitive Resource or Other Resource category. (3-20-20)T

**03. Other Resource.** (3-20-20)T

**301. MANAGEMENT OF ACTIVITIES WITH THE POTENTIAL TO DEGRADE AQUIFERS.**

**01. Sensitive Resource Category Aquifers.** (3-20-20)T

**a.** Activities with the potential to degrade Sensitive Resource aquifers shall be managed in a manner which maintains or improves existing ground water quality through the use of best management practices and best available methods except when a point of compliance is set pursuant to Section 401. (3-20-20)T

**b.** Numerical and narrative standards identified in Section 200 shall apply to aquifers or portions of aquifers categorized as Sensitive Resource. In addition, stricter numerical and narrative standards, for specified constituents, may be adopted pursuant to Section 350 on a case by case basis and listed in Section 300. (3-20-20)T

**02. General Resource Category Aquifers.** (3-20-20)T

**a.** Activities with the potential to degrade General Resource aquifers shall be managed in a manner which maintains or improves existing ground water quality through the use of best management practices and best practical methods to the maximum extent practical except when a point of compliance is set pursuant to Section 401. (3-20-20)T

**b.** Numerical and narrative standards identified in Section 200 shall apply to aquifers or portions of aquifers categorized as General Resource. (3-20-20)T

**03. Other Resource Category Aquifers.** (3-20-20)T

**a.** Activities with the potential to degrade Other Resource aquifers shall be managed in a manner which maintains existing ground water quality, except for those identified constituents which may have a less stringent standard, through the use of best management practices and best practical methods to the maximum extent practical except when a point of compliance is set pursuant to Section 401. (3-20-20)T

**b.** Numerical and narrative standards identified in Section 200 shall apply to aquifers or portions of aquifers categorized as Other Resource. In addition, less strict numerical and narrative standards, for specified constituents, may be adopted pursuant to Section 350 on a case by case basis and listed in Section 300. (3-20-20)T

**302. -- 349. (RESERVED)**

**350. PROCEDURES FOR CATEGORIZING OR RECATEGORIZING AN AQUIFER.**

The following process shall be used for categorizing or recategorizing an aquifer. (3-20-20)T

**01. Criteria for Aquifer Categories.** The following criteria shall be considered when a petition to categorize or recategorize aquifers or portions of aquifers is submitted to the Board: (3-20-20)T

**a.** For Sensitive Resource aquifers: (3-20-20)T

i. The ground water in an aquifer or portion of an aquifer is of a better quality than the ground water quality standards in Section 200 and maintenance of this quality is needed to protect an identified beneficial use(s); (3-20-20)T

ii. The ground water in an aquifer or portion of an aquifer is considered highly vulnerable; (3-20-20)T

iii. The ground water in an aquifer or portion of an aquifer represents an irreplaceable source for the identified beneficial use(s); (3-20-20)T

iv. The ground water quality in an aquifer or portion of an aquifer has been degraded and there is a need for additional protection measures to maintain or improve the water quality or prevent impairment of a beneficial use; (3-20-20)T

v. The ground water within an aquifer or portion of an aquifer is shown to be hydrologically interconnected with surface water and additional protection is needed to maintain the quality of either surface or ground water. Hydrologic interconnections can include either natural or induced ground water recharge or discharge areas; or (3-20-20)T

vi. The ground water within an aquifer or portion of an aquifer demonstrates other criteria which justify the need for additional protection. (3-20-20)T

**b.** For General Resource aquifers: (3-20-20)T

i. An activity with the potential to degrade ground water quality is initiated over an aquifer or portion of an aquifer which presently has no such activities; (3-20-20)T

ii. The ground water in an aquifer or portion of an aquifer is currently being used for drinking water or another beneficial use which requires similar protection; or (3-20-20)T

iii. The ground water in an aquifer or portion of an aquifer has a projected future beneficial use of drinking water or another beneficial use which requires similar protection. (3-20-20)T

**c.** For other resource aquifers: (3-20-20)T

i. The ground water quality within an aquifer or portion of an aquifer does not meet one or more of the ground water quality standards in Section 200; and allowing the ground water quality to remain at this level does not impair existing or projected future beneficial uses within the aquifer or portion of an aquifer; (3-20-20)T

ii. The projected ground water quality within an aquifer or portion of an aquifer will not meet one or more of the ground water quality standards in Section 200 as a result of activities over or within the aquifer or portion of an aquifer; and allowing the proposed degradation will not impair existing or projected future beneficial uses; (3-20-20)T

iii. Human caused conditions or sources of contamination have resulted in ground water quality standards in Section 200 being exceeded, and the contamination cannot be remedied for economical or technical reasons, or remediation would cause more environmental damage to correct than to leave in place; or (3-20-20)T

iv. The ground water within an aquifer or portion of an aquifer demonstrates other criteria which justify the need for categorization as an Other Resource. (3-20-20)T

**02. Petition Process.** The Department or any other person may petition the Board to initiate rulemaking to categorize or recategorize an aquifer or portion of an aquifer pursuant to IDAPA 58.01.23, "Rules of Administrative Procedure Before the Board of Environmental Quality." In addition to the information required in a rulemaking Petition pursuant to IDAPA 58.01.23, the following information shall be submitted in writing by the Petitioner for the identified aquifer or portion of an aquifer: (3-20-20)T

- a. Current category, if applicable; (3-20-20)T
- met; b. Proposed category and an explanation of how one or more of the criteria in Subsection 350.01 are (3-20-20)T
- c. An explanation of why the categorization or recategorization is being proposed; (3-20-20)T
- d. Location, description and areal extent; (3-20-20)T
- e. General location and description of existing and projected future ground water beneficial uses; (3-20-20)T
- f. Documentation of the existing ground water quality; (3-20-20)T
- g. Documentation of aquifer characteristics, where available, including, but not limited to: (3-20-20)T
  - i. Depth to ground water; (3-20-20)T
  - ii. Thickness of the water bearing section; (3-20-20)T
  - iii. Direction and rate of ground water flow; (3-20-20)T
  - iv. Known recharge and discharge areas; and (3-20-20)T
  - v. Geology of the area; (3-20-20)T
- h. Identification of any proposed standards, for specified constituents, which would be stricter or less strict than the ground water quality standards in Section 200, or any standards to be applied in addition to those in Section 200; and a rationale for the proposed standards. (3-20-20)T

**03. Preliminary Department Review.** Prior to submission of a petition to the Board to categorize or recategorize an aquifer, any person may seek a preliminary review of the petition from the Department. The Department shall respond to the petitioner with comments within forty-five (45) days. (3-20-20)T

**351. -- 399. (RESERVED)**

**400. GROUND WATER CONTAMINATION.**

**01. Releases Degrading Ground Water Quality.** No person shall cause or allow the release, spilling, leaking, emission, discharge, escape, leaching, or disposal of a contaminant into the environment in a manner that: (3-20-20)T

- a. Causes a ground water quality standard to be exceeded; (3-20-20)T
- b. Injures a beneficial use of ground water; or (3-20-20)T
- c. Is not in accordance with a permit, consent order or applicable best management practice, best available method or best practical method. (3-20-20)T

**02. Measures Taken in Response to Degradation.** (3-20-20)T

**a.** Except when a point of compliance is set pursuant to Section 401, when a numerical standard is not exceeded, but degradation of ground water quality is detected and deemed significant by the Department, the Department shall take one (1) or more of the following actions: (3-20-20)T

i. Require a modification of regulated activities to prevent continued degradation; (3-20-20)T

ii. Coordinate with the appropriate agencies and responsible persons to develop and implement prevention measures for activities not regulated by the Department; (3-20-20)T

iii. Allow limited degradation of ground water quality for the constituents identified in Subsection 200.01.a. if it can be demonstrated that: (3-20-20)T

(1) Best management practices, best available methods or best practical methods, as appropriate for the aquifer category, are being applied; and (3-20-20)T

(2) The degradation is justifiable based on necessary and widespread social and economic considerations; or (3-20-20)T

iv. Allow degradation of ground water quality up to the standards in Subsection 200.01.b., if it can be demonstrated that: (3-20-20)T

(1) Best management practices are being applied; and (3-20-20)T

(2) The degradation will not adversely impact a beneficial use. (3-20-20)T

**b.** The following criteria shall be considered when determining the significance of degradation: (3-20-20)T

i. Site specific hydrogeologic conditions; (3-20-20)T

ii. Water quality, including seasonal variations; (3-20-20)T

iii. Existing and projected future beneficial uses; (3-20-20)T

iv. Related public health issues; and (3-20-20)T

v. Whether the degradation involves a primary or secondary constituent in Section 200. (3-20-20)T

**03. Contamination Exceeding a Ground Water Quality Standard.** The discovery of any contamination exceeding a ground water standard that poses a threat to existing or projected future beneficial uses of ground water shall require appropriate actions, as determined by the Department, to prevent further contamination. These actions may consist of investigation and evaluation, or enforcement actions if necessary to stop further contamination or clean up existing contamination, as required under the Environmental Protection and Health Act, Section 39-108, Idaho Code. (3-20-20)T

**04. Agricultural Chemicals.** Agricultural chemicals found in intermittently saturated soils within the crop root zone will not be considered ground water contaminants as long as the chemicals remain within the crop root zone, and have been applied in a manner consistent with all appropriate regulatory requirements. (3-20-20)T

**05. Site-Specific Ground Water Quality Levels or Points of Compliance.** The Department may allow site-specific ground water quality levels, for any aquifer category, that vary from a standard(s) in Section 200 or Section 300, or may allow site-specific points of compliance, based on consideration of effects to human health and the environment, for: (3-20-20)T

**a.** Remediation conducted under the Department's oversight; (3-20-20)T

**b.** Permits issued by the Department; (3-20-20)T

c. Situations where the site background level varies from the ground water quality standard; (3-20-20)T

d. Dissolved concentrations of secondary constituents listed in Section 200 of this rule. The Department may allow the use of dissolved concentrations for secondary constituents if the requesting person demonstrates that doing so will not adversely affect human health and the environment; or (3-20-20)T

e. Other situations authorized by the Department in writing. (3-20-20)T

**401. MINING.**

**01. Request for Setting Point(s) of Compliance and Standards Applicable to Mining Activities.** At the request of a mine operator, pursuant to this section, the Department shall set a point of compliance, or points of compliance, at which the mine operator shall protect current and projected future beneficial uses of the ground water and meet the ground water quality standards as described in Section 200 or as allowed under Subsection 400.05. Degradation of ground water is allowed at a point of compliance if the mine operator implements the level of protection during mining activities appropriate for the aquifer category as specified in Table 1 of Subsection 150.02. If a request is not made, the mine operator must meet the ground water quality standards as described in Subsection 150.01 in ground water both within and beyond the mining area unless the Department establishes the point(s) of compliance consistent with Subsection 401.03. (3-20-20)T

**02. Application Process.** (3-20-20)T

a. If the mine operator requests a point of compliance, or points of compliance, the mine operator shall make written application to the Department. The application shall be accompanied by a fee of two thousand five hundred dollars (\$2,500). The application shall include the following information in sufficient detail to allow the Department to establish point(s) of compliance: (3-20-20)T

i. Name, location, and mailing address of the mining operation; (3-20-20)T

ii. Name, mailing address, and phone number of the mine operator; (3-20-20)T

iii. Land ownership status of the mining operation (federal, state, private or public); (3-20-20)T

iv. The legal structure (corporation, partnership, etc.) and residence of the mine operator; (3-20-20)T

v. The legal description, to the quarter-quarter section, of the location of the proposed mining operation; (3-20-20)T

vi. Evidence the mine operator is authorized by the Secretary of State to conduct business in the state of Idaho; (3-20-20)T

vii. A general description of the operational plans for the mining operation from construction through final reclamation. This description shall include any proposed phases for construction, operations, and reclamation and a map that identifies the location of all mining activities; (3-20-20)T

viii. A preconstruction topographic site map or aerial photos extending at least one (1) mile beyond the outer limits of the mining area, identifying and showing the location and extent of the following features: (3-20-20)T

(1) All wells, perennial and intermittent springs, adit discharges, wetlands, surface waters and irrigation ditches; (3-20-20)T

(2) All public and private drinking water supply source(s) within one (1) mile of the mining area; (3-20-20)T

(3) All service roads and public roads; (3-20-20)T

- (4) All buildings and structures within one (1) mile of the mining area; (3-20-20)T
  - (5) All special resource waters within one (1) mile of the mining area; and (3-20-20)T
  - (6) All Clean Water Act Section 303(d) listed streams, and their listed impairments, within one (1) mile of the mining area; (3-20-20)T
    - ix. To the extent such information is available, a description and location of underground mine workings and adits and a description of the structural geology that may influence ground water flow and direction; (3-20-20)T
    - x. Information regarding the relevant factors set forth in Subsection 401.03; and (3-20-20)T
    - xi. A proposed point of compliance, or points of compliance. (3-20-20)T
  - b.** Within thirty (30) days of receipt of an application, the Department shall issue a written notice to the mine operator indicating: (3-20-20)T
    - i. That the application is complete; or (3-20-20)T
    - ii. That the Department is rejecting the application as incomplete. In such a case, the Department shall provide a list of deficiencies. Upon a determination that the application is incomplete, the Department shall refund one-half (1/2) of the application fee. (3-20-20)T
  - c.** The Department shall establish the point(s) of compliance within one hundred eighty (180) days after receipt of a complete application unless the Department determines that additional time is necessary due to unusual circumstances. (3-20-20)T
- 03. Setting the Point(s) of Compliance.** The point(s) of compliance shall be set as close as possible to the boundary of the mining area, taking into consideration the relevant factors set forth in Subsections 401.03.a. through 401.03.h., but in no event shall the point(s) of compliance be within the boundary of the mining area. The mining area boundary means the outermost perimeter of the mining area (projected in the horizontal plane) as it would exist at the completion of the mining activity. The point(s) of compliance shall be set so that, outside the mining area boundary, there is no injury to current or projected future beneficial uses of ground water and there is no violation of water quality standards applicable to any interconnected surface waters. The Department's determination regarding the point(s) of compliance shall be based on an analysis and consideration of all relevant factors including, but not limited to: (3-20-20)T
- a.** The hydrogeological characteristics of the mining area and surrounding land, including any dilution characteristics of the aquifer and any natural attenuation supported by site-specific data; (3-20-20)T
  - b.** The concentration, volume, and physical and chemical characteristics of contaminants resulting from the mining activity, including the toxicity and persistence of the contaminants; (3-20-20)T
  - c.** The quantity, quality, and direction of flow of ground water underlying the mining area; (3-20-20)T
  - d.** The proximity and withdrawal rates of current ground water users; (3-20-20)T
  - e.** A prediction of projected future beneficial uses; (3-20-20)T
  - f.** The availability of alternative drinking water supplies; (3-20-20)T
  - g.** The existing quality of the ground water, including other sources of contamination and their cumulative impacts on the ground water; and (3-20-20)T
  - h.** Public health, safety, and welfare effects. (3-20-20)T

**04. Ground Water Monitoring and Reporting.** The Department shall require ground water monitoring and reporting whenever the Department sets the point(s) of compliance. The Department shall not require ground water monitoring that duplicates ground water monitoring required by other state or federal agencies as long as the mine operator provides the data to the Department. (3-20-20)T

- a.** A ground water monitoring system required under Subsection 401.04 shall be designed to: (3-20-20)T
- and
- i.** Represent the quality of background ground water that has not been affected by the mining activity; (3-20-20)T
- ii.** Represent the quality of ground water passing the point(s) of compliance in order to determine compliance with ground water quality standards or effectiveness of best management practices. (3-20-20)T
- b.** When practicable, indicator monitoring wells or other devices may be required. Such indicator wells and other devices shall not be used to determine compliance with the ground water quality standards, but instead may be used to evaluate modeling results, to predict the quality of ground water at the point(s) of compliance, or to determine the effectiveness of best management practices. (3-20-20)T

**c.** All monitoring wells shall be constructed (well depth, well screen size, well screen interval, gravel pack, etc.) and developed so that ground water samples represent the quality of ground water that is relevant to current and future beneficial uses. (3-20-20)T

**05. Coordination with Other State or Federal Agencies/Public Notice.** Before setting the point(s) of compliance or requiring ground water monitoring, the Department shall coordinate with and seek recommendations from other state or federal agencies that have regulatory authority over the mining activities. The Department may provide public notice and an opportunity for public comment prior to setting or changing the point(s) of compliance. The Department shall issue a public notice after it sets the point(s) of compliance. (3-20-20)T

**06. Limitations.** Section 401 addresses only those contaminants that naturally occur in the mining area ground water or in the surrounding rock or soil and are present in concentrations above the natural background level as a result of mining activities. (3-20-20)T

**07. Application of Provisions.** The provisions set out in Section 401 apply to new mining activities or to an expansion of existing mining activities commencing after July 1, 2009. All consent orders, compliance schedules, and other agreements adopted or issued by the Department prior to July 1, 2009 pertaining to ground water protection at mine sites shall remain in full force and effect. (3-20-20)T

**08. Change in Point(s) of Compliance/Ground Water Monitoring.** (3-20-20)T

**a.** A change in the point(s) of compliance may be requested by the mine operator when there is a change in, or new information regarding, the mining activity or any of the factors set forth in Subsection 401.03. A change requested by the mine operator shall include an identification of the new proposed point(s) of compliance, a description of the cause for the change and any data supporting the change. The mine operator's request shall be handled as an application submitted pursuant to Subsection 401.02.a. and shall be subject to all other provisions of Section 401. (3-20-20)T

**b.** The Department may initiate a change in the point(s) of compliance if there is a change in, or new information regarding, the mining activity or any of the factors set forth in Subsection 401.03, and the Department determines that the change is necessary to ensure there is no injury to current or projected future beneficial uses of ground water and no violation of water quality standards applicable to any interconnected surface waters. The Department shall notify the mine operator in writing of the Department's intent to change the point(s) of compliance. The Department shall make its final decision to change the point(s) of compliance within sixty (60) days of the notice to the mine operator unless the Department and the mine operator agree more time is necessary to make the decision. (3-20-20)T

c. The Department may require additional or new ground water monitoring or indicator wells when the Department changes the point(s) of compliance. The Department may also require additional or different ground water monitoring or indicator wells if the Department determines, based upon a change in or new information regarding the mining activity or any of the factors listed in Subsection 401.03, that the monitoring no longer meets the requirements set forth in Subsection 401.04. The mine operator may also request a change in the monitoring.  
(3-20-20)T

**402. -- 999. (RESERVED)**



## 58.01.12 – RULES FOR ADMINISTRATION OF WATER POLLUTION CONTROL LOANS

### 000. LEGAL AUTHORITY.

The Idaho Board of Environmental Quality, pursuant to authority granted in Chapters 1 and 36, Title 39, Idaho Code, did adopt the following rules for the administration of a Water Pollution Control Loan Program in Idaho. (3-20-20)T

### 001. TITLE AND SCOPE.

**01. Title.** These rules are titled IDAPA 58.01.12, “Rules for Administration of Water Pollution Control Loans.” (3-20-20)T

**02. Scope.** The provisions of these rules will establish administrative procedures and requirements for establishing, implementing and administering a state loan program for providing financial assistance to eligible applicants of water pollution control projects. The U.S. Environmental Protection Agency provides annual capitalization grants to the state of Idaho for this program. Financial assistance projects must be in conformance with the requirements of the Subchapter VI of the federal Clean Water Act (33 U.S.C. Sections 1381 et seq.). (3-20-20)T

### 002. WRITTEN INTERPRETATIONS.

As described in Section 67-5201(19)(b)(iv), Idaho Code, the Department of Environmental Quality may have written statements which pertain to the interpretation of these rules. If available, such written statements can be inspected and copied at cost at the Department of Environmental Quality, 1410 N. Hilton, Boise, Idaho 83706. (3-20-20)T

### 003. ADMINISTRATIVE APPEALS.

Persons may be entitled to appeal agency actions authorized under these rules pursuant to IDAPA 58.01.23, “Rules of Administrative Procedure Before the Board of Environmental Quality.” (3-20-20)T

### 004. INCORPORATION BY REFERENCE AND AVAILABILITY OF REFERENCED MATERIAL.

**01. Incorporation by Reference.** These rules do not contain documents incorporated by reference. (3-20-20)T

**02. Availability of Referenced Material.** The “Wastewater Facilities Loan Handbook of Procedures” (Handbook) is available at the Idaho Department of Environmental Quality, Water Quality Division Loan Program, 1410 N. Hilton, Boise, ID 83706-1255, (208)373-0502, DEQ website <http://www.deq.idaho.gov>. (3-20-20)T

### 005. CONFIDENTIALITY.

Information obtained by the Department under these rules is subject to public disclosure pursuant to the provisions of Chapter 1, Title 74, Idaho Code, and IDAPA 58.01.21, “Rules Governing the Protection and Disclosure of Records in the Possession of the Idaho Department of Environmental Quality.” (3-20-20)T

### 006. POLICY.

It is the policy of the Idaho Board of Environmental Quality through the Idaho Department of Environmental Quality, to administer the Water Pollution Control Loan Program for the purpose of protecting and enhancing the quality and value of the water resources of the state of Idaho by financially assisting in the prevention, control and abatement of water pollution. It is also the intent of the Board of Environmental Quality to assign a priority rating to those projects which will most significantly improve the quality of the waters of the state and most adequately protect the public health. (3-20-20)T

### 007. DEFINITIONS.

For the purpose of the rules contained in this chapter, the following definitions apply: (3-20-20)T

**01. Applicant.** A municipality or nonpoint source project sponsor which has the ability to establish and maintain a loan repayment source. Individuals and for-profit corporations are not eligible. (3-20-20)T

**02. Best Management Practice.** A practice or combination of practices, techniques or measures developed, or identified, by the designated agency and identified in the state water quality management plan which are determined to be the most cost-effective and practicable means of preventing or reducing the amount of pollution generated by nonpoint sources to a level compatible with water quality needs. (3-20-20)T

**03. Board.** The Idaho Board of Environmental Quality. (3-20-20)T

**04. Categorical Exclusion (CE).** Category of actions which do not individually or cumulatively have a significant effect on the human environment and for which, therefore, neither an environmental information

document nor an environmental impact statement is required. (3-20-20)T

**05. Close or Closing.** The date on which the loan recipient issues and physically delivers to the Department the bond or note evidencing the loan to the loan recipient, specifically determining the principal, interest and fee amounts that shall be repaid and the schedule for payment. (3-20-20)T

**06. Collector Sewer.** That portion of the wastewater treatment facility whose primary purpose is to receive sewage from individual residences and other individual public or private structures and which is intended to convey wastewater to an interceptor sewer or a treatment plant. (3-20-20)T

**07. Construction.** The erection, building, acquisition, alteration, reconstruction, improvement or extension of wastewater treatment facilities, including preliminary planning to determine the economic and engineering feasibility of wastewater treatment facilities, the engineering, architectural, legal, fiscal and economic investigations, reports and studies, surveys, designs, plans, working drawings, specifications, procedures and other action necessary in the construction of wastewater treatment facilities; the inspection and supervision of the construction; and start-up of the associated facilities. (3-20-20)T

**08. Department.** The Idaho Department of Environmental Quality. (3-20-20)T

**09. Director.** The Director of the Idaho Department of Environmental Quality or his/her designee. (3-20-20)T

**10. Disadvantaged Community.** The service area of a wastewater treatment facility that meets affordability criteria established by the Department of Environmental Quality after public review and comment. (3-20-20)T

**11. Disadvantaged Loans.** Loans made to a disadvantaged community. (3-20-20)T

**12. Eligible Costs.** Costs which are necessary for planning, designing and/or constructing wastewater treatment facilities or implementation of water pollution control projects. To be eligible, costs must be reasonable and not ineligible costs. The determination of eligible costs shall be made by the Department pursuant to Section 041. (3-20-20)T

**13. Environmental Impact Statement (EIS).** A document prepared by the applicant when the Department determines that the proposed construction project may significantly affect the environment. The major purpose of the EIS will be to describe fully the significant impacts of the project and how these impacts can be either avoided or mitigated. The environmental review procedures contained in Chapter 5 of the Handbook may be used as guidance when preparing the EIS. (3-20-20)T

**14. Environmental Information Document (EID).** Any written environmental assessment prepared by the applicant describing the environmental impacts of a proposed wastewater construction project. This document will be of sufficient scope to enable the Department to assess the environmental impacts of the proposed project and ultimately determine if an EIS is warranted. (3-20-20)T

**15. Financial Management System.** Uniform method of recording, summarizing and analyzing financial information about the water pollution control loan applicant. (3-20-20)T

**16. Finding of No Significant Impact (FONSI).** A document prepared by the Department presenting the reasons why an action, not otherwise excluded, will not have a significant effect on the human environment and for which an EIS will not be prepared. It shall include the environmental assessment or a summary of it and shall note any other environmental documents related to it. (3-20-20)T

**17. Handbook.** “Wastewater Facilities Loan Handbook of Procedures.” (3-20-20)T

**18. Implementation Plan.** Completed project implementation plan or work plan provides detailed documentation of the proposed project including list of tasks, schedule of tasks, agency/contractor/entity responsible for implementation of the project tasks, adequate time schedules for completion of all budget tasks, and the

- anticipated results of the project. (3-20-20)T
- 19. Ineligible Costs.** Costs which are not eligible for funding pursuant to these rules. (3-20-20)T
- 20. Interceptor Sewer.** That portion of the wastewater treatment facility whose primary purpose is to transport domestic sewage or nondomestic wastewater from collector sewers to a treatment plant. (3-20-20)T
- 21. Loan Recipient.** An applicant who has been awarded a loan. (3-20-20)T
- 22. National Pollutant Discharge Elimination System.** Point source permitting program established pursuant to Section 402 of the federal Clean Water Act (33 U.S.C. Section 1342). (3-20-20)T
- 23. Nondomestic Wastewater.** Wastewaters originating primarily from industrial or commercial processes which carry little or no pollutants of human origin. (3-20-20)T
- 24. Nonpoint Source Pollution.** Water pollution that enters the waters of the state from nonspecific and diffuse sources and is the result of runoff, precipitation, drainage, seepage, hydrological modification or land disturbing activities. (3-20-20)T
- 25. Nonpoint Source Project Sponsor.** Any applicant for water pollution control loan funds for a nonpoint source pollution project. (3-20-20)T
- 26. Operation and Maintenance Manual.** For wastewater treatment facilities, a guidance and training manual outlining the optimum operation and maintenance of the wastewater treatment facility or its components. For nonpoint source water pollution control projects, a plan that incorporates applicable sections of the Natural Resources Conservation Service Field Office Technical Guide, for implementation of best management practices. (3-20-20)T
- 27. Planning Document.** A document which describes the condition of a public wastewater system and presents a cost effective and environmentally sound alternative to achieve or maintain regulatory compliance. Engineering reports and facility plans are examples of such planning documents. The planning documents shall be prepared by or under the responsible charge of an Idaho licensed professional engineer and shall bear the imprint of the engineer's seal. Requirements for planning documents prepared using loan funds are provided in Section 030 of these rules and in the Handbook. (3-20-20)T
- 28. Plan of Operation.** A schedule of specific actions and completion dates for construction, start-up and operation of the wastewater treatment facility or for implementation of water pollution control projects. (3-20-20)T
- 29. Point Source.** Any discernible, confined and discrete conveyance, including but not limited to any pipe, ditch, channel, tunnel, conduit, well, discrete fissure, container, rolling stock, concentrated animal feeding operation, or vessel or other floating craft, from which pollutants are, or may be discharged to the waters of the state. This term as used in these rules does not include return flows from irrigated agriculture, discharges from dams and hydroelectric generating facilities or any source or activity considered a nonpoint source by definition. (3-20-20)T
- 30. Pollutant.** Any chemical, biological, or physical substance whether it be solid, liquid, gas, or a quality thereof, which if released into the environment can, by itself or in combination with other substances, create a nuisance or render that environment harmful, detrimental, or injurious to public health, safety or welfare or to domestic, commercial, industrial, recreational, aesthetic or other beneficial uses. (3-20-20)T
- 31. Priority List.** An integrated list of proposed wastewater treatment facility and nonpoint source pollution control projects rated as described in Section 020. (3-20-20)T
- 32. Rehabilitation.** The repair or replacement of limited segments of interceptor or collector sewers. (3-20-20)T
- 33. Reserve Capacity.** That portion of the treatment works that is designed and incorporated in the constructed facilities to handle future sewage flows and loadings. (3-20-20)T

**34. Sewer Use Ordinance/Sewer Use Resolution.** An ordinance or resolution which requires new sewers and connections to be properly designed and constructed, prohibits extraneous sources of inflow and prohibits introduction of wastes into the sewer in an amount that endangers the public safety or the physical or operational integrity of the wastewater treatment facility. (3-20-20)T

**35. State.** The state of Idaho. (3-20-20)T

**36. Supplemental Grants.** A state funded grant awarded in conjunction with a loan from the water pollution control loan account. (3-20-20)T

**37. Suspension.** An action by the Director to suspend a loan contract prior to project completion for a specified cause. Suspended contracts may be reinstated. (3-20-20)T

**38. Sustainability.** Sustainability will include efforts for energy and water conservation, extending the life of capital assets, green building practices, and other environmentally innovative approaches to infrastructure repair, replacement and improvement. (3-20-20)T

**39. Termination.** An action by the Director to permanently terminate a loan contract prior to project completion for a specific cause. Terminated contracts will not be reinstated. (3-20-20)T

**40. User Charge System.** A system of rates and service charges applicable to specific types of users, including any legal enforcement mechanism as may be required and which provides sufficient reserves and/or revenues for debt retirement, operation and maintenance, and replacement of the installed equipment or structures. (3-20-20)T

**41. Wastewater.** A combination of the liquid and water-carried wastes from dwellings, commercial buildings, industrial plants, institutions and other establishments, together with any groundwater, surface water and storm water that may be present; liquid and water that is physically, chemically, biologically, or rationally identifiable as containing excreta, urine, pollutants or domestic or commercial wastes; sewage. (3-20-20)T

**42. Wastewater Treatment Facility.** Any facility, including land, equipment, furnishings and appurtenances thereof, used for the purpose of collecting, treating, neutralizing or stabilizing wastewater and removing pollutants from wastewater including the treatment plant, collectors, interceptors, outfall and outlet sewers, pumping stations, sludge treatment and handling systems, land disposal systems; a sewage treatment plant. (3-20-20)T

**43. Water Pollution Control Project.** Any project that contributes to the removal, curtailment, or mitigation of pollution of the surface waters or groundwater of the state, or the restoration of the quality of said waters, and conforms to any applicable planning document which has been approved and/or adopted such as the State Water Quality Management Plan. This includes the planning, design, construction/implementation or any other distinct stage or phase of a project. (3-20-20)T

**008. OFFICE HOURS – MAILING ADDRESS AND STREET ADDRESS.**

The state office of the Department of Environmental Quality and the office of the Board of Environmental Quality are located at 1410 N. Hilton, Boise, Idaho 83706-1255, telephone number (208) 373-0502. The office hours are 8 a.m. to 5 p.m. Monday through Friday. (3-20-20)T

**009. (RESERVED)**

**010. FINANCIAL AND MANAGEMENT CAPABILITY ANALYSIS.**

No loans shall be awarded for projects unless the applicant has demonstrated and certified that it has the legal, technical, managerial, and financial capabilities as provided for in these rules to ensure construction, operation and maintenance, and to repay principal and interest which would be due on a loan. (3-20-20)T

**01. Information Needed.** Before an application will be considered complete, the applicant must submit all necessary information on a form prescribed by the Department along with substantiating documentation.

The information may include, but not be limited to, demographic information of the applicant, estimated construction or implementation costs, annual operating costs, and information regarding the financing of the project, including the legal debt limit of the applicant and the existence and amount of any outstanding bonds or other indebtedness which may affect the project. (3-20-20)T

**02. Incorporated Nonprofit Applicants.** (3-20-20)T

**a.** In addition to all other information required to be submitted by these rules, an incorporated nonprofit applicant must demonstrate to the satisfaction of the Department by its articles of incorporation and/or bylaws, that: (3-20-20)T

i. The corporation is nonprofit and lawfully incorporated pursuant to Chapter 3, Title 30, Idaho Code; (3-20-20)T

ii. The corporation is authorized to incur indebtedness to construct, improve or repair wastewater treatment facilities and/or implement water pollution control projects; (3-20-20)T

iii. The corporation is authorized to secure indebtedness by pledging corporation property, including any revenues raised through a user charge system; (3-20-20)T

iv. The corporation exists either perpetually or for a period long enough to repay a wastewater treatment facility loan or water pollution control project loan; and (3-20-20)T

v. The corporation is capable of raising revenues sufficient to repay a loan. (3-20-20)T

**b.** The Department may impose conditions on the making of a wastewater treatment facility loan or water pollution control project to an incorporated nonprofit applicant which are necessary to carry out the provisions of these rules and the provisions of Chapter 36, Title 39, Idaho Code. (3-20-20)T

**03. Cost Allocation.** An applicant proposing a point source or nonpoint source water pollution control project designed to serve two (2) or more entities must show how the costs will be allocated among the participating entities. Such applicants must provide an executed intermunicipal service agreement which, at a minimum, incorporates the following information: (3-20-20)T

**a.** The basis upon which the costs are allocated; (3-20-20)T

**b.** The formula by which the costs are allocated; and (3-20-20)T

**c.** The manner in which the cost allocation system will be implemented. (3-20-20)T

**04. Waivers.** The requirement in Subsection 010.03 may be waived by the Department if the applicant can demonstrate: (3-20-20)T

**a.** Such an agreement is already in place; (3-20-20)T

**b.** There is documentation of a service relationship in the absence of a formal agreement; or (3-20-20)T

**c.** An applicant exhibits sufficient financial strength to continue the project if one (1) or more of the applicants fails to participate. (3-20-20)T

**011. -- 019. (RESERVED)**

**020. INTEGRATED PRIORITY RATING SYSTEM.**

Projects are identified for placement on priority lists by surveying eligible entities directly on an annual basis. Information is also received from the Department and consulting engineers. Limited loan funds are awarded to projects based on priority ratings. Projects are rated by the Department on a standard priority rating form using public

health, sustainability, and water quality criteria. (3-20-20)T

**01. Purpose.** An integrated priority rating system shall be utilized by the Department to annually allot available funds to water quality projects determined eligible for funding assistance under the water pollution control loan program in accordance with these rules. (3-20-20)T

**02. Priority Rating.** The priority rating system shall be based on a numerical point system. Priority criteria shall contain the following points: (3-20-20)T

**a.** Public health emergency or hazard certified by the Idaho Board of Environmental Quality, the Department, a District Health Department or by a District Board of Health – one hundred and fifty (150) points. (3-20-20)T

**b.** Regulatory compliance issues (e.g., noncompliance and resulting legal actions relating to infrastructure deficiencies at a wastewater facility) -- up to one hundred (100) points. (3-20-20)T

**c.** Watershed restoration (e.g., implementation of best management practices or initiation of construction at wastewater collection and treatment facilities as part of an approved total maximum daily load plan, implementation of nonpoint source management actions in protection of a threatened water, or is part of a special water quality effort) -- up to one hundred (100) points. (3-20-20)T

**d.** Watershed protection from impacts (e.g., improvement of beneficial use(s) in a given water body, evidence of community support, or recognition of the special status of the affected water body) -- up to one hundred (100) points. (3-20-20)T

**e.** Preventing impacts to uses (nonpoint source pollution projects) -- up to one hundred (100) points. (3-20-20)T

**f.** Sustainability efforts (e.g., prospective efforts at energy conservation, water conservation, extending the life of capital assets, green building practices, and other environmentally innovative approaches to infrastructure repair, replacement and improvement) -- up to fifty (50) points. (3-20-20)T

**g.** Affordability (current system user charges exceed state affordability guidelines) -- ten (10) points. (3-20-20)T

**03. Rating Forms.** Rating criteria for Subsection 020.02 is set forth in a rating form that is available in the Handbook. (3-20-20)T

**04. Integrated Priority List.** A list shall be developed from projects rated according to Subsection 020.02. Such list shall be submitted for public review and comment, and shall thereafter be submitted to the Board for approval. (3-20-20)T

**a.** Priority Reevaluation. Whenever significant changes occur, which in the Department's judgment would affect the design parameters or treatment requirements by either increasing or decreasing the need for or scope of any project, a reevaluation of that priority rating will be conducted. (3-20-20)T

**b.** Priority Target Date. An eligible applicant whose project is on the approved priority list, and for which funding is available, will be contacted by the Department and a target date for submission of a completed loan application will be established. (3-20-20)T

**c.** Project Bypass. A project that does not or will not meet the project target date or a Department schedule that allows for timely utilization of loan funds may be bypassed, substituting in its place the next highest ranking project(s) that is ready to proceed. An eligible applicant that is bypassed will be notified in writing of the reasons for being bypassed. (3-20-20)T

**05. Amendment of Integrated Priority List.** The Director may amend the Integrated Priority List as set forth in Section 995 of these rules. (3-20-20)T

**021. DISADVANTAGED LOANS.**

Disadvantaged Loan Awards. In conjunction with the standard loans, the Department may award disadvantaged loans to applicants deemed disadvantaged using the following criteria: (3-20-20)T

**01. Qualifying for a Disadvantaged Loan.** In order to qualify for a disadvantaged loan, a loan applicant must have an annual user rate for wastewater service for residential customers which exceeds two percent (2%) of the applicant community's median household income or, if the user rate is between one and one-half percent (1½%) and two percent (2%) of the applicant community's median household income, the community must also have: unemployment that exceeds the state average; and a decreasing population. The applicant shall agree to a thirty (30) year loan unless the design life of the project is documented to be less than thirty (30) years. The annual user rate would be based on all operating, maintenance, replacement, and debt service costs (both for the existing system and for upgrades). If the applicant's service area is not within the boundaries of a municipality, or if the applicant's service area's median household income is not consistent with the municipality as a whole, the applicant may use the census data for the county in which it is located or may use a representative survey, conducted by a Department approved, objective third party, to verify the median household income of the applicant's service area. (3-20-20)T

**02. Adjustment of Loan Terms.** DEQ will equally apportion funds available for principal forgiveness to all prospective disadvantaged loan recipients. Consistent with achieving user rates as per the criteria set forth in Subsection 021.01, and where possible with available funds, loan terms may be adjusted in the following order: decreasing the interest rate and providing principal forgiveness. (3-20-20)T

**a. Decreasing Interest Rate.** The loan interest rate may be reduced from the rate established by the Director for standard loans to a rate that results in an annual user rate equaling the criteria set forth in Subsection 021.01. The interest rate may be reduced to as low as zero percent (0%). (3-20-20)T

**b. Principal Forgiveness.** If even at zero percent (0%) interest, the annual user rate per residential user still exceeds the criteria set forth in Subsection 021.01, then the principal which causes the user charge to exceed the criteria set forth in Subsection 021.01 may be partially forgiven or reduced. The principal reduction cannot exceed fifty percent (50%) of the total loan. Principal forgiveness terms may be revised (from initial estimates established in the annual Intended Use Plan) based upon final construction costs, such that loan terms do not result in user rates that are below the criteria set forth in Subsection 021.01. (3-20-20)T

**022. SUPPLEMENTAL GRANTS.**

In conjunction with loans, the Department may award state funded supplemental grants, not to exceed ninety percent (90%) of total eligible costs, to loan recipients in the following manner: (3-20-20)T

**01. Projects Not Funded by Loans.** Planning and design projects may receive grant assistance up to ninety percent (90%) funding of eligible costs not funded by a loan; and (3-20-20)T

**02. Costs in Excess of Financial Ability.** (3-20-20)T

**a.** Loan recipients may receive supplemental grant assistance for eligible costs that exceed the amount a loan recipient is able to pay. In order to qualify for a supplemental grant, a loan recipient must have the following: (3-20-20)T

**i.** An annual user rate per household which exceeds one and one-half percent (1 1/2%) of the median household income from the most recent census data. If the loan recipient's service area is not within the boundaries of a municipality, the loan recipient may use the census data for the county in which it is located or may use an income survey approved by the Department; and (3-20-20)T

**ii.** The annual user rate includes all operating, maintenance, replacement and debt service costs, both for the existing system and for upgrades. (3-20-20)T

**b.** If a loan recipient meets the requirement of Subsections 022.02.i. and 022.02.ii., a supplemental grant may be made for the amount of the project that causes the annual user rate for wastewater service per household to exceed one and one-half percent (1 1/2%) of the median household income, subject to available funds. (3-20-20)T

**03. Accrued Interest on Loans with Supplemental Grants.** Interest will not be accrued during the design and construction phases on loan projects that also have a supplemental grant. (3-20-20)T

**023. -- 029. (RESERVED)**

**030. PROJECT SCOPE AND FUNDING.**

Loan funds awarded under this program may be used to prepare a wastewater treatment facility planning document which identifies the cost effective and environmentally sound alternative to achieve or maintain compliance with IDAPA 58.01.16, "Wastewater Rules," and the Clean Water Act, 33 U.S.C. Sections 1381 et seq., and which is approvable by the Department. Loan funds may also be used for design and construction of the chosen alternative. (3-20-20)T

**01. Nonpoint Source Implementation Funding.** Eligible nonpoint source water pollution control projects may be funded when all of the following criteria are met: (3-20-20)T

- a.** Consistent with and implements the Idaho Nonpoint Source Management Plan. (3-20-20)T
- b.** Data is used to substantiate a nonpoint source pollutant problem or issue exists and is described or directly referenced. (3-20-20)T
- c.** Completed project implementation plan or work plan. (3-20-20)T
- d.** Project commitment documentation through demonstrated ability for loan repayment. (3-20-20)T
- e.** The project includes documentation that the project owner(s), manager(s), or the sponsoring agency will maintain the project for the life of the project (e.g., Maintenance Agreement). (3-20-20)T
- f.** The project provides adequate tracking and evaluation of the effectiveness of the water quality improvements being funded by either the project owner/manager or the sponsoring agency throughout the life of the project. (3-20-20)T
- g.** The project demonstrates nexus/benefit to municipality through a letter of support from one (1) or more affected municipalities. (3-20-20)T

**02. Wastewater Treatment Facility Funding.** Projects may be funded in steps: (3-20-20)T

- a.** Step 1. Planning document prepared in accordance with the Handbook. (3-20-20)T
- b.** Step 2. Design which includes the preparation of the detailed engineering plans and specifications necessary for the bidding and construction of the project. (3-20-20)T
- c.** Step 3. Construction, which includes bidding and actual construction of the project. (3-20-20)T
- d.** Step 4. A combination of Step 2 and Step 3. (3-20-20)T
- e.** Combination Step Funding. Projects may be funded in any combination of the steps with the approval of the Department. Separate loans may be awarded for Step 1 or Step 2 projects. If a Step 1 or Step 2 project proceeds to construction, either the Step 1 or Step 2 loan, or both, may be consolidated with the Step 3 loan. If a project does not proceed to construction, outstanding Step 1 and Step 2 loans will be amortized and a repayment schedule prepared by the Department. (3-20-20)T

**f.** Cost Effective Requirement. Step 2, Step 3 or Step 4 loans shall not be awarded until a final cost effective and environmentally sound alternative has been selected by the Step 1 planning document and approved by the Department. If the planning document has not been completed pursuant to IDAPA 58.01.04, "Rules for Administration of Wastewater Treatment Facility Grants," then the loan recipient shall provide an opportunity for the public to comment on the draft planning document. The public comment period shall be held after alternatives have



been developed and the Department has approved the draft planning document. The loan recipient shall provide written notice of the public comment period and hold at least one (1) public meeting within the jurisdiction of the loan recipient during the public comment period. At the public meeting, the draft planning document shall be presented by the loan recipient with an explanation of the alternatives identified. The cost effective and environmentally sound alternative selected shall consider public comments received from those affected by the proposed project. After the public meeting and public comment period, the final alternative will be selected and the Environmental Information Document will be prepared. (3-20-20)T

**g.** Funding For Reserve Capacity. Funding for reserve capacity of a treatment plant will not exceed a twenty (20) year population growth and funding for reserve capacity of an interceptor will not exceed a forty (40) year population growth as determined by the Department. (3-20-20)T

**031. LIMITATION OF PRELOAN ENGINEERING REVIEWS.**

Preloan engineering documents prepared by consulting engineers will be reviewed by Department staff only when accompanied by a certificate that the consulting engineer carries professional liability insurance in accordance with Subsection 050.05.d. (3-20-20)T

**032. LOAN FEE.**

**01. Loan Fee.** The Department may elect to impose a loan fee when necessary to offset the costs of administering the loan program, to provide planning assistance, or to otherwise facilitate the operation of the Clean Water Act State Revolving Fund (CWSRF) effort. The Department may impose a loan fee on loans scheduled to close after January 4, 2006. The loan fee shall not exceed one percent (1%) of the unpaid balance of the loan at the time each loan payment is due. (3-20-20)T

**02. Determination of Loan Fee.** The Department shall determine the amount of the loan fee on a yearly basis and shall assess a loan fee based upon each loan recipient's total interest rate. The amount of the loan fee shall be included in the Intended Use Plan, as described by Section 606(c) of the Clean Water Act. In determining the amount of the loan fee, the Department shall consider: (3-20-20)T

**a.** The Department's anticipated costs of administering the loan program for the upcoming fiscal year, including salaries and overhead; (3-20-20)T

**b.** Any Department costs related to providing technical assistance for the loan program for the upcoming fiscal year; (3-20-20)T

**c.** The amount of money generated from loan fees in previous fiscal years available for use in the upcoming fiscal year; and (3-20-20)T

**d.** The anticipated demand for planning assistance to supplement regular appropriations and other related needs to support the CWSRF loan program. (3-20-20)T

**03. Effect on Loan Interest Rate.** The loan interest rate, as described in Subsection 050.05, will be reduced by the corresponding percentage of the loan fee. (3-20-20)T

**04. Payment of Loan Fee.** The loan fee shall be due and payable concurrently with scheduled loan principal and interest repayments over the repayment period. (3-20-20)T

**033. -- 039. (RESERVED)**

**040. LOAN APPLICATION AND REVIEW.**

**01. Submission of Application.** Those eligible systems which received high priority ranking shall be invited to submit an application. The applicant shall submit to the Department, a completed application on a form as prescribed by the Department. (3-20-20)T

**02. Application Requirements.** Applications shall contain the following documentation, as

- applicable: (3-20-20)T
- a.** A lawful resolution passed by the governing body authorizing an elected official or officer of the applicant to execute a loan contract and sign subsequent loan disbursement requests; (3-20-20)T
  - b.** Contracts for engineering or other technical services and the description of costs and tasks set forth therein shall be in sufficient detail for the Department to determine whether the costs associated with the tasks are eligible costs pursuant to Section 041; (3-20-20)T
  - c.** Justification for the engineering firm selected. An engineering firm selected by the applicant must at a minimum: (3-20-20)T

    - i.** Be procured for design and/or services during construction or previously procured for planning services through the selection guidelines and procedures prescribed under Section 67-2320, Idaho Code; (3-20-20)T
    - ii.** Be a registered professional engineer currently licensed by the Idaho Board of Professional Engineers and Land Surveyors; (3-20-20)T
    - iii.** Not be debarred or otherwise prevented from providing services under another federal or state financial assistance program; and (3-20-20)T
    - iv.** Be covered by professional liability insurance in accordance with Subsection 050.05.d. of these rules. A certification of liability insurance shall be included in the application. (3-20-20)T
  - d.** A description of other costs, not included in the contracts for engineering or other technical services, for which the applicant seeks funding. The description of the costs and tasks for such costs must be in sufficient detail for the Department to determine whether the costs are eligible costs pursuant to Section 041; (3-20-20)T
  - e.** A demonstration that the obligation to pay the costs for which funding is requested is the result or will be the result of the applicant's compliance with applicable competitive bidding requirements for construction and requirements for professional service contracts, including without limitation, the requirements set forth in Sections 67-2801 et seq., 67-2320, 59-1026, and 42-3212, Idaho Code. (3-20-20)T
  - f.** Step 1 -- Scope of work describing the work tasks to be performed in the preparation of the planning document if required in accordance with Subsection 030.02, a schedule for completion of the work tasks and an estimate of staff hours and costs to complete the work tasks; (3-20-20)T
  - g.** Step 2 -- Design, or Step 4 -- Design and Construction: (3-20-20)T

    - i.** Planning document, including a final environmental document and decision in accordance with Section 042; (3-20-20)T
    - ii.** Financial and management capability analysis as provided in Subsection 010.01; and (3-20-20)T
    - iii.** Intermunicipal service agreements between all entities within the scope of the project, if applicable; (3-20-20)T
  - h.** Step 3 -- Construction: (3-20-20)T

    - i.** Documented evidence of all necessary easements and land acquisition; (3-20-20)T
    - ii.** Biddable plans and specifications of the approved wastewater treatment facility alternative; (3-20-20)T
    - iii.** A plan of operation and project schedule; (3-20-20)T

- iv. A user charge system, sewer use ordinance and financial management system; and (3-20-20)T
- v. A staffing plan and budget; (3-20-20)T
- i. Step 4 -- Design and Construction. Loan applicants must submit all documentation specified in Subsection 040.02.h. prior to advertising for bids on construction contracts; (3-20-20)T
- j. Nonpoint Source Implementation Funding: (3-20-20)T
  - i. Information demonstrating that the project is consistent with and implements the Idaho Nonpoint Source Management Plan; (3-20-20)T
  - ii. Data that substantiates a nonpoint source pollution problem or issue exists; (3-20-20)T
  - iii. A project implementation plan or workplan; (3-20-20)T
  - iv. Project commitment documentation that demonstrates the ability for loan repayment; (3-20-20)T
  - v. Documentation that the project owner, manager or sponsoring agency will maintain the project for the life of the project; (3-20-20)T
  - vi. A demonstration that there will be adequate tracking and evaluation of the effectiveness of the water quality improvements being funded by either the project owner/manager or the sponsoring agency throughout the life of the project; and (3-20-20)T
  - vii. A description of the nexus/benefit to a municipality and a letter of support from one (1) or more affected municipalities. (3-20-20)T

**03. Determination of Completeness of Application.** The Department shall review the application to determine whether it includes all of the information required by Subsection 040.02. (3-20-20)T

**04. Notification of Incompleteness of Application.** Written notification if an application is incomplete, including an explanation of missing documentation will be sent to the applicant. The applicant may provide the missing documentation. (3-20-20)T

**05. Reapplication for Loan.** The action of disapproving, recalling or terminating a loan in no way precludes or limits the former applicant from reapplying for another loan when the project deficiencies are resolved and project readiness is secured. (3-20-20)T

**041. DETERMINATION OF ELIGIBILITY OF COSTS.**

The Department shall review the application, including any contracts required to be submitted with the application, to determine whether the costs are eligible costs for funding. (3-20-20)T

**01. Eligible Costs.** Eligible costs are those determined by the Department to be: (3-20-20)T

- a. Necessary costs; (3-20-20)T
- b. Reasonable costs; and (3-20-20)T
- c. Costs that are not ineligible as described in Subsection 041.05. (3-20-20)T

**02. Necessary Costs.** The Department shall determine whether costs are necessary by comparing the tasks for which the costs will be incurred to the scope of the project as described in the plan of study for facility planning documents, the project implementation plan or work plan for nonpoint source projects, and any other relevant information in the application that describes the scope of the project to be funded. (3-20-20)T

**03. Reasonable Costs.** Costs shall be determined by the Department to be reasonable if the obligation

to pay the costs is the result of or will be the result of the applicant's compliance with applicable competitive bidding requirements for construction and requirements for professional service contracts, including without limitation, the requirements set forth in Sections 67-2801 et seq., 67-2320, 59-1026, and 42-3212, Idaho Code. (3-20-20)T

**04. Examples of Costs That May Be Eligible.** Examples of costs that may be eligible, if determined necessary, reasonable and not ineligible costs include: (3-20-20)T

**a.** Costs of salaries, benefits, and expendable material the applicant incurs in the project except ordinary operating expenses of local government, such as salaries and expenses of mayors, city council members, attorneys, commissioners, board members, or managers; (3-20-20)T

**b.** Costs under construction contracts bid and executed in compliance with state public works construction laws; (3-20-20)T

**c.** Professional and consulting services utilizing a lump sum contract, a negotiated hourly rate contract, a time and materials contract, or cost plus a fixed fee contract; (3-20-20)T

**d.** Planning directly related to the water pollution control projects; (3-20-20)T

**e.** Sewer system evaluations; (3-20-20)T

**f.** Financial and management capability analysis; (3-20-20)T

**g.** Preparation of construction drawings, specifications, estimates, and construction contract documents; (3-20-20)T

**h.** Landscaping; (3-20-20)T

**i.** Removal and relocation or replacement of utilities for which the applicant is legally obligated to pay; (3-20-20)T

**j.** Material acquired, consumed, or expended specifically for the project; (3-20-20)T

**k.** A reasonable inventory of laboratory chemicals and supplies necessary to initiate plant operations; (3-20-20)T

**l.** Preparation of an operation and maintenance manual; (3-20-20)T

**m.** Preparation of a plan of operation; (3-20-20)T

**n.** Start-up services; (3-20-20)T

**o.** Project identification signs; (3-20-20)T

**p.** Public participation for alternative selection; (3-20-20)T

**q.** Development of user charge and financial management systems; (3-20-20)T

**r.** Development of sewer use ordinance; (3-20-20)T

**s.** Staffing plans and budget development; (3-20-20)T

**t.** Certain direct and other costs as determined eligible by the Department; (3-20-20)T

**u.** Costs of complying with the Federal Water Pollution Control Act (P.L. 92-500) as amended, 33 USC Section 1251 et seq., loan requirements applied to specific projects; and (3-20-20)T

v. Site acquisition costs, including sewer right of way, sewage treatment plant site, wastewater land application sites and sludge disposal areas. Land purchase shall be from a willing seller. (3-20-20)T

**05. Ineligible Project Costs.** Costs which are ineligible for funding include, but are not limited to: (3-20-20)T

a. Basin or area wide planning not directly related to the project; (3-20-20)T

b. Bonus payments not legally required for completion of construction before a contractual completion date; (3-20-20)T

c. Personal injury compensation or damages arising out of the project; (3-20-20)T

d. Fines or penalties due to violations of, or failure to comply with, federal, state, or local laws; (3-20-20)T

e. Costs outside the scope of the approved project; (3-20-20)T

f. Ordinary operating expenses of local government, such as salaries and expenses of mayors, city council members, attorneys, commissioners, board members, or managers; (3-20-20)T

g. Construction of privately owned wastewater treatment facilities; (3-20-20)T

h. Cost of land in excess of that needed for the proposed project; (3-20-20)T

i. Cost of refinancing existing indebtedness; (3-20-20)T

j. Reserve funds; and (3-20-20)T

k. Costs incurred prior to acceptance of the loan unless specifically approved in writing as eligible pre-award costs by the Department. (3-20-20)T

**06. Notification Regarding Ineligible Costs.** Prior to providing a loan offer, the Department shall notify the applicant if certain costs are not eligible for funding and the reasons for the Department's determination. If such costs are included in the engineering contract, the Department shall also provide notification to the engineer. The applicant may provide the Department additional information in response to the notice. (3-20-20)T

**07. Eligible Costs and the Loan Offer.** The loan offer shall reflect those costs determined by the Department to be eligible costs. The loan offer, however, may include estimates of some eligible costs that have not yet been set, such as construction costs. Actual eligible costs may differ from such estimated costs set forth in the loan offer. In addition, loan disbursements may be increased or decreased if eligible costs are modified as provided in Section 060. (3-20-20)T

## **042. ENVIRONMENTAL REVIEW.**

**01. Environmental Documentation.** Projects may be a nonpoint source activity or a wastewater treatment facility or other point source facility. Guidance on how to complete an environmental review may be found in Chapter 5 of the Handbook. For eligible point source projects funded solely with non-federal funds (i.e. State Revolving Loan Fund repayments), see Subsection 042.10. For eligible point source projects, the loan recipient shall complete an environmental review as part of and in conjunction with a planning document. Projects funded exclusively as nonpoint or estuary management projects may not be required to complete an environmental review. The loan recipient shall consult with the Department at an early stage in the loan process to determine the required level of environmental review. Based on review of existing information, and assessment of environmental impacts, the loan recipient shall complete one (1) of the following per the Department's instruction: (3-20-20)T

a. Submit a request for Categorical Exclusion (CE) with supporting backup documentation as specified by the Department; (3-20-20)T

b. Prepare an Environmental Information Document (EID) in a format specified by the Department;  
or (3-20-20)T

c. Prepare an Environmental Impact Statement (EIS) in a format specified by the Department.  
(3-20-20)T

**02. Categorical Exclusions.** If the loan recipient requests a CE, the Department shall review the request and, based upon the supporting documentation, take one (1) of the following actions: (3-20-20)T

a. Determine if the action is consistent with categories eligible for exclusion whereupon the Department shall issue a notice of CE from substantive environmental review. Once the CE is granted for the selected alternative, the Department will publish a notice of CE in a local newspaper in the geographical area of the proposed project to inform the public of this action, following which the planning document can be approved and the loan award can proceed; or (3-20-20)T

b. Determine if the action is not consistent with categories eligible for exclusion and that issuance of a CE is not appropriate. If a CE is not issued, the Department shall notify the loan recipient to prepare an EID. (3-20-20)T

**03. Environmental Information Document Requirements.** When an EID is required, the loan recipient shall prepare the EID in accordance with the following Department procedures: (3-20-20)T

a. Various laws and executive orders related to environmentally sensitive resources shall be considered as the EID is prepared. Appropriate state and federal agencies shall be consulted regarding these laws and executive orders; (3-20-20)T

b. A full range of relevant impacts, both direct and indirect, of the proposed project shall be discussed in the EID, including measures to mitigate adverse impacts, cumulative impacts, and impacts that shall cause irreversible or irretrievable commitment of resources; and (3-20-20)T

c. The Department shall review the draft EID and either request additional information about one (1) or more potential impacts, or shall draft a “finding of no significant impact” (FONSI). (3-20-20)T

**04. Final Finding of No Significant Impact.** The Department shall publish the draft FONSI in a local newspaper in the geographical area of the proposed project and shall allow a minimum thirty (30) day public comment period. Following the required period of public review and comment, and after any public concerns about project impacts are addressed, the FONSI shall become final. The Department shall assess the effectiveness and feasibility of the mitigation measures identified in the FONSI and EID prior to the issuance of the final FONSI and approval of the planning document. (3-20-20)T

**05. Environmental Impact Statement (EIS) Requirements.** If an (EIS) is required, the loan recipient shall: (3-20-20)T

a. Consult with all affected federal and state agencies, and other interested parties, to determine the required scope of the document; (3-20-20)T

b. Prepare and submit a draft EIS to all interested agencies, and other interested parties, for review and comment; (3-20-20)T

c. Conduct a public meeting which may be in conjunction with a planning document meeting; and (3-20-20)T

d. Prepare and submit a final EIS incorporating all agency and public input for Department review and approval. (3-20-20)T

**06. Final Environmental Impact Statement (EIS).** Upon completion of the EIS by the loan recipient

and approval by the Department of all requirements listed in Subsection 042.05, the Department shall issue a record of decision, documenting the mitigation measures which shall be required of the loan recipient. The loan agreement can be completed once the final EIS has been approved by the Department. (3-20-20)T

**07. Partitioning the Environmental Review.** Under certain circumstances, the building of a component/partition of a wastewater system may be justified in advance of all environment review requirements for the remainder of the system. The Department shall approve partitioning the environment review in accordance with established procedures. (3-20-20)T

**08. Use of Environmental Reviews Conducted by Other Agencies.** If environmental review for the project has been conducted by another state, federal, or local agency, the Department may, at its discretion, issue its own determination by adopting the document and public participation process of the other agency. (3-20-20)T

**09. Validity of Review.** Environmental reviews, once completed by the Department, are valid for five (5) years from the date of completion. If a loan application is received for a project with an environmental review which is more than five (5) years old, the Department shall reevaluate the project, environmental conditions and public views and shall: (3-20-20)T

**a.** Reaffirm the earlier decision; or (3-20-20)T

**b.** Require supplemental information to the earlier EIS, EID, or request for CE. Based upon a review of the updated document, the Department shall issue and distribute a revised notice of CE, FONSI, or record of decision. (3-20-20)T

**10. Exemption From Review.** Loan projects may be exempt from certain federal crosscutting authorities at the discretion of the Department as long as in any given year the annual amount of loans, equal to the most recent federal capitalization grant, complies with all of the federal crosscutting authorities. (3-20-20)T

**043. -- 049. (RESERVED)**

**050. LOAN OFFER AND ACCEPTANCE.**

**01. Loan Offer.** Loan offers will be delivered to successful applicants by representatives of the Department or by registered mail. (3-20-20)T

**02. Acceptance of Loan Offer.** Applicants have sixty (60) days in which to officially accept the loan offer on prescribed forms furnished by the Department. The sixty (60) day acceptance period commences from the date indicated on the loan offer notice. If the applicant does not accept the loan offer within the sixty (60) day period the loan funds may be offered to the next project of priority. (3-20-20)T

**03. Acceptance Executed as a Contract Agreement.** Upon signature by the Director and upon signature by the authorized representative of the eligible applicant, the loan offer shall become a contract. Upon accepting a loan offer a eligible applicant becomes a loan recipient. The disbursement of funds pursuant to a loan contract is subject to a finding by the Director that the loan recipient has complied with all loan contract conditions and has prudently managed the project. The Director may, as a condition of disbursement, require that a loan recipient vigorously pursue any claims it has against third parties who will be paid in whole or in part, directly or indirectly, with loan funds. No third party shall acquire any rights against the state or its employees from a loan contract. (3-20-20)T

**04. Estimate of Reasonable Cost.** All loan contracts will include the eligible costs of the project. Some eligible costs may be estimated and disbursements may be increased or decreased as provided in Section 060. (3-20-20)T

**05. Terms of Loan Offers.** The loan offer shall contain such terms as are prescribed by the Department including, but not limited to: (3-20-20)T

**a.** Terms consistent with these rules, the project step to be funded under the loan offer, and Title 39,

Chapter 36, Idaho Code; (3-20-20)T

**b.** Special clauses as determined necessary by the Department for the successful investigation, design, construction and management of the project; (3-20-20)T

**c.** Terms consistent with applicable state and federal laws pertaining to planning documents, design, and construction, including the Public Works Contractors License Act and the Public Contracts Bond Act, Chapter 19, Title 54, Idaho Code, and the federal Clean Water Act requirements for projects funded with loan moneys of federal origin; (3-20-20)T

**d.** Requirement for the prime engineering firm(s) and their principals retained for engineering services to carry professional liability insurance to protect the public from the engineer's negligent acts and errors and omissions of a professional nature. The total aggregate of the engineer's professional liability insurance shall be one hundred thousand dollars (\$100,000) or twice the amount of the engineer's fee, whichever is greater. Professional liability insurance must cover all such services rendered for all project phases, whether or not such services or phases are state funded, until the certification of project performance is accepted by the Department; (3-20-20)T

**e.** The project shall be bid, contracted and constructed according to the current edition of Idaho Standards for Public Works Construction unless the loan recipient has approved and adopted acceptable public works construction standards approved by the Department; (3-20-20)T

**f.** The loan interest rate for loans made during the state fiscal year beginning July 1 will be established by the Director. The interest rate will be a fixed rate in effect for the life of the loan. The rate may equal but shall not exceed the current market rate; (3-20-20)T

**g.** The loan fee pursuant to Section 032; (3-20-20)T

**h.** All loans must be fully amortized within a period not to exceed thirty (30) years after project completion. The loan contract will contain a schedule of loan repayments stating the due dates and the amount due. The loan recipient may elect for either a schedule of semi-annual or annual repayments at the time the loan is finalized; and (3-20-20)T

**i.** Repayment default will occur when a scheduled loan repayment is thirty (30) days past due. If default occurs, the Department may invoke appropriate loan contract provisions and/or bond covenants. (3-20-20)T

**051. ACCOUNTING AND AUDITING PROCEDURES.**

Loan recipients must maintain project accounts in accordance with generally accepted accounting principles. Eligible nonpoint source water pollution control implementation funding project sponsors may be audited on an annual basis according to government auditing standards issued by the U.S. General Accounting Office. (3-20-20)T

**052. -- 059. (RESERVED)**

**060. DISBURSEMENTS.**

**01. Loan Disbursements.** Requests to the Department for actual disbursement of loan proceeds will be made by the loan recipient on forms provided by the Department. (3-20-20)T

**02. Loan Increases.** An increase in the loan amount as a result of an increase in eligible project costs will be considered, provided funds are available. Documentation supporting the need for an increase must be submitted to the Department for approval prior to incurring any costs above the eligible cost ceiling. (3-20-20)T

**03. Loan Decreases.** If the actual eligible cost is determined by the Department to be lower than the estimated eligible cost the loan amount will be reduced proportionately. (3-20-20)T

**04. Project Review to Determine Final Eligible Costs.** A project review by the Department or a Department designee will determine the final eligible costs. (3-20-20)T



**05. Final Disbursement.** The final loan disbursement consisting of five percent (5%) of the total loan amount shall not be made until final inspection, final review, and a final loan repayment schedule have been completed. (3-20-20)T

**061. LOAN CONSOLIDATION.**

If two (2) or more loans are consolidated into one (1) loan, the interest rate for the consolidated loan will be at the same rate as the loan being consolidated with the lowest interest rate. (3-20-20)T

**062. -- 079. (RESERVED)**

**080. SUSPENSION OR TERMINATION OF LOAN CONTRACTS.**

**01. Causes.** The Director may suspend or terminate any loan contract prior to final disbursement for failure by the loan recipient or its agents, including engineering firm(s), contractor(s) or subcontractor(s) to perform. A loan contract may be suspended or terminated for good cause including, but not limited to, the following: (3-20-20)T

**a.** Commission of fraud, embezzlement, theft, forgery, bribery, misrepresentation, conversion, malpractice, misconduct, malfeasance, misfeasance, falsification or unlawful destruction of records, or receipt of stolen property, or any form of tortious conduct; or (3-20-20)T

**b.** Commission of any crime for which the maximum sentence includes the possibility of one (1) or more years' imprisonment or any crime involving or affecting the project; or (3-20-20)T

**c.** Violation(s) of any term of the loan contract; or (3-20-20)T

**d.** Any willful or serious failure to perform within the scope of the project, plan of operation and project schedule, terms of engineering subagreements, or contracts for construction; or (3-20-20)T

**e.** Debarment of a contractor or subcontractor for good cause by any federal or state agency from working on public work projects funded by that agency. (3-20-20)T

**02. Notice.** The Director will notify the loan recipient in writing and by certified mail of the intent to suspend or terminate the loan contract. The notice of intent shall state: (3-20-20)T

**a.** Specific acts or omissions which form the basis for suspension or termination; and (3-20-20)T

**b.** That the loan recipient may be entitled to appeal the suspension or termination pursuant to IDAPA 58.01.23, "Rules of Administrative Procedure Before the Board of Environmental Quality." (3-20-20)T

**03. Determination.** A determination will be made by the Board pursuant to IDAPA 58.01.23, "Rules of Administrative Procedure Before the Board of Environmental Quality." (3-20-20)T

**04. Reinstatement of Suspended Loan.** Upon written request by the loan recipient with evidence that the causes(s) for suspension no longer exists, the Director may, if funds are available reinstate the loan contract. If a suspended loan contract is not reinstated, the loan will be amortized and a repayment schedule prepared in accordance with provisions of the loan contract. (3-20-20)T

**05. Reinstatement of Terminated Loan.** No terminated loan shall be reinstated. Terminated loans will be amortized and a repayment schedule prepared in accordance with provisions of the loan contract. (3-20-20)T

**081. -- 994. (RESERVED)**

**995. WAIVER OF REQUIREMENTS AND AMENDMENT OF INTEGRATED PRIORITY LIST.**

**01. Conditions for Waiver.** The Director may amend the Integrated Priority List and grant a waiver from the requirements of these rules on a case-by-case basis upon full demonstration by the loan recipient requesting

the waiver that the following conditions exist. See also Subsection 020.05 of these rules. (3-20-20)T

- a. Health Hazard.** A significant public health hazard exists; (3-20-20)T
- b. Water Contamination.** A significant water contamination problem exists; (3-20-20)T
- c. Pollution.** A significant point source of pollution exists causing a violation of Idaho Department of Environmental Quality Rules, IDAPA 58.01.02, “Water Quality Standards”; or (3-20-20)T
- d. Affordability Criteria Exceeded.** The project will exceed affordability criteria adopted by the Department in the event the waiver is not granted. (3-20-20)T
- 02. Availability of Federal Funds.** The waiver will not affect the availability of federal funds for the project where such funding is required by the loan recipient requesting the waiver. (3-20-20)T

**996. -- 999. (RESERVED)**

## 58.01.13 – RULES FOR ORE PROCESSING BY CYANIDATION

### 000. LEGAL AUTHORITY.

Title 39, Chapter 1, Idaho Code, grants the authority to the Board of Environmental Quality to adopt rules, regulations and standards to protect the environment and the health of the State; grants authority to the Director to issue permits as prescribed by law and by the rules of the Board; and requires Department of Environmental Quality review and approval of plans and specifications for all new facilities, or for modifications or expansions to existing facilities, that process ore by cyanidation; and authorizes the Director to require a reasonable fee for processing permit applications. (3-20-20)T

### 001. TITLE, SCOPE AND INTENT.

01. **Title.** These rules are titled IDAPA 58.01.13, “Rules for Ore Processing by Cyanidation.” (3-20-20)T

02. **Scope and Intent.** These rules establish the procedures and requirements for the issuance and maintenance of a permit to construct, operate and close that portion of a cyanidation facility that is intended to contain, treat or dispose of process water or process-contaminated water containing cyanide. The provisions of these rules also establish requirements for water quality protection which address performance, construction, operation and closure of that portion of any cyanidation facility that is intended to contain, treat, or dispose of process water. These rules are intended to ensure that process water and process-contaminated water generated in ore processing operations that utilize cyanide as a primary leaching agent and pollutants associated with the cyanidation process are safely contained, controlled, and treated so that they do not interfere with the beneficial uses of the waters of the state and do not endanger public safety or the environment. (3-20-20)T

### 002. WRITTEN INTERPRETATIONS.

As described in Section 67-5201(19)(b)(iv), Idaho Code, the Department of Environmental Quality may have written statements which pertain to the interpretation of these rules. If available, such written statements can be inspected and copied at cost at the Department of Environmental Quality, 1410 N. Hilton, Boise, Idaho 83706-1255. (3-20-20)T

### 003. ADMINISTRATIVE PROVISIONS.

Persons may be entitled to appeal agency actions authorized under these rules pursuant to IDAPA 58.01.23, “Rules of Administrative Procedure Before the Board of Environmental Quality.” (3-20-20)T

### 004. INCORPORATION BY REFERENCE.

These rules do not contain documents incorporated by reference. (3-20-20)T

### 005. OFFICE HOURS – MAILING ADDRESS AND STREET ADDRESS.

The state office of the Department of Environmental Quality and the office of the Board of Environmental Quality are located at 1410 N. Hilton, Boise, Idaho 83706-1255, telephone number (208) 373-0502. The office hours are 8:00 a.m. to 5:00 p.m. mountain time, Monday through Friday. (3-20-20)T

### 006. CONFIDENTIALITY OF RECORDS.

Information obtained by the Department under these rules is subject to public disclosure pursuant to the provisions of Title 74, Chapter 1, Idaho Code, and IDAPA 58.01.21, “Rules Governing the Protection and Disclosure of Records in the Possession of the Idaho Department of Environmental Quality.” (3-20-20)T

### 007. DEFINITIONS.

01. **Beneficial Use.** Any of the various uses which may be made of the surface and/or ground water of the state including, but not limited to, domestic water supplies, industrial water supplies, agricultural water supplies, navigation, recreation in and on the water, wildlife habitat, and aesthetics. Beneficial uses for specific stream segments are established in Idaho Department of Environmental Quality Rules, IDAPA 58.01.02, “Water Quality Standards.” (3-20-20)T

02. **Best Management Practices (BMPs).** Practices, techniques or measures developed, or identified, by the designated agency or identified in the state water quality management plan, as described in IDAPA 58.01.02, “Water Quality Standards,” which are determined to be a cost-effective and practicable means of preventing or reducing pollutants generated from nonpoint sources to a level compatible with water quality goals. (3-20-20)T

03. **Cyanidation.** The method of extracting target precious metals from ores by treatment with a cyanide solution, which is the primary leaching agent for extraction. (3-20-20)T

- 04. Cyanidation Facility.** That portion of a new ore processing facility, or a material modification or a material expansion of that portion of an existing ore processing facility, that utilizes cyanidation and is intended to contain, treat, or dispose of cyanide containing materials including spent ore, tailings and process water. (3-20-20)T
- 05. Department.** The Idaho Department of Environmental Quality. (3-20-20)T
- 06. Director.** The Director of the Department of Environmental Quality or his designee. (3-20-20)T
- 07. Discharge.** When used without qualification, any spilling, leaking, emitting, escaping, leaching, or disposing of a pollutant into the waters of the state. (3-20-20)T
- 08. Groundwater.** Any water of the state which occurs beneath the surface of the earth in a saturated geological formation of rock or soil. (3-20-20)T
- 09. Impoundment.** For the purpose of these rules an impoundment means a structure such as a pond, reservoir, tank, or vat that collects and confines liquids or slurries. (3-20-20)T
- 10. Land Application.** A process or activity involving application of process water, wastewater, surface water, or semi-liquid material to the land for the purpose of disposal, pollutant removal, or groundwater recharge. (3-20-20)T
- 11. Liner.** A continuous layer of natural or man-made materials beneath and, if applicable, on the sides of a surface impoundment or leach pad which restricts the downward and lateral movement of liquids. (3-20-20)T
- 12. Material Modification or Material Expansion.** (3-20-20)T
- a.** The addition of a new beneficiation process, or a significant change in the capacity of an existing beneficiation process, which was not identified in the original application and that significantly increases the potential to degrade the waters of the state. Such process could include, but is not limited to, heap leaching and process components for milling; or (3-20-20)T
- b.** A significant change in the location of a proposed process component or site condition which was not adequately described in the original application; or (3-20-20)T
- c.** A change in the beneficiation process that alters the characteristics of the waste stream in a way that significantly increases the potential to degrade the waters of the state. (3-20-20)T
- d.** For a cyanidation facility with an existing permit that did not actively add cyanide after January 1, 2005, reclamation and closure related activities shall not be considered to be material modifications or material expansions of the cyanidation facility. (3-20-20)T
- 13. Material Stabilization.** Managing or treating spent ore, tailings or other solids and/or sludges resulting from the cyanidation process to minimize waters or all other applied solutions from migrating through the material and transporting pollutants associated with the cyanidation facility to ensure that all discharges comply with all applicable standards and criteria. (3-20-20)T
- 14. National Pollution Discharge Elimination System (NPDES) Permit.** A permit issued by the U.S. Environmental Protection Agency for the purpose of regulating discharges into surface waters. (3-20-20)T
- 15. Neutralization.** Treatment of process waters such that discharge or final disposal of those waters does not, or shall not, violate any applicable standards and criteria. (3-20-20)T
- 16. Permanent Closure.** Those activities which result in neutralization, material stabilization and decontamination of cyanidation facilities and/or the facilities' final reclamation. (3-20-20)T
- 17. Permanent Closure Plan.** A description of the procedures, methods, and schedule that will be implemented to meet the intent and purpose of Section 39-118A, Idaho Code, and Chapter 15, Title 47, Idaho Code,

in treating and disposing of cyanide-containing materials including spent ore, tailings, and process water and in controlling and monitoring discharges and potential discharges for a reasonable period of time based on site-specific conditions. (3-20-20)T

**18. Permit.** When used without qualification, any written authorization by the Director, issued pursuant to the application, public participation and appeal procedures in these rules, governing location, operation and maintenance, monitoring, seasonal and permanent closure, discharge response, and design and construction of a new cyanidation facility or a material expansion or material modification to a cyanidation facility. (3-20-20)T

**19. Permittee.** The person in whose name a permit is issued and who is to be the principal party responsible for compliance with these rules and the conditions of a permit. (3-20-20)T

**20. Person.** An individual, corporation, partnership, association, state, municipality, commission, federal agency, special district or interstate body. (3-20-20)T

**21. Pilot Facility.** (3-20-20)T

**a.** A test cyanidation facility that is constructed primarily to obtain data on the effectiveness of the beneficiation process to determine: (3-20-20)T

**i.** The feasibility of metals recovery from an ore; or (3-20-20)T

**ii.** The optimum operating conditions for a predetermined process to extract values from an ore. (3-20-20)T

**b.** A pilot or test facility operates for one (1) year for a single test or two (2) years for multiple tests, during which time no more than ten thousand (10,000) tons of ore are evaluated for the testing process(es), unless the applicant can demonstrate that a greater amount is necessary for a specific purpose in the testing process. (3-20-20)T

**22. Pollutant.** Chemicals, chemical waste, process water, biological materials, radioactive materials, or other materials which, when discharged, cause or contribute adverse effects to any beneficial use, or for any other reason, may impact the surface or ground waters of the state. (3-20-20)T

**23. Post-Closure.** The period of time after completion of permanent closure when the permittee is monitoring the effectiveness of the closure activities. Post-closure shall last a minimum of twelve (12) months but may extend until the cyanidation facility is shown to be in compliance with the stated permanent closure objectives and requirements of Chapter 15, Title 47, Idaho Code, and these rules. (3-20-20)T

**24. Process Waters.** Any liquids which are intentionally or unintentionally introduced into any portion of the cyanidation process. These liquids may contain cyanide or other minerals, meteoric water, ground or surface water, elements and compounds added to the process solutions for leaching or the general beneficiation of ore, or hazardous materials that result from the combination of these materials. (3-20-20)T

**25. Seasonal Closure.** Annual cessation of operations that is due to weather. (3-20-20)T

**26. Small Cyanidation Processing Facility.** A cyanidation facility which chemically processes less than thirty-six thousand five hundred (36,500) tons of ore per year and no more than one hundred twenty thousand (120,000) tons of ore for the life of the project at any one (1) permitted cyanidation facility. No person or applicant may concurrently hold more than one (1) small cyanidation processing facility permit, if the facilities are located within ten (10) miles of each other. (3-20-20)T

**27. Special Resource Water.** Those waters of the state which are recognized as needing intensive protection: (3-20-20)T

**a.** To preserve outstanding or unique characteristics; or (3-20-20)T

**b.** To maintain current beneficial use (refer to Idaho Department of Environmental Quality Rules,

IDAPA 58.01.02, “Water Quality Standards,” for a complete description; special resource waters for specific stream segments are established in Idaho Department of Environmental Quality Rules, IDAPA 58.01.02, “Water Quality Standards”). (3-20-20)T

**28. State.** The state of Idaho. (3-20-20)T

**29. Temporary Closure.** Any cessation of operations exceeding thirty (30) days, other than seasonal or permanent. (3-20-20)T

**30. Treatment.** Any method, technique or process, including neutralization, designed to change the physical, chemical, or biological character or composition of a waste for the purpose of disposal. (3-20-20)T

**31. Water Balance.** An inventory and accounting process, capable of being reconciled, that integrates all potential sources of water that are entrained in the cyanidation facility or may enter into or exit from the cyanidation facility. The inventory must include the water holding capacity of specific structures within the facility that contain process water. The water balance is used to ensure that all process water and other pollutants can be contained as engineered and designed within a factor of safety as determined in the permanent closure plan. (3-20-20)T

**32. Water Management Plan.** A document that describes the results of the water balance and the methods that will be used to ensure that pollutants are not discharged from a cyanidation facility into waters of the state unless permitted or otherwise approved by the Department. (3-20-20)T

**33. Waters of the State.** All the accumulations of water, surface and underground, natural and artificial, public or private, or parts thereof which are wholly or partially within, which flow through or border upon the state. These waters shall not include municipal or industrial wastewater treatment or storage structures or private reservoirs, the operation of which has no effect on waters of the state. (3-20-20)T

**34. Weak Acid Dissociable (WAD) Cyanide.** The cyanide concentration as determined by Method C, Weak Acid Dissociable Cyanide, D2036 of American Society of Testing Materials Book of Standards, “Standard Methods for the Examination of Water and Wastewater,” Method 4500-CN- I, or other methods accepted by the scientific community and deemed appropriate by the Department. (3-20-20)T

**008. -- 009. (RESERVED)**

**010. APPLICABILITY TO FACILITIES WITH EXISTING PERMITS.**

A cyanidation facility with an existing permit approved by the Department prior to July 1, 2005 shall be subject to the applicable laws and rules for ore processing by cyanidation in effect on June 30, 2005. Material modifications or material expansions of such facilities are subject to Section 39-118A, Idaho Code. The rules for ore processing by cyanidation in effect on June 30, 2005 can be obtained by contacting the Department of Environmental Quality, Hearing Coordinator, 1410 N. Hilton, Boise, ID 83706-1255, (208)373-0502, [www.deq.idaho.gov](http://www.deq.idaho.gov). (3-20-20)T

**011. -- 049. (RESERVED)**

**050. CONCEPTUAL DESIGN APPROVAL.**

**01. Information Required for Conceptual Design Approval.** Submittal of a Conceptual Design Report is not mandatory. The Director may, if requested, give initial approval of the basic operation, design concepts, and environmental safeguards proposed based on the information included in a Conceptual Design Report. Approval of the Conceptual Design Report shall not authorize the construction, modification or operation of the cyanidation facility. It is recommended that the Conceptual Design Report address the contents for a permit application as listed in Subsection 100.03. (3-20-20)T

**02. Notice of Conceptual Design Approval or Disapproval.** The Director shall notify the applicant in writing of the decision for conceptual approval or disapproval within a period of thirty (30) days from receiving all information as required under Subsection 050.01. The time required to review and approve, if appropriate, a conceptual design shall be considered separate from and shall not be included as part of the one hundred eighty (180)

day time period for processing the formal application and issuance of a Director's determination pursuant to these rules. (3-20-20)T

**03. Preapplication Conference.** Prospective applicants are encouraged to meet with agents of the Department at least one (1) year in advance of the application submittal to discuss environmental baseline data requirements; waste characterization requirements; siting requirements for surface and ground water monitoring stations, mills, tailing impoundments, waste disposal sites and land application sites; monitoring well construction requirements; operation and maintenance plans; emergency and spill response plans; quality control/quality assurance plans for water quality sampling and analyses; required contents for permit applications; application procedures and schedules; public review and comment periods; public meetings; and agency cyanidation facility visits. The preapplication conference may trigger a period of collaborative effort between the applicant, the Idaho Department of Environmental Quality, and the Idaho Department of Lands in development of checklists to be used by the agencies in reviewing an application for completeness, accuracy and protectiveness. (3-20-20)T

**051. -- 099. (RESERVED)**

**100. PERMIT AND PERMIT APPLICATION.**

**01. Permit Required.** No person shall construct a new cyanidation facility prior to obtaining a permit from the Director. No person shall materially expand or materially modify a cyanidation facility prior to obtaining a modified permit for such expansion or modification pursuant to Section 750. (3-20-20)T

**02. Permit Application.** The owner or proposed operator of a cyanidation facility or the owner's or operator's authorized representative shall: (3-20-20)T

**a.** Make application to the Director in writing and in a manner or form prescribed herein; and (3-20-20)T

**b.** Provide five (5) paper copies of the application to the Director, unless otherwise agreed to by the Department and the applicant. (3-20-20)T

**03. Contents of Application.** A permit application and its contents shall be used to determine if an applicant can locate, construct, operate, maintain, close and monitor the proposed cyanidation facility in conformance with these and other applicable rules including, but not limited to, Idaho Department of Environmental Quality Rules, IDAPA 58.01.02, "Water Quality Standards"; IDAPA 58.01.08, "Idaho Rules for Public Drinking Water Systems"; IDAPA 58.01.05, "Rules and Standards for Hazardous Waste"; IDAPA 58.01.06, "Solid Waste Management Rules"; and IDAPA 58.01.11, "Ground Water Quality Rule." Information required shall include the following, in sufficient detail to allow the Director to make necessary application review decisions concerning design concepts and protection of human health and the environment: (3-20-20)T

**a.** Name, location, and mailing address of the cyanidation facility. (3-20-20)T

**b.** Name, mailing address, and phone number of the applicant, and a registered agent. (3-20-20)T

**c.** Land ownership status of the cyanidation facility (federal, state, private or public). (3-20-20)T

**d.** Name, mailing address, and phone number of the applicant's construction and operations manager. (3-20-20)T

**e.** The legal structure (corporation, partnership, etc.) and residence of the applicant. (3-20-20)T

**f.** The legal description, to the quarter-quarter section, of the location of the proposed cyanidation facility. (3-20-20)T

**g.** Evidence the applicant is authorized by the Secretary of State to conduct business in the State of Idaho. (3-20-20)T

**h.** A general description of the operational plans for the cyanidation facility from construction through

permanent closure. This description shall include any proposed phases for construction, operations, and permanent closure. (3-20-20)T

**i.** The design maximum daily throughput of ore through the cyanidation facility and the total projected volume of material to be processed during the life of the operation. (3-20-20)T

**j.** Cyanidation facility layouts including water management systems designed to segregate storm water from process water. (3-20-20)T

**k.** A geotechnical evaluation of all process water and process chemical containment systems within the proposed cyanidation facility. (3-20-20)T

**l.** A preconstruction topographic site map or aerial photos extending at least one (1) mile beyond the outer limits of the cyanidation facility, identifying and showing the location and extent of the following features: (3-20-20)T

**i.** All wells, perennial and intermittent springs, adit discharges, wetlands, surface waters and irrigation ditches that may be affected by the cyanidation facility; (3-20-20)T

**ii.** All process water supply source(s); (3-20-20)T

**iii.** All public and private drinking water supply source(s) within at least one (1) mile of the cyanidation facility; (3-20-20)T

**iv.** Identified floodplain areas (shown on USGS sectional Quadrangle maps); (3-20-20)T

**v.** All service roads and public roads; (3-20-20)T

**vi.** All buildings and structures within a half (1/2) mile of the cyanidation facility; (3-20-20)T

**vii.** All special resource waters within one (1) mile of the cyanidation facility; (3-20-20)T

**viii.** All Clean Water Act Section 303(d) listed streams, and their listed impairments, within ten (10) miles of the site boundary that may be affected by the cyanidation facility. (3-20-20)T

**m.** To the extent such information is available, a description and location of underground mine workings and adits and a description of the structural geology that may influence ground water flow and direction. (3-20-20)T

**n.** A description of the proposed land application site. The description shall include a potentiometric map, surface and subsurface soil characteristics, geology, hydrogeology and ground water quality. The description of these characteristics must be sufficient to determine anticipated impacts to the affected soils, associated vadose zone as well as anticipated changes in geochemistry that may affect surface and ground water quality. (3-20-20)T

**o.** Siting diagram for land application sites, monitoring wells, lysimeters, surface or ground water discharge sites, or surface water monitoring locations. (3-20-20)T

**p.** A description of measures to protect wildlife that may be affected by the facility. (3-20-20)T

**q.** Proposed post-construction topographic maps. (3-20-20)T

**r.** Engineering Plans and Specifications. Engineering plans and specifications for all portions of the cyanidation facility intended to contain, treat, convey or dispose of all process water and pollutants must be submitted to the Department for review and approval. Prior to construction, all cyanidation facility engineering plans and specifications must be stamped by a professional engineer registered in the state of Idaho. These plans and specifications shall include: (3-20-20)T



- i. The water balance, ore flow and processing calculations demonstrating the logic behind sizing of facilities. (3-20-20)T
- ii. The general ore processing overview analyses of chemical compatibility of containment materials with process chemicals and wastes, including a chemical mass balance at inputs and outputs from the cyanidation facility. (3-20-20)T
- iii. Geotechnical data and analyses demonstrating the logic for plans and specifications of foundation materials and placement. (3-20-20)T
- iv. Requirements for site preparation. (3-20-20)T
- v. Pumping and dewatering requirements. (3-20-20)T
- vi. Procedures for materials selection and placement for backfilling foundation areas. (3-20-20)T
- vii. Criteria for ensuring slope stabilization of embankments for pads, ponds and tailings impoundment. (3-20-20)T
- viii. Procedures to classify and modify, if necessary, excavated fill, bedding and cover materials for buildings, pads, ponds, and tailings impoundments. (3-20-20)T
- ix. Plumbing schematics and component specifications. (3-20-20)T
- x. Manufacturers' specifications and warranties for all materials that will or may come in contact with process waters. (3-20-20)T
- xi. Plan views and cross-section drawings of leach pad, permanent heaps, vats, process water storage ponds, tailing ponds and spent ore disposal areas. (3-20-20)T
- xii. Leak detection and collection system plans and specifications including, but not limited to, schematics and narratives describing liner and geotextile material specifications, sumping capacity and layout, location of monitoring port(s), monitoring port components, construction operation and maintenance procedures for monitoring ports and pumping systems, including backup system, triggers for primary and secondary containment repairs, replacement or other contingency mitigation, frequency of monitoring, and monitoring parameters. (3-20-20)T
- xiii. Provisions to protect primary and secondary containment systems from heavy equipment, fires, earthquakes and other natural phenomena. (3-20-20)T
- xiv. Quality control and quality assurance procedures. (3-20-20)T
- xv. The identity and qualifications of person(s) directly responsible for supervising construction and providing project quality control and quality assurance. (3-20-20)T
- s. Operation and maintenance plans that includes: (3-20-20)T
  - i. Maintenance plans, including routine service procedures for primary and secondary containment systems, process chemical storage, and disposal of contaminated water or soils, including petroleum-contaminated soils. (3-20-20)T
  - ii. A water management plan that provides for handling and containment of process water including the methods to manage and/or treat all process water and pollutants, and run-off or run-on water, emergency releases, and excess water due to flood, rain, snowmelt, or other similar events. The plan shall include the basis for impoundment volumes and estimations of the need for and operation of a land application site, injection wells, infiltration galleries or leach fields, or the need for an NPDES permit. The plan shall be updated on a regular basis to reflect the reconciliation of the water balance changes in the project through construction, operation, maintenance,

- and permanent closure, including modifications to the cyanidation facility. (3-20-20)T
- iii. A proposed water quality monitoring plan that meets the requirements of Subsection 200.08. (3-20-20)T
  - iv. An emergency and spill response plan that describes procedures and methods to be implemented for the abatement and clean up of any pollutant that may be discharged from the cyanidation facility during use, handling or disposal of processing chemicals, petrochemicals and/or fuels, and any other deleterious materials. (3-20-20)T
  - v. A seasonal/temporary closure plan, if applicable, that describes the procedures, methods, and schedule to be implemented for the treatment and disposal of process water and pollutants, the control of drainage from the cyanidation facility during the period of closure, the control of drainage from the surrounding area, and the secure storage of process chemicals. (3-20-20)T
  - t. Permanent Closure Plan. The permanent closure plan may be the same as the plan submitted to the Idaho Department of Lands pursuant to the Idaho Surface Mining Act, Chapter 15, Title 47, Idaho Code. The permanent closure plan shall: (3-20-20)T
    - i. Identify the current owner of the cyanidation facility and the party responsible for the permanent closure and the long-term care and maintenance of the cyanidation facility. (3-20-20)T
    - ii. Include a time line showing the schedule to complete permanent closure activities, including neutralization of process waters and material stabilization, and the time period for which the permittee shall be responsible for post-closure activities. (3-20-20)T
    - iii. Provide the objectives, methods and procedures, that will achieve neutralization of process waters and material stabilization during the closure period and through post-closure. (3-20-20)T
    - iv. Provide a water management plan from the time the cyanidation facility is in permanent closure through the defined post-closure period. (3-20-20)T
    - v. Include the schematic drawings for all BMPs that will be used during the closure period, through the defined post-closure period, a description of how the BMPs support the water management plan, and an explanation of the water conveyance systems that are planned for the cyanidation facility. (3-20-20)T
    - vi. Provide proposed post-construction topographic maps and scaled cross-sections showing the configuration of the final heap or tailing facility, including final cap and cover designs and the plan for long-term operation and maintenance of the cap. Caps and covers used as source control measures for cyanidation facilities must be designed to minimize the interaction of meteoric waters, surface waters, and ground waters with wastes containing pollutants that are likely to be mobilized and discharged to waters of the state. Prior to issuance of a final permit, engineering plans and specifications for caps and covers must be signed and stamped by a professional engineer registered in the state of Idaho. (3-20-20)T
    - vii. Include monitoring plans for surface and ground water during closure and post-closure periods adequate to demonstrate water quality trends and to ensure compliance with the stated permanent closure objectives and requirements of these rules. (3-20-20)T
    - viii. Provide an assessment of the potential impacts to soils and vegetation for all areas to be used for land application and provide a mitigation plan as appropriate. (3-20-20)T
    - ix. Provide information on how the permittee will comply with the Resource Conservation and Recovery Act, 42 U.S.C. Sections 6901 et seq.; the Idaho Hazardous Waste Management Act, Chapter 44, Title 39, Idaho Code; the Idaho Solid Waste Management Act, Chapter 74, Title 39, Idaho Code; and appropriate state rules, during operation and permanent closure. (3-20-20)T
    - x. Provide sufficient detail to allow the permittee to prepare an estimate of the reasonable cost for the

state of Idaho to hire a third party to implement the closure plan. (3-20-20)T

u. The application shall be accompanied by a fee pursuant to Subsection 100.05. (3-20-20)T

**04. Application for a Small Cyanidation Processing Facility and Pilot Facility.** The owner or proposed operator of a small cyanidation processing facility or the owner's or operator's authorized representative shall make application to the Director in writing of the intent to operate a small cyanidation processing facility or a pilot facility. The application shall include an explanation as to why the proposed small cyanidation processing facility qualifies as a small cyanidation processing facility or a pilot facility. The application must provide the information, plans and specifications identified in Subsection 100.03. (3-20-20)T

**05. Permit Application Fees.** (3-20-20)T

a. The application shall be accompanied by a fee as described below: (3-20-20)T

i. Five thousand dollars (\$5,000) for a pilot facility; (3-20-20)T

ii. Ten thousand dollars (\$10,000) for a small cyanidation processing facility; (3-20-20)T

iii. Twenty thousand dollars (\$20,000) for a cyanidation facility that is neither a pilot facility nor a small cyanidation processing facility; or (3-20-20)T

iv. In lieu of paying a fee at the time the application is submitted, an applicant may enter into an agreement with the Department for actual costs incurred to process an application and issue a final permit. The applicant shall not commence operations at the cyanidation facility until the terms of the agreement have been met, including that the Department has been reimbursed for all actual costs incurred for the permitting process. (3-20-20)T

b. Completeness of an application is contingent upon one (1) of the following: (3-20-20)T

i. Submission of the applicable fees as described in Subsections 100.05.a.i. through 100.05.a.iii.; or (3-20-20)T

ii. The applicant enters into an agreement with the Department as described in Subsection 100.05.a.iv. (3-20-20)T

**06. Exemptions to Fees.** Requests made by the Department to the permittee for any permit modifications shall not be subject to application fees set forth in Subsection 100.05. Requests by the permittee for minor modifications to a permit shall not be subject to application fees set forth in Subsection 100.05. (3-20-20)T

**101. -- 199. (RESERVED)**

**200. REQUIREMENTS FOR WATER QUALITY PROTECTION.**

The following design and performance standards are intended as the minimum criteria for protection of public health and the waters of the state. These standards shall apply to all facilities unless the Department determines that other site-specific criteria are appropriate to protect water quality and the public health. (3-20-20)T

**01. Cyanidation Facilities Siting and Preparation.** All cyanidation facilities including, but not limited to, the process building, laboratories, process chemical storage and containment facilities, plumbing fixtures that support process water, untreated or treated process water ponds, tailings impoundments, ore stock piles, and spent ore disposal areas must be appropriately sited and prepared for construction. Siting criteria must ensure that, at a minimum, the facilities are structurally sound and that primary and secondary containment systems can be adequately protected against factors such as wild fires, floods, land slides, surface and ground water systems, equipment operation, subsidence of underground workings, public access and public activities. All sites must be properly prepared prior to construction of foundations and facilities. Vegetation, roots, brush, large woody debris and other deleterious materials, top soil, historic foundations and plumbing, or other materials that may adversely affect appropriate construction and long term stability, must be removed from the footprint of the cyanidation facility unless approved by the Department. (3-20-20)T

**02. Process Water Storage Sizing Criteria.** All aspects of the cyanidation facility that entrain, utilize, treat, discharge, pump, or otherwise contain process water and pollutants shall be included in the water balance. The water balance shall include process water ponds, treated process water ponds, tailing impoundments, and water conveyance systems. The engineered containment criteria for each pond shall be incorporated into the water balance and must be designed to maintain a minimum two (2) foot freeboard at all times. At a minimum, a cyanidation facility shall be designed to contain the maximum expected normal operating water balance and the volume of run-on/run-off water associated with a climatic event that has a frequency of occurrence of one (1) year in one hundred (100) years or one percent (1%). Snowmelt events shall be considered in determining the containment capacity. Contingency plans for managing excesses of process water shall be described in the water management strategy. Each impoundment design must include a spillway, unless otherwise approved by the Department. (3-20-20)T

**03. Minimum Plans and Specifications for Impoundments, Leach Pads and Other Facilities Designed to Contain Process Water.** Engineering plans and specifications, which are signed and stamped by a professional engineer registered in the state of Idaho, must be approved and included in the final permit issued by the Department prior to construction of cyanidation facilities that are designed to contain process waters. The plans and specifications must provide for: (3-20-20)T

**a.** A prepared subbase of compacted soil, which shall be a minimum of twelve (12) inches thick. The soil must be compacted to ninety-five percent (95%) of Standard Proctor Test ASTM 698 or ninety-five percent (95%) of Modified Proctor Test ASTM 1557. The compacted soil layers must be placed in a minimum of two (2) lifts; (3-20-20)T

**b.** A prepared subbase, which shall be free of plus three (3) inch rocks, roots, brush, trash, debris or other deleterious materials; (3-20-20)T

**c.** Primary containment synthetic liners, which shall have a minimum thickness of eighty (80) millimeters (2.0 mm) consisting of high-density polyethylene (HDPE) material and a maximum coefficient of permeability of  $10^{-11}$  cm/sec, or comparable liners approved by the Department; (3-20-20)T

**d.** A final smoothed and compacted soil layer, which shall not contain particles in excess of point seven five (0.75) inches (nineteen (19) mm) in diameter and have a maximum coefficient of permeability of  $10^{-6}$  cm/sec, or comparable liners approved by the Department; (3-20-20)T

**e.** Primary and secondary liner systems, which shall be constructed according to manufacturers' standards, or Department-approved design standards, and which must protect against cracking, sun damage, ice, frost penetration or heaving, wildlife and wildfires, and damage that may be caused by personnel or equipment operating in or around these facilities; (3-20-20)T

**f.** Compacted clay liners (CCLs), which shall be placed within two percent (2%) of optimum moisture content for the CCL to achieve specified compaction and permeability criteria; (3-20-20)T

**g.** An appropriate interface friction strength plus a factor of safety when either a geosynthetic clay liner (GCL) or CCL is used with a geomembrane liner on a slope; (3-20-20)T

**h.** Minimum factors of safety, and the logic behind their selection, for the stability of the earthworks and the lining systems of heap leach pads and ponds; (3-20-20)T

**i.** Redundant systems, which shall be available if there are failures in primary power and/or pumping systems; (3-20-20)T

**j.** Procedures for loading ore onto the leach pads which will minimize tensile stresses in the primary and secondary containment liners that may result in failure of the liners; and (3-20-20)T

**k.** Leak detection and collection systems, which shall be designed and installed for all facilities, or portions thereof, where process waters may place an average of twelve (12) inches or greater of hydraulic head pressure on primary containment. The engineering plans and specifications shall: (3-20-20)T

- i. Provide a material between primary and secondary containment synthetic liners to collect, transport and remove all process water that passes through the primary containment synthetic liner at such a rate as to prevent hydraulic head from developing on the secondary containment synthetic liner to the level at which it may be reasonably expected to result in discharges through the secondary containment synthetic liner; (3-20-20)T
- ii. Provide routines and schedules for the evaluation of the efficiency and effectiveness of the removal of process waters from the layer placed between primary and secondary containment synthetic liners. The properly working system shall continually relieve head pressures on the secondary containment synthetic liner; (3-20-20)T
- iii. Provide specific triggers for maintenance routines, which shall be initiated in response to inadequate performance of primary or secondary containment synthetic liners; (3-20-20)T
- iv. Specify operation and maintenance procedures, which shall be initiated in response to inadequate performance of primary and secondary containment or leak detection and collection systems; and (3-20-20)T
- v. Provide secondary containment synthetic liners, which shall have a minimum thickness of eighty (80) milli-inches (two (2.0) mm) consisting of HDPE and a maximum coefficient of permeability of  $10^{-11}$  cm/sec, or comparable liners approved by the Department. (3-20-20)T

**04. Process Buildings, Process Chemical Storage Containment Areas and General Facility Criteria.** Storage, handling and use of all process chemicals, process wastes, process water and pollutants must be conducted within a clean, safe and secure work space to prevent unauthorized discharges to soils, ground water or surface water. The plans and specifications must contain sufficient detail, including pump capacity and plumbing for evacuation of collection sumps, triggering systems for sump evacuation, and monitoring and reporting requirements. Plans and specifications must be submitted with the application for the Department's review and approval. Prior to construction, plans and specifications for the process buildings and auxiliary facilities, including process chemical storage and containment facilities and laboratories, must be signed and stamped by a professional engineer registered in the state of Idaho. Where appropriate, these plans and specifications must provide for: (3-20-20)T

- a. Structural integrity of the foundation, walls and roof for process and process chemical storage buildings. (3-20-20)T
- b. Restriction of public access. (3-20-20)T
- c. Protection of wildlife. (3-20-20)T
- d. Internal sumps and spill cleanup plans. (3-20-20)T
- e. Grouted and sealed concrete stemmed walls and floors in the process and process chemical storage and containment facilities. (3-20-20)T
- f. Vapor barriers and frost protection. (3-20-20)T
- g. Segregation of process chemicals according to compatibility. (3-20-20)T
- h. Communication systems. (3-20-20)T
- i. Fire suppression systems, internal and external. (3-20-20)T
- j. Quality assurance and quality control for construction activities and construction materials. (3-20-20)T

**05. Cap and Cover Criteria.** Caps and covers used as source control measures for facilities must be designed and constructed to minimize the interaction of meteoric waters, surface waters, and ground waters with wastes containing pollutants that are likely to be mobilized and discharged to waters of the state. Caps and covers designed for permanent closure must demonstrate permanence applicable to the permittee's designed and approved

permanent closure plan. Prior to issuance of a final permit, engineering plans and specifications for caps and covers must be signed and stamped by a professional engineer registered in the state of Idaho. (3-20-20)T

**06. Plumbing and Conveyance Criteria.** Engineering plans and specifications must be submitted to the Department for review and approval. Plumbing and conveyance systems shall be structurally sound and chemically compatible with the materials being conveyed; shall provide adequate primary and secondary containment; and shall be protected against heat, cold, mechanical failures, impacts, fires, and other factors which may cause breakage and result in unauthorized discharges. Prior to construction, engineering plans and specifications of all conveyances of materials containing process water must be signed and stamped by a professional engineer registered in the state of Idaho. (3-20-20)T

**07. Operation and Maintenance Plans.** Operation and maintenance plans must be submitted to the Department for review and approval. Operation and maintenance plans must include, but are not limited to: (3-20-20)T

- a.** An overall plan that includes techniques for evaluating the integrity and performance of all primary and secondary containment systems. (3-20-20)T
- b.** Schedule for inspections of all primary and secondary containment systems. (3-20-20)T
- c.** Schedule for inspections on piping and conveyance systems that carry process water. (3-20-20)T
- d.** Response plans that detail specific actions that will result in mitigation of compromised or damaged containment systems. (3-20-20)T

**08. Water Quality Monitoring and Reporting.** The water quality monitoring plan submitted with the application shall be reviewed and, if appropriate, approved by the Department. The approved water quality monitoring plan shall: (3-20-20)T

- a.** Provide for physical, chemical and biological monitoring, including surface water flow measurements, in potentially affected surface and ground water, as appropriate. (3-20-20)T
- b.** Provide for sampling locations and frequency. (3-20-20)T
- c.** Provide an assessment of the existing surface and ground water conditions prior to construction of the proposed cyanidation facility. (3-20-20)T
- d.** Be site specific and dependent on location, design and operation of the cyanidation facilities included in the overall operating plan. (3-20-20)T
- e.** Specify compliance points and associated water quality compliance criteria. (3-20-20)T
- f.** Specify monitoring points, which will provide for early detection of discharges of pollutants. (3-20-20)T
- g.** Provide analytical methods and method detection limits for chemical analysis used in the determination of water quality. (3-20-20)T
- h.** Provide a quality assurance quality control plan for data collection and analysis. (3-20-20)T
- i.** Provide for appropriate and timely analytical data analyses including evaluations of water quality and quantity trends. (3-20-20)T
- j.** Provide an annual environmental monitoring and data analysis report of water quality and quantity trends. (3-20-20)T
- k.** Provide for the reporting and re-sampling of monitoring locations where detectable and statistically

significant changes in water quality are found. The permittee shall propose a statistical method to determine the significance of the changes in water quality. (3-20-20)T

**i.** Provide for anticipated changes or modifications to monitoring plans, which may be the result of a phased approach to cyanidation facility construction, operations and permanent closure. (3-20-20)T

**09. Monitoring Wells Siting and Construction Plans.** The applicant is encouraged to submit the purpose, objectives, location and proposed construction of monitoring wells to the Department for review and comment during the initial stages of site characterization. (3-20-20)T

**a.** Monitoring well siting and construction plans shall provide for a minimum of three (3) monitoring wells. One (1) shall be located up gradient and two (2) shall be located down gradient of primary components of the cyanidation facility to determine ground water flow direction. (3-20-20)T

**b.** Siting and planning for additional wells or replacement wells may be required in the permit application and final permit. Specifically, additional wells may be required for: (3-20-20)T

**i.** Large areas with multiple potential sources for pollutants; (3-20-20)T

**ii.** Areas with complex geology, fractured bedrock; and (3-20-20)T

**iii.** Areas with insufficient background hydrogeology. (3-20-20)T

**c.** All monitoring well construction must also conform to the well construction rules listed in IDAPA 37.03.09, "Well Construction Standards Rules." (3-20-20)T

**d.** Record diagrams along with a detailed geologic log shall be provided to the Department for each monitoring well. (3-20-20)T

**10. Land Application.** Prior to issuance of a final permit, plans and specifications for the construction or modification of land application of process water disposal systems shall be submitted to and approved by the Department. All plans and specifications for the construction, operation and closure of land application or other waste treatment or disposal facilities or modification must be signed and stamped by a registered professional engineer licensed in the state of Idaho. Plans and specifications shall include: (3-20-20)T

**a.** An operation and maintenance plan including: (3-20-20)T

**i.** Water balance for the land application site. (3-20-20)T

**ii.** Pretreatment requirements and procedures. (3-20-20)T

**iii.** Operating season for land application. (3-20-20)T

**iv.** Seasonal closeout procedures. (3-20-20)T

**v.** Special soils or vegetative amendments. (3-20-20)T

**vi.** Storm water run-on/run-off controls. (3-20-20)T

**vii.** Best management practices for all areas impacted by the land application system. (3-20-20)T

**viii.** A topographic map of the land application site and adjacent affected areas, of sufficient scale to facilitate site-specific analysis of soils, vegetation, surface water and ground water. (3-20-20)T

**b.** Chemical, physical, and volumetric characteristics of the process water to be land applied. (3-20-20)T

**c.** A complete description of the chemical and physical characteristics of the soils and applicable

- geology of the land application site. (3-20-20)T
- d. Methods of process water treatment, distribution and disposal. (3-20-20)T
  - e. Hydraulic loading capacity of the soils. (3-20-20)T
  - f. Constituent loading capacity of the site. (3-20-20)T
  - g. Attenuation capacity of the vegetative covers and soils. (3-20-20)T
  - h. Evapotranspiration capacity of the site. (3-20-20)T
  - i. Testing and analytical procedures for water quality and soils samples prior to, during, and following the land application process. (3-20-20)T
  - j. Trend analysis of the constituent loading in the affected soils, vegetation and water quality of the affected surface or ground water systems. (3-20-20)T
  - k. Reporting requirements including both frequency and form. (3-20-20)T
  - l. Standby power and pumps sufficient to maintain all treatment and distribution works. (3-20-20)T
- 11. Temporary or Seasonal Closure.** Temporary and seasonal closure plans for the entire cyanidation facility must be submitted by an applicant to the Department for review and approval prior to issuance of a final permit. Temporary and seasonal closure plans may, subject to Department approval pursuant to Section 750, be modified to provide for changes in operating conditions of the facilities and must incorporate a water management plan for the period of inactivity as well as during shut down and reactivation. (3-20-20)T
- a. Prior to seasonal closure, process buildings, process chemical storage, process water ponds, tailing ponds, spent ore disposal areas and other ancillary facilities must be stabilized and/or conditioned to prevent any emergency or unauthorized discharges to surface or ground water. (3-20-20)T
  - b. Subsequent to seasonal closure, process buildings, process chemical storage, process water ponds, tailings ponds, spent ore disposal areas and other ancillary facilities must be maintained to prevent any emergency or unauthorized discharges to surface or ground water. Cyanidation facilities shall be conditioned and maintained to provide: (3-20-20)T
    - i. Material stabilization for all solids affected by process waters. (3-20-20)T
    - ii. Optimum freeboard in all ponds, as dictated by the water management plan. (3-20-20)T
    - iii. Fully functional power and pumping systems that are ready for use; both power and pumps shall have incorporated redundant systems to allow for failure of either power or a pumping system. A failed power supply or pump is not an acceptable reason for an unauthorized discharge. (3-20-20)T
    - iv. Protection of all primary and secondary containment. (3-20-20)T
    - v. Sufficient availability of qualified staff to restrict public access, fully implement the water quality monitoring plan, and initiate the emergency and spill response plan. (3-20-20)T
- 12. Employee Education Program.** Operators and staff of facilities must be properly oriented and trained to operate, maintain and protect primary and secondary containment systems; waste disposal and discharge systems; and to implement monitoring and emergency and spill response plans. An applicant must submit an employee orientation and continuing training plan to the Department for review prior to issuance of a final permit. The plan must provide the format and contents for training, the general qualifications of the person(s) responsible for training and testing, and the person(s) or positions which should receive such training. (3-20-20)T



201. -- 299. (RESERVED)

**300. APPLICATION PROCESSING PROCEDURE.**

**01. Application Processing Time Line for Director's Final Decision.** A chart illustrating the application processing time line is located in Appendix A of these rules. (3-20-20)T

**02. Completeness Review.** Within thirty (30) days of receipt of an application, the Department will issue a written notice to the applicant and the Idaho Department of Lands, indicating: (3-20-20)T

**a.** That the application is complete; or (3-20-20)T

**b.** That the Department is rejecting the application as incomplete and shall provide a list of deficiencies. Upon determination that the application is incomplete, the Department shall refund one half (1/2) of the application fee. (3-20-20)T

**03. Accuracy and Protectiveness Review.** Within sixty (60) days of receipt of an application and upon determination by the Department that the application is complete, the Department will review the application for accuracy and protectiveness based on these and other applicable rules including, but not limited to, IDAPA 58.01.02, "Water Quality Standards," and IDAPA 58.01.11, "Ground Water Quality Rule." (3-20-20)T

**04. Notice of Intent to Deny the Permit Application or to Draft a Permit.** Within sixty (60) days of receipt of an application for a new permit or to modify an existing permit, the Director shall: (3-20-20)T

**a.** Provide public notice of intent to deny the permit application; or (3-20-20)T

**b.** Provide public notice that the Director has determined that the application is complete and the Director intends to draft a permit, is seeking public comment, and will hold at least one (1) public meeting on the draft permit in accordance with Section 400. (3-20-20)T

**05. Basis for Permit Application Denial.** The Director shall deny a permit application if: (3-20-20)T

**a.** The application is inaccurate or incomplete; (3-20-20)T

**b.** The cyanidation facility as proposed cannot be conditioned for construction, operation, and closure so as to comply with applicable state law; or (3-20-20)T

**c.** The applicant has not submitted the appropriate fees. (3-20-20)T

**06. Permit Fact Sheet.** The Director shall prepare a fact sheet, for each denial or draft permit, which briefly states the principal facts and the significant legal and policy questions considered in the Director's decision. The fact sheet shall include, when applicable: (3-20-20)T

**a.** A brief description of the proposed cyanidation facility and the operating plan. (3-20-20)T

**b.** A brief summary of the basis for the decision, including references to applicable requirements and supporting materials. (3-20-20)T

**c.** Reasons why any requested conditions or alternatives to required standards do or do not appear justified. (3-20-20)T

**d.** The name and phone number of the agency representative to contact for additional information. (3-20-20)T

301. -- 399. (RESERVED)

**400. PUBLIC INVOLVEMENT IN PERMIT PROCEDURES.**

**01. Public Notice of Permit Actions.** No public notice is required when a request for a permit modification is denied. The Director shall give public notice of: (3-20-20)T

- a. Receipt of an application for a permit; (3-20-20)T
- b. Any public meeting schedule; (3-20-20)T
- c. Issuance of a draft permit or a decision to deny the application for a permit; and (3-20-20)T
- d. An appeal that has been filed. (3-20-20)T

**02. Public Notice Information.** All public notices shall contain the name and address of the Department's office processing the permit action, where the application and draft permit will be available for public review, and a brief description of the public involvement procedures. (3-20-20)T

**03. Serving the Public Notice.** Public notice of permit actions shall be given by the following methods: (3-20-20)T

- a. By mail to: (3-20-20)T
  - i. The applicant; (3-20-20)T
  - ii. Persons on a mailing list who request to be notified; and (3-20-20)T
  - iii. Other appropriate federal, tribal, state and local government entities. (3-20-20)T
- b. Publication in a daily or weekly major newspaper of general circulation in the area of the proposed cyanidation facility; and (3-20-20)T
- c. Any other method reasonably calculated to give actual notice of the action in question to the persons potentially affected. (3-20-20)T

**04. Participation by Idaho Department of Lands.** The Department shall formally request that the Idaho Department of Lands participate in the public meeting with respect to performance criteria for permanent closure. (3-20-20)T

**05. Public Comment(s), Public Comment Period, and Public Meetings.** (3-20-20)T

a. Within thirty (30) days after the Director's decision to draft a permit, the Department shall hold a public meeting. Oral or written comments may be submitted by any person at the public meeting. The meeting may be presided by agency personnel appointed by the Director. In order for the Department to address public comments in its Response to Public Comments pursuant to Subsection 450.03., comments must be submitted in writing within sixty (60) days after the Director's decision to draft a permit. (3-20-20)T

b. From the time an application is received, until sixty (60) days after issuance of the notice pursuant to Subsection 300.04., the public may provide written comments. All written comments submitted during this public comment period shall be considered by the Director. (3-20-20)T

**401. -- 449. (RESERVED)**

**450. FINAL PERMIT DECISION.**

**01. Issuance.** Within sixty (60) days after the close of the public comment period, the Director shall either issue or deny a permit, or major modification of a permit. Provided however, that if weather conditions prevent the Director from inspecting the proposed or existing cyanidation facility site to obtain information needed to approve or reject a submitted application, he may, in writing to the applicant, extend the time not to exceed thirty (30) days

after weather conditions permit such inspection. (3-20-20)T

**02. Notification of the Decision.** The Director shall notify the applicant and each person who requested notice of the final permit decision. This notice shall include reference to the procedures for administrative appeal under Section 003. For the purpose of this section, a final permit decision means a final decision to issue, deny, modify, or revoke a permit. (3-20-20)T

**03. Response to Public Comments.** All written comments and information received during the comment period, together with the Department's final permit decision and the response to relevant written comments shall be made available to the public at the time the Director issues the final permit decision. This response shall: (3-20-20)T

**a.** Specify any differences between the final permit decision and the draft permit and state the reasons for those differences; (3-20-20)T

**b.** Briefly describe and respond to all relevant written comments on the draft permit or denial. (3-20-20)T

**04. Basis for Permit Denial.** The Director shall deny a permit if: (3-20-20)T

**a.** The application is incomplete or inaccurate; (3-20-20)T

**b.** The cyanidation facility as proposed cannot be conditioned for construction, operation, and closure so as to comply with applicable state law; or (3-20-20)T

**c.** The Idaho Department of Lands has determined that the permanent closure plan does not meet the requirements of Chapter 15, Title 47, Idaho Code. (3-20-20)T

**05. Immediate Effect of the Permit.** A valid permit authorizes the construction and operation of a cyanidation facility. (3-20-20)T

**451. -- 499. (RESERVED)**

**500. PERMIT CONDITIONS.**

The following conditions shall apply to and be specified in all permits: (3-20-20)T

**01. Compliance Required.** The applicant or permittee shall comply with all conditions of the permit. Issuance or possession of a permit issued according to these rules shall not relieve the applicant or permittee of the responsibility to comply with all other applicable local, state, and federal laws. (3-20-20)T

**02. Record Plans and Specifications.** A professional engineer registered in the state of Idaho must confirm in writing that all record drawings and specifications are complete and accurate. These record plans and specifications must be submitted by the permittee to the Director within thirty (30) days after the completion of the construction of each critical phase of facility development as approved by the Department. The record plans and specifications must be accompanied by a final construction report. If the construction proceeded in substantial compliance with the approved plans and specifications, a statement to the effect may be submitted by the registered, professional engineer. (3-20-20)T

**03. Provide Information.** The permittee shall furnish to the Director within a reasonable or specified time any information, including copies of records required by the permit or other applicable rules, which the Director may reasonably require to determine whether cause exists for modifying or revoking the permit or to determine compliance with the permit or other applicable rules. (3-20-20)T

**04. Notifications.** After initial construction and seasonal and/or temporary closure, the permittee shall, within thirty (30) days, provide written notice to the Director of the permittee's intentions to commence or restart operations. At least thirty (30) days prior to completion of operations, and/or temporary or seasonal operations, the permittee shall notify the Director of the permittee's intentions to temporarily, seasonally or permanently close

operations. Notification shall provide sufficient time for the Director to provide pre-operational or post-operational inspections, as necessary. (3-20-20)T

**05. Entry and Access.** The permittee shall allow the Director, or a designee obligated by agreement with the Director to comply with the confidentiality provisions of Section 39-111, Idaho Code, to: (3-20-20)T

**a.** Enter at reasonable times upon the premises of a permitted cyanidation facility or where records required by a permit are kept; (3-20-20)T

**b.** Have access to and copy at reasonable times any records that must be kept under the conditions of the permit; (3-20-20)T

**c.** Inspect at reasonable times any cyanidation facility, equipment, practice, or operation permitted or required by the permit; (3-20-20)T

**d.** Sample or monitor at reasonable times, substance(s) or parameter(s) directly related to permit or regulation compliance. (3-20-20)T

**06. Reporting.** It shall be the permittee's responsibility to report to the Director: (3-20-20)T

**a.** Orally, as soon as possible but no later than twenty-four (24) hours from the time the permittee knows or should reasonably know of any noncompliance which may endanger the public health or the environment. (3-20-20)T

**b.** In writing, within five (5) working days from the time a permittee knows or should reasonably know of any event which may be or which may result in a violation of these rules, or Idaho Department of Environmental Quality Rules, IDAPA 58.01.02, "Water Quality Standards," or IDAPA 58.01.11, "Ground Water Quality Rule." This report shall contain: (3-20-20)T

**i.** A description of the event and its cause; if the cause is not known, steps taken to investigate and determine the cause; (3-20-20)T

**ii.** The period of the event including, to the extent possible, the individual(s) involved in the incident(s) and the time(s) and date(s) of the incidents; (3-20-20)T

**iii.** Measures taken to mitigate or eliminate the event and protect the public health; and (3-20-20)T

**iv.** Steps taken to prevent recurrence of the event. (3-20-20)T

**c.** In writing, confirmation of any conditions which may result in violation of any permit condition. (3-20-20)T

**d.** In writing, when the permittee knows or should reasonably know of relevant facts not submitted or incorrect information submitted in a permit application or any report or notice to the Director or the Department. Those facts or the correct information shall be included as a part of this report. (3-20-20)T

**07. Discharge Response.** If an unauthorized discharge occurs the permittee shall implement the Department approved emergency and spill response plan. (3-20-20)T

**08. Temporary or Seasonal Closure Plans.** Prior to temporary or seasonal closure, the permittee shall submit a temporary or seasonal closure plan to the Director for approval. The plan shall describe the procedures, methods, and schedule to be implemented for the treatment and disposal of process water and pollutants, the control of drainage from the cyanidation facility, the control of drainage from the surrounding area, and the secure storage of chemicals during the period of closure. Within thirty (30) days of receiving the plan, the Director shall approve and/or suggest modifications necessary to protect the waters of the state. The permittee shall ensure that closure complies with an approved plan. In no case shall the permittee complete temporary or seasonal closure prior to implementation of the approved plan. Facilities may not be temporarily or seasonally closed for a period longer than two (2) years

unless approved by the Director. (3-20-20)T

**09. Begin Construction.** If the permittee fails to begin construction of a cyanidation facility within one (1) year of the effective date of the permit, the permit will be deemed void. (3-20-20)T

**10. Permanent Closure.** The permanent closure plan, as approved by the Idaho Department of Environmental Quality in coordination with the Idaho Department of Lands, shall be incorporated by reference into the Department-issued permit as a permit condition and shall be enforceable as such. The Department may evaluate permanent closure based on different performance standards than those used by the Idaho Department of Lands. (3-20-20)T

## **501. COMPLETION OF PERMANENT CLOSURE.**

**01. Implementation of a Permanent Closure Plan.** Unless otherwise specified in the approved permanent closure plan, the permittee must begin implementation of the approved permanent closure plan: (3-20-20)T

**a.** Within one (1) year of the final addition of cyanide to the ore processing circuit for pilot or small cyanidation processing facilities; or (3-20-20)T

**b.** Within two (2) years of the final addition of cyanide to the ore processing circuit for all other cyanidation facilities; or (3-20-20)T

**c.** If the product recovery phase of the cyanidation facility has been suspended for a period of more than two (2) years. (3-20-20)T

**02. Submittal of a Permanent Closure Report.** The permittee shall submit a permanent closure report to the Department for review and approval. A permanent closure report shall be of sufficient detail for the directors of the Idaho Department of Environmental Quality and the Idaho Department of Lands to issue a determination that permanent closure, as defined in Section 007 of these rules, has been achieved. The permanent closure report shall address: (3-20-20)T

**a.** The effectiveness of material stabilization. (3-20-20)T

**b.** The effectiveness of the water management plan and adequacy of the monitoring plan. (3-20-20)T

**c.** The final configuration of the cyanidation facility and its operational/closure status. (3-20-20)T

**d.** The post-closure operation, maintenance, and monitoring requirements, and the estimated reasonable cost to complete those activities. (3-20-20)T

**e.** The operational/closure status of any land application site of the cyanidation facility. (3-20-20)T

**f.** Source control systems that have been constructed or implemented to eliminate, mitigate, or contain short and long term discharge of pollutants from the cyanidation facility, unless otherwise permitted. (3-20-20)T

**g.** The short and long term water quality trends in surface and ground water through the statistical analyses of the existing monitoring data collected pursuant to the ore processing by cyanidation permit. (3-20-20)T

**h.** Ownership and responsibility for the cyanidation facility during the defined post-closure period. (3-20-20)T

**i.** The future beneficial uses of the land, surface and ground waters in and adjacent to the closed facilities. (3-20-20)T

**j.** How the permanent closure of the cyanidation facility complies with the Resource Conservation

and Recovery Act, Hazardous Waste Management Act, Solid Waste Management Act, and appropriate rules. (3-20-20)T

**502. DECISION TO APPROVE OR DISAPPROVE OF A PERMANENT CLOSURE REPORT.**

**01. Issuance of Director's Determination.** Within sixty (60) days of receipt of a permanent closure report, the Director shall issue to the permittee a Director's determination of approval or disapproval of the permanent closure report. (3-20-20)T

**02. Director's Determination to Disapprove a Permanent Closure Report.** A Director's determination to disapprove a permanent closure report shall specifically identify and discuss those reasons for disapproval, any administrative actions being considered by the Director, and the permittee's options and procedures for administrative appeal. The Director's determination to disapprove a permanent closure report must include: (3-20-20)T

- a. Identification of errors or inaccuracies in the permanent closure report. (3-20-20)T
- b. Issues or details which require additional clarification. (3-20-20)T
- c. Failures to fully implement the approved permanent closure plans. (3-20-20)T
- d. Outstanding violations or other noncompliance issues. (3-20-20)T
- e. Other issues supporting the Department's disagreement with the contents, final conclusions or recommendations of the permanent closure report. (3-20-20)T

**503. -- 549. (RESERVED)**

**550. VALIDITY AND DURATION OF PERMITS.**

A permit shall remain valid until the Director determines that permanent closure is completed or the Director revokes or modifies the permit. (3-20-20)T

**551. -- 649. (RESERVED)**

**650. FINANCIAL ASSURANCE.**

**01. Financial Assurance Required.** The permittee is required to provide financial assurance pursuant to the Idaho Surface Mining Act, Chapter 15, Title 47, Idaho Code, and the rules promulgated thereunder. The Department shall not issue a permit under these rules to a cyanidation facility unless the cyanidation facility has satisfied such financial assurance requirements. (3-20-20)T

**02. Insufficiency.** In the event the financial assurance is forfeited as described in the Idaho Surface Mining Act, Chapter 15, Title 47, Idaho Code, the Department may seek to recover the amount necessary to implement permanent closure under the Department-issued permit and these rules as provided by law. (3-20-20)T

**651. -- 749. (RESERVED)**

**750. PERMIT MODIFICATION.**

- 01. Cause for Permit Modification.** Causes for permit modification are: (3-20-20)T
  - a. A material modification or material expansion in the cyanidation facility operation, design or closure plan. (3-20-20)T
  - b. Natural phenomena substantially different from those anticipated in the original permit. (3-20-20)T
- 02. Modification at Request of Permittee.** Requests for modification from the permittee shall include: (3-20-20)T

- a. A written description of the modification(s); (3-20-20)T
- b. Data supporting the modification request; (3-20-20)T
- c. Causes and anticipated effects of the modification. (3-20-20)T

**03. Modification at Request of Director.** Pursuant to Subsection 750.01, if the Director determines that cause exists for permit modification, the Director shall notify the permittee in writing and request information necessary for the Director to modify the permit. (3-20-20)T

**04. Modification Procedure.** The Director shall evaluate the request for a permit modification, based on the information provided in Subsection 750.02 or otherwise obtained by the Department, and determine if the modification requires a major permit modification or a minor permit modification. Major permit modifications shall be subject to the provisions of Sections 100, 200, 300, 400, and 450. Minor permit modifications shall not be subject to the provisions of Sections 100, 300 and 400. The permittee shall notify and receive approval from the Department prior to making minor modifications. (3-20-20)T

**05. Major Permit Modifications.** Changes that require a major permit modification include but are not limited to: (3-20-20)T

- a. Material modifications or material expansions to a cyanidation facility as defined by these rules; or (3-20-20)T
- b. A significant increase or decrease in the time the cyanidation facility is expected to be in operation. (3-20-20)T
- c. Requests to modify or change water quality compliance criteria and/or water quality compliance monitoring points. (3-20-20)T

**06. Minor Permit Modifications.** Minor permit modifications are those which, if granted, would not result in any increased hazard to the environment or to the public health. Within thirty (30) days of receipt of a written request for a minor modification, the Department shall complete an evaluation of the request and either approve or deny the request in writing. Minor modifications may include but are not limited to: (3-20-20)T

- a. The correction of typographical errors in an approved permit. (3-20-20)T
- b. Legal transfer of ownership or operational control. (3-20-20)T
- c. A change in the requirements for monitoring or reporting frequency of the quality or quantity of the project air, water or waste generated. (3-20-20)T
- d. A change in the cost estimates submitted by a permittee to the Idaho Department of Lands to complete permanent closure. (3-20-20)T
- e. A change or modification that is required by a state or federal requirement that supersedes the authorities of these rules. (3-20-20)T

**751. -- 799. (RESERVED)**

**800. TRANSFER OF PERMITS.**

**01. Transfer of Permits Allowed.** A permit shall be transferred to a new permittee if such permittee provides written notice to the Director containing: (3-20-20)T

- a. A specific date for transfer of permit responsibility, coverage, and liability between the current and new permittees. (3-20-20)T

b. Demonstration that the new permittee has established appropriate financial assurance for permanent closure of the facility; and (3-20-20)T

c. The information required in Subsections 100.03.b., 100.03.d., 100.03.e. and 100.03.g. (3-20-20)T

**02. Decision.** The Director shall either approve of or deny the transfer of the permit within thirty (30) days of receipt of notice that the current permittee wishes to transfer the permit to a new permittee. (3-20-20)T

**03. Basis for Permit Denial.** The Director shall deny the request for the permit transfer if the new permittee has not provided the information required in Subsection 800.01. (3-20-20)T

**801. -- 849. (RESERVED)**

**850. PERMIT REVOCATION.**

**01. Cause for Revocation.** A material violation of a permit or these rules may be grounds for the Director to revoke a permit. A violation that is shown to have occurred as the result of an unforeseeable act of God despite a permittee's reasonable efforts to comply with all applicable legal requirements shall not be grounds for revocation. (3-20-20)T

**02. Revocation Hearing.** If the Director decides to revoke a permit, he shall issue a notice of intent which shall become final within thirty-five (35) days of service upon the permittee, unless the permittee requests in writing an administrative hearing. The hearing shall be conducted in accordance with IDAPA 58.01.23, Rules of Administrative Procedure Before the Board of Environmental Quality." (3-20-20)T

**851. -- 899. (RESERVED)**

**900. VIOLATIONS.**

**01. Failure to Comply.** Failure by a permittee to comply with the provisions of these rules or with any permit condition shall be deemed a violation of these rules. (3-20-20)T

**02. Falsification of Statements and Records.** It shall be a violation of these rules for any person to knowingly make a false statement, representation, or certification in any application, registration, report, document, or record developed, maintained, or submitted pursuant to these rules or the conditions of a permit. (3-20-20)T

**03. Discharges.** Any unauthorized discharge shall be a violation of these rules. (3-20-20)T

**901. -- 999. (RESERVED)**

**APPENDIX A**

**APPLICATION PROCESSING TIME LINE FOR DIRECTOR'S FINAL DECISION**

**IDAPA 58.01.13, RULES FOR ORE PROCESSING BY CYANIDATION**



The following chart illustrates the time line for processing a permit application and references the corresponding sections from IDAPA 58.01.13.

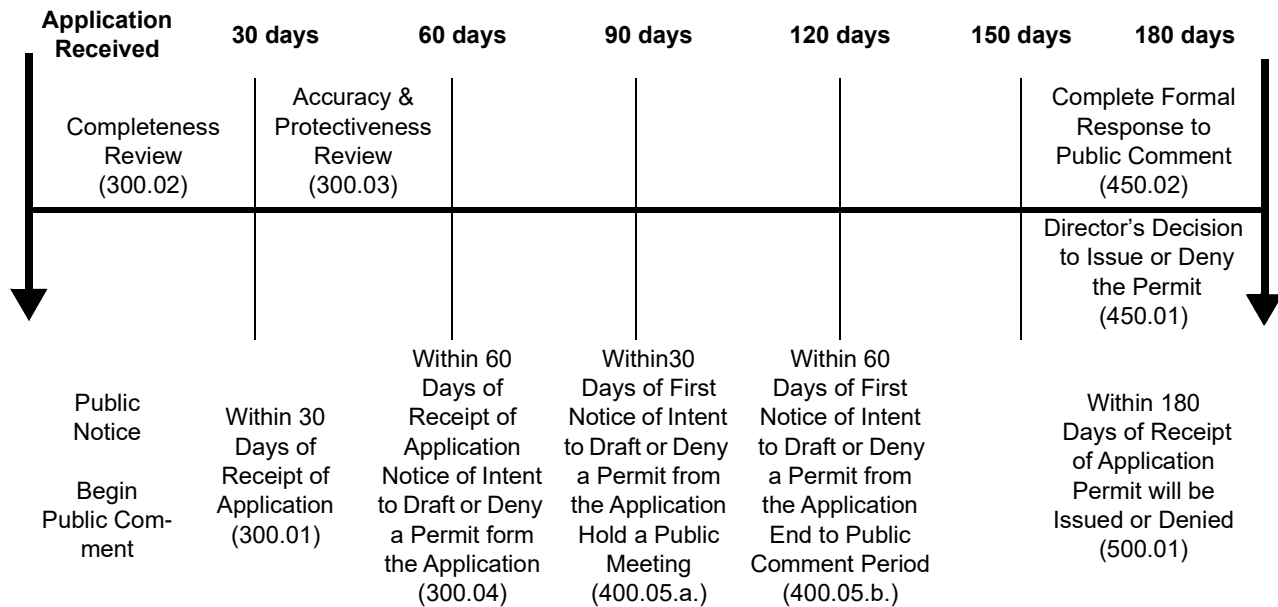

**58.01.14 – RULES GOVERNING FEES FOR ENVIRONMENTAL OPERATING PERMITS, LICENSES, AND INSPECTION SERVICES**

**000. LEGAL AUTHORITY.**

Pursuant to Sections 39-105, 39-107 and 39-119, Idaho Code, the Board of Environmental Quality is authorized to promulgate rules establishing reasonable fees to be charged and collected for any service rendered by the Department of Environmental Quality. (3-20-20)T

**001. TITLE AND SCOPE.**

**01. Title.** The rules are titled IDAPA 58.01.14, “Rules Governing Fees for Environmental Operating Permits, Licenses, and Inspection Services.” (3-20-20)T

**02. Scope.** These rules establish reasonable fees for environmental operating permits, licenses, inspection services and waiver application processing rendered by the Department of Environmental Quality or its designees. (3-20-20)T

**002. WRITTEN INTERPRETATIONS.**

In accordance with Section 67-5201(19)(b)(iv), any written statements pertaining to the interpretation of these rules will be available for review at the Department of Environmental Quality, 1410 N. Hilton, Boise, ID 83706-1255. (3-20-20)T

**003. ADMINISTRATIVE APPEALS.**

Persons may be entitled to appeal agency actions authorized under this chapter pursuant to IDAPA 58.01.23, “Rules of Administrative Procedure before the Board of Environmental Quality.” (3-20-20)T

**004. INCORPORATION BY REFERENCE.**

These rules do not contain documents incorporated by reference. (3-20-20)T

**005. OFFICE – OFFICE HOURS – MAILING ADDRESS AND STREET ADDRESS.**

The state office of the Department of Environmental Quality and the office of the Board of Environmental Quality are located at 1410 N. Hilton, Boise, Idaho 83706-1255, telephone number (208) 373-0502. The office hours are 8 a.m. to 5 p.m. Monday through Friday. (3-20-20)T

**006. CONFIDENTIALITY OF RECORDS.**

Information obtained by the Department under these rules is subject to public disclosure pursuant to the provisions of Chapter 1, Title 74, Idaho Code, and IDAPA 58.01.21, “Rules Governing the Protection and Disclosure of Records in the Possession of the Idaho Department of Environmental Quality.” (3-20-20)T

**007. DEFINITIONS.**

**01. Board.** The Idaho Board of Environmental Quality. (3-20-20)T

**02. Department.** The Idaho Department of Environmental Quality or its designee. (3-20-20)T

**03. Director.** The Director of the Idaho Department of Environmental Quality or his designee. (3-20-20)T

**008. -- 099. (RESERVED)**

**100. ENVIRONMENTAL FEES.**

The fees specified in Sections 101 through 199 shall be charged for the following environmental services rendered by the Department or its designees. Fees for services rendered by designees that are equivalent or greater than the fees listed in Sections 101 through 199 may be adopted by the district health departments or local government. The fees are to be paid by the party receiving the services to the Department or designee performing the service, in the time, place and manner specified by the performing entity. (3-20-20)T

**101. -- 109. (RESERVED)**

**110. INDIVIDUAL AND SUBSURFACE SEWAGE DISPOSAL SYSTEM PERMIT.**

For those services rendered in the process of issuing installation permits for individual and subsurface sewage disposal systems (see IDAPA 58.01.03, “Individual/Subsurface Sewage Disposal Rules”), the following fees apply: (3-20-20)T

**01. Individual Households or Buildings.** For individual households or buildings, if the individual and subsurface sewage disposal system is a new installation or a replacement or expansion of an existing system, the fee shall be ninety dollars (\$90). (3-20-20)T

**02. Multiple Households or Buildings.** For individual and subsurface sewage disposal systems serving more than one (1) household or building in any combination, the fee shall be ninety dollars (\$90) plus ten dollars (\$10) per each household or per each two hundred fifty (250) gallons of flow from buildings. (3-20-20)T

**111. -- 114. (RESERVED)**

**115. INDIVIDUAL AND SUBSURFACE SEWAGE DISPOSAL SYSTEM PUMPER PERMIT.**

For those services rendered in the process of issuing permits to persons operating individual and subsurface sewage disposal system pumping equipment (see IDAPA 58.01.15, "Rules Governing the Cleaning of Septic Tanks"), the fee shall be forty dollars (\$40) plus ten dollars (\$10) for each tank truck or tank per annum. (3-20-20)T

**116. -- 119. (RESERVED)**

**120. SUBSURFACE SEWAGE DISPOSAL SYSTEM INSTALLER'S REGISTRATION PERMIT.**

For those services rendered in the process of issuing Installer's Registration Permits (see IDAPA 58.01.03, "Individual/Subsurface Sewage Disposal Rules"), the fee shall be fifty dollars (\$50) per annum for a standard and basic alternative system installer's registration permit and one hundred dollars (\$100) per annum for a standard, basic and complex alternative system installer's registration permit. (3-20-20)T

**121. -- 149. (RESERVED)**

**150. PARCEL SURVEY.**

For those services rendered in evaluating existing water supply or sewage disposal systems when such evaluation is a condition for the sale of real property, the fee shall be sixty dollars (\$60) excluding laboratory services. (3-20-20)T

**151. -- 159. (RESERVED)**

**160. SANITARY RESTRICTION ADMINISTRATION.**

For those services rendered in the administration of sanitary restrictions, pursuant to Section 50-1326, Idaho Code, the following fees apply: (3-20-20)T

**01. Subdivisions or Plats Proposing Individual and Subsurface Sewage Disposal System Discharge to Subsurface.** For subdivisions or plats for which sewage treatment and disposal systems are designed to discharge to the subsurface, the fee shall be one hundred dollars (\$100) plus twenty dollars (\$20) per lot. (3-20-20)T

**02. Subdivisions or Plats Proposing Other Than Individual and Subsurface Sewage Disposal System Discharge to Subsurface.** For subdivisions or plats for which sewage treatment and disposal systems are not designed to discharge to the subsurface, the fee shall be twenty-five dollars (\$25). (3-20-20)T

**161. -- 899. (RESERVED)**

**900. WAIVER OF FEES.**

Upon written application to the Director of the Department of Environmental Quality, a waiver of a specific fee may be granted to an applicant who is required by these rules to pay such a fee. (3-20-20)T

**01. Determination of Good Cause.** Good cause for such a waiver must be shown before it shall be granted by the Director. Good cause may include hardship or extenuating circumstances, as determined by the Director. (3-20-20)T

**02. Duration of Waiver.** If the fee sought to be waived becomes due periodically, the fee may be waived for a designated period of time. (3-20-20)T

**03. Limitations.** Granting of a waiver shall not be considered as precedent or be given any force or effect in any other proceeding. (3-20-20)T

**901. -- 999. (RESERVED)**

## 58.01.18 – IDAHO LAND REMEDIATION RULES

### 000. LEGAL AUTHORITY.

Pursuant to the provisions of Sections 39-105, 39-107, 39-4405, 39-7210, Idaho Code, the Department of Environmental Quality has the authority to promulgate and adopt rules to carry out the purposes of the Idaho Land Remediation Act, Sections 39-7201 to 39-7210, Idaho Code. (3-20-20)T

### 001. TITLE AND SCOPE.

**01. Title and Scope.** These rules are titled IDAPA 58.01.18, “Idaho Land Remediation Rules,” and shall be applicable to eligible persons who wish to enter into a voluntary remediation agreement with the state to minimize risk of harm to public health and the environment and to restore the economic viability of contaminated real property. (3-20-20)T

**02. Intent.** The Idaho Land Remediation rules have been adopted with the purpose of fostering the remediation, transfer, reuse, or redevelopment of sites or groups of sites based on risk to human health and the environment where releases or threatened release of hazardous substances or petroleum exists. It is also the intent of these rules to establish a voluntary program for the remediation of hazardous substance or petroleum contaminated sites that will encourage innovation and cooperation between the state, local communities, and interested persons and will promote the economic revitalization of property. It is intended that this program will provide for an expedited remediation process by eliminating the need for many adversarial enforcement actions and delays in response action plan approvals. (3-20-20)T

### 002. WRITTEN INTERPRETATIONS.

As described in Section 67-5201(19)(b)(iv), Idaho Code, the Department of Environmental Quality may have written statements which pertain to the interpretation of the rules of this chapter. If available, such written statements can be inspected and copied at cost at the Department of Environmental Quality, 1410 N. Hilton, Boise, Idaho 83706-1255. (3-20-20)T

### 003. ADMINISTRATIVE APPEALS.

Persons may be entitled to appeal agency actions authorized under these rules pursuant to IDAPA 58.01.23, “Rules of Administrative Procedure Before the Board of Environmental Quality.” (3-20-20)T

### 004. -- 009. (RESERVED)

### 010. DEFINITIONS AND ABBREVIATIONS.

For the purpose of the rules contained in IDAPA 58.01.18, the following definitions and abbreviations apply. (3-20-20)T

- 01. Act.** Idaho Land Remediation Act, Title 39, Chapter 72, Idaho Code. (3-20-20)T
- 02. Applicant.** A person who submits an application to participate in the voluntary remediation program under the Idaho Land Remediation Act, Title 39, Chapter 72, Idaho Code. (3-20-20)T
- 03. Board.** The Idaho Board of Environmental Quality. (3-20-20)T
- 04. Department.** The Idaho Department of Environmental Quality. (3-20-20)T
- 05. Director.** The Director of Idaho Department of Environmental Quality or his authorized agent. (3-20-20)T
- 06. Hazardous Substance.** Has the meaning set forth in Section 101(14) of the Comprehensive Environmental, Response, Compensation and Liability Act (CERCLA), 42 U.S.C. 9601 (14), as amended. (3-20-20)T
- 07. Natural Background Level.** The level of any constituent in the affected media within a specified area as determined by representative measurements of the quality of that media unaffected by human activities. (3-20-20)T
- 08. Person.** Any individual, association, partnership, firm, joint stock company, trust, estate, political subdivision, public or private corporation, state or federal governmental department, agency or instrumentality, or any other legal entity which is recognized by law as the subject of rights and duties. (3-20-20)T

**09. Petroleum.** Includes petroleum asphalt and crude oil or any part of petroleum asphalt or crude oil that is liquid at standard conditions of temperature and pressure (sixty (60) degrees Fahrenheit and fourteen and seven-tenths (14.7) pounds per square inch absolute). (3-20-20)T

**10. Release.** Any spilling, leaking, pumping, pouring, emitting, emptying, discharging, injecting, escaping, leaching, dumping, or disposing into the environment, including the abandonment or discarding of barrels, containers, or other closed receptacles containing any hazardous substance or petroleum. (3-20-20)T

**11. Remediation.** Remediation means any of the following: (3-20-20)T

**a.** Actions necessary to prevent, minimize, or mitigate damages to the public health or welfare or to the environment, which may otherwise result from a release or threat of a release; or (3-20-20)T

**b.** Actions consistent with a permanent remedy taken instead of, or in addition to, removal actions in the event of a release or threatened release of a hazardous substance or petroleum into the environment to eliminate the release of hazardous substances or petroleum so that the hazardous substances or petroleum do not migrate to cause substantial danger to present or future public health or welfare or the environment; or (3-20-20)T

**c.** The cleanup or removal of released hazardous substances or petroleum from the environment. (3-20-20)T

**12. Site.** A parcel of real estate for which an application has been submitted under Section 39-7204, Idaho Code. (3-20-20)T

**011. -- 019. (RESERVED)**

**020. APPLICATION TO PARTICIPATE.**

**01. Application Required.** In order to participate in the voluntary remediation program as established by the Idaho Land Remediation Act and these rules, a person shall submit an application to the Department. (3-20-20)T

**02. Contents of Application.** The application shall be on a form provided by the Department and include, or be accompanied by, the following: (3-20-20)T

**a.** Identification of the applicant and the applicant's relationship to the site; (3-20-20)T

**b.** Identification of the owner or operator of the site, if different than Subsection 020.02.a. of these rules; (3-20-20)T

**c.** General information pertaining to the site, including the assessors's parcel number(s), site name, and location; (3-20-20)T

**d.** An environmental assessment that conforms to ASTM Standard Practice E 1527, Environmental Site Assessments: Phase I Environmental Site Assessment Process, as amended, or equivalent; (3-20-20)T

**e.** An application fee in the amount of two hundred and fifty dollars (\$250); and (3-20-20)T

**f.** Other background information as requested on the application form provided by the Department as necessary to determine eligibility to participate in the voluntary remediation program. (3-20-20)T

**03. Application Processing Procedure.** (3-20-20)T

**a.** Not more than thirty (30) days after receiving an application the Department shall determine if the applicant is eligible to participate in the voluntary remediation program and notify the applicant of the Department's decision. If the Department fails to comply with this subsection, the applicant shall be considered eligible for the purposes of these rules. (3-20-20)T

b. As specifically set forth in the Department's application form, an application may be rejected for the reasons set forth in Section 39-7204(4), Idaho Code. (3-20-20)T

c. Rejection of an application for any of the reasons set forth in Section 39-7204(4)(a), Idaho Code, or Section 39-7204(4)(b), Idaho Code, is a final agency action. (3-20-20)T

**021. VOLUNTARY REMEDIATION AGREEMENTS.**

**01. Negotiation of Voluntary Remediation Agreement.** If the Department accepts an application pursuant to Section 39-7204, Idaho Code, the applicant may enter into a voluntary remediation agreement with the Department. The Department shall not evaluate a voluntary remediation work plan until the voluntary remediation agreement is signed by the applicant and the Director. (3-20-20)T

**02. Contents of Agreement.** The voluntary remediation agreement shall include the following: (3-20-20)T

a. A provision for the Department's oversight including access to site and pertinent site records; (3-20-20)T

b. A timetable for the Department to do the following: (3-20-20)T

i. Reasonably review and evaluate the adequacy of the work plan; (3-20-20)T

ii. Make a determination concerning the approval or rejection of the work plan; (3-20-20)T

iii. Identify, to the extent possible, permits or approvals required to initiate and complete a voluntary remediation work plan. (3-20-20)T

c. A provision to modify the voluntary remediation agreement and voluntary remediation work plan based upon unanticipated site conditions; (3-20-20)T

d. An estimation of costs the Department may incur associated with performing all of the tasks, duties and services related to the relevant application or voluntary remediation program activities, as specified in Subsection 021.04 of these rules; (3-20-20)T

e. A mechanism and schedule for the payment of all actual reasonable costs incurred by the Department in the review and oversight of the work plan; (3-20-20)T

f. A requirement that the applicant shall comply with any applicable zoning authorities or other local, state, or federal law, in implementing the voluntary remediation work plan; (3-20-20)T

g. Any other conditions considered necessary by the Department or the applicant concerning the effective and efficient implementation of these rules. (3-20-20)T

**03. Reimbursement of Costs Included in Agreement.** (3-20-20)T

a. The voluntary remediation agreement shall include a provision for the payment and accounting of reasonable oversight costs incurred by the Department in connection with the person's application and participation in the voluntary remediation program. (3-20-20)T

b. Costs incurred by the Department for oversight of voluntary remediation actions will be reimbursed in the following manner, which shall be specified in the voluntary remediation agreement. (3-20-20)T

i. The applicant shall deposit two thousand five hundred dollars (\$2,500) with the Department. (3-20-20)T

ii. The unused portion of the deposit will be returned to the applicant within sixty (60) days of

Department issuance of a certificate of completion. (3-20-20)T

iii. Should funding be required for costs incurred in excess of the initial two thousand five hundred dollars (\$2,500) deposit, the Department will, in advance, notify the applicant of required successive deposits in the amount of two thousand five hundred dollars (\$2,500). (3-20-20)T

**04. Oversight Costs.** Oversight costs shall include the following: (3-20-20)T

a. The review, processing and negotiation of the voluntary remediation agreement; (3-20-20)T

b. The review, processing and negotiation of the voluntary remediation work plan; (3-20-20)T

c. Conducting public hearing and dissemination of public notices; (3-20-20)T

d. Oversight of work performed in accordance with the voluntary remediation work plan; (3-20-20)T

e. Issuance of the certificate of completion; (3-20-20)T

f. Issuance of a covenant not to sue; (3-20-20)T

g. Administrative expenses associated with cost recovery activities. (3-20-20)T

**05. Enforceability of Agreement.** Upon signing of the voluntary remediation agreement by the Department and the applicant, the voluntary remediation agreement shall constitute a contract between the Department and the applicant enforceable in accordance with its terms, subject to: (3-20-20)T

a. The Department's right to rescind the voluntary remediation agreement as provided in Section 39-7208, Idaho Code; and (3-20-20)T

b. The applicant's right to terminate the voluntary remediation agreement under Subsection 021.06 of these rules. (3-20-20)T

**06. Reasons for Which a Person May Terminate a Voluntary Remediation Agreement.** An applicant may terminate the voluntary remediation agreement for any of the following reasons: (3-20-20)T

a. The applicant decides to terminate the voluntary remediation agreement rather than submit additional or corrected information to the Department as provided in Section 39-7206(2)(b), Idaho Code; or (3-20-20)T

b. The voluntary remediation work plan is modified or rejected as provided in Section 39-7206(5), Idaho Code. (3-20-20)T

**07. Effect of Termination of Agreement.** The termination of a voluntary remediation agreement as provided in Section 39-7206, Idaho Code, shall not relieve the applicant from the obligation to comply with any applicable authorities regarding the contamination at the site, and the Department may initiate administrative or judicial action under applicable authorities. (3-20-20)T

## **022. VOLUNTARY REMEDIATION WORK PLAN.**

**01. Submittal of Proposed Voluntary Remediation Work Plan.** An applicant whose application has been accepted by the Department may submit a proposed voluntary remediation work plan to the Department. The Department will evaluate the work plan according to the terms and conditions of a voluntary remediation agreement signed by the Department and the applicant. (3-20-20)T

**02. Contents of Voluntary Remediation Work Plan.** The voluntary remediation work plan shall include the following: (3-20-20)T



- a. The current and reasonably anticipated future use of on-site ground and surface water; (3-20-20)T
  - b. The current and reasonably anticipated future uses of the site and immediately adjacent properties; (3-20-20)T
  - c. If a risk-based concentration is proposed as a remediation standard, the voluntary remediation work plan shall include an estimate of the human and environmental risk from releases or threatened releases of hazardous substances or petroleum at the site based upon the current use of the site and adjacent properties and reasonably anticipated future uses of the site; (3-20-20)T
  - d. Proposed remediation standards developed in accordance with Section 023 of these rules; (3-20-20)T
  - e. A proposed statement of work; (3-20-20)T
  - f. A schedule to accomplish the proposed statement of work. (3-20-20)T
- 03. Information Supporting the Voluntary Remediation Work Plan.** Sufficient information to support the voluntary remediation work plan shall be submitted and may include the following: (3-20-20)T
- a. Site assessment information including: (3-20-20)T
    - i. A legal description of the site and a map identifying the location and size of facilities and relevant features, such as property boundaries, surface topography, surface and subsurface structures, and utility lines; (3-20-20)T
    - ii. The physical characteristics of site facilities and contiguous areas, including the location of any surface water bodies and ground water aquifers; (3-20-20)T
    - iii. The location of any wells located on the site or on areas within one-half mile radius of the site and a description of the use of those wells; (3-20-20)T
    - iv. The operational history of the facility, including ownership, and the current use of the facility; (3-20-20)T
    - v. Information on the methods and results of investigations concerning the nature and extent of any releases or threatened releases of hazardous substances or petroleum that have occurred at the site and a map showing general areas of concentrations of these hazardous substances or petroleum; (3-20-20)T
    - vi. A site investigation sampling and analysis plan, and quality assurance project plan; (3-20-20)T
    - vii. Any sampling results or other data that characterizes the soil, air, ground water, surface water, or sediments on the site; and (3-20-20)T
    - viii. Available information on the environmental regulatory and compliance history of the site, including all applicable environmental permits. (3-20-20)T
  - b. Risk evaluation information including: (3-20-20)T
    - i. An evaluation of the data collected during the site investigation including identification of chemicals of potential concern; (3-20-20)T
    - ii. An exposure assessment of all potential pathways of exposure; (3-20-20)T
    - iii. A toxicity assessment estimating the toxicity of both carcinogens and non-carcinogens; (3-20-20)T
    - iv. Identify site conditions which may affect or limit migration of the contamination; and (3-20-20)T

v. A risk characterization that evaluates the uncertainties associated with the site investigation, the likelihood of exposures, and the toxicity of the contaminants. (3-20-20)T

**04. Review and Evaluation of Work Plan.** The Department shall review and evaluate the voluntary remediation work plan, provide public notice, accept public comments and may make the determination whether to hold public hearings in accordance with Section 39-7206, Idaho Code, and the voluntary remediation agreement. (3-20-20)T

**a.** For purposes of determining whether to hold a public hearing in accordance with Section 39-7206, Idaho Code, the Department will consider the following a significant number of requests for a public hearing: (3-20-20)T

i. Twenty-five (25) written requests from potentially affected persons; or (3-20-20)T

ii. One (1) or more written requests from an organization representing twenty-five (25) or more potentially affected members. (3-20-20)T

**b.** The Department shall provide for a public comment period of at least thirty (30) days following publication of a public notice under Section 39-7206(3)(d), Idaho Code. (3-20-20)T

**c.** Pursuant to Section 39-7206, Idaho Code, the Department may approve, modify and approve, or reject a voluntary remediation work plan. (3-20-20)T

**d.** The Department may reject or approve with modification any voluntary remediation work plan that does not achieve the remediation standards developed and approved by the Department pursuant to Section 023 of these rules. (3-20-20)T

**e.** If the Department rejects a voluntary remediation work plan, the Department shall: (3-20-20)T

i. Notify the applicant and specify the reasons for rejection; (3-20-20)T

ii. Provide the applicant an opportunity according to the schedule in the voluntary remediation agreement to amend the work plan; and (3-20-20)T

iii. The applicant may appeal the Department's decision to reject the work plan as provided in Section 39-7206, Idaho Code. (3-20-20)T

**f.** If an applicant determines not to amend a rejected work plan to the satisfaction of the Department, the voluntary remediation agreement shall be terminated as provided in Subsection 021.06 of these rules. (3-20-20)T

**05. Modification to an Approved Voluntary Remediation Work Plan That Requires Additional Public Notice and Comment.** After the close of the public comment period and the Department's approval of the voluntary remediation work plan, situations may arise that result in modification of an approved voluntary remediation work plan. Depending upon the significance of the modification, another opportunity for public notice and comment may be appropriate. (3-20-20)T

**a.** The Department need not provide for an additional public notice and comment period if the proposed modifications to the voluntary remediation work plan are limited to minor changes. A minor change to the voluntary remediation work plan is a change that does not fundamentally alter the overall remedial approach. (3-20-20)T

**b.** The Department shall provide for an additional public notice and comment period if the proposed modifications to the voluntary remediation work plan are fundamental. A fundamental change is a change that requires reconsideration of the remediation proposed in the approved voluntary remediation work plan. (3-20-20)T

**023. REMEDIATION STANDARDS.**

**01. Voluntary Remediation Work Plan Must Achieve Health-Based and Environmental Remediation Standards.** All hazardous substance or petroleum concentrations in media which exceed the health-based and environmental remediation standards shall be addressed through appropriate remediation and in accordance with the appropriate technical standards based upon the following: (3-20-20)T

- a. Site characteristics; (3-20-20)T
- b. Hazardous substances or petroleum; and (3-20-20)T
- c. Technical guidance approved by the Department. (3-20-20)T

**02. Establishment of Remediation Standards.** The remediation standards utilized in these rules shall be no more stringent than applicable or relevant and appropriate federal and state standards and are consistent with 42 U.S.C. 9621, taking into consideration site specific conditions. An applicant who submits a voluntary remediation work plan for approval by the Department shall select and attain compliance with one (1) or more of the following remediation standards when implementing a voluntary remediation work plan: (3-20-20)T

a. Attainment of a natural background level demonstrated by the collection and analysis of representative samples from environmental media of concern where contamination occurs. Evaluation of representative samples shall be conducted through the application of statistical tests specified in a voluntary remediation work plan. (3-20-20)T

b. An established state or federal generic numerical health standard which achieves an appropriate health-based level so that any substantial present or probable future risk to human health or the environment is eliminated or reduced to protective levels based upon present and reasonably anticipated future uses of the site. (3-20-20)T

c. Risk-based concentrations calculated for the hazardous substance or petroleum using site-specific risk assessment procedures. (3-20-20)T

d. An applicant may use a combination of standards from Subsections 023.02.a. through 023.02.c. to implement a voluntary remediation work plan. (3-20-20)T

**024. IMPLEMENTATION OF VOLUNTARY REMEDIATION WORK PLAN.**

**01. Implementation.** An approved voluntary remediation work plan shall be fully implemented by the applicant according to the terms and conditions of the voluntary remediation agreement, these rules and the Idaho Land Remediation Act. (3-20-20)T

**02. Permits or Approvals Necessary for Implementation.** The Department shall assist in the timely issuance of Department permits or approvals required to initiate and complete a voluntary remediation work plan. (3-20-20)T

**03. Progress Reports.** An applicant implementing a voluntary remediation work plan shall submit periodic progress reports to the Department according to the terms and conditions of the voluntary remediation agreement. (3-20-20)T

**04. Voluntary Remediation Work Plan Completion Report.** When the applicant believes the objectives of the voluntary remediation work plan have been achieved and successfully implemented, the applicant shall submit to the Department a voluntary remediation work plan completion report together with a request that the Department issue a certificate of completion. (3-20-20)T

a. The voluntary remediation work plan completion report shall contain information sufficient for the Department to determine whether the voluntary remediation work plan objectives were achieved and the voluntary remediation work plan was successfully implemented. (3-20-20)T

**b.** The Department shall, within thirty (30) days of the receipt of a voluntary remediation work plan completion report and a request for a certificate of completion, notify the applicant whether the voluntary remediation work plan has been successfully implemented. (3-20-20)T

**c.** If the Department notifies the applicant that the voluntary remediation work plan has not been successfully implemented, the applicant shall do the following: (3-20-20)T

**i.** Implement the voluntary remediation work plan to the satisfaction of the Department; and (3-20-20)T

**ii.** Resubmit the voluntary remediation work plan completion report. (3-20-20)T

**d.** If a voluntary remediation work plan completion report demonstrates that the voluntary remediation work plan has been successfully implemented, the Department shall certify such facts by issuing the applicant a certificate of completion. The applicant shall record the certificate of completion with the deed for the site on which the remediation took place. (3-20-20)T

**e.** The Department may provide a certificate of completion conditioned upon continued monitoring, recordation or maintenance of institutional or engineering controls, or other continuing actions by the applicant. (3-20-20)T

**f.** Decisions by the Department involving the voluntary remediation work plan completion reports required under this section are considered final agency actions. (3-20-20)T

## **025. COVENANT NOT TO SUE.**

**01. Negotiation and Provision of Covenant.** Within thirty (30) days of receipt of the Department's certificate of completion, the applicant may request the Department negotiate and provide a covenant not to sue as provided in Section 39-7207, Idaho Code. Any such covenant not to sue may be conditioned upon continuing monitoring, recordation or maintenance of institutional or engineering controls, or other continuing actions required of the applicant pursuant to an approved voluntary remediation work plan. (3-20-20)T

**02. Rescission of Covenant.** The Department may rescind a covenant not to sue in accordance with Section 39-7208, Idaho Code. If the Department rescinds a covenant not to sue, it may initiate administrative or judicial action as provided in Sections 39-7207 and 39-7208, Idaho Code. The Department shall also notify the county in which the site exists of rescission of the covenant not to sue for purposes of determining ad valorem exemptions provided under Section 63-105II, Idaho Code. (3-20-20)T

**03. Continuing Compliance.** During the implementation of an approved voluntary remediation work plan, the Department shall not bring an action, including an administrative or judicial action for any liability for remediation relating to the release or threatened release of a hazardous substance or petroleum that is the subject of the voluntary remediation work plan, against a person who entered into a voluntary remediation agreement and who is implementing the voluntary remediation work plan in accordance with such agreement implementing the voluntary remediation work plan. (3-20-20)T

## **026. LENDER LIABILITY.**

**01. General Statement.** Pursuant to Section 39-7209, Idaho Code, a person who maintains indicia of ownership primarily to protect a security interest in a site, as defined in Subsection 010.12 of these rules, and who does not participate in the management of the site, shall not be considered an owner or operator of that site, nor liable under any pollution control or other environmental protection law, rule or regulation, or otherwise responsible for any environmental contamination or response activity costs consistent with United States environmental protection agency policy, 60 Federal Register 63517, dated December 11, 1995, as amended. This Section 026 sets out the rules of the Board regarding lender liability pursuant to Sections 39-7209 and 39-7210(6), Idaho Code. (3-20-20)T

**02. Definitions and Operative Provisions.** (3-20-20)T

**a.** “Indicia of ownership” means evidence of a security interest, evidence of an interest in a security interest, or evidence of an interest in real or personal property securing a loan or other obligation, including any legal or equitable title or deed to real or personal property acquired through or incident to foreclosure or its equivalents. Evidence of such interests include, but are not limited to, mortgages, deeds of trust, liens, surety bonds and guaranties of obligations, title held pursuant to a lease financing transaction in which the lessor does not select initially the leased property (hereinafter “lease financing transaction”), legal or equitable title obtained pursuant to foreclosure, and their equivalents. Evidence of such interests also includes assignments, pledges or other rights to or other forms of encumbrance against property that are held primarily to protect a security interest. A person is not required to hold title or a security interest in order to maintain indicia of ownership. (3-20-20)T

**i.** A “holder” is a person who maintains indicia of ownership primarily to protect a security interest in a site. A holder includes the initial holder (such as a loan originator); any subsequent holder (such as a successor-in-interest or subsequent purchaser of the security interest on the secondary market); a guarantor of an obligation, surety, or any person who holds ownership indicia primarily to protect a security interest; or a receiver or other person who acts on behalf or for the benefit of a holder. (3-20-20)T

**ii.** A “borrower,” “debtor,” or “obligor” is a person who owns, leases, occupies or operates a site encumbered by a security interest. (3-20-20)T

**b.** “Primarily to protect a security interest” means that the holder’s indicia of ownership are held primarily for the purpose of securing payment or performance of an obligation. (3-20-20)T

**i.** “Security interest” means an interest in a site, created or established for the purpose of securing a loan or other obligation. Security interests include, but are not limited to, mortgages, deeds of trust, liens, security interests under Article 9 of the Uniform Commercial Code, and title pursuant to lease financing transactions. (3-20-20)T

**ii.** “Primarily to protect a security interest” does not include indicia of ownership held primarily for investment purposes, nor ownership indicia held primarily for purposes other than as protection for a security interest. A holder may have other, secondary reasons for maintaining indicia of ownership, but the primary reason why any ownership indicia are held must be as protection for a security interest. (3-20-20)T

**c.** Participation in management defined. The term “participating in the management of a site” means that the holder is engaging in acts of site management, as defined herein. (3-20-20)T

**i.** Actions that are participation in management. Participating in the management of a site means actual participation by the holder in the management or operational affairs of the site by the holder, and does not include the mere capacity or ability to influence, or the unexercised right to control, site operations. A holder is participating in management, while the borrower is still in possession of the site encumbered by the security interest, only if the holder either: (3-20-20)T

(1) Exercises decision making control over the borrower’s environmental compliance, such that the holder has undertaken responsibility for the borrower’s hazardous substance or petroleum handling or disposal practices; or (3-20-20)T

(2) Exercises control at a level comparable to that of a manager of the borrower’s enterprise, such that the holder has assumed or manifested responsibility for the overall management of the enterprise encompassing the day-to-day decision making of the enterprise with respect to (1) environmental compliance or (2) all, or substantially all, of the operational (as opposed to financial or administrative) aspects of the enterprise other than environmental compliance. (3-20-20)T

**ii.** Actions that are not participation in management. (3-20-20)T

(1) Actions at the inception of the loan or other transaction. No act or omission prior to the time that indicia of ownership are held primarily to protect a security interest constitutes evidence of participation in management. A prospective holder who undertakes or requires an environmental inspection of the site or to comply or come into compliance (whether prior or subsequent to the time that indicia of ownership are held primarily to

protect a security interest) with any applicable law or regulation, is not by such action considered to be participating in the site's management. Neither Section 39-7209, Idaho Code, or these rules require a holder to conduct or require an inspection to qualify for the exemption, and the liability of a holder cannot be based on or affected by the holder not conducting or not requiring an inspection. (3-20-20)T

(2) Loan policing and workout. Actions that are consistent with holding ownership indicia primarily to protect a security interest do not constitute participation in management. The authority for the holder to take such actions may, but need not, be contained in contractual or other documents specifying requirements for financial, environmental and other warranties, covenants, conditions, representations or promises from the borrower. Loan policing and workout activities cover and include all activities up to foreclosure and its equivalents. (3-20-20)T

(a) Policing the security interest or loan. A holder who engages in policing activities prior to foreclosure will remain within the exemption provided that the holder does not by such actions participate in the management of the site. Such actions include, but are not limited to, requiring the borrower to clean up the site during the term of the security interest; requiring the borrower to comply or come into compliance with applicable federal, state and local environmental and other laws, rules and regulations during the term of the security interest; securing or exercising authority to monitor or inspect the site (including on-site inspections) in which indicia of ownership are maintained, or the borrower's business or financial condition during the term of the security interest; or taking other actions to adequately police the loan or security interest (such as requiring a borrower to comply with any warranties, covenants, conditions, representations or promises from the borrower). (3-20-20)T

(b) Policing activities also include any activities taken by the holder to require a borrower to comply with a voluntary remediation work plan, or by agreement with the Department, to complete a voluntary remediation work plan, provided that the holder does not otherwise participate in the management of the site. (3-20-20)T

(c) Loan workout. A holder who engages in workout activities prior to foreclosure and its equivalents will remain within the exemption provided that the holder does not by such action participate in the management of the site. For purposes of this rule, "workout" refers to those actions by which a holder, at any time prior to foreclosure and its equivalents, seeks to prevent, cure or mitigate a default by the borrower or obligor, or to preserve, or prevent the diminution of, the value of the security. (3-20-20)T

**d.** Foreclosure on a site and post-foreclosure activities. (3-20-20)T

i. Foreclosure. Indicia of ownership that are held primarily to protect a security interest include legal or equitable title or deed to real or personal property acquired through or incident to foreclosure and its equivalents. "Foreclosure and its equivalents" includes purchase at foreclosure sale; acquisition or assignment of title in lieu of foreclosure; termination of a lease or other repossession; acquisition to a right to title or possession; an agreement in satisfaction of the obligation; or any other formal or informal manner (whether pursuant to law or under warranties, covenants, conditions, representations or promises from the borrower) by which the holder acquires title to or possession of the secured property. The indicia of ownership held after foreclosure continue to be maintained primarily as protection for a security interest, provided that the holder undertakes to sell, re-lease or otherwise divest itself of the site, in a reasonably expeditious manner, using whatever commercially-reasonable means are relevant or appropriate with respect to the site, taking all facts and circumstances into consideration, and provided that the holder did not participate in management prior to foreclosure. (3-20-20)T

ii. Holding foreclosed property for disposition and liquidation. A holder, who did not participate in management prior to foreclosure and its equivalents, may sell, re-lease, liquidate, maintain business activities, wind up operations, undertake any response action under federal, state or local environmental laws, rules or regulations, undertake completion of an approved voluntary remediation work plan by agreement with the Department, and take measures to preserve, protect or prepare the secured asset prior to sale or other disposition, without voiding the exemption provided by Section 39-7209, Idaho Code, and these rules. (3-20-20)T

## **027. INSTITUTIONAL CONTROLS.**

**01. Purpose.** (3-20-20)T

**a.** Institutional controls may be proposed by the applicant or the Department as an element of the

voluntary remediation work plan. Institutional controls are measures undertaken to limit or prohibit activities that may interfere with the integrity of a cleanup action or result in exposure to hazardous substances or petroleum at a site. Such measures may be used to assure both the continued protection of human health and the environment and the integrity of a cleanup action in at least the following circumstances: (3-20-20)T

**b.** Where a cleanup action results in residual concentrations of hazardous substances or petroleum which exceed risk-based health standards; or (3-20-20)T

**c.** When the Department determines such controls are required to assure the continued protection of human health and the environment or the integrity of the cleanup action. (3-20-20)T

**02. Prohibition of Use.** Institutional controls should not be used as a substitute for cleanup actions that would otherwise be technically possible. (3-20-20)T

**03. Institutional Controls.** For the purposes of this section, institutional controls may include: (3-20-20)T

**a.** Physical measures, such as fences and signs, to limit activities that may interfere with the cleanup action or result in exposure to hazardous substances at the site; and (3-20-20)T

**b.** Legal and administrative controls, such as zoning restrictions, restrictive covenants, or equitable servitudes used to ensure such measures are maintained. (3-20-20)T

**04. Legal Use Restrictions.** Institutional controls may be described in an equitable servitude, restrictive covenant, or similar legal mechanism executed by the property owner and recorded in the county in which the site is located. The use of such legal use restrictions may be addressed in the voluntary remediation agreement, the certificate of completion, or the covenant not to sue. (3-20-20)T

**05. Legal Use Restriction Requirements.** Where appropriate, the legal use restriction requirement should: (3-20-20)T

**a.** Prohibit activities on the site that may interfere with a cleanup action, operation and maintenance, monitoring, or other measures necessary to assure the integrity of the cleanup action and continued protection of human health and the environment; (3-20-20)T

**b.** Prohibit activities that may result in the release of a hazardous substance or petroleum which was contained as a part of the remediation; (3-20-20)T

**c.** Require notice to the Department of the owner's intent to convey any interest in the site. Conveyance of title, easement, lease, or other interest in the property may be conditioned upon easement, lease, or other interest in the property for the continued operation, maintenance and monitoring of the cleanup action, and for continued compliance with this subsection; (3-20-20)T

**d.** Require notice and approval by the Department of any proposal to use the site in a manner which is inconsistent with the legal use restriction. (3-20-20)T

**e.** Grant the Department and its designated representatives the right to enter the property at reasonable times for the purpose of evaluating compliance with the voluntary remediation work plan and other required plans, including the right to take samples, inspect any remedial actions taken at the site, and to inspect records. (3-20-20)T

**f.** Contain other restrictions appropriate under the circumstances. (3-20-20)T

**06. Compliance With Other Laws.** It shall be the applicant's responsibility to comply with any applicable zoning authorities or other local, state, or federal law, in implementing the voluntary remediation work plan. (3-20-20)T

**07. Financial Assurances.** The Department may require the applicant to provide financial assurances,

through a trust fund or other appropriate financial mechanism approved by the Department sufficient to cover all costs for ensuring the effectiveness of institutional controls or of operation and maintenance, including compliance monitoring and undertaking appropriate measures to ensure the integrity of institutional controls. (3-20-20)T

**08. Removal of Restrictions.** If the residual hazardous substances or petroleum remaining at the site are subsequently reduced in concentration such that risk-based health standards are met, then the owner may request the restrictive covenant or other restrictions be voided. The restrictive covenant or other restrictions may be removed, if the Department, after public notice and opportunity for comment, concurs. (3-20-20)T

**028. -- 999. (RESERVED)**



## 58.01.20 – RULES FOR ADMINISTRATION OF DRINKING WATER LOAN PROGRAM

### 000. LEGAL AUTHORITY.

The Idaho State Board of Environmental Quality, pursuant to authority granted in Chapters 1 and 76, Title 39, Idaho Code, adopted the following rules for the administration of a Drinking Water Loan Program in Idaho. (3-20-20)T

### 001. TITLE AND SCOPE.

**01. Title.** These rules are titled, IDAPA 58.01.20, “Rules for Administration of Drinking Water Loan Program.” (3-20-20)T

**02. Scope.** The provisions of these rules shall establish administrative procedures and requirements for establishing, implementing, and administering a state loan program to provide financial assistance to qualifying entities of public water system facilities. The U.S. Environmental Protection Agency provides annual capitalization grants to the state of Idaho for this program. Financial assistance projects must be in conformance with the requirements of the Safe Drinking Water Act (42 U.S.C. Section 300f et seq.). (3-20-20)T

### 002. WRITTEN INTERPRETATIONS.

As described in Idaho Code Section 67-5201(19)(b)(iv), the Department of Environmental Quality may have written statements which pertain to the interpretation of these rules. If available, such written statements can be inspected and copied at cost at the Department of Environmental Quality, 1410 N. Hilton, Boise, Idaho 83706-1255. (3-20-20)T

### 003. ADMINISTRATIVE APPEALS.

Persons may be entitled to appeal agency actions authorized under these rules pursuant to IDAPA 58.01.23, “Rules of Administrative Procedure Before the Board of Environmental Quality.” (3-20-20)T

### 004. POLICY.

It is the policy of the Idaho Board of Environmental Quality, through the Idaho Department of Environmental Quality, to administer the Drinking Water Loan Program. The Drinking Water Loan Program provides assistance to eligible public drinking water systems for the planning, design, and construction of facilities to ensure safe and adequate drinking water. It is also the intent of the Idaho Board of Environmental Quality to assign a priority rating to those projects which shall facilitate the compliance of any eligible public water system with national primary drinking water regulations applicable to the system or to otherwise significantly further the health protection objectives of these rules and the Safe Drinking Water Act (42 U.S.C. Section 300f et seq.). (3-20-20)T

### 005. INCORPORATION BY REFERENCE AND AVAILABILITY OF REFERENCED MATERIAL.

**01. Incorporation by Reference.** These rules do not contain documents incorporated by reference. (3-20-20)T

**02. Availability of Referenced Material.** The “Drinking Water Loan Handbook of Procedures” (Handbook) is available at the Idaho Department of Environmental Quality, Water Quality Division Loan Program, 1410 N. Hilton, Boise, ID 83706-1255, (208)373-0502, [www.deq.idaho.gov](http://www.deq.idaho.gov). (3-20-20)T

### 006. CONFIDENTIALITY.

Information obtained by the Department under these rules is subject to public disclosure pursuant to the provisions of Chapter 1, Title 74, Idaho Code, and IDAPA 58.01.21, “Rules Governing the Protection and Disclosure of Records in the Possession of the Idaho Department of Environmental Quality.” (3-20-20)T

### 007. SYSTEM ELIGIBILITY.

**01. Eligible Systems.** Public and private community water systems and nonprofit noncommunity water systems. (3-20-20)T

**02. Systems Not Eligible.** The following public drinking water systems will not be considered eligible for project loans: (3-20-20)T

**a.** Systems that do not have the technical, managerial, and financial capability to ensure compliance with the requirements of the Idaho Rules for Public Drinking Water Systems (IDAPA 58.01.08) and the Safe Drinking Water Act (42 U.S.C. Section 300f et seq.); (3-20-20)T

**b.** Systems in significant noncompliance with any requirement of the Idaho Rules for Public Drinking Water Systems (IDAPA 58.01.08) and the Safe Drinking Water Act (42 U.S.C. Section 300f et seq.); (3-20-20)T

c. Systems under disapproval designation as outlined in the Idaho Rules for Public Drinking Water Systems (IDAPA 58.01.08); (3-20-20)T

d. Systems under current drinking water enforcement action by the Department; or (3-20-20)T

e. Systems delinquent in payment of the annual state drinking water fee assessment. (3-20-20)T

**03. Assistance to Ensure Compliance.** Public water systems not eligible for project loans as described in Subsections 006.02.a. through 006.02.d. may receive assistance if: (3-20-20)T

a. The use of the assistance will ensure compliance; (3-20-20)T

b. The owner or operator of the system agrees to undertake feasible and appropriate changes in operations (including ownership, management, accounting, rates, maintenance, consolidation, alternative water supply, or other procedures); (3-20-20)T

c. The Department determines that the measures are necessary to ensure that the system has the technical, managerial, and financial capability to comply with state and federal drinking water requirements over the long term; and (3-20-20)T

d. Prior to providing assistance under this section to a public water system that is in significant noncompliance with any requirement of the Idaho Rules for Public Drinking Water Systems (IDAPA 58.01.08) and the Safe Drinking Water Act (42 U.S.C. Section 300f et seq.), the Department conducts a review to determine whether this section applies to the system. (3-20-20)T

**008. -- 009. (RESERVED)**

**010. DEFINITIONS.**

For the purpose of the rules contained in this chapter, the following definitions apply: (3-20-20)T

**01. Applicant.** Any qualifying entity making application for Drinking Water loan funds. (3-20-20)T

**02. Board.** The Idaho Board of Environmental Quality. (3-20-20)T

**03. Categorical Exclusion (CE).** Category of actions which do not individually or cumulatively have a significant effect on the human environment and for which, therefore, neither an environmental information document nor an environmental impact statement is required. (3-20-20)T

**04. Close or Closing.** The date on which the loan recipient issues and physically delivers to the Department the bond or note evidencing the loan to the loan recipient, specifically determining the principal, interest and fee amounts that shall be repaid and the schedule for payment. (3-20-20)T

**05. Community Water System.** A public drinking water system that: (3-20-20)T

a. Serves at least fifteen (15) service connections used by year round residents of the area served by the system; or (3-20-20)T

b. Regularly serves at least twenty-five (25) year-round residents. (3-20-20)T

**06. Construction.** The building, erection, acquisition, alteration, reconstruction, improvement, or extension of public drinking water system facilities, including preliminary planning to determine the economic and engineering feasibility of public drinking water system facilities, the engineering, architectural, legal, fiscal, and economic investigations, reports and studies, surveys, designs, plans, working drawings, specifications, procedures, other action necessary in the construction of public water system facilities, the inspection and supervision of the construction, and start-up of the associated facilities. (3-20-20)T

07. **Contaminant.** Any physical, chemical, biological, or radiological substance or matter in water. (3-20-20)T
08. **Department.** The Idaho Department of Environmental Quality. (3-20-20)T
09. **Director.** The Director of the Idaho Department of Environmental Quality or the Director's designee. (3-20-20)T
10. **Disadvantaged Community.** The service area of a public water system that meets affordability criteria established by the Department of Environmental Quality after public review and comment. (3-20-20)T
11. **Disadvantaged Loans.** Loans made to a disadvantaged community. (3-20-20)T
12. **Distribution System.** Any combination of pipes, tanks, pumps, and other equipment which delivers water from the source(s), treatment facility(ies), or a combination of source(s) and treatment facility(ies) to the consumer. Chlorination may be considered as a function of a distribution system. (3-20-20)T
13. **Eligible Costs.** Costs which are necessary for planning, designing, and/or constructing public water system facilities. To be eligible, costs must also be reasonable and not ineligible costs. The determination of eligible costs shall be made by the Department pursuant to Section 041. (3-20-20)T
14. **Eligible Systems.** Public and private community water systems and nonprofit noncommunity water systems. (3-20-20)T
15. **Environmental Impact Statement (EIS).** A document prepared by the applicant when the Department determines that the proposed drinking water construction project will significantly affect the environment. The major purpose of the EIS will be to describe fully the significant impacts of the project and how these impacts can be either avoided or mitigated. The Environmental Review Procedures contained in Chapter 5 of the Handbook may be used as guidance when preparing an EIS. (3-20-20)T
16. **Environmental Information Document (EID).** Any written environmental assessment prepared by the applicant describing the environmental impacts of a proposed drinking water construction project. This document will be of sufficient scope to enable the Department to assess the environmental impacts of the proposed project and ultimately determine if an environmental impact statement (EIS) is warranted. (3-20-20)T
17. **Financial Management System.** Uniform method of recording, summarizing, and analyzing financial information about the public water system facility. (3-20-20)T
18. **Finding Of No Significant Impact (FONSI).** A document prepared by the Department presenting the reasons why an action, not otherwise excluded, will not have a significant effect on the human environment and for which an environmental impact statement (EIS) will not be prepared. It shall include the environmental assessment or a summary of it and shall note any other environmental documents related to it. (3-20-20)T
19. **Handbook.** "Drinking Water Loan Handbook of Procedures." (3-20-20)T
20. **Ineligible Costs.** Costs which are not eligible for funding pursuant to these rules. (3-20-20)T
21. **Loan Recipient.** An applicant who has been awarded a loan. (3-20-20)T
22. **Managerial Capability.** The capabilities of the qualified entity to support the proper financial management and technical operation of the system. (3-20-20)T
23. **Maximum Contaminant Level (MCL).** The maximum permissible level of a contaminant in water which is delivered to any user of a public water system. (3-20-20)T
24. **Noncommunity Water System.** A public water system that is not a community water system. (3-20-20)T

- 25. Nonprofit Noncommunity Water System.** A public water system that is not a community water system and is governed by Section 501 of the U. S. Internal Revenue Code and includes but is not limited to: state agencies, municipalities, and nonprofit organizations such as churches and schools. (3-20-20)T
- 26. Nontransient Noncommunity Water System.** A public water system that is not a community water system and that regularly serves at least 25 (twenty-five) of the same persons over six (6) months per year. (3-20-20)T
- 27. Operation and Maintenance Manual.** Operation and Maintenance Manual is a guidance and training manual outlining the optimum operation and maintenance of the public water system facility or its components. (3-20-20)T
- 28. Person.** An individual, corporation, company, association, partnership, state agency, municipality, or federal agency (and includes officers, employees, and agents of any corporation, company, association, state agency, municipality, or federal agency). (3-20-20)T
- 29. Planning Document.** A document which describes the condition of a public drinking water system and presents a cost effective and environmentally sound alternative to achieve or maintain regulatory compliance. Engineering reports and facility plans are examples of such planning documents. The planning documents shall be prepared by or under the responsible charge of an Idaho licensed professional engineer and shall bear the imprint of the engineer's seal. Requirements for planning documents prepared using loan funds are provided in Section 030 of these rules and in the Handbook. (3-20-20)T
- 30. Plan of Operation.** A schedule of specific actions and completion dates for construction, start-up, and operation of the public water system facility. (3-20-20)T
- 31. Priority List.** A list of proposed drinking water projects rated by severity of risk to public health, the necessity to ensure compliance with IDAPA 58.01.08, "Idaho Rules for Public Drinking Water Systems," and the Safe Drinking Water Act (42 U.S.C. Section 300f et seq.), population affected, and need on a household basis for protection of Idaho's public drinking water. (3-20-20)T
- 32. Public Drinking Water System/Public Water System/Water System.** A system for the provision to the public of water for human consumption through pipes or, after August 5, 1998, other constructed conveyances, if such system has at least fifteen (15) service connections, regardless of the number of water sources or configuration of the distribution system, or regularly serves an average of at least twenty-five (25) individuals daily at least sixty (60) days out of the year. Such term includes: any collection, treatment, storage, and distribution facilities under the control of the operator of such system and used primarily in connection with such system; and any collection or pretreatment storage facilities not under such control which are used primarily in connection with such system. Such term does not include any "special irrigation district." A public water system is either a "community water system" or a "noncommunity water system." (3-20-20)T
- 33. Qualifying Entity.** Any county, city, special service district, nonprofit or investor-owned corporation, or other governmental entity, or a combination thereof, which owns or operates a public water system or irrigation system and which establishes and maintains a dedicated loan repayment source. (3-20-20)T
- 34. Rehabilitation.** The repair or replacement of segments of drinking water facilities. (3-20-20)T
- 35. Reserve Capacity.** That portion of the system in the planned facilities to handle future drinking water demand. (3-20-20)T
- 36. State.** The state of Idaho. (3-20-20)T
- 37. Supplier or Provider of Water.** Any person who owns and/or operates a public water system. (3-20-20)T
- 38. Suspension.** An action by the Director to suspend a loan contract prior to project completion for a

specified cause. Suspended contracts may be reinstated. (3-20-20)T

**39. Sustainability.** Sustainability will include efforts for energy and water conservation, extending the life of capital assets, green building practices, and other environmentally innovative approaches to infrastructure repair, replacement and improvement. (3-20-20)T

**40. Technical Capability.** The ability of the public drinking water system to comply with existing and expected drinking water rules. (3-20-20)T

**41. Termination.** An action by the Director to permanently terminate a loan contract prior to project completion for a specific cause. Terminated contracts shall not be reinstated. (3-20-20)T

**42. User Charge System.** A system of rates and service charges applicable to specific types of users, including any legal enforcement mechanism as may be required, which provides sufficient reserves and/or revenues for debt retirement, operation and maintenance, and replacement of the public water system. (3-20-20)T

**43. Water System Protection Ordinance.** An ordinance adopted pursuant to Chapter 32, Title 42, Idaho Code, or other applicable law which requires new connections to be properly designed and constructed, which prohibits cross-connections with non-potable water sources (and in all ways protects the water system from injection of contaminants), and which provides for fees for service from users or classes of users. (3-20-20)T

**44. Water Treatment Plant.** That portion of the public drinking water system whose primary purpose is to remove contaminants. (3-20-20)T

**011. FINANCIAL TECHNICAL AND MANAGEMENT CAPABILITY ANALYSIS.**

No loans shall be awarded for the construction of projects unless the applicant has demonstrated and certified that it has the legal, technical, institutional, managerial, and financial capabilities to ensure construction, operation and maintenance (including equipment replacement of the proposed public water system facility), and to repay principal and interest which would be due on a loan from the state revolving loan fund. (3-20-20)T

**01. Information Needed.** Before an application shall be considered complete, the applicant must submit all necessary information on a form prescribed by the Department along with an analysis of that information. The information shall include, but not be limited to, demographic information of the applicant, estimated construction costs, annual operating costs, and information regarding the financing of the project, including the legal debt limit of the applicant and the existence and amount of any outstanding bonds or other indebtedness which may affect the project. (3-20-20)T

**02. Incorporated Nonprofit Applicants.** (3-20-20)T

**a.** In addition to all other information required to be submitted by these rules and regulations, an incorporated nonprofit applicant must demonstrate to the satisfaction of the Department by its articles of incorporation and/or bylaws, that: (3-20-20)T

i. The corporation is nonprofit and lawfully incorporated pursuant to Chapter 03, Title 30, Idaho Code; (3-20-20)T

ii. The corporation is authorized to incur indebtedness to construct, improve, or repair public water systems facilities; (3-20-20)T

iii. The corporation is authorized to secure indebtedness by pledging corporation property, including any revenues raised through a user charge system; (3-20-20)T

iv. The corporation exists either perpetually or for a period long enough to repay a public water system facility loan; and (3-20-20)T

v. The corporation is capable of raising revenues by fixing and collecting user charges. (3-20-20)T

**b.** The Department may impose conditions on the making of a public water system facility loan to an incorporated nonprofit applicant which are necessary to carry out the provisions of these rules and regulations and the provisions of Chapter 76, Title 39, Idaho Code. (3-20-20)T

**03. Cost Allocation.** An applicant proposing to construct public water system facilities designed to serve two (2) or more qualifying entities must show how the costs shall be allocated among the participating entities. Such applicants must provide an executed inter-organizational service agreement which, at a minimum, incorporates the following information: (3-20-20)T

**a.** The basis upon which the costs are allocated; (3-20-20)T

**b.** The formula by which the costs are allocated; and (3-20-20)T

**c.** The manner in which the cost allocation system shall be implemented. (3-20-20)T

**04. Waivers.** The requirement in Subsection 011.03 may be waived by the Department if the applicant can demonstrate: (3-20-20)T

**a.** Such an agreement is already in place; (3-20-20)T

**b.** There is documentation of a service relationship in the absence of a formal agreement; or (3-20-20)T

**c.** The entity providing public drinking water exhibits sufficient financial strength to continue the project if one (1) or more of the entities supplying drinking water fails to participate. (3-20-20)T

**012. -- 019. (RESERVED)**

**020. PRIORITY RATING SYSTEM.**

Projects are identified for placement on priority lists by surveying eligible entities directly on an annual basis. Information is also received from the Department and consulting engineers. Loan funds are awarded to projects based on priority ratings. Projects are rated by the Department on a standard priority rating form using public health criteria, sustainability criteria, water quality criteria, and condition of the existing system. (3-20-20)T

**01. Purpose.** A priority rating system shall be utilized by the Department to annually allot available funds to projects determined eligible for funding assistance under the Drinking Water Loan Program in accordance with these rules. Projects considered for priority rating shall first be evaluated by Department regional staff. (3-20-20)T

**02. Priority Rating.** The priority rating system shall be based on a numerical points system. Priority criteria shall contain the following points: (3-20-20)T

**a.** Public Health Hazard. Any condition which creates, or may create, a danger to the consumer's health, which may include any one or more of the following, may be awarded a maximum of one hundred (100) points: (3-20-20)T

**i.** Documented unresolved violations of the primary drinking water standards including maximum contaminant levels, action levels, and treatment techniques (to include maximum contaminant levels for acute and chronic contaminants); (3-20-20)T

**ii.** Documented unresolved violations of pressure requirements; (3-20-20)T

**iii.** Documented reduction in source capacity that impacts the system's ability to reliably serve water; (3-20-20)T

or

**iv.** Documented significant deficiencies (e.g., documented in a sanitary survey) in the physical system that is causing the system to not reliably serve safe drinking water. (3-20-20)T

**b.** General Conditions of Existing Facilities. Points shall be given based on deficiencies (which would not constitute a public health hazard) for pumping, treating, and delivering drinking water. (up to sixty (60) points) (3-20-20)T

**c.** Sustainability Efforts (e.g., prospective efforts at energy conservation, water conservation, extending the life of capital assets, green building practices, and other environmentally innovative approaches to infrastructure repair, replacement and improvement). (up to fifty (50) points). (3-20-20)T

**d.** Consent Order, Compliance Agreement Schedule, or Court Order. Points shall be given if the system is operating under and in compliance with a Consent Order, Compliance Agreement Schedule, or Court Order and the proposed construction project will address the Consent Order, Compliance Agreement Schedule, or Court Order. (up to thirty (30) points) (3-20-20)T

**e.** Incentives. Bonus points shall be awarded to systems that promote source water protection, conservation, economy, proper operation maintenance, and monitoring. (up to ten (10) points) (3-20-20)T

**f.** Affordability. Points shall be given when current system user charges exceed state affordability guidelines. (ten (10) points) (3-20-20)T

**03. Rating Forms.** Rating criteria for Subsection 020.02 is set forth in a rating form that is available in the Handbook. (3-20-20)T

**04. Priority List.** A list shall be developed from projects rated according to Subsection 020.02. Such list shall be submitted for public review and comment, and shall thereafter be submitted to the Board for approval and adoption. (3-20-20)T

**a. Priority Reevaluation.** Whenever significant changes occur, which in the Department's judgment would affect the design parameters or treatment requirements by either increasing or decreasing the need for, or scope of any project, a reevaluation of that priority rating shall be conducted. (3-20-20)T

**b. Priority Target Date.** A qualifying entity, whose project is on the adopted priority list, and for which funding is available, shall be contacted by the Department and a target date for submission of a completed loan application shall be established. (3-20-20)T

**c. Project Bypass.** A project that does not or shall not meet the project target date or a Department schedule that allows for timely utilization of loan funds may be bypassed, substituting in its place the next highest ranking project or projects that are ready to proceed. An eligible applicant that is bypassed shall be notified in writing of the reasons for being bypassed. (3-20-20)T

**05. Amendment of Priority List.** The Director may amend the Integrated Priority List as set forth in Section 995 of these rules. (3-20-20)T

**021. DISADVANTAGED LOANS.**

Disadvantaged Loan Awards. In conjunction with the standard loans, the Department may award disadvantaged loans to applicants deemed disadvantaged using the following criteria: (3-20-20)T

**01. Qualifying for a Disadvantaged Loan.** In order to qualify for a disadvantaged loan, a loan applicant must have an annual user rater for drinking water service for residential customers which exceeds one and one-half percent (1½%) of the applicant community's median household income. The annual user rate would be based on all operating, maintenance, replacement, and debt service costs (both for the existing system and for upgrades). If the applicant's service area is not within the boundaries of a municipality, or if the applicant's service area's median household income is not consistent with the municipality as a whole, the applicant may use the census data for the county in which it is located or may use a representative survey, conducted by a Department approved, objective third party, to verify the median household income of the applicant's service area. (3-20-20)T

**02. Adjustment of Loan Terms.** DEQ will equally apportion funds available for principal forgiveness

to all prospective disadvantaged loan recipients. Consistent with achieving user rates of one and one-half percent (1½%) of the applicant community’s median household income, and where possible with available funds, loan terms may be adjusted in the following order: increasing the repayment period, decreasing the interest rate, and providing principal forgiveness. (3-20-20)T

**a.** Increasing Repayment Period. The length of the loan repayment may be extended in increments of years from twenty (20) years up to a maximum of thirty (30) years until the annual user rate equals one and one-half percent (1½%) of median household income. (3-20-20)T

**b.** Decreasing Interest Rate. If at a thirty (30) year repayment, the annual user rate still exceeds one and one-half percent (1½%) of the median household income, the loan interest rate may be reduced from the rate established by the Director for standard loans to a rate that results in an annual user rate equal to one and one-half percent (1½%) of median household income. The interest rate may be reduced to as low as zero percent (0%). (3-20-20)T

**c.** Principal Forgiveness. If even at zero percent (0%) interest and a thirty (30) year repayment, the annual user rate per residential user still exceeds one and one-half percent (1½%) of median household income, the principal which causes the user charge to exceed one and one-half percent (1½%) may be reduced except the principal reduction cannot exceed fifty percent (50%) of the total loan. Principal forgiveness terms may be revised (from initial estimates established in the annual Intended Use Plan) based upon final construction costs, such that loan terms do not result in user rates that are below one and one-half percent (1½%) of the applicant community’s median household income. (3-20-20)T

**022. -- 029. (RESERVED)**

**030. PROJECT SCOPE AND FUNDING.**

Loan funds awarded under this program may be used to prepare a drinking water facility planning document which identifies the cost effective and environmentally sound alternative to achieve or maintain compliance with IDAPA 58.01.08, “Idaho Rules for Public Drinking Water Systems,” and the Safe Drinking Water Act, 42 U.S.C., Sections 300f et seq., and which is approvable by the Department. Loan funds may also be used for design and construction of the chosen alternative. (3-20-20)T

**01. Project Step Funding.** Projects may be funded in steps: (3-20-20)T

**a.** Step 1. Planning document prepared by an Idaho licensed professional engineer who carries professional liability insurance in accordance with Subsection 050.05.d., and in a format prescribed by the Department; (3-20-20)T

**b.** Step 2. Design, which includes the preparation by an Idaho licensed professional engineer of the detailed engineering plans and specifications necessary for the bidding and construction of the project; (3-20-20)T

**c.** Step 3. Construction, which includes bidding and actual construction of the project; or (3-20-20)T

**d.** Step 4. A combination of Step 2 and Step 3. (3-20-20)T

**02. Combination Step Funding.** Projects may be funded in any combination of the steps with approval of the Department. Separate loans may be awarded for Step 1 or Step 2 projects. If a Step 1 or Step 2 project proceeds to construction, either the Step 1 or Step 2 loan, or both, may be consolidated with the Step 3 loan. If a project does not proceed to construction, outstanding Step 1 and Step 2 loans shall be amortized and a repayment schedule prepared by the Department. (3-20-20)T

**03. Requirements for Awarding a Loan.** Step 2, Step 3, or Step 4 loans shall not be awarded until a final cost effective and environmentally sound alternative has been selected by the Step 1 planning document and approved by the Department. If the planning document has not been completed pursuant to IDAPA 58.01.22, “Rules for Administration of Planning Grants for Drinking Water Facilities,” then the loan recipient shall provide an opportunity for the public to comment on the draft planning document. The public comment period shall be held after alternatives have been developed and the Department has approved the draft planning document. The loan recipient



shall provide written notice of the public comment period and hold at least one (1) public meeting within the jurisdiction of the loan recipient during the public comment period. At the public meeting, the draft planning document shall be presented by the loan recipient with an explanation of the alternatives identified. The cost effective and environmentally sound alternative selected shall consider public comments received from those affected by the proposed project. After the public meeting and public comment period, the final alternative will be selected and the Environmental Information Document will be prepared. (3-20-20)T

**04. Funding for Reserve Capacity.** Funding for reserve capacity of a drinking water system shall not exceed a twenty (20) year population growth except that distribution and transmission lines which may be planned for a forty (40) year useful life. (3-20-20)T

**031. LIMITATION OF PRE-LOAN ENGINEERING REVIEWS.**

Department staff may review engineering or facility planning documents for any drinking water system. However, in order for the costs of preparation of pre-loan engineering documents to be loan eligible, the consulting engineer must submit a certificate of professional liability indemnification in accordance with Subsection 050.05.d. (3-20-20)T

**032. LOAN FEE.**

**01. Loan Fee.** The Department may elect to impose a loan fee when necessary to offset the costs of administering the loan program, to provide planning assistance, or to otherwise facilitate the operation of the Drinking Water State Revolving Fund (DWSRF) effort. The Department may impose a loan fee on loans scheduled to close after December 2, 2009. The loan fee shall not exceed one percent (1%) of the unpaid balance of the loan at the time each loan payment is due. (3-20-20)T

**02. Determination of Loan Fee.** The Department shall determine the amount of the loan fee on a yearly basis and shall assess a loan fee based upon each loan recipient's total interest rate. The amount of the loan fee shall be included in the Intended Use Plan, as described by Section 1452 of the Safe Drinking Water Act (42 U.S.C. Section 300j-12). In determining the amount of the loan fee, the Department shall consider: (3-20-20)T

**a.** The Department's anticipated costs of administering the loan program for the upcoming fiscal year, including salaries and overhead; (3-20-20)T

**b.** Any Department costs related to providing technical assistance for the loan program for the upcoming fiscal year; (3-20-20)T

**c.** The amount of money generated from loan fees in previous fiscal years available for use in the upcoming fiscal year; and (3-20-20)T

**d.** The anticipated demand for planning assistance to supplement regular appropriations and other related needs to support the DWSRF loan program. (3-20-20)T

**03. Effect on Loan Interest Rate.** The loan interest rate, as described in Subsection 050.05, will be reduced by the corresponding percentage of the loan fee. (3-20-20)T

**04. Payment of Loan Fee.** The loan fee shall be due and payable concurrently with scheduled loan principal and interest repayments over the repayment period. (3-20-20)T

**033. -- 039. (RESERVED)**

**040. LOAN APPLICATION AND REVIEW.**

**01. Submission of Application.** The applicant shall submit to the Department, a completed application on a form as prescribed by the Department. (3-20-20)T

**02. Application Requirements.** Applications shall contain the following documentation, as applicable: (3-20-20)T

- a.** A lawful resolution passed by the governing body authorizing an elected official or authorized individual of the qualifying entity to execute a loan contract and sign subsequent loan disbursement requests; and (3-20-20)T
- b.** Contracts for engineering services or other technical services and the description of costs and tasks set forth therein shall be in sufficient detail for the Department to determine whether the costs associated with the tasks are eligible costs pursuant to Section 041; and (3-20-20)T
- c.** Justification for the engineering firm selected. An engineering firm selected by the applicant must at a minimum: (3-20-20)T
- i.** As applicable, be procured through the selection guidelines and procedures prescribed under Section 67-2320, Idaho Code; and (3-20-20)T
- ii.** Be a registered professional engineer currently licensed by the Idaho Board of Professional Engineers and Land Surveyors; and (3-20-20)T
- iii.** Not be debarred or otherwise prevented from providing services under another federal or state financial assistance program; and (3-20-20)T
- iv.** Be covered by professional liability insurance in accordance with Subsection 050.05.d. A certification of liability insurance shall be included in the application; and (3-20-20)T
- d.** A description of other costs, not included in the contracts for engineering or other technical services, for which the applicant seeks funding. The description of the costs and tasks for such costs must be in sufficient detail for the Department to determine whether the costs are eligible costs pursuant to Section 041; and (3-20-20)T
- e.** A demonstration that the obligation to pay the costs for which funding is requested is the result or will be the result of the applicant's compliance with applicable competitive bidding requirements and requirements for professional service contracts, including without limitation, the requirements set forth in Sections 67-2801 et seq., 67-2320, 59-1026, and 42-3212, Idaho Code. (3-20-20)T
- f.** In the case of a privately owned system, demonstrate that there is adequate security for the repayment of the loan. (3-20-20)T
- g.** Step 1. Engineering Report or Facility Plan. Plan of study describing the work tasks to be performed in the preparation of the planning document, a schedule for completion of the work tasks, and an estimate of staff hours and costs to complete the work tasks. (3-20-20)T
- h.** Step 2. Design. (3-20-20)T
- i.** Planning document including a final environmental document and decision in accordance with Section 042; (3-20-20)T
- ii.** Financial, technical, and management capability analysis as provided in Subsection 011.01; (3-20-20)T
- iii.** Inter-organizational service agreements between all qualifying entities within the scope of the project, if applicable; and (3-20-20)T
- i.** Step 3. Construction. (3-20-20)T
- i.** Documented evidence of all necessary easements and land acquisition. (3-20-20)T
- ii.** Biddable plans and specifications of the approved public water system facility alternative; (3-20-20)T

- iii. A plan of operation and project schedule; (3-20-20)T
- iv. A water system protection ordinance and financial management system; and (3-20-20)T
- v. A staffing plan and budget. (3-20-20)T
- j.** Step 4. Design and Construction. Loan applicants must submit all documentation specified in Subsection 040.02.d. prior to advertising for bids on construction contracts. (3-20-20)T

**03. Determination of Completeness of Application.** The Department shall review the application to determine whether it includes all of the information required by Subsection 040.02. (3-20-20)T

**04. Notification of Incompleteness of Application.** Written notification if an application is incomplete, including an explanation of missing documentation shall be sent to the applicant. The applicant may provide the missing documentation. (3-20-20)T

**05. Reapplication for Loan.** The action of disapproving, recalling, or terminating a loan in no way precludes or limits the former applicant from reapplying for another loan when the project deficiencies are resolved and project readiness is secured. (3-20-20)T

**041. DETERMINATION OF ELIGIBILITY OF COSTS.**

The Department shall review the application, including any contracts required to be submitted with the application, to determine whether the costs are eligible costs for funding. (3-20-20)T

**01. Eligible Costs.** Eligible costs are those determined by the Department to be: (3-20-20)T

- a. Necessary costs; (3-20-20)T
- b. Reasonable costs; and (3-20-20)T
- c. Costs that are not ineligible as described in Subsection 041.05. (3-20-20)T

**02. Necessary Costs.** The Department shall determine whether costs are necessary by comparing the tasks for which the costs will be incurred to the scope of the project as described in the plan of study for facility planning, planning document, and any other relevant information in the application that describes the scope of the project to be funded. (3-20-20)T

**03. Reasonable Costs.** Costs shall be determined by the Department to be reasonable if the obligation to pay the costs is the result of or will be the result of the applicant's compliance with applicable competitive bidding requirements and requirements for professional service contracts, including without limitation, the requirements set forth in Sections 67-2801 et seq., 67-2320, 59-1026, and 42-3212, Idaho Code. (3-20-20)T

**04. Examples of Costs That May Be Eligible.** Examples of costs that may be eligible, if determined necessary, reasonable, and not ineligible costs include: (3-20-20)T

- a. Costs of salaries, benefits, and expendable material the qualified entity incurs in the project except ordinary operating expenses such as salaries and expenses of a mayor, city council members, board; or city, district, or board attorney; (3-20-20)T
- b. Costs under construction contracts bid and executed in compliance with state public works construction laws; (3-20-20)T
- c. Professional and consulting services utilizing a lump sum contract, an hourly rate contract, a time and materials contract or cost plus a fixed fee contract; (3-20-20)T
- d. Engineering directly related to the public water system facilities; (3-20-20)T

- e. Financial and management capability analysis if it ensures compliance; (3-20-20)T
- f. Preparation of construction drawings, specifications, estimates, and construction contract documents; (3-20-20)T
- g. Landscaping; (3-20-20)T
- h. Removal and relocation or replacement of utilities for which the qualifying entity is legally obligated to pay; (3-20-20)T
- i. Material acquired, consumed, or expended specifically for the project; (3-20-20)T
- j. A reasonable inventory of laboratory chemicals and supplies necessary to initiate plant operations; (3-20-20)T
- k. Preparation of an operation and maintenance manual; (3-20-20)T
- l. Preparation of a plan of operation; (3-20-20)T
- m. Start-up services; (3-20-20)T
- n. Project identification signs; (3-20-20)T
- o. Public participation for alternative selection; (3-20-20)T
- p. Development of user charge and financial management systems; (3-20-20)T
- q. Development of water system protection and backflow prevention ordinance or rule; (3-20-20)T
- r. Initial staffing plans and budget development; (3-20-20)T
- s. Site acquisition costs from a willing seller, including right of way and the site for public water system; and (3-20-20)T
- t. Certain direct and other costs as determined eligible by the Department. (3-20-20)T
- 05. Ineligible Project Costs.** Costs which are ineligible for funding include, but are not limited to: (3-20-20)T
  - a. Basin or area wide planning not directly related to the project; (3-20-20)T
  - b. Bonus payments not legally required for completion of construction before a contractual completion date; (3-20-20)T
  - c. Personal injury compensation or damages arising out of the project; (3-20-20)T
  - d. Fines or penalties due to violations of, or failure to comply with, federal, state, or local laws; (3-20-20)T
  - e. Costs outside the scope of the approved project; (3-20-20)T
  - f. Ordinary operating expenses such as salaries and expenses of a mayor, city council members, board, or city, district or board attorney; (3-20-20)T
  - g. Cost of land in excess of that needed for the proposed project; (3-20-20)T
  - h. Cost of condemnations; (3-20-20)T

- i. Engineering costs incurred without professional liability insurance; (3-20-20)T
- j. Reserve funds; (3-20-20)T
- k. Cost of refinancing existing indebtedness; and (3-20-20)T
- l. Costs incurred prior to the loan acceptance unless specifically approved in writing by the Department. (3-20-20)T

**06. Notification Regarding Ineligible Costs.** Prior to providing a loan offer, the Department shall notify the applicant if certain costs are not eligible for funding and the reasons for the Department's determination. If such costs are included in the engineering contract, the Department shall also provide notification to the engineer. The applicant may provide the Department additional information in response to the notice. (3-20-20)T

**07. Eligible Costs and the Loan Offer.** The loan offer shall reflect those costs determined by the Department to be eligible costs. The loan offer, however, may include estimates of some eligible costs that have not yet been set, such as construction costs. Actual eligible costs may differ from such estimated costs set forth in the loan offer. In addition, loan disbursements may be increased or decreased if eligible costs are modified as provided in Section 060. (3-20-20)T

**042. ENVIRONMENTAL REVIEW.**

**01. Environmental Documentation.** The loan recipient shall complete an environmental review as part of and in conjunction with a planning document. Guidance on how to complete an environmental review may be found in Chapter 5 of the Handbook. The loan recipient shall consult with the Department at an early stage in the loan process to determine the required level of environmental review. Based on review of existing information and assessment of environmental impacts, the loan recipient shall complete one (1) of the following per the Department's instruction: (3-20-20)T

- a. Submit a request for Categorical Exclusion (CE) with supporting backup documentation as specified by the Department; (3-20-20)T
- or
- b. Prepare an Environmental Information Document (EID) in a format specified by the Department; (3-20-20)T
- c. Prepare an Environmental Impact Statement (EIS) in a format specified by the Department. (3-20-20)T

**02. Categorical Exclusions.** If the loan recipient requests a CE, the Department shall review the request and, based upon the supporting documentation, take one (1) of the following actions: (3-20-20)T

- a. Determine if the action is consistent with categories eligible for exclusion whereupon the Department shall issue a notice of CE from substantive environmental review. Once the CE is granted for the selected alternative, the Department will publish a notice of CE in a local newspaper to inform the public of this action, following which the planning document can be approved and the loan award can proceed. (3-20-20)T
- b. Determine if the action is not consistent with categories eligible for exclusion and that issuance of a CE is not appropriate. If a CE is not issued, the Department shall notify the loan recipient to prepare an EID. (3-20-20)T

**03. Environmental Information Document Requirements.** When an EID is required, the loan recipient shall prepare the EID in accordance with the following Department procedures: (3-20-20)T

- a. Various laws and executive orders related to environmentally sensitive resources shall be considered as the EID is prepared. Appropriate state and federal agencies shall be consulted regarding these laws and executive orders. (3-20-20)T

**b.** A full range of relevant impacts, both direct and indirect, of the proposed project shall be discussed in the EID, including measures to mitigate adverse impacts, cumulative impacts, and impacts that shall cause irreversible or irretrievable commitment of resources. (3-20-20)T

**c.** The Department shall review the draft EID and either request additional information about one (1) or more potential impacts, or shall draft a “finding of no significant impact” (FONSI). (3-20-20)T

**04. Final Finding of No Significant Impact.** The Department shall publish the draft FONSI in a newspaper of general circulation in the geographical area of the proposed project and shall allow a minimum thirty (30) day public comment period. Following the required period of public review and comment and after any public concerns about project impacts are addressed, the FONSI shall become final. The Department shall assess the effectiveness and feasibility of the mitigation measures identified in the FONSI and EID prior to the issuance of the final FONSI and approval of the planning document. (3-20-20)T

**05. Environmental Impact Statement (EIS) Requirements.** If an EIS is required, the loan recipient shall: (3-20-20)T

**a.** Contact all affected state agencies, and other interested parties, to determine the required scope of the document; (3-20-20)T

**b.** Prepare and submit a draft EIS to all interested agencies, and other interested parties, for review and comment; (3-20-20)T

**c.** Conduct a public meeting which may be in conjunction with a planning document meeting; and (3-20-20)T

**d.** Prepare and submit a final EIS incorporating all agency and public input for Department review and approval. (3-20-20)T

**06. Final EIS.** Upon completion of the EIS by the loan recipient and approval by the Department of all requirements listed in Subsection 042.05, the Department shall issue a record of decision, documenting the mitigative measures which shall be required of the loan recipient. The loan agreement can be completed once the final EIS has Department approval. (3-20-20)T

**07. Partitioning the Environmental Review.** Under certain circumstances, the building of a component/partition of a drinking water system may be justified in advance of all environment review requirements for the remainder of the system. The Department shall approve partitioning the environment review in accordance with established procedures. (3-20-20)T

**08. Use of Environmental Reviews Conducted by Other Agencies.** If environmental review for the project has been conducted by another state, federal, or local agency, the Department may, at its discretion, issue its own determination by adopting the document and public participation process of the other agency. (3-20-20)T

**09. Validity of Review.** Environmental reviews, once completed by the Department, are valid for five (5) years from the date of completion. If a loan application is received for a project with an environmental review which is more than five (5) years old, the Department shall reevaluate the project, environmental conditions, and public views and shall: (3-20-20)T

**a.** Reaffirm the earlier decision; or (3-20-20)T

**b.** Require supplemental information to the earlier Environmental Impact Statement, Environmental Information Document, or request for Categorical Exclusion. Based upon a review of the updated document, the Department shall issue and distribute a revised notice of Categorical Exclusion, finding of no significant impact, or record of decision. (3-20-20)T

**10. Exemption From Review.** Loan projects may be exempt from certain federal crosscutting

authorities at the discretion of the Department as long as in any given year the annual amount of loans, equal to the most recent federal capitalization grant, complies with all of the federal crosscutting authorities. (3-20-20)T

**043. -- 049. (RESERVED)**

**050. LOAN OFFER AND ACCEPTANCE.**

**01. Loan Offer.** Loan offers shall be delivered to successful applicants by representatives of the Department or by registered mail. (3-20-20)T

**02. Acceptance of Loan Offer.** Applicants have sixty (60) days in which to officially accept the loan offer on prescribed forms furnished by the Department. The sixty (60) day acceptance period commences from the date indicated on the loan offer notice. If the applicant does not accept the loan offer within the sixty (60) day period, the loan funds may be offered to the next project on the priority list. (3-20-20)T

**03. Acceptance Executed as a Contract Agreement.** Upon signature by the Director or the Director's designee and upon signature by the authorized representative of the qualifying entity, the loan offer shall become a contract. Upon accepting a loan offer, a qualifying entity becomes a loan recipient. The disbursement of funds, pursuant to a loan contract, is subject to a finding by the Director that the loan recipient has complied with all loan contract conditions and has prudently managed the project. The Director may, as a condition of disbursement, require that a loan recipient vigorously pursue any claims it has against third parties who shall be paid in whole or in part, directly or indirectly, with loan funds. No third party shall acquire any rights against the state or its employees from a loan contract. (3-20-20)T

**04. Estimate of Reasonable Cost.** All loan contracts shall include the eligible costs of the project. Some eligible costs may be estimated and disbursements may be increased or decreased as provided in Section 060. (3-20-20)T

**05. Terms of Loan Offers.** The loan offer shall contain such terms as are prescribed by the Department including, but not limited to: (3-20-20)T

**a.** Terms consistent with these rules, the project step to be funded under the loan offer, and Chapter 76, Title 39, Idaho Code; (3-20-20)T

**b.** Special clauses as determined necessary by the Department for the successful investigation, design, construction, and management of the project; (3-20-20)T

**c.** Terms consistent with applicable state and federal laws pertaining to planning documents, design, and construction (including the Public Works Contractors License Act (Idaho Code Sections 54-1901 through 54-1924)); the Public Contracts Bond Act (Idaho Code Sections 54-1925 through 54-1930); and the Safe Drinking Water Act (42 U.S.C. Section 300f et seq.) requirements for projects funded with loan moneys of federal origin; (3-20-20)T

**d.** Requirement for the prime engineering firm(s), retained for engineering services, to carry professional liability insurance to protect the public from negligent acts of the engineer and errors and omissions of a professional nature. The total aggregate of the professional liability of the engineer insurance shall be one hundred thousand dollars (\$100,000) or twice the amount of the fee of the engineer, whichever is greater. Professional liability insurance must cover all such services rendered for all project phases which are state funded; (3-20-20)T

**e.** The project shall be bid, contracted, and constructed according to the current edition of Idaho Standards for Public Works Construction and the Idaho Rules for Public Drinking Water Systems (IDAPA 58.01.08) unless the loan recipient has approved and adopted acceptable public works construction standards approved by the Department; (3-20-20)T

**f.** The loan interest rate for loans made during the state fiscal year beginning July 1 shall be established by the Director. The interest rate shall be a fixed rate in effect for the life of the loan. The rate may equal but shall not exceed the current market rate; (3-20-20)T

**g.** The loan fee pursuant to Section 032; (3-20-20)T

**h.** All loans, except disadvantaged loans, must be fully amortized within a period not to exceed twenty (20) years after project completion. Disadvantaged loans must be fully amortized within a period not to exceed thirty (30) years. The loan recipient may elect for either a schedule of semi-annual repayments or annual repayments at the time the loan is finalized; and (3-20-20)T

**i.** Repayment default shall occur when a scheduled loan repayment is thirty (30) days past due. If default occurs, the Department may invoke appropriate loan contract provisions and/or bond covenants. (3-20-20)T

**051. ACCOUNTING AND AUDITING PROCEDURES.**

Loan recipients must maintain project accounts in accordance with generally accepted accounting principles. (3-20-20)T

**052. -- 059. (RESERVED)**

**060. DISBURSEMENTS.**

**01. Loan Disbursements.** The loan contract shall include a schedule of estimated disbursements to be made to the loan recipient. The schedule shall include the anticipated dates and amounts of disbursements. Requests to the Department for actual disbursement of loan proceeds shall be made by the loan recipient on forms provided by the Department. (3-20-20)T

**02. Loan Increases.** An increase in the loan amount as a result of an increase in eligible project costs shall be considered, provided funds are available. Documentation supporting the need for an increase must be submitted to the Department for approval prior to incurring any costs above the eligible cost ceiling. (3-20-20)T

**03. Loan Decreases.** If the actual eligible cost is determined by the Department to be lower than the estimated eligible cost, the loan amount shall be reduced proportionately. (3-20-20)T

**04. Project Review to Determine Final Eligible Costs.** A project review by the Department shall determine the final eligible costs. (3-20-20)T

**05. Final Disbursement.** The final loan disbursement consisting of five percent (5%) of the total loan amount shall not be made until final inspection, final review, and a final loan repayment schedule have been completed. (3-20-20)T

**061. -- 079. (RESERVED)**

**080. SUSPENSION OR TERMINATION OF LOAN CONTRACTS.**

**01. Causes.** The Director may suspend or terminate any loan contract prior to final disbursement for failure by the loan recipient or its agents including engineering firm(s), contractor(s), or subcontractor(s) to perform. A loan contract may be suspended or terminated for good cause including, but not limited to, the following: (3-20-20)T

**a.** Commission of fraud, embezzlement, theft, forgery, bribery, misrepresentation, conversion, malpractice, misconduct, malfeasance, misfeasance, falsification, or unlawful destruction of records, or receipt of stolen property, or any form of tortious conduct; (3-20-20)T

**b.** Commission of any crime for which the maximum sentence includes the possibility of one (1) or more years of imprisonment or any crime involving or affecting the project; (3-20-20)T

**c.** Violation(s) of any term of the loan contract; (3-20-20)T

**d.** Any willful or serious failure to perform within the scope of the project, plan of operation, project schedule, terms of engineering sub-agreements, or contracts for construction; or (3-20-20)T



e. Debarment of a contractor or subcontractor for good cause by any federal or state agency from working on public work projects funded by that agency. (3-20-20)T

**02. Notice.** The Director shall notify the loan recipient in writing, and forwarded by certified mail, of the intent to suspend or terminate the loan contract. The notice of intent shall state: (3-20-20)T

a. Specific acts or omissions which form the basis for suspension or termination; and (3-20-20)T

b. That the loan recipient may be entitled to appeal the suspension or termination pursuant to IDAPA 58.01.23, “Rules of Administrative Procedure Before the Board of Environmental Quality.” (3-20-20)T

**03. Determination.** A determination will be made by the Board pursuant to IDAPA 58.01.23, “Rules of Administrative Procedure Before the Board of Environmental Quality.” (3-20-20)T

**04. Reinstatement of Suspended Loan.** Upon written request by the loan recipient with evidence that the causes(s) for suspension no longer exist(s), the Director may, if funds are available, reinstate the loan contract. If a suspended loan contract is not reinstated, the loan shall be amortized and a repayment schedule prepared in accordance with provisions of the loan contract. (3-20-20)T

**05. Reinstatement of Terminated Loan.** No terminated loan shall be reinstated. Terminated loans shall be amortized and a repayment schedule prepared in accordance with provisions of the loan contract. (3-20-20)T

**081. -- 994. (RESERVED)**

**995. WAIVERS.**

**01. Conditions for Waiver.** Waiver from the requirements of these rules may be granted by the Department Director or the Director’s designee, on a case-by-case basis, upon full demonstration by the loan recipient requesting the waiver that the following conditions exist. See also Subsection 020.05 of these rules. (3-20-20)T

a. **Health Hazard.** A significant public health hazard exists; or (3-20-20)T

b. **Affordability Criteria Exceeded.** The project shall exceed affordability criteria adopted by the Department in the event the waiver is not granted. (3-20-20)T

**02. Availability of Federal Funds.** The waiver shall not affect the availability of federal funds for the project where such funding is required by the loan recipient requesting the waiver. (3-20-20)T

**996. -- 999. (RESERVED)**

**58.01.25 – RULES REGULATING THE IDAHO POLLUTANT DISCHARGE  
ELIMINATION SYSTEM PROGRAM**

**000. LEGAL AUTHORITY.**

The Department and the Board are authorized to formulate and adopt rules as are necessary to obtain approval of the IPDES program by EPA pursuant to Section 39-175C, Idaho Code. The Department is authorized to implement and enforce the rules in this chapter pursuant to the Sections 39-175A-C and the provisions of the Environmental Protection and Health Act, Sections 39-101 et.seq., Idaho Code. The rules in this chapter shall not be effective until the requirements in Section 39-175C, Idaho Code, have been met and the United States EPA has approved, under 33 U.S.C. 1342(b), Idaho's administration of the IPDES program. (3-20-20)T

**001. TITLE AND SCOPE.**

**01. Title.** The rules are titled IDAPA 58.01.25, "Rules Regulating the Idaho Pollutant Discharge Elimination System Program." (3-20-20)T

**02. Scope.** These rules establish the procedures and requirements for the issuance and maintenance of permits for facilities or activities for which a person is required by Idaho Code and the Clean Water Act to obtain authorization to discharge pollutants to waters of the United States. These permits shall be referred to in these rules as "IPDES permits" or "permits." (3-20-20)T

**002. CONFIDENTIALITY OF RECORDS.**

**01. Identifying Confidential Information.** Information obtained by the Department under these rules is subject to public disclosure pursuant to the provisions of Chapter 1, Title 74, Idaho Code, and IDAPA 58.01.21 (Rules Governing the Protection and Disclosure of Records in the Possession of the Idaho Department of Environmental Quality). In accordance with Sections 74-101 through 74-119, Idaho Code, any information submitted to the Department pursuant to these rules may be claimed as confidential by the submitter. It shall be the responsibility of the submitter to give notice of the existence of a claim of confidentiality on each page or other portion of information at the time of submittal and such person shall have the burden of demonstrating that the information is confidential. (3-20-20)T

**02. Denial of Confidential Claims.** In accordance with Section 74-114, Idaho Code, a claim of confidentiality, including but not limited to a claim as to information claimed confidential as a trade secret, shall be denied and any person may inspect and copy: (3-20-20)T

**a.** The name and address of any IPDES applicant or permittee; (3-20-20)T

**b.** The content of any IPDES permit; (3-20-20)T

**c.** IPDES permit applications, and information required to be submitted by IPDES application forms under Section 105 (Application for an Individual IPDES Permit), or IPDES General Permit Notice of Intent, and information required to be submitted under Section 130 (General Permits), whether the information is submitted on the application forms themselves or in any attachments used to supply information required by the application forms; and (3-20-20)T

**d.** Effluent data as defined in 40 CFR 2.302. (3-20-20)T

**003. INCORPORATION BY REFERENCE OF FEDERAL REGULATIONS.**

**01. Availability of Reference Material.** Codes, standards and regulations may be incorporated by reference in this rule pursuant to Section 67-5229, Idaho Code. Codes, standards or regulations adopted by reference throughout this rule are available in the following locations: (3-20-20)T

**a.** Department of Environmental Quality. Department of Environmental Quality, 1410 N. Hilton, Boise, ID 83706-1255. (3-20-20)T

**b.** Law Library. State Law Library, 451 W. State Street, P.O. Box 83720, Boise, ID 83720-0051. (3-20-20)T

**c.** Electronic Code of Federal Regulations (eCFR) <http://www.ecfr.gov/cgi-bin/ECFR>. (3-20-20)T

**02. Incorporation by Reference.** The following documents are incorporated by reference into these

rules. Any reference in these rules to requirements, procedures, or specific forms contained in any section or subsection shall constitute the full adoption by reference of that section or subsection, including any notes and appendices therein, unless expressly provided otherwise in these rules: (3-20-20)T

- a. [40 CFR 122.21\(r\)](#), revised as of July 1, 2017 (Application Requirements for Facilities with Cooling Water Intake Structures); (3-20-20)T
- b. [40 CFR 122.23](#), revised as of July 1, 2017 (Concentrated Animal Feeding Operations); (3-20-20)T
- c. [40 CFR 122.24](#), revised as of July 1, 2017 (Concentrated Aquatic Animal Production Facilities); (3-20-20)T
- d. [40 CFR 122.25](#), revised as of July 1, 2017 (Aquaculture Projects); (3-20-20)T
- e. [40 CFR 122.26\(a\)](#) through (b) and [40 CFR 122.26\(e\)](#) through (g), revised as of July 1, 2017 (Storm Water Discharges); (3-20-20)T
- f. [40 CFR 122.27](#), revised as of July 1, 2017 (Silvicultural Activities); (3-20-20)T
- g. [40 CFR 122.29\(d\)](#), revised as of July 1, 2017 (Effect of Compliance with New Source Performance Standards); (3-20-20)T
- h. [40 CFR 122.30](#) and [40 CFR 122.32](#) through [40 CFR 122.37](#), revised as of July 1, 2017 (Requirements and Guidance for Small Municipal Separate Storm Sewer Systems); (3-20-20)T
- i. [40 CFR 122.42\(e\)](#), revised as of July 1, 2017 (Additional Conditions Applicable to NPDES Permits for Concentrated Animal Feeding Operations); (3-20-20)T
- j. [Appendix A to 40 CFR 122](#), revised as of July 1, 2017 (NPDES Primary Industry Categories); (3-20-20)T
- k. [Appendix C to 40 CFR 122](#), revised as of July 1, 2017 (Criteria for Determining a Concentrated Aquatic Animal Production Facility); (3-20-20)T
- l. [Appendix D to 40 CFR 122](#), revised as of July 1, 2017 (NPDES Permit Application Testing Requirements); (3-20-20)T
- m. [Appendix J to 40 CFR 122](#), revised as of July 1, 2017 (NPDES Permit Testing Requirements for Publicly Owned Treatment Works); (3-20-20)T
- n. [40 CFR 125.1](#) through [40 CFR 125.3](#) (Subpart A), revised as of July 1, 2017 (Criteria and Standards for Imposing Technology-Based Treatment Requirements Under Sections 301(b) and 402 of the Clean Water Act); (3-20-20)T
- o. [40 CFR 125.10](#) through [40 CFR 125.11](#) (Subpart B), revised as of July 1, 2017 (Criteria for Issuance of Permits to Aquaculture Projects); (3-20-20)T
- p. [40 CFR 125.30](#) through [40 CFR 125.32](#) (Subpart D), revised as of July 1, 2017 (Criteria and Standards for Determining Fundamentally Different Factors Under Sections 301(b)(1)(A) and 301(b)(2)(A) and (E) of the Clean Water Act); (3-20-20)T
- q. [40 CFR 125.70](#) through [40 CFR 125.73](#) (Subpart H), revised as of July 1, 2017 (Criteria for Determining Alternative Effluent Limitations Under Section 316(a) of the Clean Water Act); (3-20-20)T
- r. [40 CFR 125.80](#) through [40 CFR 125.89](#) (Subpart I), revised as of July 1, 2017 (Requirements Applicable to Cooling Water Intake Structures for New Facilities Under Section 316(b) of the Clean Water Act); (3-20-20)T

- s. [40 CFR 125.90](#) through 40 CFR 125.99 (Subpart J), revised as of July 1, 2017 (Requirements Applicable to Cooling Water Intake Structures for Phase II Existing Facilities Under Section 316(b) of the Clean Water Act); (3-20-20)T
- t. [40 CFR 127.11](#) through 40 CFR 127.16 (Subpart B), revised as of July 1, 2017 (Electronic reporting of NPDES Information from NPDES-Regulated Facilities); (3-20-20)T
- u. [40 CFR 129.1](#) through 40 CFR 129.105 (Subpart A), revised as of July 1, 2017 (Toxic Pollutant Effluent Standards and Prohibitions); (3-20-20)T
- v. [40 CFR 133.100](#) through 40 CFR 133.105, revised as of July 1, 2017 (Secondary Treatment Regulation); (3-20-20)T
- w. [40 CFR Part 136](#), revised as of July 1, 2017 (Guidelines Establishing Test Procedures for the Analysis of Pollutants, including Appendices A, B, C, and D); (3-20-20)T
- x. [40 CFR Part 401](#), revised as of July 1, 2017 (General Provisions); (3-20-20)T
- y. [40 CFR 403.1](#) through 40 CFR 403.3; 40 CFR 403.5 through 40 CFR 403.18, revised as of July 1, 2017 (General Pretreatment Regulations for Existing and New Sources of Pollution, including Appendices D, E, and G); (3-20-20)T
- z. [40 CFR Part 405](#) through 40 CFR Part 471, revised as of July 1, 2017 (Effluent Limitations and Guidelines); and (3-20-20)T
- aa. [40 CFR 503.2](#) through 40 CFR 503.48, revised as of July 1, 2017 (Sewage Sludge, including Appendices A and B). (3-20-20)T
- bb. The term “Waters of the United States or waters of the U.S.,” as defined in [40 CFR 122.2](#), revised as of August 28, 2015 by 80 Federal Register 37054-37127 (June 29, 2015), unless said revision is stayed, overturned or invalidated by a court of law or withdrawn by EPA, in which case the Department incorporates by reference the term “Waters of the United States or waters of the U.S.” as defined in [40 CFR 122.2](#), revised as of July 1, 2015. (3-20-20)T
- 03. Term Interpretation.** For the federal regulations incorporated by reference into these rules, unless the context in which a term is used clearly requires a different meaning, terms in this section have the following meanings: (3-20-20)T
- a. The term Administrator or Regional Administrator means the EPA Region 10 Administrator; (3-20-20)T
- b. The term Control Authority means the POTW for a facility with a Department-approved pretreatment program and the Department for a POTW without a Department-approved pretreatment program; (3-20-20)T
- c. The term Director or State Director means the Director of the Department of Environmental Quality with an NPDES permit program approved pursuant to section 402(b) of the Clean Water Act; (3-20-20)T
- d. The term National Pollutant Discharge Elimination System (NPDES) means the Idaho Pollutant Discharge Elimination System (IPDES); (3-20-20)T
- e. The term Permitting Authority (also preceded by the terms NPDES or State) means the Idaho Department of Environmental Quality with an NPDES permit program approved pursuant to section 402(b) of the Clean Water Act. (3-20-20)T

**004. ADMINISTRATIVE PROVISIONS.**

Persons may be entitled to appeal final IPDES permit decisions pursuant to Section 204 (Appeals Process) of these

rules. (3-20-20)T

**005. WRITTEN INTERPRETATIONS.**

As described in Section 67-5201(19)(b)(iv), Idaho Code, the Department of Environmental Quality may have written statements which pertain to the interpretation of these rules. If available, such written statements can be inspected and copied at cost at the Department of Environmental Quality, 1410 N. Hilton, Boise, Idaho 83706-1255. (3-20-20)T

**006. OFFICE HOURS -- MAILING ADDRESS AND STREET ADDRESS.**

The state office of the Department of Environmental Quality is located at 1410 N. Hilton, Boise, Idaho 83706, (208) 373-0502, [www.deq.idaho.gov](http://www.deq.idaho.gov). The office hours are 8 a.m. to 5 p.m. Monday through Friday. (3-20-20)T

**007. -- 009. (RESERVED)**

**010. DEFINITIONS.**

For the purpose of the rules contained in IDAPA 58.01.25, "Rules Regulating the Idaho Pollutant Discharge Elimination System Program," the following definitions apply. Terms not expressly defined in this section have the meaning provided by IDAPA 58.01.02, Section 010, "Water Quality Standards," or IDAPA 58.01.16, Section 010, "Wastewater Rules." (3-20-20)T

**01. Animal Feeding Operation.** A lot or facility (other than an aquatic animal production facility) where the following conditions are met: (3-20-20)T

**a.** Animals (other than aquatic animals) have been, are, or will be stabled or confined and fed or maintained for a total of forty-five (45) days or more in any twelve (12)-month period; and (3-20-20)T

**b.** Crops, vegetation, forage growth, or post-harvest residues are not sustained in the normal growing season over any portion of the lot or facility. (3-20-20)T

**02. Applicable Standards and Limitations.** All state, interstate, and federal standards and limitations to which a discharge, a sewage sludge use or disposal practice, or a related activity is subject under the Clean Water Act, including effluent limitations, water quality standards, standards of performance, toxic effluent standards or prohibitions, best management practices, pretreatment standards, and standards for sewage sludge use or disposal under the Clean Water Act sections 301, 302, 303, 304, 306, 307, 308, 402 and 405. (3-20-20)T

**03. Application.** The IPDES forms for applying for a permit or the EPA equivalent standard national forms when deemed acceptable by the Department, including any additions, revisions or modifications to the forms. (3-20-20)T

**04. Approved Program or Approved State.** A state or interstate program which has been approved or authorized by EPA under 40 CFR Part 123. (3-20-20)T

**05. Aquaculture Project.** A defined managed water area which uses discharges of pollutants into that designated area for the maintenance or production of harvestable freshwater, estuarine, or marine plants or animals. (3-20-20)T

**06. Average Monthly Discharge Limitation.** The highest allowable average of daily discharges over a calendar month, calculated as the sum of all daily discharges measured during a calendar month divided by the number of daily discharges measured during that month. (3-20-20)T

**07. Average Weekly Discharge Limitation.** The highest allowable average of daily discharges over a calendar week, calculated as the sum of all daily discharges measured during a calendar week divided by the number of daily discharges measured during that week. (3-20-20)T

**08. Background.** The biological, chemical or physical condition of waters measured at a point immediately upstream (up-gradient) of the influence of an individual point or nonpoint source discharge. If several discharges to the water exist or if an adequate upstream point of measurement is absent, the Department will determine where background conditions should be measured. (3-20-20)T

**09. Best Management Practices (BMPs).** Schedules of activities, prohibitions of practices, maintenance procedures, and other management practices to prevent or reduce the pollution of waters of the United States. BMPs also include treatment requirements, operating procedures, and practices to control plant site runoff, spillage or leaks, sludge or waste disposal, or drainage from raw material storage. (3-20-20)T

**10. Biochemical Oxygen Demand (BOD).** The measure of the amount of oxygen necessary to satisfy the biochemical oxidation requirements of organic materials at the time the sample is collected; unless otherwise specified, this term will mean the five (5) day BOD incubated at twenty (20) degrees C. (3-20-20)T

**11. Biological Monitoring or Biomonitoring.** The use of a biological entity as a detector and its response as a measure to determine environmental conditions. Toxicity tests and biological surveys, including habitat monitoring, are common biomonitoring methods. (3-20-20)T

**12. Bypass.** The intentional diversion of wastewater from any portion of a treatment facility. (3-20-20)T

**13. Chemical Oxygen Demand (COD).** A bulk parameter that measures the oxygen-consuming capacity of organic and inorganic matter present in water or wastewater. It is expressed as the amount of oxygen consumed from a chemical oxidant in a specific test. (3-20-20)T

**14. Class I Sludge Management Facility.** Any POTW identified under 40 CFR 403.8(a) as being required to have an approved pretreatment program (including such POTWs where the Department has elected to assume local program responsibilities pursuant to 40 CFR 403.10(e)) and any other treatment works treating domestic sewage (TWTDS) classified as a Class I sludge management facility by the Department, because of the potential for its sludge use or disposal practices to adversely affect public health and the environment. (3-20-20)T

**15. Clean Water Act.** Formerly referred to as the Federal Water Pollution Control Act or Federal Water Pollution Control Act Amendments of 1972. Public Law 92-500, as amended by Public Law 95-217, Public Law 95-576, Public Law 96-483 and Public Law 97-117, 33 U.S.C. 1251 et seq. (3-20-20)T

**16. Clean Water Act and Regulations.** The Clean Water Act and applicable regulations promulgated thereunder. In the case of an approved IPDES program, it includes Department program requirements. (3-20-20)T

**17. Compliance Schedule or Schedule of Compliance.** A schedule of remedial measures included in a permit, including an enforceable sequence of interim requirements (for example, actions, operations, or milestone events) leading to compliance with the Clean Water Act and these rules. (3-20-20)T

**18. Concentrated Animal Feeding Operation (CAFO).** Animal feeding operation that is defined as a Large CAFO in accordance with 40 CFR 122.23(b)(4), as a Medium CAFO in accordance with 40 CFR 122.23(b)(6), or that is designated as a CAFO in accordance with 40 CFR 122.23(c). Two (2) or more animal feeding operations under common ownership are considered to be a single animal feeding operation for the purposes of determining the number of animals at an operation, if they adjoin each other or if they use a common area or system for the disposal of wastes. (3-20-20)T

**19. Concentrated Aquatic Animal Production (CAAP).** A hatchery, fish farm, or other facility which meets the criteria in Appendix C of 40 CFR Part 122, or which the Department designates under 40 CFR 122.24(c). (3-20-20)T

**20. Continuous Discharge.** A discharge which occurs without interruption throughout the operating hours of the facility, except for infrequent shutdowns for maintenance, process changes, or other similar activities. (3-20-20)T

**21. Daily Discharge.** The discharge of a pollutant measured during a calendar day or any twenty-four (24)-hour period that reasonably represents the calendar day for purposes of sampling. For pollutants with limitations expressed in units of mass, the daily discharge is calculated as the total mass of the pollutant discharged over the day. For pollutants with limitations expressed in other units of measurement, the daily discharge is calculated as the

- average measurement of the pollutant over the day. (3-20-20)T
22. **Department.** The Idaho Department of Environmental Quality. (3-20-20)T
23. **Design Flow.** The average or maximum point source discharge volume per unit time that a facility or system is constructed to accommodate. (3-20-20)T
24. **Direct Discharge.** The discharge of a pollutant to waters of the United States. (3-20-20)T
25. **Director.** The Director of the Idaho Department of Environmental Quality or authorized agent. (3-20-20)T
26. **Discharge Monitoring Report (DMR).** The facility or activity report containing monitoring and discharge quality and quantity information and data required to be submitted periodically, as defined in the discharge permit. These reports must be submitted to the Department on a Department-approved format. (3-20-20)T
27. **Discharge.** When used without qualification means the discharge of a pollutant. (3-20-20)T
28. **Discharge of a Pollutant.** Any addition of any pollutant or combination of pollutants to waters of the United States from any point source. This definition includes additions of pollutants into waters of the United States from: surface runoff which is collected or channeled by man; discharges through pipes, sewers, or other conveyances owned by a state, municipality, or other person which do not lead to a treatment works; and discharges through pipes, sewers, or other conveyances, leading into privately owned treatment works. This term does not include an addition of pollutants by any indirect discharger. (3-20-20)T
29. **Draft Permit.** A document prepared under these rules indicating the Department’s tentative decision to issue or deny, modify, revoke and reissue, terminate, or reissue a permit. A notice of intent to terminate a permit, and a notice of intent to deny a permit, as discussed in Subsections 107.01 and 203.02, are types of draft permits. A denial of a request for modification, revocation and reissuance, or termination, as discussed in Subsection 201.01, is not a draft permit. A proposed permit is not a draft permit. (3-20-20)T
30. **Effluent.** Any discharge of treated or untreated pollutants into waters of the United States. (3-20-20)T
31. **Effluent Limitation.** Any restriction imposed by the Department on quantities, discharge rates, and concentrations of pollutants which are discharged from point sources into waters of the United States, in accordance with these rules and the Clean Water Act. (3-20-20)T
32. **Effluent Limitations Guidelines.** A regulation published by the EPA under the Clean Water Act section 304(b) to adopt or revise effluent limitations. (3-20-20)T
33. **Electronic Signature.** Information in digital form that is included in or associated with an electronic document for the purpose of expressing the same meaning and intention as would a handwritten signature. (3-20-20)T
34. **Environmental Protection Agency (EPA).** The United States Environmental Protection Agency. (3-20-20)T
35. **Equivalent Dwelling Unit (EDU).** A measure where one (1) equivalent dwelling unit is equivalent to wastewater generated from one (1) single-family residence. For the purposes of assessing fees associated with this rule, the number of EDUs is calculated as the population served divided by the average number of people per household as defined in the most recent Census Bureau data (for that municipality, county, or average number of persons per household for the state of Idaho). (3-20-20)T
36. **Existing Source.** Any source which is not a new source or a new discharger. (3-20-20)T
37. **Facilities or Equipment.** Buildings, structures, process or production equipment or machinery

which form a permanent part of the new source and which will be used in its operation, if these facilities or equipment are of such value as to represent a substantial commitment to construct. It excludes facilities or equipment used in connection with feasibility, engineering, and design studies regarding the source or water pollution treatment for the source. (3-20-20)T

**38. Facility or Activity.** Any point source or any other facility or activity (including land or appurtenances thereto) that is subject to regulation under the IPDES program. (3-20-20)T

**39. Fundamentally Different Factors.** The factors relating to a discharger's facilities, equipment, processes or other factors related to the discharger are fundamentally different from the factors considered by EPA in development of the national effluent limits. (3-20-20)T

**40. General Permit.** An IPDES permit issued under Section 130 (General Permits) authorizing a category of discharges within a geographical area. (3-20-20)T

**41. Hazardous Substance.** Any substance designated under 40 CFR Part 116 pursuant to the Clean Water Act section 311. (3-20-20)T

**42. Idaho Pollutant Discharge Elimination System (IPDES).** Idaho's program for issuing, modifying, revoking and reissuing, terminating, monitoring and enforcing permits, and imposing and enforcing pretreatment requirements, under these rules and the Clean Water Act sections 307, 402, 318, and 405. (3-20-20)T

**43. Indian Country.** (3-20-20)T

**a.** All land within the limits of any Indian reservation under the jurisdiction of the United States Government, notwithstanding the issuance of any patent, and, including rights-of-way running through the reservation; (3-20-20)T

**b.** All dependent Indian communities within the borders of the United States, whether within the originally or subsequently acquired territory thereof, and whether within or without the limits of the state; and (3-20-20)T

**c.** All Indian allotments, the Indian titles to which have not been extinguished including rights-of-way running through the same. (3-20-20)T

**44. Indian Tribe.** Any Indian tribe, band, group, or community recognized by the Secretary of the Interior and exercising governmental authority over a federal Indian reservation. (3-20-20)T

**45. Indirect Discharger.** A nondomestic discharger introducing pollutants to a privately or publicly owned treatment works. (3-20-20)T

**46. Industrial Wastewater.** Any waste, together with such water as is present that is the by-product of industrial processes including, but not limited to, food processing or food washing wastewater (see Process Wastewater). (3-20-20)T

**47. Infiltration.** Water other than wastewater that enters a sewer system (including sewer service connections and foundation drains) from the ground through such means as defective pipes, pipe joints, connections, or manholes. Infiltration does not include, and is distinguished from, inflow. (3-20-20)T

**48. Inflow.** Water other than wastewater that enters a sewer system (including sewer service connections) from sources such as, but not limited to, roof leaders, cellar drains, yard drains, area drains, drains from springs and swampy areas, manhole covers, cross connections between storm sewers and sanitary sewers, catch basins, cooling towers, storm waters, surface runoff, street wash waters, or drainage. Inflow does not include, and is distinguished from, infiltration. (3-20-20)T

**49. Interstate Agency.** An agency of two (2) or more states established by or under an agreement or compact, or any other agency of two (2) or more states having substantial powers or duties pertaining to the control of



pollution. (3-20-20)T

**50. Load Allocation (LA).** The portion of a receiving water body's loading capacity that is attributed either to one (1) of its existing or future nonpoint sources of pollution or to natural background sources. (3-20-20)T

**51. Major Facility.** A facility or activity that is: (3-20-20)T

**a.** A publicly or privately owned treatment works with a design flow equal to or greater than one million gallons per day (1 MGD), or serves a population of ten thousand (10,000) or more, or causes significant water quality impacts; or (3-20-20)T

**b.** A non-municipal facility that equals or exceeds the eighty (80) point accumulation as described in the Score Summary of the NPDES Non-Municipal Permit Rating Work Sheet (June 27, 1990) or the Department equivalent guidance document. (3-20-20)T

**52. Maximum Daily Discharge Limitation.** The highest allowable daily discharge. (3-20-20)T

**53. Maximum Daily Flow.** The largest volume of flow to be discharged during a continuous twenty-four-hour period expressed as a volume per unit time. (3-20-20)T

**54. Mixing Zone.** A defined area or volume of the receiving water surrounding or adjacent to a wastewater discharge where the receiving water, as a result of the discharge, may not meet all applicable water quality criteria or standards. It is considered a place where wastewater mixes with receiving water and not as a place where effluents are treated. (3-20-20)T

**55. Municipality.** A city, town, county, district, association, or other public body created by or under state law and having jurisdiction over disposal of sewage, industrial wastes, or other wastes, or an Indian tribe or an authorized Indian tribal organization, or a designated and approved management agency under the Clean Water Act section 208. (3-20-20)T

**56. National Pollutant Discharge Elimination System (NPDES).** The national program for issuing, modifying, revoking and reissuing, terminating, monitoring and enforcing permits, and imposing and enforcing pretreatment requirements, under the Clean Water Act sections 307, 402, 318, and 405. (3-20-20)T

**57. New Discharger.** Any building, structure, facility, or installation: (3-20-20)T

**a.** From which there is or may be a discharge of pollutants; (3-20-20)T

**b.** That did not commence the discharge of pollutants at a particular site prior to August 13, 1979; (3-20-20)T

**c.** Which is not a new source; and (3-20-20)T

**d.** Which has never received a finally effective NDPEs or IPDES permit for discharges at that site. (3-20-20)T

**e.** This definition includes an indirect discharger which commences discharging into waters of the United States after August 13, 1979. It also includes any existing mobile point source such as an aggregate plant, that begins discharging at a site for which it does not have a permit; (3-20-20)T

**58. New Source.** Any building, structure, facility, or installation from which there is or may be a discharge of pollutants, the construction of which commenced: (3-20-20)T

**a.** After promulgation of standards of performance under the Clean Water Act section 306 which are applicable to such source; or (3-20-20)T

**b.** After proposal of standards of performance in accordance with the Clean Water Act section 306

which are applicable to such source, but only if the standards are promulgated in accordance with section 306 within one hundred twenty (120) days of their proposal. (3-20-20)T

**59. Notice of Intent to Deny.** A type of draft permit that shall convey to a permit applicant or permittee, the Department's intent to not issue or renew an IPDES permit. (3-20-20)T

**60. Notice of Intent to Obtain Coverage under an IPDES General Permit.** An applicant seeking discharge coverage under an IPDES general permit shall submit a notice of intent to obtain coverage for discharges to waters of the United States under general permit classifications, including, but not limited to: (3-20-20)T

- a. Storm Water Construction General Permit (CGP); (3-20-20)T
- b. Multi-Sector General Permit (MSGP) for Industrial Storm Water Requirements; (3-20-20)T
- c. Municipal Separate Storm Sewer System (MS4) General Permit; (3-20-20)T
- d. Concentrated Animal Feeding Operation (CAFO) General Permit; (3-20-20)T
- e. Concentrated Aquatic Animal Production (CAAP) Facility General Permit; (3-20-20)T
- f. Ground Water Remediation General Permit; (3-20-20)T
- g. Suction Dredge General Permit; or (3-20-20)T
- h. Pesticide General Permit (PGP). (3-20-20)T

**61. Notice of Intent to Terminate.** A notice of intent to terminate shall: (3-20-20)T

- a. Convey to a permittee the Department's intent to terminate an existing IPDES permit for cause; or (3-20-20)T
- b. Convey to the Department a permittee's intent to terminate coverage for an activity under an Individual or General Permit. A construction general permit holder is obligated to submit a notice of intent to terminate upon completion of construction activities and, in the case of storm water control, that final stabilization has been achieved. (3-20-20)T

**62. Owner or Operator.** The person, company, corporation, district, association, or other organizational entity that is an owner or operator of any facility or activity subject to regulation under the IPDES program. (3-20-20)T

**63. Permit.** The authorization, license, or equivalent control document issued by the Department to implement the requirements of these rules. This does not include any permit which has not yet been the subject of final Department action, such as a draft permit or a proposed permit. (3-20-20)T

**64. Person.** An individual, public or private corporation, partnership, association, firm, joint stock company, joint venture, trust, estate, state, municipality, commission, political subdivision of the state, state or federal agency, department or instrumentality, special district, interstate body or any legal entity, or an agent or employee thereof, which is recognized by law as the subject of rights and duties. (3-20-20)T

**65. Point Source.** Any discernible, confined, and discrete conveyance, including but not limited to, any pipe, ditch, channel, tunnel, conduit, well, discrete fissure, container, rolling stock, concentrated animal feeding operation, landfill leachate collection system, vessel or other floating craft from which pollutants are or may be discharged. This term does not include return flows from irrigated agriculture or agricultural storm water runoff. (3-20-20)T

**66. Pollutant.** Dredged spoil, solid waste, incinerator residue, filter backwash, sewage, garbage, sewage sludge, munitions, chemical wastes, biological materials, radioactive materials (except those regulated under

the Atomic Energy Act of 1954, as amended (42 U.S.C. 2011 et seq.)), heat, wrecked or discarded equipment, rock, sand, cellar dirt and industrial, municipal, and agricultural waste discharged into water. It does not mean: (3-20-20)T

**a.** Sewage from vessels; or (3-20-20)T

**b.** Water, gas, or other material which is injected into a well to facilitate production of oil or gas, or water derived in association with oil and gas production and disposed of in a well, if the well used either to facilitate production or for disposal purposes is approved by authority of the state in which the well is located, and if the state determines that the injection or disposal will not result in the degradation of ground or surface water resources.

NOTE: Radioactive materials covered by the Atomic Energy Act are those encompassed in its definition of source, byproduct, or special nuclear materials. Examples of materials not covered include radium and accelerator-produced isotopes. See *Train v. Colorado Public Interest Research Group, Inc.*, 426 U.S. 1 (1976). (3-20-20)T

**67. Potable Water.** Water which is free from impurities in such amounts that it is safe for human consumption without treatment. (3-20-20)T

**68. Pretreatment.** The reduction of the amount of pollutants, the elimination of pollutants, or the alteration of the nature of pollutant properties in wastewater prior to or in lieu of discharging or otherwise introducing such pollutants into a POTW. The reduction or alteration may be obtained by physical, chemical or biological processes, process changes or by other means, except as prohibited by 40 CFR 403.6(d). Appropriate pretreatment technology includes control equipment, such as equalization tanks or facilities, for protection against surges or slug loadings that might interfere with or otherwise be incompatible with the POTW. However, where wastewater from a regulated process is mixed in an equalization facility with unregulated wastewater or with wastewater from another regulated process, the effluent from the equalization facility must meet an adjusted pretreatment limit calculated in accordance with 40 CFR 403.6(e). (3-20-20)T

**69. Primary Industry Category.** Any industry category listed in Appendix A of 40 CFR Part 122. (3-20-20)T

**70. Privately Owned Treatment Works.** Any device or system which is used to treat wastes and is not a Publicly Owned Treatment Works (POTW). (3-20-20)T

**71. Process Wastewater.** Any water which, during manufacturing or processing, comes into direct contact with or results from the production or use of any raw material, intermediate product, finished product, byproduct, or waste product (see Industrial Wastewater definition). (3-20-20)T

**72. Proposed Permit.** An IPDES permit prepared after the close of the public comment period (and, when applicable, any public meeting and administrative appeals) which is sent to EPA for review before final issuance by the Department. A proposed permit is not a draft permit. (3-20-20)T

**73. Publicly Owned Treatment Works (POTW).** A treatment works as defined by the Clean Water Act section 212, which is owned by a state or municipality, as defined by the Clean Water Act section 502(4). This definition includes any devices and systems used in the storage, treatment, recycling and reclamation of municipal sewage or industrial wastes of a liquid nature. It also includes sewers, pipes and other conveyances only if they convey wastewater to a POTW treatment plant. The term also means the municipality as defined in the Clean Water Act section 502(4), which has jurisdiction over the indirect discharges to and the discharges from such a treatment works. (3-20-20)T

**74. Receiving Waters.** Those waters of the United States to which there is a discharge of pollutants. (3-20-20)T

**75. Recommencing Discharger.** A source which renews discharges after terminating operations. (3-20-20)T

**76. Regional Administrator.** The Region 10 Administrator of the Environmental Protection Agency or the authorized representative of the Regional Administrator. (3-20-20)T

77. **Secondary Industry Category.** Any industry category which is not a primary industry category. (3-20-20)T
78. **Secondary Treatment.** Technology-based requirements for direct discharging POTWs, based on the expected performance of a combination of physical and biological processes typical for the treatment of pollutants in municipal sewage. Standards are expressed as a minimum level of effluent quality in terms of: BOD5, total suspended solids (TSS), and pH (except as provided by treatment equivalent to secondary treatment and other special considerations). (3-20-20)T
79. **Secretary.** The Secretary of the Army, acting through the Chief of Engineers. (3-20-20)T
80. **Septage.** The liquid and solid material pumped from a septic tank, cesspool, or similar domestic sewage treatment system, or a holding tank when the system is cleaned or maintained. (3-20-20)T
81. **Severe Property Damage.** Substantial physical damage to property, damage to the treatment facilities which causes them to become inoperable, or substantial and permanent loss of natural resources which can reasonably be expected to occur in the absence of a bypass. Severe property damage does not mean economic loss caused by delays in production. (3-20-20)T
82. **Sewage.** The water-carried human or animal waste from residences, buildings, industrial establishments or other places, together with such ground water infiltration and surface water as may be present. (3-20-20)T
83. **Sewage from Vessels.** Human body wastes and the wastes from toilets and other receptacles intended to receive or retain body wastes that are discharged from vessels and regulated under the Clean Water Act section 312. (3-20-20)T
84. **Sewage Sludge.** Any solid, semi-solid, or liquid residue removed during the treatment of municipal wastewater or domestic sewage. Sewage sludge includes, but is not limited to, solids removed during primary, secondary, or advanced wastewater treatment, scum, septage, portable toilet pumpings, type III marine sanitation device pumpings (33 CFR Part 159), and sewage sludge products. Sewage sludge does not include grit or screenings, or ash generated during the incineration of sewage sludge. (3-20-20)T
85. **Sewage Sludge Use or Disposal Practice.** The collection, storage, treatment, transportation, processing, monitoring, use, or disposal of sewage sludge. (3-20-20)T
86. **Significant Industrial User.** (3-20-20)T
- a. All industrial users subject to Categorical Pretreatment Standards under 40 CFR 403.6 and 40 CFR Parts 400 through 471; and (3-20-20)T
- b. Any other industrial user that: (3-20-20)T
- i. Discharges an average of twenty-five thousand (25,000) gallons per day or more of process wastewater to the POTW (excluding sanitary, noncontact cooling and boiler blowdown wastewater); (3-20-20)T
- ii. Contributes a process waste stream which makes up five percent (5%) or more of the average dry weather hydraulic or organic capacity of the POTW treatment plant; or (3-20-20)T
- iii. Is designated as such by the Control Authority on the basis that the industrial user has a reasonable potential for adversely affecting the POTW's operation or for violating any Pretreatment Standard or requirement (in accordance with 40 CFR 403.8(f)(6)). (3-20-20)T
87. **Silvicultural Point Source.** Any discernible, confined, and discrete conveyance related to rock crushing, gravel washing, log sorting, or log storage facilities which are operated in connection with silvicultural activities and from which pollutants are discharged into waters of the United States. The term does not include non-point source silvicultural activities such as nursery operations, site preparation, reforestation and subsequent cultural

treatment, thinning, prescribed burning, pest and fire control, harvesting operations, surface drainage, or road construction and maintenance from which there is natural runoff. However, some of these activities (such as stream crossing for roads) may involve point source discharges of dredged or fill material which may require a Clean Water Act section 404 permit. (3-20-20)T

**88. Site.** The land or water area where any facility or activity is physically located or conducted, including adjacent land used in connection with the facility or activity. (3-20-20)T

**89. Sludge.** The semi-liquid mass produced and removed by the wastewater treatment process. (3-20-20)T

**90. Sludge-Only Facility.** Any TWTDS whose methods of sewage sludge use or disposal are subject to regulations promulgated pursuant to the Clean Water Act section 405(d) and is required to obtain an IPDES permit. (3-20-20)T

**91. Source.** Any building, structure, facility, or installation from which there is or may be discharge of pollutants. (3-20-20)T

**92. Standards for Sewage Sludge Use or Disposal.** Regulations promulgated pursuant to the Clean Water Act section 405(d) and these rules which govern minimum requirements for sewage sludge quality, management practices, and monitoring and reporting applicable to sewage sludge or the use or disposal of sewage sludge by any person. (3-20-20)T

**93. State.** The state of Idaho. (3-20-20)T

**94. State/EPA Agreement.** An agreement between the EPA Regional Administrator and the state of Idaho which coordinates EPA and Department activities, responsibilities and programs including those under the Clean Water Act programs. (3-20-20)T

**95. Storm Water.** Storm water runoff, snow melt runoff, and surface runoff and drainage. (3-20-20)T

**96. Technology-Based Effluent Limitation (TBEL).** Treatment requirements under the Clean Water Act that represent the minimum level of control that must be imposed in a permit issued under section 402 of the Clean Water Act. (3-20-20)T

**97. Total Dissolved Solids.** The total dissolved (filterable) solids as determined by use of the method specified in 40 CFR Part 136. (3-20-20)T

**98. Toxic Pollutant.** Any substance, material or disease-causing agent, or a combination thereof, which after discharge to waters of the United States and upon exposure, ingestion, inhalation, or assimilation into any organism (including humans), either directly from the environment or indirectly by ingestion through food chains, will cause death, disease, behavioral abnormalities, malignancy, genetic mutation, physiological abnormalities (including malfunctions in reproduction) or physical deformations in affected organisms or their offspring. Toxic pollutants include, but are not limited to, the one hundred twenty-six (126) priority pollutants identified by EPA pursuant to the Clean Water Act section 307(a), or in the case of sewage sludge use or disposal practices, any pollutant identified in regulations implementing the Clean Water Act section 405(d). (3-20-20)T

**99. Treatment.** A process or activity conducted for the purpose of removing pollutants from wastewater. (3-20-20)T

**100. Treatment Facility.** Any physical facility or land area for the purpose of collecting, treating, neutralizing, or stabilizing pollutants including treatment plants; the necessary collecting, intercepting, outfall and outlet sewers; pumping stations integral to such plants or sewers; disposal or reuse facilities; equipment and furnishing thereof; and their appurtenances. For the purpose of these rules, a treatment facility may also be known as a treatment system, a wastewater system, wastewater treatment system, wastewater treatment facility, wastewater treatment plant, or privately or publicly owned treatment works. (3-20-20)T

**101. Treatment Works Treating Domestic Sewage (TWTDS).** A POTW or any other sewage sludge or waste water treatment devices or systems, regardless of ownership (including federal facilities), used in the storage, treatment, recycling, and reclamation of municipal or domestic sewage, including land dedicated for the disposal of sewage sludge. This definition does not include septic tanks or similar devices. For purposes of this definition, domestic sewage includes waste and waste water from humans or household operations that are discharged to or otherwise enter a treatment works. (3-20-20)T

**102. Upset.** An exceptional incident in which there is unintentional and temporary noncompliance with technology-based permit effluent limitations because of factors beyond the reasonable control of the permittee. An upset does not include noncompliance to the extent caused by operational error, improperly designed treatment facilities, inadequate treatment facilities, lack of preventive maintenance, or careless or improper operation. (3-20-20)T

**103. User.** Any person served by a wastewater system. (3-20-20)T

**104. Variance.** Any mechanism or provision under the Clean Water Act section 301 or 316 or under 40 CFR Part 125, or in the applicable effluent limitations guidelines allowing modification to or waiver of the generally applicable effluent limitation requirements or time deadlines of the Clean Water Act. This includes provisions which allow the establishment of alternative limitations based on fundamentally different factors or on Clean Water Act sections 301(c), 301(g), 301(h), 301(i), or 316(a). (3-20-20)T

**105. Wasteload Allocation (WLA).** The portion of a receiving water's loading capacity that is allocated to one (1) of its existing or future point sources of pollution. (3-20-20)T

**106. Wastewater.** Any combination of liquid or water and pollutants from activities and processes occurring in dwellings, commercial buildings, industrial plants, institutions and other establishments, together with any ground water, surface water, and storm water that may be present; liquid or water that is chemically, biologically, physically or rationally identifiable as containing blackwater, gray water or commercial or industrial pollutants; and sewage. (3-20-20)T

**107. Water Pollution.** Any alteration of the physical, thermal, chemical, biological, or radioactive properties of any waters of the United States, or the discharge of any pollutant into the waters of the United States, which will or is likely to create a nuisance or to render such waters harmful, detrimental or injurious to public health, safety or welfare, or to fish and wildlife, or to domestic, commercial, industrial, recreational, aesthetic, or other beneficial uses. (3-20-20)T

**108. Water Quality-Based Effluent Limitation (WQBEL).** An effluent limitation determined by selecting the most stringent of the effluent limits calculated using all applicable water quality criteria (e.g., aquatic life, human health, wildlife, translation of narrative criteria) for a specific point source to a specific receiving water. (3-20-20)T

**109. Water Transfer.** An activity that conveys or connects waters of the United States without subjecting the transferred water to intervening industrial, municipal, or commercial use. (3-20-20)T

**110. Wetlands.** Areas inundated or saturated by surface or ground water at a frequency and duration sufficient to support, and that under normal circumstances do support, a prevalence of vegetation typically adapted for life in saturated soil conditions. Wetlands generally include swamps, marshes, bogs, and similar areas. (3-20-20)T

**111. Whole Effluent Toxicity.** The aggregate toxic effect of an effluent measured directly by a toxicity test. (3-20-20)T

**011. -- 049. (RESERVED)**

**050. COMPUTATION OF TIME.**

**01. Computing Time.** In computing any period of time scheduled to begin after or before the occurrence of an act or event, the date of the act or event shall not be included. The last day of the period shall be

included, unless it is a Saturday, a Sunday, or a legal holiday, in which case the period runs until the end of the next day which is neither a Saturday, a Sunday, nor holiday. (3-20-20)T

**02. Notice by Mail.** Whenever a party or interested person has the right or is required to act within a prescribed period after the service of notice or other paper and the notice or paper is served upon him or her by mail, three (3) days shall be added to the prescribed time. (3-20-20)T

**051. -- 089. (RESERVED)**

**090. SIGNATURE REQUIREMENTS.**

**01. Permit Applications and Notices of Intent.** All IPDES permit applications and notices of intent must be signed by a certifying official as follows: (3-20-20)T

**a.** For a corporation, a responsible corporate officer shall sign the application or notice of intent. In this subsection, a responsible corporate officer means: (3-20-20)T

i. A president, secretary, treasurer, or vice-president of the corporation in charge of a principal business function, or any other person who performs similar policy- or decision-making functions for the corporation; or (3-20-20)T

ii. The manager of one (1) or more manufacturing, production, or operating facilities, if: (3-20-20)T

(1) The manager is authorized to make management decisions that govern the operation of the regulated facility, including having the explicit or implicit duty of making major capital investment recommendations, and initiating and directing other comprehensive measures to assure long-term environmental compliance with environmental statutes and regulations; (3-20-20)T

(2) The manager can ensure that the necessary systems are established or actions taken to gather complete and accurate information for IPDES permit application requirements; and (3-20-20)T

(3) Authority to sign documents has been assigned or delegated to the manager in accordance with corporate procedures; (3-20-20)T

**b.** For a partnership or sole proprietorship, the general partner or the proprietor, respectively, shall sign the application; and (3-20-20)T

**c.** For a municipality, state, or other public agency, either a principal executive officer or ranking elected official shall sign the application. In this subsection, a principal executive officer of an agency means: (3-20-20)T

i. The chief executive officer of the agency; or (3-20-20)T

ii. A senior executive officer having responsibility for the overall operations of a principal geographic unit or division of the agency. (3-20-20)T

**02. Reports and Other Information Submitted.** Any report or information required by an IPDES permit, notice of intent, monitoring and reporting provisions, and any other information requested by the Department, must be signed by a person described in Subsection 090.01, or by a duly authorized representative of that person. A person is a duly authorized representative only if: (3-20-20)T

**a.** The authorization is made in writing by a person described in Subsection 090.01; (3-20-20)T

**b.** The authorization specifies either: (3-20-20)T

i. An individual or a position having responsibility for the overall operation of the regulated facility

or activity, including the position of manager, operator, superintendent or position of equivalent responsibility; or  
(3-20-20)T

ii. An individual or position having overall responsibility for environmental matters for the company;  
and (3-20-20)T

c. The written authorization is submitted to the Department. (3-20-20)T

**03. New Authorization.** If an authorization is no longer accurate due to a change in staffing or personnel for the overall operation of the facility, a new authorization satisfying the requirements of Subsection 090.01 must be submitted to the Department before or together with any report, information, or application to be signed by an authorized representative. (3-20-20)T

**04. Certification.** Any person signing a document under Subsections 090.01 or 090.02 shall certify as follows: “I certify under penalty of law that this document and all attachments were prepared under my direction or supervision in accordance with a system designed to assure that qualified personnel properly gather and evaluate the information submitted. Based on my inquiry of the person or persons who manage the system, or those persons directly responsible for gathering the information, the information submitted is, to the best of my knowledge and belief, true, accurate, and complete. I am aware that there are significant penalties for submitting false information, including the possibility of fine and imprisonment for knowing violations.” (3-20-20)T

**05. Electronic Signatures.** The Department may require any signed, certified, or authorized information required under these rules to be submitted electronically, with an electronic signature approved by the Department. (3-20-20)T

**06. Electronic Reporting.** When documents described in Subsection 090.01 or 090.02 of this rule are submitted electronically by or on behalf of the IPDES-regulated facility, any person providing the electronic signature for such documents shall meet all relevant requirements of this section, and shall ensure that all of the relevant requirements of 40 CFR Part 3 (Cross-Media Electronic Reporting) and 40 CFR Part 127 (NPDES Electronic Reporting Requirements) are met for that submission. (3-20-20)T

**091. -- 099. (RESERVED)**

**100. EFFECT OF A PERMIT.**

**01. Rights.** The issuance of, or coverage under, an IPDES permit does not convey any property rights or any exclusive privilege nor does it authorize any injury to persons or property or invasion of other private rights, or any infringement of state or local law or regulations. The issuance of, or coverage under, an IPDES permit does not constitute authorization of the permitted activities by any other state or federal agency or private person or entity, and does not excuse the permit holder from the obligation to obtain any other necessary approvals, authorizations, or permits. (3-20-20)T

**02. Compliance.** Except for any toxic effluent standards and prohibitions imposed under the Clean Water Act section 307, and standards for sewage sludge use or disposal under the Clean Water Act section 405(d), compliance with an IPDES permit during its term constitutes compliance, for purposes of enforcement, with Clean Water Act sections 301, 302, 306, 307, 318, 403, and 405(a) through (b). However, a permit or coverage under a permit may be modified, revoked and reissued, or terminated during its term for cause as set out in Sections 130 (General Permits), 201 (Modification, or Revocation and Reissuance of IPDES Permits), and 203 (Termination of IPDES Permits). (3-20-20)T

**101. DURATION.**

**01. Permit Term.** IPDES permits shall be issued for a fixed duration not to exceed five (5) years. (3-20-20)T

a. The Department may issue a permit for a period of less than five (5) years. An explanation of the reasoning behind issuing a permit for a shorter period shall be provided in the fact sheet. (3-20-20)T



**b.** The duration of a permit may not be modified to lengthen the effective term of the permit past the maximum five (5) year duration. (3-20-20)T

**c.** A permit may be issued to expire on or after the statutory deadline set forth in the Clean Water Act sections 301(b)(2)(A), (C), and (E), if the permit includes effluent limitations to meet the requirements of the Clean Water Act sections 301(b)(2)(A), (C), (D), (E) and (F), whether or not applicable effluent limitations guidelines have been promulgated or approved. (3-20-20)T

**d.** A determination that a particular discharger falls within a given industrial category for purposes of setting a permit expiration date under Subsection 101.01.c. is not conclusive as to the discharger's inclusion in that industrial category for any other purposes, and does not prejudice any rights to challenge or change that inclusion at the time that a permit based on that determination is formulated. (3-20-20)T

**e.** A federally-issued NPDES permit, the administration of which has been transferred to the Department upon or after EPA approval of the IPDES program, shall continue in effect and be enforceable by the Department, subject to Subsections 101.02 and 101.03. (3-20-20)T

**02. Continuation of Individual Permits.** The conditions of an expired individual permit, whether a federal NPDES permit (except for permits over which EPA retains authority) or a state-issued IPDES permit, will remain fully effective and enforceable until the effective date of a new permit or the date of the Department's final decision to deny the application for the new permit, if: (3-20-20)T

**a.** The permittee has submitted a timely and complete application for a new permit under Section 105 (Application for an Individual IPDES Permit); and (3-20-20)T

**b.** The Department, because of time, resource, or other constraints, but through no fault of the permittee, does not issue a new permit with an effective date on or before the expiration date of the previous permit. (3-20-20)T

**03. Continuation of General Permits.** The conditions of an expired general permit, whether a federal NPDES permit or a state-issued IPDES permit, will remain fully effective and enforceable (except for permits over which EPA retains authority) until the date the authorization to discharge under the new permit is determined, if: (3-20-20)T

**a.** The permittee has submitted a timely notice of intent to obtain coverage under the new general permit as specified in Section 130 (General Permits); and (3-20-20)T

**b.** The Department, because of time, resource, or other constraints, but through no fault of the permittee, does not issue a new general permit with an effective date on or before the expiration date of the previous permit. (3-20-20)T

**04. Continuation of Permits During an Appeal.** Whether the conditions of an expired permit remain effective and enforceable during an appeal of a new permit, or an appeal of the denial of a permit application, is governed by Section 204 (Appeals Process). (3-20-20)T

## **102. OBLIGATION TO OBTAIN AN IPDES PERMIT.**

**01. Persons Who Must Obtain a Permit.** Any person who discharges or proposes to discharge a pollutant from any point source into waters of the United States, or who owns or operates a sludge-only facility whose sewage sludge use or disposal practice is regulated by 40 CFR Part 503 or these rules, and who does not have an IPDES or NPDES permit in effect, shall submit a complete IPDES permit application to the Department, unless the discharge, proposed discharge, or TWTDS: (3-20-20)T

**a.** Is covered by one (1) or more general permits in compliance with Section 130 (General Permits). Any applicant must complete a notice of intent for any discharge or proposed discharge that is covered by one (1) or more general permits; (3-20-20)T

- b.** Is excluded from IPDES permit requirements under Subsection 102.05; (3-20-20)T
- c.** Is by a user to a privately owned treatment works, and the Department, under Section 370 (Pretreatment Standards), does not otherwise require the person to apply for a permit; or (3-20-20)T
- d.** Is a TWTDS facility that uses or disposes of sewage sludge to which a standard applicable to its sewage sludge use or disposal practices have not been published. Such facilities shall submit limited background information, as specified in Subsection 105.17.o., within one (1) year after publication of applicable standards. (3-20-20)T
- 02. Operator’s Duty to Obtain a Permit.** When a facility or activity is owned by one person but is operated by another person, it is the operator’s duty to obtain a permit. (3-20-20)T
- 03. Permits Under the Clean Water Act Section 405(f).** All new and currently permitted TWTDS whose sewage sludge use or disposal practices are regulated by 40 CFR Part 503 must submit permit applications according to the applicable schedule in Subsection 105.17. The Department may require permit applications from any TWTDS at any time if the Department determines that a permit is necessary to protect public health and the environment from any potential adverse effects that may occur from toxic pollutants in sewage sludge. (3-20-20)T
- 04. Designation of Small Municipal Separate Storm Sewer Systems (MS4s).** DEQ shall designate a small MS4 that is not located in an urbanized area, as determined by the latest Decennial Census by the Bureau of Census, as a regulated small MS4 that must be covered by an IPDES permit if the Department determines that: (3-20-20)T
- a.** The storm water discharge results in or has the potential to result in exceedance of water quality standards or other significant water quality impacts; or (3-20-20)T
- b.** The storm water discharge contributes substantially to the pollutant loadings of a physically interconnected municipal separate storm sewer that is regulated by the IPDES storm water program. (3-20-20)T
- 05. Exclusions from Permit.** A person shall not discharge pollutants from any point source into waters of the United States without first obtaining an IPDES permit from the Department or coverage under an IPDES general permit, unless the discharge is excluded from IPDES permit requirements or the discharge is authorized by an IPDES or NPDES permit that continues in effect. The Department will not require persons to obtain IPDES permits for facilities or activities that are not required to obtain NPDES permits from EPA under the Clean Water Act and federal Clean Water Act regulations. Discharges excluded from IPDES permit requirements, but that may be regulated by other state or federal regulations include: (3-20-20)T
- a.** Any sewage discharge from vessels and any effluent from properly functioning marine engines, laundry, shower and galley sink wastes, or any other discharge incidental to the normal operation of a vessel of the U.S. Armed Forces within the meaning of the Clean Water Act section 312, and a recreational vessel within the meaning of the Clean Water Act section 502(25). None of these exclusions apply to: (3-20-20)T
- i.** Rubbish, trash, garbage, or other such materials discharged overboard; nor to (3-20-20)T
- ii.** Other discharges when the vessel is operating in a capacity other than as a means of transportation such as when used as: (3-20-20)T
- (1) An energy or mining facility; (3-20-20)T
- (2) A storage facility, or when secured to a storage facility; or (3-20-20)T
- (3) When secured to the bed of the waters of the United States for the purposes of mineral or oil exploration or development; (3-20-20)T
- b.** Any discharge of dredged or fill material into waters of the United States that is regulated under the

Clean Water Act section 404;

(3-20-20)T

**c.** Sewage, industrial wastes, or other pollutants discharged into publicly owned treatment works (POTWs) by an indirect discharger who has received a will-serve letter authorizing the discharge to the POTW. Plans or agreements to switch to this method of disposal in the future do not relieve dischargers of the obligation to have and comply with permits until all discharges of pollutants to waters of the United States are eliminated. This exclusion does not apply to the introduction of pollutants to privately owned treatment works or to other discharges through pipes, sewers, or other conveyances owned by a state, municipality, or other party not leading to treatment works;

(3-20-20)T

**d.** Any discharge in compliance with the instructions of an on-scene coordinator under 40 CFR Part 300 (The National Oil and Hazardous Substances Pollution Contingency Plan), or 33 CFR 153.10(e) (Control of Pollution by Oil and Hazardous Substances, Discharge Removal);

(3-20-20)T

**e.** Any introduction of pollutants from non-point source agricultural and silvicultural activities, including storm water runoff from orchards, cultivated crops, pastures, range lands, and forest lands; however, this exclusion does not apply to discharges from concentrated animal feeding operations (CAFO) as defined in 40 CFR 122.23, discharges from concentrated aquatic animal production (CAAP) facilities, discharges to aquaculture projects, and discharges from silvicultural point sources;

(3-20-20)T

**f.** Any return flow from irrigated agriculture;

(3-20-20)T

**g.** Discharges into a privately owned treatment works, except as the Department may otherwise require under Subsection 302.15; and

(3-20-20)T

**h.** Discharges from a water transfer. This exclusion does not apply to pollutants introduced by the water transfer activity itself to the water being transferred.

(3-20-20)T

### **103. PERMIT PROHIBITIONS.**

The Department will not issue an IPDES permit for a discharge:

(3-20-20)T

**01. Clean Water Act Compliance.** Unless the conditions of the permit provide for compliance with the applicable requirements of IDAPA 58.01.02, “Water Quality Standards” and 58.01.25 “Rules Regulating the Idaho Pollutant Discharge Elimination System Program”;

(3-20-20)T

**02. EPA Objection.** When the Department has received written objection pursuant to 40 CFR 123.44 from the EPA Regional Administrator to issuance of the permit and until the objections are resolved according to the process identified in the Memorandum of Agreement between EPA and the Department;

(3-20-20)T

**03. Water Quality Requirements.** When the imposition of conditions cannot ensure compliance with the applicable water quality requirements of all affected states;

(3-20-20)T

**04. Anchorage and Navigation Impaired.** When, in the judgment of the Secretary of the United States Army through the Army Corp Chief of Engineers, anchorage and navigation in or on any of the waters of the United States would be substantially impaired by the discharge;

(3-20-20)T

**05. Banned Content.** Of any radiological, chemical, or biological warfare agent or high level radioactive waste;

(3-20-20)T

**06. Area Wide Waste Treatment Management Plans.** That is inconsistent with a plan or plan amendment approved under the Clean Water Act section 208(b); or

(3-20-20)T

**07. New Sources or New Dischargers.** For a new source or new discharger, if the discharge from its construction or operation will cause or contribute to the violation of water quality standards.

(3-20-20)T

**a.** When the owner or operator of a new source or new discharge proposes to discharge into a water segment that does not meet applicable water quality standards, or that is not expected to meet those standards even after the application of the effluent limitations required by Clean Water Act sections 301(b)(1)(A) and (B), and for

which the state or interstate agency has performed a pollutant load allocation for the pollutant to be discharged, then the owner or operator must demonstrate that: (3-20-20)T

- i. There are sufficient remaining pollutant load allocations to allow for the discharge; and (3-20-20)T
- ii. The existing dischargers into that segment are subject to compliance schedules designed to bring the segment into compliance with applicable water quality standards. (3-20-20)T
- b. The Department may waive the submission of the information by the permit applicant required in Subsection 103.07.a. if the Department determines that it already has adequate information to evaluate the request. (3-20-20)T
- c. An explanation of the development of limitations to meet the criteria of this section is to be included in the fact sheet to the permit. (3-20-20)T

**104. PRE-APPLICATION PROCESS.**

Any person who intends to apply for a permit or who proposes to discharge a pollutant into the waters of the United States should contact the Department to schedule a meeting prior to submitting an application to discuss: (3-20-20)T

- 01. IPDES Permit Applicability.** Whether the actions or facility will require an IPDES permit, and whether other suitable permitting options are available; (3-20-20)T
- 02. Application Content.** The IPDES permit application requirements; and (3-20-20)T
- 03. Application Schedule.** The IPDES permit application submittal schedule. (3-20-20)T

**105. APPLICATION FOR AN INDIVIDUAL IPDES PERMIT.**

**01. Electronic Submittals.** The Department may require an applicant to electronically submit information required by this section, if the Department approves an electronic method of submittal. (3-20-20)T

**02. Application Retention Schedule.** An applicant shall keep records of all data used to complete a permit application and any supplemental information submitted for a period of at least three (3) years from the date the application is signed. (3-20-20)T

**03. Time to Apply.** Any person required under Subsections 102.01 through 102.03 to obtain an IPDES permit shall submit to the Department a complete application for a permit in compliance with the requirements of this subsection. A permit application must be signed and certified as required by Section 090 (Signature Requirements). (3-20-20)T

**a.** A person proposing a new discharge shall submit an application at least one hundred eighty (180) days before the date on which the discharge is to commence, unless the Department has granted permission to submit the application on a later date as specified in Subsections 105.03.e. and f. A facility proposing a new discharge of storm water associated with industrial activity shall submit an application one hundred eighty (180) days before that facility commences industrial activity that may result in a discharge of storm water associated with that industrial activity, unless the Department has granted permission to submit the application on a later date as specified in Subsections 105.03.e. and f. (3-20-20)T

**b.** Facilities described under 40 CFR 122.26(b)(14)(x) or (b)(15)(i) shall submit an application at least ninety (90) days before the date on which construction is to commence unless otherwise required by the terms of an applicable general permit. (3-20-20)T

**c.** Any TWTDS that commences operations after promulgation of any applicable “standard for sewage sludge use or disposal” must submit an application to the Department at least one hundred eighty (180) days prior to the date proposed for commencing operations. (3-20-20)T

**d.** A person discharging from a permitted facility with a currently effective permit shall submit a new

application at least one hundred eighty (180) days before the expiration date of the existing permit, unless the Department has granted permission to submit the application on a later date as specified in Subsections 105.03.e. and f. (3-20-20)T

e. Permission may be granted by the Department for submission of an application in less than one hundred eighty (180) days. The Department's prior approval must be sought and obtained in advance of the one hundred eighty (180) days before expiration of the existing permit or commencement of new discharge. (3-20-20)T

f. In no instance shall the application be accepted after the expiration date of the existing permit as an application for renewal of the permit. Any applications received after the expiration of the permit will be received and reviewed as an application for a new source or new discharger. (3-20-20)T

**04. Individual Permit Application Forms.** An applicant must submit an application on one (1) or more Department-approved forms appropriate to the number and type of discharge or outfall at the applicant's facility. A person required by Subsections 102.01 through 102.03 to obtain an individual IPDES permit shall submit an application to the Department providing the information required by this subsection and Subsections 105.05 through 105.19, as applicable. The application must be submitted on one (1) or more of the EPA forms listed in this subsection, or on the Department equivalent of the listed EPA form: (3-20-20)T

a. All applicants, other than a POTW and other TWTDS (see Subsection 105.06), EPA Form 1, revised as of August 1, 1990, and the following additional forms, if applicable: (3-20-20)T

i. Applicants for a concentrated animal feeding operation (CAFO; see Subsection 105.09) or concentrated aquatic animal production (CAAP; see Subsection 105.10) facility, EPA Form 2B, revised as of November 2008; (3-20-20)T

ii. Applicants for an existing industrial facility, including manufacturing facilities, commercial facilities, mining activities, and silviculture activities (see Subsection 105.07), EPA Form 2C, revised as of August 1, 1990; (3-20-20)T

iii. Applicants for a new industrial facility that discharges process wastewater (see Subsection 105.16), EPA Form 2D, revised as of August 1, 1990; (3-20-20)T

iv. Applicants for a new or existing industrial facility that discharges only non-process wastewater (see Subsection 105.08.a.), EPA Form 2E, revised as of August 1, 1990; (3-20-20)T

v. Applicants for a new or existing facility whose discharge is composed entirely of storm water associated with industrial activity (see Subsection 105.19), EPA Form 2F, revised May 31, 1992, unless the applicant is exempted by 40 CFR 122.26(c)(1)(ii). If the applicant's discharge is composed of storm water and non-storm water (see Subsections 105.07, 105.08, and 105.16), EPA Forms 2C, 2D, or 2E, as appropriate, are also required; or (3-20-20)T

vi. Applicants that operate a sludge-only facility (see Subsection 105.17), that currently does not have and is not applying for, an IPDES permit for a direct discharge to a surface water body, EPA Form 2S, revised January 14, 1999; (3-20-20)T

b. For an applicant that is a new or existing POTW (see Subsections 105.11 through 105.15): (3-20-20)T

i. EPA Form 2A, revised January 14, 1999; and (3-20-20)T

ii. EPA Form 2S, revised January 14, 1999, if applicable. (3-20-20)T

**05. Application Information for All Dischargers.** In addition to the application information required for specific dischargers, the Department may require the submittal of any information necessary to ensure compliance with Section 103 (Permit Prohibitions). Such information includes, but is not limited to: (3-20-20)T

**a.** Information required to determine compliance with the antidegradation policy and antidegradation implementation provisions set forth in IDAPA 58.01.02.051 and 052, “Water Quality Standards”; (3-20-20)T

**b.** Information required to determine compliance with the mixing zone provisions set forth in IDAPA 58.01.02.060, “Water Quality Standards”; or (3-20-20)T

**c.** Information necessary for the Department to authorize a compliance schedule under IDAPA 58.01.02.400, “Water Quality Standards.” (3-20-20)T

**06. Individual Permit Application Requirements for Dischargers Other than Treatment Works Treating Domestic Sewage (TWTDS) and Publicly Owned Treatment Works (POTWs).** An applicant for an IPDES permit other than a POTW and other TWTDS, shall provide the following information to the Department, using the appropriate forms specified in Subsection 105.04: (3-20-20)T

**a.** The applicant’s activity that requires an IPDES permit; (3-20-20)T

**b.** The name, mailing address, electronic mail address, and location of the facility for which the application is submitted; (3-20-20)T

**c.** Up to four (4) Standard Industrial Classification (SIC) codes that best identify the principal products or services provided by the facility; (3-20-20)T

**d.** The operator’s name, mailing address, electronic mail address, telephone number, ownership status, Employer Identification Number (EIN), and status as federal, state, private, public, or other entity; (3-20-20)T

**e.** A statement that the facility is located in Indian country, if applicable; (3-20-20)T

**f.** A listing of all permits or construction approvals received or applied for under any of the following programs: (3-20-20)T

**i.** Hazardous waste management program under IDAPA 58.01.05, “Rules and Standards for Hazardous Waste”; (3-20-20)T

**ii.** Underground injection control (UIC) program under the Idaho Department of Water Resources UIC program at IDAPA 37.03.03, “Rules and Minimum Standards for the Construction and Use of Injection Wells”; (3-20-20)T

**iii.** IPDES program under IDAPA 58.01.25 “Rules Regulating the Idaho Pollutant Discharge Elimination System Program”; (3-20-20)T

**iv.** Prevention of significant deterioration (PSD) program under IDAPA 58.01.01, “Rules for Control of Air Pollution in Idaho”; (3-20-20)T

**v.** Nonattainment program under IDAPA 58.01.01, “Rules for Control of Air Pollution in Idaho”; (3-20-20)T

**vi.** National emission standards for hazardous pollutants (NESHAPS) preconstruction approval under IDAPA 58.01.01, “Rules for Control of Air Pollution in Idaho”; (3-20-20)T

**vii.** Dredge or fill permits under the Clean Water Act section 404; or (3-20-20)T

**viii.** Other relevant environmental permits, programs or activities, including those subject to state jurisdiction, approval, and permits; and (3-20-20)T

**g.** A topographic map, or other map if a topographic map is unavailable, extending one (1) mile beyond the property boundaries of the source, depicting: (3-20-20)T

- i. The facility and each of its intake and discharge structures; (3-20-20)T
- ii. The location of the facility's hazardous waste treatment, storage, or disposal areas; (3-20-20)T
- iii. The location of each well where fluids from the facility are injected underground; and (3-20-20)T
- iv. The location of wells, springs, other surface water bodies, and drinking water wells listed in public records or otherwise known by the applicant to exist in the map area; and (3-20-20)T
- h. A brief description of the nature of the business. (3-20-20)T

**07. Individual Permit Application Requirements for Existing Manufacturing, Commercial, Mining and Silviculture Dischargers.** (3-20-20)T

a. Except for a facility subject to the requirements in Subsection 105.08, an applicant for an IPDES permit for an existing discharge from a manufacturing, commercial, mining, or silviculture facility or activity shall provide the following information to the Department, using the applicable forms specified in Subsection 105.04: (3-20-20)T

- i. For each outfall: (3-20-20)T
  - (1) The latitude and longitude to the nearest second and the name of each receiving water; (3-20-20)T
  - (2) A narrative identifying each type of process, operation, or production area that contributes wastewater to the effluent from that outfall, including process wastewater, cooling water, and storm water runoff; processes, operations, or production areas may be described in general terms, such as dye-making reactor or distillation tower; (3-20-20)T
  - (3) The average flow that each process contributes and a description of the treatment the wastewater receives, including the ultimate disposal of any solid or fluid wastes other than by discharge; (3-20-20)T
  - (4) For a privately owned treatment works, the identity of each user of the treatment works; and (3-20-20)T
  - (5) The average flow of point sources composed of storm water. For this subsection, the average flow may be estimated, and the basis for the rainfall event with the method of estimation must be submitted; (3-20-20)T
- ii. A description of the frequency, duration, and flow rate of each discharge occurrence for any of the discharges described in Subsection 105.07.a.i.(2). through 105.07.a.i.(5). that are intermittent or seasonal, except for storm water runoff, spillage, or leaks; (3-20-20)T
- iii. A reasonable measure of the applicant's actual production reported in the units used in the applicable effluent guideline, if an effluent guideline promulgated under the Clean Water Act section 304 applies to the applicant and is expressed in terms of production or other measure of operation. The reported measure must reflect the actual production of the facility as required by Subsection 303.02.b.; (3-20-20)T
- iv. If the applicant is subject to any present requirements or compliance schedules for construction, upgrading, or operation of waste treatment equipment, an identification of the abatement requirement, a description of the abatement project, and a listing of the required and projected final compliance dates; (3-20-20)T
- v. A listing of any toxic pollutant that the applicant currently uses or manufactures as an intermediate or final product or byproduct, except that the Department may waive or modify this requirement; (3-20-20)T
  - (1) If the applicant demonstrates that it would be unduly burdensome to identify each toxic pollutant; and (3-20-20)T
  - (2) The Department has adequate information to issue the permit; (3-20-20)T

vi. An identification of any biological toxicity tests that the applicant knows or has reason to believe have been made within the last three (3) years on any of the applicant's discharges or on a receiving water in relation to a discharge; and (3-20-20)T

vii. The identity of each laboratory or firm and the analyses performed, if a contract laboratory or consulting firm performed any of the analyses required by Subsection 105.07.c. through m. (3-20-20)T

**b.** The owner or operator of a facility subject to this subsection shall submit, with an application, a line drawing of the water flow through the facility with a water balance, showing operations contributing wastewater to the effluent and treatment units. (3-20-20)T

i. In the line drawing, similar processes, operations, or production areas may be indicated as a single unit, labeled to correspond to the more detailed identification under Subsection 105.07.a.i.(2) through 105.07.a.i.(5). (3-20-20)T

ii. The water balance must show approximate average flows at intake and discharge points and between units, including treatment units. (3-20-20)T

iii. If a water balance cannot be determined for certain activities, the applicant may instead provide a pictorial description of the nature and amount of any sources of water and any collection and treatment measures. (3-20-20)T

**c.** In addition to the items of information listed in Subsections 105.07.a. through 105.07.b., and except for information on storm water discharges required by 40 CFR 122.26, an applicant for an IPDES permit for an existing facility described in Subsection 105.07.a. shall: (3-20-20)T

i. Collect, prepare, and submit information regarding the effluent characteristics and discharge of pollutants specified in this section; and (3-20-20)T

ii. When quantitative data for a pollutant are required, collect a sample of effluent and analyze it for the pollutant in accordance with analytical methods approved under 40 CFR Part 136, except that when no analytical method is approved, the applicant may use any suitable method but must describe the method. (3-20-20)T

**d.** An applicant for an IPDES permit under this subsection shall: (3-20-20)T

i. Use grab samples in providing information regarding cyanide, total phenols, residual chlorine, oil and grease, fecal coliform (including *E. coli*), Enterococci (previously known as fecal streptococcus), and volatile organics; temperature, pH, and residual chlorine effluent data may be obtained from grab samples or from calibrated and properly maintained continuous monitors; (3-20-20)T

ii. For all other pollutants, use twenty-four (24) hour composite samples, except that a minimum of one (1) grab sample may be taken for effluents from holding ponds or other impoundments with a retention period greater than twenty-four (24) hours; (3-20-20)T

**e.** For purposes of Subsection 105.07.c., exceptions to testing and data provision requirements for effluent characteristics include: (3-20-20)T

i. When an applicant has two (2) or more outfalls with substantially identical effluents, the Department may allow the applicant to test only one (1) outfall and report that the quantitative data also apply to the substantially identical outfall; and (3-20-20)T

ii. An applicant's duty under Subsections 105.07.j., k., and l. to provide quantitative data for certain pollutants known or believed to be present does not apply to pollutants present in a discharge solely as the result of their presence in intake water; however, an applicant shall report that those pollutants are present. (3-20-20)T

**f.** For storm water discharges, associated with an existing facility described in Subsection 105.07.a.,



from storm events which yield more than one-tenth (0.1) inch of rainfall: (3-20-20)T

i. All samples must be collected from the discharge resulting from a storm event and at least seventy-two (72) hours after the previously measurable storm event exceeding one-tenth (0.1) inch rainfall. Where feasible, the variance in the duration of the event and the total rainfall of the event should not exceed fifty percent (50%) from the average or median rainfall event in that area; and (3-20-20)T

ii. For all applicants, a flow-weighted composite sample must be taken for either the entire discharge or for the first three (3) hours of the discharge, except for the following: (3-20-20)T

(1) The sampling may be conducted with a continuous sampler or as a combination of a minimum of three (3) sample aliquots taken in each hour of discharge for the entire discharge or for the first three (3) hours of the discharge, with each aliquot being separated by a minimum period of fifteen (15) minutes. If the Department approves, an applicant for a storm water discharge permit under Subsection 105.18 may collect flow-weighted composite samples using different protocols with respect to the time duration between the collection of sample aliquots; (3-20-20)T

(2) A minimum of one (1) grab sample may be taken for storm water discharges from holding ponds or other impoundments with a retention period greater than twenty-four (24) hours; or (3-20-20)T

(3) For a flow-weighted composite sample, only one (1) analysis of the composite of aliquots is required; (3-20-20)T

iii. For samples taken from discharges associated with industrial activities, quantitative data must be reported for the grab sample taken during the first thirty (30) minutes, or as soon thereafter as practicable, of the discharge for all pollutants specified in Subsection 105.19 except that for all storm water permit applicants taking flow-weighted composites, quantitative data must be reported for all pollutants specified in 40 CFR 122.26(a) through (b) and (e) through (g), Subsections 105.18 and 105.19, but not for pH, temperature, cyanide, total phenols, residual chlorine, oil and grease, fecal coliform, and fecal streptococcus; (3-20-20)T

iv. The Department may, on a case-by-case basis, allow or establish appropriate site-specific sampling procedures or requirements, including: (3-20-20)T

(1) Sampling locations; (3-20-20)T

(2) The season in which the sampling takes place; (3-20-20)T

(3) The minimum duration between the previous measurable storm event and the sampled storm event; (3-20-20)T

(4) The minimum or maximum level of precipitation required for an appropriate storm event; (3-20-20)T

(5) The form of precipitation sampled, whether snow melt or rain fall; (3-20-20)T

(6) Protocols for collecting samples under 40 CFR Part 136; and (3-20-20)T

(7) Additional time for submitting data; and (3-20-20)T

v. An applicant is deemed to know or have reason to believe that a pollutant is present in an effluent if an evaluation of the expected use, production, or storage of the pollutant, or any previous analyses for the pollutant, show that pollutant's presence. (3-20-20)T

g. Unless a reporting requirement is waived under Subsection 105.07.h., every applicant subject to this subsection shall report quantitative data for the following pollutants for every outfall: (3-20-20)T

i. 5-day biochemical oxygen demand (BOD5); (3-20-20)T

- ii. Chemical oxygen demand (COD); (3-20-20)T
- iii. Total organic carbon (TOC); (3-20-20)T
- iv. Total suspended solids (TSS); (3-20-20)T
- v. Ammonia, as N; (3-20-20)T
- vi. Temperature (both winter and summer); and (3-20-20)T
- vii. pH. (3-20-20)T

**h.** The Department may waive the reporting requirements under Subsection 105.07.g. for individual point sources or for a particular industry category for one (1) or more of the pollutants listed in Subsection 105.07.g. if the applicant demonstrates that information adequate to support issuance of a permit can be obtained with less stringent requirements. (3-20-20)T

**i.** Except as provided in Subsection 105.07.n., an applicant with an existing facility described in Subsection 105.07.a. that has processes that qualify in one (1) or more of the primary industry categories shown in Appendix A to 40 CFR Part 122 contributing to a discharge, must report quantitative data for pollutants in each outfall containing process wastewater as follows: (3-20-20)T

i. Data for the organic toxic pollutants listed in Table II of Appendix D to 40 CFR Part 122 in the fractions designated in Table I of Appendix D to 40 CFR Part 122. For purposes of this subsection: (3-20-20)T

(1) Table II of Appendix D to 40 CFR Part 122, lists the organic toxic pollutants in each fraction that result from the sample preparation required by the analytical procedure that uses gas chromatography/mass spectrometry; and (3-20-20)T

(2) If the Department determines that an applicant falls within an industrial category for the purposes of selecting fractions for testing, that determination does not establish the applicant's category for any other purpose; see Notes 2 and 3 to 40 CFR 122.21; and (3-20-20)T

ii. Data for the toxic metals, cyanide, and total phenols listed in Table III of Appendix D to 40 CFR Part 122. (3-20-20)T

**j.** An applicant for an IPDES permit under this section must disclose, in an application, whether the applicant knows or has reason to believe that any of the conventional and nonconventional pollutants in Table IV of Appendix D to 40 CFR Part 122 are discharged from each outfall. If an applicable effluent limitations guideline limits the pollutant either directly or indirectly by express limitations on an indicator, the applicant must report quantitative data. For every pollutant discharged that is not limited in an effluent limitations guideline, the applicant must either report quantitative data or briefly describe the reasons the pollutant is expected to be discharged. (3-20-20)T

**k.** An applicant for an IPDES permit under this subsection must disclose, in an application, whether the applicant knows or has reason to believe that any of the organic toxic pollutants listed in Table II or the toxic metals, cyanide, or total phenols listed in Table III of Appendix D to 40 CFR Part 122 for which quantitative data are not otherwise required under Subsection 105.07.i., are discharged from each outfall. Unless an applicant qualifies as a small business under Subsection 105.07.n., the applicant must: (3-20-20)T

i. Report quantitative data for every pollutant expected to be discharged in concentrations of ten (10) parts per billion or greater; (3-20-20)T

ii. Report quantitative data for acrolein, acrylonitrile, 2,4 dinitrophenol, and 2-methyl-4, 6 dinitrophenol, if any of these four (4) pollutants are expected to be discharged in concentrations of one hundred (100) parts per billion or greater; and (3-20-20)T

iii. For every pollutant expected to be discharged in concentrations less than ten (10) parts per billion, or in the case of acrolein, acrylonitrile, 2,4 dinitrophenol, and 2-methyl-4, 6 dinitrophenol, in concentrations less than one hundred (100) parts per billion, either submit quantitative data, or briefly describe the reasons the pollutant is expected to be discharged and submit any supporting documentation. (3-20-20)T

l. An applicant for an IPDES permit under this subsection must disclose, in an application, whether the applicant knows or has reason to believe that asbestos or any of the hazardous substances listed in Table V of Appendix D to 40 CFR Part 122 are discharged from each outfall. For every pollutant expected to be discharged, the applicant must briefly describe the reasons the pollutant is expected to be discharged and report any quantitative data it has for any pollutant. (3-20-20)T

m. An applicant for an IPDES permit under this subsection must disclose, in an application, and report qualitative data, generated using a screening procedure not calibrated with analytical standards, for 2,3,7, 8-tetrachlorodibenzo-p-dioxin (TCDD) if the applicant: (3-20-20)T

i. Uses or manufactures the following: (3-20-20)T

(1) 2,4,5-trichlorophenoxy acetic acid (2,4,5,-T); (3-20-20)T

(2) 2-(2,4,5-trichlorophenoxy) propanoic acid (Silvex, 2,4,5,-TP); (3-20-20)T

(3) 2-(2,4,5-trichlorophenoxy) ethyl, 2,2-dichloropropionate (Erbon); (3-20-20)T

(4) o,o-dimethyl o-(2,4,5-trichlorophenyl) phosphorothioate (Ronnel); (3-20-20)T

(5) 2,4,5-trichlorophenol (TCP); or (3-20-20)T

(6) Hexachlorophene (HCP); or (3-20-20)T

ii. Knows or has reason to believe that TCDD is or may be present in an effluent. (3-20-20)T

n. An applicant under this subsection is exempt from the quantitative data requirements in Subsections 105.07.i. or 105.07.j. for the organic toxic pollutants listed in Table II of Appendix D to 40 CFR Part 122, if that applicant qualifies as a small business under one (1) of the following criteria: (3-20-20)T

i. The applicant is a coal mine with an expected total annual production of less than one hundred thousand (100,000) tons per year; or (3-20-20)T

ii. The applicant has gross total annual sales averaging less than two hundred eighty-seven thousand, three hundred dollars (\$287,300) per year in 2014 dollars. (3-20-20)T

o. In addition to the information reported on the application form, an applicant under this subsection shall provide to the Department, at the Department's request, any other information that the Department may reasonably require to assess the discharges of the facility and to determine whether to issue an IPDES permit. The additional information may include additional quantitative data and bioassays to assess the relative toxicity of discharges to aquatic life and information required to determine the cause of the toxicity. (3-20-20)T

**08. Individual Permit Application Requirements for New or Existing Manufacturing, Commercial, Mining, and Silviculture Facilities that Discharge only Non-Process Wastewater.** (3-20-20)T

a. An applicant for an IPDES permit that is a manufacturing, commercial, mining, or silvicultural discharger that discharges only non-process wastewater not regulated by an effluent limitations guideline or new source performance standard shall provide the following information to the Department for all discharges, except for storm water discharges, using the applicable forms specified in Subsection 105.04: (3-20-20)T

i. The number of each outfall, the latitude and longitude to the nearest second, and the name of each receiving water; (3-20-20)T

- ii. For a new discharger, the date of expected commencement of discharge; (3-20-20)T
- iii. An identification of the general type of waste discharged, or expected to be discharged upon commencement of operations, including sanitary wastes, restaurant or cafeteria wastes, or non-contact cooling water; (3-20-20)T
- iv. An identification of cooling water additives, if any, that are used or expected to be used upon commencement of operations, along with their composition if existing composition is available; (3-20-20)T
- v. Effluent characteristics prepared and submitted as described in Subsections 105.08.b. and 105.08.c.; (3-20-20)T
- vi. A description of the frequency of flow and duration of any seasonal or intermittent discharge, except for storm water runoff, leaks, or spills; (3-20-20)T
- vii. A brief description of any treatment system used or to be used; (3-20-20)T
- viii. Any additional information the applicant wishes to be considered, such as influent data for the purpose of obtaining net credits under Subsection 303.07; and (3-20-20)T
- ix. The signature of the certifying official under Section 090 (Signature Requirements). (3-20-20)T
- b.** Except as otherwise provided in Subsections 105.08.d. through g., an IPDES permit application for a discharger described in Subsection 105.08.a. must include quantitative data for the following pollutants or parameters: (3-20-20)T
  - i. 5-day biochemical oxygen demand (BOD<sub>5</sub>); (3-20-20)T
  - ii. Total suspended solids (TSS); (3-20-20)T
  - iii. Fecal coliform, if believed present or if sanitary waste is or will be discharged; (3-20-20)T
  - iv. Total residual chlorine (TRC), if chlorine is used; (3-20-20)T
  - v. Oil and grease; (3-20-20)T
  - vi. Chemical oxygen demand (COD), if non-contact cooling water is or will be discharged; (3-20-20)T
  - vii. Total organic carbon (TOC), if non-contact cooling water is or will be discharged; (3-20-20)T
  - viii. Ammonia, as N; (3-20-20)T
  - ix. Discharge flow; (3-20-20)T
  - x. pH; and (3-20-20)T
  - xi. Temperature, both in winter and summer, respectively. (3-20-20)T
- c.** For purposes of the data required under Subsection 105.08.b.: (3-20-20)T
  - i. Grab samples must be used for oil and grease, fecal coliform, and volatile organics. Temperature, pH, and TRC effluent data may be obtained from grab samples or from calibrated and properly maintained continuous monitors; (3-20-20)T
  - ii. Twenty-four (24) hour composite samples must be used for pollutants listed in Subsection 105.08.b., other than those specified in Subsection 105.08.c.i. Twenty-four (24) hour composite samples must, at a

minimum, be composed of four (4) grab samples, equally spaced through the twenty-four (24)-hour period, unless specified otherwise at 40 CFR Part 136. For a composite sample, only one (1) analysis of the composite aliquots is required; (3-20-20)T

iii. The quantitative data may be collected over the past three hundred sixty-five (365) days, as long as the data is representative of current operations, and must include maximum daily value, average daily value, and number of measurements taken; and (3-20-20)T

iv. The applicant shall collect and analyze samples in accordance with 40 CFR Part 136. (3-20-20)T

d. The Department may waive the testing and reporting requirements for any of the pollutants or flow listed in Subsection 105.08.c. if the applicant requests a waiver with its application or earlier, and demonstrates that information adequate to support permit issuance can be obtained through less stringent requirements. (3-20-20)T

e. If the applicant is a new discharger, the applicant shall: (3-20-20)T

i. Complete and submit Item IV of EPA Form 2E, or the Department equivalent, as required by Subsection 105.04.a.iv., by providing quantitative data in compliance with that section no later than two (2) years after the discharge commences, except that the applicant need not complete those portions of Item IV requiring tests that the applicant has already performed and reported under the discharge monitoring requirements of its IPDES or NPDES permit; and (3-20-20)T

ii. Include estimates and the source of each estimate instead of sampling data for the pollutants or parameters listed in Subsection 105.08.b.; (3-20-20)T

f. For purposes of the data required under this subsection, all pollutant levels must be reported or estimated as concentration and as total mass, except for flow, pH, and temperature. Submittal of all estimated data shall be accompanied by documents supporting the estimated value. (3-20-20)T

g. An applicant's duty, under Subsections 105.08.b., c. and e., to provide quantitative data or estimates of certain pollutants does not apply to pollutants present in a discharge solely as a result of their presence in intake water. However, an applicant shall report the presence of those pollutants. If the requirements of Subsection 303.07 are met, net credit may be provided for the presence of pollutants in intake water. (3-20-20)T

**09. Individual Permit Application Requirements for New and Existing Concentrated Animal Feeding Operations (CAFO).** An applicant for an IPDES permit for a new or existing CAFO, as defined in 40 CFR 122.23(b) shall provide the following information to the Department, using the applicable forms specified in Subsection 105.04: (3-20-20)T

a. The name of the owner or operator; (3-20-20)T

b. The facility location and mailing addresses; (3-20-20)T

c. Latitude and longitude of the production area to the nearest second, measured at the entrance to the production area; (3-20-20)T

d. A topographic map of the geographic area in which the concentrated animal feeding operation is located, showing the specific location of the production area; (3-20-20)T

e. Specific information about the number and type of animals, including, if applicable: beef cattle, broilers, layers, swine weighing fifty-five (55) pounds or more, swine weighing less than fifty-five (55) pounds, mature dairy cows, dairy heifers, veal calves, sheep and lambs, horses, ducks, turkeys, or other animals, whether in open confinement or housed under roof; (3-20-20)T

f. The type of containment and total capacity in tons or gallons of any anaerobic lagoon, roofed storage shed, storage pond, under-floor pit, above-ground storage tank, below-ground storage tank, concrete pad, impervious soil pad, or other structure or area used for containment and storage of manure, litter, and process

wastewater; (3-20-20)T

**g.** The total number of acres available and under the applicant's control for land application of manure, litter, or process wastewater; (3-20-20)T

**h.** Estimated amounts of manure, litter, and process wastewater generated per year in tons or gallons; (3-20-20)T

**i.** Estimated amounts of manure, litter, and process wastewater transferred to other persons per year in tons or gallons; and (3-20-20)T

**j.** A nutrient management plan that has been completed and will be implemented upon the date of permit coverage. A nutrient management plan must meet, at a minimum, the requirements specified in 40 CFR 122.42(e), including for all CAFOs subject to 40 CFR 412.30 through 412.37, 412.40 through 412.47, or the requirements of 40 CFR 412.4(c), as applicable. (3-20-20)T

**10. Individual Permit Application Requirements for New and Existing Concentrated Aquatic Animal Production (CAAP) Facilities.** An applicant for an IPDES permit for a new or existing CAAP facility shall provide the following information to the Department, using the applicable forms specified in Subsection 105.04: (3-20-20)T

**a.** The maximum daily and average monthly flow from each outfall; (3-20-20)T

**b.** The number of ponds, raceways, and similar structures; (3-20-20)T

**c.** The name of the receiving water and the source of intake water; (3-20-20)T

**d.** For each species of aquatic animal, the total yearly and maximum harvestable weight; and (3-20-20)T

**e.** The calendar month of maximum feeding and the total mass of food fed during that month. (3-20-20)T

**11. Individual Permit Application Requirements for New and Existing POTWs and Other Dischargers Designated by the Department.** (3-20-20)T

**a.** Except as provided in Subsection 105.11.b., an applicant that is a POTW and any other discharger designated by the Department shall provide the information in this subsection to the Department, using the applicable forms specified in Subsection 105.04.b. A permit applicant under this subsection shall submit all information available at the time of permit application; however, an applicant may provide information by referencing information previously submitted to the Department. (3-20-20)T

**b.** The Department may waive any requirement of this subsection if the Department has access to substantially identical information. The Department may also waive any requirement of this subsection if that information is not of material concern for a specific permit, if approved by the EPA Regional Administrator. The waiver request to the Regional Administrator must include the Department's justification for the waiver. A Regional Administrator's disapproval of a Department's proposed waiver does not constitute final agency action, but does provide notice to the state and permit applicant(s) that EPA may object to any state-issued permit issued in the absence of the required information. (3-20-20)T

**c.** An applicant under this subsection must provide the following information: (3-20-20)T

**i.** Name, mailing address, and location of the facility for which the application is submitted; (3-20-20)T

**ii.** Name, mailing address, electronic mail address, EIN, and telephone number of the applicant, and a statement whether the applicant is the facility's owner, operator, or both; (3-20-20)T

iii. A list of all environmental permits or construction approvals received or applied for, including dates, under any of the following programs or types of activities: (3-20-20)T

(1) Hazardous waste management program under IDAPA 58.01.05, “Rules and Standards for Hazardous Waste”; (3-20-20)T

(2) Underground injection control (UIC) program under the Idaho Department of Water Resources UIC program at IDAPA 37.03.03, “Rules and Minimum Standards for the Construction and Use of Injection Wells”; (3-20-20)T

(3) IPDES program under IDAPA 58.01.25, “Rules Regulating the Idaho Pollutant Discharge Elimination System Program”; (3-20-20)T

(4) Prevention of significant deterioration (PSD) program under IDAPA 58.01.01, “Rules for the Control of Air Pollution in Idaho”; (3-20-20)T

(5) Nonattainment program under IDAPA 58.01.01, “Rules for the Control of Air Pollution in Idaho”; (3-20-20)T

(6) National emission standards for hazardous pollutants (NESHAPS) preconstruction approval under IDAPA 58.01.01, “Rules for the Control of Air Pollution in Idaho”; (3-20-20)T

(7) Dredge or fill permits under the Clean Water Act section 404; (3-20-20)T

(8) Sludge Management Program under IDAPA 58.01.16.650, “Wastewater Rules,” and Section 380 (Sewage Sludge) of these rules; and (3-20-20)T

(9) Other relevant environmental permits, programs, or activities, including those subject to state jurisdiction, approval, and permits; (3-20-20)T

iv. The name, population, and equivalent dwelling units (EDU) of each municipal entity served by the facility, including unincorporated connector districts, a statement whether each municipal entity owns or maintains the collection system and, if the information is available, whether the collection system is a separate sanitary sewer or a combined storm and sanitary sewer; (3-20-20)T

v. A statement whether the facility is located in Indian country and whether the facility discharges to a receiving stream that flows through Indian country; (3-20-20)T

vi. The facility’s design flow rate, or the wastewater flow rate the plant was built to handle, annual average daily flow rate, and maximum daily flow rate for each of the previous three (3) years; (3-20-20)T

vii. A statement identifying the types of collection systems, either separate sanitary sewers or combined storm and sanitary sewers, used by the treatment works, and an estimate of the percent of sewer line that each type comprises; (3-20-20)T

viii. The following information for outfalls to waters of the United States and other discharge or disposal methods: (3-20-20)T

(1) For effluent discharges to waters of the United States, the total number and types of outfalls including treated effluent, combined sewer overflows, bypasses, constructed emergency overflows; (3-20-20)T

(2) For wastewater discharged to surface impoundments, the location of each surface impoundment, the average daily volume discharged to each surface impoundment, and a statement whether the discharge is continuous or intermittent; (3-20-20)T

(3) For wastewater applied to the land, the location of each land application site, the size in acres of

each land application site, the average daily volume in gallons per day applied to each land application site, and a statement whether the land application is continuous or intermittent; (3-20-20)T

(4) For effluent sent to another facility for treatment prior to discharge, the means by which the effluent is transported, the name, mailing address, electronic mail address, contact person, and phone number of the organization transporting the discharge, if the transport is provided by a party other than the applicant, the name, mailing address, electronic mail address, contact person, phone number, and IPDES or NPDES permit number, if any, of the receiving facility, and the average daily flow rate from this facility into the receiving facility in million gallons per day (MGD); and (3-20-20)T

(5) For wastewater disposed of in a manner not included in Subsections 105.11.c.viii.(1) through (4), including underground percolation and underground injection, a description of the disposal method, the location and size of each disposal site, if applicable, the annual average daily volume in gallons per day disposed of by this method, and a statement whether disposal by this method is continuous or intermittent; and (3-20-20)T

ix. The name, mailing address, electronic mail address, telephone number, and responsibilities of all contractors responsible for any operational or maintenance aspects of the POTW facility. (3-20-20)T

**d.** In addition to the information described in Subsection 105.11.c., an applicant under this subsection with a design flow greater than or equal to zero point one (0.1) million gallons per day (MGD) must provide: (3-20-20)T

i. The current average daily volume in gallons per day of inflow and infiltration, and a statement describing steps the facility is taking to minimize inflow and infiltration; (3-20-20)T

ii. A topographic map, or other map if a topographic map is unavailable, extending at least one (1) mile beyond property boundaries of the treatment plant including all unit processes, and showing: (3-20-20)T

(1) The treatment plant area and unit processes; (3-20-20)T

(2) The major pipes or other structures through which wastewater enters the treatment plant and the pipes or other structures through which treated wastewater is discharged from the treatment plant, including outfalls from bypass piping, if applicable; (3-20-20)T

(3) Each well where fluids from the treatment plant are injected underground; (3-20-20)T

(4) Wells, springs, and other surface water bodies listed in public records or otherwise known to the applicant within one-quarter (1/4) mile of the property boundaries of the treatment works; (3-20-20)T

(5) Sewage sludge management facilities including on-site treatment, storage, and disposal sites; and (3-20-20)T

(6) Each location at which waste classified as hazardous under IDAPA 58.01.05, "Rules and Standards for Hazardous Waste," enters the treatment plant by truck, rail, or dedicated pipe; (3-20-20)T

iii. A process flow diagram or schematic as follows: (3-20-20)T

(1) A diagram showing the processes of the treatment plant, including all bypass piping and all backup power sources or redundancy in the system, including a water balance showing all treatment units, including disinfection, and showing daily average flow rates at influent and discharge points and approximate daily flow rates between treatment units; and (3-20-20)T

(2) A narrative description of the diagram; and (3-20-20)T

iv. The following information regarding scheduled improvements: (3-20-20)T

(1) The outfall number of each affected outfall; (3-20-20)T



- (2) A narrative description of each required improvement; (3-20-20)T
- (3) Scheduled dates for commencement and completion of construction, commencement of discharge and attainment of operational level, and actual completion date for any event listed in this subsection that has been completed; and (3-20-20)T
- (4) A description of permits and authorizations concerning other federal and state requirements. (3-20-20)T
- e. An applicant under this subsection must provide the following information for each outfall, including bypass points, through which effluent is discharged, as applicable: (3-20-20)T
  - i. For each outfall: (3-20-20)T
    - (1) The outfall number; (3-20-20)T
    - (2) The county, and city or town in which the outfall is located; (3-20-20)T
    - (3) The latitude and longitude, to the nearest second; (3-20-20)T
    - (4) The distance from shore and depth below surface; (3-20-20)T
    - (5) The average daily flow rate, in million gallons per day (MGD); (3-20-20)T
    - (6) If the outfall has a seasonal or periodic discharge, the number of times per year the discharge occurs, the duration of each discharge, the flow of each discharge, and the months in which discharge occurs; and (3-20-20)T
    - (7) A statement whether the outfall is equipped with a diffuser and the type of diffuser used, such as high-rate; (3-20-20)T
  - ii. For each outfall discharging effluent to waters of the United States, the following receiving water information, if the information is available: (3-20-20)T
    - (1) The name of each receiving water; (3-20-20)T
    - (2) The critical flow of each receiving stream; and (3-20-20)T
    - (3) The total hardness of the receiving stream at critical low flow; and (3-20-20)T
  - iii. For each outfall discharging to waters of the United States, the following information describing the treatment of the discharges: (3-20-20)T
    - (1) The highest level of treatment, including primary, equivalent to secondary, secondary, advanced, or other treatment level provided for: (3-20-20)T
      - (a) The design biochemical oxygen demand removal percentage; (3-20-20)T
      - (b) The design suspended solids removal percentage; (3-20-20)T
      - (c) The design phosphorus removal percentage; (3-20-20)T
      - (d) The design nitrogen removal percentage; and (3-20-20)T
      - (e) Any other removals that an advanced treatment system is designed to achieve; and (3-20-20)T

(2) A description of the type of disinfection used, and a statement whether the treatment plant de-chlorinates, if disinfection is accomplished through chlorination. (3-20-20)T

**f.** In addition to Subsection 105.11.a., and except as provided in Subsection 105.11.h., an applicant under this subsection shall undertake sampling and analysis and submit effluent monitoring information for samples taken from each outfall through which effluent is discharged to waters of the United States, except for combined sewer overflows, including the following if applicable: (3-20-20)T

i. Sampling and analysis for the pollutants listed in Appendix J, Table 1A to 40 CFR Part 122; (3-20-20)T

ii. For an applicant with a design flow greater than or equal to zero point one (0.1) million gallons per day (MGD), sampling and analysis for the pollutants listed in Appendix J, Table 1 to 40 CFR Part 122, except that a facility that does not use chlorine for disinfection, does not use chlorine elsewhere in the treatment process, and has no reasonable potential to discharge chlorine in the facility's effluent, is not required to sample or analyze chlorine; (3-20-20)T

iii. Sampling and analysis for the pollutants listed in Appendix J, Table 2 to 40 CFR Part 122 and for any other pollutants for which the state or EPA has established water quality standards applicable to the receiving waters if the facility is: (3-20-20)T

(1) A POTW that has a design flow rate equal to or greater than one (1) million gallons per day (MGD); (3-20-20)T

(2) A POTW that has an approved pretreatment program; (3-20-20)T

(3) A POTW that is required to develop a pretreatment program; or (3-20-20)T

(4) Any POTW, as required by the Department to ensure compliance with these rules; (3-20-20)T

iv. Sampling and analysis for additional pollutants, as the Department may require, on a case-by-case basis; (3-20-20)T

v. Data from a minimum of three (3) samples taken within four and one-half (4 ½) years before the date of the permit application; to meet this requirement: (3-20-20)T

(1) Samples must be representative of the seasonal variation in the discharge from each outfall; (3-20-20)T

(2) Existing data may be used, if available, in lieu of sampling done solely for the purpose of this application; and (3-20-20)T

(3) Additional samples may be required by the Department on a case-by-case basis; and (3-20-20)T

vi. All existing data for pollutants specified in Subsections 105.11.f.i. through iv. collected within four and one-half (4 ½) years of the application. This data must be included in the pollutant data summary submitted by the applicant, except that if the applicant samples for a specific pollutant on a monthly or more frequent basis, only the data collected for that pollutant within one (1) year of the application must be provided. (3-20-20)T

**g.** To meet the information requirements of Subsection 105.11.f., an applicant must: (3-20-20)T

i. Collect samples of effluent and analyze the samples for pollutants in accordance with analytical methods approved under 40 CFR Part 136 unless an alternative is specified in the existing IPDES or NPDES permit; (3-20-20)T

ii. Use the following methods: (3-20-20)T

(1) Grab samples for pH, temperature, cyanide, total phenols, residual chlorine, oil and grease, fecal coliform, and volatile organics. Temperature, pH, and residual chlorine data may be obtained from grab samples or from calibrated and properly maintained continuous monitors; (3-20-20)T

(2) Twenty-four (24) hour composite samples for all other pollutants; for a composite sample, only one (1) analysis of the composite of aliquots is required; and (3-20-20)T

iii. Provide at least the following information for each parameter: (3-20-20)T

(1) Maximum daily discharge, expressed as concentration or mass, based upon actual sample values; (3-20-20)T

(2) Average daily discharge for all samples, expressed as concentration or mass, and the number of samples used to obtain this value; (3-20-20)T

(3) The analytical method used; and (3-20-20)T

(4) The threshold level, such as the method detection limit, minimum level, or other designated method endpoint for the analytical method used; and (3-20-20)T

iv. Report metals as total recoverable, unless the Department requires otherwise. (3-20-20)T

**h.** When an applicant under this subsection has two (2) or more outfalls with substantially identical effluent discharging to the same receiving water segment, the Department may, on a case-by-case basis, allow the applicant to submit sampling data for only one (1) outfall. The Department may also allow an applicant to composite samples from one (1) or more outfalls that discharge into the same mixing zone, pursuant to IDAPA 58.01.02, "Water Quality Standards." (3-20-20)T

**12. Whole Effluent Toxicity (WET) Monitoring for POTWs.** (3-20-20)T

**a.** An applicant for a permit under Subsection 105.11 shall submit information on effluent monitoring for WET, including an identification of any WET tests conducted during the four and one-half (4 ½) years before the date of the application on any of the applicant's discharges or on any receiving water near the discharge. (3-20-20)T

**b.** An applicant under Subsection 105.11 shall submit to the Department, in compliance with Subsections 105.12.c. through f., the results of valid WET tests for acute or chronic toxicity for samples taken from each outfall through which effluent is discharged to surface waters, except for combined sewer overflows, if the applicant: (3-20-20)T

i. Has a design flow rate greater than or equal to one (1) million gallons per day (MGD); (3-20-20)T

ii. Has an approved pretreatment program or is required to develop a pretreatment program; or (3-20-20)T

iii. Is required to comply with this subsection by the Department, based on consideration of the following factors: (3-20-20)T

(1) The variability of the pollutants or pollutant parameters in the POTW effluent based on chemical-specific information, the type of treatment plant, and types of industrial contributors; (3-20-20)T

(2) The ratio of effluent flow to receiving stream flow; (3-20-20)T

(3) Existing controls on point or non-point sources, including total maximum daily load calculations for the receiving stream segment and the relative contribution of the POTW; (3-20-20)T

(4) Receiving water characteristics, including possible or known water quality impairment, and whether the POTW discharges to a water designated as an outstanding natural resource water; or (3-20-20)T

(5) Other considerations, including the history of toxic impacts and compliance problems at the POTW that the Department determines could cause or contribute to adverse water quality impacts. (3-20-20)T

c. When an applicant under Subsection 105.11 has two (2) or more outfalls with substantially identical effluent discharging to the same receiving water segment, the Department may, on a case-by-case basis, allow the applicant to submit whole effluent toxicity data for only one (1) outfall. The Department may also allow an applicant to composite samples from one (1) or more outfalls that discharge into the same mixing zone. (3-20-20)T

d. An applicant under Subsection 105.12.b. that is required to perform WET testing must provide: (3-20-20)T

i. Results of a minimum of four (4) quarterly tests for a year, from the year preceding the permit application or results from four (4) tests performed at least annually in the four and one-half (4 ½) year period before the application, if the results show no appreciable toxicity using a safety factor determined by the Department; (3-20-20)T

ii. The number of chronic or acute whole effluent toxicity tests that have been conducted since the last permit reissuance; (3-20-20)T

iii. The results using the form provided by the Department, or test summaries, if available and comprehensive, for each WET test conducted under this subsection for which the information has not been reported previously to the Department; (3-20-20)T

iv. For WET data submitted to the Department within four and one-half (4 ½) years before the date of the application, the dates on which the data were submitted and a summary of the results; and (3-20-20)T

v. Any information on the cause of toxicity and written details of any toxicity reduction evaluation conducted, if any WET test conducted within the past four and one-half (4 ½) years revealed toxicity. (3-20-20)T

e. An applicant under Subsection 105.11 must conduct tests with no less than two (2) species, including fish, invertebrate, or plant, and test for acute or chronic toxicity, depending on the range of receiving water dilution. Unless the Department directs otherwise, an applicant shall conduct acute or chronic testing based on the following dilutions: (3-20-20)T

i. Acute toxicity testing if the dilution of the effluent is greater than a ratio of one thousand to one (1,000:1) at the edge of the mixing zone; (3-20-20)T

ii. Acute or chronic toxicity testing, if the dilution of the effluent is between a ratio of one hundred to one (100:1) and one thousand to one (1,000:1) at the edge of the mixing zone; acute testing may be more appropriate at the higher end of this range (one thousand to one (1,000:1)), and chronic testing may be more appropriate at the lower end of this range (one hundred to one (100:1)); or (3-20-20)T

iii. Chronic testing if the dilution of the effluent is less than a ratio of one hundred to one (100:1) at the edge of the mixing zone. (3-20-20)T

f. For purposes of the WET testing required by this section, an applicant must conduct testing using methods approved under 40 CFR Part 136. (3-20-20)T

**13. Individual Permit Application Requirements for POTWs Receiving Industrial Discharges.** (3-20-20)T

a. An applicant for an IPDES permit as a POTW under Subsection 105.11 shall state in its application the number of significant industrial users (SIU) and categorical industrial users (CIU) discharging to the POTW. A POTW with one (1) or more SIUs shall provide the following information for each SIU that discharges to the POTW: (3-20-20)T

- i. The name and mailing address of the SIU; (3-20-20)T
  - ii. A description of all industrial processes that affect or contribute to the SIU's discharge; (3-20-20)T
  - iii. The principal products and raw materials of each SIU that affects or contributes to that SIU's discharge; (3-20-20)T
  - iv. The average daily volume of wastewater discharged by the SIU, indicating the amount attributable to process flow and non-process flow; (3-20-20)T
  - v. A statement whether the SIU is subject to local limits; (3-20-20)T
  - vi. A statement whether the SIU is subject to one (1) or more categorical standards, and if so, under which category and subcategory; and (3-20-20)T
  - vii. A statement whether any problems at the POTW, including upsets, pass-through, or interference have been attributed to the SIU in the past four and one-half (4 ½) years. (3-20-20)T
- b.** The information required in Subsection 105.13.a. may be waived by the Department for a POTW with a pretreatment program if the applicant has submitted either of the following that contains information substantially identical to the information required in Subsection 105.13.a.: (3-20-20)T
- i. An annual report submitted within one (1) year of the application; or (3-20-20)T
  - ii. A pretreatment program. (3-20-20)T

**14. Individual Permit Application Requirements for POTWs Receiving Discharges from Hazardous Waste Generators and from Waste Cleanup or Remediation Sites. (3-20-20)T**

- a.** A POTW receiving hazardous or corrective action wastes or wastes generated at another type of cleanup or remediation site must provide the following information: (3-20-20)T
- i. If the POTW receives, or has been notified that it will receive by truck, rail, or dedicated pipe, any wastes that are regulated as hazardous wastes under 40 CFR Part 261 and IDAPA 58.01.05, "Rules and Standards for Hazardous Waste," the applicant must report the following: (3-20-20)T
    - (1) The method of delivery, including by truck, rail, or dedicated pipe, by which the waste is received; and (3-20-20)T
    - (2) The applicable hazardous waste number designated in IDAPA 58.01.05, "Rules and Standards for Hazardous Waste" for the transported waste, and the amount received annually of each hazardous waste; and (3-20-20)T
  - ii. If the POTW receives, or has been notified that it will receive, wastewater that originates from remedial activities, including those undertaken under Comprehensive Environmental Response, Compensation, and Liability Act, and the Resource Conservation and Recovery Act sections 3004(u) or 3008(h), the applicant must report the following: (3-20-20)T
    - (1) The identity and description of each site or facility at which the wastewater originates; (3-20-20)T
    - (2) The identity of any known hazardous constituents specified in IDAPA 58.01.05, "Rules and Standards for Hazardous Waste," in the wastewater; and (3-20-20)T
    - (3) The extent of any treatment the wastewater receives or will receive before entering the POTW. (3-20-20)T
- b.** An applicant under this subsection is exempt from the requirements of Subsection 105.14.a.ii. if the

applicant receives no more than fifteen (15) kilograms per month of hazardous wastes, unless the wastes are acute hazardous wastes as specified in IDAPA 58.01.05, “Rules and Standards for Hazardous Waste.” (3-20-20)T

**15. Individual Permit Application Requirements for POTWs with Combined Sewer Systems and Overflows.** A POTW applicant with a combined sewer system must provide the following information on the combined sewer system and outfalls: (3-20-20)T

- a.** A system map indicating the location of: (3-20-20)T
  - i. All combined sewer overflow discharge points; (3-20-20)T
  - ii. Any sensitive use areas potentially affected by combined sewer overflows including beaches, drinking water supplies, shellfish beds, sensitive aquatic ecosystems; (3-20-20)T
  - iii. Outstanding national resource waters potentially affected by combined sewer overflows; and (3-20-20)T
  - iv. Waters supporting threatened and endangered species potentially affected by combined sewer overflows; (3-20-20)T
- b.** A system diagram of the combined sewer collection system that includes the locations of: (3-20-20)T
  - i. Major sewer trunk lines, both combined and separate sanitary; (3-20-20)T
  - ii. Points where separate sanitary sewers feed into the combined sewer system; (3-20-20)T
  - iii. In-line and off-line storage structures; (3-20-20)T
  - iv. Flow-regulating devices; and (3-20-20)T
  - v. Pump stations; (3-20-20)T
- c.** Information on each outfall for each combined sewer overflow discharge point covered by the permit application, including: (3-20-20)T
  - i. The outfall number; (3-20-20)T
  - ii. The county and city or town in which the outfall is located; (3-20-20)T
  - iii. The latitude and longitude, to the nearest second; and (3-20-20)T
  - iv. The distance from shore and depth below surface; (3-20-20)T
- d.** A statement whether the applicant monitored any of the following in the past year for a combined sewer overflow: (3-20-20)T
  - i. Rainfall; (3-20-20)T
  - ii. Overflow volume; (3-20-20)T
  - iii. Overflow pollutant concentrations; (3-20-20)T
  - iv. Receiving water quality; (3-20-20)T
  - v. Overflow frequency; and (3-20-20)T

- vi. The number of storm events monitored in the past year; (3-20-20)T
- e. Information regarding the number of combined sewer overflows from each outfall in the past year and, if available: (3-20-20)T
  - i. The average duration per event; (3-20-20)T
  - ii. The average volume for each event; and (3-20-20)T
  - iii. The minimum rainfall that caused a combined sewer overflow event in the last year; (3-20-20)T
- f. The name of each receiving water; (3-20-20)T
- g. A description of any known water quality impact caused by the combined sewer overflow operations, including permanent or intermittent beach closings, permanent or intermittent shellfish bed closings, fish kills, fish advisories, other recreational loss, or the exceedance of any applicable state water quality standard, on the receiving water; and (3-20-20)T
- h. All applicants must provide the name, mailing address, telephone number, and responsibilities of all contractors responsible for any operational or maintenance aspects of the facility. (3-20-20)T

**16. Individual Permit Application Requirements for New Sources and New Discharges.** (3-20-20)T

- a. An applicant for an IPDES permit for a new manufacturing, commercial, mining, silviculture, or other discharge, except for a new discharge from a facility subject to the requirements of Subsection 105.08 or a new discharge of storm water associated with industrial activity that is subject to the requirements of Subsection 105.19, except as provided by Subsection 105.19.c., shall provide the following information to the Department, using the applicable forms specified in Subsection 105.04.b.: (3-20-20)T
  - i. The latitude and longitude to the nearest second of the expected outfall location and the name of each receiving water; (3-20-20)T
  - ii. The expected date the discharge will commence; (3-20-20)T
  - iii. The following information on flows, sources of pollution, and treatment technologies: (3-20-20)T
    - (1) A narrative describing the treatment that the wastewater will receive, identifying all operations contributing wastewater to the effluent, stating the average flow contributed by each operation, and describing the ultimate disposal of any solid or liquid wastes not discharged; (3-20-20)T
    - (2) A line drawing of the water flow through the facility with a water balance as described in Subsection 105.07.b.; and (3-20-20)T
    - (3) If any of the expected discharges will be intermittent or seasonal, a description of the frequency, duration, and maximum daily flow rate of each discharge occurrence, except for storm water runoff, spillage, or leaks; (3-20-20)T
  - iv. If a new source performance standard promulgated under the Clean Water Act section 306 or an effluent limitation guideline applies to the applicant and is expressed in terms of production or other measure of operation, a reasonable calculation of the applicant's expected actual production reported in the units used in the applicable effluent guideline or new source performance standard, as required by Subsection 303.02.b., for each of the first three (3) years. The applicant may submit alternative estimates if production is likely to vary; (3-20-20)T
  - v. The effluent characteristics information as described in Subsection 105.16.b.; (3-20-20)T
  - vi. The existence of any technical evaluation concerning the applicant's wastewater treatment, along

- with the name and location of similar plants of which the applicant has knowledge; (3-20-20)T
- vii. Any optional information the permittee wishes the Department to consider. (3-20-20)T
- b.** An applicant under this section must provide the following effluent characteristics information: (3-20-20)T
- i. Estimated daily maximum, daily average, and the source of that information for each outfall for the following pollutants or parameters: (3-20-20)T
- (1) Five (5)-day biochemical oxygen demand (BOD<sub>5</sub>); (3-20-20)T
- (2) Chemical oxygen demand (COD); (3-20-20)T
- (3) Total organic carbon (TOC); (3-20-20)T
- (4) Total suspended solids (TSS); (3-20-20)T
- (5) Flow; (3-20-20)T
- (6) Ammonia, as N; (3-20-20)T
- (7) Temperature, in both winter and summer; and (3-20-20)T
- (8) pH. (3-20-20)T
- ii. Estimated daily maximum, daily average, and the source of that information for each outfall for all the conventional and nonconventional pollutants in Table IV of Appendix D to 40 CFR Part 122, if the applicant knows or has reason to believe any of the pollutants will be present or if any of the pollutants are limited by an effluent limitation guideline or new source performance standard either directly or indirectly through limitations on an indicator pollutant; (3-20-20)T
- iii. Estimated daily maximum, daily average, and the source of that information for the following pollutants for each outfall, if the applicant knows or has reason to believe the pollutants will be present in the discharge from any outfall: (3-20-20)T
- (1) All pollutants in Table IV of Appendix D to 40 CFR Part 122; (3-20-20)T
- (2) The toxic metals, total cyanide, and total phenols listed in Table III of Appendix D to 40 CFR Part 122; (3-20-20)T
- (3) The organic toxic pollutants in Table II of Appendix D to 40 CFR Part 122 except bis (chloromethyl) ether, dichlorofluoromethane, and trichlorofluoromethane; however, this requirement is waived for: (3-20-20)T
- (a) An applicant with expected gross sales of less than two hundred eighty-seven thousand three hundred dollars (\$287,300) per year in 2014 dollars for the next three (3) years (see also Subsection 105.07.n.ii.); or (3-20-20)T
- (b) A coal mine with expected average production of less than one hundred thousand (100,000) tons of coal per year (see also Subsection 105.07.n.i.); (3-20-20)T
- iv. The information that 2,3,7,8-tetrachlorodibenzo-p-dioxin (TCDD) may be discharged if the applicant uses or manufactures one (1) of the following compounds, or if the applicant knows or has reason to believe that TCDD will or may be present in an effluent: (3-20-20)T
- (1) 2,4,5-trichlorophenoxy acetic acid (2,4,5-T); Chemical Abstract Service (CAS) #93-76-5;



- (3-20-20)T
- (2) 2-(2,4,5-trichlorophenoxy) propanoic acid (Silvex, 2,4,5-TP) (CAS #93-72-1); (3-20-20)T
  - (3) 2-(2,4,5-trichlorophenoxy) ethyl 2,2-dichloropropionate (Erbon) (CAS #136-25-4); (3-20-20)T
  - (4) o,o-dimethyl o-(2,4,5-trichlorophenyl) phosphorothioate (Ronnell) (CAS #299-84-3); (3-20-20)T
  - (5) 2,4,5-trichlorophenol (TCP) (CAS #95-95-4); or (3-20-20)T
  - (6) Hexachlorophene (HCP) (CAS #70-30-4); and (3-20-20)T
- v. The potential presence of any of the pollutants listed in Table V of Appendix D to 40 CFR Part 122 if the applicant believes these pollutants will be present in any outfall, except that quantitative estimates are not required unless they are already available at the time the applicant applies for the permit. (3-20-20)T
- c. No later than two (2) years after the commencement of discharge from the proposed facility, the applicant is required to complete and submit Items V and VI of EPA application Form 2C or the Department equivalent. The applicant need not complete those portions of Item V or the Department equivalent requiring tests already performed and reported under the discharge monitoring requirements of its permit. (3-20-20)T
- d. The effluent characteristics requirements in Subsections 105.08.b., c., and e. that an applicant must provide estimates of certain pollutants expected to be present do not apply to pollutants present in a discharge solely as a result of their presence in intake water. However, an applicant must report that a pollutant is present. For purposes of this subsection, net credits may be provided for the presence of pollutants in intake water if the requirements of Subsection 303.07 are met, and (except for discharge flow, temperature, and pH) all levels must be estimated as concentration and as total mass. (3-20-20)T
- e. The Department may waive the reporting requirements for any of the pollutants and parameters in Subsection 105.16.b. if the applicant requests a waiver with its application, or earlier, and demonstrates that information adequate to support issuance of the permit can be obtained through less stringent reporting requirements. (3-20-20)T

**17. Individual Permit Application Requirements for Treatment Works Treating Domestic Sewage (TWTDS).** All TWTDS with a currently effective NPDES or IPDES permit must submit a permit application at the time of the next IPDES permit renewal application, using Form 2S or another application form approved by the Department. New applicants must submit all information available at the time of permit application. The information may be provided by referencing information previously submitted to the Department. (3-20-20)T

- a. The Department may waive any requirement of this subsection if there is access to substantially identical information. The Department may also waive any requirement of this subsection that is not of material concern for a specific permit, if approved by the EPA Regional Administrator. The waiver request to the Regional Administrator must include the Department's justification for the waiver. A Regional Administrator's disapproval of a Department's proposed waiver does not constitute final agency action, but does provide notice to the state and permit applicant(s) that EPA may object to any state-issued permit issued in the absence of the required information. (3-20-20)T
- b. All applicants must submit the following information: (3-20-20)T
- i. The name, mailing address, and location of the TWTDS for which the application is submitted; (3-20-20)T
  - ii. The name, mailing address, EIN, and telephone number of the applicant and indication whether the applicant is the owner, operator, or both; (3-20-20)T
  - iii. Whether the facility is a Class I Sludge Management Facility; (3-20-20)T

- iv. The design flow rate in million gallons per day (MGD); (3-20-20)T
- v. The total population and equivalent dwelling units (EDU) served; and (3-20-20)T
- vi. The TWTDS's status as federal, state, private, public, or other entity. (3-20-20)T
- c.** All applicants must submit the facility's NPDES or IPDES permit number, if applicable, and a listing of all other federal, state, and local permits or construction approvals received or applied for under any of the following programs: (3-20-20)T
  - i. Hazardous waste management program under IDAPA 58.01.05, "Rules and Standards for Hazardous Waste"; (3-20-20)T
  - ii. Underground injection control (UIC) program under the Idaho Department of Water Resources UIC program at IDAPA 37.03.03, "Rules and Minimum Standards for the Construction and Use of Injection Wells"; (3-20-20)T
  - iii. IPDES program under IDAPA 58.01.25, "Rules Regulating the Idaho Pollutant Discharge Elimination System Program"; (3-20-20)T
  - iv. Prevention of significant deterioration (PSD) program under IDAPA 58.01.01, "Rules for the Control of Air Pollution in Idaho"; (3-20-20)T
  - v. Nonattainment program under IDAPA 58.01.01, "Rules for the Control of Air Pollution in Idaho"; (3-20-20)T
  - vi. National emission standards for hazardous pollutants (NESHAPS) preconstruction approval under IDAPA 58.01.01, "Rules for the Control of Air Pollution in Idaho"; (3-20-20)T
  - vii. Dredge or fill permits under the Clean Water Act section 404; (3-20-20)T
  - viii. Sludge Management Program under IDAPA 58.01.16.650, "Wastewater Rules," and Section 380 (Sewage Sludge) of these rules; and (3-20-20)T
  - ix. Other relevant environmental permits, programs or activities, including those subject to state jurisdiction, approval, and permits. (3-20-20)T
- d.** All applicants must identify any generation, treatment, storage, land application, or disposal of sewage sludge that occurs in Indian country. (3-20-20)T
- e.** All applicants must submit a topographic map (or other map if a topographic map is unavailable) extending one (1) mile beyond property boundaries of the facility and showing the following information: (3-20-20)T
  - i. All sewage sludge management facilities, including on-site treatment, storage, and disposal sites; and (3-20-20)T
  - ii. Wells, springs, and other surface water bodies that are within one-quarter (1/4) mile of the property boundaries and listed in public records or otherwise known to the applicant. (3-20-20)T
- f.** All applicants must submit a line drawing and/or a narrative description that identifies all sewage sludge management practices employed during the term of the permit, including all units used for collecting, dewatering, storing, or treating sewage sludge, the destination(s) of all liquids and solids leaving each such unit, and all processes used for pathogen reduction and vector attraction reduction. (3-20-20)T
- g.** The applicant must submit sewage sludge monitoring data for the pollutants for which limits in sewage sludge have been established in 40 CFR Part 503 for the applicant's use or disposal practices on the date of

- permit application. (3-20-20)T
- i. The Department may require sampling for additional pollutants, as appropriate, on a case-by-case basis; (3-20-20)T
  - ii. Applicants must provide data from a minimum of three (3) samples taken within four and one-half (4 ½) years prior to the date of the permit application. Samples must be representative of the sewage sludge and should be taken at least one (1) month apart. Existing data may be used in lieu of sampling done solely for the purpose of this application; (3-20-20)T
  - iii. Applicants must collect and analyze samples in accordance with analytical methods approved under SW-846 (Test Methods for Evaluating Solid Waste, Physical/Chemical Methods) unless an alternative has been specified in an existing sewage sludge permit; and (3-20-20)T
  - iv. The monitoring data provided must include at least the following information for each parameter:  
(3-20-20)T
    - (1) Average monthly concentration for all samples (mg/kg dry weight), based upon actual sample values; (3-20-20)T
    - (2) The analytical method used; and (3-20-20)T
    - (3) The method detection level. (3-20-20)T
  - h. If the applicant is either the person who generates sewage sludge during the treatment of domestic sewage in a treatment works or the person who derives a material from sewage sludge, the following information must be provided: (3-20-20)T
    - i. If the applicant's facility generates sewage sludge, the total dry metric tons per three hundred sixty-five (365)-day period generated at the facility; (3-20-20)T
    - ii. If the applicant's facility receives sewage sludge from another facility, the following information for each facility from which sewage sludge is received: (3-20-20)T
      - (1) The name, mailing address, and location of the other facility; (3-20-20)T
      - (2) The total dry metric tons per three hundred sixty-five (365)-day period received from the other facility; and (3-20-20)T
      - (3) A description of any treatment processes occurring at the other facility, including blending activities and treatment to reduce pathogens or vector attraction characteristics; (3-20-20)T
    - iii. If the applicant's facility changes the quality of sewage sludge through blending, treatment, or other activities, the following information must be submitted: (3-20-20)T
      - (1) Whether the Class A pathogen reduction requirements in 40 CFR 503.32(a) or the Class B pathogen reduction requirements in 40 CFR 503.32(b) are met, and a description of any treatment processes used to reduce pathogens in sewage sludge; (3-20-20)T
      - (2) Whether any of the vector attraction reduction options of 40 CFR 503.33(b)(1) through (b)(8) are met, and a description of any treatment processes used to reduce vector attraction properties in sewage sludge; and (3-20-20)T
      - (3) A description of any other blending, treatment, or other activities that change the quality of sewage sludge; (3-20-20)T
    - iv. If sewage sludge from the applicant's facility meets the ceiling concentrations in 40 CFR

503.13(b)(1), the pollutant concentrations in 40 CFR 503.13(b)(3), the Class A pathogen requirements in 40 CFR 503.32(a), and one (1) of the vector attraction reduction requirements in 40 CFR 503.33(b)(1) through (b)(8), and if the sewage sludge is applied to the land, the applicant must provide the total dry metric tons per three hundred sixty-five (365)-day period of sewage sludge subject to this subsection that is applied to the land; (3-20-20)T

v. If sewage sludge from the applicant's facility is sold or given away in a bag or other container for application to the land, and the sewage sludge is not subject to Subsection 105.17.h.iv., the applicant must provide the following information: (3-20-20)T

(1) The total dry metric tons per three hundred sixty-five (365)-day period of sewage sludge subject to this subsection that is sold or given away in a bag or other container for application to the land; and (3-20-20)T

(2) A copy of all labels or notices that accompany the sewage sludge being sold or given away; and (3-20-20)T

vi. If sewage sludge from the applicant's facility is provided to another person who generates sewage sludge during the treatment of domestic sewage in a treatment works or a person who derives a material from sewage sludge, and the sewage sludge is not subject to Subsection 105.17.h.iv., the applicant must provide the following information for each facility receiving the sewage sludge: (3-20-20)T

(1) The name and mailing address of the receiving facility; (3-20-20)T

(2) The total dry metric tons per three hundred sixty-five (365)-day period of sewage sludge subject to this subsection that the applicant provides to the receiving facility; (3-20-20)T

(3) A description of any treatment processes occurring at the receiving facility, including blending activities and treatment to reduce pathogens or vector attraction characteristic; (3-20-20)T

(4) A copy of the notice and necessary information that the applicant is required to provide the receiving facility under 40 CFR 503.12(g); and (3-20-20)T

(5) If the receiving facility places sewage sludge in bags or containers for sale or give-away to application to the land, a copy of any labels or notices that accompany the sewage sludge. (3-20-20)T

i. If sewage sludge from the applicant's facility is applied to the land in bulk form, and is not subject to Subsection 105.17.h.iv., v., or vi., the applicant must provide the following information: (3-20-20)T

i. The total dry metric tons per three hundred sixty-five (365)-day period of sewage sludge subject to this subsection that is applied to the land; (3-20-20)T

ii. If any land application sites are located in states other than the state where the sewage sludge is prepared, a description of how the applicant will notify the permitting authority for the state(s) where the land application sites are located; (3-20-20)T

iii. The following information for each land application site that has been identified at the time of permit application: (3-20-20)T

(1) The name (if any), and location for the land application site; (3-20-20)T

(2) The site's latitude and longitude to the nearest second, and method of determination; (3-20-20)T

(3) A topographic map (or other map if a topographic map is unavailable) that shows the site's location; (3-20-20)T

(4) The name, mailing address, and telephone number of the site owner, if different from the applicant; (3-20-20)T

(5) The name, mailing address, and telephone number of the person who applies sewage sludge to the

site, if different from the applicant; (3-20-20)T

(6) Whether the site is agricultural land, forest, a public contact site, or a reclamation site, as such site types are defined under 40 CFR 503.11; (3-20-20)T

(7) The type of vegetation grown on the site, if known, and the nitrogen requirement for this vegetation; (3-20-20)T

(8) Whether either of the vector attraction reduction options of 40 CFR 503.33(b)(9) or (b)(10) is met at the site, and a description of any procedures employed at the time of use to reduce vector attraction properties in sewage sludge; and (3-20-20)T

(9) Other information that describes how the site will be managed, as specified by the permitting authority. (3-20-20)T

iv. The following information for each land application site that has been identified at the time of permit application, if the applicant intends to apply bulk sewage sludge subject to the cumulative pollutant loading rates in 40 CFR 503.13(b)(2) to the site: (3-20-20)T

(1) Whether the applicant has contacted the permitting authority in the state where the bulk sewage sludge subject to 40 CFR 503.13(b)(2) will be applied, to ascertain whether bulk sewage sludge subject to 40 CFR 503.13(b)(2) has been applied to the site on or since July 20, 1993, and if so, the name of the permitting authority and the name and phone number of a contact person at the permitting authority; (3-20-20)T

(2) Identification of facilities other than the applicant's facility that have sent, or are sending, sewage sludge subject to the cumulative pollutant loading rates in 40 CFR 503.13(b)(2) to the site since July 20, 1993, if, based on the inquiry in Subsection 105.17.i.iv.(1) bulk sewage sludge subject to cumulative pollutant loading rates in 40 CFR 503.13(b)(2) has been applied to the site since July 20, 1993; (3-20-20)T

v. If not all land application sites have been identified at the time of permit application, the applicant must submit a land application plan that, at a minimum: (3-20-20)T

(1) Describes the geographical area covered by the plan; (3-20-20)T

(2) Identifies the site selection criteria; (3-20-20)T

(3) Describes how the site(s) will be managed; (3-20-20)T

(4) Provides for advance notice to the permit authority of specific land application sites and reasonable time for the permit authority to object prior to land application of the sewage sludge; and (3-20-20)T

(5) Provides for advance public notice of land application sites in the manner prescribed by state and local law. When state or local law does not require advance public notice, it must be provided in a manner reasonably calculated to apprise the general public of the planned land application. (3-20-20)T

j. If sewage sludge from the applicant's facility is placed on a surface disposal site, the applicant must provide the following information: (3-20-20)T

i. The total dry metric tons of sewage sludge from the applicant's facility that is placed on surface disposal sites per three hundred sixty-five (365)-day period; (3-20-20)T

ii. The following information for each surface disposal site receiving sewage sludge from the applicant's facility that the applicant does not own or operate: (3-20-20)T

(1) The site name or number, contact person, mailing address, and telephone number for the surface disposal site; and (3-20-20)T

- (2) The total dry metric tons from the applicant's facility per three hundred sixty-five (365)-day period placed on the surface disposal site; (3-20-20)T
- iii. The following information for each active sewage sludge unit at each surface disposal site that the applicant owns or operates: (3-20-20)T
- (1) The name or number and the location of the active sewage sludge unit; (3-20-20)T
- (2) The unit's latitude and longitude to the nearest second, and method of determination; (3-20-20)T
- (3) If not already provided, a topographic map (or other map if a topographic map is unavailable) that shows the unit's location; (3-20-20)T
- (4) The total dry metric tons placed on the active sewage sludge unit per three hundred sixty-five (365)-day period; (3-20-20)T
- (5) The total dry metric tons placed on the active sewage sludge unit over the life of the unit; (3-20-20)T
- (6) A description of any liner for the active sewage sludge unit, including whether it has a maximum permeability of  $1 \times 10^{-7}$  cm/sec; (3-20-20)T
- (7) A description of any leachate collection system for the active sewage sludge unit, including the method used for leachate disposal, and any federal, state, and local permit number(s) for leachate disposal; (3-20-20)T
- (8) If the active sewage sludge unit is less than one hundred fifty (150) meters from the property line of the surface disposal site, the actual distance from the unit boundary to the site property line; (3-20-20)T
- (9) The remaining capacity (dry metric tons) for the active sewage sludge unit; (3-20-20)T
- (10) The date on which the active sewage sludge unit is expected to close, if such a date has been identified; (3-20-20)T
- (11) The following information for any other facility that sends sewage sludge to the active sewage sludge unit: (3-20-20)T
- (a) The name, contact person, and mailing address of the facility; and (3-20-20)T
- (b) Available information regarding the quality of the sewage sludge received from the facility, including any treatment at the facility to reduce pathogens or vector attraction characteristics; (3-20-20)T
- (12) Whether any of the vector attraction reduction options of 40 CFR 503.33(b)(9) through (b)(11) is met at the active sewage sludge unit, and a description of any procedures employed at the time of disposal to reduce vector attraction properties in sewage sludge; (3-20-20)T
- (13) The following information, as applicable to any ground water monitoring occurring at the active sewage sludge unit: (3-20-20)T
- (a) A description of any ground water monitoring occurring at the active sewage sludge unit; (3-20-20)T
- (b) Any available ground water monitoring data, with a description of the well locations and approximate depth to ground water; (3-20-20)T
- (c) A copy of any ground water monitoring plan that has been prepared for the active sewage sludge unit; and (3-20-20)T

(d) A copy of any certification that has been obtained from a qualified ground water scientist that the aquifer has not been contaminated; and (3-20-20)T

(14) If site-specific pollutant limits are being sought for the sewage sludge placed on this active sewage sludge unit, information to support such a request. (3-20-20)T

**k.** If sewage sludge from the applicant's facility is fired in a sewage sludge incinerator, the applicant must provide the following information: (3-20-20)T

i. The total dry metric tons of sewage sludge from the applicant's facility that is fired in sewage sludge incinerators per three hundred sixty-five (365)-day period; (3-20-20)T

ii. The following information for each sewage sludge incinerator firing the applicant's sewage sludge that the applicant does not own or operate: (3-20-20)T

(1) The name and/or number, contact person, mailing address, and telephone number of the sewage sludge incinerator; and (3-20-20)T

(2) The total dry metric tons from the applicant's facility per three hundred sixty-five (365)-day period fired in the sewage sludge incinerator; (3-20-20)T

iii. The following information for each sewage sludge incinerator that the applicant owns or operates: (3-20-20)T

(1) The name and/or number and the location of the sewage sludge incinerator; (3-20-20)T

(2) The incinerator's latitude and longitude to the nearest second, and method of determination; (3-20-20)T

(3) The total dry metric tons per three hundred sixty-five (365)-day period fired in the sewage sludge incinerator; (3-20-20)T

(4) Information, test data, and documentation of ongoing operating parameters indicating that compliance with the National Emission Standard for Beryllium in 40 CFR Part 61 will be achieved; (3-20-20)T

(5) Information, test data, and documentation of ongoing operating parameters indicating that compliance with the National Emission Standard for Mercury in 40 CFR Part 61 will be achieved; (3-20-20)T

(6) The dispersion factor for the sewage sludge incinerator, as well as modeling results and supporting documentation; (3-20-20)T

(7) The control efficiency for parameters regulated in 40 CFR 503.43, as well as performance test results and supporting documentation; (3-20-20)T

(8) Information used to calculate the risk specific concentration (RSC) for chromium, including the results of incinerator stack tests for hexavalent and total chromium concentrations, if the applicant is requesting a chromium limit based on a site-specific RSC value; (3-20-20)T

(9) Whether the applicant monitors total hydrocarbons (THC) or Carbon Monoxide (CO) in the exit gas for the sewage sludge incinerator; (3-20-20)T

(10) The type of sewage sludge incinerator; (3-20-20)T

(11) The maximum performance test combustion temperature, as obtained during the performance test of the sewage sludge incinerator to determine pollutant control efficiencies; (3-20-20)T

- (12) The following information on the sewage sludge feed rate used during the performance test: (3-20-20)T
- (a) Sewage sludge feed rate in dry metric tons per day; (3-20-20)T
  - (b) Identification of whether the feed rate submitted is average use or maximum design; and (3-20-20)T
  - (c) A description of how the feed rate was calculated; (3-20-20)T
- (13) The incinerator stack height in meters for each stack, including identification of whether actual or creditable stack height was used; (3-20-20)T
- (14) The operating parameters for the sewage sludge incinerator air pollution control device(s), as obtained during the performance test of the sewage sludge incinerator to determine pollutant control efficiencies; (3-20-20)T
- (15) Identification of the monitoring equipment in place, including (but not limited to) equipment to monitor the following: (3-20-20)T
- (a) Total hydrocarbons or Carbon Monoxide; (3-20-20)T
  - (b) Percent Oxygen; (3-20-20)T
  - (c) Percent moisture; and (3-20-20)T
  - (d) Combustion temperature; and (3-20-20)T
- (16) A list of all air pollution control equipment used with this sewage sludge incinerator. (3-20-20)T
- l.** If sewage sludge from the applicant's facility is sent to a municipal solid waste landfill (MSWLF), the applicant must provide the following information for each MSWLF to which sewage sludge is sent: (3-20-20)T
- i. The name, contact person, mailing address, location, and all applicable permit numbers of the MSWLF; (3-20-20)T
  - ii. The total dry metric tons per three hundred sixty-five (365)-day period sent from this facility to the MSWLF; (3-20-20)T
  - iii. A determination of whether the sewage sludge meets applicable requirements for disposal of sewage sludge in a MSWLF, including the results of the paint filter liquids test and any additional requirements that apply on a site-specific basis; and (3-20-20)T
  - iv. Information, if known, indicating whether the MSWLF complies with criteria set forth in 40 CFR Part 258. (3-20-20)T
- m.** All applicants must provide the name, mailing address, telephone number, and responsibilities of all contractors responsible for any operational or maintenance aspects of the facility related to sewage sludge generation, treatment, use, or disposal. (3-20-20)T
- n.** At the request of the Department, the applicant must provide any other information necessary to determine the appropriate standards for permitting under 40 CFR Part 503, and must provide any other information necessary to assess the sewage sludge use and disposal practices, determine whether to issue a permit, or identify appropriate permit requirements. (3-20-20)T
- o.** TWTDS facilities using or disposing of sewage sludge to which a standard applicable to its sewage sludge use or disposal practices have been published shall submit the following information on EPA Form 2S, Part I,



- or on the Department equivalent form: (3-20-20)T
- i. The TWTDS's name, mailing address, location, and status as federal, state, private, public, or other entity; (3-20-20)T
  - ii. The applicant's name, address, telephone number, and ownership status; (3-20-20)T
  - iii. A description of the sewage sludge use or disposal practices. Unless the sewage sludge meets the requirements of Subsection 105.17.h.iv., the description must include the name and address of any facility where sewage sludge is sent for treatment or disposal, and the location of any land application sites; (3-20-20)T
  - iv. Annual amount of sewage sludge generated, treated, used or disposed (estimated dry weight basis); and (3-20-20)T
  - v. The most recent data the TWTDS may have on the quality of the sewage sludge. (3-20-20)T

**18. Individual Permit Application Requirements for Municipal Separate Storm Sewer Discharges.** The operator of a discharge from a large or medium municipal separate storm sewer or a municipal separate storm sewer that is designated by the Department under 40 CFR 122.26(a)(1)(v), may submit a jurisdiction-wide or system-wide permit application. Where more than one (1) public entity owns or operates a municipal separate storm sewer within a geographic area (including adjacent or interconnected municipal separate storm sewer systems), such operators may be a coapplicant to the same application. Permit applications for discharges from large and medium municipal storm sewers or municipal storm sewers designated under 40 CFR 122.26 (a)(1)(v) shall include: (3-20-20)T

- a. Part 1 of the application shall consist of: (3-20-20)T
  - i. The applicants' name, address, EIN, telephone number of contact person, ownership status and status as a state or local government entity; (3-20-20)T
  - ii. A description of existing legal authority to control discharges to the municipal separate storm sewer system. When existing legal authority is not sufficient to meet the criteria provided in Subsection 105.18.b.i., the description shall list additional authorities as will be necessary to meet the criteria and shall include a schedule and commitment to seek such additional authority that will be needed to meet the criteria; (3-20-20)T
  - iii. A description of the historic use of ordinances, guidance or other controls which limited the discharge of non-storm water discharges to any POTW serving the same area as the municipal separate storm sewer system. The following information shall be provided: (3-20-20)T
    - (1) A USGS seven point five (7.5) minute topographic map (or equivalent topographic map with a scale between one to ten thousand (1:10,000) and one to twenty-four thousand (1:24,000) if cost effective) extending one (1) mile beyond the service boundaries of the municipal storm sewer system covered by the permit application; (3-20-20)T
    - (2) The location of known municipal storm sewer system outfalls discharging to waters of the United States; (3-20-20)T
    - (3) A description of the land use activities (e.g. divisions indicating undeveloped, residential, commercial, agricultural and industrial uses) accompanied with estimates of population densities and projected growth for a ten (10) year period within the drainage area served by the separate storm sewer. For each land use type, an estimate of an average runoff coefficient shall be provided; (3-20-20)T
    - (4) The location and a description of the activities of the facility of each currently operating or closed municipal landfill or other treatment, storage or disposal facility for municipal waste; (3-20-20)T
    - (5) The location and the permit number of any known discharge to the municipal storm sewer that has been issued a NPDES or IPDES permit; (3-20-20)T

- (6) The location of major structural controls for storm water discharge (retention basins, detention basins, major infiltration devices, etc.); and (3-20-20)T
- (7) The identification of publicly owned parks, recreational areas, and other open lands. (3-20-20)T
- iv. A description of the discharge including: (3-20-20)T
- (1) Monthly mean rain and snow fall estimates (or summary of weather bureau data) and the monthly average number of storm events; (3-20-20)T
- (2) Existing quantitative data describing the volume and quality of discharges from the municipal storm sewer, including a description of the outfalls sampled, sampling procedures and analytical methods used; (3-20-20)T
- (3) A list of water bodies that receive discharges from the municipal separate storm sewer system, including downstream segments, lakes and estuaries, where pollutants from the system discharges may accumulate and cause water degradation and a brief description of known water quality impacts. At a minimum, the description of impacts shall include a description of whether the water bodies receiving such discharges have been: (3-20-20)T
- (a) Assessed and reported in the Clean Water Act section 305(b) reports submitted by the Department, the basis for the assessment (evaluated or monitored), a summary of designated use support and attainment of Clean Water Act goals (fishable and swimmable waters), and causes of nonsupport of designated uses; (3-20-20)T
- (b) Listed under the Clean Water Act section 304(l)(1)(A)(i), 304(l)(1)(A)(ii), or 304(l)(1)(B) that is not expected to meet water quality standards or water quality goals; (3-20-20)T
- (c) Listed in state Nonpoint Source Assessments required by the Clean Water Act section 319(a), without additional action to control nonpoint sources of pollution, cannot reasonably be expected to attain or maintain water quality standards due to storm sewers, construction, highway maintenance and runoff from municipal landfills and municipal sludge adding significant pollution (or contributing to a violation of water quality standards); (3-20-20)T
- (d) Identified and classified according to eutrophic condition of publicly owned lakes listed in state reports required under the Clean Water Act section 314(a) (include the following: A description of those publicly owned lakes for which uses are known to be impaired, a description of procedures, processes and methods to control the discharge of pollutants from municipal separate storm sewers into such lakes, and a description of methods and procedures to restore the quality of such lakes); (3-20-20)T
- (e) Recognized by the applicant as highly valued or sensitive waters; (3-20-20)T
- (f) Defined by the state as wetlands; and (3-20-20)T
- (g) Found to have pollutants in bottom sediments, fish tissue, or biosurvey data. (3-20-20)T
- (4) Results of a field screening analysis for illicit connections and illegal dumping for either selected field screening points or major outfalls covered in the permit application. At a minimum, a screening analysis shall include a narrative description, for either each field screening point or major outfall, of visual observations made during dry weather periods. If any flow is observed, two (2) grab samples shall be collected during a twenty-four (24)-hour period with a minimum period of four (4) hours between samples. For all such samples, a narrative description of the color, odor, turbidity, the presence of an oil sheen or surface scum as well as any other relevant observations regarding the potential presence of non-storm water discharges or illegal dumping shall be provided. In addition, a narrative description of the results of a field analysis using suitable methods to estimate pH, total chlorine, total copper, total phenol, and detergents (or surfactants) shall be provided along with a description of the flow rate. Where the field analysis does not involve analytical methods approved under 40 CFR Part 136, the applicant shall provide a description of the method used including the name of the manufacturer of the test method along with the range and accuracy of the test. Field screening points shall be either major outfalls or other outfall points (or any other

point of access such as manholes) randomly located throughout the storm sewer system by placing a grid over a drainage system map and identifying those cells of the grid which contain a segment of the storm sewer system or major outfall. The field screening points shall be established using the following guidelines and criteria: (3-20-20)T

(a) A grid system consisting of perpendicular north-south and east-west lines spaced one-quarter ( $\frac{1}{4}$ ) mile apart shall be overlaid on a map of the municipal storm sewer system, creating a series of cells; (3-20-20)T

(b) All cells that contain a segment of the storm sewer system shall be identified; one (1) field screening point shall be selected in each cell; major outfalls may be used as field screening points; (3-20-20)T

(c) Field screening points should be located downstream of any sources of suspected illegal or illicit activity; (3-20-20)T

(d) Field screening points shall be located to the degree practicable at the farthest manhole or other accessible location downstream in the system, within each cell; however, safety of personnel and accessibility of the location should be considered in making this determination; (3-20-20)T

(e) Hydrological conditions, total drainage area of the site, population density of the site, traffic density, age of the structures or buildings in the area, history of the area, and land use types; (3-20-20)T

(f) For medium municipal separate storm sewer systems, no more than two hundred fifty (250) cells need to have identified field screening points; in large municipal separate storm sewer systems, no more than five hundred (500) cells need to have identified field screening points; cells established by the grid that contain no storm sewer segments will be eliminated from consideration; if fewer than two hundred fifty (250) cells in medium municipal sewers are created, and fewer than 500 in large systems are created by the overlay on the municipal sewer map, then all those cells which contain a segment of the sewer system shall be subject to field screening (unless access to the separate storm sewer system is impossible); and (3-20-20)T

(g) Large or medium municipal separate storm sewer systems which are unable to utilize the procedures described in Subsection 105.18.a.iv.(4)(a) through (f), because a sufficiently detailed map of the separate storm sewer systems is unavailable, shall field screen no more than five hundred (500) or two hundred fifty (250) major outfalls respectively (or all major outfalls in the system, if less). In such circumstances, the applicant shall establish a grid system consisting of north-south and east-west lines spaced one-quarter ( $\frac{1}{4}$ ) mile apart as an overlay to the boundaries of the municipal storm sewer system, thereby creating a series of cells. The applicant will then select major outfalls in as many cells as possible until at least five hundred (500) major outfalls (large municipalities) or two hundred fifty (250) major outfalls (medium municipalities) are selected; a field screening analysis shall be undertaken at these major outfalls; and (3-20-20)T

(5) Information and a proposed program to meet the requirements of Subsection 105.18.b.iii., which shall include: the location of outfalls or field screening points appropriate for representative data collection under Subsection 105.18.b.iii.(1), a description of why the outfall or field screening point is representative, the seasons during which sampling is intended, a description of the sampling equipment. The proposed location of outfalls or field screening points for such sampling should reflect water quality concerns (see Subsection 105.18.a.iv.(3)) to the extent practicable; (3-20-20)T

v. A description of the existing management programs to control pollutants from the municipal separate storm sewer system, which shall provide information on existing structural and source controls, including operation and maintenance measures for structural controls that are currently being implemented. Such controls may include, but are not limited to: procedures to control pollution resulting from construction activities; floodplain management controls; wetland protection measures; best management practices for new subdivisions; and emergency spill response programs. The description may address controls established under state law as well as local requirements; (3-20-20)T

vi. A description of the existing program to identify illicit connections to the municipal storm sewer system, which should include inspection procedures and methods for detecting and preventing illicit discharges, and describe areas where this program has been implemented; and (3-20-20)T

vii. A description of the financial resources currently available to the municipality to complete part 2 of the permit application. A description of the municipality's budget for existing storm water programs, including an overview of the municipality's financial resources and budget, including overall indebtedness and assets, and sources of funds for storm water programs. (3-20-20)T

b. Part 2 of the application shall consist of: (3-20-20)T

i. A demonstration that the applicant can operate pursuant to legal authority established by statute, ordinance, or series of contracts which authorizes or enables the applicant at a minimum to: (3-20-20)T

(1) Control through ordinance, permit, contract, order or similar means, the contribution of pollutants to the municipal storm sewer by storm water discharges associated with industrial activity and the quality of storm water discharged from sites of industrial activity; (3-20-20)T

(2) Prohibit through ordinance, order or similar means, illicit discharges to the municipal separate storm sewer; (3-20-20)T

(3) Control through ordinance, order or similar means the discharge to a municipal separate storm sewer of spills, dumping or disposal of materials other than storm water; (3-20-20)T

(4) Control through interagency agreements among co-applicants the contribution of pollutants from a portion of the municipal system to another portion of the municipal system; (3-20-20)T

(5) Require compliance with conditions in ordinances, permits, contracts or orders; and (3-20-20)T

(6) Carry out all inspection, surveillance, and monitoring procedures necessary to determine compliance and noncompliance with permit conditions including the prohibition on illicit discharges to the municipal separate storm sewer. (3-20-20)T

ii. The location of any major outfall that discharges to waters of the United States that was not reported under Subsection 105.18.a.iii.(2). Provide an inventory, organized by watershed of the name and address, and a description (such as Standard Industrial Classification (SIC) codes) which best reflects the principal products or services provided by each facility which may discharge, to the municipal separate storm sewer, storm water associated with industrial activity; (3-20-20)T

iii. When quantitative data for a pollutant are required under Subsection 105.18.b.iii.(1)(c), the applicant must collect a sample of effluent in accordance with Subsection 105.07.c. through 105.07.m. and analyze it for the pollutant in accordance with analytical methods approved under 40 CFR Part 136. When no analytical method is approved the applicant may use any suitable method but must provide a description of the method. The applicant must provide information characterizing the quality and quantity of discharges covered in the permit application, including: (3-20-20)T

(1) Quantitative data from representative outfalls designated by the Department developed as follows (based on information received in part 1 of the application. The Department shall designate between five (5) and ten (10) outfalls or field screening points as representative of the commercial, residential and industrial land use activities of the drainage area contributing to the system or, where there are less than five (5) outfalls covered in the application, the Department shall designate all outfalls): (3-20-20)T

(a) For each outfall or field screening point designated under this subsection, samples shall be collected of storm water discharges from three (3) storm events occurring at least one (1) month apart in accordance with the requirements at Subsection 105.07.c. through 105.07.m. (the Department may allow exemptions to sampling three (3) storm events when climatic conditions create good cause for such exemptions); (3-20-20)T

(b) A narrative description shall be provided of the date and duration of the storm event(s) sampled, rainfall estimates of the storm event which generated the sampled discharge and the duration between the storm event sampled and the end of the previous measurable (greater than one-tenth (0.1) inch rainfall) storm event; (3-20-20)T

(c) For samples collected and described under Subsections 105.18.b.iii.(1)(a) and (b), quantitative data shall be provided for the organic pollutants listed in Table II and the pollutants listed in Table III (toxic metals, cyanide, and total phenols) of Appendix D of 40 CFR Part 122, and for the following pollutants: (3-20-20)T

- (i) Total suspended solids (TSS); (3-20-20)T
- (ii) Total dissolved solids (TDS); (3-20-20)T
- (iii) Chemical oxygen demand (COD); (3-20-20)T
- (iv) Five (5)-day biochemical oxygen demand (BOD5); (3-20-20)T
- (v) Oil and grease; (3-20-20)T
- (vi) Fecal coliform; (3-20-20)T
- (vii) Fecal streptococcus; (3-20-20)T
- (viii) pH; (3-20-20)T
- (ix) Total Kjeldahl nitrogen; (3-20-20)T
- (x) Nitrate plus nitrite; (3-20-20)T
- (xi) Total ammonia plus organic nitrogen; (3-20-20)T
- (xii) Dissolved phosphorus; and (3-20-20)T
- (xiii) Total phosphorus; (3-20-20)T

(d) Additional limited quantitative data required by the Department for determining permit conditions (the Department may require that quantitative data be provided for additional parameters, and may establish sampling conditions such as the location, season of sample collection, form of precipitation (snow melt, rainfall) and other parameters necessary to insure representativeness); (3-20-20)T

(2) Estimates of the annual pollutant load of the cumulative discharges to waters of the United States from all identified municipal outfalls and the event mean concentration of the cumulative discharges to waters of the United States from all identified municipal outfalls during a storm event for BOD5, COD, TSS, dissolved solids, total nitrogen, total ammonia plus organic nitrogen, total phosphorus, dissolved phosphorus, cadmium, copper, lead, and zinc. Estimates shall be accompanied by a description of the procedures for estimating constituent loads and concentrations, including any modelling, data analysis, and calculation methods; (3-20-20)T

(3) A proposed schedule to provide estimates for each major outfall identified in either Subsection 105.18.b.ii. or 105.18.a.iii.(2) of the seasonal pollutant load and of the event mean concentration of a representative storm for any constituent detected in any sample required under Subsection 105.18.b.iii.(1); and (3-20-20)T

(4) A proposed monitoring program for representative data collection for the term of the permit that describes the location of outfalls or field screening points to be sampled (or the location of instream stations), why the location is representative, the frequency of sampling, parameters to be sampled, and a description of sampling equipment; (3-20-20)T

iv. A proposed management program covering the duration of the permit, which shall include a comprehensive planning process which involves public participation and where necessary intergovernmental coordination, to reduce the discharge of pollutants to the maximum extent practicable using management practices, control techniques and system, design and engineering methods, and such other provisions which are appropriate. The program shall also include a description of staff and equipment available to implement the program. Separate

proposed programs may be submitted by each co-applicant. Proposed programs may impose controls on a system wide basis, a watershed basis, a jurisdiction basis, or on individual outfalls. Proposed programs will be considered by the Department when developing permit conditions to reduce pollutants in discharges to the maximum extent practicable. Proposed management programs shall describe priorities for implementing controls. Such programs shall be based on: (3-20-20)T

(1) A description of structural and source control measures to reduce pollutants from runoff from commercial and residential areas that are discharged from the municipal storm sewer system that are to be implemented during the life of the permit, accompanied with an estimate of the expected reduction of pollutant loads and a proposed schedule for implementing such controls. At a minimum, the description shall include: (3-20-20)T

(a) A description of maintenance activities and a maintenance schedule for structural controls to reduce pollutants (including floatables) in discharges from municipal separate storm sewers; (3-20-20)T

(b) A description of planning procedures including a comprehensive master plan to develop, implement and enforce controls to reduce the discharge of pollutants from municipal separate storm sewers which receive discharges from areas of new development and significant redevelopment. Such plan shall address controls to reduce pollutants in discharges from municipal separate storm sewers after construction is completed (controls to reduce pollutants in discharges from municipal separate storm sewers containing construction site runoff are addressed in Subsection 105.18.b.iv.(4)); (3-20-20)T

(c) A description of practices for operating and maintaining public streets, roads and highways and procedures for reducing the impact on receiving waters of discharges from municipal storm sewer systems, including pollutants discharged as a result of deicing activities; (3-20-20)T

(d) A description of procedures to assure that flood management projects assess the impacts on the water quality of receiving water bodies and that existing structural flood control devices have been evaluated to determine if retrofitting the device to provide additional pollutant removal from storm water is feasible; (3-20-20)T

(e) A description of a program to monitor pollutants in runoff from operating or closed municipal landfills or other treatment, storage, or disposal facilities for municipal waste, which shall identify priorities and procedures for inspections and establishing and implementing control measures for such discharges (this program can be coordinated with the program developed under Subsection 105.18.b.iv.(3)); and (3-20-20)T

(f) A description of a program to reduce to the maximum extent practicable, pollutants in discharges from municipal separate storm sewers associated with the application of pesticides, herbicides, and fertilizer which will include, as appropriate, controls such as educational activities, permits, certifications and other measures for commercial applicators and distributors, and controls for application in public right-of-ways and at municipal facilities; (3-20-20)T

(2) A description of a program, including a schedule, to detect and remove (or require the discharger to the municipal separate storm sewer to obtain a separate IPDES permit for) illicit discharges and improper disposal into the storm sewer. The proposed program shall include: (3-20-20)T

(a) A description of a program, including inspections, to implement and enforce an ordinance, orders or similar means to prevent illicit discharges to the municipal separate storm sewer system. This program description shall address all types of illicit discharges; however, the following category of non-storm water discharges or flows shall be addressed where such discharges are identified by the municipality as sources of pollutants to waters of the United States: water line flushing, landscape irrigation, diverted stream flows, rising ground waters, uncontaminated ground water infiltration (as defined in Section 010) to separate storm sewers, uncontaminated pumped ground water, discharges from potable water sources, foundation drains, air conditioning condensation, irrigation water, springs, water from crawl space pumps, footing drains, lawn watering, individual residential car washing, flows from riparian habitats and wetlands, dechlorinated swimming pool discharges, and street wash water (program descriptions shall address discharges or flows from firefighting only where such discharges or flows are identified as significant sources of pollutants to waters of the United States); (3-20-20)T

(b) A description of procedures to conduct on-going field screening activities during the life of the

permit, including areas or locations that will be evaluated by such field screens; (3-20-20)T

(c) A description of procedures to be followed to investigate portions of the separate storm sewer system that, based on the results of the field screen, or other appropriate information, indicate a reasonable potential of containing illicit discharges or other sources of non-storm water (such procedures may include: sampling procedures for constituents such as fecal coliform, fecal streptococcus, surfactants (MBAS), residual chlorine, fluorides and potassium; testing with fluorometric dyes; or conducting in storm sewer inspections where safety and other considerations allow. Such description shall include the location of storm sewers that have been identified for such evaluation); (3-20-20)T

(d) A description of procedures to prevent, contain, and respond to spills that may discharge into the municipal separate storm sewer; (3-20-20)T

(e) A description of a program to promote, publicize, and facilitate public reporting of the presence of illicit discharges or water quality impacts associated with discharges from municipal separate storm sewers; (3-20-20)T

(f) A description of educational activities, public information activities, and other appropriate activities to facilitate the proper management and disposal of used oil and toxic materials; and (3-20-20)T

(g) A description of controls to limit infiltration of seepage from municipal sanitary sewers to municipal separate storm sewer systems where necessary; (3-20-20)T

(3) A description of a program to monitor and control pollutants in storm water discharges to municipal systems from municipal landfills, hazardous waste treatment, disposal and recovery facilities, industrial facilities that are subject to section 313 of title III of the Superfund Amendments and Reauthorization Act of 1986 (SARA), and industrial facilities that the municipal permit applicant determines are contributing a substantial pollutant loading to the municipal storm sewer system. The program shall: (3-20-20)T

(a) Identify priorities and procedures for inspections and establishing and implementing control measures for such discharges; and (3-20-20)T

(b) Describe a monitoring program for storm water discharges associated with the industrial facilities identified in Subsection 105.18.b.iv.(3), to be implemented during the term of the permit, including the submission of quantitative data on the following constituents: any pollutants limited in effluent guidelines subcategories, where applicable; any pollutant listed in an existing NPDES or IPDES permit for a facility; oil and grease, COD, pH, BOD5, TSS, total phosphorus, total Kjeldahl nitrogen, nitrate plus nitrite nitrogen, and any information on discharges required under Subsections 105.07.j. through l.; (3-20-20)T

(4) A description of a program to implement and maintain structural and non-structural best management practices to reduce pollutants in storm water runoff from construction sites to the municipal storm sewer system, which shall include: (3-20-20)T

(a) A description of procedures for site planning which incorporate consideration of potential water quality impacts; (3-20-20)T

(b) A description of requirements for nonstructural and structural best management practices; (3-20-20)T

(c) A description of procedures for identifying priorities for inspecting sites and enforcing control measures which consider the nature of the construction activity, topography, and the characteristics of soils and receiving water quality; and (3-20-20)T

(d) A description of appropriate educational and training measures for construction site operators; (3-20-20)T

v. Estimated reductions in loadings of pollutants from discharges of municipal storm sewer

constituents from municipal storm sewer systems expected as the result of the municipal storm water quality management program. The assessment shall also identify known impacts of storm water controls on ground water; (3-20-20)T

vi. For each fiscal year to be covered by the permit, a fiscal analysis of the necessary capital and operation and maintenance expenditures necessary to accomplish the activities of the programs under Subsections 105.18.b.iii. and iv. Such analysis shall include a description of the source of funds that are proposed to meet the necessary expenditures, including legal restrictions on the use of such funds; (3-20-20)T

vii. Where more than one (1) legal entity submits an application, the application shall contain a description of the roles and responsibilities of each legal entity and procedures to ensure effective coordination; and (3-20-20)T

viii. Where requirements under Subsections 105.18.a.iv.(5), 105.18.b.ii., 105.18.b.iii.(2), and 105.18.b.iv. are not practicable or are not applicable, the Department may exclude any operator of a discharge from a municipal separate storm sewer which is designated under 40 CFR 122.26(a)(1)(v), (b)(4)(ii) or (b)(7)(ii) from such requirements. The Department shall not exclude the operator of a discharge from a municipal separate storm sewer identified in Appendix F, G, H or I of 40 CFR Part 122, from any of the permit application requirements under this subsection except where authorized under this section. (3-20-20)T

**19. Individual Permit Application Requirements for Industrial and Construction Storm Water Discharges.** Application requirements for storm water discharges associated with industrial activity and storm water discharges associated with small construction activity. (3-20-20)T

**a.** Dischargers of storm water associated with industrial activity and with small construction activity are required to apply for an individual permit or seek coverage under a promulgated storm water general permit. Facilities that are required to obtain an individual permit or any discharge of storm water which the Department is evaluating for designation (see Section 130, General Permits) under 40 CFR 122.26(a)(1)(v) and is not a municipal storm sewer, shall submit an IPDES application in accordance with the requirements of Section 105 (Application for an Individual IPDES Permit) as modified and consistent with this subsection. (3-20-20)T

**b.** Except as provided in Subsections 105.19.c. through e., the operator of a storm water discharge associated with industrial activity subject to this section shall provide: (3-20-20)T

i. A site map showing topography (or indicating the outline of drainage areas served by the outfall(s) covered in the application if a topographic map is unavailable) of the facility including: (3-20-20)T

(1) Each of its drainage and discharge structures; (3-20-20)T

(2) The drainage area of each storm water outfall; (3-20-20)T

(3) Paved areas and buildings within the drainage area of each storm water outfall, each past or present area used for outdoor storage or disposal of significant materials, each existing structural control measure to reduce pollutants in storm water runoff, materials loading and access areas, areas where pesticides, herbicides, soil conditioners and fertilizers are applied, each of its hazardous waste treatment, storage or disposal facilities (including each area not required to have a Resource Conservation and Recovery Act permit which is used for accumulating hazardous waste under 40 CFR 262.34); (3-20-20)T

(4) Each well where fluids from the facility are injected underground; and (3-20-20)T

(5) Springs, and other surface water bodies which receive storm water discharges from the facility; (3-20-20)T

ii. An estimate of the area of impervious surfaces (including paved areas and building roofs) and the total area drained by each outfall (within a mile radius of the facility) and a narrative description of the following: (3-20-20)T



- (1) Significant materials that in the three (3) years prior to the submittal of this application have been treated, stored, or disposed in a manner to allow exposure to storm water; (3-20-20)T
  - (2) Method of treatment, storage or disposal of such materials; materials management practices employed, in the three (3) years prior to the submittal of this application, to minimize contact by these materials with storm water runoff; (3-20-20)T
  - (3) Materials loading and access areas; (3-20-20)T
  - (4) The location, manner and frequency in which pesticides, herbicides, soil conditioners and fertilizers are applied; (3-20-20)T
  - (5) The location and a description of existing structural and non-structural control measures to reduce pollutants in storm water runoff; and (3-20-20)T
  - (6) A description of the treatment the storm water receives, including the ultimate disposal of any solid or fluid wastes other than by discharge; (3-20-20)T
- iii. A certification that all outfalls that should contain storm water discharges associated with industrial activity have been tested or evaluated for the presence of non-storm water discharges which are not covered by an IPDES permit. Tests for such non-storm water discharges may include smoke tests, fluorometric dye tests, analysis of accurate schematics, as well as other appropriate tests. The certification shall include a description of the method used, the date of any testing, and the on-site drainage points that were directly observed during a test; (3-20-20)T
  - iv. Existing information regarding significant leaks or spills of toxic or hazardous pollutants at the facility that have taken place within the three (3) years prior to the submittal of this application; (3-20-20)T
  - v. Quantitative data based on samples collected during storm events and collected in accordance with Subsection 105.07 from all outfalls containing a storm water discharge associated with industrial activity for the following parameters: (3-20-20)T
    - (1) Any pollutant limited in an effluent guideline to which the facility is subject; (3-20-20)T
    - (2) Any pollutant listed in the facility's NPDES or IPDES permit for its process wastewater (if the facility is operating under an existing NPDES or IPDES permit); (3-20-20)T
    - (3) Oil and grease, pH, BOD5, COD, TSS, total phosphorus, total Kjeldahl nitrogen, and nitrate plus nitrite nitrogen; (3-20-20)T
    - (4) Any information on the discharge required under Subsections 105.07.j. through l.; (3-20-20)T
    - (5) Flow measurements or estimates of the flow rate, and the total amount of discharge for the storm event(s) sampled, and the method of flow measurement or estimation; and (3-20-20)T
    - (6) The date and duration (in hours) of the storm event(s) sampled, rainfall measurements or estimates of the storm event (in inches) which generated the sampled runoff and the duration (in hours) between the storm event sampled and the end of the previous measurable (greater than one-tenth (0.1) inch rainfall) storm event; (3-20-20)T
  - vi. Operators of a discharge which is composed entirely of storm water are exempt from the requirements of Subsections 105.07.b., 105.07.a.i.(2) through 105.07.a.i.(5), 105.07.a.ii., 105.07.a.iii., 105.07.g., 105.07.h., 105.07.i., and 105.07.m.; and (3-20-20)T
  - vii. Operators of new sources or new discharges (as defined in Section 010, Definitions) which are composed in part or entirely of storm water must include estimates for the pollutants or parameters listed in Subsection 105.19.b.v. instead of actual sampling data, along with the source of each estimate. Operators of new sources or new discharges composed in part or entirely of storm water must provide quantitative data for the parameters listed in Subsection 105.19.b.v. within two (2) years after commencement of discharge, unless such data

has already been reported under the monitoring requirements of the IPDES permit for the discharge. Operators of a new source or new discharge which is composed entirely of storm water are exempt from the requirements of Subsections 105.16.a.iii.(2), 105.16.a.iii.(3), and 105.16.b. (3-20-20)T

c. An operator of an existing or new storm water discharge that is associated with industrial activity solely under 40 CFR 122.26(b)(14)(x) or is associated with small construction activity solely under 40 CFR 122.26(b)(15), is exempt from the requirements of Subsection 105.07 and Subsection 105.19.b. Such operator shall provide a narrative description of: (3-20-20)T

i. The location (including a map) and the nature of the construction activity; (3-20-20)T

ii. The total area of the site and the area of the site that is expected to undergo excavation during the life of the permit; (3-20-20)T

iii. Proposed measures, including best management practices, to control pollutants in storm water discharges during construction, including a brief description of applicable state and local erosion and sediment control requirements; (3-20-20)T

iv. Proposed measures to control pollutants in storm water discharges that will occur after construction operations have been completed, including a brief description of applicable state or local erosion and sediment control requirements; (3-20-20)T

v. An estimate of the runoff coefficient of the site and the increase in impervious area after the construction addressed in the permit application is completed, the nature of fill material and existing data describing the soil or the quality of the discharge; and (3-20-20)T

vi. The name of the receiving water. (3-20-20)T

d. The operator of an existing or new discharge composed entirely of storm water from an oil or gas exploration, production, processing, or treatment operation, or transmission facility is not required to submit a permit application in accordance with Subsection 105.19.b., unless the facility: (3-20-20)T

i. Has had a discharge of storm water resulting in the discharge of a reportable quantity for which notification is or was required pursuant to 40 CFR 117.21 or 40 CFR 302.6 at any time since November 16, 1987; or (3-20-20)T

ii. Has had a discharge of storm water resulting in the discharge of a reportable quantity for which notification is or was required pursuant to 40 CFR 110.6 at any time since November 16, 1987; or (3-20-20)T

iii. Contributes to a violation of a water quality standard. (3-20-20)T

e. The operator of an existing or new discharge composed entirely of storm water from a mining operation is not required to submit a permit application unless the discharge has come into contact with, any overburden, raw material, intermediate products, finished product, byproduct or waste products located on the site of such operations. (3-20-20)T

f. Applicants shall provide such other information the Department may reasonably require under Subsection 105.07.o. to determine whether to issue a permit and may require any facility subject to Subsection 105.19.c. to comply with Subsection 105.19.b. (3-20-20)T

## **106. INDIVIDUAL PERMIT APPLICATION REVIEW.**

**01. Completeness Criteria.** The Department will not begin processing or issue an individual IPDES permit application before receiving a complete application. An application is complete when an application form and any supplemental information are completed and submitted to the Department's satisfaction. The Department will not consider a permit application to be complete until all applicable fees required under Section 110 (Permit Fee Schedule for IPDES Permitted Facilities) are paid. (3-20-20)T

**02. Sufficiently Sensitive Methods.** Except as specified in Subsection 106.02.c., a permit application shall not be considered complete unless all required quantitative data are collected in accordance with sufficiently sensitive analytical methods approved under 40 CFR Part 136 or required under 40 CFR Parts 400 through 471 and 501 through 503. (3-20-20)T

**a.** A method approved under 40 CFR Part 136 or required under 40 CFR Parts 400 through 471 and 501 through 503 is “sufficiently sensitive” when: (3-20-20)T

**i.** The method minimum level (ML) is at or below the level of the applicable water quality criterion for the measured pollutant or pollutant parameter; or (3-20-20)T

**ii.** The method ML is above the applicable water quality criterion, but the amount of the pollutant or pollutant parameter in a facility's discharge is high enough that the method detects and quantifies the level of the pollutant or pollutant parameter in the discharge; or (3-20-20)T

**iii.** The method has the lowest ML of the analytical methods approved under 40 CFR Part 136 or required under 40 CFR Parts 400 through 471 and 501 through 503 for the measured pollutant or pollutant parameter. (3-20-20)T

**b.** For Subsection 106.02.a., consistent with 40 CFR Part 136, applicants have the option of providing matrix or sample specific minimum levels rather than the published levels. Further, where an applicant can demonstrate that, despite a good faith effort to use a method that would otherwise meet the definition of “sufficiently sensitive,” the analytical results are not consistent with the QA/QC specifications for that method, then the Department may determine that the method is not performing adequately and the applicant should select a different method from the remaining EPA-approved methods that is sufficiently sensitive consistent with Subsection 106.02.a. Where no other EPA-approved methods exist, the applicant should select a method consistent with Subsection 106.02.c. (3-20-20)T

**c.** When there is no analytical method that has been approved under 40 CFR Part 136, required under 40 CFR Parts 400 through 471 and 501 through 503, and is not otherwise required by the Department, the applicant may use any suitable method but shall provide a description of the method. When selecting a suitable method, other factors such as a method's precision, accuracy, or resolution, may be considered when assessing the performance of the method. (3-20-20)T

**03. Independence.** The Department shall judge the completeness of any IPDES permit application independently of any other permit application or permit. (3-20-20)T

**04. Schedule.** The Department will notify an applicant in writing whether the application is deemed complete for purposes of this section within: (3-20-20)T

**a.** Thirty (30) days if the application is for a new source or new discharger under the IPDES program, (3-20-20)T  
or

**b.** Sixty (60) days if the application is for an existing source or sludge-only facility. (3-20-20)T

**05. Additional Information.** Notification that an application is complete does not preclude the Department from requiring the applicant submit additional information for the Department's use in processing the application. This additional information may only be requested when necessary to clarify, modify, or supplement previously submitted material. (3-20-20)T

**a.** Requests for additional information will not render an application incomplete. (3-20-20)T

**b.** If the Department decides that a site visit is necessary for any reason in connection with the processing of an application, the Department shall notify the applicant and a date shall be scheduled. Failure to schedule or refusal of a requested site visit are grounds for permit denial. (3-20-20)T

**c.** The applicant's failure or refusal to correct deficiencies, or supply requested information may result in permit denial, and appropriate enforcement actions may be initiated, if warranted. (3-20-20)T

**06. Incomplete Due to Waiver Denial.** The Department will not consider a permit application to be complete if the Department waived application requirements under Subsection 105.11 or 105.17 and the EPA has disapproved the waiver. (3-20-20)T

**07. Impact of Waiver Delay.** If a person required to reapply for a permit submits a waiver request to the EPA more than two hundred ten (210) days before an existing permit expires, and the EPA does not disapprove the waiver request one hundred eighty-one (181) days before the permit expires, the Department will consider the permit application to be complete without the information that is the subject of the waiver request. (3-20-20)T

**08. Application Completeness Date.** The completeness date of an application is the date on which the Department notifies the applicant that the application is complete. (3-20-20)T

**107. DECISION PROCESS.**

After the Department has determined that a permit application is complete the Department will decide whether to tentatively deny the application, or prepare an IPDES draft permit. (3-20-20)T

**01. Application Denial.** If the Department decides to tentatively deny the application: (3-20-20)T

**a.** A notice of intent to deny the permit application shall be issued. A notice of intent to deny the permit application is a type of draft permit which follows the same procedures as any draft permit and shall be made available for public comment, and the Department shall give notice of opportunity for a public meeting, as specified in Section 109 (Public Notification and Comment); (3-20-20)T

**b.** The Department shall generate a response to public comment; and (3-20-20)T

**c.** Issue a final decision. The final decision may: (3-20-20)T

**i.** Be to withdraw the notice of intent to deny the application, and proceed to prepare a draft permit and fact sheet as defined in Section 108 (Draft Permit and Fact Sheet); or (3-20-20)T

**ii.** Confirm the decision to deny the application. (3-20-20)T

**d.** The applicant may appeal the final decision to deny the application by adhering to the requirements of Section 204 (Appeals Process). (3-20-20)T

**02. Draft Permit.** If the Department decides to generate a draft permit and fact sheet it will comply with Section 108 (Draft Permit and Fact Sheet). (3-20-20)T

**a.** Upon completion of the draft permit and fact sheet the Department shall issue a public notification as required in Subsection 109.01. (3-20-20)T

**b.** An opportunity for the public to comment and request a public meeting shall be provided. (3-20-20)T

**c.** The Department shall generate a response to public comment as stipulated in Subsection 109.03. (3-20-20)T

**03. Proposed Permit.** After the close of the public comment period on a draft permit, the Department will make appropriate changes in response to comments, and generate a proposed permit and fact sheet. (3-20-20)T

**04. Final Permit.** After the close of the public comment period on a draft permit, and after receipt of comments on the proposed permit, if any, from EPA, the Department shall issue a final permit decision and fact sheet. A final permit decision means a final decision to issue, deny, modify, revoke and reissue, or terminate a permit.

(3-20-20)T

**a.** The Department shall notify the applicant and each person who has submitted written comments or requested notice of the final permit decision. (3-20-20)T

**b.** A final permit decision shall become effective twenty-eight (28) days after the service of notice of the decision unless: (3-20-20)T

i. A later effective date is specified in the decision; or (3-20-20)T

ii. A Petition for Review is filed with the Department as specified in Section 204 (Appeals Process). (3-20-20)T

**108. DRAFT PERMIT AND FACT SHEET.**

**01. Draft Permit.** (3-20-20)T

**a.** If the Department decides to prepare a draft permit, it shall contain the following information: (3-20-20)T

i. All conditions established under Section 300 (Conditions Applicable to All Permits); (3-20-20)T

ii. All conditions for specific categories established under Section 301 (Permit Conditions for Specific Categories) and 40 CFR 122.42(e). (3-20-20)T

iii. All conditions established under Section 302 (Establishing Permit Provisions); (3-20-20)T

iv. All conditions established under Section 303 (Calculating Permit Provisions); (3-20-20)T

v. All monitoring requirements established under Section 304 (Monitoring and Reporting Requirements); (3-20-20)T

vi. Schedules of compliance established under Section 305 (Compliance Schedules); and (3-20-20)T

vii. Any variances that are approved. (3-20-20)T

**b.** General and individual proposed permits shall be available to the EPA Region 10 Administrator for comment as specified in Subsections 107.03 (Proposed Permit) and 107.04 (Final Permit). (3-20-20)T

**02. Fact Sheets.** (3-20-20)T

**a.** A fact sheet containing the information required in Subsection 108.02.b. must accompany the draft permit prepared for: (3-20-20)T

i. A major IPDES facility or activity; (3-20-20)T

ii. A Class I sludge management facility; (3-20-20)T

iii. An IPDES general permit; (3-20-20)T

iv. A permit that incorporates a variance or requires an explanation under Subsection 108.02.b.ix. through 108.02.b.x.; (3-20-20)T

v. A permit that includes a sewage sludge land application plan under 40 CFR 501.15(a)(2)(ix); and (3-20-20)T

vi. A permit that the Department finds is the subject of wide-spread public interest or raises major

- issues. (3-20-20)T
- b.** A fact sheet must briefly set out the principal facts and the significant factual, legal, methodological, and policy questions considered in preparing the draft permit and must include, if applicable, the following information: (3-20-20)T
- i.** A brief description of the type of facility or activity that is the subject of the draft permit; (3-20-20)T
- ii.** The type and quantity of wastes, fluids, or pollutants that are proposed to be or are being treated, stored, disposed of, injected, emitted, or discharged; (3-20-20)T
- iii.** A brief summary of the basis for the draft permit conditions, including references to applicable statutes or regulations and appropriate supporting references to the administrative record; (3-20-20)T
- iv.** Reasons for the Department’s tentative decision on any requested variances or alternatives to required standards; (3-20-20)T
- v.** A description of the procedures for reaching a final decision on the draft permit, including: (3-20-20)T
- (1)** The beginning and ending dates of the comment period under Subsection 109.02 and the address where comments should be submitted; (3-20-20)T
- (2)** The procedure for requesting a public meeting and the nature of that meeting; and (3-20-20)T
- (3)** Any other procedures by which the public may participate in the final decision; (3-20-20)T
- vi.** The name and telephone number of a person to contact for additional information; (3-20-20)T
- vii.** The justification for waiver of any application requirements under Section 105 (Application for an Individual IPDES Permit) for new and existing POTWs; (3-20-20)T
- viii.** Any calculations or other necessary explanation of the derivation of specific effluent limitations and conditions, including a citation to the applicable effluent limitation guideline or performance standard as required by Section 302 (Establishing Permit Provisions), and reasons why the effluent limitations and conditions are applicable, or an explanation of how any alternate effluent limitation was developed; (3-20-20)T
- ix.** If applicable, an explanation of why the draft permit contains the following conditions or waivers: (3-20-20)T
- (1)** Limitations to control toxic pollutants under Subsection 302.07; (3-20-20)T
- (2)** Limitations on internal waste streams under Section 304 (Monitoring and Reporting Requirements); (3-20-20)T
- (3)** Limitations on indicator pollutants under 40 CFR 125.3(g); (3-20-20)T
- (4)** Limitations established on a case-by-case basis under 40 CFR 125.3 (c)(2) or (c)(3) or pursuant to the Clean Water Act section 405(d)(4); (3-20-20)T
- (5)** Limitations to meet the criteria for permit issuance under Subsection 103.07; or (3-20-20)T
- (6)** Waivers from monitoring requirements granted under Subsection 302.03; (3-20-20)T
- x.** For a draft permit for a treatment works owned by a person other than a state or municipality, an explanation of the Department’s decision on regulation of users under Subsection 302.15; (3-20-20)T

xi. If appropriate, a sketch or detailed description of the location of the discharge or regulated activity described in the application; and (3-20-20)T

xii. For permits that include a sewage sludge land application plan under 40 CFR 501.15(a)(2)(ix), a brief description of how each of the required elements of the land application plan are addressed in the permit. (3-20-20)T

**109. PUBLIC NOTIFICATION AND COMMENT.**

**01. Public Notification.** (3-20-20)T

**a.** The Department will give notice to the public that: (3-20-20)T

i. A draft permit has been prepared under Subsection 108.01; (3-20-20)T

ii. The Department intends to deny a permit application under Subsection 107.01; (3-20-20)T

iii. A public meeting is scheduled; or (3-20-20)T

iv. An IPDES new source determination has been made. (3-20-20)T

**b.** A public notice may describe more than one (1) permit or permit action. (3-20-20)T

**c.** The Department will allow at least thirty (30) days for public comment on the items in the notice, and will provide at least thirty (30) days' notice before the public meeting. Notice of the draft permit and the meeting may be combined and given at the same time. (3-20-20)T

**d.** Public notice that a draft permit has been prepared, and any public meeting on the draft permit must be given by the following methods: (3-20-20)T

i. By mailing a copy of the notice to the following persons, unless any person entitled to receive notice under this subsection waives that person's right to receive notice for any classes and categories of permits: (3-20-20)T

(1) The applicant, unless there is no applicant for an IPDES general permit; (3-20-20)T

(2) Any other agency (including EPA when the draft permit is prepared by the state) that the Department knows has issued or is required to issue a permit for the same facility or activity under the following laws and programs: (3-20-20)T

(a) Resource Conservation and Recovery Act, under IDAPA 58.01.05, "Rules and Standards for Hazardous Waste"; (3-20-20)T

(b) Underground Injection Control (UIC) Program under Idaho Department of Water Resources as authorized under Idaho Code Title 42 Chapter 39 and regulated under IDAPA 37.03.03, "Rules and Minimum Standards for the Construction and Use of Injection Wells"; (3-20-20)T

(c) Clean Air Act, under IDAPA 58.01.01, "Rules for the Control of Air Pollution in Idaho"; (3-20-20)T

(d) Idaho Pollution Discharge Elimination System Program, under IDAPA 58.01.25, "Rules Regulating the Idaho Pollutant Discharge Elimination System Program"; or (3-20-20)T

(e) Sludge Management Program, under IDAPA 58.01.16.650, "Wastewater Rules"; and (3-20-20)T

(f) Dredge and Fill Permit Program (Clean Water Act section 404); (3-20-20)T

- (3) Affected federal and state agencies with jurisdiction over fish, shellfish, wildlife, and other natural resources, state historic preservation officers, and any affected Indian tribe; (3-20-20)T
- (4) Any state agency responsible for plan development under the Clean Water Act sections 208(b)(2), 208(b)(4), or 303(e), and the United States Army Corps of Engineers, the United States Fish and Wildlife Service, and the National Marine Fisheries Service; (3-20-20)T
- (5) Any user identified in the permit application of a privately owned treatment works; (3-20-20)T
- (6) Persons on a mailing list developed by: (3-20-20)T
- (a) Recording those who request in writing to be on the list; (3-20-20)T
- (b) Soliciting persons for area lists from participants in past permit proceedings in that area; and (3-20-20)T
- (c) Publishing notice of the opportunity to be on the mailing list on the Department's website and through periodic publication in the local press and in regional and state-funded newsletters, environmental bulletins, state law journals or similar publications. The Department may update the mailing list from time to time by requesting written indication of continued interest from those listed, and may delete from the list the name of any person who fails to respond to the Department's request; (3-20-20)T
- (7) Any unit of local government having jurisdiction over the area where the facility is proposed to be located; and (3-20-20)T
- (8) Each state agency having any authority under state law with respect to the construction or operation of the facility; (3-20-20)T
- ii. For a major facility permit, a general permit, and a permit that includes sewage sludge land application plans, by publishing a notice in a daily or weekly newspaper within the area affected by the facility or activity; and (3-20-20)T
- iii. By any other method reasonably calculated to give actual notice of the action in question to the persons potentially affected by it, including press releases or use of any other forum or media to elicit public participation. (3-20-20)T
- e. A public notice issued under this subsection must contain at least the following information: (3-20-20)T
- i. Name and address of the office processing the permit action for which notice is being given and where comments may be submitted; (3-20-20)T
- ii. Name and address of the permittee or permit applicant and, if different, of the facility or activity regulated by the permit, except in the case of IPDES draft general permits; (3-20-20)T
- iii. A brief description of the business conducted at the facility or activity described in the permit application, or for general permits when there is no application, in the draft permit; (3-20-20)T
- iv. Name, address, and telephone number of a person from whom interested persons may obtain further information, including copies of the draft permit or draft general permit, fact sheet, and the application; (3-20-20)T
- v. A brief description of the comment and public meeting procedures required by this subsection and the time and place of any meeting that will be held; if no meeting has already been scheduled, a statement of procedures to request a meeting and other procedures by which the public may participate in the final permit decision; (3-20-20)T



- vi. A general description of the location of each existing or proposed discharge point and the name of the receiving water; (3-20-20)T
- vii. The sludge use and disposal practices and the location of each sludge TWTDS and use or disposal sites known at the time of permit application; (3-20-20)T
- viii. A description of requirements applicable to cooling water intake structures under the Clean Water Act section 316(b), in accordance with 40 CFR 125.80 through 89, 125.90 through 99, and 125.130 through 139; and (3-20-20)T
- ix. Directions to the Department’s website where interested parties can obtain copies of the draft permit, fact sheet, and the permit application, if any; and (3-20-20)T
- f. In addition to the information required by Subsection 109.01.e., the public notice for a draft permit for a discharge for which a request has been filed under the Clean Water Act section 316(a) must include: (3-20-20)T
  - i. A statement that the thermal component of the discharge is subject to effluent limitations under the Clean Water Act sections 301 or 306, and a brief description, including a quantitative statement, of the thermal effluent limitations proposed under the Clean Water Act sections 301 or 306; (3-20-20)T
  - ii. A statement that a request has been filed under the Clean Water Act section 316(a), that alternative less stringent effluent limitations may be imposed on the thermal component of the discharge under the Clean Water Act section 316(a), and a brief description, including a quantitative statement, of the alternative effluent limitations, if any, included in the request; and (3-20-20)T
  - iii. If the applicant has filed an early screening request under 40 CFR 125.72 for a variance under the Clean Water Act section 316(a), a statement that the applicant has submitted that early screening request. (3-20-20)T
- g. In addition to the general public notice described in Subsection 109.01.e., the public notice of a meeting under this section must contain the following information: (3-20-20)T
  - i. Reference to the date of previous public notices relating to the permit; (3-20-20)T
  - ii. Date, time, and place of the meeting; and (3-20-20)T
  - iii. A brief description of the nature and purpose of the meeting, including the applicable rules and procedures. (3-20-20)T
- h. The Department shall mail a copy of the general public notice described in Subsection 109.01.e. to all persons identified in Subsections 109.01.d.i.(1), (2), (3), and (4). (3-20-20)T
  - i. The Department will hold a public meeting whenever the Department finds, on the basis of requests, a significant degree of public interest in a draft permit. The Department may also hold a public meeting if a meeting might clarify one (1) or more issues involved in the permit decision or for other good reason in the Department’s discretion. (3-20-20)T
- 02. Public Comment.** (3-20-20)T
  - a. During the public comment period, any interested person may submit written comments on the draft permit. Written comments shall be submitted to the person identified in the notice and as specified in Subsection 109.01.e. (3-20-20)T
  - b. During the public comment period, any interested person may request a public meeting if no public meeting has been scheduled. The Department shall schedule and hold a public meeting if the Department determines that significant public interest exists in the draft permit. (3-20-20)T
    - i. A request for a public meeting shall be in writing and must be submitted to the Department within

fourteen (14) days after the date of the public notice required by Subsection 109.01. (3-20-20)T

ii. If a public meeting is held for the purpose of receiving comments, the Department will make an audio recording or hire a court reporter to record the meeting and shall prepare a transcript of the meeting if an appeal is filed. (3-20-20)T

c. If, during the comment period for an IPDES draft permit, the district engineer of the United States Army Corps of Engineers advises the Department in writing that anchorage and navigation of any of the waters of the United States would be substantially impaired by the granting of a permit, the Department will deny the permit and notify the applicant of the denial. If the district engineer advises the Department that imposing specified conditions upon the permit is necessary to avoid any substantial impairment of anchorage or navigation, the Department will include the specified conditions in the permit. Review or appeal of denial of a permit or of conditions specified by the district engineer must be sought through the applicable procedures of the United States Army Corps of Engineers and not through the state procedures. If a court of competent jurisdiction stays the conditions or if applicable procedures of the United States Army Corps of Engineers result in a stay of the conditions, those conditions must be considered stayed in the IPDES permit for the duration of the stay. (3-20-20)T

d. If, during the comment period for an IPDES draft permit, the United States Fish and Wildlife Service, the National Marine Fisheries Service, or any other state or federal agency with jurisdiction over fish, wildlife, or public health advises the Department in writing that the imposition of specified conditions upon the permit is necessary to avoid substantial impairment of fish, shellfish, or wildlife resources, the Department may include the specified conditions in the permit to the extent the Department determines they are necessary to comply with the provisions of the Clean Water Act. (3-20-20)T

e. In some cases, the Department may confer with one (1) or more of the agencies referred to in Subsections 109.02.c. and 109.02.d. before issuing a draft permit and may set out an agency's view in the fact sheet or the draft permit. (3-20-20)T

f. The Department will consider all comments in making the final decision and will answer the comments as provided in this subsection. (3-20-20)T

g. Requests for extending a public comment period must be received in writing by the Department prior to the last day of the comment period. (3-20-20)T

h. After the close of the public comment period and prior to the issuance of the final permit decision, the Department shall afford the permit applicant an opportunity to provide additional information to respond to public comments. In addition, in order to respond to comments, the Department may request the applicant provide additional information. (3-20-20)T

**03. Response to Comments.** When the Department issues a final permit, the Department will issue a response to comments, which must be available to the public. The response must: (3-20-20)T

a. Specify which provisions, if any, of the draft permit have been changed in the final permit decision, and the reasons for the change; and (3-20-20)T

b. Briefly describe and respond to all significant comments on the draft permit raised during the public comment period, or during any meeting. (3-20-20)T

## **110. FEE SCHEDULE FOR IPDES PERMITTED FACILITIES.**

**01. Effective Date.** Annual fees shall be paid for each fee year beginning one (1) year after the effective date of the IPDES program for the affected category of discharger and continuing for each succeeding year. (3-20-20)T

**02. Fee Schedule.** (3-20-20)T

a. Publicly and privately owned treatment works, and any other discharger designated by the

Department (Subsection 105.11.a.), shall pay an annual fee based on the number of equivalent dwelling units (EDUs). The fee shall be \$1.74 per EDU. EDUs and the appropriate annual fee will be calculated by the following:

(3-20-20)T

- i. The Department calculates facility EDUs according to the definition of EDUs in Section 010; or  
(3-20-20)T
  - ii. Existing facilities may annually report to the Department the number of EDUs served; or  
(3-20-20)T
  - iii. New facilities may report to the Department the number of EDUs to be served, based on the facility planning design as part of the IPDES permit application.  
(3-20-20)T
- b. All other permitted IPDES dischargers shall pay an annual fee, an application fee, or both according to the following schedule:

Permit Type	Application	Annual
<b>Industrial Permits</b>		
<b>Major</b>	\$0	\$13,000
<b>Minor</b>	\$0	\$4,000
<b>Storm Water Permits</b>		
<b>Construction (CGP)</b>		
<b>1-10 acres</b>	\$200	\$0
<b>10-50 acres</b>	\$400	\$75
<b>50-100 acres</b>	\$750	\$100
<b>100-500 acres</b>	\$1,000	\$400
<b>&gt;500 acres</b>	\$1,250	\$400
<b>Low Erosivity Waiver (CGP)</b>	\$125	\$0
<b>Industrial (MSGP) Permits</b>	\$1,500	\$1,000
<b>Cert. of No Exposure (MSGP)</b>	\$250	\$100
<b>Other General Permits</b>	\$0	\$0

(3-20-20)T

**03. Fee Assessment.** (3-20-20)T

a. An annual fee assessment will be generated for each IPDES-permitted facility for which an annual fee is required as set forth in Subsection 110.02. Annual fees will be determined based on the twelve (12) months between October 1 and September 30 of the following calendar year.  
(3-20-20)T

b. Application Fees and Annual Fees: (3-20-20)T

i. Application fees, as identified in Subsection 110.02.b., are assessed at the time of application for coverage under an individual permit, or notice of intent for coverage under a general permit.  
(3-20-20)T

ii. Owners or operators of multi-year storm water facilities or construction projects are subject to annual fees that will be assessed in the year (October through September) immediately following the receipt of the application or notice of intent for coverage.  
(3-20-20)T

c. Assessment of annual fees will consider the number of months a permittee was covered under either a general or an individual permit in a given year (October through September of the following calendar year). If the permittee was covered for less than a full twelve (12) months, the assessed fee shall be pro-rated to account for less than a full year's coverage under the permit. (3-20-20)T

**04. Billing.** For those permitted facilities subject to an annual fee, the annual fee shall be assessed and a statement will be mailed by the Department on or before July 1 of each year. (3-20-20)T

**05. Payment.** (3-20-20)T

a. Payment of the annual fee shall be due on October 1, unless it is a Saturday, Sunday, or legal holiday, in which event the payment shall be due on the successive business day. Fees paid by check or money order shall be made payable to the Idaho Department of Environmental Quality and sent to 1410 North Hilton Street, Boise, ID 83706-1255. (3-20-20)T

b. If a POTW serves five hundred seventy-five (575) EDUs or more, the facility may request to divide its annual fee payment into equal monthly or quarterly installments by submitting a request to the Department on the proper request form provided with the initial billing statement. (3-20-20)T

i. The Department will notify an applicable POTW, in writing, of approval or denial of a requested monthly or quarterly installment plan within ten (10) business days of the Department receiving such a request. (3-20-20)T

ii. If a POTW has been approved to pay monthly installments then each installment shall be due by the first day of each month, unless it is a Saturday, a Sunday, or a legal holiday, in which event the installment shall be due on the successive business day. (3-20-20)T

iii. If a POTW has been approved to pay quarterly installments then each installment shall be due by the first day of the month of each quarter (October 1, January 1, April 1, and July 1), unless it is a Saturday, a Sunday, or a legal holiday, in which event the installment shall be due on the first successive business day. (3-20-20)T

c. Payment of the application fee is due with the application for an individual permit or notice of intent for coverage under a general permit. (3-20-20)T

**06. Delinquent Unpaid Fees.** A permittee covered under either a general permit or an individual permit will be delinquent in payment if the annual fee assessed has not been received by the Department by November 1; or if having first opted to pay monthly or quarterly installments, its monthly or quarterly installment has not been received by the Department by the last day of the month in which the monthly or quarterly payment is due. (3-20-20)T

**07. Suspension of Services and Disapproval Designation.** (3-20-20)T

a. For any permittee delinquent in payment of fee assessed under Subsections 110.02 and 110.06 in excess of ninety (90) days, technical services provided by the Department shall be suspended. The permittee will be informed of the fee delinquency in a warning letter, which shall identify administrative enforcement actions the Department may pursue if the permittee does not comply with the terms of the permit. (3-20-20)T

b. For any permittee delinquent in payment of fee assessed under Subsections 110.02 and 110.06, in excess of one hundred and eighty (180) days, the Department shall suspend all technical services provided by the Department and consider the permittee in non-compliance with permit conditions and these rules, and subject to provisions described in Section 500 (Enforcement) of these rules. (3-20-20)T

**08. Reinstatement of Suspended Services and Approval Status.** For any permittee for which delinquency of fee payment pursuant to Subsection 110.07 has resulted in the suspension of technical services, determination of non-compliance of permit condition, or both, the continuation of technical services, determination of compliance based on payment of fee, or both will occur upon payment of delinquent annual fee assessments.

(3-20-20)T

**09. Enforcement Action.** Nothing in Section 110 (Fee Schedule for IPDES Permitted Facilities) waives the Department's right to undertake a non-fee related enforcement action at any time, including seeking penalties, as provided in Sections 39-108, 39-109, and 39-117, Idaho Code. (3-20-20)T

**10. Responsibility to Comply.** Subsection 110.07 shall in no way relieve any permittee from its obligation to comply with all applicable state and federal statutes, rules, regulations, permits, or orders. (3-20-20)T

**111. -- 119. (RESERVED)**

**120. NEW SOURCES AND NEW DISCHARGES.**

**01. Criteria for New Source Determination.** Except as otherwise provided in an applicable new source performance standard, a source is a new source if it meets the definition in Section 010 (Definitions), and: (3-20-20)T

**a.** Is constructed at a site at which no other source is located; or (3-20-20)T

**b.** Totally replaces the process or production equipment that causes the discharge of pollutants at an existing source; or (3-20-20)T

**c.** Its processes are substantially independent of an existing source at the same site. In determining whether these processes are substantially independent, the Department shall consider such factors as: (3-20-20)T

**i.** The extent to which the new facility is integrated with the existing plant; and (3-20-20)T

**ii.** The extent to which the new facility is engaged in the same general type of activity as the existing source. (3-20-20)T

**02. New Source vs. New Discharger.** A source meeting the requirements of Subsection 120.01 is a new source only if a new source performance standard is independently applicable to it. If there is no such independently applicable standard, the source is a new discharger, as defined in Section 010 (Definitions). (3-20-20)T

**03. Modification vs. New Source/Discharger.** Construction on a site at which an existing source is located, results in a modification subject to Subsection 201.02, rather than a new source (or a new discharger) if the construction does not create a new building, structure, facility, or installation meeting the criteria of Subsection 120.01, but otherwise alters, replaces, or adds to existing process or production equipment. (3-20-20)T

**04. New Source Construction.** Construction of a new source has commenced if the owner or operator has: (3-20-20)T

**a.** Begun, or caused to begin as part of a continuous on-site construction program: (3-20-20)T

**i.** Any placement, assembly, or installation of facilities or equipment; or (3-20-20)T

**ii.** Significant site preparation work including clearing, excavation or removal of existing buildings, structures, or facilities which is necessary for the placement, assembly, or installation of new source facilities or equipment; or (3-20-20)T

**b.** Entered into a binding contractual obligation for the purchase of facilities or equipment which are intended to be used in its operation within a reasonable time. Items which do not constitute contractual obligations under this section include: (3-20-20)T

**i.** Options to purchase or contracts which can be terminated or modified without substantial loss; (3-20-20)T

- ii. Contracts for feasibility engineering; and (3-20-20)T
- iii. Design studies. (3-20-20)T

**121. -- 129. (RESERVED)**

**130. GENERAL PERMITS.**

- 01. Coverage.** The Department may issue a general permit in accordance with the following: (3-20-20)T

**a.** Within a geographic area, the general permit shall be written to cover one (1) or more categories or subcategories of discharges or sludge use or disposal practices or facilities described in the permit under Subsection 130.01.b.ii., except those covered by individual permits within a geographic area. The area should correspond to existing geographic or political boundaries such as: (3-20-20)T

- i. Designated planning areas under the Clean Water Act sections 208 and 303; (3-20-20)T
- ii. Sewer districts or sewer authorities; (3-20-20)T
- iii. City, county, or state political boundaries; (3-20-20)T
- iv. State highway systems; (3-20-20)T
- v. Standard metropolitan statistical areas as defined by state or federal agencies; (3-20-20)T
- vi. Urbanized areas as designated by the U.S. Census Bureau; or (3-20-20)T
- vii. Any other appropriate division or combination of boundaries. (3-20-20)T

**b.** The general permit may be written to regulate one (1) or more categories or subcategories of discharges or sludge use or disposal practices or facilities, within the area described in Subsection 130.01.a., where the sources within a covered subcategory of discharges are either: (3-20-20)T

- i. Storm water point sources; or (3-20-20)T
- ii. One (1) or more categories or subcategories of point sources other than storm water point sources or TWTDS, if the point sources or TWTDS within each category or subcategory all:
  - (1) Involve the same or substantially similar types of operations; (3-20-20)T
  - (2) Discharge the same types of wastes or engage in the same types of sludge use or disposal practices; (3-20-20)T
  - (3) Require the same effluent limitations, operating conditions, or standards for sewage sludge use or disposal; (3-20-20)T
  - (4) Require the same or similar monitoring; and (3-20-20)T
  - (5) In the opinion of the Department, are more appropriately controlled under a general permit than under individual permits. (3-20-20)T

**c.** Where sources within a specific category or subcategory of dischargers are subject to water quality-based limits imposed pursuant to Section 302 (Establishing Permit Provisions), the sources in that specific category or subcategory shall be subject to the same water quality-based effluent limitations. (3-20-20)T

- d.** Other requirements: (3-20-20)T

- i. The general permit must clearly identify the applicable conditions for each category or subcategory of dischargers or TWTDS covered by the permit; and (3-20-20)T
- ii. The general permit may exclude specified sources or areas from coverage. (3-20-20)T
- iii. For general permits issued under Subsection 130.01.b. for small MS4s, the Department must establish the terms and conditions necessary to meet the requirements of 40 CFR 122.34 using one (1) of the two (2) permitting approaches described in Subsections 130.01.d.iii.(1) and (2). The Department must indicate in the permit or fact sheet which approach is being used. (3-20-20)T
- (1) Comprehensive general permit. The Department includes all required permit terms and conditions in the general permit; or (3-20-20)T
- (2) Two-step general permit. The Department includes required permit terms and conditions in the general permit applicable to all eligible small MS4s and, during the process of authorizing small MS4s to discharge, establishes additional terms and conditions not included in the general permit to satisfy one (1) or more of the permit requirements in 40 CFR 122.34 for individual small MS4 operators. (3-20-20)T
- (a) The general permit must require that any small MS4 operator seeking authorization to discharge under the general permit submit a Notice of Intent (NOI) consisting of the minimum required information in Subsection 130.05.b., and any other information the Director identifies as necessary to establish additional terms and conditions that satisfy the permit requirements of 40 CFR 122.34, such as the information required under Subsection 130.05.b. The general permit will explain any other steps necessary to obtain permit authorization. (3-20-20)T
- (b) The Department must review the NOI submitted by the small MS4 operator to determine whether the information in the NOI is complete and to establish the additional terms and conditions necessary to meet the requirements of 40 CFR 122.34. The Department may require the small MS4 operator to submit additional information. If the Department makes a preliminary decision to authorize the small MS4 operator to discharge under the general permit, the Department must give the public notice of and opportunity to comment and request a public meeting on its proposed authorization and the NOI, the proposed additional terms and conditions, and the basis for these additional requirements. The public notice, the process for submitting public comments and meeting requests, and the meeting process if a request for a meeting is granted, must follow the procedures applicable to draft permits set forth in Sections 108 and 109 except Subsection 109.01.d. The Department must respond to significant comments received during the comment period as provided in Subsection 109.03. (3-20-20)T
- (c) Upon authorization for the MS4 to discharge under the general permit, the final additional terms and conditions applicable to the MS4 operator become effective. The Department must notify the permittee and inform the public of the decision to authorize the MS4 to discharge under the general permit and of the final additional terms and conditions specific to the MS4. (3-20-20)T
- 02. Electronic Submittals.** As of December 21, 2020, all notices of intent submitted in compliance with this section must be submitted electronically by the discharger (or treatment works treating domestic sewage) to the Department unless waived pursuant to 40 CFR 127.15. (3-20-20)T
- 03. Information Retention Schedule.** An applicant must keep records of all data used to complete a notice of intent and any supplemental information submitted for a period of at least three (3) years from the date the notice of intent is signed. (3-20-20)T
- 04. Notice of Intent.** (3-20-20)T
- a.** Any person required under Subsections 102.01 through 102.03 must submit a notice of intent to the Department for coverage under an IPDES general permit as set out in Subsection 130.05. (3-20-20)T
- b.** A notice of intent must be signed and certified as required by Section 090 (Signature Requirements). (3-20-20)T

- 05. Administration.** (3-20-20)T
- a.** General permits may be issued, modified, revoked and reissued, or terminated in accordance with Sections 201 (Modification, or Revocation and Reissuance of IPDES Permits) and 203 (Termination of IPDES Permits). (3-20-20)T
- b.** Authorization to discharge, or authorization to engage in sludge use and disposal practices shall follow these procedures: (3-20-20)T
- i.** Except as provided in Subsections 130.05.b.xi. and 130.05.b.xii., a discharger shall submit, in accordance with general permit requirements, a complete and timely notice of intent which will fulfill the requirements for permit applications; (3-20-20)T
- ii.** A discharger (or TWTDS) who fails to submit a notice of intent in accordance with the terms of the permit is not authorized to discharge (or in the case of sludge disposal permit, to engage in a sludge use or disposal practice) under the terms of the general permit unless: (3-20-20)T
- (1)** The general permit, in accordance with Subsections 130.05.b.xi., contains a provision that a notice of intent is not required; or (3-20-20)T
- (2)** The Department notifies a discharger (or TWTDS) that it is covered by a general permit in accordance with Subsection 130.05.b.xii.; (3-20-20)T
- iii.** All notices of intent shall be signed as required in Section 090 (Signature Requirements); (3-20-20)T
- iv.** The contents of the notice of intent shall be specified in the general permit and shall require the submission of information necessary for adequate program implementation, including at a minimum: (3-20-20)T
- (1)** The legal name, address, and EIN of the owner or operator; (3-20-20)T
- (2)** The facility name and address; (3-20-20)T
- (3)** Type of facility or discharges; and (3-20-20)T
- (4)** The receiving stream(s); (3-20-20)T
- v.** Coverage under a general permit may be terminated or revoked in accordance with Subsection 130.05.c. through e.; (3-20-20)T
- vi.** Notices of intent for coverage under a general permit for CAFOs must include the information specified in Subsection 105.09 and 40 CFR 122.21(i)(1), including a topographic map; (3-20-20)T
- vii.** A CAFO owner or operator may be authorized to discharge under a general permit only in accordance with the process described in 40 CFR 122.23(h); (3-20-20)T
- viii.** General permits for storm water discharges associated with industrial activity from inactive mining, inactive oil and gas operations, or inactive landfills occurring on federal lands where an operator cannot be identified may contain alternative notice of intent requirements; (3-20-20)T
- ix.** General permits shall specify the deadlines for submitting notices of intent to be covered and the date(s) when a discharger is authorized to discharge under the permit; (3-20-20)T
- x.** General permits shall specify whether a discharger (or TWTDS), who has submitted a complete and timely notice of intent to be covered in accordance with the general permit and is eligible for coverage under the permit, is authorized to discharge (or in the case of a sludge disposal permit, to engage in a sludge use or disposal practice) in accordance with the permit either: (3-20-20)T



- (1) Upon receipt of the notice of intent by the Department; (3-20-20)T
  - (2) After a waiting period specified in the general permit; (3-20-20)T
  - (3) On a date specified in the general permit; or (3-20-20)T
  - (4) Upon receipt of notification of inclusion by the Department; (3-20-20)T
- xi. Discharges other than discharges from POTWs, combined sewer overflows, municipal separate storm sewer systems, primary industrial facilities, and storm water discharges associated with industrial activity, may, at the discretion of the Department, be authorized to discharge under a general permit without submitting a notice of intent where the Department finds that a notice of intent requirement would be inappropriate. The Department shall provide in the public notice of the general permit the reasons for not requiring a notice of intent. In making such a finding, the Department shall consider: (3-20-20)T
- (1) The type of discharge; (3-20-20)T
  - (2) The expected nature of the discharge; (3-20-20)T
  - (3) The potential for toxic and conventional pollutants in the discharges; (3-20-20)T
  - (4) The expected volume of the discharges; (3-20-20)T
  - (5) Other means of identifying discharges covered by the permit; and (3-20-20)T
  - (6) The estimated number of discharges to be covered by the permit; and (3-20-20)T
- xii. The Department may notify a discharger (or TWTDS) that it is covered by a general permit, even if the discharger (or TWTDS) has not submitted a notice of intent to be covered. A discharger (or TWTDS) so notified may request an individual permit as specified in Subsection 130.05.d. (3-20-20)T
- c. The Department may terminate, revoke, or deny coverage under a general permit, and require the discharger or applicant to apply for and obtain an individual IPDES permit. Any interested person may petition the Department to take action under this subsection. Cases where an individual IPDES permit may be required include the following: (3-20-20)T
- i. The discharger or TWTDS is not in compliance with the conditions of the general permit; (3-20-20)T
  - ii. A change has occurred in the availability of demonstrated technology or practices for the control or abatement of pollutants applicable to the point source or TWTDS; (3-20-20)T
  - iii. Effluent limitation guidelines are promulgated for point sources covered by the general permit; (3-20-20)T
  - iv. A Water Quality Management plan containing requirements applicable to such point sources is approved; (3-20-20)T
  - v. Circumstances have changed since the time of the request to be covered so that the discharger is no longer appropriately controlled under the general permit, or either a temporary or permanent reduction or elimination of the authorized discharge is necessary; (3-20-20)T
  - vi. Standards for sewage sludge use or disposal have been promulgated for the sludge use and disposal practice covered by the general IPDES permit; or (3-20-20)T
  - vii. The discharge(s) is a significant contributor of pollutants. In making this determination, the

Department may consider the following factors: (3-20-20)T

- (1) The location of the discharge with respect to waters of the United States; (3-20-20)T
- (2) The size of the discharge; (3-20-20)T
- (3) The quantity and nature of the pollutants discharged to waters of the United States; and (3-20-20)T
- (4) Other relevant factors. (3-20-20)T

**d.** Any owner or operator authorized by a general permit may request to be excluded from the coverage of the general permit by applying for an individual permit. (3-20-20)T

**i.** The owner or operator shall submit an application under Section 105 (Application for an Individual IPDES Permit), with reasons supporting the request, to the Department no later than ninety (90) days after the publication of the general permit. (3-20-20)T

**ii.** The Department shall process the request under Sections 106 (Individual Permit Application Review), 107 (Decision Process), 108 (Draft Permit and Fact Sheet) and 109 (Public Notification and Comment). (3-20-20)T

**iii.** The Department shall grant a request by issuing an individual permit if the reasons cited by the owner or operator are adequate to support the request. (3-20-20)T

**e.** When an individual IPDES permit is issued to an owner or operator otherwise subject to a general IPDES permit, the applicability of the general permit to the individual IPDES permittee is automatically terminated on the effective date of the individual permit. (3-20-20)T

**f.** A source excluded from a general permit, solely because it already has an individual permit, may request that the individual permit be revoked, and that it be covered by the general permit. Upon revocation of the individual permit, the general permit shall apply to the source. (3-20-20)T

**06. Case-by-Case Requirements for Individual Permits. (3-20-20)T**

**a.** The Department may require any owner or operator authorized by a general permit to apply for an individual IPDES permit as provided in Subsection 130.05.c., only if the owner or operator has been notified in writing that a permit application is required. This notice shall include a brief statement of the reasons for this decision, an application form, a statement setting a time for the owner or operator to file the application, a statement that on the effective date of the individual IPDES permit, the general permit as it applies to the individual permittee shall automatically terminate, and a statement that the owner or operator may appeal the Department's decision as provided in Section 204 (Appeals Process). The Department may grant additional time upon request of the applicant. (3-20-20)T

**b.** Prior to a case-by-case determination that an individual permit is required for a storm water discharge under this section (see 40 CFR 122.26(a)(1)(v), (a)(9)(iii), and Subsection 105.19), the Department may require the discharger to submit a permit application or other information regarding the discharge described in the Clean Water Act section 308. (3-20-20)T

**i.** In requiring such information, the Department shall notify the discharger in writing and shall send an application form with the notice. (3-20-20)T

**ii.** The discharger must apply for a permit within one hundred eighty (180) days of notice, unless permission for a later date is granted by the Department. (3-20-20)T

**131. -- 199. (RESERVED)**

**200. RENEWAL OF IPDES PERMITS.**

**01. Interim Effluent Limits.** Except as provided in Subsection 200.02, when a permit is renewed or reissued, interim effluent limitations, standards or conditions must be at least as stringent as the final effluent limitations, standards, or conditions in the previous permit unless the circumstances on which the previous permit was based: (3-20-20)T

- a. Have materially and substantially changed since the time the permit was issued; and (3-20-20)T
- b. Would constitute cause for permit modification or revocation and reissuance under Subsection 201.02. (3-20-20)T

**02. Final Clean Water Act Section 402(a)(1)(B) Effluent Limits.** In the case of effluent limitations established by the Department on the basis of the Clean Water Act section 402(a)(1)(B), a permit may not be renewed, reissued, or modified on the basis of effluent guidelines promulgated under Clean Water Act section 304(b) after the original issuance of a permit, to contain effluent limitations which are less stringent than the comparable effluent limitations in the previous permit, except a permit may be renewed, reissued, or modified to contain a less stringent effluent limitation applicable to a pollutant, if: (3-20-20)T

- a. Material and substantial alterations or additions to the permitted facility occurred after permit issuance, which justify the application of a less stringent effluent limitation; (3-20-20)T
- b. Information is available: (3-20-20)T
  - i. Which was not available at the time of permit issuance (other than revised regulations, guidance, or test methods) and which would have justified the application of a less stringent effluent limitation at the time of permit issuance; or (3-20-20)T
  - ii. Which the Department determines indicates that technical mistakes or mistaken interpretations of law were made in issuing the permit under the Clean Water Act section 402(a)(1)(b); (3-20-20)T
- c. A less stringent effluent limitation is necessary because of events over which the permittee has no control and for which there is no reasonably available remedy; (3-20-20)T
- d. The permittee has received a permit modification under the Clean Water Act section 301(c), 301(g), 301(i), 301(k), 301(n), or 316(a); or (3-20-20)T
- e. The permittee has installed the treatment facilities required to meet the effluent limitations in the previous permit and has properly operated and maintained the facilities but has nevertheless been unable to achieve the previous effluent limitations. In this case the limitations in the reviewed, reissued, or modified permit may reflect the level of pollutant control actually achieved (but shall not be less stringent than required by effluent guidelines in effect at the time of permit renewal, reissuance, or modification). (3-20-20)T

**03. Final Clean Water Act Section 301(b)(1)(C) or 303 Effluent Limits.** In the case of effluent limitations established on the basis of Clean Water Act section 301(b)(1)(C) or section 303(d) or (e), a permit may not be renewed, reissued, or modified to contain effluent limitations which are less stringent than the comparable effluent limitations in the previous permit except when: (3-20-20)T

- a. One of the exceptions in Subsection 200.02 apply; or (3-20-20)T
- b. The water to which the discharge occurs is identified as impaired on Idaho's Integrated Report and the effluent limitation is based on a total maximum daily load or other waste load allocation established under Clean Water Act section 303, if the cumulative effect of all revised effluent limitations based on such total maximum daily load or waste load allocation will assure the attainment of applicable water quality standards; or (3-20-20)T
- c. The water quality in the water to which the discharge occurs meets or exceeds levels required by applicable water quality standards and the effluent limitation is based on a total maximum daily load or other waste load allocation established under Clean Water Act section 303, any water quality standard, or any permitting standard, if such revision is subject to and consistent with the antidegradation policy and implementation procedures

in the water quality standards.

(3-20-20)T

**04. Effluent Limits and Water Quality Standards.** In no event may a permit with respect to which Subsection 200.02 or 200.03 applies be renewed, reissued, or modified to contain an effluent limitation which is less stringent than required by effluent guidelines in effect at the time the permit is renewed, reissued, or modified. In no event may such a permit to discharge into waters of the United States be renewed, issued, or modified to contain a less stringent effluent limitation if the implementation of such limitation would result in a violation of a water quality standard under IDAPA 58.01.02, “Water Quality Standards.”

(3-20-20)T

**201. MODIFICATION, OR REVOCATION AND REISSUANCE OF IPDES PERMITS.**

**01. Procedures to Modify, or Revoke and Reissue Permits.**

(3-20-20)T

**a.** Permits may be modified, or revoked and reissued either at the request of any interested person (including the permittee) or upon the Department’s initiative. However, permits may only be modified or revoked and reissued for the reasons specified in Subsection 201.02. All requests shall be in writing and shall contain facts or reasons supporting the request.

(3-20-20)T

**b.** If the Department tentatively decides to modify or revoke and reissue a permit, the Department shall prepare a draft permit under Section 108 (Draft Permit and Fact Sheet), incorporating the proposed changes.

(3-20-20)T

**i.** The Department may request additional information and, in the case of a modified permit, may require the submission of an updated application. If the tentative decision is to revoke and reissue a permit, the Department shall require the submission of a new application.

(3-20-20)T

**ii.** In a permit modification under this section, only those conditions to be modified shall be reopened when a new draft permit is prepared. All other aspects of the existing permit shall remain in effect for the duration of the unmodified permit.

(3-20-20)T

**iii.** When a permit is revoked and reissued under this section, the entire permit is reopened just as if the permit had expired and was being reissued. During any revocation and reissuance proceeding, the permittee shall comply with all conditions of the existing permit until a new final permit is reissued.

(3-20-20)T

**iv.** Minor modifications, as defined in Subsection 201.03, do not require the development of a draft permit, fact sheet, nor must minor modifications be subjected to public notification and comment.

(3-20-20)T

**02. Causes to Modify, or Revoke and Reissue Permits.** When the Department receives any pertinent information (for example, inspects the facility, receives information submitted by the permittee as required in the permit, receives a request for modification or revocation and reissuance under Subsection 201.01, or conducts a review of the permit file), the Department may determine whether or not one (1) or more of the causes listed in Subsections 201.02.c. and 201.02.d. for modification or revocation and reissuance or both exist.

(3-20-20)T

**a.** If cause exists, the Department may modify or revoke and reissue the permit accordingly, subject to the limitations of Subsection 201.01.b., and may request a new or updated application, if necessary.

(3-20-20)T

**b.** If cause does not exist under this section, the Department shall not modify or revoke and reissue the permit.

(3-20-20)T

**c.** The following are causes for modification but not revocation and reissuance of permits except when the permittee requests or agrees:

(3-20-20)T

**i.** There are material and substantial alterations or additions to the permitted facility or activity (including a change or changes in the permittee's sludge use or disposal practice), which occurred after permit issuance, and which justify the application of permit conditions that are different or absent in the existing permit.

(3-20-20)T

ii. The Department has received new information. Permits may be modified during their terms for this cause only if the information was not available at the time of permit issuance (other than revised regulations, guidance, or test methods) and would have justified the application of different permit conditions at the time of issuance: (3-20-20)T

(1) For IPDES general permits (Section 130) this cause includes any information indicating that cumulative effects on the environment are unacceptable; and (3-20-20)T

(2) For new source or new discharger IPDES permits (Section 120), this cause shall include any significant information derived from effluent testing required under Subsection 105.08 or 105.16 after issuance of the permit. (3-20-20)T

iii. The standards or regulations on which the permit was based have been changed by promulgation of amended standards or regulations or by judicial decision after the permit was issued. Permits may be modified during their terms for this cause only as follows: (3-20-20)T

(1) For promulgation of amended standards or regulations, when: (3-20-20)T

(a) The permit condition requested to be modified was based on a promulgated effluent limitation guideline, EPA approved or promulgated water quality standards, or the Secondary Treatment Regulations under 40 CFR Part 133; (3-20-20)T

(b) EPA has revised, withdrawn, or modified that portion of the regulation or effluent limitation guideline on which the permit condition was based, or has approved a state action with regard to a water quality standard on which the permit condition was based; and (3-20-20)T

(c) A permittee requests modification in accordance with Subsection 201.01 or 203.01 within ninety (90) days after notice of the action on which the request is based; and (3-20-20)T

(2) For judicial decisions, a court of competent jurisdiction has remanded and stayed EPA or Idaho promulgated regulations or effluent limitation guidelines, if the remand and stay concerns that portion of the regulations or guidelines on which the permit condition was based and a request is filed by the permittee in accordance with Subsection 201.01 or 203.01 within ninety (90) days of judicial remand. (3-20-20)T

iv. The Department determines good cause exists for modification of a compliance schedule, such as an act of God, strike, flood, or materials shortage or other events over which the permittee has little or no control and for which there is no reasonably available remedy. However, in no case may an IPDES compliance schedule be modified to extend beyond an applicable Clean Water Act statutory deadline. (3-20-20)T

v. When the permittee has filed a request for a variance under Clean Water Act section 301(c), 301(g), 301(i), 301(k), or 316(a) or for fundamentally different factors within the time specified in Section 310 (Variances). (3-20-20)T

vi. When required to incorporate an applicable Clean Water Act 307(a) toxic effluent standard or prohibition, under Subsection 302.04. (3-20-20)T

vii. When required by the reopener conditions in a permit, which are established in the permit under Subsection 302.05 or 40 CFR 403.18(e) (Pretreatment Standards). (3-20-20)T

viii. Upon request of a permittee who qualifies for effluent limitations on a net basis, or when a discharger is no longer eligible for net limitations, as provided in Subsection 303.07. (3-20-20)T

ix. As necessary under 40 CFR 403.8(e) (Pretreatment Program Requirements: Development and Implementation by POTW). (3-20-20)T

x. Upon failure of an approved state to notify, as required by the Clean Water Act section 402(b)(3), another state whose waters may be affected by a discharge from the approved state. (3-20-20)T

xi. When the level of discharge of any pollutant which is not limited in the permit exceeds the level which can be achieved by the technology-based treatment requirements appropriate to the permittee under 40 CFR 125.3(c). (3-20-20)T

xii. To establish a notification level as provided in Subsection 302.08. (3-20-20)T

xiii. To modify a schedule of compliance to reflect the time lost during construction of an innovative or alternative facility, in the case of a POTW which has received a loan under IDAPA 58.01.12, “Rules for Administration of Water Pollution Control Loans.” In no case shall the compliance schedule be modified to extend beyond an applicable Clean Water Act statutory deadline. (3-20-20)T

xiv. For a small MS4, to include an effluent limitation requiring implementation of a minimum control measure or measures as specified in 40 CFR 122.34(b) when: (3-20-20)T

(1) The permit does not include such measure(s) based upon the determination that another entity was responsible for implementation of the requirement(s), and (3-20-20)T

(2) The other entity fails to implement measure(s) that satisfy the requirement(s). (3-20-20)T

xv. To correct technical mistakes, such as errors in calculation, or mistaken interpretations of law made in determining permit conditions. (3-20-20)T

xvi. When the discharger has installed the treatment technology considered by the permit writer in setting effluent limitations imposed under the Clean Water Act section 402(a)(1) and has properly operated and maintained the facilities but nevertheless has been unable to achieve those effluent limitations. In this case, the limitations in the modified permit may reflect the level of pollutant control actually achieved (but shall not be less stringent than required by a subsequently promulgated effluent limitations guideline). (3-20-20)T

xvii. The incorporation of the terms of a CAFO’s nutrient management plan into the terms and conditions of a general permit when a CAFO obtains coverage under a general permit in accordance with 40 CFR 122.23(h) and Section 130 (General Permits) is not a cause for modification pursuant to the requirements of this section. (3-20-20)T

xviii. When required by a permit condition to incorporate a land application or sludge disposal plan for beneficial reuse of sewage sludge, to revise an existing land application or sludge disposal plan, or to add a land application or sludge disposal plan as required by IDAPA 58.01.16.650, “Wastewater Rules,” and Section 380 (Sewage Sludge) of these rules. (3-20-20)T

**d.** The following are causes to modify or, alternatively, revoke and reissue a permit: (3-20-20)T

i. Cause exists for termination under Subsection 203.03, and the Department determines that modification or revocation and reissuance is appropriate; (3-20-20)T

ii. The Department has received notification, as required in the permit, of a proposed transfer of the permit; or (3-20-20)T

iii. A permit also may be modified to reflect a transfer after the effective date of an automatic transfer (Subsection 202.02) but will not be revoked and reissued after the effective date of the transfer except upon the request of the new permittee. (3-20-20)T

**03. Minor Modifications of Permits.** Upon the consent of the permittee, the Department may modify a permit to make the corrections or allowances for changes in the permitted activity listed in this subsection without following the procedures of Sections 108 (Draft Permit and Fact Sheet), 109 (Public Notification and Comment), and Subsection 201.01. Any permit modification not processed as a minor modification under this subsection must be made for cause and must meet the requirements of Section 108 (Draft Permit and Fact Sheet) and Section 109 (Public Notification and Comment). Minor modifications may: (3-20-20)T

- a. Correct typographical errors; (3-20-20)T
- b. Require more frequent monitoring or reporting by the permittee; (3-20-20)T
- c. Change an interim compliance date in a schedule of compliance, provided the new date is not more than one hundred twenty (120) days after the date specified in the existing permit and does not interfere with attainment of the final compliance date requirement; (3-20-20)T
- d. Allow for a change in ownership or operational control of a facility where the Department determines that no other change in the permit is necessary, provided that a written agreement containing a specific date for transfer of permit responsibility, coverage, and liability between the current and new permittee has been submitted to the Department; (3-20-20)T
- e. Change the construction schedule for a discharger which is a new source. No such change shall affect a discharger's obligation to have all pollution control equipment installed and in operation prior to discharge under Section 120 (New Sources and New Discharges), and 40 CFR 122.29(d); (3-20-20)T
- f. Delete a point source outfall when the discharge from that outfall is terminated and does not result in discharge of pollutants from other outfalls except in accordance with permit limits; (3-20-20)T
- g. Incorporate conditions of a POTW pretreatment program that has been approved in accordance with the procedures in 40 CFR 403.11 or a modification that has been approved in accordance with the procedures in 40 CFR 403.18 as enforceable conditions of the POTW's permits; (3-20-20)T
- h. Incorporate changes to the terms of a CAFO's nutrient management plan that have been revised in accordance with the requirements of 40 CFR 122.42(e)(6); or (3-20-20)T
- i. Require electronic reporting requirements (to replace paper reporting requirements) including those specified in 40 CFR Part 127 (NPDES Electronic Reporting). (3-20-20)T

## **202. TRANSFER OF IPDES PERMITS.**

**01. Transfers by Modification.** Except as provided in Subsection 202.02, a permit may be transferred by the permittee to a new owner or operator only if the permit has been modified or revoked and reissued under Subsection 201.02.d., or a minor modification made under Subsection 201.03, to identify the new permittee and incorporate such other requirements as may be necessary under the Clean Water Act. (3-20-20)T

**02. Automatic Transfers.** As an alternative to transfers by modification, any IPDES permit may be automatically transferred to a new permittee if: (3-20-20)T

a. The current permittee notifies the Department at least thirty (30) days in advance of the proposed transfer date; (3-20-20)T

b. The notice includes a written agreement between the existing and new permittees containing a specific date for transfer of permit responsibility, coverage, and liability between the current and new permittee; and (3-20-20)T

c. The Department does not notify the existing permittee and the proposed new permittee of its intent to modify or revoke and reissue the permit. A modification under this subsection may also be a minor modification under Subsection 201.03. If this notice is not received, the transfer is effective on the date specified in the agreement. (3-20-20)T

## **203. TERMINATION OF IPDES PERMITS.**

**01. Request to Terminate or Termination Initiated by the Department.** Permits may be terminated either at the request of any interested person (including the permittee) or upon the Department's own initiative.

However, permits may only be terminated for the reasons specified in Subsection 203.03 or 203.04. (3-20-20)T

**a.** Request for termination by persons other than the permittee shall be submitted in writing to the Department. (3-20-20)T

**b.** As of December 21, 2020, all NOTs submitted in compliance with this section must be submitted electronically by the permittee to the Department in compliance with this section and 40 CFR Part 127 unless waived pursuant to 40 CFR 127.15. 40 CFR Part 127 is not intended to undo existing requirements for electronic reporting. Prior to this date, and independent of 40 CFR Part 127, the permittee may be required to report electronically if specified by a particular permit. (3-20-20)T

**02. Tentative Permit Termination.** Except as provided in Subsection 203.04, if the Department tentatively decides to terminate a permit under Subsection 203.03, the Department shall issue a notice of intent to terminate. A notice of intent to terminate shall be available for public comment, and the Department shall give notice of an opportunity for public meetings, as specified in Section 109 (Public Notification and Comment). (3-20-20)T

**03. Cause to Terminate Permits.** The following are causes for terminating a permit during its term, or for denying a permit renewal application: (3-20-20)T

**a.** Noncompliance by the permittee with any condition of the permit; (3-20-20)T

**b.** The permittee's failure in the application or during the permit issuance process to disclose fully all relevant facts, or the permittee's misrepresentation of any relevant facts at any time; (3-20-20)T

**c.** A determination that the permitted activity endangers human health or the environment and can only be regulated to acceptable levels by permit modification or termination; or (3-20-20)T

**d.** A change in any condition that requires either a temporary or permanent reduction or elimination of any discharge or sludge use or disposal practice controlled by the permit (for example, plant closure or termination of discharge by connection to a POTW). (3-20-20)T

**04. Expedited Termination Process for Terminated or Eliminated Discharge.** If the entire discharge is permanently terminated by elimination of the flow or by connection to a POTW (but not by land application or disposal into a well), the Department may terminate the permit by notice to the permittee. (3-20-20)T

**a.** Termination by notice shall be effective thirty (30) days after notice is sent (expedited permit termination), unless the permittee objects within that time. (3-20-20)T

**b.** If the permittee objects during that period, the Department shall follow procedures for termination in Subsection 203.02. (3-20-20)T

**c.** Expedited permit termination procedures are not available to permittees that are subject to pending state and/or federal enforcement actions including citizen suits brought under federal law. If requesting expedited permit termination procedures, a permittee must certify that it is not subject to any pending state or federal enforcement actions including citizen suits brought under federal law. (3-20-20)T

## **204. APPEALS PROCESS.**

**01. Petition for Review of a Permit Decision.** Appeal of a final IPDES permit decision, issued under Section 107 (Decision Process), to the Hearing Authority is commenced by filing a Petition for Review with the Department's Hearing Coordinator within the time prescribed in Subsection 204.01.b. The "Hearing Authority" shall be a Hearing Officer appointed by the Director from a pool of Hearing Officers approved by the Board. (3-20-20)T

**a.** Any person who is aggrieved by the final permit decision may file a Petition for Review as provided in this section. A person aggrieved is limited to the permit holder or applicant, and any person or entity who filed comments or who participated in the public meeting on the draft permit. (3-20-20)T



**b.** A Petition for Review must be filed with the Department's Hearing Coordinator within twenty-eight (28) days after the Department serves notice of the final permit decision under Section 107 (Decision Process). A petition is filed when it is received by the Department's Hearing Coordinator at the address specified in Subsection 204.13. (3-20-20)T

**c.** In addition to meeting the requirements in Subsection 204.06, a Petition for Review must: (3-20-20)T

**i.** Be confined to the issues raised during the public comment process or to changes made to the permit by the Department after the close of the public comment period; (3-20-20)T

**ii.** Identify the permit condition or other specific aspect of the permit decision that is being challenged; (3-20-20)T

**iii.** Set forth the legal and factual basis for the petitioner's contentions; (3-20-20)T

**iv.** Set forth the relief sought; and (3-20-20)T

**v.** Set forth the basis for asserting that the petitioner is an aggrieved person. (3-20-20)T

**02. Public Notice of the Petition for Review.** Within fourteen (14) days of the date a Petition for Review has been filed, the Hearing Authority must give reasonable notice to the public of the petition. (3-20-20)T

**03. Administrative Record Filed By the Department.** The Department shall file a certified copy of the administrative record, as identified in Section 600 (Administrative Records and Data Management), with an index within twenty-eight (28) days of the date the Petition for Review was filed. (3-20-20)T

**04. Participation by the Permit Applicant or Permit Holder.** A permit applicant or permit holder who did not file a petition but who wishes to participate in the appeal process must file a notice of appearance within twenty-eight (28) days of the date the Petition for Review was filed. (3-20-20)T

**05. Petition to Intervene.** Any person who has a direct and substantial interest in the outcome of the Petition for Review may file a Petition to Intervene. (3-20-20)T

**a.** The Petition to Intervene must set forth the interest of the intervener, and why intervention would not unduly broaden the issues and cause delay or prejudice to the parties. (3-20-20)T

**b.** Petitions to Intervene must be filed within fourteen (14) days of the notice of filing of the Petition for Review. (3-20-20)T

**c.** Any party opposing a Petition to Intervene must file objections within seven (7) days after service of the Petition to Intervene and serve the objection upon all parties of record and upon the person petitioning to intervene. (3-20-20)T

**d.** If a Petition to Intervene shows direct and substantial interest in the outcome of the Petition for Review, does not unduly broaden the issues, and will not cause delay or prejudice to the parties, the Hearing Authority shall grant intervention. (3-20-20)T

**06. Content and Form Requirements for Petitions and Briefs.** All petitions and briefs filed under this section must: (3-20-20)T

**a.** Identify, in the caption, the permit applicant or holder, the permitted facility, and the permit number. The caption should also include the case number, if available at the time of filing, and the title of the document, and (3-20-20)T

**b.** Specify on the upper left corner of the first page, the name, address, telephone number, e-mail address and facsimile number, if any, of the person filing the document. If the person filing the document is a

representative of a party as provided in Subsection 204.11, the document must identify the name of the person or entity represented. No more than two (2) representatives for service of documents may be listed. (3-20-20)T

**07. Augmenting the Administrative Record.** Consideration of the Petition for Review by the Hearing Authority is limited to the certified administrative record unless, upon the request of a party, the Hearing Authority allows the record to be augmented. A request to augment the record must be filed within fourteen (14) days of the filing of the certified administrative record, unless intervention is granted, in which case the request to augment must be filed within fourteen (14) days of the date the order granting intervention is issued. The Hearing Authority may allow the record to be augmented if the requesting party shows that the additional information is material, is relevant to the issues raised in the appeal and that: (3-20-20)T

a. There were good reasons for failure to present the information during the permitting proceeding; or (3-20-20)T

b. There were alleged irregularities in the permitting proceeding and the party wishes to introduce evidence of the alleged irregularities. (3-20-20)T

**08. Brief of the Petitioner.** Once all requests to augment the record and motions to intervene have been determined, the Hearing Authority shall issue an order notifying the parties that the administrative record has been settled and of the date by which the petitioner must file petitioner's brief in support of the Petition for Review. In addition to meeting the requirements of Subsection 204.06, the brief must include: (3-20-20)T

a. The legal arguments and citations to legal authority that support the allegations in the Petition for Review; and (3-20-20)T

b. The factual support for the allegations in the Petition for Review, including citations to the administrative record. (3-20-20)T

c. A statement regarding whether the party desires an opportunity for oral argument. (3-20-20)T

**09. Response Briefs.** Unless an alternative date is set by the Hearing Authority, the Department and all other parties must file response briefs within twenty-eight (28) days of the service of the petitioner's brief. In addition to meeting the requirements of Subsection 204.06, the response briefs must include: (3-20-20)T

a. A response to the arguments and assertions in the petitioner's brief (either in support or opposed); (3-20-20)T

b. A citation to all legal authorities and facts in the administrative record relied upon; and (3-20-20)T

c. A statement regarding whether the party desires an opportunity for oral argument. (3-20-20)T

**10. Reply Briefs by the Petitioner.** Unless an alternative date is set by the Hearing Authority, the petitioner may file a reply brief within fourteen (14) days after service of response briefs. A petitioner may not raise new issues or arguments in the reply. (3-20-20)T

**11. Representation of Parties.** Unless otherwise authorized or required by law, appearances and representation of parties or other persons shall be as follows: (3-20-20)T

a. A natural person may represent himself or herself or be represented by an attorney or, if the person lacks full legal capacity to act for himself or herself, then by a legal guardian or guardian ad litem or representative of an estate; (3-20-20)T

b. A general partnership may be represented by a partner or an attorney; (3-20-20)T

c. A corporation, or any other business entity other than a general partnership, must be represented by an attorney; (3-20-20)T

**d.** A municipal corporation, local government agency, unincorporated association or nonprofit organization must be represented by an attorney; or (3-20-20)T

**e.** A state, federal or tribal governmental entity or agency must be represented by an attorney. (3-20-20)T

**12. Substitution and Withdrawal of Representatives.** A party's representative may be changed and a new representative may be substituted by notice to all parties so long as the proceedings are not unreasonably delayed. Representatives who wish to withdraw from a proceeding must immediately file a motion to withdraw representation and serve that motion on the party represented and all other parties. (3-20-20)T

**13. Filing and Service Requirements.** (3-20-20)T

**a.** All documents concerning actions governed by these rules must be filed with the Hearing Coordinator at the following address: Hearing Coordinator, Department of Environmental Quality, 1410 N. Hilton, Boise, ID 83706. Documents may also be filed by fax or may be filed electronically. The Hearing Coordinator's fax number and email address for filing electronically are available at [www.deq.idaho.gov/petitions-for-review](http://www.deq.idaho.gov/petitions-for-review). The documents are deemed to be filed on the date received by the Hearing Coordinator. Upon receipt of the filed document, the Hearing Coordinator will provide confirmation to the originating party. (3-20-20)T

**b.** All documents subsequent to the petition must be served on all parties or representatives, unless otherwise directed by the Hearing Authority. (3-20-20)T

**c.** Service of documents on the named representative is valid service upon the party for all purposes in the proceeding. (3-20-20)T

**14. Proof of Service.** Every document meeting the requirements for service must be attached to or accompanied by proof of service containing the following certificate:

I hereby certify that on this (insert date), a true and correct copy of the foregoing (insert name of document) was served on the following as indicated below:

(insert names and addresses of parties and method of delivery (first class U.S. mail, facsimile, hand-delivery, or overnight express))

(Signature)

(3-20-20)T

**15. Motions.** A request for an interlocutory or procedural order or other relief must be made by written motion unless these rules prescribe another form. (3-20-20)T

**a.** A motion must state with particularity the grounds for the motion, the relief sought, and the legal argument necessary to support the motion. In advance of filing a motion, parties must attempt to ascertain whether the other parties concur or object to the motion and must indicate in the motion the attempt made and the response obtained. (3-20-20)T

**b.** Any party may file a response to a motion. Responses must state with particularity the grounds for opposition and the legal argument necessary to support the motion. The response must be filed within fifteen (15) days after service of the motion unless the Hearing Authority shortens or extends the time for response. (3-20-20)T

**c.** Any reply to a response must be filed within ten (10) days after service of the response. A reply must not introduce any new issues or arguments and may respond only to matters presented in the response. (3-20-20)T

**d.** The Hearing Authority may act on a motion for a procedural order at any time without awaiting a response. (3-20-20)T

e. Parties must file motions for extensions of time sufficiently in advance of the due date to allow other parties to have a reasonable opportunity to respond to the request for more time and to provide the Hearing Authority with a reasonable opportunity to issue an order prior to the due date. (3-20-20)T

**16. Oral Argument.** The Hearing Authority may hold oral argument on its own initiative or at its discretion in response to a request by one or more of the parties. (3-20-20)T

**17. Withdrawal of Permit or Portions of Permit by the Department.** The Department may, at any time, upon notification to the Hearing Authority and all parties, withdraw the permit or specified portions of the permit and prepare a new draft permit under Section 108 (Draft Permit and Fact Sheet) addressing the portions so withdrawn. The new draft permit must proceed through the same process of public comment and opportunity for a public meeting as would apply to any other draft permit. If applicable, any portions of the permit that are not withdrawn continue to apply, unless stayed under Sections 205 (Contested Permit Conditions) and 206 (Stays of Contested Permit Conditions). The appeal shall continue with respect to those portions of the permit that are contested in the appeal that the Department does not withdraw. (3-20-20)T

**18. Request to Dismiss Petition.** The petitioner, by motion, may request to have the Hearing Authority dismiss its appeal. The motion must briefly state the reason for its request. (3-20-20)T

**19. Burden of Proof.** The petitioner has the burden of proving the allegations in the Petition for Review. Factual allegations must be proven by a preponderance of the evidence. (3-20-20)T

**20. Appointment of Hearing Officers.** The Hearing Authority shall be a Hearing Officer appointed by the Director from a pool of Hearing Officers approved by the Board. Hearing Officers should be persons with technical expertise or experience in the issues involved in IPDES appeals. Notice of appointment of a Hearing Officer shall be served on all parties. No Hearing Officer shall be appointed that has a conflict of interest as defined in 40 CFR 123.25(c). (3-20-20)T

**21. Scope of Authority of the Hearing Authority.** The Hearing Authority shall have the following authority: (3-20-20)T

a. The authority to set schedules and take such other actions to ensure an efficient and orderly adjudication of the issues raised in the Petition for Review; (3-20-20)T

b. The authority to hear and decide motions; and (3-20-20)T

c. The authority to issue an order that decides the issues raised in the appeal and includes findings of fact and conclusions of law. The required contents of an order are set forth in Subsection 204.24. (3-20-20)T

**22. Ex Parte Communications.** The Hearing Authority shall not communicate, directly or indirectly, regarding any substantive issue in the permit appeal with any party, except upon notice and opportunity for all parties to participate in the communication. The Hearing Authority may communicate ex parte with a party concerning procedural matters (e.g., scheduling). When the Hearing Authority becomes aware of a written ex parte communication regarding any substantive issue from a party or representative of a party during an appeal, the Hearing Authority shall place a copy of the communication in the file for the case and order the party providing the written communication to serve a copy of the written communication upon all parties of record. Written communications from a party showing service upon all other parties are not ex parte communications. (3-20-20)T

**23. Alternative Dispute Resolution.** Parties to the permit appeal may agree to use a means of alternative dispute resolution. (3-20-20)T

**24. Final Orders.** (3-20-20)T

a. Final orders are issued by the Hearing Authority upon review of the petitions, briefs and the administrative record on appeal. (3-20-20)T

b. Every final order shall contain the following: (3-20-20)T

- i. A reasoned statement in support of the decision; (3-20-20)T
- ii. Findings of fact, with reference to the portions of the administrative record that support the findings. The findings of fact must be based exclusively on the administrative record, or if augmented during the appeal, the augmented record; (3-20-20)T
- iii. Conclusions of law with respect to legal issues raised in the appeal; (3-20-20)T
- iv. The final order shall either affirm the permitting decision, or vacate and remand the decision to the Department with instructions; and (3-20-20)T
- v. A statement of the right to judicial review as set forth in Section 204.26. (3-20-20)T
- c. Motions for reconsideration of any final order shall not be considered. (3-20-20)T
- 25. Final Agency Action for Purposes of Judicial Review. (3-20-20)T**
  - a. Filing a Petition for Review is a prerequisite to seeking judicial review of the Department's permitting decision. (3-20-20)T
  - b. For purposes of judicial review under Sections 39-107 and 67-5270, Idaho Code, final agency action or determination regarding an appeal of a permit occurs when a final order that affirms the Department's permitting decision is issued. (3-20-20)T
  - c. An order that vacates and remands the decision to the Department with instructions is not a final agency action for purposes of judicial review. (3-20-20)T
- 26. Petition for Judicial Review. (3-20-20)T**
  - a. Any person aggrieved by a final agency action or determination by the Department as defined in Subsection 204.25 has a right to judicial review by filing a petition for judicial review. (3-20-20)T
  - b. The petition for judicial review must be filed with the Hearing Coordinator as set out in Subsection 204.13 and with the district court and served on all parties. The petition for judicial review shall also be served upon the Hearing Authority, the Director of the Department, and upon the Attorney General of the State of Idaho. Pursuant to Section 67-5272, Idaho Code, petitions for judicial review may be filed in the District Court of the county in which: (3-20-20)T
    - i. The hearing was held; (3-20-20)T
    - ii. The final agency action was taken; (3-20-20)T
    - iii. The party seeking review of the agency action resides; or (3-20-20)T
    - iv. The real property or personal property that was the subject of the agency action is located. (3-20-20)T
  - c. Pursuant to Section 67-5273, Idaho Code, a petition for judicial review of a final agency action must be filed within twenty-eight (28) days of the service date of a final order issued by the Hearing Authority. (3-20-20)T
- 27. IPDES General Permits. (3-20-20)T**
  - a. Persons affected by an IPDES general permit may not file a petition under this section or otherwise challenge the conditions of a general permit in further Department proceedings. Instead, they may do either of the following: (3-20-20)T

- i. Challenge the conditions in a general permit by filing an action in court; or (3-20-20)T
- ii. Apply for an individual IPDES permit under Section 105 (Application for an Individual IPDES Permit), as authorized in Section 130 (General Permits), and may then petition the Hearing Authority to review the individual permit as provided by in these rules. (3-20-20)T

**b.** As provided in Subsection 130.05.c., any interested person may also petition the Department to require an individual IPDES permit for any discharger eligible for authorization to discharge under an IPDES general permit. (3-20-20)T

**c.** The Department's decision to terminate, revoke or deny coverage under a general permit and to require application for an individual permit may be appealed pursuant to the provisions of Section 204 (Appeals Process). (3-20-20)T

**28. Appeals of Variances.** (3-20-20)T

**a.** When the Department issues a permit on which EPA has made a variance decision, separate appeals of the Department permit and of the EPA variance decision are possible. If the owner or operator is challenging the same issues in both proceedings, the EPA Region 10 Administrator will decide, in consultation with the Department, which case will be heard first. (3-20-20)T

**b.** Variance decisions made by EPA may be appealed under the provisions of 40 CFR 124.19. (3-20-20)T

**c.** Stays for variances other than Clean Water Act section 301(g) variances are governed by Section 205 (Contested Permit Conditions) and 206 (Stays of Contested Permit Conditions). (3-20-20)T

**205. CONTESTED PERMIT CONDITIONS.**

**01. Force and Effect of Conditions.** As provided in Subsection 206.01, if an appeal of a permit decision is filed under Section 204 (Appeals Process), the force and effect of the contested conditions of the permit shall be stayed until final Department action. The Department must notify the discharger and all interested parties of the uncontested conditions of the permit that are enforceable obligations of the discharger in accordance with Subsection 206.01.c. (3-20-20)T

**02. Control Technologies.** When effluent limitations are contested, but the underlying control technology is not, the notice must identify the installation of the technology in accordance with the permit compliance schedules as an uncontested, enforceable obligation of the permit. (3-20-20)T

**03. Combination of Technologies.** When a combination of technologies is contested, but a portion of the combination is not contested, that portion must be identified as uncontested if compatible with the combination of technologies proposed by the requester. (3-20-20)T

**04. Inseverable Conditions.** Uncontested conditions, if inseverable from a contested condition, must be considered contested. (3-20-20)T

**05. Enforceable Dates.** Uncontested conditions shall become enforceable thirty (30) days after the date of notice under Subsection 205.01. (3-20-20)T

**06. Uncontested Conditions.** Uncontested conditions shall include: (3-20-20)T

**a.** Preliminary design and engineering studies or other requirements necessary to achieve the final permit conditions which do not entail substantial expenditures; and (3-20-20)T

**b.** Permit conditions which will have to be met regardless of the outcome of the appeal under Section 204 (Appeals Procedure). (3-20-20)T

**206. STAYS OF CONTESTED PERMIT CONDITIONS.**

**01. Stays.** (3-20-20)T

**a.** If a Petition for Review of an IPDES permit under Section 204 (Appeals Process) is filed, the effect of the contested permit conditions shall be stayed and will not be subject to judicial review pending final Department action. Uncontested permit conditions shall be stayed only until the date specified in Subsection 206.01.b. If the permit involves a new facility or new injection well, new source, new discharger or a recommencing discharger, the applicant will not be issued a permit for the proposed new facility, injection well, source or discharger pending final Department action. (3-20-20)T

**b.** Uncontested conditions which are not severable from those contested shall be stayed together with the contested conditions. The Department must identify the stayed provisions of permits for existing facilities, injection wells, and sources. All other provisions of the permit for the existing facility, injection well, or source become fully effective and enforceable thirty (30) days after the date of the notification required in Subsection 206.01.c. (3-20-20)T

**c.** As soon as possible after receiving notification from the Hearing Coordinator of the filing of a Petition for Review, the Department must notify the Hearing Authority, the applicant, and all other parties of the uncontested (and severable) conditions of the final permit that will become fully effective enforceable obligations of the permit as of the date specified in Subsection 206.01.b., and the notice must comply with the requirements of Section 205 (Contested Permit Conditions). (3-20-20)T

**02. Stays Based on Cross Effects.** (3-20-20)T

**a.** The Department may grant a stay based on the grounds that an appeal to the Hearing Authority under Section 204 (Appeals Process) of one permit may result in changes to another Department-issued IPDES permit only when each of the permits involved has been appealed to the Department. (3-20-20)T

**b.** No stay of an EPA-issued NPDES permit shall be granted based on the staying of any Department-issued IPDES permit except at the discretion of the EPA Region 10 Administrator and only upon written request from the Department. (3-20-20)T

**03. Permittee Responsibilities.** Any facility or activity holding an existing permit must: (3-20-20)T

**a.** Comply with the conditions of that permit during any modification or revocation and reissuance proceeding under Section 201 (Modification, or Revocation and Reissuance of IPDES Permits); and (3-20-20)T

**b.** To the extent conditions of any new permit are stayed under this section, comply with the conditions of the existing permit which correspond to the stayed conditions, unless compliance with the existing conditions would be technologically incompatible with compliance with other conditions of the new permit which have not been stayed. (3-20-20)T

**207. -- 299. (RESERVED)**

**300. CONDITIONS APPLICABLE TO ALL PERMITS.**

The following conditions apply to all IPDES permits. Additional conditions applicable to IPDES permits are in Sections 301 (Permit Conditions for Specific Categories), 302 (Establishing Permit Provisions), and 40 CFR 122.42(e). All conditions applicable to IPDES permits shall be incorporated into the permits either expressly or by reference. If incorporated by reference, a specific citation must be given in the permit. (3-20-20)T

**01. Duty to Comply.** The permittee must comply with all conditions of the permit. (3-20-20)T

**a.** Any permit noncompliance constitutes a violation of Idaho law, the Clean Water Act, and is grounds for: (3-20-20)T

- i. Enforcement action; (3-20-20)T
- ii. Permit termination, revocation and reissuance, or modification; or (3-20-20)T
- iii. Denial of a permit renewal application. (3-20-20)T

**b.** The permittee shall comply with effluent standards or prohibitions established under the Clean Water Act section 307(a) for toxic pollutants and with standards for sewage sludge use or disposal established under the Clean Water Act section 405(d), Section 380 (Sewage Sludge) of these rules, and IDAPA 58.01.16.650, “Wastewater Rules,” within the time provided in the regulations that establish these standards or prohibitions or standards for sewage sludge use or disposal, even if the permit has not yet been modified to incorporate the requirement. (3-20-20)T

**02. Duty to Reapply.** If the permittee wishes to continue an activity regulated by the permit after the expiration date of the permit, the permittee must apply for and obtain a new permit. If the permittee complies with the application requirements of Section 105 (Application for an Individual IPDES Permit), or the notice of intent requirements of Section 130 (General Permits) for a general permit, and a permit is not issued prior to the permit’s expiration date, the permit shall remain in force as stipulated in Subsections 101.02 and 101.03. (3-20-20)T

**03. Need to Halt or Reduce Activity.** In an enforcement action, a permittee may not assert as a defense that compliance with the conditions of the permit would have made it necessary for the permittee to halt or reduce the permitted activity. (3-20-20)T

**04. Duty to Mitigate.** The permittee shall take all reasonable steps to minimize or prevent any discharge or sludge use or disposal in violation of the permit which has a reasonable likelihood of adversely affecting human health or the environment. (3-20-20)T

**05. Proper Operation and Maintenance.** The permittee shall at all times properly operate and maintain all facilities and systems of treatment and control (and related appurtenances) which are installed or used by the permittee to achieve compliance with the conditions of the permit. (3-20-20)T

**a.** Proper operation and maintenance also includes adequate laboratory controls and appropriate quality assurance procedures. (3-20-20)T

**b.** This provision requires the operation of back-up or auxiliary facilities or similar systems which are installed by a permittee only when the operation is necessary to achieve compliance with the conditions of the permit or are required by IDAPA 58.01.16 “Wastewater Rules.” (3-20-20)T

**06. Permit Actions.** The permit may be modified, revoked and reissued, or terminated for cause. The filing of a request by the permittee for a permit modification, revocation and reissuance, or termination, or a notification of planned changes or anticipated noncompliance does not stay any permit condition. (3-20-20)T

**07. Property Rights.** The permit does not convey any property rights of any sort, or any exclusive privilege. (3-20-20)T

**08. Duty to Provide Information.** The permittee shall furnish to the Department, within a reasonable time, any information which the Department may request to determine whether cause exists for modifying, revoking and reissuing, or terminating the permit or to determine compliance with the permit. The permittee shall also furnish to the Department upon request, copies of records required to be kept by the permit. (3-20-20)T

**09. Inspection and Entry.** The permittee shall provide the Department’s inspectors, or authorized representatives, including authorized contractors acting as representatives of the Department, upon presentation of credentials and other documents as may be required by law, access to: (3-20-20)T

**a.** Enter upon the permittee's premises where a regulated facility or activity is located or conducted, or where records must be kept under the conditions of the permit; (3-20-20)T



**b.** Any records that must be kept under the conditions of the permit and, at reasonable times, to copy such records; (3-20-20)T

**c.** Inspect, at reasonable times, any facilities, equipment (including monitoring and control equipment), practices, or operations regulated or required under the permit; and (3-20-20)T

**d.** Sample or monitor at reasonable times, for the purposes of assuring permit compliance or as otherwise authorized by the Clean Water Act, any substances or parameters at any location. (3-20-20)T

**10. Monitoring and Records.** A permittee must comply with the following monitoring and recordkeeping conditions: (3-20-20)T

**a.** Samples and measurements taken for the purpose of monitoring shall be representative of the monitored activity. (3-20-20)T

**b.** The permittee shall retain the following records: (3-20-20)T

**i.** All monitoring information, for a period of at least three (3) years from the date of the sample, measurement, report or application. This period may be extended by request of the Department at any time; and (3-20-20)T

**ii.** The permittee's sewage sludge use and disposal activities shall be retained for a period of at least five (5) years or longer as required by 40 CFR Part 503. (3-20-20)T

**c.** Records of monitoring information shall include: (3-20-20)T

**i.** All calibration and maintenance records; (3-20-20)T

**ii.** All original strip chart recordings for continuous monitoring instrumentation or other forms of data approved by the Department; (3-20-20)T

**iii.** Copies of all reports required by the permit; (3-20-20)T

**iv.** Records of all data used to complete the application or notice of intent for the permit; (3-20-20)T

**v.** The date, exact place, and time of sampling or measurements; (3-20-20)T

**vi.** The name of any individual(s) who performed the sampling or measurements; (3-20-20)T

**vii.** The date(s) any analyses were performed; (3-20-20)T

**viii.** The name of any individual(s) who performed the analyses; (3-20-20)T

**ix.** The analytical techniques or methods used; and (3-20-20)T

**x.** The results of the analysis. (3-20-20)T

**d.** Monitoring must be conducted according to test procedures approved under 40 CFR Part 136 unless another test method is required by 40 CFR Part 401 through 471 or Part 501 through 503. (3-20-20)T

**11. Signatory Requirements.** All applications, reports, or information submitted to the Department shall be signed and certified in accordance with Section 090 (Signature Requirements) and must include penalty provisions pursuant to Section 500 (Enforcement). (3-20-20)T

**12. Reporting Requirements.** (3-20-20)T

**a.** The permittee shall give notice to the Department as soon as possible of any planned physical

alterations or additions to the permitted facility. Notice is required only when: (3-20-20)T

i. The alteration or addition to a permitted facility may meet one (1) of the criteria for determining whether a facility is a new source as defined in Section 120 (New Sources and New Discharges) and 010 (Definitions); (3-20-20)T

ii. The alteration or addition could significantly change the nature or increase the quantity of pollutants discharged. This notification applies to pollutants which are subject neither to effluent limitations in the permit, nor to notification requirements under Subsection 301.01.a.; or (3-20-20)T

iii. The alteration or addition results in a significant change in the permittee's sludge use or disposal practices, and such alteration, addition, or change may justify the application of permit conditions that are different from or absent in the existing permit, including notification of additional use or disposal sites: (3-20-20)T

(1) Not reported during the permit application process, or (3-20-20)T

(2) Not reported pursuant to an approved land application or sludge disposal plan. (3-20-20)T

b. The permittee shall give advance notice to the Department of any planned changes in the permitted facility or activity which may result in noncompliance with permit requirements. (3-20-20)T

c. The permit is not transferable to any person except after notice to the Department. The Department may require modification or revocation and reissuance of the permit to change the name of the permittee and incorporate such other requirements as may be necessary under Section 202 (Transfer of IPDES Permits). (3-20-20)T

d. Monitoring results shall be reported at the intervals specified in the permit. (3-20-20)T

i. Monitoring results must be reported on a Discharge Monitoring Report (DMR) or forms (which may be electronic) provided or specified by the Department for reporting results of monitoring of sludge use or disposal practices. All reports and forms submitted in compliance with this section must be submitted electronically by the permittee to the Department in compliance with this section and 40 CFR Part 127 unless waived pursuant to 40 CFR 127.15. 40 CFR Part 127 is not intended to undo existing requirements for electronic reporting. Prior to this date, and independent of 40 CFR Part 127, permittees may be required to report electronically if specified by a particular permit. (3-20-20)T

ii. If the permittee monitors any pollutant more frequently than required by the permit using test procedures approved under 40 CFR Part 136, or another method required for an industry-specific waste stream specified in the permit or under 40 CFR Part 401 through 471 or Part 501 through Part 503, the results of such monitoring shall be included in the calculation and reporting of the data submitted in the DMR or sludge reporting form specified by the Department. (3-20-20)T

iii. Calculations for all limitations which require averaging of measurements shall utilize an arithmetic mean unless otherwise specified by the Department in the permit. (3-20-20)T

e. A permittee must submit reports of compliance or noncompliance with, or any progress reports on, interim and final requirements contained in any compliance schedule of the permit no later than fourteen (14) days following each schedule date of each requirement. As of December 21, 2020, all reports related to combined sewer overflows, sanitary sewer overflows, or bypass events submitted in compliance with this section must be submitted electronically by the permittee to the Department in compliance with this section and 40 CFR Part 127 unless waived pursuant to 40 CFR 127.15. 40 CFR Part 127 is not intended to undo existing requirements for electronic reporting. Prior to this date, and independent of 40 CFR Part 127, permittees may be required to electronically submit reports related to combined sewer overflows, sanitary sewer overflows, or bypass events under this section by a particular permit. The Director may also require permittees to electronically submit reports not related to combined sewer overflows, sanitary sewer overflows, or bypass events under this section. (3-20-20)T

f. The permittee shall report to the Department any noncompliance which may endanger health or the environment as follows: (3-20-20)T

i. Any information shall be provided orally within twenty-four (24) hours from the time the permittee becomes aware of the circumstances; (3-20-20)T

ii. A written submission shall also be provided within five (5) days of the time the permittee becomes aware of the circumstances. The written submission shall contain a description of: (3-20-20)T

(1) The noncompliance and its cause; (3-20-20)T

(2) The period of noncompliance, including exact dates and times; (3-20-20)T

(3) If the noncompliance has not been corrected, the anticipated time it is expected to continue; and (3-20-20)T

(4) Steps taken or planned to reduce, eliminate, and prevent reoccurrence of the noncompliance; (3-20-20)T

(5) As of December 21, 2020, all reports related to combined sewer overflows, sanitary sewer overflows, or bypass events submitted in compliance with this section must be submitted electronically by the permittee to the Department in compliance with this section and 40 CFR Part 127 unless waived pursuant to 40 CFR 127.15. 40 CFR Part 127 is not intended to undo existing requirements for electronic reporting. Prior to this date, and independent of 40 CFR Part 127, permittees may be required to electronically submit reports related to combined sewer overflows, sanitary sewer overflows, or bypass events under this section by a particular permit. The Director may also require permittees to electronically submit reports not related to combined sewer overflows, sanitary sewer overflows, or bypass events under this section. (3-20-20)T

iii. The following shall be included as information which must be reported within twenty-four (24) hours: (3-20-20)T

(1) Any unanticipated bypass which exceeds any effluent limitation in the permit (see Subsection 300.07, Property Rights); (3-20-20)T

(2) Any upset which exceeds any effluent limitation in the permit; and (3-20-20)T

(3) Violation of a maximum daily discharge limitation for any of the pollutants listed by the Department in the permit to be reported within twenty-four (24) hours (see Subsection 302.09, Twenty-Four Hour Reporting); and (3-20-20)T

iv. The Department may waive the written report on a case-by-case basis for reports under Subsection 300.12.f.iii. if the oral report has been received within twenty-four (24) hours. (3-20-20)T

g. The permittee shall report all instances of noncompliance not reported under Subsections 300.12.d., e., and f., at the time monitoring reports are submitted. The reports of noncompliance shall contain the information listed in Subsection 300.12.f. As of December 21, 2020, all reports related to combined sewer overflows, sanitary sewer overflows, or bypass events submitted in compliance with this section must be submitted electronically by the permittee to the Department in compliance with this section and 40 CFR Part 127 unless waived pursuant to 40 CFR 127.15. 40 CFR Part 127 is not intended to undo existing requirements for electronic reporting. Prior to this date, and independent of 40 CFR Part 127, permittees may be required to electronically submit reports related to combined sewer overflows, sanitary sewer overflows, or bypass events under this section by a particular permit. The Director may also require permittees to electronically submit reports not related to combined sewer overflows, sanitary sewer overflows, or bypass events under this section. (3-20-20)T

h. Where the permittee becomes aware that it failed to submit any relevant facts in a permit application, or submitted incorrect information in a permit application or in any report to the Department, it shall promptly submit such facts or correct information. (3-20-20)T

**13. Bypass Terms and Conditions.** (3-20-20)T

**a.** Bypass, as defined in Section 010 (Definitions), is prohibited, and the Department may take enforcement action against a permittee for bypass, unless: (3-20-20)T

i. The bypass was unavoidable to prevent loss of life, personal injury, or severe property damage; (3-20-20)T

ii. There were no feasible alternatives to the bypass, such as the use of auxiliary treatment facilities, retention of untreated wastes, or maintenance during normal periods of equipment downtime. This condition is not satisfied if adequate back-up equipment should have been installed in the exercise of reasonable engineering judgment to prevent a bypass which occurred during normal periods of equipment downtime or preventive maintenance; and (3-20-20)T

iii. The permittee submitted a notice of a bypass to the Department in accordance with Subsections 300.13.c. and d. As of December 21, 2020, all notices submitted in compliance with this section must be submitted electronically by the permittee to the Department in compliance with this section and 40 CFR Part 127 unless waived pursuant to 40 CFR 127.15. 40 CFR Part 127 is not intended to undo existing requirements for electronic reporting. Prior to this date, and independent of CFR Part 127, permittees may be required to report electronically if specified by a particular permit. (3-20-20)T

**b.** The Department may approve an anticipated bypass, after considering its adverse effects, if the Department determines that it will meet the three (3) conditions listed in Subsection 300.13.a. (3-20-20)T

**c.** If the permittee knows in advance of the need for a bypass, it shall submit prior notice to the Department, if possible at least ten (10) days before the date of the bypass. (3-20-20)T

**d.** The permittee shall submit notice of an unanticipated bypass as required in Subsection 300.12.f. (24-hour notice). (3-20-20)T

**e.** Bypasses not exceeding limitations, are allowed to occur, and are not subject to Subsection 300.13.a. or 300.13.d. if: (3-20-20)T

i. The bypass does not cause effluent limitations to be exceeded, and (3-20-20)T

ii. Only if it also is for essential maintenance to assure efficient operation. (3-20-20)T

**14. Upset Terms and Conditions.** (3-20-20)T

**a.** In any enforcement action for noncompliance with technology-based permit effluent limitations, a permittee may claim upset, as defined in Section 010 (Definitions), as an affirmative defense. A permittee seeking to establish the occurrence of an upset has the burden of proof. (3-20-20)T

**b.** Any determination made in administrative review of a claim that noncompliance was caused by upset, before an action for noncompliance is commenced, is not final administrative action subject to judicial review. (3-20-20)T

**c.** The following conditions are necessary for a permittee to demonstrate that an upset occurred. A permittee who wishes to establish the affirmative defense of upset shall demonstrate, through properly signed, contemporaneous operating logs, or other relevant evidence that: (3-20-20)T

i. An upset occurred and that the permittee can identify the cause(s) of the upset; (3-20-20)T

ii. The permitted facility was at the time being properly operated; (3-20-20)T

iii. The permittee submitted twenty-four (24)-hour notice of the upset as required Subsection 300.12.f.iii.(2); and (3-20-20)T

- iv. The permittee complied with any remedial measures required under Subsection 300.04. (3-20-20)T

**15. Penalties and Fines.** Permits must include penalty and fine requirements pursuant to Section 500 (Enforcement). (3-20-20)T

**301. PERMIT CONDITIONS FOR SPECIFIC CATEGORIES.**

In addition to conditions set forth in Section 300 (Conditions Applicable to all Permits), conditions identified in this section apply to all IPDES permits within the categories specified below. (3-20-20)T

**01. Existing Manufacturing, Commercial, Mining, and Silvicultural Dischargers.** In addition to the reporting requirements under Subsection 300.12, all existing manufacturing, commercial, mining, and silvicultural dischargers must notify the Department as soon as they know or have reason to believe: (3-20-20)T

**a.** That any activity has occurred or will occur which would result in the discharge, on a routine or frequent basis, of any toxic pollutant which is not limited in the permit if that discharge will exceed the highest of the following notification levels: (3-20-20)T

- i. One hundred micrograms per liter (100 µg/L); (3-20-20)T
- ii. Two hundred micrograms per liter (200 µg/L) for acrolein and acrylonitrile; (3-20-20)T
- iii. Five hundred micrograms per liter (500 µg/L) for 2,4-dinitrophenol and for 2-methyl-4,6-dinitrophenol; and (3-20-20)T
- iv. One milligram per liter (1 mg/L) for antimony; (3-20-20)T
- v. Five (5) times the maximum concentration value reported for that pollutant in the permit application in accordance with Subsection 105.07; or (3-20-20)T
- vi. The level established by the Department in accordance with Subsection 302.08; and (3-20-20)T

**b.** That any activity has occurred or will occur which would result in any discharge, on a non-routine or infrequent basis, of a toxic pollutant which is not limited in the permit if that discharge will exceed the highest of the following notification levels: (3-20-20)T

- i. Five hundred micrograms per liter (500 µg/L); (3-20-20)T
- ii. One milligram per liter (1 mg/L) for antimony; (3-20-20)T
- iii. Ten (10) times the maximum concentration value reported for that pollutant in the permit application in accordance with Subsection 105.07; or (3-20-20)T
- iv. The level established by the Department in accordance with Subsection 302.08. (3-20-20)T

**02. Publicly Owned Treatment Works.** All POTWs must provide adequate notice to the Department of the following: (3-20-20)T

**a.** Any new introduction of pollutants into the POTW from an indirect discharger which would be subject to the Clean Water Act section 301 or 306 if it were directly discharging those pollutants; and (3-20-20)T

**b.** Any substantial change in the volume or character of pollutants being introduced into that POTW by a source introducing pollutants into the POTW at the time of issuance of the permit. For purposes of this subsection, adequate notice shall include information on: (3-20-20)T

- i. The quality and quantity of effluent introduced into the POTW, and (3-20-20)T
- ii. Any anticipated impact of the change on the quantity or quality of effluent to be discharged from

the POTW. (3-20-20)T

**03. Municipal Separate Storm Sewer Systems.** The operator of a large or medium municipal separate storm sewer system or a municipal separate storm sewer that has been designated by the Department under 40 CFR 122.26(a)(1)(v) must submit an annual report by the anniversary of the date of the issuance of the permit for such system. As of December 21, 2020, all reports submitted in compliance with this section must be submitted electronically by the owner, operator, or the duly authorized representative of the MS4 to the Department in compliance with this section and 40 CFR Part 127 unless waived pursuant to 40 CFR 127.15. 40 CFR Part 127 is not intended to undo existing requirements for electronic reporting. Prior to this date, and independent of 40 CFR Part 127, the owner, operator, or the duly authorized representative of the MS4 may be required to report electronically if specified by a particular permit. The report shall include: (3-20-20)T

**a.** The status of implementing the components of the storm water management program that are established as permit conditions; (3-20-20)T

**b.** Proposed changes to the storm water management programs that are established as permit conditions. Such proposed changes shall be consistent with Subsection 105.18.b.iii.; (3-20-20)T

**c.** Revisions, if necessary, to the assessment of controls and the fiscal analysis reported in the permit application under Subsection 105.18.b.iv. and 105.18.b.v.; (3-20-20)T

**d.** A summary of data, including monitoring data, that is accumulated throughout the reporting year; (3-20-20)T

**e.** Annual expenditures and budget for the year following each annual report; (3-20-20)T

**f.** A summary describing the number and nature of enforcement actions, inspections, and public education programs; and (3-20-20)T

**g.** Identification of water quality improvements or degradation. (3-20-20)T

**04. Storm Water Dischargers.** The initial permits for discharges composed entirely of storm water issued pursuant to 40 CFR 122.26(e)(7) shall require compliance with the conditions of the permit as expeditiously as practicable but in no event later than three (3) years after the date of issuance of the permit. (3-20-20)T

**05. Concentrated Animal Feeding Operations (CAFOs).** Any applicable permit must include provisions pursuant to 40 CFR 122.42(e). (3-20-20)T

### **302. ESTABLISHING PERMIT PROVISIONS.**

The Department shall establish conditions, as required on a case-by-case basis, to provide for and ensure compliance with all applicable requirements of the Clean Water Act and state rules. These shall include conditions under Section 101 (duration of permits), Section 305 (compliance schedules), Section 304 (monitoring), and electronic reporting requirements identified under 40 CFR Part 127. An IPDES permit must include conditions meeting the following requirements, when applicable, in addition to other applicable sections of these rules. (3-20-20)T

**01. Incorporation.** All permit conditions shall be incorporated either expressly or by reference. If incorporated by reference, a specific citation to the applicable regulations or requirements must be given in the permit. (3-20-20)T

**02. Applicable Requirements.** The Department shall establish conditions, as required on a case-by-case basis, to provide for and assure compliance with all applicable requirements of the Clean Water Act and Section 101 (Duration), and Subsections 304.01, and 305.01 of these rules. (3-20-20)T

**a.** Applicable requirements include all statutory or regulatory requirements which take effect prior to final administrative disposition of the permit. (3-20-20)T

**b.** Applicable requirements also include any requirement which takes effect prior to the modification

or revocation and reissuance of a permit under Section 201 (Modification, or Revocation and Reissuance of IPDES Permits). (3-20-20)T

**c.** New or reissued permits, and to the extent allowed under Section 201 (Modification, or Revocation and Reissuance of IPDES Permits) for modified or revoked and reissued permits, shall incorporate each of the applicable requirements referenced in Sections 200 (Renewal of IPDES Permits), and 302 (Establishing Permit Provisions) through 304 (Monitoring and Reporting Requirements). (3-20-20)T

**03. Technology-Based Effluent Limitations and Standards.** (3-20-20)T

**a.** Technology-based effluent limitations and standards shall be based on: (3-20-20)T

i. Effluent limitations and standards promulgated under the Clean Water Act section 301; (3-20-20)T

ii. New source performance standards promulgated under the Clean Water Act section 306; (3-20-20)T

iii. Effluent limitations determined on a case-by-case basis under the Clean Water Act section 402(a)(1); or (3-20-20)T

iv. A combination of the three (3), in accordance with 40 CFR 125.3. (3-20-20)T

**b.** For new sources or new dischargers, these technology based limitations and standards are subject to the provisions of 40 CFR 122.29(d). (3-20-20)T

**c.** The Department may authorize a discharger, subject to technology-based effluent limitations guidelines and standards in an IPDES permit, to forgo sampling of a pollutant found at 40 CFR Parts 401 through 471, if the discharger has demonstrated through sampling and other technical factors that the pollutant is not present in the discharge or is present only at background levels from intake water and without any increase in the pollutant due to activities of the discharger. (3-20-20)T

i. This waiver is good only for the term of the permit and is not available during the term of the first NPDES or IPDES permit issued to a discharger. (3-20-20)T

ii. Any request for this waiver must be submitted when applying for a reissued permit or modification of a reissued permit. The request must demonstrate through sampling or other technical information, including information generated during an earlier permit term that the pollutant is not present in the discharge or is present only at background levels from intake water and without any increase in the pollutant due to activities of the discharger. (3-20-20)T

iii. Any grant of the monitoring waiver must be included in the permit as an express permit condition and the reasons supporting the grant must be documented in the permit's fact sheet. (3-20-20)T

iv. This provision does not supersede certification processes and requirements already established in existing effluent limitations guidelines and standards. (3-20-20)T

**04. Other Effluent Limitations and Standards.** (3-20-20)T

**a.** If any applicable toxic effluent limitations and standards under the Clean Water Act sections 301, 302, 303, 307, 318, and 405 or prohibition (including any schedule of compliance specified in such effluent standard or prohibition) is promulgated under the Clean Water Act section 307(a) for a toxic pollutant and that standard or prohibition is more stringent than any limitation on the pollutant in the permit, the Department shall initiate proceedings under Section 201 (Modification, or Revocation and Reissuance of IPDES Permits) to modify or revoke and reissue the permit to conform to the more stringent toxic effluent standard or prohibition (see also Subsection 300.01). (3-20-20)T

**b.** Standards for sewage sludge use or disposal under the Clean Water Act section 405(d), Section 380

(Sewage Sludge) of these rules, and IDAPA 58.01.16.650, “Wastewater Rules,” shall be applied, unless those standards have been included in a permit issued under the appropriate provisions of: (3-20-20)T

- i. Subtitle C of the Solid Waste Disposal Act; (3-20-20)T
- ii. Part C of Safe Drinking Water Act; (3-20-20)T
- iii. The Clean Air Act; or (3-20-20)T
- iv. State permit programs approved by the EPA. (3-20-20)T

**c.** When there are no applicable standards for sewage sludge use or disposal, the permit may include requirements developed on a case-by-case basis to protect public health and the environment from any adverse effects which may occur from toxic pollutants in sewage sludge. (3-20-20)T

**d.** If any applicable standard for sewage sludge use or disposal is promulgated under the Clean Water Act section 405(d), Section 380 (Sewage Sludge) of these rules, and IDAPA 58.01.16.650, “Wastewater Rules,” that standard is more stringent than any limitation on the pollutant or practice in the permit, the Department may initiate proceedings under these regulations to modify or revoke and reissue the permit, in compliance with Section 201 (Modification, or Revocation and Reissuance of IPDES Permits), to conform to the standard for sewage sludge use or disposal. (3-20-20)T

**e.** Include any requirements applicable to cooling water intake structures under the Clean Water Act section 316(b), in accordance with 40 CFR 125.80 through 125.99. (3-20-20)T

**05. Reopener Clause.** For any permit issued to a TWTDS (including sludge-only facilities), the Department shall include a reopener clause to incorporate any applicable standard for sewage sludge use or disposal promulgated under the Clean Water Act section 405(d). The Department may promptly modify or revoke and reissue any permit containing the reopener clause required by this subsection if the standard for sewage sludge use or disposal: (3-20-20)T

- a.** Is more stringent than any requirements for sludge use or disposal in the permit, or (3-20-20)T
- b.** Controls a pollutant or practice not limited in the permit. (3-20-20)T

**06. Water Quality Standards and Requirements.** Any requirements in addition to or more stringent than promulgated effluent limitations guidelines or standards under the Clean Water Act sections 301, 304, 306, 307, 318 and 405 shall be included in a permit if they are necessary to: (3-20-20)T

**a.** Achieve water quality standards established in IDAPA 58.01.02, “Water Quality Standards,” including narrative criteria for water quality and antidegradation provisions. (3-20-20)T

**i.** Effluent limitations in a permit must control all pollutants or pollutant parameters (either conventional, nonconventional, or toxic pollutants) which the Department determines are or may be discharged at a level which will cause, have the reasonable potential to cause, or contribute to an excursion above any water quality standard, including narrative criteria for water quality. (3-20-20)T

**ii.** When the Department determines whether a discharge causes, has the reasonable potential to cause, or contributes to an in-stream excursion above a narrative or numeric criteria within a water quality standard, the Department shall use procedures which account for: (3-20-20)T

- (1) Existing controls on point and nonpoint sources of pollution; (3-20-20)T
- (2) The variability of the pollutant or pollutant parameter in the effluent; (3-20-20)T
- (3) The sensitivity of the species to toxicity testing (when evaluating whole effluent toxicity); and where appropriate, (3-20-20)T



- (4) The dilution of the effluent in the receiving water; (3-20-20)T
- iii. When the Department determines, using the procedures in Subsection 302.06.a.ii., that a discharge causes, has the reasonable potential to cause, or contributes to an in-stream excursion above the allowable ambient concentration of a state numeric criteria within a state water quality standard for an individual pollutant, the permit must contain effluent limits for that pollutant. (3-20-20)T
- iv. When the Department determines, using the procedures in Subsection 302.06.a.ii., that a discharge causes, has the reasonable potential to cause, or contributes to an in-stream excursion above the numeric criterion for whole effluent toxicity, the permit must contain effluent limits for whole effluent toxicity. (3-20-20)T
- v. Except as provided in this subsection, when the Department determines, using the procedures in Subsection 302.06.a.ii., toxicity testing data, or other information, that a discharge causes, has the reasonable potential to cause, or contributes to an in-stream excursion above a narrative criterion within an applicable water quality standard, the permit must contain effluent limits for whole effluent toxicity. Limits on whole effluent toxicity are not necessary where the Department demonstrates in the fact sheet of the IPDES permit, using the procedures in Subsection 302.06.a.ii., that chemical-specific limits for the effluent are sufficient to attain and maintain applicable numeric and narrative state water quality standards. (3-20-20)T
- vi. When the state has not established a numeric water quality criterion for a specific chemical pollutant that is present in an effluent at a concentration that causes, has the reasonable potential to cause, or contributes to an excursion above a narrative criterion within an applicable state water quality standard, the Department must establish effluent limits using one (1) or more of the following options: (3-20-20)T
- (1) Establish effluent limits using a calculated numeric water quality target or concentration value for the pollutant which the Department demonstrates will attain and maintain applicable narrative water quality criteria and will fully protect the designated use. Such a target or concentration value may be derived: (3-20-20)T
- (a) Using a proposed criterion, or an explicit policy or regulation interpreting its narrative water quality criterion, and (3-20-20)T
- (b) Supplemented with other relevant information which may include EPA's Water Quality Standards Handbook, as currently revised, risk assessment data, exposure data, information about the pollutant from the Food and Drug Administration (FDA), and current EPA criteria documents; (3-20-20)T
- (2) Establish effluent limits on a case-by-case basis, using EPA's water quality criteria, published under the Clean Water Act section 304(a), supplemented where necessary by other relevant information; or (3-20-20)T
- (3) Establish effluent limitations on an indicator parameter for the pollutant of concern, provided: (3-20-20)T
- (a) The permit identifies which pollutants are intended to be controlled by the use of the effluent limitation; (3-20-20)T
- (b) The required fact sheet sets forth the basis for the limit, including a finding that compliance with the effluent limit on the indicator parameter will result in controls on the pollutant of concern which are sufficient to attain and maintain applicable water quality standards; (3-20-20)T
- (c) The permit requires all effluent and ambient monitoring necessary to show that during the term of the permit the limit on the indicator parameter continues to attain and maintain applicable water quality standards; and (3-20-20)T
- (d) The permit contains a reopener clause allowing the Department to modify or revoke and reissue the permit if the limits on the indicator parameter no longer attain and maintain applicable water quality standards. (3-20-20)T
- vii. When developing water quality-based effluent limits under this subsection, the Department shall

ensure that: (3-20-20)T

(1) The level of water quality to be achieved by limits on point sources established under this subsection is derived from, and complies with all applicable water quality standards; and (3-20-20)T

(2) Effluent limits developed to protect a narrative water quality criterion, a numeric water quality criterion, or both, are consistent with the assumptions and requirements of any available wasteload allocation for the discharge prepared by the state and approved by EPA pursuant to 40 CFR 130.7; (3-20-20)T

**b.** Attain or maintain a specified water quality through water quality related effluent limits established under the Clean Water Act section 302; (3-20-20)T

**c.** Conform to applicable water quality requirements under the Clean Water Act section 402(b)(5) when the discharge affects a state other than Idaho; (3-20-20)T

**d.** Incorporate any more stringent limitations, treatment standards, or schedules of compliance requirements established under federal or state law or regulations in accordance with the Clean Water Act section 301(b)(1)(C); (3-20-20)T

**e.** Ensure consistency with the requirements of a Water Quality Management plan approved by EPA under the Clean Water Act section 208(b); or (3-20-20)T

**f.** Incorporate alternative effluent limitations or standards where warranted by fundamentally different factors, under 40 CFR 125.30 through 125.32. (3-20-20)T

**07. Technology-Based Controls for Toxic Pollutants.** (3-20-20)T

**a.** In determining whether to include limitations on toxic pollutants in a permit under this section, the Department will establish limits in accordance with Subsections 302.03, 302.04, and 302.06 and in a notification under Section 301 (Permit Conditions for Specific Categories), or other relevant information. The fact sheet must explain the development of limitations included in the permit. (3-20-20)T

**b.** An IPDES permit must include limitations to control all toxic pollutants which the Department determines (based on information reported in a permit application under Subsection 105.07 and 301.01.a., or on other information) are or may be discharged at a level greater than the level which can be achieved by the technology-based treatment requirements appropriate to the permittee under 40 CFR 125.3(c). (3-20-20)T

**c.** The requirement that the limitations control the pollutants meeting the criteria of Subsection 302.07.b. will be satisfied by: (3-20-20)T

i. Limitations on those toxic pollutants; or (3-20-20)T

ii. Limitations on other pollutants which, in the judgment of the Department, will provide treatment of the pollutants under Subsection 302.07.b. to the levels required by 40 CFR 125.3(c). (3-20-20)T

**08. Notification Level.** An IPDES permit must include a condition requiring a notification level which exceeds the notification level of Subsection 301.01.a., upon a petition from the permittee or on the Department's initiative. This new notification level may not exceed the level which can be achieved by the technology-based treatment requirements appropriate to the permittee under 40 CFR 125.3(c). (3-20-20)T

**09. Twenty-Four (24) Hour Reporting.** A permit shall list pollutants for which the permittee is required to report violations of maximum daily discharge limitations within twenty-four (24) hours under Subsection 300.12.f.iii.(3). This list shall include any toxic pollutant or hazardous substance, or any pollutant specifically identified as the method to control a toxic pollutant or hazardous substance. (3-20-20)T

**10. Permit Durations.** Permits must include permit durations pursuant to Subsection 101.01. (3-20-20)T

**11. Monitoring Requirements.** Permits must include monitoring requirements pursuant to Section 304 (Monitoring and Reporting Requirements). (3-20-20)T

**12. Pretreatment Program for POTWs.** A POTW permit must include pretreatment program conditions requiring the permittee to: (3-20-20)T

**a.** Identify, in terms of character and volume of pollutants, any Significant Industrial Users discharging into the POTW subject to Pretreatment Standards under the Clean Water Act section 307(b) and 40 CFR Part 403; (3-20-20)T

**b.** Submit a local program when required by and in accordance with 40 CFR Part 403, to ensure compliance with pretreatment standards to the extent applicable under the Clean Water Act section 307(b): (3-20-20)T

**i.** The local program shall be incorporated into the permit as described in 40 CFR Part 403, and (3-20-20)T

**ii.** The program must require all indirect dischargers to the POTW to comply with the reporting requirements of 40 CFR Part 403; (3-20-20)T

**c.** Provide written technical evaluation of the need to revise local limits under 40 CFR 403.5(c)(1), following permit issuance or reissuance; and (3-20-20)T

**d.** POTWs which are sludge-only facilities, are required to develop a pretreatment program under 40 CFR Part 403, when the Department determines that a pretreatment program is necessary to assure compliance with the Clean Water Act section 405(d). (3-20-20)T

**13. Best Management Practices.** An IPDES permit must include best management practices (BMPs) to control or abate the discharge of pollutants when: (3-20-20)T

**a.** Authorized under the Clean Water Act section 304(e) for the control of toxic pollutants and hazardous substances from ancillary industrial activities; (3-20-20)T

**b.** Authorized under the Clean Water Act section 402(p) for the control of storm water discharges; (3-20-20)T

**c.** Numeric effluent limitations are infeasible; or (3-20-20)T

**d.** The practices are reasonably necessary to achieve effluent limitations and standards or to carry out the purposes and intent of the Clean Water Act. (3-20-20)T

**14. Reissued Permits.** When a permit is renewed or reissued, it must include provisions pursuant to Section 200 (Renewal of IPDES Permits). (3-20-20)T

**15. Privately-Owned Treatment Works.** For a privately owned treatment works, any conditions expressly applicable to any user, as a limited co-permittee, that may be necessary in the permit issued to the treatment works to ensure compliance with applicable requirements under this section. (3-20-20)T

**a.** Alternatively, the Department may issue separate permits to the treatment works and to its users, or may require a separate permit application from any user. (3-20-20)T

**b.** The Department's decision to issue a permit with no conditions applicable to any user, to impose conditions on one (1) or more users, to issue separate permits, or to require separate applications, and the basis for that decision, shall be stated in the fact sheet for the draft permit for the treatment works. (3-20-20)T

**16. Grants.** An IPDES permit must include any conditions imposed in grants made by the EPA to

POTWs under the Clean Water Act sections 201 and 204, which are reasonably necessary for the achievement of effluent limitations under the Clean Water Act section 301. (3-20-20)T

**17. Sewage Sludge.** An IPDES permit must include any requirements under the Clean Water Act section 405 governing the disposal of sewage sludge from POTWs or any other TWTDS for any use for which regulations have been established, in accordance with any applicable regulations. (3-20-20)T

**18. Navigation.** An IPDES permit must include any conditions that the Secretary of the Army considers necessary to ensure that navigation and anchorage will not be substantially impaired, in accordance with Subsection 103.04 and 109.02. (3-20-20)T

**19. Qualifying State or Local Programs.** (3-20-20)T

**a.** For storm water discharges associated with small construction activity disturbing one (1) acre or more, but less than five (5) acres as specified in 40 CFR 122.26(b)(15), the Department may include permit conditions that incorporate by reference qualifying state or local erosion and sediment control program requirements. Where a qualifying state or local program does not include one (1) or more of the elements in this subsection, then the Department must include those elements as conditions in the permit. (3-20-20)T

**b.** A qualifying state or local erosion and sediment control program is one that includes: (3-20-20)T

**i.** Requirements for construction site operators to implement appropriate erosion and sediment control best management practices; (3-20-20)T

**ii.** Requirements for construction site operators to control waste such as discarded building materials, concrete truck washout, chemicals, litter, and sanitary waste at the construction site that may cause adverse impacts to water quality; (3-20-20)T

**iii.** Requirements for construction site operators to develop and implement a storm water pollution prevention plan, which must include: (3-20-20)T

(1) Site descriptions; (3-20-20)T

(2) Descriptions of appropriate control measures; (3-20-20)T

(3) Copies of approved state or local requirements; (3-20-20)T

(4) Maintenance procedures; (3-20-20)T

(5) Inspection procedures; (3-20-20)T

(6) Identification of non-storm water discharges; and (3-20-20)T

**iv.** Requirements to submit a site plan for review that incorporates consideration of potential water quality impacts. (3-20-20)T

**c.** For storm water discharges from a construction activity disturbing five (5) acres or more, including activities that disturb less than five (5) acres but are part of a larger common plan of development or sale that will ultimately disturb five (5) acres or more, as specified in 40 CFR 122.26(b)(14)(x), the Department may include permit conditions that incorporate by reference qualifying state or local erosion and sediment control program requirements. A qualifying state or local erosion and sediment control program is one that includes the elements listed in Subsections 302.19.a. and b. and any additional requirements necessary to achieve the applicable technology-based standards of best available technology and best conventional technology based on the best professional judgment of the permit writer. (3-20-20)T

**20. Water Quality Trading.** The Department may include provisions in IPDES permits that allow for compliance with water quality based permit limits to be achieved through water quality trading. (3-20-20)T

**303. CALCULATING PERMIT PROVISIONS.**

**01. Outfalls and Discharge Points.** All permit effluent limitations, standards and prohibitions shall be established for each outfall or discharge point of the permitted facility, except as otherwise provided under Subsection 302.13, (Best Management Practices,) and Subsection 303.08, (Internal Waste Streams.) (3-20-20)T

**02. Production-Based Limitations.** (3-20-20)T

**a.** In the case of POTWs, permit effluent limitations, standards, or prohibitions shall be calculated based on design flow. (3-20-20)T

**b.** Except in the case of POTWs or as provided in Subsection 303.02.b.ii., calculation of any permit limitations, standards, or prohibitions which are based on production (or other measure of operation) shall be based upon a reasonable measure of actual production of the facility. (3-20-20)T

**i.** For new sources or new dischargers, actual production shall be estimated using projected production. The time period of the measure of production shall correspond to the time period of the calculated permit limitations; for example, monthly production shall be used to calculate average monthly discharge limitations. (3-20-20)T

**ii.** The Department may include a condition establishing alternate permit limitations, standards, or prohibitions based upon anticipated increased (not to exceed maximum production capability) or decreased production levels. (3-20-20)T

**iii.** For the automotive manufacturing industry only, the Department shall establish an alternate condition under 303.02.b.ii., if the applicant satisfactorily demonstrates to the Department, at the time the application is submitted, that: (3-20-20)T

(1) Its actual production, as indicated in Subsections 303.02.b. and 303.02.b.i. is substantially below maximum production capability, and (3-20-20)T

(2) There is a reasonable potential for an increase above actual production during the duration of the permit. (3-20-20)T

**iv.** If the Department establishes permit conditions under Subsection 303.02.b.ii.: (3-20-20)T

(1) The permit shall require the permittee to notify the Department at least two (2) business days prior to a month in which the permittee expects to operate at a level higher than the lowest production level identified in the permit. The notice shall specify: (3-20-20)T

(a) The anticipated level, and the period during which the permittee expects to operate at the alternate level; and (3-20-20)T

(b) If the notice covers more than one (1) month, the notice shall specify the reasons for the anticipated production level increase; and (3-20-20)T

(c) New notice of discharge at alternate levels is required to cover a period or production level not covered by prior notice or, if during two (2) consecutive months otherwise covered by a notice, the production level at the permitted facility does not in fact meet the higher level designated in the notice; (3-20-20)T

(2) The permittee shall comply with the limitations, standards, or prohibitions that correspond to the lowest level of production specified in the permit, unless the permittee has notified the Department under Subsection 303.02.b.ii., in which case the permittee shall comply with the lower of the actual level of production during each month or the level specified in the notice; and (3-20-20)T

(3) The permittee shall submit, with the Discharge Monitoring Report, the level of production that

actually occurred during each month and the limitations, standards, or prohibitions applicable to that level of production. (3-20-20)T

**03. Metals.** All permit effluent limitations, standards, or prohibitions for a metal shall be expressed in terms of total recoverable metal as defined in 40 CFR Part 136, unless: (3-20-20)T

**a.** An applicable effluent standard or limitation has been promulgated under the Clean Water Act and specifies the limitation for the metal in the dissolved or valent or total form; (3-20-20)T

**b.** In establishing permit limitations on a case-by-case basis under 40 CFR 125.3, it is necessary to express the limitation on the metal in the dissolved or valent or total form to carry out the provisions of the Clean Water Act; or (3-20-20)T

**c.** All approved analytical methods for the metal inherently measure only its dissolved form (e.g., hexavalent chromium). (3-20-20)T

**04. Continuous Discharges.** For continuous discharges all permit effluent limitations, standards, and prohibitions, including those necessary to achieve water quality standards, shall, unless impracticable, be stated as: (3-20-20)T

**a.** Maximum daily and average monthly discharge limitations for all dischargers other than POTWs; (3-20-20)T  
or

**b.** Average weekly and average monthly discharge limitations for POTWs. (3-20-20)T

**05. Noncontinuous Discharges.** Discharges which are not continuous, as defined in Section 010 (Definitions), shall be particularly described and limited, considering the following factors, as appropriate: (3-20-20)T

**a.** Frequency (for example, a batch discharge shall not occur more than once every three (3) weeks); (3-20-20)T

**b.** Total mass (for example, not to exceed one hundred (100) kilograms of zinc and two hundred (200) kilograms of chromium per batch discharge); (3-20-20)T

**c.** Maximum rate of discharge of pollutants during the discharge (for example, not to exceed two (2) kilograms of zinc per minute); and (3-20-20)T

**d.** Prohibition or limitation of specified pollutants by mass, concentration, or other appropriate measure (for example, shall not contain at any time more than one-tenth (0.1) mg/L zinc or more than two hundred fifty (250) grams (one-fourth (¼) kilogram) of zinc in any discharge). (3-20-20)T

**06. Mass Limitations.** (3-20-20)T

**a.** All pollutants limited in permits shall have limitations, standards, or prohibitions expressed in terms of mass except: (3-20-20)T

**i.** pH, temperature, radiation, or other pollutants which cannot appropriately be expressed by mass; (3-20-20)T

**ii.** When applicable standards and limitations are expressed in terms of other units of measurement; or (3-20-20)T

**iii.** If in establishing permit limitations on a case-by-case basis under 40 CFR 125.3, limitations expressed in terms of mass are infeasible because the mass of the pollutant discharged cannot be related to a measure of operation (for example, discharges of TSS from certain mining operations), and permit conditions ensure that dilution will not be used as a substitute for treatment. (3-20-20)T

**b.** Pollutants limited in terms of mass, may also be limited in terms of other units of measurement, and the permit shall require the permittee to comply with both limitations. (3-20-20)T

**07. Pollutant Credits for Intake Water.** (3-20-20)T

**a.** The following definitions apply to the consideration of intake credits in determining reasonable potential and establishing technology based and water quality based effluent limits for IPDES permits. (3-20-20)T

**i.** An intake pollutant is the amount of a pollutant that is present in waters of the United States (including ground water as provided in Subsection 303.07.a.iv.) at the time water is removed from the same body of water by the discharger or other facility supplying the discharger with intake water. (3-20-20)T

**ii.** An intake pollutant must be from the same body of water as the discharge in order to be eligible for an intake credit. An intake pollutant is considered to be from the same body of water as the discharge if the Department finds that the intake pollutant would have reached the vicinity of the outfall point in the receiving water within a reasonable period had it not been removed by the permittee. This finding will be established if: (3-20-20)T

(1) The background concentration of the pollutant in the receiving water (excluding any amount of the pollutant in the facility's discharge) is similar to that in the intake water; (3-20-20)T

(2) There is a direct hydrological connection between the intake and discharge points; and (3-20-20)T

(3) Water quality characteristics (e.g., temperature, pH, hardness) are similar in the intake and receiving waters. (3-20-20)T

**iii.** The Department may also consider other site-specific factors relevant to the transport and fate of the pollutant to make the finding in a particular case that a pollutant would or would not have reached the vicinity of the outfall point in the receiving water within a reasonable period had it not been removed by the permittee. (3-20-20)T

**iv.** An intake pollutant from ground water may be considered to be from the same body of water if the Department determines that the pollutant would have reached the vicinity of the outfall point in the receiving water within a reasonable period had it not been removed by the permittee, except that such a pollutant is not from the same body of water if the ground water contains the pollutant partially or entirely due to human activity, such as industrial, commercial, or municipal operations, disposal actions, or treatment processes. (3-20-20)T

**v.** The determinations made under Subsections 303.07.b. and c. will be made on a pollutant-by-pollutant and outfall-by-outfall basis. (3-20-20)T

**vi.** These provisions do not alter Department's obligation under Subsection 302.06.a.vii.(2) to develop effluent limitations consistent with the assumptions and requirements of any available waste load allocations for the discharge, that is part of a TMDL prepared by the Department and approved by EPA pursuant to 40 CFR 130.7, or prepared by EPA pursuant to 40 CFR 130.7(d). (3-20-20)T

**b.** Consideration of intake pollutants for technology based effluent limitations: (3-20-20)T

**i.** Upon request of the discharger, technology-based effluent limitations or standards shall be adjusted to reflect credit for pollutants in the discharger's intake water if: (3-20-20)T

(1) The applicable effluent limitations and standards contained in 40 CFR Part 401 through 471, specifically provide that they shall be applied on a net basis; or (3-20-20)T

(2) The discharger demonstrates that the control system it proposes or uses to meet applicable technology-based limitations and standards would, if properly installed and operated, meet the limitations and standards in the absence of pollutants in the intake waters. (3-20-20)T

ii. Credit for generic pollutants such as BOD or TSS should not be granted unless the permittee demonstrates that the constituents of the generic measure in the effluent are substantially similar to the constituents of the generic measure in the intake water or unless appropriate additional limits are placed on process water pollutants either at the outfall or elsewhere. (3-20-20)T

iii. Credit shall be granted only to the extent necessary to meet the applicable limitation or standard, up to a maximum value equal to the influent value. Additional monitoring may be necessary to determine eligibility for credits and compliance with permit limits. (3-20-20)T

iv. Credit shall be granted only if the discharger demonstrates that the intake water is drawn from the same body of water into which the discharge is made. The Department may waive this requirement if the Department finds that no environmental degradation will result. (3-20-20)T

v. This section does not apply to the discharge of raw water clarifier sludge generated from the treatment of intake water. (3-20-20)T

c. Consideration of intake pollutants for water quality based effluent limitations: (3-20-20)T

i. The Department will evaluate if there is reasonable potential for the discharge of an identified intake pollutant to cause or contribute to an exceedance of a narrative or numeric water quality criterion. If the Department determines that an intake pollutant in the discharge does not have the reasonable potential to cause or contribute to an exceedance of an applicable water quality standard, the Department is not required to include a water quality-based effluent limit for the identified intake pollutant in the facility's permit. (3-20-20)T

ii. If a reasonable potential exists, then water quality-based effluent limits may be established that reflect a credit for intake pollutants where a discharger demonstrates that the following conditions are met: (3-20-20)T

(1) The facility removes the intake water containing the pollutant from the same body of water into which the discharge is made; (3-20-20)T

(2) The ambient background concentration of the pollutant does not meet the most stringent applicable water quality criterion for that pollutant; (3-20-20)T

(3) The facility does not alter the identified intake pollutant chemically or physically in a manner that would cause adverse water quality impacts to occur that would not occur if the pollutants had not been removed from the body of water; (3-20-20)T

(4) The timing and location of the discharge would not cause adverse water quality impacts to occur that would not occur if the identified intake pollutant had not been removed from the body of water; (3-20-20)T

(5) For the purpose of determining water quality-based effluent limits, the facility does not increase the identified intake pollutant concentration at the point of discharge as compared to the pollutant concentration in the intake water. (3-20-20)T

iii. Where the conditions in Subsection 303.07.c.i. and ii are met, the Department may establish a water quality-based effluent limitation allowing a facility to discharge a mass and concentration of the intake pollutant that are no greater than the mass and concentration found in the facility's intake water. A discharger may add mass of the pollutant to its waste stream if an equal or greater mass is removed prior to discharge, so there is no net addition of the pollutant in the discharge compared to the intake water. (3-20-20)T

iv. Where intake water for a facility is provided by a municipal water supply system and the supplier provides treatment of the raw water that removes an intake water pollutant, the concentration of the intake water pollutant will be determined at the point where the water enters the water supplier's distribution system. (3-20-20)T

v. Where a facility discharges intake pollutants from multiple sources that originate from the receiving water body and from other water bodies, the Department may derive an effluent limit reflecting the flow-



weighted amount of each source of the pollutant provided that conditions in 303.07.c.ii. of this subsection are met and adequate monitoring to determine compliance can be established and is included in the permit. (3-20-20)T

vi. The permit will specify how compliance with mass and concentration-based limitations for the intake water pollutant will be assessed. This may be done by basing the effluent limitation on background concentration data. Alternatively, the Department may determine compliance by monitoring the pollutant concentrations in the intake water and in the effluent. This monitoring may be supplemented by monitoring internal waste streams or by a Department evaluation of the use of best management practices. (3-20-20)T

vii. Effluent limitations must be established to comply with all other applicable state and federal laws and regulations including technology-based requirements and anti-degradation policies. (3-20-20)T

viii. When determining whether water quality based effluent limitations are necessary, information from chemical-specific, whole effluent toxicity and biological assessments will be considered independently. (3-20-20)T

ix. Permit limits must be consistent with the assumptions and requirement of waste load allocations or other provisions in a TMDL that has been approved by the EPA. (3-20-20)T

**08. Internal Waste Streams. (3-20-20)T**

a. When permit effluent limitations or standards imposed at the point of discharge are impractical or infeasible, effluent limitations or standards for discharges of pollutants may be imposed on internal waste streams before mixing with other waste streams or cooling water streams. In those instances, the monitoring required by Section 304 (Monitoring and Reporting Requirements) shall also be applied to the internal waste streams. (3-20-20)T

b. Limits on internal waste streams will be imposed only when the fact sheet sets forth the exceptional circumstances which make such limitations necessary, such as: (3-20-20)T

i. When the final discharge point is inaccessible (for example, under ten (10) meters of water); (3-20-20)T

ii. The wastes at the point of discharge are so diluted as to make monitoring impracticable; or (3-20-20)T

iii. The interferences among pollutants at the point of discharge would make detection or analysis impracticable. (3-20-20)T

**09. Disposal of Pollutants into Wells, into POTWs, or by Land Application. (3-20-20)T**

a. When part of a discharger's process wastewater is not being discharged into waters of the United States because it is disposed into a well, into a POTW, or by land application thereby reducing the flow or level of pollutants being discharged into waters of the United States, applicable effluent standards and limitations for the discharge in an IPDES permit shall be adjusted to reflect the reduced raw waste resulting from such disposal. Effluent limitations and standards in the permit shall be calculated by one (1) of the following methods: (3-20-20)T

i. If none of the waste from a particular process is discharged into waters of the United States, and effluent limitations guidelines provide separate allocation for wastes from that process, all allocations for the process shall be eliminated from calculation of permit effluent limitations or standards; or (3-20-20)T

ii. In all cases other than those described in Subsection 303.09.a.i., effluent limitations shall be adjusted by multiplying the effluent limitation derived by applying effluent limitation guidelines to the total waste stream by the amount of wastewater flow to be treated and discharged into waters of the United States, and dividing the result by the total wastewater flow. Effluent limitations and standards so calculated may be further adjusted under 40 CFR Part 125, subpart D, to make them more or less stringent if discharges to wells, POTWs, or by land application change the character or treatability of the pollutants being discharged to receiving waters. This method may be algebraically expressed as:

$P=(E \times N)/T$ ; where P is the permit effluent limitation, E is the limitation derived by applying effluent guidelines to the total waste stream, N is the wastewater flow to be treated and discharged to waters of the United States, and T is the total wastewater flow.

(3-20-20)T

- b.** Subsection 303.09.a. does not apply to the extent that promulgated effluent limitations guidelines: (3-20-20)T

  - i. Control concentrations of pollutants discharged but not mass; or (3-20-20)T
  - ii. Specify a different specific technique for adjusting effluent limitations to account for well injection, land application, or disposal into POTWs. (3-20-20)T
- c.** Subsection 303.09.a. does not alter a discharger's obligation to meet any more stringent requirements established under Sections 300 (Conditions Applicable to all Permits), 301 (Permit Conditions for Specific Categories), 40 CFR 122.42(e), and 302 (Establishing Permit Provisions). (3-20-20)T
- d.** Disposal of discharge into injection wells is regulated by: (3-20-20)T

  - i. Idaho Department of Water Resources, in compliance with the IDAPA 37.03.03, "Rules and Minimum Standards for the Construction and Use of Injection Wells," for a Class I injection well; or (3-20-20)T
  - ii. Health District having jurisdiction, in compliance with IDAPA 58.01.03, "Individual/Subsurface Sewage Disposal Rules," for a Class V injection well. (3-20-20)T
- e.** Disposal of discharge onto the surface of the land is regulated by the Department under IDAPA 58.01.17, "Recycled Water Rules." (3-20-20)T

#### **304. MONITORING AND REPORTING REQUIREMENTS.**

- 01. Monitoring Requirements.** A permit must include the following requirements for monitoring: (3-20-20)T

  - a.** Requirements concerning the proper use, maintenance, and installation, when appropriate, of monitoring equipment or methods (including biological monitoring methods when appropriate); (3-20-20)T
  - b.** The type, intervals, and frequency of monitoring sufficient to yield data which are representative of the monitored activity including, when appropriate, continuous monitoring; (3-20-20)T
  - c.** Provisions for reporting the results of monitoring, including frequency, appropriate for the regulated activity based on the impact of that activity and as specified in 40 CFR Part 127 (NPDES Electronic Reporting). Reporting shall be no less frequent than specified in 40 CFR 122.44; (3-20-20)T
  - d.** The mass (or other measurement specified in the permit) for each pollutant limited in the permit; (3-20-20)T
  - e.** The volume of effluent discharged from each outfall; (3-20-20)T
  - f.** Other measurements as appropriate, including: (3-20-20)T

    - i. Pollutants in internal waste streams under Subsection 303.08; (3-20-20)T
    - ii. Pollutants in intake water for net limitations under Subsection 303.07; (3-20-20)T
    - iii. Frequency, rate of discharge, etc., for non-continuous discharges under Subsection 303.05;

- (3-20-20)T
- iv. Pollutants subject to notification requirements under Subsection 301.01; and (3-20-20)T
- v. Pollutants in sewage sludge or other monitoring as specified in 40 CFR Part 503; or as determined to be necessary on a case-by-case basis pursuant to the Clean Water Act section 405(d)(4), Section 380 (Sewage Sludge) of these rules, and IDAPA 58.01.16.650, “Wastewater Rules”; (3-20-20)T
- g.** According to sufficiently sensitive test procedures (i.e., methods) approved under 40 CFR Part 136 for the analysis of pollutants or pollutant parameters, or another method required under 40 CFR Part 401 through 471 or Part 501 through 503. Consistent with 40 CFR Part 136, applicants or permittees have the option of providing matrix or sample specific minimum levels rather than the published levels. Further, where an applicant or permittee can demonstrate that, despite a good faith effort to use a method that would otherwise meet the definition of “sufficiently sensitive,” the analytical results are not consistent with the QA/QC specifications for that method, then the Department may determine that the method is not performing adequately and the Department should select a different method from the remaining EPA-approved methods that is sufficiently sensitive consistent with provisions outlined in Subsections 304.01.g.i. and ii. For the purposes of this section, a method is “sufficiently sensitive” when: (3-20-20)T
- i. The method minimum level (ML) is at or below the level of the effluent limit established in the permit for the measured pollutant or pollutant parameter; or (3-20-20)T
- ii. The method has the lowest ML of the analytical methods approved under 40 CFR Part 136 or required under 40 CFR Chapter I, Subchapter N or O, for the measured pollutant or pollutant parameter; and (3-20-20)T
- h.** In the case of pollutants or pollutant parameters for which there are no approved methods under 40 CFR Part 136, or methods are not otherwise required under 40 CFR Part 401 through 471 or Part 501 through 503, monitoring shall be conducted according to a test procedure specified in the permit for such pollutants or pollutant parameters. (3-20-20)T
- 02. Reporting Monitoring Results.** (3-20-20)T
- a.** Except as provided in Subsections 304.02.d. and 304.02.e., the Department will establish requirements to report monitoring results on a case-by-case basis with a frequency dependent on the nature and effect of the discharge, but in no case less than once a year. All results must be electronically reported in compliance with 40 CFR Part 127. (3-20-20)T
- b.** For sewage sludge use or disposal practices, the Department will establish requirements to monitor and report results on a case-by-case basis with a frequency dependent on the nature and effect of the sewage sludge use or disposal practice; minimally this shall be as specified in 40 CFR Part 503, Section 380 (Sewage Sludge) of these rules, and Idaho’s Wastewater Rules, IDAPA 58.01.16.650, “Wastewater Rules,” (where applicable), but in no case less than once a year. All results must be electronically reported in compliance with 40 CFR Part 127. (3-20-20)T
- c.** The Department will establish requirements to report monitoring results for storm water discharges associated with industrial activity which are subject to an effluent limitation guideline on a case-by-case basis with a frequency dependent on the nature and effect of the discharge, but in no case less than once a year. (3-20-20)T
- d.** The Department will establish requirements to report monitoring results for storm water discharges associated with industrial activity, other than those addressed in Subsection 304.02.c., on a case-by-case basis with a frequency dependent on the nature and effect of the discharge. At a minimum, a permit for such a discharge must require the discharger to: (3-20-20)T
- i. Conduct an annual inspection of the facility site to identify areas contributing to a storm water discharge associated with industrial activity; (3-20-20)T

- ii. Evaluate whether measures to reduce pollutant loadings identified in a storm water pollution prevention plan are adequate and properly implemented in accordance with the terms of the permit or whether additional control measures are needed; (3-20-20)T
- iii. Maintain for a period of three (3) years a record summarizing the results of the inspection and a certification that the facility is in compliance with the plan and the permit, and identifying any incidents of noncompliance; (3-20-20)T
- iv. Sign the report and certification in accordance with Section 090 (Signature Requirements); and (3-20-20)T
- v. Permits for storm water discharges associated with industrial activity from inactive mining operations may, where annual inspections are impracticable, require certification that the facility is in compliance with the permit, or alternative requirements, once every three (3) years by an Idaho licensed professional engineer. (3-20-20)T
- e. A permit that does not require monitoring results reports at least annually must require the permittee to report, at least annually, all instances of noncompliance not reported under Subsection 300.12. (3-20-20)T

**305. COMPLIANCE SCHEDULES.**

- 01. General.** An IPDES permit may, when appropriate, specify a schedule of compliance leading to compliance with the Clean Water Act and these rules. (3-20-20)T
  - a. Any schedules of compliance under this section shall require compliance as soon as possible. (3-20-20)T
  - b. The first IPDES permit issued to a new source or a new discharger shall contain a schedule of compliance only when necessary to allow a reasonable opportunity to attain compliance with requirements issued or revised after commencement of construction, but less than three (3) years before commencement of the relevant discharge. (3-20-20)T
  - c. For recommencing dischargers, a schedule of compliance shall be available only when necessary to allow a reasonable opportunity to attain compliance with requirements issued or revised less than three (3) years before recommencement of discharge. (3-20-20)T
  - d. If a permit establishes a schedule of compliance under this section that exceeds one (1) year from the date of permit issuance, the schedule must set out interim requirements and dates for achievement of the interim requirements. If the schedule includes interim requirements: (3-20-20)T
    - i. The time between interim dates shall not exceed one (1) year, except that in the case of a schedule for compliance with standards for sewage sludge use and disposal, the time between interim dates shall not exceed six (6) months; or (3-20-20)T
    - ii. If the time necessary for completion of any interim requirement (such as the construction of a control facility) is more than one (1) year and is not readily divisible into stages for completion, the permit shall specify interim dates for the submission of reports of progress toward completion of the interim requirements and indicate a projected completion date. (3-20-20)T
  - e. Within fourteen (14) days following each interim and final date of compliance, the permittee shall notify the Department in writing of its compliance or noncompliance with the interim or final requirements, or submit progress reports if Subsection 305.01.d.ii. is applicable. (3-20-20)T
  - f. Permits may incorporate compliance schedules which allow a discharger to phase in, over time, compliance with water quality-based effluent limitations in accordance with IDAPA 58.01.02.400, "Water Quality Standards." (3-20-20)T

**02. Alternative Schedules of Compliance.** An IPDES permit applicant or permittee may cease conducting regulated activities (by terminating direct discharge for point sources) rather than continuing to operate and meet permit requirements as follows: (3-20-20)T

**a.** If the permittee decides to cease conducting regulated activities at a given time within the term of a permit which has already been issued: (3-20-20)T

**i.** The permit may be modified to contain a new or additional schedule leading to timely cessation of activities; or (3-20-20)T

**ii.** The permittee shall cease conducting permitted activities before noncompliance with any interim or final compliance schedule requirement already specified in the permit. (3-20-20)T

**b.** If the decision to cease conducting regulated activities is made before issuance of a permit whose term will include the termination date, the permit shall contain a schedule leading to termination which will ensure timely compliance with applicable requirements no later than the statutory deadline. (3-20-20)T

**c.** If the permittee is undecided whether to cease conducting regulated activities, the Department may issue or modify a permit to contain two (2) schedules, as follows: (3-20-20)T

**i.** Both schedules shall contain an identical interim deadline requiring a final decision on whether to cease conducting regulated activities no later than a date which ensures sufficient time to comply with applicable requirements in a timely manner if the decision is to continue conducting regulated activities; (3-20-20)T

**ii.** One (1) schedule shall lead to timely compliance with applicable requirements, no later than the statutory deadline; (3-20-20)T

**iii.** The second schedule shall lead to cessation of regulated activities by a date which will ensure timely compliance with applicable requirements no later than the statutory deadline; and (3-20-20)T

**iv.** Each permit containing two (2) schedules shall include a requirement that after the permittee has made a final decision under Subsection 305.02.c., it shall follow the schedule leading to compliance if the decision is to continue conducting regulated activities, and follow the schedule leading to termination if the decision is to cease conducting regulated activities. (3-20-20)T

**d.** The applicant's or permittee's decision to cease conducting regulated activities shall be evidenced by a firm public commitment satisfactory to the Department, such as a resolution of the board of directors of a corporation. (3-20-20)T

**306. -- 309. (RESERVED)**

**310. VARIANCES.**

**01. Variance Requests by non-POTWs.** (3-20-20)T

**a.** A discharger which is not a POTW may request a variance from otherwise applicable effluent limitations under the following statutory or regulatory provisions, within the times specified in this subsection. (3-20-20)T

**i.** A request for a variance based on the presence of fundamentally different factors from those on which the effluent limitations guideline was based shall be filed as follows: (3-20-20)T

(1) For a request from best practicable control technology currently available (BPT), by the close of the public comment period under Section 109 (Public Notification and Comment); or (3-20-20)T

(2) For a request from best available technology economically achievable (BAT) and/or best

conventional pollutant control technology (BCT), by no later than one hundred eighty (180) days after the date on which an effluent limitation guideline is published in the Federal Register for a request based on an effluent limitation guideline promulgated on or after February 4, 1987. (3-20-20)T

ii. The request shall explain how the requirements of the applicable regulatory and/or statutory criteria have been met. (3-20-20)T

**b.** An applicant may request a variance for non-conventional pollutants under this section for the following: (3-20-20)T

i. A variance from the BAT requirements for Clean Water Act section 301(b)(2)(F) pollutants (commonly called non-conventional pollutants) pursuant to the Clean Water Act section 301(c) because of the economic capability of the owner or operator; or (3-20-20)T

ii. A variance pursuant to the Clean Water Act section 301(g) provided: (3-20-20)T

(1) The variance may only be requested for ammonia; chlorine; color; iron; total phenols (4AAP), when determined by the EPA Administrator to be a pollutant covered by the Clean Water Act section 301(b)(2)(F); and (3-20-20)T

(2) Any other pollutant which the EPA Administrator lists under the Clean Water Act section 301(g)(4). (3-20-20)T

**c.** The request for variance as outlined in Subsection 310.01.b. must be made as follows: (3-20-20)T

i. For those requests for a variance from an effluent limitation based upon an effluent limitation guideline, by submitting an initial request to the Department no later than two hundred seventy (270) days after promulgation of the applicable effluent limitation guideline followed by a completed request no later than the close of the public comment period under Section 109 (Public Notification and Comment). (3-20-20)T

(1) The initial request to the Department shall contain: (3-20-20)T

(a) The name of the discharger; (3-20-20)T

(b) The permit number; (3-20-20)T

(c) The outfall number(s); (3-20-20)T

(d) The applicable effluent guideline; and (3-20-20)T

(e) Whether the discharger is requesting a Clean Water Act section 301(c) or section 301(g) modification or both. (3-20-20)T

(2) The completed request shall demonstrate that the applicable requirements of 40 CFR Part 125 have been met. Notwithstanding this provision, the complete application for a request under the Clean Water Act section 301(g) shall be filed one hundred eighty (180) days before the Department must make a decision (unless the Department establishes a shorter or longer period). (3-20-20)T

ii. For those requests for a variance from effluent limitations not based on effluent limitation guidelines, the request need only comply with Subsection 310.01.c.i.(2) and need not be preceded by an initial request under Subsection 310.01.c.i.(1). (3-20-20)T

**d.** A modification under the Clean Water Act section 302(b)(2) of requirements under the Clean Water Act section 302(a) for achieving water quality related effluent limitations may be requested no later than the close of the public comment period under Section 109 (Public Notification and Comment) on the permit from which the modification is sought. (3-20-20)T

**e.** A variance under the Clean Water Act section 316(a) for the thermal component of any discharge must be filed with a timely application for a permit under Section 105 (Application for an Individual IPDES Permit), except that if thermal effluent limitations are established under the Clean Water Act section 402(a)(1) or are based on water quality standards, the request for a variance may be filed by the close of the public comment period under Section 109 (Public Notification and Comment). (3-20-20)T

**02. Variance Requests by POTWs.** A discharger which is a POTW may request a variance from water quality based effluent limitations. A modification under the Clean Water Act section 302(b)(2) of the requirements under the Clean Water Act section 302(a) for achieving water quality based effluent limitations shall be requested no later than the close of the public comment period under Section 109 (Public Notification and Comment) on the permit from which the modification is sought. (3-20-20)T

**03. Permit Variance Decision Process.** (3-20-20)T

**a.** The Department may deny requests for variances. A variance that has been denied by the Department may be appealed according to the process identified in Section 204 (Appeals Process). (3-20-20)T

**b.** The Department may grant (subject to EPA objection under Subsection 103.02 or 40 CFR 123.44): (3-20-20)T

**i.** Variances for extensions under the Clean Water Act section 301(i) based on delay in completion of a POTW; (3-20-20)T

**ii.** Variances after consultation with EPA, extensions under the Clean Water Act section 301(k) based on the use of innovative technology; (3-20-20)T

**iii.** Variances under the Clean Water Act section 316(a) for thermal pollution; or (3-20-20)T

**iv.** Variances from water quality standards under IDAPA 58.01.02.260, "Water Quality Rules." (3-20-20)T

**c.** The Department may forward to EPA with or without a recommendation: (3-20-20)T

**i.** A variance based on the economic capability of the applicant under the Clean Water Act section 301(c); or (3-20-20)T

**ii.** A variance based on water quality related effluent limitations under the Clean Water Act section 302(b)(2). (3-20-20)T

**d.** The Department may forward to EPA with a written concurrence: (3-20-20)T

**i.** A variance based on the presence of fundamentally different factors from those on which an effluent limitations guideline was based (Clean Water Act section 301(n)); or (3-20-20)T

**ii.** A variance based upon certain water quality factors under the Clean Water Act section 301(g). (3-20-20)T

**e.** The EPA may grant or deny a request for a variance that is forwarded by the Department. If the EPA Administrator (or his delegate) approves the variance, the Department shall prepare a draft permit incorporating the variance. (3-20-20)T

**f.** Any public notice of a draft permit for which a variance or modification has been approved or denied shall identify the applicable procedures for appealing that decision under Section 204 (Appeals Process). (3-20-20)T

**04. Expedited Variance Procedures and Time Extensions.** (3-20-20)T

**a.** Notwithstanding the time requirements in Subsections 310.01 and 310.02, the Department may notify a permit applicant before a draft permit is issued under Section 108 (Draft Permit and Fact Sheet) that the draft permit will likely contain limitations which are eligible for variances. (3-20-20)T

**i.** In the notice, the Department may require the applicant, as a condition of consideration of any potential variance request, to submit a request explaining how the requirements of 40 CFR Part 125, applicable to the variance, have been met and may require its submission within a specified reasonable time after receipt of the notice. (3-20-20)T

**ii.** The Department may send the notice before the permit application has been submitted. The draft or final permit may contain the alternative limitations which may become effective upon final grant of the variance. (3-20-20)T

**b.** A discharger who cannot file a timely complete request required under Subsections 310.01.c.i.(2) or 310.01.c.ii. may request an extension. (3-20-20)T

**i.** The extension may be granted or denied at the discretion of the Department. (3-20-20)T

**ii.** The extension shall be no more than six (6) months in duration. (3-20-20)T

**05. Special Procedures for Decisions on Thermal Variances.** (3-20-20)T

**a.** The only issues connected with issuance of a particular permit on which the Department will make a final decision before the final permit is issued, are whether alternative effluent limitations would be justified under the Clean Water Act section 316(a) or whether cooling water intake structures will use the best available technology under section 316(b). (3-20-20)T

**i.** Permit applicants who wish an early decision on these issues should make a request to the Department, furnished with supporting reasons at the time their permit applications are filed. (3-20-20)T

**ii.** The Department will then decide whether or not to make an early decision. If it is granted, both the early decision on Clean Water Act section 316 (a) or (b) issues and the grant of the balance of the permit shall be: (3-20-20)T

(1) Considered permit issuance under these regulations, and (3-20-20)T

(2) Subject to the same requirements of public notice and comment and the same opportunity for an appeal. (3-20-20)T

**b.** If the Department, on review of the administrative record, determines that the information necessary to decide whether or not the Clean Water Act section 316(a) issue is not likely to be available in time for a decision on permit issuance, the Department may issue a permit for a term up to five (5) years. (3-20-20)T

**i.** The permit shall require achievement of the effluent limitations initially proposed for the thermal component of the discharge, no later than the date otherwise required by law. (3-20-20)T

**ii.** However, the permit shall also afford the permittee an opportunity to file a demonstration under Clean Water Act section 316(a), after conducting such studies as are required under 40 CFR 125.70 through 125.73. (3-20-20)T

**iii.** A new discharger may not exceed the thermal effluent limitation which is initially proposed unless and until its Clean Water Act section 316(a) variance request is finally approved. (3-20-20)T

**c.** Any proceeding held under Subsection 310.05.a. shall be: (3-20-20)T

**i.** Publicly noticed as required by Section 109 (Public Notification and Comment), and (3-20-20)T



ii. Conducted at a time allowing the permittee to take necessary measures to meet the final compliance date in the event its request for modification of thermal limits is denied. (3-20-20)T

d. Whenever the Department defers the decision under the Clean Water Act section 316(a), any decision under the Clean Water Act section 316(b) may be deferred. (3-20-20)T

**311. -- 369. (RESERVED)**

**370. PRETREATMENT STANDARDS.**

**01. Purpose and Applicability.** This section and 40 CFR Part 403 apply to: (3-20-20)T

a. Pollutants from non-domestic sources covered by Pretreatment Standards which are indirectly discharged into or transported by truck or rail or otherwise introduced into POTWs as defined in Subsection 370.04 and 40 CFR 403.3; (3-20-20)T

b. POTWs which receive wastewater from sources subject to National Pretreatment Standards; and (3-20-20)T

c. Any new or existing source subject to Pretreatment Standards. National Pretreatment Standards do not apply to sources which discharge to a sewer which is not connected to a POTW Treatment Plant. (3-20-20)T

**02. Objectives of General Pretreatment Regulations.** This section and 40 CFR Part 403 fulfill three (3) objectives: (3-20-20)T

a. To prevent the introduction of pollutants into POTWs which will interfere with the operation of a POTW, including interference with its use or disposal of municipal sludge; (3-20-20)T

b. To prevent the introduction of pollutants into POTWs which will pass through the treatment works or otherwise be incompatible with such works; and (3-20-20)T

c. To improve opportunities to recycle and reclaim municipal and industrial wastewaters and sludges. (3-20-20)T

**03. Department Program in Lieu of a POTW Program.** 40 CFR 403.8(a) requires certain POTWs develop a pretreatment program. The Department may, however, assume responsibility for implementing the POTW pretreatment program requirements set forth in 40 CFR 403.8(f) in lieu of requiring the POTW to develop a pretreatment program. This does not preclude POTWs from independently developing pretreatment programs. (3-20-20)T

**04. Term Interpretation.** When used in the context of 40 CFR Part 403, unless the context in which a term is used clearly requires a different meaning, terms 40 CFR Part 403 that are incorporated by reference in these rules have the following meanings: (3-20-20)T

a. The terms Administrator or Regional Administrator mean the EPA Region 10 Administrator; (3-20-20)T

b. The term Approval Authority means the Department of Environmental Quality; (3-20-20)T

c. The term Approved POTW Pretreatment Program or Program or POTW Pretreatment Program means a program administered by a POTW that meets the criteria established in 40 CFR 403.8 and 403.9, and which has been approved by the Department in accordance with 40 CFR 403.1; (3-20-20)T

d. The term Control Authority means the POTW for a facility with a Department-approved pretreatment program and the Department for a POTW without a Department-approved pretreatment program; (3-20-20)T

**e.** The term Director means the Department of Environmental Quality with an NPDES permit program approved pursuant to the Clean Water Act section 402(b); (3-20-20)T

**f.** The terms National Pretreatment Standard, Pretreatment Standard, or Standard mean any regulation containing pollutant discharge limits promulgated by the EPA in accordance with section 307 (b) and (c) of the Act, which applies to Industrial Users. This term includes prohibitive discharge limits established pursuant to 40 CFR 403.5; and (3-20-20)T

**g.** The term Water Management Division Director means a Director of the Water Management Division within the Region 10 office of the Environmental Protection Agency or this person's delegated representative. (3-20-20)T

**05. Exceptions to Incorporation by Reference.** The following sections of 40 CFR Part 403 are excluded from the incorporation by reference in Section 003 (Incorporation by Reference) of these rules. (3-20-20)T

**a.** 40 CFR 403.4 (State or Local Law). (3-20-20)T

**b.** 40 CFR 403.19 (Provisions of Specific Applicability to the Owatonna Wastewater Treatment Facility). (3-20-20)T

**c.** 40 CFR 403.20 (Pretreatment Program Reinvention Pilot Projects Under Project XL). (3-20-20)T

**371. -- 379. (RESERVED)**

**380. SEWAGE SLUDGE.**

**01. Purpose.** The purpose of this section and 40 CFR Part 503 is to: (3-20-20)T

**a.** Establish standards, which consist of general requirements, pollutant limits, management practices, and operational standards, for the final use or disposal of sewage sludge. (3-20-20)T

**i.** Include standards for sewage sludge applied to the land, placed on a surface disposal site, or fired in a sewage sludge incinerator. (3-20-20)T

**ii.** Include: (3-20-20)T

**(1)** Pathogen and alternative vector attraction reduction requirements for sewage sludge applied to the land or placed on a surface disposal site; and (3-20-20)T

**(2)** On a case-by-case basis, controls for storm water runoff from lands where sewage sludge or septage has been placed for treatment or disposal. (3-20-20)T

**b.** Include the frequency of monitoring and recordkeeping requirements when sewage sludge is: (3-20-20)T

**i.** Applied to the land; (3-20-20)T

**ii.** Placed on a surface disposal site; or (3-20-20)T

**iii.** Fired in a sewage sludge incinerator; and (3-20-20)T

**c.** Include reporting requirements for: (3-20-20)T

**i.** Class I sludge management facilities; (3-20-20)T

**ii.** POTWs with a design flow rate equal to or greater than one million gallons per day (1 MGD); and (3-20-20)T

- iii. POTWs that serve ten thousand (10,000) people or more. (3-20-20)T
- 02. Applicability.** This section and 40 CFR Part 503 applies to: (3-20-20)T
  - a.** Any person, who prepares sewage sludge, applies sewage sludge to the land, or fires sewage sludge in a sewage sludge incinerator and to the owner or operator of a surface disposal site; (3-20-20)T
  - b.** Sewage sludge applied to the land, placed on a surface disposal site, or fired in a sewage sludge incinerator; (3-20-20)T
  - c.** The exit gas from a sewage sludge incinerator stack; or (3-20-20)T
  - d.** Land where sewage sludge is applied, to a surface disposal site, and to a sewage sludge incinerator. (3-20-20)T
- 03. Term Interpretation.** When used in the context of 40 CFR Part 503, unless the context in which a term is used clearly requires a different meaning, terms in the 40 CFR Part 503 that are incorporated by reference in these rules have the following meanings: (3-20-20)T
  - a.** The terms Administrator or Regional Administrator mean the EPA Region 10 Administrator; (3-20-20)T
  - b.** The terms Director or State Program Director mean the Department of Environmental Quality as the agency designated by the Governor as having the lead responsibility for managing or coordinating the approved IPDES program; and (3-20-20)T
  - c.** The term permitting authority is the Department of Environmental Quality. (3-20-20)T
- 04. Exceptions to Incorporation by Reference.** 40 CFR 503.1 (Purpose and Applicability) is excluded from the incorporation by reference found in Section 003 (Incorporation by Reference) of these rules. (3-20-20)T

**381. -- 399. (RESERVED)**

**400. COMPLIANCE EVALUATION.**

- 01. Non-Compliance Actions.** When the permittee is not in compliance with any condition of the existing or expired permit that has been administratively continued, the Department may choose to do one (1) or more of the following: (3-20-20)T
  - a.** Initiate an enforcement action; (3-20-20)T
  - b.** Issue a notice of intent to deny the new application. If the application is denied and the expired permit is no longer effective as provided in Subsection 101.02, the owner or operator must cease the activities authorized by the permit or be subject to enforcement action for operating without a permit; (3-20-20)T
  - c.** Issue a new permit with appropriate conditions; or (3-20-20)T
  - d.** Take other actions authorized by state law. (3-20-20)T

**401. -- 499. (RESERVED)**

**500. ENFORCEMENT.**

- 01. General Enforcement and Penalties.** Any person who violates any permit condition, filing or reporting requirement, duty to allow or carry out inspections, entry or monitoring requirements or any other provision

in these rules shall be subject to administrative, civil or criminal enforcement and those remedies authorized in the Environmental Protection and Health Act, Sections 39-101 et seq., Idaho Code, including without limitation, civil and criminal penalties as provided in Sections 39-108 and 39-117, Idaho Code. (3-20-20)T

**02. Truth in Reporting.** It is a violation of these rules for any person to falsify, tamper with, or knowingly render inaccurate any monitoring device or method required to be maintained under an IPDES permit. In addition to any other remedy available to the Department, such a violation is punishable by a fine as provided in Section 39-117, Idaho Code. (3-20-20)T

**03. False Statements.** It is a violation of these rules for any person to knowingly make any false statement, representation, or certification in any record or other document submitted or required to be maintained under an IPDES permit, including monitoring reports or reports of compliance or non-compliance. In addition to any other remedy available to the Department, such a violation is punishable by a fine as provided in Section 39-117, Idaho Code. (3-20-20)T

**04. Public Participation in Enforcement.** The Department shall provide for public participation in the state enforcement process by: (3-20-20)T

**a.** Investigating and providing written responses to citizen complaints; (3-20-20)T

**b.** Not opposing intervention by any citizen when permissive intervention may be authorized by statute, rule, or regulation; and (3-20-20)T

**c.** Publishing notice of and providing at least thirty (30) days for public comment on any proposed settlement of a state enforcement action. (3-20-20)T

**501. -- 599. (RESERVED)**

**600. ADMINISTRATIVE RECORDS AND DATA MANAGEMENT.**

**01. Administrative Record for Draft Permits.** (3-20-20)T

**a.** The provisions of a draft permit prepared by the Department under Subsection 108.01 shall be based on the administrative record defined in this section. (3-20-20)T

**b.** For preparing a draft permit, the record shall consist of: (3-20-20)T

**i.** The application, if required, and any supporting data furnished by the applicant; (3-20-20)T

**ii.** The draft permit or notice of intent to deny the application or to terminate the permit; (3-20-20)T

**iii.** The fact sheet; (3-20-20)T

**iv.** All documents cited in the fact sheet; and (3-20-20)T

**v.** Other documents contained in the supporting file for the draft permit. (3-20-20)T

**c.** Material readily available at the Department or published material that is generally available, and that is included in the administrative record under Subsection 600.01, need not be physically included with the rest of the record as long as it is specifically referred to in the fact sheet. (3-20-20)T

**d.** This subsection applies to all draft permits when public notice was given after the effective date of these rules. (3-20-20)T

**02. Administrative Record for Final Permits.** (3-20-20)T

**a.** The Department shall base final permit decisions on the administrative record defined in this

section. (3-20-20)T

**b.** The administrative record for any final permit, including issuance, denial, transfer, modification, revocation and reissuance, or termination shall consist of the administrative record for the draft permit and fact sheet, as defined in Subsection 600.01, the proposed permit and associated information, and the following: (3-20-20)T

i. All comments received during the public comment period provided under Section 109 (Public Notification and Comment); (3-20-20)T

ii. The record of, and any written materials submitted as part of, any meeting(s) held under Section 109 (Public Notification and Comment); (3-20-20)T

iii. The application or notice of intent to obtain coverage under a general permit, notice of intent to deny the application, or to terminate the permit, and any supporting data furnished by the applicant; (3-20-20)T

iv. The response to comments required by Subsections 109.02 and 109.03 and any new material placed in the record under that section; and (3-20-20)T

v. Any other relevant correspondence and documents. (3-20-20)T

**c.** The final permit and fact sheet shall become part of the administrative record after the final permit is issued. (3-20-20)T

**d.** The additional documents identified under Subsection 600.02.b., 107.03, and 109.02 should be added to the record as soon as possible after their receipt or publication by the Department. The record shall be complete on the date the final permit is issued. (3-20-20)T

**e.** This subsection applies to all IPDES permits when the draft permit was included in a public notice. (3-20-20)T

**f.** Material readily available from the Department or published materials which are generally available and which are included in the administrative record under Subsection 600.02 or Section 109 (Public Notification and Comment), need not be physically included in the same file as the rest of the record as long as it is specifically referred to in the fact sheet or in the response to comments. (3-20-20)T

**03. Electronic Submittals.** Any information which the Department requires to be submitted electronically, with an electronic signature approved by the Department, will become part of the Administrative Record in accordance with Subsections 600.01 and 02. (3-20-20)T

**601. -- 999. (RESERVED)**

# IDAPA 60 – IDAHO STATE SOIL AND WATER CONSERVATION COMMISSION

DOCKET NO. 60-0501-2000F (FEE RULE)

## NOTICE OF OMNIBUS RULEMAKING – ADOPTION OF TEMPORARY RULE

**EFFECTIVE DATE:** The effective date of the temporary rule being adopted through this omnibus rulemaking is the adjournment date of the second regular session of the 65th Idaho State Legislature - March 20, 2020.

**AUTHORITY:** In compliance with Sections 67-5226, Idaho Code, notice is hereby given this agency has adopted a temporary rule. The action is authorized pursuant to Sections 22-2718, 22-2727, and 22-2730, Idaho Code.

**DESCRIPTIVE SUMMARY:** The following is the required finding and concise statement of its supporting reasons for adopting a temporary rule:

This temporary rule adopts the following chapter under IDAPA 60:

### **IDAPA 60**

- 60.05.01, *Rules of the Idaho State Soil and Water Conservation Commission*

**TEMPORARY RULE JUSTIFICATION:** Pursuant to Sections 67-5226(1) and 67-5226(2), Idaho Code, the Governor has found that temporary adoption of the rule is appropriate for the following reasons:

These temporary rules are necessary to protect the public health, safety, and welfare of the citizens of Idaho and confer a benefit on its citizens. These temporary rules implement the duly enacted laws of the state of Idaho, provide citizens with the detailed rules and standards for complying with those laws, and assist in the orderly execution and enforcement of those laws. The expiration of these rules without due consideration and processes would undermine the public health, safety, and welfare of the citizens of Idaho and deprive them of the benefit intended by these rules.

**FEE SUMMARY:** Pursuant to Section 67-5226(2), the Governor has found that the fee(s) or charge(s) being imposed or increased is justified and necessary to avoid immediate danger and the fee(s) is described herein:

This rulemaking does not impose a fee or charge, or increase a fee or charge, beyond what was previously approved and codified in the prior rules.

The following is a specific description of the fees or charges: Rule 60.05.01.102.05 states, “[t]he applicant is required to cover all costs incurred for loan closure, title insurance, and recording fees.” Rule 60.05.01.103 states that the Commission may require additional title insurance to protect against intervening materialman’s liens should the borrower choose to begin installing practices prior to the loan being approved and the conditions of approval being met.

**ASSISTANCE ON TECHNICAL QUESTIONS:** For assistance on technical questions concerning the temporary rule, contact Corrine Dalzell, Rules Review Officer, (208) 332-1792.

DATED this 14th day of February, 2020.

Corrine Dalzell  
Rules Review Officer  
Idaho Soil & Water Conservation Commission  
322 E. Front St., Suite 560  
P.O. Box 83720  
Boise, ID 83720-0083  
Phone: (208) 332-1792  
Fax: (208) 332-1799

# IDAPA 60 – IDAHO STATE SOIL AND WATER CONSERVATION COMMISSION

## 60.05.01 – RULES OF THE IDAHO STATE SOIL AND WATER CONSERVATION COMMISSION

### 000. LEGAL AUTHORITY.

This chapter is adopted by the Idaho State Soil and Water Conservation Commission, under the legal authority of Sections 22-2718, 22-2727, and 22-2730, Idaho Code. (3-20-20)T

### 001. TITLE AND SCOPE.

**01. Title.** The title of this chapter is IDAPA 60.05.01, “Rules of the Idaho State Soil and Water Conservation Commission.” (3-20-20)T

**02. Scope.** The provisions of these rules set forth procedures and requirements for establishing, implementing, and administering a state loan from the RCRDP fund as provided in Sections 22-2730, through 22-2732, Idaho Code, and provide for the allocation of state funds appropriated for distribution to conservation districts pursuant to Section 22-2727, Idaho Code. (3-20-20)T

### 002. -- 009. (RESERVED)

### 010. DEFINITIONS.

For the purpose of these rules, unless the context indicates otherwise, the terms and phrases are used as defined herein: (3-20-20)T

**01. Applicant.** An eligible applicant as defined in Section 22-2717, Idaho Code. (3-20-20)T

**02. Application.** The loan request document that sets forth the information required by Section 22-2732, Idaho Code and Subsection 057.03 of these rules, including a conservation plan. (3-20-20)T

**03. Base Funding.** Funds appropriated to the Commission to be allocated equally to the various soil conservation districts in a sum not to exceed eight thousand five hundred dollars (\$8,500) per district per year. (3-20-20)T

**04. Board of Supervisors.** Governing body of a district as provided in Section 22-2717(25), Idaho Code. (3-20-20)T

**05. Certify.** To confirm formally as true, accurate, or genuine. (3-20-20)T

**06. Commission.** The Idaho State Soil and Water Conservation Commission as defined in Section 22-2718, Idaho Code. (3-20-20)T

**07. Conservation District or District.** A soil (and water) conservation district as defined in Section 22-2717, Idaho Code. (3-20-20)T

**08. Conservation Plan.** A conservation plan as defined in Sections 22-2717 and 22-2732, Idaho Code that sets forth the information required by Subchapter A. of these rules. (3-20-20)T

**09. Contractee.** The applicant when the loan has been closed and recorded. (3-20-20)T

**10. Coordinated Resource Planning Process.** A process that considers all the resources and resource users within a geographical area and encourages active involvement and input from all interested parties. (3-20-20)T

**11. District.** A Conservation District, Soil Conservation District, or Soil and Water Conservation District as defined in Section 22-2717, Idaho Code. (3-20-20)T

**12. Eligible Land.** Private, state, county, or federal lands within the state of Idaho. (3-20-20)T

**13. Field Office.** The local United States Department of Agriculture Natural Resources Conservation Service (NRCS) office usually located with the principal headquarters of the local District. (3-20-20)T

**14. Field Office Technical Guide.** The primary scientific reference for NRCS that contains technical

information about the conservation of soil, water, air, and related plant and animal resources. Technical guides used in each field office are localized so that they apply specifically to the geographic area for which they are prepared. Copies of the field office technical guides may be obtained from a local District or field office. (3-20-20)T

15. **Financial and Match Report.** Documentation certified by the Board of Supervisors that:  
(3-20-20)T
  - a. Itemizes local funds and services received by a district during the previous fiscal year; and  
(3-20-20)T
  - b. Describes how state base and match funds were utilized during the previous fiscal year. (3-20-20)T
16. **Fiscal Year.** As set forth in Section 67-2201, Idaho Code, the fiscal year will begin on July 1 and close on June 30 of the following year. (3-20-20)T
17. **Five (5) Year Plan.** The plan reviewed and updated annually by each district pursuant to the Final Agreement to implement an Antidegradation Policy for the State of Idaho (August 18, 1988). The plan will contain the following components, as further specified by Commission policy: physical characteristics, economic condition and outlook, assessment of the District's resource conditions and conservation needs, prioritized objectives, water quality component, and an annual work plan. (3-20-20)T
18. **Fund.** The RCRDP fund established pursuant to Section 22-2730, Idaho Code. (3-20-20)T
19. **Funding Criteria.** Criteria considered by the Commission to determine the amount of base and match funding to be allocated to the conservation districts. Criteria may include district budgets, district budget requests, district programs and work plans, and district work load analysis. The following documents may be required on an annual basis in order to consistently apply the criteria to all districts: (3-20-20)T
  - a. Five (5) year plans; (3-20-20)T
  - b. Financial and match reports; and (3-20-20)T
  - c. Performance reports. (3-20-20)T
20. **Local Funds.** Monies received in the previous fiscal year from local units of government and organizations for the general purposes of a conservation district. Funds received for special projects, used as required match for specific grants or projects, or on a fee-for-service basis will not be used to calculate match funding. (3-20-20)T
21. **Local Services.** Non-cash contributions received in the previous fiscal year from local units of government and organizations for the general purposes of a conservation district. Services received for special projects, used as required match for specific grants or projects, or on a fee-for-service basis will not be used to calculate match funding. (3-20-20)T
22. **Local Units of Government.** Any general or special purpose political subdivision of the state which has the power to levy taxes and/or appropriate and spend funds. (3-20-20)T
23. **Match Funding.** Funds appropriated to the Commission for distribution to conservation districts in excess of base funding not to exceed twice the amount of local funds and services received by each district in the previous fiscal year. (3-20-20)T
24. **Maximum Allocation.** The total of base funding and match funding allocated to any one (1) conservation district shall not exceed fifty-eight thousand and five hundred dollars (\$58,500) in a fiscal year. (3-20-20)T
25. **Organizations.** A group of two (2) or more persons structured and managed to pursue a collective goal on a continuing basis. (3-20-20)T



26. **Other Funds.** Funds to be dedicated to conservation practice implementation costs which are not from the RCRDP fund or provided by the applicant. (3-20-20)T
27. **Performance Report.** Documentation summarizing conservation activities, projects, and programs implemented by a conservation district during the previous fiscal year. (3-20-20)T
28. **Practice or Eligible Practice for Loans.** A practice listed in the field office technical guide or a special practice approved under Section 058 of these rules. (3-20-20)T
29. **Practice Life.** The number of years, with proper maintenance and operation, that a practice is expected to last, as shown in the field office technical guide. (3-20-20)T
30. **Program Year.** The state fiscal year as provided in Section 67-2201, Idaho Code. (3-20-20)T
31. **Project.** One (1) or more practices to be installed with a RCRDP loan. (3-20-20)T
32. **Rangeland.** Land used primarily for the grazing of domestic livestock and wildlife. (3-20-20)T
33. **Riparian Areas.** Riparian areas are sites directly influenced by free water. They have visible vegetation or physical characteristics that reflect free water influence. Lake shores and stream banks are typical riparian areas. Excluded are sites such as ephemeral streams or washes that do not exhibit the presence of vegetation dependent upon free water in the soil. (3-20-20)T
34. **Security.** Collateral provided by an approved applicant to secure requested RCRDP funds. (3-20-20)T
35. **Special Practice.** A practice (not listed in the field office technical guide) that includes a proven, modern technique that is necessary to solve a resource problem and meet program objectives. (3-20-20)T

**011. ABBREVIATIONS.**

01. **RCRDP.** The Idaho Resource Conservation and Rangeland Development Program. (3-20-20)T
02. **NRCS.** United States Department of Agriculture Natural Resources Conservation Service. (3-20-20)T

**SUBCHAPTER A – RULES FOR ADMINISTRATION OF THE IDAHO RESOURCE CONSERVATION AND RANGELAND DEVELOPMENT PROGRAM**

**012. PROGRAM POLICY.**

01. **Administration.** It is the policy of the Commission to administer the Resource Conservation and Rangeland Development Program to provide the greatest benefits to all concerned from the agricultural lands and rangelands within the state. (3-20-20)T
02. **Equal Opportunity.** Each applicant regardless of handicap, race, age, sex, creed, color or national origin, must be given the opportunity to apply for a loan. (3-20-20)T
03. **Filing Applications.** An application may be filed at anytime during the program year. (3-20-20)T
04. **Use of Loan Money in Conjunction with State or Federal Programs.** Requests for state or federal cost-share assistance and for loan approval are handled by different governmental agencies and approval for one does not guarantee approval for the other. (3-20-20)T

**013. PROGRAM OBJECTIVES.**

- 01. Objectives.** The objectives of the RCRDP are to: (3-20-20)T
- a.** Conserve soil resources. (3-20-20)T
  - b.** Conserve water resources. (3-20-20)T
  - c.** Improve riparian areas for multiple use benefits. (3-20-20)T
  - d.** Protect or improve existing beneficial uses of the state’s waters. (3-20-20)T
  - e.** Conserve and improve fish and wildlife habitat. (3-20-20)T
  - f.** Increase agricultural productivity of cropland, orchards, pasture and hayland, rangeland, and woodland. (3-20-20)T

**02. Achieving Program Objectives.** Decisions concerning the use of program funds must be based on achievement of program objectives. The administration of the program must emphasize coordinated resource management planning and decision-making to ensure maximum benefit of funds. (3-20-20)T

**014. -- 055. (RESERVED)**

**056. RESPONSIBILITIES.**

- 01. District.** The local District must: (3-20-20)T
- a.** Receive the conservation plan for program participation. (3-20-20)T
  - b.** Within sixty (60) days of receipt, review and evaluate the conservation plan to determine if the project is consistent with the District’s program goals and objectives. (3-20-20)T
  - c.** Assign a priority of high, medium, or low to the project. (3-20-20)T
  - d.** Forward conservation plans to the Commission with a recommendation for funding. (3-20-20)T
  - e.** Prepare and forward to the Commission special practice requests. (3-20-20)T
  - f.** The local District may assign a priority to practices in the field office technical guide and have that priority ranking apply to all future projects seeking to implement the pre-ranked practices. The local District Board must consider pre-ranking practices at a scheduled Board meeting. The Board’s decision including the name and identification number of the practice(s), the assigned ranking and the recommendation for funding must be reflected in the meeting minutes and be forwarded to the Commission. (3-20-20)T
  - g.** If the local District does not review and evaluate a conservation plan within sixty (60) days of receipt, the Commission may review and evaluate the conservation plan and assign a priority ranking for the project based on the District’s five (5) year plan. (3-20-20)T

- 02. Commission.** The Commission must: (3-20-20)T
- a.** Review and evaluate applications. (3-20-20)T
  - b.** Approve loans, if: (3-20-20)T
    - i.** The applicant has adequate assets for security to protect the state from risk of loss. (3-20-20)T
    - ii.** There is reasonable assurance that the borrower can repay the loan. (3-20-20)T
    - iii.** Money is available in the RCRDP fund. (3-20-20)T

- c. Disapprove loans for reasons including but not limited to: (3-20-20)T
  - i. The purpose of the loan is to pay for conservation plan practices that have been implemented prior to Commission approval. (3-20-20)T
  - ii. If all the requirements in Paragraph 056.02.b. of these rules are not met. (3-20-20)T
- d. Reconsider loan disapproval if the applicant, within fifteen (15) business days after notice of disapproval, requests the Commission, in writing, to reconsider its determination in any matter affecting the loan or the amount of loan funds. Reconsideration of the determination must take place within ninety (90) business days from the date the written request is received at the time, place, and date determined by the Commission. The applicant must be notified of the time, place, and date and must have the right to appear. (3-20-20)T
- e. After loan approval, execute a promissory note and other security documents with the applicant for loan repayment. (3-20-20)T
- f. Not less than once per year, determine the loan interest rate not to exceed six percent (6%) annually. (3-20-20)T
- g. Prepare an annual report showing RCRDP accomplishments and benefits resulting from use of loan and grant funds. (3-20-20)T
- h. Administer and monitor loan proceeds to assure that the intent of the law is met. (3-20-20)T
- i. Approve or disapprove special practice requests. (3-20-20)T

**057. APPLICATION FOR LOAN.**

- 01. How to Apply.** Any applicant desiring a loan from the RCRDP fund must: (3-20-20)T
  - a. Prepare and submit a conservation plan. The conservation plan must be presented by the applicant (or representative appointed by the applicant) to the local District Board at a scheduled meeting unless the project includes only practices that have been pre-ranked by the local District in accordance with Paragraph 56.01.f. of these rules. If the project includes only pre-ranked practices, the applicant must submit the conservation plan to the Commission. (3-20-20)T
  - b. Prepare and submit a completed application. The application including all information required under Subsection 57.03 of these rules must be submitted to the Commission. (3-20-20)T
- 02. Two or More Applicants.** Two (2) or more applicants may install a practice(s) as a group providing the loan can be adequately collateralized and all parties agree to joint and several liability. (3-20-20)T
- 03. Application Form.** The application must be on a form prescribed by the Commission and include: (3-20-20)T
  - a. Name of applicant, and the location, size, and type of agricultural enterprise. (3-20-20)T
  - b. Identification and extent of the resource problem (erosion, plant community deterioration, water loss, water quality, low production, etc.). (3-20-20)T
  - c. Statement of applicant's objectives and expected benefits. (3-20-20)T
  - d. Estimate of costs of implementing the project and of total loan funds needed. (3-20-20)T
    - i. Applicant must be required to supply at least five percent (5%) of the total project costs through personal funds or in-kind services. (3-20-20)T

- ii. Total RCRDP loan funds combined with other funds cannot exceed ninety-five percent (95%) of total project costs. (3-20-20)T
- e. Applicant's statement of security offered. (3-20-20)T
- f. Applicant's statement of willingness to allow continued monitoring and evaluation of impacts resulting from applied land treatment and management practices. (3-20-20)T
- g. All documentation required under Subsection 101.03 of these rules and any other documentation requested by the Commission needed to determine whether there is reasonable assurance that the applicant can repay the loan. (3-20-20)T
- h. A copy of the applicant's conservation plan which becomes a part of the application for assistance. The conservation plan must include: (3-20-20)T
  - i. A map showing project location and extent of the resource problem. (3-20-20)T
  - ii. The eligible practices to be installed. (3-20-20)T
  - iii. Estimated costs of applying the practices. (3-20-20)T
  - iv. An implementation schedule. (3-20-20)T
  - v. A statement whereby the applicant agrees to properly maintain and operate installed practices. (3-20-20)T
  - vi. Needed clearances, easements and rights of way. (3-20-20)T
  - vii. Any other appropriate documentation needed to complete the implementation of the conservation plan as requested by the local District or Commission. (3-20-20)T

**058. SPECIAL PRACTICE(S) APPROVAL FOR LOANS.**

- 01. Special Practice Approval.** A special practice must be approved by the Commission before it becomes an eligible practice. (3-20-20)T
- 02. Special Practice Requests.** Special practice requests may be prepared by the local District or the Commission and must include: (3-20-20)T
  - a. A description of the proposed practice. (3-20-20)T
  - b. A justification of need for the special practice. (3-20-20)T
  - c. Standards and specifications for the proposed practice. (3-20-20)T
  - d. A statement from the appropriate agency as to the technical adequacy of the special practice in solving the resource problem. (3-20-20)T

**059. -- 080. (RESERVED)**

**081. ENCOURAGING PUBLIC BENEFITS WHEN INSTALLING PRACTICES.**

District Boards must encourage persons responsible for any aspect of performing practices to promote public benefit by improving or preserving environmental quality and ecological balance when the practices are being installed. Multiple objective achievement and total resource evaluation and treatment must receive high priority consideration for loan funds. When reviewing loan requests the following considerations must be made: (3-20-20)T

- 01. Preventing Degradation.** Preventing or abating pollution and other environmental degradation. (3-20-20)T
- 02. Benefiting the Community.** Benefiting the community by means such as outdoor recreational opportunities or enhancing the appearance of the area. (3-20-20)T
- 03. Benefiting Habitat.** Benefiting fish and wildlife habitat. (3-20-20)T

**082. -- 100. (RESERVED)**

**101. CREDIT GUIDELINES.**

**01. Standards for Acceptable Loans.** There must be adequate assets and collateral for security to protect the state from risk of loss. (3-20-20)T

**02. Required Documentation.** The applicant must provide documentation to the Commission sufficient to determine the applicant's ability and willingness to repay the loan. Such documentation may include: financial statements; balance sheets; profit and loss statements; driver's license; income tax returns; budgets; credit reports; estimates/quotes; deeds; leases; and other supporting documents as deemed necessary relative to the size, complexity, and financial responsibility of the individual or entity being financed. (3-20-20)T

**03. Duty to Inform.** After submitting the application and before funds are dispersed, the applicant must inform and provide documentation to the Commission of any significant change of circumstance that may impact their financial standing or ability to repay the loan. (3-20-20)T

**04. Field Inspections.** The Commission may require a field inspection in order to: (3-20-20)T

**a.** Determine loan and security positions, provide repayment estimates and verify assets. (3-20-20)T

**b.** Indicate the applicant's management ability. (3-20-20)T

**c.** Secure a complete and accurate description of collateral for the security agreement. (3-20-20)T

**05. Additional Information Required for Loans Secured with Real Estate.** Where real estate is offered as collateral the following information must be provided: (3-20-20)T

**a.** A legal description of the offered collateral. (3-20-20)T

**b.** Real estate appraisal, consisting of at least one (1) of the following: (3-20-20)T

**i.** Copy of appraisal made by a licensed professional appraiser approved by the Commission. (3-20-20)T

**ii.** Copy of the most recent property tax assessment. (3-20-20)T

**iii.** Evaluation made by Commission or the local District according to its knowledge of the estimated average value of the property in the area in which the project is to be implemented. (3-20-20)T

**c.** A map designating the location of the real estate. (3-20-20)T

**06. Other Collateral.** Any item having tangible value may be accepted as security for these loans. Condition of the collateral must be updated periodically and additions to the security agreement may be required over time. (3-20-20)T

**102. LOAN CLOSURE AND ADMINISTRATION.**

**01. Servicing and Documentation.** All loans must be assigned to a loan officer (Commission

employee) who must be responsible for servicing the loan. (3-20-20)T

**02. Loan Securing Documents.** Following approval of the application, the Commission, must prepare all necessary loan securing documents. (3-20-20)T

**03. Loan Note and Security Agreement.** The loan must be secured by utilizing a promissory note and security document listing the parties and the collateral, as well as terms and conditions of the loan. A mortgage or deed of trust must be executed and recorded with the county recorder where the collateral is located if the collateral is real property. A security agreement and any other necessary documents must be executed if the collateral is not real property. Appropriate financing statements must be executed and filed with the Secretary of State on all collateral consisting of personal property. (3-20-20)T

**04. Fund Obligation.** Funds must be obligated when all loan conditions established by the Commission have been met and when all necessary loan securing documents are in order and appropriately signed by the applicant. Funds will then be obligated. Upon notification of fund obligation, the applicant who is now the contractee, may complete implementation of the project. (3-20-20)T

**05. Cost Incurred.** The applicant is required to cover all costs incurred for loan closure, title insurance, and recording fees. (3-20-20)T

**103. IMPLEMENTATION OF AGREED TO PRACTICES.**

The applicant may, at their own risk, begin installing practices as identified and scheduled in the conservation plan provided the project is not completed before the loan is approved and the conditions of approval are met. Should the applicant choose to begin installing practices prior to the conditions of approval being met, the Commission may require additional title insurance to protect against intervening materialman's liens. The applicant/contractee has the responsibility to obtain appropriate technical assistance to ensure practices are properly designed, constructed, and managed. The applicant/contractee may install practices themselves or contract work out. Whatever method is used, the applicant/contractee is responsible to ensure the quality of materials and workmanship meets the approved standards and specifications for each practice. (3-20-20)T

**01. Practice Completion.** Upon completion of the scheduled practice the applicant/contractee must notify the provider of technical assistance. The provider of technical assistance must inspect and document the amount and extent of the installed practice and certify its completion if it meets the quality standards and construction specifications of the practice and notify the applicant/contractee. If the practice does not meet practice standards and specifications the applicant/contractee must be notified by the provider of technical assistance, in writing, of the deficiencies and what needs to be done so the practice meets standards and specifications. (3-20-20)T

**02. Submitting Vouchers and Bills.** (3-20-20)T

**a.** The provider of technical assistance must provide a written certification of completion of the project to the Commission. The applicant/contractee must submit invoices, vouchers and bills for the project to the Commission. (3-20-20)T

**b.** Up to ninety-five percent (95%) of loan funds can be disbursed toward submitted bills during the loan installment period. The remaining loan funds will be disbursed upon receipt of written certification of project completion from the provider of technical assistance. (3-20-20)T

**03. Warrant Requests.** The Commission staff must prepare warrant request(s). The warrant(s) are paid to the order of the contractee(s) and the vendor, and are mailed to the contractee. (3-20-20)T

**04. Drawing Loan Funds.** The applicant/contractee must implement the practices as scheduled and the contractee may draw loan funds in multiple disbursements during installation of the project. (3-20-20)T

**104. -- 125. (RESERVED)**

**126. REPAYMENT OF LOAN.**

**01. Repayment of the Loan.** Repayment of the loan, together with interest, must commence no later than two (2) full years from the date the note is signed. (3-20-20)T

**02. Repayment Schedule.** The repayment schedule must be identified in the loan documents with a fifteen (15) year maximum loan period. One (1) month before payment is due, the commission will mail the contractee a notice of payment due. (3-20-20)T

**03. First Payment.** The first payment is due as required on the signed loan documents as prepared by the Commission. Any additional interest incurred during the installment period of the loan will be added to the first payment notice. (3-20-20)T

**127. FORECLOSURE.**

In the event of a contractee not adhering to the payment terms and conditions of the mortgage, promissory note, or security agreement, the Commission may seek foreclosure according to the laws of the state of Idaho. (3-20-20)T

**128. -- 150. (RESERVED)**

**151. LOAN POLICIES.**

The maximum amount of any one (1) loan is six hundred thousand dollars (\$600,000). (3-20-20)T

**152. -- 199. (RESERVED)**

**SUBCHAPTER B – RULES FOR ALLOCATION OF FUNDS TO CONSERVATION DISTRICTS**

**200. ALLOCATION OF FUNDS TO DISTRICTS.**

**01. Base Funding.** The Commission shall determine the dollar amount to allocate equally to conservation districts on an annual basis. As soon as practicable after the start of the fiscal year, the Commission shall immediately distribute base funding to the districts that submitted the required documents during the previous fiscal year. (3-20-20)T

**02. Match Funding.** Following determination of base funding, the Commission shall review and approve the additional amount of state appropriations available for proportional allocation to each district in match funding. The amount of match funding allocated will be based upon local funds and services received in the previous fiscal year by each conservation district for the general purposes of the district. Funds received for special projects, used as required match for specific grants or projects, or on a fee-for-service basis will not be used to calculate match funding. Once the required documents for match funding are submitted and determined to be complete, the Commission shall distribute match funding to each district as soon as practicable. (3-20-20)T

**03. Required Documents.** The Commission may require submission of certain documents prior to allocation of base and match funding to districts. These documents may include five (5) year plans, financial and match reports, and performance reports. (3-20-20)T

**a.** The Board of Supervisors shall certify in writing that the district has examined all documentation submitted and that the statements and representations in the documents are true and accurate. (3-20-20)T

**b.** The district shall submit any required documents by a date established by the Commission. (3-20-20)T

**04. State Budget Requests.** The Commission shall conduct a public hearing to consider the needs of the conservation districts on or before June 15th of each year, giving twenty (20) days' written notice of the hearing to each conservation district and to all other persons requesting notice of the hearing. The Commission shall hear and consider testimony at the hearing and all information submitted by the districts prior to submission of the annual budget request to the legislature and governor based upon the criteria of Subsection 010.19 of this rule. (3-20-20)T

**201. -- 999. (RESERVED)**

# Sections Affected Index

---

## **IDAPA 01 – BOARD OF ACCOUNTANCY**

### ***Docket No. 01-0101-2000F (Fee Rule)***

#### *01.01.01 – Idaho Accountancy Rules*

000. Legal Authority (Rule 000).....	22
001. Title And Scope (Rule 001).....	22
002. -- 003. (Reserved).....	22
004. Incorporation By Reference (Rule 004).....	22
005. -- 009. (Reserved).....	22
010. Definitions (Rule 010).....	22
011. -- 017. (Reserved).....	23
018. Compliance With These Rules (Rule 018).....	23
019. Computation Of Time (Rule 019).....	23
020. Good Moral Character (Rule 020).....	23
021. Notification Of Change Of Address, Felony Charges, Or Actions Taken (Rule 021).....	23
022. -- 099. (Reserved).....	24
100. CPA Examination (Rule 100).....	24
101. Exam Applications (Rule 101).....	24
102. Authorization To Test And Notification To Schedule (Rule 102).....	24
103. Failure To Appear (Rule 103).....	24
104. CPA Exam Educational Qualifications (Rule 104).....	24
105. Testing Period And Credit (Rule 105).....	24
106. Cheating (Rule 106).....	24
107. Security And Irregularities (Rule 107).....	25
108. -- 199. (Reserved).....	25
200. Initial Certified Public Accountant Licensure (Rule 200).....	25
201. Annual License Renewal And Late Fee (Rule 201).....	26
202. Practice Privileges (Rule 202).....	26
203. Reciprocal Licensure (Rule 203).....	26
204. -- 299. (Reserved).....	27
300. Applicability Of Rules (Rule 300).....	27
301. Commissions And Contingent Fees (Rule 301).....	27
302. Confidential Client Information (Rule 302).....	28
303. Records (Rule 303).....	28
304. Firm Names (Rule 304).....	29
305. Communications (Rule 305).....	29
306. -- 399. (Reserved).....	29
400. CPE Basic Requirements (Rule 400).....	29
401. CPE Reporting, Controls, And Late Fees (RULE 405).....	30
402. CPE Exceptions, Extensions, And Exemptions (Rule 402).....	30
403. Review And Audit Of CPE Reports (Rule 403).....	30
404. Notification (Rule 404).....	30
405. Action (Rule 405).....	30
406. Reinstatement And Re-Entry (Rule 406).....	31
407. Formerly Licensed (Rule 407).....	31
408. Continuing Professional Education Committee (Rule 408).....	31
409. -- 499. (Reserved).....	31
500. Purpose Of Firm Registration And Peer Review (Rule 500).....	31
501. Issuance Of Reports And Form Of Practice (Rule 501).....	31
502. Peer Review Program Participation (Rule 502).....	31
503. Exemption From Participation (Rule 503).....	32
504. Scheduling Of The Peer Review (Rule 504).....	32



505. Minimum Standards (Rule 505).....	33
506. Reporting To The Board (Rule 506).....	33
507. Retention Of Documents Relating To Peer Reviews (Rule 507).....	33
508. Confidentiality (Rule 508).....	33
509. Remedies For Failure To Comply (Rule 509).....	33
510. Administering Organizations (Rule 510).....	34
511. Peer Review Oversight Committee (Rule 511).....	34
512. -- 599. (Reserved).....	35
600. Fees (Rule 600).....	35
701. -- 999. (Reserved).....	35

**IDAPA 02 – DEPARTMENT OF AGRICULTURE**

**Docket No. 02-0000-2000F (Fee Rule)**

*02.01.04 – Rules Governing the Idaho Preferred® Promotion Program*

000. Legal Authority.....	40
001. Title And Scope.....	40
002. -- 009. (Reserved).....	40
010. Definitions.....	40
011. -- 014. (Reserved).....	41
015. Voluntary Program.....	41
016. -- 099. (Reserved).....	41
100. Application For Participation.....	41
101. Participation Duration And Renewal.....	41
102. -- 109. (Reserved).....	42
110. Participation Fees.....	42
111. Participation Privileges.....	42
112. -- 199. (Reserved).....	42
200. Product Qualification.....	42
201. -- 299. (Reserved).....	44
300. Logo.....	44
301. Special Promotional Activities.....	45
302. Other Idaho Promotion Programs.....	45
303. Distribution Of Promotional Material.....	45
304. -- 309. (Reserved).....	46
310. Self-Certification.....	46
311. Compliance.....	46
312. -- 314. (Reserved).....	46
315. Violation.....	46
316. -- 999. (Reserved).....	46

*02.01.05 – Rules Governing Certificates of Free Sale*

000. Legal Authority.....	47
001. Title And Scope.....	47
002. -- 009. (Reserved).....	47
010. Definitions.....	47
011. -- 099. (Reserved).....	47
100. Application For Certification - Procedures.....	47
101. -- 109. (Reserved).....	47
110. Applicant Requirements.....	47
111. -- 119. (Reserved).....	47
120. Special Requests.....	47
121. -- 299. (Reserved).....	47
300. Fees And Charges.....	48

301. -- 999. (Reserved).....	48
<i>02.02.07 – Rules Governing Bulk Permits and Retail Sale of Potatoes</i>	
000. Legal Authority.....	49
001. Title And Scope.....	49
002. -- 003. (Reserved).....	49
004. Incorporation By Reference.....	49
005. -- 119. (Reserved).....	49
120. Permit Fees.....	49
121. Application Form.....	49
122. Marketing Order.....	49
123. Request For Permit.....	49
124. -- 219. (Reserved).....	49
220. Inspections, Restrictions, And Identification Required.....	49
221. Lots Tagged Not For Sale -- Removal Thereof.....	50
222. Compliance Or Non-Compliance Certificate.....	50
223. Second Notice Action -- Non-Compliance.....	50
224. Bulk Lots Labeled Not For Sale -- Removal Thereof.....	50
225. Responsibility Of Permanent And Condition Defects.....	50
226. Restricting Standards To Tablestock Grades.....	50
227. -- 999. (Reserved).....	50
<i>02.02.11 – Rules Governing Eggs and Egg Products</i>	
000. Legal Authority.....	51
001. Title And Scope.....	51
002. -- 011. (Reserved).....	51
012. Grades And Standards.....	51
013. -- 049. (Reserved).....	52
050. Terms Descriptive Of Shell.....	52
051. -- 099. (Reserved).....	52
100. Terms Descriptive Of The Air Cell.....	52
101. -- 149. (Reserved).....	52
150. Terms Descriptive Of The White.....	52
151. -- 199. (Reserved).....	53
200. Terms Descriptive Of The Yolk.....	53
201. -- 249. (Reserved).....	53
250. General Terms.....	53
251. -- 299. (Reserved).....	54
300. Consumer Grades For Shell Eggs - General.....	54
301. -- 349. (Reserved).....	54
350. Grade Standards - Tolerances.....	54
351. -- 399. (Reserved).....	55
400. Additional Tolerances -- In Lots Of Two Or More Cases.....	55
401. -- 449. (Reserved).....	55
450. Summary Of Idaho Consumer Grades For Shell Eggs.....	55
451. -- 499. (Reserved).....	58
500. Egg Products And Breaking Operations.....	58
501. -- 549. (Reserved).....	58
550. Sanitation And Storage.....	58
551. -- 599. (Reserved).....	59
600. Egg Seals, Tax And Cartons.....	59
601. -- 999. (Reserved).....	61
<i>02.02.12 – Bonded Warehouse Rules</i>	

000. Legal Authority.....	62
001. Title And Scope.....	62
002. -- 009. (Reserved).....	62
010. Definitions.....	62
011. (Reserved).....	62
012. Licensing.....	62
013. -- 049. (Reserved).....	63
050. Receipting.....	63
051. -- 079. (Reserved).....	64
080. Forwarding Agricultural Commodities.....	64
081. -- 099. (Reserved).....	64
100. Office Records.....	64
101. -- 129. (Reserved).....	65
130. License Application And Conditions Of Issuance.....	65
131. Amount Of Bond, Irrevocable Letter Of Credit, Certificate Of Deposit, Or Single Bond.....	66
132. -- 149. (Reserved).....	66
150. Warehouses To Be Kept Clean.....	66
151. -- 179. (Reserved).....	66
180. Warehouseman Responsibilities.....	66
181. -- 199. (Reserved).....	67
200. Insurance Settlement.....	67
201. -- 229. (Reserved).....	67
230. Agricultural Commodities -- Warehouse Obligations.....	68
231. -- 299. (Reserved).....	68
300. Financial Statements.....	68
301. -- 329. (Reserved).....	68
330. Amending Tariff.....	68
331. -- 379. (Reserved).....	68
380. License -- Duration.....	68
381. -- 399. (Reserved).....	68
400. Insurance Deductible.....	68
401. -- 429. (Reserved).....	69
430. Additional Bonding Requirements.....	69
431. -- 479. (Reserved).....	69
480. Commodity Indemnity Fund.....	69
481. How Assessments Are To Be Calculated.....	69
482. Recordkeeping And Payment Schedule.....	70
483. Trust Funds.....	70
484. Penalties For Failure To Collect, Account For, Or Remit Assessments.....	70
485. Return Of Commodity Due To Failure.....	70
486. -- 500. (Reserved).....	70
501. NPE Contract Claims On The Fund.....	70
502. -- 999. (Reserved).....	71
<i>02.02.13 – Commodity Dealers’ Rules</i>	
000. Legal Authority.....	72
001. Title And Scope.....	72
002. -- 009. (Reserved).....	72
010. Definitions.....	72
011. Abbreviations.....	72
012. Licensing.....	72
013. -- 099. (Reserved).....	73
100. Office Records.....	73

101. -- 149. (Reserved).....	73
150. Inspection.....	73
151. -- 199. (Reserved).....	74
200. Licensing Application Format.....	74
201. -- 249. (Reserved).....	74
250. Records -- Separate.....	74
251. -- 299. (Reserved).....	74
300. Financial Statement.....	75
301. -- 349. (Reserved).....	75
350. Shipping Records.....	75
351. -- 399. (Reserved).....	75
400. Scale Tickets.....	75
401. -- 450. (Reserved).....	76
451. Amount Of Bond, Irrevocable Letter Of Credit, Certificate Of Deposit, Or Single Bond.....	76
452. -- 499. (Reserved).....	76
500. Commodity Indemnity Fund.....	76
501. NPE Contract Claims On The Fund.....	77
502. How Assessments Are To Be Calculated.....	77
503. Recordkeeping And Payment Schedule.....	77
504. Trust Funds.....	77
505. Penalties For Failure To Collect, Account For, Or Remit Assessments -- Other Violations.....	77
506. Return Of Commodity Due To Failure.....	78
507. -- 599. (Reserved).....	78
600. Unlawful Practices.....	78
601. -- 999. (Reserved).....	78
 <i>02.02.14 – Rules for Weights and Measures</i>	
000. Legal Authority.....	79
001. Title And Scope.....	79
002. -- 003. (Reserved).....	79
004. Incorporation By Reference.....	79
005. -- 009. (Reserved).....	79
010. Definitions.....	79
011. Abbreviations.....	82
012. License Required For Commercially-Used Weighing Or Measuring Instrument Or Device.....	82
013. License Application.....	82
014. Annual License Period.....	82
015. License Renewals.....	82
016. Maximum And Minimum License Fee Schedule For Commercially-Used Weighing And Measuring Instruments And Devices.....	82
017. Voluntary Inspection Of Weighing And Measuring Instruments And Devices, Fees.....	83
018. License Displayed.....	83
019. -- 099. (Reserved).....	83
100. Charges For Special Request Testing Or Examination.....	83
101. -- 149. (Reserved).....	84
150. Packaging And Labeling Rules.....	84
151. -- 169. (Reserved).....	84
170. Identity.....	84
171. Declaration Of Quantity -- Consumer Packages.....	85
172. Prescribed Units.....	86
173. Polyethylene Sheeting.....	88
174. Supplementary Declarations.....	89
175. -- 179. (Reserved).....	89

180. Declaration Of Quantity -- Non-consumer Packages .....	89
181. -- 199. (Reserved).....	90
200. Prominence And Placement -- Consumer Packages.....	90
201. -- 209. (Reserved).....	91
210. Prominence And Placement -- Non-consumer Packages General.....	91
211. -- 219. (Reserved).....	91
220. Requirements -- Specific Consumer Commodities, Packages, Containers.....	91
221. -- 229. (Reserved).....	92
230. Measurement Of Container-Type Commodities, How Expressed.....	92
231. -- 239. (Reserved).....	93
240. Textile Products, Threads, And Yarns.....	93
241. -- 249. (Reserved).....	95
250. Exemptions.....	95
251. -- 259. (Reserved).....	98
260. Variations To Be Allowed.....	98
261. -- 269. (Reserved).....	99
270. Misleading Packages.....	99
271. Advertising Packages For Sale.....	99
272. -- 299. (Reserved).....	99
300. Petroleum Products.....	99
301. -- 349. (Reserved).....	100
350. Sale And Labeling Of Gasoline Which Contains Oxygenates.....	100
351. Biodiesel.....	101
352. -- 399. (Reserved).....	101
400. Unattended Vending Machines.....	101
401. -- 449. (Reserved).....	101
450. Registration Of Servicemen And Service Agencies For Commercial Weighing And Measuring Devices.....	101
451. -- 499. (Reserved).....	103
500. Bread.....	103
501. -- 599. (Reserved).....	103
600. Single Draft Vehicle Weighing.....	103
601. -- 649. (Reserved).....	103
650. Rule For National Type Evaluation.....	103
651. -- 999. (Reserved).....	103
<i>02.02.15 – Rules Governing the Seed Indemnity Fund</i>	
000. Legal Authority.....	104
001. Title And Scope.....	104
002. -- 009. (Reserved).....	104
010. Definitions.....	104
011. Abbreviations.....	104
012. Delivery Voucher.....	104
013. Warehouse Receipts.....	104
014. Scale Weight Tickets.....	105
015. -- 025. (Reserved).....	105
026. License.....	105
027. -- 035. (Reserved).....	106
036. Amount Of Bond For Seed Stored For Withdrawal.....	106
037. Amount Of Bond, Irrevocable Letter Of Credit, Certificate Of Deposit, Or Single Bond.....	106
038. -- 046. (Reserved).....	106
047. Maintenance Of Records.....	106
048. -- 049. (Reserved).....	106

050. Insurance Requirements .....	106
051. -- 059. (Reserved).....	107
060. Noncompliance -- Requirements.....	107
061. -- 069. (Reserved).....	107
070. How Assessments Are To Be Calculated. ....	107
071. -- 079. (Reserved).....	108
080. Collection And Remittance Of SIF Assessments. ....	108
081. -- 089. (Reserved).....	108
090. Claim Forms And Payment From The Fund.....	108
091. -- 099. (Reserved).....	108
100. Exemptions. ....	108
101. -- 999. (Reserved).....	108
<i>02.03.03 – Rules Governing Pesticide and Chemigation Use and Application</i>	
000. Legal Authority. ....	109
001. Title And Scope.....	109
002. Written Interpretations.....	109
003. Administrative Appeal.....	109
004. Incorporation By Reference. ....	109
005. Address, Office Hours, Telephone, Fax Numbers, Web Address. ....	109
006. Public Records Act Compliance.....	109
007. -- 009. (Reserved).....	109
010. Definitions. ....	109
011. -- 049. (Reserved).....	111
050. Private Applicator Licensing.....	111
051. -- 099. (Reserved).....	112
100. Licensing Professional Applicators And Pesticide Dealers.....	112
101. Registration And Licensing Requirements For Use Of The LPC. ....	117
102. -- 149. (Reserved).....	119
150. Records Requirements.....	119
151. -- 199. (Reserved).....	121
200. Fees.....	121
201. -- 249. (Reserved).....	121
250. Financial Responsibility.....	121
251. -- 299. (Reserved).....	122
300. Deviations From Pesticide Labels And Labeling.....	122
301. -- 320. (Reserved).....	122
321. Change Of License Status.....	122
322. (Reserved).....	122
323. Pesticide-Fertilizer Mix Restrictions.....	122
324. Experimental Permits.....	122
325. -- 399. (Reserved).....	123
400. Restrictions To Protect Pollinators.....	123
401. -- 449. (Reserved).....	124
450. Storage Of Pesticide Containers.....	124
451. -- 499. (Reserved).....	124
500. Non-Domestic Pesticides.....	125
501. -- 549. (Reserved).....	125
550. Phenoxy Herbicide Restrictions.....	125
551. -- 799. (Reserved).....	125
800. Pesticide Use On Seed Crop Fields.....	125
801. -- 849. (Reserved).....	126
850. Unusable Pesticides Collection And Disposal.....	126

851. -- 960. (Reserved).....	127
961. General Chemigation Requirements.....	127
962. Irrigation Systems.....	127
963. Chemical Injection Line Shut Down (System Interlock).....	128
964. Injection Line Check Valve.....	130
965. Chemical Injection System.....	130
966. Irrigation Line Check Valve.....	131
967. Gooseneck Pipe Loop, Downhill And Over-A-Hill.....	132
968. Vacuum Relief Valve Or Combination Air And Vacuum Relief Valve.....	132
969. Inspection Port.....	132
970. Automatic Low Pressure Drain.....	132
971. Variances.....	133
972. -- 999. (Reserved).....	133
<i>02.04.03 – Rules Governing Animal Industry</i>	
000. Legal Authority.....	134
001. Title And Scope.....	134
002. -- 010. (Reserved).....	134
011. Abbreviations.....	134
012. -- 103. (Reserved).....	134
104. Incorporation By Reference.....	134
110. Definitions.....	134
111. Abbreviations.....	136
112. -- 113. (Reserved).....	137
114. Samples For Official Regulatory Tests.....	137
115. Quarantine.....	137
116. -- 119. (Reserved).....	137
120. Disinfection Of Premises, Buildings And Vehicles.....	137
121. -- 124. (Reserved).....	138
125. Transit Inspection.....	138
126. -- 129. (Reserved).....	138
130. Slaughtering Of Diseased Animals.....	138
131. -- 139. (Reserved).....	138
140. Inspection Of Animals.....	138
141. -- 144. (Reserved).....	138
145. Certificates Of Veterinary Inspection.....	138
146. -- 149. (Reserved).....	138
150. State And Federal Seals.....	138
151. Notification Of Broken Seals.....	138
152. Livestock Identification Removal.....	139
153. -- 199. (Reserved).....	139
200. Artificial Insemination.....	139
201. -- 209. (Reserved).....	139
210. Cancer Eye - Epithelioma.....	139
211. Epithelioma -- Public Livestock Markets.....	140
212. -- 219. (Reserved).....	140
220. Rabies.....	140
221. -- 229. (Reserved).....	140
230. Biologicals.....	140
231. -- 239. (Reserved).....	140
240. Poultry And Ratites.....	140
241. Record Requirements.....	140
242. Inspections.....	140

243. NPIP Certificates Of Participation .....	141
244. -- 249. (Reserved) .....	141
250. Equidae -- Equine Infectious Anemia .....	141
251. EIA Is A Reportable Disease .....	141
252. EIA Infected Animals .....	141
253. Disposition Of EIA Reactors .....	141
254. Isolation Of EIA Reactors .....	142
255. Identification Of EIA Reactors .....	142
256. Exposed Equidae .....	142
257. Extended Validity Equine Certificates .....	142
258. -- 299. (Reserved) .....	142
300. Foreign Animal And Reportable Diseases .....	142
301. Foreign Animal And Reportable Diseases: Multiple Species .....	142
302. Foreign Animal And Reportable Diseases - Avian Diseases .....	143
303. Foreign Animal And Reportable Diseases - Bovine Diseases .....	143
304. Foreign Animal And Reportable Diseases - Cervidae Diseases .....	144
305. Foreign Animal And Reportable Diseases - Equine Diseases .....	144
306. Foreign Animal And Reportable Diseases - Fish Diseases .....	144
307. Foreign Animal And Reportable Diseases - Lagomorph Diseases .....	144
308. Foreign Animal And Reportable Diseases - Sheep And Goat Diseases .....	144
309. Foreign Animal And Reportable Diseases - Swine Diseases .....	144
310. -- 329. (Reserved) .....	145
330. Notifiable Diseases .....	145
331. Notifiable Diseases: Mixed Species Diseases .....	145
332. Notifiable Diseases: Avian Diseases .....	145
333. Notifiable Diseases: Bovine Diseases .....	145
334. Notifiable Diseases: Equine Diseases .....	145
335. Notifiable Diseases: Fish Diseases .....	145
336. Notifiable Diseases: Lagomorph Diseases .....	145
337. Notifiable Diseases: Sheep And Goat Diseases .....	145
338. Notifiable Diseases: Swine Diseases .....	146
339. -- 359. (Reserved) .....	146
360. Actinomycosis (Lump Jaw) .....	146
361. -- 399. (Reserved) .....	146
400. Garbage Feeding .....	146
401. Pseudorabies -- Procedures For Control And Eradication .....	146
402. Pseudorabies Vaccine .....	147
403. Vaccinated Swine .....	147
404. -- 419. (Reserved) .....	147
420. Eradication Methods .....	147
421. -- 429. (Reserved) .....	147
430. Identification Of Infected Swine .....	147
431. Identification Of Exposed Swine .....	147
432. -- 449. (Reserved) .....	147
450. Qualified Pseudorabies-Negative Herds .....	147
451. -- 459. (Reserved) .....	147
460. Cleaning And Disinfection .....	147
461. -- 503. (Reserved) .....	147
504. Incorporation By Reference .....	148
510. Definitions .....	148
511. -- 520. (Reserved) .....	149
521. Circumstances Of An Animal Health Emergency .....	149



522.	Declaration Of An Animal Health Emergency. ....	149
523.	Quarantine Authority. ....	149
524.	Utilization Of Vaccination In Animal Health Emergencies. ....	149
525. -- 529.	(Reserved).....	149
530.	Quarantine Procedures For An Animal Health Emergency.....	149
531.	Quarantine Area.....	149
532.	Quarantine Area Security.....	150
533.	Quarantine Area Bio-Security.....	150
534.	Animal Movement In Quarantine Area.....	150
535.	Sale Of Diseased Or Exposed Animals Not Allowed.....	150
536.	Exposure Of Another's Animals Not Allowed.....	150
537.	Movement Or Sale Of Animal Products.....	150
538. -- 539.	(Reserved).....	150
540.	Restrictions On Animals From Areas Or States Affected By Emergency Diseases.....	150
541.	Animals In Transit At Time Of Declared Emergency.....	150
542. -- 549.	(Reserved).....	150
550.	Condemnation Of Infected, Exposed, Or Susceptible Animals.....	150
551. -- 559.	(Reserved).....	150
560.	Depopulation Of Animals.....	151
561.	Method Of Depopulation.....	151
562.	Time Limit For Depopulation.....	151
563. -- 569.	(Reserved).....	151
570.	Compensation For Appraised Animals.....	151
571.	Compensation For Animals Destroyed.....	151
572.	Appraisal Procedure For Animals Depopulated.....	151
573.	Time Limit For Appraisal.....	151
574. -- 579.	(Reserved).....	151
580.	Compensation For Labor Employed.....	151
581.	Compensation For Property Destroyed.....	151
582. -- 589.	(Reserved).....	152
590.	Cleaning And Disinfection Of Premises.....	152
591.	Cleaning And Disinfection Of Animal Conveyance.....	152
572. -- 999.	(Reserved).....	152
 <i>02.04.05 – Rules Governing Grade A Milk And Manufacture Grade Milk</i>		
000.	Legal Authority.....	153
001.	Title And Scope.....	153
002. -- 103.	(Reserved).....	153
104.	Incorporation By Reference.....	153
105.	Regulatory Framework.....	153
106. -- 119.	(Reserved).....	153
120.	grade A Milk and Milk Products Quality Standards.....	153
121. -- 209.	(Reserved).....	154
210.	Definitions.....	154
211 - 219.	(Reserved).....	155
220.	Milk And Cream Procurement And Testing Requirements.....	155
221.	Laboratory Licensing Requirements.....	155
222 - 229.	(Reserved).....	155
230.	Official Laboratories - Responsibilities And Operating Procedures.....	155
231.	Third Party Laboratories.....	156
232. - 239.	(Reserved).....	156
240.	Milk Component Testing Devices.....	156
241.	Calibration Of Milk Component Testing Devices.....	156

242. Daily Performance Checks.....	157
243. Accuracy Checks.....	157
244 - 249. (Reserved).....	158
250. Sample Integrity.....	158
251. -- 259. (Reserved).....	158
260. Abnormal Tests.....	158
261. -- 269. (Reserved).....	158
270. Detailed Pricing Description.....	158
271. -- 279. (Reserved).....	159
280. Regulatory Compliance - Inspections And Records Review.....	159
281. Regulatory Samples.....	159
282. License Suspension And Revocation Based On Regulatory Samples.....	160
283. -- 289. (Reserved).....	161
290. Record Keeping.....	161
291. Enforcement.....	161
292. -- 303. (Reserved).....	161
304. Incorporation By Reference.....	162
305. -- 309. (Reserved).....	162
310. Definitions.....	162
311. -- 319. (Reserved).....	163
320. Raw Manufacture grade Milk Or Cream.....	163
321. Quality Requirements For Milk For Manufacturing Purposes.....	164
322. -- 329. (Reserved).....	165
330. Bacterial Estimate Classification.....	165
331. -- 339. (Reserved).....	166
340. Rejected Milk.....	166
341. Excluded Milk.....	166
342. -- 349. (Reserved).....	166
350. Records Of Tests.....	166
351. Somatic Cell Count.....	166
352. Drug Residue Level.....	167
353. Radionuclides.....	168
354. Pesticides And Herbicides.....	168
355. Added Water.....	169
356. -- 359. (Reserved).....	169
360. Farm Requirements Of Milk For Manufacturing.....	169
361. -- 369. (Reserved).....	171
370. Dairy Farm Certification.....	171
371. -- 379. (Reserved).....	172
380. Standards For Bulk Milk Haulers.....	172
381. -- 389. (Reserved).....	173
390. Standards Of Identity, Labeling, And Quality Standards For Ice Cream And Frozen Dairy Products And Desserts.....	173
391. Standards For Butter.....	174
392. Standards For Whey Butter.....	174
393. -- 394. (Reserved).....	178
395. New Dairy Products.....	178
396. -- 403. (Reserved).....	178
404. Incorporation By Reference.....	178
405. -- 999. (Reserved).....	178
 <i>02.04.19 – Rules Governing Domestic Cervidae</i>	
000. Legal Authority.....	179

001. Title And Scope.....	179
002. -- 003. (Reserved).....	179
004. Incorporation By Reference.....	179
005. -- 009. (Reserved).....	179
010. Definitions.....	179
011. Abbreviations.....	182
012. Applicability.....	183
013. AZA Accredited Facilities And USDA Licensed Facilities.....	183
014. Importation Of Domestic Cervidae.....	183
015. -- 019. (Reserved).....	183
020. Location Of Domestic Cervidae.....	183
021. Official Identification.....	184
022. Types Of Official Identification.....	184
023. National CWD Herd Certification Program Official Identification.....	185
024. -- 029. (Reserved).....	185
030. Official Visible Identification.....	185
031. Reidentification Of Domestic Cervidae.....	185
032. -- 039. (Reserved).....	186
040. Inspections.....	186
041. -- 049. (Reserved).....	186
050. Genetics.....	186
051. -- 059. (Reserved).....	186
060. Wild Cervidae.....	186
061. -- 069. (Reserved).....	186
070. Supervision Of Domestic Cervidae Program.....	186
071. -- 079. (Reserved).....	186
080. Disposal Of Domestic Cervidae.....	186
081. -- 089. (Reserved).....	187
090. Fees.....	187
091. -- 099. (Reserved).....	187
100. Domestic Cervidae Ranches.....	187
101. Domestic Cervidae Ranch Facility Requirements.....	187
102. Perimeter Fence Requirements.....	187
103. Gathering And Restraining System.....	188
104. Water System.....	188
105. Quarantine Facility.....	188
106. -- 199. (Reserved).....	189
200. Records And Reporting.....	189
201. Annual Inventory Report.....	189
202. Inventory Verification.....	189
203. Change Of Address.....	189
204. Escape Of Domestic Cervidae.....	190
205. Notice Of Death Of Domestic Cervidae.....	190
206. (Reserved).....	191
207. Notification Of Exposure To Disease.....	191
208. Intrastate Movement Certificate.....	191
209. Ranch Management Plan.....	191
210. -- 249. (Reserved).....	192
250. Intrastate Movement Of Domestic Cervidae.....	192
251. -- 299. (Reserved).....	192
300. Disease Control.....	192
301. Duty To Restrain.....	193

302. Testing Methods.....	193
303. Testing, Treatment, Quarantine, Or Disposal Required.....	193
304. Quarantines.....	193
305. Declaration Of Animal Health Emergency.....	193
306. -- 399. (Reserved).....	193
400. Brucellosis.....	193
401. -- 449. (Reserved).....	193
450. Tuberculosis.....	194
451. -- 499. (Reserved).....	194
500. Surveillance For CWD.....	194
501. Collection Of Samples For CWD Testing.....	194
502. Official CWD Tests.....	195
503. CWD Status.....	195
504. Investigation Of CWD.....	196
505. Duration Of CWD Quarantine.....	196
506. Cleaning, Treating, Decontaminating, Or Disinfecting.....	197
507. -- 999. (Reserved).....	197
 <i>02.04.26 – Rules Governing the Public Exchange of Livestock</i>	
000. Legal Authority.....	198
001. Title And Scope.....	198
002. -- 109. (Reserved).....	198
110. Definitions.....	198
111. Abbreviations.....	199
112. -- 119. (Reserved).....	199
120. Applicability.....	199
121. -- 129. (Reserved).....	199
130. Inspections.....	199
131. -- 139. (Reserved).....	200
140. Livestock Treatment.....	200
141. -- 149. (Reserved).....	200
150. Dead Animal Disposal.....	200
151. -- 159. (Reserved).....	200
160. Environmental Requirements.....	200
161. -- 199. (Reserved).....	200
200. Livestock Dealers.....	200
201. -- 209. (Reserved).....	200
220. Content Of Records.....	200
221. -- 229. (Reserved).....	201
230. Records Retention.....	201
231. -- 239. (Reserved).....	201
240. Approved Forms Of Identification.....	201
241. -- 299. (Reserved).....	201
300. Approved Buying Stations.....	201
301. Application For Designation As An Idaho Approved Buying Station.....	201
302. Administrator Approval.....	201
303. Approved Buying Station Number.....	201
304. Expiration Of Approved Status.....	201
305. Revocation Of Approved Buying Station Status.....	202
306. Disposition Of Cattle.....	202
307. -- 314. (Reserved).....	202
315. Identification.....	202
316. -- 319. (Reserved).....	202

320. Buying Station Records.....	202
321. Content Of Records -- Buying Stations.....	202
322. Buying Station Records Retention.....	203
323. -- 329. (Reserved).....	203
330. Cattle Subject To Quarantine -- Buying Stations.....	203
331. -- 339. (Reserved).....	203
340. Premises Requirements.....	203
341. -- 349. (Reserved).....	203
350. Sanitation.....	203
351. -- 359. (Reserved).....	203
360. Signage.....	203
361. -- 369. (Reserved).....	204
370. Location Of Buying Stations.....	204
371. -- 499. (Reserved).....	204
500. Approved Livestock Trader Lots.....	204
501. Application For Approved Livestock Trader Lot Status.....	204
502. Administrator Approval.....	204
503. Approved Livestock Trader Lot Number.....	204
504. Expiration Of Approved Status.....	204
505. -- 519. (Reserved).....	204
520. Identification.....	204
521. Approved Forms Of Identification.....	205
522. Content Of Records For Approved Livestock Trader Lots.....	205
523. Trader Lot Records Retention.....	205
524 -- 529. (Reserved).....	205
530. Cattle Subject To Quarantine -- Trader Lots.....	206
531. -- 539. (Reserved).....	206
540. Removal Requirements.....	206
541. Livestock Dealer's Duty.....	206
542. -- 549. (Reserved).....	206
550. Livestock Trader Lot Premises.....	206
551. -- 559. (Reserved).....	206
560. Sanitation.....	206
561. -- 569. (Reserved).....	206
570. Revocation Of Approved Status.....	206
571. -- 603. (Reserved).....	207
604. Incorporation By Reference.....	207
605. -- 609. (Reserved).....	207
610. Definitions.....	207
611. -- 629. (Reserved).....	208
630. Inspections.....	208
631. -- 639. (Reserved).....	208
640. Livestock Treatment.....	208
641. -- 649. (Reserved).....	209
650. Dead Animal Disposal.....	209
651. -- 659. (Reserved).....	209
660. Environmental Requirements.....	209
661. -- 699. (Reserved).....	209
700. Public Livestock Market Charter.....	209
701. Public Livestock Market Minimum Sale Requirement.....	209
702. -- 709. (Reserved).....	209
710. Market Release.....	209

711. -- 714. (Reserved).....	209
715. Bio-Security Plan.....	209
716. -- 719. (Reserved).....	210
720. Identification.....	210
721. Approved Forms Of Identification.....	210
722. -- 729. (Reserved).....	210
730. Quarantine Pens.....	210
731. -- 749. (Reserved).....	211
750. Restraint Facilities.....	211
751. -- 759. (Reserved).....	211
760. Sanitary Conditions.....	211
761. -- 769. (Reserved).....	211
770. Records.....	211
771. -- 999. (Reserved).....	211
 <i>02.04.32 – Rules Governing Poultry Operations</i>	
000. Legal Authority.....	212
001. Title And Scope.....	212
002. Written Interpretations.....	212
003. Administrative Appeal.....	212
004. Incorporation By Reference.....	212
005. Address, Office Hours, Telephone, Fax Numbers, Web Address.....	212
006. Idaho Public Records Act.....	212
007. -- 009. (Reserved).....	212
010. Definitions.....	212
011. Abbreviations.....	213
012. -- 109. (Reserved).....	213
110. Permit Application.....	213
111. -- 129. (Reserved).....	215
130. Permit Conditions.....	215
131. -- 139. (Reserved).....	216
140. Fees And Assessments.....	216
141. -- 149. (Reserved).....	216
150. Permit Modification.....	216
151. -- 159. (Reserved).....	216
160. Transfer Of Permits.....	216
161. -- 199. (Reserved).....	217
200. Waste Storage And Containment Facilities.....	217
201. -- 249. (Reserved).....	218
250. Nutrient Management.....	218
251. Nutrient Management Plan Retention.....	218
252. Nutrient Management Records.....	218
253. NMP Violations.....	218
254. -- 259. (Reserved).....	219
260. Ground Water Quality Monitoring.....	219
261. -- 299. (Reserved).....	219
300. Prohibited Discharges.....	219
301. -- 309. (Reserved).....	219
310. Notification Of Discharge.....	219
311. -- 499. (Reserved).....	219
500. Inspections.....	219
501. -- 549. (Reserved).....	219
550. Violations.....	219

551. -- 999. (Reserved)..... 219

*02.06.01 – Rules Governing the Production and Distribution of Seed*

000. Legal Authority..... 220

001. Title And Scope..... 220

002. -- 109. (Reserved)..... 220

110. Definitions..... 220

111. (Reserved) 220

112. Methods Of Sampling -- General Procedure..... 220

113. -- 119. (Reserved)..... 221

120. Germination Standards For vegetable seeds..... 221

121. -- 129. (Reserved)..... 222

130. Germination Standards For Flower Seeds..... 223

131. -- 139. (Reserved)..... 228

140. Germination Standards For Seed In Hermetically Sealed Containers..... 228

141. -- 149. (Reserved)..... 230

150. Noxious Weeds..... 230

151. -- 159. (Reserved)..... 233

160. Label Requirements Of Seeds For Sprouting..... 233

161. -- 169. (Reserved)..... 233

170. Viability By TZ%..... 233

171. -- 179. (Reserved)..... 233

180. Methods Of Testing..... 233

181. -- 189. (Reserved)..... 233

190. Service Testing Fees -- Purity, Germination And Tetrazolium Fees..... 233

191. Service Testing Fees -- Special Tests..... 235

192. Service Testing Fees -- Miscellaneous Fees..... 236

193. -- (Reserved)..... 236

194. Seed Dealer's License Fees..... 236

195. -- 209. (Reserved)..... 237

210. Definitions..... 237

211. (Reserved)..... 238

212. Production Districts..... 238

213. -- 219. (Reserved)..... 238

220. Restrictions..... 238

221. -- 229. (Reserved)..... 238

230. Requirements For All Brassica Seeds To Be Planted In Idaho..... 238

231. -- 239. (Reserved)..... 239

240. Rapeseed Growing Outside Cultivated Fields Enforcement And Penalties..... 239

241. -- 249. (Reserved)..... 239

250. Transportation Of Brassica Seeds Into And Throughout Idaho..... 239

251. -- 309. (Reserved)..... 239

310. Definitions..... 239

311. -- 319. (Reserved)..... 240

320. Annual Bluegrass Regulated Area..... 240

321. Rough Bluegrass Regulated Area..... 240

322. Rough Bluegrass Quarantine – Restrictions..... 240

323. -- 329. (Reserved)..... 240

330. Regulated Articles..... 240

331. -- 339. (Reserved)..... 240

340. Rules Governing Planting Of Regulated Articles (Annual Bluegrass)..... 240

341. Qualifications Of Regulated Articles For Quarantine Release (Rough Bluegrass)..... 241

342. -- 349. (Reserved)..... 241

350. Infested Seed Stock (Annual Bluegrass) .....	241
351. Rough Bluegrass Quarantine - Inspections .....	241
352. -- 359. (Reserved).....	241
360. Application For Nursery Inspection .....	241
361. -- 369. (Reserved).....	241
370. Exemptions (Annual Bluegrass).....	241
371. Exemptions (Rough Bluegrass) .....	242
372. -- 379. (Reserved).....	242
380. Fees And Charges .....	242
381. -- 999. (Reserved).....	242
<i>02.06.02 – Rules Governing Registrations And Licenses</i>	
000. Legal Authority .....	243
001. Title And Scope.....	243
002. -- 103. (Reserved).....	243
104. Incorporation By Reference .....	243
105. -- 109. (Reserved).....	243
110. Definitions And Terms .....	243
111. -- 114. (Reserved).....	244
115. Registration And Fees.....	244
116. -- 119. (Reserved).....	244
120. Label Format .....	244
121. -- 124. (Reserved).....	246
125. Brand And Product Names .....	246
126. -- 129. (Reserved).....	246
130. Expression Of Guarantees .....	246
131. -- 134. (Reserved).....	246
135. Non-Protein Nitrogen .....	246
136. -- 139. (Reserved).....	247
140. Drug And Feed Additives .....	247
141. -- 144. (Reserved).....	247
145. Adulterants .....	247
146. -- 149. (Reserved).....	248
150. Adoptions And Promulgation.....	248
151. -- 159. (Reserved).....	248
160. Cottonseed .....	248
161. -- 169. (Reserved).....	249
170. Cottonseed -- Exemptions.....	249
171. -- 179. (Reserved).....	249
180. Detained Commercial Feeds.....	249
181. -- 211. (Reserved).....	250
212. Special Service .....	250
213. -- 219. (Reserved).....	250
220. Shipping Permit Number .....	250
221. -- 309. (Reserved).....	251
310. Definitions .....	251
311. -- 314. (Reserved).....	251
315. Regulated Bee Diseases .....	251
316. -- 329. (Reserved).....	251
330. Regulated Products And Related Equipment.....	251
331. -- 339. (Reserved).....	251
340. Registration And Collection Of Fees .....	251
341. -- 349. (Reserved).....	251



350. Inspection Procedures.....	251
351. -- 359. (Reserved).....	252
360. Duty Of Owner Of Bees.....	252
361. -- 369. (Reserved).....	252
370. Fees And Charges.....	252
371. -- 403. (Reserved).....	252
404. Incorporation By Reference.....	252
405. -- 409. (Reserved).....	253
410. Definitions.....	253
411. -- 419. (Reserved).....	253
420. Sampling And Analysis.....	253
421. -- 429. (Reserved).....	253
430. Rules Regarding The Registration Of Fertilizers Containing Plant Nutrients In Addition To Nitrogen, Phosphate, And Potash.....	253
431. -- 439. (Reserved).....	254
440. Warning Or Caution Statements.....	254
441. -- 449. (Reserved).....	255
450. Fertilizer Labels.....	255
451. -- 454. (Reserved).....	256
455. Product Registration.....	256
456. -- 459. (Reserved).....	256
460. Slowly Released Plant Nutrients.....	256
461. -- 469. (Reserved).....	257
470. Investigational Allowances.....	257
471. -- 479. (Reserved).....	260
480. Itemization Of Plant Food Elements Within The Guaranteed Analysis.....	260
481. -- 489. (Reserved).....	261
490. Organic Nitrogen.....	261
491. -- 503. (Reserved).....	261
504. Incorporation By Reference.....	261
505. -- 509. (Reserved).....	261
510. Definitions.....	261
511. Abbreviations.....	262
512. -- 519. (Reserved).....	262
520. Soil Amendment And Plant Amendment Registration.....	262
521. -- 529. (Reserved).....	262
530. Soil Amendment And Plant Amendment Labels.....	262
531. -- 539. (Reserved).....	264
540. Sampling And Analysis.....	264
541. -- 999. (Reserved).....	264
<i>02.06.04 – Rules Governing Plant Exports</i>	
000. Legal Authority.....	265
001. Title And Scope.....	265
002. -- 109. (Reserved).....	265
110. Definitions.....	265
111. -- 119. (Reserved).....	265
120. Designated Inspection Areas.....	265
121. -- 129. (Reserved).....	266
130. Crop/Commodity, Disease And Pest(s) Inspections.....	266
131. -- 139. (Reserved).....	267
140. Application For Inspection - Procedures.....	267
141. -- 149. (Reserved).....	267

150. Inspection Authority.....	267
151. -- 159. (Reserved).....	267
160. Inspection Procedures.....	267
161. -- 169. (Reserved).....	268
170. Procedure For Obtaining Phytosanitary Certificates.....	268
171. -- 179. (Reserved).....	268
180. Size Of Samples.....	268
181. -- 189. (Reserved).....	268
190. Post-entry Quarantine Certification.....	268
191. -- 194. (Reserved).....	268
195. Fees And Charges.....	268
196. -- 209. (Reserved).....	270
210. Definitions.....	270
211. -- 219. (Reserved).....	271
220. Requirements.....	271
221. -- 229. (Reserved).....	272
230. Scion-Blocks.....	272
231. -- 234. (Reserved).....	272
235. Seed-Blocks.....	272
236. -- 239. (Reserved).....	272
240. Stool-Beds.....	272
241. -- 244. (Reserved).....	273
245. Nursery Stock.....	273
246. -- 249. (Reserved).....	273
250. Block Expansion.....	273
251. -- 259. (Reserved).....	273
260. Inspection Procedures.....	273
261. -- 264. (Reserved).....	274
265. Testing Procedures.....	274
266. -- 269. (Reserved).....	274
270. Tagging, Identity, And Records.....	274
271. -- 279. (Reserved).....	274
280. Fees.....	274
281. -- 309. (Reserved).....	274
310. Definitions.....	274
311. -- 319. (Reserved).....	275
320. Regulated Products.....	275
321. -- 329. (Reserved).....	275
330. Collection Of Wild Ginseng.....	275
331. Dealers And Growers Annual Registration With The Department.....	275
332. --339. (Reserved).....	276
340. Grower Records.....	276
341. -- 349. (Reserved).....	276
350. Dealer Records.....	276
351. -- 359. (Reserved).....	276
360. Out-Of-State Ginseng.....	276
361. Selling Or Shipping Of Ginseng -- Certificates.....	276
362. -- 369. (Reserved).....	277
370. Maintaining Separate Lots Of Ginseng.....	277
371. Dealer Or Grower Holding Ginseng After December 31 Of The Year.....	277
372. -- 379. (Reserved).....	277
380. Inspection And Disclosure Of Records.....	278

381. -- 389. (Reserved).....	278
390. Export Procedures.....	278
391. Fees - Hourly, Overtime.....	278
392. Schedule Of Fees And Charges.....	278
393. -- 999. (Reserved).....	278
<i>02.06.05 – Rules Governing Plant Disease And Quarantines</i>	
000. Legal Authority.....	279
001. Title And Scope.....	279
002. -- 009. (Reserved).....	279
010. Definitions.....	279
011. -- 111. (Reserved).....	279
112. Regulated Pests.....	279
113. -- 119. (Reserved).....	279
120. Regulated Articles.....	279
121. -- 129. (Reserved).....	279
130. Quarantine Area.....	279
131. -- 139. (Reserved).....	279
140. Restrictions On Import.....	279
141. --149. (Reserved).....	279
150. Movement Of Used Farming Equipment.....	280
151. -- 159. (Reserved).....	280
160. Special Permits.....	280
161. -- 169. (Reserved).....	280
170. Pest Detection.....	280
171. -- 179. (Reserved).....	280
180. Authority To Enter And Inspect.....	280
181. -- 189. (Reserved).....	280
190. Fees And Charges.....	280
191. -- 211. (Reserved).....	280
212. Regulated Pest.....	281
213. -- 219. (Reserved).....	281
220. Designated Counties.....	281
221. -- 229. (Reserved).....	281
230. Regulated Products.....	281
231. -- 249. (Reserved).....	281
250. Rules Governing Shipments.....	281
251. -- 259. (Reserved).....	282
260. Disposition Of Violations.....	282
261. -- 269. (Reserved).....	282
270. Inspection And Control Procedures.....	282
271. -- 279. (Reserved).....	282
280. Special Exemptions.....	282
281. -- 309. (Reserved).....	282
310. Definitions.....	282
311. -- 319. (Reserved).....	283
320. Regulated Pests.....	283
321. Regulated Articles.....	283
322. --329. (Reserved).....	283
330. Regulated Areas - Apple Maggot.....	283
331. -- 339. (Reserved).....	284
340. Restrictions - Apple Maggot.....	284
341. -- 349. (Reserved).....	285

350. Regulated Areas - Cherry Fruit Fly .....	285
351. -- 359. (Reserved) .....	285
360. Restrictions - Cherry Fruit Fly .....	285
361. -- 369. (Reserved) .....	286
370. Special Permits .....	286
371. -- 411. (Reserved) .....	286
412. Regulated Pest .....	286
413. -- 419. (Reserved) .....	286
420. Area And Articles Under Quarantine .....	286
421. -- 429. (Reserved) .....	287
430. Restrictions And Exemptions .....	287
431. -- 439. (Reserved) .....	288
440. Violations .....	288
441. -- 511. (Reserved) .....	288
512. Regulated Pests .....	288
513. -- 519. (Reserved) .....	288
520. Area Under Quarantine .....	288
521. -- 524. (Reserved) .....	288
525. Regulated Articles .....	288
526. -- 529. (Reserved) .....	288
530. Restrictions Governing Shipments .....	288
531. -- 539. (Reserved) .....	288
540. Official Certificate Requirements .....	288
541. -- 549. (Reserved) .....	289
550. Exemptions .....	289
551. -- 559. (Reserved) .....	289
560. Penalty .....	289
561. -- 569. (Reserved) .....	289
570. Common Carrier Agents Must Hold Shipments .....	289
571. -- 609. (Reserved) .....	289
610. Definitions .....	289
611. -- 619. (Reserved) .....	289
620. Regulated Area .....	289
621. -- 629. (Reserved) .....	289
630. Regulated Products .....	289
631. -- 639. (Reserved) .....	290
640. Disposition Of Cull Onions .....	290
641. Disposal Methods .....	290
642. Inclement Weather .....	291
643. (Reserved) 291	
644. Notification Required .....	291
645. -- 649. (Reserved) .....	291
650. Disposition Of Cull Potatoes .....	291
651. Cull Potato Disposal Methods .....	291
652. -- 659. (Reserved) .....	291
660. Authority To Enter And Inspect .....	291
661. -- 709. (Reserved) .....	291
710. Definitions .....	291
711. (Reserved) 292	
712. Regulated Pests .....	292
713. -- 714. (Reserved) .....	293
715. Regulated Products .....	293

716. -- 719. (Reserved).....	293
720. Control Areas.....	293
721. -- 729. (Reserved).....	293
730. Requirements For Mint Rootstock To Be Planted In Idaho.....	293
731. -- 739. (Reserved).....	294
740. Inspection Procedures.....	294
741. Movement Of Farm Equipment.....	296
742. -- 744. (Reserved).....	296
745. Greenhouses.....	296
746. -- 749. (Reserved).....	296
750. Posting Of Fields.....	296
751. -- 759. (Reserved).....	296
760. Authority To Enter, Inspect, And Control Requirements.....	296
761. -- 769. (Reserved).....	296
770. Penalty.....	296
771. -- 779. (Reserved).....	296
780. Exemptions.....	296
781. -- 789. (Reserved).....	297
790. Fees And Charges.....	297
791. -- 819. (Reserved).....	297
820. Regulated Areas.....	297
821. -- 829. (Reserved).....	297
830. Regulated Commodities.....	297
831. Regulated Pests.....	297
832. -- 834. (Reserved).....	298
835. Rules Governing Shipments.....	298
836. -- 839. (Reserved).....	298
840. Acceptable Treatments.....	298
841. -- 844. (Reserved).....	299
845. Disposition Of Commodities In Violation Of Rules.....	299
846. -- 849. (Reserved).....	299
850. Authority To Enter, Inspect, And Control.....	299
851. -- 854. (Reserved).....	299
855. Regulated Pest.....	299
856. -- 859. (Reserved).....	299
860. Areas Under Quarantine.....	299
861. -- 869. (Reserved).....	299
870. Articles And Commodities Under Quarantine.....	299
871. -- 879. (Reserved).....	300
880. Restrictions.....	300
881. -- 889. (Reserved).....	301
890. Penalty.....	301
891. -- 919. (Reserved).....	301
920. Regulated Disease.....	301
921. -- 929. (Reserved).....	301
930. Regulated Products.....	301
931. -- 934. (Reserved).....	301
935. Area Under Quarantine.....	301
936. -- 939. (Reserved).....	301
940. Shipments.....	301
941. -- 949. (Reserved).....	301
950. Inspection And Control Procedures.....	301

951. -- 959. (Reserved).....	302
960. Regulated Pest.....	302
961. -- 969. (Reserved).....	302
970. Area Under Quarantine.....	302
971. -- 979. (Reserved).....	302
980. Articles And Commodities Covered.....	302
981. -- 989. (Reserved).....	303
990. Restrictions.....	303
991. -- 999. (Reserved).....	304
<i>02.06.06 – Rules Governing the Planting of Beans</i>	
000. Legal Authority.....	305
001. Title And Scope.....	305
002. -- 009. (Reserved).....	305
010. Definitions.....	305
011. Abbreviations.....	306
012. Regulated Pests (Phaseolus And Non-Phaseolus).....	306
013. Regulated Pests (Non-Phaseolus Only).....	307
014. -- 049. (Reserved).....	307
050. Regulated Articles.....	307
051. Edible Harvest Exemption.....	307
052. Home Garden Exemption.....	307
053. -- 149. (Reserved).....	307
150. Inspection (Phaseolus).....	307
151. Inspection (Non-Phaseolus).....	308
152. -- 199. (Reserved).....	308
200. Requirements For Planting Bean Seed In Idaho (Phaseolus).....	308
201. Requirements For Planting Bean Seed In Idaho (Non-Phaseolus).....	310
202. -- 249. (Reserved).....	311
250. Trial Grounds.....	311
251. -- 299. (Reserved).....	312
300. Special Situations.....	312
301. -- 349. (Reserved).....	312
350. Detection, Identification, And Reporting Of Regulated Pests.....	312
351. -- 399. (Reserved).....	312
400. Disposition Of Diseased Seed And Infected Fields.....	312
401. -- 449. (Reserved).....	312
450. Exemptions From Destruction (Phaseolus).....	313
451. Exemptions From Destruction (Non-Phaseolus).....	313
452. -- 549. (Reserved).....	313
550. Fees And Charges.....	313
551. -- 999. (Reserved).....	314
<i>02.06.09 – Rules Governing Invasive Species and Noxious Weeds</i>	
000. Legal Authority.....	315
001. Title And Scope.....	315
002. -- 109. (Reserved).....	315
110. Definitions.....	315
111. Abbreviations.....	316
112. -- 119. (Reserved).....	316
120. Prohibition On Possession, Importation, Shipping Or Transportation Of Invasive Species.....	316
121. Introduction Of New Species To The State.....	316
122. Possession Permits.....	317
123. Exempt Species.....	318

124. Energy Crop Possession/Production Permits.....	319
125. Trap Crop Invasive Species Permits.....	321
126. -- 129. (Reserved).....	322
130. Early Detection and Rapid Response Aquatic Invertebrate Invasive Species.....	322
131. Reporting Requirements.....	323
132. Inspections.....	323
133. Hold Orders.....	324
134. EDRR AIIS Decontamination.....	324
135. -- 139. (Reserved).....	324
140. Invasive Species - Aquatic Invertebrates.....	325
141. Invasive Species - Fish.....	325
142. Invasive Species - Amphibians.....	326
143. Invasive Species - Reptiles.....	326
144. Invasive Species - Birds.....	326
145. Invasive Species - Mammals.....	326
146. Invasive Species - Insects.....	327
147. Invasive Species - Plant Pathogens And Parasitic Nematodes.....	328
148. Invasive Species - Invasive Mollusks (Terrestrial Snails And Slugs).....	329
149. Invasive Species - Invasive Plants: Energy Crops.....	330
150. Invasive Species - Invasive Plants: Trap Crops.....	330
151. -- 209. (Reserved).....	331
210. Definitions.....	331
211. Abbreviations.....	331
212. -- 219. (Reserved).....	331
220. Noxious Weeds - Designations.....	331
221. -- 229. (Reserved).....	335
230. Treatment Of Articles.....	335
231. -- 303. (Reserved).....	335
304. Incorporation By Reference.....	335
305. -- 309. (Reserved).....	335
310. Definitions.....	335
311. Abbreviations.....	336
312. -- 319. (Reserved).....	337
320. Voluntary Noxious Weed Free Forage And Straw Certification Program.....	337
321. -- 329. (Reserved).....	340
330. NAISMA Weed Free Forage Prohibited Weed List.....	340
331. -- 339. (Reserved).....	340
340. Application Form Requirements.....	340
341. -- 349. (Reserved).....	340
350. Certification Marking.....	340
351. -- 359. (Reserved).....	341
360. Procedures For Certification Of Forage Cubes/Pellets/Compressed Forage/Straw Bales.....	341
361. -- 999. (Reserved).....	342
 <i>02.06.10 – Rules Governing the Growing of Potatoes</i>	
000. Legal Authority.....	343
001. Title And Scope.....	343
002. -- 103. (Reserved).....	343
104. Incorporation By Reference.....	343
105. -- 109. (Reserved).....	343
110. Definitions And Terms.....	343
111. Abbreviations.....	343
112. -- 119. (Reserved).....	343

120. Intrastate Movement .....	344
121. Quarantined Areas .....	344
122. Restrictions .....	344
123. Conditions For Intrastate Or Interstate Movement Of Regulated Articles .....	344
124. -- 129. (Reserved).....	344
130. Inspection, Sampling, And Testing.....	344
131. -- 209. (Reserved) .....	344
210. Definitions .....	344
211. Abbreviations .....	344
212. -- 219. (Reserved).....	345
220. Seed Potato Crop Management Areas .....	345
221. -- 229. (Reserved).....	348
230. Regulated Articles.....	348
231. -- 239. (Reserved).....	348
240. Diseases And Pests Of Concern.....	348
241. -- 249. (Reserved).....	349
250. Planting Of Potatoes .....	349
251. -- 259. (Reserved).....	349
260. Peach, Apricot Trees, Or Any Host.....	349
261. Bedding Plants.....	349
262. -- 269. (Reserved).....	350
270. Storage Of Potatoes.....	350
271. Seed Disposition Notification .....	350
272. -- 279. (Reserved).....	350
280. Cull And Volunteer Potatoes.....	350
281. -- 289. (Reserved).....	350
290. Transportation Of Potatoes.....	350
291. -- 294. (Reserved) .....	351
295. Potatoes For Consumption .....	351
296. -- 303. (Reserved).....	351
304. Incorporation By Reference .....	351
305. -- 309. (Reserved).....	351
310. Definitions .....	351
311. Abbreviations .....	351
312. -- 319. (Reserved) .....	352
320. Regulated Pest - Bacterial Ring Rot .....	352
321. -- 329. (Reserved).....	352
330. Reporting Of BRR .....	352
331. Hold Harmless.....	352
332. Trace Back Investigation, Sampling, And Testing.....	352
333. Restriction On The Use Of Infected Potatoes .....	353
334. -- 349. (Reserved).....	353
350. Testing For BRR .....	353
351. -- 359. (Reserved).....	353
360. Hold Orders.....	353
361. -- 369. (Reserved).....	353
370. Fees .....	353
371. -- 409. (Reserved).....	353
410. Definitions .....	353
411. -- 449. (Reserved).....	354
450. Requirements For Uncertified Seed Potatoes Are:.....	354
451. -- 459. (Reserved).....	354



460. Enforcement .....	354
461. -- 999. (Reserved) .....	354
<b>02.06.33 – Organic Food Products Rules</b>	
000. Legal Authority .....	355
001. Title And Scope .....	355
002. -- 003. (Reserved) .....	355
004. Incorporation By Reference .....	355
005. -- 009. (Reserved) .....	355
010. Definitions .....	355
011. -- 199. (Reserved) .....	355
200. Idaho Organic Certification Seal .....	355
201. Registration Of Approved Materials .....	356
202. -- 299. (Reserved) .....	358
300. Certification Requirements And Fees .....	358
301. Graduated Gross Sales Fee Schedule .....	358
302. -- 999. (Reserved) .....	359

**IDAPA 02.07 – IDAHO HOP GROWERS’ COMMISSION**

**Docket No. 02-0701-2000F (Fee Rule)**

**02.07.01 – Rules of the Idaho Hop Growers' Commission**

000. Legal Authority .....	361
001. Title And Scope .....	361
002. -- 009. (Reserved) .....	361
010. Definitions .....	361
011. -- 099. (Reserved) .....	361
100. Markings Required .....	361
101. Removal Or Defacing Of Stencils .....	361
102. Misrepresentation .....	361
103. Time Of Payment Of Hop Assessment Levy .....	361
104. Computation Of Assessment .....	361
105. Collection Of Hop Assessment Levy .....	361
106. Assessment Return .....	362
107. -- 999. (Reserved) .....	362

**IDAPA 02.08 – IDAHO SHEEP AND GOAT HEALTH BOARD**

**Docket No. 02-0801-2000F (Fee Rule)**

**02.08.01 – Sheep and Goat Rules of the Idaho Sheep and Goat Health Board**

000. Legal Authority .....	364
001. Title And Scope .....	364
002. -- 003. (Reserved) .....	364
004. Incorporation By Reference .....	364
005. -- 009. (Reserved) .....	364
010. Definitions .....	364
011. Abbreviations .....	367
012. Applicability .....	367
013. Additional Import Requirements .....	367
014. -- 099. (Reserved) .....	367
100. Sheep And Goat State Entrance Requirements .....	367
101. Permits .....	368
102. Scabies .....	368
103. Animals In Transit .....	368

104. Dairy Goats .....	368
105. Importation Of Scrapie Exposed, Suspect And High Risk Animals.....	369
106. Idaho Origin Sheep Interstate Grazing Permit .....	369
107. Interstate Shipments .....	369
108. -- 199. (Reserved).....	369
200. Scrapie Program Standards, Scrapie Flock Certification, Scrapie Control And Eradication.....	369
201. Identification Of Breeding Sheep .....	369
202. Quarantine .....	370
203. Restriction Of High-Risk Animals .....	370
204. Movement Of Restricted Animals.....	370
205. -- 399. (Reserved).....	371
400. Condemnation And Destruction Of Diseased Animals Or Flocks .....	371
401. -- 499. (Reserved).....	371
500. Indemnification.....	371
501. -- 599. (Reserved).....	372
600. Cleaning And Disinfection .....	372
601. -- 699. (Reserved).....	372
700. Sheep Assessments .....	372
701. Goat Assessments .....	372
702. -- 899. (Reserved).....	373
900. Violations.....	373
901. -- 999. (Reserved).....	373

**IDAPA 07 – DIVISION OF BUILDING SAFETY*****Docket No. 07-0000-2000F (Fee Rule)******07.01.01 – Rules of the Idaho Electrical board***

000. Legal Authority .....	376
001. Title And Scope.....	376
002. Incorporation By Reference .....	376
003. Definitions .....	376
004. -- 010. (Reserved).....	376
011. Electrical Permits .....	376
012. Electrical Permitting And Inspection Requirements For Persons Exempt From Licensing.....	377
013. Electrical Permit And Inspection Requirements For Facility Accounts.....	377
014. Temporary Installations Connected Prior To Inspection .....	377
015. -- 049. (Reserved).....	377
050. Fees For Electrical Permits And Inspections .....	377
051. -- 099. (Reserved).....	380
100. Licensure History .....	380
101. License And Registration Application.....	380
102. Apprentice Electrician Registration .....	381
103. Journeyman Electrician Examination And License .....	381
104. Master Electrician.....	382
105. Electrical Contractor .....	382
106. -- 149. (Reserved).....	384
150. Qualified Journeyman Electricians .....	384
151. Minimum Experience Requirements .....	384
152. Limited Experience Requirement .....	385
153. Electrical Installations Requiring A Limited Electrical Installer License.....	385
154. Applications For Limited Electrical Installer License .....	387
155. Licensure Period And Fees.....	388
156. Limited Electrical Contractor License.....	388

157. -- 199. (Reserved).....	388
200. Examinations.....	388
201. -- 249. (Reserved).....	389
250. Adoption And Incorporation By Reference Of The National Electrical Code.....	389
251. --299. (Reserved).....	392
300. Continuing Education Requirements.....	392
301. Course Approval Requirements.....	392
302. -- 349. (Reserved).....	393
350. Appeals.....	394
351. -- 399. (Reserved).....	394
400. Certification And Approval Of Electrical Products And Materials.....	395
401. -- 449. (Reserved).....	395
450. Civil Penalties.....	395
451. -- 999. (Reserved).....	396
<i>07.02.02 – Rules Governing Plumbing</i>	
000. Legal Authority.....	397
001. Title And Scope.....	397
002. Administrative Appeals.....	397
003. Incorporation By Reference.....	397
004. -- 006. (Reserved).....	397
007. Definitions.....	397
008. -- 100. (Reserved).....	397
101. Permits.....	397
102. Permit Fee Schedule.....	398
103. Required Inspections.....	400
104. -- 199. (Reserved).....	400
201. Licensure History.....	400
202. Apprentice Registration.....	400
203. Journeyman.....	401
204. Plumbing Contractor.....	402
205. Applications.....	403
206. Examinations.....	403
207. Certificates Of Competency -- Issuance, Renewal, Expiration, Revival -- Fees.....	404
208. Specialty Plumbing Licenses.....	405
209. Appliance Plumbing Specialty License.....	405
210. Water Pump Plumbing Specialty License.....	406
211. -- 300. (Reserved).....	408
301. Adoption And Incorporation By Reference Of The Idaho State Plumbing Code.....	408
302. -- 400. (Reserved).....	412
401. Civil Penalties.....	413
402. -- 999. (Reserved).....	413
<i>07.03.01 – Rules of Building Safety (Building Code Rules)</i>	
000. Legal Authority.....	414
001. Title And Scope.....	414
002. -- 003. (Reserved).....	414
004. Adoption And Incorporation By Reference.....	414
005. -- 025. (Reserved).....	422
026. Definitions.....	422
027. Permits.....	424
028. Plan Review.....	424
029. Fees.....	425
030. Right Of Entry.....	426

031. Work Proceeding Without Permit Or Approval.....	426
032. Stop Work Orders.....	427
033. Prohibited Sale Or Occupancy Notice.....	427
034. Removal Of Orders And Notices; Sale, Rent, Lease Or Occupancy Of A Unit Bearing Such Order Or Notice.....	427
035. Modular Buildings.....	427
036. Manufactured Homes.....	429
037. (Reserved).....	430
038. Integrated Design And Fundamental Commissioning Of Public School Facilities.....	430
039. -- 999. (Reserved).....	431
<i>07.03.03 – Rules for Modular Buildings</i>	
000. Legal Authority.....	432
001. Title And Scope.....	432
002. -- 009. (Reserved).....	432
010. Definitions.....	432
011. -- 026. (Reserved).....	432
027. Permits.....	432
028. Plan Review.....	432
029. Fees.....	433
030. Right Of Entry.....	434
031. Removal Of Orders And Notices Prohibited.....	434
032. Modular Buildings.....	435
033. Civil Penalties.....	436
034. -- 999. (Reserved).....	436
<i>07.03.11 – Rules Governing Manufactured/Mobile Home Industry Licensing</i>	
000. Legal Authority.....	437
001. Title And Scope.....	437
002. -- 009. (Reserved).....	437
010. Definitions.....	437
011. (Reserved).....	438
012. License Required.....	438
013. The Division's Mailing Address.....	440
014. Proof Of Education Required.....	440
015. Examination Of Applicant For License.....	441
016. Disciplinary Action Against Licensees.....	441
017. Procedures For Licensing Suspension, Revocation Or Nonrenewal.....	442
018. Application For New License.....	442
019. Fees.....	442
020. Licensing Complaints.....	443
021. Civil Penalties.....	443
022. Manufactured Home Buyer's Information And Disclosure Form.....	444
023. -- 999. (Reserved).....	444
<i>07.03.12 – Rules Governing Manufactured or Mobile Home Installations</i>	
000. Legal Authority.....	445
001. Title And Scope.....	445
002. -- 003. (Reserved).....	445
004. Adoption And Incorporation By Reference.....	445
005. Application -- Compliance.....	445
006. -- 011. (Reserved).....	445
012. Use Of Manufacturers' Installation Instructions.....	445
013. Installation Permits And Inspections Required.....	445

014. Installation Permit Fees.....	445
015. Installation Tags Required.....	446
016. Approval Of Local Manufactured Home Installation Inspection Programs.....	446
017. Withdrawal Of Approval Of Programs.....	446
018. Minimum Training Requirements For Inspectors.....	446
019. Quality Assurance.....	446
020. Minimum Scope Of Installation Inspection.....	447
021. Supervision By Responsible Managing Employee.....	447
022. -- 999. (Reserved).....	447
<i>07.04.02 – Safety Rules for Elevators, Escalators, and Moving Walks</i>	
000. Legal Authority.....	448
001. Title And Scope.....	448
002. Adoption And Incorporation By Reference.....	448
003. -- 009. (Reserved).....	448
010. Definitions.....	448
011. Inspection Requirements.....	449
012. Approval Of New Or Alternative Technology.....	449
013. -- 999. (Reserved).....	449
<i>07.05.01 – Rules of the Public Works Contractors License Board</i>	
000. Legal Authority.....	450
001. Title.....	450
002. -- 009. (Reserved).....	450
010. Definitions.....	450
011. -- 101. (Reserved).....	450
102. Communication.....	450
103. Petitions.....	450
104. Form And Content Of Petition.....	450
105. License Renewal -- Filing Deadlines; Petitions For Extension Of Time To File; Lapsed Licenses.....	451
106. Special Provisions Covered In A Petition To Change Or Add Types Of Construction.....	451
107. -- 108. (Reserved).....	451
109. Notice.....	451
110. Application For Licensure -- Documentation; Appraisals; References; Bonding; And Financial Statements.....	452
111. Financial Requirements.....	453
112. Examination.....	453
113. Individual Qualified By Examination.....	454
114. -- 198. (Reserved).....	454
199. Limitations.....	454
200. Type 4-Specialty Construction Categories.....	455
201. Fees.....	465
202. Complaints.....	466
203. -- 299. (Reserved).....	466
300. Business Organization -- Changes In Organization Or Structure -- Members Of Joint Ventures - Changes For Reasons Other Than Death.....	466
301. -- 399. (Reserved).....	466
400. Certificates -- Display And Possession.....	467
401. License Number On Bids.....	467
402. Changes In License Certificate.....	467
403. -- 501. (Reserved).....	467
502. Technicalities Of Form.....	467
503. Hearings.....	467

504. -- 599. (Reserved).....	467
600. Construction Manager Examinations.....	467
601. -- 999. (Reserved).....	467
<i>07.07.01 – Rules Governing Installation of Heating, Ventilation, and Air Conditioning Systems</i>	
000. Legal Authority.....	468
001. Title And Scope.....	468
002. (Reserved).....	468
003. Administrative Appeals.....	468
004. Adoption And Incorporation By Reference Of The International Mechanical Code, 2018 Edition; The International Fuel Gas Code, 2018 Edition; And Part V (Mechanical) And Part VI (Fuel Gas) Of The International Residential Code For One (1)- And Two (2)-Family Dwellings, 2018 Edition. ....	468
005. Office – Office Hours – Mailing Address And Street Address.....	471
006. Filing Of Documents.....	471
007. Public Records Act Compliance.....	471
008. -- 009. (Reserved).....	471
010. Changes In Name And Address -- Address For Notification Purposes.....	471
011. Meetings.....	471
012. Definitions.....	471
013. Certificates Of Competency -- Issuance, Renewal, Expiration -- Revival.....	472
014. -- 019. (Reserved).....	472
020. HVAC Contractor And HVAC Journeyman Applications For Examination And Certificates Of Competency, And Registration Of Apprentices.....	472
021. HVAC Contractor Certificate Of Competency - Requirements.....	472
022. HVAC Specialty Contractor Certificate Of Competency - Requirements.....	473
023. HVAC Journeyman Certificates Of Competency And Examination Requirements.....	473
024. HVAC Hearth Specialty Journeyman Certificates Of Competency Limitations: Requirements.....	474
025. HVAC Apprentice Requirements For Registration.....	474
026. HVAC Specialty Apprentice Requirements For Registration.....	474
027. HVAC Waste Oil Heating Specialty Journeyman Certificates Of Competency Limitations: Requirements.....	474
028. HVAC Fuel Gas Piping Specialty Journeyman Certificates Of Competency Limitations: Requirements.....	475
029. -- 049. (Reserved).....	475
050. HVAC Permits.....	475
051. HVAC Permit Fee Schedule.....	475
052. -- 059. (Reserved).....	477
060. Required Inspections.....	477
061. Inspector Qualifications.....	477
062. -- 069. (Reserved).....	477
070. Civil Penalties.....	477
071. -- 999. (Reserved).....	478
<i>07.10.01 – Rules Governing the Damage Prevention Board</i>	
000. Legal Authority.....	479
001. Title And Scope.....	479
002. Administrative Appeals.....	479
004. -- 006. (Reserved).....	479
007. Funding Of Board Activities.....	479
008. Audit Of One-Number Service Records.....	479
009. -- 014. (Reserved).....	479
015. Educational And Training Materials.....	479
016. Adequacy Of Facility Owners Locating Underground Facilities.....	480

017. Improvement Of Technology And Communications By Stakeholders.....	480
018. Damage Prevention Complaints. ....	480
019. Claims And Reports Of Damage Or Excavator Downtime. ....	481
020. Civil Penalties. ....	481
021. -- 999. (Reserved).....	482

**IDAPA 08 – STATE BOARD OF EDUCATION**

***Docket No. 08-0000-2000F (Fee Rule)***

<i>08.01.11 – Registration of Postsecondary Educational Institutions and Proprietary Schools</i>	
200. Registration Of Postsecondary Educational Institutions. ....	485
300. Registration Of Proprietary Schools. ....	487
<i>08.02.02 – Rules Governing Uniformity</i>	
066. Fees. ....	490
075. Fingerprinting And Background Investigation Checks (Sections 33-130 And 33-512, Idaho Code). ....	490
<i>08.02.03 – Rules Governing Thoroughness</i>	
128. Curricular Materials Selection And Online Course Approval (Sections 33-118; 33-118A, Idaho Code). ....	493

**IDAPA 10 – BOARD OF PROFESSIONAL ENGINEERS  
AND PROFESSIONAL LAND SURVEYORS**

***Docket No. 10-0101-2000F (Fee Rule)***

<i>10.01.01 – Rules of the Idaho Board of Licensure of Professional Engineers and Professional Land Surveyors</i>	
000. Legal Authority. ....	496
001. Title And Scope. ....	496
002. -- 009. (Reserved).....	496
010. Definitions. ....	496
011. Fees. ....	497
012. Reissuance Of Certificates.....	497
013. (Reserved) .....	497
014. Seals. ....	497
015. Certificates. ....	497
016. Application For Licensure Or Certification.....	497
017. Examinations And Education. ....	498
018. Reexaminations. ....	501
019. Licensees Or Certificate Holders Of Other States, Boards, and Countries.....	502
020. Discontinued, Retired, And Expired Licenses And Certificates.....	504
021. (Reserved) .....	505
022. Requirements To Be Considered "Exceptional" Under Section 54-1223(2), Idaho Code.....	505
023. Professional Engineer Licensure For Faculty Applicants.....	506
024. -- 099. (Reserved).....	506
100. Responsibility To The Public.....	506
101. Competency For Assignments.....	507
102. Public Statements. ....	507
103. Conflict Of Interest. ....	507
104. Solicitation Of Work.....	508
105. Improper Conduct. ....	509
106. -- 199. (Reserved).....	509
200. Requirements.....	509
201. Units.....	510
202. Determination Of Credit. ....	510

203. Record Keeping.....	511
204. Exemptions.....	511
205. Comity/Out-Of-Jurisdiction Residents.....	512
206. Use Of NCEES Model CPC Standard.....	512
207. -- 299. (Reserved).....	512
300. Form.....	512
301. Completion Of Form.....	512
302. Contents on the form.....	512
303. -- 999. (Reserved).....	513

**IDAPA 11 – IDAHO STATE POLICE**

***Docket No. 11-0000-2000F (Fee Rule)***

***11.05.01 – Rules Governing Alcohol Beverage Control***

000. Legal Authority.....	516
001. Title And Scope.....	516
002. -- 009. (Reserved).....	516
010. Definitions.....	516
011. General Provisions.....	518
012. Transfer Of Alcoholic Beverage Licenses.....	518
013. Priority Lists.....	519
014. Conduct Of Licensed Premises.....	520
015. -- 020. (Reserved).....	520
021. Age Restriction Requirements.....	520
022. Age Restriction Requirements For Licensed Movie Theaters - When Minors Permitted.....	521
023. -- 999. (Reserved).....	521

***11.10.02 – Rules Governing State Criminal History Records and Crime Information***

000. Legal Authority.....	522
001. Title And Scope.....	522
002. -- 009. (Reserved).....	522
010. Definitions.....	522
011. -- 020. (Reserved).....	522
021. Expungement Procedure.....	522
022. Transmittal Of Criminal History Records.....	523
023. Procedure For Contesting The Accuracy And Completeness Of A Criminal History Record Contained In Agency File.....	523
024. -- 030. (Reserved).....	523
031. Fees For Services.....	523
032. -- 999. (Reserved).....	523

**IDAPA 11 – IDAHO STATE POLICE –  
STATE BRAND BOARD**

***Docket No. 11-0201-2000F (Fee Rule)***

***11.02.01 – Rules of the Idaho State Brand Board***

000. Legal Authority.....	526
001. Title And Scope.....	526
002. -- 004. (Reserved).....	526
005. Definitions.....	526
006. -- 010. (Reserved).....	528
011. Recording, Use And Placement Of Brands.....	528
012. -- 014. (Reserved).....	529
015. Brand Alternatives.....	530
016. Branding Of Sheep.....	530



017. -- 018. (Reserved)..... 530  
019. Brand Inspections..... 530  
020. Baby Calves – Owner Inspection..... 531  
021. Annual Brand Inspection Certificate..... 532  
022. Lifetime Ownership And Transportation Certificates..... 532  
023. -- 029. (Reserved)..... 532  
030. Transportation Of Livestock..... 532  
031. Idaho Livestock Moving To Pasture Out Of State..... 533  
032. Livestock Auction Sales..... 533  
033. Brand Inspections At Slaughter Plants And Mobile Slaughter Units..... 533  
034. Schedule Of Fees For The Idaho State Brand Board..... 534  
035. -- 039. (Reserved)..... 535  
040. Claims For Funds Or Livestock Subject To A Hold Order..... 535  
041. -- 099. (Reserved)..... 535  
100. Application Fees..... 535  
101. Financial Information..... 535  
102. Livestock Dealer Bonds..... 536  
103. Application For A License To Represent A Licensed Livestock Dealer..... 536  
104. License Certificates And Cards..... 536  
105. Notification Required..... 536  
106. Brand Inspector To Require Dealer License Number..... 536  
107. Rules Apply To Out Of State Buyers..... 536  
108. -- 999. (Reserved)..... 536

**IDAPA 11 – IDAHO STATE POLICE –  
RACING COMMISSION**

**Docket No. 11-0400-2000F (Fee Rule)**

**11.04.02 – Rules Governing Simulcasting**

000. Legal Authority..... 539  
001. Title And Scope..... 539  
002. -- 009. (Reserved)..... 539  
010. Definitions..... 539  
011. -- 014. (Reserved)..... 540  
015. Requirements For Licensure Of A Simulcast Facility..... 540  
016. Criteria For Approval Of Application For Simulcast Operator..... 541  
017. -- 025. (Reserved)..... 542  
026. Host Association..... 542  
027. Guest Associations..... 542  
028. Interstate Common Pool Wagering..... 542  
029. Net Pool Pricing..... 543  
030. Host Participating In Interstate Common Pools..... 544  
031. -- 034. (Reserved)..... 544  
035. Licenses For Simulcast Operators..... 544  
036. Simulcast Purse Money Collection And Distribution..... 545  
037. -- 039. (Reserved)..... 545  
040. Duties Of Simulcast Operator..... 545  
041. Prohibition Of Simulcast Signal..... 546  
042. -- 044. (Reserved)..... 546  
045. Distribution Of Deposits..... 546  
046. Conflict Of Laws..... 547  
047. Totalizator Or Other Approved Equipment Required..... 547  
048. -- 999. (Reserved)..... 547

**11.04.03 – Rules Governing Licensing and Fees**

000. Legal Authority.....	548
001. Title And Scope.....	548
002. -- 009. (Reserved).....	548
010. Definitions.....	548
011. -- 019. (Reserved).....	550
020. Applicability.....	550
021. -- 029. (Reserved).....	550
030. Refusal To Issue License.....	550
031. -- 039. (Reserved).....	551
040. Cruelty To Animals.....	551
041. -- 049. (Reserved).....	551
050. Fingerprints.....	551
051. -- 089. (Reserved).....	552
090. Applications.....	552
091. -- 094. (Reserved).....	552
095. Add-On.....	552
096. Duplicate License.....	552
097. -- 099. (Reserved).....	552
100. Licenses Requiring Racing Association Signatures.....	552
101. -- 109. (Reserved).....	553
110. Apprentice Jockey License.....	553
111. -- 129. (Reserved).....	553
130. Assistant Starter License.....	553
131. -- 139. (Reserved).....	553
140. Authorized Agent License.....	553
141. -- 144. (Reserved).....	554
145. Bad Checks.....	554
146. -- 159. (Reserved).....	554
160. Concessionaire License.....	554
161. -- 165. (Reserved).....	554
166. Concession Employee License.....	554
167. -- 189. (Reserved).....	554
190. Emergency Medical Technician License.....	554
191. -- 199. (Reserved).....	554
200. Exercise Person License.....	554
201. -- 209. (Reserved).....	554
210. Groom License.....	554
211. -- 239. (Reserved).....	554
240. Jockey License.....	554
241. -- 249. (Reserved).....	554
250. Jockey Agent License.....	554
251. -- 279. (Reserved).....	555
280. Mutuel Employee License.....	555
281. -- 299. (Reserved).....	555
300. Official License.....	555
301. -- 329. (Reserved).....	555
330. Owner License.....	555
331. -- 359. (Reserved).....	555
360. Plater License.....	555
361. -- 369. (Reserved).....	555
370. Pony Person License.....	555

371. -- 389. (Reserved).....	555
390. Stable Name License.....	555
391. Stable Name Change.....	556
392. Stable Names Prohibited.....	556
393. -- 419. (Reserved).....	556
420. State Veterinarian License.....	556
421. -- 429. (Reserved).....	556
430. Steward License.....	556
431. -- 459. (Reserved).....	556
460. Track Security License.....	556
461. -- 469. (Reserved).....	556
470. Trainer License.....	556
471. -- 489. (Reserved).....	557
490. Veterinarian License.....	557
491. -- 499. (Reserved).....	557
500. Vet Assistant License.....	557
501. -- 599. (Reserved).....	557
600. License Fees.....	557
601. -- 989. (Reserved).....	558
990. Penalties.....	558
991. -- 999. (Reserved).....	558
 <i>11.04.05 – Rules Governing Advanced Deposit Wagering</i>	
000. Legal Authority.....	559
001. Title And Scope.....	559
002. -- 009. (Reserved).....	559
010. Definitions.....	559
011. -- 014. (Reserved).....	560
015. Licensing For Advanced Deposit Wagering.....	560
016. -- 019 (Reserved).....	560
020. Advanced Deposit Wagering License.....	560
021. -- 024. (Reserved).....	560
025. Advance Deposit Wagering License Application.....	560
026. Detailed Plan Of Operation For Advanced Deposit Wagering.....	561
027. -- 029. (Reserved).....	561
030. Investigations Or Inspections.....	561
031. -- 039. (Reserved).....	561
040. Claims Of Non-Payment.....	561
041. -- 049. (Reserved).....	561
050. Promote And Advertise.....	561
051. -- 059. (Reserved).....	561
060. Out-Of-State Providers.....	561
061. -- 069. (Reserved).....	562
070. Residence Outside The State Of Idaho.....	562
071. -- 079. (Reserved).....	562
080. Establishing An Account.....	562
081. Account Information.....	562
082. Identifying An Account Number.....	562
083. -- 089. (Reserved).....	563
090. Close Or Refuse To Open An Account.....	563
091. -- 094. (Reserved).....	563
095. Account Holder Responsibilities.....	563
096. -- 099. (Reserved).....	563

100. Operation Of An Account .....	563
101. -- 104. (Reserved).....	563
105. Credits To An Account.....	563
106. Debits To An Account.....	564
107. Wagers In Excess Of Account Balance.....	564
108. Accounts Will Not Bear Any Interest.....	565
109. Payments On Winning Pari-Mutuel Wagers.....	565
110. Mailing Address.....	565
111. -- 119. (Reserved).....	565
120. Powers Of The Racing Commission To Review And Audit Records.....	565
121. -- 124. (Reserved).....	565
125. Confidential Information.....	565
126. -- 129. (Reserved).....	565
130. Applicable Laws, Rules, And Regulations.....	565
131. -- 999. (Reserved).....	565
 <i>11.04.07 – Rules Governing Racing Associations</i>	
000. Legal Authority.....	566
001. Title And Scope.....	566
002. -- 009. (Reserved).....	566
010. Definitions.....	566
011. -- 019. (Reserved).....	567
020. Enter, Search And Inspect.....	567
021. -- 039. (Reserved).....	567
040. Racing Commission.....	567
041. -- 049. (Reserved).....	568
050. Employees.....	568
051. -- 054. (Reserved).....	568
055. Disturbing The Peace.....	568
056. -- 059. (Reserved).....	568
060. Ruled Off.....	568
061. -- 069. (Reserved).....	568
070. Prohibited Printed Material.....	568
071. -- 074. (Reserved).....	568
075. Handbooks.....	568
076. -- 079. (Reserved).....	569
080. Bookmakers.....	569
081. -- 089. (Reserved).....	569
090. Idaho Bred Races.....	569
091. Breeder Awards.....	569
092. -- 094. (Reserved).....	569
095. Breed Associations.....	569
096. -- 099. (Reserved).....	569
100. Racing Association License.....	570
101. -- 109. (Reserved).....	570
110. Racing Association License Fees.....	570
111. -- 119. (Reserved).....	570
120. Racing Association License Applications.....	570
121. -- 129. (Reserved).....	570
130. Applications For Succeeding Seasons.....	570
131. -- 139. (Reserved).....	570
140. Horsemen’s Agreement.....	570
141. -- 149. (Reserved).....	570

150. Racing Associations Operation.....	570
151. -- 159. (Reserved).....	570
160. Report Of Funds.....	570
161. -- 169. (Reserved).....	570
170. Approval Of Racing Association Licenses.....	571
171. -- 179. (Reserved).....	571
180. License Granted Upon Conditions.....	571
181. -- 189. (Reserved).....	571
190. Refusal To Issue License.....	571
191. -- 199. (Reserved).....	571
200. Fingerprints -- Photograph.....	571
201. -- 209. (Reserved).....	571
210. Racing Dates.....	571
211. -- 219. (Reserved).....	571
220. License Not Transferable.....	571
221. -- 239. (Reserved).....	572
240. Proposed Officials.....	572
241. -- 249. (Reserved).....	572
250. Racing Associations: General Rules.....	572
251. -- 259. (Reserved).....	573
260. Horsemen's Account.....	573
261. -- 269. (Reserved).....	573
270. Purse Money.....	573
271. -- 279. (Reserved).....	573
280. Communication.....	573
281. -- 289. (Reserved).....	573
290. Documents Filed With Racing Commission.....	573
291. -- 299. (Reserved).....	574
300. Horse Race Tracks.....	574
301. -- 309. (Reserved).....	574
310. Jockey Room.....	574
311. -- 319. (Reserved).....	574
320. Officials' Stands.....	574
321. -- 329. (Reserved).....	574
330. Photo Finish Devices.....	574
331. -- 339. (Reserved).....	575
340. Videotaping System.....	575
341. -- 349. (Reserved).....	575
350. Starting Gate.....	575
351. -- 359. (Reserved).....	576
360. Distance Markers.....	576
361. -- 369. (Reserved).....	576
370. Barns.....	576
371. -- 379. (Reserved).....	576
380. Test Area.....	576
381. -- 389. (Reserved).....	576
390. Isolation Area.....	576
391. -- 899. (Reserved).....	576
900. Security.....	576
901. -- 909. (Reserved).....	577
910. Complaints.....	577
911. -- 919. (Reserved).....	577

920. Exclusion And Ejection.....	577
921. -- 999. (Reserved).....	577
<i>11.04.11 – Rules Governing Equine Veterinary Practices, Permitted Medications, Banned Substances and Drug Testing of Horses</i>	
000. Legal Authority.....	578
001. Title And Scope.....	578
002. -- 009. (Reserved).....	578
010. Definitions And Abbreviations.....	578
011. -- 019. (Reserved).....	579
020. Enter, Search And Inspect.....	579
021. Authority Of The Commission Veterinarian.....	579
022. Report Of Disease.....	579
023. Restrictions Of Wagering.....	579
024. -- 029. (Reserved).....	580
030. Treatment Restrictions.....	580
031. Administration Of Non-Injectable Substances.....	580
032. -- 034. (Reserved).....	580
035. Hypodermic Needles.....	580
036. -- 039. (Reserved).....	580
040. Banned Substances.....	580
041. -- 049. (Reserved).....	580
050. Non-Permitted Medication.....	581
051. -- 059. (Reserved).....	581
060. Medications.....	581
061. -- 069. (Reserved).....	581
070. Anti-Ulcer Medications.....	581
071. -- 074. (Reserved).....	581
075. Environmental Contaminants And Substances Of Human Use.....	581
076. -- 099. (Reserved).....	581
100. Testing Facilities.....	581
101. -- 104. (Reserved).....	581
105. Laboratory Minimum Standards.....	581
106. -- 109. (Reserved).....	582
110. Testing.....	582
111. Out-Of-Competition Testing.....	582
112. -- 114. (Reserved).....	583
115. Random Or Extra Testing.....	583
116. -- 119. (Reserved).....	583
120. Trainer Present.....	583
121. -- 129. (Reserved).....	583
130. Specimens.....	583
131. -- 139. (Reserved).....	583
140. Determination Of Sample.....	583
141. -- 149. (Reserved).....	584
150. Storage And Shipment Of Split Samples.....	584
151. -- 159. (Reserved).....	584
160. Testing Split Samples.....	584
161. -- 179. (Reserved).....	585
180. Chain Of Custody.....	585
181. -- 199. (Reserved).....	585
200. Non-Steroidal Anti-Inflammatory Drugs.....	585
201. -- 209. (Reserved).....	585

210. Non-Steroidal Anti-Inflammatory Drug Request Form.....	585
211. -- 219. (Reserved).....	585
220. Approval Of Non-Steroidal Anti-Inflammatory Drug Request.....	585
221. -- 229. (Reserved).....	586
230. Expiration Of Approval. ....	586
231. -- 239. (Reserved).....	586
240. Permitted Non-Steroidal Anti-Inflammatory Drugs.....	586
241. -- 249. (Reserved).....	586
250. Daily Racing Program.....	586
251. -- 259. (Reserved).....	586
260. Non-Steroidal Anti-Inflammatory Drug Administration.....	586
261. -- 264. (Reserved).....	586
265. Bleeder Treatment.....	586
266. -- 269. (Reserved).....	587
270. Idaho Bleeder List.....	587
271. -- 279. (Reserved).....	587
280. Urine Samples.....	587
281. -- 289. (Reserved).....	587
290. Blood Samples.....	587
291. Hair Testing.....	588
292. -- 299. (Reserved).....	588
300. Lasix Administration.....	588
301. -- 319. (Reserved).....	588
320. Horses Not Stabled On Grounds.....	588
321. -- 399. (Reserved).....	588
400. Bicarbonate Testing.....	588
401. -- 499. (Reserved).....	589
500. Protection Of Horses.....	589
501. Illegal Practices By Trainer.....	589
502. -- 599. (Reserved).....	589
600. Non-Approved Medication.....	589
601. -- 699. (Reserved).....	589
700. Medication Report Form.....	590
701. -- 989. (Reserved).....	590
990. Penalties.....	590
991. -- 994. (Reserved).....	590
995. Violations.....	590
996. -- 999. (Reserved).....	590
 <i>11.04.15 – Rules Governing Controlled Substance and Alcohol Testing of Licensees and Applicants</i>	
000. Legal Authority.....	591
001. Title And Scope.....	591
002. -- 009. (Reserved).....	591
010. Definitions.....	591
011. -- 019. (Reserved).....	591
020. Primary Purpose.....	591
021. -- 049. (Reserved).....	591
050. Use Of Controlled Substances.....	591
051. -- 059. (Reserved).....	591
060. Consumption Of Alcohol.....	592
061. -- 099. (Reserved).....	592
100. Testing.....	592

101. -- 119. (Reserved).....	592
120. Post-Accident Testing.....	592
121. -- 129. (Reserved).....	592
130. Refusal To Test.....	592
131. -- 149. (Reserved).....	592
150. Testing Procedure.....	592
151. -- 199. (Reserved).....	593
200. A Positive Test.....	593
201. -- 219. (Reserved).....	593
220. Procedures Following A Positive Chemical Analysis.....	593
221. -- 249. (Reserved).....	594
250. Confidentiality Of Test Results.....	594
251. -- 299. (Reserved).....	594
300. Testing Expense.....	594
301. -- 999. (Reserved).....	594

**IDAPA 11 – IDAHO STATE POLICE –  
IDAHO PUBLIC SAFETY AND SECURITY INFORMATION SYSTEM**

***Docket No. 11-1001-2000F (Fee Rule)***

***11.10.01 – Rules Governing Idaho Public Safety and Security Information System***

000. Legal Authority.....	597
001. Title And Scope.....	597
002. Incorporation By Reference.....	597
003. -- 009. (Reserved).....	597
010. Definitions.....	597
011. (Reserved).....	598
012. Executive Officer Of The Board.....	598
013. ILETS Board: Meetings And Quorum.....	599
014. ILETS Board: Powers And Duties, Chairman, And Ad Hoc Advisory Committees.....	599
015. (Reserved).....	599
016. ILETS Network.....	599
017. Agency Access To ILETS.....	600
018. User Access Fees.....	601
019. Adjusted Access Fees During Pilot Projects.....	602
020. User Responsibilities.....	602
021. Information Access And Dissemination.....	603
022. -- 023. (Reserved).....	603
024. ILETS Security.....	603
025. -- 027. (Reserved).....	605
028. User Agency Sanctions.....	606
029. -- 999. (Reserved).....	606

**IDAPA 11 – IDAHO STATE POLICE –  
PEACE OFFICER STANDARDS AND TRAINING COUNCIL**

***Docket No. 11-1101-2000F (Fee Rule)***

***11.11.01 – Rules of the Idaho Peace Officer Standards and Training Council***

000. Legal Authority.....	609
001. Title And Scope.....	609
002. Applications And Forms.....	609
003. Documentation – Copies.....	609
004. -- 009. (Reserved).....	609
010. Definitions.....	609



011. – 029. (Reserved) .....	613
030. POST Council .....	613
031. Powers And Duties Of POST Council .....	613
032. POST Hearing Board .....	614
033. POST Division Administrator .....	614
034 – 049. (Reserved) .....	614
050. Basic Certification Of Law Enforcement Officers .....	614
051. Mandatory And Voluntary Certification .....	614
052. Citizenship .....	615
053. Education .....	615
054. Age .....	616
055. Ineligibility Based Upon Past Conduct .....	616
056. Documentation Of Criminal, Traffic, And Military Discharge Records .....	617
057. Requirements For Basic Certification .....	617
058. Standards Of Conduct For Basic Training Academy Students .....	619
059. Challenging A Basic Training Academy .....	620
060. Agreement To Serve – Reimbursement Requirement .....	620
061. – 069. (Reserved) .....	622
070. Higher Level Certification .....	622
071. Law Enforcement Experience, Military Experience, And College Credits For Purposes Of Higher Certification .....	622
072. Intermediate And Advanced Certification .....	623
073. Supervisor Certification .....	626
074. Master Certification .....	626
075. Management Certification .....	626
076. Executive Certification .....	627
077. – 079. (Reserved) .....	627
080. Certifications For Part-Time Officers .....	627
081. Reserve Peace Officer Certification .....	628
082. Marine Deputy Certification .....	629
083. Part-Time Juvenile Detention Officer Certification .....	629
084. – 089. (Reserved) .....	630
090. Canine-Related Certifications .....	630
091. Canine Team Certification .....	630
092. Canine Evaluator Certification .....	630
093. – 099. (Reserved) .....	631
100. Lapse Of Basic Certification – Reinstatement .....	631
101. – 109. (Reserved) .....	632
110. Decertification .....	632
111. Due Process Procedures In Decertification Proceedings .....	633
112. Decertification Proceedings .....	633
113. – 119. (Reserved) .....	635
120. POST Instructor Certification .....	635
121. POST Instructor Certification – General Provisions .....	635
122. Requirements For Instructors Of Law Enforcement Subjects .....	635
123. Requirements For High Liability Instructor Endorsement .....	635
124. Requirements For Canine Instructor Certification .....	636
125. Master Instructor Certification .....	636
126. Maintaining POST Instructor Certifications And Endorsements .....	637
127. Suspension And Revocation Of Instructor Certification Or Endorsement .....	637
128. – 129. (Reserved) .....	637
130. In-Service Training Requirements .....	637

131. In-Service Training Requirements For Retaining Basic Certification .....	637
132. Documentation Of In-Service Training .....	638
133. POST Credit For In-Service Training .....	638
134. Course Evaluation Fee.....	639
135. Alternative Methods Of In-Service Training .....	640
136. – 139. (Reserved) .....	640
140. Law Enforcement Certification Program Approval .....	640
141. Law Enforcement Certification Program – General Provisions .....	640
142. Administration Of College Or University Program.....	641
143. Maintenance Of Records .....	641
144. Minimum Attendance Requirements .....	641
145. Post-Graduation Self-Evaluation.....	641
146. Instruction.....	641
147. Standards.....	642
148. Periodic Assessment By POST.....	642
149. – 999. (Reserved) .....	642

**IDAPA 12 – IDAHO DEPARTMENT OF FINANCE**

***Docket No. 12-0000-2000F (Fee Rule)***

***12.01.08 – Rules Pursuant to the Uniform Securities Act (2004)***

000. Legal Authority .....	644
001. Title And Scope.....	644
002. -- 003. (Reserved).....	644
004. Securities Exemptions, Opinions, And No-Action Letters .....	644
005. Incorporation By Reference .....	644
006. -- 009. (Reserved).....	645
010. Definitions .....	645
011. -- 019. (Reserved).....	647
020. Application For Registration Of Securities .....	647
021. Amendments To Registration Statement .....	648
022. Financial Statements.....	649
023. -- 035. (Reserved).....	649
036. NASAA Statements Of Policy -- Registered Offerings.....	649
037. Registration Of Debt Securities.....	649
038. Withdrawal/Abandonment Of A Registration Statement .....	649
039. Report Of Completion Of Offering.....	650
040. Annual Report For The Renewal Of A Registration Statement .....	650
041. Subscription Agreement.....	650
042. Delivery Of Prospectus .....	650
043. Registrations -- Notice Of Intended Idaho Broker -- Dealer Or Agent .....	650
044. Records To Be Preserved By Issuers .....	651
045. Examination Of Application.....	651
046. On-Site Examination Of Issuers.....	651
047. Advertising .....	651
048. Department Access.....	652
049. -- 051. (Reserved).....	653
052. Issuer Agent Registration.....	653
053. Federal Covered Securities (Rule 53).....	653
054. Not For Profit Debt Securities Notice Filing.....	654
055. Mortgage Note Exemption .....	655
056. Manual Exemption .....	655
057. Mining, Oil Or Gas Exploration Exemption Requirements .....	655

058.	Stock Exchange Listed Securities.....	655
059.	(Reserved).....	656
060.	Registration Or Exemption Of “Blind Pool” Offerings Prohibited.....	656
061.	Cross-Border Transactions Exemption.....	656
062.	Designated Matching Services.....	656
063. --	077. (Reserved).....	658
078.	Implementation Of CRD.....	658
079.	Implementation Of IARD.....	659
080.	Broker-Dealer Registration -- Application/Renewal.....	660
081.	Withdrawal Of Broker -- Dealer And Agent Registration.....	661
082.	Withdrawal Of Agent Of Issuer Registration.....	662
083.	Broker-Dealer Agent/Issuer Agent Registration.....	662
084.	Cross-Border Licensing Exemption.....	664
085.	Relicensing (Formerly Temporary Agent Transfer (TAT) System).....	664
086.	Agent Termination.....	665
087.	Net Capital Requirements For Broker-Dealers.....	665
088.	Records Required For Broker-Dealers.....	665
089.	Investment Adviser Registration -- Application/Renewal.....	665
090.	Investment Adviser Representative Registration -- Application/Renewal.....	666
091.	Withdrawal Of Investment Adviser And Investment Adviser Representative Registration.....	668
092.	Notice Filing Requirements For Federal Covered Advisers.....	668
093.	Records Required Of Investment Advisers.....	668
094.	Client Contracts -- Investment Advisers.....	668
095.	Investment Adviser Brochure Rule.....	669
096.	Requirements For Custody.....	669
097.	Investment Adviser Affiliation With Broker-Dealers/Issuers/Agents.....	669
098.	Names Used By Broker-Dealers And Investment Advisers.....	669
099.	Circumvention Of Orders Prohibited.....	670
100.	Waiver By Administrator.....	670
101.	Notification Of Opening, Closing Or Relocation Of Branch Offices.....	670
102.	Cancellation Of Registration Or Application -- Grounds.....	670
103.	Examination Requirements.....	670
104.	Fraudulent, Dishonest And Unethical Practices - Broker-Dealer, Broker-Dealer Agents, Issuer Agents, Investment Advisers, Investment Adviser Representatives.....	671
105.	Supervision Of Agents, Investment Adviser Representatives And Employees.....	676
106. --	999. (Reserved).....	677

**IDAPA 13 – DEPARTMENT OF FISH AND GAME**

***Docket No. 13-0000-2000F (Fee Rule)***

***13.01.02 – Rules Governing Mandatory Education and Mentored Hunting***

200.	Hunter And Archery Education.....	681
201.	Trapper Education.....	681

***13.01.04 – Rules Governing Licensing***

601.	Refunds To Nonresidents.....	682
------	------------------------------	-----

***13.01.08 – Rules Governing the Taking of Big Game Animals***

263.	Refunds of Controlled Hunt Fees.....	683
------	--------------------------------------	-----

***13.01.10 – Rules Governing the Importation, Possession, Release, Sale, or Salvage of Wildlife***

410.	Large Commercial Wildlife Facilities.....	684
------	---	-----

***13.01.19 – Rules for Selecting, Operating, Discontinuing, and Suspending Vendors***

102.	Selection.....	685
------	----------------	-----

**IDAPA 15 – OFFICE OF THE GOVERNOR –  
IDAHO FOREST PRODUCTS COMMISSION**

**Docket No. 15-0300-2000F (Fee Rule)**

**15.03.01 – Rules of Administrative Procedure of the Idaho  
Forest Products Commission**

000. Legal Authority .....	687
001. Title And Scope .....	687
002. -- 003. (Reserved) .....	687
004. Definitions .....	687
005. -- 099. (Reserved) .....	687
100. Nominations, Vacancies And Terms .....	687
101. -- 199. (Reserved) .....	687
200. Assessments And Fees .....	687
201. -- 299. (Reserved) .....	688
300. Late Payments And Penalties .....	688
301. -- 999. (Reserved) .....	688

**IDAPA 15 – OFFICE OF THE GOVERNOR –  
IDAHO MILITARY DIVISION**

**Docket No. 15-0600-2000F (Fee Rule)**

**15.06.03 – Public Safety Communications Systems Installation  
and Maintenance Fee Rules**

000. Legal Authority .....	690
001. Title And Scope .....	690
002. -- 009. (Reserved) .....	690
010. Definitions .....	690
011. Fees .....	690
012. -- 999. (Reserved) .....	690

**IDAPA 15 – OFFICE OF THE GOVERNOR –  
IDAHO STATE LIQUOR DIVISION**

**Docket No. 15-1000-2000F (Fee Rule)**

**15.10.01 – Rules of the Idaho State Liquor Division**

000. Legal Authority .....	692
001. Title And Scope .....	692
002. Definitions .....	692
003. -- 009. (Reserved) .....	693
010. Retail Stores .....	693
011. Distributing Stations .....	694
012. Distillery Distributing Stations .....	697
013. -- 019. (Reserved) .....	697
020. Store Conversions .....	697
021. Suppliers .....	697
022. Schedule Of Fees .....	699
023. -- 030. (Reserved) .....	699
031. State Stores Solicitation And Promotional Presentations .....	699
032. Wines .....	699
033. Liquor Fund .....	699
034. -- 999. (Reserved) .....	699

**IDAPA 16 – DEPARTMENT OF HEALTH AND WELFARE****Docket No. 16-0000-2000F (Fee Rule)****16.01.07 – Emergency Medical Services (EMS) – Personnel Licensing Requirements**

000. Legal Authority.....	702
001. Title And Scope.....	702
002. -- 008. (Reserved).....	702
009. Criminal History And Background Check Requirements.....	702
010. Definitions.....	702
011. -- 074. (Reserved).....	702
075. Investigation Of Complaints For Personnel Licensing Violations.....	702
076. Administrative Action Imposed For License Or Certification.....	702
077. Standards Of Professional Conduct For EMS Personnel.....	702
078. -- 089. (Reserved).....	703
090. Advance Do Not Resuscitate (DNR) Directives.....	703
091. -- 099. (Reserved).....	703
100. Personnel Licensure Required.....	703
101. Affiliation Required To Practice.....	703
102. (Reserved).....	704
103. Recognition Of EMS Personnel Licensure Interstate Compact (REPLICA).....	704
104. (Reserved).....	704
105. Application And Instructions For EMS Personnel Licensure.....	704
106. Time Frame For Personnel Licensure After Successful Completion Of Education Course.....	704
107. Licensure Of Members Of The Military, Veterans, And Spouses.....	704
108. Qualifications For Licensure By Endorsement -- Members Of The Military, Veterans, And Spouses.....	705
109. (Reserved).....	705
110. Initial Personnel Licensure.....	705
111. Application Fees For Personnel Licensure.....	707
112. -- 114. (Reserved).....	707
115. EMS Personnel License Duration.....	707
116. Personnel License Transition.....	707
117. (Reserved) 707	
118. REPLICA Expiration.....	708
119. (Reserved) 708	
120. Personnel License Renewal.....	708
121. -- 124. (Reserved).....	708
125. Submission Of EMS Personnel Licensure Application And Documentation.....	709
126. -- 129. (Reserved).....	709
130. Lapsed License.....	709
131. Reinstatement Of A Lapsed EMS Personnel License.....	709
132. -- 139. (Reserved).....	710
140. Recognition Of Registration, Certification, Or Licensure From Other Jurisdictions.....	710
141. -- 144. (Reserved).....	711
145. Changes To An Existing License.....	711
146. Multiple Licenses.....	711
147. -- 149. (Reserved).....	712
150. Certificate Of Eligibility Requirements.....	712
151. Ambulance Certification.....	712
152. -- 174. (Reserved).....	712
175. EMS Bureau Review Of Applications.....	712
176. -- 299. (Reserved).....	713
300. Continuing Education And Skills Proficiency.....	713

301. Continuing Education Records Are Subject To Audit.....	713
302. -- 304. (Reserved).....	714
305. Continuing Education Categories For Personnel Licensure Renewal.....	714
306. -- 309. (Reserved).....	714
310. Venues Of Continuing Education For Personnel Licensure Renewal.....	714
311. -- 319. (Reserved).....	715
320. License Renewal Continuing Education Requirements.....	715
321. -- 324. (Reserved).....	715
325. License Renewal Skills Proficiency Requirements.....	715
326. -- 999. (Reserved).....	715
<i>16.02.01 – Idaho Time Sensitive Emergency System Council</i>	
000. Legal Authority.....	716
001. Title, Scope, And Intent.....	716
002. -- 003. (Reserved).....	716
004. Incorporation By Reference.....	716
005. -- 009. (Reserved).....	716
010. Definitions.....	716
011. -- 074. (Reserved).....	718
075. TSE Council.....	718
076. TSE Council -- Responsibilities And Duties.....	718
077. -- 079. (Reserved).....	718
080. TSE Regions.....	718
081. TSE Regions -- Realignment Of Region.....	719
082. Regional TSE Committees -- Organization And Responsibilities.....	719
083. -- 099. (Reserved).....	719
100. Designation Of TSE Centers -- Criteria.....	719
101. -- 104. (Reserved).....	719
105. Trauma Designation Centers.....	719
106. -- 109. (Reserved).....	719
110. Stroke Designation Centers.....	719
111. -- 114. (Reserved).....	719
115. STEMI (Heart Attack) Designation Centers.....	719
116. -- 119. (Reserved).....	720
120. Designation Of Centers -- General Requirements.....	720
121. -- 189. (Reserved).....	720
190. TSE Designation -- Length Of Designation.....	720
191. Renewal Of TSE Designation.....	720
192. -- 194. (Reserved).....	720
195. Notification Of Loss Of Certification Or Licensure.....	720
196. -- 199. (Reserved).....	720
200. Designation And TSE On-Site Survey Fees.....	720
201. -- 249. (Reserved).....	722
250. TSE On-Site Survey.....	722
251. TSE On-Site Survey -- General Requirements.....	722
252. TSE On-Site Survey -- Survey Team Composition.....	723
253. On-Site Survey -- Additional Surveys.....	723
254. -- 259. (Reserved).....	723
260. Designation Decision.....	723
261. -- 269. (Reserved).....	724
270. Waivers.....	724
271. -- 279. (Reserved).....	725
280. Denial And Modification.....	725

281. -- 284. (Reserved).....	725
285. Revocation And Suspension.....	725
286. -- 289. (Reserved).....	726
290. Designation At A Lesser Level.....	726
291. -- 999. (Reserved).....	726
<i>16.02.08 – Vital Statistics Rules</i>	
000. Legal Authority.....	727
001. Title.....	727
002. -- 049. (Reserved).....	727
050. Terms And Definitions.....	727
051. -- 099. (Reserved).....	728
100. Certificates, Records, And Forms.....	728
101. -- 149. (Reserved).....	728
150. Additional Offices.....	728
151. Local Registration Officers.....	729
152. -- 199. (Reserved).....	730
200. Transmittal Of Certificates And Local Records -- Reports.....	730
201. Completion And Correction Of Certificates.....	730
202. -- 250. (Reserved).....	733
251. Fees For Copies, Searches, And Other Services.....	733
252. -- 299. (Reserved).....	735
300. Registration Of Births.....	735
301. Registration Of Foundlings.....	735
302. -- 399. (Reserved).....	736
400. New Certificates Of Birth Following Marriage Of Natural Parents.....	736
401. Adoption Of Persons Born In Idaho.....	736
402. Registration System For Adult Adoptees.....	736
403. -- 449. (Reserved).....	737
450. Registration Of Deaths And Stillbirths.....	737
451. Induced Abortion Reporting Forms -- Compilations.....	738
452. -- 500. (Reserved).....	738
501. Marriage License Recording Fees.....	738
502. -- 599. (Reserved).....	738
600. Divorce Certificate Filing Fee.....	738
601. -- 649. (Reserved).....	739
650. Late Or Delayed Registration Of Birth.....	739
651. Late Or Delayed Registration Of Deaths.....	741
652. -- 699. (Reserved).....	741
700. Late And Delayed Registration Of Marriage.....	741
701. Late And Delayed Registration Of Divorce.....	742
702. -- 799. (Reserved).....	742
800. Delayed Registration Of Stillbirth.....	742
801. -- 849. (Reserved).....	742
850. Removal Of Dead Body Or Fetus From Place Of Death Or Stillbirth.....	742
851. Authorization For Disinterment And Reinterment.....	743
852. -- 999. (Reserved).....	744
<i>16.02.13 – State of Idaho Drinking Water Laboratory Certification Program</i>	
000. Legal Authority.....	745
001. Title And Scope.....	745
002. Incorporation By Reference.....	745
003. -- 009. (Reserved).....	745
010. Definitions.....	745

011. -- 099. (Reserved).....	747
100. Application For Certification.....	747
101. Certification Fees.....	748
102. Types Of Certification.....	748
103. Subcontracting.....	748
104. -- 109. (Reserved).....	748
110. On-Site Evaluation.....	748
111. -- 119. (Reserved).....	749
120. Personnel Qualifications.....	749
121. -- 129. (Reserved).....	750
130. Reporting, Notification, And Distribution Of Laboratory Results.....	750
131. -- 139. (Reserved).....	751
140. Laboratory Quality Assurance.....	751
141. -- 149. (Reserved).....	752
150. Evaluation.....	752
151. -- 199. (Reserved).....	752
200. Maintenance Of Certification.....	752
201. -- 209. (Reserved).....	752
210. Criteria And Procedures For Downgrading Or Revoking Certification Status.....	753
211. -- 999. (Reserved).....	754
 <i>16.02.14 – Construction and Operation of Public Swimming Pools</i>	
000. Legal Authority.....	755
001. Title, Scope, And Intent.....	755
002. Applicability.....	755
003. -- 009. (Reserved).....	755
010. Definitions.....	755
011. -- 019. (Reserved).....	756
020. Submission Of Plans And Specifications.....	756
021. -- 029. (Reserved).....	757
030. Permits.....	757
031. Application.....	757
032. Permit Fee And Plan Review Fee.....	757
033. Waiver Of Fees.....	757
034. -- 039. (Reserved).....	757
040. Inspections.....	757
041. Notice Of Violation.....	757
042. Reinspection.....	757
043. -- 049. (Reserved).....	757
050. Temporary Suspension And Revocation Of Permits.....	757
051. -- 059. (Reserved).....	758
060. Penalty.....	758
061. -- 069. (Reserved).....	758
070. Construction Requirements: Plumbing Codes.....	758
071. Construction Requirements: Electrical Code.....	758
072. Construction Requirements: Uniform Building Code.....	758
073. Construction Requirements: Materials.....	758
074. Construction Requirements: Corners.....	758
075. Construction Requirements: Finish.....	758
076. -- 079. (Reserved).....	758
080. Design Detail: Dimensions.....	758
081. Design Detail: Circulation.....	758
082. Design Detail: Shape.....	759



083.	Design Detail: Wading Pools.....	759
084.	Design Detail: No Diving Sign.....	759
085.	Design Detail: Safety Line.....	759
086. -- 089.	(Reserved).....	759
090.	Slope Of Floor: Shallow Area.....	759
091.	Slope Of Floor: Deep Area.....	759
092. -- 099.	(Reserved).....	759
100.	Side Walls.....	759
101.	Illustration Of Pool Side Wall.....	760
102. -- 109.	(Reserved).....	760
110.	Width Of Decks And Walkways.....	760
111.	Slope Of Decks And Walkways.....	760
112. -- 119.	(Reserved).....	761
120.	Ladders, Recessed Steps, And Stairs Requirements.....	761
121.	Recessed Steps.....	761
122.	Stairs.....	761
123.	Ladders.....	761
124.	Handrails.....	761
125.	Access To Diving Boards.....	761
126. -- 129.	(Reserved).....	761
130.	Diving Area: Headroom.....	761
131.	Diving Area: Water Depth.....	761
132.	Illustration Of Dimensions Of Diving Area.....	762
133.	Separation Of Low Diving Boards.....	762
134.	Separation Of High Diving Boards.....	762
135.	Anchoring Of Diving Boards.....	763
136. -- 139.	(Reserved).....	763
140.	Lighting And Electrical Requirements.....	763
141.	Portable Electrical Devices.....	763
142.	Overhead Wiring.....	763
143.	Underwater Lighting.....	763
144. -- 149.	(Reserved).....	763
150.	Ventilation.....	763
151. -- 159.	(Reserved).....	763
160.	Dressing Rooms, Toilets, And Showers.....	763
161.	Location Of Dressing Rooms.....	763
162.	Floors In Dressing Rooms, Toilets, And Showers.....	763
163.	Construction Of Dressing Rooms.....	763
164.	Toilets.....	763
165.	Showers.....	763
166.	Hand Sinks.....	764
167.	Exception.....	764
168. -- 169.	(Reserved).....	764
170.	Water Supply.....	764
171. -- 179.	(Reserved).....	764
180.	Sewer System.....	764
181. -- 189.	(Reserved).....	764
190.	Health And Safety: Pool Closure.....	764
191.	Health And Safety: Operator.....	764
192.	Health And Safety: Lifeguard Requirement.....	764
193.	Health And Safety: Lifeguard Chairs.....	765
194.	Health And Safety: Lifesaving Equipment.....	765

195. Health And Safety: Safety And Sanitation.....	765
196. Health And Safety: Access.....	765
197. Health And Safety: Emergency Communication.....	765
198. Clarity.....	766
199. (Reserved).....	766
200. Supervision.....	766
201. Operations Manual.....	766
202. Record Keeping.....	766
203. Reportable Accidents.....	766
204. -- 209. (Reserved).....	766
210. Depth Marking Locations.....	766
211. Depth Markers.....	766
212. -- 219. (Reserved).....	767
220. Water Quality Standards.....	767
221. Chlorine Disinfection.....	767
222. Bromine Disinfection.....	767
223. Chlorinated Isocyanurates Disinfection.....	767
224. ORP Or HRR Disinfection.....	767
225. Other Disinfection Methods.....	767
226. Acid Based Chemistry.....	767
227. Other Chemicals.....	767
228. Chemical Storage.....	767
229. Cleaning.....	767
230. Bacteriological Quality Of Pool Waters.....	768
231. Monthly Sampling.....	768
232. -- 239. (Reserved).....	768
240. Disinfectant And Chemical Feeders.....	768
241. -- 249. (Reserved).....	769
250. Recirculation System: Flow Rate.....	769
251. Recirculation System: Sizing.....	769
252. Recirculation System: Cleaning.....	769
253. Recirculation System: Flow Indicator.....	769
254. Recirculation System: Cleaning.....	769
255. Recirculation System: Thermometers.....	769
256. Recirculation System: Strainer.....	770
257. -- 259. (Reserved).....	770
260. Filtration System And Filters.....	770
261. Disposal Of Waste.....	770
262. -- 269. (Reserved).....	770
270. Wall Inlets.....	770
271. Floor Inlets.....	770
272. -- 279. (Reserved).....	770
280. Overflow Systems.....	770
281. Overflow Gutters.....	771
282. Skimmers: Requirement.....	771
283. Skimmers: Capacity.....	771
284. Skimmers: Equalizers.....	771
285. Skimmers: Location.....	772
286. -- 289. (Reserved).....	772
290. Location Of Drains.....	772
291. Multiple Drains.....	772
292. Drain Grating.....	772

293. -- 299. (Reserved).....	772
300. Fence And Barriers.....	772
301. -- 309. (Reserved).....	772
310. Geothermal Pool Exemptions.....	772
311. -- 319. (Reserved).....	772
320. Technical Waivers Or Modifications.....	773
321. -- 999. (Reserved).....	773
<i>16.02.25 – Fees Charged by the State Laboratory</i>	
000. Legal Authority.....	774
001. Title, Scope, And Policy.....	774
002. -- 009. (Reserved).....	774
010. Definitions.....	774
011. -- 099. (Reserved).....	774
100. Fees For Clinical Laboratory Tests.....	774
101. -- 199. (Reserved).....	776
200. Fees For Environmental Laboratory Tests.....	776
201. -- 899. (Reserved).....	779
900. Waiver Of Fees.....	779
901. -- 999. (Reserved).....	779
<i>16.02.26 – The Idaho Children’s Special Health Program</i>	
000. Legal Authority.....	780
001. Title And Scope.....	780
002. Written Interpretation.....	780
003. -- 009. (Reserved).....	780
010. Definitions.....	780
011. -- 050. (Reserved).....	780
051. Diagnostic/Consultative Services.....	780
052. Treatment Services.....	781
053. Follow Up And Case Management.....	781
054. Hospital In-Patient Services.....	781
055. -- 099. (Reserved).....	781
100. Diagnostic Categories.....	781
101. Cardiac.....	781
102. Cleft Lip And Palate.....	781
103. Craniofacial.....	781
104. Cystic Fibrosis.....	782
105. Neurologic.....	782
106. Orthopedic.....	782
107. Phenylketonuria (PKU).....	783
108. Plastic/Burn.....	783
109. -- 148. (Reserved).....	783
149. Program Eligibility.....	783
150. Insurance Status.....	783
151. Age.....	783
152. Diagnosis.....	783
153. Residence.....	783
154. (Reserved).....	784
155. Income.....	784
156. Family Size.....	784
157. Sliding Fee Scale.....	784
158. Application For Other Resources.....	784
159. -- 199. (Reserved).....	784

200. Applications.....	784
201. -- 249. (Reserved).....	784
250. Payments To Providers.....	785
251. Prior Authorization.....	785
252. Maximum On Hospital In-Patient Payments.....	785
253. Billing Third Parties First.....	785
254. Third Party Payments In Excess Of CSHP Limits.....	785
255. Medicaid Eligibility.....	785
256. Out-Of-State-Care.....	785
257. Durable Medical Equipment.....	785
258. -- 349. (Reserved).....	785
350. Program Exclusions.....	785
351. -- 999. (Reserved).....	787
 <i>16.02.27 – Idaho Radiation Control Rules</i>	
000. Legal Authority.....	788
001. Title And Scope.....	788
002. -- 003. (Reserved).....	788
004. Incorporation By Reference.....	788
005. -- 049. (Reserved).....	789
050. Licensing.....	789
051. Machines Required To Be Licensed.....	789
052. Fees.....	789
053. Application For License.....	790
054. -- 099. (Reserved).....	793
100. General Provisions.....	793
101. Scope.....	793
102. Definitions.....	793
103. Violations.....	793
104. Impounding.....	793
105. Communications.....	793
106. -- 199. (Reserved).....	793
200. Licensure Of Radiation Machine Facilities, (Services) - And Associated Healthcare Professionals.....	794
201. Licensure of Radiation Machine Facilities.....	794
202. Reciprocal Recognition Of Out-Of-State Radiation Machines.....	794
203. -- 399. (Reserved).....	794
400. Radiation Safety Requirements For Industrial Radiographic Operations.....	794
401. Licensing and Registration Requirements for Industrial Radiography Operations.....	794
402. Leak Testing And Replacement Of Sealed Sources.....	794
403. Quarterly Inventory.....	794
404. Labeling, Storage, and Transportation.....	794
405. Conducting Industrial Radiographic Operations.....	794
406. Records of Leak Testing of Sealed Sources and Devices Containing DU.....	794
407. Records of Quarterly Inventory.....	794
408. Utilization Logs.....	794
409. Location Of Documents and Records.....	794
410. Notifications.....	795
411. Application and Examinations.....	795
412. Certification Identification (ID) Card.....	795
413. Reciprocity.....	795
414. Specific Requirements for Radiographic Personnel Performing Industrial Radiography.....	795
415. -- 599. (Reserved).....	795

600. Notices, Instructions And Reports To Workers; Inspections.....	795
601. -- 999. (Reserved).....	795
<i>16.03.03 – Child Support Services</i>	
000. Legal Authority.....	796
001. Title, Scope, And Goal.....	796
002. -- 049. (Reserved).....	796
050. Distribution Of Support Collected In Title IV-E Foster Care Maintenance Cases.....	796
051. – 074. (Reserved).....	796
075. Fees.....	796
076. – 099. (Reserved).....	797
100. Legal Costs.....	797
101. -- 199. (Reserved).....	797
200. securing and enforcing medical support.....	797
201. Administrative Review For Enforcement Of Medical Support.....	797
202. -- 299. (Reserved).....	797
300. Review And Modification Of Support Orders.....	797
301. Consumer Reporting Agencies.....	798
302. Good Cause Determination In License Suspension Proceedings.....	798
303. -- 999. (Reserved).....	799
<i>16.03.18 – Medicaid Cost-Sharing</i>	
000. Legal Authority.....	803
001. Title And Scope.....	803
002. Written Interpretations.....	803
003. -- 009. (Reserved).....	803
010. Definitions.....	803
011. -- 024. (Reserved).....	804
025. Participants Exempt From Cost-Sharing.....	804
026. -- 049. (Reserved).....	804
050. General Cost-Sharing.....	804
051. - 199. (Reserved).....	804
200. Premiums For Participation Under The State Children’s Health Insurance Program (SCHIP).....	804
201. -- 204. (Reserved).....	805
205. Premiums For Participation Under Home Care For Certain Disabled Children (HCCDC).....	805
206. (Reserved) 806	
207. Premiums For Participation Under The Youth Empowerment Services (YES) Program.....	806
208. -- 209. (Reserved).....	806
210. Department Responsibilities.....	806
211. -- 214. (Reserved).....	806
215. Premiums For Participation In Medicaid Enhanced Plan.....	806
216. -- 249. (Reserved).....	807
250. Delinquent Premium Payments.....	807
251. -- 299. (Reserved).....	807
300. Participants Exempt From CoPayment.....	807
301. -- 309. (Reserved).....	808
310. CoPayment Fee Amounts.....	808
311. -- 319. (Reserved).....	808
320. Medicaid Outpatient Services Subject To Copayments.....	808
321. -- 324. (Reserved).....	809
325. Exception To Charging A Copayment.....	809
326. -- 329. (Reserved).....	809
330. Collection Of Copayments.....	809

331. -- 399. (Reserved).....	809
400. Participation In The Cost Of Home And Community-Based Waiver Services.....	809
401. -- 999. (Reserved).....	811
<i>16.03.19 – Certified Family Homes</i>	
000. Legal Authority.....	812
001. Title, Scope, And Exceptions.....	812
002. Incorporation By Reference.....	812
003. -- 008. (Reserved).....	812
009. Criminal History And Background Check Requirements.....	812
010. Definitions And Abbreviations -- A Through K.....	813
011. Definitions And Abbreviations -- L Through Z.....	814
012. -- 099. (Reserved).....	815
100. Certification Requirements.....	816
101. Application For Certification.....	817
102. -- 108. (Reserved).....	818
109. Application And Certification Fees For Certified Family Homes.....	818
110. Issuance Of Certificate.....	818
111. Renewal Of Certificate.....	819
112. Change Of Provider Or Location.....	820
113. Denial Of Application For Certificate.....	820
114. Family Home Operating Without A Certificate.....	821
115. Voluntary Closure Of The Home.....	821
116. Required Ongoing Training.....	822
117. -- 119. (Reserved).....	822
120. Waivers.....	822
121. General Variances.....	823
122. Revoking A Waiver Or Variance.....	823
123. -- 129. (Reserved).....	824
130. Nursing Facility Level Of Care Variance.....	824
131. -- 139. (Reserved).....	824
140. Variance To The Two Resident Limit.....	824
141. -- 149. (Reserved).....	826
150. Inspections Of Homes.....	826
151. -- 159. (Reserved).....	827
160. Complaint Procedure.....	827
161. -- 169. (Reserved).....	827
170. Minimum Standards Of Care.....	827
171. -- 173. (Reserved).....	828
174. Activities And Community Integration.....	828
175. Room, Utilities And Meals.....	829
176. -- 179. (Reserved).....	830
180. Hourly Adult Care.....	830
181. -- 199. (Reserved).....	832
200. Resident Rights Policy.....	832
201. Notice Of Resident Rights.....	835
202. Access By Advocates And Representatives.....	835
203. -- 209. (Reserved).....	836
210. Reporting Requirements.....	836
211. -- 224. (Reserved).....	837
225. Uniform Assessment Requirements.....	837
226. -- 249. (Reserved).....	838
250. Plan Of Service.....	838

251. – 259. (Reserved) .....	839
260. Admissions .....	839
261. -- 269. (Reserved) .....	842
270. Resident Records .....	842
271. -- 274. (Reserved) .....	843
275. Resident Funds And Financial Records .....	843
276. -- 299. (Reserved) .....	845
300. Short-Term Care And Supervision .....	845
301. -- 399. (Reserved) .....	846
400. Medication Policy .....	846
401. Self-Administration Of Medication .....	847
402. Assistance With Medication .....	847
403. -- 499. (Reserved) .....	849
500. Environmental Sanitation Standards .....	849
501. -- 599. (Reserved) .....	850
600. Fire And Life Safety Standards .....	850
601. -- 699. (Reserved) .....	853
700. Home Construction And Physical Home Standards .....	853
701. Manufactured Homes And Modular Buildings .....	856
702. -- 709. (Reserved) .....	856
710. Site Requirements For Certified Family Homes .....	856
711. -- 899. (Reserved) .....	857
900. Emergency Powers Of The Director .....	857
901. Enforcement Process .....	857
902. Failure To Comply .....	857
903. Repeated Noncompliance .....	857
904. -- 908. (Reserved) .....	857
909. Enforcement Remedy Of Provisional Certification .....	857
910. Enforcement Remedy Of Ban On All Admissions .....	858
911. Enforcement Remedy Of Ban On Admissions Of Resident With Specific Diagnosis .....	858
912. Enforcement Remedy Of Summary Suspension And Transfer Of Resident .....	858
913. Enforcement Remedy Of Revocation Of Certificate .....	858
914. (Reserved) .....	859
915. Transfer Of Resident .....	859
916. -- 949. (Reserved) .....	859
950. Right To Sell .....	859
951. -- 999. (Reserved) .....	859
<b>16.03.22 – Residential Assisted Living Facilities</b>	
000. Legal Authority .....	860
001. Title, Scope, And Responsibilities .....	860
002. Written Interpretations .....	860
003. Administrative Appeals, Contested Cases, And Informal Dispute Resolution .....	860
004. Incorporation By Reference .....	860
005. Office – Office Hours – Mailing Address – Street Address – Telephone -- Internet Website ...	861
006. Confidentiality Of Records And Public Records Requests .....	862
007. -- 008. (Reserved) .....	862
009. Criminal History And Background Check Requirements .....	862
010. Definitions And Abbreviations A Through E .....	863
011. Definitions And Abbreviations F Through N .....	866
012. Definitions And Abbreviations O Through Z .....	867
013. -- 049. (Reserved) .....	869
050. Variances .....	869

051. -- 099. (Reserved).....	869
100. Licensing Requirements.....	870
101. -- 104. (Reserved).....	870
105. Change Of Ownership.....	870
106. -- 109. (Reserved).....	870
110. Facility License Application.....	870
111. -- 114. (Reserved).....	872
115. Expiration And Renewal Of License.....	872
116. -- 125. (Reserved).....	872
126. Effect Of Enforcement Action Against A License.....	872
127. -- 129. (Reserved).....	872
130. Inspection Of Facilities.....	872
131. -- 149. (Reserved).....	874
150. Policies And Procedures.....	874
151. Activity Requirements.....	874
152. Admission Requirements.....	874
153. Financial Requirements.....	875
154. Staff Training Requirements.....	876
155. Emergency Preparedness Requirements.....	877
156. Hourly Adult Care Requirements.....	877
157. -- 160. (Reserved).....	878
161. Smoking Requirements.....	878
162. -- 214. (Reserved).....	878
215. Requirements For A Facility Administrator.....	878
216. Requirements For Admission Agreements.....	880
217. Requirements For Termination Of Admission Agreement.....	882
218. -- 249. (Reserved).....	883
250. Requirements For Building Construction And Physical Standards.....	883
251. -- 254. (Reserved).....	886
255. Requirements For Additional Physical Standards.....	886
256. -- 259. (Reserved).....	886
260. Requirements For Environmental Sanitation.....	886
261. -- 299. (Reserved).....	888
300. Requirements For Nursing Services.....	888
301. -- 304. (Reserved).....	888
305. Requirements For The Licensed Registered Nursing Assessment.....	888
306. -- 309. (Reserved).....	889
310. Requirements For Medication.....	889
311. -- 318. (Reserved).....	890
319. Comprehensive Assessment Requirements.....	890
320. Negotiated Service Agreement (NSA) Requirements.....	891
321. -- 329. (Reserved).....	892
330. Requirements For Facility Records.....	892
331. -- 334. (Reserved).....	896
335. Requirements For Infection Control.....	896
336. -- 399. (Reserved).....	896
400. Requirements For Fire And Life Safety Standards.....	896
401. Fire And Life Safety Standards For New Buildings Housing Three Through Sixteen Residents.....	896
402. Fire And Life Safety Standards For New Buildings Housing Seventeen Or More Residents And Multi-story Buildings.....	897
403. Fire And Life Safety Standards For Existing Buildings Licensed For Three Through Sixteen Residents.....	897



404. Fire And Life Safety Standards For Existing Buildings Licensed For Seventeen Or More Residents And Multi-story Buildings. ....	897
405. Additional Fire And Life Safety Standards For All Buildings And Facilities. ....	897
406. -- 409. (Reserved).....	898
410. Requirements For Emergency Actions And Fire Drills. ....	898
411. -- 429. (Reserved).....	898
430. Requirements For Furnishings, Equipment, Supplies, and Basic Services. ....	898
431. -- 449. (Reserved).....	899
450. Requirements For Food And Nutritional Care Services. ....	899
451. Menu And Diet Planning. ....	899
452. -- 454. (Reserved).....	900
455. Food Supply. ....	900
456. -- 459. (Reserved).....	900
460. Food Preparation And Service. ....	900
461. -- 509. (Reserved).....	901
510. Requirements To Protect Residents From Abuse.....	901
511. -- 514. (Reserved).....	901
515. Requirements To Protect Residents From Exploitation. ....	901
516. -- 519. (Reserved).....	901
520. Requirements To Protect Residents From Inadequate Care. ....	901
521. -- 524. (Reserved).....	901
525. Requirements To Protect Residents From Neglect.....	901
526. -- 549. (Reserved).....	901
550. Requirements For Residents' Rights.....	901
551. -- 559. (Reserved).....	905
560. Notice Of Residents' Rights. ....	905
561. -- 599. (Reserved).....	905
600. Requirements For Staffing Standards. ....	905
601. -- 619. (Reserved).....	905
620. Requirements For Training Of Facility Personnel. ....	905
621. -- 624. (Reserved).....	906
625. Orientation Training Requirements. ....	906
626. -- 629. (Reserved).....	906
630. Training Requirements For Facilities Admitting Residents With Diagnosis Of Dementia, Mental Illness, Developmental Disability, Or Traumatic Brain Injury. ....	906
631. -- 639. (Reserved).....	908
640. Continued Training Requirements. ....	908
641. Additional Training Related To Changes. ....	908
642. -- 644. (Reserved).....	908
645. Assistance With Medications. ....	908
646. -- 899. (Reserved).....	908
900. Enforcement Actions. ....	908
901. Enforcement Action Of Summary Suspension.....	908
902. -- 909. (Reserved).....	909
910. Enforcement Action Of Consultant. ....	909
911. -- 919. (Reserved).....	909
920. Enforcement Action Of Limit On Admissions. ....	909
921. -- 924. (Reserved).....	909
925. Enforcement Action Of Civil Monetary Penalties. ....	909
926. -- 929. (Reserved).....	910
930. Enforcement Action Of Temporary Management.....	910
931. -- 934. (Reserved).....	911

935. Enforcement Action Of Provisional License .....	912
936. -- 939. (Reserved) .....	912
940. Enforcement Action Of Revocation Of Facility License .....	912
941. -- 999. (Reserved) .....	913
<i>16.04.07 – Rules Governing Fees for State Hospital North</i>	
000. Legal Authority .....	914
001. Title And Scope .....	914
002. Policy .....	914
003. -- 009 (Reserved) .....	914
010. Definitions .....	914
011. -- 029 (Reserved) .....	914
030. Fees .....	914
031. -- 049. (Reserved) .....	914
050. Charges .....	914
051. -- 069. (Reserved) .....	915
070. Waiver .....	915
071. -- 089. (Reserved) .....	915
090. Personal Needs Allowance .....	915
091. -- 999. (Reserved) .....	915
<i>16.05.06 – Criminal History and Background Checks</i>	
000. Legal Authority .....	916
001. Title, Scope And Policy .....	916
002. -- 009. (Reserved) .....	916
010. Definitions And Abbreviations .....	916
011. -- 049. (Reserved) .....	918
050. Fees And Costs For Criminal History And Background Checks .....	918
051. -- 059. (Reserved) .....	918
060. Employer Registration .....	918
061. Employer Responsibilities .....	918
062. Employer Responsibilities .....	919
063. -- 069. (Reserved) .....	919
070. Non-Compliance With These Rules .....	919
071. -- 099. (Reserved) .....	919
100. Individuals Subject To A Criminal History And Background Check .....	919
101. Department Individuals Subject To A Criminal History And Background Check .....	921
102. -- 119. (Reserved) .....	921
120. Application For A Criminal History And Background Check .....	922
121. -- 124. (Reserved) .....	922
125. Idaho Child Protection Central Registry Checks .....	922
126. Applicants Receiving A Department Enhanced Clearance .....	923
127. -- 129. (Reserved) .....	923
130. Submission Of Application .....	923
131. -- 139. (Reserved) .....	923
140. Submission Of Fingerprints .....	923
141. -- 149. (Reserved) .....	924
150. Time Frame For Submitting Application And Fingerprints .....	924
151. -- 159. (Reserved) .....	924
160. Withdrawal Of Application .....	924
161. -- 169. (Reserved) .....	925
170. Availability To Provide Services Pending Completion Of The Criminal History And Background Check .....	925
171. -- 179. (Reserved) .....	925

180. Criminal History And Background Check Results .....	925
181. Application Status .....	925
182. -- 189. (Reserved) .....	925
190. Criminal History And Background Check Clearance .....	925
191. -- 199. (Reserved) .....	926
200. Unconditional Denial .....	926
201. -- 209. (Reserved) .....	927
210. Disqualifying Crimes Resulting In An Unconditional Denial .....	927
211. -- 219. (Reserved) .....	930
220. Conditional Denial .....	930
221. -- 229. (Reserved) .....	930
230. Relevant Records Resulting In A Conditional Denial .....	930
231. -- 239. (Reserved) .....	931
240. Medicaid Exclusion .....	931
241. -- 249. (Reserved) .....	931
250. Exemption Reviews .....	931
251. -- 259. (Reserved) .....	932
260. Previous Exemption Review Denials .....	932
261. -- 269. (Reserved) .....	932
270. Criminal Or Relevant Record - Action Pending .....	932
271. -- 299. (Reserved) .....	932
300. Updating Criminal History And Background Checks .....	932
301. -- 349. (Reserved) .....	933
350. Criminal History And Background Check Records .....	933
351. -- 999. (Reserved) .....	934
<b>16.06.01 – Child and Family Services</b>	
000. Legal Authority .....	935
001. Title, Scope, And Goal .....	935
002. -- 008. (Reserved) .....	935
009. Criminal History And Background Check Requirements .....	935
010. Definitions And Abbreviations A Through E .....	935
011. Definitions And Abbreviations F Through K .....	936
012. Definitions And Abbreviations L Through R .....	938
013. Definitions And Abbreviations S Through Z .....	939
014. -- 019. (Reserved) .....	940
020. General Requirements Applicable To All Child And Family Services Programs .....	940
021. -- 029. (Reserved) .....	941
030. Core Child And Family Services .....	941
031. -- 049. (Reserved) .....	942
050. Protections And Safeguards For Children And Families .....	942
051. Notice Requirements For ICWA .....	945
052. -- 059. (Reserved) .....	945
060. Family Case Records .....	945
061. -- 239. (Reserved) .....	946
240. Six-Month Reviews For Children In Alternate Care Placement .....	946
241. -- 399. (Reserved) .....	946
400. Authority For Alternate Care Services .....	946
401. Considerations For Placement In Alternate Care .....	947
402. Involuntary Placement Of Indian Children .....	947
403. Date A Child Entered Foster Care .....	948
404. Foster Care Goal .....	948
405. Alternate Care Case Management .....	948

406. -- 421. (Reserved).....	949
422. Alternate Care Planning.....	949
423. -- 424. (Reserved).....	950
425. Title IV-E Eligibility.....	950
426. (Reserved) 951	
427. Determination Of Eligibility For Title IV-E.....	951
428. Custody And Placement.....	951
429. Effective Date.....	951
430. Ongoing Eligibility.....	951
431. (Reserved) 952	
432. Title XIX Foster Child.....	952
433. Income, Benefits And Savings Of Children In Foster Care.....	952
434. Forwarding Of Benefits.....	952
435. (Reserved) 952	
436. Parental Financial Support For Children In Alternate Care.....	952
437. Accounting And Reporting.....	953
438. Support Agreement For Voluntary Placements.....	953
439. Support In Court-Ordered Placement.....	953
440. Insurance Coverage.....	953
441. Referral To Child Support Services.....	953
442. Medicaid For Children In Alternate Care.....	953
443. EPSDT Screening.....	953
444. Medical Emergencies.....	953
445. Dental Care.....	953
446. Costs Of Prescription Drugs.....	954
447. Medical Examination Upon Entering Alternate Care.....	954
448. -- 450. (Reserved).....	954
451. Drivers' Training, Drivers' Licenses, And Permits For Children In Alternate Care.....	954
452. -- 479. (Reserved).....	954
480. Alternate Care Licensure.....	954
481. Facilities Operated By The State.....	954
482. Payment For Shelter Care.....	954
483. Payment To Family Alternate Care Providers.....	955
484. Additional Payments To Family Alternate Care Providers.....	955
485. Treatment Foster Care.....	956
486. Group Foster Care.....	956
487. Residential Care Facilities.....	957
488. -- 491. (Reserved).....	957
492. Reimbursement In The Home Of A Relative.....	957
493. -- 549. (Reserved).....	957
550. Child Protection Services.....	957
551. Reporting Abuse, Neglect, Or Abandonment.....	957
552. Reporting System.....	958
553. Assigning Reports For Safety Assessment.....	958
554. Response Priorities.....	958
555. Supervisory Review - Certain Priority I And II Cases.....	959
556. Reports Involving Indian Children.....	959
557. Reports Involving Military Families.....	959
558. Community Resources.....	959
559. Child Protection Safety And Comprehensive Assessments.....	959
560. Disposition Of Child Protection Reports.....	960
561. Child Protection Central Registry.....	961

562. Confidentiality Of The Child Protection Central Registry And Requests To Check The Registry. ....	961
563. Levels Of Risk On The Child Protection Central Registry. ....	961
564. Notification Of A Substantiated Incident Of Abuse, Neglect, Or Abandonment, And Related Administrative Review And Contested Case Appeal Rights. ....	963
565. Petition For Removal Of An Individual's Name On The Child Protection Central Registry Prior To October 1, 2007. ....	964
566. Petition For Removal Of An Individual's Name From The Child Protection Central Registry. ....	964
567. "Safe Haven" Exemption For Parents Of Certain Abandoned Infants. ....	965
568. Court-Ordered Child Protection Safety Assessment. ....	965
569. Petition Under The Child Protective Act. ....	965
570. Cooperation With Law Enforcement. ....	965
571. Child Custody Investigations For The District Court. ....	965
572. -- 699. (Reserved).....	966
700. Adoption Services Policy.....	966
701. Services To Be Provided In Adoptions.....	966
702. Conditions For Guardianship Assistance. ....	967
703. Federally-Funded Guardianship Assistance Eligibility, Requirements, And Benefits.....	968
704. State-Funded Guardianship Assistance Eligibility, Requirement, And Benefits.....	969
705. -- 709. (Reserved).....	970
710. Family History. ....	970
711. Decision And Approval Process For Termination Of Parent And Child Relationship (TPR). ....	971
712. -- 713. (Reserved).....	971
714. Voluntary Termination. ....	971
715. Voluntary Consent.....	971
716. Voluntary Termination Of Parental Rights To An Indian Child. ....	971
717. Filing Of Petition For Voluntary Termination. ....	971
718. Report To Court -- Voluntary Termination. ....	971
719. Investigation. ....	971
720. Filing Of A Petition For Involuntary Termination Of Parent And Child Relationship.....	972
721. Report To The Court -- Involuntary Termination. ....	972
722. -- 749. (Reserved).....	974
750. Application To Be Adoptive Parent(s). ....	974
751. -- 761. (Reserved).....	975
762. Completing The Adoption Home Study.....	975
763. Pre-Adoptive Parent Responsibilities. ....	977
764. Adoptive Home Study. ....	977
765. -- 769. (Reserved).....	977
770. Closure Of Adoptive Home Studies. ....	977
771. Home Study Update.....	977
772. -- 789. (Reserved).....	977
790. Foster Parent Adoptions. ....	977
791. -- 799. (Reserved).....	977
800. Placement Of The Child. ....	977
801. -- 829. (Reserved).....	978
830. Adoption Application Fee. ....	978
831. Home Study, Supervisory Reports, And Reports Of The Court Fees. ....	978
832. Fee Schedule - Adoptions Through Department.....	978
833. Placement Supervision -- Transfer From Out Of State Private Agency. ....	979
834. -- 849. (Reserved).....	979
850. Independent, Relative And Stepparent Adoptions. ....	979
851. -- 859. (Reserved).....	979

860.	Procedures Following The Adoptive Placement .....	979
861.	Progress Reports .....	979
862.	Petition To Adopt Under The Adoption Of Children Act .....	980
863.	Investigation Of Petition To Adopt And Report To The Court .....	980
864. -- 869.	(Reserved) .....	982
870.	Removal Of A Child From A Prospective Adoptive Home .....	982
871.	Temporary Replacement After Disruption .....	982
872. -- 880.	(Reserved) .....	982
881.	Closure Of Case .....	982
882.	Records Of Placement .....	982
883.	Post-Legal Adoption Services .....	982
884.	Opening Sealed Records Of Adoptions .....	982
885. -- 888.	(Reserved) .....	982
889.	Certified Adoption Professional Requirements .....	983
890.	Terms Of Certification For Adoption Professionals .....	983
891.	Certified Adoption Professional's Client Relationship .....	985
892.	Minimum Standards For Service .....	985
893.	Records Of The Certified Adoption Professional .....	985
894.	Fees Charged By The Department .....	986
895.	Department Responsibility To Certified Adoption Professional .....	986
896. -- 899.	(Reserved) .....	986
900.	Adoption Assistance .....	986
901.	Attempt To Place Without Adoption Assistance .....	988
902. -- 909.	(Reserved) .....	988
910.	Types And Amounts Of Assistance .....	988
911.	Adoption Assistance Program Agreement .....	989
912. -- 919.	(Reserved) .....	990
920.	Request For Reconsideration For Adoption Assistance .....	990
921.	Burden Of Proof -- Extenuating Circumstances .....	990
922.	Retroactive Adoption Assistance Benefits .....	991
923.	Disruption Of International Adoptions .....	991
924. -- 999.	(Reserved) .....	991
 <i>16.06.02 – Rules Governing Standards for Child Care Licensing</i>		
000.	Legal Authority .....	992
001.	Title, Scope, Policy, Purpose, Exceptions, And Exemptions To Licensing .....	992
002.	Incorporation By Reference .....	993
003. -- 008.	(Reserved) .....	993
009.	Criminal History And Background Check Requirements .....	993
010.	Definitions A Through M .....	994
011.	Definitions N Through Z .....	997
012. -- 099.	(Reserved) .....	999
100.	Licensing .....	999
101.	Applications For License .....	999
102.	Disposition Of Applications .....	999
103.	Restrictions On Applicability And Nontransfer .....	1001
104.	Mandatory Visitations .....	1001
105.	Revisit And Relicense .....	1002
106.	Complaints Against Daycare Centers, Group Daycare Facilities, Family Daycare Homes, Foster Homes, Children's Residential Care Facilities, Children's Therapeutic Outdoor Programs, Children's Camps, And Children's Agencies .....	1002
107.	Suspension For Circumstances Beyond Control Of Foster Parent Or Operator .....	1002
108.	Suspension Or Revocation For Infractions .....	1002

109. Non-renewal, Denial, Revocation, Or Suspension Of License.....	1002
110. Enforcement Remedy Of Ban On Admissions.....	1003
111. Enforcement Remedy Of Summary Suspension And Transfer Of Residents Or Children.....	1003
112. Enforcement Remedy Revocation Of License And Transfer Of Residents Or Children.....	1003
113. Effect Of Previous Revocation Or Denial Of A License.....	1004
114. -- 299. (Reserved).....	1004
300. Standards For Daycare.....	1004
301. Types Of Daycare Licenses.....	1004
302. -- 308. (Reserved).....	1005
309. Criminal History And Background Check For Daycare Standards.....	1005
310. -- 319. (Reserved).....	1005
320. Daycare Licensing Maximum Total Fees.....	1005
321. Application For Daycare License Or Renewal.....	1006
322. -- 324. (Reserved).....	1007
325. Issuance Of License.....	1007
326. -- 329. (Reserved).....	1007
330. Staff And Other Individual Record Requirements.....	1007
331. Child Record Content Requirements.....	1008
332. -- 334. (Reserved).....	1008
335. Child-Staff Ratio.....	1008
336. -- 339. (Reserved).....	1009
340. Daycare Center Training Requirements.....	1009
341. -- 344. (Reserved).....	1010
345. Mandatory Reporting Of Abuse, Abandonment, Or Neglect.....	1010
346. Visitation And Access.....	1010
347. -- 349. (Reserved).....	1010
350. Fire Safety Standards.....	1010
351. Facility Capacity And Determining Occupant Load.....	1011
352. Fire Extinguishers And Safety Requirements.....	1011
353. Fire Safety And Evacuation Plans.....	1012
354. -- 359. (Reserved).....	1012
360. Health Standards.....	1012
361. Miscellaneous Safety Requirements.....	1014
362. -- 364. (Reserved).....	1015
365. Buildings, Grounds, Furnishings, And Equipment.....	1015
366. -- 389. (Reserved).....	1016
390. Continued Compliance, Reporting Changes, And Critical Incidents.....	1016
391. -- 394. (Reserved).....	1017
395. Failure To Comply.....	1017
396. -- 399. (Reserved).....	1017
400. Standards For Foster Homes.....	1017
401. Licensing Provisions Related To The Indian Child Welfare Act.....	1017
402. Foster Parent Qualifications And Suitability.....	1017
403. Member Of Household Qualifications And Suitability.....	1018
404. Criminal History And Background Checks For Foster Care License.....	1018
405. Initial Evaluation.....	1019
406. Subsequent Evaluations.....	1021
407. Foster Parent Duties.....	1021
408. Foster Parent Training.....	1022
409. -- 429. (Reserved).....	1022
430. Child Care And Safety Requirements.....	1022
431. Installation, Maintenance And Inspection Of Flame And Heat Producing Equipment.....	1023

432.	Smoke And Carbon Monoxide Detecting Devices .....	1023
433.	Exits .....	1024
434.	Dangerous And Hazardous Materials .....	1024
435.	Firearms And Ammunition .....	1024
436.	Pets And Domestic Animals .....	1024
437.	Adequate Heat, Light, And Ventilation .....	1024
438.	Bathrooms, Water Supply, And Sewage Disposal .....	1024
439.	Transportation .....	1024
440.	Telephone .....	1025
441.	Wheelchair Access .....	1025
442.	Child Placement Requirements .....	1025
443.	Interagency Placement Of Children .....	1025
444.	Substitute Care Placement And Children's Agency Notification .....	1026
445.	Bedrooms .....	1026
446.	Behavior Management And Discipline .....	1027
447.	Medical And Dental Care .....	1028
448.	Personal Care And Hygiene .....	1028
449.	Food And Nutrition .....	1028
450.	Necessary Clothing .....	1028
451.	Personal Possessions, Allowances, And Money .....	1028
452.	Child Tasks .....	1028
453.	Education .....	1029
454.	Religious And Cultural Practices .....	1029
455.	Recreation .....	1029
456.	Mail .....	1029
457.	Reasonable And Prudent Parent Standard .....	1029
458. -- 469.	(Reserved) .....	1029
470.	Record Management And Reporting Requirements .....	1029
471.	Reporting Foster Home Changes .....	1030
472.	Confidentiality .....	1030
473.	Unusual Incident Notification .....	1030
474. -- 499.	(Reserved) .....	1031
500.	General Standards For Organizations Known As Children's Agencies And Children's Residential Care Facilities .....	1031
501.	Access By Department Authorized Agents .....	1031
502.	Compliance Required .....	1031
503.	Notification To The Licensing Authority .....	1031
504.	Notification To The Licensing Authority No Later Than One Working Day .....	1031
505.	Unauthorized Absences .....	1031
506.	Death Of A Child In Care Notification .....	1031
507. -- 519.	(Reserved) .....	1031
520.	Written Bylaws .....	1032
521.	Governing Body Required .....	1032
522.	Delineation Of Job Responsibilities .....	1032
523.	Organizational Chart, Policies And Procedures .....	1032
524.	Insurance Coverage .....	1032
525.	Quality Of Services Environment .....	1032
526.	Research Protections For Persons Served .....	1032
527.	Confidentiality And Privacy Protections Of Persons Served .....	1032
528.	Description Of Services .....	1033
529.	Intake Policy .....	1033
530.	Continued Care .....	1033



531. Documentation Requirements For Continued Care .....	1033
532. -- 534. (Reserved).....	1033
535. Sufficient Financial Resources .....	1033
536. Annual Audit .....	1033
537. -- 543. (Reserved).....	1034
544. Human Resources Needed.....	1034
545. Service Worker Or Social Worker .....	1034
546. Staff Recruitment, Hiring, Supervision, Training, Evaluation, Promotion And Discipline. ....	1034
547. Person Filling More Than One Position. ....	1035
548. (Reserved) .....	1035
549. Tuberculosis Screening.....	1035
550. Volunteer Supervision .....	1035
551. Employee And Volunteer Orientation.....	1035
552. Employee And Volunteer Training. ....	1035
553. -- 559. (Reserved).....	1035
560. Permanent Register .....	1035
561. Content Of Child's Record.....	1035
562. Authorizations Required.....	1037
563. Service Plans .....	1037
564. Shelter Care Admission And Plans .....	1037
565. Maintenance Of Records .....	1038
566. Record Retention .....	1038
567. -- 569. (Reserved).....	1038
570. Reporting Of Child Abuse, Neglect, And Abandonment. ....	1038
571. Health Services.....	1038
572. Dental Services .....	1038
573. Non-Violent Physical Intervention .....	1039
574. Client Grievance Policy .....	1039
575. Suicide Prevention Plan.....	1039
576. Clothing .....	1039
577. Visitation Policy .....	1039
578. Correspondence Policy .....	1040
579. Religious And Culture Policy.....	1040
580. Education Policy.....	1040
581. Personal Possessions, Allowance, And Money Policy.....	1040
582. Emergency Policies.....	1040
583. Reasonable And Prudent Parent Standard For An Organization Providing Services To Children Placed By The Department. ....	1041
584. -- 599. (Reserved).....	1041
600. Additional Standards For Children's Agencies.....	1041
601. Chief Administrator Position And Qualifications.....	1041
602. Service Worker Supervisor Position.....	1041
603. (Reserved) .....	1041
604. Social Worker Position And Qualifications .....	1041
605. Service Worker Position And Qualifications .....	1042
606. Social Worker Or Service Worker Responsibilities .....	1042
607. Self-Supervision Prohibited.....	1042
608. Staff Workloads .....	1042
609. -- 614. (Reserved).....	1042
615. Additional Provisions For Foster Home Certification.....	1042
616. Program Description .....	1042

617.	Licensing And Certification Agency Policies And Procedures For Foster Homes.....	1042
618.	Application Request Process.....	1042
619.	(Reserved).....	1043
620.	Initial And Subsequent Family Foster Home Evaluation Study Process And Contents.....	1043
621.	Training.....	1043
622.	Placement Agreement Required Contents.....	1043
623.	Complaint Investigation, Basis, Time Requirements, Notifying Foster Parents, Contents, And Process.....	1043
624.	Records Management, Maintenance, Availability To Foster Parent, And Contents.....	1044
625. -- 629.	(Reserved).....	1044
630.	Additional Placement Considerations.....	1044
631.	Emergency Evacuation Plan.....	1044
632.	Unusual Incident Policy.....	1044
633.	Service Plans And Participants.....	1045
634.	Children's Agency Supervision Of Child.....	1045
635. -- 649.	(Reserved).....	1045
650.	Additional Provisions For Transitional Living Services.....	1045
651.	Program Statement For Transitional Living Services.....	1045
652.	Policies And Procedures For Transitional Living Services.....	1045
653.	Record Management.....	1045
654.	Service Components.....	1045
655.	Transitional Living Placement.....	1046
656.	Supervision And Support.....	1046
657.	Termination Of Transitional Living Services.....	1046
658.	Required Information For Youth At Service Termination.....	1046
659.	(Reserved).....	1047
660.	Additional Provisions For Adoption Services.....	1047
661.	Adoption Services - Nonprofit Status.....	1047
662.	Program Statement.....	1047
663.	Written Policies And Procedures - Adoption.....	1047
664.	Services For Children AS The Primary Consideration.....	1047
665.	Services For Child's Birth Parents.....	1047
666.	Services For Adoptive Applicants.....	1048
667.	Recruitment Of Adoptive Applicants.....	1048
668.	Payment Limitations In Adoption.....	1048
669.	Prohibition Of Contributions In Adoptions.....	1048
670.	Prohibition Of Staff Adoptions.....	1048
671.	(Reserved).....	1048
672.	Services For Adoptive Parents.....	1049
673.	Selection Of An Adoptive Placement.....	1049
674.	Conditions For Placement In An Adoptive Home.....	1049
675.	Adoptive Parent Information.....	1049
676.	Supervision.....	1050
677. -- 679.	(Reserved).....	1050
680.	Additional Provisions For Inter-Country Adoption Services.....	1050
681.	Inter-Country Adoption Services.....	1050
682.	Legal Requirements For Inter-Country Adoption Services.....	1050
683.	Financial.....	1051
684.	Inter-Country Adoption Services To Adoptive Parents.....	1051
685.	Collecting And Exchanging Information About A Child.....	1051
686.	Post-Placement And Post-Finalization Adoption Services.....	1051
687. -- 699.	(Reserved).....	1052

700. Additional Standards For Children's Residential Care Facilities .....	1052
701. -- 704. (Reserved).....	1052
705. Chief Administrator Qualifications .....	1052
706. Service Worker Supervisor Qualifications.....	1052
707. Direct Care Staff Supervisor Qualifications.....	1052
708. (Reserved) .....	1053
709. Direct Care Staff Qualifications.....	1053
710. Required Staff Ratios.....	1053
711. House Parent Relief Staff.....	1053
712. Staff Training.....	1053
713. -- 714. (Reserved).....	1053
715. Compliance With Applicable Laws.....	1054
716. Children's Residential Care Facility Building Requirements.....	1054
717. National Electrical Code Compliance.....	1054
718. Fire Safety Requirements.....	1054
719. Emergency Procedures.....	1054
720. Emergency Drills.....	1055
721. Public Health District Inspection.....	1055
722. Buildings, Grounds, Furnishings And Equipment.....	1055
723. Maintenance.....	1055
724. Equipment Storage.....	1055
725. Service Sink.....	1055
726. Hazardous Materials Or Toxins.....	1055
727. Lighting.....	1055
728. Heating.....	1055
729. Bathroom Facilities.....	1056
730. Sleeping Rooms.....	1056
731. Beds.....	1056
732. Storage Of Poisonous And Toxic Materials.....	1056
733. Flammable Liquids.....	1056
734. Firearms.....	1056
735. Sufficient Recreational Space.....	1056
736. General Safety Provisions.....	1056
737. Diapering And Sanitation.....	1057
738. -- 744. (Reserved).....	1057
745. Education Program.....	1057
746. Work.....	1057
747. Recreation, Physical Exercise, And Leisure Time Activities.....	1057
748. Sleep.....	1057
749. Swimming Pool, Pond, Or Other Body Of Water.....	1057
750. Water Front.....	1059
751. Supervision Of Recreational Activity.....	1059
752. Medication Storage And Administration.....	1059
753. Universal Precautions.....	1060
754. First Aid Kit.....	1060
755. Nutrition.....	1060
756. Animals And Pets.....	1060
757. Use Of Tobacco Products, Alcohol, And Illegal Drugs Prohibited.....	1060
758. Transporting Children.....	1060
759. Contraband.....	1061
760. Searches.....	1061
761. Behavior Management And Discipline Policy.....	1062

762. Time-Out .....	1062
763. Unlocked Seclusion.....	1063
764. Locked Seclusion.....	1064
765. Locked Seclusion Room Requirements.....	1065
766. Mechanical Restraint.....	1065
767. Alternative Forms Of Restraint.....	1066
768. Transportation Of Children In Restraints Prohibited.....	1068
769. (Reserved) .....	1068
770. Additional Provisions For Children’s Residential Maternity Care.....	1068
771. Service Worker Available.....	1068
772. Prenatal And Postpartum Care.....	1068
773. Discharge Plans.....	1068
774. -- 779. (Reserved).....	1068
780. Additional Provisions For Children’s Alcohol-Drug Abuse Residential Care Facilities.....	1069
781. --789. (Reserved).....	1069
790. Additional Provisions For Non-Accredited Children’s Residential Schools.....	1069
791. Application Process.....	1069
792. Staff Ratios Required.....	1069
793. Child’s Record.....	1069
794. -- 799. (Reserved).....	1070
800. Additional Standards For Children’s Therapeutic Outdoor Programs.....	1070
801. (Reserved) .....	1070
802. Policies And Procedures.....	1070
803. -- 804. (Reserved).....	1070
805. Base Camp Requirements.....	1070
806. High Adventure Requirements.....	1071
807. -- 809. (Reserved).....	1071
810. Staff Qualifications For Children’s Therapeutic Outdoor Programs.....	1071
811. Staff Health Requirements.....	1073
812. Skills And Training.....	1073
813. Staff Ratios And Group Size.....	1074
814. Staff Use Of Alcohol Or Controlled Substances Prohibited.....	1075
815. -- 820. (Reserved).....	1075
821. Assessments.....	1075
822. Physical Examination.....	1075
823. Grouping By Age.....	1076
824. Expeditions.....	1076
825. Safety.....	1077
826. Communications.....	1077
827. Emergency Plan.....	1077
828. Expedition And Hiking Limit Requirements.....	1078
829. Water Requirements.....	1078
830. Nutritional And Sanitary Requirements.....	1079
831. -- 834. (Reserved).....	1079
835. Health Care.....	1079
836. Medication Storage And Administration.....	1080
837. -- 839. (Reserved).....	1080
840. Participant Clothing, Equipment And Supplies.....	1080
841. Contraband.....	1081
842. Searches.....	1081
843. Behavior Management And Discipline Policy.....	1082
844. Time-Out.....	1083

845. Work.....	1083
846. Animals And Pets.....	1083
847. Transporting Children.....	1083
848. Firearms.....	1084
849. (Reserved).....	1084
850. Program Summary.....	1084
851. -- 859. (Reserved).....	1084
860. Standards For Solo Experiences In Children’s Therapeutic Outdoor Programs.....	1084
861. Plan.....	1084
862. Solo Sites.....	1085
863. Supervision.....	1085
864. Emergency Procedures.....	1085
865. -- 869. (Reserved).....	1086
870. Additional Provisions For Stationary Children’s Therapeutic Outdoor Programs.....	1086
871. Fire Safety Requirements.....	1086
872. Health Safety Requirements.....	1086
873. -- 999. (Reserved).....	1086
<b>16.07.01 – Behavioral Health Sliding Fee Schedules</b>	
000. Legal Authority.....	1087
001. Title And Scope.....	1087
002. -- 009. (Reserved).....	1087
010. Definitions.....	1087
011. -- 099. (Reserved).....	1088
100. Financial Responsibility Of Parents For Children’s Mental Health Services.....	1088
101. -- 199. (Reserved).....	1088
200. Financial Responsibility For Adult Mental Health Services.....	1089
201. -- 299. (Reserved).....	1089
300. Sliding Fee Schedule For Children’s Mental Health, Adult Mental Health, And Substance Use Disorders Services.....	1089
301. -- 399. (Reserved).....	1090
400. Calculating Income To Apply The Sliding Fee Schedule For Children’s Mental Health And Adult Mental Health Services.....	1090
401. -- 999. (Reserved).....	1091

**IDAPA 17 – INDUSTRIAL COMMISSION**

**Docket No. 17-0000-2000F (Fee Rule)**

<b>17.01.01 – Administrative Rules Under the Worker’s Compensation Law</b>	
000. Legal Authority.....	1093
001. Title and Scope.....	1093
002. Written Interpretations.....	1093
003 -- 009. (Reserved).....	1093
010. Definitions.....	1093
011. Abbreviations.....	1096
012. Liberal Construction.....	1097
013. -- 200. (Reserved).....	1097
201. Rule Governing 72-212(5) Exemptions.....	1097
202. -- 300. (Reserved).....	1097
301. Rules Governing Qualifications To Write Insurance Or Self-Insure.....	1097
302. Rules Governing Continuing Requirements To Underwrite Insurance Or Self-insure.....	1099
303. Rule Governing The Collection Of Premium Tax On Worker’s Compensation Insurance Policies.....	1103
304. Rule Governing Premium Tax Computation For Self-insured Employers.....	1103

305. Requirements For Maintaining Idaho Worker's Compensation Claims Files .....	1104
306. Rule Prohibiting Use Of Sick Leave Or Other Alternative Compensation .....	1109
307. Rule Governing Reporting Indemnity And Medical Payments And Making Payment Of Industrial Special Indemnity Fund Assessment. ....	1110
308. -- 400. (Reserved) .....	1110
401. Rule Governing Computation Of Average Weekly Wage.....	1110
402. Rule Governing Conversion Of Impairment Ratings To "Whole Man" Standard.....	1111
403. Rule Governing Compensation For Disability Due To Loss Of Teeth.....	1111
404. Submission Of Medical Reports From Providers .....	1111
405. Rule Governing Reimbursement For Travel Expenses.....	1112
406. -- 500. (Reserved).....	1112
501. Rule Governing Protection And Disclosure Of Rehabilitation Division Records .....	1112
502. Rule Governing Reports Of Attorney Costs And Fees In Litigated Cases .....	1113
503. -- 600. (Reserved).....	1113
601. Submission Of FROI And SROI.....	1113
602. Summaries Of Payments.....	1114
603. -- 800. (Reserved).....	1114
801. Rule Governing Change Of Status Notice To Claimants.....	1114
802. Rule Governing Approval Of Attorneys Fees .....	1115
803. Medical Fees.....	1116
804. -- 999. (Reserved) .....	1122

**IDAPA 18 – IDAHO DEPARTMENT OF INSURANCE**

***Docket No. 18-0000-2000F (Fee Rule)***

***18.01.02 – Schedule of Fees, Licenses, and Miscellaneous Charges***

000. Legal Authority .....	1124
001. Title And Scope.....	1124
002. -- 010. (Reserved).....	1124
011. Fees Payable In Advance.....	1124
012. -- 019. (Reserved).....	1124
020. Insurer Fees.....	1124
021. -- 029. (Reserved).....	1125
030. Producer And Miscellaneous Licensing Fees.....	1126
031. -- 039. (Reserved).....	1127
040. Miscellaneous Fees.....	1127
041. -- 049. (Reserved).....	1127
050. Refunds.....	1127
051. Overpayments.....	1127
052. -- 999. (Reserved).....	1127

***18.08.02 – Fire Protection Sprinkler Contractors***

000. Legal Authority .....	1128
001. Title And Scope.....	1128
002. -- 009. (Reserved).....	1128
010. Definitions.....	1128
011. Powers And Duties Of The State Fire Marshal.....	1128
012. Qualifications For Contractors License.....	1129
013. License Requisite.....	1129
014. License, Display, Renewals, Duplicates, Applications.....	1129
015. Action On Applications And License Fees.....	1129
016. Financial Responsibility.....	1130
017. Revocation, Suspension, And Non-Renewal Of License.....	1131
018. Hearings.....	1131

019. Approved Equipment And Materials.....	1131
020. Service Evidence.....	1131
021. Design Requirements.....	1132
022. Service Tag.....	1132
023. Fitters.....	1132
024. -- 999. (Reserved).....	1133

**IDAPA 19 – IDAHO STATE BOARD OF DENTISTRY**

**Docket No. 19-0101-2000F (Fee Rule)**

*19.01.01 – Rules of the Idaho State Board of Dentistry*

000. Legal Authority.....	1135
001. Title And Scope.....	1135
002. Incorporation By Reference.....	1135
003. -- 009. (Reserved).....	1135
010. Definitions And Abbreviations.....	1135
011. Application And License Fees.....	1136
012. Examinations For Licensure.....	1137
013. Requirements For Licensure.....	1137
014. Requirement For BLS.....	1137
015. Continuing Education Requirements.....	1137
016. – 020. (Reserved).....	1138
021. Provisional Licensure.....	1138
022. Volunteer Dental Hygiene Services.....	1138
023. Dental Hygienists – License Endorsements.....	1138
024. Licensure Of Dental Specialists.....	1139
025. Specialty Advertising.....	1140
026. Patient Records.....	1140
027. – 030. (Reserved).....	1141
031. Infection Control.....	1141
032. Emergency Medications Or Drugs.....	1141
033. Dental Hygienists – Practice.....	1141
034. Dental Hygienists – Prohibited Practice.....	1142
035. Dental Therapists – Practice.....	1143
036. Dental Therapists – Prohibited Practice.....	1143
037. Dental Assistants – Practice.....	1143
038. – 040. (Reserved).....	1144
041. Local Anesthesia.....	1144
042. Nitrous Oxide/Oxygen.....	1144
043. Minimal Sedation.....	1145
044. Moderate Sedation, General Anesthesia And Deep Sedation.....	1145
045. Sedation Permit Renewal.....	1148
046. Suspension, Revocation Or Restriction Of Sedation Permit.....	1148
047. Determination Of Degree Of Sedation By The Board.....	1148
048. Use Of Other Anesthesia Personnel.....	1148
049. Incident Reporting.....	1149
050. – 054. (Reserved).....	1149
055. Telehealth Services.....	1149
056. Unprofessional Conduct.....	1149
057. – 999. (Reserved).....	1151

**IDAPA 20 – IDAHO DEPARTMENT OF LANDS**

**Docket No. 20-0000-2000F (Fee Rule)**

*20.02.14 – Rules for Selling Forest Products on State-Owned Endowment Lands*

000. Legal Authority.....	1154
001. Title And Scope.....	1154
002. Incorporation By Reference.....	1154
003. -- 009. (Reserved).....	1154
010. Definitions.....	1154
011. -- 018. (Reserved).....	1154
019. Firewood And Other Personal Use Product Permits.....	1154
020. Direct Sales.....	1154
021. Timber Sales.....	1155
022. -- 025. (Reserved).....	1155
026. Annual Sales Plan.....	1155
027. -- 030. (Reserved).....	1155
031. Timber Sale Auctions.....	1155
032. Initial Deposit And Bonds.....	1155
033. -- 040. (Reserved).....	1155
041. Stumpage And Interest Payment.....	1155
042. Timber Sale Cancellation.....	1156
043. Premature Timber Sale Termination.....	1156
044. -- 999. (Reserved).....	1156

*20.03.01 – Rules Governing Dredge and Placer Mining Operations in Idaho*

000. Legal Authority.....	1157
001. Title and Scope.....	1157
002. Administrative Appeals.....	1157
003. -- 009. (Reserved).....	1157
010. Definitions.....	1157
011. Abbreviations.....	1159
012. Purpose And General Provisions.....	1159
013. Applicability.....	1160
014. Administration.....	1161
015. -- 019. (Reserved).....	1161
020. Placer Or Dredge Exploration Operations.....	1161
021. Application Procedure For Placer Or Dredge Mining Permit.....	1162
022. Procedures For Review And Decision Upon An Application.....	1165
023. -- 024. (Reserved).....	1166
025. Amending An Approved Permit.....	1166
026. Deviation From An Approved Permit.....	1166
027. Transfer Of Permits.....	1166
028. -- 029. (Reserved).....	1166
030. Public Hearing For Permit Application.....	1167
031. -- 034. (Reserved).....	1167
035. Performance Bond Requirements.....	1167
036. -- 039. (Reserved).....	1170
040. Best Management Practices And Reclamation For Placer And Dredge Mining Operation.....	1170
041. -- 049. (Reserved).....	1175
050. Termination Of A Permit.....	1175
051. Enforcement And Failure To Comply.....	1176
052. -- 054. (Reserved).....	1178
055. Computation Of Time.....	1178
056. -- 059. (Reserved).....	1178
060. Placer Or Dredge Mining Of Certain Waterbodies Prohibited.....	1178
061. -- 064. (Reserved).....	1179



065. Deposit Of Forfeitures And Damages.....	1179
066. -- 069. (Reserved).....	1179
070. Compliance Of Existing Plans With These Rules.....	1179
071. -- 999. (Reserved).....	1179
<i>20.03.02 – Rules Governing Mined Land Reclamation</i>	
000. Legal Authority.....	1180
001. Title And Scope.....	1180
002. -- 009. (Reserved).....	1181
010. Definitions.....	1181
011. Abbreviations.....	1184
012. -- 049. (Reserved).....	1184
050. Administration.....	1184
051. -- 059. (Reserved).....	1184
060. Exploration Operations And Required Reclamation.....	1184
061. -- 067. (Reserved).....	1185
068. Application Fees.....	1185
069. Application Procedure And Requirements For Quarries, Decorative Stone, Building Stone, And Aggregate Materials Including Sand, Gravel And Crushed Rock. ....	1186
070. Application Procedure And Requirements For Other Mining Operations Including Hardrock, Underground And Phosphate Mining. ....	1187
071. Application Procedure And Requirements For Permanent Closure Of Cyanidation Facilities. ....	1189
072. -- 079. (Reserved).....	1192
080. Procedures For Review And Decision Upon An Application For A Reclamation Plan Or Permanent Closure Plan. ....	1192
081. -- 089. (Reserved).....	1195
090. Amending An Approved Reclamation Plan.....	1195
091. Amending An Approved Permanent Closure Plan.....	1195
092. -- 099. (Reserved).....	1196
100. Deviation From An Approved Reclamation Plan.....	1196
101. -- 109. (Reserved).....	1196
110. Public Hearing.....	1196
111. Completion Of Permanent Closure.....	1197
112. Decision To Approve Or Disapprove Of A Permanent Closure Report.....	1198
113. -- 119. (Reserved).....	1199
120. Financial Assurance Requirements For Mining.....	1199
121. Financial Assurance Requirements For Cyanidation Facilities.....	1201
122. Form Of Financial Assurance.....	1203
123. Forfeiture Of Financial Assurance.....	1207
124. -- 129. (Reserved).....	1207
130. Transfer Of Approved Plans.....	1208
131. -- 139. (Reserved).....	1208
140. Best Management Practices And Reclamation For Mining Operation And Permanent Closure Of Cyanidation Facilities. ....	1208
141. -- 149. (Reserved).....	1214
150. Termination Of A Plan.....	1214
151. -- 154. (Reserved).....	1214
155. Five (5) Year Updates And Periodic Inspections.....	1214
156. -- 159. (Reserved).....	1215
160. Enforcement And Failure To Comply.....	1215
161. -- 169. (Reserved).....	1215
170. Computation Of Time.....	1215
171. -- 179. (Reserved).....	1215

180. Public And Confidential Information .....	1215
181. -- 189. (Reserved).....	1215
190. Deposit Of Forfeitures And Damages .....	1215
191. -- 199. (Reserved).....	1216
200. Compliance Of Existing Reclamation Plans .....	1216
201. -- 999. (Reserved).....	1216
<i>20.03.03 – Rules Governing Administration of the Reclamation Fund</i>	
000. Legal Authority .....	1217
001. Title And Scope.....	1217
002. Administrative Appeals.....	1217
003. -- 009. (Reserved).....	1217
010. Definitions .....	1217
011. -- 015. (Reserved).....	1218
016. Required Participants .....	1218
017. Ineligible Mines Or Operators .....	1218
018. Acreage And Reclamation Cost Limitations .....	1219
019. Optional Participation .....	1219
020. Federal Agency Non-Acceptance Of Reclamation Fund .....	1219
021. -- 025. (Reserved).....	1219
026. Payment.....	1220
027. -- 030. (Reserved).....	1220
031. Enforcement And Failure To Comply .....	1220
032. Minimum Balance For The Reclamation Fund.....	1220
033. -- 999. (Reserved).....	1220
<i>20.03.04 – Rules for the Regulation of Beds, Waters, and Airspace Over Navigable Lakes in the State of Idaho</i>	
000. Legal Authority .....	1221
001. Title And Scope.....	1221
002. Administrative Appeals.....	1221
003. Incorporation By Reference .....	1221
004. -- 009. (Reserved).....	1221
010. Definitions .....	1221
011. Abbreviations .....	1224
012. Policy.....	1224
013. -- 014. (Reserved).....	1224
015. Encroachment Standards.....	1224
016. -- 019. (Reserved).....	1230
020. Applications.....	1230
021. -- 024. (Reserved).....	1233
025. Processing Of Applications For Single-Family And Two-Family Navigational Encroachments Within Line Of Navigability. ....	1233
026. -- 029. (Reserved).....	1234
030. Processing Of Applications For All Other Types Of Encroachments. ....	1234
031. -- 034. (Reserved).....	1236
035. Temporary Permits.....	1236
036. -- 049. (Reserved).....	1236
050. Recordation.....	1236
051. -- 054. (Reserved).....	1236
055. Leases And Easements .....	1236
056. -- 059. (Reserved).....	1236
060. Installation .....	1236
061. -- 064. (Reserved).....	1237

065. Assignments.....	1237
066. -- 069. (Reserved).....	1237
070. Miscellaneous.....	1237
071. -- 079. (Reserved).....	1238
080. Violations - Penalties.....	1238
081. -- 999. (Reserved).....	1239
<i>20.03.05 – Riverbed Mineral Leasing in Idaho</i>	
000. Authority.....	1240
001. Title And Scope.....	1240
002. -- 009. (Reserved).....	1240
010. Definitions.....	1240
011. -- 014. (Reserved).....	1241
015. Casual Exploration And Recreational Mining.....	1241
016. Exploration Locations.....	1241
017. -- 019. (Reserved).....	1242
020. Riverbed Mineral Lease.....	1242
021. -- 024. (Reserved).....	1242
025. Public Notice And Hearing.....	1242
026. -- 029. (Reserved).....	1242
030. Rental And Royalty And Late Payments.....	1242
031. Size And Composition Of Leasable Tract.....	1243
032. -- 034. (Reserved).....	1243
035. Assignments.....	1243
036. -- 039. (Reserved).....	1243
040. Bond.....	1243
041. -- 044. (Reserved).....	1244
045. Fees.....	1244
046. -- 999. (Reserved).....	1244
<i>20.03.08 – Easements on State-Owned Lands</i>	
000. Legal Authority.....	1245
001. Title And Scope.....	1245
002. Administrative Appeals.....	1245
003. -- 009. (Reserved).....	1245
010. Definitions.....	1245
011. -- 019. (Reserved).....	1245
020. Policy.....	1245
021. Fees And Compensation.....	1246
022. -- 024. (Reserved).....	1247
025. Easement Amendment.....	1247
026. -- 029. (Reserved).....	1247
030. Emergency Work.....	1247
031. -- 034. (Reserved).....	1247
035. Cooperative Use And Reciprocal Use Agreements.....	1247
036. -- 039. (Reserved).....	1248
040. Assignments.....	1248
041. Abandonment, Relinquishment, And Termination.....	1248
042. -- 045. (Reserved).....	1248
046. Procedure.....	1248
047. Easements On State Land Under Land Sale Contract.....	1249
048. -- 999. (Reserved).....	1249
<i>20.03.09 – Easements on State-Owned Submerged Lands and Formerly Submerged Lands</i>	

000. Legal Authority .....	1250
001. Title And Scope .....	1250
002. (Reserved) .....	1250
003. Administrative Appeals .....	1250
004. -- 009. (Reserved) .....	1250
010. Definitions .....	1250
011. Policy .....	1251
012. -- 019. (Reserved) .....	1252
020. Fees And Compensation .....	1252
021. -- 029. (Reserved) .....	1253
030. Term Of Easement .....	1253
031. -- 039. (Reserved) .....	1253
040. Use, Facility, Or Structure Modification .....	1253
041. -- 049. (Reserved) .....	1253
050. Assignments .....	1253
051. -- 059. (Reserved) .....	1253
060. Abandonment, Relinquishment, And Termination .....	1253
061. -- 069. (Reserved) .....	1254
070. Procedure .....	1254
071. -- 079. (Reserved) .....	1255
080. Easement Access And Emergency Work .....	1255
081. -- 999. (Reserved) .....	1255
 <i>20.03.13 – Administration of Cottage Site Leases on State Lands</i>	
000. Legal Authority .....	1256
001. Title And Scope .....	1256
002. -- 009. (Reserved) .....	1256
010. Definitions .....	1256
011. -- 019. (Reserved) .....	1256
020. Sale And Assignment - Required Documentation .....	1256
021. -- 024. (Reserved) .....	1256
025. Lease Rate Determination -- Annual Rental .....	1256
026. -- 999. (Reserved) .....	1256
 <i>20.03.14 – Rules Governing Grazing, Farming, Conservation, Noncommercial Recreation, and Communication Site Leases</i>	
000. Legal Authority .....	1257
001. Title And Scope .....	1257
002. Administrative Appeals .....	1257
003. -- 009. (Reserved) .....	1257
010. Definitions .....	1257
011. -- 018. (Reserved) .....	1258
019. Lessee Mailing Address .....	1258
020. Applications And Processing .....	1258
021. Length Of Lease .....	1260
022. -- 029. (Reserved) .....	1260
030. Change In Land Use .....	1260
031. -- 039. (Reserved) .....	1260
040. Rental .....	1260
041. Change Of Rental .....	1261
042. Late Payments .....	1261
043. -- 048. (Reserved) .....	1261
049. Breach .....	1261
050. Lease Cancellation .....	1261

051. Lease Adjustments.....	1261
052. Extensions Of Annual Farming Lease Payment.....	1261
053. -- 059. (Reserved).....	1262
060. Fees.....	1262
061. -- 069. (Reserved).....	1262
070. Subleasing.....	1262
071. Assignments.....	1262
072. Mortgage Agreements.....	1262
073. -- 079. (Reserved).....	1262
080. Management Plans.....	1262
081. -- 089. (Reserved).....	1262
090. Trespass.....	1262
091. -- 099. (Reserved).....	1263
100. Construction And Maintenance Of Improvements.....	1263
101. Improvement Credit.....	1263
102. Valuation Of Improvements.....	1264
103. -- 104. (Reserved).....	1264
105. Conflict Auctions.....	1264
106. Board Review Of Auction.....	1265
107. -- 110. (Reserved).....	1265
111. Noxious Weed Control.....	1265
112. Livestock Quarantine.....	1266
113. Animal Damage Control.....	1266
114. Liability (Indemnity).....	1266
115. Rules And Laws Of The State.....	1266
116. -- 999. (Reserved).....	1266
 <i>20.03.15 – Rules Governing Geothermal Leasing on Idaho State Lands</i>	
000. Legal Authority.....	1267
001. Title And Scope.....	1267
002. Administrative Appeals.....	1267
003. -- 009. (Reserved).....	1267
010. Definitions.....	1267
011. Abbreviations.....	1269
012. -- 019. (Reserved).....	1269
020. Qualified Applicants And Lessees.....	1269
021. Lease Award Through Auction.....	1269
022. -- 029. (Reserved).....	1269
030. Term.....	1269
031. -- 034. (Reserved).....	1269
035. Rentals.....	1269
036. Royalties.....	1269
037. -- 039. (Reserved).....	1271
040. Size Of A Leasable Tract.....	1271
041. -- 049. (Reserved).....	1271
050. Land Surface Use Rights And Obligations.....	1271
051. -- 053. (Reserved).....	1271
054. Exploration Under The Lease.....	1272
055. Development And Production Under The Lease.....	1272
056. Waste Prevention, Drilling And Production Obligations.....	1273
057. -- 059. (Reserved).....	1274
060. Exploration And Operation Records, Confidentiality.....	1274
061. -- 064. (Reserved).....	1274

065. Lessee's Records, Right Of Inspection By Department .....	1274
066. -- 069. (Reserved) .....	1274
070. Water Rights .....	1274
071. -- 074. (Reserved) .....	1275
075. Assignments .....	1275
076. -- 079. (Reserved) .....	1276
080. Overriding Royalty Interests .....	1276
081. -- 084. (Reserved) .....	1276
085. Unit Or Cooperative Plans Of Development Or Operation .....	1276
086. -- 094. (Reserved) .....	1277
095. Surrender, Termination, Expiration Of Lease .....	1277
096. -- 099. (Reserved) .....	1278
100. Bond Requirements .....	1278
101. Liability Insurance .....	1278
102. -- 104. (Reserved) .....	1279
105. Title .....	1279
106. -- 110. (Reserved) .....	1279
111. Taxes .....	1279
112. Rental Notices .....	1279
113. Outstanding Leases .....	1279
114. -- 119. (Reserved) .....	1279
120. Fees .....	1279
121. -- 999. (Reserved) .....	1279
 <i>20.03.16 – Rules Governing Oil and Gas Leasing on Idaho State Lands</i>	
000. Legal Authority .....	1280
001. Title And Scope .....	1280
002. Administrative Appeals .....	1280
003. -- 009. (Reserved) .....	1280
010. Definitions .....	1280
011. -- 014. (Reserved) .....	1282
015. Control Of State Lands .....	1282
016. Withdrawal Of Lands .....	1282
017. -- 019. (Reserved) .....	1282
020. Qualified Applicants And Lessees .....	1282
021. Exploration .....	1282
022. Lease Acquisition Process .....	1282
023. -- 044. (Reserved) .....	1284
045. Royalties .....	1284
046. -- 049. (Reserved) .....	1285
050. Land Use, Surface Rights And Obligations .....	1285
051. Diligent Exploration Required .....	1286
052. -- 054. (Reserved) .....	1286
055. Operations Under The Lease .....	1286
056. Water Rights .....	1287
057. -- 059. (Reserved) .....	1287
060. Assignments .....	1287
061. -- 069. (Reserved) .....	1288
070. Surrender - Relinquishment .....	1288
071. Termination - Cancellation Of Lease .....	1288
072. -- 079. (Reserved) .....	1289
080. Bond Requirements .....	1289
081. -- 089. (Reserved) .....	1290

090. Unit Or Cooperative Plans Of Development Or Operation.....	1290
091. -- 094. (Reserved).....	1291
095. Liability Insurance; Special Endorsements. ....	1291
096. Hold Harmless.....	1292
097. -- 099. (Reserved).....	1292
100. Title.....	1292
101. Impossibility Of Performance.....	1292
102. Taxes.....	1292
103. -- 119. (Reserved).....	1292
120. Fees.....	1292
121. -- 999. (Reserved).....	1292
 <i>20.03.17 – Rules Governing Leases on State-Owned Submerged Lands and Formerly Submerged Lands</i>	
000. Legal Authority.....	1293
001. Title And Scope.....	1293
002. Administrative Appeals.....	1293
003. -- 009. (Reserved).....	1293
010. Definitions.....	1293
011. -- 019. (Reserved).....	1294
020. Applicability.....	1294
021. -- 024. (Reserved).....	1295
025. Policy.....	1295
026. -- 029. (Reserved).....	1296
030. Lease Application, Fee, And Procedure.....	1296
031. -- 034. (Reserved).....	1296
035. Rental.....	1296
036. Yearly Reporting.....	1297
037. -- 039. (Reserved).....	1297
040. Late Payment, Extensions Of Payment.....	1297
041. -- 044. (Reserved).....	1297
045. Appraisal Procedures.....	1297
046. -- 049. (Reserved).....	1298
050. Lease Modification Or Amendment.....	1298
051. -- 054. (Reserved).....	1298
055. Assignments, Assignment Fee.....	1298
056. -- 059. (Reserved).....	1298
060. Cancellation And Additional Remedies.....	1298
061. -- 064. (Reserved).....	1299
065. Bond.....	1299
066. -- 069. (Reserved).....	1299
070. Liability And Indemnity.....	1299
071. -- 074. (Reserved).....	1299
075. Other Rules And Laws.....	1299
076. -- 079. (Reserved).....	1300
080. Binding On Heirs.....	1300
081. -- 084. (Reserved).....	1300
085. Civil Rights.....	1300
086. -- 999. (Reserved).....	1300
 <i>20.04.02 – Rules Pertaining to the Idaho Forestry Act and Fire Hazard Reduction Laws</i>	
000. Legal Authority.....	1301
001. Title And Scope.....	1301
002. -- 009. (Reserved).....	1301

010. Definitions .....	1301
011. -- 029. (Reserved).....	1302
030. Certificate Of Compliance-Fire Hazard Management Agreement.....	1302
031. -- 039. (Reserved).....	1302
040. Addendum To Certificate Of Compliance-Fire Hazard Management Agreement.....	1302
041. -- 049. (Reserved).....	1302
050. Bond.....	1302
051. -- 059. (Reserved).....	1303
060. Contracts With Forest Landowners Or Operators.....	1303
061. -- 069. (Reserved).....	1303
070. Cash Bond Release.....	1303
071. -- 079. (Reserved).....	1303
080. Added Protection In Lieu Of Hazard Reduction.....	1303
081. -- 089. (Reserved).....	1304
090. Purchaser Requirements.....	1304
091. -- 099. (Reserved).....	1304
100. Injunction Against Further Cutting.....	1304
101. -- 109. (Reserved).....	1304
110. Burning Of Slash.....	1304
111. -- 119. (Reserved).....	1304
120. Standards -- Treatment Of Hazards.....	1304
121. -- 129. (Reserved).....	1308
130. Liability.....	1308
131. -- 139. (Reserved).....	1309
140. Certificate Of Clearance.....	1309
141. -- 149. (Reserved).....	1309
150. Fire Suppression And Forest Practices Assessment.....	1309
151. -- 159. (Reserved).....	1310
160. Prelogging Conference And Agreement.....	1310
161. -- 999. (Reserved).....	1310
 <i>20.06.01 – Rules of the Idaho Board of Scaling Practices</i>	
000. Legal Authority.....	1311
001. Title And Scope.....	1311
002. Incorporation By Reference.....	1311
003. -- 009. (Reserved).....	1311
010. Definitions.....	1311
011. -- 049. (Reserved).....	1312
050. Assessment.....	1312
051. -- 059. (Reserved).....	1312
060. Log Brands.....	1312
061. -- 069. (Reserved).....	1312
070. Prize Logs.....	1312
071. -- 099. (Reserved).....	1313
100. Payment For Logging Or Hauling.....	1313
101. -- 199. (Reserved).....	1313
200. Licenses.....	1313
201. -- 219. (Reserved).....	1313
220. Apprenticeship Certificate.....	1313
221. -- 239. (Reserved).....	1313
240. Temporary Permit.....	1313
241. -- 259. (Reserved).....	1314
260. Specialty License.....	1314



261. -- 279. (Reserved).....	1314
280. Standard License.....	1314
281. -- 299. (Reserved).....	1314
300. Standard License Examination.....	1314
301. -- 399. (Reserved).....	1315
400. Renewal Of Standard And Specialty Licenses.....	1315
401. -- 499. (Reserved).....	1315
500. Method Of Scaling Forest Products For Commercial Purposes.....	1315
501. Gross Volume Conversions.....	1316
502. General Scaling Requirements.....	1316
503. Gross Decimal "C" Scale Determination.....	1316
504. Net Decimal "C" Scale Determination.....	1316
505. -- 799. (Reserved).....	1316
800. Check Scaling Procedures.....	1316
801. -- 809. (Reserved).....	1317
810. Check Scaling Standards Of Variation.....	1317
811. -- 819. (Reserved).....	1318
820. Requested Check Scale.....	1318
821. -- 829. (Reserved).....	1318
830. Check Scale Report.....	1318
831. -- 909. (Reserved).....	1318
910. Informal Hearings -- Scope And Authority.....	1318
911. -- 919. (Reserved).....	1319
920. Complaints.....	1319
921. -- 929. (Reserved).....	1319
930. Response To Complaint.....	1319
931. Access To Records.....	1319
932. -- 939. (Reserved).....	1319
940. Conduct Of Informal Hearings.....	1319
941. -- 949. (Reserved).....	1320
950. Time For Board Determination.....	1320
951. -- 959. (Reserved).....	1320
960. Final Determination.....	1320
961. -- 969. (Reserved).....	1320
970. Board Action Upon Determination Of Probable Violation.....	1320
971. -- 999. (Reserved).....	1320
 <i>20.07.02 – Rules Governing Conservation of Oil and Natural Gas in the State of Idaho</i>	
000. Legal Authority.....	1321
001. Title And Scope.....	1321
002. Administrative Appeals.....	1321
003. Incorporation By Reference.....	1321
004. -- 009. (Reserved).....	1322
010. Definitions.....	1322
011. Abbreviations.....	1325
012. -- 014. (Reserved).....	1326
015. Protection Of Correlative Rights.....	1326
016. -- 019. (Reserved).....	1326
020. Applicability.....	1326
021. Class II Injection wells.....	1326
022. -- 029. (Reserved).....	1326
030. Notices - General.....	1326

031. Forms .....	1326
032. Organization Reports .....	1326
033. Designation Of Agent .....	1327
034. -- 039. (Reserved).....	1327
040. Public Comment.....	1327
041. -- 049. (Reserved).....	1327
050. Enforcement .....	1327
051. -- 099. (Reserved).....	1327
100. Geophysical Operations.....	1327
101. -- 199. (Reserved).....	1332
200. Permit To Drill, Deepen, Or Plug Back.....	1332
201. Multiple Zone Completions.....	1333
202. -- 209. (Reserved).....	1333
210. Well Treatments.....	1333
211. Hydraulic Fracturing .....	1336
212. -- 219. (Reserved).....	1338
220. Bonding .....	1338
221. Transfer Of Drilling Permits.....	1339
222. -- 229. (Reserved).....	1339
230. Pit Requirements.....	1339
231. -- 299. (Reserved).....	1343
300. Identification Of Wells.....	1343
301. Well Site Operations.....	1343
302. Accidents And Fires.....	1343
303. -- 309. (Reserved).....	1343
310. General Drilling Rules .....	1344
311. Loss Of Tool With Radioactive Material.....	1347
312. Chokes.....	1347
313. Use Of Earthen Reservoirs.....	1347
314. Vacuum Pumps Prohibited.....	1347
315. Pulling Outside Strings Of Casing.....	1347
316. -- 319. (Reserved).....	1347
320. Mechanical Integrity Testing.....	1348
321. -- 329. (Reserved).....	1348
330. Well Directional Control.....	1348
331. -- 339. (Reserved).....	1349
340. Well Completion/Recompletion Report And Well Report.....	1350
341. Drilling Logs.....	1350
342. -- 399. (Reserved).....	1350
400. Production Reports.....	1350
401. Measurement Of Oil.....	1350
402. Measurement Of Gas.....	1351
403. Gas-Oil Ratio For Well Classifications.....	1351
404. Gas-Oil Ratio Limitation.....	1351
405. Gas-Oil Ratio Surveys And Reports.....	1351
406. -- 409. (Reserved).....	1351
410. Meters.....	1352
411. Separators.....	1352
412. Producing From Different Pools Through The Same Casing String.....	1352
413. Gas Utilization.....	1352
414. -- 419. (Reserved).....	1352
420. Tank Batteries.....	1352

421. -- 429. (Reserved).....	1353
430. Gas Processing Facilities.....	1353
431. -- 499. (Reserved).....	1353
500. Active Wells.....	1353
501. Inactive Wells.....	1354
502. Well Plugging.....	1354
503. -- 509. (Reserved).....	1356
510. Surface Reclamation.....	1356
511. -- 999. (Reserved).....	1358

**IDAPA 21 – IDAHO DIVISION OF VETERANS SERVICES**

***Docket No. 21-0000-2000F (Fee Rule)***

***21.01.01 – Rules Governing Admission, Residency, and Maintenance Charges in Idaho State Veterans Homes and Division of Veterans Services Administrative Procedure***

000. Legal Authority.....	1360
001. Title And Scope.....	1360
002. Policy.....	1360
003. Incorporation By Reference.....	1360
004. -- 009. (Reserved).....	1360
010. Definitions.....	1360
011. -- 049. (Reserved).....	1361
050. Administrative Powers.....	1361
051. -- 074. (Reserved).....	1362
075. Administrative Duties.....	1362
076. -- 099. (Reserved).....	1362
100. Eligibility Requirements.....	1362
101. -- 149. (Reserved).....	1364
150. Application Procedure.....	1364
151. -- 199. (Reserved).....	1364
200. Conditions For Admission.....	1364
201. Weapons.....	1365
202. Acknowledgment Of Conditions Leading To Discharge.....	1365
203. -- 299. (Reserved).....	1365
300. Conduct Of Residents.....	1365
301. -- 349. (Reserved).....	1367
350. Transfer And Discharge Of Residents.....	1367
351. (Reserved)	1368
352. Unauthorized Absences -- Residential And Domiciliary Care.....	1368
353. -- 850. (Reserved).....	1368
851. Available Services.....	1368
852. -- 879. (Reserved).....	1369
880. Financial Condition Of Applicants/Residents.....	1369
881. -- 914. (Reserved).....	1369
915. Maintenance Charges.....	1369
916. Monthly Charges And Allowances.....	1371
917. -- 949. (Reserved).....	1372
950. Financial Grounds For Rejection Or Discharge.....	1372
951. -- 979. (Reserved).....	1372
980. Notice Of Resident Transfer Or Discharge And Notice Of Denial Of An Application For Residency.....	1372
981. Appeal Procedure.....	1374
982. Provisions For Contested Cases.....	1374

983. Prehearing Provisions For Residential And Domiciliary Care. ....	1375
984. Hearing Provisions For Residential And Domiciliary Care. ....	1377
985. Post Hearing Provisions For Residential And Domiciliary Care. ....	1380
986. -- 999. (Reserved).....	1381
<i>21.01.04 – Rules Governing the Idaho State Veterans Cemetery</i>	
000. Legal Authority. ....	1382
001. Title And Scope.....	1382
002. Incorporation By Reference. ....	1382
003. -- 009. (Reserved).....	1382
010. Definitions. ....	1382
011. -- 019. (Reserved).....	1383
020. Eligibility For Interment.....	1383
021. Application For Interment. ....	1383
022. Interment And Reinterment. ....	1384
023. Disinterment And Reinterment. ....	1384
024. Fees For Interment, Disinterment, And Reinterment.....	1384
025. -- 029. (Reserved).....	1385
030. Cemetery Use. ....	1385
031. -- 039. (Reserved).....	1385
040. Memorials And Donations. ....	1385
041. -- 049. (Reserved).....	1385
050. Public Behavior In The Cemetery. ....	1385
051. -- 999. (Reserved).....	1386

**IDAPA 22 – BOARD OF MEDICINE*****Docket No. 22-0000-2000F (Fee Rule)******22.01.01 – Rules of the Board of Medicine for the Licensure to Practice  
Medicine and Osteopathic Medicine in Idaho***

000. Legal Authority. ....	1388
001. Title And Scope.....	1388
002. -- 009. (Reserved).....	1388
010. Definitions. ....	1388
011. Abbreviations. ....	1388
012. -- 049. (Reserved).....	1388
050. General Qualifications For Licensure And Renewal. ....	1389
051. Licensure For Graduates Of International Medical Schools Located Outside Of The United States And Canada. ....	1389
052. Graduates Of Unapproved International Medical Schools Located Outside Of The United States Or Canada. ....	1390
053. -- 078. (Reserved).....	1390
079. Continuing Medical Education (CME) Required.....	1390
080. Physician Panelist For Prelitigation Consideration Of Medical Malpractice Claims. ....	1391
081. -- 099. (Reserved).....	1391
100. Fees -- Table.....	1391
101. -- 150. (Reserved).....	1392
151. Definitions Relating to Supervising and Directing Physicians. ....	1392
152. -- 160. (Reserved).....	1393
161. Duties Of Directing Physicians.....	1393
162. Duties Of Supervising Physicians. ....	1393
163. Duties Of Supervising Physicians Of Interns And Residents. ....	1394
164. Supervising Physicians Of Medical Personnel.....	1394
165. -- 200. (Reserved).....	1396

201. Registration By Supervising And Directing Physicians .....	1396
202. -- 239. (Reserved) .....	1397
240. Fees - Table .....	1397
241. (Reserved) .....	1397
242. Definitions Related To Interns And Residents. ....	1397
243. Resident and Intern Registration.....	1397
244. Fees - Table .....	1398
245. -- 999. (Reserved).....	1398
<i>22.01.03 – Rules for the Licensure of Physician Assistants</i>	
000. Legal Authority .....	1399
001. Title And Scope.....	1399
002. -- 009. (Reserved).....	1399
010. Definitions. ....	1399
011. -- 019. (Reserved).....	1399
020. Requirements For Licensure.....	1399
021. -- 027. (Reserved).....	1399
028. Scope Of Practice. ....	1399
029. Continuing Education Requirements.....	1400
030. Practice Standards.....	1400
031. Participation In Disaster And Emergency Care.....	1400
032. -- 035. (Reserved).....	1400
036. Graduate Physician Assistant.....	1400
037. -- 041. (Reserved).....	1401
042. Prescription Writing.....	1401
043. -- 050. (Reserved).....	1401
051. Fees - Table .....	1401
052. -- 999. (Reserved).....	1402
<i>22.01.07 – Rules for the Licensure of Naturopathic Medical Doctors</i>	
000. Legal Authority .....	1403
001. Title And Scope.....	1403
002. -- 009. (Reserved).....	1403
010. Definitions. ....	1403
011. -- 019. (Reserved).....	1403
020. General Qualifications For Licensure.....	1403
021. Application For Licensure.....	1403
022. Authority To Prescribe, Dispense, Administer, And Order.....	1403
023. -- 031. (Reserved).....	1404
032. Grounds For Discipline Or Denial Of A License.....	1404
033. Continuing Medical Education (CME) Requirements.....	1405
034. -- 040. (Reserved).....	1405
041. Fees.....	1405
042. -- 999. (Reserved).....	1405
<i>22.01.10 – Rules for the Licensure of Athletic Trainers to Practice in Idaho</i>	
000. Legal Authority .....	1406
001. Title And Scope.....	1406
002. -- 009. (Reserved).....	1406
010. Definitions. ....	1406
011. Scope Of Practice. ....	1406
012. Athletic Training Service Plan Or Protocol.....	1406
013. -- 019. (Reserved).....	1407
020. General Qualifications For Licensure and Renewal.....	1407

021. -- 029. (Reserved).....	1407
030. Application For Licensure.....	1407
031. -- 051. (Reserved).....	1408
052. Denial Or Refusal To Renew Licensure Or Suspension Or Revocation Of Licensure.....	1408
053. -- 060. (Reserved).....	1408
061. Fees -- Table.....	1408
062. -- 999. (Reserved).....	1408
<b>22.01.11 – Rules for Licensure of Respiratory Therapists and Permitting of Polysomnographers in Idaho</b>	
000. Legal Authority.....	1409
001. Title And Scope.....	1409
002. -- 009. (Reserved).....	1409
010. Definitions.....	1409
011. Application To Both Permits And Licenses.....	1409
012. -- 030. (Reserved).....	1409
031. General Qualifications For Licensure And Renewal.....	1409
032. Continuing Education.....	1410
033. Supervision of Respiratory Care.....	1410
034. Denial Or Refusal To Renew License Or Permit Or Suspension Or Revocation Of License Or Permit.....	1410
035. -- 045. (Reserved).....	1410
046. Fees -- Table.....	1410
047. -- 999. (Reserved).....	1411
<b>22.01.13 – Rules for the Licensure of Dietitians</b>	
000. Legal Authority.....	1412
001. Title And Scope.....	1412
002. -- 019. (Reserved).....	1412
020. General Qualifications For Licensure and Renewal.....	1412
021. Provisional Licensure.....	1412
022. -- 031. (Reserved).....	1412
032. Denial Or Refusal To Renew, Suspension Or Revocation Of License.....	1412
033. -- 040. (Reserved).....	1412
041. Fees -- Table.....	1412
042. -- 999. (Reserved).....	1412

**IDAPA 23 – BOARD OF NURSING**

**Docket No. 23-0101-2000F (Fee Rule)**

<b>23.01.01 – Rules of the Idaho Board of Nursing</b>	
000. Legal Authority.....	1415
001. Title And Scope.....	1415
002. Filing Of Documents.....	1415
003. Changes In Name And Address – Address For Notification Purposes.....	1415
004. -- 009. (Reserved).....	1415
010. Definitions.....	1415
011. -- 039. (Reserved).....	1418
040. Temporary License.....	1418
041. -- 059. (Reserved).....	1418
060. LPN, RN, And APRN License Renewal.....	1418
061. Continued Competence Requirements For Renewal Of An Active License.....	1419
062. Documenting Compliance With Continued Competence Requirements.....	1420
063. Reinstatement (Non-Discipline).....	1421
064. Reinstatement After Discipline.....	1421

065. -- 075. (Reserved).....	1421
076. Persons Exempted By Board.....	1421
077. -- 089. (Reserved).....	1423
090. Reapplication For A License After Previous Denial.....	1423
091. -- 099. (Reserved).....	1423
100. Grounds For Discipline.....	1423
101. Standards Of Conduct.....	1425
102. -- 131. (Reserved).....	1427
132. Restricted Licenses.....	1427
133. Advisory Committee.....	1430
134. Emergency Action.....	1430
135. -- 164. (Reserved).....	1430
165. Petition For Rehearing Or Reconsideration.....	1430
166. -- 219. (Reserved).....	1430
220. Qualifications For Licensure By Examination.....	1430
221. Examination Application.....	1431
222. Examination And Re-Examination.....	1431
223. -- 239. (Reserved).....	1431
240. Qualifications For Licensure By Endorsement.....	1431
241. Licensure By Equivalency And Endorsement Licensure.....	1431
242. -- 259. (Reserved).....	1432
260. Qualifications For Licensure Of Graduates Of Schools Of Nursing Located Outside The United States, Its Territories, Or Commonwealths.....	1432
261. Application For Licensure Of Graduates Of Schools Of Nursing Located Outside The United States, Its Territories, Or Commonwealths.....	1432
262. -- 270. (Reserved).....	1432
271. Definitions Related To Advanced Practice Registered Nursing.....	1432
272. -- 279. (Reserved).....	1434
280. Standards Of Practice For Advanced Practice Registered Nursing.....	1434
281. -- 284. (Reserved).....	1435
285. Qualifications For Advanced Practice Registered Nurse.....	1435
286. -- 289. (Reserved).....	1435
290. Application For Licensure -- Advanced Practice Registered Nurse.....	1436
291. -- 294. (Reserved).....	1436
295. Temporary Licensure -- Advanced Practice Registered Nurse.....	1436
296. -- 299. (Reserved).....	1436
300. Renewal Of Advanced Practice Registered Nurse License.....	1436
301. Reinstatement Of Advanced Practice Registered Nurse License.....	1437
302. -- 304. (Reserved).....	1437
305. Persons Exempted From Advanced Practice Registered Nursing License Requirements.....	1437
306. Disciplinary Enforcement.....	1438
307. -- 314. (Reserved).....	1438
315. Prescriptive And Dispensing Authorization For Advanced Practice Registered Nurses.....	1438
316. Grounds For Discipline Of An Advanced Practice Registered Nurse License.....	1439
317. -- 319. (Reserved).....	1439
320. Recognition Of National Certifying Organizations For Advanced Practice Registered Nursing.....	1439
321. -- 389. (Reserved).....	1439
390. Use Of Titles, Abbreviations, And Designations For The Practice Of Nursing.....	1439
391. -- 399. (Reserved).....	1440
400. Decision-Making Model.....	1440
401. Licensed registered Nurse (RN).....	1441
402. Licensed Registered Nurse Functioning In Specialty Areas.....	1443

403. -- 459. (Reserved).....	1443
460. Licensed Practical Nurse (LPN).....	1443
461. -- 490. (Reserved).....	1444
491. Technicians/Technologists.....	1444
492. -- 599. (Reserved).....	1444
600. Nursing Education For Registered And Practical Nurses.....	1444
601. Purpose Of Approval.....	1444
602. Approval Of A New Educational Program.....	1444
603. Continuance Of Full Approval Of Educational Program.....	1446
604. Discontinuance Of An Educational Program.....	1447
605. -- 629. (Reserved).....	1447
630. Philosophy And Objectives Of Educational Program.....	1447
631. Administration Of Educational Program.....	1447
632. Financial Support Of Educational Program For Practical Nurse, Registered Nurse, And Advanced Practice Registered Nurse.....	1447
633. Records Of Educational Program.....	1447
634. -- 639. (Reserved).....	1448
640. Faculty Qualifications.....	1448
641. Faculty.....	1449
642. (Reserved).....	1449
643. Administrator Responsibilities And Qualifications.....	1449
644. Faculty Responsibilities.....	1450
645. -- 659. (Reserved).....	1451
660. Students, Educational Program.....	1451
661. -- 679. (Reserved).....	1451
680. Curriculum, Educational Program.....	1451
681. Curriculum Requirements For Nursing Education Programs.....	1452
682. -- 699. (Reserved).....	1454
700. Curriculum Change, Educational Program.....	1454
701. -- 729. (Reserved).....	1454
730. Practice Sites.....	1454
731. -- 899. (Reserved).....	1454
900. Initial license, Renewal And Reinstatement Fees.....	1454
901. Other Fees.....	1455
902. (Reserved).....	1455
903. Education Program Fees.....	1455
904. No Refunds.....	1455
905. Only One License - Exception.....	1455
906. -- 998. (Reserved).....	1455
999. Administrative Fine.....	1455

**IDAPA 24 – DIVISION OF OCCUPATIONAL AND PROFESSIONAL LICENSES**

***Docket No. 24-0101-2000F (Fee Rule)***

***24.01.01 – Rules of the Board of Architectural Examiners***

000. Legal Authority.....	1458
001. Title And Scope.....	1458
002. Incorporation By Reference.....	1458
003. -- 009. (Reserved).....	1458
010. Definitions.....	1458
011. -- 099. (Reserved).....	1458
100. Organization.....	1458
101. -- 149. (Reserved).....	1458



150. Procedures And Duties .....	1458
151. -- 174. (Reserved).....	1458
175. Applicant Past Crime Review.....	1458
176. -- 199. (Reserved).....	1459
200. Fees For Examinations And Licensure.....	1459
201. -- 249. (Reserved).....	1459
250. Qualifications Of Applicants For Examination.....	1459
251. -- 299. (Reserved) .....	1460
300. Application.....	1460
301. -- 349. (Reserved).....	1460
350. Registration Examination.....	1460
351. -- 374. (Reserved).....	1461
375. Architectural Intern.....	1461
376. -- 399. (Reserved).....	1461
400. Firm Name.....	1461
401. -- 409. (Reserved).....	1462
410. Use Of An Architect's Seal.....	1462
411. -- 449. (Reserved).....	1462
450. Continuing Education.....	1462
451. -- 749. (Reserved).....	1463
750. Code Of Ethics.....	1463
751. -- 999. (Reserved).....	1463
 <i>24.02.01 – Rules of the State Athletic Commission</i>	
000. Legal Authority.....	1466
001. Title And Scope.....	1466
002. -- 009. (Reserved).....	1466
010. Definitions.....	1466
011. -- 099. (Reserved).....	1466
100. Licensing.....	1466
101. Age And Physical Condition.....	1467
102. Ability Of Combatant.....	1467
103. Physical Examination Of Combatant.....	1467
104. Fees.....	1468
105. Honoring Actions Of Regulatory Agencies In Other Jurisdictions.....	1468
106. Time Between Contests.....	1468
107. Female Combatants.....	1468
108. Requirements For License As A Promoter.....	1469
109. Amateur Athletic Sanctioning Organizations.....	1469
110. Manager Acting As Second.....	1472
111. Requirements For License As Ring Official.....	1472
112. (Reserved).....	1473
113. Applicants, Licensees, And Officials.....	1473
114. Grounds For Denial Or Revocation Of License.....	1473
115. -- 199. (Reserved).....	1473
200. Contract Between Manager And Combatant.....	1473
201. Manager's Advances -- Accounting.....	1474
202. Contract Between Promoter And Combatant.....	1474
203. Filing Certain Contracts With Commission.....	1474
204. Percentage Of Gate Receipts To Combatant.....	1475
205. Promoter's Advances To Combatant Or Manager Or Occurrence Of Debt On His Behalf.....	1475
206. Failure Of Combatant To Appear.....	1475
207. Payment Of Combatant.....	1475

208.	Payment Of Purse.....	1475
209.	Retaining Portion Of Purse Pending Determination Of Whether Penalty Will Be Charged. ....	1476
210. -- 298.	(Reserved).....	1476
299.	Health Insurance.....	1476
300.	Surety Bond Or Other Security.....	1476
301.	Approval Of Events.....	1477
302.	(Reserved).....	1477
303.	Program For Charity.....	1477
304.	Arrangement Of Contest For Promoter.....	1478
305. -- 306.	(Reserved).....	1478
307.	Certain Persons Retained Must Have Licenses.....	1478
308.	Officials Of Events.....	1478
309.	Referees.....	1478
310.	Judges.....	1478
311.	Admission Of Licensees And Agents To Events.....	1479
312.	Payment Of Fee To Official Designated By Commission.....	1479
313.	Postponement Of Program.....	1479
314.	Main And Semi-Main Events.....	1479
315.	Containers.....	1479
316. -- 399.	(Reserved).....	1479
400.	Admission Fee At Quarters Where Combatant Trains.....	1479
401.	Approval Of Facilities By Commission Before Tickets May Be Sold.....	1480
402.	Tickets Limited To Seating Capacity Of Arena.....	1480
403.	Tickets.....	1480
404.	Contents Of Tickets.....	1480
405.	Complimentary Tickets.....	1480
406.	Provisions Of Tickets Without Charge Or At Reduced Rates.....	1481
407.	Speculation In Tickets Prohibited.....	1481
408. -- 414.	(Reserved).....	1482
415.	Tickets: Removal And Retention After Match; Destruction.....	1482
416. -- 499.	(Reserved).....	1482
500.	Sanitation.....	1482
501.	Required Number Of Ambulances; Notice To Ambulance Service And Hospital.....	1482
502.	Dressing Rooms -- Only Authorized Persons Are Allowed To Enter.....	1483
503.	Boxing Gloves.....	1483
504.	Bandaging Of Combatant's Hands.....	1484
505.	Equipment Of The Chief Second.....	1484
506.	Boxing Ring.....	1484
507.	Bell Or Gong.....	1485
508.	Equipment Of A Timekeeper.....	1485
509. -- 599.	(Reserved).....	1485
600.	Weights And Classes Of Combatants.....	1485
601.	Champions.....	1486
602.	Weigh-in, Examination Of Combatant May Be Ordered By The Commission.....	1487
603.	Advance Appearance Of Combatant Scheduled To Fight In Main Event.....	1487
604.	Weighing In Of Combatants.....	1487
605.	Forfeiture For Failure To Make Weight.....	1487
606.	Physical And Eye Examination Of Combatants.....	1487
607.	Physician -- Suitable Place To Examine Contestant; Fee; Emergency Treatment.....	1488
608.	Physician's Determination Of Fitness Of Combatants And Referee; Certification; Report.....	1488
609.	Combatant's Report Of Own Illness Or Injury; Examination; Fee.....	1488

610. Suspension Of Licensee For Medical Reason.....	1488
611. -- 699. (Reserved).....	1488
700. Combatants Must Report.....	1488
701. Boxer's Costume And Equipment.....	1488
702. Combatant's Physical Appearance.....	1489
703. Procedure For Use Of Scorecards.....	1489
704. Method Of Judging.....	1489
705. Introduction From Ring.....	1490
706. Referee's Instructions To Combatants.....	1490
707. Limitations On Seconds.....	1490
708. Continuous Presence Of Physician At Ringside.....	1490
709. Warning Before Start Of Round.....	1490
710. Duration Of Round.....	1490
711. Persons Allowed In Ring.....	1490
712. Fair Blows And Fouls.....	1490
713. Unfair Practices; Duties Of Referees.....	1491
714. Fouls: Deduction For Points; Effect Of Claiming Low Blow By Opponent.....	1491
715. Fouls: Disqualification Of Combatant And Withholding Of Purse.....	1492
716. Accidental Fouling.....	1492
717. Stopping Of Contest: Injury To Combatant.....	1492
718. Stopping Of Contest: One-Sided Contest; Risk Of Injury; Examination By Physician.....	1492
719. Stopping The Contest: Combatant Not Honestly Competing.....	1492
720. Failure Of Combatant To Resume.....	1492
721. Gloves To Be Wiped By Referee After Boxer Falls.....	1492
722. Knockdown Of Combatant; Procedure For Counting.....	1492
723. Resuming Count On Boxer.....	1493
724. Adjudication Of Technical Knockout.....	1493
725. Procedure When Combatant Is Knocked Out; Period Before His Next Contest; Examination In Case Of Head Injury.....	1493
726. When Combatant Falls From Ring During Round.....	1494
727. When A Boxer Shall Be Deemed Down.....	1494
728. Announcement Of Winner Of Bout.....	1494
729. Change Of Decision In Contest.....	1494
730. Physician's Report To Commission After Contest.....	1495
731. Martial Arts And Mixed Martial Arts (MMA).....	1495
732. MMA Equipment.....	1495
733. Fair Techniques And Fouls In MMA Events.....	1497
734. Suspension Of MMA Contest For Unforeseen Reasons.....	1501
735. Standing Eight Count In MMA Contest.....	1502
736. Weight Categories - Mixed Martial Arts.....	1502
737. MMA Event Rounds.....	1503
738. Methods Of Winning MMA Contest.....	1503
739. MMA Contest Scoring.....	1504
740. Combatant Down After The Sound Of The Bell.....	1504
741. Blows At Or After The Bell In MMA Contest.....	1505
742. Termination Of A Contest Due To A Fair Blow In MMA Contest.....	1505
743. Combat Platforms (Ring/Cage).....	1505
744. -- 799. (Reserved).....	1505
800. Wrestling: Special License Is Required For A Contest.....	1505
801. Wrestling: Disqualification For Dangerous Tactics.....	1505
802. Licensee's Duties At Wrestling Exhibition.....	1505
803. Wrestlers -- Physical Examination.....	1505

804. -- 899. (Reserved).....	1505
900. Administration Or Use Of Alcohol, Drugs, Stimulants.....	1505
901. Preparations To Stop Hemorrhaging.....	1506
902. Combatant Not To Have Promoter Or Certain Others Act As Manager Or Hold Financial Interest.....	1506
903. Report To Commission Of Solicitation To Conduct Contest Fraudulently.....	1506
904. Suspension Of A License -- Debts In Connection With Training.....	1506
905. Grounds For Disciplinary Action.....	1507
906. (Reserved) 1507	
907. Licensees Prohibited From Dealing With Persons Whose Licenses Are Suspended Or Revoked.....	1507
908. Suspension And Revocation Of Licenses.....	1507
909. Penalties For Certain Violations; Review By Commission.....	1508
910. -- 999. (Reserved).....	1508
 <i>24.03.01 – Rules of the State Board of Chiropractic Physicians</i>	
000. Legal Authority.....	1511
001. Title And Scope.....	1511
002. -- 009. (Reserved).....	1511
010. Definition.....	1511
011. -- 099. (Reserved).....	1511
100. Applications.....	1511
101. -- 149. (Reserved).....	1512
150. Fees.....	1512
151. -- 199. (Reserved).....	1512
200. Examinations.....	1512
201. -- 299. (Reserved).....	1512
300. Inactive License.....	1512
301. -- 349. (Reserved).....	1513
350. Continuing Education.....	1513
351. Approval Of Continuing Education Courses.....	1514
352. -- 399. (Reserved).....	1515
400. Approved Schools Of Chiropractic.....	1515
401. -- 449. (Reserved).....	1515
450. Advertisements.....	1515
451. -- 549. (Reserved).....	1515
550. Chiropractic Assistants.....	1515
551. Chiropractic Intern.....	1516
552. Temporary Practice Permits.....	1516
553. -- 604. (Reserved).....	1517
605. Code Of Ethics.....	1517
606. -- 699. (Reserved).....	1517
700. Clinical Nutrition Certification And Practice.....	1517
701. (Reserved).....	1517
702. Requirements For Clinical Nutrition Certification.....	1517
703. Annual Issuance Of Clinical Nutrition Certification With License Renewal.....	1519
704. Reissuance Of Cancelled Clinical Nutrition Certification.....	1520
705. Clinical Nutrition Certification Cancelled For Over Three (3) Years.....	1520
706. Clinical Nutrition Recertification Requirement.....	1520
707. Obtaining And Independently Administering Clinical Nutrition Prescription Drug Products....	1521
708. Clinical Nutrition Formulary.....	1522
709. Medical Waste.....	1523
710. -- 999. (Reserved).....	1523

24.04.01 – Rules of the Board of Registration for Professional Geologists

000. Legal Authority.....	1527
001. Title And Scope.....	1527
002. -- 009. (Reserved).....	1527
010. Definitions.....	1527
011. -- 099. (Reserved).....	1527
100. General Provisions.....	1527
101. -- 149. (Reserved).....	1528
150. Fees.....	1528
151. -- 199. (Reserved).....	1528
200. Application Procedures.....	1528
201. -- 299. (Reserved).....	1529
300. Examinations.....	1529
301. -- 399. (Reserved).....	1530
400. Geologist In Training.....	1530
401. -- 999. (Reserved).....	1530

24.05.01 – Rules of the Board of Drinking Water and Wastewater Professionals

000. Legal Authority.....	1535
001. Title And Scope.....	1535
002. -- 009. (Reserved).....	1535
010. Definitions.....	1535
011. -- 099. (Reserved).....	1536
100. Organization.....	1536
101. -- 149. (Reserved).....	1536
150. Application.....	1536
151. -- 174. (Reserved).....	1537
175. License Types And Classifications.....	1537
176. -- 199. (Reserved).....	1538
200. Fees For Examination And Licensure.....	1538
201. -- 249. (Reserved).....	1538
250. License Required -- Scope Of Practice.....	1538
251. -- 299. (Reserved).....	1539
300. General Requirements For License.....	1539
301. -- 309. (Reserved).....	1540
310. Requirements For Operator-In-Training License.....	1540
311. -- 314. (Reserved).....	1540
315. Requirements For A Very Small Water System License.....	1540
316. -- 319. (Reserved).....	1540
320. Requirements For A Very Small Wastewater System License.....	1540
321. -- 324. (Reserved).....	1541
325. Requirements For Class I Restricted Water Or Wastewater License.....	1541
326. -- 327. (Reserved).....	1541
328. Requirements For A Class I Operator License.....	1541
329. (Reserved).....	1541
330. Requirements For A Class II Operator License.....	1541
331. -- 334. (Reserved).....	1541
335. Requirements For A Class III Operator License.....	1541
336. -- 339. (Reserved).....	1542
340. Requirements For A Class IV Operator License.....	1542
341. -- 344. (Reserved).....	1542
345. Requirements For A Lagoon Operator License.....	1542
346. -- 349. (Reserved).....	1542

350. Requirements For A Wastewater Land Application License.....	1542
351. -- 354. (Reserved).....	1542
355. Requirements For A Backflow Assembly Tester License.....	1542
356. -- 359. (Reserved).....	1543
360. Requirements For Wastewater Laboratory Analyst License.....	1543
361. -- 374. (Reserved).....	1543
375. Substitutions.....	1543
376. -- 399. (Reserved).....	1545
400. Endorsement.....	1545
401. -- 449. (Reserved).....	1545
450. Wastewater Grandparent Provision.....	1545
451. -- 499. (Reserved).....	1545
500. Continuing Education.....	1545
501. -- 599. (Reserved).....	1547
600. Renewal Or Reinstatement Of License.....	1547
601. -- 649. (Reserved).....	1547
650. Backflow Assembly Tester Code Of Ethics And Standards Of Conduct.....	1547
651. -- 699. (Reserved).....	1547
700. Discipline.....	1547
701. -- 799. (Reserved).....	1547
800. Stakeholder Involvement.....	1547
801. -- 999. (Reserved).....	1548
 <i>24.06.01 – Rules for the Licensure of Occupational Therapists and Occupational Therapy Assistants</i>	
000. Legal Authority.....	1552
001. Title And Scope.....	1552
002. -- 009. (Reserved).....	1552
010. Definitions.....	1552
011. Supervision.....	1552
012. Deep Thermal, Electrotherapeutic, Mechanical Physical Agent Modalities, And Wound Care.....	1553
013. Record Keeping.....	1554
014. -- 019. (Reserved).....	1554
020. General Qualifications For Licensure.....	1554
021. Application For Licensure.....	1555
022. Written Statement Of Suitability For Licensure.....	1555
023. -- 024. (Reserved).....	1556
025. Continuing Education.....	1556
026. -- 029. (Reserved).....	1557
030. Inactive Status.....	1557
031. (Reserved).....	1558
032. Denial Or Refusal To Renew, Suspension Or Revocation Of License.....	1558
033. -- 040. (Reserved).....	1559
041. Fees.....	1559
042. Standards of Practice for Telehealth.....	1559
043. -- 999. (Reserved).....	1560
 <i>24.07.01 – Rules of the Idaho State Board of Landscape Architects</i>	
000. Legal Authority (Rule 0).....	1563
001. Title And Scope (Rule 1).....	1563
002. Incorporation By Reference (Rule 4).....	1563
003. Address Of Idaho Board Of Landscape Architects (Rule 5).....	1563
004. -- 100. (Reserved).....	1563

101. Approved Education (Rule 101).....	1563
102. Practical Experience In Lieu Of Education (Rule 102).....	1563
103. -- 199. (Reserved).....	1563
200. Application (Rule 200).....	1563
201. Application Form (Rule 201).....	1563
202. -- 249. (Reserved).....	1564
250. Landscape Architect-in-Training (Rule 250).....	1564
251. -- 299. (Reserved).....	1564
300. Exam nations (Rule 300).....	1564
301. (Reserved).....	1564
302. Endorsement (Rule 302).....	1564
303. -- 399. (Reserved).....	1564
400. Fees (Rule 400).....	1565
401. -- 424. (Reserved).....	1565
425. Rules Of Professional Responsibility (Rule 425).....	1565
426. -- 449. (Reserved).....	1565
450. Discipline (Rule 450).....	1565
451. -- 499. (Reserved).....	1565
500. Meetings (Rule 500).....	1565
501. -- 999. (Reserved).....	1565
<i>24.08.01 – Rules of the State Board of Morticians</i>	
000. Legal Authority.....	1568
001. Title And Scope.....	1568
002. -- 099. (Reserved).....	1568
100. Meetings (Rule 100).....	1568
101. -- 149. (Reserved).....	1568
150. Time Of Examinations (Rule 150).....	1568
151. -- 199. (Reserved).....	1568
200. Application (Rule 200).....	1568
201. -- 249. (Reserved).....	1568
250. Resident Trainee (Rule 250).....	1568
251. -- 299. (Reserved).....	1569
300. Applications And Examination (Rule 300).....	1569
301. -- 324. (Reserved).....	1570
325. Approved Examination.....	1570
326. -- 349. (Reserved).....	1571
350. Endorsement.....	1571
351. -- 379. (Reserved).....	1571
380. Inactive License.....	1571
381. -- 399. (Reserved).....	1572
400. Expiration Of License.....	1572
401. -- 409. (Reserved).....	1572
410. Continuing Education.....	1572
411. -- 424. (Reserved).....	1573
425. Maintenance Of Pre-Need Trust Account Fees.....	1573
426. -- 449. (Reserved).....	1573
450. Funeral Establishment And Crematory Establishment.....	1573
451. (Reserved).....	1574
452. Minimum Standards.....	1574
453. Receipt For Bodies To Be Cremated.....	1575
454. Records Of Bodies.....	1575
455. Responsibility, Inspection, And Confidentiality Of Records.....	1575

456. -- 499. (Reserved).....	1576
500. Fees.....	1576
501. Discipline.....	1576
502. -- 999. (Reserved).....	1576
<i>24.09.01 – Rules of the Board of Examiners of Nursing Home Administrators</i>	
000. Legal Authority.....	1579
001. Title And Scope.....	1579
002. Address Of The Board Of Examiners Of Nursing Home Administrators.....	1579
003. -- 099. (Reserved).....	1579
100. Examination For Licensure (Rule 100).....	1579
101. -- 199. (Reserved).....	1580
200. Continuing Education Requirements.....	1580
201. -- 299. (Reserved).....	1580
300. Endorsement.....	1580
301. -- 399. (Reserved).....	1580
400. Nursing Home Administrators-In-Training.....	1580
401. -- 449. (Reserved).....	1582
450. Administrator Designee Qualification.....	1582
451. -- 499. (Reserved).....	1582
500. Permits.....	1582
501. -- 599. (Reserved).....	1582
600. Fees.....	1582
601. -- 999. (Reserved).....	1582
<i>24.10.01 – Rules of the State Board of Optometry</i>	
000. Legal Authority.....	1585
001. Title And Scope.....	1585
002. -- 009. (Reserved).....	1585
010. Definitions.....	1585
011. -- 149. (Reserved).....	1585
150. Meeting Of The Board.....	1585
151. -- 174. (Reserved).....	1585
175. Method Of Application-examination Of Applicants.....	1585
176. -- 199. (Reserved).....	1585
200. Approval Of Schools Of Optometry.....	1585
201. -- 224. (Reserved).....	1586
225. Approval Of Preliminary Education.....	1586
226. -- 249. (Reserved).....	1586
250. Licenses Canceled For Failure To Renew.....	1586
251. -- 274. (Reserved).....	1586
275. Endorsement.....	1586
276. -- 299. (Reserved).....	1586
300. Continuing Education In Optometry.....	1586
301. -- 324. (Reserved).....	1587
325. Code Of Ethics.....	1587
326. -- 424. (Reserved).....	1588
425. Rules Defining Gross Incompetence.....	1588
426. -- 449. (Reserved).....	1589
450. Prescriptions For Spectacles And Contact Lenses.....	1589
451. -- 474. (Reserved).....	1590
475. Patients Records.....	1590
476. -- 499. (Reserved).....	1591
500. Preceptorship Program.....	1591



501. -- 524. (Reserved).....	1591
525. General Rules.....	1591
526. -- 574. (Reserved).....	1591
575. Fees.....	1591
576. -- 599. (Reserved).....	1592
600. Board Certification Of Optometrist Authorized To Obtain And Use Pharmaceutical Agents.....	1592
601. -- 999. (Reserved).....	1593
<i>24.11.01 – Rules of the State Board of Podiatry</i>	
000. Legal Authority.....	1596
001. Title And Scope.....	1596
002. Incorporation By Reference.....	1596
003. -- 009. (Reserved).....	1596
010. Definitions And Standards.....	1596
011. -- 149. (Reserved).....	1596
150. Pre-Professional Education.....	1596
151. Professional Education.....	1596
152. Podiatric Residency.....	1596
153. -- 199. (Reserved).....	1596
200. Credentials To Be Filed By All Applicants.....	1596
201. -- 299. (Reserved).....	1596
300. Fees.....	1597
301. -- 399. (Reserved).....	1597
400. Licensure By Examination.....	1597
401. Licensure By Endorsement.....	1597
402. Temporary Licenses.....	1598
403. -- 409. (Reserved).....	1598
410. Original Application.....	1598
411. -- 424. (Reserved).....	1598
425. Inactive Status.....	1598
426. -- 449. (Reserved).....	1598
450. Scope Of Practice.....	1598
451. -- 499. (Reserved).....	1599
500. Standards Of The Ethical Practice Of Podiatry.....	1599
501. -- 549. (Reserved).....	1599
550. Discipline.....	1599
551. -- 699. (Reserved).....	1599
700. Continuing Education.....	1599
701. -- 999. (Reserved).....	1599
<i>24.12.01 – Rules of the Idaho State Board of Psychologist Examiners</i>	
000. Legal Authority.....	1602
001. Title And Scope.....	1602
002. Incorporation By Reference (Rule 4).....	1602
003. -- 009. (Reserved).....	1602
010. Definitions.....	1602
011. -- 099. (Reserved).....	1602
100. Application.....	1602
101. -- 149. (Reserved).....	1603
150. Fees.....	1603
151. -- 199. (Reserved).....	1603
200. Examinations.....	1603
201. Examination For Provisional Certification Of Prescriptive Authority.....	1604

202. -- 249. (Reserved).....	1604
250. Endorsement.....	1604
251. Endorsement For Certification Of Prescriptive Authority (Rule 251).....	1604
252. -- 274. (Reserved).....	1605
275. Inactive Status.....	1605
276. -- 299. (Reserved).....	1605
300. Temporary Licenses (Rule 300).....	1605
301. -- 349. (Reserved).....	1605
350. Code Of Ethics.....	1605
351. -- 374. (Reserved).....	1606
375. Discipline.....	1606
376. -- 379. (Reserved).....	1606
380. Rehabilitation Components.....	1606
381. -- 399. (Reserved).....	1606
400. Renewal Of License -- Continuing Education.....	1606
401. Continuing Education Requirements For Relicensure In Psychology.....	1607
402. Guidelines For Approval Of Continuing Education Credits (Rule 402).....	1607
403. -- 449. (Reserved).....	1609
450. Guidelines For Use Of Service Extenders To Licensed Psychologists.....	1609
451. -- 499. (Reserved).....	1611
500. Educational And Credentialing Requirements For Licensure.....	1612
501. -- 549. (Reserved).....	1613
550. Requirements For Supervised Practice.....	1613
551. -- 600. (Reserved).....	1613
601. Telepsychology.....	1613
602. -- 699. (Reserved).....	1615
700. Qualifications For Provisional Certification Of Prescriptive Authority.....	1615
701. Supervised Practice Of Provisional Certification Holder.....	1617
702. Qualifications To Prescribe For Pediatric Or Geriatric Patients.....	1617
703. -- 709. (Reserved).....	1618
710. Qualifications For Certification Of Prescriptive Authority.....	1618
711. -- 719. (Reserved).....	1618
720. Standards Of Practice For Prescriptive Authority.....	1618
721. -- 729. (Reserved).....	1620
730. Formulary.....	1620
731. -- 999. (Reserved).....	1621
<i>24.13.01 – Rules Governing the Physical Therapy Licensure Board</i>	
000. Legal Authority (Rule 0).....	1624
001. Title And Scope (Rule 1).....	1624
002. -- 009. (Reserved).....	1624
010. Definitions (Rule 10).....	1624
011. -- 015. (Reserved).....	1626
016. Supervision (Rule 16).....	1626
017. -- 099. (Reserved).....	1628
100. Meetings And Organization (Rule 100).....	1628
101. -- 149. (Reserved).....	1628
150. Application (Rule 150).....	1628
151. -- 174. (Reserved).....	1628
175. Requirements For Licensure (Rule 175).....	1628
176. -- 179. (Reserved).....	1629
180. Requirements To Practice Dry Needling (Rule 180).....	1629
181. Practice Of Dry Needling (Rule 181).....	1629

182. -- 199. (Reserved).....	1629
200. Fees (Rule 200).....	1629
201. -- 249. (Reserved).....	1630
250. Continuing Education Requirement (Rule 250).....	1630
251. -- 274. (Reserved).....	1632
275. Disciplinary Penalty (Rule 275).....	1632
276. -- 299. (Reserved).....	1633
300. Code Of Ethics (Rule 300).....	1633
301. -- 999. (Reserved).....	1633
<i>24.14.01 – Rules of the State Board of Social Work Examiners</i>	
000. Legal Authority.....	1637
001. Title And Scope.....	1637
002. -- 009. (Reserved).....	1637
010. Definitions.....	1637
011. -- 099. (Reserved).....	1637
100. Approved Colleges And Universities.....	1637
101. -- 149. (Reserved).....	1637
150. Board Meetings.....	1637
151. -- 199. (Reserved).....	1637
200. Licensing Qualifications And Definition Of Terms.....	1637
201. Practice Of Social Work.....	1637
202. -- 209. (Reserved).....	1638
210. Supervision.....	1638
211. Social Work Supervisor Registration.....	1640
212. -- 224. (Reserved).....	1640
225. Inactive Status.....	1640
226. -- 299. (Reserved).....	1641
300. Fees.....	1641
301. -- 349. (Reserved).....	1641
350. Examinations And Endorsement.....	1641
351. Continuing Education.....	1642
352. -- 399. (Reserved).....	1644
400. Unprofessional Conduct.....	1644
401. -- 449. (Reserved).....	1644
450. Statement Of Public Policy And Code Of Professional Conduct.....	1644
451. -- 474. (Reserved).....	1647
475. Discipline.....	1647
476. -- 999. (Reserved).....	1647
<i>24.15.01 – Rules of the Idaho Licensing Board of Professional Counselors and Marriage and Family Therapists</i>	
000. Legal Authority.....	1650
001. Title And Scope.....	1650
002. -- 003. (Reserved).....	1650
004. Incorporation By Reference.....	1650
005. -- 009. (Reserved).....	1650
010. Definitions.....	1650
011. -- 149. (Reserved).....	1650
150. Qualifications For Professional Counselor Licensure.....	1650
151. -- 224. (Reserved).....	1652
225. Clinical Professional Counselor Licensure.....	1652
226. -- 229. (Reserved).....	1652
230. Qualifications For Associate Marriage And Family Therapist.....	1652

231. – 237. (Reserved) .....	1653
238. Marriage And Family Therapists .....	1653
239. Supervisor Requirements .....	1655
240. Examination For Licensure .....	1656
242. -- 244. (Reserved) .....	1656
245. Registered Interns .....	1656
246. -- 249. (Reserved) .....	1657
250. Fees .....	1657
251. -- 299. (Reserved) .....	1657
300. Endorsement .....	1657
301. -- 349. (Reserved) .....	1657
350. Code Of Ethics .....	1657
351. -- 359. (Reserved) .....	1657
360. Inactive Status .....	1657
361. -- 374. (Reserved) .....	1658
375. Senior Status .....	1658
376. -- 424. (Reserved) .....	1658
425. Continuing Education .....	1658
426. – 524. (Reserved) .....	1660
525. Documentation Of Informed Consent .....	1660
526. -- 999. (Reserved) .....	1660
<i>24.16.01 – Rules of the State Board of Dentistry</i>	
000. Legal Authority .....	1663
001. Title And Scope .....	1663
002. -- 009. (Reserved) .....	1663
010. Definitions .....	1663
011. -- 149. (Reserved) .....	1663
150. Examinations .....	1663
151. -- 199. (Reserved) .....	1663
200. Applications .....	1663
201. -- 249. (Reserved) .....	1664
250. Fees .....	1664
251. -- 299. (Reserved) .....	1664
300. Internship .....	1664
301. -- 314. (Reserved) .....	1666
315. Inactive Licensure Status .....	1666
316. -- 349. (Reserved) .....	1667
350. Continuing Education .....	1667
351. -- 399. (Reserved) .....	1667
400. Inspections .....	1667
401. -- 449. (Reserved) .....	1668
450. Standards Of Conduct And Practice .....	1668
451. -- 474. (Reserved) .....	1669
475. Registration Statement .....	1669
476. Guarantee Of Denturist Services .....	1669
477. -- 479. (Reserved) .....	1670
480. Discipline .....	1670
481. -- 999. (Reserved) .....	1670
<i>24.17.01 – Rules of the State Board of Acupuncture</i>	
000. Legal Authority .....	1673
001. Title And Scope .....	1673
002. -- 009. (Reserved) .....	1673

010. Definitions.....	1673
011. -- 199. (Reserved).....	1673
200. Qualifications For Licensure Or Certification.....	1673
201. Acupuncture Trainee Permit.....	1674
202. -- 225. (Reserved).....	1674
226. Request For Approval Of Qualification.....	1674
227. -- 299. (Reserved).....	1674
300. Fees.....	1674
301. Reinstatement Of License.....	1675
302. Inactive Status.....	1675
303. -- 304. (Reserved).....	1675
305. Continuing Education Requirements.....	1675
306. Approval Of Continuing Education Courses.....	1676
307. Content Of Continuing Education Courses.....	1676
308. -- 400. (Reserved).....	1677
401. Records.....	1677
402. (Reserved).....	1677
403. Employment Of Unlicensed, Non-Exempt Individuals.....	1677
404. Supervision Of Trainees.....	1677
405. Advertising.....	1678
406. -- 524. (Reserved).....	1678
525. Display Of License.....	1678
526. -- 574. (Reserved).....	1678
575. Discipline.....	1678
576. -- 999. (Reserved).....	1678
<i>24.18.01 – Rules of the Real Estate Appraiser Board</i>	
000. Legal Authority.....	1681
001. Title And Scope.....	1681
002. -- 003. (Reserved).....	1681
004. Incorporation By Reference.....	1681
005. -- 009. (Reserved).....	1681
010. Definitions.....	1681
011. -- 099. (Reserved).....	1682
100. Organization And Meetings.....	1682
101. -- 149. (Reserved).....	1682
150. Fees.....	1682
151. -- 199. (Reserved).....	1683
200. Application.....	1683
201. -- 249. (Reserved).....	1683
250. Requirements For Licensure.....	1683
251. -- 274. (Reserved).....	1685
275. Registered Trainee Real Estate Appraiser.....	1685
276. Registered Trainee Supervisors.....	1686
277. -- 299. (Reserved).....	1687
300. Licensed Residential Real Estate Appraiser Classification Appraiser Qualification Criteria. ...	1687
301. -- 349. (Reserved).....	1688
350. Certified Residential Real Estate Appraiser Classification Appraiser Qualification Criteria. ...	1688
351. -- 399. (Reserved).....	1689
400. Certified General Real Estate Appraiser Classification Appraiser Qualification Criteria. ....	1689
401. Continuing Education.....	1691
402. -- 449. (Reserved).....	1692
450. Reciprocity.....	1692

451. -- 499. (Reserved).....	1692
500. Temporary Practice.....	1692
501. -- 524. (Reserved).....	1692
525. Discipline.....	1692
526. -- 539. (Reserved).....	1692
540. Appraisals In Litigation.....	1692
541. -- 699. (Reserved).....	1693
700. Uniform Standards Of Professional Appraisal Practice/Code Of Ethics.....	1693
701. -- 999. (Reserved).....	1693
<i>24.19.01 – Rules of the Board of Examiners of Residential Care Facility Administrators</i>	
000. Legal Authority.....	1696
001. Title And Scope.....	1696
002. -- 003. (Reserved).....	1696
004. Incorporation By Reference.....	1696
005. -- 099. (Reserved).....	1696
100. Applications.....	1696
101. -- 149. (Reserved).....	1696
150. Qualifications For Administrator License.....	1696
151. -- 159. (Reserved).....	1696
160. Nursing Home Administrator Qualifications For License.....	1696
161. -- 199. (Reserved).....	1696
200. Board Meetings -- Dates -- Places.....	1696
201. -- 299. (Reserved).....	1697
300. Examinations.....	1697
301. -- 399. (Reserved).....	1697
400. Educational And Training Requirements.....	1697
401. Continuing Education.....	1697
402. -- 449. (Reserved).....	1698
450. Scope Of Practice.....	1698
451. -- 599. (Reserved).....	1698
600. Fees.....	1698
601. -- 649. (Reserved).....	1698
650. Discipline.....	1698
651. -- 999. (Reserved).....	1698
<i>24.21.01 – Rules of the Idaho State Contractors Board</i>	
000. Legal Authority.....	1701
001. Title And Scope.....	1701
002. -- 099. (Reserved).....	1701
100. Organization.....	1701
101. -- 149. (Reserved).....	1701
150. Application.....	1701
151. -- 164. (Reserved).....	1701
165. Additional Qualifications For Registration.....	1701
166. -- 174. (Reserved).....	1702
175. Fees.....	1702
176. -- 999. (Reserved).....	1702
<i>24.22.01 – Rules of the Idaho State Liquefied Petroleum Gas Safety Board</i>	
000. Legal Authority.....	1705
001. Title And Scope.....	1705
002. -- 003. (Reserved).....	1705
004. Incorporation By Reference.....	1705

005. -- 099. (Reserved).....	1705
100. Organization.....	1705
101. -- 174. (Reserved).....	1705
175. Fees.....	1705
176. -- 224. (Reserved).....	1705
225. Approved Education And Examinations.....	1705
226. -- 249. (Reserved).....	1705
250. Practical Experience.....	1705
251. -- 349. (Reserved).....	1706
350. Facility Licensure.....	1706
351. -- 354. (Reserved).....	1706
355. General Liability Insurance Requirement.....	1706
356. -- 374. (Reserved).....	1707
375. Inspection Rules.....	1707
376. -- 399. (Reserved).....	1707
400. Endorsement.....	1707
401. -- 449. (Reserved).....	1707
450. Discipline.....	1707
451. -- 999. (Reserved).....	1707
<i>24.23.01 – Rules of the Speech, Hearing, and Communication Services Licensure Board</i>	
000. Legal Authority.....	1710
001. Title And Scope.....	1710
002. -- 003. (Reserved).....	1710
004. Incorporation By Reference.....	1710
005. -- 009. (Reserved).....	1710
010. Definitions.....	1710
011. -- 174. (Reserved).....	1710
175. Fees.....	1710
176. -- 204. (Reserved).....	1711
205. Inactive Status.....	1711
206. -- 209. (Reserved).....	1711
210. Qualifications For Audiologist Licensure.....	1711
211. Support Personnel: Audiology.....	1711
212. Newborn Hearing Screening Tests.....	1713
213. -- 219. (Reserved).....	1713
220. Qualifications For Speech-Language Pathologist Licensure.....	1713
221. -- 229. (Reserved).....	1714
230. Qualifications For Speech-Language Pathologist Aide Licensure.....	1714
231. -- 239. (Reserved).....	1714
240. Qualifications For Speech-Language Pathologist Assistant Licensure.....	1714
241. -- 249. (Reserved).....	1714
250. Qualifications For Hearing Aid Dealer And Fitter Licensure.....	1714
251. -- 259. (Reserved).....	1714
260. Qualifications For Sign Language Interpreter Licensure.....	1714
261. Telepractice Of Sign Language Interpreting.....	1715
262. -- 264. (Reserved).....	1715
265. Code Of Ethics And Standards For Sign Language Interpreters.....	1715
266. -- 269. (Reserved).....	1715
270. Registration For Out-Of-State Licensees.....	1715
271. -- 279. (Reserved).....	1715
280. Deaf Interpreters.....	1715

281. -- 309. (Reserved).....	1716
310. Endorsement.....	1716
311. -- 319. (Reserved).....	1716
320. Written Statement Of Suitability For Licensure. ....	1716
321. -- 399. (Reserved).....	1717
400. Continuing Education.....	1717
401. -- 449. (Reserved).....	1717
450. Provisional Permits.....	1717
451. -- 499. (Reserved).....	1719
500. Hearing Evaluation.....	1720
551. -- 599. (Reserved).....	1720
600. Written Contracts.....	1720
601. -- 999. (Reserved).....	1721
<i>24.24.01 – Rules of the Genetic Counselors Licensing Board</i>	
000. Legal Authority.....	1724
001. Title And Scope.....	1724
002. Incorporation By Reference.....	1724
005. -- 099. (Reserved).....	1724
100. Organization Of The Board.....	1724
101. -- 249. (Reserved).....	1724
250. Fees.....	1724
251. -- 299. (Reserved).....	1724
300. Requirements For Original Licensure.....	1724
301. -- 309. (Reserved).....	1725
310. Requirements For Licensure By Endorsement.....	1725
311. Requirements For Provisional License.....	1725
312. Inactive Status.....	1725
313. -- 499. (Reserved).....	1726
500. Continuing Education.....	1726
501. -- 699. (Reserved).....	1726
700. Unprofessional And Unethical Conduct.....	1726
701. -- 899. (Reserved).....	1726
900. Discipline.....	1726
901. -- 999. (Reserved).....	1726
<i>24.25.01 – Rules of the Idaho Driving Businesses Licensure Board</i>	
000. Legal Authority.....	1729
001. Title And Scope.....	1729
002. Changes In Licensee Information (Rule 7).....	1729
003. -- 099. (Reserved).....	1729
100. Organization.....	1729
101. -- 149. (Reserved).....	1729
150. Application.....	1729
151. -- 174. (Reserved).....	1729
175. Fees.....	1729
176. -- 199. (Reserved).....	1730
200. Renewal Of License.....	1730
201. Continuing Education.....	1730
202 -- 224. (Reserved).....	1731
225. Driving Business License.....	1731
226. Driving Business -- Minimum Curriculum Components.....	1733
227. Driving Business - Course Of Instruction.....	1735
228. Driving Business - Initial Audit.....	1736



229. -- 249. (Reserved).....	1736
250. Driving Instructor License.....	1736
251. -- 274. (Reserved).....	1738
275. Instructor Apprenticeship Training Program.....	1738
276. -- 449. (Reserved).....	1739
450. Discipline.....	1739
451. -- 999. (Reserved).....	1739
<i>24.26.01 – Rules of the Idaho Board of Midwifery</i>	
000. Legal Authority.....	1743
001. Title And Scope.....	1743
002. Incorporation By Reference.....	1743
003. -- 019. (Reserved).....	1743
020. Organization.....	1743
021. -- 099. (Reserved).....	1743
100. Qualifications For Licensure.....	1743
101. -- 174. (Reserved).....	1743
175. Fees.....	1743
176. -- 199. (Reserved).....	1744
200. Renewal Of License.....	1744
201. -- 299. (Reserved).....	1745
300. Continuing Education Requirement.....	1745
301. -- 324. (Reserved).....	1746
325. Informed Consent.....	1746
326. -- 349. (Reserved).....	1746
350. Formulary.....	1746
351. Use Of Formulary Drugs.....	1747
352. Obtaining, Storing, And Disposing Of Formulary Drugs.....	1749
353. -- 354. (Reserved).....	1750
355. Medical Waste.....	1750
356. Scope And Practice Standards.....	1750
357. -- 359. (Reserved).....	1751
360. Newborn Transfer Of Care Or Consultation.....	1751
361. -- 449. (Reserved).....	1752
450. Unprofessional Conduct.....	1752
451. -- 999. (Reserved).....	1753
<i>24.27.01 – Rules of the Idaho State Board of Massage Therapy</i>	
000. Legal Authority.....	1756
001. Title And Scope.....	1756
002. -- 009. (Reserved).....	1756
010. Definitions.....	1756
011. -- 099. (Reserved).....	1756
100. Organization And Operations Of The Board.....	1756
101. -- 199. (Reserved).....	1756
200. Application.....	1756
201. -- 249. (Reserved).....	1756
250. Fees.....	1757
251. -- 299. (Reserved).....	1757
300. Requirements For Original Licensure.....	1757
301. -- 304. (Reserved).....	1757
305. Approved Examinations.....	1757
306. Written Statement Of Suitability For Licensure.....	1758
307. -- 309. (Reserved).....	1758

310. Requirements For Licensure By Endorsement .....	1758
311. -- 319. (Reserved).....	1759
320. Temporary License .....	1759
321. -- 329. (Reserved).....	1759
330. Provisional Permit .....	1759
331. -- 399. (Reserved).....	1759
400. Renewal Or Expiration Of License .....	1759
401. -- 499. (Reserved).....	1760
500. Continuing Education .....	1760
501. Approval Of Continuing Education Courses.....	1761
502. Continuing Education Activities .....	1761
503. Content Of Continuing Education .....	1762
504. -- 599. (Reserved).....	1762
600. Educational Program Standards .....	1762
601. Supervision .....	1763
602. -- 699. (Reserved).....	1763
700. Scope Of Practice .....	1763
701. -- 749. (Reserved).....	1763
750. Standards Of Practice .....	1763
751. -- 799. (Reserved).....	1763
800. Code Of Ethics .....	1763
801. -- 899. (Reserved).....	1763
900. Discipline .....	1763
901. -- 999. (Reserved).....	1764
 <i>24.28.01 – Rules of the Barber and Cosmetology Services Licensing Board</i>	
000. Legal Authority .....	1769
001. Title And Scope.....	1769
002. -- 009. (Reserved).....	1769
010. Definitions .....	1769
011. Update Of Records .....	1770
012. -- 099. (Reserved).....	1770
100. Organization And Operations Of The Board .....	1770
101. -- 199. (Reserved).....	1770
200. Application.....	1770
201. -- 249. (Reserved).....	1771
250. Fees .....	1771
251. -- 299. (Reserved).....	1771
300. Qualifications For All Licenses Or Certificates For Individuals.....	1771
301. Qualifications For Original Barber License.....	1772
302. Qualifications For Original Barber-Stylist License.....	1772
303. Qualifications For Original Cosmetologist License.....	1773
304. Qualifications For Original Electrologist License.....	1774
305. Qualifications For Original Esthetician License.....	1774
306. Qualifications For Original Haircutter License.....	1774
307. Qualifications For Original Nail Technician License.....	1775
308. Qualifications For Makeup Artist Certificate .....	1775
309. Qualifications For Original Barber Or Barber-Stylist Instructor License.....	1776
310. Qualifications For Original Cosmetology Instructor License.....	1777
311. Approved Examination .....	1778
312. Written Statement Of Suitability For Licensure Or Certification.....	1778
313. Requirements For Licensure By Endorsement .....	1778
314. -- 324. (Reserved).....	1779

325. Licensure And Operation Of Primary And Contiguous Establishments. ....	1779
326. Establishment Changes In Ownership or Location. ....	1780
327. Retail Cosmetics Dealer License. ....	1780
328. Retail Thermal Styling Equipment Dealer Registration. ....	1781
329. -- 399. (Reserved).....	1781
400. Renewal Or Expiration Of License. ....	1782
401. -- 499. (Reserved).....	1782
500. Barber And Cosmetology School Requirements.....	1782
501. Rules For Cosmetology Schools Approved To Teach Electrology.....	1783
502. Educational Program Standards For Courses Of Instruction. ....	1784
503. -- 549. (Reserved).....	1787
550. Apprentice Registration And Apprenticeships.....	1787
551. -- 699. (Reserved).....	1789
700. Scope Of Practice. ....	1789
701. -- 709. (Reserved).....	1789
710. Practice Outside Of A Licensed Establishment.....	1789
711. -- 799. (Reserved).....	1790
800. Unprofessional Conduct.....	1790
801. -- 849. (Reserved).....	1790
850. Inspection Of Establishments, Schools And Facilities. ....	1790
851. Safety And Disinfection For Establishments And Schools. ....	1791
852. Safety And Disinfection For Retail Cosmetics Dealer Facilities And Makeover Or Glamour Photography Businesses. ....	1792
853. Safety And Disinfection For Retail Thermal Styling Dealer Facilities. ....	1793
854. -- 999. (Reserved).....	1793
 <i>24.29.01 – Rules of Procedure of the Idaho Certified Shorthand Reporters Board</i>	
000. Legal Authority. ....	1796
001. Title And Scope.....	1796
002. -- 100. (Reserved).....	1796
101. Committees. ....	1796
102. -- 124. (Reserved).....	1796
125. Fees. ....	1796
126. -- 200. (Reserved).....	1796
201. Written Statement Of Suitability For Licensure Or Permit. ....	1796
202. -- 299. (Reserved).....	1797
300. Examinations.....	1797
301. -- 399. (Reserved).....	1798
400. Temporary Permit. ....	1798
401. -- 499. (Reserved).....	1799
500. Disciplinary Penalty.....	1799
501. -- 999. (Reserved).....	1799

**IDAPA 25 – IDAHO OUTFITTERS AND GUIDES LICENSING BOARD**

***Docket No. 25-0101-2000F (Fee Rule)***

<i>25.01.01 – Rules of the Outfitters and Guides Licensing Board</i>	
000. Legal Authority. ....	1801
001. Title And Scope.....	1801
002. Definitions. ....	1801
003. -- 004. (Reserved).....	1804
005. License Production.....	1804
006. First Aid Kit.....	1804
007. License Restrictions. ....	1805

008.	Employment Of Outfitters.....	1805
009.	(Reserved) .....	1805
010.	Compliance With Laws.....	1805
011.	(Reserved) .....	1806
012.	Outfitter Responsibilities.....	1806
013. --	014. (Reserved).....	1806
015.	Annual Date, Fees, And Payment.....	1806
016. --	017. (Reserved).....	1807
018.	New Outfitter Or Outfitter License Amendment Application.....	1807
019.	(Reserved) .....	1808
020.	Examination.....	1808
021.	Evaluation Of The Outfitter Application.....	1808
022.	Issuance Of An Outfitter License.....	1808
023.	Third Party Agreements.....	1808
024.	Standards For Non-Use.....	1809
025.	Outfitter Renewal.....	1810
026.	Operating Area Adjustments.....	1810
027.	Outfitter License Priority.....	1811
028.	Outfitter Business Purchase, License Considerations.....	1811
029.	Outfitter Bond Or Insurance Cancellation.....	1811
030.	Outfitter Waiting Lists.....	1811
031. --	033. (Reserved).....	1812
034.	Guide Application Requirements - General.....	1812
035.	Guide Application Requirements - Hunting.....	1812
036.	(Reserved) .....	1813
037.	Boatman License Trainees.....	1813
038.	Float Boat Guide -- Unclassified Rivers.....	1813
039.	Float Boat Guide -- Classified Rivers.....	1813
040.	Float Boatman Qualifications -- Classified Rivers.....	1813
041.	Float Lead Boatman Qualifications.....	1814
042.	Power Boat Guide.....	1814
043.	(Reserved) .....	1814
044.	Skiing, Non-Hazardous And Hazardous Terrain Outfitter, Designated Agent, Ski Guide And Ski Guide Trainee.....	1814
045.	(Reserved) .....	1815
046.	Technical Mountaineering/rock Climbing Guide.....	1816
047.	Snowmobiling Guide.....	1816
048.	Power Boat Fishing Guide -- (Lakes And Reservoirs).....	1816
049. --	050. (Reserved).....	1816
051.	Placement Of Hunting Camps And Leaving Outfitter's Operating Area, Big Game Hunting And Incidental Trapping.....	1816
052.	Boat Transport Of Hunting Clients.....	1817
053.	Controlled Hunts Outside Outfitter's Operating Area.....	1817
054.	Boat Equipment Requirements.....	1817
055.	Boating Client/Guide Ratio.....	1818
056.	(Reserved) .....	1818
057.	Designation Of Allocated Deer And Elk Tags.....	1818
058.	Number Of Outfitters And Guides Limited.....	1819
059.	River, Lake And Reservoir Power And Float Outfitter Limits.....	1819
060.	(Reserved) .....	1830
061.	Technical Mountaineering/Rock Climbing.....	1830
062.	(Reserved) .....	1830

063. Snowmobiling.....	1830
064. Authorization For Granting, Denial And Revocation Of Licenses.....	1830
065. -- 066. (Reserved).....	1831
067. Inspections.....	1831
068. Administrative Fines/Probation/Restrictions.....	1831
069. -- 999. (Reserved).....	1832

**IDAPA 26 – DEPARTMENT OF PARKS AND RECREATION**

***Docket No. 26-0000-2000F (Fee Rule)***

***26.01.10 – Rules Governing the Administration of Temporary Permits on Lands Owned by the Idaho Department of Parks and Recreation***

000. Legal Authority.....	1836
001. Title And Scope.....	1836
002. -- 009. (Reserved).....	1836
010. Definitions.....	1836
011. -- 049. (Reserved).....	1836
050. Policy.....	1836
051. -- 099. (Reserved).....	1837
100. Processing Fees.....	1837
101. -- 149. (Reserved).....	1837
150. Compensation.....	1837
151. -- 199. (Reserved).....	1837
200. Standard Conditions.....	1837
201. -- 249. (Reserved).....	1838
250. Special Conditions.....	1838
251. -- 299. (Reserved).....	1838
300. Application Procedure.....	1838
301. -- 349. (Reserved).....	1839
350. Modification Of Existing Temporary Permit.....	1839
351. -- 399. (Reserved).....	1839
400. Assignment.....	1839
401. -- 449. (Reserved).....	1839
450. Renewal.....	1839
451. -- 499. (Reserved).....	1839
500. Abandonment.....	1839
501. -- 549. (Reserved).....	1839
550. Relinquishment.....	1839
551. -- 599. (Reserved).....	1840
600. Expiration.....	1840
601. -- 649. (Reserved).....	1840
650. Cancellation.....	1840
651. -- 699. (Reserved).....	1840
700. Enforcement.....	1840
701. -- 749. (Reserved).....	1840
750. Administration.....	1840
751. -- 799. (Reserved).....	1840
800. Processing.....	1840
801. -- 999. (Reserved).....	1840

***26.01.20 – Rules Governing the Administration of Park and Recreation Areas and Facilities***

000. Legal Authority.....	1841
001. Title And Scope.....	1841
002. -- 009. (Reserved).....	1841

010. Definitions.....	1841
011. Purchase, Expiration, Display and Placement of MVEF and Passport Stickers.....	1843
012. -- 074. (Reserved).....	1844
075. Authority Conferrable On Employees - Enforcement.....	1844
076. -- 099. (Reserved).....	1844
100. Penalties For Violations.....	1844
101. -- 124. (Reserved).....	1844
125. Preservation Of Public Property.....	1844
126. -- 149. (Reserved).....	1844
150. Use Of Motor Vehicles.....	1844
151. Parking Violations.....	1845
152. -- 174. (Reserved).....	1846
175. Public Behavior.....	1846
176. -- 199. (Reserved).....	1847
200. Camping.....	1847
201. Boating Facilities.....	1848
202. Overnight Use.....	1849
203. Waterfront Areas.....	1849
204. Winter Recreation Programs.....	1849
205. -- 224. (Reserved).....	1850
225. Fees And Services.....	1850
226. -- 244. (Reserved).....	1851
245. Fee Schedule: Fee Collection Surcharge.....	1851
246. (Reserved).....	1851
247. Fee Schedule: Entrance.....	1851
248. -- 249. (Reserved).....	1852
250. Fee Schedule: Individual Campsite or facility.....	1852
251. -- 253. (Reserved).....	1852
254. Fee Schedule: Group Campsite or Facility.....	1852
255. (Reserved).....	1853
256. Fee Schedule: Boating Facilities.....	1853
257. -- 258. (Reserved).....	1853
259. Fee Schedule: Winter Recreation Programs.....	1853
260. -- 274. (Reserved).....	1853
275. Criteria For Reservations.....	1853
277. -- 399. (Reserved).....	1855
400. Park Capacities.....	1855
401. -- 499. (Reserved).....	1855
500. Livestock.....	1855
501. -- 576. (Reserved).....	1855
577. Spreading of Human Ashes.....	1855
578. -- 624. (Reserved).....	1855
625. Advertisements/Promotions/Demonstrations.....	1855
626. -- 649. (Reserved).....	1856
650. Authorized Operations.....	1856
651. -- 674. (Reserved).....	1856
675. Department Responsibility.....	1856
676. Nondiscrimination.....	1856
677. -- 999. (Reserved).....	1856
<i>26.01.33 – Rules Governing the Administration of the Land and Water Conservation Fund Program</i>	
000. Legal Authority.....	1857

001. Title And Scope.....	1857
002. -- 009. (Reserved).....	1857
010. Definitions.....	1857
011. -- 049. (Reserved).....	1858
050. General Provisions.....	1858
051. -- 064. (Reserved).....	1858
065. Compliance With Laws.....	1858
066. -- 079. (Reserved).....	1858
080. Fund Allocation.....	1858
081. -- 094. (Reserved).....	1859
095. Contingency Fund.....	1859
096. -- 109. (Reserved).....	1859
110. Sponsor's Matching Share.....	1859
111. -- 124. (Reserved).....	1859
125. Project Time Limitations.....	1859
126. -- 139. (Reserved).....	1859
140. Eligible Projects.....	1859
141. -- 154. (Reserved).....	1860
155. Eligible Project Costs.....	1860
156. -- 169. (Reserved).....	1860
170. Acquisition Of Publicly Owned Lands.....	1860
171. -- 184. (Reserved).....	1860
185. Acquisition Of Structures.....	1860
186. -- 199. (Reserved).....	1860
200. Waiver Of Retroactively.....	1860
201. -- 214. (Reserved).....	1860
215. Encumbrances.....	1860
216. -- 229. (Reserved).....	1860
230. Acquisition Costs Exceeding Fair Market Value.....	1860
231. -- 259. (Reserved).....	1860
260. Acquisitions Involving Compatible Multiple Uses.....	1860
261. -- 274. (Reserved).....	1861
275. Acquisitions Involving Nonrecreation Use.....	1861
276. -- 289. (Reserved).....	1861
290. Public Park And School Development Projects.....	1861
291. -- 304. (Reserved).....	1861
305. Donated Real Property As Matching Share.....	1861
306. -- 319. (Reserved).....	1861
320. Donated Goods And Services As Matching Share.....	1861
321. -- 334. (Reserved).....	1862
335. Force Account As Matching Share.....	1862
336. -- 349. (Reserved).....	1862
350. Appraisal Requirements.....	1862
351. -- 364. (Reserved).....	1862
365. Appraisal Reviews.....	1862
366. -- 379. (Reserved).....	1862
380. Revenue Feasibility Studies.....	1862
381. -- 394. (Reserved).....	1862
395. Technical Review.....	1862
396. -- 409. (Reserved).....	1862
410. Funding Cycle.....	1862
411. -- 424. (Reserved).....	1863

425. Application Procedure.....	1863
426. -- 439. (Reserved).....	1863
440. Open Project Selection Process (OPSP).....	1863
441. -- 454. (Reserved).....	1863
455. Evaluation Committee.....	1863
456. -- 469. (Reserved).....	1864
470. Board Review And Approval.....	1864
471. -- 484. (Reserved).....	1864
485. NPS Project Approval.....	1864
486. -- 499. (Reserved).....	1864
500. Proceeding On The Project.....	1864
501. -- 514. (Reserved).....	1864
515. Disbursement Of Funds.....	1864
516. -- 529. (Reserved).....	1865
530. Project Contract.....	1865
531. -- 544. (Reserved).....	1865
545. Control And Tenure.....	1865
546. -- 559. (Reserved).....	1866
560. Applicability.....	1866
561. -- 574. (Reserved).....	1866
575. Sponsor Commitment.....	1866
576. -- 589. (Reserved).....	1866
590. Restriction On Title.....	1866
591. -- 604. (Reserved).....	1866
605. Records.....	1866
606. -- 619. (Reserved).....	1866
620. Project Amendments, Cost Increases And Time Extensions.....	1866
621. -- 634. (Reserved).....	1867
635. Development Project Contract Requirements.....	1867
636. -- 649. (Reserved).....	1867
650. Conversion To Other Uses.....	1867
651. -- 664. (Reserved).....	1868
665. User Fees, Charges And Income.....	1868
666. -- 679. (Reserved).....	1868
680. Permanent Project Signs.....	1868
681. -- 694. (Reserved).....	1869
695. Architectural Barriers.....	1869
696. -- 709. (Reserved).....	1869
710. Uniform Relocation Complaint Procedure.....	1869
711. -- 724. (Reserved).....	1869
725. Availability To Users.....	1869
726. -- 739. (Reserved).....	1869
740. Civil Rights Complaint Procedure.....	1869
741. -- 999. (Reserved).....	1869

**IDAPA 27 – IDAHO BOARD OF PHARMACY**

***Docket No. 27-0101-2000F (Fee Rule)***

***27.01.01 – Rules of the Idaho State Board of Pharmacy***

000. Legal Authority.....	1872
001. Title And Scope.....	1872
002. – 009. (Reserved).....	1872
010. Definitions And Abbreviations (A – N).....	1872



011. Definitions And Abbreviations (O – Z).....	1873
012. – 099. (Reserved) .....	1874
100. Practice Of Pharmacy: General Approach .....	1874
101. Prescriber Performance Of Pharmacy Functions.....	1875
102. Waivers Or Variances .....	1875
103. Board Inspections And Investigations.....	1875
104. Unprofessional Conduct.....	1876
105. – 199. (Reserved) .....	1877
200. Board Of Pharmacy Licensure And Registration. ....	1877
201. Licensure And Registration: General Requirements.....	1877
202. Board Fees.....	1878
203. Fee Schedule.....	1878
204. – 209. (Reserved) .....	1879
210. Determination Of Need For Nonresident Licensure Or Registration.....	1879
211. Pharmacist Licensure By Examination.....	1879
212. Pharmacist Licensure By Reciprocity.....	1880
213. Pharmacist License Renewal: CPE Requirements.....	1880
214. Pharmacist License: Reinstatement.....	1880
215. Nonresident PIC Registration To Practice Pharmacy Into Idaho.....	1880
216. Pharmacist Intern Registration.....	1881
217. – 219. (Reserved) .....	1881
220. Technician Registration.....	1881
221. – 223. (Reserved) .....	1881
224. Practitioner Controlled Substance Registration.....	1881
225. – 229. (Reserved) .....	1882
230. Drug Outlet Licensure And Registration: General Requirements.....	1882
231. -- 239. (Reserved).....	1882
240. Wholesaler Licensure And Registration.....	1882
241. – 249. (Reserved) .....	1883
250. Manufacturer Registration.....	1883
251. – 299. (Reserved) .....	1883
300. Drug Outlets: Minimum Facility Standards.....	1883
301. Drug Outlets That Dispense Prescription Drugs: Minimum Prescription Filling Requirements.....	1884
302. Drug Outlets That Dispense Drugs To Patients Without An Onsite Pharmacist Or Prescriber.....	1884
303. Drugs Stored Outside Of A Drug Outlet For Retrieval By A Licensed Health Professional.....	1885
304. – 349. (Reserved) .....	1885
350. Pharmacist Prescribing: General Requirements.....	1885
351. Collaborative Pharmacy Practice.....	1886
352. -- 399. (Reserved).....	1886
400. Prescription Drug Order: Validity.....	1886
401. Prescription Drug Order: Minimum Requirements.....	1886
402. Filling Prescription Drug Orders: Practice Limitations.....	1887
403. Filling Prescription Drug Orders: Adaptation.....	1887
404. Filling Prescription Drug Orders: Drug Product Substitution.....	1887
405. Filling Prescription Drug Orders: Transfers.....	1888
406. Labeling Standards.....	1888
407. Prescription Delivery: Restrictions.....	1888
408. Destruction Or Return Of Drugs Or Devices: Restrictions.....	1889
409. -- 499. (Reserved).....	1889
500. Recordkeeping: Maintenance And Inventory Requirements.....	1889

501. Reporting Requirements .....	1890
502. -- 599. (Reserved) .....	1890
600. Controlled Substances: PDMP .....	1890
601. -- 699. (Reserved) .....	1890
700. Compounding Drug Preparations .....	1890
701. Sterile Preparation .....	1892
702. Hazardous Drugs Preparation .....	1894
703. Outsourcing Facility .....	1895
704. Medication Limitations .....	1895
705. -- 999. (Reserved) .....	1896

**IDAPA 32 – ENDOWMENT FUND INVESTMENT BOARD*****Docket No. 32-0101-2000F (Fee Rule)******32.01.01 – Rules Governing the Credit Enhancement Program for School Districts***

000. Legal Authority .....	1898
001. Title And Scope .....	1898
002. -- 009. (Reserved) .....	1898
010. Definitions And References .....	1898
011. -- 019. (Reserved) .....	1898
020. Application .....	1898
021. -- 029. (Reserved) .....	1899
030. Fees .....	1899
031. -- 039. (Reserved) .....	1899
040. Approval And Denial Of Applications .....	1899
041. -- 999. (Reserved) .....	1900

**IDAPA 33 – REAL ESTATE COMMISSION*****Docket No. 33-0101-2000F (Fee Rule)******33.01.01 – Rules of the Idaho Real Estate Commission***

000. Legal Authority .....	1903
001. Title And Scope .....	1903
002. -- 005. (Reserved) .....	1903
006. Electronic Signatures .....	1903
007. -- 099. (Reserved) .....	1903
100. Fees .....	1903
101. -- 104. (Reserved) .....	1903
105. Conditions To Renew Expired License .....	1903
106. -- 116. (Reserved) .....	1904
117. Mandatory Errors And Omissions Insurance .....	1904
118. Insurance Plan .....	1904
119. (Reserved) .....	1905
120. Certification A Prerequisite For License Issuance Or Renewal .....	1905
121. Failure To Maintain Insurance .....	1905
122. Falsification Of Certificates .....	1905
123. -- 299. (Reserved) .....	1905
300. Disputes Concerning Commissions And Fees .....	1905
301. (Reserved) .....	1905
302. Title Opinions .....	1905
303. Legal Opinions .....	1905
304. (Reserved) .....	1905
305. Education Records Access .....	1905
306. -- 399. (Reserved) .....	1905

400. -- 401. (Reserved).....	1905
402. Approved Topics For Continuing Education.....	1906
403. -- 499. (Reserved).....	1906
500. Minimum Teaching Standards. ....	1906
501. -- 999. (Reserved).....	1906

**IDAPA 34 – SECRETARY OF STATE**

***Docket No. 34-0000-2000F (Fee Rule)***

***34.05.01 – Rules Governing Farm Products Central Filing System***

000. Legal Authority.....	1909
001. Title And Scope.....	1909
002. -- 009. (Reserved).....	1909
010. Definitions. ....	1909
011. Abbreviations. ....	1909
012. -- 019. (Reserved).....	1909
020. Unique Identifier Number (UIN).....	1910
021. -- 099. (Reserved).....	1910
100. Farm Products Financing Statement Requirements. ....	1910
101. Amendment, Assignment, Continuation, And Termination Of A Farm Products Financing Statement. ....	1910
102. Farm Products Financing Statements Under The Uniform Commercial Code.....	1910
103. -- 199. (Reserved).....	1911
200. Collateral Information Codes.....	1912
201. Registration Of Buyers, Commission Merchants, And Selling Agents -- Subscription To A PML. ....	1916
202. -- 299. (Reserved).....	1917
300. Form And Distribution Of A PML And CS. ....	1917
301. Generation Of Ad Hoc Information Reports. ....	1918
302. Requests For Information.....	1918
303. Fees. ....	1918
304. -- 999. (Reserved).....	1919

***34.05.02 – Rules Governing Liens in Crops for Seed or Liens in Crops for Farm Labor***

000. Legal Authority.....	1920
001. Title And Scope.....	1920
002. -- 009. (Reserved).....	1920
010. Definitions. ....	1920
011. -- 099. (Reserved).....	1920
100. Requirements For Notice Of Claim Of Lien.....	1920
101. Amendment, Assignment, Extension, And Release Of Claim Of Lien. ....	1920
102. -- 199. (Reserved).....	1921
200. Registration And Subscription For List Of Liens In Crops For Seed Or Liens In Crops For Farm Labor. ....	1921
201. List Of Notices Of Claim Of Lien (LIST). ....	1921
202. -- 299. (Reserved).....	1921
300. Request For Information. ....	1921
301. Fees. ....	1921
302. -- 999. (Reserved).....	1922

***34.05.03 – Requests for Information – Form UCC-4 – Fees***

000. Legal Authority And References. ....	1923
001. -- 003. (Reserved).....	1923
004. Definitions. ....	1923
005. -- 010. (Reserved).....	1923

011. Requests For Information.....	1923
012. Verbal Requests For Information.....	1924
013. Fees.....	1924
014. -- 999. (Reserved).....	1924
<i>34.05.06 – Rules Governing Lien Filings Under the UCC</i>	
000. Legal Authority And References.....	1925
001. Title And Scope.....	1925
002. -- 100. (Reserved).....	1925
101. Definitions.....	1925
102. Singular And Plural Forms.....	1926
103. Place Of Filing.....	1926
104. Filing Office Identification.....	1926
105. Office Hours.....	1926
106. UCC Document Delivery.....	1926
107. Search Request Delivery.....	1927
108. Acceptable Forms.....	1927
109. -- 110. (Reserved).....	1927
111. Filing Fees.....	1927
112. (Reserved).....	1927
113. Methods Of Payment.....	1927
114. Overpayment And Underpayment Policies.....	1928
115. Public Records Services.....	1928
116. Fees For Public Records Services.....	1928
117. New Practices And Technologies.....	1929
118. -- 199. (Reserved).....	1929
200. Role Of Filing Officer.....	1929
201. Duty To File.....	1929
202. Grounds For Refusal Of UCC Document.....	1929
203. (Reserved).....	1930
204. Time Limit.....	1930
205. Procedure Upon Refusal.....	1930
206. Acknowledgment.....	1930
207. Other Notices.....	1931
208. Refusal Errors.....	1931
209. -- 299. (Reserved).....	1931
300. Policy Statement.....	1931
301. Primary Data Elements.....	1931
302. Names Of Debtors Who Are Individuals.....	1932
303. Names Of Debtors That Are Organizations.....	1932
304. Estates.....	1933
305. Trusts.....	1933
306. Initial Financing Statement.....	1933
307. Amendment.....	1933
308. Assignment Of Powers Of Secured Party Of Record.....	1934
309. Continuation.....	1934
310. Termination.....	1934
311. Correction Statement.....	1935
312. Procedure Upon Lapse.....	1935
313. -- 399. (Reserved).....	1935
400. Policy Statement.....	1935
401. Document Indexing And Other Procedures Before Archiving.....	1935
402. Filing Date.....	1935

403.	Filing Time.....	1935
404.	Lapse Date And Time.....	1936
405.	Errors Of The Filing Officer.....	1936
406.	Errors Other Than Filing Office Errors.....	1936
407.	Data Entry Of Names – Designated Fields.....	1936
408.	Data Entry Of Names -- No Designated Fields.....	1936
409.	Verification Of Data Entry.....	1937
410.	Initial Financing Statement.....	1937
411.	Amendment.....	1937
412.	Correction Statement.....	1938
413.	Global Filings.....	1938
414.	Notice Of Bankruptcy.....	1938
415.	-- 499. (Reserved).....	1938
500.	General Requirements.....	1938
501.	Search Requests.....	1938
502.	Optional Information.....	1939
503.	Rules Applied To Search Requests.....	1939
504.	Search Responses.....	1939
505.	-- 599. (Reserved).....	1940
600.	Policy Statement.....	1940
601.	Notice Of Federal Tax Lien.....	1940
602.	Notice Of State Tax Lien.....	1941
603.	Notice Of Other Lien In Favor Of A Governmental Body (Nature And Duration).....	1941
604.	Seed And Farm Labor Liens.....	1942
605.	Agriculture Commodity Liens.....	1942
606.	Farm Product Liens.....	1943
607.	-- 999. (Reserved).....	1943

**IDAPA 36 – IDAHO STATE BOARD OF TAX APPEALS**

***Docket No. 36-0101-2000F (Fee Rule)***

***36.01.01 – Idaho Board of Tax Appeals Rules***

000.	Legal Authority (Rule 0).....	1945
001.	Title And Scope (Rule 1).....	1945
002.	-- 009. (Reserved).....	1945
010.	Definitions (Rule 10).....	1945
011.	Abbreviations (Rule 11).....	1945
012.	Organization (Rule 12).....	1946
013.	-- 019. (Reserved).....	1946
020.	Procedure Governed (Rule 20).....	1946
021.	Liberal Construction (Rule 21).....	1946
022.	-- 029. (Reserved).....	1946
030.	Representation And Practice Before The Board (Rule 30).....	1946
031.	Initial Pleading -- Listing Of Representatives (Rule 31).....	1946
032.	Substitution Of Representative (Rule 32).....	1947
033.	Participation By Taxing Authority (Rule 33).....	1947
034.	(Reserved).....	1947
035.	Conduct (Rule 35).....	1947
036.	Enforcement (Rule 36).....	1947
037.	Ex Parte Communications (Rule 37).....	1947
038.	-- 044. (Reserved).....	1947
045.	Notice Of Appeal: Contents (Rule 45).....	1947
046.	Notice Of Appeal: BOE Appeals (Rule 46).....	1948

047. Notice Of Appeal: STC Appeals (Rule 47).....	1948
048. Acknowledgment (Rule 48).....	1948
049. (Reserved).....	1948
050. Answer To Appeal (Rule 50).....	1948
051. (Reserved).....	1948
052. County Auditor Requirement (Rule 52).....	1948
053. -- 054. (Reserved).....	1949
055. Consolidation (Rule 55).....	1949
056. -- 059. (Reserved).....	1949
060. Form Of Pleadings (Rule 60).....	1949
061. Service Of Documents (Rule 61).....	1949
062. Defective, Insufficient Or Late Pleading (Rule 62).....	1950
063. Amendments To Pleadings -- Withdrawal Of Pleadings (Rule 63).....	1950
064. (Reserved).....	1950
065. Computation Of Time (Rule 65).....	1950
066. Filing (Rule 66).....	1950
067. -- 069. (Reserved).....	1951
070. Prehearing Conference (Rule 70).....	1951
071. (Reserved).....	1951
072. Motions (Rule 72).....	1951
073. (Reserved).....	1952
074. Briefs (Rule 74).....	1952
075. Discovery (Rule 75).....	1952
076. -- 084. (Reserved).....	1953
085. Intervention (Rule 85).....	1953
086. -- 099. (Reserved).....	1954
100. Fair Hearing (Rule 100).....	1954
101. Failure To Appear (Rule 101).....	1954
102. Withdrawal (Rule 102).....	1955
103. -- 104. (Reserved).....	1955
105. Informal Disposition -- Settlement (Rule 105).....	1955
106. Presiding Officer (Rule 106).....	1955
107. Procedure And Testimony (Rule 107).....	1955
108. -- 109. (Reserved).....	1956
110. Stipulations (Rule 110).....	1956
111. Continuance (Rule 111).....	1956
112. -- 114. (Reserved).....	1956
115. Official Notice (Rule 115).....	1956
116. Open Hearings And Closed Deliberations (Rule 116).....	1956
117. Rules Of Evidence (Rule 117).....	1957
118. Exhibit (Rule 118).....	1957
119. -- 124. (Reserved).....	1958
125. Confidentiality -- Protective Orders (Rule 125).....	1958
126. -- 138. (Reserved).....	1958
139. Scope Of Appeal In Ad Valorem Case (Rule 139).....	1958
140. Decisions And Orders (Rule 140).....	1958
141. -- 144. (Reserved).....	1958
145. Reconsideration -- Rehearing (Rule 145).....	1958
146. -- 150. (Reserved).....	1958
151. Official Record (Rule 151).....	1959
152. -- 154. (Reserved).....	1959
155. Subpoena (Rule 155).....	1959

156. Request For Transcript (Rule 156).....	1960
157. -- 999. (Reserved).....	1960

**IDAPA 37 – IDAHO DEPARTMENT OF WATER RESOURCES –  
IDAHO WATER RESOURCE BOARD**

***Docket No. 37-0000-2000F (Fee Rule)***

***37.01.01 – Rules of Procedure of the Idaho Department of Water Resources***

000. Legal Authority (Rule 0).....	1964
001. Title And Scope (Rule 1).....	1964
002. -- 004. (Reserved).....	1964
005. Definitions (Rule 5).....	1964
006. (Reserved).....	1965
007. Office – Office Hours – Mailing Address And Street Address (Rule 7).....	1965
008. Filing Of Documents -- Number Of Copies (Rule 8).....	1966
009. -- 049. (Reserved).....	1966
050. Proceedings Governed (Rule 50).....	1966
051. Reference To Agency (Rule 51).....	1966
052. Liberal Construction (Rule 52).....	1966
053. Communications With Agency (Rule 53).....	1966
054. Identification Of Communications (Rule 54).....	1966
055. Service By Agency (Rule 55).....	1966
056. Computation Of Time (Rule 56).....	1966
057. Additional Time After Service By Mail (Rule 57).....	1967
058. Fees And Remittances (Rule 58).....	1967
059. -- 099. (Reserved).....	1967
100. Informal Proceedings Defined (Rule 100).....	1967
101. Informal Procedure (Rule 101).....	1967
102. Further Proceedings (Rule 102).....	1967
103. Informal Proceedings Do Not Exhaust Administrative Remedies (Rule 103).....	1967
104. Formal Proceedings (Rule 104).....	1967
105. -- 149. (Reserved).....	1968
150. Parties To Contested Cases Listed (Rule 150).....	1968
151. Applicants/Claimants/Appellants (Rule 151).....	1968
152. Petitioners (Rule 152).....	1968
153. Complainants (Rule 153).....	1968
154. Respondents (Rule 154).....	1968
155. Protestants (Rule 155).....	1968
156. Intervenors (Rule 156).....	1968
157. Rights Of Parties And Of Agency Staff (Rule 157).....	1968
158. Persons Not Parties -- Interested Persons (Rule 158).....	1968
159. -- 199. (Reserved).....	1968
200. Initial Pleading By Party -- Listing Of Representatives (Rule 200).....	1968
201. Taking Of Appearances -- Participation By Agency Staff (Rule 201).....	1969
202. Representation Of Parties At Hearing (Rule 202).....	1969
203. Service On Representatives Of Parties And Other Persons (Rule 203).....	1969
204. Withdrawal Of Parties (Rule 204).....	1969
205. Substitution Of Representative -- Withdrawal Of Representative (Rule 205).....	1969
206. Conduct Required (Rule 206).....	1969
207. -- 209. (Reserved).....	1970
210. Pleadings Listed -- Miscellaneous (Rule 210).....	1970
211. -- 219. (Reserved).....	1970
220. Applications/claims/appeals -- Defined -- Form And Contents (Rule 220).....	1970

221. -- 229. (Reserved).....	1970
230. Petitions -- Defined -- Form And Contents (Rule 230).....	1970
231. -- 239. (Reserved).....	1970
240. Complaints -- Defined -- Form And Contents (Rule 240).....	1971
241. -- 249. (Reserved).....	1971
250. Protests -- Defined -- Form And Contents (Rule 250).....	1971
251. -- 259. (Reserved).....	1971
260. Motions -- Defined -- Form And Contents -- Time For Filing (Rule 260).....	1971
261. -- 269. (Reserved).....	1972
270. Answers -- Defined -- Form And Contents -- Time For Filing (Rule 270).....	1972
271. -- 279. (Reserved).....	1972
280. Consent Agreements -- Defined -- Form And Contents (Rule 280).....	1972
281. -- 299. (Reserved).....	1972
300. Filing Documents With The Agency -- Number Of Copies -- Facsimile Transmission (Fax) -- Electronically Signed Documents (Rule 300).....	1972
301. Form Of Pleadings (Rule 301).....	1973
302. Service On Parties And Other Persons (Rule 302).....	1973
303. Proof Of Service (Rule 303).....	1973
304. Defective, Insufficient Or Late Pleadings (Rule 304).....	1973
305. Amendments To Pleadings -- Withdrawal Of Pleadings (Rule 305).....	1974
306. Electronically Signed Communications (Rule 306).....	1974
307. Criteria For Acceptable Electronic Signature Technology (Rule 307).....	1974
308. Public Key Cryptography (Rule 308).....	1974
309. Criteria For Accepting An Electronic Signature (Rule 309).....	1976
310. Retention Of Certificates (Rule 310).....	1976
311. Electronic Signature Repudiation (Rule 311).....	1976
312. -- 349. (Reserved).....	1976
350. Order Granting Intervention Necessary (Rule 350).....	1976
351. Form And Contents Of Petitions To Intervene (Rule 351).....	1977
352. Timely Filing Of Petitions To Intervene (Rule 352).....	1977
353. Granting Petitions To Intervene (Rule 353).....	1977
354. Orders Granting Intervention -- Opposition (Rule 354).....	1977
355. Public Witnesses (Rule 355).....	1977
356. -- 399. (Reserved).....	1977
400. Form And Contents Of Petition For Declaratory Rulings (Rule 400).....	1977
401. Notice Of Petition For Declaratory Ruling (Rule 401).....	1978
402. Petitions For Declaratory Rulings To Be Decided By Order (Rule 402).....	1978
403. -- 409. (Reserved).....	1978
410. Appointment Of Hearing Officers (Rule 410).....	1978
411. Hearing Officers Contrasted With Agency Head (Rule 411).....	1978
412. Disqualification Of Officers Hearing Contested Cases (Rule 412).....	1978
413. Scope Of Authority Of Hearing Officers (Rule 413).....	1978
414. Presiding Officer(s) (Rule 414).....	1979
415. Challenges To Statutes (Rule 415).....	1979
416. Review Of Rules (Rule 416).....	1979
417. Ex Parte Communications (Rule 417).....	1979
418. -- 499. (Reserved).....	1980
500. Alternative Resolution Of Contested Cases (Rule 500).....	1980
501. Neutrals (Rule 501).....	1980
502. Confidentiality (Rule 502).....	1980
503. -- 509. (Reserved).....	1980
510. Purposes Of Prehearing Conferences (Rule 510).....	1980



511. Notice Of Prehearing Conference (Rule 511) .....	1980
512. Record Of Conference (Rule 512) .....	1980
513. Orders Resulting From Prehearing Conference (Rule 513).....	1980
514. Facts Disclosed Not Part Of The Record (Rule 514).....	1981
515. -- 519. (Reserved).....	1981
520. Kinds And Scope Of Discovery Listed (Rule 520).....	1981
521. When Discovery Authorized (Rule 521).....	1981
522. Rights To Discovery Reciprocal (Rule 522).....	1981
523. Depositions (Rule 523).....	1981
524. Production Requests Or Written Interrogatories And Requests For Admission (Rule 524).....	1981
525. Subpoenas (Rule 525).....	1981
526. Statutory Inspection, Examination, Investigation, Etc. -- Contrasted With Other Discovery (Rule 526).....	1982
527. Answers To Production Requests Or Written Interrogatories And To Requests For Admission (Rule 527).....	1982
528. Filing And Service Of Discovery-related Documents (Rule 528).....	1982
529. Exhibit Numbers (Rule 529).....	1982
530. Prepared Testimony And Exhibits (Rule 530).....	1982
531. Sanctions For Failure To Obey Order Compelling Discovery (Rule 531).....	1982
532. Protective Orders (Rule 532).....	1982
533. -- 549. (Reserved).....	1982
550. Notice Of Hearing (Rule 550).....	1982
551. Facilities At Or For Hearing And A.d.a. Requirements (Rule 551).....	1982
552. How Hearings Held (Rule 552).....	1983
553. Conduct At Hearings (Rule 553).....	1983
554. Conference At Hearing (Rule 554).....	1983
555. Preliminary Procedure At Hearing (Rule 555).....	1983
556. Consolidation Of Proceedings (Rule 556).....	1983
557. Stipulations (Rule 557).....	1983
558. Order Of Procedure (Rule 558).....	1983
559. Testimony Under Oath (Rule 559).....	1983
560. Parties And Persons With Similar Interests (Rule 560).....	1983
561. Continuance Of Hearing (Rule 561).....	1983
562. Rulings At Hearings (Rule 562).....	1984
563. Oral Argument (Rule 563).....	1984
564. Briefs -- Memoranda -- Proposed Orders Of The Parties -- Statements Of Position -- Proposed Order Of The Presiding Officer (Rule 564).....	1984
565. Procedure On Prehearing Motions (Rule 565).....	1984
566. Joint Hearings (Rule 566).....	1984
567. -- 599. (Reserved).....	1984
600. Rules Of Evidence -- Evaluation Of Evidence (Rule 600).....	1984
601. Documentary Evidence (Rule 601).....	1984
602. Official Notice -- Agency Staff Memoranda (Rule 602).....	1984
603. Depositions (Rule 603).....	1984
604. Objections -- Offers Of Proof (Rule 604).....	1984
605. Prepared Testimony (Rule 605).....	1985
606. Exhibits (Rule 606).....	1985
607. -- 609. (Reserved).....	1985
610. Confidentiality Of Settlement Negotiations (Rule 610).....	1985
611. Suggestion For Or Inquiry About Settlements (Rule 611).....	1985
612. Consideration Of Settlements (Rule 612).....	1985
613. Burdens Of Proof (Rule 613).....	1985

614.	Settlement Not Binding (Rule 614).....	1985
615. -- 649.	(Reserved).....	1985
650.	Record For Decision (Rule 650).....	1986
651.	Recording Of Hearings (Rule 651).....	1986
652. -- 699.	(Reserved).....	1986
700.	Notice Of Proposed Default After Failure To Appear Or Respond (Rule 700).....	1986
701.	Seven Days To Challenge Proposed Default Order (Rule 701).....	1986
702.	Issuance Of Default Order (Rule 702).....	1986
703. -- 709.	(Reserved).....	1987
710.	Interlocutory Orders (Rule 710).....	1987
711.	Review Of Interlocutory Orders (Rule 711).....	1987
712.	Contents Of Orders (Rule 712).....	1987
713. -- 719.	(Reserved).....	1987
720.	Recommended Orders (Rule 720).....	1987
721. -- 729.	(Reserved).....	1988
730.	Preliminary Orders (Rule 730).....	1988
731. -- 739.	(Reserved).....	1989
740.	Final Orders (Rule 740).....	1989
741. -- 749.	(Reserved).....	1990
750.	Order Not Designated (Rule 750).....	1990
751. -- 759.	(Reserved).....	1990
760.	Modification Of Order On Presiding Officer's Own Motion (Rule 760).....	1990
761. -- 769.	(Reserved).....	1990
770.	Clarification Of Orders (Rule 770).....	1990
771. -- 779.	(Reserved).....	1990
780.	Stay Of Orders (Rule 780).....	1990
781. -- 789.	(Reserved).....	1991
790.	Persons Who May Appeal (Rule 790).....	1991
791.	Notice Of Appeal (Rule 791).....	1991
792. -- 999.	(Reserved).....	1991
<i>37.02.03 – Water Supply Bank Rules</i>		
000.	Legal Authority (Rule 0).....	1992
001.	Title And Scope (Rule 1).....	1992
002. -- 009.	(Reserved).....	1992
010.	Definitions (Rule 10).....	1992
011. -- 024.	(Reserved).....	1993
025.	Acquisition Of Water Rights For The Board's Water Supply Bank (Rule 25).....	1993
026. -- 029.	(Reserved).....	1995
030.	Sale Or Rental Of Water Rights From The Board's Water Supply Bank (Rule 30).....	1995
031. -- 034.	(Reserved).....	1996
035.	Handling Of Money Associated With The Board's Water Supply Bank (Rule 35).....	1996
036. -- 039.	(Reserved).....	1996
040.	Appointment Of Local Rental Pool Committees (Rule 40).....	1996
041. -- 999.	(Reserved).....	1997
<i>37.03.01 – Adjudication Rules</i>		
000.	Legal Authority.....	1998
001.	Title And Scope.....	1998
002. -- 009.	(Reserved).....	1998
010.	Definitions.....	1998
011.	Abbreviations.....	1999
012. -- 024.	(Reserved).....	1999
025.	General.....	1999

026. -- 029. (Reserved).....	1999
030. Flat Fees.....	2000
031. -- 034. (Reserved).....	2000
035. Variable Fees.....	2000
036. -- 044. (Reserved).....	2001
045. Amendment Fees.....	2001
046. -- 049. (Reserved).....	2001
050. Late Fees.....	2001
051. -- 054. (Reserved).....	2001
055. Refunds.....	2001
056. -- 059. (Reserved).....	2001
060. Sufficiency Of Claims.....	2001
061. -- 064. (Reserved).....	2005
065. Rejected And Returned Claims.....	2005
066. -- 999. (Reserved).....	2005
<i>37.03.02 – Beneficial Use Examination Rules</i>	
000. Legal Authority (Rule 0).....	2006
001. Title And Scope (Rule 1).....	2006
002. -- 008. (Reserved).....	2006
009. Applicability (Rule 9).....	2006
010. Definitions (Rule 10).....	2006
011. Abbreviations.....	2008
012. -- 024. (Reserved).....	2008
025. Authority Of Representative (Rule 25).....	2008
026. -- 029. (Reserved).....	2008
030. Qualification, Examination And Appointment Of Certified Water Right Examiner (Rule 30).....	2008
031. -- 034. (Reserved).....	2009
035. Examination For Beneficial Use (Rule 35).....	2009
036. -- 039. (Reserved).....	2012
040. Water Measurement (Rule 40).....	2012
041. -- 044. (Reserved).....	2013
045. Drawings, Map, And Schematic Diagram (Rule 45).....	2013
046. -- 049. (Reserved).....	2013
050. License Examination Fee (Rule 50).....	2013
051. -- 054. (Reserved).....	2014
055. Penalty (Rule 55).....	2014
056. -- 999. (Reserved).....	2014
<i>37.03.03 – Rules and Minimum Standards for the Construction and Use of Injection Wells</i>	
000. Legal Authority.....	2016
001. Title And Scope.....	2016
002. Incorporation By Reference.....	2016
003. -- 009. (Reserved).....	2016
010. Definitions.....	2016
011. -- 014. (Reserved).....	2022
015. Violations, Formal Notification And Enforcement.....	2022
016. -- 019. (Reserved).....	2022
020. Hearing Before The Water Resource Board.....	2023
021. -- 034. (Reserved).....	2023
035. Classification Of Injection Wells.....	2023
036. -- 039. (Reserved).....	2025
040. Authorizations, Prohibitions and Exemptions.....	2025

041. -- 069. (Reserved).....	2027
070. Class V: Criteria And Standards. ....	2027
071. -- 999. (Reserved).....	2037
<i>37.03.04 – Drilling for Geothermal Resources Rules</i>	
000. Legal Authority (Rule 0). ....	2038
001. Title And Scope (Rule 1). ....	2038
002. -- 009. (Reserved).....	2038
010. Definitions (Rule 10).....	2038
011. -- 024. (Reserved).....	2040
025. Drilling (Rule 25). ....	2040
026. -- 029. (Reserved).....	2042
030. Records (Rule 30). ....	2042
031. -- 034. (Reserved).....	2043
035. Blow Out Prevention (Rule 35).....	2043
036. -- 039. (Reserved).....	2044
040. Injection Wells (Rule 40). ....	2044
041. -- 044. (Reserved).....	2045
045. Abandonment (Rule 45). ....	2045
046. -- 049. (Reserved).....	2046
050. Maintenance (Rule 50).....	2046
051. -- 054. (Reserved).....	2046
055. Hearings, Notice, Procedure (Rule 55). ....	2046
056. -- 059. (Reserved).....	2047
060. Hearings On Refused, Limited, Or Conditioned Permit (Rule 60).....	2047
061. -- 064. (Reserved).....	2047
065. Penalties (Rule 65).....	2047
066. -- 069. (Reserved).....	2047
070. Forms (Rule 70). ....	2047
071. -- 999. (Reserved).....	2048
<i>37.03.05 – Mine Tailings Impoundment Structures Rules</i>	
000. Legal Authority (Rule 0). ....	2049
001. Title And Scope (Rule 1). ....	2049
002. -- 009. (Reserved).....	2049
010. Definitions (Rule 10).....	2049
011. -- 024. (Reserved).....	2050
025. Authority Of Representative (Rule 25). ....	2050
026. -- 029. (Reserved).....	2050
030. Forms (Rule 30). ....	2050
031. -- 034. (Reserved).....	2050
035. Plans, Drawings, And Specifications (Rule 35).....	2050
036. -- 039. (Reserved).....	2053
040. Bonding (Rule 40). ....	2053
041. -- 044. (Reserved).....	2054
045. Mine Tailings Impoundment Structures Design Criteria (Rule 45). ....	2054
046. -- 049. (Reserved).....	2058
050. Dams Storing Tailing And Water (Rule 50). ....	2058
051. -- 054. (Reserved).....	2058
055. Provisions Of Chapter 17, Title 42, Idaho Code (Rule 55). ....	2058
056. -- 999. (Reserved).....	2058
<i>37.03.06 – Safety of Dams Rules</i>	
000. Legal Authority (Rule 0). ....	2059

001. Title And Scope (Rule 1).....	2059
002. -- 009. (Reserved).....	2059
010. Definitions (Rule 10).....	2059
011. -- 024. (Reserved).....	2061
025. Dam Size Classification And Risk Category (Rule 25).....	2061
026. -- 029. (Reserved).....	2062
030. Authority Of Representative (Rule 30).....	2062
031. -- 034. (Reserved).....	2062
035. Forms (Rule 35).....	2062
036. -- 039. (Reserved).....	2062
040. Construction Plans, Drawings And Specifications (Rule 40).....	2062
041. -- 044. (Reserved).....	2065
045. Operation Plan (Rule 45).....	2065
046. -- 049. (Reserved).....	2065
050. New Intermediate Or Large Dams (Rule 50).....	2065
051. -- 054. (Reserved).....	2070
055. Existing Intermediate Or Large Dams (Rule 55).....	2070
056. -- 061. (Reserved).....	2072
060. Small Dam Design Criteria (Rule 60).....	2072
061. -- 064. (Reserved).....	2073
065. Dams Storing Tailings And Water (Rule 65).....	2073
066. -- 999. (Reserved).....	2073
 <i>37.03.07 – Stream Channel Alteration Rules</i>	
000. Legal Authority (Rule 0).....	2074
001. Title And Scope (Rule 1).....	2074
002. -- 009. (Reserved).....	2074
010. Definitions (Rule 10).....	2074
011. -- 024. (Reserved).....	2075
025. Exemptions (Rule 25).....	2075
026. -- 029. (Reserved).....	2075
030. Applications (Rule 30).....	2075
031. -- 034. (Reserved).....	2076
035. Application Review (Rule 35).....	2076
036. -- 039. (Reserved).....	2076
040. Approval (Rule 40).....	2076
041. -- 044. (Reserved).....	2077
045. Enforcement Of Act (Rule 45).....	2077
046. -- 049. (Reserved).....	2077
050. Emergency Waiver (Rule 50).....	2077
051. -- 054. (Reserved).....	2077
055. Minimum Standards (Rule 55).....	2077
056. Construction Procedures (Rule 56).....	2078
057. Dumped Rock Riprap (Rule 57).....	2078
058. Drop Structures, Sills And Barbs (Rule 58).....	2081
059. Culverts And Bridges (Rule 59).....	2082
060. Removal Of Sand And Gravel Deposits (Rule 60).....	2084
061. Suction Dredges And Non-powered Sluice Equipment (Rule 61).....	2084
062. Piling (Rule 62).....	2085
063. Pipe Crossings (Rule 63).....	2085
064. Concrete Plank Boat Launch Ramps (Rule 64).....	2085
065. -- 069. (Reserved).....	2086
070. Hearings On Denied, Limited, Or Conditioned Permit Or Other Decisions	

Of The Director (Rule 70) .....	2086
071. -- 999. (Reserved).....	2086
<b>37.03.08 – Water Appropriation Rules</b>	
000. Legal Authority (Rule 0) .....	2097
001. Title And Scope (Rule 1) .....	2097
002. -- 009. (Reserved).....	2097
010. Definitions (Rule 10).....	2097
011. -- 024. (Reserved).....	2098
025. General Description Of The Procedure To Be Used For Allocation (Rule 25).....	2098
026. -- 029. (Reserved).....	2099
030. Location And Nature Of Trust Water (Rule 30).....	2099
031. -- 034. (Reserved).....	2100
035. Application Requirements (Rule 35).....	2100
036. -- 039. (Reserved).....	2103
040. Processing Applications For Permit And Reprocessing Permits (Rule 40).....	2103
041. -- 044. (Reserved).....	2108
045. Evaluation Criteria (Rule 45).....	2108
046. -- 049. (Reserved).....	2113
050. Conditions Of Approval (Rule 50).....	2113
051. -- 054. (Reserved).....	2114
055. Moratorium (Rule 55).....	2114
056. -- 999. (Reserved).....	2115
<b>37.03.09 – Well Construction Standards Rules</b>	
000. Legal Authority (Rule 0) .....	2119
001. Title And Scope (Rule 1).....	2119
002. -- 009. (Reserved).....	2119
010. Definitions (Rule 10).....	2119
011. -- 024. (Reserved).....	2125
025. Construction Of Cold Water Wells (Rule 25).....	2125
026. -- 029. (Reserved).....	2136
030. Construction Of Low Temperature Geothermal Resource Wells And Bonding (Rule 30).....	2136
031. -- 034. (Reserved).....	2138
035. Health Standards (Rule 35).....	2138
036. Owners Responsibilities For Well Use And Maintenance (Rule 36).....	2139
037. -- 039. (Reserved).....	2139
040. Areas Of Drilling Concern (Rule 40).....	2139
041. -- 044. (Reserved).....	2140
045. Drilling Permit Requirements (Rule 45).....	2140
046. -- 049. (Reserved).....	2141
050. Penalties (Rule 50).....	2141
051. -- 999. (Reserved).....	2142
<b>37.03.10 – Well Driller Licensing Rules</b>	
000. Legal Authority (Rule 0) .....	2155
001. Title And Scope (Rule 1).....	2155
002. Other Authorities Remain Applicable (Rule 2).....	2155
003. -- 009. (Reserved).....	2155
010. Definitions (Rule 10).....	2155
011. -- 019. (Reserved).....	2157
020. Applicability Of Licensing Requirements (Rule 20).....	2157
021. Construction And Use Of Holes That Are Not Wells (Rule 21).....	2158
022. -- 029. (Reserved).....	2158

030. Obtaining A License For An Individual Driller (Rule 30).....	2158
031. Obtaining A License For A Company (Rule 31).....	2159
032. Obtaining An Operator’s Permit (Rule 32).....	2160
033. Processing Application For A Driller’s License Or Operator’s Permit (Rule 33).....	2161
034. Examination Procedures (Rule 34).....	2161
035. Expiration And Renewal Of License (Rule 35).....	2161
036. Expiration And Renewal Of An Operator’s Permit (Rule 36).....	2162
037. Processing Application To Renew License Or Operator’s Permit (Rule 37).....	2162
038. -- 049. (Reserved).....	2163
050. Duties And Responsibilities Of Drillers, Companies And Operators (Rule 50).....	2163
051. -- 059. (Reserved).....	2165
060. Bonding (Rule 60).....	2165
061. -- 069. (Reserved).....	2165
070. Continuing Education (Rule 70).....	2165
071. Continuing Education Committee Contingency Plan (Rule 71).....	2166
072. -- 079. (Reserved).....	2166
080. Driller’s Advisory Committee (Rule 80).....	2166
081. -- 089. (Reserved).....	2167
090. Enforcement (Rule 90).....	2167
091. -- 999. (Reserved).....	2167

**IDAPA 38 – DEPARTMENT OF ADMINISTRATION**

***Docket No. 38-0000-2000F (Fee Rule)***

***38.04.04 – Rules Governing Capitol Mall Parking***

000. Legal Authority.....	2170
001. Title And Scope.....	2170
002. -- 009. (Reserved).....	2170
010. Definitions.....	2170
011. -- 019. (Reserved).....	2171
020. Parking Lot Locations.....	2171
021. Types Of Available Parking.....	2171
022. Parking Space Allocation.....	2171
023. -- 029. (Reserved).....	2173
030. Parking Permits.....	2173
031. Parking Permit Fees.....	2174
032. -- 039. (Reserved).....	2175
040. Parking Lot Violations.....	2175
041. Enforcement.....	2176
042. Suspension Or Revocation Of Parking Privileges.....	2177
043. Surrender Of Parking Permit.....	2177
044. -- 049. (Reserved).....	2177
050. Loading Zone Parking Spaces.....	2177
051. Waiver Of Rules.....	2177
052. -- 999. (Reserved).....	2177

**IDAPA 39 – IDAHO TRANSPORTATION DEPARTMENT**

***Docket No. 39-0000-2000F (Fee Rule)***

***39.02.04 – Rules Governing Manufacturer and New Vehicle Dealer Hearing Fees***

000. Legal Authority.....	2180
001. Title And Scope.....	2180
002. -- 099. (Reserved).....	2180
100. General Provisions.....	2180

101. -- 999. (Reserved).....	2180
<i>39.02.05 – Rules Governing Issuance of Certificates of Title</i>	
000. Legal Authority.....	2181
001. Title And Scope.....	2181
003. – 009. (Reserved).....	2181
010. Definitions.....	2181
011. – 099. (Reserved).....	2182
100. General.....	2182
101. – 199. (Reserved).....	2183
200. Lien Filing.....	2183
201. Odometers.....	2184
202. Vehicle Identification Number (VIN) Inspections.....	2184
203. – 299. (Reserved).....	2185
300. Title Branding.....	2185
301. Bonded Title.....	2186
302. Specially Constructed Vehicles.....	2187
303. Rebuilt Salvage Vehicles.....	2187
304. Glider Kits.....	2188
305. Title Application Requirements For Replica, Street Rods, Replica Street Rods, And Assembled Vehicles.....	2189
306. -- 399. (Reserved).....	2190
400. Abandoned Vehicles.....	2190
401. Gray Market Vehicles.....	2190
402. – 899. (Reserved).....	2191
900. Waiver Of Titling Requirements.....	2191
901. – 999. (Reserved).....	2191
<i>39.02.22 – Rules Governing Registration and Permit Fee Administration</i>	
000. Legal Authority.....	2192
001. Title And Scope.....	2192
002. -- 009. (Reserved).....	2192
010. Definitions.....	2192
011. -- 099. (Reserved).....	2192
100. Quarterly Road Use Fee Reports For Annual Overweight Permits.....	2192
101. Quarterly Road Use Fee Reporting.....	2193
102. -- 199. (Reserved).....	2193
200. Installment Payments For Commercial Vehicle Registration.....	2193
201. -- 299. (Reserved).....	2195
300. Refunds.....	2195
301. -- 599. (Reserved).....	2196
600. Insufficient Funds.....	2196
601. Acceptance Of Checks.....	2196
602. Credit Card Payments.....	2196
603. -- 699. (Reserved).....	2196
700. Suspension Of Registration.....	2196
701. Revocation Of Registration.....	2196
702. Requirements For Reinstatement Of Revoked Or Suspended Vehicle Registration.....	2196
703. Requirements For Collections.....	2196
704. -- 799. (Reserved).....	2197
800. Enforcement.....	2197
801. -- 899. (Reserved).....	2197
900. Appeal Procedure.....	2197
901. -- 999.....	(Reserved) 2197



*39.02.26 – Rules Governing Temporary Vehicle Clearance for Carriers*

000. Legal Authority.....	2198
001. Title And Scope.....	2198
002. -- 009. (Reserved).....	2198
010. Definitions.....	2198
011. -- 099. (Reserved).....	2198
100. Administration.....	2198
101. -- 199. (Reserved).....	2198
200. Issuance Of TVC.....	2198
201. Issuance Of Vehicle Registration (CAB Card) And License Plate(s).....	2198
202. -- 299. (Reserved).....	2198
300. Cost And Payment.....	2198
301. -- 999. (Reserved).....	2198

*39.02.41 – Rules Governing Special Provisions Applicable to Fees for Services*

000. Legal Authority.....	2199
001. Title And Scope.....	2199
002. -- 099. (Reserved).....	2199
100. Administration.....	2199
101. -- 199. (Reserved).....	2200
200. Law Enforcement Inquiries.....	2200
201. Jury Lists.....	2200
202. Special Agreements.....	2200
203. Miscellaneous.....	2200
204. -- 999. (Reserved).....	2200

*39.02.60 – Rules Governing License Plate Provisions*

000. Legal Authority.....	2201
001. Title And Scope.....	2201
002. -- 009. (Reserved).....	2201
010. Definitions.....	2201
011. License Plate Provisions For All License Plates.....	2201
012. Proof Of Registration For New, Replacement, Or Reissued License Plates.....	2202
013. -- 099. (Reserved).....	2202
100. License Plate Provisions For Standard Plates.....	2202
101. License Plate Provisions For Restricted Vehicle Plates.....	2203
102. -- 149. (Reserved).....	2203
150. Vehicle Dealer License Plates Formats.....	2203
151. Vehicle Dealer License Plates Restrictions.....	2203
152. Vehicle Dealer Loaner Plates.....	2204
153. Vehicle Dealer Transporter Registration And Plate.....	2205
154. Provisions For Wrecker Plates.....	2206
155. Provisions For Special License Plate Program Prequalification And Application Procedures.....	2206
156. -- 198. (Reserved).....	2207
199. License Plate Provisions For Special Program And Personalized Plates For Trailers.....	2207
200. License Plate Provisions For Special Plates.....	2207
201. Provisions For Legislative License Plates.....	2208
202. Provisions For Personalized License Plates.....	2208
203. Provisions For Former Prisoner Of War (POW) License Plates.....	2210
204. -- 299. (Reserved).....	2210
300. Provisions For Sample Plates.....	2210
301. -- 399. (Reserved).....	2211
400. Standard Exempt Plate Designators.....	2211

401. Issuing Agency.....	2211
402. Information To Be Provided By An Authorized Agency.....	2211
403. Vehicle Titling.....	2211
404. Exempt And Undercover Plate Fees.....	2212
405. Exempt Plate Display.....	2212
406. Undercover Plate Display.....	2212
407. Alternative Plates.....	2212
408. Exempt Plate Status.....	2212
409. Undercover Plate Status.....	2212
410. -- 999. (Reserved).....	2213
 <i>39.03.03 – Rules Governing Special Permits – General Conditions and Requirements</i>	
000. Legal Authority.....	2214
001. Title And Scope.....	2214
002. -- 009. (Reserved).....	2214
010. Definitions.....	2214
011. -- 049. (Reserved).....	2214
050. Safety Inspection Requirements For Permitted Vehicles And/Or Loads.....	2214
051. -- 059. (Reserved).....	2214
060. Brakes.....	2214
061. -- 069. (Reserved).....	2214
070. Lighting Requirements For Loads Traveling After Dark.....	2214
071. -- 079. (Reserved).....	2215
080. Flagging Requirements For Oversize Vehicles And/Or Loads.....	2215
081. -- 089. (Reserved).....	2215
090. Sign Requirements For Vehicles Combinations Inclusive Of Load.....	2215
091. -- 099. (Reserved).....	2215
100. Responsibility Of Issuing Authority.....	2215
101. -- 199. (Reserved).....	2216
200. Authority To Issue Permits.....	2216
201. -- 299. (Reserved).....	2216
300. Offices For Issuance Of Special Permits.....	2216
301. -- 399. (Reserved).....	2217
400. Insurance Or Bond For Extraordinary Hazard.....	2217
401. -- 449. (Reserved).....	2217
450. Responsibility Of Permittee.....	2217
451. -- 499. (Reserved).....	2218
500. Allowable Tolerance, Legal Or Permitted Size Limits.....	2218
501. -- 509. (Reserved).....	2218
510. Dromedary Tractors.....	2218
511. -- 519. (Reserved).....	2219
520. Load Overhang.....	2219
521. -- 599. (Reserved).....	2219
600. General.....	2219
601. -- 619. (Reserved).....	2219
620. Compliance With Other Laws And Ordinances.....	2219
621. -- 629. (Reserved).....	2219
630. Waiver Of Limitations For Emergency Movements.....	2219
631. -- 699. (Reserved).....	2220
700. Spring Breakup Season Type Of Load Restrictions.....	2220
701. -- 709. (Reserved).....	2220
710. Weight Limits Based On Tire Sizes.....	2220

711. – 719. (Reserved) .....	2220
720. Width Limitation On Two Lane Road .....	2220
721. – 729. (Reserved) .....	2220
730. Speed Restrictions .....	2220
731. – 739. (Reserved) .....	2220
740. Special Permit Policy During Spring Breakup .....	2220
741. – 749. (Reserved) .....	2221
750. Legal Weight Limits Maintained On Certain Highways .....	2221
751. – 759. (Reserved) .....	2221
760. Enforcement Of Posted Weight And/Or Speed Restrictions .....	2221
761. – 769. (Reserved) .....	2221
770. Temporary Suspension Of Posted Weight And Speed Restrictions .....	2221
771. – 779. (Reserved) .....	2221
780. Special Allowances For Emergency And Critical Service Vehicles .....	2221
781. – 799. (Reserved) .....	2221
800. Special Permit Fees Costs To Be Borne By Permittee .....	2221
801. – 909. (Reserved) .....	2221
910. Payment Of Special Permit Fees .....	2221
911. – 949. (Reserved) .....	2223
950. Revocation Of Permit For Non-Compliance With The Limitations Or Provisions Of The Permit. ....	2223
951. – 979. (Reserved) .....	2223
980. Permittee Responsible For Injury To Persons Or Property .....	2223
981. – 999. (Reserved) .....	2224

**IDAPA 41 – IDAHO PUBLIC HEALTH DISTRICTS  
(PANHANDLE HEALTH DISTRICT #1)**

**Docket No. 41-0101-2000**

**41.01.01 – Rules of Idaho Public Health District #1**

000. Legal Authority .....	2226
001. Title And Scope .....	2226
002. Office – Office Hours – Mailing Address – Street Address .....	2226
003. -- 009. (Reserved) .....	2226
010. Definitions .....	2226
011. -- 099. (Reserved) .....	2227
100. Water Quality Control .....	2227
101. -- 109. (Reserved) .....	2227
110. Sewage Disposal On The Rathdrum Prairie In Kootenai County, Idaho .....	2227
111. -- 199. (Reserved) .....	2228
200. Open Water Protection .....	2228
201. -- 399. (Reserved) .....	2229
400. Critical Materials At Fixed Facilities On The Rathdrum Prairie In Kootenai County, Idaho .....	2229
401. -- 499. (Reserved) .....	2233
500. Contaminant Management In The Bunker Hill Superfund Site, Shoshone County, Idaho .....	2233
501. -- 509. (Reserved) .....	2235
510. The Bunker Hill Superfund Site; Application Of Regulations .....	2235
511. Contaminant Management Rules In The Bunker Hill Superfund Site Operable Unit #3 Institutional Controls Administrative Area, Shoshone And Kootenai Counties, Idaho. ....	2237
512. Application Of Regulations; Institutional Controls Administrative Area .....	2240
513. -- 519. (Reserved) .....	2242
520. Permit Application And Administration .....	2242
521. Inspection .....	2243

522. Permit Revocation Or Stop Work Order.....	2243
523. Record Of Compliance.....	2243
524. -- 529. (Reserved).....	2243
530. Contractor Licensing.....	2243
531. Licenses For Public Utilities And Government Entities.....	2244
532. -- 539. (Reserved).....	2244
540. Performance Of Work.....	2244
541. Performance Standards.....	2244
542. Approval Of Alternative Standards.....	2245
543. Owner And Applicant Responsibility For Claims And Liabilities.....	2245
544. -- 899. (Reserved).....	2245
900. Administrative Procedures, Exceptions, Penalties.....	2245
901. (Reserved).....	2247
902. Violation And Enforcement.....	2247
903. -- 999. (Reserved).....	2247

**IDAPA 42 – IDAHO WHEAT COMMISSION**

***Docket No. 42-0101-2000F (Fee Rule)***

***42.01.01 – Rules of the Idaho Wheat Commission***

000. Legal Authority.....	2255
001. Title And Scope.....	2255
002. -- 009. (Reserved).....	2255
010. Definitions.....	2255
011 -- 099. (Reserved).....	2255
100. Wheat Tax Return Form.....	2255
101. Mixtures.....	2255
102. Net Weight.....	2255
103. Truckers.....	2255
104. Wheat Delivered On Account Or Exchanged For Other Wheat.....	2255
105. End Use.....	2255
106. -- 199. (Reserved).....	2255
200. Penalty For Late Payment Of Wheat Tax.....	2255
201. -- 299. (Reserved).....	2256
300. Wheat Under Commodity Credit Corporation Loans.....	2256
301. Invoices And Records.....	2256
302. -- 999. (Reserved).....	2256

**IDAPA 43 – IDAHO OILSEED COMMISSION**

***Docket No. 43-0101-2000F (Fee Rule)***

***43.01.01 – Rules Governing the Idaho Oilseed Commission***

000. Legal Authority.....	2258
001. Title And Scope.....	2258
002. -- 009. (Reserved).....	2258
010. First Purchaser Rules.....	2258
011. -- 499. (Reserved).....	2258
500. Refund Applications.....	2258
501. -- 999. (Reserved).....	2259

**IDAPA 46 – IDAHO BOARD OF VETERINARY MEDICINE**

***Docket No. 46-0101-2000F (Fee Rule)***

***46.01.01 – Rules of the State of Idaho Board of Veterinary Medicine***

000. Legal Authority.....	2262
001. Title And Scope.....	2262
002. -- 004. (Reserved).....	2262
005. Incorporation By Reference.....	2262
006. -- 009. (Reserved).....	2262
010. License.....	2262
011. Fees.....	2262
012. Mandatory Continuing Veterinary Education.....	2262
013. -- 099. (Reserved).....	2263
100. Certification Of Veterinary Technicians.....	2263
101. Temporary Certification.....	2264
102. Mandatory Continuing Education For Certified Veterinary Technicians.....	2265
103. Supervising Veterinarians.....	2266
104. Veterinary Technician Certification -- Renewal.....	2267
105. Grounds For Discipline Of Veterinary Technicians.....	2267
106. -- 149. (Reserved).....	2269
150. Valid Veterinarian/Client/Patient Relationship.....	2269
151. Unprofessional Conduct.....	2270
152. Code Of Professional Conduct.....	2270
153. Standards Of Practice.....	2271
154. Record Keeping Standards.....	2272
155. -- 199. (Reserved).....	2275
200. Committee On Humane Euthanasia.....	2275
201. Methods Of Euthanasia, Pre-Euthanasia Sedation, And Chemical Capture.....	2275
202. Procurement And Administration Of Approved Drugs.....	2276
203. Fees.....	2276
204. Certified Euthanasia Agency.....	2276
205. Certified Euthanasia Technician.....	2279
206. Grounds For Discipline -- CEAs And CETs.....	2283
207. Inspection Deficiencies.....	2285
208. -- 999. (Reserved).....	2285

**IDAPA 48 – IDAHO GRAPE GROWERS AND WINE PRODUCERS COMMISSION**

***Docket No. 48-0101-2000F (Fee Rule)***

***48.01.01 – Rules of the Idaho Grape Growers and Wine Producers Commission***

000. Legal Authority.....	2287
001. Title And Scope.....	2287
002. Definitions.....	2287
003. -- 019. (Reserved).....	2287
020. Tax And Late Payment Penalty.....	2287
021. -- 999. (Reserved).....	2287

**IDAPA 51 – IDAHO BEEF COUNCIL**

***Docket No. 51-0101-2000F (Fee Rule)***

***51.01.01 – Idaho Beef Council Rules***

000. Legal Authority.....	2289
001. Title And Scope.....	2289
002. Administrative Appeals.....	2289
003. Incorporation By Reference.....	2289
004. -- 099. (Reserved).....	2289
100. Funding.....	2289
101. -- 199. (Reserved).....	2290

200. Disbursements.....	2290
201. -- 299. (Reserved).....	2290
300. Personnel.....	2290
301. -- 999. (Reserved).....	2290

**IDAPA 52 – IDAHO STATE LOTTERY COMMISSION**

***Docket No. 52-0103-2000F (Fee Rule)***

***52.01.03 – Rules Governing Operations of the Idaho State Lottery***

000. Legal Authority.....	2292
001. Title And Scope.....	2292
002. -- 009. (Reserved).....	2292
010. Definitions.....	2292
011. -- 099. (Reserved).....	2292
100. Definitions.....	2292
101. Operating Provisions.....	2295
102. Conflict Of Interest Policy.....	2299
103. -- 199. (Reserved).....	2301
200. Lottery Contracting Rules.....	2301
201. Criteria For Review Of Retailer Applications And Conduct Of Operations.....	2307
202. General Instant Ticket Game Operating Rules.....	2310
203. (Reserved).....	2315
204. On-Line Computer Games.....	2315
205. Breakopen Instant Ticket Games.....	2320
206. -- 299. (Reserved).....	2323
300. Definitions.....	2323
301. Bingo By Charitable Or Nonprofit Organizations.....	2326
302. Number Of Sessions Per Week.....	2327
303. Posting Of License And Hours.....	2327
304. Members Of Organization In Attendance -- Training Of Employees.....	2327
305. Employees Ineligible To Play.....	2327
306. Minors.....	2327
307. Tracking Requirements In Games Using Paper Bingo Cards.....	2327
308. Duties Of Bingo Caller And Employees Or Volunteers In Games Using Paper Bingo Cards.....	2328
309. Determining Winners When A Player Using A Paper Bingo Card Claims To Be A Winner.....	2328
310. Miscellaneous Rules For Games Using Non-Electronic Bingo Cards.....	2328
311. Bingo Operations Using Electronic Bingo Machines.....	2329
312. Requirements For Bingo Game Operations Using Electronic Bingo Machines.....	2330
313. Play Using Electronic Bingo Machines.....	2331
314. Maximum Prizes.....	2331
315. (Reserved).....	2332
316. Limits On Bingo Operation’s Prize Payout Ratios And Administrative Expenses.....	2332
317. Payment Of Expenses, Winnings, And Charitable Contributions.....	2332
318. Minimum Charitable Or Nonprofit Donation.....	2332
319. Maximum Prizes.....	2332
320. (Reserved).....	2332
321. Accounting And Reporting Required.....	2332
322. Separate Bank Account And Limitations On Use.....	2332
323. General Ledger.....	2333
324. Annual Report.....	2333
325. Records Of Prize Disbursements.....	2333

326.	Accounting Of Revenues And Expenses .....	2333
327.	Inspection Of Financial Records And Documents .....	2334
328. -- 399.	(Reserved) .....	2334
400.	Requirements For Organizations Conducting Raffles .....	2334
401.	Limitation On Annual Number Of Raffles .....	2334
402.	Ownership Of Prizes .....	2334
403.	Maximum Prizes .....	2334
404.	Requirements For Donation To Charity -- Limitation On Expenses .....	2334
405.	General Ledger And Recordkeeping .....	2334
406.	Annual Raffle Report .....	2334
407.	Independent Audit Of Large Raffles .....	2335
408. -- 499.	(Reserved) .....	2335
500.	Application .....	2335
501.	License Fees .....	2335
502.	Information To Be Provided In Application .....	2335
503.	Multiple Chapters Licensed Together .....	2336
504.	Compensation Of Certain Persons And Contracts With Certain Persons Prohibited .....	2336
505.	Action On Licenses .....	2336
506.	Suspension Or Revocation Of License -- Civil And Criminal Penalties .....	2337
507.	Exemption From Licensing And Licensing Fees .....	2337
508.	Rules And Forms .....	2337
509. -- 599.	(Reserved) .....	2337
600.	Vendor's License Required .....	2337
601.	License Fees .....	2337
602.	Information To Be Provided In Application .....	2337
603.	Approval, Denial Or Dismissal Of Application For Issuance Of License .....	2338
604.	Suspension Or Revocation Of License .....	2338
605. -- 609.	(Reserved) .....	2338
610.	Gaming Devices, Equipment Or Materials .....	2338
611.	Paper Bingo Card Manufacturers Standards .....	2338
612.	Number Selectors .....	2339
613.	Distribution And Use Of Electronic Bingo Machines .....	2339
614. -- 699.	(Reserved) .....	2340
700.	Suspension, Revocation Or Denial Of License .....	2340
701.	Grounds For Suspension, Revocation Or Denial Of License .....	2340
702.	Complaint Against And Investigation Of Licensees .....	2340
703.	Procedure Upon Finding Of Reasonable Cause .....	2340
704.	Conduct Of Hearing In Contested Case .....	2340
705. -- 999.	(Reserved) .....	2340

**IDAPA 53 – IDAHO BARLEY COMMISSION**

***Docket No. 53-0101-2000F (Fee Rule)***

***53.01.01 – Rules of the Idaho Barley Commission***

000.	Legal Authority .....	2342
001.	Title And Scope .....	2342
002. -- 009.	(Reserved) .....	2342
010.	Definitions .....	2342
011. -- 099.	(Reserved) .....	2342
100.	First Purchaser Rules .....	2342
101. -- 199.	(Reserved) .....	2343
200.	Exemptions .....	2343
201. -- 999.	(Reserved) .....	2343

**IDAPA 57 – SEXUAL OFFENDER MANAGEMENT BOARD**

*Docket No. 57-0101-2000F (Fee Rule)*

*57.01.01 – Rules of the Sexual Offender Management Board*

000. Legal Authority.....	2345
001. Title And Scope.....	2345
002. Administrative Appeals.....	2345
003. Incorporation By Reference.....	2345
005. Public Records Act Compliance.....	2346
006. -- 009. (Reserved).....	2346
010. Definitions.....	2346
011. Abbreviations.....	2348
012. -- 019. (Reserved).....	2348
020. Recordkeeping.....	2348
021. Board Meetings.....	2348
022. -- 039. (Reserved).....	2348
040. Certified Evaluator Qualifications.....	2348
041. Levels Of Psychosexual Evaluator Certification.....	2349
042. -- 079. (Reserved).....	2349
080. Sexual Offender Treatment Provider Qualifications.....	2349
081. Levels Of Sexual Offender Treatment Provider Certification.....	2350
082. -- 099. (Reserved).....	2351
100. Specialized Training For Psychosexual Evaluators And Sexual Offender Treatment Providers.....	2351
101. Continuing Education For Psychosexual Evaluators And Sexual Offender Treatment Providers.....	2351
102. -- 149. (Reserved).....	2351
150. Request For Conditional Waiver.....	2352
151. (Reserved).....	2352
152. Reciprocity.....	2352
153. Exclusion.....	2352
154. Request For Change In Certification Level.....	2352
155. Application For Change In Certification Level.....	2352
156. -- 199. (Reserved).....	2353
200. Post Conviction Sexual Offender Polygraph Examiner Qualifications.....	2353
201. Levels Of Post Conviction Sexual Offender Polygraph Examiner Certification.....	2353
202. -- 230. (Reserved).....	2353
231. Continuing Education For Post Conviction Sexual Offender Polygraph Examiners.....	2353
232. -- 299. (Reserved).....	2354
300. Standards For Professional Conduct And Client Relations.....	2354
301. -- 329. (Reserved).....	2355
330. Initial Certification Application.....	2355
331. Expiration And Renewal Of Certification.....	2355
332. Fees.....	2355
333. Certification Period.....	2356
334. Applicability And Notification Of Changes.....	2356
335. Request For Placement On Inactive Status.....	2356
336. -- 349. (Reserved).....	2356
350. Central Roster Of Psychosexual Evaluators, Sexual Offender Treatment Providers And Post Conviction Sexual Offender Polygraph Examiners.....	2356
351. -- 379. (Reserved).....	2357
380. Denial And Grounds For Discipline.....	2357
381. Reapplication Following Certification Denial Or Disciplinary Action.....	2358



382. Levels Of Discipline.....	2358
383. Formal Discipline.....	2358
384. Informal Discipline.....	2358
385. Withholding Formal Discipline And Probation.....	2358
386. Complaints.....	2359
387. Disciplinary Process.....	2359
388. -- 399. (Reserved).....	2359
400. Quality Assurance.....	2359
401. -- 449. (Reserved).....	2359
450. Psychosexual Evaluations.....	2359
451. -- 479. (Reserved).....	2359
480. Polygraph Examinations.....	2359
481. -- 499. (Reserved).....	2359
500. Sexual Offender Treatment.....	2360
501. -- 999. (Reserved).....	2360

**IDAPA 58 – DEPARTMENT OF ENVIRONMENTAL QUALITY**

***Docket No. 58-0000-2000F (Fee Rule)***

***58.01.01 – Rules for the Control of Air Pollution in Idaho***

000. Legal Authority.....	2364
001. Title And Scope.....	2364
002. Written Interpretations.....	2364
003. Administrative Appeals.....	2364
004. (Reserved).....	2364
005. Definitions.....	2364
006. General Definitions.....	2364
007. Definitions For The Purposes Of Sections 200 Through 228 And 400 Through 461.....	2379
008. Definitions For The Purposes Of Sections 300 Through 386.....	2382
009. Definitions For The Purposes Of 40 CFR Part 60.....	2384
010. Definitions For The Purposes Of 40 CFR Part 61 And 40 CFR Part 63.....	2384
011. Definitions For The Purposes Of Sections 790 Through 799.....	2385
012. -- 105. (Reserved).....	2385
106. Abbreviations.....	2385
107. Incorporations By Reference.....	2386
108. -- 120. (Reserved).....	2387
121. Compliance Requirements By Department.....	2387
122. Information Orders By The Department.....	2388
123. Certification Of Documents.....	2389
124. Truth, Accuracy And Completeness Of Documents.....	2389
125. False Statements.....	2389
126. Tampering.....	2389
127. Format Of Responses.....	2389
128. Confidential Information.....	2389
129. (Reserved).....	2389
130. Startup, Shutdown, Scheduled Maintenance, Safety Measures, Upset And Breakdown.....	2389
131. Excess Emissions.....	2389
132. Correction Of Condition.....	2390
133. Startup, Shutdown And Scheduled Maintenance Requirements.....	2390
134. Upset, Breakdown And Safety Requirements.....	2392
135. Excess Emissions Reports.....	2394
136. Excess Emissions Records.....	2394
137. -- 139. (Reserved).....	2395

140. Variances .....	2395
141. Petition .....	2395
142. Notice .....	2395
143. Investigation And Recommendation .....	2395
144. Objections To Petition .....	2395
145. Authorization Of Hearing .....	2395
146. Notice Of Hearing .....	2396
147. Decision .....	2396
148. Proof Of Hardship .....	2396
149. Variance From New Rule .....	2396
150. -- 154. (Reserved) .....	2396
155. Circumvention .....	2396
156. Total Compliance .....	2396
157. Test Methods And Procedures .....	2396
158. -- 159. (Reserved) .....	2398
160. Provisions Governing Specific Activities And Conditions .....	2398
161. Toxic Substances .....	2398
162. Modifying Physical Conditions .....	2398
163. Source Density .....	2399
164. Polychlorinated Biphenyls (PCBs) .....	2399
165. -- 174. (Reserved) .....	2399
175. Procedures And Requirements For Permits Establishing A Facility Emissions Cap .....	2399
176. Facility Emissions Cap .....	2399
177. Application Procedures .....	2400
178. Standard Contents Of Permits Establishing A Facility Emissions Cap .....	2400
179. Procedures For Issuing Permits Establishing A Facility Emissions Cap .....	2401
180. Revisions To Permits Establishing A Facility Emissions Cap .....	2402
181. Notice And Record-Keeping Of Estimates Of Ambient Concentrations .....	2402
182. -- 199. (Reserved) .....	2403
200. Procedures And Requirements For Permits To Construct .....	2403
201. Permit To Construct Required .....	2403
202. Application Procedures .....	2403
203. Permit Requirements For New And Modified Stationary Sources .....	2405
204. Permit Requirements For New Major Facilities Or Major Modifications In Nonattainment Areas .....	2406
205. Permit Requirements For New Major Facilities Or Major Modifications In Attainment Or Unclassifiable Areas .....	2407
206. Optional Offsets For Permits To Construct .....	2408
207. Requirements For Emission Reduction Credit .....	2408
208. Demonstration Of Net Air Quality Benefit .....	2408
209. Procedure For Issuing Permits .....	2408
210. Demonstration Of Preconstruction Compliance With Toxic Standards .....	2412
211. Conditions For Permits To Construct .....	2419
212. Obligation To Comply .....	2420
213. Pre-Permit Construction .....	2420
214. Demonstration Of Preconstruction Compliance For New And Reconstructed Major Sources Of Hazardous Air Pollutants .....	2421
215. Mercury Emission Standard For New Or Modified Sources .....	2421
216. -- 219. (Reserved) .....	2422
220. General Exemption Criteria For Permit To Construct Exemptions .....	2422
221. Category I Exemption .....	2422
222. Category II Exemption .....	2423
223. Exemption Criteria And Reporting Requirements For Toxic Air Pollutant Emissions .....	2425

224.	Permit To Construct Application Fee. ....	2425
225.	Permit To Construct Processing Fee. ....	2425
226.	Payment Of Fees For Permits To Construct. ....	2426
227.	Receipt And Usage Of Fees. ....	2426
228.	Appeals. ....	2427
229. -- 299.	(Reserved).....	2427
300.	Procedures And Requirements For Tier I Operating Permits.....	2427
301.	Requirement To Obtain Tier I Operating Permit. ....	2427
302.	Optional Tier I Operating Permit. ....	2427
303. -- 310.	(Reserved).....	2427
311.	Standard Permit Applications. ....	2427
312.	Duty To Apply.....	2427
313.	Timely Application. ....	2427
314.	Required Standard Application Form And Required Information. ....	2429
315.	Duty To Supplement Or Correct Application. ....	2432
316.	Effect Of Inaccurate Information In Applications Or Failure To Submit Relevant Information. ....	2432
317.	Insignificant Activities. ....	2432
318. -- 320.	(Reserved).....	2439
321.	Tier I Operating Permit Content. ....	2439
322.	Standard Contents Of Tier I Operating Permits. ....	2439
323. -- 324.	(Reserved).....	2444
325.	Additional Contents Of Tier I Operating Permits -- Permit Shield. ....	2444
326. -- 331.	(Reserved).....	2445
332.	Emergency As An Affirmative Defense Regarding Excess Emissions.....	2445
333. -- 334.	(Reserved).....	2445
335.	General Tier I Operating Permits And Authorizations To Operate. ....	2445
336.	Tier I Operating Permits For Tier I Portable Sources. ....	2446
337. -- 359.	(Reserved).....	2446
360.	Standard Processing Of Tier I Operating Permit Applications. ....	2446
361.	Completeness Of Applications. ....	2447
362.	Technical Memorandums For Tier I Operating Permits. ....	2447
363.	Preparation Of Draft Permit Or Draft Denial. ....	2447
364.	Public Notices, Comments And Hearings. ....	2447
365.	Preparation Of Proposed Permit Or Proposed Denial. ....	2448
366.	EPA Review Procedures. ....	2448
367.	Action On Application. ....	2449
368.	Expiration Of Preceding Permits. ....	2450
369.	Tier I Operating Permit Renewal. ....	2450
370. -- 379.	(Reserved).....	2450
380.	Changes To Tier I Operating Permits. ....	2450
381.	Administrative Permit Amendments. ....	2451
382.	Significant Permit Modification. ....	2452
383.	Minor Permit Modification. ....	2453
384.	Section 502(b)(10) Changes And Certain Emission Trades. ....	2455
385.	Off-Permit Changes And Notice. ....	2456
386.	Reopening For Cause. ....	2457
387.	Registration And Registration Fees. ....	2458
388.	Applicability. ....	2458
389.	Registration Information. ....	2458
390.	Registration Fee. ....	2459
391.	Request For Information. ....	2460

392.	Registration Fee Assessment.....	2460
393.	Payment Of Tier I Registration Fee.....	2460
394.	Effect Of Delinquency On Applications.....	2460
395.	Appeals.....	2460
396.	Exemptions.....	2460
397.	Lump Sum Payments Of Registration Fees.....	2461
398. -- 399.	(Reserved).....	2461
400.	Procedures And Requirements For Tier II Operating Permits.....	2461
401.	Tier II Operating Permit.....	2461
402.	Application Procedures.....	2462
403.	Permit Requirements For Tier II Sources.....	2463
404.	Procedure For Issuing Permits.....	2463
405.	Conditions For Tier II Operating Permits.....	2465
406.	Obligation To Comply.....	2466
407.	Tier II Operating Permit Processing Fee.....	2466
408.	Payment Of Tier II Operating Permit Processing Fee.....	2467
409.	Receipt And Usage Of Fees.....	2467
410.	Appeals.....	2467
411. -- 439.	(Reserved).....	2467
440.	Requirements For Alternative Emission Limits (Bubbles).....	2467
441.	Demonstration Of Ambient Equivalence.....	2468
442. -- 459.	(Reserved).....	2468
460.	Requirements For Emission Reduction Credit.....	2468
461.	Requirements For Banking Emission Reduction Credits (ERC's).....	2469
462. -- 499.	(Reserved).....	2469
500.	Registration Procedures And Requirements For Portable Equipment.....	2469
501. -- 509.	(Reserved).....	2470
510.	Stack Heights And Dispersion Techniques.....	2470
511.	Applicability.....	2470
512.	Definitions.....	2470
513.	Requirements.....	2472
514.	Opportunity For Public Hearing.....	2472
515.	Approval Of Field Studies And Fluid Models.....	2472
516.	No Restriction On Actual Stack Height.....	2472
517.	Motor Vehicle Inspection And Maintenance Program.....	2472
518.	Requirements For Licensing Authorized Inspection Stations Or Retest Stations.....	2473
519.	Requirements For Licensing Authorized Emissions Technicians.....	2474
520.	Inspection Frequency.....	2474
521.	Test Procedure Requirements.....	2474
522.	Test Standards.....	2475
523.	Test Equipment.....	2475
524.	Inspection Fee.....	2475
525.	Public Outreach.....	2475
526.	Waivers.....	2475
527.	Extensions.....	2475
528. -- 549.	(Reserved).....	2475
550.	Air Pollution Emergency Rule.....	2475
551.	Episode Criteria.....	2475
552.	Stages.....	2475
553.	Effect Of Stages.....	2476
554. -- 555.	(Reserved).....	2476
556.	Criteria For Defining Levels Within Stages.....	2476

557. Public Notification.....	2477
558. Information To Be Given.....	2477
559. Manner And Frequency Of Notification.....	2478
560. Notification To Sources.....	2478
561. General Rules.....	2478
562. Specific Emergency Episode Abatement Plans For Point Sources.....	2480
563. Transportation Conformity.....	2480
564. (Reserved).....	2480
565. Abbreviations.....	2480
566. Definitions For The Purpose Of Sections 563 Through 574 And 582.....	2481
567. Agencies Affected By Consultation.....	2483
568. ICC Member Roles In Consultation.....	2484
569. ICC Member Responsibilities In Consultation.....	2484
570. General Consultation Process.....	2486
571. Consultation Procedures.....	2487
572. Final Conformity Determinations By USDOT.....	2489
573. Resolving Conflicts.....	2490
574. Public Consultation Procedures.....	2490
575. Air Quality Standards And Area Classification.....	2491
576. General Provisions For Ambient Air Quality Standards.....	2491
577. Ambient Air Quality Standards For Fluorides.....	2491
578. Designation Of Attainment, Unclassifiable, And Nonattainment Areas.....	2491
579. Baselines For Prevention Of Significant Deterioration.....	2492
580. Classification Of Prevention Of Significant Deterioration Areas.....	2493
581. Prevention Of Significant Deterioration (PSD) Increments.....	2494
582. -- 584. (Reserved).....	2494
585. Toxic Air Pollutants Non-carcinogenic Increments.....	2494
586. Toxic Air Pollutants Carcinogenic Increments.....	2512
587. Listing Or Delisting Toxic Air Pollutant Increments.....	2515
588. -- 591. (Reserved).....	2515
592. Stage 1 Vapor Collection.....	2515
593. Affected Equipment Or Processes.....	2515
594. Compliance Dates.....	2515
595. Submerged Fill Requirements.....	2516
596. Vapor Balance Requirements.....	2516
597. Testing And Monitoring Requirements.....	2516
598. Registration, Recordkeeping, And Reporting Requirements.....	2517
599. Gasoline Cargo Tanks.....	2518
600. Rules For Control Of Open Burning.....	2518
601. Fire Permits, Hazardous Materials, And Liability.....	2519
602. Nonpreemption Of Other Jurisdictions.....	2519
603. General Restrictions.....	2519
604. -- 605. (Reserved).....	2519
606. Categories Of Allowable Burning.....	2519
607. Recreational And Warming Fires.....	2520
608. Weed Control Fires.....	2520
609. Training Fires.....	2520
610. Industrial Flares.....	2520
611. Residential Solid Waste Disposal Fires.....	2520
612. Landfill Disposal Site Fires.....	2520
613. Orchard Fires.....	2520
614. Prescribed Burning.....	2521

615. Dangerous Material Fires.....	2521
616. Infectious Waste Burning.....	2521
617. Crop Residue Disposal.....	2521
618. Permit By Rule.....	2521
619. Registration For Permit By Rule.....	2522
620. Burn Fee.....	2522
621. Burn Determination.....	2522
622. General Provisions.....	2523
623. Public Notification.....	2524
624. Spot Burn, Baled Agricultural Residue Burn, And Propane Flaming Permits.....	2525
625. Visible Emissions.....	2526
626. General Restrictions On Visible Emissions From Wigwam Burners.....	2526
627. -- 649. (Reserved).....	2526
650. Rules For Control Of Fugitive Dust.....	2527
651. General Rules.....	2527
652. Agricultural Activities.....	2527
653. -- 664. (Reserved).....	2528
665. Regional Haze Rules.....	2528
666. Reasonable Progress Goals.....	2528
667. Long-Term Strategy For Regional Haze.....	2528
668. BART Requirement For Regional Haze.....	2530
669. -- 674. (Reserved).....	2531
675. Fuel Burning Equipment -- Particulate Matter.....	2531
676. Standards For New Sources.....	2531
677. Standards For Minor And Existing Sources.....	2531
678. Combinations Of Fuels.....	2532
679. Averaging Period.....	2532
680. Altitude Correction.....	2532
681. Test Methods And Procedures.....	2532
682. -- 699. (Reserved).....	2532
700. Particulate Matter -- Process Weight Limitations.....	2532
701. Particulate Matter -- New Equipment Process Weight Limitations.....	2532
702. Particulate Matter -- Existing Equipment Process Weight Limitations.....	2533
703. Particulate Matter -- Other Processes.....	2534
704. -- 724. (Reserved).....	2535
725. Rules For Sulfur Content Of Fuels.....	2535
726. -- 749. (Reserved).....	2536
750. Rules For Control Of Fluoride Emissions.....	2536
751. General Rules.....	2536
752. -- 759. (Reserved).....	2537
760. Rules For The Control Of Ammonia From Dairy Farms.....	2537
761. General Applicability.....	2537
762. Permit By Rule.....	2538
763. Registration for Permit by Rule.....	2538
764. Dairy Farm Best Management Practices.....	2538
765. -- 774. (Reserved).....	2541
775. Rules For Control Of Odors.....	2541
776. General Rules.....	2541
777. -- 784. (Reserved).....	2541
785. Rules For Control Of Incinerators.....	2541
786. Emission Limits.....	2541
787. Exceptions.....	2542

788. -- 789. (Reserved).....	2542
790. Rules For The Control Of Nonmetallic Mineral Processing Plants.....	2542
791. General Control Requirements.....	2542
792. Emissions Standards For Nonmetallic Mineral Processing Plants Subject To 40 CFR 60, Subpart OOO.....	2542
793. Emissions Standards For Nonmetallic Mineral Processing Plants Not Subject To 40 CFR 60, Subpart OOO.....	2543
794. Permit Requirements.....	2543
795. Permit By Rule Requirements.....	2544
796. Applicability.....	2544
797. Registration For Permit By Rule.....	2544
798. Electrical Generators.....	2544
799. Nonmetallic Mineral Processing Plant Fugitive Dust Best Management Practice.....	2545
800. Registration Fee For Permit By Rule.....	2551
801. Payment Of Fees For Permits By Rule Registration.....	2551
802. Receipt And Usage Of Fees.....	2551
803. -- 804. (Reserved).....	2551
805. Rules For Control Of Hot-Mix Asphalt Plants.....	2551
806. Emission Limits.....	2551
807. Multiple Stacks.....	2551
808. Fugitive Dust Control.....	2551
809. -- 814. (Reserved).....	2551
815. Rules For Control Of Kraft Pulp Mills.....	2551
816. Recovery Furnace TRS Standard.....	2552
817. Recovery Furnace TRS Monitoring And Recordkeeping.....	2552
818. Kraft Pulp Mill LVHC And HVLC Gas Venting Notification And Reporting.....	2552
819. -- 834. (Reserved).....	2552
835. Rules For Control Of Rendering Plants.....	2552
836. Control Of Cookers.....	2552
837. Control Of Expellers.....	2552
838. Control Of Plant Air.....	2552
839. Exceptions.....	2552
840. -- 859. (Reserved).....	2552
860. Emission Guidelines For Municipal Solid Waste Landfills That Commenced Construction, Reconstruction Or Modification Before May 30, 1991.....	2552
861. -- 999. (Reserved).....	2554
<i>58.01.05 – Rules and Standards for Hazardous Waste</i>	
000. Legal Authority.....	2555
001. Title.....	2555
002. Incorporation By Reference Of Federal Regulations.....	2555
003. Definitions.....	2555
004. Hazardous Waste Management System.....	2556
005. Identification And Listing Of Hazardous Waste.....	2556
006. Standards Applicable To Generators Of Hazardous Waste.....	2559
007. Standards Applicable To Transporters Of Hazardous Waste.....	2559
008. Standards For Owners And Operators Of Hazardous Waste Treatment, Storage And Disposal Facilities.....	2559
009. Interim Status Standards For Owners And Operators Of Hazardous Waste Treatment, Storage And Disposal Facilities.....	2559
010. Standards For The Management Of Specific Hazardous Wastes And Specific Types Of Hazardous Waste Facilities.....	2560
011. Land Disposal Restrictions.....	2560
012. Hazardous Waste Permit Program.....	2560

013. Procedures For Decision-Making (State Procedures For RCRA Or HWMA Permit Applications) .....	2560
014. (Reserved) .....	2560
015. Standards For The Management Of Used Oil .....	2560
016. Standards For Universal Waste Management .....	2561
017. Criteria For The Management Of Granular Mine Tailings (CHAT) In Asphalt Concrete And Portland Cement Concrete In Transportation Construction Projects Funded In Whole Or In Part By Federal Funds. ....	2561
018. Standards For Owners And Operators Of Hazardous Waste Facilities Operating Under A Standardized Permit. ....	2561
019. -- 354. (Reserved) .....	2561
355. Hazardous Waste Facility Siting License Fee .....	2561
356. Variance Applications For TSD Facilities Or Sites .....	2562
357. -- 499. (Reserved) .....	2562
500. Routing Of Hazardous Waste Shipments. ....	2562
501. -- 799. (Reserved) .....	2563
800. Inspection Plan -- Frequency Levels .....	2563
801. -- 849. (Reserved) .....	2563
850. Illegal Actions .....	2563
851. -- 899. (Reserved) .....	2563
900. Expenditures From Hazardous Waste Emergency Account .....	2563
901. -- 995. (Reserved) .....	2564
996. Administrative Provisions .....	2564
997. Confidentiality Of Records .....	2564
998. -- 999. (Reserved) .....	2564
<i>58.01.06 – Solid Waste Management Rules</i>	
000. Legal Authority .....	2565
001. Title And Scope .....	2565
002. Written Interpretations .....	2567
003. Administrative Appeals .....	2567
004. Applicability .....	2567
005. Definitions .....	2567
006. Abbreviations .....	2572
007. Incorporation By Reference .....	2572
008. Office – Office Hours – Mailing Address And Street Address .....	2572
009. Solid Waste Management Facility Classification .....	2573
010. Below Regulatory Concern Facilities .....	2574
011. Applicable Requirements For Tier I Facilities .....	2575
012. Applicable Requirements For Tier II Facilities .....	2577
013. Applicable Requirements For Tier III Facilities .....	2586
014. -- 031. (Reserved) .....	2596
032. Tier II And Tier III Application And Plan Review And Approval .....	2596
033. -- 059. (Reserved) .....	2597
060. Violations .....	2597
061. -- 993. (Reserved) .....	2597
994. Commercial Solid Waste Siting License Fee .....	2597
995. Commercial Solid Waste Siting License Application .....	2598
996. -- 998. (Reserved) .....	2598
999. Confidentiality Of Records .....	2598
<i>58.01.07 – Rules Regulating Underground Storage Tank Systems</i>	
000. Legal Authority .....	2599
001. Title And Scope .....	2599



002. Written Interpretations.....	2599
003. Administrative Provisions.....	2599
004. Incorporation By Reference.....	2599
005. Office Hours – Mailing Address And Street Address.....	2600
006. Confidentiality Of Records.....	2600
007. -- 009. (Reserved).....	2600
010. Definitions.....	2600
011. -- 099. (Reserved).....	2602
100. Additional Measures To Protect Ground Water From Contamination.....	2602
101. Alternative Periodic Testing Of Containment Sumps Used For Interstitial Monitoring Of Piping.....	2603
102. -- 199. (Reserved).....	2604
200. Release Reporting Requirements.....	2604
201. -- 299. (Reserved).....	2605
300. Training Requirements.....	2605
301. -- 399. (Reserved).....	2606
400. Inspections.....	2606
401. -- 499. (Reserved).....	2607
500. Delivery Prohibition.....	2607
501. -- 599. (Reserved).....	2609
600. Petroleum Underground Storage Tank Database.....	2609
601. Fee Schedule For Underground Storage Tanks.....	2609
602. -- 999. (Reserved).....	2610
<i>58.01.08 – Idaho Rules for Public Drinking Water Systems</i>	
000. Legal Authority.....	2611
001. Title And Scope.....	2611
002. Incorporation By Reference And Availability Of Referenced Materials.....	2611
003. Definitions.....	2613
004. Coverage.....	2628
005. General Provisions For Waivers, Variances, And Exemptions.....	2628
006. Siting Requirements.....	2629
007. Disapproval Designation.....	2629
008. Health Hazards.....	2630
009. Monitoring.....	2630
010. Fee Schedule For Public Drinking Water Systems.....	2630
011. Continuity Of Service.....	2632
012. Written Interpretations.....	2632
013. Use Of Guidance.....	2633
014. Administrative Provisions.....	2633
015. Confidentiality Of Records.....	2633
016. Office Hours -- Mailing Address And Street Address.....	2633
017. -- 049. (Reserved).....	2633
050. Maximum Contaminant Levels And Maximum Residual Disinfectant Levels.....	2633
051. -- 099. (Reserved).....	2634
100. Monitoring And Analytical Requirements.....	2634
101. -- 149. (Reserved).....	2636
150. Reporting, Public Notification, Recordkeeping.....	2636
151. Consumer Confidence Reports.....	2636
152. -- 199. (Reserved).....	2636
200. Special Regulations.....	2636
201. -- 249. (Reserved).....	2637
250. Maximum Contaminant Level Goals And	

Maximum Residual Disinfection Level Goals .....	2637
251. -- 299. (Reserved).....	2637
300. Filtration And Disinfection .....	2637
301. Enhanced Filtration And Disinfection - Systems Serving Ten Thousand Or More People. ....	2642
302. Sanitary Surveys For Systems Using Surface Water Or Ground Water Under The Direct Influence Of Surface Water. ....	2642
303. Sanitary Surveys For Public Water Systems Using Ground Water.....	2643
304. Composite Correction Program (CCP).....	2644
305. Coliform Treatment Technique Triggers And Assessment Requirements For Protection Against Potential Fecal Contamination. ....	2644
306. -- 309. (Reserved).....	2647
310. Enhanced Filtration And Disinfection - Systems Serving Fewer Than Ten Thousand People. ....	2647
311. Enhanced Treatment For Cryptosporidium -- Long Term 2 Enhanced Surface Water Treatment Rule. ....	2647
312. -- 319. (Reserved).....	2647
320. Disinfectant Residuals, Disinfection Byproducts, And Disinfection Byproduct Precursors. ....	2647
321. Initial Distribution System Evaluations. ....	2648
322. Stage 2 Disinfection Byproducts Requirements.....	2648
323. Ground Water Rule. ....	2648
324. -- 349. (Reserved).....	2648
350. Control Of Lead And Copper.....	2648
351. -- 399. (Reserved).....	2649
400. Secondary MCLS.....	2649
401. -- 449. (Reserved).....	2650
450. Use Of Non-Centralized Treatment Devices.....	2650
451. Treatment Techniques. ....	2652
452. -- 499. (Reserved).....	2652
500. Facility And Design Standards: Demonstration Of Technical, Financial, And Managerial Capacity Of Public Drinking Water Systems. ....	2652
501. Facility And Design Standards: General Design Requirements For Public Drinking Water Systems. ....	2654
502. Facility And Design Standards: Facility Plans.....	2658
503. Facility And Design Standards: Preliminary Engineering Reports. ....	2660
504. Facility And Design Standards: Review Of Plans And Specifications. ....	2664
505. -- 509. (Reserved).....	2668
510. Facility And Design Standards: Siting And Construction Of Wells.....	2668
511. Facility And Design Standards: Well Pumps, Discharge Piping, And Appurtenances. ....	2673
512. Facility And Design Standards: Well Lot. ....	2676
513. Facility And Design Standards: Number Of Ground Water Sources Required – Existing Systems. ....	2676
514. Facility And Design Standards: Spring Sources. ....	2677
515. Facility And Design Standards: Surface Sources And Ground Water Sources Under The Direct Influence Of Surface Water. ....	2677
516. -- 517. (Reserved).....	2679
518. Facility And Design Standards: Additional Design Criteria For Surface Water Treatment. ....	2679
519. Facility And Design Standards: Surface Water Treatment; Design Standards For Microscreening. ....	2681
520. Facility And Design Standards: Surface Water Treatment: Clarification Processes. ....	2681
521. Facility And Design Standards: Surface Water Treatment: Filtration Using Rapid Rate Gravity Filters. ....	2684

522. Facility And Design Standards: Surface Water Treatment: Filtration Using Diatomaceous Earth. ....	2689
523. Facility And Design Standards: Surface Water Treatment: Slow Sand Filtration.....	2690
524. Facility And Design Standards: Surface Water Treatment: Direct Filtration.....	2692
525. Facility And Design Standards: Low Pressure Membrane Filtration. ....	2692
526. -- 528. (Reserved).....	2697
529. Facility And Design Standards: Disinfection Of Drinking Water, Ultraviolet Light. ....	2697
530. Facility And Design Standards: Disinfection Of Drinking Water, Disinfecting Agents. ....	2701
531. Facility And Design Standards: Design Standards For Chemical Application.....	2707
532. Facility And Design Standards: Design Standards For Softening. ....	2713
533. Facility And Design Standards: Design Standards For Taste And Odor Control. ....	2715
534. Facility And Design Standards: Aeration Processes.....	2716
535. Facility And Design Standards: Design Standards For Iron And Manganese Control Systems. ....	2719
536. Facility And Design Standards: Design Standards For Fluoridation. ....	2721
537. Facility And Design Standards: Design Standards For Stabilization.....	2722
538. -- 539. (Reserved).....	2723
540. Facility And Design Standards: Design Standards For Treatment And Disposal Of Treatment Plant Waste Residuals. ....	2723
541. Facility And Design Standards: Pumping Facilities.....	2726
542. Facility And Design Standards - Distribution System.....	2728
543. Facility And Design Standards: Cross Connection Control.....	2732
544. Facility And Design Standards: General Design Of Finished Water Storage.....	2733
545. Facility And Design Standards: Treatment Plant Storage Facilities.....	2735
546. Facility And Design Standards: Distribution System Storage Facilities.....	2736
547. Facility And Design Standards: Hydropneumatic Tank Systems. ....	2736
548. Facility And Design Standards: Disinfection Of Facilities Prior To Use.....	2737
549. -- 551. (Reserved).....	2737
552. Operating Criteria For Public Water Systems. ....	2737
553. Classification Of Water Systems.....	2742
554. License Requirements. ....	2743
555. -- 559. (Reserved).....	2743
560. Contracting For Services.....	2743
561. -- 562. (Reserved).....	2743
563. Advisory Group. ....	2743
564. -- 899. (Reserved).....	2743
900. Tables. ....	2743
901. -- 999. (Reserved).....	2745
 <i>58.01.09 – Rules Regulating Swine Facilities</i>	
000. Legal Authority. ....	2746
001. Title And Scope.....	2746
002. Written Interpretations.....	2746
003. Administrative Appeals.....	2746
004. -- 009. (Reserved).....	2746
010. Definitions. ....	2746
011. -- 099. (Reserved).....	2747
100. Applicability. ....	2747
101. -- 199. (Reserved).....	2747
200. Permit Application. ....	2748
201. -- 204. (Reserved).....	2750
205. Financial Assurance Requirements. ....	2750
206. -- 209. (Reserved).....	2753

210. Existing Facilities.....	2753
211. -- 249. (Reserved).....	2754
250. Requirements For Water Quality Protection.....	2754
251. -- 299. (Reserved).....	2754
300. Application Processing Procedure.....	2754
301. -- 399. (Reserved).....	2756
400. Permit Conditions.....	2756
401. -- 449. (Reserved).....	2757
450. Specific Permit Conditions.....	2757
451. -- 499. (Reserved).....	2758
500. Permit Modification.....	2758
501. -- 549. (Reserved).....	2759
550. Transfer Of Permits.....	2759
551. -- 599. (Reserved).....	2759
600. Violations.....	2759
601. -- 998. (Reserved).....	2760
999. Confidentiality Of Records.....	2760
 <i>58.01.11 – Ground Water Quality Rule</i>	
000. Legal Authority.....	2761
001. Title And Scope.....	2761
002. Administrative Appeals.....	2761
003. Written Interpretations.....	2761
004. -- 005. (Reserved).....	2761
006. Policies.....	2761
007. Definitions.....	2762
008. -- 010. (Reserved).....	2764
011. Incorporation By Reference.....	2764
012. -- 149. (Reserved).....	2764
150. Implementation.....	2764
151. -- 199. (Reserved).....	2765
200. Ground Water Quality Standards.....	2765
201. -- 299. (Reserved).....	2769
300. Categorized Aquifers Of The State.....	2770
301. Management Of Activities With The Potential To Degrade Aquifers.....	2770
302. -- 349. (Reserved).....	2770
350. Procedures For Categorizing Or Recategorizing An Aquifer.....	2770
351. -- 399. (Reserved).....	2772
400. Ground Water Contamination.....	2772
401. Mining.....	2774
402. -- 999. (Reserved).....	2777
 <i>58.01.12 – Rules for Administration of Water Pollution Control Loans</i>	
000. Legal Authority.....	2778
001. Title And Scope.....	2778
002. Written Interpretations.....	2778
003. Administrative Appeals.....	2778
004. Incorporation By Reference And Availability Of Referenced Material.....	2778
005. Confidentiality.....	2778
006. Policy.....	2778
007. Definitions.....	2778
008. Office Hours – Mailing Address And Street Address.....	2781
009. (Reserved).....	2781
010. Financial And Management Capability Analysis.....	2781

011. -- 019. (Reserved).....	2782
020. Integrated Priority Rating System. ....	2782
021. Disadvantaged Loans. ....	2784
022. Supplemental Grants. ....	2784
023. -- 029. (Reserved).....	2785
030. Project Scope And Funding. ....	2785
031. Limitation Of Preloan Engineering Reviews. ....	2786
032. Loan Fee. ....	2786
033. -- 039. (Reserved).....	2786
040. Loan Application And Review. ....	2786
041. Determination Of Eligibility Of Costs. ....	2788
042. Environmental Review. ....	2790
043. -- 049. (Reserved).....	2792
050. Loan Offer And Acceptance. ....	2792
051. Accounting And Auditing Procedures.....	2793
052. -- 059. (Reserved).....	2793
060. Disbursements. ....	2793
061. Loan Consolidation. ....	2794
062. -- 079. (Reserved).....	2794
080. Suspension Or Termination Of Loan Contracts. ....	2794
081. -- 994. (Reserved).....	2794
995. Waiver Of Requirements And Amendment Of Integrated Priority List. ....	2794
996. -- 999. (Reserved).....	2795
 <i>58.01.13 – Rules for Ore Processing by Cyanidation</i>	
000. Legal Authority. ....	2796
001. Title, Scope And Intent. ....	2796
002. Written Interpretations. ....	2796
003. Administrative Provisions. ....	2796
004. Incorporation By Reference. ....	2796
005. Office Hours – Mailing Address And Street Address. ....	2796
006. Confidentiality Of Records. ....	2796
007. Definitions. ....	2796
008. -- 009. (Reserved).....	2799
010. Applicability To Facilities With Existing Permits. ....	2799
011. -- 049. (Reserved).....	2799
050. Conceptual Design Approval. ....	2799
051. -- 099. (Reserved).....	2800
100. Permit And Permit Application. ....	2800
101. -- 199. (Reserved).....	2804
200. Requirements For Water Quality Protection. ....	2804
201. -- 299. (Reserved).....	2810
300. Application Processing Procedure. ....	2810
301. -- 399. (Reserved).....	2810
400. Public Involvement In Permit Procedures. ....	2810
401. -- 449. (Reserved).....	2811
450. Final Permit Decision. ....	2811
451. -- 499. (Reserved).....	2812
500. Permit Conditions. ....	2812
501. Completion Of Permanent Closure. ....	2814
502. Decision To Approve Or Disapprove Of A Permanent Closure Report. ....	2815
503. -- 549. (Reserved).....	2815
550. Validity And Duration Of Permits.....	2815

551. -- 649. (Reserved).....	2815
650. Financial Assurance.....	2815
651. -- 749. (Reserved).....	2815
750. Permit Modification.....	2815
751. -- 799. (Reserved).....	2816
800. Transfer Of Permits.....	2816
801. -- 849. (Reserved).....	2817
850. Permit Revocation.....	2817
851. -- 899. (Reserved).....	2817
900. Violations.....	2817
901. -- 999. (Reserved).....	2817
 <i>58.01.14 – Rules Governing Fees for Environmental Operating Permits, Licenses, and Inspection Services</i>	
000. Legal Authority.....	2819
001. Title And Scope.....	2819
002. Written Interpretations.....	2819
003. Administrative Appeals.....	2819
004. Incorporation By Reference.....	2819
005. Office – Office Hours – Mailing Address And Street Address.....	2819
006. Confidentiality Of Records.....	2819
007. Definitions.....	2819
008. -- 099. (Reserved).....	2819
100. Environmental Fees.....	2819
101. -- 109. (Reserved).....	2819
110. Individual And Subsurface Sewage Disposal System Permit.....	2819
111. -- 114. (Reserved).....	2820
115. Individual And Subsurface Sewage Disposal System Pumper Permit.....	2820
116. -- 119. (Reserved).....	2820
120. Subsurface Sewage Disposal System Installer's Registration Permit.....	2820
121. -- 149. (Reserved).....	2820
150. Parcel Survey.....	2820
151. -- 159. (Reserved).....	2820
160. Sanitary Restriction Administration.....	2820
161. -- 899. (Reserved).....	2820
900. Waiver Of Fees.....	2820
901. -- 999. (Reserved).....	2821
 <i>58.01.18 – Idaho Land Remediation Rules</i>	
000. Legal Authority.....	2822
001. Title And Scope.....	2822
002. Written Interpretations.....	2822
003. Administrative Appeals.....	2822
004. -- 009. (Reserved).....	2822
010. Definitions And Abbreviations.....	2822
011. -- 019. (Reserved).....	2823
020. Application To Participate.....	2823
021. Voluntary Remediation Agreements.....	2824
022. Voluntary Remediation Work Plan.....	2825
023. Remediation Standards.....	2827
024. Implementation Of Voluntary Remediation Work Plan.....	2828
025. Covenant Not To Sue.....	2829
026. Lender Liability.....	2829
027. Institutional Controls.....	2831

028. -- 999. (Reserved).....	2833
<i>58.01.20 – Rules for Administration of Drinking Water Loan Program</i>	
000. Legal Authority.....	2834
001. Title And Scope.....	2834
002. Written Interpretations.....	2834
003. Administrative Appeals.....	2834
004. Policy.....	2834
005. Incorporation By Reference And Availability Of Referenced Material.....	2834
006. Confidentiality.....	2834
007. System Eligibility.....	2834
008. -- 009. (Reserved).....	2835
010. Definitions.....	2835
011. Financial Technical And Management Capability Analysis.....	2838
012. -- 019. (Reserved).....	2839
020. Priority Rating System.....	2839
021. Disadvantaged Loans.....	2840
022. -- 029. (Reserved).....	2841
030. Project Scope And Funding.....	2841
031. Limitation Of Pre-loan Engineering Reviews.....	2842
032. Loan Fee.....	2842
033. -- 039. (Reserved).....	2842
040. Loan Application And Review.....	2842
041. Determination Of Eligibility Of Costs.....	2844
042. Environmental Review.....	2846
043. -- 049. (Reserved).....	2848
050. Loan Offer And Acceptance.....	2848
051. Accounting And Auditing Procedures.....	2849
052. -- 059. (Reserved).....	2849
060. Disbursements.....	2849
061. -- 079. (Reserved).....	2849
080. Suspension Or Termination Of Loan Contracts.....	2849
081. -- 994. (Reserved).....	2850
995. Waivers.....	2850
996. -- 999. (Reserved).....	2850
<i>58.01.25 – Rules Regulating the Idaho Pollutant Discharge Elimination System Program</i>	
000. Legal Authority.....	2851
001. Title And Scope.....	2851
002. Confidentiality Of Records.....	2851
003. Incorporation By Reference Of Federal Regulations.....	2851
004. Administrative Provisions.....	2853
005. Written Interpretations.....	2854
006. Office Hours -- Mailing Address And Street Address.....	2854
007. -- 009. (Reserved).....	2854
010. Definitions.....	2854
011. -- 049. (Reserved).....	2863
050. Computation Of Time.....	2863
051. -- 089. (Reserved).....	2864
090. Signature Requirements.....	2864
091. -- 099. (Reserved).....	2865
100. Effect Of A Permit.....	2865
101. Duration.....	2865
102. Obligation To Obtain An IPDES Permit.....	2866

103.	Permit Prohibitions.....	2868
104.	Pre-Application Process.....	2869
105.	Application For An Individual IPDES Permit.....	2869
106.	Individual Permit Application Review.....	2907
107.	Decision Process.....	2909
108.	Draft Permit And Fact Sheet.....	2910
109.	Public Notification And Comment.....	2912
110.	Fee Schedule For IPDES Permitted Facilities.....	2915
111. -- 119.	(Reserved).....	2918
120.	New Sources And New Discharges.....	2918
121. -- 129.	(Reserved).....	2919
130.	General Permits.....	2919
131. -- 199.	(Reserved).....	2923
200.	Renewal Of IPDES Permits.....	2923
201.	Modification, Or Revocation And Reissuance Of IPDES Permits.....	2925
202.	Transfer Of IPDES Permits.....	2928
203.	Termination Of IPDES Permits.....	2928
204.	Appeals Process.....	2929
205.	Contested Permit Conditions.....	2935
206.	Stays Of Contested Permit Conditions.....	2936
207. -- 299.	(Reserved).....	2936
300.	Conditions Applicable To All Permits.....	2936
301.	Permit Conditions For Specific Categories.....	2942
302.	Establishing Permit Provisions.....	2943
303.	Calculating Permit Provisions.....	2950
304.	Monitoring And Reporting Requirements.....	2955
305.	Compliance Schedules.....	2957
306. -- 309.	(Reserved).....	2958
310.	Variances.....	2958
311. -- 369.	(Reserved).....	2962
370.	Pretreatment Standards.....	2962
371. -- 379.	(Reserved).....	2963
380.	Sewage Sludge.....	2963
381. -- 399.	(Reserved).....	2964
400.	Compliance Evaluation.....	2964
401. -- 499.	(Reserved).....	2964
500.	Enforcement.....	2964
501. -- 599.	(Reserved).....	2965
600.	Administrative Records And Data Management.....	2965
601. -- 999.	(Reserved).....	2966

**IDAPA 60 – IDAHO STATE SOIL AND WATER CONSERVATION COMMISSION**

***Docket No. 60-0501-2000F (Fee Rule)***

***60.05.01 – Rules of the Idaho State Soil And Water Conservation Commission***

000.	Legal Authority.....	2968
001.	Title And Scope.....	2968
002. -- 009.	(Reserved).....	2968
010.	Definitions.....	2968
011.	Abbreviations.....	2970
012.	Program Policy.....	2970
013.	Program Objectives.....	2970
014. -- 055.	(Reserved).....	2971



056. Responsibilities .....	2971
057. Application For Loan .....	2972
058. Special Practice(s) Approval For Loans .....	2973
059. -- 080. (Reserved) .....	2973
081. Encouraging Public Benefits When Installing Practices .....	2973
082. -- 100. (Reserved) .....	2974
101. Credit Guidelines .....	2974
102. Loan Closure And Administration .....	2974
103. Implementation Of Agreed To Practices .....	2975
104. -- 125. (Reserved) .....	2975
126. Repayment Of Loan .....	2975
127. Foreclosure .....	2976
128. -- 150. (Reserved) .....	2976
151. Loan Policies .....	2976
152. -- 199. (Reserved) .....	2976
200. Allocation Of Funds To Districts .....	2976
201. -- 999. (Reserved) .....	2976

# LEGAL NOTICE

## Summary of Proposed Rulemakings

---

### **PUBLIC NOTICE OF INTENT TO PROPOSE OR PROMULGATE NEW OR CHANGED AGENCY RULES**

*THERE ARE NO PROPOSED RULES PUBLISHED  
IN THE APRIL 15, 2020, IDAHO ADMINISTRATIVE BULLETIN, VOL. 20-4SE.*

Please refer to the Idaho Administrative Bulletin, [April 15, 2020, Vol. 20-4SE](#), for notices and text of all rulemakings, public hearings schedules, details on negotiated rulemaking, executive orders of the Governor, and agency contact information.

*Issues of the Idaho Administrative Bulletin can be viewed at [adminrules.idaho.gov](http://adminrules.idaho.gov).*

Office of the Administrative Rules Coordinator, Dept. of Administration, P.O. Box 83720, Boise, ID 83720-0306  
Phone: 208-332-1820; Email: [adminrules@adm.idaho.gov](mailto:adminrules@adm.idaho.gov)

# **CUMULATIVE RULEMAKING INDEX OF IDAHO ADMINISTRATIVE RULES**

*Office of the Administrative Rules Coordinator  
Division of Financial Management  
Office of the Governor*

*July 1, 1993 – Present*

## **CUMULATIVE RULEMAKING INDEX OF IDAHO ADMINISTRATIVE RULES**

This index provides a history of all agency rulemakings beginning with the first Administrative Bulletin in July 1993 to the most recent Bulletin publication. It tracks all rulemaking activities on each chapter of rules by the rulemaking docket numbers and includes negotiated, temporary, proposed, pending and final rules, public hearing notices, vacated rulemaking notices, notice of legislative actions taken on rules, and executive orders of the Governor.

---

## **ABRIDGED RULEMAKING INDEX OF IDAHO ADMINISTRATIVE RULES**

**(Index of Current and Active Rulemakings)**

*Office of the Administrative Rules Coordinator  
Division of Financial Management*

*April 11, 2019 – May 6, 2020*

*(PLR 2020) – Final Effective Date Is Pending Legislative Review in 2020*

*(eff. date)L – Denotes Adoption by Legislative Action*

*(eff. date)T – Temporary Rule Effective Date*

*SCR # – denotes the number of a Senate Concurrent Resolution (Legislative Action)*

*HCR # – denotes the number of a House Concurrent Resolution (Legislative Action)*

*(This Abridged Index includes all active rulemakings.)*

**IDAPA 01 – IDAHO BOARD OF ACCOUNTANCY**

- 01-0101-2000F** *Idaho Accountancy Rules* – Notice of Omnibus Rulemaking – Adoption of Temporary (Fee) Rule – Reauthorizes Title 01, Chapter 01 – Bulletin Vol. 20-4SE (eff. 3-20-20)T
- 01-0101-1900F** *Idaho Accountancy Rules* - Notice of Omnibus Rulemaking - Temporary and Proposed Fee Rulemaking - Reauthorizes Title 01, Chapter 01 -- Bulletin Vol. 19-6SE (eff. 6-30-19)T
- 01-0101-1900F** *Idaho Accountancy Rules* - Notice of Omnibus Fee Rulemaking - Notice of Public Hearing, Bulletin Vol. 19-9
- 01-0101-1900F** *Idaho Accountancy Rules* - Notice of Omnibus Fee Rulemaking - Adoption of Pending Fee Rule, Bulletin Vol. 19-11SE (PLR 2020)

**IDAPA 02 – IDAHO DEPARTMENT OF AGRICULTURE**

- 02-0000-2000F** *Rules of the Idaho Department of Agriculture* – Notice of Omnibus Rulemaking – Adoption of Temporary (Fee) Rule – Reauthorizes **Title 01**, Chapters 04, 05; **Title 02**, Chapters 07, 11-15; **Title 03**, Chapter 03; **Title 04**, Chapters 03, 05, 19, 26, 32; **Title 06**, Chapters 01, 02, 04-06, 09, 10, 33 – Bulletin Vol. 20-4SE (eff. 3-20-20)T
- 02-0100-1901OM** Notice of Intent to Promulgate - Omnibus Negotiated Rulemaking, Bulletin Vol. 19-9  
(*Omnibus Negotiated Rulemaking – Consolidation & Reorganization of Chapters Under the Direction of ISDA Chapters 02.02.02 through 02.06.41*)
- 02-0000-1900** *Rules of the Idaho Department of Agriculture* - Notice of Omnibus Rulemaking - Temporary and Proposed Rulemaking - Reauthorizes **Title 02**, Chapters 04-06, 10; **Title 04**, Chapters 05-06, 22, 24; **Title 05**, Chapter 01 - Bulletin Vol. 19-6SE (eff. 6-30-19)T
- 02-0000-1900** *Rules of the Idaho Department of Agriculture* - Notice of Omnibus Rulemaking - Adoption of Pending Rule, Bulletin Vol. 19-11SE (PLR 2020)
- 02-0000-1900A** *Rules of the Idaho Department of Agriculture* - Notice of Omnibus Rulemaking - Temporary and Proposed Rulemaking (for rules requiring 22-101A statement) - Reauthorizes **Title 01**, Chapter 03; **Title 02**, Chapters 02, 09; **Title 04**, Chapters 04, 08, 13, 18, 20-21, 25, 27-29; **Title 06**, Chapters 07-11, 13, 15, 17, 20, 22, 24, 26, 32, 38, 39 -- Bulletin Vol. 19-6SE (eff. 6-30-19)T
- 02-0000-1900A** *Rules of the Idaho Department of Agriculture* - Notice of Omnibus Rulemaking - Adoption of Pending Rule, Bulletin Vol. 19-11SE (PLR 2020)
- 02-0000-1900F** *Rules of the Idaho Department of Agriculture* - Notice of Omnibus Rulemaking - Temporary and Proposed Fee Rulemaking - Reauthorizes **Title 01**, Chapters 02, 04, 05; **Title 06**, Chapter 33 -- Bulletin Vol. 19-6SE (eff. 6-30-19)T
- 02-0000-1900F** *Rules of the Idaho Department of Agriculture* - Notice of Omnibus Rulemaking - Adoption of Pending Fee Rule, Bulletin Vol. 19-11SE (PLR 2020)
- 02-0000-1900FA** *Rules of the Idaho Department of Agriculture* - Notice of Omnibus Rulemaking - Temporary and Proposed Fee Rulemaking (Rules requiring 22-101A statement) - Reauthorizes **Title 02**, Chapters 07, 11-15; **Title 04**, Chapters 03, 09, 19, 26; **Title 06**, Chapters 01-06, 12, 14, 18, 27, 30-31, 34, 40-41 -- Bulletin Vol. 19-6SE (eff. 6-30-19)T
- 02-0000-1900FA** *Rules of the Idaho Department of Agriculture* - Notice of Omnibus Rulemaking - Adoption of Pending Fee Rule, Bulletin Vol. 19-11SE (PLR 2020)
- 02-0000-1900FA** *Rules of the Idaho Department of Agriculture* - Notice of Correction to Omnibus Pending Fee Rulemaking, Bulletin Vol. 19-12 (PLR 2020)
- 02-0616-1900** *Rules Governing Honey Standards* - Notice of Omnibus Rulemaking - Temporary and Proposed Rulemaking - Reauthorizes **Title 06**, Chapter 16 -- Bulletin Vol. 19-6SE (eff. 6-30-19)T
- 02-0616-1900** *Rules Governing Honey Standards* - Notice of Omnibus Rulemaking - Adoption of Pending Rule, Bulletin Vol. 19-11SE (PLR 2020)
- 02-0701-2000F** *Rules of the Idaho Hop Growers Commission* – Notice of Omnibus Rulemaking – Adoption of Temporary (Fee) Rule – Reauthorizes **Title 07**, Chapter 01 – Bulletin Vol. 20-4SE (eff. 3-20-20)T
- 02-0701-1900F** *Rules of the Idaho Hop Growers Commission* - Notice of Omnibus Rulemaking - Temporary and Proposed Fee Rulemaking - Reauthorizes **Title 07**, Chapter 01 -- Bulletin Vol. 19-6SE (eff. 6-30-19)T

**02-0701-1900F** *Rules of the Idaho Hop Growers Commission* - Notice of Omnibus Rulemaking - Adoption of Pending Fee Rule, Bulletin Vol. 19-11SE (PLR 2020)

**02-0801-2000F** *Rules of the Idaho Sheep and Goat Health Board* – Notice of Omnibus Rulemaking – Adoption of Temporary (Fee) Rule – Reauthorizes **Title 08**, Chapter 01 – Bulletin Vol. 20-4SE (eff. 3-20-20)T

**02-0801-1900F** *Rules of the Idaho Sheep and Goat Health Board* - Notice of Omnibus Fee Rulemaking - Temporary and Proposed Fee Rulemaking - Reauthorizes **Title 08**, Chapter 01 -- Bulletin Vol. 19-6SE (eff. 6-30-19)T

**02-0801-1900F** *Rules of the Idaho Sheep and Goat Health Board* - Notice of Omnibus Rulemaking - Adoption of Pending Fee Rule, Bulletin Vol. 19-11SE (PLR 2020)

#### **02.01.04, Rules Governing the Idaho Preferred<sup>®</sup> Promotion Program**

**02-0104-1801\*** *Notice of Intent to Promulgate a Rule – Negotiated Rulemaking, Bulletin Vol. 18-6 (\*Rulemaking terminated by agency)*

**02-0104-1901** Notice of Intent to Promulgate a Rule – Negotiated Rulemaking, Bulletin Vol. 19-5

**02-0104-1901** Proposed Rulemaking, Bulletin Vol. 19-8

**02-0104-1901** Adoption of Pending Rule, Bulletin Vol. 19-11 (PLR 2020)

#### **02.01.06, Rules Governing the Labeling of Hemp Receptacles**

**02-0106-2001** Adoption of Temporary Rule (New Chapter), Bulletin Vol. 20-1 (eff. 11-26-19)T

**02-0106-2002** Adoption of Temporary Rule (New Chapter), Bulletin Vol. 20-4 (eff. 3-20-20)T

#### **02.02.02, Idaho Department of Agriculture Controlled Atmosphere Storage Rules**

**02-0100-1901OM** Notice of Intent to Promulgate - Omnibus Negotiated Rulemaking, Bulletin Vol. 19-9

*(\*Combines previously codified chapter 02.02.02 into new chapter 02.02.02 - see next entry)*

#### **02.02.02, Rules Governing Grading and Controlled Atmosphere Storage of Apples**

**02-0202-1901\*** Proposed Rulemaking (New Chapter), Bulletin Vol. 19-11

*(\*Rulemaking combines previously codified chapters 02.02.02 and 02.02.04 into this new chapter)*

**02-0202-1901\*** Adoption of Pending Rule (New Chapter), Bulletin Vol. 20-1 (PLR 2020)

#### **02.02.04, Idaho Standards for Grades of Apples**

**02-0100-1901OM** Notice of Intent to Promulgate - Omnibus Negotiated Rulemaking, Bulletin Vol. 19-9

*(\*Combines previously codified chapter 02.02.04 into new chapter 02.02.02 - see above entry)*

#### **02.02.05, Prune Standards**

**02-0205-1901** Notice of Intent to Promulgate a Rule – Negotiated Rulemaking, Bulletin Vol. 19-7

**02-0100-1901OM** Notice of Intent to Promulgate - Omnibus Negotiated Rulemaking, Bulletin Vol. 19-9

*(\*Combines previously codified chapter 02.02.05 into new chapter 02.02.05 - see next entry)*

#### **02.02.05, Rules Governing Stone Fruit Grades**

**02-0205-1902\*** Proposed Rulemaking (New Chapter), Bulletin Vol. 19-11

*(\*Rulemaking combines previously codified chapters 02.02.05, 02.02.06 and 02.02.10 into this new chapter)*

**02-0205-1902\*** Adoption of Pending Rule (New Chapter), Bulletin Vol. 20-1 (PLR 2020)

#### **02.02.06, Idaho Standards for Grades of Sweet Cherries**

**02-0100-1901OM** Notice of Intent to Promulgate - Omnibus Negotiated Rulemaking, Bulletin Vol. 19-9

*(\*Combines previously codified chapter 02.02.06 into new chapter 02.02.05 - see above entry)*

#### **02.02.07, Bulk Permit Procedure (Potatoes)**

**02-0100-1901OM** Notice of Intent to Promulgate - Omnibus Negotiated Rulemaking, Bulletin Vol. 19-9

*(\*Combines previously codified chapter 02.02.07 into new chapter 02.02.07 - see next entry)*

#### **02.02.07, Rules Governing Bulk Permit and Retail Sale of Potatoes**

**02-0207-1901\*** Proposed Rulemaking (New Chapter, Fee Rule), Bulletin Vol. 19-11

*(\*Rulemaking combines previously codified chapters 02.02.07 and 02.02.09 into this new chapter)*

**02-0207-1901\*** Adoption of Pending Rule (New Chapter), Bulletin Vol. 20-1 (PLR 2020)

**02.02.09, Rules Requiring Inspection of Potatoes Intended for Sale or Offered for Sale in Retail Outlets**

**02-0100-1901OM** Notice of Intent to Promulgate - Omnibus Negotiated Rulemaking, Bulletin Vol. 19-9  
(\*Combines previously codified chapter 02.02.09 into new chapter 02.02.07 - see above entry)

**02.02.10, Idaho Standards for Apricots**

**02-0100-1901OM** Notice of Intent to Promulgate - Omnibus Negotiated Rulemaking, Bulletin Vol. 19-9  
(\*Combines previously codified chapter 02.02.10 into new chapter 02.02.05)

**02.02.12, Bonded Warehouse Rules**

**02-0212-1901** Notice of Intent to Promulgate a Rule – Negotiated Rulemaking, Bulletin Vol. 19-6  
**02-0212-1902** Adoption of Temporary Rule, Bulletin Vol. 19-6 (eff. 7-1-19)T  
**02-0212-1901** Proposed Rulemaking, Bulletin Vol. 19-9  
**02-0212-1901** Adoption of Pending Rule, Bulletin Vol. 19-11 (PLR 2020)

**02.02.14, Rules for Weights and Measures**

**02-0214-1901** Notice of Intent to Promulgate a Rule – Negotiated Rulemaking, Bulletin Vol. 19-5  
**02-0214-1901** 2nd Notice of Intent to Promulgate a Rule – Negotiated Rulemaking, Bulletin Vol. 19-7

**02.03.01, Rules Governing Pesticide Management Plans for Ground Water Protection**

**02-0301-1901** Adoption of Temporary Rule, Bulletin Vol. 19-7 (eff. 7-1-19)T  
**02-0301-1901** Proposed Rulemaking, Bulletin Vol. 19-9  
**02-0301-1901** Adoption of Pending Rule, Bulletin Vol. 19-11 (PLR 2020)

**02.03.03, Idaho Department of Agriculture Rules Governing Pesticide and Chemigation Use and Application**

**02-0303-1901** Adoption of Temporary Rule, Bulletin Vol. 19-7 (eff. 7-1-19)T  
**02-0303-1901** Proposed Rulemaking (Fee Rule), Bulletin Vol. 19-9  
**02-0303-1901** Adoption of Pending Fee Rule, Bulletin Vol. 19-11 (PLR 2020)

**02.04.03, Rules Governing Animal Industry**

**02-0100-1901OM** Notice of Intent to Promulgate - Omnibus Negotiated Rulemaking, Bulletin Vol. 19-9  
(\*Combines previously codified chapter 02.04.03 into new chapter 02.04.03 - see next entry)

**02.04.03, Rules Governing Animal Industry**

**02-0403-1901\*** Proposed Rulemaking (New Chapter, Fee Rule), Bulletin Vol. 19-11  
(\*Rulemaking combines previously codified chapters 02.04.03 and 02.04.22 into this new chapter - no change to chapter name)  
**02-0403-1901\*** Adoption of Pending Fee Rule (New Chapter), Bulletin Vol. 20-1 (PLR 2020)

**02.04.05, Rules Governing Manufacture Grade Milk**

**02-0100-1901OM** Notice of Intent to Promulgate - Omnibus Negotiated Rulemaking, Bulletin Vol. 19-9  
(\*Combines previously codified chapter 02.04.05 into new chapter 02.04.05 - see next entry)

**02.04.05, Rules Governing Grade A Milk and Manufacture Grade Milk**

**02-0405-1901\*** Proposed Rulemaking (New Chapter, Fee Rule), Bulletin Vol. 19-11  
(\*Rulemaking combines previously codified chapters 02.04.05, 02.04.06, 02.04.08 and 02.04.09 into this new chapter)  
**02-0405-1901\*** Adoption of Pending Fee Rule (New Chapter), Bulletin Vol. 20-1 (PLR 2020)

**02.04.06, Rules Governing Licensed Dairy Plants**

**02-0100-1901OM** Notice of Intent to Promulgate - Omnibus Negotiated Rulemaking, Bulletin Vol. 19-9  
(\*Combines previously codified chapter 02.04.06 into new chapter 02.04.05)

**02.04.08, Rules Governing Grade A Milk and Milk Products**

**02-0100-1901OM** Notice of Intent to Promulgate - Omnibus Negotiated Rulemaking, Bulletin Vol. 19-9  
(\*Combines previously codified chapter 02.04.08 into new chapter 02.04.05)

**02.04.09, Rules Governing Milk and Cream Procurement and Testing**

- 02-0100-1901OM** Notice of Intent to Promulgate - Omnibus Negotiated Rulemaking, Bulletin Vol. 19-9  
(\*Combines previously codified chapter 02.04.09 into new chapter 02.04.05)

**02.04.14, Rules Governing Dairy Byproduct**

- 02-0414-1901** Adoption of Temporary Rule, Bulletin Vol. 19-7 (eff. 7-1-19)T  
**02-0414-2001** Adoption of Temporary Rule, Bulletin Vol. 20-4 (eff. 3-20-20)T

**02.04.15, Rules Governing Beef Cattle Animal Feeding Operations**

- 02-0415-1901** Adoption of Temporary Rule, Bulletin Vol. 19-7 (eff. 7-1-19)T  
**02-0415-1901** Proposed Rulemaking, Bulletin Vol. 19-9  
**02-0415-1901** Adoption of Pending Rule, Bulletin Vol. 19-11 (PLR 2020)

**02.04.16, Rules Governing Agriculture Odor Management**

- 02-0416-1901** Adoption of Temporary Rule, Bulletin Vol. 19-7 (eff. 7-1-19)T  
**02-0100-1901OM** Notice of Intent to Promulgate - Omnibus Negotiated Rulemaking, Bulletin Vol. 19-9  
(\*Combines previously codified chapter 02.04.16 into new chapter 02.04.30)

**02.04.17, Rules Governing Dead Animal Movement and Disposal**

- 02-0417-1901** Adoption of Temporary Rule, Bulletin Vol. 19-7 (eff. 7-1-19)T  
**02-0417-1901** Proposed Rulemaking, Bulletin Vol. 19-9  
**02-0417-1901** Adoption of Pending Rule, Bulletin Vol. 19-11 (PLR 2020)

**02.04.18, Rules Governing CAFO Site Advisory Team**

- 02-0418-1901** Notice of Intent to Promulgate a Rule – Negotiated Rulemaking, Bulletin Vol. 19-6  
**02-0100-1901OM** Notice of Intent to Promulgate - Omnibus Negotiated Rulemaking, Bulletin Vol. 19-9  
(\*Combines previously codified chapter 02.04.18 into new chapter 02.04.30)

**02.04.20, Rules Governing Brucellosis**

- 02-0420-1901** Notice of Intent to Promulgate a Rule – Negotiated Rulemaking, Bulletin Vol. 19-6  
**02-0420-1901** Proposed Rulemaking, Bulletin Vol. 19-9  
**02-0420-1901** Adoption of Pending Rule, Bulletin Vol. 19-11 (PLR 2020)

**02.04.21, Rules Governing the Importation of Animals**

- 02-0421-1901** Notice of Intent to Promulgate a Rule – Negotiated Rulemaking, Bulletin Vol. 19-6  
**02-0421-1901** Proposed Rulemaking, Bulletin Vol. 19-9  
**02-0421-1901** Adoption of Pending Rule, Bulletin Vol. 19-11 (PLR 2020)

**02.04.22, Rules Governing Animal Health Emergencies**

- 02-0100-1901OM** Notice of Intent to Promulgate - Omnibus Negotiated Rulemaking, Bulletin Vol. 19-9  
(\*Combines previously codified chapter 02.04.22 into new chapter 02.04.03)

**02.04.23, Rules Governing Commercial Livestock Truck Washing Facilities**

- 02-0423-1901** Adoption of Temporary Rule, Bulletin Vol. 19-7 (eff. 7-1-19)T  
**02-0423-1901** Proposed Rulemaking, Bulletin Vol. 19-9  
**02-0423-1901** Adoption of Pending Rule, Bulletin Vol. 19-11 (PLR 2020)

**02.04.26, Rules Governing Livestock Marketing**

- 02-0100-1901OM** Notice of Intent to Promulgate - Omnibus Negotiated Rulemaking, Bulletin Vol. 19-9  
(\*Combines previously codified chapter 02.04.26 into new chapter 02.04.26 - see next entry)

**02.04.26, Rules Governing the Public Exchange of Livestock**

- 02-0426-1901\*** Proposed Rulemaking (New Chapter, Fee Rule), Bulletin Vol. 19-11  
(\*Rulemaking combines previously codified chapters 02.04.26 and 02.04.28 into this new chapter)

**02-0426-1901\*** Adoption of Pending Fee Rule (New Chapter), Bulletin Vol. 20-1 (PLR 2020)

**02.04.28, Rules Governing Livestock Dealers, Buying Stations, and Livestock Trader Lots**

**02-0100-1901OM** Notice of Intent to Promulgate - Omnibus Negotiated Rulemaking, Bulletin Vol. 19-9  
(\*Combines previously codified chapter 02.04.28 into new chapter 02.04.26 - see above entry)

**02.04.30, Rules Governing Nutrient Management**

**02-0430-1901** Notice of Intent to Promulgate a Rule – Negotiated Rulemaking, Bulletin Vol. 19-6  
**02-0430-1902** Adoption of Temporary Rule, Bulletin Vol. 19-7 (eff. 7-1-19)T  
**02-0100-1901OM** Notice of Intent to Promulgate - Omnibus Negotiated Rulemaking, Bulletin Vol. 19-9  
(\*Combines previously codified chapter 02.04.30 into new chapter 02.04.30 - see next entry)

**02.04.30, Rules Governing Environmental and Nutrient Management**

**02-0430-1903\*** Proposed Rulemaking (New Chapter), Bulletin Vol. 19-11  
(\*Rulemaking combines previously codified chapters 02.04.16, 02.04.18, 02.04.30 and 02.04.31 into this new chapter)  
**02-0430-1903\*** Adoption of Pending Rule (New Chapter), Bulletin Vol. 20-1 (PLR 2020)

**02.04.31, Rules Governing the Stockpiling of Agricultural Waste**

**02-0431-1901** Adoption of Temporary Rule, Bulletin Vol. 19-7 (eff. 7-1-19)T  
**02-0100-1901OM** Notice of Intent to Promulgate - Omnibus Negotiated Rulemaking, Bulletin Vol. 19-9  
(\*Combines previously codified chapter 02.04.31 into new chapter 02.04.30 - see above entry)

**02.04.32, Rules Governing Poultry Operations**

**02-0432-1901** Adoption of Temporary Rule, Bulletin Vol. 19-7 (eff. 7-1-19)T  
**02-0432-1901** Proposed Rulemaking (Fee Rule), Bulletin Vol. 19-9  
**02-0432-1901** Adoption of Pending Fee Rule, Bulletin Vol. 19-11 (PLR 2020)

**02.06.01, Rules Governing the Pure Seed Law**

**02-0100-1901OM** Notice of Intent to Promulgate - Omnibus Negotiated Rulemaking, Bulletin Vol. 19-9  
(\*Combines previously codified chapter 02.06.01 into new chapter 02.06.01 - see next entry)

**02.06.01, Rules Governing the Production and Distribution of Seed**

**02-0601-1901\*** Proposed Rulemaking (New Chapter, Fee Rule), Bulletin Vol. 19-11  
(\*Rulemaking combines previously codified chapters 02.06.01, 02.06.13 and 02.06.14 into this new chapter)  
**02-0601-1901\*** Adoption of Pending Fee Rule (New Chapter), Bulletin Vol. 20-1 (PLR 2020)

**02.06.02, Rules Pertaining to the Idaho Commercial Feed Law**

**02-0602-1901** Notice of Intent to Promulgate a Rule – Negotiated Rulemaking, Bulletin Vol. 19-6  
**02-0100-1901OM** Notice of Intent to Promulgate - Omnibus Negotiated Rulemaking, Bulletin Vol. 19-9  
(\*Combines previously codified chapter 02.06.02 into new chapter 02.06.02 - see next entry)

**02.06.02, Rules Governing Registrations and Licenses**

**02-0602-1902\*** Proposed Rulemaking (New Chapter, Fee Rule), Bulletin Vol. 19-11  
(\*Rulemaking combines previously codified chapters 02.06.02, 02.06.03, 02.06.12, 02.06.31 and 02.06.41 into this new chapter)  
**02-0602-1902\*** Adoption of Pending Fee Rule (New Chapter), Bulletin Vol. 20-1 (PLR 2020)

**02.06.03, Rules Pertaining to the Idaho Nurseries and Florists Law**

**02-0100-1901OM** Notice of Intent to Promulgate - Omnibus Negotiated Rulemaking, Bulletin Vol. 19-9  
(\*Combines previously codified chapter 02.06.03 into new chapter 02.06.02 - see above entry)

**02.06.04, Phytosanitary and Post-Entry Certification Rules**

**02-0100-1901OM** Notice of Intent to Promulgate - Omnibus Negotiated Rulemaking, Bulletin Vol. 19-9  
(\*Combines previously codified chapter 02.06.04 into new chapter 02.06.04 - see next entry)

**02.06.04, Rules Governing Plant Exports**



- 02-0604-1901\*** Proposed Rulemaking (New Chapter, Fee Rule), Bulletin Vol. 19-11  
(\*Rulemaking combines previously codified chapters **02.06.04**, **02.06.34**, and **02.06.40** into this new chapter)  
**02-0604-1901\*** Adoption of Pending Fee Rule (New Chapter), Bulletin Vol. 20-1 (PLR 2020)

**02.06.05, Rules Governing Diseases of Hops (*Humulus lupulus*)**

- 02-0100-1901OM** Notice of Intent to Promulgate - Omnibus Negotiated Rulemaking, Bulletin Vol. 19-9  
(\*Combines previously codified chapter **02.06.05** into new chapter **02.06.05** - see next entry)

**02.06.05, Rules Governing Plant Disease and Quarantines**

- 02-0605-1901\*** Proposed Rulemaking (New Chapter, Fee Rule), Bulletin Vol. 19-11  
(\*Rulemaking combines previously codified chapters **02.06.05**, **02.06.07**, **02.06.08**, **02.06.11**, **02.06.15**, **02.06.17**, **02.06.18**, **02.06.20**, **02.06.24**, **20.06.32** and **02.06.38** into this new chapter)  
**02-0605-1901\*** Adoption of Pending Fee Rule (New Chapter), Bulletin Vol. 20-1 (PLR 2020)

**02.06.07, Rules Governing White Rot Disease of Onion (*Sclerotium cepivorum*)**

- 02-0100-1901OM** Notice of Intent to Promulgate - Omnibus Negotiated Rulemaking, Bulletin Vol. 19-9  
(\*Combines previously codified chapter **02.06.07** into new chapter **02.06.05** - see above entry)

**02.06.08, Quarantine Rules Pertaining to Apples and Cherries**

- 02-0100-1901OM** Notice of Intent to Promulgate - Omnibus Negotiated Rulemaking, Bulletin Vol. 19-9  
(\*Combines previously codified chapter **02.06.08** into new chapter **02.06.05**)

**02.06.09, Rules Governing Invasive Species**

- 02-0100-1901OM** Notice of Intent to Promulgate - Omnibus Negotiated Rulemaking, Bulletin Vol. 19-9  
(\*Combines previously codified chapter **02.06.09** into new chapter **02.06.09** - see next entry)

**02.06.09, Rules Governing Invasive Species and Noxious Weeds**

- 02-0609-1901\*** Proposed Rulemaking (New Chapter, Fee Rule), Bulletin Vol. 19-11  
(\*Rulemaking combines previously codified chapters **02.06.09**, **02.06.22**, and **02.06.39** into this new chapter)  
**02-0609-1901\*** Adoption of Pending Fee Rule (New Chapter), Bulletin Vol. 20-1 (PLR 2020)

**02.06.10, Rules Governing the Pale Cyst Nematode (*Globodera pallida*)**

- 02-0100-1901OM** Notice of Intent to Promulgate - Omnibus Negotiated Rulemaking, Bulletin Vol. 19-9  
(\*Combines previously codified chapter **02.06.10** into new chapter **02.06.10** - see next entry)

**02.06.10, Rules Governing the Growing of Potatoes**

- 02-0610-1901\*** Proposed Rulemaking (New Chapter, Fee Rule), Bulletin Vol. 19-11  
(\*Rulemaking combines previously codified chapters **02.06.10**, **02.06.26**, **02.06.27** and **02.06.31** into this new chapter)  
**02-0610-1901\*** Adoption of Pending Fee Rule (New Chapter), Bulletin Vol. 20-1 (PLR 2020)

**02.06.11, Rules Governing European Corn Borer (*Ostrinia nubilalis*)**

- 02-0100-1901OM** Notice of Intent to Promulgate - Omnibus Negotiated Rulemaking, Bulletin Vol. 19-9  
(\*Combines previously codified chapter **02.06.11** into new chapter **02.06.05**)

**02.06.12, Rules Pertaining to the Idaho Fertilizer Law**

- 02-0612-1901** Notice of Intent to Promulgate a Rule – Negotiated Rulemaking, Bulletin Vol. 19-6  
**02-0100-1901OM** Notice of Intent to Promulgate - Omnibus Negotiated Rulemaking, Bulletin Vol. 19-9  
(\*Combines previously codified chapter **02.06.12** into new chapter **02.06.02**)

**02.06.13, Rules Relating to Rapeseed Production and Establishment of Rapeseed Districts in the State of Idaho**

- 02-0100-1901OM** Notice of Intent to Promulgate - Omnibus Negotiated Rulemaking, Bulletin Vol. 19-9  
(\*Combines previously codified chapter **02.06.13** into new chapter **02.06.01**)

**02.06.14, Rules Governing Annual Bluegrass (*Poa annua*)**

- 02-0100-1901OM** Notice of Intent to Promulgate - Omnibus Negotiated Rulemaking, Bulletin Vol. 19-9

(\*Combines previously codified chapter 02.06.14 into new chapter 02.06.01)

**02.06.15, Rules Governing Peach Tree Diseases**

**02-0100-1901OM** Notice of Intent to Promulgate - Omnibus Negotiated Rulemaking, Bulletin Vol. 19-9  
(\*Combines previously codified chapter 02.06.15 into new chapter 02.06.05)

**02.06.16, Rules Governing Honey Standards**

**02-0616-1900 Rules Governing Honey Standards** - Notice of Omnibus Rulemaking - Temporary and Proposed Rulemaking - Reauthorizes Title 06, Chapter 16 -- Bulletin Vol. 19-6SE (eff. 6-30-19)T  
**02-0616-1900 Rules Governing Honey Standards** - Notice of Omnibus Rulemaking - Adoption of Pending Rule, Bulletin Vol. 19-11SE (PLR 2020)

**02.06.17, Rules Governing the Disposal of Cull Onions and Potatoes**

**02-0100-1901OM** Notice of Intent to Promulgate - Omnibus Negotiated Rulemaking, Bulletin Vol. 19-9  
(\*Combines previously codified chapter 02.06.17 into new chapter 02.06.05)

**02.06.18, Rules Governing Mint Rootstock and Clone Production**

**02-0100-1901OM** Notice of Intent to Promulgate - Omnibus Negotiated Rulemaking, Bulletin Vol. 19-9  
(\*Combines previously codified chapter 02.06.18 into new chapter 02.06.05)

**02.06.20, Rules Governing Grape Planting Stock**

**02-0620-1901** Notice of Intent to Promulgate a Rule – Negotiated Rulemaking, Bulletin Vol. 19-8  
**02-0100-1901OM** Notice of Intent to Promulgate - Omnibus Negotiated Rulemaking, Bulletin Vol. 19-9  
(\*Combines previously codified chapter 02.06.20 into new chapter 02.06.05)

**02.06.22, Noxious Weed Rules**

**02-0100-1901OM** Notice of Intent to Promulgate - Omnibus Negotiated Rulemaking, Bulletin Vol. 19-9  
(\*Combines previously codified chapter 02.06.22 into new chapter 02.06.09)

**02.06.24, Rules Governing the Japanese Beetle (*Popillia japonica*)**

**02-0100-1901OM** Notice of Intent to Promulgate - Omnibus Negotiated Rulemaking, Bulletin Vol. 19-9  
(\*Combines previously codified chapter 02.06.24 into new chapter 02.06.05)

**02.06.26, Rules Concerning Seed Potato Crop Management Areas**

**02-0100-1901OM** Notice of Intent to Promulgate - Omnibus Negotiated Rulemaking, Bulletin Vol. 19-9  
(\*Combines previously codified chapter 02.06.26 into new chapter 02.06.10)

**02.06.27, Rules Governing Bacterial Ring Rot Caused By (*Clavibacter michiganensis* subsp. *sepedonicus*) of Potato**

**02-0100-1901OM** Notice of Intent to Promulgate - Omnibus Negotiated Rulemaking, Bulletin Vol. 19-9  
(\*Combines previously codified chapter 02.06.27 into new chapter 02.06.10)

**02.06.30, Rules Under the Idaho Bee Inspection Law**

**02-0100-1901OM** Notice of Intent to Promulgate - Omnibus Negotiated Rulemaking, Bulletin Vol. 19-9  
(\*Combines previously codified chapter 02.06.30 into new chapter 02.06.02)

**02.06.31, Noxious Weed Free Forage and Straw Certification Rules**

**02-0631-1901** Notice of Intent to Promulgate a Rule – Negotiated Rulemaking, Bulletin Vol. 19-6  
**02-0100-1901OM** Notice of Intent to Promulgate - Omnibus Negotiated Rulemaking, Bulletin Vol. 19-9  
(\*Combines previously codified chapter 02.06.31 into new chapter 02.06.09)

**02.06.32, Rules Concerning the Anthracnose Disease of Lentil (*lens culinaris medik*)**

**02-0100-1901OM** Notice of Intent to Promulgate - Omnibus Negotiated Rulemaking, Bulletin Vol. 19-9  
(\*Combines previously codified chapter 02.06.32 into new chapter 02.06.05)

**02.06.34, Rules Concerning Virus-Free Certification of Nursery Stock**

**02-0100-1901OM** Notice of Intent to Promulgate - Omnibus Negotiated Rulemaking, Bulletin Vol. 19-9  
(\*Combines previously codified chapter **02.06.34** into new chapter **02.06.04**)

**02.06.38, Rules Governing Plum Curculio (*Conotrachelus nenuphar*)**

**02-0100-1901OM** Notice of Intent to Promulgate - Omnibus Negotiated Rulemaking, Bulletin Vol. 19-9  
(\*Combines previously codified chapter **02.06.38** into new chapter **02.06.05**)

**02.06.39, Rules Governing Minimum Standards for Planting Uncertified Seed Potatoes in Idaho**

**02-0100-1901OM** Notice of Intent to Promulgate - Omnibus Negotiated Rulemaking, Bulletin Vol. 19-9  
(\*Combines previously codified chapter **02.06.39** into new chapter **02.06.10**)

**02.06.40, Rules Governing Ginseng Export**

**02-0100-1901OM** Notice of Intent to Promulgate - Omnibus Negotiated Rulemaking, Bulletin Vol. 19-9  
(\*Combines previously codified chapter **02.06.40** into new chapter **02.06.04**)

**02.06.41, Rules Pertaining to the Idaho Soil and Plant Amendment Act of 2001**

**02-0641-1901** Notice of Intent to Promulgate a Rule – Negotiated Rulemaking, Bulletin Vol. 19-6  
**02-0100-1901OM** Notice of Intent to Promulgate - Omnibus Negotiated Rulemaking, Bulletin Vol. 19-9  
(\*Combines previously codified chapter **02.06.41** into new chapter **02.06.02**)

**02.07.01, Rules of the Idaho Hop Growers' Commission**

**02-0701-2000F** *Rules of the Idaho Hop Growers Commission* – Notice of Omnibus Rulemaking – Adoption of Temporary (Fee) Rule – Reauthorizes **Title 07**, Chapter 01 – Bulletin Vol. 20-4SE (eff. 3-20-20)T  
**02-0701-1900F** *Rules of the Idaho Hop Growers Commission* - Notice of Omnibus Rulemaking - Temporary and Proposed Fee Rulemaking - Reauthorizes **Title 07**, Chapter 01 -- Bulletin Vol. 19-6SE (eff. 6-30-19)T  
**02-0701-1900F** *Rules of the Idaho Hop Growers Commission* - Notice of Omnibus Rulemaking - Adoption of Pending Fee Rule, Bulletin Vol. 19-11SE (PLR 2020)

**02.08.01, Sheep and Goat Rules of the Idaho Board of Sheep Commissioners**

**02-0801-2000F** *Rules of the Idaho Sheep and Goat Health Board* – Notice of Omnibus Rulemaking – Adoption of Temporary (Fee) Rule – Reauthorizes **Title 08**, Chapter 01 – Bulletin Vol. 20-4SE (eff. 3-20-20)T  
**02-0801-1900F** *Rules of the Idaho Sheep and Goat Health Board* - Notice of Omnibus Fee Rulemaking - Temporary and Proposed Fee Rulemaking - Reauthorizes **Title 08**, Chapter 01 -- Bulletin Vol. 19-6SE (eff. 6-30-19)T  
**02-0801-1900F** *Rules of the Idaho Sheep and Goat Health Board* - Notice of Omnibus Rulemaking - Adoption of Pending Fee Rule, Bulletin Vol. 19-11SE (PLR 2020)

**STATE ATHLETIC COMMISSION**

*(Moved and Re-designated) - Rules of the State Athletic Commissions* (This chapter has been re-designated from **IDAPA 03.01.01** to **IDAPA 24.02.01** under the Division of Occupational and Professional Licenses - See IDAPA 24 in this Index.)

**IDAPA 04 -- OFFICE OF THE ATTORNEY GENERAL**

**04-0000-1900** *Rules of the Attorney General* - Notice of Omnibus Rulemaking - Temporary and Proposed Rulemaking - Reauthorizes Title 02, Chapter 01; Title 11, Chapter 01; Title 12, Chapter 01; Title 20, Chapter 01 - Bulletin Vol. 19-6SE (eff. 6-30-19)T

**04-0000-1900** *Rules of the Attorney General* - Notice of Omnibus Rulemaking - Adoption of Pending Rule, Bulletin Vol. 19-11SE (PLR 2020)

**04-0000-1900F** *Rules of the Attorney General* - Notice of Omnibus Rulemaking - Temporary and Proposed Fee Rulemaking - Reauthorizes Title 02, Chapter 02 -- Bulletin Vol. 19-6SE (eff. 6-30-19)T

**04-0000-1900F** *Rules of the Attorney General* - Notice of Omnibus Rulemaking - Adoption of Pending Fee Rule, Bulletin Vol. 19-11SE (PLR 2020)

***IDAPA 05 -- DEPARTMENT OF JUVENILE CORRECTIONS***

- 05-0000-1900** *Rules of the Department of Juvenile Corrections* - Notice of Omnibus Rulemaking - Temporary and Proposed Rulemaking - Reauthorizes Title 01, Chapters 02-04; Title 02, Chapters 01-03 -- Bulletin Vol. 19-6SE (eff. 6-30-19)T
- 05-0000-1900** *Rules of the Department of Juvenile Corrections* - Notice of Omnibus Rulemaking - Adoption of Pending Rule, Bulletin Vol. 19-11SE (PLR 2020)

***05.01.04, Uniform Standards for Juvenile Probation Services***

- 05-0104-1901** Notice of Intent to Promulgate a Rule – Negotiated Rulemaking, Bulletin Vol. 19-8

***IDAPA 06 -- STATE BOARD OF CORRECTION***

- 06-0000-1900** *Rules of the State Board of Correction* - Omnibus Notice of Proclamation of Rulemaking - Reauthorizes Title 01, Chapters 01-02; Title 02, Chapters 01-02 -- Bulletin Vol. 19-6SE (eff. 6-30-19)

***06.02.02, Rules Governing Establishment and Operation of a Limited Supervision Unit by the Department of Correction, Division of Probation and Parole***

- 06-0202-1901** Notice of Proclamation of Rulemaking, Bulletin Vol. 19-10 (eff. 11-1-19)

***IDAPA 07 – DIVISION OF BUILDING SAFETY***

- 07-0000-2000F** *Rules of the Division of Building Safety* – Notice of Omnibus Rulemaking – Adoption of Temporary (Fee) Rule – Reauthorizes Title 01, Chapter 01; Title 02, Chapter 02; Title 03, Chapters 01, 03, 11-12; Title 04, Chapter 02; Title 05, Chapter 01; Title 07, Chapter 01; Title 10, Chapter 01 – Bulletin Vol. 20-4SE (eff. 3-20-20)T

- 07-0000-1900\*** *Rules of the Division of Building Safety* - Notice of Omnibus Rulemaking - Temporary and Proposed Rulemaking - Reauthorizes Title 01, Chapters 01, 04-08, 10; Title 02, Chapters 04-06; Title 03, Chapters 09, 13; Title 04, Chapter 01; Title 06, Chapter 01; Title 08, Chapter 01 -- Bulletin Vol. 19-6SE (eff. 6-30-19)T

(\*Rulemaking combines Title 08, Chapters 02-17 into 07.08.01

- 07-0000-1900** *Rules of the Division of Building Safety* - Notice of Omnibus Rulemaking - Notice of Public Hearing, Bulletin Vol. 19-9

- 07-0000-1900** *Rules of the Division of Building Safety* - Notice of Omnibus Rulemaking - Adoption of Pending Rule, Bulletin Vol. 19-11SE (PLR 2020)

- 07-0000-1900F** *Rules of the Division of Building Safety* - Notice of Omnibus Rulemaking - Temporary and Proposed Fee Rulemaking, Reauthorizes Title 01, Chapters 02-03, 11; Title 02, Chapters 02- 03, 07; Title 03, Chapters 01, 03, 11-12; Title 04, Chapter 02; Title 05, Chapter 01; Title 07, Chapter 01; Title 10, Chapter 01 -- Bulletin Vol. 19-6SE (eff. 6-30-19)T

- 07-0000-1900F** *Rules of the Division of Building Safety* - Notice of Omnibus Fee Rulemaking - Notice of Public Hearing, Bulletin Vol. 19-9

- 07-0000-1900F** *Rules of the Division of Building Safety* - Notice of Omnibus Rulemaking - Adoption of Pending Fee Rule, Bulletin Vol. 19-11SE (PLR 2020)

***07.01.01, Rules of the Idaho Electrical Board***

- 07-0101-1901\*** Proposed Rulemaking (New Chapter - Rule Consolidation), Bulletin Vol. 19-9

(\*This rulemaking consolidates all rules previously promulgated under Title 01, Chapters 01-11)

- 07-0101-1901\*** Adoption of Pending Rule (New Chapter - Rule Consolidation), Bulletin Vol. 19-12 (PLR 2020)

***07.01.03, Rules of Electrical Licensing and Registration – General***

- 07-0103-1901\*** Notice of Intent to Promulgate a Rule – Negotiated Rulemaking, Bulletin Vol. 19-5 (Terminated)

(\*Rulemaking has been included in the newly consolidated rule chapter under Docket 07-0101-1901)

***07.02.02, Rules Governing Plumbing Permits***

- 07-0202-1901\*** Proposed Fee Rulemaking, Bulletin Vol. 19-7

(\*This rulemaking consolidates provisions from IDAPA 07.02.03, 07.02.04, and 07.02.07 into this chapter)

07-0202-1901\* Notice of Vacation of Proposed Fee Rulemaking, Bulletin Vol. 19-10

**07.02.03, Rules Governing Permit Fee Schedule**

07-0203-1901 Notice of Intent to Promulgate a Rule – Negotiated Rulemaking, Bulletin Vol. 19-5  
07-0203-1902 Proposed Rulemaking (Chapter Repeal), Bulletin Vol. 19-7  
07-0203-1902 Notice of Vacation of Proposed Rulemaking, Bulletin Vol. 19-10

**07.02.04, Rules Governing Plumbing Safety Inspections**

07-0204-1901 Proposed Rulemaking (Chapter Repeal), Bulletin Vol. 19-7  
07-0204-1901 Notice of Vacation of Proposed Rulemaking, Bulletin Vol. 19-10

**07.02.05, Rules Governing Plumbing Safety Licensing**

07-0205-1901 Notice of Intent to Promulgate a Rule – Negotiated Rulemaking, Bulletin Vol. 19-5  
07-0205-1901 Proposed Rulemaking, Bulletin Vol. 19-7  
07-0205-1901 Notice of Vacation of Proposed Rulemaking, Bulletin Vol. 19-10

**07.02.07, Rules Governing Civil Penalties**

07-0207-1901 Proposed Rulemaking (Chapter Repeal), Bulletin Vol. 19-7  
07-0207-1901 Notice of Vacation of Proposed Rulemaking, Bulletin Vol. 19-10

**07.03.01, Rules of Building Safety**

07-0301-1901 Notice of Intent to Promulgate a Rule – Negotiated Rulemaking, Bulletin Vol. 19-6  
07-0301-1901 Proposed Rulemaking, Bulletin Vol. 19-10  
07-0301-1901 Adoption of Pending Rule, Bulletin Vol. 19-12 (PLR 2020)

**07.03.12, Rules Governing Manufactured or Mobile Home Installations**

07-0312-1901\* Notice of Intent to Promulgate a Rule – Negotiated Rulemaking, Bulletin Vol. 19-7 (\*Rulemaking has been terminated)

**07.05.01, Rules of the Public Works Contractors License Board**

07-0501-1901 Notice of Intent to Promulgate a Rule – Negotiated Rulemaking, Bulletin Vol. 19-5  
07-0501-1901 Temporary and Proposed Rulemaking, Bulletin Vol. 19-9 (eff. 7-15-19)T  
07-0501-1901 Adoption of Pending Rule, Bulletin Vol. 19-12 (PLR 2020)

**07.07.01, Rules Governing Installation of Heating, Ventilation, and Air Conditioning Systems**

07-0701-1901 Notice of Intent to Promulgate a Rule – Negotiated Rulemaking, Bulletin Vol. 19-5  
07-0701-1901 Proposed Rulemaking, Bulletin Vol. 19-7  
07-0701-1902 Notice of Intent to Promulgate a Rule – Negotiated Rulemaking, Bulletin Vol. 19-7  
07-0701-1902 Proposed Rulemaking (Fee Rule), Bulletin Vol. 19-9  
07-0701-1901 Adoption of Pending Rule, Bulletin Vol. 20-1 (PLR 2020)  
07-0701-1902 Adoption of Pending Fee Rule, Bulletin Vol. 20-1 (PLR 2020)

**07.08.01, Idaho Minimum Safety Standards and Practices for Logging**

07-0801-1901 Notice of Intent to Promulgate a Rule – Negotiated Rulemaking, Bulletin Vol. 19-6  
07-0801-1901 Proposed Rulemaking, Bulletin Vol. 19-10  
07-0801-1901 Adoption of Pending Rule, Bulletin Vol. 19-12 (PLR 2020)

**07.11.01, Rules of the Division of Building Safety**

07-1101-1901 Proposed Rulemaking (New Chapter), Bulletin Vol. 19-9  
07-1101-1901 Adoption of Pending Rule (New Chapter), Bulletin Vol. 19-12 (PLR 2020)

**IDAPO 08 – IDAHO STATE BOARD OF EDUCATION  
AND STATE DEPARTMENT OF EDUCATION**

**08-0000-2000F** *Rules of the State Board of Education and the Department of Education* – Notice of Omnibus Rulemaking – Adoption of Temporary (Fee) Rule – Reauthorizes Title 01, Chapter 11, Sections 200 and 300 only; Title 02, Chapter 02, Sections 066 and 075 only; Title 02, Chapter 03, Section 128 only – Bulletin Vol. 20-4SE (eff. 3-20-20)T

**08-0000-1900** *Rules of the State Board of Education and the Department of Education* - Notice of Omnibus Rulemaking - Temporary and Proposed Rulemaking - Reauthorizes Title 01, Chapters 02, 10, 11, 13; Title 02, Chapters 01-05; Title 03, Chapter 01; Title 04, Chapter 01; Title 05, Chapter 01 -- Bulletin Vol. 19-6SE (eff. 6-30-19)T

**08-0000-1900** *Rules of the State Board of Education and the Department of Education* - Notice of Public Hearing, Bulletin Vol. 19-8

**08-0000-1900** *Rules of the State Board of Education and the Department of Education* - Notice of Public Hearing, Bulletin Vol. 19-10

**08-0000-1900** *Rules of the State Board of Education and the Department of Education* - Notice of Omnibus Rulemaking - Adoption of Pending Fee Rule, Bulletin Vol. 20-1 (PLR 2020)

**08-0000-1900F** *Rules of the State Board of Education and the Department of Education* - Notice of Omnibus Rulemaking - Temporary and Proposed Fee Rulemaking - Reauthorizes Title 01, Chapter 11, Sections 200 and 300 only; Title 02, Chapter 02, Sections 066 and 075 only; Title 02, Chapter 03, Section 128 only -- Bulletin Vol. 19-6SE (eff. 6-30-19)T

**08-0000-1900F** *Rules of the State Board of Education and the Department of Education* - Notice of Omnibus Rulemaking - Adoption of Pending Fee Rule, Bulletin Vol. 20-1 (PLR 2020)

### **08.01.13, Rules Governing the Idaho Opportunity Scholarship Program**

**08-0113-1901** Notice of Intent to Promulgate a Rule – Negotiated Rulemaking, Bulletin Vol. 19-7

**08-0113-1901** Temporary and Proposed Rulemaking, Bulletin Vol. 19-10 (eff. 8-29-19)T

**08-0113-1901** Adoption of Pending Rule, Bulletin Vol. 20-1 (PLR 2020)

### **08.02.01, Rules Governing Administration**

**08-0201-1901** Notice of Intent to Promulgate a Rule – Negotiated Rulemaking, Bulletin Vol. 19-7

**08-0201-1902** Notice of Intent to Promulgate a Rule – Negotiated Rulemaking, Bulletin Vol. 19-7

**08-0201-1902** Proposed Rulemaking, Bulletin Vol. 19-10

**08-0201-1903** Notice of Adoption of Temporary Rule, Bulletin Vol. 19-12 (eff. 10-17-19)T

**08-0201-1902** Adoption of Pending Rule, Bulletin Vol. 20-1 (PLR 2020)

### **08.02.02, Rules Governing Uniformity**

**08-0202-1901** Notice of Intent to Promulgate a Rule – Negotiated Rulemaking, Bulletin Vol. 19-3

**08-0202-1902** Notice of Intent to Promulgate a Rule – Negotiated Rulemaking, Bulletin Vol. 19-3

**08-0202-1903** Notice of Intent to Promulgate a Rule – Negotiated Rulemaking, Bulletin Vol. 19-7

**08-0202-1902** Proposed Rulemaking, Bulletin Vol. 19-8

**08-0202-1901** Proposed Rulemaking, Bulletin Vol. 19-10

**08-0202-1903** Proposed Rulemaking, Bulletin Vol. 19-10

**08-0202-1902** Adoption of Pending Rule, Bulletin Vol. 19-12 (PLR 2020)

**08-0202-1901** Adoption of Pending Rule, Bulletin Vol. 20-1 (PLR 2020)

**08-0202-1903** Adoption of Pending Rule, Bulletin Vol. 20-1 (PLR 2020)

**08-0202-2001** Notice of Adoption of Temporary Rule, Bulletin Vol. 20-5 (eff. 4-1-20)T

### **08.02.03, Rules Governing Thoroughness**

**08-0203-1901** Notice of Intent to Promulgate a Rule – Negotiated Rulemaking, Bulletin Vol. 19-7

**08-0203-1902** Notice of Intent to Promulgate a Rule – Negotiated Rulemaking, Bulletin Vol. 19-7

**08-0203-1903** Temporary and Proposed Rulemaking, Bulletin Vol. 19-8 (eff. 7-1-19)T

**08-0203-1901** Proposed Rulemaking, Bulletin Vol. 19-10

**08-0203-1902** Proposed Rulemaking, Bulletin Vol. 19-10

**08-0203-1903** Adoption of Pending Rule, Bulletin Vol. 19-12 (PLR 2020)

**08-0203-1901** Adoption of Pending Rule, Bulletin Vol. 20-1 (PLR 2020)

**08-0203-1902** Adoption of Pending Rule, Bulletin Vol. 20-1 (PLR 2020)

### **08.02.04, Rules Governing Public Charter Schools**

**08-0204-1901** Notice of Intent to Promulgate a Rule – Negotiated Rulemaking, Bulletin Vol. 19-7

**08-0204-1901** Proposed Rulemaking, Bulletin Vol. 19-10

**08-0204-1901** Adoption of Pending Rule, Bulletin Vol. 20-1 (PLR 2020)

### ***IDAPA 09 – IDAHO DEPARTMENT OF LABOR***

- 09-0000-1900** *Rules of the Idaho Department of Labor* - Notice of Omnibus Rulemaking - Temporary and Proposed Rulemaking - Reauthorizes Title 01, Chapters 01, 08, 30, 35, 60; Title 02, Chapter 01; Title 05, Chapter 03 -- Bulletin Vol. 19-6SE (eff. 6-30-19)T
- 09-0000-1900** *Rules of the Idaho Department of Labor* - Notice of Omnibus Rulemaking - Adoption of Pending Rule, Bulletin Vol. 19-11SE (PLR 2020)

#### ***09.01.30, Unemployment Insurance Benefits Administration Rules***

- 09-0130-1901\*** *Notice of Adoption of Temporary Rule, Bulletin Vol. 19-3 (eff. 3-6-19)T (\*Temporary rule expired 7-1-19)*
- 09-0130-1902** Notice of Intent to Promulgate a Rule – Negotiated Rulemaking, Bulletin Vol. 19-5
- 09-0130-1903** Notice of Intent to Promulgate a Rule – Negotiated Rulemaking, Bulletin Vol. 19-5
- 09-0130-1902\*** 2nd Filing - Notice of Intent to Promulgate a Rule – Negotiated Rulemaking, Bulletin Vol. 19-7
- 09-0130-1903\*** 2nd Filing - Notice of Intent to Promulgate a Rule – Negotiated Rulemaking, Bulletin Vol. 19-7
- 09-0130-1902** Proposed Rulemaking, Bulletin Vol. 19-9
- 09-0130-1903** Proposed Rulemaking, Bulletin Vol. 19-9
- 09-0130-1902** Adoption of Pending Rule, Bulletin Vol. 19-11 (PLR 2020)
- 09-0130-1903** Adoption of Pending Rule, Bulletin Vol. 19-11 (PLR 2020)

### ***IDAPA 10 – IDAHO BOARD OF LICENSURE OF PROFESSIONAL ENGINEERS AND PROFESSIONAL LAND SURVEYORS***

- 10-0101-2000F** *Rules of the Board of Professional Engineers and Professional Land Surveyors* – Notice of Omnibus Rulemaking – Adoption of Temporary (Fee) Rule – Reauthorizes Title 01, Chapter 01 – Bulletin Vol. 20-4SE (eff. 3-20-20)T
- 10-0000-1900F** *Rules of the Board of Professional Engineers and Professional Land Surveyors* - Notice of Omnibus Rulemaking - Temporary and Proposed Fee Rulemaking - Reauthorizes Title 01, Chapters 01-04 -- Bulletin Vol. 19-6SE (eff. 6-30-19)T
- 10-0000-1900F** *Rules of the Board of Professional Engineers and Professional Land Surveyors* - Notice of Public Hearing, Bulletin Vol. 19-8
- 10-0000-1900F** *Rules of the Board of Professional Engineers and Professional Land Surveyors* - Notice of Omnibus Rulemaking - Adoption of Pending Fee Rule, Bulletin Vol. 19-11SE (PLR 2020)

#### ***10.01.01, Rules of Procedure***

- 10-0101-1901** Notice of Intent to Promulgate Rules - Negotiated Rulemaking, Bulletin Vol. 19-6

#### ***10.01.04, Rules of Continuing Professional Development***

- 10-0104-1901** Notice of Intent to Promulgate Rules - Negotiated Rulemaking, Bulletin Vol. 19-6

#### ***10.01.05, Rules for Military or Veterans Licensure***

- 10-0105-1901** Notice of Intent to Promulgate Rules - Negotiated Rulemaking (New Chapter), Bulletin Vol. 19-6

### ***IDAPA 11 – IDAHO STATE POLICE***

- 11-0000-2000F** *Rules of the Idaho State Police* – Notice of Omnibus Rulemaking – Adoption of Temporary (Fee) Rule – Reauthorizes Title 05, Chapter 01; Title 10, Chapter 02 – Bulletin Vol. 20-4SE (eff. 3-20-20)T
- 11-0000-1900** *Rules of the Idaho State Police* - Notice of Omnibus Rulemaking - Temporary and Proposed Rulemaking - Reauthorizes Title 03, Chapter 01; Title 06, Chapter 01; Title 07, Chapters 01-03; Title 10, Chapter 03; Title 13, Chapter 01 -- Bulletin Vol. 19-6SE (eff. 6-30-19)T
- 11-0000-1900** *Rules of the Idaho State Police* - Notice of Omnibus Rulemaking - Adoption of Pending Rule, Bulletin Vol. 19-11SE (PLR 2020)

- 11-0000-1900F** *Rules of the Idaho State Police* - Notice of Omnibus Rulemaking - Temporary and Proposed Fee Rulemaking - Reauthorizes Title 05, Chapter 01; **Title 10**, Chapter 02 -- Bulletin Vol. 19-6SE (eff. 6-30-19)T
- 11-0000-1900F** *Rules of the Idaho State Police* - Notice of Omnibus Rulemaking - Adoption of Pending Fee Rule, Bulletin Vol. 19-11SE (PLR 2020)
- 11-0201-2000F** *Rules of the Idaho State Brand Board* – Notice of Omnibus Rulemaking – Adoption of Temporary (Fee) Rule – Reauthorizes Title 02, Chapter 01 – Bulletin Vol. 20-4SE (eff. 3-20-20)T
- 11-0200-1900F** *Rules of the Idaho State Brand Board* - Notice of Omnibus Rulemaking - Temporary and Proposed Fee Rulemaking - Reauthorizes **Title 02**, Chapters 01-02 -- Bulletin Vol. 19-6SE (eff. 6-30-19)T
- 11-0200-1900F** *Rules of the Idaho State Brand Board* - Notice of Omnibus Rulemaking - Adoption of Pending Fee Rule, Bulletin Vol. 19-11SE (PLR 2020)
- 11-0400-2000F** *Rules of the Idaho State Racing Commission* – Notice of Omnibus Rulemaking – Adoption of Temporary (Fee) Rule – Reauthorizes Title 04, Chapters 02, 03, 05, 07, 11, 15 – Bulletin Vol. 20-4SE (eff. 3-20-20)T
- 11-0400-1900** *Rules of the Idaho State Racing Commission* - Notice of Omnibus Rulemaking - Temporary and Proposed Rulemaking - Reauthorizes **Title 04**, Chapters 04, 06, 08-10, 13-14 -- Bulletin Vol. 19-6SE (eff. 6-30-19)T
- 11-0400-1900** *Rules of the Idaho State Racing Commission* - Notice of Omnibus Rulemaking - Adoption of Pending Rule, Bulletin Vol. 19-11SE (PLR 2020)
- 11-0400-1900F** *Rules of the Idaho State Racing Commission* - Notice of Omnibus Rulemaking - Temporary and Proposed Fee Rulemaking - Reauthorizes Title 04, Chapters 02, 03, 05, 07, 11, 15 -- Bulletin Vol. 19-6SE (eff. 6-30-19)T
- 11-0400-1900F** *Rules of the Idaho State Racing Commission* - Notice of Omnibus Rulemaking - Adoption of Pending Fee Rule, Bulletin Vol. 19-11SE (PLR 2020)
- 11-1001-2000F** *Idaho Public Safety and Public Information Systems* – Notice of Omnibus Rulemaking – Adoption of Temporary (Fee) Rule – Reauthorizes Title 10, Chapter 01 – Bulletin Vol. 20-4SE (eff. 3-20-20)T
- 11-1001-1900F** *Idaho Public Safety and Public Information Systems* - Notice of Omnibus Rulemaking - Temporary and Proposed Fee Rulemaking, - Reauthorizes **Title 10**, Chapter 01, Bulletin Vol. 19-6SE (eff. 6-30-19)T
- 11-1001-1900F** *Idaho Public Safety and Public Information Systems* - Notice of Omnibus Rulemaking - Adoption of Pending Fee Rule, Bulletin Vol. 19-11SE (PLR 2020)
- 11-1101-2000F** *Rules of the Peace Officer Standards and Training Council* – Notice of Omnibus Rulemaking – Adoption of Temporary (Fee) Rule – Reauthorizes Title 11, Chapter 01 – Bulletin Vol. 20-4SE (eff. 3-20-20)T
- 11-1101-1900F\*** *Rules of the Peace Officer Standards and Training Council* - Notice of Omnibus Rulemaking - Temporary and Proposed Fee Rulemaking, - Reauthorizes **Title 11**, Chapter 01, Bulletin Vol. 19-6SE (eff. 6-30-19)T  
\*(Reauthorization combines previous chapters 11.02, 11.03, 11.04, 11.05, and 11.06 into Title 11, Chapter 01)
- 11-1101-1900F** *Rules of the Peace Officer Standards and Training Council* - Notice of Omnibus Rulemaking - Adoption of Pending Fee Rule, Bulletin Vol. 19-11SE (PLR 2020)

### **Idaho State Brand Board**

- 11-0201-2000F** *Rules of the Idaho State Brand Board* – Notice of Omnibus Rulemaking – Adoption of Temporary (Fee) Rule – Reauthorizes Title 02, Chapter 01 – Bulletin Vol. 20-4SE (eff. 3-20-20)T
- 11-0200-1900F** *Rules of the Idaho State Brand Board* - Notice of Omnibus Rulemaking - Temporary and Proposed Fee Rulemaking - Reauthorizes Title 02, Chapters 01-02 -- Bulletin Vol. 19-6SE (eff. 6-30-19)T
- 11-0200-1900F** *Rules of the Idaho State Brand Board* - Notice of Omnibus Rulemaking - Adoption of Pending Fee Rule, Bulletin Vol. 19-11SE (PLR 2020)



**11.02.01, Rules of the Idaho State Brand Board**

- 11-0201-1901** Adoption of Temporary Rule, Bulletin Vol. 19-6 (eff. 7-1-19)T
- 11-0201-1902** Notice of Intent to Promulgate a Rule – Negotiated Rulemaking, Bulletin Vol. 19-7

**Idaho State Police Forensic Services**

- 11-0000-1900** *Rules of the Idaho State Police* - Notice of Omnibus Rulemaking - Temporary and Proposed Rulemaking - Reauthorizes **Title 03, Chapter 01**; Title 06, Chapter 01; Title 07, Chapters 01-03; Title 13, Chapter 01 -- Bulletin Vol. 19-6SE (eff. 6-30-19)T
- 11-0000-1900** *Rules of the Idaho State Police* - Notice of Omnibus Rulemaking - Adoption of Pending Rule, Bulletin Vol. 19-11SE (PLR 2020)

**11.03.01, Rules Governing Alcohol Testing**

- 11-0301-1801** Adoption of Temporary Rule, Bulletin Vol. 18-1 (eff. 12-14-17)T
- 11-0301-1801** OARC Omnibus Notice of Legislative Action-Extension of Temporary Rule - SCR150, Bulletin Vol. 18-5 (eff. 10-2-17)T
- 11-0301-1801** OARC Omnibus Notice of Legislative Action-Extension of Temporary Rule - SCR113, Bulletin Vol. 19-5 (eff. 12-14-19)T
- 11-0301-1901** Proposed Rulemaking, Bulletin Vol. 19-11
- 11-0301-1901** Adoption of Pending Rule, Bulletin Vol. 20-1 (PLR 2020)

**Idaho State Racing Commission**

- 11-0400-2000F** *Rules of the Idaho State Racing Commission* – Notice of Omnibus Rulemaking – Adoption of Temporary (Fee) Rule – Reauthorizes Title 04, Chapters 02, 03, 05, 07, 11, 15 – Bulletin Vol. 20-4SE (eff. 3-20-20)T
- 11-0400-1900** *Rules of the Idaho State Racing Commission* - Notice of Omnibus Rulemaking - Temporary and Proposed Rulemaking - Reauthorizes **Title 04**, Chapters 04, 06, 08-10, 13-14 -- Bulletin Vol. 19-6SE (eff. 6-30-19)T
- 11-0400-1900** *Rules of the Idaho State Racing Commission* - Notice of Omnibus Rulemaking - Adoption of Pending Rule, Bulletin Vol. 19-11SE (PLR 2020)
- 11-0400-1900F** *Rules of the Idaho State Racing Commission* - Notice of Omnibus Rulemaking - Temporary and Proposed Fee Rulemaking - Reauthorizes **Title 04**, Chapters 02, 03, 05, 07, 11, 15 -- Bulletin Vol. 19-6SE (eff. 6-30-19)T
- 11-0400-1900F** *Rules of the Idaho State Racing Commission* - Notice of Omnibus Rulemaking - Adoption of Pending Fee Rule, Bulletin Vol. 19-11SE (PLR 2020)

**11.04.03, Rules Governing Licensing and Fees**

- 11-0403-1801** Adoption of Temporary Rule, Bulletin Vol. 18-11 (eff. 9-17-18)T
- 11-0403-1801** OARC Omnibus Notice of Legislative Action-Extension of Temporary Rule by SCR 114, Bulletin Vol. 19-5 (eff. 9-17-18)T

**11.04.11, Rules Governing Equine Veterinary Practices, Permitted Medications, Banned Substances and Drug Testing of Horses**

- 11-0411-1801\*** *Notice of Intent to Promulgate Rules – Negotiated Rulemaking, Bulletin Vol. 18-3 (\*Rulemaking terminated by agency)*
- 11-0411-1802** Adoption of Temporary Rule, Bulletin Vol. 18-11 (eff. 9-17-18)T
- 11-0411-1802** OARC Omnibus Notice of Legislative Action-Extension of Temporary Rule by SCR 114, Bulletin Vol. 19-5 (eff. 9-17-18)T
- 11-0000-1900** *Rules of the Idaho State Police* - Notice of Omnibus Rulemaking - Temporary and Proposed Rulemaking - Reauthorizes Title 03, Chapter 01; **Title 06, Chapter 01**; Title 07, Chapters 01-03; Title 10, Chapter 03; Title 13, Chapter 01 -- Bulletin Vol. 19-6SE (eff. 6-30-19)T
- 11-0000-1900** *Rules of the Idaho State Police* - Notice of Omnibus Rulemaking - Adoption of Pending Rule, Bulletin Vol. 19-11SE (PLR 2020)

**11.06.01, Rules Governing Civil Asset Forfeiture Reporting**

- 11-0601-1901** *Notice of Adoption of Temporary Rule, Bulletin Vol. 19-3 (eff. 2-7-19)T (Expired 6-30-19) (See entry above)*

**11.08.01, Rules Governing Hemp Transportation**

- 11-0801-2001** Adoption of Temporary Rule (New Chapter), Bulletin Vol. 20-1 (eff. 11-19-19)T  
**11-0801-2002** Adoption of Temporary Rule (New Chapter), Bulletin Vol. 20-4 (eff. 3-20-20)T

### Public Safety and Security Information Bureau

- 11-1001-2000F** *Idaho Public Safety and Public Information Systems* – Notice of Omnibus Rulemaking – Adoption of Temporary (Fee) Rule – Reauthorizes Title 10, Chapter 01 – Bulletin Vol. 20-4SE (eff. 3-20-20)T
- 11-0000-1900** *Rules of the Idaho State Police* - Notice of Omnibus Rulemaking - Temporary and Proposed Rulemaking - Reauthorizes Title 03, Chapter 01; Title 06, Chapter 01; Title 07, Chapters 01-03; **Title 10, Chapter 03**; Title 13, Chapter 01 -- Bulletin Vol. 19-6SE (eff. 6-30-19)T
- 11-0000-1900** *Rules of the Idaho State Police* - Notice of Omnibus Rulemaking - Adoption of Pending Rule, Bulletin Vol. 19-11SE (PLR 2020)
- 11-0000-1900F** *Rules of the Idaho State Police* - Notice of Omnibus Rulemaking - Temporary and Proposed Fee Rulemaking - Reauthorizes Title 05, Chapter 01; **Title 10, Chapter 02** -- Bulletin Vol. 19-6SE (eff. 6-30-19)T
- 11-0000-1900F** *Rules of the Idaho State Police* - Notice of Omnibus Rulemaking - Adoption of Pending Fee Rule, Bulletin Vol. 19-11SE (PLR 2020)
- 11-1001-1900F** *Idaho Public Safety and Public Information Systems* - Notice of Omnibus Rulemaking - Temporary and Proposed Fee Rulemaking, - Reauthorizes **Title 10, Chapter 01**, Bulletin Vol. 19-6SE (eff. 6-30-19)T
- 11-1001-1900F** *Idaho Public Safety and Public Information Systems* - Notice of Omnibus Rulemaking - Adoption of Pending Fee Rule, Bulletin Vol. 19-11SE (PLR 2020)

### 11.10.02, Rules Governing State Criminal History Records and Crime Information

- 11-1002-1901** *Adoption of Temporary Rule, Bulletin Vol. 19-3 (eff. 2-5-19)T (Expired)*

### Peace Officer Standards and Training (POST) Council

- 11-1101-2000F** *Rules of the Peace Officer Standards and Training Council* – Notice of Omnibus Rulemaking – Adoption of Temporary (Fee) Rule – Reauthorizes Title 11, Chapter 01 – Bulletin Vol. 20-4SE (eff. 3-20-20)T
- 11-1101-1900F** *Rules of the Peace Officer Standards and Training Council* - Notice of Omnibus Rulemaking - Temporary and Proposed Rulemaking, - Reauthorizes **Title 11, Chapter 01**, Bulletin Vol. 19-6SE (eff. 6-30-19)T  
*\*(Reauthorization combines previous chapters 11.02, 11.03, 11.04, 11.05, and 11.06 into Chapter 11.01)*
- 11-1101-1900F** *Rules of the Peace Officer Standards and Training Council* - Notice of Omnibus Rulemaking - Adoption of Pending Fee Rule, Bulletin Vol. 19-11SE (PLR 2020)

### 11.11.01, Rules of the Idaho Peace Officer Standards and Training Council

- 11-1101-1901** *Adoption of Temporary Rule, Bulletin Vol. 19-4 (eff. 3-14-19)T (Expired)*

## IDAPA 12 – DEPARTMENT OF FINANCE

- 12-0000-2000F** *Rules of the Department of Finance* – Notice of Omnibus Rulemaking – Adoption of Temporary (Fee) Rule – Reauthorizes Title 01, Chapter 08 – Bulletin Vol. 20-4SE (eff. 3-20-20)T
- 12-0000-1900** *Rules of the Department of Finance* - Notice of Omnibus Rulemaking - Temporary and Proposed Rulemaking, Reauthorizes Title 01, Chapters 04, 09, 10, 11 -- Bulletin Vol. 19-6SE (eff. 6-30-19)T
- 12-0000-1900** *Rules of the Department of Finance* - Notice of Omnibus Rulemaking - Adoption of Pending Rule, Bulletin Vol. 19-11SE (PLR 2020)
- 12-0000-1900F** *Rules of the Department of Finance* - Notice of Omnibus Rulemaking - Temporary and Proposed Fee Rulemaking, Reauthorizes Title 01, Chapters 06, 08 -- Bulletin Vol. 19-6SE (eff. 6-30-19)T

**12-0000-1900F** *Rules of the Department of Finance* - Notice of Omnibus Rulemaking - Adoption of Pending Fee Rule, Bulletin Vol. 19-11SE (PLR 2020)

**12.01.08, Rules Pursuant to the Uniform Securities Act (2004)**

**12-0108-1901** Proposed Rulemaking, Bulletin Vol. 19-10  
**12-0108-1901** Adoption of Pending Rule, Bulletin Vol. 19-12 (PLR 2020)

**12.01.09, Rules Pursuant to the Idaho Credit Code**

**12-0109-1901** Notice of Intent to Promulgate Rules - Negotiated Rulemaking, Bulletin Vol. 19-8  
**12-0109-1901** Proposed Rulemaking, Bulletin Vol. 19-10  
**12-0109-1901** Adoption of Pending Rule, Bulletin Vol. 19-12 (PLR 2020)

**12.01.10, Rules Pursuant to the Idaho Residential Mortgage Practices Act**

**12-0110-1901** Notice of Intent to Promulgate Rules - Negotiated Rulemaking, Bulletin Vol. 19-8  
**12-0110-1901** Proposed Rulemaking, Bulletin Vol. 19-10  
**12-0110-1901** Adoption of Pending Rule, Bulletin Vol. 19-12 (PLR 2020)

**12.01.11, Rules Pursuant to the Idaho Collection Agency Act**

**12-0111-1901** Notice of Intent to Promulgate Rules - Negotiated Rulemaking, Bulletin Vol. 19-8  
**12-0111-1901** Proposed Rulemaking, Bulletin Vol. 19-10  
**12-0111-1901** Adoption of Pending Rule, Bulletin Vol. 19-12 (PLR 2020)

**IDAHA 13 – IDAHO FISH AND GAME COMMISSION**

**13-0000-2000F** *Rules of the Idaho Fish and Game Commission* – Notice of Omnibus Rulemaking – Adoption of Temporary (Fee) Rule – Reauthorizes Title 01, Chapter 02, Sections 200 and 201 only; Title 01, Chapter 04, Section 601 only; Title 01, Chapter 08, Section 263 only; Title 01, Chapter 10, Section 410 only; Title 01, Chapter 19, Section 102 only – Bulletin Vol. 20-4SE (eff. 3-20-20)T

**13-0000-1900** *Rules of the Idaho Fish and Game Commission* - Notice of Omnibus Rulemaking - Temporary and Proposed Rulemaking, Reauthorizes Title 01, Chapters 01-04, 06-12, 14-19 -- Bulletin Vol. 19-6SE (eff. 6-30-19)T

**13-0000-1900** Notice of Omnibus Rulemaking - Notice of Public Hearing, Bulletin Vol. 19-9

**13-0000-1900** *Rules of the Idaho Fish and Game Commission* - Notice of Omnibus Rulemaking - Adoption of Pending Rule, Bulletin Vol. 19-11SE (PLR 2020)

**13-0000-1900F** *Rules of the Idaho Fish and Game Commission* - Notice of Omnibus Rulemaking - Temporary and Proposed Fee Rulemaking, Reauthorizes Title 01, Chapter 02, Sections 100 and 102 only; Title 01, Chapter 04, Section 600 only; Title 01, Chapter 08, Subsection 260.06 only; Title 01, Chapter 10, Subsection 400.09 only; Title 01, Chapter 19, Section 112 only; Title 01, Chapter 20, Subsection 102.04 only -- Bulletin Vol. 19-6SE (eff. 6-30-19)T

**13-0000-1900F** Notice of Omnibus Fee Rulemaking - Notice of Public Hearing, Bulletin Vol. 19-9

**13-0000-1900F** *Rules of the Idaho Fish and Game Commission* - Notice of Omnibus Rulemaking - Adoption of Pending Fee Rule, Bulletin Vol. 19-11SE (PLR 2020)

**13.01.04, Rules Governing Licensing**

**13-0104-2001** Notice of Adoption of Temporary Rule, Bulletin Vol. 20-5 (eff. 4-4-20)T (add'l. amendments eff. 4-9-20)T

**13.01.07, Rules Governing the Taking of Upland Game Animals**

**13-0107-2001P** Notice of Proclamation of Rulemaking, Bulletin Vol. 20-2

**13.01.08, Rules Governing the Taking of Big Game Animals in the State of Idaho**

**13-0108-1902P** Notice of Proclamation of Rulemaking, Bulletin Vol. 19-4

**13-0108-1902AP\*** Notice of Amended Proclamation of Rulemaking, Bulletin Vol. 19-6 (\*1st Amendment)

**13-0108-1903** Notice of Intent to Promulgate Rules - Negotiated Rulemaking, Bulletin Vol. 19-6

**13-0108-1904** Notice of Intent to Promulgate Rules - Negotiated Rulemaking, Bulletin Vol. 19-6

**13-0108-1903** Proposed Rulemaking, Bulletin Vol. 19-9

- 13-0108-1904 Proposed Rulemaking, Bulletin Vol. 19-9
- 13-0108-1903 Adoption of Pending Rule, Bulletin Vol. 20-1 (PLR 2020)
- 13-0108-1904 Adoption of Pending Rule, Bulletin Vol. 20-1 (PLR 2020)
- 13-0108-1902AAP\* Notice of Amended Proclamation of Rulemaking, Bulletin Vol. 20-2 (\*2nd Amendment)
- 13-0108-1902AAAP\* Notice of Amended Proclamation of Rulemaking, Bulletin Vol. 20-4 (\*3rd Amendment)
- 13-0108-1902AAAAP\* Notice of Amended Proclamation of Rulemaking, Bulletin Vol. 20-5 (\*4th Amendment)

**13.01.09, Rules Governing the Taking of Game Birds in the State of Idaho**

- 13-0109-1901P Notice of Proclamation of Rulemaking, Bulletin Vol. 19-6
- 13-0109-1902 Notice of Intent to Promulgate Rules - Negotiated Rulemaking, Bulletin Vol. 19-6
- 13-0109-1902 Proposed Rulemaking, Bulletin Vol. 19-9
- 13-0109-1801AP Notice of Amended Proclamation of Rulemaking, Bulletin Vol. 19-10
- 13-0109-1903P Notice of Proclamation of Rulemaking, Bulletin Vol. 19-10
- 13-0109-1902 Adoption of Pending Rule, Bulletin Vol. 20-1 (PLR 2020)
- 13-0109-2001P Notice of Proclamation of Rulemaking, Bulletin Vol. 20-2

**13.01.10, Rules Governing the Importation, Possession, Release, Sale, or Salvage of Wildlife**

- 13-0110-1901 Notice of Intent to Promulgate Rules - Negotiated Rulemaking, Bulletin Vol. 19-6
- 13-0110-1901 Proposed Rulemaking, Bulletin Vol. 19-9
- 13-0110-1901 Adoption of Pending Rule, Bulletin Vol. 20-1 (PLR 2020)

**13.01.11, Rules Governing Fish**

- 13-0111-1901P Notice of Proclamation, Bulletin Vol. 19-1
- 13-0111-1902P Notice of Proclamation of Rulemaking, Bulletin Vol. 19-4
- 13-0111-1903P Notice of Proclamation of Rulemaking, Bulletin Vol. 19-8
- 13-0111-1901AP Notice of Amended Proclamation of Rulemaking, Bulletin Vol. 19-10
- 13-0111-1904P Notice of Proclamation of Rulemaking, Bulletin Vol. 19-10
- 13-0111-1901AAP\* Notice of Amended Proclamation of Rulemaking, Bulletin Vol. 19-11 (\*2nd Amendment)
- 13-0111-1905P Notice of Proclamation of Rulemaking, Bulletin Vol. 19-11
- 13-0111-1901AAAAP\* Notice of Amended Proclamation of Rulemaking, Bulletin Vol. 19-12 (\*3rd Amendment)
- 13-0111-1901AAAAAP\* Notice of Amended Proclamation of Rulemaking, Bulletin Vol. 20-2 (\*4th Amendment)
- 13-0111-1901AAAAAAP\* Notice of Amended Proclamation of Rulemaking, Bulletin Vol. 20-5 (\*5th Amendment)
- 13-0111-2001P Notice of Proclamation of Rulemaking, Bulletin Vol. 20-5

**13.01.14, Rules Governing Falconry**

- 13-0114-1901P Notice of Proclamation of Rulemaking, Bulletin Vol. 19-4

**13.01.16, The Trapping of Predatory and Unprotected Wildlife and the Taking of Furbearing Animals**

- 13-0116-2001P Notice of Proclamation of Rulemaking, Bulletin Vol. 20-2

**13.01.17, Rules Governing the Use of Bait and Trapping for Taking Big Game Animals**

- 13-0117-1901 Notice of Intent to Promulgate Rules - Negotiated Rulemaking, Bulletin Vol. 19-6
- 13-0117-1901 Proposed Rulemaking, Bulletin Vol. 19-10
- 13-0117-1901 Adoption of Pending Rule, Bulletin Vol. 20-1 (PLR 2020)

**BOARD OF REGISTRATION OF PROFESSIONAL GEOLOGISTS**

*Moved and Re-designated*) - Rules of the Board of Registration of Professional Geologists (This chapter has been re-designated from IDAPA 14.01.01 to IDAPA 24.04.01 under the Division of Occupational and Professional Licenses - See IDAPA 24 in this Index.)

**IDAPA 15 – OFFICE OF THE GOVERNOR**

**Executive Orders of the Governor**

- Executive Order No. 2019-01 Licensing Freedom Act of 2019, Bulletin Vol. 19-2

Executive Order No. <a href="#">2019-02</a>	Red Tape Reduction Act, Bulletin Vol. 19-2
Executive Order No. <a href="#">2019-03</a>	Regional Government Efficiency Working Group, Bulletin Vol. 19-6
Executive Order No. <a href="#">2019-04</a>	Idaho Medal of Achievement, Bulletin Vol. 19-11
Executive Order No. <a href="#">2019-05</a>	Governor's Leadership In Nuclear Energy (LINE) Commission, Bulletin Vol. 19-11
Executive Order No. <a href="#">2019-06</a>	Continuing the Board of Juvenile Corrections, as the Primary Advisory Body for the Governor and Director of the Department of Juvenile Corrections on Matters Pertaining to Juvenile Corrections, Bulletin Vol. 19-11
Executive Order No. <a href="#">2019-07</a>	Idaho Broadband Task Force, Bulletin Vol. 19-11
Executive Order No. <a href="#">2019-08</a>	Continuing the Workforce Development Council for Planning and Oversight of the State's Workforce Development System Amending Executive Order 2017-13, Bulletin Vol. 19-11
Executive Order No. <a href="#">2019-09</a>	Combating the Opioid and Substance Use Disorder Crisis, Bulletin Vol. 19-11
Executive Order No. <a href="#">2019-10</a>	Organization of the Lewis and Clark Trail Committee, Bulletin Vol. 19-11
Executive Order No. <a href="#">2019-11</a>	Establishing the Governor's Commission on Service and Volunteerism, Bulletin Vol. 19-11
Executive Order No. <a href="#">2019-12</a>	Reviewing the Preparation and Administration of Idaho's Plan Under the Juvenile Justice and Delinquency Act; Repealing and Replacing Executive Order 2015-11, Bulletin Vol. 19-11
Executive Order No. <a href="#">2019-13</a>	Transportation of Hemp, Bulletin Vol. 20-1
Executive Order No. <a href="#">2020-01</a>	Zero-Based Regulation, Bulletin Vol. 20-2
Executive Order No. <a href="#">2020-02</a>	Transparency In Agency Guidance Documents, Bulletin Vol. 20-2
Executive Order No. <a href="#">2020-03</a>	Families First Act, Bulletin Vol. 20-4
Executive Order No. <a href="#">2020-04</a>	Creating the Idaho Behavioral Health Council, Bulletin Vol. 20-4
Executive Order No. <a href="#">2020-05</a>	Temporary Reduction of General Fund Spending Authority, Bulletin Vol. 20-4
Executive Order No. <a href="#">2020-06</a>	Authorizing the Transfer of Funds to the Disaster Emergency Account, Bulletin Vol. 20-4

### **Idaho Commission On Aging**

- [15-0100-1900](#) *Rules of the Idaho Commission on Aging* - Notice of Omnibus Rulemaking - Temporary and Proposed Rulemaking, Reauthorizes Title 01, Chapters 01-03, 20, 30 -- Bulletin Vol. 19-6SE (eff. 6-30-19)T
- [15-0100-1900](#) Notice of Omnibus Rulemaking - Notice of Public Hearing, Bulletin Vol. 19-9
- [15-0100-1900](#) *Rules of the Idaho Commission on Aging* - Notice of Omnibus Rulemaking - Adoption of Pending Rule, Bulletin Vol. 19-11SE (PLR 2020)

### **Idaho Commission for the Blind and Visually Impaired**

- [15-0200-1900](#) *Rules of the Idaho Commission for the Blind and Visually Impaired* - Notice of Omnibus Rulemaking - Temporary and Proposed Rulemaking, Reauthorizes Title 02, Chapters 02-04, 30 -- Bulletin Vol. 19-6SE (eff. 6-30-19)T
- [15-0200-1900](#) *Rules of the Idaho Commission for the Blind and Visually Impaired* - Notice of Omnibus Rulemaking - Adoption of Pending Rule, Bulletin Vol. 19-11SE (PLR 2020)

### **Idaho Forest Products Commission**

- [15-0300-2000F](#) *Rules of the Idaho Forest Products Commission* – Notice of Omnibus Rulemaking – Adoption of Temporary (Fee) Rule – Reauthorizes Title 03, Chapter 01 – Bulletin Vol. 20-4SE (eff. 3-20-20)T
- [15-0300-1900F](#) *Rules of the Idaho Forest Products Commission* - Notice of Omnibus Rulemaking - Temporary and Proposed Rulemaking, Reauthorizes Title 03, Chapter 01 -- Bulletin Vol. 19-6SE (eff. 6-30-19)T
- [15-0300-1900F](#) *Rules of the Idaho Forest Products Commission* - Notice of Omnibus Rulemaking - Adoption of Pending Fee Rule, Bulletin Vol. 19-11SE (PLR 2020)

### **Division of Human Resources and Personnel Commission**

- [15-0400-1900](#) *Rules of the Division of Human Resources and Personnel Commission* - Notice of Omnibus Rulemaking - Temporary and Proposed Rulemaking, Reauthorizes Title 04, Chapter 01 -- Bulletin Vol. 19-6SE (eff. 6-30-19)T
- [15-0400-1900](#) *Rules of the Division of Human Resources and Personnel Commission* - Notice of Omnibus Rulemaking - Adoption of Pending Rule, Bulletin Vol. 19-11SE (PLR 2020)

### **15.04.01, Rules of DHR & Idaho Personnel Commission**

- [15-0401-2001](#) Adoption of Temporary Rule, Bulletin Vol. 20-4 (eff. 3-25-20)T

### **Idaho Military Division**

- 15-0600-2000F** *Rules of the Idaho Military Division* – Notice of Omnibus Rulemaking – Adoption of Temporary (Fee) Rule – Reauthorizes Title 06, Chapter 03 – Bulletin Vol. 20-4SE (eff. 3-20-20)T
- 15-0600-1900** *Rules of the Idaho Military Division* - Notice of Omnibus Rulemaking - Temporary and Proposed Rulemaking, Reauthorizes Title 06, Chapters 01-02, 04-06 -- Bulletin Vol. 19-6SE (eff. 6-30-19)T
- 15-0600-1900** *Rules of the Idaho Military Division* - Notice of Omnibus Rulemaking - Adoption of Pending Rule, Bulletin Vol. 19-11SE (PLR 2020)
- 15-0600-1900F** *Rules of the Idaho Military Division* - Notice of Omnibus Rulemaking - Temporary and Proposed Fee Rulemaking, Reauthorizes Title 06, Chapter 03 -- Bulletin Vol. 19-6SE (eff. 6-30-19)T
- 15-0600-1900F** *Rules of the Idaho Military Division* - Notice of Omnibus Rulemaking - Adoption of Fee Pending Rule, Bulletin Vol. 19-11SE (PLR 2020)

### **Idaho State Liquor Division**

- 15-1000-2000F** *Rules of the Idaho State Liquor Division* – Notice of Omnibus Rulemaking – Adoption of Temporary (Fee) Rule – Reauthorizes Title 10, Chapter 01 – Bulletin Vol. 20-4SE (eff. 3-20-20)T
- 15-1000-1900F** *Rules of the Idaho State Liquor Division* - Notice of Omnibus Rulemaking - Temporary and Proposed Fee Rulemaking, Reauthorizes Title 10, Chapter 01 -- Bulletin Vol. 19-6SE (eff. 6-30-19)T
- 15-1000-1900F** *Rules of the Idaho State Liquor Division* - Notice of Omnibus Rulemaking - Adoption of Fee Pending Rule, Bulletin Vol. 19-11SE (PLR 2020)

## ***IDAPA 16 – DEPARTMENT OF HEALTH AND WELFARE***

- 16-0000-2000F** *Rules of the Department of Health and Welfare* – Notice of Omnibus Rulemaking – Adoption of Temporary (Fee) Rule – Reauthorizes Title 01, Chapter 07; Title 02, Chapters 01, 08, 13, 14, 25-27; Title 03, Chapters 03, 18, 19, 22; Title 04, Chapter 07; Title 05, Chapter 06; Title 06, Chapters 01, 02; Title 07, Chapter 01 – Bulletin Vol. 20-4SE (eff. 3-20-20)T
- 16-0000-1900** *Rules of the Department of Health and Welfare* - Notice of Omnibus Rulemaking - Temporary and Proposed Rulemaking, Reauthorizes Title 01, Chapters 01-06, 12; Title 02, Chapters 02, 06, 10-12, 15, 19, 23-24; Title 03, Chapters 01-02, 04-11, 13-14, 17, 20-21, 23-25; Title 04, Chapters 10, 13-14, 16-17; Title 05, Chapters 01, 03-04, 07; Title 06, Chapters 05, 12-13; Title 07, Chapters 17, 19, 25, 33, 37, 39 -- Bulletin Vol. 19-6SE (eff. 6-30-19)T
- 16-0000-1900** *Rules of the Department of Health and Welfare* - Notice of Public Hearing, Bulletin 19-8
- 16-0000-1900** *Rules of the Department of Health and Welfare* - Notice of Omnibus Rulemaking - Adoption of Pending Rule, Bulletin Vol. 19-11SE (PLR 2020)
- 16-0000-1900F** *Rules of the Department of Health and Welfare* - Notice of Omnibus Rulemaking - Temporary and Proposed Fee Rulemaking, Reauthorizes Title 01, Chapter 07; Title 02, Chapters 01, 08, 13-14, 25-27; Title 03, Chapters 03, 18, 19, 22; Title 04, Chapters 07, 08; Title 05, Chapter 06; Title 06, Chapters 01-02; Title 07, Chapters 01, 15 -- Bulletin Vol. 19-6SE (eff. 6-30-19)T
- 16-0000-1900F** *Rules of the Department of Health and Welfare* - Notice of Public Hearing, Bulletin 19-8
- 16-0000-1900F** *Rules of the Department of Health and Welfare* - Notice of Omnibus Rulemaking - Adoption of Fee Pending Rule, Bulletin Vol. 19-11SE (PLR 2020)

### ***16.01.02, Emergency Medical Services (EMS) - Rule Definitions***

- 16-0102-1901** Proposed Rulemaking, Bulletin Vol. 19-9
- 16-0102-1901** Adoption of Pending Rule, Bulletin Vol. 20-1 (PLR 2020)

### ***16.01.03, Emergency Medical Services (EMS) – Agency Licensing Requirements***

- 16-0103-1901** Notice of Intent to Promulgate a Rule – Negotiated Rulemaking, Bulletin Vol. 19-5
- 16-0103-1901** Proposed Rulemaking, Bulletin Vol. 19-9
- 16-0103-1901** Adoption of Pending Rule, Bulletin Vol. 20-1 (PLR 2020)

### ***16.01.07, Emergency Medical Services (EMS) – Personnel Licensing Requirements***

- 16-0107-1901** Notice of Intent to Promulgate a Rule – Negotiated Rulemaking, Bulletin Vol. 19-5
- 16-0107-1901** Proposed Rulemaking, Bulletin Vol. 19-9

16-0107-1901 Adoption of Pending Rule, Bulletin Vol. 20-1 (PLR 2020)

**16.02.01, Rules of the Idaho Time Sensitive Emergency System Council**

16-0201-1901 Notice of Intent to Promulgate a Rule – Negotiated Rulemaking, Bulletin Vol. 19-7

16-0201-1901 Proposed Rulemaking, Bulletin Vol. 19-10

16-0201-1901 Adoption of Pending Rule, Bulletin Vol. 20-1 (PLR 2020)

**16.02.02, Rules of the Idaho Emergency Medical Services (EMS) Physician Commission**

16-0202-1901 Proposed Rulemaking, Bulletin Vol. 19-10

16-0202-1901 Adoption of Pending Rule, Bulletin Vol. 20-1 (PLR 2020)

**16.02.04, Syringe and Needle Exchange Program**

16-0204-1901 Notice of Intent to Promulgate Rules - Negotiated Rulemaking (New Chapter), Bulletin Vol. 19-6

**16.02.08, Vital Statistics Rules (Rule Null and Void)**

16-0208-1901 Temporary and Proposed Rulemaking, Bulletin Vol. 19-7 (eff. 7-1-19)T

16-0208-1901 Notice of Public Hearing, Bulletin 19-9

16-0208-1901 Notice of Rescission of Temporary Rule and Vacation of Proposed Rulemaking, Bulletin Vol. 20-1 (eff. 11-14-19)

**16.02.14, Rules Governing Construction and Operation of Public Swimming Pools in Idaho**

16-0214-1901 Proposed Rulemaking, Bulletin Vol. 19-10

16-0214-1901 Notice of Vacation of Proposed Rulemaking, Bulletin Vol. 20-1

**16.03.01, Eligibility for Health Care Assistance for Families and Children**

16-0301-1901 Temporary and Proposed Rulemaking, Bulletin Vol. 19-10 (eff. 1-1-20)T

16-0301-1901 Adoption of Pending Rule, Bulletin Vol. 20-1 (PLR 2020)

**16.03.09, Medicaid Basic Plan Benefits**

16-0309-1803 Notice of Intent to Promulgate a Rule – Negotiated Rulemaking, Bulletin Vol. 18-7

16-0309-1803 Temporary and Proposed Rulemaking, Bulletin Vol. 19-7 (eff. 7-1-19)T

16-0309-1803 Adoption of Pending Rule, Bulletin Vol. 20-1 (PLR 2020)

16-0309-2001 Adoption of Temporary Rule, Bulletin Vol. 20-1 (eff. 1-1-20)T

16-0309-2002 Adoption of Temporary Rule, Bulletin Vol. 20-4 (eff. 3-20-20)T

16-0309-2003 Adoption of Temporary Rule, Bulletin Vol. 20-4 (eff. 3-13-20)T

**16.03.10, Medicaid Enhanced Plan Benefits**

16-0310-1704\* 4th Notice of Intent to Promulgate Rules - Negotiated Rulemaking, Bulletin Vol. 19-6

16-0310-1806 Notice of Intent to Promulgate a Rule – Negotiated Rulemaking, Bulletin Vol. 18-7

16-0310-1806 Temporary and Proposed Rulemaking, Bulletin Vol. 19-7 (eff. 7-1-19)T

16-0310-1704\* Proposed Rulemaking, Bulletin Vol. 19-10

16-0310-1704\* Notice of Vacation of Proposed Rulemaking, Bulletin Vol. 20-01

16-0310-1806 Adoption of Pending Rule, Bulletin Vol. 20-1 (PLR 2020)

16-0310-2001 Adoption of Temporary Rule, Bulletin Vol. 20-4 (eff. 3-13-20)T

**16.03.13, Consumer-Directed Services**

16-0313-2001 Adoption of Temporary Rule, Bulletin Vol. 20-4 (eff. 3-13-20)T

**16.03.18, Medicaid Cost-Sharing**

16-0318-1901 Notice of Intent to Promulgate Rules - Negotiated Rulemaking, Bulletin Vol. 19-6

16-0318-1901 Proposed Rulemaking, Bulletin Vol. 19-10

16-0318-1901 Adoption of Pending Rule and Adoption of Temporary Rule, Bulletin Vol. 20-1 (PLR 2020) / (eff. 1-1-20)T

**16.03.19, Rules Governing Certified Family Homes**

16-0319-1901 Notice of Intent to Promulgate a Rule – Negotiated Rulemaking, Bulletin Vol. 19-5

16-0319-1901 Proposed Rulemaking, Bulletin Vol. 19-9

**16-0319-1901** Adoption of Pending Rule, Bulletin Vol. 20-1 (PLR 2020)

***16.03.22, Residential Care or Assisted Living Facilities in Idaho***

**16-0322-1901** Notice of Intent to Promulgate a Rule – Negotiated Rulemaking, Bulletin Vol. 19-7

**16-0322-1901** Proposed Rulemaking, Bulletin Vol. 19-9

**16-0322-1901** Adoption of Pending Rule, Bulletin Vol. 20-1 (PLR 2020)

***16.05.04, Rules of the Idaho Council on Domestic Violence and Victim Assistance Grant Funding***

**16-0504-1901** Notice of Intent to Promulgate a Rule – Negotiated Rulemaking, Bulletin Vol. 19-7

**16-0504-1901** Proposed Rulemaking, Bulletin Vol. 19-10

**16-0504-1901** Adoption of Pending Rule, Bulletin Vol. 20-1 (PLR 2020)

***16.05.06, Criminal History and Background Checks***

**16-0506-1901** OARC Omnibus Notice of Legislative Action-Extension of Temporary Rule by SCR 114, Bulletin Vol. 19-5 (eff. 1-1-19)T

**16-0506-1902** Notice of Intent to Promulgate Rules - Negotiated Rulemaking, Bulletin Vol. 19-6

**16-0506-1901** Proposed Rulemaking, Bulletin Vol. 19-9

**16-0506-1902** Proposed Rulemaking, Bulletin Vol. 19-9

**16-0506-1901** Adoption of Pending Rule, Bulletin Vol. 20-1 (PLR 2020)

**16-0506-1902** Adoption of Pending Rule, Bulletin Vol. 20-1 (PLR 2020)

***16.06.12, Rules Governing the Idaho Child Care Program (ICCP)***

**16-0612-1901** Proposed Rulemaking, Bulletin Vol. 19-10

**16-0612-1901** Adoption of Pending Rule, Bulletin Vol. 20-1 (PLR 2020)

***IDAPA 17 – INDUSTRIAL COMMISSION***

**17-0000-2000F** *Rules of the Idaho Industrial Commission* – Notice of Omnibus Rulemaking – Adoption of Temporary (Fee) Rule – Reauthorizes Title 01, Chapter 01 – Bulletin Vol. 20-4SE (eff. 3-20-20)T

**17-0000-1900** *Rules of the Idaho Industrial Commission* - Notice of Omnibus Rulemaking - Temporary and Proposed Rulemaking, Reauthorizes Title 10, Chapter 01; Title 11, Chapter 01 -- Bulletin Vol. 19-6SE (eff. 6-30-19)T

**17-0000-1900** *Rules of the Idaho Industrial Commission* - Notice of Omnibus Rulemaking - Adoption of Pending Rule, Bulletin Vol. 19-11SE (PLR 2020)

**17-0000-1900F** *Rules of the Idaho Industrial Commission* - Notice of Omnibus Rulemaking - Temporary and Proposed Fee Rulemaking, Reauthorizes Title 01, Chapter 01 -- Bulletin Vol. 19-6SE (eff. 6-30-19)T

**17-0000-1900F** *Rules of the Idaho Industrial Commission* - Notice of Omnibus Rulemaking - Adoption of Pending Fee Rule, Bulletin Vol. 19-11SE (PLR 2020)

***IDAPA 18 – DEPARTMENT OF INSURANCE***

**18-0000-2000F** *Rules of the Idaho Department of Insurance* – Notice of Omnibus Rulemaking – Adoption of Temporary (Fee) Rule – Reauthorizes Title 01, Chapter 02; Title 08, Chapter 02 – Bulletin Vol. 20-4SE (eff. 3-20-20)T

**18-0000-1900\*** *Rules of the Idaho Department of Insurance* - Notice of Omnibus Rulemaking - Temporary and Proposed Rulemaking, Reauthorizes and Re-designates Title 01, Chapter 01; Title 02, Chapters 01-03; Title 03, Chapters 01-05; Title 04, Chapters 01-15; Title 05, Chapters 01-03; Title 06, Chapters 01-06; Title 07, Chapters 01-12; Title 08, Chapter 01 -- Bulletin Vol. 19-6SE (eff. 6-30-19)T

**18-0000-1900\*** *Rules of the Idaho Department of Insurance* - Notice of Omnibus Rulemaking - Adoption of Pending Rule, Bulletin Vol. 19-11SE (PLR 2020)

**18-0000-1900F\*** *Rules of the Idaho Department of Insurance* - Notice of Omnibus Rulemaking - Temporary and Proposed Fee Rulemaking, Reauthorizes and Re-designates Title 01, Chapter 02; Title 08, Chapter 02 --- Bulletin Vol. 19-6SE (eff. 6-30-19)T

**18-0000-1900F\*** *Rules of the Idaho Department of Insurance* - Notice of Omnibus Rulemaking - Adoption of Pending Fee Rule, Bulletin Vol. 19-11SE (PLR 2020)



\*These chapters indexed under IDAPA 18 are re-designated with new Title and Chapter numbers as follows:

New Designation [Old Designation]: 18.01.01 [18.01.48]; 18.01.02 [18.01.44]; 18.02.01 [18.01.19]; 18.02.02 [18.01.20]; 18.02.03 [18.01.34]; 18.03.01 [18.01.09]; 18.03.02 [18.01.13]; 18.03.03 [18.01.16]; 18.03.04 [18.01.41]; 18.03.05 [18.01.61]; 18.04.01 [18.01.05]; 18.04.02 [18.01.06]; 18.04.03 [18.01.24]; 18.04.04 [18.01.26]; 18.04.05 [18.01.27]; 18.04.06 [18.01.28]; 18.04.07 [18.01.29]; 18.04.08 [18.01.30]; 18.04.09 [18.01.31]; 18.04.10 [18.01.54]; 18.04.11 [18.01.60]; 18.4.12 [18.01.69]; 18.04.13 [18.01.70]; 18.04.14 [18.01.72]; 18.04.15 [18.01.77]; 18.05.01 [18.01.01]; 18.05.02 [18.01.25]; 18.05.03 [18.01.56]; 18.06.01 [18.01.04]; 18.06.02 [18.01.10]; 18.06.03 [18.01.52]; 18.06.04 [18.01.53]; 18.06.05 [18.01.64]; 18.06.06 [18.01.65]; 18.07.01 [18.01.23]; 18.07.02 [18.01.46]; 18.07.03 [18.01.47]; 18.07.04 [18.01.62]; 18.07.05 [18.01.66]; 18.07.06 [18.01.67]; 18.07.07 [18.01.68]; 18.07.08 [18.01.75]; 18.07.09 [18.01.76]; 18.07.10 [18.01.77]; 18.07.11 [18.01.78]; 18.07.12 [18.01.81]; 18.08.01 [18.01.50]; 18.08.02 [18.01.49]

#### **18.04.08, [18.01.30] Individual Disability and Group Supplemental Disability Insurance Minimum Standards Rule**

- 18-0408-1901** Notice of Intent to Promulgate a Rule – Negotiated Rulemaking, Bulletin Vol. 19-8
- 18-0408-1901** Proposed Rulemaking, Bulletin Vol. 19-10
- 18-0408-1901** Adoption of Pending Rule, Bulletin Vol. 20-1 (PLR 2020)

#### **18.04.16, Rules Governing Short-Term Health Insurance Coverage**

- 18-0416-1901** Notice of Intent to Promulgate a Rule – Negotiated Rulemaking (New Chapter), Bulletin Vol. 19-7
- 18-0416-1902** Adoption of Temporary Rule (New Chapter), Bulletin Vol. 19-8 (eff. 7-1-19)T
- 18-0416-1901** Proposed Rulemaking (New Chapter), Bulletin Vol. 19-10
- 18-0416-1901** Adoption of Pending Rule (New Chapter), Bulletin Vol. 20-1 (PLR 2020)

#### **18.06.06, [18.01.65] Rules for the Surplus Lines Brokers**

- 18-0606-1901** Notice of Intent to Promulgate a Rule – Negotiated Rulemaking, Bulletin Vol. 19-8
- 18-0606-1901** Proposed Rulemaking, Bulletin Vol. 19-10
- 18-0606-1901** Adoption of Pending Rule, Bulletin Vol. 20-1 (PLR 2020)

### **IDAPA 19 – BOARD OF DENTISTRY**

**19-0101-2000F** *Rules of the Idaho State Board of Dentistry* – Notice of Omnibus Rulemaking – Adoption of Temporary (Fee) Rule – Reauthorizes Title 01, Chapter 01 – Bulletin Vol. 20-4SE (eff. 3-20-20)T

**19-0101-1900F** *Rules of the Idaho State Board of Dentistry* - Notice of Omnibus Rulemaking - Temporary and Proposed Fee Rulemaking, Reauthorizes Title 01, Chapter 01 -- Bulletin Vol. 19-6SE (eff. 6-30-19)T

**19-0101-1900F** *Rules of the Idaho State Board of Dentistry* - Notice of Public Hearing (Omnibus Fee Rulemaking), Bulletin Vol. 19-8

**19-0101-1900F** *Rules of the Idaho State Board of Dentistry* - Notice of Omnibus Rulemaking - Adoption of Pending Fee Rule, Bulletin Vol. 19-11SE (PLR 2020)

#### **19.01.01, Rules of the Idaho State Board of Dentistry**

- 19-0101-1901** Notice of Intent to Promulgate a Rule – Negotiated Rulemaking, Bulletin Vol. 19-7
- 19-0101-1901** Temporary and Proposed Rulemaking (Fee Rule), Bulletin Vol. 19-9 (eff. 7-27-19)T
- 19-0101-1901** Adoption of Pending Fee Rule, Bulletin Vol. 19-12 (PLR 2020)

### **IDAPA 20 – DEPARTMENT OF LANDS**

**20-0000-2000F** *Rules of the Idaho Department of Lands* – Notice of Omnibus Rulemaking – Adoption of Temporary (Fee) Rule – Reauthorizes Title 02, Chapter 14; Title 03, Chapters 01-05, 08, 09, 13-17; Title 04, Chapter 02; Title 06, Chapter 01; Title 07, Chapter 02 – Bulletin Vol. 20-4SE (eff. 3-20-20)T

**20-0000-1900** *Rules of the Idaho Department of Lands* - Notice of Omnibus Rulemaking - Temporary and Proposed Rulemaking, Reauthorizes Title 01, Chapter 01; Title 02, Chapter 01; Title 04, Chapter 01 -- Bulletin Vol. 19-6SE (eff. 6-30-19)T

**20-0000-1900** *Rules of the Idaho Department of Lands* - Notice of Public Hearing (Omnibus Rulemaking), Bulletin Vol. 19-8

**20-0000-1900** *Rules of the Idaho Department of Lands* - Notice of Omnibus Rulemaking - Adoption of Pending Rule, Bulletin Vol. 19-11SE (PLR 2020)

**20-0000-1900F** *Rules of the Idaho Department of Lands* - Notice of Omnibus Rulemaking - Temporary and Proposed Fee Rulemaking, Reauthorizes Title 02, Chapter 14; Title 03, Chapters 01-05, 08, 09, 13-17; Title 04, Chapter 02; Title 06, Chapter 01; Title 07, Chapter 02 -- Bulletin Vol. 19-6SE (eff. 6-30-19)T

**20-0000-1900F** *Rules of the Idaho Department of Lands* - Notice of Public Hearing (Omnibus Fee Rulemaking), Bulletin Vol. 19-8

**20-0000-1900F** *Rules of the Idaho Department of Lands* - Notice of Omnibus Rulemaking - Adoption of Pending Fee Rule, Bulletin Vol. 19-11SE (PLR 2020)

### **20.03.02, Rules Governing Mined Land Reclamation**

**20-0302-1901** Notice of Intent to Promulgate a Rule – Negotiated Rulemaking, Bulletin Vol. 19-5

**20-0302-1902\*** Adoption of Temporary Rule (Fee Rule), Bulletin Vol. 19-9 (eff. 7-16-19)T

(\*Temporary Rulemaking changes chapter name to: “Rules Governing Mined Land Reclamation”  
from: “Rules Governing Exploration, Surface Mining, and Closure of Cyanidation Facilities”)

**20-0302-1901** 2nd Notice of Intent to Promulgate a Rule – Negotiated Rulemaking, Bulletin Vol. 19-10

**20-0302-2001** Notice of Intent to Promulgate a Rule – Negotiated Rulemaking (New Chapter), Bulletin Vol. 20-5

### **20.03.03, Rules Governing Administration of the Reclamation Fund**

**20-0303-1901** Notice of Intent to Promulgate Rules - Negotiated Rulemaking, Bulletin Vol. 19-6

**20-0303-1901** Proposed Rulemaking, Bulletin Vol. 19-9

**20-0303-1901** Adoption of Pending Rule, Bulletin Vol. 19-12 (PLR 2020)

### **20.03.04, Rules Governing the Regulation of Beds, Waters, and Airspace Over Navigable Lakes in the State of Idaho**

**20-0304-1901** Notice of Intent to Promulgate Rules - Negotiated Rulemaking, Bulletin Vol. 19-6

**20-0304-1901** Proposed Rulemaking (Fee Rule), Bulletin Vol. 19-9

**20-0304-1901** Adoption of Pending Fee Rule, Bulletin Vol. 19-12 (PLR 2020)

## **IDAPA 21 -- DIVISION OF VETERANS SERVICES**

**21-0000-2000F** *Rules of the Division of Veterans Services* – Notice of Omnibus Rulemaking – Adoption of Temporary (Fee) Rule – Reauthorizes Title 01, Chapters 01, 04 – Bulletin Vol. 20-4SE (eff. 3-20-20)T

**21-0000-1900** *Rules of the Division of Veterans Services* - Notice of Omnibus Rulemaking - Temporary and Proposed Rulemaking, Reauthorizes Title 01, Chapter 06 -- Bulletin Vol. 19-6SE (eff. 6-30-19)T

**21-0000-1900** *Rules of the Division of Veterans Services* - Notice of Omnibus Rulemaking - Adoption of Pending Rule, Bulletin Vol. 19-11SE (PLR 2020)

**21-0000-1900F** *Rules of the Division of Veterans Services* - Notice of Omnibus Rulemaking - Temporary and Proposed Fee Rulemaking, Reauthorizes Title 01, Chapters 01, 04 -- Bulletin Vol. 19-6SE (eff. 6-30-19)T

**21-0000-1900F** *Rules of the Division of Veterans Services* - Notice of Omnibus Rulemaking - Adoption of Pending Fee Rule, Bulletin Vol. 19-11SE (PLR 2020)

## **IDAPA 22 – BOARD OF MEDICINE**

**22-0000-2000F** *Rules of the Idaho Board of Medicine* – Notice of Omnibus Rulemaking – Adoption of Temporary (Fee) Rule – Reauthorizes Title 01, Chapters 01, 03, 07, 10, 11, 13 – Bulletin Vol. 20-4SE (eff. 3-20-20)T

**22-0000-1900** *Rules of the Idaho Board of Medicine* - Notice of Omnibus Rulemaking - Temporary and Proposed Rulemaking, Reauthorizes Title 01, Chapter 05 -- Bulletin Vol. 19-6SE (eff. 6-30-19)T

**22-0000-1900** Notice of Public Hearing (Omnibus Rulemaking), Bulletin Vol. 19-8

**22-0000-1900** *Rules of the Idaho Board of Medicine* - Notice of Omnibus Rulemaking - Adoption of Pending Rule, Bulletin Vol. 19-11SE (PLR 2020)

**22-0000-1900F** *Rules of the Idaho Board of Medicine* - Notice of Omnibus Rulemaking - Temporary and Proposed Fee Rulemaking, Reauthorizes Title 01, Chapters 01, 03, 10, 11, 13 -- Bulletin Vol. 19-6SE (eff. 6-30-19)T

**22-0000-1900F** Notice of Public Hearing (Omnibus Fee Rulemaking), Bulletin Vol. 19-8

**22-0000-1900F** *Rules of the Idaho Board of Medicine* - Notice of Omnibus Rulemaking - Adoption of Pending Fee Rule, Bulletin Vol. 19-11SE (PLR 2020)

### **22.01.07, Rules for the Licensure of Naturopathic Medical Doctors**

**22-0000-2000F** *Rules of the Idaho Board of Medicine* – Notice of Omnibus Rulemaking – Adoption of Temporary (Fee) Rule – Reauthorizes Title 01, Chapters 01, 03, 07, 10, 11, 13 – Bulletin Vol. 20-4SE (eff. 3-20-20)T

**22-0107-1901** Notice of Intent to Promulgate Rules - Negotiated Rulemaking (New Chapter), Bulletin Vol. 19-8

**22-0107-1901** Proposed Rulemaking (New Chapter, Fee Rule), Bulletin Vol. 19-11

**22-0107-1901** Adoption of Pending Rule (New Chapter), Bulletin Vol. 20-1 (PLR 2020)

## **IDAPA 23 – BOARD OF NURSING**

**23-0101-2000F** *Rules of the Idaho Board of Nursing* – Notice of Omnibus Rulemaking – Adoption of Temporary (Fee) Rule – Reauthorizes Title 01, Chapter 01 – Bulletin Vol. 20-4SE (eff. 3-20-20)T

**23-0101-1900F** *Rules of the Idaho Board of Nursing* - Notice of Omnibus Rulemaking - Temporary and Proposed Fee Rulemaking, Reauthorizes Title 01, Chapter 01 -- Bulletin Vol. 19-6SE (eff. 6-30-19)T

**23-0101-1900F** Notice of Public Hearing (Omnibus Fee Rulemaking), Bulletin Vol. 19-9

**23-0101-1900F** *Rules of the Idaho Board of Medicine* - Notice of Omnibus Rulemaking - Adoption of Pending Fee Rule, Bulletin Vol. 19-11SE (PLR 2020)

### **23.01.01, Rules of the Idaho Board of Nursing**

**23-0101-1901** Notice of Intent to Promulgate Rules - Negotiated Rulemaking, Bulletin Vol. 19-6

**23-0101-1901** Proposed Rulemaking, Bulletin Vol. 19-10

**23-0101-1901** Adoption of Pending Rule, Bulletin Vol. 19-12 (PLR 2020)

## **IDAPA 24 – DIVISION OF OCCUPATIONAL AND PROFESSIONAL LICENSES**

**24-0101-2000F** *Rules of the Board of Architectural Examiners* – Notice of Omnibus Rulemaking – Adoption of Temporary (Fee) Rule – Reauthorizes Title 01, Chapter 01 – Bulletin Vol. 20-4SE (eff. 3-20-20)T

**24-0101-1900F** *Rules of the Board of Architectural Examiners* - Notice of Omnibus Rulemaking - Temporary and Proposed Fee Rulemaking, Reauthorizes Title 01, Chapter 01 -- Bulletin Vol. 19-6SE (eff. 6-30-19)T

**24-0101-1900F** *Rules of the Board of Architectural Examiners* - Notice of Omnibus Rulemaking - Adoption of Pending Fee Rule, Bulletin Vol. 19-11SE (PLR 2020)

**24-0201-2000F** *Rules of the State Athletic Commission* – Notice of Omnibus Rulemaking – Adoption of Temporary (Fee) Rule – Reauthorizes Title 02, Chapter 01 – Bulletin Vol. 20-4SE (eff. 3-20-20)T

**24-0201-1900F\*** *Rules of the State Athletic Commission* - Notice of Omnibus Rulemaking - Temporary and Proposed Fee Rulemaking - Reauthorizes re-designated Title 02, Chapter 01 -- Bulletin Vol. 19-6SE (eff. 6-30-19)T

\*(Re-designated from IDAPA 03.01.01 to 24.02.01)

**24-0201-1900F\*** *Rules of the State Athletic Commission* - Notice of Omnibus Rulemaking - Adoption of Pending Fee Rule, Bulletin Vol. 19-11SE (PLR 2020)

**24-0301-2000F** *Rules of the State Board of Chiropractic Physicians* – Notice of Omnibus Rulemaking – Adoption of Temporary (Fee) Rule – Reauthorizes Title 03, Chapter 01 – Bulletin Vol. 20-4SE (eff. 3-20-20)T

**24-0301-1900F** *Rules of the State Board of Chiropractic Physicians* - Notice of Omnibus Rulemaking - Temporary and Proposed Fee Rulemaking, Reauthorizes Title 03, Chapter 01 -- Bulletin Vol. 19-6SE (eff. 6-30-19)T

**24-0301-1900F** *Rules of the State Board of Chiropractic Physicians* - Notice of Omnibus Rulemaking - Adoption of Pending Fee Rule, Bulletin Vol. 19-11SE (PLR 2020)

**24-0401-2000F** *Rules of Procedure of the Board of Registration for Professional Geologists* – Notice of Omnibus Rulemaking – Adoption of Temporary (Fee) Rule – Reauthorizes Title 04, Chapter 01 – Bulletin Vol. 20-4SE (eff. 3-20-20)T

- 24-0401-1900F\*** *Rules of Procedure of the Board of Registration for Professional Geologists* - Notice of Omnibus Rulemaking - Temporary and Proposed Fee Rulemaking, Reauthorizes re-designated Title 04, Chapter 01 -- Bulletin Vol. 19-6SE (eff. 6-30-19)T  
*\*(Re-designated from IDAPA 14.01.01 to 24.04.01)*
- 24-0401-1900F\*** *Rules of Procedure of the Board of Registration for Professional Geologists* - Notice of Omnibus Rulemaking - Adoption of Pending Fee Rule, Bulletin Vol. 19-11SE (PLR 2020)
- 24-0501-2000F** *Rules of the Board of Drinking Water and Wastewater Professionals* – Notice of Omnibus Rulemaking – Adoption of Temporary (Fee) Rule – Reauthorizes Title 05, Chapter 01 – Bulletin Vol. 20-4SE (eff. 3-20-20)T
- 24-0501-1900F** *Rules of the Board of Drinking Water and Wastewater Professionals* - Notice of Omnibus Rulemaking - Temporary and Proposed Fee Rulemaking, Reauthorizes Title 05, Chapter 01 -- Bulletin Vol. 19-6SE (eff. 6-30-19)T
- 24-0501-1900F** *Rules of the Board of Drinking Water and Wastewater Professionals* - Notice of Omnibus Rulemaking - Adoption of Pending Fee Rule, Bulletin Vol. 19-11SE (PLR 2020)
- 24-0601-2000F** *Rules for the Licensure of Occupational Therapists & Occupational Therapy Assistants* – Notice of Omnibus Rulemaking – Adoption of Temporary (Fee) Rule – Reauthorizes Title 06, Chapter 01 – Bulletin Vol. 20-4SE (eff. 3-20-20)T
- 24-0601-1900F** *Rules for the Licensure of Occupational Therapists & Occupational Therapy Assistants* - Notice of Omnibus Rulemaking - Temporary and Proposed Fee Rulemaking, Reauthorizes Title 06, Chapter 01 -- Bulletin Vol. 19-6SE (eff. 6-30-19)T
- 24-0601-1900F** *Rules for the Licensure of Occupational Therapists & Occupational Therapy Assistants* - Notice of Omnibus Rulemaking - Adoption of Pending Fee Rule, Bulletin Vol. 19-11SE (PLR 2020)
- 24-0701-2000F** *Rules of the Idaho State Board of Landscape Architects* – Notice of Omnibus Rulemaking – Adoption of Temporary (Fee) Rule – Reauthorizes Title 07, Chapter 01 – Bulletin Vol. 20-4SE (eff. 3-20-20)T
- 24-0701-1900F** *Rules of the Idaho State Board of Landscape Architects* - Notice of Omnibus Rulemaking - Temporary and Proposed Fee Rulemaking, Reauthorizes Title 07, Chapter 01 -- Bulletin Vol. 19-6SE (eff. 6-30-19)T
- 24-0701-1900F** *Rules of the Idaho State Board of Landscape Architects* - Notice of Omnibus Rulemaking - Adoption of Pending Fee Rule, Bulletin Vol. 19-11SE (PLR 2020)
- 24-0801-2000F** *Rules of the State Board of Morticians* – Notice of Omnibus Rulemaking – Adoption of Temporary (Fee) Rule – Reauthorizes Title 08, Chapter 01 – Bulletin Vol. 20-4SE (eff. 3-20-20)T
- 24-0801-1900F** *Rules of the State Board of Morticians* - Notice of Omnibus Rulemaking - Temporary and Proposed Fee Rulemaking, Reauthorizes Title 08, Chapter 01 -- Bulletin Vol. 19-6SE (eff. 6-30-19)T
- 24-0801-1900F** *Rules of the State Board of Morticians* - Notice of Omnibus Rulemaking - Adoption of Pending Fee Rule, Bulletin Vol. 19-11SE (PLR 2020)
- 24-0901-2000F** *Rules of the Board of Examiners of Nursing Home Administrators* – Notice of Omnibus Rulemaking – Adoption of Temporary (Fee) Rule – Reauthorizes Title 09, Chapter 01 – Bulletin Vol. 20-4SE (eff. 3-20-20)T
- 24-0901-1900F** *Rules of the Board of Examiners of Nursing Home Administrators* - Notice of Omnibus Rulemaking - Temporary and Proposed Fee Rulemaking, Reauthorizes Title 09, Chapter 01 -- Bulletin Vol. 19-6SE (eff. 6-30-19)T
- 24-0901-1900F** *Rules of the Board of Examiners of Nursing Home Administrators* -Notice of Omnibus Rulemaking - Adoption of Pending Fee Rule, Bulletin Vol. 19-11SE (PLR 2020)
- 24-1001-2000F** *Rules of the Board of Optometry* – Notice of Omnibus Rulemaking – Adoption of Temporary (Fee) Rule – Reauthorizes Title 10, Chapter 01 – Bulletin Vol. 20-4SE (eff. 3-20-20)T
- 24-1001-1900F** *Rules of the Board of Optometry* - Notice of Omnibus Rulemaking - Temporary and Proposed Fee Rulemaking, Reauthorizes Title 10, Chapter 01 -- Bulletin Vol. 19-6SE (eff. 6-30-19)T
- 24-1001-1900F** *Rules of the Board of Optometry* - Notice of Omnibus Rulemaking - Adoption of Pending Fee Rule, Bulletin Vol. 19-11SE (PLR 2020)
- 24-1101-2000F** *Rules of the State Board of Podiatry* – Notice of Omnibus Rulemaking – Adoption of Temporary (Fee) Rule – Reauthorizes Title 11, Chapter 01 – Bulletin Vol. 20-4SE (eff. 3-20-20)T
- 24-1101-1900F** *Rules of the State Board of Podiatry* - Notice of Omnibus Rulemaking - Temporary and Proposed Fee Rulemaking, Reauthorizes Title 11, Chapter 01 -- Bulletin Vol. 19-6SE (eff. 6-30-19)T
- 24-1101-1900F** *Rules of the State Board of Podiatry* - Notice of Omnibus Rulemaking - Adoption of Pending Fee Rule, Bulletin Vol. 19-11SE (PLR 2020)
- 24-1201-2000F** *Rules of the Idaho State Board of Psychological Examiners* – Notice of Omnibus Rulemaking – Adoption of Temporary (Fee) Rule – Reauthorizes Title 12, Chapter 01 – Bulletin Vol. 20-4SE (eff. 3-20-20)T

- 24-1201-1900F** *Rules of the Idaho State Board of Psychological Examiners* - Notice of Omnibus Rulemaking - Temporary and Proposed Fee Rulemaking, Reauthorizes Title 12, Chapter 01 -- Bulletin Vol. 19-6SE (eff. 6-30-19)T
- 24-1201-1900F** *Rules of the State Board of Psychological Examiners* - Notice of Omnibus Rulemaking - Adoption of Pending Fee Rule, Bulletin Vol. 19-11SE (PLR 2020)
- 24-1301-2000F** *Rules Governing the Physical Therapy Licensure Board* – Notice of Omnibus Rulemaking – Adoption of Temporary (Fee) Rule – Reauthorizes Title 13, Chapter 01 – Bulletin Vol. 20-4SE (eff. 3-20-20)T
- 24-1301-1900F** *Rules Governing the Physical Therapy Licensure Board* - Notice of Omnibus Rulemaking - Temporary and Proposed Fee Rulemaking, Reauthorizes Title 13, Chapter 01 -- Bulletin Vol. 19-6SE (eff. 6-30-19)T
- 24-1301-1900F** *Rules Governing the Physical Therapy Licensure Board* - Notice of Omnibus Rulemaking - Adoption of Pending Fee Rule, Bulletin Vol. 19-11SE (PLR 2020)
- 24-1401-2000F** *Rules of the State Board of Social Work Examiners* – Notice of Omnibus Rulemaking – Adoption of Temporary (Fee) Rule – Reauthorizes Title 14, Chapter 01 – Bulletin Vol. 20-4SE (eff. 3-20-20)T
- 24-1401-1900F** *Rules of the State Board of Social Work Examiners* - Notice of Omnibus Rulemaking - Temporary and Proposed Fee Rulemaking, Reauthorizes Title 14, Chapter 01 -- Bulletin Vol. 19-6SE (eff. 6-30-19)T
- 24-1401-1900F** *Rules of the State Board of Social Work Examiners* - Notice of Omnibus Rulemaking - Adoption of Pending Fee Rule, Bulletin Vol. 19-11SE (PLR 2020)
- 24-1501-2000F** *Rules of the Idaho Licensing Board of Professional Counselors and Marriage and Family Therapists*-Notice of Omnibus Rulemaking-Adoption of Temporary (Fee) Rule-Reauthorizes Title 15, Chapter 01 – Bulletin Vol. 20-4SE (eff. 3-20-20)T
- 24-1501-1900F** *Rules of the Idaho Licensing Board of Professional Counselors and Marriage and Family Therapists*-Notice of Omnibus Rulemaking - Temporary and Proposed Fee Rulemaking, Reauthorizes Title 15, Chapter 01 -- Bulletin Vol. 19-6SE (eff. 6-30-19)T
- 24-1501-1900F** *Rules of the Idaho Licensing Board of Professional Counselors and Marriage and Family Therapists* - Notice of Omnibus Rulemaking - Adoption of Pending Fee Rule, Bulletin Vol. 19-11SE (PLR 2020)
- 24-1601-2000F** *Rules of the State Board of Dentistry* – Notice of Omnibus Rulemaking – Adoption of Temporary (Fee) Rule – Reauthorizes Title 16, Chapter 01 – Bulletin Vol. 20-4SE (eff. 3-20-20)T
- 24-1601-1900F** *Rules of the State Board of Dentistry* - Notice of Omnibus Rulemaking - Temporary and Proposed Fee Rulemaking, Reauthorizes Title 16, Chapter 01 -- Bulletin Vol. 19-6SE (eff. 6-30-19)T
- 24-1601-1900F** *Rules of the State Board of Dentistry* - Notice of Omnibus Rulemaking - Adoption of Pending Fee Rule, Bulletin Vol. 19-11SE (PLR 2020)
- 24-1701-2000F** *Rules of the State Board of Acupuncture* – Notice of Omnibus Rulemaking – Adoption of Temporary (Fee) Rule – Reauthorizes Title 17, Chapter 01 – Bulletin Vol. 20-4SE (eff. 3-20-20)T
- 24-1701-1900F** *Rules of the State Board of Acupuncture* - Notice of Omnibus Rulemaking - Temporary and Proposed Fee Rulemaking, Reauthorizes Title 17, Chapter 01 -- Bulletin Vol. 19-6SE (eff. 6-30-19)T
- 24-1701-1900F** *Rules of the State Board of Acupuncture* - Notice of Omnibus Rulemaking - Adoption of Pending Fee Rule, Bulletin Vol. 19-11SE (PLR 2020)
- 24-1801-2000F** *Rules of the Real Estate Appraiser Board* – Notice of Omnibus Rulemaking – Adoption of Temporary (Fee) Rule – Reauthorizes Title 18, Chapter 01 – Bulletin Vol. 20-4SE (eff. 3-20-20)T
- 24-1801-1900F** *Rules of the Real Estate Appraiser Board* - Notice of Omnibus Rulemaking - Temporary and Proposed Fee Rulemaking, Reauthorizes Title 18, Chapter 01 -- Bulletin Vol. 19-6SE (eff. 6-30-19)T
- 24-1801-1900F** *Rules of the Real Estate Appraiser Board* - Notice of Omnibus Rulemaking - Adoption of Pending Fee Rule, Bulletin Vol. 19-11SE (PLR 2020)
- 24-1901-2000F** *Rules of the Board of Examiners of Residential Care Facility Administrators* – Notice of Omnibus Rulemaking – Adoption of Temporary (Fee) Rule – Reauthorizes Title 19, Chapter 01 – Bulletin Vol. 20-4SE (eff. 3-20-20)T
- 24-1901-1900F** *Rules of the Board of Examiners of Residential Care Facility Administrators* - Notice of Omnibus Rulemaking - Temporary and Proposed Fee Rulemaking, Reauthorizes Title 19, Chapter 01 -- Bulletin Vol. 19-6SE (eff. 6-30-19)T
- 24-1901-1900F** *Rules of the Board of Examiners of Residential Care Facility Administrators* - Notice of Omnibus Rulemaking - Adoption of Pending Fee Rule, Bulletin Vol. 19-11SE (PLR 2020)
- 24-2001-1900** *Rules of the Bureau of Occupational Licenses* - Notice of Omnibus Rulemaking - Temporary and Proposed Rulemaking, Reauthorizes Title 20, Chapter 01 -- Bulletin Vol. 19-6SE (eff. 6-30-19)T

- 24-2001-1900** *Rules of the Bureau of Occupational Licenses* - Notice of Omnibus Rulemaking - Adoption of Pending Rule, Bulletin Vol. 19-11SE (PLR 2020)
- 24-2101-2000F** *Rules of the Idaho State Contractors Board* – Notice of Omnibus Rulemaking – Adoption of Temporary (Fee) Rule – Reauthorizes Title 21, Chapter 01 – Bulletin Vol. 20-4SE (eff. 3-20-20)T
- 24-2101-1900F** *Rules of the Idaho State Contractors Board* - Notice of Omnibus Rulemaking - Temporary and Proposed Fee Rulemaking, Reauthorizes Title 21, Chapter 01 -- Bulletin Vol. 19-6SE (eff. 6-30-19)T
- 24-2101-1900F** *Rules of the Idaho State Contractors Board* - Notice of Omnibus Rulemaking - Adoption of Pending Fee Rule, Bulletin Vol. 19-11SE (PLR 2020)
- 24-2201-2000F** *Rules of the Idaho State Liquefied Petroleum Gas Safety Board* – Notice of Omnibus Rulemaking – Adoption of Temporary (Fee) Rule – Reauthorizes Title 22, Chapter 01 – Bulletin Vol. 20-4SE (eff. 3-20-20)T
- 24-2201-1900F** *Rules of the Idaho State Liquefied Petroleum Gas Safety Board* - Notice of Omnibus Rulemaking - Temporary and Proposed Fee Rulemaking, Reauthorizes Title 22, Chapter 01 -- Bulletin Vol. 19-6SE (eff. 6-30-19)T
- 24-2201-1900F** *Rules of the Idaho State Liquefied Petroleum Gas Safety Board* - Notice of Omnibus Rulemaking - Adoption of Pending Fee Rule, Bulletin Vol. 19-11SE (PLR 2020)
- 24-2301-2000F** *Rules of the Speech, Hearing and Communication Services Licensure Board* – Notice of Omnibus Rulemaking – Adoption of Temporary (Fee) Rule – Reauthorizes Title 23, Chapter 01 – Bulletin Vol. 20-4SE (eff. 3-20-20)T
- 24-2301-1900F** *Rules of the Speech, Hearing and Communication Services Licensure Board* - Notice of Omnibus Rulemaking - Temporary and Proposed Fee Rulemaking, Reauthorizes Title 23, Chapter 01 -- Bulletin Vol. 19-6SE (eff. 6-30-19)T
- 24-2301-1900F** *Rules of the Speech, Hearing and Communication Services Licensure Board* - Notice of Omnibus Rulemaking - Adoption of Pending Fee Rule, Bulletin Vol. 19-11SE (PLR 2020)
- 24-2401-2000F** *Rules of the Genetic Counselors Licensing Board* – Notice of Omnibus Rulemaking – Adoption of Temporary (Fee) Rule – Reauthorizes Title 24, Chapter 01 – Bulletin Vol. 20-4SE (eff. 3-20-20)T
- 24-2401-1900F** *Rules of the Genetic Counselors Licensing Board* - Notice of Omnibus Rulemaking - Temporary and Proposed Fee Rulemaking, Reauthorizes Title 24, Chapter 01 -- Bulletin Vol. 19-6SE (eff. 6-30-19)T
- 24-2401-1900F** *Rules of the Genetic Counselors Licensing Board* - Notice of Omnibus Rulemaking - Adoption of Pending Fee Rule, Bulletin Vol. 19-11SE (PLR 2020)
- 24-2501-2000F** *Rules of the Idaho Driving Businesses Licensure Board* – Notice of Omnibus Rulemaking – Adoption of Temporary (Fee) Rule – Reauthorizes Title 25, Chapter 01 – Bulletin Vol. 20-4SE (eff. 3-20-20)T
- 24-2501-1900F** *Rules of the Idaho Driving Businesses Licensure Board* - Notice of Omnibus Rulemaking - Temporary and Proposed Fee Rulemaking, Reauthorizes Title 25, Chapter 01 -- Bulletin Vol. 19-6SE (eff. 6-30-19)T
- 24-2501-1900F** *Rules of the Idaho Driving Businesses Licensure Board* - Notice of Omnibus Rulemaking - Adoption of Pending Fee Rule, Bulletin Vol. 19-11SE (PLR 2020)
- 24-2601-2000F** *Rules of the Idaho Board of Midwifery* – Notice of Omnibus Rulemaking – Adoption of Temporary (Fee) Rule – Reauthorizes Title 26, Chapter 01 – Bulletin Vol. 20-4SE (eff. 3-20-20)T
- 24-2601-1900F** *Rules of the Idaho Board of Midwifery* - Notice of Omnibus Rulemaking - Temporary and Proposed Fee Rulemaking, Reauthorizes Title 26, Chapter 01 -- Bulletin Vol. 19-6SE (eff. 6-30-19)T
- 24-2601-1900F** *Rules of the Idaho Board of Midwifery* - Notice of Omnibus Rulemaking - Adoption of Pending Fee Rule, Bulletin Vol. 19-11SE (PLR 2020)
- 24-2701-2000F** *Rules of the Idaho State Board of Massage Therapy* – Notice of Omnibus Rulemaking – Adoption of Temporary (Fee) Rule – Reauthorizes Title 27, Chapter 01 – Bulletin Vol. 20-4SE (eff. 3-20-20)T
- 24-2701-1900F** *Rules of the Idaho State Board of Massage Therapy* - Notice of Omnibus Rulemaking - Temporary and Proposed Fee Rulemaking, Reauthorizes Title 27, Chapter 01 -- Bulletin Vol. 19-6SE (eff. 6-30-19)T
- 24-2701-1900F** *Rules of the Idaho State Board of Massage Therapy* - Notice of Omnibus Rulemaking - Adoption of Pending Fee Rule, Bulletin Vol. 19-11SE (PLR 2020)
- 24-2801-2000F** *Rules of the Barber and Cosmetology Services Licensing Board* – Notice of Omnibus Rulemaking – Adoption of Temporary (Fee) Rule – Reauthorizes Title 28, Chapter 01 – Bulletin Vol. 20-4SE (eff. 3-20-20)T
- 24-2801-1900F** *Rules of the Barber and Cosmetology Services Licensing Board* - Notice of Omnibus Rulemaking - Temporary and Proposed Fee Rulemaking, Reauthorizes Title 28, Chapter 01 -- Bulletin Vol. 19-6SE (eff. 6-30-19)T

**24-2801-1900F** *Rules of the Barber and Cosmetology Services Licensing Board* - Notice of Omnibus Rulemaking - Adoption of Pending Fee Rule, Bulletin Vol. 19-11SE (PLR 2020)

**24-2901-2000F** *Rules of Procedure of the Idaho Certified Shorthand Reporters Board* – Notice of Omnibus Rulemaking – Adoption of Temporary (Fee) Rule – Reauthorizes Title 29, Chapter 01 – Bulletin Vol. 20-4SE (eff. 3-20-20)T

**24-2901-1900F\*** *Rules of Procedure of the Idaho Certified Shorthand Reporters Board* - Notice of Omnibus Rulemaking - Temporary and Proposed Fee Rulemaking, Reauthorizes re-designated Title 29, Chapter 01 -- Bulletin Vol. 19-6SE (eff. 6-30-19)T  
*\*(Re-designated from IDAPA 49.01.01 to 24.29.01)*

**24-2901-1900F\*** *Rules of Procedure of the Idaho Certified Shorthand Reporters Board* - Notice of Omnibus Rulemaking - Adoption of Pending Fee Rule, Bulletin Vol. 19-11SE (PLR 2020)

#### ***24.02.01, Rules of the State Athletic Commission***

**24-0201-2000F** *Rules of the State Athletic Commission* – Notice of Omnibus Rulemaking – Adoption of Temporary (Fee) Rule – Reauthorizes Title 02, Chapter 01 – Bulletin Vol. 20-4SE (eff. 3-20-20)T

**24-0201-2001** Notice of Intent to Promulgate Rules - Negotiated Rulemaking, Bulletin Vol. 20-4

#### ***24.08.01, Rules of the State Board of Morticians***

**24-0801-2000F** *Rules of the State Board of Morticians* – Notice of Omnibus Rulemaking – Adoption of Temporary (Fee) Rule – Reauthorizes Title 08, Chapter 01 – Bulletin Vol. 20-4SE (eff. 3-20-20)T

**24-0801-2001** Notice of Intent to Promulgate Rules - Negotiated Rulemaking, Bulletin Vol. 20-4

#### ***24.12.01, Rules of the Idaho State Board of Psychologist Examiners***

**24-1201-2000F** *Rules of the Idaho State Board of Psychological Examiners* – Notice of Omnibus Rulemaking – Adoption of Temporary (Fee) Rule – Reauthorizes Title 12, Chapter 01 – Bulletin Vol. 20-4SE (eff. 3-20-20)T

**24-1201-2001** Notice of Intent to Promulgate Rules - Negotiated Rulemaking, Bulletin Vol. 20-4

#### ***24.13.01, Rules Governing the Physical Therapy Licensure Board***

**24-1301-2000F** *Rules Governing the Physical Therapy Licensure Board* – Notice of Omnibus Rulemaking – Adoption of Temporary (Fee) Rule – Reauthorizes Title 13, Chapter 01 – Bulletin Vol. 20-4SE (eff. 3-20-20)T

**24-1301-2001** Notice of Intent to Promulgate Rules - Negotiated Rulemaking, Bulletin Vol. 20-4

#### ***24.20.01, Rules of the Division of Occupational and Professional Licenses***

**24-2001-2001** Notice of Intent to Promulgate Rules - Negotiated Rulemaking, Bulletin Vol. 20-4

#### ***24.25.01, Rules of the Idaho Driving Businesses Licensure Board***

**24-2501-2000F** *Rules of the Idaho Driving Businesses Licensure Board* – Notice of Omnibus Rulemaking – Adoption of Temporary (Fee) Rule – Reauthorizes Title 25, Chapter 01 – Bulletin Vol. 20-4SE (eff. 3-20-20)T

**24-2501-2001** Notice of Intent to Promulgate Rules - Negotiated Rulemaking, Bulletin Vol. 20-4

#### ***24.28.01, Rules of the Barber and Cosmetology Services Licensing Board***

**24-2801-2000F** *Rules of the Barber and Cosmetology Services Licensing Board* – Notice of Omnibus Rulemaking – Adoption of Temporary (Fee) Rule – Reauthorizes Title 28, Chapter 01 – Bulletin Vol. 20-4SE (eff. 3-20-20)T

**24-2801-2001** Notice of Intent to Promulgate Rules - Negotiated Rulemaking, Bulletin Vol. 20-4

### ***IDAPA 25 – OUTFITTERS AND GUIDES LICENSING BOARD***

**25-0101-2000F** *Rules of the Outfitters and Guides Licensing Board* – Notice of Omnibus Rulemaking – Adoption of Temporary (Fee) Rule – Reauthorizes Title 01, Chapter 01 – Bulletin Vol. 20-4SE (eff. 3-20-20)T

- 25-0101-1900F** *Rules of the Outfitters and Guides Licensing Board* - Notice of Omnibus Rulemaking - Temporary and Proposed Fee Rulemaking, Reauthorizes Title 01, Chapter 01 -- Bulletin Vol. 19-6SE (eff. 6-30-19)T
- 25-0101-1900F** *Rules of the Outfitters and Guides Licensing Board* - Notice of Public Hearing for Omnibus Fee Rule, Bulletin Vol. 19-9
- 25-0101-1900F** *Rules of the Outfitters and Guides Licensing Board* - Notice of Omnibus Rulemaking - Adoption of Pending Fee Rule, Bulletin Vol. 19-11SE (PLR 2020)

**25.01.01, Rules of the Outfitters and Guides Licensing Board**

- 25-0101-1901** Notice of Intent to Promulgate Rules - Negotiated Rulemaking, Bulletin Vol. 19-6
- 25-0101-1902\*** *Adoption of Temporary Rule, Bulletin Vol. 19-6 (eff. 4-26-19)T & (5-22-19)T (\*Expired 7-1-19)*
- 25-0101-2001** Notice of Intent to Promulgate Rules - Negotiated Rulemaking, Bulletin Vol. 20-3

**IDAPA 26 – DEPARTMENT OF PARKS AND RECREATION**

- 26-0000-2000F** *Rules of the Department of Parks and Recreation* – Notice of Omnibus Rulemaking – Adoption of Temporary (Fee) Rule – Reauthorizes Title 01, Chapters 10, 20, 33 – Bulletin Vol. 20-4SE (eff. 3-20-20)T
- 26-0000-1900** *Rules of the Department of Parks and Recreation* - Notice of Omnibus Rulemaking - Temporary and Proposed Rulemaking, Reauthorizes Title 01, Chapters 03, 21-22, 24, 30-31, 34, 37 -- Bulletin Vol. 19-6SE (eff. 6-30-19)T
- 26-0000-1900** *Rules of the Department of Parks and Recreation* - Notice of Omnibus Rulemaking - Adoption of Pending Rule, Bulletin Vol. 19-11SE (PLR 2020)
- 26-0000-1900F** *Rules of the Department of Parks and Recreation* - Notice of Omnibus Rulemaking - Temporary and Proposed Fee Rulemaking, Reauthorizes Title 01, Chapters 10, 20, 33, 36 -- Bulletin Vol. 19-6SE (eff. 6-30-19)T
- 26-0000-1900F** *Rules of the Department of Parks and Recreation* - Notice of Omnibus Rulemaking - Adoption of Pending Fee Rule, Bulletin Vol. 19-11SE (PLR 2020)

**26.01.20, Rules Governing the Administration of Park and Recreation Areas and Facilities**

- 26-0120-1901\*** *Notice of Intent to Promulgate Rules - Negotiated Rulemaking, Bulletin Vol. 19-7*
- 26-0120-1901\*** *Proposed Rulemaking (Fee Rule), Bulletin Vol. 19-10*
- 26-0120-1901\*** *Notice of Vacation of Proposed Rulemaking, Bulletin Vol. 20-1 (PLR 2020)*

**26.01.36, Rules Governing the Winter Recreational Parking Permit Program**

- 26-0136-1901\*** *Notice of Intent to Promulgate Rules - Negotiated Rulemaking, Bulletin Vol. 19-7*
- 26-0136-1901\*** *Proposed Rulemaking (Chapter Repeal), Bulletin Vol. 19-10*
- 26-0136-1901\*** *Notice of Vacation of Proposed Rulemaking, Bulletin Vol. 20-1 (PLR 2020)*

**IDAPA 27 – BOARD OF PHARMACY**

- 27-0101-2000F** *Rules of the Idaho Board of Pharmacy* – Notice of Omnibus Rulemaking – Adoption of Temporary (Fee) Rule – Reauthorizes Title 01, Chapter 01 – Bulletin Vol. 20-4SE (eff. 3-20-20)T
- 27-0101-1900F\*** *Rules of the Idaho Board of Pharmacy* - Notice of Omnibus Rulemaking - Temporary and Proposed Fee Rulemaking, Reauthorizes Title 01, Chapter 01 (\*This rulemaking consolidates contents from Chapters 27.01.02, 27.01.03, 27.01.04, and 27.01.05 into IDAPA 27.01.01) -- Bulletin Vol. 19-6SE (eff. 6-30-19)T
- 27-0000-1900F** *Rules of the Idaho Board of Pharmacy* - Notice of Public Hearing (Omnibus Fee Rulemaking), Bulletin 19-8
- 27-0000-1900F** *Rules of the Idaho Board of Pharmacy* - Notice of Omnibus Rulemaking - Adoption of Pending Fee Rule, Bulletin Vol. 19-11SE (PLR 2020)

**27.01.01, General Provisions**

- 27-0101-1901\*** *1st Notice of Intent to Promulgate Rules - Negotiated Rulemaking, Bulletin Vol. 19-6*
- 27-0101-1901\*** *2nd Notice of Intent to Promulgate Rules - Negotiated Rulemaking, Bulletin Vol. 19-7 (\*Rulemaking Terminated)*

**IDAPA 28 – DEPARTMENT OF COMMERCE**



**28-0000-1900** *Rules of the Idaho Department of Commerce* - Notice of Omnibus Rulemaking - Temporary and Proposed Rulemaking, Reauthorizes Title 02, Chapters 03-05, 07; Titles 03, Chapter 01; Title 04, Chapter 01 -- Bulletin Vol. 19-6SE (eff. 6-30-19)T

**28-0000-1900** *Rules of the Idaho Department of Commerce* - Notice of Omnibus Rulemaking - Adoption of Pending Rule, Bulletin Vol. 19-11SE (PLR 2020)

### ***IDAPA 29 – IDAHO POTATO COMMISSION***

**29-0000-1900** *Rules of the Idaho Potato Commission* - Notice of Omnibus Rulemaking - Temporary and Proposed Rulemaking, Reauthorizes Title 01, Chapter 01 -- Bulletin Vol. 19-6SE (eff. 6-30-19)T

**29-0000-1900** *Rules of the Idaho Potato Commission* - Notice of Omnibus Rulemaking - Adoption of Pending Rule, Bulletin Vol. 19-11SE (PLR 2020)

### ***IDAPA 30 – IDAHO COMMISSION FOR LIBRARIES***

**30-0101-1900** *Rules of the Idaho Commission for Libraries Governing the Use of Commission Services* - Notice of Omnibus Rulemaking - Temporary and Proposed Rulemaking, Reauthorizes Title 01, Chapter 01 -- Bulletin Vol. 19-6SE (eff. 6-30-19)T

**30-0101-1900** *Rules of the Idaho Commission for Libraries Governing the Use of Commission Services* - Notice of Omnibus Rulemaking - Adoption of Pending Rule, Bulletin Vol. 19-11SE (PLR 2020)

### ***IDAPA 31 – PUBLIC UTILITIES COMMISSION***

**31-0000-1900** *Rules of the Idaho Public Utilities Commission* - Notice of Omnibus Rulemaking - Temporary and Proposed Rulemaking, Reauthorizes Title 01, Chapter 01; Title 11, Chapter 01; Title 12, Chapter 01; Title 21, Chapter 01; Title 26, Chapter 01; Title 31, Chapter 01; Title 36, Chapter 01; Title 41, Chapter 01; Title 46, Chapters 01-02; Title 51, Chapter 01; Title 61, Chapter 01; Title 71, Chapters 01, 03; Title 81, Chapter 01 -- Bulletin Vol. 19-6SE (eff. 6-30-19)T

**31-0000-1900** *Rules of the Idaho Public Utilities Commission* - Notice of Public Hearing (Omnibus Rulemaking), Bulletin 19-8

**31-0000-1900** *Rules of the Idaho Public Utilities Commission* - Notice of Omnibus Rulemaking - Adoption of Pending Rule, Bulletin Vol. 19-11SE (PLR 2020)

### ***IDAPA 32 – ENDOWMENT FUND INVESTMENT BOARD***

**32-0101-2000F** *Rules of the Credit Enhancement Program for School Districts* – Notice of Omnibus Rulemaking – Adoption of Temporary (Fee) Rule – Reauthorizes Title 01, Chapter 01 – Bulletin Vol. 20-4SE (eff. 3-20-20)T

**32-0101-1900F** *Rules of the Credit Enhancement Program for School Districts* - Notice of Omnibus Rulemaking - Temporary and Proposed Rulemaking, Reauthorizes Title 01, Chapter 01 -- Bulletin Vol. 19-6SE (eff. 6-30-19)T

**32-0101-1900F** *Rules of the Credit Enhancement Program for School Districts* - Notice of Omnibus Rulemaking - Adoption of Pending Fee Rule, Bulletin Vol. 19-11SE (PLR 2020)

### ***IDAPA 33 – REAL ESTATE COMMISSION***

**33-0101-2000F** *Rules of the Idaho Real Estate Commission* – Notice of Omnibus Rulemaking – Adoption of Temporary (Fee) Rule – Reauthorizes Title 01, Chapter 01 – Bulletin Vol. 20-4SE (eff. 3-20-20)T

**33-0000-1900F** *Rules of the Idaho Real Estate Commission* - Notice of Omnibus Rulemaking - Temporary and Proposed Fee Rulemaking, Reauthorizes Title 01, Chapter 01 -- Bulletin Vol. 19-6SE (eff. 6-30-19)T

**33-0000-1900F** *Rules of the Idaho Real Estate Commission* - Notice of Omnibus Rulemaking - Adoption of Pending Fee Rule, Bulletin Vol. 19-11SE (PLR 2020)

***IDAPA 34 – SECRETARY OF STATE***

- 34-0000-2000F** *Rules of the Idaho Secretary of State* – Notice of Omnibus Rulemaking – Adoption of Temporary (Fee) Rule – Reauthorizes Title 05, Chapters 01-03, 06 – Bulletin Vol. 20-4SE (eff. 3-20-20)T
- 34-0000-1900** *Rules of the Idaho Secretary of State* - Notice of Omnibus Rulemaking - Temporary and Proposed Rulemaking, Reauthorizes Title 02, Chapter 02; Title 03, Chapter 01; Title 04, Chapter 02; Title 05, Chapter 05; Title 06, Chapter 01-02 -- Bulletin Vol. 19-6SE (eff. 6-30-19)T
- 34-0000-1900** *Rules of the Idaho Secretary of State* - Notice of Omnibus Rulemaking - Adoption of Pending Rule, Bulletin Vol. 19-11SE (PLR 2020)
- 34-0000-1900F** *Rules of the Idaho Secretary of State* - Notice of Omnibus Rulemaking - Temporary and Proposed Fee Rulemaking, Reauthorizes Title 04, Chapter 01; Title 05, Chapter 01-03, 06 -- Bulletin Vol. 19-6SE (eff. 6-30-19)T
- 34-0000-1900F** *Rules of the Idaho Secretary of State* - Notice of Omnibus Rulemaking - Adoption of Pending Fee Rule, Bulletin Vol. 19-11SE (PLR 2020)

***34.07.01, Rules Governing Notarial Acts Performed for Remotely Located Individuals***

- 34-0701-2001** Adoption of Temporary Rule (New Chapter), Bulletin Vol. 20-1 (eff. 1-1-20)T
- 34-0701-2002** Adoption of Temporary Rule (New Chapter), Bulletin Vol. 20-4 (eff. 3-20-20)T

***IDAPA 35 – STATE TAX COMMISSION***

- 35-0000-1900** *Rules of the Idaho State Tax Commission* - Notice of Omnibus Rulemaking - Temporary and Proposed Rulemaking, Reauthorizes Title 01, Chapters 01-03, 05-10, 12, 14; Title 02, Chapter 01 -- Bulletin Vol. 19-6SE (eff. 6-30-19)T
- 35-0000-1900** *Rules of the Idaho State Tax Commission* - Notice of Omnibus Rulemaking - Adoption of Pending Rule, Bulletin Vol. 19-11SE (PLR 2020)

***35.01.01, Income Tax Administrative Rules***

- 35-0101-1901\*** *Adoption of Temporary Rule, Bulletin Vol. 19-2 (eff. 1-4-19)T (\*Temporary rule expired 7-1-19)*
- 35-0101-1901** OARC Omnibus Notice of Legislative Action - Extension of Temporary Rule - SCR 113, Bulletin Vol. 19-5 (eff. 1-4-19)T
- 35-0101-1902** Notice of Intent to Promulgate Rules - Negotiated Rulemaking, Bulletin Vol. 19-6
- 35-0101-1903** Proposed Rulemaking, Bulletin Vol. 19-7
- 35-0101-1902** Proposed Rulemaking, Bulletin Vol. 19-8
- 35-0101-1904** Proposed Rulemaking, Bulletin Vol. 19-8
- 35-0101-1902** Adoption of Pending Rule, Bulletin Vol. 20-1 (PLR 2020)
- 35-0101-1903** Adoption of Pending Rule, Bulletin Vol. 20-1 (PLR 2020)
- 35-0101-1904** Adoption of Pending Rule, Bulletin Vol. 20-1 (PLR 2020)

***35.01.02, Idaho Sales and Use Tax Administrative Rules***

- 35-0102-1901\*** *Notice of Intent to Promulgate Rules - Negotiated Rulemaking, Bulletin Vol. 19-6*
- 35-0102-1902\*** *Notice of Intent to Promulgate Rules - Negotiated Rulemaking, Bulletin Vol. 19-6*
- 35-0102-1903** Notice of Intent to Promulgate Rules - Negotiated Rulemaking, Bulletin Vol. 19-6
- 35-0102-1904\*** *Notice of Intent to Promulgate Rules - Negotiated Rulemaking, Bulletin Vol. 19-6*
- 35-0102-1905** Notice of Intent to Promulgate Rules - Negotiated Rulemaking, Bulletin Vol. 19-6
- 35-0102-1906** Notice of Intent to Promulgate Rules - Negotiated Rulemaking, Bulletin Vol. 19-6
- 35-0102-1907** Notice of Intent to Promulgate Rules - Negotiated Rulemaking, Bulletin Vol. 19-7
- 35-0102-1901\*** *Proposed Rulemaking, Bulletin Vol. 19-8*
- 35-0102-1902\*** *Proposed Rulemaking, Bulletin Vol. 19-8*
- 35-0102-1903** Proposed Rulemaking, Bulletin Vol. 19-8
- 35-0102-1904\*** *Proposed Rulemaking, Bulletin Vol. 19-8*
- 35-0102-1901\*** *Notice of Vacation of Proposed Rulemaking, Bulletin Vol. 19-10*
- 35-0102-1902\*** *Notice of Vacation of Proposed Rulemaking, Bulletin Vol. 19-10*
- 35-0102-1904\*** *Notice of Vacation of Proposed Rulemaking, Bulletin Vol. 19-10*
- 35-0102-1903** Adoption of Pending Rule, Bulletin Vol. 20-1 (PLR 2020)

**35.01.03, Property Tax Administrative Rules**

- 35-0103-1901 Notice of Intent to Promulgate Rules - Negotiated Rulemaking, Bulletin Vol. 19-6
- 35-0103-1902 Notice of Intent to Promulgate Rules - Negotiated Rulemaking, Bulletin Vol. 19-6
- 35-0103-1903 Notice of Intent to Promulgate Rules - Negotiated Rulemaking, Bulletin Vol. 19-6
- 35-0103-1904 Notice of Intent to Promulgate Rules - Negotiated Rulemaking, Bulletin Vol. 19-6
- 35-0103-1905 Notice of Intent to Promulgate Rules - Negotiated Rulemaking, Bulletin Vol. 19-6
- 35-0103-1906 Notice of Intent to Promulgate Rules - Negotiated Rulemaking, Bulletin Vol. 19-6
- 35-0103-1907\* *Adoption of Temporary Rule, Bulletin Vol. 19-6 (eff. 1-1-19)T>(\*Temporary rule expired 7-1-19)*
- 35-0103-1908 Notice of Intent to Promulgate Rules - Negotiated Rulemaking, Bulletin Vol. 19-7
- 35-0103-1901 Proposed Rulemaking, Bulletin Vol. 19-8
- 35-0103-1909 Notice of Intent to Promulgate Rules - Negotiated Rulemaking, Bulletin Vol. 19-8
- 35-0103-1910 Notice of Intent to Promulgate Rules - Negotiated Rulemaking, Bulletin Vol. 19-8
- 35-0103-1911 Notice of Intent to Promulgate Rules - Negotiated Rulemaking, Bulletin Vol. 19-8
- 35-0103-1912 Notice of Intent to Promulgate Rules - Negotiated Rulemaking, Bulletin Vol. 19-8
- 35-0103-1913 Notice of Intent to Promulgate Rules - Negotiated Rulemaking, Bulletin Vol. 19-8
- 35-0103-1914 Notice of Intent to Promulgate Rules - Negotiated Rulemaking, Bulletin Vol. 19-8
- 35-0103-1915 Notice of Intent to Promulgate Rules - Negotiated Rulemaking, Bulletin Vol. 19-8
- 35-0103-1903 Proposed Rulemaking, Bulletin Vol. 19-9
- 35-0103-1906 Proposed Rulemaking, Bulletin Vol. 19-9
- 35-0103-1902 Proposed Rulemaking, Bulletin Vol. 19-10
- 35-0103-1904 Proposed Rulemaking, Bulletin Vol. 19-10
- 35-0103-1905 Proposed Rulemaking, Bulletin Vol. 19-10
- 35-0103-1901 Adoption of Pending Rule, Bulletin Vol. 20-1 (PLR 2020)
- 35-0103-1902 Adoption of Pending Rule, Bulletin Vol. 20-1 (PLR 2020)
- 35-0103-1903 Adoption of Pending Rule, Bulletin Vol. 20-1 (PLR 2020)
- 35-0103-1904 Adoption of Pending Rule, Bulletin Vol. 20-1 (PLR 2020)
- 35-0103-1905 Adoption of Pending Rule, Bulletin Vol. 20-1 (PLR 2020)
- 35-0103-1906 Adoption of Pending Rule, Bulletin Vol. 20-1 (PLR 2020)

**35.01.05, Motor Fuels Tax Administrative Rules**

- 35-0105-1901\* *Notice of Intent to Promulgate Rules - Negotiated Rulemaking, Bulletin Vol. 19-6*
- 35-0105-1902\* *Proposed Rulemaking, Bulletin Vol. 19-8*
- 35-0105-1901 Proposed Rulemaking, Bulletin Vol. 19-9
- 35-0105-1902\* *Notice of Vacation of Proposed Rulemaking, Bulletin Vol. 19-10*
- 35-0105-1901 Adoption of Pending Rule, Bulletin Vol. 20-1 (PLR 2020)

**35.01.06, Hotel/Motel Room and Campground Sales Tax Administrative Rules**

- 35-0106-1901 Notice of Intent to Promulgate a Rule – Negotiated Rulemaking, Bulletin Vol. 19-5

**35.01.09, Idaho County Option Kitchen and Table Wine Tax Administrative Rules**

- 35-0109-1901 Notice of Intent to Promulgate Rules - Negotiated Rulemaking (Chapter Repeal), Bulletin Vol. 19-7

**35.01.12, Idaho Beer Tax Administrative Rules**

- 35-0112-1901 Notice of Intent to Promulgate Rules - Negotiated Rulemaking (Chapter Repeal), Bulletin Vol. 19-7

**35.01.15, Idaho Beer and Wine Tax Administrative Rules**

- 35-0115-1901 Notice of Intent to Promulgate Rules - Negotiated Rulemaking (New Chapter), Bulletin Vol. 19-7

**35.02.01, Tax Commission Administration and Enforcement Rules**

- 35-0201-1901 Proposed Rulemaking, Bulletin Vol. 19-10
- 35-0201-1901 Adoption of Pending Rule, Bulletin Vol. 20-1 (PLR 2020)

**IDAPA 36 – IDAHO BOARD OF TAX APPEALS**

**36-0101-2000F** *Idaho Board of Tax Appeals Rules* – Notice of Omnibus Rulemaking – Adoption of Temporary (Fee) Rule – Reauthorizes Title 01, Chapter 01 – Bulletin Vol. 20-4SE (eff. 3-20-20)T

**36-0101-1900F** *Idaho Board of Tax Appeals Rules* - Notice of Omnibus Rulemaking - Temporary and Proposed Rulemaking, Reauthorizes Title 01, Chapter 01 -- Bulletin Vol. 19-6SE (eff. 6-30-19)T

**36-0101-1900F** *Idaho Board of Tax Appeals Rules* - Notice of Omnibus Rulemaking - Adoption of Pending Fee Rule, Bulletin Vol. 19-11SE (PLR 2020)

### ***IDAPA 37 – DEPARTMENT OF WATER RESOURCES***

**37-0000-2000F** *Rules of the Idaho Department of Water Resources* – Notice of Omnibus Rulemaking – Adoption of Temporary (Fee) Rule – Reauthorizes Title 01, Chapter 01; Title 02, Chapter 03; Title 03, Chapters 01-10 – Bulletin Vol. 20-4SE (eff. 3-20-20)T

**37-0000-1900** *Rules of the Idaho Department of Water Resources* - Notice of Omnibus Rulemaking - Temporary and Proposed Rulemaking, Reauthorizes Title 02, Chapters 01, 04; Title 03, Chapters 11, 12 -- Bulletin Vol. 19-6SE (eff. 6-30-19)T

**37-0000-1900** *Rules of the Idaho Department of Water Resources* - Notice of Public Hearing, Bulletin 19-8

**37-0000-1900** *Rules of the Idaho Department of Water Resources* - Notice of Omnibus Rulemaking - Adoption of Pending Rule, Bulletin Vol. 19-11SE (PLR 2020)

**37-0000-1900F** *Rules of the Idaho Department of Water Resources* - Notice of Omnibus Rulemaking - Temporary and Proposed Fee Rulemaking, Reauthorizes Title 01, Chapter 01; Title 02, Chapter 03; Title 03, Chapters 01-10 -- Bulletin Vol. 19-6SE (eff. 6-30-19)T

**37-0000-1900F** *Rules of the Idaho Department of Water Resources* - Notice of Public Hearing (Fee Rules), Bulletin 19-8

**37-0000-1900F** *Rules of the Idaho Department of Water Resources* - Notice of Omnibus Rulemaking - Adoption of Pending Fee Rule, Bulletin Vol. 19-11SE (PLR 2020)

### ***IDAPA 38 – IDAHO DEPARTMENT OF ADMINISTRATION***

**38-0000-2000F** *Rules of the Idaho Department of Administration* – Notice of Omnibus Rulemaking – Adoption of Temporary (Fee) Rule – Reauthorizes Title 04, Chapter 04 – Bulletin Vol. 20-4SE (eff. 3-20-20)T

**38-0000-1900** *Rules of the Idaho Department of Administration* - Notice of Omnibus Rulemaking - Temporary and Proposed Rulemaking, Reauthorizes Title 04, Chapters 06-09; Title 05, Chapters 01-02 -- Bulletin Vol. 19-6SE (eff. 6-30-19)T

**38-0000-1900** *Rules of the Idaho Department of Administration* - Notice of Omnibus Rulemaking - Adoption of Pending Rule, Bulletin Vol. 19-11SE (PLR 2020)

**38-0000-1900F** *Rules of the Idaho Department of Administration* - Notice of Omnibus Rulemaking - Temporary and Proposed Fee Rulemaking, Reauthorizes Title 04, Chapter 04 -- Bulletin Vol. 19-6SE (eff. 6-30-19)T

**38-0000-1900F** *Rules of the Idaho Department of Administration* - Notice of Omnibus Rulemaking - Adoption of Pending Fee Rule, Bulletin Vol. 19-11SE (PLR 2020)

### ***IDAPA 39 – IDAHO TRANSPORTATION DEPARTMENT***

**39-0000-2000F** *Rules of the Idaho Transportation Department* – Notice of Omnibus Rulemaking – Adoption of Temporary (Fee) Rule – Reauthorizes Title 02, Chapters 04, 05, 22, 26, 41, 60; Title 03, Chapter 03 – Bulletin Vol. 20-4SE (eff. 3-20-20)T

**39-0000-1900** *Rules of the Idaho Transportation Department* - Notice of Omnibus Rulemaking - Temporary and Proposed Rulemaking, Reauthorizes Title 02, Chapters 01-03, 05, 09, 11-12, 24, 27, 42-43, 45-46, 61, 70-73, 75-76, 80; Title 03, Chapters 01-02, 04-08, 40-44, 47-50, 60-65, 80-81; Title 04, Chapters 01-08 -- Bulletin Vol. 19-6SE (eff. 6-30-19)T

**39-0000-1900** *Rules of the Idaho Transportation Department* - Notice of Omnibus Rulemaking - Adoption of Pending Rule, Bulletin Vol. 19-11SE (PLR 2020)

**39-0000-1900** *Rules of the Idaho Transportation Department* - Notice of Correction to Notice of Omnibus Pending Rule, Bulletin Vol. 20-2 – Affecting Chapters 39.02.09 and 39.02.46 only

- 39-0000-1900F** *Rules of the Idaho Transportation Department* - Notice of Omnibus Rulemaking - Temporary and Proposed Fee Rulemaking, Reauthorizes Title 02, Chapter 04, 07, 22, 26, 41, 60; Title 03, Chapter 03 -- Bulletin Vol. 19-6SE (eff. 6-30-19)T
- 39-0000-1900F** *Rules of the Idaho Transportation Department* - Notice of Omnibus Rulemaking - Adoption of Pending Fee Rule, Bulletin Vol. 19-11SE (PLR 2020)

***Omnibus Negotiated Rulemaking – Rules Regulating Vehicles Titles***

***Chapters 39.02.05, 39.02.07, 39.02.11, 39.02.12, 39.02.24***

- 39-0200-1901** Notice of Intent to Promulgate - Omnibus Negotiated Rulemaking, Bulletin Vol. 19-7

***Omnibus Negotiated Rulemaking – Rules Regulating Commercial Motor Vehicle Permits and Registration***

***Chapters 39.02.22, 39.03.01, 39.03.05, 39.03.06***

- 39-0300-1901** Notice of Intent to Promulgate - Omnibus Negotiated Rulemaking, Bulletin Vol. 19-7

***Omnibus Negotiated Rulemaking – Traffic Signs and Right-Of-Way Rules***

***Chapters 39.03.41, 39.03.60, 39.03.61, 39.03.62, 39-03.63, 39.03.64***

- 39-0300-1902** Notice of Intent to Promulgate - Omnibus Negotiated Rulemaking, Bulletin Vol. 19-7

***39.02.03, Rules Governing Vehicle Dealer's Principle Place of Business and Claims to the Idaho Consumer Asset Recovery Fund***

- 39-0203-1901\*** Temporary and Proposed Rulemaking, Bulletin Vol. 19-10 (eff. 8-22-19)T

*\*(Rulemaking changes chapter name from: "Rules Governing Vehicle Dealer's Principle Place of Business")*

- 39-0203-1901\*** Adoption of Pending Rule, Bulletin Vol. 20-1 (PLR 2020)

***39.02.22, Rules Governing Registration and Permit Fee Administration***

- 39-0222-1901** Proposed Rulemaking, Bulletin Vol. 19-10

- 39-0222-1901** Adoption of Pending Rule, Bulletin Vol. 20-1 (PLR 2020)

***39.02.42, Temporary Vehicle Registration When Proof of Ownership Is Insufficient***

- 39-0242-1901** Notice of Intent to Promulgate - Omnibus Negotiated Rulemaking, Bulletin Vol. 19-7

- 39-0242-1901** Proposed Rulemaking, Bulletin Vol. 19-10

- 39-0242-1901** Adoption of Pending Rule, Bulletin Vol. 20-1 (PLR 2020)

***39.02.75, Rules Governing Names on Driver's Licenses and Identification Cards***

- 39-0275-1901** Notice of Intent to Promulgate - Omnibus Negotiated Rulemaking, Bulletin Vol. 19-7

- 39-0275-1901** Proposed Rulemaking, Bulletin Vol. 19-10

- 39-0275-1901** Adoption of Pending Rule, Bulletin Vol. 20-1 (PLR 2020)

***39.02.76, Rules Governing Driver's License Renewal-by-Mail and Electronic Renewal Process***

- 39-0276-1901** Notice of Intent to Promulgate - Omnibus Negotiated Rulemaking, Bulletin Vol. 19-7

- 39-0276-1901** Proposed Rulemaking, Bulletin Vol. 19-10

- 39-0276-1901** Adoption of Pending Rule, Bulletin Vol. 20-1 (PLR 2020)

***39.03.01, Rules Governing Definitions Regarding Special Permits***

- 39-0301-1901** Proposed Rulemaking, Bulletin Vol. 19-10

- 39-0301-1901** Adoption of Pending Rule, Bulletin Vol. 20-1 (PLR 2020)

***39.03.05, Rules Governing Special Permits - Oversize Non-Reducible***

- 39-0305-1901** Proposed Rulemaking, Bulletin Vol. 19-10

- 39-0305-1901** Adoption of Pending Rule, Bulletin Vol. 20-1 (PLR 2020)

***39.03.06, Rules Governing Special Permits for Extra-Length/Excess Weight, Up to 129,000 Pound Vehicle Combinations***

- 39-0306-1901** Adoption of Temporary Rules, Bulletin Vol. 19-7 (eff. 7-1-19)T

- 39-0306-1902** Proposed Rulemaking, Bulletin Vol. 19-10  
**39-0306-1902** Adoption of Pending Rule, Bulletin Vol. 20-1 (PLR 2020)

**39.03.49, Rules Governing Ignition Interlock Breath Alcohol Devices**

- 39-0349-1901** Proposed Rulemaking, Bulletin Vol. 19-7  
**39-0349-1901** Adoption of Pending Rule, Bulletin Vol. 20-1 (PLR 2020)

***IDAPA 40 – IDAHO COMMISSION ON THE ARTS***

- 40-0101-1900** *Rules of the Idaho Commission on the Arts* - Notice of Omnibus Rulemaking - Temporary and Proposed Rulemaking, Reauthorizes Title 01, Chapter 01 -- Bulletin Vol. 19-6SE (eff. 6-30-19)T  
**40-0101-1900** *Rules of the Idaho Commission on the Arts* - Notice of Omnibus Rulemaking - Adoption of Pending Rule, Bulletin Vol. 19-11SE (PLR 2020)
- 40-0101-1901** *Notice of Intent to Promulgate Rules - Negotiated Rulemaking, Bulletin Vol. 19-8*  
**40-0101-1901\*** *Proposed Rulemaking, Bulletin Vol. 19-10 (\*Combined with docket no. 40-0101-1900)*  
**40-0101-1901\*** *Notice of Vacation of Proposed Rulemaking, Bulletin Vol. 20-1*

***IDAPA 41 – PUBLIC HEALTH DISTRICTS***

- 41-0101-2000** *Rules of the Idaho Public Health Districts (Panhandle Health District #1)* – Notice of Omnibus Rulemaking – Adoption of Temporary Rule – Reauthorizes Title 01, Chapter 01 – Bulletin Vol. 20-4SE (eff. 3-20-20)T
- 41-0101-1900** *Rules of the Idaho Public Health Districts (Panhandle Health District #1)* - Notice of Omnibus Rulemaking - Temporary and Proposed Rulemaking, Reauthorizes Title 01, Chapter 01 -- Bulletin Vol. 19-6SE (eff. 6-30-19)T  
**41-0101-1900** *Rules of the Idaho Public Health Districts (Panhandle Health District #1)* - Notice of Omnibus Rulemaking - Adoption of Pending Rule, Bulletin Vol. 19-11SE (PLR 2020)

***IDAPA 42 – IDAHO WHEAT COMMISSION***

- 42-0101-2000F** *Rules of the Idaho Wheat Commission* – Notice of Omnibus Rulemaking – Adoption of Temporary (Fee) Rule – Reauthorizes Title 01, Chapter 01 – Bulletin Vol. 20-4SE (eff. 3-20-20)T
- 42-0101-1900F** *Rules of the Idaho Wheat Commission* - Notice of Omnibus Rulemaking - Temporary and Proposed Fee Rulemaking, Reauthorizes Title 01, Chapter 01 -- Bulletin Vol. 19-6SE (eff. 6-30-19)T  
**42-0101-1900F** *Rules of the Idaho Wheat Commission* - Notice of Omnibus Rulemaking - Adoption of Pending Fee Rule, Bulletin Vol. 19-11SE (PLR 2020)

***IDAPA 43 – IDAHO OILSEED COMMISSION***

- 43-0101-2000F** *Rules Governing the Idaho Oilseed Commission* – Notice of Omnibus Rulemaking – Adoption of Temporary (Fee) Rule – Reauthorizes Title 01, Chapter 01 – Bulletin Vol. 20-4SE (eff. 3-20-20)T
- 43-0101-1900F** *Rules Governing the Idaho Oilseed Commission* - Notice of Omnibus Rulemaking - Temporary and Proposed Fee Rulemaking, Reauthorizes Title 01, Chapter 01 -- Bulletin Vol. 19-6SE (eff. 6-30-19)T  
**43-0101-1900F** *Rules Governing the Idaho Oilseed Commission* - Notice of Omnibus Rulemaking - Adoption of Pending Fee Rule, Bulletin Vol. 19-11SE (PLR 2020)

***IDAPA 45 – HUMAN RIGHTS COMMISSION***

- 45-0101-1900** *Rules of the Idaho Human Rights Commission* - Notice of Omnibus Rulemaking - Temporary and Proposed Rulemaking, Reauthorizes Title 01, Chapter 01 -- Bulletin Vol. 19-6SE (eff. 6-30-19)T
- 45-0101-1900** *Rules of the Idaho Human Rights Commission* - Notice of Omnibus Rulemaking - Adoption of Pending Rule, Bulletin Vol. 19-11SE (PLR 2020)

### ***IDAPA 46 – BOARD OF VETERINARY MEDICAL EXAMINERS***

- 46-0101-2000F** *Rules of the Idaho Board of Veterinary Medicine* – Notice of Omnibus Rulemaking – Adoption of Temporary (Fee) Rule – Reauthorizes Title 01, Chapter 01 – Bulletin Vol. 20-4SE (eff. 3-20-20)T
- 46-0101-1900F** *Rules of the Idaho Board of Veterinary Medicine* - Notice of Omnibus Rulemaking - Temporary and Proposed Fee Rulemaking, Reauthorizes Title 01, Chapter 01 -- Bulletin Vol. 19-6SE (eff. 6-30-19)T
- 46-0101-1900F** *Rules of the Idaho Board of Veterinary Medicine* - Notice of Omnibus Rulemaking - Adoption of Pending Fee Rule, Bulletin Vol. 19-11SE (PLR 2020)

#### ***46.01.01, Rules of the State of Idaho Board of Veterinary Medicine***

- 46-0101-1901** Notice of Intent to Promulgate Rules - Negotiated Rulemaking, Bulletin Vol. 19-6
- 46-0101-1902** Notice of Intent to Promulgate Rules - Negotiated Rulemaking, Bulletin Vol. 19-6
- 46-0101-1902** Proposed Rulemaking (Fee Rule), Bulletin Vol. 19-10
- 46-0101-1902** Adoption of Fee Pending Rule, Bulletin Vol. 19-12 (PLR 2020)

### ***IDAPA 47 – STATE BOARD OF EDUCATION/ DIVISION OF VOCATIONAL REHABILITATION***

#### ***47.01.01, Rules Governing Vocational Rehabilitation Services***

- 47-0101-1901** Adoption of Temporary Rule (New Chapter), Bulletin Vol. 19-10 (eff. 8-29-19)T

### ***IDAPA 48 – GRAPE GROWERS AND WINE PRODUCERS COMMISSION***

- 48-0101-2000F** *Rules of the Idaho Grape Growers and Wine Producers Commission* – Notice of Omnibus Rulemaking – Adoption of Temporary (Fee) Rule – Reauthorizes Title 01, Chapter 01 – Bulletin Vol. 20-4SE (eff. 3-20-20)T
- 48-0101-1900F** *Rules of the Idaho Grape Growers and Wine Producers Commission* - Notice of Omnibus Rulemaking - Temporary and Proposed Fee Rulemaking, Reauthorizes Title 01, Chapter 01 -- Bulletin Vol. 19-6SE (eff. 6-30-19)T
- 48-0101-1900F** *Rules of the Idaho Grape Growers and Wine Producers Commission* - Notice of Omnibus Rulemaking - Adoption of Pending Fee Rule, Bulletin Vol. 19-11SE (PLR 2020)

### ***CERTIFIED SHORTHAND REPORTERS BOARD***

***(Moved and Re-designated)*** - *Rules of Procedure of the Idaho Board of Certified Shorthand Reporters* (This chapter has been re-designated from *IDAPA 49.01.01* to *IDAPA 24.29.01* under the Division of Occupational and Professional Licenses - See IDAPA 24 in this Index.)

### ***IDAPA 50 – COMMISSION FOR PARDONS AND PAROLE***

- 50-0101-1900** *Rules of the Commission of Pardons and Parole* - Notice of Omnibus Rulemaking - Temporary and Proposed Rulemaking, Reauthorizes Title 01, Chapter 01 -- Bulletin Vol. 19-6SE (eff. 6-30-19)T
- 50-0101-1900** *Rules of the Commission of Pardons and Parole* - Notice of Omnibus Rulemaking - Notice of Public Hearing, Bulletin Vol. 19-10
- 50-0101-1900** *Rules of the Commission of Pardons and Parole* - Notice of Omnibus Rulemaking - Adoption of Pending Rule - Bulletin Vol. 19-11SE (PLR 2020)
- 50-0101-2001** Adoption of Temporary Rule, Bulletin Vol. 20-3 (eff. 1-13-20)T

### ***IDAPA 51 – IDAHO BEEF COUNCIL***

- 51-0101-2000F** *Rules of the Idaho Beef Council* – Notice of Omnibus Rulemaking – Adoption of Temporary (Fee) Rule – Reauthorizes Title 01, Chapter 01 – Bulletin Vol. 20-4SE (eff. 3-20-20)T
- 51-0101-1900F** *Rules of the Idaho Beef Council* - Notice of Omnibus Rulemaking - Temporary and Proposed Fee Rulemaking, Reauthorizes Title 01, Chapter 01 -- Bulletin Vol. 19-6SE (eff. 6-30-19)T
- 51-0101-1900F** *Rules of the Idaho Beef Council* - Notice of Omnibus Rulemaking - Adoption of Pending Fee Rule, Bulletin Vol. 19-11SE (PLR 2020)

### ***IDAPA 52 – IDAHO STATE LOTTERY COMMISSION***

- 52-0103-2000F** *Rules of the Idaho State Lottery Commission* – Notice of Omnibus Rulemaking – Adoption of Temporary (Fee) Rule – Reauthorizes Title 01, Chapter 03 – Bulletin Vol. 20-4SE (eff. 3-20-20)T
- 52-0000-1900F** *Rules of the Idaho State Lottery Commission* - Notice of Omnibus Rulemaking - Temporary and Proposed Fee Rulemaking, Reauthorizes Title 01, Chapters 02-03 -- Bulletin Vol. 19-6SE (eff. 6-30-19)T
- 52-0000-1900F** *Rules of the Idaho State Lottery Commission* - Notice of Omnibus Rulemaking - Adoption of Pending Fee Rule, Bulletin Vol. 19-11SE (PLR 2020) (\*Rulemaking consolidates IDAPA 52.01.02 into IDAPA 52.01.03)

### ***IDAPA 53 – IDAHO BARLEY COMMISSION***

- 53-0101-2000F** *Rules of the Idaho Barley Commission* – Notice of Omnibus Rulemaking – Adoption of Temporary (Fee) Rule – Reauthorizes Title 01, Chapter 01 – Bulletin Vol. 20-4SE (eff. 3-20-20)T
- 53-0101-1900F** *Rules of the Idaho Barley Commission* - Notice of Omnibus Rulemaking - Temporary and Proposed Fee Rulemaking, Reauthorizes Title 01, Chapter 01 -- Bulletin Vol. 19-6SE (eff. 6-30-19)T
- 53-0101-1900F** *Rules of the Idaho Barley Commission* - Notice of Omnibus Rulemaking - Adoption of Pending Fee Rule, Bulletin Vol. 19-11SE (PLR 2020)

### ***IDAPA 54 – OFFICE OF THE STATE TREASURER***

- 54-0000-1900** *Rules of the Idaho State Treasurer* - Notice of Omnibus Rulemaking - Temporary and Proposed Rulemaking, Reauthorizes Title 02, Chapter 01; Title 03, Chapter 01 -- Bulletin Vol. 19-6SE (eff. 6-30-19)T
- 54-0000-1900** *Rules of the Idaho State Treasurer* - Notice of Omnibus Rulemaking - Adoption of Pending Rule, Bulletin Vol. 19-11SE (PLR 2020)

### ***IDAPA 55 – DIVISION OF CAREER TECHNICAL EDUCATION***

- 55-0000-1900** *Rules of the Idaho Division of Career Technical Education* - Notice of Omnibus Rulemaking - Temporary and Proposed Rulemaking, Reauthorizes Title 01, Chapters 03-04 -- Bulletin Vol. 19-6SE (eff. 6-30-19)T
- 55-0000-1900** *Rules of the Idaho Division of Career Technical Education* - Notice of Omnibus Rulemaking - Adoption of Pending Rule, Bulletin Vol. 20-1 (PLR 2020)

#### ***55.01.03, Rules of Career Technical Schools***

- 55-0103-1901** Notice of Intent to Promulgate a Rule - Negotiated Rulemaking, Bulletin Vol. 19-7
- 55-0103-1901** Proposed Rulemaking, Bulletin Vol. 19-10
- 55-0103-1902** Adoption of Temporary Rule, Bulletin Vol. 19-12 (eff. 10-17-19)T
- 55-0103-1901** Adoption of Pending Rule, Bulletin Vol. 20-1 (PLR 2020)



***IDAPA 56 -- IDAHO RANGELAND RESOURCES COMMISSION***

- 56-0101-1900F** *Rules of the Idaho Rangeland and Resources Commission* - Notice of Omnibus Rulemaking - Temporary and Proposed Fee Rulemaking, Reauthorizes Title 01, Chapter 01-- Bulletin Vol. 19-6SE (eff. 6-30-19)T
- 56-0101-1900F** *Rules of the Idaho Rangeland and Resources Commission* - Notice of Vacation of Omnibus Proposed Rulemaking, Bulletin Vol. 19-11SE

***IDAPA 57 – SEXUAL OFFENDER MANAGEMENT BOARD***

- 57-0101-2000F** *Rules of the Sexual Offender Management Board* – Notice of Omnibus Rulemaking – Adoption of Temporary (Fee) Rule – Reauthorizes Title 01, Chapter 01 – Bulletin Vol. 20-4SE (eff. 3-20-20)T
- 57-0101-1900F** *Rules of the Sexual Offender Management Board* - Notice of Omnibus Rulemaking - Temporary and Proposed Fee Rulemaking, Reauthorizes Title 01, Chapter 01-- Bulletin Vol. 19-6SE (eff. 6-30-19)T
- 57-0101-1900F** *Rules of the Sexual Offender Management Board* - Notice of Omnibus Rulemaking - Adoption of Pending Fee Rule, Bulletin Vol. 19-11SE (PLR 2020)
- 57-0101-1901** Proposed Rulemaking (Fee Rule), Bulletin Vol. 19-10
- 57-0101-1901** Adoption of Pending Fee Rule, Bulletin Vol. 20-1 (PLR 2020)

***IDAPA 58 – DEPARTMENT OF ENVIRONMENTAL QUALITY***

- 58-0000-2000F** *Rules of the Department of Environmental Quality* – Notice of Omnibus Rulemaking – Adoption of Temporary (Fee) Rule – Reauthorizes Title 01, Chapters 01, 05-09, 11-14, 18, 20, 25 – Bulletin Vol. 20-4SE (eff. 3-20-20)T
- 58-0000-1900** *Rules of the Department of Environmental Quality* - Notice of Omnibus Rulemaking - Temporary and Proposed Rulemaking, Reauthorizes Title 01, Chapters 02, 04, 10, 16, 21-24 -- Bulletin Vol. 19-6SE (eff. 6-30-19)T
- 58-0000-1900** *Rules of the Department of Environmental Quality* - Notice of Omnibus Rulemaking - Adoption of Pending Rule, Bulletin Vol. 19-11SE (PLR 2020)
- 58-0000-1900F** *Rules of the Department of Environmental Quality* - Notice of Omnibus Rulemaking - Temporary and Proposed Rulemaking, Reauthorizes Title 01, Chapters 05-08, 12-14, 18, 20, 25 -- Bulletin Vol. 19-6SE (eff. 6-30-19)T
- 58-0000-1900F** *Rules of the Department of Environmental Quality* - Notice of Omnibus Rulemaking - Adoption of Pending Fee Rule, Bulletin Vol. 19-11SE (PLR 2020)

**TMDLs:**

- 58-0000-1901** Curlew Valley Subbasin Assessment and Total Maximum Daily Load (TMDL): 2018 (HUC 16020309), Bulletin Vol. 19-1
- 58-0000-1902** Curlew Valley Subbasin Assessment and Total Maximum Daily Load (TMDL): 2019 (HUC 16020309), Bulletin Vol. 19-6
- 58-0000-1903** Big Lost River Subbasin Temperature Total Maximum Daily Load (TMDL): 2019 Addendum and Five-Year Review (HUC 17040218), Bulletin Vol. 19-7
- 58-0000-1904** Palisade Subbasin 2019 Total Maximum Daily Load (TMDL) And Five-Year Review (HUC 17040104), Bulletin Vol. 19-8
- 58-0000-1905** Hatwai Creek Subbasin Assessment and Total Maximum Daily Loads (TMDL) – 2019 Temperature TMDL (HUC 17060306), Bulletin Vol. 19-9

***58.01.01, Rules for the Control of Air Pollution in Idaho***

- 58-0101-1901** Notice of Intent to Promulgate a Rule - Negotiated Rulemaking, Bulletin Vol. 19-3
- 58-0101-1902** Notice of Intent to Promulgate a Rule – Negotiated Rulemaking, Bulletin Vol. 19-5
- 58-0101-1903** Notice of Intent to Promulgate a Rule – Negotiated Rulemaking, Bulletin Vol. 19-5
- 58-0101-1904** Adoption of Temporary Fee Rule, Bulletin Vol. 19-7 (eff. 6-30-19)T
- 58-0101-1903** Proposed Rulemaking, Bulletin Vol. 19-8
- 58-0101-1905** Proposed Rulemaking, Bulletin Vol. 19-8
- 58-0101-1904** Proposed Rulemaking (Fee Rule), Bulletin Vol. 19-9
- 58-0101-1903** Adoption of Pending Rule, Bulletin Vol. 19-12 (PLR 2020)
- 58-0101-1904** Adoption of Pending Fee Rule, Bulletin Vol. 19-12 (PLR 2020)
- 58-0101-1905** Adoption of Pending Rule, Bulletin Vol. 19-12 (PLR 2020)

**58.01.02, Water Quality Standards**

- 58-0102-1901 Notice of Meeting of the Idaho Board of Environmental Quality, Bulletin Vol. 19-9
- 58-0102-1901 Proposed Rulemaking, Bulletin Vol. 19-9
- 58-0102-1901 Adoption of Pending Rule, Bulletin Vol. 19-12 (PLR 2020)
- 58-0102-2001 Notice of Intent to Promulgate Rules - Negotiated Rulemaking, Bulletin Vol. 20-4

**58.01.03, Individual/Subsurface Sewage Disposal Rules**

- 58-0103-1901 Notice of Intent to Promulgate Rules - Negotiated Rulemaking, Bulletin Vol. 19-6
- 58-0103-1902 Adoption of Temporary Rule, Bulletin Vol. 19-7 (eff. 6-30-19)T
- 58-0103-1902 Proposed Rulemaking, Bulletin Vol. 19-9
- 58-0103-1902 Adoption of Pending Rule, Bulletin Vol. 19-12 (PLR 2020)

**58.01.04, Rules for Administration of Wastewater Treatment Facility Grants**

- 58-0104-1901 Notice of Intent to Promulgate Rules - Negotiated Rulemaking, Bulletin Vol. 19-8
- 58-0104-1901 Proposed Rulemaking (Chapter Repeal), Bulletin Vol. 19-11 (*\*Repealed and Consolidated into 58.01.22*)

**58.01.05, Rules and Standards for Hazardous Waste**

- 58-0105-1901 Proposed Rulemaking, Bulletin Vol. 19-8
- 58-0105-1901 Adoption of Pending Rule, Bulletin Vol. 19-12 (PLR 2020)

**58.01.06, Solid Waste Management Rules**

- 58-0106-1901 Notice of Intent to Promulgate Rules - Negotiated Rulemaking, Bulletin Vol. 19-8
- 58-0106-1901 Proposed Rulemaking, Bulletin Vol. 19-11

**58.01.09, Rules Regulating Swine Facilities**

- 58-0109-1901 Adoption of Temporary Fee Rule, Bulletin Vol. 19-7 (eff. 6-30-19)T
- 58-0109-1901 Proposed Rulemaking (Fee Rule), Bulletin Vol. 19-9
- 58-0109-1901 Adoption of Pending Fee Rule, Bulletin Vol. 19-12 (PLR 2020)

**58.01.11, Ground Water Quality Rule**

- 58-0111-1901 Adoption of Temporary Fee Rule, Bulletin Vol. 19-7 (eff. 6-30-19)T
- 58-0111-1901 Proposed Rulemaking (Fee Rule), Bulletin Vol. 19-9
- 58-0111-1901 Adoption of Pending Fee Rule, Bulletin Vol. 19-12 (PLR 2020)

**58.01.12, Rules for Administration of Water Pollution Control Loans**

- 58-0112-1901 Notice of Intent to Promulgate Rules - Negotiated Rulemaking, Bulletin Vol. 19-8
- 58-0112-1901\* Proposed Rulemaking\*\*, Bulletin Vol. 19-11 (*\*Consolidates 58.01.20 into this chapter*)

(\*\*Rulemaking changes chapter name to: "Rules for Administration of Wastewater and Drinking Water Loan Funds")

**58.01.13, Rules for Ore Processing by Cyanidation**

- 58-0000-2000F **Rules of the Department of Environmental Quality** – Notice of Omnibus Rulemaking – Adoption of Temporary (Fee) Rule – Reauthorizes Title 01, Chapters 01, 05-09, 11-14, 18, 20, 25 – Bulletin Vol. 20-4SE (eff. 3-20-20)T
- 58-0113-1901 Notice of Intent to Promulgate a Rule – Negotiated Rulemaking, Bulletin Vol. 19-5
- 58-0113-1901 (Second) Notice of Intent to Promulgate Rules - Negotiated Rulemaking, Bulletin Vol. 20-2

**58.01.15, Rules Governing the Cleaning of Septic Tanks**

- 58-0115-1901 Adoption of Temporary Rule, Bulletin Vol. 19-7 (eff. 6-30-19)T
- 58-0115-1901 Notice of Status of Rulemaking, Bulletin Vol. 19-9

**58.01.17, Recycled Water Rules**

- 58-0117-1901 Adoption of Temporary Rule, Bulletin Vol. 19-7 (eff. 6-30-19)T
- 58-0117-1901 Proposed Rulemaking, Bulletin Vol. 19-9
- 58-0117-1901 Adoption of Pending Rule, Bulletin Vol. 19-12 (PLR 2020)

**58.01.19, Rules for the Design and Construction of Phosphogypsum Stacks**

**58-0119-2001** Notice of Intent to Promulgate Rules - Negotiated Rulemaking (New Chapter), Bulletin Vol. 20-4

**58.01.20, Rules for Administration of Drinking Water Loan Program**

**58-0120-1901** Notice of Intent to Promulgate Rules - Negotiated Rulemaking, Bulletin Vol. 19-8

**58-0120-1901\*** Proposed Rulemaking (Chapter Repeal), Bulletin Vol. 19-11 (*\*Repealed and Consolidated into 58.01.12*)

**58.01.22, Rules for Administration of Planning Grants for Drinking Water Facilities**

**58-0122-1901** Notice of Intent to Promulgate Rules - Negotiated Rulemaking, Bulletin Vol. 19-8

**58-0122-1901\*** Proposed Rulemaking\*\*, Bulletin Vol. 19-11 (*\*Consolidates 58.01.04 into this chapter*)

(*\*\*Rulemaking changes chapter name to: "Rules for Administration of Planning Grants for Drinking Water and Wastewater Facilities"*)

**58.01.25, Rules Regulating the Idaho Pollutant Discharge Elimination System Program**

**58-0000-2000F** *Rules of the Department of Environmental Quality* – Notice of Omnibus Rulemaking – Adoption of Temporary (Fee) Rule – Reauthorizes Title 01, Chapters 01, 05-09, 11-14, 18, 20, 25 – Bulletin Vol. 20-4SE (eff. 3-20-20)T

**58-0125-2001** Notice of Intent to Promulgate Rules - Negotiated Rulemaking, Bulletin Vol. 20-4

**IDAPA 59 – PUBLIC EMPLOYEE RETIREMENT SYSTEM OF IDAHO (PERSI)**

**59-0000-1900** *Rules of the Idaho Public Retirement System of Idaho* - Notice of Omnibus Rulemaking - Temporary and Proposed Rulemaking, Reauthorizes Title 01, Chapters 01-06, 08; Title 02, Chapter 01 -- Bulletin Vol. 19-6SE (eff. 6-30-19)T

**59-0000-1900** *Rules of the Idaho Public Retirement System of Idaho* - Notice of Omnibus Rulemaking - Adoption of Pending Rule, Bulletin Vol. 19-11SE (PLR 2020)

**IDAPA 60 – IDAHO STATE SOIL AND WATER CONSERVATION COMMISSION**

**60-0501-2000F** *Rules of the Idaho State Soil and Water Conservation Commission* – Notice of Omnibus Rulemaking – Adoption of Temporary (Fee) Rule – Reauthorizes Title 05, Chapter 01 – Bulletin Vol. 20-4SE (eff. 3-20-20)T

**60-0000-1900** *Rules of the Idaho State Soil and Water Conservation Commission - Notice of Omnibus Rulemaking - Temporary and Proposed Rulemaking, Reauthorizes Title 05, Chapter 04 -- Bulletin Vol. 19-6SE (eff. 6-30-19)T*

**60-0000-1900** *Rules of the Idaho State Soil and Water Conservation Commission - Notice of Vacation of Omnibus Proposed Rulemaking, Bulletin Vol. 19-11SE*

**60-0000-1900F** *Rules of the Idaho State Soil and Water Conservation Commission* - Notice of Omnibus Rulemaking - Temporary and Proposed Rulemaking, Reauthorizes Title 05, Chapter 01 -- Bulletin Vol. 19-6SE (eff. 6-30-19)T

**60-0000-1900F\*** *Rules of the Idaho State Soil and Water Conservation Commission* - Notice of Omnibus Rulemaking - Adoption of Pending Fee Rule (New Chapter), Bulletin Vol. 19-11SE (PLR 2020)  
(*\*Consolidates IDAPA 60.05.01 and 60.05.04 into a new chapter designated 60.05.01*)

**60.05.01, Resource Conservation and Rangeland Development Program**

**60-0501-1901** Notice of Intent to Promulgate Rules - Negotiated Rulemaking, Bulletin Vol. 19-6

**60-0501-1901** Proposed Rulemaking, Bulletin Vol. 19-10

**60-0501-1901\*** Notice of Vacation of Proposed Rulemaking, Bulletin Vol. 19-12

(*\*Consolidates IDAPA 60.05.01 and 60.05.04 into a new chapter designated 60.05.01, "Rules of the Idaho Soil and Water Conservation Commission"*)

**IDAPA 61 – STATE PUBLIC DEFENSE COMMISSION**

**61-0000-1900** *Rules of the Idaho State Public Defense Commission* - Notice of Omnibus Rulemaking - Temporary and Proposed Rulemaking, Reauthorizes Title 01, Chapters 01-04, 06-08 -- Bulletin Vol. 19-6SE (eff. 6-30-19)T

**61-0000-1900** *Rules of the Idaho State Public Defense Commission* - Notice of Omnibus Rulemaking - Adoption of Pending Rule, Bulletin Vol. 19-11SE (PLR 2020)

**61.01.08, Rules Governing the Administration of Idaho's Indigent Defense Delivery Systems - Rule Definitions**

**61-0108-1901** Notice of Intent to Promulgate Rules - Negotiated Rulemaking, Bulletin Vol. 19-7

**61-0108-1902** Notice of Intent to Promulgate Rules - Negotiated Rulemaking, Bulletin Vol. 19-7

# Subject Index

## A

- A Positive Test 593
- Confidentiality 593
- Hearing Set 593
- Lacking Satisfactory Explanation 593
- Notification 593
- Opportunity for Explanation 593
- Written Notice 593
- Abandoned Vehicles 2190
- Abandonment 1839, 2045
  - General Requirements 2045
  - Objectives 2045
- Abandonment, Relinquishment, & Termination 1248, 1253
  - Non-Use 1248, 1254
  - Removal of Improvements 1248
  - Section 58-603, Idaho Code 1248, 1254
  - Voluntary Relinquishment 1248, 1254
- Abbreviations 72, 82, 104, 134, 182, 306, 367, 1096, 1159, 1184, 1269, 1325, 1388, 1909, 1945, 2348, 2385, 2970
- AAC 2385
- AACC. Acceptable Ambient Concentration for a Carcinogen 2385
- AAMC, Association of American Medical Colleges 1388
- AAVLD. American Association of Veterinary Laboratory Diagnosticians 182
- ACGME, Accreditation Council for Graduate Medical Education 1388
- AMA, American Medical Association 1388
- AOA, American Osteopathic Association 1388
- APA 2348
- APC 1096
- APHIS, Animal & Plant Health Inspection Service 134, 182
- APHIS, Animal Plant Health Inspection Service 367
- API 1325
- ASC 1096
- AVIC, Area Veterinarian in Charge 182, 367
- AWP 1096
- AZA, Association of Zoos & Aquariums 182
- BBL 1325
- BMP 1159, 1184
- BOE, County Board of Equalization 1945
- BTA, Idaho Board of Tax Appeals 1945
- CACMS, Committee on Accreditation of Canadian Medical Schools 1388
- CAS. Chemical Abstract Service 2385
- CFR, Code of Federal Regulations 134, 182, 367
- CIF, Commodity Indemnity Fund 72
- CL. Derived form ACGIH ceiling Limit UF = 10 2385
- CMS 1096
- COCA, Commission on Osteopathic College Accreditation 1388
- CPT 1096
- CS 1909
- CWD, Chronic Wasting Disease 182
- CWDP, Chronic Wasting Disease Program 183
- DEQ 1159, 1184
- ECFMG, Educational Commission for Foreign Medical Graduates 1388
- EDI 1096
- EL. Emissions Screening Level 2385
- FAIMER, Foundation for Advancement of International Medical Education 1388
- FROI 1096
- FSMB, Federation of State Medical Boards 1388
- GAAP, Generally Accepted Accounting Principles 104
- GIH. American Conference of Government Industrial Hygienists 2385
- HCPCS 1096
- IAIABC 1096
- ICIA, Idaho Crop Improvement Association 306
- ID. Idaho Division of Environmental Quality 2385
- IDWR 1269
- ISDA, Idaho State Department of Agriculture 82, 104, 183, 306
- ISIF 1096
- LA. From LA Dept. of Environmental Quality 2385
- LCME, Liaison Committee on Medical Education 1388
- LSS 1096
- MA. From MA Dept. of Environmental Protection, Div. of Air Quality Control 2385
- MCF 1326
- MI. From MI Dept. of Natural Resources, Air Quality Div. Based on toxicological data, annual av. time, no uf 2385
- MSDRG 1096
- NAEBA, North American Elk Breeders Association 183
- NCCI 1096
- NDC 1097
- NIST, National Institute of Standards & Technology 82
- NPE, No Price Established Contract 72
- NRCS 2970
- NVSL, National Veterinary Services Laboratory 183
- NY. From New York Dept. of Conservation, Div. of Air Quality 2385
- OEL. Reference Occupational Exposure Level 2386
- PCSOT 2348
- PEMMP, Post Exposure Monitoring and Management Plan 367
- PL. From Phil. Dept. of Air Management Services 2386
- PL1. From Phil. Dept. of Air Management Services 2386
- PL3. From Phil. Dept. of Air Management Services 2386
- PML 1909
- PVC 1326
- RBRVS 1097
- RCRDP 2970
- RVU 1097
- SIF, Seed Indemnity Fund 72
- SIF, The Idaho Seed Indemnity Fund 104
- SOCB 2348
- SOMB 2348
- SOS 1909
- SROI 1097
- STC, Idaho State Tax Commission 1945
- TB, Tuberculosis 183
- TWA. Time Weighted Average 2386
- U.S.C. 1184
- UF. Uncertainty Factor 2386
- UM&R, Uniform Methods & Rules 183
- URF. Unit Risk Factor 2386
- USDA 1909
- USDA, United States Department of Agriculture 134, 183, 367
- USMLE, United States Medical Licensing Exam 1388
- USPS, United States Postal Service 104
- VS, Veterinary Services 134, 183, 367
- WA. From Washington Dept. of Ecology, Air Programs 2386
- WAD 1184
- WFME, World Federation for Medical Education 1388
- Abbreviations, IDAPA 02.04.32 213
- ASABE 213
- CAFO 213
- DEQ 213
- FEMA 213
- IPDES 213
- NMP 213
- NMS 213

- NRCS 213  
USGS 213
- Abbreviations, IDAPA 02.06.02, Subchapter E 262  
AAPFCO 262  
AOAC 262  
ISDA 262
- Abbreviations, IDAPA 02.06.10, Subchapter B 344  
ICIA 345
- Abbreviations, IDAPA 02.06.10, Subchapter C 351  
BRR 351  
Cms 351  
ICIA 352  
ISDA 352
- Abbreviations, IDAPA 20.03.04 1224  
ATON 1224  
HDPE 1224
- Abbreviations, IDAPA 37.03.02 2008  
AF 2008  
CFS 2008  
P.D. or POD 2008  
P.U. or POU 2008  
USGS 2008
- Abbreviations, IDAPA 58.01.06 2572  
BRC, Below Regulatory Concern 2572  
CFR' Code of Federal Regulations 2572  
EPA, Environmental Protection Agency 2572  
ISWFA, Idaho Solid Waste Facilities Act 2572  
MSWLF, Municipal Solid Waste Land Fill 2572  
NMSW, Non-Municipal Solid Waste 2572  
NMSWLF, Non-Municipal Solid Waste Land Fill 2572  
PCS, Petroleum Contaminated Soils 2572  
RCRA, Resource Conservation and Recovery Act 2572  
U.S.C., United States Code 2572
- Abbreviations, Subchapter A 136, 199, 316, 343  
AGID, Agar gel immunodiffusion 136  
AIIS, Aquatic Invertebrate Invasive Species 316  
APHIS, Animal & Plant Health Inspection Service 199, 343  
AVIC, Area Veterinarian In Charge 199  
CAFO, Concentrated Animal Feeding Operation 199  
c-ELISA, Competitive Enzyme Linked Immunosorbent Assay 136  
CFR, Code of Federal Regulations 199  
EDRR, Early Detection/Rapid Response 316
- EIA, Equine Infectious Anemia 136  
HACCP, Hazard Analysis & Critical Control Points 316  
ISDA, Idaho State Department of Agriculture 343  
NAIS, National Animal Identification System 199  
NPIP, National Poultry Improvement Plan 137  
PCN, Potato Cyst Nematode 343  
PPQ, Plant Protection & Quarantine 343  
USDA, United States Department of Agriculture 199, 343  
VS, Veterinary Services 199
- Abbreviations, Subchapter B 331  
CWMA, Cooperative Weed Management Area 331  
EDRR, Early Detection/Rapid Response 331  
ISDA, Idaho State Department of Agriculture 331
- Abbreviations, Subchapter C 336  
ISDA, The Idaho State Department of Agriculture 336  
NAISMA, North American Invasive Species Management Association 337  
NWFF&S, Noxious Weed Free Forage & Straw 337
- Abbreviations, Used In IDAPA 58.01.01, Sections 563 through 574 2480  
CAA 2480  
CFR 2480  
CO 2480  
EPA 2480  
FHWA 2480  
FTA 2480  
HPMS 2480  
ICC 2480  
IDEQ 2480  
ITD 2480  
LHTAC 2480  
LRTP 2480  
MPO 2480  
NAAQS 2480  
NEPA 2480  
O3 2480  
PM 2480  
PMx 2480  
STIP 2481  
TCM 2481  
TIP 2481  
USDOT 2481  
VMT 2481
- Ability Of Combatant 1467  
Questioned Ability 1467  
Satisfy Commission 1467
- Abnormal Tests 158  
Accidents & Sampling Errors 158  
Alternate Tests 158  
Documentation 158  
Acceptable Forms 1927
- Acceptable Treatments 298  
Fumigation 298  
Hot Water Treatment 298  
Other Methods 299
- Acceptance & Refusal Of Documents 1929  
Acceptance Of Checks 2196
- Access By Advocates & Representatives 835  
Advise & Represent 836  
Assist Residents to Secure Rights 835  
Communicate Privately 836  
Inform Residents of Rights 835  
Inform Residents of Services 835
- Access By Department Authorized Agents, Residential Care Facility 1031
- Access To Diving Boards 761  
Access To Records 1319
- Accessibility for Persons with Mobility & Sensory Requirements For Building Construction & Physical Standards  
Impairments 884
- Accessibility of Area, Outfitter Application 1808
- Accidental Fouling 1492  
Accidental Foul 1492  
Contest Stopped by Referee 1492  
Contest Stopped Due to Accidental Foul 1492
- Accidents & Fires 1343  
Initiate Spill Response & Corrective Actions 1343  
Notify the Department 1343  
Provide Information to Emergency Response 1343
- Account Holder Responsibilities  
Account Losses 563  
Notification of Account Security Breach 563  
Personal Use Only 563  
Security 563
- Account Information 562
- Accounting & Auditing Procedures 2793, 2849
- Accounting & Reporting 953  
Accounting & Reporting Required 2332
- Accounting Of Revenues & Expenses 2333  
Deposit of Receipts 2333  
Ledger Entries & Receipts for Expenses 2333  
Recording of Wages 2333  
Submission With Annual Report 2334
- Accounts Will Not Bear Any Interest 565
- Accuracy Checks 157  
Daily Accuracy Check 157  
Hourly Accuracy Check 158  
Acid Based Chemistry 767

- Acknowledgment 1930, 1948  
  Acknowledgment Letter 1948  
  Defective Appeal 1948  
  When Filing Is a Paper or Paper-Based UCC Document 1930  
  When Filing Is Not a Paper or Paper-Based UCC Document 1931
- Acknowledgment Of Conditions  
  Leading To Discharge 1365
- Acquisition Costs Exceeding Fair Market Value 1860
- Acquisition Of Publicly Owned Lands 1860
- Acquisition Of Structures 1860
- Acquisition Of Water Rights For The Board's Water Supply Bank 1993
- Acquisition Of Water Rights For The Board's Water Supply Bank  
  Application 1993  
  Consideration 1993  
  Criteria 1993  
  General 1993  
  Inadequate Application 1993  
  Placement of Water Right 1994  
  Resolution of Board 1994  
  Review 1993
- Acquisitions Involving Compatible Multiple Uses 1860
- Acquisitions Involving Nonrecreation Use 1861  
  Life Estates 1861  
  Nonrecreation Use Limited 1861
- Acreage And Reclamation Cost Limitations 1219  
  Actual Allowable Participation 1219  
  Maximum Disturbance & Reclamation Cost 1219  
  Multiple Plans or Permits 1219
- Actinomycosis (Lump Jaw) 146  
  Public Livestock Markets 146  
  Selling Diseased Animal 146
- Action 30
- Action On Application 2449  
  Copy to EPA 2450  
  Deadline for Tier I Operating Permits for Phase II Sources 2450  
  Deadline for Tier I Operating Permits with Early Reductions 2450  
  Deadlines for Final Actions After Initial Period 2450  
  Deadlines for Final Actions During Initial Period 2450  
  Issuance Conditions 2449  
  Original to Permittee 2450
- Action On Applications & License Fees 1129  
  Arson, Fire, & Fraud Prevent Account 1130  
  Branch Office License 1130  
  Fees 1130  
  Investigation of Applicants 1129
- Action On Licenses 2336  
  Applications for Licenses 2336
- Issuance of Licenses 2336  
  Notice of Intended Actions 2336
- Active Wells 1353  
  Annual Reports for Active Wells 1354  
  Extension of Active Status 1354  
  Gas Storage Wells 1353
- Activities & Community  
  Integration 828  
  Activities 828  
  Activity Supplies 829  
  Transportation 829
- Activity Requirements 874  
  Education 874  
  Facility 874  
  Physical Activities 874  
  Socialization 874
- Acupuncture Trainee Permit 1674  
  Education 1674  
  Supervision 1674
- Added Protection In Lieu Of Hazard Reduction 1303
- Added Water In Milk Samples 169
- Addendum To Certificate Of Compliance-Fire Hazard Management Agreement 1302
- Additional Bonding Requirements 69
- Additional Contents Of Tier I Operating Permits - Permit Shield 2444  
  General Permit Shield 2444  
  Limitation on Permit Shield 2445
- Additional Fire & Life Safety Standards For All Buildings & Facilities 897
- Additional Fire And Life Safety Standards For All Buildings And Facilities  
  Electrical Installations & Equipment 897  
  Fuel-Fired Heating 897  
  Medical Gases 897  
  Natural or Man-Made Hazards 897  
  Prohibited Applications 897  
  Telephone 898
- Additional Import Requirements, Sheep Board May Impose 367
- Additional Measures To Protect Ground Water From Contamination 2602  
  Certification 2603  
  Notification 2602  
  Notification Forms 2602  
  Requirements for Hazardous Substance UST Systems 2603  
  Requirements for Petroleum UST Systems 2602
- Additional Offices 728  
  Assignment of Duties 729  
  Copies of Original Certificates 729  
  Determination 728
- Additional Payments To Family  
  Alternate Care Providers 955  
  Highest Level of Need 955  
  Lowest Level of Need 955  
  Moderate Level of Need 955  
  Reportable Income 956
- Additional Placement  
  Considerations 1044  
  Child Placement Preparation 1044  
  Placement Emergency Change 1044  
  Placement Service  
    Termination 1044
- Additional Policies Required  
  Notification of Changes to Resident Health or Mental Status 876  
  Provided Care & Services by Staff 876  
  Response of Staff to Emergencies 876
- Additional Provisions for Adoption Services 1047
- Additional Provisions For Adoption Services, Sections 662 Through 681 1047
- Additional Provisions For Children's Alcohol-drug Abuse Residential Care Facilities 1069
- Additional Provisions for Children's Alcohol-Drug Abuse Residential Care Facilities 1069
- Additional Provisions for Children's Residential Maternity Care 1068
- Additional Provisions For Children's Residential Maternity Care, Also See Sections 500 Through 599 & 700 Through 769 1068
- Additional Provisions For Foster Home Certification 1042
- Additional Provisions for Inter-Country Adoption Services 1050
- Additional Provisions For Inter-Country Adoption Services, Sections 680 Through 699 1050
- Additional Provisions For Non-Accredited Children's Residential Schools 1069
- Additional Provisions for Non-Accredited Children's Residential Schools 1069
- Additional Provisions For Stationary Children's Therapeutic Outdoor Programs 1086
- Fire Safety Requirements 1086  
  Electrical 1086  
  Escape Routes 1086  
  Fire Extinguishers 1086  
  Flammable Liquids 1086  
  Smoke Detectors 1086
- Health Safety Requirements 1086  
  Food 1086  
  Sewage Disposal 1086  
  Water Supply 1086
- Additional Provisions for Transitional Living Services 1045
- Additional Qualifications For Registration 1701  
  Exemption Review 1701  
  Felony Conviction 1701  
  Fraud in Application Process 1702  
  Additional Standards for Children's

- Agencies 1041  
Additional Standards for Children's Residential Care Facilities 1052  
Additional Standards For Children's Residential Care Facilities, Sections 700 Through 769 1052  
Additional Standards For Children's Therapeutic Outdoor Programs 1070  
Additional Standards for Children's Therapeutic Outdoor Programs 1070  
Additional Standards for Solo Experiences In Children's Therapeutic Outdoor Programs 1084  
Additional Standards for Stationary Children's Therapeutic Outdoor Programs 1086  
Additional Time After Service By Mail 1967  
Additional Tolerances - In Lots Of Two Or More Cases 55  
Grade A 55  
Grade AA 55  
Grade B 55  
Lots of Two or More Cartons 55  
Single Egg Exemption 55  
Additional Training Related To Changes 908  
Add-On 552  
Additional License 552  
Higher Fee 552  
Address Of Idaho Board Of Landscape Architects 1563  
Address Of The Board Of Examiners Of Nursing Home Administrators 1579  
Address, Office Hours, Telephone, Fax Numbers, Web Address 109, 212  
Adequacy Of Facility Owners Locating Underground Facilities 480  
Adequate Heat, Light, & Ventilation 1024  
Adjudication Of Technical Knockout 1493  
Contest Termination 1493  
Win by Other Than Full Count 1493  
Adjusted Access Fees During Pilot Projects 602  
Adjusted Gross Income 1087  
Administering Organizations 34  
Administration 1161, 1184, 1840, 2198, 2199  
Automated Records 2199  
Bureau Responsible 1840  
Disposition of Fees 1840  
Electronic Media Must Be Provided 2199  
Paper or Imaged Records 2199  
Records Provided Free of Charge 2199  
Rules for Providing Records Free of Charge 2199  
Status Report 1840  
Administration Of College Or University Program 641  
Chair & Vice-Chair 641  
Duties of Chair & Vice-Chair 641  
Administration Of Educational Program 1447  
Administration Of Non-Injectable Substances 580  
Non-Prescription 580  
Nutritional Supplement 580  
Prescription 580  
Administration Or Use Of Alcohol, Drugs, Stimulants 1505  
Procedure for Testing for Illegal Substance(s) 1506  
Prohibitions 1506  
Subject to Disciplinary Action 1506  
Suspension 1506  
Urinalysis 1506  
Administrative Action Imposed For License Or Certification 702  
Administrative Appeal 109, 212  
Administrative Appeals 397, 468, 479, 1157, 1217, 1221, 1245, 1250, 1257, 1267, 1280, 1293, 1321, 2289, 2345, 2364, 2567, 2746, 2761, 2778, 2819, 2822, 2834  
Administrative Appeals, Contested Cases, & Informal Dispute Resolution 860  
Administrative Duties 1362  
Management of Records 1362  
Response to Complaints 1362  
Administrative Fine 1455  
Administrative Fines/Probation/Restrictions 1831  
Penalties -- Table 1831  
Restrictions 1832  
Terms of Probation 1832  
Administrative Permit Amendments 2451  
Administrative Permit Amendment Application Procedures 2451  
Criteria 2451  
Implementation Procedures 2452  
Permit Shield 2452  
Administrative Powers 1361  
Emergency Powers 1362  
Inspection Powers 1362  
Investigation Powers 1361  
Representative Powers 1361  
Administrative Procedures, Exceptions, Penalties 2245  
Permit Revocation 2245  
Responsibility of Permit Applicant 2245  
Variance Procedures 2245  
Variance Standards 2245  
Administrative Provisions 2564, 2599, 2633, 2796, 2853  
Administrative Records & Data Management 2965  
Administrative Record for Draft Permits 2965  
Administrative Record for Final Permits 2965  
Electronic Submittals 2966  
Administrative Review For Enforcement Of Medical Support 797  
Request 797  
Scope of Administrative Review 797  
Administrator Approval 201, 204  
Adequate Facilities 204  
Adequate Records 204  
Past History 204  
Administrator Designee Qualification 1582  
Authorization 1582  
Criminal History 1582  
Education 1582  
Experience 1582  
Administrator Responsibilities & Qualifications 1449  
Administrator Qualifications 1450  
Administrator Responsibilities 1449  
Numbers of Administrators Needed 1450  
Admission Fee At Quarters Where Combatant Trains 1479  
Fee 1480  
State Fee 1480  
Admission Of Licensees & Agents To Events 1479  
Commissioner or Agent 1479  
Participants 1479  
Admission Requirements 874  
Admissions Policies 874  
Policies of Acceptable Admissions 874  
Resident Admission, Discharge, & Transfer 874  
Admissions 839  
Admission Agreement 840  
Discharge Procedure 841  
Emergency Admission 840  
Emergency Temporary Placement 841  
Notification 839  
Prior Approval Required 839  
Return of Resident's Possessions 841  
Termination of Admission Agreement 841  
Adoption & Incorporation By Reference 414, 445  
Adoption & Incorporation by Reference 448  
Adoption & Incorporation By Reference Of The National Electrical Code 389  
Availability 392  
Documents 389  
Adoption And Incorporation By Reference Of The Idaho State Plumbing Code 408  
Adoption And Incorporation By Reference Of The International



- Mechanical Code, 2018 Edition 468  
Adoption Application Fee 978  
Adoption Assistance 986  
    Determination of Eligibility for State Funded Adoption Assistance 988  
    Determination of Eligibility for Title IV-E Adoption Assistance 986  
    Interjurisdictional Adoptions 988  
    International Adoptions & Adoption Assistance 988  
    Special Needs Criteria 987  
Adoption Assistance Program Agreement 989  
Adoption Assistance Follows the Child 990  
Agreement Specifications 989  
Termination of Adoption Assistance 990  
Adoption Of Persons Born In Idaho 736  
    Corrections on Adoptive Certificates 736  
    Examination of Adoptive Child Born in Idaho for Whom No Original Certificate of Birth Can Be Located 736  
Adoption Services 966  
Adoption Services - Nonprofit Status, Children's Agencies 1047  
Adoption Services Policy 966  
Adoptions & Promulgation 248  
Adoptive Home Study 977  
Adoptive Parent Information 1049  
    Circumstances of the Placement 1050  
    Date, Time & Location of Birth 1050  
    Family of Origin 1050  
    Medical Records 1050  
    Name 1049  
    Other Information 1050  
    Preparation for Placement 1050  
    Racial, Ethnic, & Religious Considerations 1050  
Adulterants 247  
    Screenings or By-Products 248  
    Substances 247  
    Viable Noxious Weed Seed 248  
Advance Appearance Of Boxers Scheduled To Fight In Main Event Expenses 1487  
    When to Appear 1487  
Advance Appearance Of Combatant Scheduled To Fight In Main Event 1487  
Advance Deposit Wagering License Application 560  
    Budget 560  
    Corporation 560  
    Financial Information 560  
    Legal Name 560  
    Number of Days 560  
    Partnership 560  
    Race Tracks 560  
Advance Do Not Resuscitate (DNR) Directives 703  
Advanced Deposit Wagering License 560  
Advertisements 1515  
    Prohibited Advertising 1515  
Advertisements/Promotions/ Demonstrations 1855  
    Demonstrations 1855  
    Political Advertising 1855  
    Printed Material 1855  
Advertising 651, 1678  
    Application of Antifraud Provisions 652  
    Definitions 651  
    Exemption From Filing 652  
    Filing Requirement 652  
    Piecemeal Filings 652  
    Prohibited Disclosures 652  
Advertising Packages For Sale, Weights & Measures 99  
Advisory Committee 1430  
Advisory Group 2743  
Affected Equipment Or Processes 2515  
    Applicability 2515  
    Existing Sources 2515  
    New Sources 2515  
    Reconstructed Sources 2515  
Affected Lands 1217  
Affiliation Required To Practice 703  
AFO 213  
Age 616  
    Eighteen (18) Years of Age 616  
    Twenty-One (21) Years of Age 616  
Age & Physical Condition 1467  
    Age of Combatant 1467  
    Cerebral Hemorrhage 1467  
    Poor Vision 1467  
    Serious Head Injuries 1467  
Age Restriction Requirements 520  
    Counterfeit or Altered Age Documents 520  
    Over/Under Clubs 520  
    Posting of Age Restriction Signs 520  
Age Restriction Requirements For Licensed Movie Theaters - When Minors Permitted 521  
    Exemption 521  
    Minors Permitted 521  
    Minors Prohibited 521  
Age, Program Eligibility 783  
Agencies Affected By Consultation 2483  
    Agencies Entitled to Participate 2483  
    Delegation 2484  
    General Actions Requiring Consultation 2484  
    ICC Members 2483  
    Interagency Consultation Committee 2483  
    More Than One Pollutant 2484  
    Open to the Public 2484  
Agency Access To ILETS 600  
    Authorized Agencies 600  
    Board Approval 601  
    Management Control Agreements 600  
Agent Termination 665  
Agreement To Serve – Reimbursement Requirement 620  
    Agreement 620  
    Decertification 621  
    Fulfillment of Agreement 621  
    Multiple Basic Training Academies 621  
    Proration 621  
    Reimbursement 621  
    Relief from Obligation to Serve 621  
Agricultural Activities 2527  
    Agricultural Activity 2527  
    Generally Recognized Agricultural Practices 2528  
Agricultural Commodities-- Warehouse Obligations 68  
Agriculture Commodity Liens 1942  
    Mechanics of Filing 1942  
    Mechanics of Search 1942  
Air Pollution Emergency Rule 2475  
Air Quality Standards & Area Classification 2491  
Allocated Tag 1801  
Allocation Of Funds To Districts 2976  
    Base Funding 2976  
    Match Funding 2976  
    Required Documents 2976  
    State Budget Requests 2976  
Allowable Deviation 1349  
Allowable Tolerance, Legal Or Permitted Size Limits 2218  
Appurtenances 2218  
    Determination of Vehicular Dimensions 2218  
    Other Appurtenances 2218  
Alternate (Out-Of-Home) Care 946  
Alternate Care Case Management 948  
    Consent for Medical Care 949  
    Contact with Child 949  
    Discharge Planning 949  
    Financial & Support Services 949  
    Financial Arrangements 949  
    Information for Alternate Care Provider 948  
    Preparation for Placement 948  
    Transition Planning 949  
Alternate Care Licensure 954  
Alternate Care Plan Required 950  
Alternate Care Planning 949  
Alternative Forms Of Restraint 1066  
    Counsel 1067  
    Intervention 1067  
    Monitoring 1067  
    Re-Introduction 1068  
    Restraint Approval 1067  
    Restraint Is Prohibited 1067  
    Restraint Log 1067

- Restraint Used as a Last Resort 1066
- Review 1068
- Staff Training 1067
- Used Only Until the Child Has Regained Control 1067
- Alternative Methods Of In-Service Training 640
  - Course Evaluation Fee 640
  - Specialized Equipment 640
  - Training Medium 640
- Alternative Periodic Testing Of Containment Sumps Used For Interstitial Monitoring Of Piping 2603
- Alternative Test Method Allowed 2604
- Applicability 2603
- Alternative Plates 2212
- Alternative Resolution Of Contested Cases 1980
- Altitude Correction, Fuel Burning Equipment -- Particulate Matter 2532
- Amateur Athletic Sanctioning Organizations 1469
- Annual Review of Approval 1472
- Application for Approval 1469
- Criteria for Eligibility 1470
- Violations 1472
- Ambient Air Quality Standards For Fluorides 2491
  - Annual Standard 2491
  - Bimonthly Standard 2491
  - Monthly Standard 2491
- Ambulance Certification 712
  - Ambulance Certification is Required 712
  - Ambulance Certification Requirements 712
  - Disciplinary & Corrective Action 712
  - Duration of Certification 712
- Amending An Approved Permanent Closure Plan 1195
  - Adjustment 1196
  - Cause for Permanent Closure Plan Amendment 1195
  - Modification At Request Of Director 1196
  - Modifications at an Operator's Request 1195
- Amending An Approved Permit 1166
  - Application to Amendment 1166
  - Processing 1166
- Amending An Approved Reclamation Plan 1195
  - Cause for Reclamation Plan Amendment 1195
  - Minor Amendments 1195
  - Review of Amendment 1195
- Amending Tariff 68
- Amendment 1933, 1937
  - Amendment Financing Statement Lapses 1938
  - Amendment Initial Financing Statement 1938
  - Date & Time of Filing Amendment 1937
  - New Lapse Date is Established 1938
  - Status of Financing Statement 1934
  - Status of Secured Party & Debtor 1933
- Amendment Fees 2001
- Amendment, Assignment, Continuation, & Termination Of A Farm Products Financing Statement 1910
  - Completion of Form 1910
  - Form 1910
  - Termination 1910
- Amendment, Assignment, Extension, & Release Of Claim Of Lien 1920, 1921
  - Form 1920
  - Supplement 1921
- Amendments To Pleadings -- Withdrawal Of Pleadings 1950, 1974
- Amendments To Registration Statement 648
  - Amendments Required 648
  - Contents of Amendment Filing 648
  - Effect of Failure to Amend 648
  - Time of Filing & Undertaking 648
- Amount Of Bond For Seed Stored For Withdrawal 106
- Amount Of Bond, Irrevocable Letter Of Credit, Certificate Of Deposit, Or Single Bond 76, 106
  - Additional Bonding Requirements 76
  - Bonding Requirement 66, 76, 106
  - Single Bond, Irrevocable Letter of Credit or Certificate of Deposit 66, 76, 106
- Anchoring Of Diving Boards 763
- And Part V (Mechanical) And Part VI (Fuel Gas) Of The International Residential Code For One (1)- And Two (2)-Family Dwellings, 2018 Edition 468
- Animal Damage Control 1266
- Animal Display & Security 684
- Animal Movement In Quarantine Area 150
- Animals & Pets, Children's Residential Care Facilities 1060
- Animals & Pets, Children's Therapeutic Outdoor Programs 1083
- Animals In Transit 368
- Animals In Transit At Time Of Declared Emergency 150
- Announcement Of Winner Of Bout 1494
- Annual Audit 1033
- Annual Bluegrass Regulated Area 240
- Annual Brand Inspection Certificate 532
- Agreements 532
- Annual Brand Inspection Form Also Known as "Seasonal" 532
- Annual Inspection 532
- Certificates 532
- Fee, Annual Brand Inspection 532
- Annual Date, Fees, & Payment 1806
- Due Dates 1806
- Fees 1806
- License Lapsed & Relinquished 1806
- Payment 1806
- Penalty Fee 1806
- Annual Inventory Report 189
  - Individual Domestic Cervidae 189
  - Inventory Report 189
- Annual Issuance Of Clinical Nutrition Certification With License Renewal 1519
- Expiration Date 1519
- Failure to Comply with Issuance Requirements 1519
- Issuance 1519
- Annual License Period 82
- Annual License Renewal & Late Fee 26
  - Late Fee 26
  - Non-Renewal 26
  - Renewal 26
- Annual Raffle Report 2334
- Annual Report 2333
  - Independent Audit 2333
  - Information Required by Forms 2333
  - When Due 2333
- Annual Report For The Renewal Of A Registration Statement 650
  - Consent to Service 650
  - Cover Letter 650
  - Filing Fee 650
- Annual Sales Plan 1155
- Answer To Appeal 1948
- Answers To Production Requests Or Written Interrogatories & To Requests For Admission 1982
- Answers--Defined--Form & Contents-- Time For Filing 1972
- Answers to Motions 1972
- Answers to Pleadings Other than Motions 1972
- Anti-Ulcer Medications 581
  - Cimetidine (Tagamet®) 581
  - Omeprazole (Gastrogard®) 581
  - Ranitidine (Zantac®) 581
- Appeal Procedure 1374, 2197
  - Delivery of Appeal 2197
  - Delivery of Decision 2197
  - Filing of Appeal 2197
- Appeals 394, 2427
  - Appeals Board 394
  - Appeals Hearing Fee 394
  - Conditions Disqualifying Board Member 394
  - Filing Date 394

- Function of Appeals Board 394  
Limitations of Appeal 394  
Motions for Reconsideration 394  
Notice of Appeal 394  
Preliminary Order 394  
Rules of Evidence 394  
Appeals Process 2929  
Administrative Record Filed By the Department 2930  
Alternative Dispute Resolution 2933  
Appeals of Variances 2935  
Appointment of Hearing Officers 2933  
Augmenting the Administrative Record 2931  
Brief of the Petitioner 2931  
Burden of Proof 2933  
Content & Form Requirements for Petitions & Briefs 2930  
Ex Parte Communications 2933  
Filing & Service Requirements 2932  
Final Agency Action for Purposes of Judicial Review 2934  
Final Orders 2933  
IPDES General Permits 2934  
Motions 2932  
Oral Argument 2933  
Participation by the Permit Applicant or Permit Holder 2930  
Petition for Judicial Review 2934  
Petition for Review of a Permit Decision 2929  
Petition to Intervene 2930  
Proof of Service 2932  
Public Notice of the Petition for Review 2930  
Reply Briefs by the Petitioner 2931  
Representation of Parties 2931  
Request to Dismiss Petition 2933  
Response Briefs 2931  
Scope of Authority of the Hearing Authority 2933  
Substitution & Withdrawal of Representatives 2932  
Withdrawal of Permit or Portions of Permit by the Department 2933  
Appendix A, Construction of Drilled Wells 2142  
Appendix A, Idaho Backflow Assembly Tester Code Of Ethics & Standards Of Conduct 1548  
Appendix A, Milner Dam to Swan Falls Dam Reach 2116  
Appendix A, Occupational Therapy Code Of Ethics 1560  
Appendix A, Physical Therapist Code Of Ethics 1633  
Appendix A, Riprap Gradation Using FWS Method 2086  
Appendix B, (Continued), Toe Protection 2088  
Appendix B, Physical Therapist Assistant Code Of Ethics 1634  
Appendix B, Suggested Irrigation Seasons in Idaho 2117  
Appendix B, Toe Protection 2087  
Appendix C, Administrative Regions of the IDWR 2118  
Appendix C, Protection Against Undermining 2089  
Appendix D, Mattress Construction 2089  
Appendix E, Rock Drop Structure Details 2090  
Appendix F, Log Drop Structure Details 2091  
Appendix H, Barb Details 2092  
Appendix I, Swimming Capability of Migrating Salmon & Trout 2092  
Appendix J, Downstream Control Structure 2093  
Appendix J, Sill Details 2091  
Appendix K, Culvert Backfill Using Sandy or Silty Material 2093  
Appendix L, Launch Ramp 2094  
Appendix M, Concrete Plank, Boat Ramp 2094  
Appendix N, Concrete Launch Plank Detail 2095  
Appendix O, Concrete Launch-Plan View, Boat Launch 2095  
Appendix P, Concrete Launch-Cross-Section 2096  
Appliance Plumbing Specialty License 405  
Applicability 183, 367, 550, 755, 1160, 1294, 1326, 1866, 2006, 2470, 2567, 2747  
All Lands in State 1160  
Applicability 2458  
Common Control 2747  
Deferred Sources 2458  
Encroachments Free to the Public 1294  
Examination 2006  
Examination Fee 2006  
Exclusions 1326  
Existing Swine Facilities 2747  
Navigational Improvements 1160  
Nonapplicability 1160  
Oil & Gas Development 1326  
Permit Required 2747  
Proof of Beneficial Use 2006  
Re-Examination 2006  
Regulated Facilities 2747  
Single Family Docks 1294  
Single or Multiple Family Docks 1294  
Stream Channel Alterations 1160  
Suction Dredges 1161  
Temporary Permits or Easements 1295  
Two-Family Docks 1294  
Types of Operations 1160  
Applicability & Notification Of Changes 2356  
Applicability Of Licensing Requirements 2157  
Company to be Licensed 2158  
Driller to Have Responsible Charge of Other Workers 2157  
Drillers to Decommission (Abandon) Wells 2158  
Laborer Exempted 2157  
Licensing Requirements 2157  
Operators to Have Permits 2157  
Applicability Of Rules 27  
Acceptance of Licensure 27  
Applicability 27  
Interpretation of Rules 27  
Investigative Committee 27  
Reliance 27  
Responsibility 27  
Rules 27  
Applicability To Facilities With Existing Permits 2799  
Applicability, Nonmetallic Mineral Processing Plants 2544  
Permit by Rule 2544  
Permit Option 2544  
Applicability, Subchapter A 199  
Applicable Laws, Rules, & Regulations 565  
Applicable Requirements For Tier I Facilities 2575  
Applicable Requirements 2575  
Application Content, Review & Approval Requirements 2577  
Documentation Requirements 2577  
Applicable Requirements For Tier II Facilities 2577  
Closure Plan Application 2580  
Closure Requirement 2580  
Documentation Requirements 2581  
General Operating Requirements 2578  
General Siting Requirements 2577  
Modification Application 2581  
Operating Plan 2580  
Siting Application 2578  
Tier II Incinerators, CESQG Management Facility & Transfer Stations 2582  
Tier II NMSWLF 2583  
Tier II Processing Facilities 2581  
Applicable Requirements For Tier III Facilities 2586  
Closure Plan Application 2590  
Closure Requirement 2589  
Documentation Requirements 2591  
General Operating Requirements 2587  
General Siting Requirements 2586  
Ground Water Monitoring Application 2589  
Ground Water Monitoring Requirements 2589  
Modification Application 2591  
Operating Plan 2589  
Siting Application 2587

- Tier III Incinerators 2592
- Tier III NMSWLFs 2593
- Tier III Processing Facilities 2591
- Applicant Past Crime Review 1458
  - Exemption Review 1459
  - Review Authority 1459
- Applicant Requirements 47
  - Applicant Health Inspection 47
  - Applicant Licenses or Registrations 47
- Applicants Receiving A Department Enhanced Clearance 923
  - Adoptive Parent Applicants 923
  - Behavioral Health Programs 923
  - Children's Agency Facility Staff 923
  - Children's Residential Care Facilities 923
  - Children's Therapeutic Outdoor Programs 923
  - Citizen Review Panel Members 923
  - Idaho Child Care Program (ICCP) 923
    - Licensed Day Care 923
    - Licensed Foster Care 923
    - Mental Health Services 923
    - Substance Use Disorders Services 923
- Applicants, Licensees, & Officials 1473
- Applicants/Claimants/Appellants 1968
- Application 439, 757, 1460, 1536, 1563, 1568, 1602, 1628, 1683, 1701, 1729, 1756, 1770, 1898, 2335, 2842
  - AMC Registration Application 1683
  - Application Deadline Date 1770
  - Application Required 1536
  - Applications Must Be Complete 1770
  - Appraiser License Application 1683
  - Criminal Convictions 1628
  - Disciplinary Action 1628
  - Education 1628
  - Eligibility for Examination 1683
  - Evidence of Graduation 1628
  - Filing an Application 1602, 1756, 1770
  - Lack of Activity 1536, 1568, 1628, 1771
  - License or Registration Denial 1628
  - Licensure by Endorsement 1536
  - Licensure by Endorsement -- Blue Cover 1460
  - Licensure by Endorsement - Equivalency 1460
  - Licensure By Examination 1460
  - Licensure by Examination 1536
  - Other Information 1628
  - References 1628
  - Required Materials 1898
  - Submission Deadlines 1899
  - Supplemental Documents 1756
  - Supporting Documents 1602, 1770
- Trainee Registration Application 1683
  - Application -- Compliance 445
  - Application -- State Preemption 445
  - Compliance -- Disciplinary Action Against Licensees 445
- Application & Calculating Income To Apply The Sliding Fee Schedule For Children's Mental Health & Adult Mental Health Services
  - Application & Fee Determination Form 1090
- Application & Certification Fees For Certified Family Homes 818
  - Application Fee Amount 818
  - Certification Fees 818
  - Payment of Application Fees 818
- Application & Examinations 795
- Application & Instructions For EMS Personnel Licensure 704
  - Application & License Fees 1136
  - Application Fees 535, 1185
    - Annual Fees 535
    - Livestock Dealer 535
  - Application Fees For Personnel Licensure 707
    - Initial Licensure 707
    - Reinstatement 707
    - Renewal 707
- Application For A Criminal History & Background Check 922
  - Application Form 922
  - Disclosures 922
  - Failure to Disclose Information 922
- Application For A License To Represent A Licensed Livestock Dealer 536
- Application For An Individual IPDES Permit 2869
  - Application Information for All Dischargers 2870
  - Application Retention Schedule 2869
  - Electronic Submittals 2869
  - Individual Permit Application Forms 2870
- Individual Permit Application Requirements for Dischargers Other than Treatment Works Treating Domestic Sewage (TWTDS) & Publicly Owned Treatment Works (POTWs) 2871
  - Individual Permit Application Requirements for Existing Manufacturing, Commercial, Mining & Silviculture Dischargers 2872
- Individual Permit Application Requirements for Industrial & Construction Storm Water Discharges 2905
- Individual Permit Application Requirements for Municipal Separate Storm Sewer Discharges 2898
- Individual Permit Application Requirements for New & Existing Concentrated Animal Feeding Operations (CAFO) 2878
- Individual Permit Application Requirements for New & Existing Concentrated Aquatic Animal Production (CAAP) Facilities 2879
- Individual Permit Application Requirements for New & Existing POTWs & Other Dischargers Designated by the Department 2879
- Individual Permit Application Requirements for New or Existing Manufacturing, Commercial, Mining, & Silviculture Facilities that Discharge only Non-Process Wastewater 2876
- Individual Permit Application Requirements for New Sources & New Discharges 2888
- Individual Permit Application Requirements for POTWs Receiving Discharges from Hazardous Waste Generators & from Waste Cleanup or Remediation Sites 2886
- Individual Permit Application Requirements for POTWs Receiving Industrial Discharges 2885
- Individual Permit Application Requirements for POTWs with Combined Sewer Systems & Overflows 2887
- Individual Permit Application Requirements for Treatment Works Treating Domestic Sewage (TWTDS) 2890
  - Time to Apply 2869
  - Whole Effluent Toxicity (WET) Monitoring for POTWs 2884
- Application For Approved Livestock Trader Lot Status 204
- Application For Certification 747, 817
  - Application For Certification Reapplication for Additional Analytes or to Change Methods 747
    - Required Information on Application 747
    - Time Frame for Renewal of Application for Reciprocity 747
  - Completed & Signed Application 817
  - Criminal History & Background Checks 817
  - Electrical Inspection 817
  - Environmental Sanitation Inspection 817
  - List of Individuals Living in the Home 818

- Other Information as Requested 818
- Payment of Application Fee 818
- Proof of Insurance 818
- Reapplication for Certification 747
- Reciprocity for Out-State-Laboratories 748
- Statement Disclosing Revocation or Disciplinary Actions 817
- Statement to Comply 817
- Termination of Application Process 818
- Application For Certification -
  - Procedures 47
  - Application 47
  - Application Forms 47
  - Multiple Certificates 47
- Application For Change In Certification Level 2352
  - Advance to Associate/Supervised Level of Certification Application Fee 2352
  - Advance to Senior/Approved Level of Certification Application Fee 2352
  - Change to a Less Independent Level of Certification Application Fee 2352
- Application For Daycare License Or Renewal 1006
  - Additional Requirements for License Renewal 1007
  - Completed & Signed Application 1006
  - Criminal History & Background Clearance 1006
  - Inspection Reports 1006
  - Licensing Fee 1006
  - Other Information as Requested 1007
  - Proof of Insurance 1006
  - Statement Disclosing Revocation or Disciplinary Actions 1006
  - Statement to Comply 1006
  - Termination of Application Process 1007
- Application For Designation As An Idaho Approved Buying Station 201
- Application For Inspection -
  - Procedures 267
  - Application for Area Inspection (Peas & Corn Only) 267
  - Application for Field Inspection 267
  - Deadlines 267
  - Special Field Inspection Requests 267
- Application For Interment 1383
  - Application Following Death 1384
  - Pre-Registration for Interment Who May Apply 1383
- Application For License 790
  - Application For License 790
  - Emergency Action 793
  - Minimum Safety Requirements 790
  - Modification, Revocation, and Termination of Licensees 792
- Operator Qualifications 790
- Qualifications for Authorized Operation, Service, & Repair of X-ray Machines 790
- Responsible Authority 790
- Subjects to Be Covered During the Instruction of Radiographers 791
- Application For Licensure 1403, 1407, 1555
  - Application 1403
  - Application for Provisional Licensure 1407
  - Licensing Examinations 1403
  - Licensure by Endorsement 1555
  - Limited Permit 1555
  - Personal Interview 1555
  - Temporary License 1555
- Application For Licensure -- Advanced Practice Registered Nurse 1436
- Application For Licensure -
  - Documentation, Appraisals, References, Bonding, & Financial Statements 452
  - Application Documentation 452
  - Application for Change in Licensing Class 453
  - Appraisals 453
  - Extension of Time to File Financial Statement 453
  - References 453
- Application For Licensure Of Graduates Of Schools Of Nursing Located Outside The United States, Its Territories, Or Commonwealths 1432
- Application For Licensure Or Certification 497
  - Completion of Application 498
  - Confidentiality of References 498
  - Forms 497
  - Minimum Boundary Survey Experience 498
  - Minimum Standards -- References 498
  - Residency Requirement 498
  - Submittal of Applications & Examination Cutoff Date 498
- Application For Loan 2972
  - Application Form 2972
  - How to Apply 2972
  - Two or More Applicants 2972
- Application For New License 442
- Application For Nursery Inspection 241
- Application For Other Resources 784
- Application For Participation 41
  - Application Requirement 41
  - Application Review & Compliance Verification 41
- Application For Registration Of Securities 647
- Other Forms 648
- Registration by Coordination 647
- Registration by Qualification 647
- Application Form 49, 1563
  - Deadlines 1564
  - Inactive Applications 1564
  - Materials Submitted to Board 1563
  - Reference Requirements 1563
- Application Form Requirements 340
- Application Of Regulations 2235
  - Barriers, Construction & Maintenance 2236
  - ICP Permits Required 2237
  - Standards Adopted 2235
- Application Of Regulations, Institutional Controls Administrative Area 2240
  - Barriers, Construction & Maintenance Required 2241
  - ICP Permits Required 2242
  - Standards Adopted 2240
- Application Procedure 1364, 1838, 1863
  - Application Processing 1364
  - Application Submission 1839
  - Contents of Application 1838
  - Eligible Projects 1863
  - Engineering Certification 1839
  - Initial Review 1863
  - Provision If Application Rejected 1364
  - Submission of Application 1364
  - Waiting List 1364
- Application Procedure & Requirements For Other Mining Operations Including Hardrock, Underground & Phosphate Mining 1187
  - Application Package 1187
  - Map Requirements 1188
  - Operating Plan Requirements 1188
  - Reclamation Plan Approval Required 1187
  - Reclamation Plan Requirements 1188
- Application Procedure & Requirements For Permanent Closure Of Cyanidation Facilities 1189
  - Application Fee 1191
  - Application Package for Permanent Closure 1191
  - Permanent Closure Cost Estimate Verification Fee 1192
  - Permanent Closure Plan Approval Required 1189
  - Permanent Closure Plan Requirements 1189
  - Preapplication Conference 1190
  - Processing & Review Fee 1191
- Application Procedure & Requirements For Quarries, Decorative Stone, Building Stone, & Aggregate Materials Including Sand, Gravel & Crushed Rock 1186
  - Application Package 1186
  - Approval Required 1186
  - Map Requirements 1186

- No Operator Shall Conduct Mining Operations 1186
- Reclamation Plan Requirements 1187
- Application Procedure For Placer Or Dredge Mining Permit 1162
- Application Package 1162
- Application Review & Inspection 1165
- Approved Reclamation Plan Required 1162
- Incomplete Applications 1162
- Requirements for Reclamation Plan 1164
- Requirements of Maps 1163
- Settling Ponds 1163
- State Approval Required 1165
- Application Procedures 1528, 2400, 2403
- Additional Information 2405
- Appeal 1529
- Applications 1528
- Dates 1529
- Estimates of Ambient Concentrations 2400, 2405
- Estimates of Emissions 2400
- Lack of Activity 1529
- Monitoring & Recordkeeping 2400
- References 1529
- Required Information 2403
- Application Procedures, Tier II Operating Permit 2462
- Additional Information 2463
- Additional Specific Information 2462
- Estimates of Ambient Concentrations 2463
- Required Information 2462
- Application Process 1069
- Affiant Administrative Employees 1069
- Affidavit Statement 1069
- School Administrative Description 1069
- Application Processing Procedure 2754, 2810
- Accuracy & Protectiveness Review 2810
- Additional Information 2755
- Application Completeness 2755
- Application Processing Time Line for Director's Final Decision 2810
- Basis for Permit Application Denial 2810
- Completeness Review 2810
- Draft Permit 2755
- Final Permit 2755
- Notice of Environmental Suitability of Facility Location 2755
- Notice of Intent to Deny the Permit Application or to Draft a Permit 2810
- Permit Denial 2755
- Permit Fact Sheet 2810
- Public Comments 2755
- Application Request Process, Children's Agencies 1042
- Application Requirements 2100
- Amended Applications 2102
- Effect of an Application 2101
- General Provisions 2100
- Requirements for Applications to Be Acceptable for Filing 2101
- Application Review 2076
- Prior to Issuance of Permit 2076
- Proposed Alteration Which Does Not Follow Minimum Standards 2076
- Application Status 925
- Application To Be Adoptive Parent(s) 974
- Application for Subsequent Adoptions 975
- Denial of Application 974
- Initial Application 974
- Orientation of Potential Applicants 974
- Psychological Evaluation 974
- Application To Both Permits & Licenses 1409
- Application To Participate 2823
- Application Processing Procedure 2823
- Application Required 2823
- Contents of Application 2823
- Application, Licensure & Termination Of Licenses 1903
- Applications 403, 552, 784, 1230, 1511, 1663, 1696, 2075
- Age 552
- Applicant Following Minimum Standards 2075
- Application Filing Date 1663
- Application Form for Licensure 1663
- Application Forms 552
- Application Must Be Complete 1663, 1664
- Encroachment Applications 1231
- Joint Application Permit Form 2075
- Other Forms 552
- Other Permits 1231
- Qualifications 1511
- Repairs, Reinstallation of Structures 1231
- Signature Requirement 1231
- Stream Channel Alteration Permit 2075
- Submission of Copies 2075
- Applications & Forms 609
- Applications & Processing 1258
- Application Process 1258
- Eligible Applicant 1258
- Expiring Leases 1260
- Rental Deposit 1260
- Applications & Renewals 497
- Applications & Requirements 1569
- Age 1570
- Completion of One Year as a Resident Trainee 1570
- Funeral Director Educational Requirements 1570
- Moral Character 1570
- Mortician Educational Requirements 1570
- Applications For License 999
- Applications For Limited Electrical Installer License 387
- Applications For Succeeding Seasons 570
- Applications/Claims/Appeals--Defined-Form & Contents 1970
- Appointment Of Hearing Officers 1978
- Appointment Of Local Rental Pool Committees 1996
- Annual Report 1997
- Board Meetings for Committee Appointments 1996
- Local Committee Procedures 1997
- Review by Director 1997
- Submission of Amendments to Procedures to Board 1997
- Appraisal Procedure For Animals Depopulated 151
- Animal Appraisal 151
- Dispute of Appraisal 151
- Appraisal Procedures 1297
- Appraisal 1298
- Cost of Appraisal 1298
- Appraisal Requirements 1862
- Appraisal Reviews 1862
- Appraisals In Litigation 1692
- Apprentice Electrician Direct Supervision & Training 384
- Apprentice Electrician Registration 381
- Registration Requirements 381
- Renewal Requirements 381
- Apprentice Jockey 553
- Apprentice Registration 400
- Journeyman Examination 401
- Schooling Requirements 401
- Work Requirements 401
- Apprentice Registration & Apprenticeships 1787
- Application & Qualifications 1787
- Instruction 1788
- Out of State Apprenticeship 1789
- Recordkeeping 1788
- Supervision 1788
- Termination of Registration 1788
- Apprenticeship Certificate 1313
- General 1313
- Procedure to Obtain Certificate 1313
- Regulations Governing Use of Certificate 1313
- Approval 2076
- Conformance to Application 2076
- Permits Allowed Without Review 2076
- Reinstatement of Expired

- Permit 2077
- Approval & Denial Of
  - Applications 1899
  - Delegation of Review & Approval 1899
  - Denial of Application for Unpaid Fees 1900
  - Discretionary Investment 1900
  - Review Periods 1899
- Approval Of A New Educational Program 1444
  - Educational Programs 1444
- Approval Of Alternative Standards 2245
- Approval Of Continuing Education Courses 1514, 1676, 1761
  - A College or University 1761
  - Accredited Schools 1676
  - Approved Continuing Education Courses 1514
  - Federal, State or Local Governmental Entities 1761
  - Licensee Course Approval 1515, 1761
  - National and State Massage Therapy Associations 1761
  - NCCAOM 1676
  - Other Courses May Be Approved By The Board 1676
  - Provider Course Approval 1761
- Approval Of Events 1477
  - Cancellation 1477
  - Deadline 1477
  - Prior Approval 1477
- Approval Of Facilities By Commission Before Tickets May Be Sold 1480
  - Approval 1480
  - Other Considerations 1480
- Approval Of Field Studies & Fluid Models 2472
- Approval Of Local Manufactured Home Installation Inspection Programs 446
  - Division Approval 446
  - Voluntary Withdrawal 446
- Approval Of New Or Alternative Technology 449
  - Administrator Approval Required 449
  - Engineer Approval 449
  - Submission Deadline 449
- Approval Of Non-Steroidal Anti-Inflammatory Drug Request 585
  - Professional Diagnosis 586
  - Professional Judgment 586
- Approval Of Preliminary Education 1586
- Approval Of Racing Association Licenses 571
- Approval Of Schools Of Optometry 1585
- Approval, Denial Or Dismissal Of Application For Issuance Of License 2338
- Approved 198
- Approved Buying Station Number 201
- Approved Buying Stations 201
- Approved Colleges & Universities 1637
- Approved Education 1563
- Approved Education & Examinations 1705
  - 1705
  - Licensure Examination 1705
- Approved Equipment & Materials 1131
  - Minimum Requirements 1131
  - Sprinklers 1131
- Approved Examination 1570, 1778
  - Funeral Director 1571
  - Grading 1571
  - Mortician Examination 1570
- Approved Examinations 1757
  - Date of Exam 1758
  - Successful Passage 1758
- Approved Forms Of Identification 201, 205, 210
  - Administrator Approval 201, 205, 210
  - Back Tag 210
  - Brand Inspection 201, 205, 210
  - Ear Tag 210
  - Official USDA Ear Tag 201, 205
  - Registration Tattoo 201, 205, 210
  - Removal of Animal Identification 201
  - Removal of Identification 210
  - Removal of Individual Animal Identification 205
  - USDA Approved Backtag 201, 205
- Approved Livestock Trader Lot Number 204
- Approved Livestock Trader Lots 204
  - Cattle Are Received 204
  - Sold to Individuals 204
- Approved Schools Of
  - Chiropractic 1515
  - New Schools 1515
  - Requirement for Approval 1515
- Approved Topics For Continuing Education 1906
  - Topics Approved by the Commission 1906
  - Topics Not Eligible for Continuing Education Credits 1906
- Architectural Barriers 1869
- Architectural Intern 1461
  - AXP Enrollment 1461
  - Prohibitions 1461
  - Record 1461
  - Supervision 1461
- Area & Articles Under Quarantine 286
  - Articles & Commodities Covered 287
  - Infested Area 286
  - Noninfested Area 287
- Area Under Quarantine, Subchapter E 288
- Area Under Quarantine, Subchapter J 301
- Area Under Quarantine, Subchapter K 302
- Areas Of Drilling Concern 2139
  - Additional Requirements 2140
  - Bond Requirement 2140
  - General 2139
- Areas Under Quarantine, Subchapter I 299
  - Canada 299
  - Other Areas 299
  - States 299
- Arrangement Of Match For Promoter 1478
- Articles & Commodities Covered, Subchapter K 302
  - Fresh Fruit of All Plants 302
  - Soil 303
- Articles & Commodities Under Quarantine, Subchapter I 299
  - Free From Soil 300
  - Possible Hosts & Carriers 299
  - Soil 300
- Artificial Insemination 139
  - Examination 139
  - Issuance Denial 139
  - License Application 139
  - License Expiration 139
  - License Renewal 139
  - Passing Examination 139
  - Renewal Delinquency 139
  - Temporary License 139
  - Training 139
- Assessment 1312
  - Assessment 1312
  - Purchaser 1312
  - Weight 1312
- Assessment Return 362
  - Dealer Assessment Return 362
  - Grower Assessment Return 362
- Assessments 1075
  - Preadmission Assessment 1075
  - Psychological Problems 1075
  - Subsequent Assessments 1075
- Assessments & Fees 687
  - Assessments Levied 688
  - Insufficient Funds Checks 688
  - Payment Method 688
- Assigning Reports For Safety Assessment, Reporting Abuse, Abandonment Or Neglect 958
- Assignment 1839
- Assignment Of Powers Of Secured Party Of Record 1934
  - Status of Financing Statement 1934
  - Status of the Parties 1934
- Assignments 1237, 1243, 1248, 1253, 1262, 1275, 1287
  - Application 1275, 1288
  - Approval Required for Assignment 1237
  - Assignment Fee 1237, 1253
  - Assignment of Encroachment

- Permit 1237
- Assignment With New Permit 1237
- Denial 1276, 1288
- Fee 1248, 1288
- Form of Assignment 1288
- Full or Partial 1275
- Joint Principal 1275, 1288
- Multiple Assignments 1248, 1253
- Overriding Royalty Disclosure 1275
- Partition 1243
- Prior Written Approval 1243, 1275, 1287
- Prior Written Consent 1248, 1253
- Qualified Assignee 1287
- Responsibilities 1287
- Responsibility 1275
- Segregation of Assignment 1275, 1287
- Segregation of Lease 1243
- Assignments, Assignment Fee 1298
- Approval Required for Assignment 1298
- Assignment Fee 1298
- Assignment of Lease 1298
- Permit Assignment 1298
- Assistance With Medication 847
- Condition of the Resident 847
- Containers and Labels 847
- Disposal of Medication 849
- Documentation of Assistance 848
- Nursing Assessment 847
- Safeguarding Medications 848
- Training 847
- Assistance With Medications 908
- Delegation 908
- Training Requirements 908
- Assistant Starter 553
- ASTM Grade 1, Distillate Fuel Oil 2536
- Athletic Training Service Plan Or Protocol 1406
- Listing of Services & Activities 1406
- Locations & Facilities 1407
- Methods to be Used 1407
- Attempt To Place Without Adoption Assistance 988
- Audit Of One-Number Service Records 479
- Authority 1240
- Authority Conferrable On Employees - Enforcement 1844
- Director Authority 1844
- Park or Program Manager Authority 1844
- Authority For Alternate Care Services 946
- Department Custody 947
- Voluntary Placement 947
- Authority Of Representative 2008, 2050, 2062
- Proof of Beneficial Use 2008
- Responsibility 2008
- Authority Of The Commission
- Veterinarian 579
- Authority To Enter & Inspect 280, 291
- Authority To Enter, Inspect & Control Control & Destruction of Infected Plants 299
- Entry & Inspection 299
- Authority To Enter, Inspect, & Control 299
- Authority To Enter, Inspect, & Control Requirements 296
- Agent Authorization 296
- Submission for Inspection 296
- Authority To Issue Permits 2216
- Authority 2216
- Special Permit 2216
- Authority To Prescribe, Dispense, Administer, And Order 1403
- Formulary Exclusions 1404
- Laboratory and Diagnostic Procedures 1403
- Naturopathic Formulary 1404
- Authorization For Disinterment & Reinterment 743
- Disinterment & Reinterment of a Dead Body or Fetus 743
- Mass Disinterment & Reinterment 743
- Nature of Permit 744
- Authorization For Granting, Denial & Revocation Of Licenses 1830
- Board Conditions 1831
- Executive Director Authorizations 1830
- Authorization Of Hearing 2395
- Early Hearing 2396
- No Hearing 2396
- No Objection 2396
- Authorization To Test & Notification To Schedule 24
- Authorizations Required, Residential Care Facility 1037
- Authorizations, Prohibitions & Exemptions 2025
- Authorizations 2025
- Exemptions 2026
- Prohibitions 2026
- Authorized Agent License 553
- Changes 553
- Each Owner Represented 553
- Power of Attorney 553
- Termination 553
- Written Instrument 553
- Authorized Operations 1856
- Automatic Low Pressure Drain 132
- Availability of Referenced Material 2600
- Availability To Provide Services
- Pending Completion Of The Criminal History & Background Check 925
- Employees of Providers, Contractors, Emergency Medical Services (EMS), or the Department 925
- Individuals Licensed or Certified by the Department 925
- Availability To Users 1869
- Nondiscrimination 1869
- Seasons & Hours 1869
- Available Services 1368
- Nursing Care 1368
- Residential & Domiciliary Care 1368
- Averaging Period, Sections 675
- Through 680 2532
- One Cycle 2532
- One Hour 2532
- AZA Accredited Facilities & USDA Licensed Facilities 183
- Movement Between AZA & USDA Facilities 183
- Transfer of Cervidae 183

**B**

- Baby Calves - Owner Inspection 531
- General Requirements for Baby Calf Inspection 531
- Inspection of Calves Eleven Days or More Old 532
- Backflow Assembly Tester Code Of Ethics & Standards Of Conduct 1547
- Backflow Protection, Distribution System 2731
- Bacterial Estimate Classification 165
- Bacterial Estimate Procedures 165
- Methods of Testing 165
- Bacteriological Quality Of Pool Waters 768
- Bad Checks 554
- Bandaging Of Combatant's Hands 1484
- Bandaging Of Combatant's Hands Additional Requirements 1484
- General 1484
- Witnesses 1484
- Banned Substances 580
- Administration by Veterinarians 580
- Banned Substances 580
- Barber & Cosmetology School Requirements 1782
- Cessation of School 1783
- Change in Ownership or Location 1783
- Clinical Work 1782
- Curriculum 1782
- Faculty or Instructors 1782
- Operations 1782
- Outside School Activities 1783
- Premises 1782
- Student Records To be Maintained by the School 1783
- Barns 576
- Good Repair 576
- Stall Size 576
- BART Requirement For Regional Haze 2530
- Alternative to Infeasible Emission Standards 2530



- BART Alternative 2531  
BART Determination 2530  
BART Installation & Operation Due Date 2530  
BART-Eligible Sources 2530  
Maintenance of BART Equipment 2530  
Reasonable Progress Goal Requirements for BART-Eligible Sources 2531  
Base Camp Requirements 1070  
Base Camp 1070  
Proof of Compliance 1070  
Baselines For Prevention Of Significant Deterioration 2492  
Baseline Area 2492  
Baseline Concentration 2492  
Baseline Date(s) 2492  
Basic Certification Of Law Enforcement Officers 614  
Bathroom Facilities, Children's Residential Care Facilities 1056  
Bathrooms, Water Supply, & Sewage Disposal 1024  
Sewage Disposal 1024  
Toilet Facilities 1024  
Water Supply 1024  
Becoming an Adoptive Parent 974  
Bedding Plants 349  
Aphid Inspection 350  
Treatment for Infestation 350  
Treatment of Cemeteries 350  
Treatment of Property 350  
Bedrooms 1026  
Appropriate Bedding 1027  
Children of the Opposite Gender 1027  
Maximum Number of Children in a Bedroom 1027  
Non-Ambulatory Child 1026  
Number of Children in a Bed 1027  
Restrictions on Sleeping Arrangements 1027  
Sharing a Bedroom with a Foster Parent 1026  
Sharing Bedroom with a Non-Parent Adult 1026  
Sleeping Arrangements 1026  
Beds, Children's Residential Care Facilities 1056  
Behavior Management & Discipline 1027  
Agency Consultation 1028  
Authority 1028  
Prohibitions 1027  
Restraint 1028  
Behavior Management & Discipline Policy 1062, 1082  
Behavior Management 1062, 1082  
Documentation 1062, 1083  
Bell Or Gong 1485  
Below Regulatory Concern Facilities 2574  
Applicable Requirements 2574  
Application Content, Review & Approval Requirements 2575  
Documentation Requirements 2575  
Bentonite Grout 2120  
Best Available Retrofit Technology (BART) 2367  
Best Management Practices & Reclamation For Mining Operation & Permanent Closure Of Cyanidation Facilities 1208  
Backfilling & Grading 1210  
Clearing & Grubbing 1209  
Disposal of Waste in Areas Other Than Mine Excavation 1210  
Nonpoint Source Control 1208  
Overburden/Topsoil 1209  
Permanent Cessation & Time Limits for Planting 1212  
Petroleum-Based Products & Chemicals 1214  
Revegetation Activities 1212  
Roads 1209  
Sediment Control 1208  
Settling Ponds 1211  
Tailings Impoundments 1211  
Best Management Practices & Reclamation For Placer & Dredge Mining Operation 1170  
Backfilling & Grading 1172  
Clearing & Grubbing 1171  
Dam Safety 1172  
Dewatering Settling Ponds 1172  
Modification of Management Practices 1171  
Mulching 1173  
Nonpoint Source Sediment Control 1170  
Overburden/Topsoil 1171  
Permanent Cessation & Time Limits for Planting 1173  
Revegetating Waste Piles 1173  
Revegetation Activities 1174  
Roads 1171  
Settling Ponds -- Minimum Criteria 1172  
Soil Amendments 1173  
Topsoil Redistribution 1173  
Topsoil Replacement 1172  
Waste Disposal - In Areas Other Than Mine Excavations 1173  
Bicarbonate Testing 588  
Administration Prohibited 589  
Collection of Test Samples 589  
Positive Test Level 589  
Split Sample Testing Prohibited 589  
Billing Third Parties First 785  
Binding On Heirs 1300  
Bingo By Charitable Or Nonprofit Organizations 2326  
Bingo Operations Using Electronic Bingo Machines 2329  
Electronic Bingo Machines Defined 2329  
Inspection & Testing 2329  
List of Approved Hardware & Software 2329  
Pre-Game Testing 2330  
Requirements for Approved Site Systems 2329  
Use of Approved Hardware & Software 2329  
Biodiesel 101  
Documentation For Dispenser Labeling Purposes 101  
Exemption 101  
Identification of Product 101  
Labeling of Retail Dispensers 101  
Biologicals, Animal Industry 140  
Bio-Security Plan 209  
Diagnosis 210  
Disposition 210  
Identification 210  
Records 210  
Blanket Bond 1168  
Bleeder Treatment 586  
Bleeders 586  
Lasix 586  
Premarin 586  
Written Approval Needed 586  
Block Expansion, Virus-Free Certification Of Nursery Stock 273  
Blood Samples 587  
Flunixin 587  
Ketoprofen 588  
Lasix 588  
Mechlofenamic Acid 587  
Phenylbutazone 587  
Blow Out Prevention 2043  
Explored Areas 2044  
Unexplored Areas 2043  
Blows At Or After The Bell In MMA Contest 1505  
Illegal Blow 1505  
Legal Blow 1505  
Board 1637  
Board Action Upon Determination Of Probable Violation 1320  
Board Certification Of Optometrist Authorized To Obtain & Use Pharmaceutical Agents 1592  
The Right to Obtain & Use Topically Applied Diagnostic Pharmaceutical Agents 1592  
The Right to Prescribe, Administer & Dispense Therapeutic Pharmaceutical Agents 1593  
Board Fees 1878  
Fee Determination & Collection 1878  
Fee Exemption for Controlled Substance Registrations 1878  
Fee For Dishonored Payment 1878  
Overpayment of Fees 1878  
Time & Method of Payment 1878  
Board Inspections & Investigations 1875  
Inspection Deficiencies 1875  
Inspection Reports 1875

- Inspections 1875
- Investigations 1876
- Records Subject to Board
  - Inspection 1875
- Board Meetings 1637, 2348
  - Agenda 2348
  - Meetings 2348
- Board Meetings - Dates - Places 1696
  - Board Meeting Dates 1696
  - Dates & Places May be Changed 1697
- Board Of Pharmacy Licensure & Registration 1877
- Board Review & Approval 1864
- Board Review Of Auction 1265
- Boat Equipment Requirements 1817
  - Clearwater 1818
  - Identification 1817
- Boat Transport Of Hunting
  - Clients 1817
- Boating Client/Guide Ratio 1818
- Boating Facilities 1848
  - Moorage & Use of Marine Facilities 1848
  - Moorage Fees 1848
  - Self-Registration 1848
  - Use of Onshore Campsites 1848
- Boatman License Trainees 1813
- Bond 439, 1243, 1299, 1302
  - Amount of Bond 1302
  - Bond Requirement Determined by Director 1299
  - Exceeding Minimum Bond 1303
  - Performance Bond 1299
  - Rates 1302
- Bond Requirements 1278, 1289
  - Bond Cancellation 1290
  - Form 1290
  - Form of Performance Bond 1290
  - Minimum Bond 1278, 1289
  - Operator Bond 1278
  - Period of Liability 1278, 1289
  - Statewide Bond 1278, 1289
  - Surety License 1290
- Bonded 573
- Bonded Title 2186
  - Bond Surety 2186
  - Claims Against The Bond 2186
  - Conditions & Requirements 2186
  - Expiration Of Bonding Requirement 2187
  - Return Of Bond Prior To Three Year Period 2187
  - Sales & Use Tax 2187
- Bonding 1338, 2053, 2165
  - Additional Bonding 1339
  - Amount of Bond 2053
  - Authorized Bonds 1339
  - Blanket Bond 1338
  - Bonding Requirements 2165
  - Cash Bonds 2165
  - Cost Estimate Submitted by Engineer 2053
  - Current Costs for
    - Abandonment 2054
    - Determination of Bond Amount 2054
    - Filing Copy of Performance Bond 2054
    - Filing Initial Bond 2054
    - Filing of Bond 2053
    - Inactive Well Bond 1338
    - Individual Bond 1338
    - Provisions of Bond 2053
  - Bookmakers 569
    - Ejection 569
    - Entry Prohibited 569
    - License Revocation 569
  - Boxer's Costume & Equipment 1488
    - Costume 1489
    - Fit 1489
    - Other Equipment 1489
  - Boxing Gloves 1483
    - Distal Portion 1484
    - Extra Set 1483
    - General 1483
    - Glove Specifications 1483
    - Sanitary 1483
    - Weight of Gloves 1483
  - Boxing Ring 1484
    - Ring Dimensions 1484
    - Ring Platform 1484
    - Ropes 1484
  - Brakes 2214
  - Brand & Product Names 246
    - Intended Use 246
  - Brand Alternatives 530
    - Identification 530
  - Brand Inspections 530
    - Fees 531
    - General Procedures 530
    - Owners 530
    - Proof of Ownership 531
  - Brand Inspections At Slaughter Plants & Mobile Slaughter Units 533
    - Collection 533
    - Inspection 534
    - Notification 533
    - Record of Ownership 533
    - Records 533
  - Brand Inspector To Require Dealer License Number 536
  - Branding Of Sheep 530
    - Breach 1261
      - Damages for Breach 1261
      - Non-Compliance 1261
  - Bread, Weights & Measures 103
  - Breakopen Instant Ticket Games 2320
    - All Devices Must Comply with Requirements 2322
    - Breakopen Instant Ticket Operation 2322
    - Breakopen Instant Ticket Price per Play to be Posted 2322
    - Breakopen Instant Ticket Series Assembly & Packaging 2322
    - Breakopen Instant Ticket Special Inspection 2321
    - Certificate Modification 2323
    - Definitions 2320
    - Limitation on Breakopen Instant Ticket Dispensing 2322
    - Prize Structure 2323
    - Retailer Application & Fee 2323
    - Retailers Eligible to Sell Breakopen Tickets 2323
    - Standards for Flares 2323
  - Breed Associations 569
    - Failure to File 569
    - Representatives 569
  - Breeder Awards 569
  - Briefs 1952
  - Briefs -- Memoranda -- Proposed Orders Of The Parties -- Statements Of Position -- Proposed Order Of The Presiding Officer 1984
  - Broker-Dealer Agent/Issuer Agent Registration 662
    - Agents of Issuer 662
    - Annual Renewal 663
    - Broker-Dealer Agents 662
    - Completion of Filing 664
    - Deferral of Effectiveness 664
    - Incomplete Applications 663
    - Updates & Amendments 663
  - Broker-Dealer Registration -- Application/Renewal 660
    - Annual Renewal 661
    - Completion of Filing 661
    - Deferral of Effectiveness 661
    - Incomplete Applications 661
    - Initial Application -- FINRA Member Firms 660
    - Initial Application -- Non-FINRA Member Firms 660
    - Updates & Amendments 661
  - Bromine Disinfection 767
  - Brucellosis, Domestic Cervidae Ranches 193
  - Buildings, Grounds, Furnishings & Equipment, Children's Residential Care Facilities 1055
  - Buildings, Grounds, Furnishings, & Equipment 1015
    - Appliances & Electrical Cords 1015
    - Balconies & Stairways 1015
    - Fueled Equipment 1015
    - Hazard Areas Restrictions 1015
    - Indoor Play Areas & Toys 1016
    - Outdoor Play Areas & Toys 1016
    - Stairway Protection 1015
    - Water Hazards 1015
  - Bulk Lots Labeled Not For Sale -- Removal Thereof, Potatoes 50
  - Burden Of Proof - Extenuating Circumstances 990
  - Burdens Of Proof 1985
  - Burn Determination 2522
    - Burn Approval Criteria 2522
    - Notification of Approval 2523
  - Burn Fee 2522
    - Burn Fee 2522

- Effect of Delinquent Fee  
 Payment 2522  
 Burning Of Slash 1304  
 Burn Plan 1304  
 Permits 1304  
 Burning, Agriculture Fields 2521  
 Business Conduct 1905  
 Business Organization - Changes In  
 Organization Or Structure - Members  
 Of Joint Ventures - Changes For  
 Reasons Other Than Death 466  
 Buying Station Records 202  
 Buying Station Records Retention 203  
 Buying Stations, Cattle Subject To  
 Quarantine 203
- C**
- Calculating Income To Apply The  
 Sliding Fee Schedule For Children's  
 Mental Health & Adult Mental Health  
 Services 1090  
 Ability to Pay 1090  
 Fees Established by the  
 Department 1091  
 Financial Obligation 1090  
 Required Information 1090  
 Time of Payment 1090  
 Calculating Permit Provisions 2950  
 Continuous Discharges 2951  
 Disposal of Pollutants into Wells, into  
 POTWs, or by Land  
 Application 2954  
 Internal Waste Streams 2954  
 Mass Limitations 2951  
 Metals 2951  
 Noncontinuous Discharges 2951  
 Outfalls & Discharge Points 2950  
 Pollutant Credits for Intake  
 Water 2952  
 Production-Based Limitations 2950  
 Calibration Of Milk Component Testing  
 Devices 156  
 Calibration Frequency 156  
 Calibration Procedure 156  
 Calibration Samples 156  
 Camping 1847  
 ADA Accessible Facilities 1848  
 ADA Designated Campsites 1848  
 Camping 1848  
 Camping & Occupancy 1847  
 Campsite Parking 1848  
 Check Out 1848  
 Condition of Campsite 1847  
 Equipment 1848  
 Length of Stay 1847  
 Liquid Waste Disposal 1847  
 Motorized Equipment 1848  
 Registration Required 1847  
 Responsible Party 1848  
 Self Registration 1847  
 Visitors 1848  
 Camping Day, Definitions 1841  
 Cancellation 1840  
 Cancellation & Additional  
 Remedies 1298  
 Additional Remedies  
 Available 1299  
 Cancellation of Lease for Use Other  
 Than Intended Purpose 1299  
 Cancellation of Lease for Violation of  
 Terms 1298  
 Reinstatement of Lease 1299  
 Removal of Improvements Upon  
 Cancellation 1299  
 Cancellation Of Registration Or  
 Application -- Grounds 670  
 Cancer Eye - Epithelioma 139  
 Animal Rendering Plants 139  
 Fur Farms 140  
 Canine Evaluator Certification 630  
 Certification 630  
 Eligibility 630  
 Retaining Certification 631  
 Revocation 631  
 Canine Team Certification 630  
 Areas of Certification 630  
 Eligibility 630  
 Evaluation 630  
 Expiration of Certification 630  
 Failed Evaluation 630  
 Mandatory Certification 630  
 Canine-Related Certifications 630  
 Capped Zone 1801  
 Cardiac 781  
 Eligible Conditions 781  
 Excluded Conditions 781  
 Spending Limit 781  
 Cash Bond Release 1303  
 Casual Exploration & Recreational  
 Mining 1241  
 Categories Of Allowable  
 Burning 2519  
 Categorized Aquifers Of The  
 State 2770  
 General Resource 2770  
 Other Resource 2770  
 Sensitive Resource 2770  
 Category I Exemption 2422  
 Below Regulatory Concern 2422  
 Mercury 2423  
 Radionuclides 2422  
 Toxic Air Pollutants 2422  
 Category II Exemption 2423  
 Exempt Source 2423  
 Other Exempt Sources 2424  
 Cause for Hearing 1333  
 Cementing & Testing  
 Requirements 1346  
 Cemetery Use 1385  
 Interment Schedule 1385  
 Public Use 1385  
 Central Roster Of Psychosexual  
 Evaluators, Sexual Offender  
 Treatment Providers & Post  
 Conviction Sexual Offender  
 Polygraph Examiners 2356  
 Availability 2357  
 Identification 2356  
 Certain Persons Retained Must Have  
 Licenses 1478  
 Combatant 1478  
 Matchmaker 1478  
 Ring Official 1478  
 Second 1478  
 Certificate Of Clearance 1309  
 Certificate Of Compliance-Fire Hazard  
 Management Agreement 1302  
 Contents 1302  
 Extensions 1302  
 Period of Time 1302  
 Responsibility 1302  
 Certificate Of Eligibility  
 Requirements 712  
 Certificate of Eligibility  
 Duration 712  
 Criminal History and Background  
 Check 712  
 Personnel Licensure Requirements  
 are Met 712  
 Renewal of Certificate of  
 Eligibility 712  
 Revocation of Certificate of  
 Eligibility 712  
 Certificates 497  
 Certificates Of Competency -- Issuance,  
 Renewal, Expiration -- Revival 472  
 Expiration-Revival 472  
 Issuance 472  
 Renewal 472  
 Certificates Of Competency -- Issuance,  
 Renewal, Expiration, Revival --  
 Fees 404  
 Expiration - Revival 404  
 Issuance 404  
 Renewal 404  
 Certificates Of Veterinary  
 Inspection 138  
 Copies 138  
 Idaho Certificates 138  
 Certificates, Records, & Forms 728  
 Certificates with Defects 728  
 Form & Content 728  
 Official Nature of Forms 728  
 Requirements for Preparation of  
 Certificates 728  
 Certification & Approval Of Electrical  
 Products & Materials 395  
 Availability of NFPA Standards 395  
 Field Evaluation 395  
 Testing Laboratory 395  
 Certification A Prerequisite For License  
 Issuance Or Renewal 1905  
 Certification Fees 358, 748  
 Annual Base Fee 748  
 Non-Refundable Application  
 Fee 748  
 Certification Identification (ID)  
 Card 795  
 Certification Inspection Fees 358  
 Certification Marking 340  
 Bale Tag 341  
 Certified Compressed Forage/Straw

- Bale Binding Material 341
- Forage Cube/Pellet Tag/Label 341
- NAISMA Twine 341
- Certification Of Documents 2389
- Certification Of Veterinary Technicians 2263
  - Application for Certification -- Contents -- Examinations 2264
- Certificate Required 2264
- Certification Period 2356
  - Associate/Supervised Post Conviction Sexual Offender Polygraph Examiner 2356
  - Associate/Supervised Psychosexual Evaluator or Treatment Provider 2356
  - Provisional/Supervised Psychosexual Evaluator or Treatment Provider 2356
  - Senior/Approved Post Conviction Sexual Offender Polygraph Examiner 2356
  - Senior/Approved Psychosexual Evaluator or Treatment Provider 2356
- Certification Requirements 816
  - Accessibility to the Home 816
  - Certificate Issued in the Name of Provider 816
  - Certification Limitations 816
  - Certification Study Required 816
  - Effect of Previous Revocation or Denial of Certificate or License 817
  - Number of Residents in the Home 816
  - Provider Training Requirements 817
- Certification Requirements & Fees 358
- Certifications For Part-Time Officers 627
  - Decertification 628
  - Lapse of Certification 628
  - Requirements 627
- Certified Adoption Professional 983
- Certified Adoption Professional Requirements 983
  - Adoption Training 983
  - Application Fee 983
  - College Degree 983
  - Department Criminal History & Background Clearance 983
  - Experience 983
  - Insurance 983
  - License 983
  - References 983
- Certified Adoption Professional's Client Relationship 985
- Certified Euthanasia Agency 2276
  - Approved Drugs 2276
  - Certification Renewal 2279
  - Equipment Stored 2279
  - Other Site Conditions 2278
  - Proper Labeling 2277
  - Proper Sanitation 2278
  - Proper Storage 2277
  - Record Keeping 2277
  - Temporary Storage 2277
- Certified Euthanasia Technician 2279
  - Certification 2281
  - Certification Renewal 2282
  - Certification Standards 2279
  - Duties 2282
  - Training & Examinations 2279
- Certified Evaluator
  - Qualifications 2348
  - Certification Requirements 2348
- Certified General Real Estate Appraiser
  - Classification Appraiser Qualification Criteria 1689
  - Education 1689
  - Experience 1691
- Certified Public Accountant Examination 24
- Certified Residential Real Estate Appraiser
  - Appraiser Classification Appraiser Qualification Criteria 1688
  - Education 1688
  - Experience 1689
- Chain Of Custody 585
- Challenges To Statutes 1979
- Challenging A Basic Training Academy 620
  - Patrol & Detention Law Enforcement Certification Program or POST Academy Graduates 620
  - Requirements for Challenging a Basic Training Academy 620
- Champions 1486
  - Commission Names Champions 1486
  - Defending a Title 1486
  - Fighting a Boxer From Heavier Class 1486
  - General 1486
  - Presentation of Championship Belt to Commission Before Title Contest 1487
  - Title at Stake 1486
  - Title Not at Stake 1486
- Change In Land Use 1260
- Change Of Address 189
- Change Of Decision In Boxing Contest
  - Collusion 1494
  - Error in Interpretation of Rules 1495
  - Error in Scoring 1495
  - Failure of Drug Test 1495
- Change Of Decision In Contest 1494
- Change Of License Status 122
  - Change Notification 122
  - Transferable 122
- Change Of Ownership 870
  - Application for Change of Ownership 870
  - Change of Ownership for a Facility In Litigation 870
  - Non-Transfer of Facility License 870
- Change Of Provider Or Location 820
  - Change of Location 820
  - Change of Provider 820
- Change Of Rental 1261
- Changes In License Certificate 467
- Changes In Licensee Information 1729
  - Address for Notification Purposes 1729
  - Information Update 1729
- Changes In Name & Address -- Address For Notification Purposes 471
  - Address for Notification Purposes 471
  - Change of Address 471
  - Change of Name 471
- Changes In Name & Address -- Address For Notification Purposes 1415
  - Address for Notification Purposes 1415
  - Change of Name 1415
- Changes To An Existing License 711
  - Personnel License Duration Shortened 711
  - Relinquish a Current EMS Personnel License for a Lower Level License 711
  - Relinquishment of a License to a Lower Level License to Prevent Investigation or Disciplinary Action 711
  - Reporting Requirements for Changes in Status 711
  - Surrender of a Current EMS Personnel License 711
  - Surrender of License to Prevent Investigation or Disciplinary Action 711
- Changes To Tier I Operating Permits 2450
  - Acid Rain 2451
  - Applicability 2450
  - Changes Requiring Notice 2450
  - Changes Requiring Permit Revisions 2450
  - Reopening 2451
- Charges 914
  - Insurance 914
  - Other Benefits 915
- Charges For Special Request Testing Or Examination 83
  - Fee Collection 83
  - Mileage Charges 83
  - Personnel Charges 83
- Charitable Gaming Rules of the Idaho State Lottery 2323
- Cheating 24
  - Actions 24
  - Hearings 24
  - Notice 25
- Check Scale Report 1318
  - Check Scale Results 1318
  - Persons Entitled to a Copy of the Check Scale Report 1318

- Check Scaling Procedures 1316  
  Cooperative Scaling 1317  
  Holding Check Scale Log Loads 1317  
  Team Scaling 1317  
  Valid Check Scale 1316  
Check Scaling Standards Of Variation 1317  
  Allowable Limits of Variation 1317  
  Check Scales Involving Multiple Variations 1318  
  Combination Logs 1318  
Chemical Injection Line Shut Down (System Interlock) 128  
  Electrical Interlock 128  
  Human Interlock 130  
  Hydraulic Interlock 130  
  Mechanical Interlock 129  
  Other Approved Option 130  
Chemical Injection System 130  
  Metering Pump 130  
  Venturi System 130  
Chemical Storage 767  
Chief Administrator Position & Qualifications 1041  
  Bachelor's Degree 1041  
  Master's Degree 1041  
Chief Administrator  
  Qualifications 1052  
  Bachelor's Degree 1052  
  Career Development Program 1052  
Child Care & Safety  
  Requirements 1022  
  Access by Children Five Years of Age & Under 1022  
  Irrigation Canals or Similar Body of Water 1023  
  Other Safety Water Precautions 1023  
  Pools, Hot Tubs, Ponds, & Other Bodies of Water 1022  
Child Custody Investigations For The District Court 965  
  Conduct of the Assessment 965  
  Department Clients 966  
  Report to Court 966  
  Requests From Private Attorney 965  
Child Placement Requirements 1025  
  Children Under Two Years of Age 1025  
  Continued Care 1025  
  Determining Factors 1025  
  Maximum Number of Children 1025  
  Special Circumstances Regarding Maximum Numbers of Children 1025  
Child Protection Central Registry 961  
Child Protection Safety & Comprehensive Assessments 959  
  Collateral Interviews 960  
  Completion of a Comprehensive Assessment 960  
  Notification of the Person Who Made the Referral 960  
  Role of Law Enforcement 960  
Child Protection Services 957  
Child Record Content  
  Requirements 1008  
  Child's Full Name 1008  
  Child's Health Information 1008  
  Date of Birth 1008  
  Emergency Contact Information 1008  
  Parent or Guardian's Name, Address, & Contact Information 1008  
  Record of Attendance 1008  
  Child Tasks 1028  
Child's Record 1069  
  Content 1069  
  Record Entries 1070  
Children's Residential Care Facility Building Requirements 1054  
Children's Agencies & Children's Residential Care Facilities 1031  
Children's Agency Supervision Of Child, Children's Agencies 1045  
Children's Residential Care Facility Building Requirements  
  Access to Community Resources 1054  
  Location Restrictions 1054  
  Occupancy Restrictions 1054  
Child-Staff Ratio 1008  
  Compliance with Child-Staff Ratios 1009  
  Daycare Child-Staff Ratio Point System 1008  
  Napping Children 1009  
  Overnight Daycare 1009  
  Supervision of Children 1009  
Chips 2119  
Chiropractic Assistants 1515  
  Chiropractic Assistant Limitations 1516  
  Chiropractic Physician Responsible & Liable 1515  
Chiropractic Intern 1516  
  Chiropractic Intern Limitations 1516  
  Chiropractic Physician Responsible & Liable 1516  
Chlorinated Isocyanurates Disinfection 767  
Chlorine Disinfection 767  
Chokes 1347  
Circumstances Of An Animal Health Emergency 149  
Circumvention 2396  
Circumvention Of Orders Prohibited 670  
Citizenship 615  
  Birth Certificate 615  
  Certificate of Citizenship 615  
  Consular Report of Birth Abroad or Certification of Birth 615  
  Naturalization Certificate 615  
  Passport 615  
Civil Penalties 395, 413, 436, 443, 477, 481  
  Certification or Registration 413, 478  
  Corrections 396, 413, 478  
  Dealing with Stolen Manufactured or Mobile Homes 443  
  Deceptive Practice 443  
  Electrical Contractor 395  
  Employees 395  
  Failure to Disclose 396, 413  
  Failure to Maintain a Principal Place of Business 443  
  Fees & Permits 396, 478  
  Fees, Permits, and Inspections 413  
  Gross Violation 396, 413, 444, 478  
  Heating, Ventilation, & Air Conditioning Contractor or Specialty Contractor 478  
  Industry Licensing 443  
  Installation 436  
  Journeyman to Apprentice Ratio 396  
  Knowingly Employing 478  
  Lawful Orders 436  
  License or Registration 395  
  Modification 436  
  Multiple Violations 482  
  Performance Outside Scope of License 396  
  Performance Outside Scope of Specialty Certificate 413  
  Performance Outside Scope of Specialty License 478  
  Plumbing Contractor 413  
  Removal of Orders 436  
  Second Offense 482  
  Supervision 396, 478  
  Violation of Rules & Statutes 443  
  Violations of Title 55, Chapter 22, Idaho Code 481  
Civil Rights Complaint Procedure 1869  
Claim Forms & Payment From The Fund 108  
  Claim Forms 108  
  Contract 108  
  Not Contracted or Stored for Withdrawal 108  
Claiming of Prizes, Breakopen Instant Ticket Games 2322  
Claims & Reports Of Damage Or Excavator Downtime 481  
  Claims 481  
  Reports 481  
Claims For Funds Or Livestock Subject To A Hold Order 535  
  Claim 535  
  Hearing 535  
  Investigation 535  
  More Than One Claimant 535  
Claims Of Non- Payment  
  Claim of Non-Payment 561  
  Commission Determination 561

- Investigation of Claim 561  
Clarification Of Orders 1990  
Clarity 766  
Class II Injection wells 1326  
Class V  
  Criteria & Standards 2027  
    Additional Information 2029  
    Application Information  
      Required 2028  
    Application Processing 2030  
    Application Requirements 2028  
    Class V Deep Injection Well  
      Requirements 2028  
    Class V Shallow Injection Well  
      Requirements 2027  
    Conditions of Permanent  
      Decommissioning 2033  
    Consideration 2031  
    Construction Requirements 2032  
    Criteria for Location & Use of  
      Class V Wells Requiring  
      Permits 2034  
    Draft Permit 2030  
    Duration of Approved  
      Permits 2033  
    Fact-Finding Hearings 2031  
    Inter-Agency Cooperation 2028  
    Issuance of Permit 2031  
    Monitoring, Record Keeping &  
      Reporting Requirements 2035  
    Open-Loop Heat Pump Return  
      Wells (Subclass 5A7) 2031  
    Operational Conditions 2032  
    Other Information 2030  
    Permanent Decommission 2027  
    Permit Assignable 2037  
    Permit Conditions &  
      Requirements 2031  
    Permit Requirements 2027  
    Public Notice 2030  
    Review by the Directors of Other  
      State Agencies 2031  
    Standards for Quality of Fluids In-  
      jected into Class V Wells 2034  
    Standards for the Quality of Fluids  
      Injected by Subclass 5A7 Wells  
      (Open-Loop Heat Pump  
      Return) 2035  
    Standards For The Quality of In-  
      jected Fluids & Criteria For Lo-  
      cation & Use 2033  
    The Director's Action On Draft  
      Permits & Duration Of Ap-  
      proved Permits 2031  
Classification Of Injection Wells 2023  
  Subclassification 2024  
Classification Of Prevention Of  
  Significant Deterioration  
  Areas 2493  
  Procedures for Redesignation of  
  Prevention of Significant  
  Deterioration (PSD) Areas 2493  
  Restrictions On Area  
  Classification 2493  
Classification Of Water Systems 2742  
  Classification Criteria 2742  
  System Classification  
  Required 2742  
Cleaning 767  
  Bathrooms, Showers, & Dressing  
  Rooms 767  
  Decks 767  
  Pools 767  
Cleaning & Disinfection 372  
Cleaning & Disinfection Of Animal  
  Conveyance 152  
Cleaning & Disinfection Of  
  Premises 152  
Cleaning, Treating, Decontaminating,  
  Or Disinfecting 197  
  Exemptions 197  
  Extension of Time 197  
  Requests for Extensions or  
  Exemptions 197  
Cleft Lip & Palate 781  
  Eligible Conditions 781  
  Excluded Conditions 781  
  Spending Limits 781  
Client Contracts - Investment  
  Advisers 668  
  Contents of Client Contract 669  
  Contract 668  
Client Grievance Policy, Residential  
  Care Facility 1039  
Clinical Nutrition Certification &  
  Practice 1517  
  Certified Clinical Nutritional  
  Practice 1517  
  Non-Certified Clinical Nutritional  
  Practice 1517  
Clinical Nutrition Certification  
  Cancelled For Over Three (3)  
  Years 1520  
  Current Competency &  
  Training 1520  
  New Clinical Nutrition  
  Certification 1520  
Clinical Nutrition Formulary 1522  
  Chiropractic Clinical Nutrition  
  Prescription Drug  
  Formulary 1522  
  Compliance with Federal and State  
  Requirements 1522  
  Expired, Deteriorated, Adulterated,  
  Damaged or Contaminated  
  Prescription Drug Products 1522  
  Limitations on Possession of  
  Prescription Drug Products 1522  
  No Compounding of Prescription  
  Drug Products 1522  
  Prescription Drug Product  
  Storage 1522  
  Sources of Clinical Nutrition  
  Prescription Drug Products 1522  
Clinical Nutrition Recertification  
  Requirement 1520  
  Annual Verification of Meeting  
  Requirements 1520  
Failure to Timely Recertify in  
  Clinical Nutrition 1521  
Recertification in Clinical Nutrition  
  Every Three (3) Years 1520  
Recertification is in Addition to  
  Required Annual Continuing  
  Education 1521  
Clinical Professional Counselor  
  Licensure 1652  
  Experience 1652  
  License 1652  
  Recommendation of the  
  Supervisor(s) 1652  
Close Or Refuse To Open An  
  Account 563  
Closure Of Adoptive Home  
  Studies 977  
Closure Of Case 982  
Clothing, Residential Care  
  Facility 1039  
Coaxial System 2378  
Code Of Ethics 1463, 1517, 1587,  
  1605, 1633, 1657, 1763  
  Conduct of Practice 1588  
  Confidentiality 1588  
  Patient's Visual Welfare 1587  
  Rules of Conduct 1463  
  Unprofessional Conduct 1588  
Code Of Ethics & Standards For Sign  
  Language Interpreters 1715  
Code Of Professional Conduct 2270  
  Ability to Practice 2271  
  Confidentiality 2271  
  Conflicting Interests 2271  
  Consent for Transporting 2271  
  Cooperation with Authorities 2271  
  DEA Registration & Controlled  
  Substance License 2270  
  Health Certificate 2270  
  Improper Disposal of Controlled  
  Substances 2271  
  Patient Record 2271  
  Physical Abuse-Patient 2271  
  Preservation of Patient's Body 2271  
  Refusal to Render Services 2271  
  Supervision 2271  
  Veterinarian/Client/Patient  
  Relationship 2270  
Coliform Treatment Technique Triggers  
  & Assessment Requirements For  
  Protection Against Potential Fecal  
  Contamination 2644  
  Approved Parties for Level 2  
  Assessments 2646  
  Requirements For  
  Assessments 2645  
  Treatment Technique Triggers 2644  
Collaborative Pharmacy Practice 1886  
  Identification 1886  
  Monitoring 1886  
  Scope 1886  
Collateral Information Codes 1912  
  County Codes 1916  
  PML Groupings & Farm Product

- Codes 1912
- Unit Codes 1916
- Collecting & Exchanging Information
  - About A Child, Inter-Country Adoption, Children's Agencies 1051
- Collection & Remittance Of SIF Assessments 108
- Collection Of Copayments 809
  - Denial of Services 809
  - Reduction in Reimbursement 809
  - Responsibility for Collection 809
  - Waiver of Copayment 809
- Collection Of Hop Assessment Levy 361
- Collection Of Samples For CWD
  - Testing 194
  - Brain Samples 194
  - Failure to Meet Annual CWD Tissue Submission Requirement 195
  - Handling of Samples 195
  - Non-Testable or Samples That Do not Contain Appropriate Tissues 195
  - Sample Submission Time 195
  - Submission of Head 195
- Collection Of Wild Ginseng 275
- Combat Platforms (Ring/Cage) 1505
- Combatant Down After The Sound Of The Bell 1504
  - Combatant Down After Round Has Ended 1504
  - End of Round 1504
- Combatant Not To Have Promoter Or Certain Others Act As Manager Or Hold Financial Interest 1506
  - Financial Interest 1506
  - Manager 1506
- Combatant's Physical Appearance 1489
- Combatant's Physical Appearance
  - Grease of Foreign Substances 1489
  - Hair 1489
- Combatant's Report Of Own Illness Or Injury 1488
- Combatants Must Report 1488
- Combinations Of Fuels, Fuel Burning Equipment -- Particulate Matters 2532
- Comity/Out-Of-Jurisdiction Residents 512
- Commercial Navigational Encroachment 1222
- Commercial Solid Waste Siting License Application 2598
  - Application Format 2598
  - Copies of Application 2598
  - Location 2598
- Commercial Solid Waste Siting License Fee 2597
  - Commercial Solid Waste Siting License Fee Criteria 2597
  - Commercial Solid Waste Siting License Fee Not Refundable 2598
  - Commercial Solid Waste Siting License Fee Scale 2597
- Expansion or Enlargement of a Commercial Solid Waste Facility 2598
- Notification of Adjustment of Fee 2598
- Commissions & Contingent Fees 27
  - Disclosures 28
- Committee On Humane Euthanasia 2275
  - Compensation 2275
  - Duties 2275
  - Term 2275
- Committees 1796
  - Appointment 1796
  - Certificates 1796
- Commodity Indemnity Fund 69, 76
  - Exemptions to Assessment 76
  - Exemptions to Assessments 69
  - Rate of Assessment 69, 76
- Common Carrier Agents Must Hold Shipments 289
- Communication 450, 573
  - Communication System 573
  - Public Address System 573
- Communications 29, 793, 1077
  - Communication Requirements 1077
  - Communication Support System 1077
  - Complaints 29
  - Emergencies 1077
  - Response 29
- Communications With Agency 1966
- Community Resources, Reporting Abuse, Abandonment Or Neglect 959
- Community Water System 2623
  - Compensation 1837
    - Cost per Acre 1837
    - Noncash Compensation 1837
    - Nonrefundable 1837
    - Payable in Advance 1837
- Compensation For Animals Destroyed 151
- Compensation For Appraised Animals 151
- Compensation For Labor Employed 151
  - Cleaning & Disinfection 151
  - Disposal of Animals 151
- Compensation For Property Destroyed 151
  - Actual Value 152
  - Property Destroyed Otherwise 152
- Compensation Of Certain Persons & Contracts With Certain Persons Prohibited 2336
- Competency For Assignments 507
  - Aiding & Abetting An Unregistered Person 507
  - Assignments in Field of Competence 507
  - Use of Seal on Documents 507
- Complainants 1968
- Complaint Against & Investigation Of Licensees 2340
- Complaint Investigation, Basis, Time Requirements, Notifying Foster Parents, Contents, & Process 1043
  - Agency Written Report 1043
  - Conclusion of Investigation 1044
  - Investigation Timeline & Extension 1043
  - Summary of Findings 1043
- Complaint Procedure 827
  - Investigation 827
  - Investigation Method 827
  - Public Disclosure 827
  - Statement of Deficiencies 827
  - Written Report 827
- Complaints 466, 577, 1319, 2359
  - Accidents or Injuries 577
  - Contents of Complaint 1319
  - Initial Review 2359
  - Investigation 2359
  - Submittal of Complaint 1319
  - Unsafe Conditions 577
  - Violations 577
- Complaints Against Daycare Centers, Group Daycare Facilities, Family Daycare Homes, Foster Homes, Children's Residential Care Facilities, Children's Therapeutic Outdoor Programs, Children's Camps, & Children's Agencies 1002
  - Informed of Action 1002
  - Investigation 1002
- Complaints--Defined--Form & Contents 1971
  - Complaints - Defined 1971
  - Form & Contents 1971
- Completeness Of Applications 2447
  - Criteria for Completeness 2447
  - Effects of Completeness Determination 2447
  - Timelines for Determinations of Completeness 2447
- Completing The Adoption Home Study 975
  - Content 975
  - Interviews 975
- Completion & Correction Of Certificates 730
  - Acknowledgment of Paternity 731
  - Addition of Given Names on Birth Certificates 731
  - All Other Amendments 732
  - Amendment of Indicator of Gender 731
  - Amendment of Registrant's Given Name on Birth Certificate After the First Year 730
  - Amendment of Registrant's Given Names or Surname on Birth Certificates Within the First Year 730
  - Amendment of the Same Item More

- Than Once 733
- Correction of Minor Errors on Certificates During the First Year 730
- Methods of Amending Certificates 733
- Completion Of Form 512
- Completion Of Permanent Closure 1197, 2814
- Implementation of a Permanent Closure Plan 1197, 2814
- Submittal of a Permanent Closure Report 1198, 2814
- Compliance 46
  - Authority of Director 46
  - Random Compliance Inspection 46
  - Samples 46
- Compliance Dates 2515
  - Existing Sources 2516
  - New or Reconstructed Sources 2515
- Compliance Evaluation 2964
- Non-Compliance Actions 2964
- Compliance Of Existing Plans With These Rules 1179
- Compliance Of Existing Reclamation Plans 1216
  - Applicability 1216
  - Approval 1216
  - Submittal 1216
- Compliance Or Non-Compliance Certificate, Potatoes 50
- Compliance Required, Residential Care Facility 1031
- Compliance Requirements By
  - Department 2387
  - Episode Plans 2388
  - Monitoring 2388
  - Records 2387
  - Report 2387
  - Schedule 2387
- Compliance Schedules 2957
  - Alternative Schedules of Compliance 2958
  - General 2957
- Compliance With Applicable Laws 1054
  - Corrective Action & Fees 1054
  - Fire Inspection 1054
  - Planning & Zoning 1054
  - Sanitation Inspection 1054
- Compliance With Laws 1805, 1858
  - Examination by Board 1805
  - Violations 1805
- Compliance With Other Laws & Ordinances 2219
- Compliance With These Rules, Idaho Accountancy Rules 23
- Complimentary Tickets 1480
  - Limitation 1480
  - More Than Two Percent Issued 1480
- Composite Correction Program (CCP) 2644
- Comprehensive Performance Evaluation (CPE) 2644
- Comprehensive Technical Assistance (CTA) 2644
- Compounding Drug Preparations 1890
  - Application 1890
  - Drug Compounding Controls 1891
  - General Compounding Standards 1891
  - Limited Compounding 1891
  - Prohibited Compounding 1891
- Comprehensive Assessment Requirements 890
  - Assessment Results 891
  - Level of Personal Assistance Required 891
  - Maladaptive Behaviors 891
  - Nursing Assessment 891
  - Outside Services 891
  - Resident Demographics 890
  - Resident Preferences 891
- Computation Of Assessment 361
- Computation Of Time 23, 1178, 1215, 1950, 1966, 2863
  - Computing Time 2863
  - Notice by Mail 2864
- Conceptual Design Approval
  - Information Required for Conceptual Design Approval 2799
  - Notice of Conceptual Design Approval or Disapproval 2799
  - Preapplication Conference 2800
- Concession Employee 554
- Concessionaire License 554
  - Names of Owners 554
  - Proof of Financial Stability 554
  - Type of Business 554
- Concrete Plank Boat Launch Ramps 2085
  - Assembly of Planks 2086
  - Concrete Planks 2085
  - Construction of Boat Ramp 2086
  - Construction of Concrete Plank Boat Launch Ramps 2085
  - Construction of Planks 2085
  - Water Depth 2086
- Condemnation & Destruction Of
  - Diseased Animals Or Flocks 371
  - Animals or Flocks Condemned 371
  - Animals or Flocks Infected 371
- Condemnation Of Infected, Exposed, Or Susceptible Animals 150
- Conditional Denial 930
  - Effective Date of a Conditional Denial 930
  - Reasons for a Conditional Denial Issuance 930
  - Request an Exemption Review 930
- Conditions Applicable To All Permits 2936
  - Bypass Terms & Conditions 2940
  - Duty to Comply 2936
  - Duty to Mitigate 2937
  - Duty to Provide Information 2937
  - Duty to Reapply 2937
- Inspection & Entry 2937
- Monitoring & Records 2938
- Need to Halt or Reduce Activity 2937
- Penalties & Fines 2942
- Permit Actions 2937
- Proper Operation & Maintenance 2937
- Property Rights 2937
- Reporting Requirements 2938
- Signatory Requirements 2938
- Upset Terms & Conditions 2941
- Conditions For Admission 1364
  - Assignment of Personal Property 1364
  - Denial of Admission 1364
  - Conditions For Emergency Order 1351
- Conditions For Guardianship Assistance 967
  - Administrative Review for Guardianship Assistance 968
  - Assessment of Suitability 967
  - Eligibility for Guardianship Assistance 967
  - Guardianship & Foster Care Licensure 967
  - Guardianship Assistance Agreements & Payments 967
  - Termination of Guardianship Assistance 968
- Conditions For Intrastate Or Interstate Movement Of Regulated Articles 344
- Conditions For Permits To Construct 2419
  - Cancellation 2419
  - Notification to The Department 2419
  - Performance Test 2419
  - Reasonable Conditions 2419
- Conditions For Placement In An Adoptive Home, Children's Agencies 1049
- Conditions For Tier II Operating Permits 2465
  - Performance Tests 2465
  - Permit Term 2466
  - Reasonable Conditions 2465
  - Single Tier II Operating Permit 2466
- Conditions Of Approval 2113
  - Applications and Existing Permits That Are Junior and Subordinate 2113
  - Insuring Assignment of Interest 2114
  - Insuring Compliance with Water Quality Standards 2114
  - Insuring Minimum Stream Flows & Prior Rights 2114
  - Issuance of Permits with Conditions 2113
  - Reprocessed Permits 2113
  - Requirements to Mitigate Impact of



- Flow Depletion 2113
- Retention of Jurisdiction 2114
- Voiding Approval of Permit 2114
- Well Spacing & Well Construction Requirements 2113
- Conditions To Renew Expired License 1903
- Investigate or Discipline a Licensee 1904
- Payment of Late Fee 1903
- Renewal After Expiration of Active License 1903
- Conduct 1947
- Conduct At Hearings 1983
- Conduct Of Hearing In Contested Case 2340
- Conduct Of Informal Hearings 1319
- Hearing Procedure 1319
- Questions Asked by the Board 1320
- Questions Directed to the Board 1320
- Representation by Counsel 1320
- Statements 1319
- Conduct Of Licensed Premises 520
- Conduct Of Residents 1365
- Housekeeping 1365
- No Operation of Motor Vehicles by Nursing Care Residents 1365
- Operation of Motor Vehicles by Domiciliary and Residential Care Residents 1365
- Conduct Required 1969
- Conducting Industrial Radiographic Operations 794
- Conference At Hearing 1983
- Confidential Client Information 28
- Confidentiality 28
- Disciplinary Proceedings 28
- Exemptions 28
- Confidential Information 565, 2389
- Confidentiality 33, 1030, 1980, 2778, 2834
- Confidentiality -- Protective Orders 1958
- Confidentiality & Privacy Protections Of Persons Served, Residential Care Facility 1032
- Confidentiality Of Records 2564, 2598, 2600, 2760, 2796, 2819, 2851
- Denial of Confidential Claims 2851
- Identifying Confidential Information 2851
- Confidentiality Of Records & Public Records Requests 862
- Confidential Records 862
- Disclosure of Resident Identity 862
- Public Availability of Survey Documents 862
- Public Records Act 862
- Confidentiality Of Settlement Negotiations 1985
- Confidentiality Of Test Results 594
- Confidentiality Of The Child Protection Central Registry & Requests To Check The Registry 961
- Child Protection Central Registry Check Fee 961
- Confidentiality of Child Protection Central Registry 961
- Conflict Auctions 1264
- Auction Bidding 1265
- Auction Procedures 1265
- High Bid Deposit 1265
- Minimum Bid 1265
- Two or More Applicants 1265
- Withdrawal After Auction 1265
- Withdrawal Prior to or Failure to Participate in an Auction 1265
- Conflict Of Interest 507
- Compensations From Multiple Parties on the Same Project 508
- Conflict of Interest to be Avoided 507
- Gratuities 508
- Professional Services Decisions of Agencies 508
- Solicitation From Agencies 508
- Solicitation From Material or Equipment Suppliers 508
- Unfair Advantage of Position & Work Outside Regular Employment 508
- Conflict Of Interest Policy 2299
- Conduct of Commission Business 2300
- Gift Prohibitions 2300
- Outside Activities Restricted 2300
- Personal Conduct 2301
- Persons Ineligible for Prizes 2299
- Persons Prohibited from Providing Services 2300
- Persons Subject to Conflict of Interest Policy 2299
- Signature of Conflict Policy Required 2301
- Statements for Economic Interest 2299
- Use of Lottery Property 2301
- Conflict Of Laws 547
- Conflict Resolution at the Governor's Level, Resolving Conflicts 2490
- Consent Agreements--Defined--Form & Contents 1972
- Additional 1972
- Requirements 1972
- Consideration Of Settlements 1985
- Considerations For Placement In Alternative Care 947
- Ability of Providers 947
- Family Assessment 947
- Family Involvement 947
- Consolidation 1949
- Consolidation Of Proceedings 1983
- Construction & Maintenance Of Improvements 1263
- Bond 1263
- Maintenance 1263
- Prior Written Approval 1263
- Construction & Use Of Holes That Are Not Wells 2158
- Converting a Hole Not Constructed as a Well for Use as a Well 2158
- Holes Not Defined as Wells 2158
- When a License Is Not Required 2158
- Construction Manager Examinations 467
- Construction Of Cold Water Wells 2125
- Access Port or Pressure Gage 2133
- Alternative Methods for Sealing Wells 2132
- Amount of Chlorine Needed Per 100 Feet of Water in Well 2135
- Casing 2127
- Cathodic Protection Wells 2132
- Closed Loop Heat Exchange Wells 2132
- Completion of a Well 2134
- Decommissioning (Abandoning) of Wells 2133
- Disinfection & Contamination 2135
- Drilling Fluids or Drilling Additives 2135
- Explosives 2135
- General 2125
- Hydraulic Fracturing 2135
- Injection Wells 2132
- Liner 2128
- Minimum Single-Wall Steel Well Casing Thickness for Selected Diameters (inches) 2127
- Monitoring and Remediation Wells 2132
- Pitless Adapters 2134
- Pump Installation 2134
- Records 2127
- Sand Production 2135
- Screen 2128
- Sealing Artesian Wells 2131
- Sealing of Wells 2130
- Separation of Well from 2125
- Use of Approved Sealing Materials & Required Annular Space 2129
- Waivers 2126
- Well Development & Testing 2136
- Construction Of Dressing Rooms 763
- Construction Of Low Temperature Geothermal Resource Wells & Bonding 2136
- Blow Out Prevention Equipment 2138
- Casing 2137
- Decommissioning (Abandoning) of Wells 2138
- General 2136
- Repair of Wells 2138
- Sealing of Casing 2137
- Well Owner Bonding 2136
- Construction Plans, Drawings & Specifications 2062
- Additional Information/

- Waiver 2065
  - Alternate Plans 2065
  - Applying for & Obtaining Written Approval 2062
  - Changes to Specifications 2063
  - Design Report 2064
  - Detailing Provisions of Specifications 2064
  - Information Included with Plans 2063
  - Inspection, Examination & Testing of Materials 2064
  - Inspections 2064
  - Plans Shall Be Prepared on a Good Quality Vellum or Mylar 2063
  - Preparation & Submission of Plans 2063
  - Rejection of Defective Material 2064
  - Responsibility of Engineer 2064
  - Specifications 2063
  - Submission of Duplicate Plans, Dam Drawings & Specifications 2062
  - Suspension of Work 2064
  - Construction Procedures 2078
  - Conformance to Procedures 2078
  - Disposal of Removed Materials 2078
  - Fill Material 2078
  - Limitations on Construction Period 2078
  - Minimizing Disturbance of Area 2078
  - New Cut of Fill Slopes 2078
  - Operation of Construction Equipment 2078
  - Temporary Structures 2078
  - Construction Requirements
    - Corners 758
    - Electrical Code 758
    - Finish 758
    - Materials 758
    - Plumbing Codes 758
    - Uniform Building Code 758
  - Consultation Procedures, Among ICC Members 2487
  - Notification Process 2489
  - Specific Air Quality Related Activities 2489
  - Specific Major Activities 2487
  - Specific Routine Activities 2488
  - Consumer Confidence Report 2636
  - Consumer Grades For Shell Eggs -
    - General 54
    - Applicability 54
    - No Grade 54
    - Substitution 54
  - Consumer Reporting Agencies 798
    - Consumer Reporting Agency 798
    - Reports 798
  - Consumption Of Alcohol 592
  - Containers, Drinks 1479
  - Contaminant Management In The Bunker Hill Superfund Site,
    - Shoshone County, Idaho 2233
    - Additional Provisions by District 2235
    - Administrative Appeals 2233
    - Definitions 2233
    - Legal Authority 2233
    - Purpose 2233
    - Statement of Intent 2234
    - Written Interpretations 2233
  - Contaminant Management Rules In The Bunker Hill Superfund Site Operable Unit #3 Institutional Controls
    - Administrative Area, Shoshone & Kootenai Counties, Idaho 2237
    - Additional Provisions by PHD 2240
    - Administrative Appeals 2237
    - Definitions 2237
    - Implementation Policy & Standards 2237
    - Purpose 2237
    - Statement of Intent 2239
  - Content Of Child's Record 1035
  - Content Of Child's Record
    - Child's Health Record 1036
    - Minimum Information 1036
  - Content Of Continuing
    - Education 1762
    - Continuing Education 1762
  - Content Of Continuing Education
    - Courses 1676
    - Category I 1676
    - Category II 1676
  - Content Of Records 200
    - Buying Stations
      - Approved Slaughter Establishment Destination 203
      - Date of Shipment to Slaughter 202
      - Dead Animals 203
      - Death Loss 203
      - Individual Identification 202
      - Name, Telephone Number, & Address 202
      - Previous Location 202
      - The Date of Entry 202
    - Date of Sale 201
    - Death Loss 201
    - Identification 200
    - Name, Telephone Number, & Address 200
    - Name, Telephone Number, & Address of the Purchaser of Cattle 201
    - Previous Location 200
    - The Date of Purchase 200
  - Content Of Records For Approved Livestock Trader Lots 205
    - Date of Shipment Out of the Livestock Trader Lot 205
    - Dead Animals 205
    - Death Loss 205
    - Identification 205
    - Name, Telephone Number, & Address 205
  - Name, Telephone Number, & Address of Shipment Destination 205
  - Previous Location 205
  - Requirements 205
  - The Date of Entry 205
- Contents Of Orders 1987
  - Findings of Fact & Conclusions of Law 1987
  - Statement of Available Procedure 1987
- Contents Of Tickets 1480
  - Changes 1480
  - General 1480
  - License to Sell 1480
  - Contents on the form. 512
- Contested Permit Conditions 2935
  - Combination of Technologies 2935
  - Control Technologies 2935
  - Enforceable Dates 2935
  - Force & Effect of Conditions 2935
  - Inseverable Conditions 2935
  - Uncontested Conditions 2935
- Contingency Fund 1859
- Continuance 1956
  - Consideration 1956
  - Continuances 1956
- Continuance Of Full Approval Of Educational Program 1446
- Continuance Of Hearing 1983
- Continuation 1934
  - Continuation of Lapse Date 1934
  - Status of Financing Statement 1934
  - Status of Parties 1934
- Continued Care 1033
  - Department or Department of Juvenile Corrections (DJC) Placed Individuals 1033
  - Individuals Not Placed by Department or DJC 1033
- Continued Competence Requirements For Renewal Of An Active License 1419
  - APRN Continued Competence Requirements 1420
  - Beyond the Control of Licensee Exemption 1420
  - Compliance Effective Dates 1420
  - Disciplinary Proceeding 1420
  - Extension 1420
  - First Renewal Exemption 1420
  - Learning Activities 1419
- Continued Compliance, Reporting Changes, & Critical Incidents 1016
  - Critical Incidents 1017
  - Posting of License & Other Information 1016
  - Reporting Changes 1017
- Continuing Education 1410, 1462, 1513, 1545, 1556, 1572, 1599, 1642, 1658, 1667, 1691, 1697, 1717, 1726, 1730, 1760, 1905, 2165
  - Approved Contact Hours, Limitations, & Required

- Documents 1658
- Approved Courses 1546
- Approved Credit 1463
- Architectural Health, Safety & Welfare Requirement 1462
- Attestation 1556
- Carry Over & Duplication 1556
- Carryover of Continuing Education Hours 1514, 1599, 1726, 1731, 1761
- Categories of Continuing Education 1643
- Contact Hours 1658
- Continuing Education (CE) Requirement 1572, 1730
- Continuing Education Activities 1514
- Continuing Education Requirement 1462, 1545
- Continuing Education Requirements 1642
- Continuing Education Sources 1643
- Course Approval 1546, 1697
- Courses & Activities 1556
- Credit 1572, 1698
- Credit for Appraisal Educational Processes & Programs 1692
- Credit for Attending the Licensure Board Meetings 1692
- Credit for Continuing Education Attendance 1667
- Distance Learning & Independent Study 1546
- Documentation 1513, 1557, 1644, 1717, 1726, 1760, 2165
- Documentation of Attendance 1658
- Earning Credit Units 2165
- Education Requirement for License Renewal 1599
- Evidence of Completion 1410
- Exemption 1514, 1761
- Exemptions 1463, 1547, 1557
- Failure to Fulfill the Continuing Education Requirements 1463, 1546, 1573, 1731
- Hours 1731
- Hours Required 1691
- Insufficient Credit Units 2166
- Minimum Hours Required 1697
- Out-of-State Residents 2166
- Polysomnographer Continuing Education 1410
- Providers/Sponsors/Subjects of Continuing Education 1572, 1731
- Purpose of Continuing Education 1691
- Request for Approval 1667
- Requests for Approval of Programs 1667
- Requests for Pre-Approval 1667
- Requirement 1513, 1556, 1717, 1726, 1760
- Requirement When a Certificate/License Is Canceled 1692
- Requirements 2165
- Responsibility for Education Development & Implementation 2166
- Special Exemption 1573, 1599, 1698, 1731
- Subject Material 1546
- Subjects 1667
- Submission of License Renewal Application Form 1599
- Submittal & Maintenance of Records 2166
- Verification of Attendance 1463, 1546, 1573, 1731
- Verification of Completion 1599
- Waiver 1514, 1726, 1761
- Continuing Education & Skills Proficiency 713
- Continuing Education Must Meet Objectives of Initial Course Curriculum 713
- Documentation of Continuing Education 713
- Transition to New Scope of Practice 713
- Continuing Education Activities 1761
- Publishing Articles or Books 1762
- Self Study 1762
- Teaching a Course For The First Time, Not to Exceed Six Hours 1762
- Continuing Education Categories For Personnel Licensure Renewal 714
  - Airway 714
  - Cardiovascular 714
  - Medical 714
  - Operations 714
  - Pediatrics 714
  - Trauma 714
- Continuing Education Committee Contingency Plan 2166
- Continuing Education For Post Conviction Sexual Offender Polygraph Examiners 2353
- Continuing Education For Psychosocial Evaluators & Sexual Offender Treatment Providers 2351
- Provisional/Supervised Certification Level 2351
- Senior/Approved & Associate/Supervised Certification Levels 2351
- Continuing Education In Optometry 1586
- Additional Hours Required to Use Therapeutic Pharmaceutical Agents 1587
- Audit 1587
- Correspondence/Home Study Courses/Observation 1587
- Documentation of Attendance 1587
- Excess Hours 1587
- Hours Required, Advance Approval 1586
- Renewal Application Form 1587
- Waiver of Requirements 1587
- Continuing Education Records Are Subject To Audit 713
- Documentation Record 713
- Continuing Education Records are Subject to Audit Proof of Completion 713
- Continuing Education Requirement 1630, 1745
- Annual Continuing Education Requirement 1745
- Carryover Hours 1746
- Compliance Audit 1630
- Contact Hours 1630
- Continuing Education Credit Hours 1631
- Course Approval 1632
- Distance Learning & Independent Study 1745
- Documentation of Attendance 1630
- Excess Hours 1630
- Failure to Receive the Renewal Application 1632
- Hardship Waiver 1746
- Peer Review System 1745
- Reinstatement of License 1630
- Renewal of License 1630
- Requests for Board Approval 1745
- Special Exemption 1630
- Subject Material 1745
- Submitting False Reports or Failure to Comply 1632
- Verification of Attendance 1745
- Continuing Education Requirements 1137, 1400, 1580, 1675
- Carryover 1676
- Carryover of Continuing Education Hours 1580
- Credit for Teaching 1676
- Distance Learning & Independent Study 1676
- Documentation 1138
- Educational Requirements 1580
- Nature of Education 1138
- Number of Credits 1137
- Prorated Credits 1138
- Renewal of License 1580
- Requirement 1675
- Special Exemption 1676
- Verification of Attendance 1675
- Volunteer Practice 1138
- Waiver 1580
- Continuing Education Requirements For Relicensure In Psychology 1607
- Carryover of Continuing Education Hours 1607
- Certificates of Satisfactory Attendance & Completion 1607
- Licenses Who Do Not Fulfill the Continuing Education Requirements 1607
- Newly Licensed Individuals 1607

- Number of Hours Required 1607  
Professional Level of Continuing Education - Time Period Records Kept - Audit 1607  
Special Exemption 1607  
Continuing Education Requirements, Electricians 392  
Continuing Educational & Skills Proficiency Requirements for Personnel Licensure 713  
Continuing Medical Education (CME) Required 1390  
Alternate Compliance 1391  
Penalties for Noncompliance 1391  
Purpose 1390  
Renewal 1390  
Verification of Compliance 1391  
Continuing Medical Education (CME) Requirements 1405  
Renewal 1405  
Verification of Compliance 1405  
Continuing Professional Education Appointment 31  
Powers & Duties 31  
Continuing Professional Education Committee 31  
Continuing Training Requirements 908  
Continuity Of Service 2632  
Maintenance of Standards 2632  
Transfer of Ownership 2632  
Continuous Presence Of Physician At Ringside 1490  
Injury to Boxer During Round 1490  
Presences of Physician at Ringside 1490  
Contraband 1081  
Confiscation 1081  
Disposal 1081  
Law Enforcement Notification 1081  
Contraband, Children's Residential Care Facilities 1061  
Contract Between Manager & Combatant 1473  
After Contract Services 1473  
Contract Approval 1474  
Contractual Obligations 1473  
Manager Limitations 1474  
Manager Responsibilities 1474  
Options 1474  
Contract Between Promoter & Combatant 1474  
Contract Prohibitions 1474  
Gate Receipts 1474  
Contracting For Services 2743  
Contractor Licensing 2243  
Bonding 2243  
License Required 2243  
Suspension or Revocation of License 2244  
Training 2243  
Contracts With Forest Landowners Or Operators 1303  
Control & Tenure 1865  
Control Areas 293  
Commercial Production Area. Ada, Canyon, Elmore, Gem, Gooding, Payette, Owyhee, & Washington Counties 293  
Restricted Area 293  
Control Of Cookers, Rendering Plants 2552  
Control Of Expellers, Rendering Plant 2552  
Control Of Lead & Copper 2648  
Analytical Methods 2649  
Applicability of Corrosion Control Treatment Steps to Small, Medium-Size, & Large Water Systems 2649  
Description of Corrosion Control Treatment Requirements 2649  
General Requirements 2649  
Lead Service Line Replacement Requirements 2649  
Monitoring Requirements for Lead & Copper in Source Water 2649  
Monitoring Requirements for Lead & Copper in Tap Water 2649  
Monitoring Requirements for Water Quality Parameters 2649  
Public Education & Supplemental Monitoring Requirements 2649  
Recordkeeping Requirements 2649  
Reporting Requirements 2649  
Source Water Treatment Requirements 2649  
Control Of Plant Air, Rendering Plant 2552  
Control Of State Lands 1282  
Controlled Hunt 1801  
Controlled Hunts Outside Outfitter's Operating Area 1817  
Compensation Between Outfitters 1817  
Identification of Hunter 1817  
Written Permission 1817  
Controlled Substances PDMP 1890  
Online Access to PDMP 1890  
Profile Requests 1890  
Use Outside Scope of Practice 1890  
Conversion To Other Uses 1867  
Fees 1868  
Generally 1867  
Prerequisites to Approval of Conversion 1867  
Project Amendments 1868  
Cooperation With Law Enforcement 965  
Cooperative Use & Reciprocal Use Agreements 1247  
Applicability 1248  
Joint Agreements 1247  
Reciprocal Use Agreements 1247  
Co-Payment Fee Amounts 808  
Annual Increase 808  
Fee Amount 808  
Nominal Amount 808  
Core Family & Children's Services 941  
Administrative Services 942  
Adoption Services 942  
Alternate Care (Placement) Services 941  
Assessment & Safety/Service Planning Services 941  
Community Support Services 941  
Court-Ordered Services 941  
Crisis Services 941  
Independent Living 941  
Interstate Compact on Out-of-State Placements 941  
Preventative Services 941  
Screening Services 941  
Correction Of Condition 2390  
Correction Statement 1935, 1938  
Status of Financing Statement 1935  
Status of Parties 1935  
Correspondence Policy, Residential Care Facility 1040  
Cost & Payment 2198  
Costs Of Prescription Drugs 954  
Cottonseed 248  
Certification 248  
Certification Performance 249  
Registration 248  
Storage Location & Destination 248  
Cottonseed -- Exemptions 249  
County Auditor Requirement 1948  
Contents 1949  
Minutes 1949  
Course Approval Requirements 392  
Appeals 393  
Board & Negotiated Rulemaking Meetings 393  
Code-Related Programs 392  
Code-Update Programs 392  
General Course Requirements 392  
Industry-Related Programs 392  
Instructor Approval Procedures 393  
Program Approval Procedures 392  
Revocation of Approval 393  
Schedule of Approved Classes 393  
Course Evaluation Fee 639  
Exception 640  
Fee Schedule 639  
Waiver 640  
Court-Ordered Child Protection Safety Assessment 965  
Covenant Not To Sue 2829  
Continuing Compliance 2829  
Negotiation & Provision of Covenant 2829  
Rescission of Covenant 2829  
Coverage 2628  
CPA Exam Educational Qualifications 24  
CPA Examination and Credit 24  
CPE Basic Requirements 29  
CPE Basic Requirements, Continuing

- Education
    - New & Reciprocal 30
    - Renewal 29
  - CPE Exceptions, Extensions, & Exemptions 30
    - Exceptions & Extensions 30
    - Inactive or Retired 30
  - CPE Reporting, Controls & Late Fees
    - CPE Late Fees 30
  - CPE Reporting, Controls, & Late Fees 30
  - Craniofacial 781
    - Eligible Conditions 781
    - Excluded Conditions 782
    - Spending Limits 782
  - Credentials To Be Filed By All Applicants 1596
    - Certified Copy of National Board Results 1596
    - Diploma 1596
    - Educational Certificate Requirement 1596
    - Residency Certification Requirement 1596
  - Credit Card Payments 2196
  - Credit Guidelines 2974
    - Additional Information Required for Loans Secured with Real Estate 2974
    - Duty to Inform 2974
    - Field Inspections 2974
    - Other Collateral 2974
    - Required Documentation 2974
    - Standards for Acceptable Loans 2974
  - Crediting, Improvement Credit 1263
  - Credits To An Account
    - Accordance with Financial Institution 564
    - Credit for Winnings 564
    - Deposits 563
  - Criminal History & Background Check
    - Clearance 925
    - Clearance 925
    - Clearance Types 926
    - Revocation of Clearance 926
  - Criminal History & Background Check For Daycare Standards 1005
    - Cost of Criminal History & Background Check & Juvenile Justice Records 1005
  - Criminal History & Background Check for Daycare Centers & Group Daycare Facilities 1005
  - Criminal History & Background Check for Family Daycare Homes 1005
  - Criminal History & Background Check for Private Schools & Private Kindergartens 1005
  - Juvenile Justice Records 1005
  - On-going Duty to Report Convictions 1005
- Criminal History & Background Check
    - Records 933
    - Release of Criminal History & Background Check Records 933
    - Retention of Records 934
    - Use & Dissemination Restrictions for FBI Criminal Identification Records 934
  - Criminal History & Background Check Requirements 702, 812, 862, 935, 993
    - Additional Criminal Convictions, Pending Investigations, or Charges 813
    - Availability to Work 862
    - Compliance with Department Criminal History & Background Check 993
    - Criminal History & Background Check 862
    - Criminal History & Background Check at Any Time 994
    - Department Criminal History and Background Check Clearance 812
    - Employer Discretion 863
    - Exceptions to Criminal History & Background Checks for Certain Youths 994
    - Individuals Subject to Criminal History Check Requirements 993
    - Minor Child Turns Eighteen 813
    - New Adults in the Home After Certification Is Granted 812
    - New Criminal History & Background Check 863
    - Renewal of Clearance 813
    - Scope of a Criminal History & Background Check 862
    - Submission of Fingerprints 863
    - Substitute Caregiver 813
    - Use of Previous Criminal History & Background Check 863
    - When Certification Can Be Granted 812
    - When License is Granted 993
  - Criminal History & Background Check Results 925
    - Findings for Court Required Criminal History & Background Checks 925
    - Results of Criminal History & Background Checks 925
  - Criminal History & Background Checks For Foster Care License 1018
    - Change in Household Membership 1018
    - Criminal History & Background Check at Any Time 1019
    - Foster Parent's Child Turns Eighteen 1018
    - Required Procedures 1018
  - Criminal Or Relevant Record - Action Pending 932
    - Availability to Provide Services 932
    - Notice of Inability to Proceed 932
    - Reconsideration of Action Pending 932
  - Criteria & Procedures For Downgrading Or Revoking Certification Status 753
    - Criteria for Revoking Certification Status 753
    - Procedure for Downgrading to Provisionally Certified Status 753
    - Procedure for Revocation 754
    - Reasons a Laboratory May be Downgraded to Provisionally Certified Status 753
    - Upgrading or Reinstatement of Certification 754
  - Criteria For Acceptable Electronic Signature Technology 1974
    - Additional Criteria 1974
    - Statutory Criteria 1974
  - Criteria For Accepting An Electronic Signature 1976
    - Certificate Format Used by the Signer 1976
    - Level of Security Used to Identify the Signer 1976
    - Level of Security Used to Transmit the Signature 1976
  - Criteria For Approval Of Application For Simulcast Operator 541
    - Financial Stability 542
    - General Benefit to Horse Racing Industry 541
    - General Benefit to the State 541
    - Operator's Credibility 542
    - Operator's Integrity 541
  - Criteria For Defining Levels Within Stages 2476
    - Stage 1 - Forecast & Caution 2476
    - Stage 2 -- Alert 2476
    - Stage 3 -- Warning 2477
    - Stage 4 -- Emergency 2477
  - Criteria For Individual Campsite, Camping Cabin, & Yurt Reservations Additional Park or Program Manager Authority 1844
  - Criteria For Reservations 1853
    - Cleaning Fee 1854
    - Confirmation Requirements 1854
    - Insufficient Payment 1854
    - Reservation Cancellations 1854
    - Reservation Modifications 1854
    - Reservation Service Charges, Individual or Group Campsite or Facility 1853
    - Responsible Party 1853
  - Criteria For Review Of Retailer Applications & Conduct Of Operations 2307
    - Certificate Not a Vested or Legal Right 2308
    - Certified Retailers 2309
    - Criteria That May Be Grounds for Refusal 2307

- Dishonored Checks & Electronic Fund Transfers 2310  
 Display of Certificate & Other Materials 2310  
 Fees, Procedure, & Criteria Precluding Issuing Contract 2307  
 Inspection of Lottery Materials & Retailer Premises 2310  
 Provisional Certifications 2307  
 Reporting Changes in Circumstances of the Retailer 2308  
 Requirements for the Sale of Tickets 2310  
 Retailer's Application 2307  
 Surrender of Certificate upon Revocation 2309  
 Suspension or Revocation of a Certificate 2308  
 Criteria For The Management Of Granular Mine Tailings (CHAT) In Asphalt Concrete & Portland Cement Concrete In Transportation Construction Projects Funded In Whole Or In Part By Federal Funds 2561  
 Critical Materials At Fixed Facilities On The Rathdrum Prairie In Kootenai County, Idaho 2229  
 Applicability 2231  
 Application Requirements of Fixed Facilities Engaged in Critical Materials Use Activities 2231  
 Definitions 2230  
 Performance Standards for Fixed Facilities 2232  
 Purpose & Intent 2229  
 Violation 2233  
 Crop Residue Disposal 2521  
 Crop/Commodity, Disease & Pest(s) Inspections 266  
 Minimum Field Inspection(s) 266  
 Special Inspection Requests 267  
 Cross-Border Licensing  
 Exemption 664  
 Anti-Fraud Provisions 664  
 Canadian Broker-Dealer 664  
 Consent to Service 664  
 Customers 664  
 Disclosure 664  
 Jurisdiction 664  
 Provide Requested Information 664  
 Registered Broker-Dealer 664  
 Cross-Border Transactions  
 Exemption 656  
 Cruelty To Animals 551  
 Cull & Volunteer Potatoes 350  
 Destroying Volunteer Potatoes 350  
 Plant Growth 350  
 Cull Potato Disposal Methods 291  
 Culverts & Bridges 2082  
 Areas to be Filled 2083  
 Construction of Crossings 2083  
 Culverts & Bridges 2082  
 Ideal Gradient, Culverts & Bridges 2082  
 Installation of Pipe & Arch Culvert 2084  
 Location of Culverts & Bridges 2082  
 Multiple Openings 2083  
 Size of Culvert or Bridge Opening 2082  
 Curricular Materials Selection & Online Course Approval 493  
 Bids 493  
 Depository 493  
 Local Policies 493  
 Multiple Adoptions are Made in Each Subject Area 493  
 Online Course Review & Approval Process 493  
 Subject Areas 493  
 Curriculum Change, Educational Program 1454  
 Curriculum Requirements For Nursing Education Programs 1452  
 Advanced Practice Professional Nursing Program Curriculum 1453  
 Curriculum Changes 1452  
 General Curriculum 1452  
 Practical Nurse Curriculum 1452  
 Practice Sites 1452  
 Registered Nurse Curriculum 1453  
 Curriculum, Educational Program 1451  
 Program Evaluation 1452  
 Student Competence 1451  
 Custody & Placement 951  
 Interstate Placements 951  
 Intrastate Placements That Become Interstate Placements 951  
 CWD Status 195  
 Cervidae of Lesser Status 196  
 Change of Ownership 196  
 Contact With CWD Positive Animals 196  
 Status Date 195  
 Status Review 195  
 Cystic Fibrosis 782  
 Eligible Conditions 782  
 Excluded Services 782  
 Services Provided 782  
 Pending Limit 782
- D**
- Daily Performance Checks 157  
 Calibration Based On Daily Performance Check 157  
 Daily Performance Check Samples 157  
 Procedure 157  
 Daily Racing Program 586  
 Dairy Farm Best Management Practices 2538  
 BMPs 2538  
 Table - Ammonia Control Practices for Idaho Dairies 2538  
 Dairy Farm Certification 171  
 Certification 171  
 Initial Inspection 171  
 Inspection 171  
 Probationary Period 172  
 Reinstatement 172  
 Dairy Goats 368  
 Dam Size Classification & Risk Category 2061  
 Determination of Size & Risk Category 2062  
 Risk Category 2062  
 Size Classification 2061  
 Damage Prevention Complaints 480  
 Complaint Forms 480  
 Complaint Procedures & Timelines 480  
 Contents 480  
 Dams Storing Tailing & Water 2058  
 Dams Storing Tailings & Water 2073  
 Abandonment Plan 2073  
 Construction of Dams Storing Fifty Acre-Feet or More 2073  
 Dangerous & Hazardous Materials 1024  
 Dangerous Material Fires 2521  
 Data Entry Of Names – Designated Fields 1936  
 Designated Fields Encouraged 1936  
 Individual Names 1936  
 Organization Names 1936  
 Data Entry Of Names -- No Designated Fields 1936  
 Identification of Individuals 1936  
 Identification of Organizations 1936  
 Individual and Organization Names on a Single Line 1937  
 Individual Names 1937  
 Date A Child Entered Foster Care 948  
 Daycare Center Training  
 Requirements 1009  
 Child Development Training 1009  
 Documented Training 1009  
 Pediatric Rescue Breathing, Infant-Child CPR & First Aid Treatment Training 1010  
 Staff Training Records 1010  
 Daycare Licensing Maximum Total Fees 1005  
 Daycare Fire Inspection Fee 1006  
 Daycare Licensing Maximum Total Fee Amounts 1006  
 Dead Animal Disposal 200, 209  
 Deaf Interpreters 1715  
 Letter of Endorsement 1715  
 Withdrawal of Endorsement 1716  
 Dealer Or Grower Holding Ginseng After December 31 Of The Year 277  
 Dealer Records 276  
 Purchase Records 276  
 Sales Records Shall Include 276  
 Dealers & Growers Annual Registration With The Department 275  
 Death Of A Child In Care Notification,

- Residential Care Facility 1031
- Debits To An Account  
 Account Withdrawals 564  
 Debits to an Account 564
- Decertification 632  
 Discretionary Decertification 632  
 Effect of Decertification 633  
 Mandatory Decertification 632  
 Required Notifications by Officers & Agencies 633
- Decertification Proceedings 633  
 Decision – Request for Hearing 634  
 Hearing & Order 634  
 Notice of Intent to Decertify 633  
 Petition for Review 634  
 Service 635
- Decision & Approval Process For Termination Of Parent & Child Relationship (TPR) 971
- Decision Process 2909  
 Application Denial 2909  
 Draft Permit 2909  
 Final Permit 2909  
 Proposed Permit 2909
- Decision To Approve Or Disapprove Of A Permanent Closure Report 1198, 2815  
 Director's Determination to Disapprove a Permanent Closure Report 2815  
 Issuance of Director's Determination 2815  
 Permanent Closure Report Is Disapproved 1198  
 Receipt of a Permanent Closure Report 1198
- Decision-Making Model 1440  
 Deciding to Delegate 1440  
 Determining Scope of Practice 1440  
 Monitoring Delegation 1441
- Decisions & Orders 1958  
 Decisions 1958  
 Notice 1958  
 Proposed Orders 1958  
 Submission for a Decision 1958
- Declaration Of An Animal Health Emergency 149  
 Disease Presence 149  
 Eradicated Diseases 149  
 Specific Diseases 149
- Declaration Of Animal Health Emergency 193  
 Condemnation of Animals 193  
 Failure to Notify 193  
 Indemnity 193  
 Notification to Administrator 193
- Declaration Of Quantity - Consumer Packages 85  
 Abbreviations 86  
 Combination Declaration 85  
 Largest Whole Unit 85  
 Lines of Print or Type 85  
 Net Quantity 85  
 Terms - Weight, Liquid Measures, or Count 85  
 Units -- Weight, Measure 85  
 Units With Two or More Meanings 86  
 Use of Net Weight 85
- Declaration Of Quantity -- Nonconsumer Packages 89  
 Abbreviations 90  
 Character of Declaration -- Average 90  
 Location 89  
 Terms -- Weight, Liquid Measure, or Count 89  
 Units -- Weight, Measure 89
- Deep Thermal, Electrotherapeutic Mechanical Physical Agent Modalities, & Wound Care 1553  
 Obtaining Education & Supervised Training 1554  
 Qualifications 1553  
 Supervised Training by Qualified Individual 1554
- Defective, Insufficient Or Late Pleading 1950
- Defective, Insufficient Or Late Pleadings 1973
- Definition, IDAPA 24.03.01 1511  
 Chiropractic Assistant 1511  
 Chiropractic Intern 1511  
 Direct Personal Supervision 1511  
 Inactive Retired 1511
- Definitions 279, 702, 745, 755, 774, 793, 1087, 1128, 1154, 1157, 1181, 1217, 1221, 1240, 1245, 1250, 1256, 1257, 1267, 1403, 1756, 1769, 2181, 2201, 2255, 2292, 2346, 2364, 2968
- A Through E 935  
 Adoption & Safe Families Act of 1997 (P.L. 105-89) (ASFA) 935  
 Adoption Assistance 935  
 Adoption Services 935  
 Alternate Care 935  
 Alternate Care Plan 936  
 Board 936  
 Case Management 936  
 Certified Adoption Professional (formerly "qualified individual") 936  
 Child & Family Services (CFS) 936  
 Child Protection 936  
 Child Protective Services 936  
 Compact Administrator 936  
 Day Care for Children 936  
 Department 936  
 Deprivation 936  
 Director 936  
 Extended Family Member of an Indian Child 936
- A Through M 994  
 Accredited Residential School 994  
 Alcohol-Drug Abuse Treatment Facility 995  
 Attendance 995  
 Board 995  
 Chief Administrator 995  
 Child 995  
 Child Care 995  
 Children's Agency 995  
 Children's Camp 995  
 Children's Institution 995  
 Children's Residential Care Facility 995  
 Children's Therapeutic Outdoor Program 996  
 Child-Staff Ratio 995  
 Continued Care 996  
 Contraband 996  
 Daycare 996  
 Daycare Center 996  
 Department 996  
 Direct Care Staff 996  
 Director 996  
 Family Daycare Home 996  
 Foster Care 996  
 Foster Home 996  
 Foster Parent 996  
 Group Daycare Facility 996  
 Inter-Country Adoption 996  
 International Building Code 996  
 International Fire Code 996  
 Mechanical Restraint 997  
 Medical Professionals 997  
 Member of the Household 997
- Ability to Pay 1087  
 Act 793, 1157  
 Actual Allowable Cost 1217  
 Actual Allowable Disturbance 1217  
 Adjacent 1221  
 Administrative Costs 2292  
 Adult 1087  
 Adult Mental Health Program 1087  
 Agency 793  
 Aids to Navigation 1221  
 Allowable Annual Deductions 1087  
 Amortization 1257  
 Analyst 745  
 Animal Unit Month (AUM) 1257  
 Annual Rental 1256  
 Applicant 2968  
 Application 2968  
 Appropriate Governmental Entity 2181  
 Approved Massage Program 1756  
 Approximate Previous Contour 1157, 1181  
 Artificial High Water Mark 1221, 1250  
 Assembled Vehicle 2181  
 Assignment 1257  
 Associated By-Products or By-Product 1267  
 Authorized Employees 2201  
 Available State Lands 1240  
 Base Funding 2968  
 Bather 755

- Beds of Navigable Lakes 1221  
Behavioral Health Services 1087  
Benefit 2292  
Best Management Practices 1157  
Best Management Practices (BMP) 1181  
Board 746, 755, 1154, 1157, 1217, 1221, 1240, 1245, 1250, 1256, 1257, 1267, 2346  
Board of Supervisors 2968  
Boat Garage 1221  
Boat Lift 1221  
Boat Ramp 1221  
Body/Center Passenger Area 2181  
Brand 2181  
Break In Grade 755  
Cab 2181  
Casual Exploration 1240, 1267  
Central Roster 2346  
Certificate 2292  
Certificate Holder 2346  
Certification Authority for the State of Idaho (CA) 746  
Certification Officer (CO) 746  
Certified Drinking Water Laboratory (CDWL) 746  
Certified Evaluator 2346  
Certified Post Conviction Sex Offender Polygraph Examiner 2346  
Certified Treatment Provider 2346  
Certify 2968  
Chapter 1181  
Child 1087  
Children's Mental Health Program 1087  
Clean 1769  
Client 2346  
Clinical Laboratory Tests 774  
Clinical Services or Clinical Work 1769  
Clinical Work 1756  
Code of Ethics 1756  
Commercial 1240  
Commercial Marina 1221  
Commercial Navigational Encroachment 1222  
Commission 2968  
Commission or State Lottery Commission 2292  
Commissioner 2292  
Community Docks 1222  
Completion 1267  
Conflict Application 1257  
Conservation District or District 2968  
Conservation Plan 2968  
Construction Materials 1240  
Contract 1154  
Contractee 2968  
Control Person 2292  
Coordinated Resource Planning Process 2968  
Cottage Site 1256  
Council on Naturopathic Medical Education (CNME) 1403  
Court-Ordered Obligations 1087  
Court-Ordered Recipient 1088  
Covered Slip 1222  
CPR 1756  
Dam 1250  
Damage or Impairment of Rights to the Remainder of the Property 1245  
Definitions  
Request for Proposal 2294  
Department 746, 755, 774, 1088, 1154, 1157, 1181, 1217, 1222, 1245, 1250, 1256, 1257, 1267  
Department of Environmental Quality (DEQ) 746  
Dependent Support 1088  
Development Credits 1154  
Direct Use 1267  
Director 746, 755, 774, 1154, 1157, 1222, 1240, 1245, 1250, 1257, 1267, 2292  
Director's Designee 755  
Discharge 1182  
Discipline 746  
Disinfect 1769  
Disinfectant 1769  
District 2968  
Disturbed Acres 1217  
Disturbed Land or Affected Land 1157  
Dredge Mining Act 1217  
Drinking Water Coordinator (DWC) 746  
Easement 1245, 1250  
Electrical Generation 1267  
Eligible Land 2968  
Encroachments in Aid of Navigation 1222  
Encroachments Not in Aid of Navigation 1222  
Endowment Lands 1245  
Environmental Laboratory Tests 774  
Established Standards 2346  
Establishment 1769  
Executive Staff 2293  
Exempt License Plate 2201  
Exempt Personalized License Plate 2201  
Expenses 2293  
Extension 1258  
Extraordinary Rehabilitative Expenses 1088  
F Through K 936  
Family 936  
Family (Case) Plan 937  
Family Assessment 937  
Family Case Record 937  
Family Services Worker 937  
Federally-Funded Guardianship Assistance for Relatives 937  
Field Office 937  
Goal 937  
Independent Living 937  
Indian 937  
Indian Child 937  
Indian Child Welfare Act (ICWA) 937  
Indian Child's Tribe 937  
Indian Tribe 937  
Intercountry Adoption Act of 2000 (P.L. 106-279) 937  
Interethnic Adoption Provisions of 1996 (IEP) 938  
Interstate Compact on the Placement of Children (ICPC) 938  
Kin 938  
Facility 1769  
Family 1088  
Family Household 1088  
Federal Poverty Guidelines 1088  
Field 1267  
Field Office 2968  
Field Office Technical Guide 2968  
Final Order of the Board 1158  
Financial & Match Report 2969  
Financial Assurance 1217  
Fire Protection Sprinkler Contractor 1128  
Fire Protection Sprinkler System 1128  
First-Aid Kit 1769  
Fiscal Year 2293, 2969  
Fitters 1128  
Five (5) Year Plan 2969  
Floating Home or Float Home 1222  
Floating Toys 1222  
Flow-Through Pool 755  
Forest Products 1154  
Formerly Submerged Lands 1250  
Frame 2181  
Fund 2969  
Funding Criteria 2969  
Furtherance or Pursuance of Business 2201  
Geothermal Pool 755  
Geothermal Resources 1267  
Geothermal Water 755  
Gift 2293  
Grantee 1251  
Grantor 1251  
Gray Market Vehicle 2181  
Groundwater 1182  
Hearing Officer 1158  
Herd Stock 1258  
Hydroelectric Facilities 1251  
Idaho Bureau of Laboratories (IBL) 746  
Immediate Family 2293  
Improvement Valuation 1258  
Instant Game 2293  
Invitation to Bid 2293  
Jet Ski Ramp, Port, or Lift 1222  
L Through R  
Legal Guardianship 938  
Licensed 938



- Licensing 938  
Medicaid 938  
Multiethnic Placement Act of 1994 (MEPA) 938  
P.L. 105-89 938  
P.L. 96-272 938  
Parent 938  
Permanency Planning 938  
Personal Care Services (PCS) 938  
Planning 938  
Qualified Expert Witness--  
ICWA 938  
Relative 939  
Relative Guardian 939  
Reservation 939  
Respite Care 939  
Responsible Party 939  
Laboratory Supervisor 746  
Land Application 1182  
Lease 1258, 1268  
Lease Application 1258  
Leased or Rented Vehicles 2201  
Lessee 1256, 1268  
Lifeguard 755  
Lifeguard Chair 755  
LIMS 746  
Line of Navigability 1222  
Local Funds 2969  
Local Services 2969  
Local Units of Government 2969  
Lottery Contract or Contract 2293  
Lottery Contractor or Contractor 2293  
Lottery Game or Game 2293  
Lottery Game Retailer or Retailer 2293  
Lottery or State Lottery 2292  
Lottery Revenue 2293  
Lottery Vendor or Vendor 2293  
Low Water Mark 1222  
Low, Medium & High Tier Claims 2293  
Major Procurement 2293  
Makeup 1769  
Manageable Unit 1258  
Management Plan 1258  
Management Service Contractor (MSC) 1088  
Market Value 1245, 1251, 1268  
Match Funding 2969  
Material Change 1182  
Material Modification or Material Expansion 1182  
Material Stabilization 1182  
Maximum Allocation 2969  
Maximum Contaminant Level (MCL) 746  
Mileage 2181  
Mine 1217  
Mine Panel 1158  
Mined Land Reclamation Act 1217  
Mineral 1158  
Mineral Lease 1218  
Mineral Leasing Act 1218  
Mineral Lessee 1218  
Moorage 1222  
Mortgage Agreement 1258  
Motorized Earth-Moving Equipment 1158, 1182, 1268  
Motorized Exploration 1218, 1240  
Mulch 1158  
N Through Z 997  
Nonaccredited Residential School 997  
Non-Compliance 997  
Operator 997  
Organization 997  
Person 997  
Physical Intervention 997  
Placement 997  
Plan of Correction 997  
Regularly on the Premises 997  
Relative 997  
Representative 997  
Residential School 997  
Restraint 998  
Seclusion 998  
Second Degree of Relationship 998  
Secure 998  
Security Risk 998  
Service Worker 998  
Shelter Care 998  
Social Worker 998  
Soft Restraints 998  
Staff 998  
Supervision 998  
Time-Out 998  
Training 998  
Transitional Living 998  
Variance 999  
Waiver 999  
Natural or Ordinary High Water Mark 1222, 1240, 1251  
Natural Watercourse 1158  
Naturopathic Medical Doctor 1403  
Naturopathic Physicians Licensing Exam (NPLEX) 1403  
Navigable Lake 1222  
Navigable River 1241  
Navigable Water Courses 1268  
Net Appraised Value 1154  
Net Income 2293  
Net Sale Value 1154  
Neutralization 1182  
North American Board of Naturopathic Examiners (NABNE) 1403  
On-Line System 2293  
On-Site Evaluation 746  
Operator 755, 1218, 1268  
Organizations 2969  
Other Funds 2969  
Overburden 1158  
Overburden Disposal Area 1158  
Overriding Royalty 1268  
Parent 1088  
Party 1223  
Patron 1769  
Performance Report 2970  
Permanent Cessation 1158  
Permanent Closure 1182  
Permit 1183, 1218  
Permit Area 1158  
Permittee 1158  
Person 756, 1158, 1223, 1240, 1251, 1258, 1268, 2292  
Piling 1223  
Pilot Facility 1183  
Pit 1158  
Placer Deposit 1158  
Placer or Dredge Exploration Operation 1159  
Placer or Dredge Mining Operation 1159  
Placer or Dredge Mining or Dredge or Other Placer Mining 1159  
Placer Stockpile 1158  
Plans 1223  
Play Symbols 2294  
Pollutant 1183  
Pool 756  
Practice Life 2970  
Practice or Eligible Practice for Loans 2970  
Primacy 746  
Primary Care 1403  
Private Pool 756  
Prize 2294  
Process Waters 1183  
Proficiency Test (or Testing) (PT) 746  
Program Year 2970  
Project 2970  
Proposed Management Plan 1258  
Provisional Retailer 2294  
Provisional/Supervised Psychosexual Evaluator 2346  
Provisional/Supervised Sex Offender Treatment Provider 2347  
Psychosexual Evaluation 2347  
Public Hearing 1223  
Public Swimming Pool 756  
Public Trust Doctrine 1223  
Public Water System (PWS) 746  
Purchaser 1154  
Pylon 1223  
Quality Assurance 2347  
Quality Assurance (QA) 746  
Quality Assurance Plan (QA Plan) 747  
Quality Control (QC) 747  
Rangeland 2970  
Real Property 1183  
Recipient 1088  
Reciprocity 747  
Reclamation 1159, 1183  
Reclamation Fund 1218  
Reclamation Fund Act 1218  
Record of Instruction 1769  
Record Title 1268  
Recreational Mining 1241

- Redemption Value 2294  
 Regulatory Agency 747  
 Remodel 756  
 Replica Street Rod 2181  
 Reservoir or Pool 1268  
 Responsible Maintenance  
   Employee 1128  
 Retailer Validation Code 2294  
 Revegetation 1159, 1183  
 Right-of-Way 1251  
 Riparian Areas 2970  
 Riparian or Littoral Owner 1223  
 Riparian or Littoral Right  
   Lines 1223  
 Riparian or Littoral Rights 1223  
 River Mile 1241  
 Road 1159  
 Roads 1154  
 S Through Z 939  
   Safety Assessment 939  
   Safety Plan 939  
   Sibling 939  
   SSI (Supplemental Security  
     Income) 939  
   State-Funded Guardianship  
     Assistance 939  
   TAFI, Temporary Assistance to  
     Families in Idaho 939  
   Title IV-E 939  
   Title IV-E Foster Care 939  
   Title XIX (Medicaid) 939  
   Title XXI 939  
   Tribal Court 940  
   Unmarried Parents' Services 940  
   Voluntary Services  
     Agreement 940  
 Security 2970  
 Sensitive Procurement 2294  
 Settling Pond 1159  
 Sexual Offender 2347  
 Sexual Offender Classification  
   Board 2347  
 Share 2294  
 Shut In 1268  
 Side Tie 1223  
 Single-Family Dock 1223  
 Single-Use 1769  
 Sliding Fee Scale 1088  
 Slip 1223  
 Small Cyanidation Processing  
   Facility 1183  
 Spa 756  
 Special Practice 2970  
 Special-Use Pool 756  
 Standard Methods (SM) 747  
 Standard Operating Procedure  
   (SOP) 747  
 Standards of Practice 1756  
 State Health Official 774  
 State Lands 1268  
 State Lottery Act of 1988 or  
   Act 2294  
 State-Owned Lands 1245  
 Sterilant 1770  
 Sterilize 1769  
 Street Rod Vehicle 2181  
 Subcontracting 747  
 Subcontractor 2294  
 Sublease 1258  
 Submerged Lands 1223, 1241, 1251  
 Substance Use Disorders  
   Program 1088  
 Supervision 2347  
 Surface Mining Reclamation  
   Plan 1218  
 Surface Waters 1159, 1183  
 Temporary Permit 1245  
 Temporary Retailer 2294  
 Third-Party Payor 1088  
 Ticket 2294  
 Ticket Bearer 2294  
 Ticket Validation Number or  
   Validation Number 2294  
 Topsoil 1159  
 Total Annual Revenue or Annual  
   Revenue 2295  
 Transferee 2182  
 Transferor 2182  
 Treatment 1183, 2347  
 Two-Family Dock 1223  
 Unclaimed Prize 2295  
 Undercover License Plate 2201  
 Upland 1224  
 Uplands 1251  
 Value 2295  
 Vehicles Not Held in Stock 2201  
 Vehicles Sold 2201  
 Violent Sexual Predator 2347  
 Wading Pool 756  
 Waste 1268  
 Water Balance 1183  
 Water Management Plan 1184  
 Waters of the State 1184  
 Weak Acid Dissociable  
   Cyanide 1184  
 Definitions & Abbreviations 578, 916,  
   1872  
   Agency 916  
   Application 916  
   Bleeder List 578  
   Calendar Year 578  
   Clearance 916  
   Colt 578  
   Commission Veterinarian 578  
   Conviction 916  
   Criminal History & Background  
     Check 917  
   Criminal History Unit 917  
   Denial 917  
   Department 917  
   Direct Patient Access Employee 917  
   Disqualifying Crime 917  
   DMSO 578  
   Employer 917  
   Enhanced Clearance 917  
   Exemption Review 917  
   Federal Bureau of Investigation  
     (FBI) 917  
   Filly 578  
   Gelding 578  
   Good Cause 917  
   Horse 578  
   Hypodermics 578  
   Idaho State Police Bureau of Criminal  
     Identification 918  
   Inspection of Horses 578  
   Mare 578  
   Medication Report Form 578  
   Needle & Syringe 578  
   Owner 578  
   Penalties 578  
   Primary Laboratory 578  
   Prohibited Substances 578  
   Racing Association 579  
   Racing Condition 579  
   Referee Laboratory 579  
   Relevant Record 918  
   Sample 579  
   Split Sample 579  
   Suspension 579  
   Test Area 579  
   Trainer 579  
   Veterinarian 579  
   Veterinarian's List 579  
   Veterinarians' Reports 579  
 Definitions & Abbreviations -- A  
   Through K 813  
   Abuse 813  
   Activities of Daily Living 813  
   Adult 813  
   Alternate Caregiver 813  
   Assessment 813  
   Certificate 813  
   Certified Family Home 813  
   Certified Family Home Care  
     Provider 813  
   Certifying Agent 813  
   Chemical Restraint 814  
   Core Issue 814  
   Criminal Offense 814  
   Critical Incident 814  
   Department 814  
   Director 814  
   Exploitation 814  
   Health Care Professional 814  
   Immediate Jeopardy 814  
   Inadequate Care 814  
   Incident 814  
   Incidental Supervision 814  
   Instrumental Activities of Daily  
     Living 814  
 Definitions & Abbreviations -- L  
   Through Z 814  
   Level of Care 814  
   Neglect 814  
   Negotiated Service Agreement 814  
   Personal Assistance 815  
   Plan of Service 815  
   PRN (Pro Re Nata) 815  
   Relative 815  
   Resident 815  
   Substitute Caregiver 815

- Supervision 815  
 Supportive Services 815  
 Variance 815  
 Vulnerable Adult 815  
 Waiver 815  
 Definitions & Abbreviations (A – N)  
 ACCME 1872  
 Accredited School or College of Pharmacy 1872  
 ACPE 1872  
 ADS – Automated Dispensing & Storage 1872  
 Change of Ownership 1872  
 CME 1872  
 Collaborative Pharmacy Practice 1872  
 CPE 1872  
 CPE Monitor 1872  
 DEA 1872  
 Distributor 1872  
 DME Outlet 1872  
 DTM – Drug Therapy Management 1873  
 FDA 1873  
 Flavoring Agent 1873  
 Floor Stock 1873  
 FPGEC Certification 1873  
 Hazardous Drug 1873  
 HIPAA 1873  
 Limited Service Outlet 1873  
 NABP 1873  
 NAPLEX 1873  
 NDC 1873  
 Definitions & Abbreviations (O – Z) 1873  
 Parenteral Admixture 1873  
 PDMP 1874  
 Pharmaceutical Care Services 1873  
 Prepackaging 1874  
 Prescriber 1874  
 Purple Book 1874  
 Readily Retrievable 1874  
 Reconstitution 1874  
 Restricted Drug Storage Area 1874  
 Technician 1874  
 Therapeutic Equivalent Drugs 1874  
 USP 1874  
 USP-NF 1874  
 VAWD – Verified Accredited Wholesale Distributor 1874  
 Definitions & Abbreviations A Through E 863  
 Abuse 863  
 Accident 863  
 Activities 863  
 Activities of Daily Living 863  
 Administrator 864  
 Administrator’s Designee 864  
 Adult 864  
 Advance Directive 864  
 Advocate 864  
 Ambulatory Person 864  
 Assessment 864  
 Authentication 864  
 Authorized Provider 864  
 Behavior Plan 864  
 Call System 864  
 Chemical Restraint 864  
 Cognitive Impairment 864  
 Complaint 864  
 Complaint Investigation 864  
 Core Issue 864  
 Criminal Offense 865  
 Deficiency 865  
 Dementia 865  
 Department 865  
 Developmental Disability 865  
 Direct Resident Access 865  
 Director 865  
 Electronic Signature 865  
 Elopement 865  
 Exit Conference 865  
 Exploitation 866  
 Definitions & Abbreviations F Through N 866  
 Follow-Up Survey 866  
 Governmental Unit 866  
 Hourly Adult Care 866  
 Immediate Danger 866  
 Inadequate Care 866  
 Incident 866  
 Independent Mobility 866  
 Legal Guardian or Conservator 866  
 License 866  
 Licensing Agency 866  
 Maladaptive Behavior 866  
 Medication 866  
 Medication Administration 866  
 Medication Assistance 866  
 Mental Disorders 866  
 Mental Illness 866  
 Neglect 867  
 Negotiated Service Agreement 867  
 Non-Core Issue 867  
 Nursing Assessment 867  
 Definitions & Abbreviations O Through Z 867  
 Outside Services 867  
 Owner 867  
 Personal Assistance 867  
 Personnel 867  
 Physical Restraint 867  
 Portable Heating Device 867  
 Pressure Injury 867  
 PRN 867  
 Provisional License 867  
 Publicly-Funded Program 867  
 Punishment 868  
 Relative 868  
 Repeat Deficiency 868  
 Reportable Incident 868  
 Resident 868  
 Residential Assisted Living Facility 868  
 Room & Board 868  
 Scope 868  
 Self-Administration of Medication 868  
 Story 868  
 Substantial Compliance 868  
 Substantial Evening Meal 868  
 Supervision 868  
 Survey 869  
 Surveyor 869  
 Therapeutic Diet 869  
 Toxic Chemical 869  
 Traumatic Brain Injury (TBI) 869  
 Unlicensed Assistive Personnel (UAP) 869  
 Variance 869  
 Definitions & Abbreviations, IDAPA 19.01.01 1135  
 AAOMS 1135  
 ACLS 1135  
 ADA 1135  
 ADHA 1135  
 Analgesia 1135  
 BLS 1135  
 CDC 1135  
 CE 1135  
 CODA 1135  
 CRNA 1135  
 Deep Sedation 1135  
 Enteral 1135  
 EPA 1135  
 General Anesthesia 1135  
 GI 1136  
 Inhalation 1136  
 Local Anesthesia 1136  
 Minimal Sedation 1136  
 Moderate Sedation 1136  
 Monitor or Monitoring 1136  
 MRD 1136  
 NBDE 1136  
 NBDHE 1136  
 Operator 1136  
 Parenteral 1136  
 PMP 1136  
 Sedation 1136  
 Definitions & References, IDAPA 32.01.01 1898  
 Administrative Fees 1898  
 Application Fee 1898  
 Credit Enhancement Program 1898  
 EFIB, Endowment Fund Investment Board 1898  
 Endowments 1898  
 Guarantee Fee 1898  
 Guaranty Program 1898  
 Pass-Through Fee 1898  
 School District 1898  
 Total Debt Service 1898  
 Definitions & Terms, IDAPA 02.06.02, Subchapter A 243  
 All Life Stages 243  
 Family 243  
 Hay 243  
 Immediate Container 243  
 Ingredient Statement 243  
 Principal Display Panel 243  
 Viable Noxious Weed Seed 244  
 Definitions 10.01.01

- Active Participation 496  
Activity 496  
Board 496  
Certificate Holder 496  
College Semester or Quarter Credit Hour 496  
Continuing Education Unit (CEU) 496  
Deceit 496  
Documented Self-Study 496  
Incompetence 496  
Licensee 496  
Misconduct 496  
Professional Development Hour (PDH) 497  
Definitions 17.01.01 1093  
Adjustor 1093  
Ambulatory Payment Classification 1093  
Ambulatory Surgery Center 1093  
Approval by Commission 1093  
Available Funds 1093  
Average Wholesale Price 1093  
Charge 1093  
Charging Lien 1094  
Claim 1094  
Claimant 1094  
Claims Administrator 1094  
Commission 1094  
Critical Access Hospital 1094  
Current Procedural Terminology 1094  
Death Claim 1094  
Electronic Data Interchange 1094  
Fee Agreement 1094  
First Degree of Consanguinity 1094  
First Report of Injury 1095  
Gross Direct Premiums Written 1095  
Healthcare Common Procedure Coding System 1095  
Hospital 1095  
IAIABC EDI Release 3.0 1095  
Impairment Rated Claim 1095  
Implantable Hardware 1095  
Indemnity Benefits 1095  
Indemnity Claim 1095  
Legacy Claim 1095  
Litigated Case 1095  
Medical Only Claim 1095  
Medical Report 1095  
Medicare Severity - Diagnosis Related Group 1095  
Net Premiums Written 1095  
Payor 1095  
Payroll 1095  
Pharmacy 1096  
Termination of Disability 1096  
Time Loss Claim 1096  
Trading Partner 1096  
Trading Partner Agreement 1096  
Definitions 25.01.01  
Classified River 1801  
IFGC 1802  
Training Log 1803  
Unethical/Unprofessional Conduct 1804  
Definitions For The Purpose Of Sections 563 Through 574 & 582 2481  
Applicable Implementation Plan 2481  
Consult or Consultation 2481  
Distribute 2481  
Distribution List 2481  
Exempt Projects 2481  
Lead Agency 2481  
Lead Air Quality Agency 2481  
Local Highway Jurisdiction 2481  
Local Highway Technical Assistance Council (LHTAC) 2481  
Maximum Priority 2482  
Metropolitan Planning Organization (MPO) 2482  
Public Notice 2482  
Recipient of Funds Designated Under Title 23 U.S.C. or the Federal Transit Laws 2482  
Regionally Significant Project 2482  
Transit Agency 2483  
Transportation Agency 2482  
Definitions For The Purposes Of 40 CFR Part 60 2384  
Definitions For The Purposes Of 40 CFR Part 61 & 40 CFR Part 63 2384  
Definitions For The Purposes Of Sections 300 Through 386 2382  
Affected States 2382  
Allowance 2382  
Applicable Requirement 2383  
Designated Representative 2383  
Draft Permit 2383  
Emergency 2383  
Final Permit 2383  
General Permit 2383  
Insignificant Activity 2384  
Major Facility 2384  
Definitions For The Purposes Of Sections 790 Through 799  
Best Management Practice 2385  
Control Strategy Trigger 2385  
Nonmetallic Mineral Processing Plant 2385  
NSPS Regulated Facility or Plant 2385  
Permit by Rule 2385  
Progressive Control Strategy 2385  
Site of Operations 2385  
Definitions IDAPA 02.06.06 305  
Department Approved Tag (Yellow Tag) (Non-Phaseolus) 305  
Department Approved Tag (Yellow Tag) (Phaseolus) 305  
Department In-State Planting Tag (Green Tag) 305  
Detailed Varietal Planting Plan 305  
Edible Harvest 305  
Experimental Plots 305  
Farmstead 305  
Home Garden 305  
ICIA Tag 305  
In-State Planting Tag Number (State Number) 305  
Introduction Plots 305  
Oregon Department of Agriculture Inspection Tag 306  
Pre-Harvest Inspection 306  
Rill Irrigation 306  
Seed Borne 306  
Seed Lot 306  
Seed Transmitted 306  
Sprinkler Irrigation 306  
Trial Grounds 306  
True Identity of Seed Lot 306  
Windrow Inspection 306  
Definitions IDAPA 58.01.20 2835  
Applicant 2835  
Board 2835  
Categorical Exclusion (CE) 2835  
Close or Closing 2835  
Community Water System 2835  
Construction 2835  
Contaminant 2836  
Department 2836  
Director 2836  
Disadvantaged Community 2836  
Disadvantaged Loans 2836  
Distribution System 2836  
Eligible Costs 2836  
Eligible Systems 2836  
Environmental Impact Statement (EIS) 2836  
Environmental Information Document (EID) 2836  
Financial Management System 2836  
Finding Of No Significant Impact (FONSI) 2836  
Handbook 2836  
Ineligible Costs 2836  
Loan Recipient 2836  
Managerial Capability 2836  
Maximum Contaminant Level (MCL) 2836  
Noncommunity Water System 2836  
Nonprofit Noncommunity Water System 2837  
Nontransient Noncommunity Water System 2837  
Operation & Maintenance 2837  
Person 2837  
Plan of Operation 2837  
Planning Document 2837  
Priority List 2837  
Public Drinking Water System/Public Water System/Water System 2837  
Qualifying Entity 2837  
Rehabilitation 2837  
Reserve Capacity 2837  
State 2837  
Supplier or Provider of Water 2837  
Suspension 2837

- Sustainability 2838  
 Technical Capability 2838  
 Termination 2838  
 User Charge System 2838  
 Water System Protection  
     Ordinance 2838  
 Water Treatment Plant 2838  
 Definitions Related To Advanced  
     Practice Registered Nursing 1432  
     Accountability 1432  
     Advanced Practice Registered  
         Nurse 1432  
     Authorized Advanced Practice  
         Registered Nurse 1432  
     Certification 1433  
     Certified Nurse Practitioner 1433  
     Certified Nurse-Midwife 1433  
     Certified Registered Nurse  
         Anesthetist 1433  
     Clinical Nurse Specialist 1433  
     Collaboration 1433  
     Consultation 1433  
     Diagnosis 1433  
     Intervention 1433  
     Peer Review Process 1433  
     Population Focus 1433  
     Prescriptive & Dispensing  
         Authorization 1434  
     Referral 1434  
     Scope of Practice of Advanced  
         Practice Registered Nurse 1434  
     Specialization 1434  
 Definitions Related To Interns &  
     Residents 1397  
     Acceptable Post Graduate Training  
         Program 1397  
     Acceptable Training Program 1397  
 Definitions Relating To Supervising &  
     Directing Physicians 1392  
     Alternate Directing Physician 1392  
     Alternate Supervising Physician for  
         Externs, Interns, &  
         Residents 1392  
     Alternate Supervising Physician of  
         Medical Personnel 1392  
     Athletic Trainer 1392  
     Directing Physician 1392  
     Medical Personnel 1392  
     Supervising Physician of Interns,  
         Externs, or Residents 1392  
     Supervising Physician of Medical  
         Personnel 1393  
 Definitions, IDAPA 01.01.01 22  
     Administering Organization 22  
     Board 22  
     Candidate 22  
     CPA Examination 22  
     CPE 22  
     Ethics CPE 22  
     NASBA, National Association of  
         State Boards of Accountancy 22  
     National Candidate Database 22  
     State-Specific Ethics for Idaho 22  
     Year of Review 22  
     Year Under Review 22  
 Definitions, IDAPA 02.01.04 40  
     Agricultural Product 40  
     Apicultural Product 40  
     Aquacultural Product 40  
     Avicultural Product 40  
     Beverage 40  
     Broker 40  
     Cervidae Product 40  
     Dairy Product 40  
     Florist Stock 40  
     Foodservice 40  
     Forest Products 40  
     Fresh Produce, Commodities, &  
         Fresh Meat 40  
     Horticultural Products 40  
     Livestock 41  
     Livestock Product 41  
     Non-Food Agricultural Products 41  
     Nursery Stock 41  
     Packer/Shipper 41  
     Participant 41  
     Processed Food 41  
     Processor 41  
     Producer 41  
     Retailer 41  
     Supporting Organization 41  
     Viticultural Products 41  
     Wholesaler 41  
 Definitions, IDAPA 02.01.05 47  
     Applicant 47  
     Certificate of Free Sale 47  
 Definitions, IDAPA 02.02.12 62  
     Cash Sale 62  
     Commodity Indemnity Fund  
         (CIF) 62  
     Credit-Sale Contract 62  
     Dealer 62  
     Deposit for Service 62  
     NPE, No Price Established 62  
     Open Storage 62  
     Warehouse 62  
 Definitions, IDAPA 02.02.13 72  
     Cash Sale 72  
     Commodity Indemnity Fund 72  
     Credit-Sale Contract 72  
     Dealer 72  
     NPE, No Price Established  
         Contract 72  
     Seed Crops 72  
     Warehouse 72  
 Definitions, IDAPA 02.02.14 79  
     Alcohol 79  
     Biodiesel 79  
     Biodiesel Blends 79  
     Certificate of Conformance 80  
     Commercial Weighing & 80  
     Compressed Natural Gas (CNG) 80  
     Co-Solvent 80  
     Diesel Gallon Equivalent (DGE) 80  
     Ethanol 80  
     Gasoline 80  
     Gasoline Gallon Equivalent  
         (GGE) 80  
     Gasoline Liter Equivalent (GLE) 80  
     Gasoline-Oxygenate Blend 80  
     Label 80  
     Liquefied Natural Gas (LNG) 80  
     Methanol 80  
     Motor Vehicles 81  
     Multi-Unit Package 81  
     National Type Evaluation  
         Program 81  
     Package 81  
     Participating Laboratory 81  
     Principal Display Panel or Panels 81  
     Random Package 81  
     Registered Service Agency 81  
     Registered Serviceman 81  
     Retail Dealer 81  
     Sale from Bulk 81  
     Spark-Ignition Motor Fuel 81  
     Type 81  
     Type Evaluation 82  
     Wholesale Dealer 82  
 Definitions, IDAPA 02.02.15 104  
 Definitions, IDAPA 02.03.03 109  
     Air Gap 109  
     Basin Irrigation 109  
     Border Irrigation 109  
     Certification 109  
     Check Valve 109  
     Chemigator 109  
     Cross-Connection 109  
     Demonstration & Research 110  
     Domestic Water Supply System 110  
     Drip Irrigation 110  
     Flood Irrigation 110  
     Flow Rate 110  
     Furrow Irrigation 110  
     Hazard Area 110  
     High Volatile Esters 110  
     Injection Pump 110  
     Inspection Port 110  
     Low Volatile Esters 110  
     Mixer-Loader 110  
     Pressure Switch 110  
     Recertification 110  
     Reduced Pressure Principle Backflow  
         Prevention Assembly (RP) 110  
     Seminar 110  
     Sprinkler Irrigation 110  
     System Interlock 110  
     Vacuum Relief Valve 111  
     Venturi Injection System 111  
     Waters of the State 111  
     Working Pressure 111  
 Definitions, IDAPA 02.04.03,  
     Subchapter A 134  
     Accredited Veterinarian 134  
     Animal 134  
     Approved Pseudorabies  
         Vaccine 135  
     Cachexia 135  
     Epithelioma 135  
     Equidae 135  
     Exposed Livestock 135  
     Gamebirds 135

- Garbage 135  
Hatching Eggs 135  
Herd 135  
Infected Livestock 135  
Interstate Movement 135  
Intrastate Movement 135  
Known Infected Herd 135  
Livestock 135  
Necrosis 135  
Negative 135  
Neoplastic Tissue 135  
Official Pseudorabies Test 135  
Orbital Region 135  
Positive 136  
Poultry 136  
Pseudorabies 136  
Quarantine 136  
Quarantined 136  
Quarantined Area 136  
Ratites 136  
Registered Veterinarians 136  
Restrain 136  
Stockyards 136  
Suppuration 136  
Suspect 136  
Swine 136  
Swine Feedlot 136  
Waterfowl 136  
Wildfowl 136  
Definitions, IDAPA 02.04.03,  
Subchapter B 148  
Animals 148  
Conveyance 148  
Domestic Cervidae 148  
Emergency Disease 148  
Epidemiology 148  
Exposed 148  
Federal Animal Health Official 148  
Foreign Animal Disease 148  
Infected Zone 148  
Livestock 148  
Operator 148  
Premises 148  
Quarantine 148  
Quarantine Area 148  
State Animal Health Official 148  
Surveillance Zone 149  
Definitions, IDAPA 02.04.05,  
Subchapter B 154  
Abnormal Test 154  
Accuracy Check 154  
Approved Testing Methods 154  
Calibration 154  
Clearance Test 154  
Component Testing 154  
Control Samples 154  
Detailed Pricing Description 154  
Milk Component or Component 154  
Official Laboratory 154  
Outlier 154  
Pay Records 154  
Performance Error 154  
Processor 155  
Producer 155  
Quality Parameter 155  
Rolling Group of Thirteen (13) 155  
Sample Set 155  
Testing Device 155  
Tolerance 155  
Definitions, IDAPA 02.04.05,  
Subchapter C 162  
3-A Sanitary Standards 162  
Acceptable Milk 162  
Atmosphere Relatively Free From  
Mold 162  
Bulk Milk Hauler or Bulk Milk  
Sampler 162  
C-I-P or Cleaned-in-Place 162  
Commingled Milk 162  
Dairy Certification 162  
Dairy Farm or Farm 162  
Dairy Plant or Dairy Processor 163  
Dairy Products 163  
Excluded Milk 163  
Farm Tank 163  
Fieldman 163  
Fieldman, Approved 163  
Inspector 163  
Milk 163  
Milk for Manufacturing  
Purposes 163  
Probational Milk 163  
Producer 163  
Rejected Milk 163  
Sanitizing Treatment 163  
Transportation Tank 163  
Universal Sample 163  
Definitions, IDAPA 02.04.19 179  
Accredited Veterinarian 179  
Approved Laboratory 179  
Approved Slaughter  
Establishment 179  
Area Veterinarian in Charge 179  
Breed Associations &  
Registries 179  
Certificate 179  
Cervid Herd 180  
Cervidae 180  
Chronic Wasting Disease 180  
Commingling 180  
Custom Exempt Slaughter  
Establishment 180  
CWD-Adjacent Herd 180  
CWD-Exposed Animal 180  
CWD-Exposed Herd 180  
CWD-Positive Cervid 180  
CWD-Positive Herd 180  
CWD-Suspect Cervid 180  
CWD-Suspect Herd 180  
Death Certificate 180  
Designated Epidemiologist 180  
Disposal 181  
Domestic Cervidae 181  
Domestic Cervidae Ranch 181  
Electronic Identification 181  
Escape 181  
Federal Animal Health Official 181  
Harvest 181  
Herd of Origin 181  
Herd Status 181  
Individual CWD Herd Plan 181  
Intrastate Movement Certificate 181  
Limited Contact 181  
National CWD Herd Certification  
Program 181  
Official CWD Test 181  
Official Identification 181  
Operator 181  
Premises 181  
Quarantine 181  
Quarantine Facility 182  
Ranch Management Plan 182  
Re-Identification 182  
Restrain 182  
Restricted Movement Permit 182  
Source Herd 182  
State Animal Health Official 182  
Status Date 182  
Trace Back Herd 182  
Trace Forward Herd 182  
Traceback 182  
Wild Cervidae 182  
Wild Ungulate 182  
Wild Ungulate Cooperative Herd  
Plan 182  
Definitions, IDAPA 02.04.26  
Official Individual  
Identification 208  
Definitions, IDAPA 02.04.26,  
Subchapter A 198  
Accredited Veterinarian 198  
Approved Slaughter  
Establishment 198  
Cattle 198  
Domestic Bison 198  
Domestic Cervidae 198  
Epithelioma of the Eye 198  
Federal Animal Health Official 198  
Interstate Movement 198  
Livestock 198  
Lump Jaw 198  
Official Brucellosis Vaccination Ear  
Tag 198  
Official Ear Tag 198  
Official Identification 198  
Operator 198  
Owner 199  
Parturient 199  
Postparturient 199  
Premises 199  
Previous Location 199  
Restraint 199  
State Animal Health Official 199  
Test Eligible 199  
USDA Backtag 199  
Definitions, IDAPA 02.04.26,  
Subchapter B 207  
Accredited Veterinarian 207  
Approved Slaughter  
Establishment 207  
Brucellosis 207  
Cattle 207

- Domestic Bison 207  
Domestic Cervidae 207  
Epithelioma of the Eye 207  
Federal Animal Health Official 207  
Herd 208  
Interstate Movement 208  
Livestock 208  
Lump Jaw 208  
Official Ear Tag 208  
Official Vaccination Ear Tag 208  
Operator 208  
Owner 208  
Restraint 208  
State Animal Health Official 208  
Tuberculosis 208  
USDA Back Tag 208  
Definitions, IDAPA 02.04.32 212  
Discharge 212  
Idaho Pollutant Discharge  
Elimination System (IPDES) 213  
Runoff 213  
Definitions, IDAPA 02.06.01,  
Subchapter A 220  
Condition 220  
Definitions, IDAPA 02.06.01,  
Subchapter B 237  
Condiment Mustard 238  
Green Manure Rapeseed 238  
Producer 237  
Rapeseed 237  
Types 237  
Volunteer Rapeseed 238  
Definitions, IDAPA 02.06.01,  
Subchapter C 239  
Annual Bluegrass 239  
Annual Bluegrass Analysis  
Certificate 239  
Annual Bluegrass Quarantine Release  
Tag 239  
Grass Species 239  
Official Seed Laboratory 239  
Regulated Pest 240  
Representative Sample 240  
Rough Bluegrass 240  
Rough Bluegrass Analysis  
Certificate 240  
Rough Bluegrass Quarantine Release  
Tag 239  
Seed Stock 240  
Definitions, IDAPA 02.06.02,  
Subchapter C 251  
Definitions, IDAPA 02.06.02,  
Subchapter D 253  
Guarantee 253  
Ultimate Dealer 253  
Definitions, IDAPA 02.06.02,  
Subchapter E 261  
Animal Manure 261  
Dried Animal Manure 261  
Definitions, IDAPA 02.06.04,  
Subchapter A 265  
Applicant 265  
Federal Phytosanitary  
Certificate 265  
Federal Phytosanitary Certificate for  
Reexport 265  
Post-Entry Quarantine  
Certification 265  
Rush Service 265  
State Phytosanitary Certificate 265  
Definitions, IDAPA 02.06.04,  
Subchapter B 270  
Certification 270  
Idaho Certified Nursery Seed 270  
Idaho Certified Nursery Stock 270  
Index 270  
Indicator Plant 270  
Interstock 270  
Nursery Stock 270  
Off-Type 270  
Registered Tree 270  
Rootstock 270  
Scion (Scionwood) 271  
Scion-Block 270  
Seed Block 271  
Stool Bed 271  
Top-Stock 271  
True Seedling 271  
Virus-Infected 271  
Virus-Like 271  
Definitions, IDAPA 02.06.04,  
Subchapter C 274  
Cultivated Ginseng 275  
Dealer 275  
Dealer Registration 275  
Dry Weight 275  
Export 275  
Ginseng 275  
Green Ginseng 275  
Green Weight 275  
Grower 275  
Grower Registration 275  
Out-of-State Ginseng 275  
Wild Ginseng 275  
Wild Simulated Ginseng 275  
Woodsgrown Ginseng 275  
Definitions, IDAPA 02.06.05,  
Subchapter C 282  
Commercial Fruit 282  
Commercial Orchard 282  
Graded Culls 283  
Infested Area 283  
Threatened with Infestation 283  
Definitions, IDAPA 02.06.05,  
Subchapter F 289  
Cull Onions 289  
Cull Potatoes 289  
Definitions, IDAPA 02.06.05,  
Subchapter G 291  
Certified Defined Generation 291  
Certified Defined Generation 1  
(CDG-1) 292  
Certified Defined Generation 2  
(CDG-2) 292  
Certified Defined Generation 3  
(CDG-3) 292  
Certified Defined Generation 4  
(CDG-4) 292  
Field 292  
Healthy Clones (HC) 291  
In-State Defined Generation 292  
In-State Defined Generation 1 (SDG-  
1) 292  
In-State Defined Generation 2 (SDG-  
2) 292  
In-State Defined Generation 3 (SDG-  
3) 292  
In-State Defined Generation 4 (SDG-  
4) 292  
Nuclear Planting Stock (NPS) 292  
Definitions, IDAPA 02.06.09,  
Subchapter A 315  
Acts 315  
Aquatic Invertebrate Invasive  
Species 315  
Control 315  
Conveyance 315  
Dreissenia Infested Waterbody 315  
Early Detection/Rapid  
Response 315  
Energy Crop Invasive Species 315  
Equipment 315  
Facility 315  
Possession 316  
Trap Crop Invasive Species 316  
Water Body 316  
Water Supply System 316  
Definitions, IDAPA 02.06.09,  
Subchapter B 331  
Early Detection & Rapid Response  
(EDRR) 331  
Implements of Husbandry 331  
Subtaxa(on) 331  
Definitions, IDAPA 02.06.09,  
Subchapter C 335  
Agent 335  
Approved Inspector 335  
Bale 335  
Bale Tag 335  
Certificate of Inspection 335  
Certification 335  
Certification Markings 335  
Certified Compressed Forage/Straw  
Bale Binding Material 336  
Compressed Forage/Straw Bale 336  
Field 336  
Forage 336  
Forage Cube/Pellet Tag 336  
Forage Cubes 336  
Idaho State Noxious Weed Free 336  
Idaho State Noxious Weed Free  
Standards 336  
NAISMA Noxious Weed Free 336  
NAISMA Twine 336  
NAISMA Weed Free Forage  
Certification Program 336  
Noxious Weed Free 336  
Pellets 336  
Straw 336  
Transit Certificate 336  
Definitions, IDAPA 02.06.10 343  
Inspector 343

- Interstate 343  
Intrastate 343  
Definitions, IDAPA 02.06.10,  
Subchapter B 344  
Cull Potatoes 344  
Grower 344  
Volunteer Potatoes 344  
Definitions, IDAPA 02.06.10,  
Subchapter C 351  
Bacterial Ring Rot 351  
Contact Lot 351  
Idaho Crop Improvement  
Association, Inc 351  
Seed Lot 351  
Seed Potato Certification  
Process 351  
Seed Stock 351  
Sister Lot 351  
Definitions, IDAPA 02.06.10,  
Subchapter D 353  
Disease 354  
Pest 354  
Definitions, IDAPA 02.06.33 355  
Agent 355  
Certification 355  
Educational Activity 355  
Food Products 355  
Materials 355  
Definitions, IDAPA 02.07.01 361  
Definitions, IDAPA 02.08.01 364  
Accredited Veterinarian 364  
Animals 364  
Authorized Federal Inspector 364  
Authorized State Inspector 364  
Board 364  
Breeding Stock 364  
Brucella Ovis Test Negative 364  
Brucella Ovis Test Positive 364  
Brucella Ovis Test Suspect 364  
Brucellosis 364  
Certificate 364  
Commercial Low-Risk Goats 365  
Contemporary Lambing Group 365  
Exposed 365  
Federal Animal Health Official 365  
Flock 365  
Flock Plan 365  
Goats Requiring Premises/Flock  
Identification Number 365  
Idaho Premises/Flock Identification  
Number 365  
Low Risk Commercial Sheep 365  
Negative 365  
Official Individual  
Identification 365  
Post Exposure Monitoring &  
Management Plan 365  
Premises 365  
Quarantine 366  
Scrapie 366  
Scrapie Exposed Animal 366  
Scrapie Flock Certification  
Program 366  
Scrapie High Risk Animal 366  
State Scrapie Certification  
Board 367  
Terminal Feedlot 367  
Trace 367  
Definitions, IDAPA 03.01.01 1466  
Champion 1466  
Combatant 1466  
Event 1466  
Main Event 1466  
Mixed Martial Arts (MMA) 1466  
Stub 1466  
Ticket 1466  
Definitions, IDAPA 07.01.01 376  
Associated Buildings 376  
Board 376  
Division 376  
Person 376  
Recognized License 376  
Registration Card 376  
Definitions, IDAPA 07.02.02 397  
Administrator 397  
Board 397  
Division 397  
Fixture 397  
Definitions, IDAPA 07.03.01 422  
Act 422  
Administrator 422  
Alterations or Conversions of  
Modular Buildings or Commercial  
Coaches 422  
Alterations to Manufactured  
Homes 422  
Board 423  
Commercial Coach 423  
Division 423  
Equipment 423  
Field Technical Service 423  
First Purchaser 423  
Insignia 423  
Labeled 423  
Listed 423  
Listing Agency 423  
Minor Alteration 423  
Model 423  
Running Gear 424  
State Buildings 424  
Substantially Prefabricated or  
Assembled 424  
Systems Plan 424  
Technical Service 424  
Testing/Listing Agency 424  
Transit Damage 424  
Definitions, IDAPA 07.03.03 432  
Administrator 432  
Alterations or Conversions of  
Modular Buildings 432  
Commercial Coach 432  
Insignia 432  
Technical Service 432  
Definitions, IDAPA 07.03.11 437  
Administrator 437  
Board 437  
Bond 437  
Branch Office 437  
Business 437  
Deceptive Practice 437  
Division 437  
Installation 437  
Installer 437  
Manufactured Home 437  
Manufactured Home Retailer 438  
Manufacturer 438  
Mobile Home 438  
Person 438  
Principal Place of Business 438  
Used Manufactured Home or Mobile  
Home 438  
Definitions, IDAPA 07.04.02 448  
Administrator 448  
Division 449  
Definitions, IDAPA 07.05.01 450  
Administrator 450  
Applicant 450  
Board 450  
Compiled 450  
Estimated Cost 450  
Financial Statement 450  
Incidental Work 450  
Independent Audit Report 450  
Licensee 450  
Qualified Individual 450  
Reviewed 450  
Definitions, IDAPA 07.07.01 471  
Additional Definitions 471  
Administrator 471  
Board 471  
Division 471  
Recognized Jurisdiction 472  
Definitions, IDAPA 10.01.01 496  
Definitions, IDAPA 11.02.01 526  
Auction Brand Inspection 526  
Auction Brand Inspection  
Certificate 526  
Bar Brand 526  
Bill of Sale 526  
Board 526  
Brand Card 526  
Brand Inspection 526  
Consignee 526  
Courtesy Brand Inspection 527  
Dash Brand 527  
Destination 527  
DOT Brands 527  
Field Brand Inspection 527  
Field Brand Inspection  
Certificate 527  
Hold Order 527  
Idaho Livestock Owner 527  
Lifetime Certificate 527  
Livestock 527  
Order Buyer 527  
Ownership & Transportation  
Certificate 527  
Person 527  
Release Order 528  
Representative of a Licensee 528  
Tally Sheet 528  
Definitions, IDAPA 11.04.02 539



Authorized User 539  
Breakage 539  
Downlink 539  
Enclosure, Enclosure-Public 539  
Encryption 539  
Guest, Guest Association or  
  Simulcast Operator 539  
Handle or Gross Handle 539  
Horse 539  
Host or Host Association 539  
Hub 539  
Intrastate Simulcasting  
  Wagering 539  
Racing Association 539  
Satellite Transponder,  
  Transponder 540  
Simulcast Facility 540  
Simulcast Service Supplier 540  
Take or Takeout 540  
Terminal 540  
Totalizer 540  
Uplink 540  
Definitions, IDAPA 11.04.03 548  
  Admissions 548  
  Announcer 548  
  Apprentice Jockey 548  
  Assistant Starter 548  
  Authorized Agent 548  
  Chart Person 548  
  Clerk of Scales 548  
  Clocker 548  
  Concession Employee 548  
  Concessionaire 548  
  Duplicate 548  
  Emergency Medical Technician 548  
  Exercise Person 548  
  Groom 548  
  Horsemen's Bookkeeper 548  
  Identifier 548  
  Jockey 549  
  Jockey Agent 549  
  Jocks Room Custodian 549  
  Maintenance 549  
  Medical Professional 549  
  Mutuel Employee 549  
  Office Personnel 549  
  Official 549  
  Outrider 549  
  Owner 549  
  Owner/Trainer 549  
  Paddock Judge 549  
  Photographer 549  
  Plater 549  
  Pony Person 549  
  Racetrack 549  
  Racing Association 549  
  Racing Secretary 549  
  Stable Name 549  
  Stall Superintendent 550  
  Starter 550  
  State Veterinarian 550  
  Steward 550  
  Tote Employee 550  
  Track Security 550  
  Track Superintendent 550  
  Trainer 550  
  Valet 550  
  Vet Assistant 550  
  Veterinarian 550  
  Video Employee 550  
Definitions, IDAPA 11.04.05 559  
  Account 559  
  Account Holder 559  
  Advance Deposit Wagering  
    Facility 559  
  Advance Deposit Wagering  
    Operator 559  
  Confidential Information 559  
  Credits 559  
  Debits 559  
  Deposit 559  
  Natural Person 559  
  Principal Residence Address 559  
  Proper Identification 560  
  Secure Personal Identification  
    Code 560  
  Source Market Fee 560  
  Withdrawal 560  
  Withdrawal Slip 560  
Definitions, IDAPA 11.04.07 566  
  Bookmaker 566  
  Breed Association 566  
  Breeder 566  
  Chemical 566  
  Claiming Race 566  
  Conditions 566  
  Drug 566  
  Entry 566  
  Forfeit 566  
  Grounds 566  
  Handbook 566  
  Horse 566  
  Horsemen's Agreement 566  
  Idaho Bred 566  
  Jockey 567  
  Meet 567  
  Month 567  
  Owner 567  
  Place 567  
  Purse Race 567  
  Racing Association 567  
  Racing Dates 567  
  Ruled Off 567  
  Starter 567  
  Stewards 567  
  Winner 567  
  Year 567  
Definitions, IDAPA 11.04.15 591  
  Alcohol 591  
  Applicant 591  
  Controlled Substance 591  
  Licensee 591  
  Person 591  
  Racing Association 591  
  Reasonable Suspicion 591  
  Sample 591  
  Suspension 591  
Definitions, IDAPA 11.05.01 516  
  Licensed Premises 516  
  Multipurpose Arena 516  
  New Licenses 516  
  Partition 517  
  Place 517  
  Restaurant 517  
  Stock Transfer 518  
Definitions, IDAPA 11.10.01 597  
  Access Agency 597  
  Administration of Criminal  
    Justice 597  
  Associated System 597  
  Board 597  
  Criminal Justice Agency 598  
  Department 598  
  Executive Officer 598  
  III, Interstate Identification  
    Index 598  
  ILETS, Idaho Law Enforcement  
    Teletypewriter System 598  
  Interface Agency 598  
  Management Control  
    Agreement 598  
  NCIC 2000, National Crime  
    Information Center 598  
  NLETS, National Law Enforcement  
    Telecommunication System 598  
  Non-Criminal Justice Agency 598  
Definitions, IDAPA 11.10.02 522  
  Acquittal 522  
  Criminal Summons 522  
  Dismissal 522  
  Expunge 522  
  Serious Misdemeanor 522  
Definitions, IDAPA 11.11.01 609  
  Act 609  
  Adult Felony Probation & Parole  
    Officer 609  
  Adult Misdemeanor Probation  
    Officer 609  
  Agency 609  
  Agency Head 609  
  Applicant 610  
  Basic Training Academy 610  
  Canine Team 610  
  Canine Team Evaluator 610  
  Challenge Examination 610  
  College Credit 610  
  Conviction 610  
  Correction Officer 610  
  Council 610  
  County Detention Officer 610  
  Crime of Deceit 610  
  Division Administrator 611  
  Emergency Communications  
    Officer 611  
  Field Training 611  
  Full Time 611  
  Hearing Board 611  
  Hearing Officer 611  
  In-Service Training 611  
  Juvenile Corrections Direct Care  
    Staff 611  
  Juvenile Detention Center 611

- Juvenile Detention Officer 611  
 Juvenile Probation Department 611  
 Juvenile Probation Officer 612  
 Law Enforcement Certification Program 612  
 Law Enforcement Certification Program Facility 612  
 Law Enforcement Profession 612  
 Marine Deputy 612  
 Misdemeanor Probation Department 612  
 Part-Time Employee 612  
 Peace Officer 612  
 POST Certified Instructor 612  
 Program Coordinator 612  
 Prosecutor 612  
 Public Safety Answering Point (PSAP) 612  
 Regional Training Specialist 612  
 Reserve Peace Officer 612  
 School 613  
 State 613  
 Student 613  
 Temporary/Seasonal 613  
 Trainee 613  
 Definitions, IDAPA 12.01.08 645  
 Act 645  
 Administrator 645  
 Agent of Issuer 645  
 CRD, Central Registration Depository 645  
 Department 645  
 EFD 645  
 FINRA 645  
 Form 1-A 646  
 Form ADV 645  
 Form ADV-H 645  
 Form ADV-W 645  
 Form BD 645  
 Form BDW 645  
 Form BR 645  
 Form D 646  
 Form NF 646  
 Form S-18 646  
 Form U-1 646  
 Form U-2 646  
 Form U-4 646  
 Form U-5 646  
 Form U-7 646  
 IARD, Investment Adviser Registration Depository 646  
 NASAA, The North American Securities Administrators Association, Inc 646  
 NASD, The National Association of Securities Dealers, Inc 646  
 NASDAQ, The National Association of Securities Dealers Automated Quotations 646  
 SEC, The U.S. Securities & Exchange Commission 646  
 Transact Business 646  
 Unsolicited Order or Offer 646  
 USA, The Uniform Securities Act 2004 646  
 Definitions, IDAPA 14.01.01, Rules Of Procedure Of The Idaho Board Of Registration For Professional Geologists 1527  
 Geologist-in-Training 1527  
 Registrant 1527  
 Responsible Charge 1527  
 Responsible Position 1527  
 Definitions, IDAPA 15.03.01 687  
 Assessment 687  
 Financial Supporter 687  
 Person 687  
 Definitions, IDAPA 15.06.03 690  
 Interoperable Communications 690  
 Microwave Systems 690  
 Public Safety Communications 690  
 Public Safety Communications Systems 690  
 Wireless Communications 690  
 Definitions, IDAPA 15.10.01 692  
 Bailment 692  
 Central Office 692  
 Close Relative 692  
 Delisting 692  
 Director 692  
 Distillery Distributing Station 692  
 Distressed Liquor 692  
 Distributing Station 692  
 Division 692  
 Licensee 692  
 Liquor 692  
 Listing (Listed) 692  
 Political Office 692  
 Price Quotation 693  
 Product Line 693  
 Promotional Samples 693  
 Retail Store 693  
 Samples 693  
 Shortage 693  
 Special Distributor (Distributor) 693  
 Special Distributor Agreement (Agreement) 693  
 Special Order 693  
 State Store 693  
 Supplier 693  
 Supplier Representative 693  
 Warehouse 693  
 Wine 693  
 Wine Gallon 693  
 Definitions, IDAPA 16.02.01 716  
 American College of Surgeons (ACS) 716  
 Department 716  
 Director 716  
 Division 716  
 EMS Agency 716  
 EMS Bureau 716  
 Facility 716  
 Heart Attack 717  
 Idaho Time Sensitive Emergency (TSE) System Council 717  
 National Accrediting Body 717  
 Regional Time Sensitive Emergency (TSE) Committee 717  
 STEMI 717  
 Stroke 717  
 Time Sensitive Emergency (TSE) 717  
 Trauma 718  
 TSE Registry 718  
 TSE System 718  
 TSE-Designated Center 718  
 Definitions, IDAPA 16.02.26, Rules Governing The Idaho Children's Special Health Program 780  
 Applicant 780  
 Care Coordinator 780  
 Children's Special Health Program (CSHP) 780  
 Client 780  
 Department 780  
 Diagnosis 780  
 Division 780  
 Medical Food 780  
 Patient 780  
 Definitions, IDAPA 16.03.18 803  
 Copayment (Copay) 803  
 Cost-Sharing 803  
 Creditable Health Insurance 803  
 Department 803  
 Family Income 803  
 Family Size 803  
 Federal Poverty Guidelines (FPG) 803  
 Financially Responsible Adult 803  
 Medical Assistance 803  
 Participant 803  
 Physician Office Visit 803  
 Premium 804  
 Social Security Act 804  
 State 804  
 Title XIX 804  
 Title XXI 804  
 Definitions, IDAPA 16.04.07, Rules Governing Fees For State Hospital North 914  
 Charge 914  
 Cost Per Patient Day 914  
 Responsible Relatives 914  
 Services 914  
 Third Party Payor 914  
 Definitions, IDAPA 20.03.16 1280  
 Board 1280  
 Collateral Surety Bond & Corporate Surety Bond 1280  
 Commission 1280  
 Department 1280  
 Director 1280  
 Discretion 1280  
 Exploration 1280  
 Final Board Approval 1280  
 Lease 1281  
 Legal Subdivision 1281  
 Lessee 1281  
 Lessor 1281  
 Motorized Exploration Equipment 1281

- Natural Gas Plant Liquids 1281  
Oil & Gas 1281  
Person 1281  
Production in Paying  
  Quantities 1281  
State Lands 1281  
Tract 1281  
Definitions, IDAPA 20.03.17 1293  
Artificial High Water Mark 1293  
  Board 1293  
Commercial Marina 1293  
Commercial Navigational  
  Encroachment 1293  
Community Dock 1293  
Department 1293  
Director 1293  
Dock Surface Area 1293  
Encroachment in Aid of  
  Navigation 1293  
Encroachments Not in Aid of  
  Navigation 1293  
Formerly Submerged Lands 1294  
Market Value 1294  
Natural or Ordinary High Water  
  Mark 1294  
Person 1294  
Riparian or Littoral Rights 1294  
Single Family Dock 1294  
Submerged Lands 1294  
Two-Family Dock 1294  
Uplands 1294  
Definitions, IDAPA 20.04.02, Rules  
  Pertaining To The Idaho Forestry Act  
  & Fire Hazard Reduction  
  Laws 1301  
  Agreement 1301  
  Contract Area 1301  
  Contractor 1301  
  Department 1301  
  Director 1301  
  District 1301  
  Fire Line 1301  
  Fire Warden 1301  
  Fuel 1301  
  Fuel Break 1301  
  Hazard Reduction 1301  
  Initial Purchaser or Purchaser 1301  
  Operational Period 1301  
  Slash Load 1301  
  Slash or Slashing 1301  
  State 1301  
Definitions, IDAPA 20.06.01 1311  
  Board 1311  
  Check Scaling 1311  
  Combination Log 1311  
  Complainant 1311  
  Complaint 1311  
  Cubic Volume 1311  
  Decimal "C" 1311  
  Gross Scale 1311  
  Informal Hearing 1311  
  Log Brands 1311  
  Net Scale 1311  
  Official Seal 1311  
  Prize Logs 1311  
  Product Classification 1312  
  Purchaser 1312  
  Relicense Check Scale 1312  
  Requested Check Scale 1312  
  Respondent 1312  
  Routine Check Scale 1312  
  Temporary Permit Check  
  Scale 1312  
  Written Scaling Specifications 1312  
Definitions, IDAPA 20.07.02 1322  
  Act 1322  
  Active Well 1322  
  Barrel 1322  
  Blowout 1322  
  Blowout Preventer 1322  
  Bonus Payment 1322  
  Casing Pressure 1322  
  Casinghead 1322  
  Casinghead Gas 1322  
  Common Source of Supply 1322  
  Completion 1322  
  Conductor Pipe 1323  
  Cubic Foot of Gas 1323  
  Day 1323  
  Development 1323  
  Director 1323  
  Drilling Logs 1323  
  Fresh Water 1323  
  Gas Processing Facility 1323  
  Gas Well 1323  
  Gas-Oil Ratio 1323  
  Geophysical or Seismic  
  Operations 1323  
  Hydraulic Fracturing, or  
  Fracing 1323  
  Inactive Well 1323  
  Intermediate Casing 1324  
  Junk 1324  
  Lease 1324  
  Mechanical Integrity Test 1324  
  Oil Well 1324  
  Pit 1324  
  Pollution 1324  
  Pressure Maintenance 1324  
  Produced Water 1324  
  Production Casing 1324  
  Proppant 1324  
  Release 1324  
  Spud 1324  
  Surface Casing 1324  
  Surface Water 1324  
  Systems Approach 1324  
  Tank 1324  
  Tank Battery 1324  
  Tank Dike 1325  
  Tubing 1325  
  Volatile Organic Compound 1325  
  Waterflooding 1325  
  Well Report 1325  
  Well Site 1325  
  Well Treatment 1325  
  Wildcat Well 1325  
Definitions, IDAPA 21.01.01 1360  
  Applicant 1360  
  Asset 1360  
  Bona Fide Resident 1360  
  Commission 1360  
  Division 1360  
  Division Administrator 1361  
  Home 1361  
  Home Administrator 1361  
  Idaho State Veterans Home 1361  
  Income 1361  
  Legal Dependents 1361  
  Liquid Assets 1361  
  Maintenance Charge 1361  
  Net Income 1361  
  Resident 1361  
  Spouse 1361  
  VA, United States Department of  
  Veterans Affairs 1361  
  Veteran 1361  
Definitions, IDAPA 21.01.04 1382  
  Administrator 1382  
  Applicant 1382  
  Armed Forces Member 1382  
  Cemetery 1382  
  Committal Service 1382  
  Cremains 1382  
  Designated Interpretive Trail 1382  
  Disinterment 1382  
  Division 1382  
  Interment 1382  
  Qualified Person 1382  
  Reinterment 1383  
  Unremarried Spouse 1383  
  USDVA 1383  
Definitions, IDAPA 22.01.01 1388  
  Acceptable International School of  
  Medicine 1388  
  Educational Commission for Foreign  
  Medical Graduates  
  (ECFMG) 1388  
  Federation of State Medical Boards of  
  the United States (FSMB) 1388  
  Medical Practice Act 1388  
Definitions, IDAPA 22.01.03 1399  
  Approved Program 1399  
  Delegation of Services (DOS)  
  Agreement 1399  
  Supervision 1399  
Definitions, IDAPA 22.01.10 1406  
  Actively Engaged 1406  
  Association 1406  
  Athletic Training Service Plan or  
  Protocol 1406  
Definitions, IDAPA 22.01.11 1409  
  Board of Registered  
  Polysomnographic  
  Technologists 1409  
  Comprehensive Registry  
  Exam 1409  
  Conditional Permit 1409  
  Medical Practice Act 1409  
  Written Registry & Clinical  
  Simulation Examinations 1409  
Definitions, IDAPA 23.01.01 1415

- Abandonment 1415  
 Accreditation 1415  
 Administration of Medications 1416  
 Approval 1416  
 Assist 1416  
 Assistance With Medications 1416  
 Board Staff 1416  
 Charge Nurse 1416  
 Clinical Preceptor 1416  
 Competence 1416  
 Curriculum 1416  
 Delegation 1416  
 Disability 1416  
 Emeritus License 1416  
 License in Good Standing 1416  
 Licensing Examination 1416  
 Nursing Assessment 1416  
 Nursing Diagnosis 1416  
 Nursing Intervention 1416  
 Nursing Jurisdiction 1416  
 Nursing Service Administrator 1417  
 Organized Program of Study 1417  
 Patient Education 1417  
 Patient/Client 1417  
 Plan of Care 1417  
 Practice Standards 1417  
 Probation 1417  
 Protocols 1417  
 Restricted License 1417  
 Revocation 1417  
 Scope of Practice 1417  
 Supervision 1417  
 Suspension 1417  
 Technician/Technologist 1417  
 Unlicensed Assistive Personnel (UAP) 1417  
 Definitions, IDAPA 24.01.01 1458  
   AXP 1458  
   Direct Supervision 1458  
   NAAB 1458  
   NCARB 1458  
 Definitions, IDAPA 24.05.01 1535  
   Class I Restricted License 1535  
   DEQ 1535  
   Direct Supervision 1535  
   Endorsement 1535  
   EPA 1535  
   Experience 1535  
   On-Site Operating Experience 1535  
   Operating Personnel 1535  
   Person 1535  
   Responsible Charge Operator 1535  
   Substitute or Back-Up Responsible Charge Operator 1535  
   Very Small Public Drinking Water System 1535  
   Very Small Wastewater System 1535  
 Definitions, IDAPA 24.06.01 1552  
   Client-Related Tasks 1552  
   Direct Line-of-Sight Supervision 1552  
   Direct Supervision 1552  
   Evaluation 1552  
   General Supervision 1552  
   Routine Supervision 1552  
 Definitions, IDAPA 24.10.01 1585  
   Low Vision 1585  
   Opticianry 1585  
   Vision Therapy 1585  
 Definitions, IDAPA 24.11.01 1596  
   Licensure 1596  
   Reputable School 1596  
 Definitions, IDAPA 24.12.01 1602  
   Certificate of Professional Qualification 1602  
   Collaboration or Collaborative Relationship 1602  
   Geriatric Patient 1602  
   Licensed Medical Provider 1602  
   Mental, Nervous, Emotional, Behavioral, Substance Abuse & Cognitive Disorders 1602  
   Pediatric Patient 1602  
   Prescribing Psychologist 1602  
   Supervising Physician 1602  
 Definitions, IDAPA 24.13.01 1624  
   Direct Personal Supervision 1625  
   Direct Supervision 1625  
   Dry Needling 1625  
   Examination 1626  
   Functional Mobility Training 1625  
   General Supervision 1625  
   Manual Therapy 1625  
   Nationally Accredited School 1626  
   Non-Treatment Patient Related Tasks 1624  
   Physical Agents or Modalities 1625  
   Physical Therapist Assistant 1624  
   Routine Physical Therapy Tasks 1624  
   Supervising Physical Therapist 1625  
   Supportive Personnel 1624  
   Testing 1624  
 Definitions, IDAPA 24.14.01 1637  
   Professionalism 1637  
   Psychotherapy 1637  
   Relative 1637  
   Supportive Counseling 1637  
 Definitions, IDAPA 24.15.01 1650  
   Accredited University or College 1650  
   Face-to-face Setting 1650  
   Licensed Mental Health Professional Supervisor 1650  
   Practicum 1650  
   Supplemental Practicum Hours 1650  
 Definitions, IDAPA 24.16.01 1663  
   Denturist Services 1663  
 Definitions, IDAPA 24.17.01 1673  
   Accredited College or University 1673  
   Approved Acupuncture Program 1673  
   License 1673  
   Practitioner 1673  
   Definitions, IDAPA 24.18.01 1681  
   Accredited 1681  
   Advisory Committee 1681  
   Appraisal Management Company or AMC 1682  
   Appraisal Standards Board 1681  
   Appraiser Qualifications Board 1681  
   Classroom Hour 1681  
   Field Real Estate Appraisal Experience 1681  
   FIRREA, Financial Institutions Reform, Recovery & Enforcement Act 1681  
   Real Estate 1681  
   Real Property 1681  
   Residential Unit 1681  
   Uniform Standards of Professional Appraisal Practice or USPAP 1681  
   USPAP Course 1682  
 Definitions, IDAPA 24.23.01 1710  
   Audiology Support Personnel 1710  
   Direct Client Contact 1710  
   Dual Licensure 1710  
 Definitions, IDAPA 25.01.01 1801  
   Act 1801  
   Authorized Person 1801  
   Booking Agent 1801  
   Compensation or Consideration 1801  
   Desert 1801  
   Designated Agent 1801  
   Enforcement Agent 1801  
   Facilities & Services 1801  
   First Aid Card 1802  
   Fishing 1802  
   Float Boats 1802  
   Hazardous Excursions 1802  
   Hunting 1802  
   Major Activity 1802  
   Major Amendment 1802  
   Minor Amendment 1802  
   Minor or Incidental Activity 1803  
   Mountainous 1803  
   New Opportunity 1803  
   Operating Area 1803  
   Operating Plan 1803  
   Outfitted Tag Use 1803  
   Out-of-Pocket Costs 1803  
   Power Boats 1803  
   Relinquishment of License Privileges 1803  
   Third Party Agreement 1803  
   Trainee 1803  
   Watercraft 1804  
 Definitions, IDAPA 26.01.10 1836  
   Board 1836  
   Department & IDPR 1836  
   Director 1836  
   Grantee 1836  
   Grantor 1836  
   Park Manager 1836  
   Person 1836

- Temporary Permit 1836  
 Definitions, IDAPA 26.01.20 1841  
 ADA, Americans with Disabilities Act 1841  
 Annual Motor Vehicle Entrance Fee Sticker 1841  
 Annual Motor Vehicle Entrance Fee Sticker Replacement 1841  
 Board 1841  
 Camping Day 1841  
 Camping Unit 1841  
 Campsite 1841  
 Commercial Motor Vehicle 1841  
 Day Use 1841  
 Department 1841  
 Designated Beach 1842  
 Designated Roads & Trails 1842  
 Director 1842  
 Division Administrator 1842  
 Dock & Boating Facility 1842  
 Encroachments 1842  
 Extra Vehicle 1842  
 Facilities 1842  
 Group Use 1842  
 Idaho State Parks Passport 1842  
 Idaho State Parks Passport Replacement 1842  
 Motor Vehicle Entrance Fee (MVEF) 1842  
 Motorized Vehicle 1842  
 Overnight Use 1842  
 Overnight Use Fee 1842  
 Park or Program Manager 1842  
 Recreational Vehicle (RV) 1843  
 Vessel 1843  
 Definitions, IDAPA 26.01.33 1857  
 Acquisition 1857  
 Board 1857  
 Development 1857  
 Director 1857  
 Evaluation Committee 1857  
 Grants Program 1857  
 IDPR 1857  
 LWCF 1857  
 NPS 1857  
 Open Project Selection Process (OPSP) 1857  
 Participation Manual & Internal Procedures Manuals 1857  
 Planning 1857  
 Priority Needs Assessment 1857  
 Project 1858  
 Retroactive Cost 1858  
 Scope Element 1858  
 SCORP/SCORTP 1858  
 Sponsor 1858  
 State Liaison Officer (SLO) 1858  
 Definitions, IDAPA 34.05.01 1909  
 Crop Year 1909  
 Farm Products Financing Statement 1909  
 Item on a Master List or Portion of a Master List 1909  
 PML Grouping 1909  
 Definitions, IDAPA 34.05.02 1920  
 Family 1920  
 Farm Laborer 1920  
 Notice of Claim of Lien 1920  
 SOS, Idaho Secretary of State 1920  
 Definitions, IDAPA 34.05.03 1923  
 Debtor 1923  
 EFS 1923  
 Notice of Federal Lien 1923  
 Notice of Lien in Crops 1923  
 Notices 1923  
 Secured Party 1923  
 SOS 1923  
 UCCFS 1923  
 Definitions, IDAPA 34.05.06 1925  
 Amendment 1925  
 Assignment 1925  
 Continuation 1925  
 Correction Statement 1925  
 File Number 1925  
 Filing Office & Filing Officer 1925  
 Financing Statement 1925  
 Individual 1925  
 Initial Financing Statement 1925  
 Organization 1925  
 Remitter 1925  
 Secured Party of Record 1926  
 Termination 1926  
 UCC Document 1926  
 UCC, Uniform Commercial Code 1926  
 Definitions, IDAPA 36.01.01 1945  
 Appellant 1945  
 Board 1945  
 Case File 1945  
 Comparable Sales 1945  
 De Novo 1945  
 Ex Parte 1945  
 Parcel 1945  
 Party 1945  
 Presiding Officer or Hearing Officer 1945  
 Respondent 1945  
 Subject Property 1945  
 Substantive Issue 1945  
 Definitions, IDAPA 37.01.01 1964  
 Administrative Code 1964  
 Agency 1964  
 Agency Action 1964  
 Agency Head 1964  
 Board 1964  
 Bulletin 1964  
 Contested Case 1964  
 Coordinator 1964  
 Department 1964  
 Director 1964  
 Document 1964  
 Electronically Signed Communication 1964  
 License 1965  
 Official Text 1965  
 Order 1965  
 Party 1965  
 Person 1965  
 Provision of Law 1965  
 Publish 1965  
 Rule 1965  
 Rulemaking 1965  
 Signer 1965  
 Definitions, IDAPA 37.02.03 1992  
 Board 1992  
 Board's Water Supply Bank 1992  
 Department 1992  
 Director 1992  
 Lease 1992  
 Local Committee 1992  
 Natural Flow 1992  
 Person 1992  
 Rent 1992  
 Rental Pool 1992  
 Stored Water 1992  
 Water Right 1992  
 Water Supply Bank 1992  
 Year 1992  
 Definitions, IDAPA 37.03.01 1998  
 Amendment Fee 1998  
 Aquaculture 1998  
 Aquaculture Fee 1998  
 Claim 1998  
 Department 1998  
 Director 1998  
 Domestic Use 1998  
 Flat Fee 1998  
 Late Fee 1998  
 Per Acre Fee 1998  
 Per CFS Fee 1998  
 Per Kilowatt Fee 1998  
 State Law Claim Form 1998  
 Stock Watering Use 1998  
 Total Fee 1998  
 Variable Fee 1998  
 Water Delivery Organization 1999  
 Water Delivery System 1999  
 Definitions, IDAPA 37.03.02 2006  
 Acre-Foot (AF) 2006  
 Acre-Foot/Annum 2006  
 Amendment 2006  
 Capacity Measurement 2006  
 Certified Water Right Examiner 2006  
 Conveyance Works 2007  
 Cubic Foot Per Second (CFS) 2007  
 Department 2007  
 Director 2007  
 Duty of Water 2007  
 Examination or Field Examination 2007  
 Field Report 2007  
 Headworks or Diversion Works 2007  
 Legal Subdivision 2007  
 License 2007  
 License Examination Fee 2007  
 Measuring Device 2007  
 Nature of Use 2007  
 Period of Use 2007  
 Permit Holder or Owner 2007  
 Permit or Water Right Permit 2007

Place of Use (P.U. or POU) 2008  
 Point of Diversion (P.D. or POD) 2008  
 Project Works 2008  
 Proof of Beneficial Use 2008  
 Source 2008  
 Definitions, IDAPA 37.03.03 2016  
 Abandoned Well 2016  
 Abandonment 2016  
 Agricultural Runoff Waste 2016  
 Applicant 2016  
 Application 2016  
 Aquifer 2016  
 Beneficial Use 2017  
 Best Management Practice (BMP) 2017  
 Casing 2017  
 Cementing 2017  
 Cesspool 2017  
 Coliform Bacteria 2017  
 Confining Bed 2017  
 Construct 2017  
 Contaminant 2017  
 Contamination 2017  
 Conventional Mine 2017  
 Decommission 2017  
 Deep Injection Well 2017  
 Department 2018  
 DEQ 2017  
 Director 2018  
 Disposal Well 2018  
 Draft Permit 2018  
 Drilling Fluid 2018  
 Drywell 2018  
 Endangerment 2018  
 Exempted Aquifer 2018  
 Existing Injection Well 2018  
 Experimental Technology 2018  
 Facility or Activity 2018  
 Fault 2018  
 Flow Rate 2018  
 Fluid 2018  
 Formation 2018  
 Generator 2018  
 Ground Water 2018  
 Ground Water Quality Standards 2019  
 Hazardous Waste 2019  
 Improved Sinkhole 2019  
 Indian Lands 2019  
 Individual Subsurface Sewage Disposal System 2019  
 Injection 2019  
 Injection Well 2019  
 Injection Zone 2019  
 IWRB 2019  
 Large Capacity Cesspools 2019  
 Large Capacity Septic System 2019  
 Maintain 2019  
 Modify 2020  
 Motor Vehicle Waste Injection Wells 2020  
 New Injection Well 2020  
 Open-Loop Heat Pump Return Wells 2020  
 Operate 2020  
 Operator 2020  
 Owner 2020  
 Packer 2020  
 Perched Aquifer 2020  
 Permanent Decommission 2020  
 Permit 2020  
 Person 2020  
 Point of Beneficial Use 2020  
 Point of Diversion for Beneficial Use 2020  
 Point of Injection 2020  
 Pressure 2020  
 Radioactive Material 2020  
 Radioactive Waste 2021  
 RCRA 2021  
 Remediation Project 2021  
 Residential (Domestic) Activities 2021  
 Sanitary Waste 2021  
 Schedule of Compliance 2021  
 Septic System 2021  
 Shallow Injection Well 2021  
 Site 2021  
 State 2021  
 Stratum (plural strata) 2021  
 Subsidence 2021  
 Subsurface Fluid Distribution System 2021  
 UIC, Underground Injection Control 2021  
 Unauthorized Decommission 2021  
 Underground Injection 2021  
 Underground Source of Drinking Water (USDW) 2021  
 Unreasonable Contamination 2022  
 Water Quality Standards 2022  
 Well 2022  
 Definitions, IDAPA 37.03.04 2038  
 Applicant 2038  
 Board 2038  
 BOPE 2038  
 Completion 2038  
 Conductor Pipe 2038  
 Department 2038  
 Director 2038  
 Drilling Logs 2038  
 Drilling Operations 2038  
 Exploratory Well 2038  
 Geothermal Area 2038  
 Geothermal Field 2038  
 Geothermal Resource 2039  
 Injection Well 2039  
 Intermediate String or Casing 2039  
 Material Medium 2039  
 Notice of Intent or Notice 2039  
 Observation Well 2039  
 Operator 2039  
 Owner 2039  
 Permit 2039  
 Person 2039  
 Production String 2039  
 Production Well 2039  
 Surface Casing 2039  
 Suspension of Operations 2039  
 Waste 2039  
 Well 2040  
 Definitions, IDAPA 37.03.05 2049  
 Alterations, Repairs or Either of Them 2050  
 Board 2049  
 Borrowed Fill Embankment 2049  
 Certificate of Approval 2050  
 Days Used in Establishing Deadlines 2050  
 Department 2049  
 Director 2049  
 Engineer 2050  
 Enlargement 2050  
 Mine Tailings Impoundment Structure 2049  
 Mine Tailings Slurry 2049  
 Mine Tailings Storage Capacity 2049  
 Owner 2049  
 Reservoir 2049  
 Definitions, IDAPA 37.03.06 2059  
 Active Storage 2059  
 Alterations, Repairs or Either of Them 2059  
 Appurtenant Structures 2059  
 Board 2059  
 Certificate of Approval 2059  
 Dam 2059  
 Days Used in Establishing Deadlines 2060  
 Dead Storage 2060  
 Department 2060  
 Department Jurisdiction 2060  
 Design Evaluation 2060  
 Director 2060  
 Engineer 2060  
 Enlargement 2060  
 Factor of Safety 2060  
 Flood Surcharge 2060  
 Inflow Design Flood (IDF) 2060  
 Intermediate Dams 2059  
 Large Dams 2060  
 Maximum Credible Earthquake 2060  
 Operation Plan 2061  
 Owner 2061  
 Release Capability 2061  
 Reservoir 2061  
 Small Dams 2059  
 Storage Capacity 2061  
 Water Storage Elevation 2061  
 Definitions, IDAPA 37.03.07 2074  
 Alteration 2074  
 Applicant 2074  
 Base Flood Elevation 2075  
 Board 2074  
 Continuously Flowing Water 2074  
 Department 2074  
 Director 2074  
 Drop Structures, Sills & Barbs 2074  
 Mean High Water Mark 2074

- Non-Powered Sluice  
     Equipment 2074  
 Plans 2074  
 Repair 2074  
 Stream Channel 2075  
 Definitions, IDAPA 37.03.08 2097  
 Acre-Foot (AF) 2097  
 Advertisement 2097  
 Applicant 2097  
 Application for Permit 2097  
 Beneficial Use 2097  
 Board 2097  
 Cubic Foot Per Second (CFS) 2097  
 DDMI 2097  
 Department 2098  
 Director 2098  
 Legal Subdivision 2098  
 Permit or Water Right Permit 2098  
 Priority, or Priority of Appropriation,  
     or Priority Date 2098  
 Project Works 2098  
 Single Family Domestic  
     Purposes 2098  
 Subordinated Water Right 2098  
 Trust Water 2098  
 Unappropriated Water 2098  
 Definitions, IDAPA 37.03.09 2119  
 Annular Space 2119  
 Approved Seal or Seal  
     Material 2119  
 Aquifer 2119  
 Area of Drilling Concern 2119  
 Artesian Water 2119  
 Artificial Gravel Pack 2119  
 Bentonite 2119  
 Board 2120  
 Bore Diameter 2120  
 Borehole (also Well Bore) 2120  
 Bottom Hole Temperature of an  
     Existing or Proposed Well 2120  
 Casing 2120  
 Cathodic Protection Well 2120  
 Closed Loop Heat Exchange  
     Well 2120  
 Conductor Pipe 2120  
 Confining Layer 2120  
 Consolidated Formations 2120  
 Contaminant 2120  
 Contamination 2120  
 Decommissioned (Abandoned)  
     Well 2121  
 Decontamination 2121  
 Department 2121  
 Dewatering Well 2121  
 Director 2121  
 Disinfection 2121  
 Draw Down 2121  
 Drive Point (also known as a Sand  
     Point) 2121  
 Exploratory Well 2121  
 Global Positioning System  
     (GPS) 2121  
 Hydraulic Conductivity 2121  
 Hydraulic Fracturing 2121  
 Injection Well 2121  
 Intermediate String or Casing 2122  
 Liner 2122  
 Mineralized Water 2122  
 Modify 2122  
 Monitoring Well 2122  
 Neat Cement 2122  
 Neat Cement Grout 2122  
 Oxidized Sediments 2122  
 Perforated Well Casing 2122  
 Pitless Adaptor or Pitless Unit 2122  
 Potable Water 2122  
 Pressure Grouting (Grouting) 2122  
 Production String 2122  
 Public Water System 2123  
 Reduced Sediments 2123  
 Remediation Well 2123  
 Sand 2123  
 Screen (Well Screen) 2123  
 Seal or Sealing 2123  
 Start Card 2123  
 Static Water Level 2123  
 Surface Casing 2123  
 Temporary Surface Casing 2123  
 Thermoplastic/PVC Casing 2123  
 Transmissivity 2123  
 Tremie Pipe 2124  
 Unconfined Aquifer 2124  
 Unconsolidated Formation 2124  
 Unstable Unit 2124  
 Unusable Well 2124  
 Waiver 2124  
 Waste 2124  
 Water Table 2124  
 Well 2124  
 Well Development 2124  
 Well Driller or Driller 2125  
 Well Drilling or Drilling 2125  
 Well Owner 2125  
 Well Rig (Drill Rig) 2125  
 Definitions, IDAPA 37.03.10 2155  
 Abandonment 2155  
 Adequate Supervision 2155  
 Applicant 2155  
 Area of Drilling Concern 2155  
 Auxiliary Equipment 2155  
 Board 2155  
 Bond 2155  
 Bottom Hole Temperature of an  
     Existing or Proposed Well 2155  
 Company 2155  
 Compliance History 2155  
 Continuing Education 2155  
 Continuing Education Committee  
     (CEC) 2155  
 Credit Unit 2156  
 Critical Phases of Well  
     Drilling 2156  
 Decommissioned (Abandoned)  
     Well 2156  
 Department 2156  
 Director 2156  
 Drilling or Well Drilling 2156  
 Drilling Permit 2156  
 Drilling Site 2156  
 Global Positioning System  
     (GPS) 2156  
 License 2156  
 Licensed Driller 2156  
 Modify 2156  
 Operator 2156  
 Operator's Permit 2156  
 Principal Driller 2156  
 Responsible Charge 2157  
 Start Card 2157  
 Well 2157  
 Well Construction Standards 2157  
 Well Driller's Report or Driller's  
     Report 2157  
 Well Log 2157  
 Well Rig or Drill Rig 2157  
 Definitions, IDAPA 38.04.04 2170  
 Capitol Mall 2170  
 Capitol Mall Employee 2170  
 Carpool 2170  
 Employee with a Disability 2170  
 Executive Branch  
     Departments 2170  
 Facilities Services 2170  
 General Parking 2170  
 Legislative Personnel 2170  
 Legislator 2170  
 Reserved Parking 2170  
 State Elected Officials 2170  
 Temporary Contract  
     Employee 2170  
 Visitor 2171  
 Definitions, IDAPA 39.02.22 2192  
 Combination of Vehicles 2192  
 Customer 2192  
 Insufficient Funds (ISF) 2192  
 Non-Reducible Load 2192  
 Probable Cause 2192  
 Quarterly Report 2192  
 Registrant 2192  
 Revocation of Registration 2192  
 Road Use Fee 2192  
 Suspension of Registration 2192  
 Third-Party Checks 2192  
 Definitions, IDAPA 39.02.26, Rules  
 Governing Temporary Vehicle  
 Clearance For Carriers 2198  
 Carrier 2198  
 Temporary Vehicle Clearance  
     (TVC) 2198  
 Definitions, IDAPA 39.03.03 2214  
 Definitions, IDAPA 41.01.01 2226  
 Board 2226  
 Code 2226  
 Floathouse 2226  
 Health Officer 2226  
 Public Sewage Treatment  
     Facility 2226  
 Variance 2227  
 Definitions, IDAPA 48.01.01 2287  
 Definitions, IDAPA 52.01.02  
 Disposable Paper Bingo Card 2325  
 Distributor 2325

- Duck Race 2325  
 Electronic Bingo Device 2325  
 Electronic Gaming Devices 2325  
 Gaming 2325  
 Gross Revenues 2325  
 Hard Bingo Cards 2325  
 Host System 2325  
 Instant Bingo 2325  
 License 2325  
 Licensed Game Operator 2325  
 Licensed Vendor 2326  
 Manufacturer 2326  
 Net Proceeds of a Charitable Raffle 2326  
 Nonprofit Organization 2326  
 Organization 2326  
 Raffle 2326  
 Reusable Bingo Cards 2326  
 Separate Bank Account 2326  
 Session 2326  
 Site System 2326  
 Tracking 2326  
 U-Pick Ems 2326  
 Vendor 2326  
 Definitions, IDAPA 52.01.03 - Subchapter C 2323  
 Audit 2323  
 Autodaubing Features or Autodaubing 2324  
 Bingo 2324  
 Bingo-Raffle Advisory Board or Board 2324  
 Blackout 2324  
 Bonanza 2324  
 Charitable Contribution Acknowledgment Report Form or CCARF 2324  
 Charitable Donation Reporting Form 2324  
 Charitable Organization 2325  
 Charitable Purpose 2325  
 Concessions 2325  
 Definitions, IDAPA 53.01.01 2342  
 Definitions, IDAPA 58.01.05 2555  
 Board 2555  
 CFR 2555  
 Department 2555  
 Director 2555  
 Environmental Appeals Board 2555  
 HWFSA, Hazardous Waste Facility Siting Act 2556  
 HWMA, Hazardous Waste Management Act 2556  
 IDAPA, The Idaho Administrative Procedures Act 2556  
 RCRA, The Resource Conservation & Recovery Act 2556  
 Regional Administrator 2556  
 TSD, Treatment, Storage or Disposal 2556  
 U.S. Environmental Protection Agency or EPA 2555  
 United States or U.S. 2556  
 Definitions, IDAPA 58.01.06 2567  
 Active Portion 2567  
 Backyard Composting 2567  
 Beneficial Use 2567  
 Commercial Solid Waste Facility 2567  
 Composting Facility 2567  
 Conditionally Exempt Small Quantity Generator (CESQG) Hazardous Waste 2567  
 Conditionally Exempt Small Quantity Generator (CESQG) Management Facility 2567  
 Contamination 2567  
 Degradation 2568  
 Department 2568  
 Director 2568  
 Disposal 2568  
 Existing Facility 2568  
 Facility 2568  
 Garbage 2568  
 Ground Water 2569  
 Household Waste 2569  
 Incinerator 2569  
 Inert Waste 2569  
 Landfill 2569  
 Leachate 2569  
 Lift 2569  
 Modification 2569  
 Municipal Solid Waste Landfill Unit (MSWLF) 2569  
 Non-Municipal Solid Waste (NMSW) 2569  
 Non-Municipal Solid Waste Landfill (NMSWLF) 2570  
 Open Burning 2570  
 Operator 2570  
 Owner 2570  
 Person 2570  
 Point of Compliance 2570  
 Processing Facility 2570  
 Projected Waste Volume 2570  
 Pumpable Waste 2570  
 Qualified Professional, Geologist or Engineer 2570  
 Recyclables 2570  
 Recycling 2570  
 Recycling Center 2570  
 Salvage 2570  
 Scavenge 2570  
 Septage 2571  
 Site 2571  
 Site Size 2571  
 Solid Waste 2571  
 Speculative Accumulation 2571  
 Storm Water 2571  
 Surface Water 2571  
 Tipping Floor 2571  
 Toxic Leachate or Gas 2571  
 Transfer Station 2571  
 Wood or Mill Yard Debris Facility 2571  
 Yard Waste 2572  
 Definitions, IDAPA 58.01.07 2600  
 Board 2600  
 Community Water System 2600  
 Department 2600  
 Director 2600  
 EPA 2600  
 Existing 2600  
 Installation of a New Motor Fuel Dispenser System 2601  
 Installer 2601  
 New Underground Storage Tank 2601  
 Non-Community Water System 2601  
 Piping 2601  
 Potable Drinking Water Well 2601  
 Product Deliverer 2601  
 Public Water System 2601  
 Red Tag 2601  
 Replace 2601  
 Under-Dispenser Spill Containment 2602  
 Definitions, IDAPA 58.01.08 2613  
 Action Level 2613  
 Administrator 2614  
 Annual Samples 2614  
 Annular Opening 2614  
 Aquifer 2614  
 Average Day Demand 2614  
 Backflow 2614  
 Bag Filters 2614  
 Bank Filtration 2614  
 Board 2614  
 Capacity 2614  
 Cartridge Filters 2615  
 Clean Compliance History 2615  
 Combined Distribution System 2615  
 Community Water System 2615  
 Components of Finished Water Storage 2615  
 Composite Correction Program (CCP) 2615  
 Composting of Samples 2616  
 Confining Layer 2616  
 Confirmation Sample 2616  
 Connection 2616  
 Consecutive System 2616  
 Consumer 2616  
 Consumer Confidence Report (CCR) 2616  
 Contaminant 2616  
 Cross Connection 2616  
 Dead End Main 2616  
 Dead Storage 2616  
 Department 2616  
 Direct Integrity Test (DIT) 2617  
 Director 2617  
 Disinfection 2617  
 Disinfection Profile 2617  
 Distribution System 2617  
 Drinking Water 2617  
 Drinking Water System 2617  
 Dual Sample Set 2617  
 Effective Contact Time 2617  
 Effective Storage 2617



- Enhanced Coagulation 2617  
Enhanced Softening 2617  
Equalization Storage 2617  
Equivalent Dwelling Unit (EDU) 2617  
Exemption 2618  
Facility Plan 2618  
Facility Standards & Design Standards 2618  
Fee Assessment 2618  
Filter Profile 2618  
Filtrate 2618  
Finished Water 2618  
Finished Water Storage Structures or Facilities 2618  
Fire Flow Capacity 2618  
Fire Suppression Storage 2619  
Fixture Protection 2619  
Flowing Stream 2619  
Flux 2619  
Ground Water System 2619  
Ground Water Under The Direct Influence of Surface Water (GWUDI) 2619  
Haloacetic Acids (Five) (HAA5) 2619  
Health Hazards 2619  
Indirect Integrity Monitoring 2619  
Inorganic 2619  
Internal or In-Plant Isolation 2619  
Lake/Reservoir 2619  
Level 1 Assessment 2619  
Level 2 Assessment 2620  
License 2620  
Locational Running Annual Average (LRAA) 2620  
Log 2620  
Log Removal Value (LRV) 2620  
Material Deviation 2620  
Material Modification 2620  
Maximum Contaminant Level (MCL) 2620  
Maximum Day Demand 2620  
Maximum Pumping Capacity 2620  
Maximum Residual Disinfectant Level (MRDL) 2620  
Maximum Residual Disinfectant Level Goal (MRDLG) 2621  
Membrane Filtration 2621  
Membrane Unit 2621  
Method Detection Limit (MDL) 2621  
Microfiltration (MF) 2621  
Module 2621  
Nanofiltration (NF) 2621  
New System 2621  
Noncommunity Water System 2621  
Non-Potable Fluids 2621  
Non-Potable Mains 2621  
Non-Potable Services or Lines 2621  
Nontransient Noncommunity Water System 2621  
Operating Shift 2622  
Operation & Maintenance Manual 2622  
Operational Storage 2622  
Operations Plan 2622  
Owner/Purveyor of Water/Supplier of Water 2622  
Peak Hour Demand 2622  
Person 2622  
Pesticides 2622  
Plant 2622  
Plant Design Capacity 2622  
Point of Use (POU) Treatment Device 2622  
Point of Use (POU) Treatment System 2622  
Potable Mains 2622  
Potable Services 2622  
Potable Water 2623  
Preliminary Engineering Report 2623  
Premises Isolation or Containment 2623  
Presedimentation 2623  
Protected Water Source 2623  
Public Drinking Water System 2623  
Public Notice 2623  
Public Water System/Water System/System 2623  
Pump House 2623  
Qualified Licensed Professional Engineer (QLPE) 2624  
Quasi-Municipal Corporation 2624  
Raw Water 2624  
Redundancy 2624  
Regulated Public Utility 2624  
Repeat Compliance Period 2624  
Resolution 2624  
Responsible Charge (RC) 2624  
Responsible Charge Operator 2624  
Reverse Osmosis (RO) 2624  
Reviewing Authority 2624  
Sampling Point 2624  
Sanitary Defect 2624  
Sanitary Survey 2624  
SDWIS-State, Safe Drinking Water Information System-State Version 2625  
Seasonal System 2625  
Sensitivity 2625  
Sewage 2625  
Significant Deficiency 2625  
Simple Water Main Extension 2625  
Special Irrigation District 2625  
Spring 2625  
Standby Storage 2625  
Substantially Modified 2626  
Substitute Responsible Charge Operator 2626  
Surface Water System 2626  
Total Organic Carbon (TOC) 2626  
Total Trihalomethanes (TTHM) 2626  
Transient Noncommunity Water System 2626  
Treatment Facility 2626  
Turbidity 2626  
Ultrafiltration (UF) 2626  
Ultraviolet (UV) Light Technology 2626  
Unregulated Contaminant 2626  
Use Assessment 2626  
UV Transmittance (UVT) 2626  
Variance 2626  
Very Small Public Drinking Water System 2627  
Volatile Organic Chemicals (VOCs) 2627  
Vulnerability Assessment 2627  
Waiver 2627  
Wastewater 2627  
Water Demand 2627  
Water For Human Consumption 2627  
Water Main 2627  
Watershed 2627  
Wholesale System 2627  
Definitions, IDAPA 58.01.09 2746  
Animal Unit 2746  
Animal Waste 2746  
Animal Waste Management System 2746  
Certified Planner 2746  
Department 2746  
Director 2746  
Existing Facility 2746  
Expanding Facility 2746  
Facility or Swine Facility 2746  
Land Application 2746  
Nutrient Management Plan 2746  
Nutrient Management Standard 2747  
One-Time Animal Unit Capacity 2747  
Operate 2747  
Permit 2747  
Permittee 2747  
Person 2747  
Process Wastewater 2747  
Unauthorized Discharge 2747  
Waters of the State 2747  
Definitions, IDAPA 58.01.11 2762  
Agricultural Chemical 2762  
Aquifer 2762  
Beneficial Uses 2762  
Best Available Method 2762  
Best Management Practice 2762  
Best Practical Method 2762  
Board 2762  
Cleanup 2762  
Constituent 2762  
Contaminant 2762  
Contamination 2762  
Crop Root Zone 2762  
Degradation 2762  
Department 2762  
Extraction 2762  
Ground Water 2762  
Ground Water Quality Standard 2763

Highly Vulnerable Ground Water 2763	Wastewater 2781 Wastewater Treatment Facility 2781	Applicable Standards & Limitations 2854
Irreplaceable Source 2763	Water Pollution Control Project 2781	Application 2854
Mine Operator 2763	Definitions, IDAPA 58.01.13 2796	Approved Program or Approved State 2854
Mining Activity 2763	Beneficial Use 2796	Aquaculture Project 2854
Mining Area 2763	Best Management Practices (BMPs) 2796	Average Monthly Discharge Limitation 2854
Natural Background Level 2763	Cyanidation 2796	Average Weekly Discharge Limitation 2854
Person 2763	Cyanidation Facility 2797	Background 2854
Point of Compliance 2763	Department 2797	Best Management Practices (BMPs) 2855
Practical Quantitation Level 2763	Director 2797	Biochemical Oxygen Demand (BOD) 2855
Projected Future Beneficial Uses 2763	Discharge 2797	Biological Monitoring or Biomonitoring 2855
Recharge Area 2763	Groundwater 2797	Bypass 2855
Reclamation 2763	Impoundment 2797	Chemical Oxygen Demand (COD) 2855
Remediation 2763	Land Application 2797	Class I Sludge Management Facility 2855
Site Background Level 2764	Liner 2797	Clean Water Act 2855
Definitions, IDAPA 58.01.12 2778	Material Modification or Material Expansion 2797	Clean Water Act & Regulations 2855
Applicant 2778	Material Stabilization 2797	Compliance Schedule or Schedule of Compliance 2855
Best Management Practice 2778	National Pollution Discharge Elimination System (NPDES) Permit 2797	Concentrated Animal Feeding Operation (CAFO) 2855
Board 2778	Neutralization 2797	Concentrated Aquatic Animal Production (CAAP) 2855
Categorical Exclusion (CE) 2778	Permanent Closure 2797	Continuous Discharge 2855
Close or Closing 2779	Permanent Closure Plan 2797	Daily Discharge 2855
Collector Sewer 2779	Permit 2798	Department 2856
Construction 2779	Permittee 2798	Design Flow 2856
Department 2779	Person 2798	Direct Discharge 2856
Director 2779	Pilot Facility 2798	Director 2856
Disadvantaged Community 2779	Pollutant 2798	Discharge 2856
Disadvantaged Loans 2779	Post-Closure 2798	Discharge Monitoring Report (DMR) 2856
Eligible Costs 2779	Process Waters 2798	Discharge of a Pollutant 2856
Environmental Impact Statement (EIS) 2779	Seasonal Closure 2798	Draft Permit 2856
Environmental Information Document (EID) 2779	Small Cyanidation Processing Facility 2798	Effluent 2856
Financial Management System 2779	Special Resource Water 2798	Effluent Limitation 2856
Finding of No Significant Impact (FONSI) 2779	State 2799	Effluent Limitations Guidelines 2856
Handbook 2779	Temporary Closure 2799	Electronic Signature 2856
Implementation Plan 2779	Treatment 2799	Environmental Protection Agency (EPA) 2856
Ineligible Costs 2780	Water Balance 2799	Equivalent Dwelling Unit (EDU) 2856
Interceptor Sewer 2780	Water Management Plan 2799	Existing Source 2856
Loan Recipient 2780	Waters of the State 2799	Facilities or Equipment 2856
National Pollutant Discharge Elimination System 2780	Weak Acid Dissociable (WAD) Cyanide 2799	Facility or Activity 2857
Nondomestic Wastewater 2780	Definitions, IDAPA 58.01.14 2819	Fundamentally Different Factors 2857
Nonpoint Source Pollution 2780	Board 2819	General Permit 2857
Nonpoint Source Project Sponsor 2780	Department 2819	Hazardous Substance 2857
Operation & Maintenance Manual 2780	Director 2819	Idaho Pollutant Discharge Elimination System (IPDES) 2857
Plan of Operation 2780	Definitions, IDAPA 58.01.18	Indian Country 2857
Planning Document 2780	Act 2822	Indian Tribe 2857
Point Source 2780	Applicant 2822	Indirect Discharger 2857
Pollutant 2780	Board 2822	
Priority List 2780	Department 2822	
Rehabilitation 2780	Director 2822	
Reserve Capacity 2780	Hazardous Substance 2822	
Sewer Use Ordinance/Sewer Use Resolution 2781	Natural Background Level 2822	
State 2781	Person 2822	
Supplemental Grants 2781	Petroleum 2823	
Suspension 2781	Release 2823	
Sustainability 2781	Remediation 2823	
Termination 2781	Site 2823	
User Charge System 2781	Definitions, IDAPA 58.01.25 2854	
	Animal Feeding Operation 2854	

- Industrial Wastewater 2857  
 Infiltration 2857  
 Inflow 2857  
 Interstate Agency 2857  
 Load Allocation (LA) 2858  
 Major Facility 2858  
 Maximum Daily Discharge Limitation 2858  
 Maximum Daily Flow 2858  
 Mixing Zone 2858  
 Municipality 2858  
 National Pollutant Discharge Elimination System (NPDES) 2858  
 New Discharger 2858  
 New Source 2858  
 Notice of Intent to Deny 2859  
 Notice of Intent to Obtain Coverage under an IPDES General Permit 2859  
 Notice of Intent to Terminate 2859  
 Owner or Operator 2859  
 Permit 2859  
 Person 2859  
 Point Source 2859  
 Pollutant 2859  
 Potable Water 2860  
 Pretreatment 2860  
 Primary Industry Category 2860  
 Privately Owned Treatment Works 2860  
 Process Wastewater 2860  
 Proposed Permit 2860  
 Publicly Owned Treatment Works (POTW) 2860  
 Receiving Waters 2860  
 Recommencing Discharger 2860  
 Regional Administrator 2860  
 Secondary Industry Category 2861  
 Secondary Treatment 2861  
 Secretary 2861  
 Septage 2861  
 Severe Property Damage 2861  
 Sewage 2861  
 Sewage from Vessels 2861  
 Sewage Sludge 2861  
 Sewage Sludge Use or Disposal Practice 2861  
 Significant Industrial User 2861  
 Silvicultural Point Source 2861  
 Site 2862  
 Sludge 2862  
 Sludge-Only Facility 2862  
 Source 2862  
 Standards for Sewage Sludge Use or Disposal 2862  
 State 2862  
 State/EPA Agreement 2862  
 Storm Water 2862  
 Technology-Based Effluent Limitation (TBEL) 2862  
 Total Dissolved Solids 2862  
 Toxic Pollutant 2862  
 Treatment 2862  
 Treatment Facility 2862  
 Treatment Works Treating Domestic Sewage (TWTDS) 2863  
 Upset 2863  
 User 2863  
 Variance 2863  
 Wasteload Allocation (WLA) 2863  
 Wastewater 2863  
 Water Pollution 2863  
 Water Quality-Based Effluent Limitation (WQBEL) 2863  
 Water Transfer 2863  
 Wetlands 2863  
 Whole Effluent Toxicity 2863  
 Definitions, Sections 200 Through 225 & 400 Through 461  
 Agricultural Activities & Services 2379  
 Baseline Actual Emissions 2380  
 Begin Actual Construction 2381  
 Emissions Increase 2381  
 Innovative Control Technology 2381  
 Net Emissions Increase 2381  
 Pilot Plant 2381  
 Reasonable Further Progress (RFP) 2382  
 Sensitive Receptor 2382  
 Short Term Source 2382  
 Toxic Air Pollutant Reasonably Available Control Technology (T-RACT) 2382  
 Definitions, Sections 500 Through 516 2470  
 Dispersion Technique 2470  
 Excessive Concentration 2470  
 Nearby Structures or Terrain Features 2472  
 Stack in Existence 2472  
 Delayed Registration Of Stillbirth 742  
 Delineation Of Job Responsibilities 1032  
 Delinquent Premium Payments 807  
 Delinquent Payments 807  
 Premium Debt 807  
 Reestablishing Eligibility 807  
 Delivery Of Prospectus 650  
 Registration by Coordination 650  
 Registration by Qualification 650  
 Delivery Prohibition 2607  
 Classification as Ineligible, Delivery Prohibition 2607  
 Compliance Conference 2608  
 Declining Classification 2609  
 Department Authority 2609  
 Duration of Ineligible Classification 2608  
 Prohibition 2607  
 Proper Notice 2609  
 Red-Tagging 2608  
 Service of Notice 2608  
 Unlawful to Tamper with Red Tag 2609  
 Warning of Violations 2607  
 Written Notice 2608  
 Delivery Voucher 104  
 Producer 104  
 Seed Buyer 104  
 Seed Crop Shipped 104  
 Ship To 104  
 Transportation Company 104  
 Demonstration Of Ambient Equivalence 2468  
 Other Trades 2468  
 VOC Trades 2468  
 Demonstration Of Net Air Quality Benefit 2408  
 Mobile Sources 2408  
 Other Regulated Air Pollutants 2408  
 VOCs 2408  
 Demonstration Of Preconstruction Compliance For New & Reconstructed Major Sources Of Hazardous Air Pollutants 2421  
 Compliance with Federal MACT 2421  
 Definitions 2421  
 Development of MACT by the Director After EPA Deadline 2421  
 Permitting Authority 2421  
 Requirement to Obtain Preconstruction MACT Determination from the Director 2421  
 Demonstration Of Preconstruction Compliance With Toxic Standards 2412  
 Controlled Ambient Concentration 2414  
 Controlled Emissions 2414  
 Environmental Remediation Source 2417  
 Identification of Toxic Air Pollutants 2412  
 Interpollutant Determination 2418  
 Interpollutant Trading Ambient Concentration 2417  
 Interpollutant Trading Determination Processing 2418  
 Interpretation & Implementation of Other Sections 2419  
 Net Ambient Concentration 2415  
 Net Emissions 2415  
 NSPS & NESHAP Sources 2419  
 Permit Compliance Demonstration 2419  
 Preconstruction Compliance Demonstration 2414  
 Quantification of Ambient Concentrations 2413  
 Quantification of Emission Rates 2412  
 Short Term Source Factor 2417  
 Toxic Air Pollutant Offset Ambient Concentration 2415  
 T-RACT Ambient Concentration for Carcinogens 2415

- T-RACT Determination 2416  
 T-RACT Determination Processing 2416  
 Uncontrolled Ambient Concentration 2414  
 Uncontrolled Emissions 2414  
 Denial & Grounds For Discipline 2357  
 Cause 2357  
 Emergency Suspension 2358  
 Mirroring Orders 2358  
 Denial & Modification 725  
 Denial 725  
 Modification 725  
 Notification & Appeal 725  
 Denial Of Application For Certificate 820  
 Additional Causes For Denial 820  
 Notice of Denial 821  
 Denial Or Refusal To Renew License Or Permit Or Suspension Or Revocation Of License Or Permit 1410  
 Denial Or Refusal To Renew Licensure Or Suspension Or Revocation Of Licensure 1408  
 Application or Renewal Denial 1408  
 Petitions for Reconsideration of Denial 1408  
 Denial Or Refusal To Renew, Suspension Or Revocation Of Dietitians License 1412  
 Disciplinary Authority 1412  
 Denial Or Refusal To Renew, Suspension Or Revocation Of License 1558  
 Disciplinary Authority 1558  
 Grounds for Discipline 1558  
 Penalties 1559  
 Dental Assistants – Practice 1143  
 Prohibited Duties 1143  
 Dental Care 953  
 Costs Paid by Medicaid 954  
 Emergencies 954  
 Dental Hygienists – License  
 Endorsements 1138  
 Extended Access Endorsement 1138  
 Extended Access Restorative Endorsement 1139  
 Renewal 1139  
 Dental Hygienists – Practice 1141  
 Direct Supervision 1142  
 General Supervision 1141  
 Dental Hygienists – Prohibited Practice 1142  
 Anesthesia 1142  
 Cutting Procedures 1142  
 Diagnosis and Treatment 1142  
 Final Placement 1142  
 Final Removal 1142  
 Intraoral Placement or Carving 1142  
 Occlusal Equilibration Procedures 1143  
 Operative Preparation 1142  
 Other Final Placement 1143  
 Root Canal 1143  
 Dental Services, Residential Care Facility 1038  
 Dental Therapists – Practice 1143  
 Dental Therapists – Prohibited Practice 1143  
 All Extractions with Exception 1143  
 Cutting Procedures 1143  
 Periodontal Therapy 1143  
 Sedation 1143  
 Department Access 652  
 Department Individuals Subject To A Criminal History & Background Check 921  
 Emergency Medical Services (EMS) Employees 921  
 Employees at State Institutions 921  
 Employees of Bureau of Audits & Investigations 921  
 Employees, Contractors, & Volunteers 921  
 Other Employees 921  
 Department of Water Resources Permits 1241  
 Department Responsibilities 806  
 Assessed Premiums 806  
 No Retroactive Premiums Assessed 806  
 Notification of Premiums 806  
 Premiums Not Assessed Due to Late Review 806  
 Department Responsibility 1856  
 Department Responsibility To Certified Adoption Professional 986  
 Depopulation Of Animals 151  
 Preventive Slaughter or Destruction 151  
 Scope of Depopulation 151  
 Deposit Of Forfeitures & Damages 1179, 1215  
 Cyanidation Facility Closure Fund 1216  
 Funds for Reclamation 1179  
 Mine Reclamation Fund 1215  
 Mining Account 1179  
 Depositions 1981, 1984  
 Depth Markers 766  
 Depth Marking Locations 766  
 Depth Markers 766  
 Water Depth 766  
 Description & Sketch Of Monument & Accessories Established To Perpetuate The Location Of This Corner 512  
 Description Of Corner Evidence Found 512  
 Description Of Services, Residential Care Facility 1033  
 Design Detail  
 Circulation 758  
 Dimensions 758  
 No Diving Sign 759  
 Safety Line 759  
 Shape 759  
 Wading Pools 759  
 Design Requirements 1132  
 Conformance to Standards 1132  
 Corrected Plans 1132  
 Detail 1132  
 Exemption 1132  
 Prior Approval of Plans 1132  
 Scale 1132  
 Submission of Plans 1132  
 Tests 1132  
 Design Standards For  
 Microscreening 2681  
 Design Considerations 2681  
 Design Requirements 2681  
 Designated Counties 281  
 Designated Inspection Areas - 1 Through 14 265  
 Designated Matching Services 656  
 Application 657  
 Definitions 656  
 Designation Consistent with Act 657  
 Disqualifications 657  
 In General 656  
 Notice of Transaction 658  
 Withdrawal of Designation 657  
 Designation & TSE On-Site Survey Fees 720  
 Application With National Verification 720  
 Application Without National Verification 720  
 Designation Fee Payment 721  
 STEMI (Heart Attack) Designation & TSE On-Site Survey Fees 721  
 Stroke Designation and TSE On-Site Survey Fees 721  
 Trauma Designation & TSE On-Site Survey Fees 720  
 Designation At A Lesser Level 726  
 Inability to Meet Criteria 726  
 Notification & Appeal 726  
 Designation Decision 723  
 Denial 724  
 Final Determination 723  
 Provisional Designation 723  
 Summary Report 723  
 Written Report 723  
 Designation Of Agent 1327  
 Designation Of Allocated Deer & Elk Tags 1818  
 Calculation & Designation of Allocated Tags 1818  
 Change in Operating Area or Owner of Business 1819  
 Hardship Request 1819  
 Objection to Calculation 1819  
 Stipulation by Outfitters 1819  
 Designation Of Attainment, Unclassifiable, & Nonattainment Areas 2491  
 Annual Review 2491  
 Area Designation 2491  
 Boundaries 2491

- Redesignations 2492  
Designation Of Centers -- General Requirements 720  
Application 720  
Initial Designation 720  
Designation Of TSE Centers -- Criteria 719  
Destruction Or Return Of Drugs Or Devices  
Restrictions 1889  
Did Not Reach Patient 1889  
Donation 1889  
Potential Harm 1889  
Detailed Plan Of Operation For Advanced Deposit Wagering  
Detailed Plan of Operation 561  
Requirements for Accounts  
Established & Operated for Persons Whose Principal Residence is Outside of the State of Idaho 561  
Detailed Pricing Description 158  
Availability 159  
Bonuses & Deductions 159  
Component Information 159  
Hauling Charges 159  
Other Deductions 159  
Other Factors 159  
Pricing Method & Pounds Purchased 158  
Total Weight or Volume 158  
Detained Commercial Feeds 249  
Appropriate Compliance Procedure 250  
Stop Sale, Use, or Removal 249  
Violation of Stop Sale, Use, or Removal Order 250  
Detection, Identification, & Reporting Of Regulated Pests 312  
Disagreement 312  
Observation 312  
Release of Information 312  
Reporting 312  
Determination Of Credit 510  
Determination Of Degree Of Sedation By The Board 1148  
Determination Of Eligibility For Title IV-E 951  
Determination Of Eligibility Of Costs 2788, 2844  
Eligible Costs 2788, 2844  
Eligible Costs & the Loan Offer 2790, 2846  
Examples of Costs That May Be Eligible 2789, 2844  
Ineligible Project Costs 2790, 2845  
Necessary Costs 2788, 2844  
Notification Regarding Ineligible Costs 2790, 2846  
Reasonable Costs 2788, 2844  
Determination Of Need For Nonresident Licensure Or Registration 1879  
Exemption from Separate Controlled Substance Registration 1879  
Independent Practice 1879  
Multistate Pharmacists 1879  
Practice for an Idaho Registered Drug Outlet 1879  
Determination Of Sample 583  
Less Than The Minimum 583  
Minimum Sample 583  
More Than The Minimum 583  
Determining Winners When A Player Using A Paper Bingo Card Claims To Be A Winner 2328  
Game Stops to Verify Winner 2328  
Player's Responsibility 2328  
Prizes for Multiple Winners 2328  
Verification of Winning Card 2328  
Winning Cards 2328  
Development & Production Under The Lease 1272  
Amendments 1273  
Best Practices 1272  
Diligent Development of Lease & Production 1272  
Notice of Production 1273  
Plans Required 1272  
Waste & Damage 1273  
Development Project Contract Requirements 1867  
Deviation From An Approved Permit 1166  
Notification 1166  
Unforeseen Events 1166  
Deviation From An Approved Reclamation Plan 1196  
Notification 1196  
Unforeseen Events 1196  
Deviations From Pesticide Labels & Labeling 122  
Diagnosis, Program Eligibility 783  
Diagnostic Categories 781  
Diagnostic, Consultative Services 780  
Diagram, Section Diagram 513  
Diapering & Sanitation, Children's Residential Care Facilities 1057  
Diligent Exploration Required 1286  
Direct Care Staff Qualifications, Children's Residential Care Facilities 1053  
Direct Care Staff Supervisor Qualifications 1052  
Associate's Degree 1052  
Bachelor's Degree 1052  
Experience 1053  
Direct Filtration 2692  
Filtration Requirements 2692  
Redundancy 2692  
Siting Requirements 2692  
Direct Sales 1154  
Disadvantaged Loans 2784, 2840  
Adjustment of Loan Terms 2784, 2840  
Decreasing Interest Rate 2841  
Increasing Repayment Period 2841  
Principal Forgiveness 2841  
Qualifying for a Disadvantaged Loan 2784, 2840  
Disapproval Designation 2629  
Defects 2629  
Monitoring 2630  
Non-Payment of Annual Fee Assessment 2630  
Operating Procedures 2629  
Public Notification 2630  
Quality 2630  
Unapproved Source 2630  
Disbursement Of Funds 1864  
Advance Payment 1865  
Authorization 1864  
Documentation 1865  
Partial Reimbursement 1865  
Request for Reimbursement 1865  
Disbursements 2290, 2793, 2849  
Collection Fee, Brand Inspector 2290  
Final Disbursement 2794, 2849  
Idaho Beef Council 2290  
Loan Decreases 2793, 2849  
Loan Disbursements 2793, 2849  
Loan Increases 2793, 2849  
National Beef Promotion and Research Board 2290  
Project Review to Determine Final Eligible Costs 2793, 2849  
Discharge Plans, Children's Residential Maternity Care 1068  
Disciplinary Action Against Licensees  
Conviction of Felony 442  
Conviction of Misdemeanor 442  
Dealing With Stolen Manufactured or Mobile Homes 442  
Deceptive Practice 441  
Disclosing Contents of Examination 441  
Encouraging Falsification 441  
Failure of Organizations to License its Employees 441  
Failure to Have Principal Place of Business 441  
Failure to Honor Warranties 441  
Failure to Maintain Any Required License 442  
Failure to Permit Access to Documentary Materials 442  
Failure to Provide Business Name 441  
Failure to Respond to Notice 442  
False Information 441  
Installation Supervisor Required 441  
Poor Workmanship 441  
Revocation or Denial of License 441  
Violation of Permit or Inspection Requirements 442  
Violation of Rules & Statutes 441  
Disciplinary Enforcement 1438  
Disciplinary Penalty 1632, 1799  
Civil Fine 1632  
Costs & Fees 1632

- Disciplinary Procedures 1632  
Disciplinary Process 2359  
Discipline 1547, 1565, 1576, 1599,  
1606, 1647, 1670, 1678, 1692, 1698,  
1707, 1726, 1739, 1763  
Administrative Fine 1764  
Civil Fine 1547, 1565, 1576, 1599,  
1647, 1670, 1678, 1692, 1698,  
1707  
Code of Ethics 1698  
Costs & Fees 1547, 1565, 1576,  
1599, 1647, 1670, 1678, 1692,  
1698, 1707  
Disciplinary Action 1726  
Disciplinary Sanctions 1739  
Grounds for Discipline 1739  
Licensee Costs 1764  
Refuse License 1763  
Restrict License 1763  
Revoke License 1763  
Disclosure 2314  
Discontinuance Of An Educational  
Program 1447  
Follow Plan 1447  
Notify in Writing 1447  
Discontinued, Retired, & Expired  
Licenses & Certificates 504  
Continuing Professional  
Development 505  
Designation 505  
Discontinued Certificate of  
Authorization 505  
Eligibility 505  
Fee for Reinstatement of  
Discontinued Certificate of  
Authorization 505  
Fee for Reinstatement of Expired  
License 505  
Fee for Reinstatement of Retired  
License 505  
Practice Not Permitted 505  
Reinstatement – Disciplinary 504  
Reinstatement –  
Nondisciplinary 505  
Discovery 1952  
Sanctions 1953  
Scope & Method of Discovery  
BOE Appeals 1952  
STC Appeals 1953  
Special Case 1953  
Supplementation of Response 1953  
Written Permission 1952  
Disease Control, Domestic  
Cervidae 192  
Diseases & Pests Of Concern 348  
Columbia Root Knot Nematode 349  
Corky Ring Spot 349  
Green Peach Aphid 349  
Introduction of Pests 348  
Leaf Roll 349  
Northern Root Knot Nematode 349  
Potato Late Blight 349  
Powdery Scab 349  
Ring Rot 349  
Stubby Root Nematode 349  
Disinfectant & Chemical Feeders 768  
Backflow Prevention 768  
Chlorine Gas Equipment 768  
Feeder 768  
Hypochlorite Equipment 769  
Disinfectant Residuals, Disinfection  
Byproducts, & Disinfection  
Byproduct Precursors 2647  
Analytical Requirements 2648  
Compliance Requirements 2648  
General Requirements 2648  
Monitoring Requirements 2648  
Treatment Techniques for Control of  
Disinfection Byproduct (DBP)  
Precursors 2648  
Disinfection Of Premises, Buildings &  
Vehicles 137  
Disinfectants 137  
Moving Contaminated Vehicle 137  
Owner Responsibility 137  
Supervision of Cleaning &  
Disinfection 137  
Yards & Other Premises 137  
Disinterment & Reinterment 1384  
Disinterment 1384  
Reinterment 1384  
Display Of License 1678  
Disposal Methods 290  
Disposal by Chopping or  
Shredding 291  
Disposal by Composting 290  
Disposal by Covering in Dumps or  
Pits 290  
Disposal by Feeding After March  
15th of Each Year 290  
Disposal by Spreading 291  
Disposal of Residue in Onion  
Producing Fields 290  
Disposal Of Domestic Cervidae 186  
Disposal Of Waste, Filters 770  
Disposition Of Applications 999  
Approval of Application 999  
Denial of Application 1001  
Failure to Complete Application  
Process 1001  
Limited License 1001  
Provisional License 1001  
Regular License 1000  
Variance 1000  
Waiver 1000  
Disposition Of Cattle 202  
Disposition Of Child Protection  
Reports 960  
Substantiated 960  
Unsubstantiated 960  
Disposition Of Commodities In  
Violation Of Rules 299  
Disposition Of Cull Onions 290  
Disposition Of Cull Potatoes 291  
Disposition Of Diseased Seed &  
Infected Fields 312  
Destruction 312  
Quarantine 312  
Threshing & Segregating 312  
Disposition Of EIA Reactors 141  
Duration of Quarantine 142  
Quarantined 141  
Disposition of Violations 282  
Disputes Concerning Commissions &  
Fees 1905  
Disqualification Of Officers Hearing  
Contested Cases 1978  
Disqualifying Crimes Resulting In An  
Unconditional Denial 927  
Disqualifying Crimes 927  
Disqualifying Five-Year  
Crimes 929  
Underlying Facts &  
Circumstances 929  
Disruption Of International  
Adoptions 991  
Distance Markers 576  
Distillery Distributing Stations 697  
Retail Sales 697  
Sample Tasting 697  
Distributing Stations 694  
Acceptance of Applications 695  
Agreement Evaluations 694  
Agreement Renewal 694  
Agreement Termination for  
Cause 696  
Agreement Termination  
Procedure 697  
Applicant Selection 695  
Automatic Agreement  
Termination 696  
Compensation 696  
Days & Hours of Operation 696  
General Operational  
Obligations 695  
Supplies 696  
Term of Agreement 694  
Transfer of Agreement 694  
Voluntary Agreement  
Termination 696  
Distribution & Use Of Electronic Bingo  
Machines 2339  
Approved Sources 2339  
Approved Users 2339  
Initial Use 2339  
Installation, Maintenance, Service &  
Repair 2339  
Invoices & Payments 2339  
Site Systems & Transportation of Site  
Systems 2339  
Transportation of Electronic Bingo  
Devices 2339  
Distribution Of Deposits 546  
Distribution Of Promotional  
Material 45  
Authorized Use 45  
Fees 45  
Distribution Of Support Collected In  
Title IV-E Foster Care Maintenance  
Cases 796  
Payment of Support Obligation 796  
Termination of Foster Care

- Payments 796
- Disturbing The Peace 568
- Diving Area
  - Headroom 761
  - Water Depth 761
- Divorce Certificate Filing Fee 738
- Dock Reconfiguration 1231
- Document Indexing & Other Procedures
  - Before Archiving 1935
  - Cash Management 1935
  - Document Review 1935
- Documentary Evidence 1984
- Documentation – Copies 609
  - Citizenship, Education, Military & Criminal Records 609
  - Notice of Employment/  
Termination 609
  - Training & Other Records 609
- Documentation Of Criminal, Traffic, & Military Discharge Records 617
  - Criminal or Traffic Matters 617
  - Military Discharge 617
- Documentation Of Informed Consent 1660
  - Board Information 1660
  - Client's Rights 1660
  - Education 1660
  - License Type and License Number, Credentials, & Certifications 1660
  - Name, Business Address & Phone Number of Licensee or Intern 1660
  - Relationship 1660
  - The Extent and Limits of Confidentiality 1660
  - Theoretical Orientation & Approach 1660
  - Written Statement 1660
- Documentation Of In-Service Training 638
  - Agency Responsibility to Ensure Accuracy of Training Records 638
  - Agency Retention of Training Records 638
  - College Courses 638
  - Notice of Non-Compliance 638
  - POST Training Credit 638
- Documentation Requirements For Continued Care 1033
  - Additional Continued Care Plans 1033
  - Assessment for Others Safety 1033
  - Documentation of Care Prior to Eighteenth Birthday 1033
  - Documentation of Need for Continued Care 1033
  - Voluntary Agreement 1033
- Documenting Compliance With Continued Competence Requirements 1420
  - Documentation of Compliance 1420
  - Retention of Original Documentation 1420
- Documents Filed With Racing Commission 573
  - Accident Insurance or Workmen's Compensation 574
  - Bond 574
  - Liability Insurance 574
- Domestic Cervidae Ranch Facility Requirements 187
  - Inspections 187
  - Maintenance 187
- Domestic Cervidae Ranches 187
  - Each Premises 187
  - Premises Registration 187
  - Vehicle Access 187
- Donated Goods & Services As Matching Share 1861
  - Excess Value 1862
  - Generally 1861
  - Requirements 1862
- Donated Real Property As Matching Share 1861
  - Appraisal Required 1861
  - Generally 1861
  - Limitations 1861
- Draft Permit & Fact Sheet 2910
  - Draft Permit 2910
  - Fact Sheets 2910
- Drain Grating 772
  - Area of Openings 772
  - Maximum Width of Openings 772
  - Securely Fastened 772
- Drawings, Map, & Schematic Diagram 2013
  - Attachment Sheets 2013
  - Drawings 2013
  - Photographs 2013
  - Scale of Map 2013
  - Submittal of Drawings, Maps, Photos & Schematic Diagrams 2013
- Dressing Rooms
  - Only Authorized Persons Are Allowed To Enter
  - Authorized Persons to Enter 1483
  - Other Persons 1483
- Dressing Rooms, Toilets, Showers 763
- Driller's Advisory Committee 2166
  - Reimbursement 2166
  - Selection & Duties 2166
- Drilling 2040
  - Bonds 2040
  - Casing 2041
  - Electric Logging 2042
  - General 2040
  - Permits & Notices 2040
  - Well Spacing 2041
- Drilling Logs 1350
  - Bottom Hole Survey 1350
  - Cement Bond Log 1350
  - Log Submittal 1350
  - Minimum Required Logs 1350
  - Other Logs 1350
- Drilling Permit Requirements 2140
  - Converting an Artificial Openings or Excavations Not Constructed as a Well for Use as a Well 2141
  - Effect of a Permit 2141
  - Exclusions 2141
  - Fees 2141
  - General Provisions 2140
- Drilling, Well Treatment, & Pit Permits 1332
- Drivers' Training, Drivers' Licenses, & Permits For Children In Alternate Care 954
  - Payment by Parent(s) or Legal Guardian(s) 954
  - Payments by Department 954
- Driving Business - Course Of Instruction 1735
  - Driving Log 1736
  - Grading Criteria 1736
  - In-Car Documentation 1736
  - Maximum Daily Driving & Observation Time 1736
  - Maximum Number of Students In Vehicle 1736
  - Parental Involvement 1736
  - Record Retention 1736
  - Reporting 1736
  - Student Permit Required 1736
- Driving Business - Initial Audit 1736
- Driving Business -- Minimum Curriculum Components 1733
  - Component Eight for Classroom 1734
  - Component Eleven for In-Car 1735
  - Component Five for Classroom 1734
  - Component Four for Classroom 1734
  - Component Fourteen for In-Car 1735
  - Component Nine for Classroom 1734
  - Component One for Classroom 1733
  - Component Seven for Classroom 1734
  - Component Six for Classroom 1734
  - Component Ten for Classroom 1734
  - Component Thirteen for In-Car 1735
  - Component Three for Classroom 1733
  - Component Twelve for In-Car 1735
  - Component Two for Classroom 1733
- Driving Business License 1731
  - Applicant Identity 1731
  - Certificate of Vehicle Insurance 1732
  - Classroom Locations & Certificates of Occupancy 1732
  - Course of Instruction 1733
  - Criminal History Background Check 1732
  - Instructor Apprenticeship Training

- Program 1733
  - Licensed Instructors 1732
  - On-line Instruction 1733
  - Vehicles 1732
  - Driving Instructor License 1736
    - Age 1736
    - Application 1736
    - Criminal History Background Check 1737
    - Driving Record & Drivers License 1737
    - Education 1737
    - Instructor Apprenticeship Training Program 1737
    - Medical Certificate 1737
    - Waiver of Instructor Apprenticeship Training Program 1737
  - Dromedary Tractors 2218
  - Drop Structures, Sills & Barbs 2081
    - Barb or Partial Drop Structure 2081
    - Drop Structures 2081
    - Sills 2081
  - Drug & Feed Additives 247
    - Satisfactory Evidence 247
  - Drug Outlet Licensure & Registration
    - General Requirements 1882
      - Change of Ownership or Location 1882
      - Exemption from Separate Controlled Substance Registration 1882
      - License & Registration Transferability 1882
      - New Drug Outlet Inspections 1882
      - Nonresident Drug Outlet 1882
      - Permanent Closing 1882
      - Sterile Preparation Endorsement 1882
  - Drug Outlets
    - Minimum Facility Standards 1883
    - Authorized Access to the Restricted Drug Storage Area 1883
    - Controlled Substance Storage 1883
    - Electronic Recordkeeping System 1883
    - Security and Privacy 1883
    - Staffing 1883
  - Drug Outlets That Dispense Drugs To Patients Without An Onsite Pharmacist Or Prescriber 1884
  - Controlled Substances
    - Inventories 1884
    - Exemption for Self-Service Systems 1884
    - Exemption for Veterinarians 1884
    - Security and Access 1884
    - Self-Inspection 1884
    - Technology 1884
  - Drug Outlets That Dispense Prescription Drugs
    - Minimum Prescription Filling Requirements 1884
  - Labeling 1884
  - Patient Counseling 1884
  - Prospective Drug Review 1884
  - Valid Prescription Drug Order 1884
  - Verification of Dispensing Accuracy 1884
  - Drug Residue Level 167
  - Dairy Plants Sampling & Testing Responsibilities 167
  - Departments Monitoring & Surveillance Responsibilities 168
  - Enforcement 168
  - Drugs Stored Outside Of A Drug Outlet For Retrieval By A Licensed Health Professional 1885
  - Controlled Substances 1885
  - Secure Storage 1885
  - Stocking and Replenishing 1885
  - Supervising Drug Outlet 1885
  - Dual Point System 2378
  - Due Process Procedures In Decertification Proceedings 633
  - Decertification Investigations 633
  - Legal Authority 633
  - Overview 633
  - Dumped Rock Riprap 2078
    - Design Procedure 2080
    - Extension of Riprap Area 2080
    - Finished Surface 2080
    - Methods Used for Determining Gradation of Riprap 2079
    - Minimum Thickness of Riprap 2079
    - Placement of Riprap 2078, 2080
    - Riprap Protection 2079
    - Rock Used for Riprap 2079
    - Sideslopes of Riprap 2079
    - Size & Gradation of Riprap 2079
    - Toe Protection 2080
    - Use of Filter Material 2079
  - Duplicate License 552
  - Durable Medical Equipment 785
  - Duration 2865
    - Continuation of General Permits 2866
    - Continuation of Individual Permits 2866
    - Continuation of Permits During an Appeal 2866
    - Permit Term 2865
  - Duration Of CWD Quarantine 196
    - Adjacent Herds 196
    - Complete Depopulation 196
    - CWD Positive Herds 196
    - CWD Suspect Herds 196
    - Disposal of Positive or Exposed Cervidae 197
    - Exposed Herds 196
    - Fencing Requirements 196
    - Source Herds & Herds of Origin 196
  - Duration Of Round 1490
  - Duties & Responsibilities Of Drillers, Companies & Operators 2163
  - Companies 2164
  - Licensed Drillers & Principal Drillers 2163
  - Operators 2164
  - Duties Of Bingo Caller & Employees Or Volunteers In Games Using Paper Bingo Cards 2328
  - Duties Of Bingo Caller And Employees Or Volunteers In Games Using Paper Bingo Cards
    - Displaying Numbers During Play 2328
    - End of Game 2328
    - Pre-Game Duties 2328
  - Duties Of Directing Physicians 1393
    - Available Supervision 1393
    - Directing Responsibility 1393
    - Disclosure 1393
    - Responsibilities 1393
    - Scope of Practice 1393
  - Duties Of Simulcast Operator 545
    - Compliance 546
    - Filing 546
    - General 545
    - Locations Listing 546
    - Pari-Mutuel Inspector 546
    - Provisions 545
    - Security 546
    - Test Program 546
    - Video Record 546
  - Duties Of Supervising Physicians 1393
    - Available Supervision 1394
    - Disclosure 1394
    - Pre-Signed Prescriptions 1393
    - Responsibilities 1393
    - Supervisory Responsibility 1394
  - Duties Of Supervising Physicians Of Interns & Residents 1394
    - Available Supervision 1394
    - Disclosure 1394
    - Responsibilities 1394
  - Duty Of Owner Of Bees 252
    - Compliance With Rules 252
    - Quarantined Apiary 252
  - Duty To File 1929
  - Duty To Restrain, Domestic Cervidae Ranch 193
  - Duty To Supplement Or Correct Application 2432
    - Additional Information After Completeness 2432
    - Failure to Submit 2432
    - Necessary Additional Information 2432
- E**
- Early Detection & Rapid Response
    - Aquatic Invertebrate Invasive Species 322
    - Construction & Road Building & Maintenance Equipment 323
    - Contaminated Conveyances in Idaho Waters 323
    - Firefighting Equipment 323



- Statewide EDRR AIIS List 322  
Transporting EDRR AIIS Over  
Public Roads 323
- Easement Access & Emergency  
Work 1255  
Emergency Work 1255  
Use of Land 1255
- Easement Modification 1247
- Easements On State Land Under Land  
Sale Contract 1249  
Approval of Contract  
Purchaser 1249  
Compensation 1249  
Co-Signature of Contract  
Purchaser 1249
- Edible Harvest Exemption 307
- EDRR AIIS Decontamination 324  
Decontamination Protocol 324  
Proof of Decontamination 324  
Reinspection 324
- Education 615, 1029  
Acceptable Education 615  
Documentation of Education 615
- Education Policy, Residential Care  
Facility 1040
- Education Program 1057  
Core Curriculum 1057  
Grading System 1057  
Minimum Hours 1057  
Release of Records 1057  
Special Education 1057  
Teacher Qualifications 1057  
Teacher Ratio 1057  
Written Transcripts & An Individual  
Education Plan (IEP) 1057
- Education Program Fees 1455  
Evaluation of Courses of  
Instruction 1455  
Evaluation of Nursing Education  
Programs 1455
- Education Records Access 1905
- Education Teaching Standards 1906
- Educational & Credentialing  
Requirements For Licensure 1612  
Authority and Primary  
Responsibility 1612  
Content of Program 1612  
Curriculum 1612  
Program Must Have an Identifiable  
Body 1612  
There Must be an Identifiable  
Training Faculty & a Psychologist  
Responsible for the  
Program 1612  
Training in Professional  
Psychology 1612  
Training Program 1612  
What the Program Must  
Include 1612
- Educational & Training Materials 479  
Accessibility of Training &  
Educational Programs 480  
Approval of Training & Educational  
Programs 480
- Purposes of Training & Educational  
Programs 480  
Scope of Training & Educational  
Programs 480
- Educational & Training  
Requirements 1697  
Approval of Other Courses 1697  
Approved Course 1697
- Educational Program Standards 1762  
Clinical Work 1763  
Coursework Content & Hours 1762
- Educational Program Standards For  
Courses Of Instruction 1784  
Barber 1784  
Barber-Stylist 1785  
Cosmetology 1785  
Electrology 1787  
Esthetics 1786  
Haircutter 1786  
Instructor 1787  
Nail Technology 1786
- Effect Of A Permit 2865  
Compliance 2865  
Rights 2865
- Effect Of Delinquency On  
Applications 2460
- Effect Of Enforcement Action Against  
A License 872
- Effect Of Inaccurate Information In  
Applications Or Failure To Submit  
Relevant Information 2432
- Effect Of Previous Revocation Or  
Denial Of A License 1004
- Effect Of Stages 2476
- Egg Products & Breaking  
Operations 58
- Egg Seals, Tax & Cartons 59  
Assessments in Lieu of Egg Seals 60  
Cartons 59  
Distributor 60  
Divided Cartons Design 61  
Facsimile Idaho Egg Seal 60  
Imprinting 60  
Proofs 60  
Reporting Form 61  
Top Panel, Egg Carton 60
- EIA Is A Reportable Disease 141
- EIA Test Positive Animals Declared To  
Be Infected 141
- Electrical Contractor 382  
Electrical Contracting Work  
Defined 383  
Failure to Correct Defects in  
Electrical Installations 384  
Overcharging of Fees 384  
Previous Revocation 383  
Qualification & Duties for  
Supervising Journeyman or  
Master 383  
Qualifications for Electrical  
Contractor 382  
Required Signatures on  
Application 383  
Reviving an Expired License 383
- Electrical Generators 2544  
Fuel Type 2545  
Generator Opacity Limit 2545  
Generator Operating  
Requirements 2545  
Monitoring & Recordkeeping  
Requirements 2545
- Electrical Installations Requiring A  
Limited Electrical Installer  
License 385  
Elevator, Dumbwaiter, Escalator, or  
Moving-Walk Electrical 385  
Irrigation Sprinkler Electrical 386  
Limited Energy Electrical 386  
Manufacturing or Assembling  
Equipment 385  
Outside Wireman 387  
Refrigeration, Heating, & Air-  
Conditioning Electrical  
Installer 387  
Sign Electrical 385  
Solar Photovoltaic 387  
Well Driller & Water Pump  
Installer 386
- Electrical Permit & Inspection  
Requirements For Facility  
Accounts 377
- Electrical Permits 376  
Completion of Electrical  
Installation 376  
Power Supply Company 377  
Purchase of Electrical Permit 376
- Electrical Permitting & Inspection  
Requirements for Persons Exempt  
from Licensing 377  
Electrical Permit 377  
Notice to Power Supplier 377
- Electronic Signature Repudiation 1976
- Electronic Signatures 1903
- Electronically Signed  
Communications 1974
- Eligibility & Funding Information 950
- Eligibility For Interment 1383  
Burden of Proof 1383  
Eligibility 1383  
Requirements/Interment 1383
- Eligibility Requirements 1362  
Agreements for Behavior & Care  
Needs 1364  
Financial Statement 1363  
Idaho Residency 1362  
Income Limitation 1363  
Incompetent Applicants 1362  
Limit on Admission of  
Spouses 1364  
Medicare Coverage 1363  
Necessity of Services 1362  
Placement Restriction 1363  
Social Security Benefits 1363  
VA Pension -- Nursing Care, 1363  
Veterans or Eligible Spouse 1362
- Eligible Project Costs 1860
- Eligible Projects 1859  
Generally 1859

- Ineligible Projects 1859  
 Less Than Fee Acquisition 1859  
 SCORTP 1859  
 Emergency Action 1430  
 Emergency As An Affirmative Defense  
 Regarding Excess Emissions 2445  
 Applicability 2445  
 Burden of Proof 2445  
 Demonstration of Emergency 2445  
 General 2445  
 Emergency Drills 1055  
 Disaster Drill 1055  
 Fire Drills 1055  
 Emergency Evacuation Plan, Children's  
 Agencies 1044  
 Emergency Medical Technician 554  
 Emergency Medications Or  
 Drugs 1141  
 Emergency Plan 1077  
 Emergency Drills 1078  
 Written Plan 1077  
 Emergency Policies 1040  
 Bomb Threat 1041  
 Fire 1040  
 Hostage Taking 1041  
 Medical 1041  
 Missing Child 1041  
 Natural Disasters 1040  
 Other Dangers Unique to the  
 Location of an Organization 1041  
 Power Outage 1041  
 Serious Accident or Injury 1040  
 Severe Weather 1041  
 Emergency Powers Of The  
 Director 857  
 Emergency Preparedness Policies  
 Written Procedures 877  
 Emergency Preparedness  
 Requirements 877  
 Emergency Generators 877  
 Relocation Agreements 877  
 Emergency Procedures, Children's  
 Residential Care Facilities 1054  
 Emergency Treatment  
 Emergency Treatment 1488  
 Fees 1488  
 Suitable Examination Place 1488  
 Emergency Waiver 2077  
 Conformance to Conditions of  
 Waiver 2077  
 Emergency Waiver 2077  
 Verbal Waivers 2077  
 Waiver of Provisions of Stream  
 Protection Act 2077  
 Waivers Granted by Designated  
 Employees 2077  
 Emergency Work 1247  
 Emission Guidelines For Municipal  
 Solid Waste Landfills That  
 Commenced Construction,  
 Reconstruction Or Modification  
 Before May 30, 1991 2552  
 Applicability 2552  
 Compliance Schedules & Increments  
 of Progress For Municipal Solid  
 Waste Landfills That Have  
 Nonmethane Organic Compound  
 Emission Rates Less Than 50 Mg/  
 yr 2554  
 Compliance Schedules and  
 Increments of Progress 2554  
 Definitions, Section 860 2552  
 General Requirements 2553  
 Permitting Requirements 2553  
 Reporting Requirements 2553  
 Emission Limits, Hot-Mix  
 Asphalt 2551  
 Emission Limits, Incinerators 2541  
 Averaging Period 2541  
 General Restrictions 2541  
 Test Methods & Procedures 2542  
 Emissions Standards For Nonmetallic  
 Mineral Processing Plants Not  
 Subject To 40 CFR 60, Subpart  
 OOO 2543  
 Emissions Standards for Fugitive  
 Emissions 2543  
 Processing Plants Not Regulated by  
 NSPS 2543  
 Emissions Standards For Nonmetallic  
 Mineral Processing Plants Subject To  
 40 CFR 60, Subpart OOO 2542  
 Applicability & Designation of  
 Affected Facilities 2542  
 Facilities Not Applicable to 40 CFR  
 60.670(a)(2), (b), and (c) 2542  
 Standards of Performance for  
 Nonmetallic Mineral Processing  
 Plants 2543  
 Employee & Volunteer  
 Orientation 1035  
 Child Abuse, Neglect, &  
 Abandonment Reporting 1035  
 Job Function 1035  
 Job Responsibilities 1035  
 Organization 1035  
 Employee & Volunteer Training,  
 Residential Care Facility 1035  
 Employees 568  
 Licenses 568  
 Report to Stewards 568  
 Suspension or Fine 568  
 Employees Ineligible To Play 2327  
 Employer Registration 918  
 Change in Name or Ownership 918  
 Initial Registration 918  
 Employer Responsibilities 918, 919  
 Employment Determination 919  
 Ensure Time Frames Are Met 919  
 Maintain Printed Copy of  
 Application 918, 919  
 Screen Applicants 918, 919  
 Employment Of Outfitters 1805  
 Agreement 1805  
 No Sharing of Profits 1805  
 Other 1805  
 Other Outfitter 1805  
 Employment Of Unlicensed, Non-  
 Exempt Individuals 1677  
 EMS Bureau Review Of  
 Applications 712  
 EMS Bureau Review of Renewal  
 Application 713  
 Review of License Applications 713  
 EMS Personnel License Duration 707  
 EMS Personnel License Renewal  
 Duration for AEMT & Paramedic  
 Level Licensure 707  
 EMS Personnel License Renewal  
 Duration for EMR & EMT Level  
 Licensure 707  
 EMS REPLICA Licensure  
 Duration 707  
 Initial License Duration for AEMT &  
 Paramedic Level Licensure 707  
 Initial License Duration for EMR &  
 EMT Level Licensure 707  
 Encouraging Public Benefits When  
 Installing Practices 2973  
 Benefiting Habitat 2974  
 Benefiting the Community 2973  
 Preventing Degradation 2973  
 Encroachment Standards 1224  
 ATONs 1228  
 Boat Garage 1226  
 Breakwaters 1226  
 Commercial Marina 1225  
 Community Docks 1224  
 Covered Slip 1226  
 Excavated or Dredged  
 Channel 1228  
 Float Homes 1227  
 Floating Toys 1230  
 General Encroachment  
 Standards 1228  
 Lake Specific Encroachment Permit  
 Terms 1230  
 Mooring Buoys 1227  
 Riprap 1227  
 Seawalls 1226  
 Single-Family & Two-Family  
 Docks 1224  
 Encumbrances 1860  
 End Use 2255  
 Endorsement 1545, 1564, 1571, 1580,  
 1586, 1604, 1657, 1707, 1716  
 A Valid License 1580  
 Conditions to be Granted A  
 License 1586  
 Criminal History 1580  
 Eligibility for Endorsement 1604  
 Endorsement 1586  
 Experience/Education 1580  
 Has Documented Experience 1657  
 Holds a Current License 1657  
 National Examination 1580  
 Requirements for  
 Endorsement 1604  
 State Examination 1580  
 Endorsement For Certification Of  
 Prescriptive Authority 1604  
 Advisory Panel 1605

- Credit Toward Requirements 1605
- Holds a Current Certificate of Prescriptive Authority 1605
- Holds a Current License 1605
- Energy Crop Possession/Production Permits 319
  - Annual Report 321
  - Application for Energy Crop Invasive Species Permits 319
  - Application Process 320
  - Disposition of Non-Permitted Invasive Species 321
  - Duration of Possession Permit 321
  - Grant or Denial of the Permit 320
  - Permit Revocation 321
- Enforcement 161, 354, 1327, 1840, 1947, 2167, 2176, 2197, 2964
  - Delayed Movement 2197
  - Effect of License Suspension 161
  - Enforcement Policy 2167
  - False Statements 2965
  - General Enforcement & Penalties 2964
  - License Suspension 161
  - Notice of Violation 2176
  - Public Participation in Enforcement 2965
  - Records - Certified Seed Potatoes 354
  - Reporting Uncertified Seed Potatoes 354
  - Revoked Registrations 2197
  - Security & Patrol 2176
  - Truth in Reporting 2965
  - Violations 2167
- Enforcement & Failure To Comply 1176, 1215, 1220
  - Appeal of Final Order 1215
  - Civil Action 1177
  - Civil Penalty 1178, 1215
  - Department Remedies 1176
  - Financial Assurance Forfeiture 1215
  - Forfeiture 1220
  - Hearing Procedures 1178
  - Injunctive Procedures 1177, 1215
  - Inspection 1176
  - Penalties 1220
  - Violation of an Order 1177
- Enforcement Action Of Civil Monetary Penalties 909
  - Assessment Amount for Civil Monetary Penalty 909
  - Civil Monetary Penalties 909
  - Failure to Pay 910
  - Notice of Civil Monetary Penalties & Appeal Rights 910
  - Payment of Penalties 910
- Enforcement Action Of Consultant 909
- Enforcement Action Of Limit On Admissions 909
  - Notification of Limit on Admissions 909
  - Reasons for Limit on Admissions 909
- Enforcement Action Of Provisional License 912
- Enforcement Action Of Revocation Of Facility License 912
  - Reasons for Revocation or Denial of a Facility License 912
  - Revocation of Facility's License 912
- Enforcement Action Of Summary Suspension 908
- Enforcement Action Of Temporary Management 910
  - Need for Temporary Management 910
  - Notice of Temporary Management 910
  - Powers & Duties of the Temporary Manager 911
  - Responsibility for Payment of the Temporary Manager 911
  - Termination of Temporary Management 911
  - Who May Serve as a Temporary Manager 910
- Enforcement Actions 908
- Enforcement Of Act 2077
  - Failure to Comply with Stream Protection Act 2077
  - Written Orders Issued by Designated Employees of Department 2077
- Enforcement Of Posted Weight And/Or Speed Restrictions 2221
- Enforcement Process 857
  - Notice of Enforcement Remedy 857
  - Recommendation of Remedy 857
- Enforcement Remedy Of Ban On Admissions 1003
- Enforcement Remedy Of Ban On Admissions Of Resident With Specific Diagnosis 858
- Enforcement Remedy Of Ban On All Admissions 858
- Enforcement Remedy Of Provisional Certification 857
  - Certification or Revocation 858
  - Conditions of Provisional Certification 858
  - Failure to Meet Conditions of Provisional Certification 858
- Enforcement Remedy Of Revocation Of Certificate 858
  - Causes for Revocation of the Certificate 858
  - Revocation of the Certificate 858
- Enforcement Remedy Of Summary Suspension & Transfer Of Resident 858
- Enforcement Remedy Of Summary Suspension & Transfer Of Residents Or Children 1003
- Enforcement Remedy Revocation Of License & Transfer Of Residents Or Children 1003
- Endangers Health or Safety 1003
- Misrepresented or Omitted Information 1004
- No Progress to Meet Plan of Correction 1003
- Not in Substantial Compliance 1003
- Refusal to Allow Access 1004
- Repeat Violations 1004
- Violation of Terms of Provisional License 1004
- Enhanced Filtration & Disinfection - Systems Serving Fewer Than Ten Thousand People 2647
- Enhanced Filtration & Disinfection - Systems Serving Ten Thousand Or More People 2642
  - Criteria for Avoiding Filtration 2642
  - Disinfection Profiling & Benchmarking 2642
  - Filtration 2642
  - Filtration Sampling Requirements 2642
  - General Requirements 2642
- Enhanced Treatment For Cryptosporidium -- Long Term 2
- Enhanced Surface Water Treatment Rule 2647
  - Assessment of Significant Changes in the Watershed 2647
  - Cryptosporidium Treatment Credit for Approved Watershed Control Program 2647
- Enter, Search & Inspect 567, 579
- Environmental Contaminants & Substances Of Human Use 581
  - Caffeine 581
  - Positive Test 581
- Environmental Fees 2819
- Environmental Requirements 200, 209
- Environmental Review 2790, 2846
  - Categorical Exclusions 2791, 2846
  - Environmental Documentation 2790, 2846
  - Environmental Impact Statement (EIS) Requirements 2791, 2847
  - Environmental Information Document Requirements 2791, 2846
  - Exemption From Review 2792, 2847
  - Final EIS 2847
  - Final Environmental Impact Statement (EIS) 2791
  - Final Finding of No Significant Impact 2791, 2847
  - Partitioning the Environmental Review 2792, 2847
  - Use of Environmental Reviews Conducted by Other Agencies 2792, 2847
  - Validity of Review 2792, 2847
- Environmental Sanitation Standards 849

- Garbage & Refuse Disposal 849  
Housekeeping & Maintenance 850  
Insect & Rodent Control 850  
Laundry Facilities and Services 850  
Nonmunicipal Sewage Disposal 849  
Sewage Disposal 849  
Water Supply 849  
Yard 850  
EPA Review Procedures 2448  
Opportunity for EPA  
Objection 2449  
Public Petitions to EPA 2449  
Response to EPA Objections 2449  
Submittal Of Proposal to EPA 2448  
Episode Criteria 2475  
Epithelioma - Public Livestock  
Markets 140  
EPSDT Screening 953  
Equidae -- Equine Infectious  
Anemia 141  
Blood Samples 141  
Official Samples 141  
Official Tests 141  
Equipment Limitations 1241  
Equipment Of A Timekeeper 1485  
Equipment Of The Chief Second 1484  
Ammonia 1484  
Equipment 1484  
Ring Physician 1484  
Equipment Storage, Children's  
Residential Care Facilities 1055  
Eradication Methods 147  
Errors Of The Filing Officer, Filing &  
Data Entry Procedures 1936  
Errors Other Than Filing Office Errors,  
Filing & Data Entry  
Procedures 1936  
Escape Of Domestic Cervidae 190  
Capture 190  
Duty to Retrieve Escaped  
Cervidae 190  
Failure to Notify 190  
Fish & Game 190  
Notification of Escape 190  
Sheriff & State Brand Inspector 190  
Taking of Escaped Domestic  
Cervidae 190  
Establishing An Account  
Establishing an Account 562  
Other Information 562  
Establishing Permit Provisions 2943  
Applicable Requirements 2943  
Best Management Practices 2948  
Grants 2948  
Incorporation 2943  
Monitoring Requirements 2948  
Navigation 2949  
Notification Level 2947  
Other Effluent Limitations &  
Standards 2944  
Permit Durations 2947  
Pretreatment Program for  
POTWs 2948  
Privately-Owned Treatment  
Works 2948  
Qualifying State or Local  
Programs 2949  
Reissued Permits 2948  
Reopener Clause 2945  
Sewage Sludge 2949  
Technology-Based Controls for  
Toxic Pollutants 2947  
Technology-Based Effluent  
Limitations & Standards 2944  
Twenty-Four (24) Hour  
Reporting 2947  
Water Quality Standards &  
Requirements 2945  
Water Quality Trading 2949  
Establishment Changes In Ownership or  
Location 1780  
Addition of an Owner 1780  
Board Must Be Informed of All  
Changes 1780  
Deletion of an Owner 1780  
License Status 1780  
Out of Business 1780  
Transfer of Ownership 1780  
Estates 1933  
Evaluation 752  
Adequacy of Corrective Action 752  
Continued Certification of Other  
Tests 752  
Documentation of Corrective  
Action 752  
Unacceptable PT Result 752  
Evaluation Committee 1863  
Appointment & Term 1864  
Composition 1864  
Quorum 1864  
Evaluation Criteria 2108  
Criteria for Evaluating All  
Applications to Appropriate  
Water 2108  
Criteria for Evaluating Public  
Interest 2111  
Criteria for Evaluating Whether a  
Proposed Use of Trust Water Will  
Cause a Significant  
Reduction 2110  
Evaluation Of The Outfitter  
Application 1808  
Area Requested 1808  
Need for Services 1808  
Operating Plan 1808  
Other 1808  
Previous Record 1808  
Qualifications 1808  
Ex Parte Communications 1947, 1979  
Permitted Ex Parte 1947  
Prohibited Ex Parte 1947  
Exam Applications 24  
Examination 453, 1488, 1808  
Failed Examinations 454  
Frequency of Conducting of  
Examinations 453  
Professional Testing Services 454  
Required Score 454  
Examination & Re-Examination 1431  
Examination & Re-Examination  
Applicants for Professional or  
Practical Nurse Licensure 1431  
Examination Application 1431  
Examination By Physician  
One-Sided Contested 1492  
Risk of Injury & Examination by  
Physician 1492  
Examination For Beneficial Use 2009  
Field Report 2009  
Field Report Acceptability 2012  
General 2012  
Examination For Licensure 1579, 1656  
Content of Exam, Passing  
Scores 1579  
Date & Location of Exam 1579  
Examination 1656  
Examination Fee 1579  
Good Moral Character 1579  
Successful Passage 1656  
Time & Place 1656  
Examination For Provisional  
Certification Of Prescriptive  
Authority 1604  
Date of Exam 1604  
Passing Score 1604  
Examination In Case Of Head Injury  
Combatant Who Has Been Knocked  
Out 1494  
Decision of Technical Knockout  
Rendered by Referee 1494  
Head Injury 1494  
Knockout from Blow to Head 1494  
Examination Of Applicant For  
License 441  
Approval of Examination &  
Grade 441  
Required Examinations 441  
Examination Of Application 651  
Examination Procedures 2161  
Assistance Must Be  
Authorized 2161  
Examination Scoring 2161  
Oral Examination 2161  
Written Examination 2161  
Examination Requirements 670  
Examination Required 670  
Investment Adviser Representatives -  
Waiver 671  
Specialized Examination  
Authority 671  
Waiver 671  
Examinations 388, 403, 1512, 1529,  
1564, 1603, 1663, 1697, 1797  
Authorization 1529  
Content 1663  
Date of Licensure  
Examination 1663  
Examination Process 1797  
Examinations for Journeyman  
Plumber 403  
Failed Examinations 389  
Failing a Section of Exam 1564

- Failure of Exam 1603  
Frequency of Conducting of Examinations 388, 404  
Fundamentals of Geology 1529  
Grading 1663, 1797  
Inspection of Examination 1798  
Inspection Review 1798  
Minimum Passing Score 1564  
Passing Score 1603  
Practice of Geology 1529  
Professional Testing Services 388, 404  
Re-Examination 1663  
Reexamination 1530  
Required Scores 389  
Re-Score or Review of Examination 1530  
Retention of Examinations 1798  
Scope of Examination 1797  
Scores 1530  
Time & Place 1530  
Time & Place of Exam 1603  
Written Exam Required 1603  
Examinations & Education 498  
Eligibility for Licensure, Educational Requirements 499  
Exemption - Examination on the Fundamentals of Engineering 501  
Fundamentals of Engineering 501  
Grading 501  
Oral or Unassembled Examinations 501  
Principles & Practice of Engineering - Disciplines 501  
Review of Examination By Examinee 501  
Special or Oral Examination 498  
Three Examinations for Land Surveying Registration 501  
Two Examinations for Engineering Registration 500  
Use of NCEES Examinations 499  
Examinations & Endorsement 1641  
Examinations For Licensure 1137  
Clinical Examination 1137  
Written Examination 1137  
Exception To Charging A Copayment 809  
Exception To The Two Resident Limit Variance To The Two Resident Limit Determination 824  
Exceptions, Emission Limits, Incinerators 2542  
Exceptions, Odor Control Equipment In Rendering Plants 2552  
Excess Emissions 2389  
Applicability 2389  
Effect of Determination 2390  
Enforcement Action Criteria 2389  
Excess Emissions Records 2394  
Availability of Excess Emissions Records 2394  
Contents of Excess Emissions Records 2394  
Maintenance of Excess Emissions Records 2394  
Protections Under Section 128 2394  
Excess Emissions Reports 2394  
Contents of Excess Emissions Reports 2394  
Deadline for Excess Emissions Reports 2394  
Excluded Milk 166  
Exceeding Maximum Bacteria 166  
Insanitary Conditions 166  
Maximum Somatic Cell Count 166  
Positive Drug Test 166  
Probational Sediment Content 166  
Exclusion 2352  
Exclusion & Ejection 577  
Lawful Reason 577  
Readmission 577  
Executive Certification 627  
Position 627  
Prior Certification 627  
Training 627  
Executive Officer Of The Board 598  
Additional Responsibilities 598  
Authority of Office 598  
Governing Policies & Rules 599  
Exempt & Undercover Plate Fees 2212  
Adjusted Fees 2212  
Department Reimbursement 2212  
Exempt Plate Display 2212  
Exempt Plate Status 2212  
Non-Expiring Plates 2212  
Reissue of Plates 2212  
Transfer of Plates 2212  
Exempt Species 318  
Application for Transport Permits 318  
Exempt Species List 318  
Location of Known Established Populations 318  
Transport Permits 318  
Exemption Criteria & Reporting Requirements For Toxic Air Pollutant Emissions 2425  
Annual Report for Toxic Air Pollutant Exemption 2425  
Below Regulatory Concern (BRC) Exemption 2425  
Level I Exemption 2425  
Level II Exemption 2425  
Exemption From Licensing & Licensing Fees 2337  
Exemption From Licensing Not Exemption From Rules 2337  
Low-Stakes Bingo 2337  
Low-Stakes Raffle 2337  
Exemption From Participation 32  
Firms 32  
Licensees Not in Public Practice 32  
Licensees Not Issuing Reports 32  
Exemption Reviews 931  
Exemption Review Appeal 932  
Exemption Review Decision Effective Dates 932  
Exemption Review Determination 932  
Factors Considered at the Exemption Review 931  
Scheduling an Exemption Review 931  
Exemptions 95, 108, 289, 296, 511, 2075, 2343, 2460  
Active Duty in the Armed Forces 511  
Automotive Cooling System Antifreeze 98  
Butter 97  
Camera Film 98  
Cigarettes & Small Cigars 96  
Cleaning, Maintenance, Construction or Repair Work 2075  
Combination Packages 97  
Corn Flour 98  
Cuts, Plugs, & Twists of Tobacco & Cigars 95  
Decorative Containers 97  
Deliveries or Transfers to Unlicensed Seed Facilities 108  
Eggs 97  
Expired License 512  
Extenuating Circumstances 511  
First Renewal Period 511  
Flour 97  
Fluid Dairy Products, Ice Cream, & Similar Frozen Desserts 96  
General 95  
Government Agencies 296  
Individual Servings 95  
Margarine 97  
Motor Oils 98  
Multi-Unit Soft Drink Packages 97  
Packaged Commodities With Labeling Requirements Specified in Federal Law 96  
Paints & Kindred Products 98  
Paying Fees 2461  
Prescription & Insulin Containing Drugs 98  
Private, Non-Commercial Home Use 296  
Producers That Sell or Transfer to Another Producer 108  
Producers With a Financial or Management Interest 108  
Random Packages 95  
Registering & Paying Fees 2461  
Registration Fees 2460  
Removal of Debris 2075  
Retired 511  
Reusable (Returnable) Glass Containers 95  
Single Strength & Less Than Single Strength Fruit Juice Beverages, Imitations Thereof, & Drinking Water 96  
Small Confections 95  
Small Packages 97  
Snake & Clearwater Rivers 2075

- Soft-Drink Bottles 97
  - Work on Existing or Proposed Reservoir Projects 2075
  - Exemptions (Annual Bluegrass) 241
    - Experiments 241
    - Forage 241
  - Exemptions (Rough Bluegrass) 242
    - Experiments or Trial Grounds 242
    - Rough Bluegrass 242
  - Exemptions From Destruction (Non-Phaseolus) 313
  - Exemptions From Destruction (Phaseolus) 313
    - Beans for Processing or Fresh Consumption 313
    - Brown Spot 313
  - Exercise Person 554
  - Exhibit 1957
    - Copies 1957
    - Custody 1957
    - Form 1957
    - Marking 1957
    - Objection 1957
  - Exhibit Numbers 1982
  - Exhibits 1985
  - Existing Facilities 2753
    - Expanding Facility 2754
    - Plan Requirement 2754
    - Registration Requirement 2753
  - Existing Intermediate Or Large Dams 2070
    - Analyses Required 2070
    - Other Requirements 2071
  - Exits 1024
  - Expedition & Hiking Limit Requirements 1078
    - Acclimation to Environment 1078
    - Inability or Refusal to Hike 1078
    - Log 1078
    - Maps & Itinerary 1078
    - Maximum Temperature 1078
    - Physical Capability 1078
  - Expeditions 1076
    - Expedition Evaluations 1076
    - Expedition Summary 1077
    - Global Positioning System (GPS) 1076
    - Group Size 1076
    - Participant De-Briefing 1077
    - Staff Briefing 1076
    - Staff De-Briefing 1076
    - Wilderness First Responder (WFR) 1076
    - Written Description 1076
  - Expenditures From Hazardous Waste Emergency Accounts 2563
  - Experimental Permits 122
    - Active Ingredient 123
    - Acute Toxicity 123
    - Applicant 123
    - Experimental Use 123
    - Name 123
    - Proposed Labeling 123
    - Quantity Limit 123
    - Quantity Statement 123
    - Shipment 123
    - Statement of Scope 123
    - Temporary Tolerance 123
  - Expiration 1840
  - Expiration & Renewal Of An Operator's Permit 2162
    - Continuing Education Required for Renewals 2162
    - Expiration of Operator's Permits 2162
    - Renewal Application 2162
    - Welding Competency 2162
  - Expiration & Renewal Of Certification 2355
    - Removal from the Roster 2355
    - Renewal 2355
    - Renewal After Certification Expiration 2355
  - Expiration & Renewal Of License 872, 2161
    - Application for License Renewal 872
    - Continuing Education Requirements 2162
    - Existing License 872
    - Expiration of Licenses 2162
    - Renewal Application 2162
    - Welding Competency 2162
  - Expiration Of Approval, Non-Steroidal Anti-inflammatory Drug 586
  - Expiration Of Approved Status 201
  - Expiration Of Approved Status, Livestock Trader Lot 204
  - Expiration Of License 1572
  - Expiration Of Preceding Permits 2450
  - Exploration 1282
    - Permit Conditions 1282
    - Written Permit Required 1282
  - Exploration & Development 1327
  - Exploration & Operation Records, Confidentiality 1274
    - Continuing Obligations 1274
    - Drilling Records 1274
    - Well Logs 1274
  - Exploration Locations 1241
    - Lands Open 1241
    - Record Keeping Requirement 1241
    - Size of Location 1241
    - When No Written Approval Required 1242
    - When Written Approval Required 1242
  - Exploration Operations & Required Reclamation 1184
    - Additional Reclamation 1185
    - Confidentiality 1184
    - Contents of Notification 1184
    - Diligence 1184
    - Exploration Reclamation (Less Than Two Acres) 1185
    - Exploration Reclamation (More Than Two Acres) 1185
    - Notification 1184
    - When Exploration is Mining 1184
  - Exploration Under The Lease 1272
    - Casual Exploration 1272
    - Diligent Exploration 1272
    - Plan Required 1272
  - Export Procedures 278
  - Exports 339
  - Exposed Equidae 142
    - Hold Order 142
    - Movement of Exposed Equids 142
  - Exposure Of Another's Animals Not Allowed 150
    - Housed 150
    - Turned Out 150
  - Expression Of Guarantees 246
    - Commercial Feeds 246
    - Percentage by Weight 246
    - Vitamin Content 246
  - Expungement Procedure 522
    - Application 522
    - Certified Copy of Order of Acquittal or Order of Dismissal 522
    - Required Information Included 522
  - Extended Validity Equine Certificates 142
  - Extensions 2475
  - Extensions Of Annual Farming Lease Payment 1261
    - Due Date 1262
    - Farming Lease Extensions 1261
    - Liens 1262
  - Extensions Of Payment 1297
    - Extension in Time for Payment of Rent 1297
    - Interest Rate for Extension in Time for Payment of Rent 1297
    - Penalty for Late Payment of Rent 1297
    - Request for Extension in Time for Payment of Rent 1297
- F**
- Facilities At Or For Hearing & ADA Requirements 1982
  - Facilities Operated By The State 954
  - Facility & Design Standards
    - Additional Design Criteria For Surface Water Treatment 2679
    - Acceptable Technology 2680
    - Continuous Monitoring of Disinfectant 2680
    - Continuous Operation Required 2680
    - Continuous Turbidity Monitoring 2679
    - Disinfection 2679
    - Engineering Design Requirements 2679
    - Enhanced Disinfection 2679
    - Filter to Waste 2679
    - Pilot Studies 2680
    - Redundant Disinfection 2681
    - Removal of Pathogens 2679
  - Aeration Processes 2716

- Disinfection 2719
- Forced or Induced Draft Aeration 2716
- Natural Draft Aeration 2716
- Other Methods of Aeration 2719
- Packed Tower Aeration 2717
- Pressure Aeration 2717
- Protection of Aerators 2719
- Spray Aeration 2717
- Cross Connection Control 2732
  - Assembly Selection 2732
  - Atmospheric Vacuum Breakers 2732
  - Replacement Parts & Components 2732
  - Testable Assemblies 2732
- Demonstration Of Technical, Financial, & Managerial Capacity Of Public Drinking Water Systems 2652
  - Consolidation 2653
  - Exclusion 2653
  - Expanding Systems 2653
  - Financial Capacity 2652
  - Managerial Capacity 2653
  - Submittal Form 2653
  - Technical Capacity 2652
- Design Standards For Chemical Application 2707
  - Chemicals 2710
  - Design Requirements for Specific Applications 2712
  - Facility Design 2708
  - General Equipment Design 2707
  - Operator Safety 2712
  - Safety Requirements for Chemical Facilities 2710
- Design Standards For Fluoridation 2721
  - Chemical Feed Equipment & Methods 2721
  - Dust Control 2722
  - Secondary Controls 2722
- Design Standards For Iron & Manganese Control Systems 2719
  - Biological Removal 2721
  - Removal by Ion Exchange 2720
  - Removal by Manganese Coated Media Filtration 2720
  - Removal by Oxidation, Detention & Filtration 2719
  - Sampling Taps 2721
  - Sequestration by
    - Polyphosphates 2721
    - Sequestration by Sodium Silicates 2721
- Design Standards For Softening 2713
  - Cation Exchange Process 2714
  - Lime or Lime-Soda Process 2713
- Design Standards For Stabilization 2722
  - Carbon Dioxide Addition 2722
  - Phosphates 2723
  - Split Treatment 2723
  - Water Unstable Due to Biochemical Action in Distribution System 2723
- Design Standards For Taste & Odor Control 2715
  - Chlorination 2715
  - Chlorine Dioxide 2715
  - Copper Sulfate & Other Copper Compounds 2715
  - Granular Activated Carbon 2715
  - Other Methods 2716
  - Ozone 2716
  - Potassium Permanganate 2715
  - Powdered Activated Carbon 2715
- Design Standards For Treatment & Disposal Of Treatment Plant Waste Residuals 2723
  - Liquid Concentrates 2723
  - Sanitary Waste 2723
  - Sludge Waste 2724
  - Spent Media 2725
- Disinfection Of Drinking Water, Disinfecting Agents 2701
  - Chlorination 2701
  - Disinfection with Chlorine Dioxide 2707
  - Disinfection with Ozone 2703
  - Other Disinfecting Agents 2707
- Disinfection Of Drinking Water, Ultraviolet Light 2697
  - Alarms 2700
  - Controls 2699
  - General 2697
  - Initial Startup 2701
  - Monitoring 2700
  - Operation & Maintenance Manual 2701
  - Pilot Studies & Validation 2697
  - Reactor Design 2698
  - Reliability 2700
  - UV Dose Table 2698
- Disinfection Of Facilities Prior To Use 2737
- Distribution System 2728
  - Air Valves 2731
  - Backflow Protection 2732
  - Dead End Mains 2731
  - Flow Meter Required 2729
  - Installation of Water Mains 2728
  - Isolation Valves 2731
  - Meter Vault Required 2731
  - Minimum Pressure at Building Sites 2731
  - Pipe & Jointing Materials 2729
  - Pressure Relief Valves 2729
  - Protection from
    - Contamination 2728
    - Repair of Leaks 2731
    - Separation from Structures 2731
    - Separation from Subsurface Wastewater Systems & Other Sources of
- Contamination 2730
- Separation of Potable, Non-Potable, & Raw Water Pipelines 2729
- Size of Water Mains 2729
- Surface Water Crossings 2732
- Distribution System Storage Facilities 2736
  - Design 2736
  - Drain 2736
  - Isolation 2736
  - Level Controls 2736
- Facility Plans 2658
  - Engineer's Seal Required 2658
  - Existing Public Water System Facility Plan 2659
  - Facility Plan Contents 2658
  - Facility Plans Required 2658
  - Public Water System Facility Plan funded by the State Revolving Fund 2659
    - Submittal to the Department 2658
- General Design Of Finished Water Storage 2733
  - Abandonment 2735
  - Access 2734
  - Coatings & Cathodic Protection 2735
  - Construction Materials 2735
  - Disinfection 2735
  - Drains 2733
  - Grading 2735
  - Internal Catwalk 2735
  - Location 2733
  - Overflow 2734
  - Protection from
    - Contamination 2733
    - Protection from Freezing 2735
    - Protection from Trespassers 2733
  - Roof & Sidewall 2735
  - Silt Stops 2735
  - Sizing & Isolation Requirements 2733
  - Vents 2734
- General Design Requirements For Public Drinking Water Systems 2654
  - Additives Used in
    - Operation 2654
    - Design Basis 2654
  - Design of Buildings 2654
  - Design of Treatment Facilities 2654
  - Electrical 2655
  - Facility Potable Water Supply 2656
  - Ground Water Source Redundancy 2656
  - Materials Used in
    - Construction 2654
    - Meters 2656
  - On-Site Analysis & Testing Capabilities 2655
  - Operation & Maintenance

- Manual 2656
- Other Regulations 2656
- Pilot Studies 2657
- Redundant Fire Flow
  - Capacity 2656
- Reliability & Emergency Operation 2655
- Safety 2656
- Sample Taps 2656
- Security 2656
- Start-Up Training 2656
- Hydropneumatic Tank Systems 2736
  - General Design of Hydropneumatic Systems 2736
  - Requirements Specific to Bladder Tanks 2737
  - Requirements Specific to Conventional Hydropneumatic Tanks 2737
- Low Pressure Membrane Filtration 2692
  - Membrane Selection & Design Considerations 2693
  - Monitoring & Compliance Requirements for Membranes 2693
- Number Of Ground Water Sources
  - Required – Existing Systems 2676
  - Existing System with All Sources Constructed Prior to July 1, 1985 2677
  - Existing System with Any Sources Constructed After July 1, 1985 2677
- Preliminary Engineering Reports 2660
  - Preliminary Engineering Report Contents 2660
  - Seal Required 2660
  - Submittal to Reviewing Authority 2660
- Pumping Facilities 2726
  - Appurtenances 2727
  - Booster Pumps 2728
  - Pump Houses 2726
  - Pumping Units 2727
- Review Of Plans & Specifications 2664
  - Connection to an Existing System 2664
  - Construction 2668
  - Contents of Plans & Specifications 2666
  - Criteria for Review 2666
  - Engineer's Seal Required 2666
  - Exception 2668
  - Notification of Material Deviations 2668
  - Ownership 2664
  - Plans & Specifications Required 2664
  - Record Plans and Specifications Required 2668
- Requirement to Have Approved Plans & Specifications & Approval Letter On-Site During Construction 2668
- Schedule for Review 2666
- Siting & Construction Of Wells 2668
  - Construction Standards 2669
  - Conversion of Non-Public Water System Wells for Public Water System Use 2672
  - Disinfection 2671
  - Location 2669
  - Observation Wells 2673
  - Site Approval 2669
  - Test Pumping 2672
  - Well Abandonment 2673
  - Well Completion Report Required 2671
- Spring Sources 2677
  - Flow Measurement 2677
  - Protected Area 2677
  - Protection of the Spring 2677
  - Sample Tap Required 2677
  - Spring Box or Combined Spring Box/Finished Water Storage Design 2677
- Surface Sources And Ground Water Sources Under The Direct Influence Of Surface Water 2677
  - Intake Structures 2678
  - Offstream Raw Water Storage 2678
  - Raw Water Pumps 2678
  - Reservoirs 2679
- Surface Water Treatment 2681, 2692
  - Clarification Processes 2681
    - Flocculation 2682
    - High Rate Clarification 2684
    - Independent Units 2682
    - Manual Start-Up 2682
    - Parallel or Serial Operation 2682
    - Pre-Treatment 2682
    - Rapid Mix 2682
  - Sedimentation Units 2682
  - Settler Units 2684
  - Small Systems May Use Baffling 2682
  - Solids Contact Clarifiers 2683
  - Two Units Required 2681
- Filtration Using Diatomaceous Earth 2689
  - Appurtenances 2690
  - Backwash 2690
  - Body Feed 2689
  - Conditions of Use 2689
  - Filtration Requirements 2689
  - Monitoring 2690
  - Number of Units 2689
  - Precoat 2689
  - Treated Water Storage 2689
- Filtration Using Rapid Rate Gravity Filters 2684
  - Air Scouring 2687
  - Backwash 2688
  - Filter Appurtenances 2688
  - Filter Bottoms & Strainer Systems 2687
  - Filter Material 2685
  - Number of Units 2684
  - Pretreatment 2684
  - Rate of Filtration 2684
  - Roof Drainage 2689
  - Structure & Hydraulics 2684
  - Surface or Subsurface Wash 2687
  - Washwater Troughs 2685
- Slow Sand Filtration 2690
  - Control Appurtenances 2691
  - Depth of Water Over Filter Beds 2691
  - Filter Bed Control & Minimum Rate of Flow 2692
  - Filter Material 2690
  - Filter Sand Support 2691
  - Number of Units 2690
  - Quality of Raw Water 2690
  - Ripening 2691
  - Structural Details & Hydraulics 2690
  - Supernatant Drain Required 2692
  - Underdrains 2690
- Treatment Plant Storage Facilities 2735
  - Adjacent Storage 2736
  - Clearwell 2736
  - Filter Wash Water 2735
  - Other Treatment Plant Storage Tanks 2736
- Well Lot 2676
  - Location of Hydrants 2676
  - Parking Lots & Vehicle Storage 2676
  - Storage of Hazardous Materials on the Well Lot 2676
  - Use of Chemicals on the Well Lot 2676
- Well Pumps, Discharge Piping, & Appurtenances 2673
  - Casings and Sanitary Well Caps 2674
  - Discharge Piping 2673
  - Discharge Pumps 2675
  - Flow Meter & Check Valve 2674
  - Pitless Adapters & Units 2674
  - Pressure Gauge Required 2674
  - Sample Tap Required 2673
  - Well Houses 2674
  - Well Vent 2674
  - Wells Not Allowed in Pits 2675
- Facility Capacity & Determining Occupant Load 1011
  - Area for Daycare Use Only 1011
  - Exit Signs 1011



- Facilities With An Occupancy Load  
Of Fifty Or More 1011
- Facility Emissions Cap 2399  
Applicability 2399  
Definitions 2399  
Optional Facility Emissions  
Cap 2399
- Facility License Application 870  
Building Evaluation Fee 871  
Failure to Complete Application  
Process 871  
Identification of the Licensed  
Administrator 871  
License Application 870  
Written Request for Building  
Evaluation 871
- Facility Licensure 1706  
Facility Changes in Ownership or  
Location 1706  
Facility Licensure & Operation  
Requirements 1706
- Fact 2031
- Facts Disclosed Not Part Of The  
Record 1981
- Faculty 1449  
Faculty-Student Ratio 1449  
Numbers Needed 1449
- Faculty Qualifications 1448  
Advanced Practice Registered Nurse  
Program Faculty  
Qualifications 1448  
Clinical Preceptors in Registered  
Nurse, Practical Nurse, &  
Advanced Practice Registered  
Nurse Programs 1448  
Continued Study 1449  
Non-clinical Nursing Courses Faculty  
Qualifications 1448  
Practical Nurse Program Faculty  
Qualifications 1448  
Registered Nurse Program Faculty  
Qualifications 1448
- Faculty Responsibilities 1450
- Failure Of Combatant To Appear 1475
- Failure Of Contestant To Resume  
Boxing 1492
- Failure To Appear 24, 1954  
Default or Dismissal 1954  
Waiver of Appearance 1954
- Failure To Comply 857, 1017  
Lack of Progress 857  
Misdemeanor to Operate a Family  
Daycare Home for Four or More  
Children Without Obtaining a  
Criminal History Check 1017  
Misdemeanor to Provide Daycare if  
Guilty of Certain Offenses 1017  
Misdemeanors to Operate Without a  
License 1017  
Out of Compliance 857  
Failure To Maintain Insurance 1905
- Fair Blows & Fouls 1490  
Fair Blow 1490  
Fouls 1490
- Fair Hearing 1954  
Conference or Recess 1954  
Hearing Opportunity 1954  
Notice of Hearing -- Contents 1954  
Notice of Hearing -- Mailing 1954  
Purpose of Hearing 1954  
Setting of Hearing 1954  
Telephonic Hearing 1954
- Fair Techniques & Fouls In MMA Event  
Accidental Fouling 1500  
Concussive Head Impact Fouls in  
MMA Contest 1500  
Disqualification 1501  
Fair Techniques 1497  
Fouls 1497  
Fouls Or Unsportsmanlike Conduct  
During the One Minute Rest Period  
In MMA Contest 1500  
Intentional Fouling 1499  
Low Blow in MMA Contest 1501  
Referee Action On Fouls in MMA  
Contest 1501  
Time Considerations for Fouls 1499
- Fair Techniques & Fouls In MMA  
Events 1497
- Falsification Of Certificates 1905
- Family Case Records 945  
Electronic & Physical Files 945  
Storage of Records 945
- Family History 970  
Current Picture 970  
Evaluations/Assessments 970  
Hospital Records 970  
Informational Forms 970  
Narrative Social History 970
- Family Home Operating Without A  
Certificate 821  
Operating Without Certificate 821  
Placement or Transfer of  
Resident 821
- Family Size, Program Eligibility 784
- Farm Product Liens 1943  
Mechanics of Filing 1943  
Mechanics of Search 1943
- Farm Products Financing Statement  
Requirements 1910  
Completion of Form 1910  
Form 1910
- Farm Products Financing Statements  
Under The Uniform Commercial  
Code 1910
- Farm Requirements Of Milk For  
Manufacturing  
Cooling 170  
Farm Chemicals & Animal  
Drugs 170  
Health of Herd 169  
Milkhouse or Milkroom 170  
Milking & Facility Housing 169  
Milking Procedure 169  
Qualifications for Dairy Farm  
Certification 171  
Sewage Disposal 171  
Utensils & Equipment 171
- Water Supply 171
- Federal Agency Non-Acceptance Of  
Reclamation Fund 1219
- Federal Covered Securities 653  
Investment Company Notices 653  
Regulation D Rule 506 Notice  
Filing 653
- Federally-Funded Guardianship  
Assistance Eligibility, Requirements,  
& Benefits 968  
Case Plan Requirements 969  
Criminal History & Background  
Checks 969  
Eligibility 968  
Medicaid 969  
Nonrecurring Expenses 969  
Siblings of an Eligible Child 969
- Fee 1488  
Combatant's Report of Non-  
Participation to  
Commission 1488  
Payment of Fees to Physician 1488
- Fee Schedule 1878  
Administrative Services 1879  
Boating Facilities 1853  
Certificates of Registration &  
Licensure -- Facilities 1878  
Fee Collection Surcharge 1851  
Group Campsite or Facility 1852  
Individual Campsite or facility 1852  
Late Fees & Reinstatements 1879  
Licenses & Registrations --  
Professionals 1878  
Motor Vehicle Entrance Fee 1851  
Reservations 1854  
Winter Recreation Programs 1853
- Fee Schedule - Adoptions Through  
Department 978
- Fee Schedule For IPDES Permitted  
Facilities 2915  
Billing 2917  
Delinquent Unpaid Fees 2917  
Effective Date 2915  
Enforcement Action 2918  
Fee Assessment 2916  
Fee Schedule 2915  
Payment 2917  
Reinstatement of Suspended Services  
& Approval Status 2917  
Responsibility to Comply 2918  
Suspension of Services &  
Disapproval Designation 2917
- Fee Schedule For Public Drinking  
Water Systems 2630  
Billing 2631  
Delinquent Unpaid Fees 2631  
Effective Date 2630  
Enforcement Action 2632  
Fee Assessment 2631  
Fee Schedule 2630  
Payment 2631  
Reinstatement of Suspended Services  
& Approval Status 2632  
Responsibility to Comply 2632

- Suspension of Services & Disapproval Designation 2632  
Fee Schedule For Underground Storage Tanks 2609  
Billing 2610  
Delinquent Unpaid Fees 2610  
Enforcement 2610  
Fee Amount and Schedule 2609  
Fee Criteria 2609  
Fee Report 2610  
Nonrefundable 2610  
Payment 2610  
Fees 35, 121, 187, 274, 353, 425, 433, 442, 465, 490, 497, 690, 789, 796, 914, 1244, 1262, 1279, 1292, 1391, 1397, 1398, 1405, 1410, 1412, 1468, 1512, 1528, 1559, 1565, 1576, 1582, 1591, 1597, 1603, 1629, 1641, 1657, 1664, 1674, 1682, 1698, 1702, 1705, 1710, 1724, 1729, 1743, 1757, 1771, 1796, 1899, 1903, 1918, 1921, 1924, 2262, 2276, 2355  
Ad Hoc Lists 1919  
Additions or Changes During the Life of an Existing Certificate 490  
Administrative Fees 1899  
Administrative Fees for Services 1392  
Administrative Services 35, 2262  
Alternate Route Authorization 490  
Annual Assessment Fee 187  
Application Fee 796  
Application Fee for Approval of Assignment 1279  
Application Fees 274  
Application Filed With Fees 466  
Building Permit Fees 425  
Change in Certification Level 2356  
Construction Manager Licensing Fees 466  
Continuing Education Extension 2356  
Copies 1924  
Document Fees 425  
Examination & License 35  
Examination Fee per Examination Category 121  
Examination Fees 1710  
Exploration Permit 1292  
Farm Products Financing Statement 1918  
Federally Mandated Annual Service Fees 796  
Fee Adjustment 1292  
Fees 1391, 2262  
Fees Followed By “\*” Means 1682, 1683  
Fees for Annual Permits 426  
Fees for Issuance & Renewal of License 442  
Fees for Requests for Information 1919, 1922  
Guarantee Fee 1899  
Import, Export, and Movement Fees 187  
Income Tax Offset Fees 796  
Initial Certificate 490  
Initial Certification 2355  
Insignia Tag Fee 425, 434  
Internal Revenue Service (IRS) Referral Fees 796  
Investigation Fee 434  
Laboratory Fees 274  
Late Fees 35  
Late Payment Fee 1279  
License, Permit, & Registration Fees 1710  
Locate Fees 796  
Modular Building Fees 425  
Modular Building Permit Fees 433  
Money or Securities Deposit in Lieu of Performance Bond 442  
Multiple Types 1924  
Non-Refundable Application Fee for Lease 1279  
Nonrefundable Application Fee for Lease 1244  
Nonrefundable Dual Licensure/ Permit Fees for Practitioners of Respiratory & Polysomnography Related Respiratory Care 1411  
Nonrefundable Fee for Advertising Application 1244  
Nonrefundable fees for Respiratory Care Practitioners 1410  
Nonrefundable Nominal Fee 1292  
Nonrefundable Permit Fees for Polysomnography Related Respiratory Care Practitioners 1410  
Non-Standard 1924  
Notice of Amendment, Assignment, or Extension 1921  
Notice of Claim of Lien 1921  
Notice of Release 1921  
Other Inspections & Fees 434  
Payment 2276  
Payment of Fees 466  
Performance Bonding Requirements 442  
Pesticide Dealer’s License 121  
Pesticide Registration 121  
Plan Review 434  
Plan Review Fees 426  
Private Applicator’s License 121  
Processing Fee 1292  
Professional Applicator’s License 121  
Public Works Contractor Licensing Fees 465  
Radiation Licensing Fees 789  
Radiation Safety Program Fee 790  
Refund of Permit Fees 426, 434  
Refund Of Plan Review Fees 426  
Refund of Plan Review Fees 434  
Refunds 2276  
Registration and Subscription for List of Notices 1921  
Registration of Buyers, Commission Merchants, & Selling Agents 1918  
Renewal Certificate 490  
Renewal Certification 2355  
Service Fees 274  
Service Suspension 1924  
Single Copies 1924  
Single Type 1924  
Specialized Service Costs 914  
State Hospital North (SHN) - Diagnostic & Treatment Unit Costs 914  
State Hospital South (SHS) - Nursing Facility & Treatment Unit Costs 914  
Subscription to PMLs by Buyers, Commission Merchants, & Selling Agents 1918  
Technical Service Fee 425  
To Replace an Existing Certificate 490  
Verbal Report 1924  
X-Ray Shielding Plan Review & Fee 789  
Fees - Hourly, Overtime 278  
Certification & Overtime Rate 278  
Minimum Charges 278  
Fees - License Issuance, Renewal, Cancellation & Reinstatement 1401  
Fees & Assessments 216  
Annual Fees or Assessments 216  
Payment of Annual Fees or Assessments 216  
Fees & Charges 48, 242, 252, 268, 280, 297, 313  
Applications 313  
Area Inspections 269  
Certification Fees 48  
Confirmation Fees 314  
Express Mailing 48  
Field Inspections 297, 313  
Field or Lot Inspections 269  
General Fees & Charges 280  
Inspection 242  
Inspection, Sampling & Other Field Work 252  
Laboratory Examination 252  
Laboratory Seed Sampling 313  
Nematode Analysis 314  
Notary Charges 48  
Payment 48  
Phytosanitary Certificates 269  
Phytosanitary Certification & Like Inspections & Official Treatment Observations 269  
Plant Pathological Laboratory Services 269, 314  
Post-Entry Quarantine Inspections 269  
Quarantine Release Tags 242  
Sampling 242  
Seed Analysis 242  
Shipping & Delivery Charges 48

- Soil Analysis 314  
Special Permits 280  
Special Project Fee 269, 314  
Tags 313  
Transfer Permits 297  
Fees & Compensation 1246, 1252  
Administrative Fee 1252  
Application Fee 1246  
Appraisal 1253  
Appraisal Costs 1247  
Appraisal Required 1247  
Cost of Appraisal 1253  
Easement Fee 1246  
Minimum Compensation 1247  
Performance of Appraisal 1247  
Supplemental Compensation 1252  
Term Easements 1247  
Fees & Costs For Criminal History &  
Background Checks 918  
Fees & Remittances 1967  
Fees & Services 1850  
Admission Fees 1851  
Authority 1850  
Camping 1850  
Cooperative Fee Programs 1851  
Encroachment Permit Application  
Fee 1851  
Fee Collection Surcharge 1851  
Fees & Deposits 1851  
Group Use 1850  
Payment 1850  
Returned Checks 1851  
Sales Tax 1851  
Fees Charged By The Department 986  
Fees For Clinical Laboratory Tests 774  
Fees For Copies, Searches, & Other  
Services 733  
Certified Copies 733  
Fees for Other Services 734  
Searches 733  
Statistical, Research, or Public Health  
Services 734  
Verifications 734  
Waiver of Fee Requirement 735  
Fees For Electrical Permits And  
Inspections 377  
Additional Fees & Reinspection  
Fees 379  
Domestic Water Pump Permit 378  
Electric Signs & Outline Lighting  
Permit 379  
Electrically-Driven Irrigation  
Machine Permit 379  
Expiration of Permits 380  
Fees for Temporary Amusement/  
Industry Electrical  
Inspections 380  
Mobile/Manufactured Home  
Permit 378  
New Residential 378  
No Permit 380  
Other Installation (Including  
Industrial & Commercial)  
Permit 378  
Plan Check Fee 380  
Pumps (Water/Domestic Water/  
Irrigation, Sewage) Each Motor  
Permit 379  
Refunds of Permits 380  
Requested Inspection Permit 379  
Residential Electric Space Heating &  
Air Conditioning 378  
Temporary Construction Service  
(Temporary Power) Permit 377  
Transferring a Permit 380  
Fees For Environmental Laboratory  
Tests 776  
Environmental Laboratory Tests, Air  
-- Table 776  
Environmental Laboratory Tests,  
Inorganic -- Table 777  
Environmental Laboratory Tests,  
Microbiology -- Table 777  
Environmental Laboratory Tests,  
Organic -- Table 779  
Fees For Examination &  
Licensure 1538  
Fees For Examinations &  
Licensure 1459  
Fees For Interment, Disinterment, &  
Reinterment 1384  
Disinterment 1385  
Interment 1384  
Reinterment 1385  
Fees For Public Records Services 1928  
Charge for Paper Copies 1928  
Data From the Information  
Management System 1928  
Fees For Services 523  
Fingerprint Check 523  
Name Check 523  
Rolling Fingerprint 523  
Fees Payable In Advance 1124  
Female Combatants 1468  
Addendum Requirement 1469  
General Requirements 1469  
Limitation 1469  
Limitation on Contest 1469  
Qualifications 1468  
Separate Dressing Rooms 1469  
Fence & Barriers 772  
For Pools 1,800 Square Feet or  
Greater 772  
For Pools Under 1,800 Square  
Feet 772  
Fertilizer Labels 255  
Brand 255  
Grade 255  
Guaranteed Analysis 255  
Name & Address 255  
Net Weight or Net Volume, If  
Liquid 255  
Packaging 256  
Sources 255  
Specialty Fertilizers 255  
Field Burning 2521  
Filing 1950  
Document Filing Place 1950  
Fax Filing 1950  
Number of Copies 1950  
Filing & Data Entry Procedures 1935  
Filing & Service Of Discovery-Related  
Documents 1982  
Filing Certain Contracts With  
Commission 1474  
Disciplinary Action 1474  
Main & Semi-Main Events 1474  
Media Contracts 1474  
Other Combatants 1474  
Filing Date, Filing & Data Entry  
Procedures 1935  
Filing Documents With The Agency --  
Number Of Copies -- Facsimile  
Transmission (Fax) -- Electronically  
Signed Documents 1972  
Filing Fees 1927  
Filing Fee 1927  
UCC Search Fee 1927  
Filing Of A Petition For Involuntary  
Termination Of Parent & Child  
Relationship 972  
Abandonment 972  
Reasonable Efforts to Reunify the  
Family Are Not Required 972  
Filing Of Documents 471, 1415  
Filing Of Documents -- Number Of  
Copies 1966  
Filing Of Petition For Voluntary  
Termination 971  
Filing Office Identification 1926  
Filing Time, Filing & Data Entry  
Procedures 1935  
Filling Prescription Drug Orders  
Adaptation 1887  
Change Dosage Form 1887  
Change Quantity 1887  
Complete Missing  
Information 1887  
Documentation 1887  
Drug Product Substitution 1887  
Biosimilars 1888  
Drug Shortage 1888  
Hospital 1887  
Institutional Facility 1887  
Therapeutic Interchange 1888  
Practice Limitations 1887  
Drug Product Selection 1887  
Partial Filling 1887  
Refill Authorization 1887  
Transfers 1888  
Filtration & Disinfection 2637  
Analytical & Monitoring  
Requirements 2639  
Criteria for Avoiding  
Filtration 2638  
Disinfection 2638  
Filtration 2637  
General Requirements 2637  
Recycle Provisions 2642  
Reporting & Recordkeeping  
Requirements 2641  
Filtration System & Filters 770

- Filters 770
- Filtration System 770
- Final Conformity Determinations By USDOT 2489
- Final Conformity Determination Process 2489
  - New or Revised Information 2490
- Final Determination 1320
- Final Orders 1989
  - Content of Final Order 1989
  - Definition 1989
- Final Permit Decision 2811
  - Basis for Permit Denial 2812
  - Immediate Effect of the Permit 2812
  - Issuance 2811
  - Notification of the Decision 2812
  - Response to Public Comments 2812
- Financial & Management Capability Analysis 2781
  - Cost Allocation 2782
  - Incorporated Nonprofit Applicants 2782
  - Information Needed 2781
  - Waivers 2782
- Financial Assurance 2815
  - Financial Assurance Required 2815
  - Insufficiency 2815
- Financial Assurance Requirements 2750
  - Adjustment of Financial Assurance Amounts 2753
  - Continuous Coverage 2753
  - Financial Assurance Mechanisms 2750
  - Owner Liability 2753
  - Release from Financial Assurance Requirements 2753
  - Written Estimate of Costs 2750
- Financial Assurance Requirements For Cyanidation Facilities 1201
- Financial Assurance 1203
  - Financial Assurance for Permanent Closure Plans Affecting Five (5) or Less Disturbed Acres 1201
  - Financial Assurance for Permanent Closure Plans Affecting More Than Five (5) Disturbed Acres 1202
  - Financial Assurance Release During Permanent Closure 1203
  - Financial Assurance Review 1202
  - Indirect Costs for Permanent Closure Cost Calculations 1202
  - Liabilities for Permanent Closure Costs Not Covered by Financial Assurance 1203
  - Other Government Agency Financial Assurance 1202
  - Salvage Value Not Allowed 1202
  - Submittal of Financial Assurance Before Operating a Cyanidation Facility 1201
- Financial Assurance Requirements For Mining 1199
  - Annual Financial Assurance Review 1200
  - Cooperative Agreements 1201
  - Financial Assurance for Operation With More Than Five (5) Disturbed Acres 1199
  - Financial Assurance for Operations With Five (5) or Less Disturbed Acres 1199
  - Financial Assurance Reduction 1200
  - Financial Assurance Release Following Reclamation 1200
  - Financial Assurance to the Federal Government 1200
  - Indirect Costs for Reclamation Cost Calculations 1199
  - Liabilities for Reclamation Costs Not Covered by Financial Assurance 1201
  - Mining Operation Conducted by Public or Government 1200
  - Salvage Value Not Allowed 1200
  - Submittal of Financial Assurance Before Mining 1199
- Financial Condition Of Applicants/ Residents 1369
  - Investigation of Financial Condition 1369
  - Retroactive Income 1369
- Financial Grounds For Rejection Or Discharge 1372
  - Disposal of Assets 1372
  - Failure to Pay for Services 1372
  - Failure to Pay Maintenance Charge 1372
- Financial Information 535
- Financial Requirements 453, 875
  - Safeguarding of Funds 875
  - Statement 875
- Financial Responsibility 121, 1130
  - Bonding 1130
  - Cancellation or Reduction 122
  - Coverage Waived 122
  - Insurance 1130
  - Minimum Coverage Required 122
  - Proof of Financial Ability 121
  - Target Property not Required to be Covered 122
- Financial Responsibility For Adult Mental Health Services 1089
- Financial Responsibility Of Parents For Children's Mental Health Services 1088
- Financial Statement 75
  - Financial Statements 75
  - Statement Compliance 75
  - Statement Content 75
- Financial Statements 68, 649
  - Application of Antifraud Provisions 649
  - Application of Regulation S-X 649
  - Financial Statements Incorporated by Reference 649
- Statement Compliance 68
  - Statement Content 68
- Financial Support Of Educational Program For Practical Nurse, Registered Nurse, & Advanced Practice Registered Nurse 1447
- Financial Technical & Management Capability Analysis 2838
  - Cost Allocation 2839
  - Incorporated Nonprofit Applicants 2838
  - Information Needed 2838
  - Waivers 2839
- Financial, Inter-Country Adoption Services, Children's Agencies 1051
- Fingerprinting & Background Investigation Checks 490
  - Background Investigation Checks for Certification 491
  - Break In Service 492
  - Definitions 490
  - Fee 491
  - Individuals Required to Complete a Background Investigation Check 491
  - Postsecondary 492
  - Rejected Fingerprint Cards or Scans 491
  - Secured Background Investigation Check Website 491
  - Substitute Teachers 492
- Fingerprints 551
  - Existing Licensees 552
  - Fees 552
  - License Applicants 552
  - Fingerprints – Photograph 571
- Fire & Life Safety Standards 850
  - Emergency Preparedness 852
  - Fire and Life Safety Requirements 850
  - Fire Drills 852
  - General Requirements 850
  - Maintenance of Equipment 853
  - Report of Fire 853
  - Smoking 852
- Fire And Life Safety Standards For Existing Buildings Licensed For Seventeen Or More Residents And Multi-Story Buildings 897
- Fire And Life Safety Standards For Existing Buildings Licensed For Three Through Sixteen Residents 897
- Fire And Life Safety Standards For New Buildings Housing Seventeen Or More Residents And Multi-Story Buildings 897
- Fire And Life Safety Standards For New Buildings Housing Three Through Sixteen Residents 896
- Fire Extinguishers & Safety Requirements 1011
  - Automatic Sprinkler Systems 1012
  - Facilities Over Three Thousand

- Square Feet 1012
- Fire Alarm System 1012
- Fire Extinguishers 1011
- Kitchen Area 1011
- Portable Fire Extinguisher 1011
- Smoke Detectors 1012
- Fire Permits, Hazardous Materials & Liability 2519
- Fire Safety & Evacuation Plans 1012
  - Annual Review 1012
  - Assembly Point 1012
  - Evacuation 1012
  - Evacuation Routes 1012
  - Location of Fire Alarms 1012
  - Location of Fire Extinguishers 1012
  - Locations of Facility Exits 1012
- Fire Safety Requirements 1054
  - Carbon Monoxide Detecting Devices 1054
  - Fire Extinguishers 1054
  - Smoke Detecting Devices 1054
- Fire Safety Standards 1010
  - Inspections 1010
  - Unobstructed Exits 1010
- Fire Suppression & Forest Practices Assessment 1309
  - Assessment Costs 1310
  - Withholding 1309
- Firearms & Ammunition 1024
  - Gun Safe 1024
  - Locked Cabinet or Container 1024
  - Trigger Locks 1024
  - Unassembled & Inoperable 1024
- Firearms, Children's Residential Care Facilities 1056
- Firearms, Children's Therapeutic Outdoor Programs 1084
- Firewood & Other Personal Use Product Permits 1154
- Firm Name 1461
  - Firm Names 1461
- Firm Names 29
  - General 29
  - Title 29
- First Aid Kit 1804
- First Aid Kit, Children's Residential Care Facilities 1060
- First Purchaser Rules 2258, 2342
  - Barley Tax Return (Form Number 1) 2342
  - Deduction of Tax on Net Weight of Barley 2343
  - Delivery of Documents to Commission (Form Number 2) 2342
  - Designated Quarters 2258, 2342
  - Late Payment Penalty 2258, 2343
  - Oilseed Tax Invoice (Form Number 1) 2258
- Fitters 1132
  - Duplicate License 1133
  - Examination 1133
  - Fees 1133
  - Period of Time 1133
- Renewal 1133
- Five (5) Year Updates & Periodic Inspections 1214
  - Five (5) Year Updates 1214
  - Frequency of Inspection 1214
  - Right of Inspection 1214
- Flagging Requirements For Oversize Vehicles And/Or Loads 2215
  - Color 2215
  - Placement of Flags 2215
  - Size 2215
  - Warning Flags 2215
- Flammable Liquids, Children's Residential Care Facilities 1056
- Flat Fees 2000
  - Other Claims 2000
  - Small Domestic & Stockwater 2000
- Float Boat Guide - Classified Rivers 1813
- Float Boat Guide - Unclassified Rivers 1813
- Float Boatman Qualifications - Classified Rivers 1813
  - Float Lead Boatman 1814
  - General 1813
  - Other 1814
- Float Lead Boatman Qualifications 1814
- Floor Inlets 770
- Floors In Dressing Rooms, Toilets, Showers 763
- Fluid Containment 1346
- Follow Up & Case Management 781
- Food & Nutrition 1028
- Food Preparation & Service 900
  - Disposable Items 900
  - Food Preparation 900
  - Food Preparation Area 900
  - Frequency of Meals 900
- Food Supply 900
- Force Account As Matching Share 1862
- Foreclosure 2976
- Foreign Animal & Reportable Diseases 142
  - Avian Diseases 143
    - Avian Chlamydiosis (Psittacosis) 143
    - Avian Influenza 143
    - Exotic Newcastle Disease 143
- Bovine Diseases 143
  - Babesiosis 143
  - Bovine Brucellosis (B. abortus) 143
  - Bovine Spongiform Encephalopathy 143
  - Bovine Tuberculosis 143
  - Contagious Bovine Pleuropneumonia 143
  - Crimean Congo Hemorrhagic Fever 143
  - Lumpy Skin Disease 143
  - Malignant Catarrhal Fever (Foreign Type) 143
- Rinderpest 143
- Trichomoniasis 143
- Cervidae Diseases 144
- Equine Diseases 144
  - African Horse Sickness 144
  - Contagious Equine Metritis 144
  - Dourine 144
  - Equine Encephalomyelitis (Eastern, Western, Venezuelan) 144
  - Equine Infectious Anemia 144
  - Equine Piroplasmosis (Babesiosis) 144
  - Equine Viral Arteritis 144
  - Glanders 144
  - Hendra Virus 144
  - Japanese Encephalitis 144
  - Surra (Trypanosoma evansi) 144
- Fish Diseases 144
  - Asian Tapeworm of Carp 144
  - Oncorhynchus Masou Virus Disease 144
  - Spring Viremia of Carp 144
  - Viral Hemorrhagic Septicemia 144
- Lagomorph Diseases 144
- Multiple Species 142
  - Anthrax 142
  - Brucellosis 142
  - Foot & Mouth Disease 142
  - Heartwater 142
  - Leishmaniasis 143
  - Plague (Yersinia pestis) 143
  - Pseudorabies 143
  - Q Fever (Coxiella burnetti) 143
  - Rabies 143
  - Rift Valley Fever 143
  - Scabies 143
  - Screw Worms 143
  - Theileriosis 143
  - Trypanosomiasis 143
  - Tuberculosis 143
  - Tularemia 143
  - Vesicular Stomatitis 143
- Sheep & Goat Diseases 144
  - Contagious Caprine Pleuropneumonia 144
  - Nairobi Sheep Disease 144
  - Ovine Brucellosis (B. melitensis) 144
  - Peste des Petits Ruminants 144
  - Scrapie 144
  - Sheep & Goat Pox 144
- Swine Diseases 144
  - African Swine Fever 144
  - Classical Swine Fever (Hog Cholera) 145
  - Enterovirus Encephalitis (Teschen Disease) 145
  - Nipah Virus Encephalitis 145
  - Porcine Brucellosis (B. suis) 145
  - Swine Vesicular Disease 145
- Forfeiture For Failure To Make Weight 1487
- Dividing Forfeit 1487

- Exception 1487
- Failure to Make Weight 1487
- Forfeiture Of Financial Assurance 1207
- Form 512
- Form & Content Of Petition 450
  - Form 451
  - Service 451
- Form & Contents Of Petition For Declaratory Rulings 1977
  - Form 1977
  - Legal Assertions 1977
- Form & Contents Of Petitions To Intervene 1977
- Form & Distribution Of A PML & CS 1917
  - Content of List 1917
  - Cut-Off 1917
  - PML Publication Dates 1917
  - Schedule 1917
  - Supplementation 1917
- Form Contents
  - Record of Original Corner and Subsequent History 512
- Form Of Financial Assurance 1203
  - Blanket Financial Assurance 1207
  - Collateral Bond 1204
  - Corporate Guarantees 1206
  - Corporate Surety Bond 1204
  - Letters of Credit 1204
  - Real Property 1205
  - Reclamation 1207
  - Trusts 1205
- Form Of Pleadings 1949, 1973
  - Form 1949, 1973
  - Pleadings 1973
- Formal Discipline 2358
- Formal Proceedings 1967
- Format Of Responses 2389
- Formerly Licensed 31
- Forms 1326, 2047, 2050, 2062
  - Form 1721 2050
  - Samples of Forms 2047, 2050
- Formulary 1620, 1746
  - Disorders & Conditions 1621
  - Midwifery Formulary 1746
  - Other Legend Drugs 1747
  - Prohibited Medications & Controlled Substances 1620
- Forwarding Agricultural Commodities 64
- Forwarding Of Benefits 952
  - Home Visit 952
  - Return to Foster Care 952
- Foster Parent Adoptions 977
- Foster Parent Duties 1021
  - Reporting Progress & Problems 1021
  - Service Plan Implementation 1021
  - Termination of Placement by the Foster Family 1021
  - Written Policies & Procedures for Foster Families 1021
- Foster Parent Qualifications & Suitability, Foster Homes 1017
- Acceptance of Foster Children 1018
- Availability for Child Placement 1018
- Character 1018
- Child Care & Supervision 1018
- Compliance with Licensing Rules 1018
- Family Supports 1018
- Harmonious Home Life 1018
- Health 1018
- Income & Resources 1018
- Knowledge & Skill 1018
- Minimum Age 1018
- Personal Attributes & Experiences 1018
- Foster Parent Training 1022
  - Annual Training 1022
  - Individualized Training 1022
  - Initial Training 1022
  - Orientation 1022
  - Required Training 1022
- Fouls
  - Deduction For Points
    - Effect Of Claiming Low Blow By Opponent
    - Contestant Claiming Low Blow 1491
    - Deducting Points Because of Fouls 1491
    - Deduction of Points in Round Foul Occurs 1491
    - Notification of Point Deduction 1491
  - Disqualification of Combatants & Withholding Of Purse 1492
- Fraudulent, Dishonest & Unethical Practices - Broker-Dealer, Broker-Dealer Agents, Issuer Agents, Investment Advisers, Investment Adviser Advertising 675
- Advisory Contract Disclosures 675
- Advisory Contract to Comply with Federal Law 675
- Bona Fide Distribution 673
- Bona Fide Price Reports 673
- Churning 672
- Conflicts of Interest 675
- Contradicting Prospectus Information 674
- Contradictory Recommendations 674
- Customer Communication 673
- Deceptive or Misleading Advertising 673
- Delivery Delays 672
- Disclosure of Control 673
- Disclosure of Private Information 675
- Discretionary Authority 672
- Failure to Supervise 672
- Fictitious Accounts 674
- FINRA & NASD Rules
- Compliance 674
- Fraudulent, Deceptive or Manipulative Acts 675
- Fraudulent, Dishonest & Unethical Practices 671
- Guaranteeing Specific Results 675
- Hypothecating Customer Securities 672
- Inside Information 674
- Loans from Customers 673
- Loans to Customers 674
- Loss Guarantees 673
- Manipulative, Deceptive or Fraudulent Practices 673
- Margin Accounts 672
- Misleading Filings 676
- Misrepresentations Concerning Advisory Services 674
- Outside Business Activities - Selling Away 675
- Penny Stock Sales 674
- Profit/Loss Sharing 674
- Prospectus Delivery 674
- Protection of Non-Public Information 675
- Sales at the Market 673
- Segregation of Client Securities 672
- Splitting Commissions 674
- Third Party Conduct 675
- Unauthorized Transactions 672
- Unreasonable Advisory Fees 674
- Unreasonable Fees 672
- Unreasonable Price, Commission 672
- Unrecorded Transactions 674
- Unsolicited Transactions 674
- Unsuitable Recommendations 672
- Waiver of State or Federal Law Prohibited 675
- Fraudulent, Dishonest & Unethical Practices - Broker-Dealer, Broker-Dealer Agents, Issuer Agents, Investment Advisers, Investment Adviser Representatives 671
- Frequency of Fire & Emergency Evacuation Drills 1012
- Fuel Burning Equipment -- Particulate Matter 2531
- Fugitive Dust Control 2551
  - Fugitive Emission Controls 2551
  - Plant Property Dust Controls 2551
- Fund Allocation 1858
  - Allocation of Funds 1858
  - Eligible Applicants 1858
  - Exceptions 1859
  - Project Requests Insufficient 1859
- Funding 2289
  - Assessments 2289
  - Collection 2289
  - Refunds 2289
- Funding Cycle 1862
  - Fees 1863
  - Generally 1862
  - Procedure 1863

- Funding Of Board Activities 479  
  Fee Assessed 479  
  Notices Issued 479  
  Payment Submission 479  
Funeral Establishment & Crematory  
  Establishment 1573  
  Change in Ownership or  
  Location 1573  
  Contents of Application 1573  
  Crematory Establishment 1574  
  Funeral Establishment 1573  
  Funeral Firm 1574  
Further Proceedings 1967
- G**
- Gaming Devices, Equipment Or  
  Materials 2338  
  Bingo Cards 2338  
  Miscellaneous 2338  
  Number Selectors & Related  
  Equipment 2338  
Garbage Feeding 146  
  Household Wastes 146  
  Inspection & Investigation 146  
Gas Processing Facilities 1353  
  Flaring 1353  
  Inspections 1353  
  Meters & Facility Plans 1353  
  Operations 1353  
Gas Utilization 1352  
Gas-Oil Ratio For Well  
  Classifications 1351  
Gas-Oil Ratio Limitation 1351  
  Determination of Inefficient  
  Ratios 1351  
  Notice & Cause for Hearing 1351  
  Waste Prevention 1351  
Gas-Oil Ratio Surveys & Reports 1351  
Gasoline Cargo Tanks 2518  
  Compliance 2518  
  Prohibitions 2518  
  Recordkeeping & Reporting 2518  
Gathering & Restraining System 188  
  Exceptions 188  
  Gathering System 188  
  Restraining System 188  
General 1999, 2182, 2219  
  Certificate of Registration 2182  
  Certificate of Title 2182  
  Fire-Fighting 1999  
  Government Voucher 1999  
  MCO/MSO 2182  
  Method of Payment 1999  
  Personal Check 1999  
  Rejection of Claim 1999  
  Requirement to Pay 1999  
  Salvage Vehicles 2182  
  Specially Constructed  
  Vehicles 2182  
  Time of Payment 1999  
  Transfer by Operation of Law 2182  
General Applicability, Control Of  
  Ammonia From Dairy Farms 2537  
General Chemigation  
  Requirements 127  
  Chemigating Over Waters of the  
  State 127  
  Chemigation Equipment  
  Standards 127  
  Pesticides Labeled for  
  Chemigation 127  
  Posting Requirements, Category  
  I 127  
General Consultation Process 2486  
  Final Document Distribution 2487  
  Lead Agency in Consultation 2486  
  Public Comment Period to Satisfy  
  Thirty Day Document Distribution  
  Requirement 2487  
  Separate Times or in  
  Combination 2487  
  Use of Checklist for Distribution of  
  Material 2487  
  Use of Other Meetings for  
  Consultation 2487  
General Control Requirements,  
  Nonmetallic Mineral Processing  
  Plants 2542  
  Control of Fugitive Dust 2542  
  Prohibition 2542  
General Cost-Sharing 804  
  Cost-Sharing Maximum  
  Amount 804  
  Cost-Sharing Suspended 804  
  Exception to Cost-Sharing  
  Maximum 804  
  Excess Cost-Sharing 804  
  Proof of Cost-Sharing Payment 804  
General Definitions, IDAPA  
  58.01.01 2364  
  Accountable 2364  
  Act 2364  
  Actual Emissions 2364  
  Adverse Impact on Visibility 2364  
  Air Pollutant/Air Contaminant 2365  
  Air Pollution 2365  
  Air Quality 2365  
  Air Quality Criterion 2365  
  Allowable Emissions 2365  
  Ambient Air 2365  
  Ambient Air Quality Violation 2365  
  Atmospheric Stagnation  
  Advisory 2365  
  Attainment Area 2365  
  BART-Eligible Source 2365  
  Baseline, Area, Concentration, &  
  Date 2366  
  Board 2367  
  Breakdown 2367  
  BTU 2367  
  Clean Air Act 2367  
  Collection Efficiency 2367  
  Commence Construction or  
  Modification 2367  
  Complete 2367  
  Construction 2367  
  Control Equipment 2367  
  Controlled Emission 2367  
  Criteria Air Pollutant 2367  
  Deciview 2367  
  Department 2367  
  Designated Facility 2367  
  Director 2368  
  Effective Dose Equivalent 2368  
  Emission 2368  
  Emission Standard 2369  
  Emissions Unit 2369  
  Environmental Remediation  
  Source 2369  
  EPA 2369  
  Excess Emissions 2369  
  Existing Stationary Source or  
  Facility 2369  
  Facility 2369  
  Federal Class I Area 2369  
  Federal Land Manager 2369  
  Federally Enforceable 2369  
  Fire Hazard 2369  
  Fuel-Burning Equipment 2369  
  Fugitive Dust 2369  
  Fugitive Emissions 2369  
  Garbage 2370  
  Gasoline 2370  
  Gasoline Cargo Tank 2370  
  Gasoline Dispensing Facility  
  (GDF) 2370  
  Grain Elevator 2370  
  Grain Storage Elevator 2370  
  Grain Terminal Elevator 2370  
  Hazardous Air Pollutant  
  (HAP) 2370  
  Hazardous Waste 2370  
  Hot-Mix Asphalt Plant 2370  
  Incinerator 2370  
  Indian Governing Body 2370  
  Integral Vista 2371  
  Kraft Pulping 2371  
  Least Impaired Days 2371  
  Lowest Achievable Emission Rate  
  (LAER) 2371  
  Mandatory Federal Class I  
  Area 2371  
  Member of the Public 2371  
  Mercury 2371  
  Mercury Best Available Control  
  Technology (MBACT) 2371  
  Modification, Stationary Source or  
  Facility 2371  
  Monitoring 2372  
  Most Impaired Days 2372  
  Multiple Chamber Incinerator 2372  
  Natural Conditions 2372  
  New Stationary Source or  
  Facility 2372  
  Nonattainment Area 2372  
  Noncondensibles 2372  
  Odor 2372  
  Opacity 2372  
  Open Burning 2372  
  Operating Permit 2373  
  Particulate Matter 2373  
  Particulate Matter Emissions 2373

- Permit to Construct 2373  
 Person 2373  
 PM10 2373  
 PM10 Emissions 2373  
 PM2.5 2373  
 PM2.5 Emissions 2373  
 Portable Equipment 2373  
 Potential to Emit/Potential Emissions 2373  
 PPM (Parts Per Million) 2373  
 Prescribed Fire Management Burning 2373  
 Primary Ambient Air Quality Standard 2374  
 Process or Process Equipment 2374  
 Process Weight 2374  
 Process Weight Rate 2374  
 Quantifiable 2374  
 Radionuclide 2374  
 Regional Haze 2374  
 Regulated Air Pollutant 2374  
 Replicable 2375  
 Responsible Official 2375  
 Safety Measure 2375  
 Salvage Operation 2375  
 Scheduled Maintenance 2375  
 Secondary Ambient Air Quality Standard 2376  
 Secondary Emissions 2376  
 Shutdown 2376  
 Significant 2376  
 Significant Contribution 2377  
 Small Fire 2377  
 Smoke 2377  
 Smoke Management Plan 2377  
 Smoke Management Program 2377  
 Source 2378  
 Source Operation 2378  
 Special Fuels 2378  
 Stack 2378  
 Stage 1 Vapor Collection 2378  
 Standard Conditions 2378  
 Startup 2378  
 Stationary Source 2378  
 Tier I Source 2378  
 Total Suspended Particulates 2379  
 Toxic Air Pollutant 2379  
 Toxic Air Pollutant Carcinogenic Increments 2379  
 Toxic Air Pollutant Non-Carcinogenic Increments 2379  
 Toxic Substance 2379  
 Trade Waste 2379  
 TRS (Total Reduced Sulfur) 2379  
 Unclassifiable Area 2379  
 Uncontrolled Emission 2379  
 Upset 2379  
 Visibility Impairment 2379  
 Visibility in Any Mandatory Class I Federal Area 2379  
 Wigwam Burner 2379  
 Wood Stove Curtailment Advisory 2379  
 General Description Of The Procedure
- To Be Used For Allocation 2098  
 Applications to Appropriate Unappropriated Water & Water Held in Trust 2098  
 Applications to Appropriate Water From Sources Held by State in Trust 2098  
 General Drilling Rules 1344  
 Conductor Pipe or Casing Requirements 1344  
 Drilling Mud Disposal 1346  
 General Design Requirements for Casing & Cementing 1344  
 High Temperature Conditions 1344  
 Interim Drill Site Clean Up 1347  
 Intermediate Casing 1345  
 Mud Pits 1346  
 Production Casing 1346  
 Report of Water Encountered 1346  
 Requirements for BOP Equipment 1344  
 Spill Prevention, Control, & Countermeasures Plan 1347  
 Step-off 1346  
 Surface Casing Requirements 1344  
 Well Control (Cable Tools) 1346  
 Well Control (Rotary Tools) 1346  
 Wildcat & High-Pressure Conditions 1344  
 General Exemption Criteria For Permit To Construct Exemptions 2422  
 General Exemption Criteria 2422  
 Record Retention 2422  
 General Instant Ticket Game Operating Rules 2310  
 Confidentiality of Tickets 2314  
 Definitions 2310  
 Instant Ticket Validation Bar Code 2310  
 ITA System 2310  
 Pack 2310  
 Pack-Ticket Number 2311  
 Play Symbol Caption 2311  
 Play Symbols 2311  
 Retailer Validation Code 2311  
 Ticket 2311  
 Ticket Validation Number 2311  
 Determination of Winners 2312  
 Discharge of All Liability upon Payment 2314  
 Governing Law 2314  
 Instant Games -- Authorized -- Director's Authority 2310  
 Instant Games Ticket Price 2311  
 Number & Value of Instant Ticket Prizes 2311  
 Official End of Game 2314  
 Official Start of Game 2311  
 Payment of Prizes 2312  
 Payment of Prizes to Persons Under Eighteen Years of Age 2314  
 Prize Rights Unassignable 2313  
 Prize Structures 2311  
 Prizes Payable After Death or
- Disability of Owner 2314  
 Sale of Tickets 2311  
 Ticket Validation Requirements 2313  
 Unclaimed Prize Money 2314  
 General Ledger 2333  
 Annual Report 2333  
 Documentation 2333  
 Establishment of General Ledger 2333  
 Retention of Records 2333  
 General Ledger & Recordkeeping 2334  
 General Liability Insurance Requirement 1706  
 Original Facility License Application 1706  
 Renewal of Facility License 1706  
 General Permits 2919  
 Administration 2921  
 Case-by-Case Requirements for Individual Permits 2923  
 Coverage 2919  
 Electronic Submittals 2920  
 Information Retention Schedule 2920  
 Notice of Intent 2920  
 General Provisions 518, 1321, 1527, 1858, 1925, 2180, 2523  
 Address Change 1528  
 Advisory Committee 2524  
 Allocation of Revenues for Prizes 2297  
 Annual Report 2524  
 Authority to Stagger the Renewal of Licenses to Sell Alcohol 518  
 Burn Provisions 2523  
 Burning Prohibitions 2523  
 Certificates 1527  
 Claims 2298  
 Committees 1527  
 Contingency Reserve 2296  
 Delegation of Authority to License Alcoholic Beverages 518  
 Director 2296  
 Disability of Prize Winner 2299  
 Disputed Prizes 2299  
 Effect of Game Rules 2299  
 Filing of Documents 1527  
 Hearing Fee Refunds & Additional Charges 2180  
 Hearing Filing Fee 2180  
 Hearing Officer Appointment 2180  
 Location of Hearings 2180  
 Lottery Budgets & Financial Statements 2296  
 Lottery Commission 2295  
 Meetings 1527  
 Officers 1527  
 Open Meeting Law 2295  
 Ownership of Lottery Tickets 2298  
 Powers & Duties of the Commission 2295  
 Powers & Duties of the



- Director 2296
- Prizes Payable After Death of Winner 2299
- Purpose 2295
- Retail Drawings 2297
- Retail Ticket Price Discounts 2297
- Sale of Lottery Tickets 2299
- Seals 1527
- Special Drawings 2297
- Stolen or Lost Tickets 2299
- Time & Place of Meetings 2295
- General provisions 793
- General Provisions For Ambient Air Quality Standards 2491
  - Applicability 2491
  - Control of Unregulated Contaminants 2491
  - Methods 2491
  - Revisions 2491
  - Standard Conditions 2491
- General Provisions For Registration
  - Annual Renewal of Registration 1397
  - Disclosure 1398
  - Notification of Change 1398
  - Termination of Registration 1397
- General Provisions For Waivers, Variances, & Exemptions 2628
  - Conditions 2629
  - Exceptions 2629
  - Exemptions 2629
  - Public Hearing 2629
  - Surface Water Exemptions 2629
  - Surface Water Variances 2629
  - Variances 2628
  - Waivers 2628
- General Qualifications For Licensure 1403, 1554
  - Applicant 1554
  - Education 1554
  - Examination 1554
- General Qualifications For Licensure & Renewal 1389, 1409
  - Additional Circumstances 1389
  - Application for Respiratory Care & Polysomnography Related Respiratory Care Practitioner 1409
  - Board Determinations 1389
  - Special Purpose Examination 1389
- General Qualifications For Licensure and Renewal 1407
- General Qualifications for Licensure and Renewal 1412
- General Requirements 1938
- General Requirements & Services 940
- General Requirements Applicable To All Child & Family Services Programs 940
  - Individual Authorized to Request Voluntary Services 940
  - Information to Be Provided to Family 940
  - Information, Referral & Screening 940
  - Initiating Child & Family Services 940
  - Record of Request for Services 940
- General Requirements For License 1539
  - Apprenticeship Program 1539
  - Education Requirements 1539
  - Examination Requirement 1539
  - Experience Requirement 1539
- General Resource Category Aquifers, Management of Activities With the Potential to Degrade Aquifers 2770
- General Restrictions On Visible Emissions From Wigwam Burners 2526
- General Restrictions, Open Burning 2519
  - Air Pollution Episodes 2519
  - Categories & Materials 2519
  - Emergency Authority 2519
- General Rules 1591
  - Engaging as an Advisor or Staff Optometrist 1591
  - Professional Responsibilities 1591
- General Rules, Emergency Episode Stage 2478
  - Stage 1 - Air Pollution Forecast & Caution 2478
  - Stage 2 -- Alert 2478
  - Stage 3 -- Warning 2478
  - Stage 4 -- Emergency 2479
- General Rules, Odorous Gases, Liquids & Solids 2541
  - General Restrictions 2541
  - Restrictions on Rendering Plants 2541
- General Rules, Particulate Matter 2527
  - Application of Dust Suppressants 2527
  - Covering of Trucks 2527
  - Paving 2527
  - Removal of Materials 2527
  - Use of Control Equipment 2527
  - Use of Water or Chemicals 2527
- General Rules, Sections 750 & 751 2536
  - Emission Limitations -- Phosphate Fertilizer Plants 2536
  - Exemptions 2537
  - Monitoring, Testing, & Reporting Requirements 2536
  - Source Specific Permits 2536
- General Safety Provisions 1056
  - Balconies & Stairways 1056
  - Hazard Areas Restrictions 1057
  - Reasonable Precaution 1056
  - Stairway Protection 1056
- General Scaling Requirements 1316
  - Load Identification 1316
  - Recording Measurements on Scale Tickets 1316
  - Written Scaling Specifications 1316
- General Standards For Organizations Known As Children's Agencies & Children's Residential Care Facilities 1031
- General Terms 53
- Inedible Eggs 53
- Leaker 54
- Loss 53
- General Tier I Operating Permits & Authorizations To Operate 2445
  - Applications for Authorizations to Operate 2446
  - Contents of General Tier I Operating Permits 2445
  - Issuance of General Tier I Operating Permits 2445
  - Phase II Sources 2446
  - Procedures for Issuing Authorizations to Operate 2446
  - Review of Authorizations to Operate 2446
- General Variances 823
  - Special Conditions 823
  - Variance Not Transferable 823
  - Variance Renewal 823
  - Written Request 823
- Generation Of Ad Hoc Information Reports 1918
  - Additional Criteria 1918
  - Internal Organization 1918
  - Options 1918
- Genetics 186
- Geologist In Training 1530
  - Limitation 1530
  - Supervised Practice 1530
- Geophysical Operations 1327
  - Bond Required 1329
  - Client-Contractor Responsibility 1331
  - Department Notifications 1330
  - Forfeiture of Geophysical Exploration Bond 1331
  - Newspaper Notice 1330
  - Operating Requirements 1328
  - Owner & Occupant Notification 1330
  - Permit Required 1327
  - Plugging 1331
  - Reports & Notices Required 1330
- Geothermal Pool Exemptions 772
  - Exemptions 772
  - Remodeling 772
- Germination Standards For Flower Seeds 223
  - Below Standard 228
  - Table 1 223
- Germination Standards For Seed In Hermetically Sealed Containers 228
  - Conditions of Packaging 228
  - Germination 230
  - Germination Tests 228
  - Labeling 230
  - Moisture 229
  - Table 1 229
  - Table 2 229

- Germination Standards For Vegetable Seeds 221  
Glider Kits 2188  
Assignment of VIN 2189  
Make of Vehicle 2189  
Model Year 2189  
Title Application Requirements 2188  
Title Branded 2189  
Global Filings 1938  
Filing a Single UCC Document 1938  
Global Filing 1938  
Gloves To Be Wiped By Referee After Boxer Falls 1492  
Goat Assessments 372  
Assessment as Resident Goats 372  
Costs of Collection 373  
Payment of Assessment 372  
Good Cause Determination In License Suspension Proceedings 798  
Definitions 798  
Good Cause in Motor Vehicle & Occupational License Suspension Proceedings 799  
Good Cause in Recreational License Suspension Proceedings 799  
Not Good Cause in Motor Vehicle & Occupational License Suspension Proceedings 799  
Res Judicata 798  
Good Engineering Practice (GEP) Stack Height 2471  
Good Moral Character 23  
Demonstrating Good Moral Character 23  
Evidence 23  
Rehabilitation 23  
Gooseneck Pipe Loop, Downhill & Over-A-Hill 132  
Location 132  
Location of Chemical Injection Port 132  
Pipe Loop 132  
Position 132  
Use Restriction 132  
Governing Body Required 1032  
Grade A Milk And Milk Products Quality Standards 153  
Bacterial Limit Standard 153  
Out of State Milk 154  
Somatic Cell Count Standard 154  
Grade Standards - Tolerances 54  
Grade A (At Destination) 54  
Grade A (At Origin) 54  
Grade AA (At Destination) 54  
Grade AA (At Origin) 54  
Grade B (At Destination) 55  
Grade B (At Origin) 55  
Grades & Standards 51  
A Quality 51  
AA Quality 51  
Application 51  
B Quality 51  
Check 52  
Classifications 51  
Dirty 52  
Interior Egg Quality Specifications 51  
Standards 51  
Graduate of Basic Police Academy 629  
Graduate Physician Assistant 1400  
Licensure Prior to Certification Examination -- Board Consideration 1400  
Licensure Prior to College Baccalaureate Degree -- Board Consideration 1401  
No Prescribing Authority 1401  
Weekly Record Review 1401  
Graduated Gross Sales Fee Schedule 358  
Graduated Gross Sales Fee Table 358  
Non-Refundable 359  
Graduates Of Unapproved Medical Schools Located Outside Of The United States Or Canada 1390  
Board Certification 1390  
Five Years Unrestricted Practice 1390  
Three Years of Completed Post Graduate Training 1390  
Valid ECFMG Certificate 1390  
Granting Petitions To Intervene 1977  
Granules (also Granular) 2119  
Gray Market Vehicles 2190  
Conditional Registration 2190  
Designation of Model Year 2190  
Exception 2190  
Foreign Documents 2190  
Required Documents 2190  
Greenhouses 296  
Groom 554  
Gross Decimal "C" Scale Determination 1316  
Gross Scale Determination 1313  
Gross Volume Conversions 1316  
Conversion Factors 1316  
Conversion to Gross Decimal "C" or Gross Cubic Volume 1316  
Other Conversion Factors 1316  
Ground Water Contamination 2772  
Agricultural Chemicals 2773  
Contamination Exceeding a Ground Water Quality Standard 2773  
Measures Taken in Response to Degradation 2772  
Releases Degrading Ground Water Quality 2772  
Site-Specific Ground Water Quality Levels or Points of Compliance 2773  
Ground Water Quality Monitoring 219  
Ground Water Quality Standards 2765  
Narrative Ground Water Quality Standards 2769  
Natural Background Level 2769  
Numerical Ground Water Quality Standards 2765  
Primary Constituent Standards 2765  
Secondary Constituent Standards 2769  
Ground Water Rule 2648  
Chlorine Purging Prior to Triggered Source Sampling 2648  
Discontinuation of Treatment 2648  
Grounds For Denial Or Revocation Of License 1473  
Specific Conduct 1473  
Subject to Discipline 1473  
Grounds For Disciplinary Action 1507  
Good Conduct 1507  
Valid Orders of Commission 1507  
Violation of Laws 1507  
Violation of Rules 1507  
Grounds For Discipline 1423  
Action Against a License 1424  
Conduct to Deceive, Defraud or Endanger 1424  
Conviction of a Felony 1423  
Failure to Cooperate With Authorities 1424  
Failure to Make Timely and Appropriate Inquiry 1424  
False or Assumed Name 1423  
False Statement 1423  
Gross Negligence or Recklessness 1424  
Habitual Use of Alcohol or Drugs 1424  
Offense Involving Moral Turpitude 1423  
Patterns of Poor Practice 1424  
Physical or Mental Unfitness 1424  
Violations of Standards of Conduct 1424  
Grounds For Discipline - CEAs & CETs 2283  
Abuse of Chemical Substances 2283  
Administration of Approved Drugs Without Proper Supervision 2283  
Aiding & Abetting 2284  
Conviction of a Charge or Crime 2284  
Conviction of Violating Any Federal or State Statute, Rule or Regulation 2284  
Current Certification 2285  
Euthanizing of Animals Without Proper Certification 2283  
Euthanizing of Animals Without Proper Supervision 2283  
Failure to Carry Out Duties 2283  
Failure to Cooperate 2284  
Fraud, Misrepresentation, or Deception 2283  
Improper Disposal of Approved Drugs & Equipment 2284  
Improper Drug Preparation 2285

- Improper Labeling of Approved Drugs 2284
  - Improper Record Keeping 2284
  - Improper Security for Approved Drugs 2284
  - Improper Storage of Equipment & Approved Drugs 2284
  - Revocation, Suspension, Limitation or Restriction 2284
  - Unethical or Unprofessional Conduct 2283
  - Violation of any Law, Rules or Orders 2285
  - Grounds For Discipline Of An Advanced Practice Registered Nurse License 1439
  - Other Than Therapeutic Purposes 1439
  - Outside Scope of Practice 1439
  - Prescribing or Dispensing Controlled Substances 1439
  - Violating Governing Law 1439
  - Grounds For Discipline Of Veterinary Technicians 2267
  - Acceptance of Fees 2269
  - Aiding or Abetting 2269
  - Continuing Education 2269
  - Conviction of a Charge or Crime 2268
  - Conviction of Violating Any Federal or State Statute, Rule or Regulation 2268
  - Cruelty to Animals 2268
  - Current Certification 2269
  - Failure to Cooperate 2269
  - Fraud, Misrepresentation, or Deception 2267
  - Malpractice or Negligence 2268
  - Medical Incompetence 2268
  - Physical or Mental Incompetence 2268
  - Revocation, Suspension, Limitation or Subjection 2269
  - Unethical or Unprofessional Conduct 2267
  - Unlawful Practice 2269
  - Violation of Law, Rules or Order 2269
  - Grounds For Discipline Or Denial Of A License 1404
  - Ability to Practice 1404
  - Controlled Substance or Alcohol Abuse 1404
  - Education or Experience 1404
  - Failure to Obey Laws & Rules 1405
  - Failure to Report 1405
  - Interfering with or Influencing Disciplinary Outcome 1405
  - Medical Records 1404
  - Sexual Misconduct 1404
  - Untrained Practice 1404
  - Grounds For Refusal Of UCC Document 1929
  - Additional Debtor Identification 1929
  - Debtor Name & Address 1929
  - Fee 1930
  - Lack of Identification of Initial Financing Statement 1930
  - Means of Communication 1930
  - Other Required Information 1930
  - Secured Party Name & Address 1930
  - Timeliness of Continuation 1930
  - Grounds For Suspension, Revocation Or Denial Of License 2340
  - Group Foster Care 956
  - Payment - Group Foster Care 957
  - Placement 957
  - Referral - Group Foster Care 957
  - Group Insurance Plan Approved Policy 1904
  - Grouping By Age 1076
  - Age 1076
  - Placement 1076
  - Grower Records 276
  - Certificate of Origin 276
  - Record of Sale 276
  - Records 276
  - Guarantee Of Denturist Services 1669
  - Cancellation of Agreement 1670
  - Limitation 1670
  - Ninety Day Period 1669
  - Nonrefundable Amount 1669
  - Written Contract 1669
  - Guest Associations 542
  - Contract Approval 542
  - Plan for Testing 542
  - Guide Application Requirements - Amendment 1812
  - Guide Application Requirements - General 1812
  - First Aid Card 1812
  - Signatures 1812
  - Guide Application Requirements - Hunting 1812
  - Apprentice Guide 1813
  - Guide 1813
  - Upgraded 1813
  - Guidelines For Approval Of Continuing Education Credits 1607
  - Board Assessment of Continuing Education Activities 1608
  - Continuing Education Credit 1607
  - Credit for International, National & Regional Meetings of Psychological Organizations 1608
  - Credit for Other Relevant Workshops, Licensed Psychologist Classes or Training Experiences 1608
  - Electronic Continuing Education Courses 1609
  - Presentation of Papers 1608
  - Self-Study, Lectures or Public or Professional Publications & Presentations 1608
  - Guidelines For Use Of Service Extenders To Licensed Psychologists 1609
  - Conditions for Use of Service Extenders 1610
  - General Provisions for Licensed Psychologists Extending Their Services Through Others 1609
  - Qualifications for Service Extenders 1610
- H**
- Hair Testing 588
  - Hair Sample 588
  - Positive Finding for Prohibited Substance 588
  - Presence of Prohibited Substances 588
  - Racing Commission Authority 588
  - Hand Sinks 764
  - Handbooks 568
  - Handling Of Money Associated With The Board's Water Supply Bank 1996
  - Handling Of Money Associated With The Board's Water Supply Bank Credited Amount 1996
  - Excess Funds 1996
  - Handrails 761
  - Hazardous Drugs Preparation 1894
  - Clear Identification 1895
  - Compliance With Laws 1895
  - Contamination Prevention 1895
  - Labeling 1895
  - Policy and Procedures Manual 1895
  - Protective Equipment & Supplies 1895
  - Training 1895
  - Ventilated Cabinet 1895
  - Ventilation 1895
  - Hazardous Materials Or Toxins, Children's Residential Care Facilities 1055
  - Hazardous Waste Facility Siting License Fee 2561
  - Expansion, Enlargement or Alteration of a Commercial Hazardous Waste Disposal, Treatment or Storage Facility or Any On-Site Land Disposal Facility for Wastes Listed Pursuant to Section 201(D)(2) and (E), as Modified by Section 209 of the Hazardous & Solid Waste Amendments of 1984 2562
  - License Fee Criteria 2561
  - License Fee for Facilities Required to Submit Engineering or Hydrogeological Information 2561
  - License Fee Scale 2561
  - Siting License Fee Nonrefundable 2562
  - Hazardous Waste Management

- System 2556
- Hazardous Waste Permit Program 2560
- Health & Safety
  - Safety & Sanitation 765
    - Contamination 765
    - Disease 765
    - Glass 765
    - Running & Roughhousing 765
    - Shower 765
- Health And Safety
  - Access 765
  - Emergency Communication 765
  - Lifeguard Chairs 765
  - Lifeguard Requirement 764
    - When Lifeguards are Not Required 765
    - When Lifeguards are Required 764
  - Lifesaving Equipment 765
    - Equipment Accessibility & Condition 765
    - Rescue Tube 765
    - Shepherd's Crook, Backboard, & First & Kit 765
  - Operator 764
  - Pool Closure 764
- Health Care 1079
  - Daily Physical Assessment 1079
  - Documentation 1079
  - Field Treatment 1079
  - First Aid 1079
  - Negative Consequences 1079
  - Weekly Physical Assessment 1079
- Health Hazards 2630
  - Prohibited 2630
  - Schedule 2630
  - Standards 2630
- Health Insurance 1476
- Health Services, Residential Care Facility 1038
- Health Standards 1012, 2138
  - Adequate Heat, Light & Ventilation 1014
  - Diaper Changing 1013
  - Dishwashing Sanitizing 1013
  - Distances From Contaminant Sources 2138
  - Food Contact Surfaces 1013
  - Food Preparation 1013
  - Food Source 1013
  - Food Storage 1013
  - Food Temperatures 1013
  - Garbage 1013
  - Hand Washing 1013
  - Immunizations 1014
  - Medication 1014
  - Public Water System Wells 2138
  - Restrooms, Water Supply & Sewage 1013
  - Sewage Disposal 1014
  - Sleeping Areas 1013
  - Smoke Free Environment 1014
  - Special Standards for Construction of Wells When Mineralized or Contaminated Water Is Encountered 2138
  - Use of Alcohol & Illegal Drugs 1014
  - Utensil Storage 1013
  - Water Supply 1013
- Hearing Before The Water Resource Board 2023
  - General 2023
  - Hearings on Conditional Permits, Disapproved Applications, or Petitions for Exemption 2023
  - Hearings on Permit Cancellations 2023
- Hearing Evaluation 1720
  - Exemptions 1720
  - Pre-Fitting Testing 1720
  - Purpose of Rule 1720
  - Records 1720
  - Sound Field Testing 1720
- Hearing Officers Contrasted With Agency Head 1978
- Hearing Provisions For Residential And Domiciliary Care 1377
  - Appearance & Representation 1378
  - Computation of Time 1377
  - Contents of the Record 1380
  - Default 1379
  - Evidence 1379
  - Ex Parte Consultations 1378
  - Hearing Officer Authority 1378
  - Hearing Officer Decision 1379
  - Judicial Review 1380
  - Official Notice 1379
  - Open Hearings 1378
  - Order of Presentation & Burden of Proof 1379
  - Representation by Counsel 1378
  - Review by the Division Administrator & Issuance of the Final Order 1380
  - Service of Documents 1377
  - Testimony by Telephone or Other Electronic Means 1379
  - Testimony Under Oath 1378
- Hearings 467, 1131
  - Notes 467
  - Procedure 467
- Hearings On Denied, Limited, Or Conditioned Permit Or Other Decisions Of The Director 2086
- Hearings On Refused, Limited, Or Conditioned Permit 2047
- Hearings, Notice, Procedure 2046
- Heating, Children's Residential Care Facilities 1055
- High Adventure Requirements 1071
  - High Adventure Activities 1071
  - High Adventure Activities Leader 1071
  - High Adventure Activity Policy & Procedures 1071
- Higher Level Certification 622
- Requirements 622
  - Types of Higher-Level Certification 622
- Hold Harmless 352, 1292
- Hold Orders 324, 353
  - Hold Order 324
  - Notification to Owner 324
  - Release of Hold Order 324
- Home Construction & Physical Home Standards 853
  - Accessibility for Residents with Physical & Sensory Impairments 854
  - General Requirements 854
  - Heating and Cooling 855
  - Lighting 855
  - Plumbing 855
  - Resident Sleeping Rooms 855
  - Storage Areas 855
  - Telephone 854
  - Toilet Facilities & Bathrooms 854
  - Ventilation 855
  - Walls & Floors 854
- Home Garden Exemption 307
- Home Study Update 977
  - A Home Study Update Completed for the Purpose of Adoptive Placement of an Additional Child or Children in the Home 977
  - Circumstances Adversely Impacting Child Placed for Adoption 977
  - Family Functioning and Inter-Relationships 977
  - Initial Adoption Home Study and Subsequent Home Study Updates 977
- Home Study, Supervisory Reports, & Reports Of The Court Fees 978
- Honoring Actions Of Regulatory Agencies In Other Jurisdictions 1468
  - Suspension 1468
- Horse Race Tracks 574
  - Implements 574
  - Limit on Number of Horses 574
  - Racing Surface 574
  - Rails 574
  - Track Width 574
- Horsemen's Account 573
- Horsemen's Agreement 570
- Horses Not Stabled On Grounds 588
- Hospital In-Patient Services 781
- Host Association 542
  - Content 542
  - Contract 542
  - Security Controls 542
  - Video 542
- Host Participating In Interstate Common Pools 544
  - Rules of Racing Established 544
  - When Impossible to Merge Pools 544
- Hourly Adult Care 830
  - Enrollment Contract 830

- Fire and Life Safety 831  
Medications 831  
Participants 830  
Records 830  
Resident's Personal Space 831  
Service Logs 831  
Space and Accommodations 831  
Staffing 831  
Hourly Adult Care Requirements 877  
Accommodations 878  
Assistance with Medications 878  
Cost of Hourly Adult Care 877  
Documentation 878  
Hours for Care 878  
Individuals Accepted 877  
Services Offered 877  
Staffing 878  
Hours of Supervision 1618  
House Parent Relief Staff, Children's Residential Care Facilities 1053  
How Assessments Are To Be Calculated 69, 77, 107  
Cash Sale or Credit Sale Contract 69, 77  
Contract 107  
Incidental Costs & Expenses 69, 77, 108  
Open Storage or Deposit for Service 69  
Seed Stored for Withdrawal 107  
Unpaid Assessments 69, 77, 108  
How Hearings Held 1983  
Human Resources Needed, Residential Care Facility 1034  
Hunter & Archery Education 681  
Fees 681  
Mandatory Hunter & Archery Education Programs 681  
Parent to Attend Shooting Clinic with Student 681  
HVAC Apprentice Requirements For Registration 474  
Registration 474  
Supervision 474  
HVAC Contractor & HVAC Journeyman Applications For Examination & Certificates Of Competency, & Registration Of Apprentices 472  
Application Forms 472  
Application Submission 472  
Application, Renewal, & Registration Fees 472  
HVAC Contractor Certificate Of Competency - Requirements 472  
Bond 472  
Examination 472  
Out-of-State Contractor Applications 472  
Qualification 472  
HVAC Fuel Gas Piping Specialty Journeyman Certificates Of Competency Limitations Requirements 475  
Education 475  
Examination 475  
Experience 475  
HVAC Hearth Specialty Journeyman Certificates Of Competency Limitations Requirements 474  
Education 474  
Examination 474  
Experience 474  
HVAC Journeyman Certificates Of Competency & Examination Requirements 473  
Certificate of Competency Requirements 473  
Examination Requirement 473  
Out of State Journeyman Applications 473  
HVAC Permit Fee Schedule 475  
Additional Fees 476  
Miscellaneous 476  
No Permit 477  
Other Installations Including Industrial & Commercial 476  
Residential 476  
HVAC Permits 475  
Home Owners 475  
HVAC Contractors & HVAC Specialty Contractors 475  
Refunds of Permits 475  
Serial Number 475  
Transferring a Permit 475  
HVAC Specialty Apprentice Requirements For Registration 474  
Age 474  
Supervision 474  
Training 474  
HVAC Specialty Contractor Certificate Of Competency - Requirements 473  
Bond 473  
Examination 473  
Qualification 473  
HVAC Waste Oil Heating Specialty Journeyman Certificates Of Competency Limitations Requirements 474  
Examination 475  
Experience 474  
Hydraulic Fracturing 1336  
Application Requirements 1336  
Post Treatment Report 1338  
Pressure Monitoring 1337  
Volatile Organic Compounds & Petroleum Distillates 1337  
Well Integrity 1337  
Hypodermic Needles 580  
Disposable Needles 580  
Medical Condition 580  
Possession Prohibited 580
- I**
- ICC Member Responsibilities In Consultation 2484  
Designated Lead Air Quality Agency Responsibilities 2484  
Designated MPO Responsibilities 2485  
EPA Responsibilities 2486  
FHWA & FTA Responsibilities 2485  
Non-MPO Area Responsibilities 2485  
Responsibility to Disclose Potentially Regionally Significant Projects 2486  
ICC Member Roles In Consultation 2484  
Areas with an MPO 2484  
Areas Without an MPO 2484  
Designated Lead Air Quality Agency 2484  
Idaho 277  
Idaho Bleeder List 587  
Bleeder 587  
Bleeder from Another Jurisdiction 587  
Placed on Idaho Bleeder List 587  
Removal from Bleeder List 587  
Idaho Bred Races 569  
Certificate of Registration 569  
Number of Races 569  
Idaho Child Protection Central Registry Checks 922  
Department Response 923  
Fee Amount 923  
Request for an Idaho Child Protection Central Registry Check 923  
Idaho Grown Seeds Shipped East of the Continental Divide in the Contiguous United States or to a Foreign Country and Returned 309  
Idaho Livestock Moving To Pasture Out Of State 533  
Idaho Organic Certification Seal 355  
Description of Seal 355  
Utilization of Seal 356  
Idaho Origin Sheep Interstate Grazing Permit 369  
Idaho Public Records Act 212  
Identification 202, 210  
Identification & Listing Of Hazardous Waste 2556  
Excluded Wastes 2556  
Hazardous Secondary Materials Managers Emergency Notification 2556  
Identification Of Breeding Sheep Acceptable Identification 370  
Assignment of APHIS Approved Idaho Premises/Flock Identification Numbers 369  
Identification Exemption 370  
Importation Identification 370  
Loss of Identification 370  
Responsibility for Identification 369  
Time of Identification 370  
Identification Of Communications 1966

- Identification Of EIA Reactors 142  
 Identification Of Exposed Swine 147  
 Identification Of Infected Swine 147  
 Identification of Wells 1343  
     Signs 1343  
 Identification, Livestock Trader Lot  
     Cattle 204  
 Identifying An Account Number  
     Name of Natural Persons 562  
     Nontransferable 562  
     Principle Residence 562  
     Secure Personal Identification  
         Code 562  
     Upon Approval Account Holder  
         Receives 562  
 Identity 84  
     Declaration of Identity -- Consumer  
         Package 84  
     Declaration of Identity --  
         Nonconsumer Package 84  
     Declaration of Responsibility --  
         Consumer & Nonconsumer  
         Packages 84  
     Parallel Identity Declaration --  
         Consumer Package 84  
 ILETS Board  
     Meetings & Quorum 599  
         Quorum 599  
         Representation at Meetings 599  
         Schedule of Meetings 599  
     Powers & Duties, Chairman, & Ad  
         Hoc Advisory Committees 599  
         Advisory Committees 599  
         Election of Chairman 599  
         Powers & Duties 599  
         Presiding Officer 599  
 ILETS Network 599  
     Establishment 599  
     Responsibilities 599  
 ILETS Security 603  
     Agency Security Contacts 604  
     Definitions 603  
     General Policy 603  
     ILETS Security Officer 604  
     Interface Agency Agreements 604  
     Network Security Standards 605  
     Peer Networks 604  
     Physical Security Standards 604  
 Illegal Actions 2563  
     Failure to Comply with These Rules,  
         the HWMA, or Other  
         Requirements 2563  
     False Statements or  
         Representations 2563  
 Illegal Practices By Trainer 589  
     Disciplinary Sanctions 589  
     Disqualification for Non-Permitted  
         Substance 589  
 Illustration Of Dimensions Of Diving  
     Area 762  
 Illustration Of Pool Side Wall 760  
 Implementation 2764  
     Aquifer Categorization 2764  
         Level of Protection & Application  
             of Standards to Aquifer  
                 Categories 2764  
     Ground Water Quality  
         Standards 2764  
     Ground Water-Surface Water  
         Interconnection 2765  
     Interagency Coordination 2765  
 Implementation Of Agreed To  
     Practices 2975  
     Drawing Loan Funds 2975  
     Practice Completion 2975  
     Submitting Vouchers & Bills 2975  
     Warrant Requests 2975  
 Implementation Of CRD 658  
     Designation & Use of CRD  
         System 658  
     Electronic Signature 659  
     Registrations Not Automatic 659  
 Implementation Of IARD 659  
     Designation 659  
     Electronic Filing 659  
     Hardship Exemptions 659  
     Use of IARD 659  
 Implementation Of Voluntary  
     Remediation Work Plan 2828  
     Implementation 2828  
     Permits or Approvals Necessary for  
         Implementation 2828  
     Progress Reports 2828  
     Voluntary Remediation Work Plan  
         Completion Report 2828  
 Importation Of Domestic  
     Cervidae 183  
 Importation Of Scrapie Exposed,  
     Suspect & High Risk Animals  
     Officially Identified 369  
     Valid Permit 369  
 Impossibility Of Performance 1292  
 Impounding 793  
 Improper 2284  
 Improper Conduct 509  
     Actions by Other Jurisdictions 509  
     Confidentiality 509  
     Fraudulent or Dishonest  
         Enterprises 509  
 Improvement Credit 1263  
     Cost Sharing 1264  
     Exchange 1263  
     Maintenance Costs 1264  
     Sale or Auction 1263  
     Unauthorized Improvements 1264  
     Value Only to Lessee 1263  
 Improvement Of Technology &  
     Communications By  
     Stakeholders 480  
     Adoption of Technology and  
         Communications Materials 480  
     Availability of Technology &  
         Communications Materials 480  
     Inactive License 1512, 1571  
     Clinical Nutrition Certificate  
         Expires 1513  
     Inactive License Status 1571  
     Inactive License Status  
         Renewal 1512  
         Inactive Status 1512  
     Reissuance of Clinical Nutrition  
         Certificate 1513  
     Request for Inactive License 1571  
     Return to Active License  
         Status 1571  
     Return to Active Status of License  
         Inactive for Five (5) or Fewer  
         Years 1512  
     Return to Active Status of License  
         Inactive for More Than Five (5)  
         Years 1513  
     Inactive Licensure Status 1666  
     License Fee for Inactive Status 1667  
     License Inactive Over Five  
         Years 1667  
     Reactivating Inactive License 1667  
     Request License be Placed on  
         Inactive Status 1666  
     While on Inactive Status 1667  
     Inactive Status 1557, 1598, 1605,  
         1640, 1657, 1675, 1711, 1725  
     Inactive License Status 1558, 1598,  
         1605, 1641, 1658, 1711, 1726  
     Reinstatement to Full Licensure from  
         Inactive Status 1558, 1726  
     Request for Inactive Status 1558,  
         1598, 1605, 1641, 1658, 1711,  
         1726  
     Return to Active Status 1675  
     Waiving Continuing Education  
         Requirements - Inactive  
         Status 1675  
     Inactive Wells 1354  
         Converting Inactive Wells to Active  
         Wells 1354  
         Determination of Inactive  
         Status 1354  
         Inactive Review & Decision 1354  
         Owner's or Operator's Responsibility  
         for Inactive Wells 1354  
         Testing of Inactive Wells 1354  
     Incident Reporting 1149  
     Inclement Weather 291  
     Income, Benefits & Savings Of Children  
         In Foster Care 952  
     Income, Program Eligibility 784  
     Incorporation By Reference 22, 49, 79,  
         109, 179, 212, 335, 343, 351, 355,  
         364, 376, 397, 597, 644, 716, 745,  
         788, 812, 860, 993, 1135, 1154, 1221,  
         1311, 1321, 1360, 1382, 1458, 1563,  
         1596, 1602, 1650, 1681, 1696, 1705,  
         1710, 1724, 1743, 2016, 2262, 2289,  
         2345, 2572, 2599, 2764, 2796, 2819  
         335  
     "Idaho Sexual Offender Management  
         Board Standards & Guidelines for  
         Practitioners, Evaluations &  
         Treatment of Juvenile Sexual  
         Offenders" 2345  
     "Bylaws & Constitution of the  
         American Association of Police

- Polygraphists” 2345  
 “Bylaws of the American Polygraph Association” 2345  
 “Idaho Sexual Offender Management Board Standards & Guidelines for Adult Sexual Offender Management Practices” 2345  
 2016 Job Analysis Survey 1743  
 Availability of Referenced Documents 645  
 Essential Documents of the National Association of Certified Professional Midwives 1743  
 IDAPA 08.05.01.000 et seq., Rules Governing Seed & Plant Certification and materials incorporated therein by reference 351  
 Incorporated Documents 644  
 Mammography Quality Standards Act Regulations, Part 900 788  
 National Council of Radiation Protection (NCRP) Report No. 147 788  
 Prevention of Perinatal Group B Streptococcal Disease 1743  
 Suggested State Regulations for Control of Radiation, Volume 1 788  
 The Sexual Offender Management Board’s “Required Format for Juvenile Psychosexual Evaluation Reports” 2345  
 The Sexual Offender Management Board’s “Required Format for Adult Psychosexual Evaluation Reports” 2345  
 Incorporation By Reference & Availability Of Referenced Material 2778, 2834  
 Incorporation By Reference & Availability Of Referenced Materials 2611  
 Incorporation By Reference Of Federal Regulations 2555, 2851  
 Availability of Referenced Material 2555  
 Exceptions 2555  
 Incorporation By Reference, Subchapter A 134, 153, 243  
 The Association of American Feed Control Officials (AAFCO) Official Publication 243  
 The Merck Index 243  
 Incorporation By Reference, Subchapter B 148, 207  
 Incorporation By Reference, Subchapter C 162  
 Incorporation By Reference, Subchapter D 178, 252  
 The Association of American Plant Food Control Officials (AAPFCO) Official Publication 252  
 The Association of Official Agricultural Chemists (AOAC) International 252  
 The Merck Index 252  
 Incorporation By Reference, Subchapter E 261  
 The Association of American Plant Food Control Officials (AAPFCO) Official Publication 261  
 The Association of Official Agricultural Chemists (AOAC) International 261  
 The Merck Index 261  
 Incorporations By Reference 2386  
 Availability of Referenced Material 2386  
 Documents Incorporated by Reference 2386  
 General 2386  
 Indemnification 371  
 Amount Of Indemnity to be Paid For Each Animal 371  
 Appraisals 371  
 Indemnity Payment Upon Approval of Appraisal 372  
 Indemnity Payments Paid 371  
 Maximum Amount of Indemnity 371  
 Owners, Individuals, Partnerships, Corporations or Other Legal Entities 371  
 Independent Audit Of Large Raffles 2335  
 Independent, Relative & Stepparent Adoptions 979  
 Individual 1937  
 Individual & Subsurface Sewage Disposal System Permit 2819  
 Individual Households or Buildings, Sewage Disposal System Permit 2820  
 Multiple Households or Buildings, Sewage Disposal System Permit 2820  
 Individual & Subsurface Sewage Disposal System Pumper Permit 2820  
 Individual Permit Application Review 2907  
 Additional Information 2908  
 Application Completeness Date 2909  
 Completeness Criteria 2907  
 Impact of Waiver Delay 2909  
 Incomplete Due to Waiver Denial 2909  
 Independence 2908  
 Schedule 2908  
 Sufficiently Sensitive Methods 2908  
 Individual Qualified By Examination 454  
 Individual Qualified By Examination Reasonable Length of Time 454  
 Written Notice 454  
 Individuals Subject To A Criminal History & Background Check 919  
 Induced Abortion Reporting Forms -- Compilations 738  
 Compilations 738  
 Form of Report 738  
 Nature of Reports 738  
 Patient Identification 738  
 Industrial Flares 2520  
 Ineligibility Based Upon Past Conduct 616  
 Criminal Conviction 616  
 Decertification or Denial of Certification 617  
 Driver’s License 616  
 Marijuana 617  
 Military Discharge 617  
 Use of Prescription or Other Legally Obtainable Controlled Substance 617  
 Violations of Idaho Controlled Substances Act 617  
 Ineligible Mines Or Operators 1218  
 Disturbed Acres Limit 1218  
 Geothermal 1219  
 Hardrock Mines 1218  
 Off Lease Exploration 1219  
 Oil & Gas Conservation 1219  
 Oil & Gas Leasing 1219  
 Operators Providing Acceptable Financial Assurance 1219  
 Other Forfeitures 1219  
 Phosphate Mines 1218  
 Potential Heavy Metal Releases 1219  
 Reclamation Cost Limit 1218  
 Reclamation Fund Forfeitures 1219  
 Violators 1219  
 Infection Control 1141  
 Clinical Contact Surfaces 1141  
 Disposal 1141  
 Gloves 1141  
 Instrument Sterilization 1141  
 Masks and Eyewear 1141  
 Non-Critical Surfaces 1141  
 Sterilizing Devices Testing 1141  
 Infectious Waste Burning 2521  
 Infested Seed Stock (Annual Bluegrass) 241  
 Informal Discipline 2358  
 Informal Disposition -- Settlement 1955  
 Burden of Proof 1955  
 Confidentiality 1955  
 Consideration of Settlement 1955  
 Formalizing Agreements 1955  
 Informal Hearings -- Scope & Authority 1318  
 Informal Procedure 1967  
 Informal Proceedings Defined 1967  
 Informal Proceedings Do Not Exhaust Administrative Remedies 1967  
 Information Access & Dissemination 603  
 Administrative Messages 603

- Criminal History Records 603
- General Policy 603
- Information Orders By The
  - Department 2388
  - Persons 2388
  - Purpose 2388
  - Requirements 2388
- Information To Be Given, Emergency
  - Episode Stages 2477
  - Information to Be Given 2477
- Information To Be Provided By An Authorized Agency 2211
  - Actual Name & Address 2211
  - Authorized Official 2211
  - Fictitious Name & Address 2211
  - Vehicle Description 2211
- Information To Be Provided In Application 2335, 2337
  - Background Check of Applicants 2335
  - Charitable Organizations 2335
  - Failure to Provide Information 2336
  - Identification of Applicants 2337
  - Incomplete Applications 2338
  - Incorporated Nonprofit Organizations 2336
  - License Year & Fiscal Year 2336
  - Locations 2336
  - Proper Identification 2335
  - Raffle Drawings 2336
- Informed Consent 1746
  - Informed Consent Required 1746
  - Record of Informed Consent 1746
- Initial & Subsequent Family Foster Home Evaluation Study Process & Contents, Children's Agencies 1043
- Initial Certification Application 2355
- Initial Certified Public Accountant Licensure 25
- Initial Deposit & Bonds 1155
  - Guarantee of Payment 1155
  - Initial Deposit 1155
  - Performance Bond 1155
- Initial Distribution System
  - Evaluations 2648
- Initial Evaluation 1019
  - Applicant Participation 1019
  - Disclosure of Information 1020
  - Members of the Household Physical & Mental Health 1019
- Initial Financing Statement 1933, 1937
  - Lapse Date 1937
  - Name & Address of Each Debtor 1937
  - Name & Address of Each Secured Party 1937
  - New Record Bears the Unique UCC File Number 1937
  - Record is Indexed According to the Name of The Debtor 1937
  - Status of Debtor 1933
  - Status of Financing Statement 1933
  - Status of Secured Party 1933
- Initial license, Renewal And Reinstatement Fees 1454
- Initial Personnel Licensure 705
  - Authorization for Release of Information 706
  - Candidate Age Requirements 705
  - Criminal History & Background Check 706
  - Declaration of Previous Applications & Licensures 706
  - Pass Standardized Examination 706
  - Provide Current Affiliation with EMS Agency 706
  - Standardized Exam Attempts For Initial Licensure 706
  - Submit Required Licensure Fee 706
  - Valid Identification 706
- Initial Pleading - Listing Of Representatives 1946
- Initial Pleading By Party -- Listing Of Representatives 1968
- Injection Line Check Valve 130
  - A Substitute System 130
  - Injection Line Check Valve 130
- Injection Wells 2044
  - Construction 2044
  - Surveillance 2045
- Injunction Against Further Cutting 1304
- In-Service Training Requirements 637
- In-Service Training Requirements For Retaining Basic Certification 637
- Emergency Communications Officers 638
- Peace Officers & County Detention Officers 638
- Tolling of Two-Year Period 638
- Insignificant Activities 2432
- Applicability Criteria 2432
- Inspection 73, 2243
- Inspection (Non-Phaseolus) 308
  - Application for Inspection 308
  - Inspections 308
- Inspection (Phaseolus) 307
  - Active Growth Inspection 307
  - Application for Inspection 307
  - Windrow or Pre-Harvest Inspection 308
- Inspection & Control Procedures 282, 301
  - Control 302
  - Controls 282
  - Inspection 282, 301
  - Movement 282
- Inspection & Disclosure Of Records 278
  - Disclosure 278
  - Inspection 278
- Inspection Authority 267
- Inspection Deficiencies 2285
- Inspection Fee 2475
- Inspection Frequency 2474
- Inspection Of Animals 138
- Inspection Of Establishments, Schools & Facilities 1790
- Classification Card 1790
- Form 1790
- Reinspection 1791
- Inspection of Facilities 872
  - Correction of Non-Core Issues 873
  - Follow-Up Surveys 874
  - Inspection or Survey Services 872
  - Plan of Correction for Core Issues 873
  - Surveys of Facilities 872
  - Unannounced Inspections 872
- Inspection Of Financial Records & Documents 2334
- Inspection Plan -- Frequency Levels 2563
  - Commercial TSD Facilities 2563
  - Conduct Inspections 2563
  - Generator On-Site TSD Facilities 2563
  - Generators 2563
  - Transport Facilities 2563
  - Transport Vehicles 2563
- Inspection Port 132
  - Inspection Port 132
- Inspection Procedures 251, 267, 273, 294
  - Disease Inspection 251
  - Exemptions - Issuance of In-State Transfer Numbers 295
  - First Field Inspection 294
  - Inspection of Nursery Stock for Certification 273
  - Inspection Requests 294
  - Issuance of Certified Defined Generation & In-State Defined Generation Transfer Permits 294
  - Laboratory Tests 295
  - Mechanics of Inspection 268
  - Necessary Precautions 252
  - Notification of Infestation 294
  - Notification of the Detection of Disease(s) or Pest(s) 268
  - Posting of Registration 252
  - Refusal of Certification 274
  - Reports of Inspection Summaries & Requests for Inventory 268
  - Request for Inspection 251
  - Second Field Inspection 294
  - Time of Inspection 273
  - Transfer Permits & Resale 295
- Inspection Requirements 449
  - Access 449
  - Inspection Fees 449
  - Installation 449
  - Technician on Site 449
- Inspection Rules 1707
- Inspection, Sampling & Testing 344
- Inspections 140, 186, 219, 323, 757, 795, 1667, 1831, 2606
  - Access to Records 186
  - All Other Conveyances 324
  - Conveyances That Have Been in Infested Waters 324
  - Decontamination 324



- Department Authority 2606
- Entry 186
- Frequency 219
- Inspecting Records 141
- Inspection Methods 219, 324
- Inspection Results 324
- Inspections 2607
- Qualified Inspectors 324
- Reason for Inspection 1668
- Scheduling of Inspections 141
- Third-Party Inspections 2606
- Who May Examine or Inspect 1667
- Inspections Of Homes 826
  - Inspection by Department or Certifying Agent 826
  - List of Deficiencies 827
  - Notice of Inspection 286
  - Plan of Correction 826
  - Statement of Deficiencies 826
- Inspections Restrictions And Identification Required Certification & Markings 49
- Inspections 50
- Restrictions 50
- Inspections, Restrictions, And Identification Required 49
- Inspections, Subchapter A 199
  - Emergencies 200
  - Entering Premises 199
  - Inspecting Records 200
- Inspections, Subchapter B 208
  - Entering Premises 208
  - Inspecting Records 208
- Inspector Qualifications 477
- Installation 1236
  - Compliance With Permit 1237
  - Installation Only After Permit Issued 1236
  - Removal of Construction Waste 1237
  - Sunset Clause 1237
- Installation Permit Fees 445
  - Double Section Unit 445
  - Electrical & Plumbing Permits 446
  - More Than Two Sections 446
  - Single Section Unit 445
- Installation Permits & Inspections Required 445
- Installation Tags Required 446
- Installation, Maintenance & Inspection Of Flame & Heat Producing Equipment 1023
- Fire Inspections 1023
- Installation & Maintenance of Flame & Heat-Producing Equipment 1023
- Portable Heating Devices 1023
- Installation Payments For Commercial Vehicle Registration 2193
- Billings, Payments & Due Dates of Installment Plan 2194
- Failure to Pay Installment Payment by Due Date 2194
- Reinstatement Fee for Payment Plan Registration 2194
- Repetitive Suspensions Result 2195
- Requirements to Participate in Installment Payments 2193
- Suspension of Registrant's Account Due to Non-Payment of Payment Plan 2194
- Institutional Controls 2831
  - Compliance With Other Laws 2832
  - Financial Assurances 2832
  - Institutional Controls 2832
  - Legal Use Restriction Requirements 2832
  - Legal Use Restrictions 2832
  - Prohibition of Use 2832
  - Purpose 2831
  - Removal of Restrictions 2833
- Instruction 641
  - Evaluation of Instructors 642
  - Lesson Plans 641
  - Monitoring of Instruction 641
  - Student Complaints 642
- Instructor Apprenticeship Training Program 1738
  - Application for Approval 1738
  - Apprentices 1738
  - Certificate of Proficiency 1738
  - Discontinuance of Program 1739
  - Instruction & Training Hours 1738
  - Instructors 1738
  - Recordkeeping 1738
  - Suspension or Revocation of Approval & Discipline 1738
- Insufficient Funds 2196
  - No Further Transactions 2196
  - Payment With Insufficient Fund Check 2196
  - Suspension of Account 2196
- Insurance Coverage 953
- Insurance Coverage, Residential Care Facility 1032
- Insurance Deductible 68
- Insurance Or Bond For Extraordinary Hazard 2217
- Insurance Plan 1904
- Insurance Requirements 106
  - Insurance Coverage 106
  - Insurance Deductible 106
  - Insurance Settlement 107
  - Seed Stored for Withdrawal 107
  - Self-Insurance 107
- Insurance Settlement, Commodities 67
- Insurance Status 783
- Insurer Fees 1124
  - Annual Continuation Fee 1124
  - Failure to Pay Fee 1125
  - Fee for Insurers 1124
  - Fees of Other Entities 1124
  - Fees Provide 1125
  - Not Provided in Fees 1125
  - Reinstatement Fee 1125
- Intake Policy, Residential Care Facility 1033
- Integrated Design & Fundamental Commissioning Of Public School Facilities 430
  - Annual Optimization Review 430
  - Commissioning Agents 430
  - Commissioning Anniversary Date 431
  - Definitions 430
  - Fundamental Building Commissioning Requirements 431
  - Technical & Educational Information 430
- Integrated Priority Rating System 2782
  - Amendment of Integrated Priority List 2783
  - Integrated Priority List 2783
  - Priority Rating 2783
  - Purpose 2783
  - Rating Forms 2783
- Interagency Placement Of Children 1025
- Inter-Country Adoption Services To Adoptive Parents 1051
  - Adoption Finalization 1051
  - Determination of Adoptive Applicant's Ability 1051
  - Documenting Child's Legal Status 1051
  - Eligibility Criteria Disclosure 1051
  - Information Disclosure 1051
  - Inter-Country Adoption Orientation 1051
  - Post-Placement Supervision 1051
  - Procedures for United States Placement 1051
- Inter-Country Adoption Services, Children's Agencies 1050
- Interim Status Standards For Owners & Operators Of Hazardous Waste Treatment, Storage & Disposal Facilities 2559
- Interlocutory Orders 1987
- Intermediate & Advanced Certification 623
  - Advanced Certification 625
  - Intermediate Certification 623
  - Probationary Period 626
- Interment & Reinterment 1384
  - Committal Services 1384
  - Remains 1384
- Internship 1664
  - Denture Clinic Requirements 1666
  - Internship Equivalency 1665
  - Internship Not to Exceed One Year 1665
  - Internship Supervisor Requirements 1666
  - Reporting Requirements 1666
  - Requirements & Conditions for Internship 1664
  - Training Requirements 1665
- Interstate Common Pool Wagering 542

- Access to Reports & Wagering  
Information Requirement 543  
Breakage 543  
Licensing Requirement 542  
Pari-Mutuel Systems  
Requirement 542  
Interstate Shipments 369  
Carriers, Permits 369  
Waybill Requirement 369  
Waybill Violation 369  
Who May Inspect 369  
Intervenors 1968  
Intervention 1953  
Intervention of Right 1953  
Permissive Intervention 1953  
Intrastate Movement 344  
Intrastate Movement Certificate,  
Domestic Cervidae 191  
Intrastate Movement Of Domestic  
Cervidae 192  
Intrastate Movement Certificate 192  
Movement of Cervidae Between  
Accredited AZA or USDA  
Licensed Facilities 192  
TB Test 192  
Introduction From Ring 1490  
Introduction Of New Species To The  
State 316  
Introductory Provisions &  
Definitions 2292  
Invasive Species - Amphibians 326  
Bullfrog 326  
Rough-skinned Newt 326  
Invasive Species - Aquatic  
Invertebrates 325  
Asian Clam 325  
Fishhook Waterflea 325  
Marbled Crayfish 325  
Marmorkrebs 325  
Marone Crayfish 325  
New Zealand Mud Snail 325  
Quagga Mussel 325  
Red Claw Crayfish 325  
Rusty Crayfish 325  
Spiny Waterflea 325  
Yabby Crayfish 325  
Zebra Mussel 325  
Invasive Species - Birds 326, 327  
Monk Parakeet 326  
Invasive Species - Fish 325  
Bighead Carp 325  
Black Carp 325  
Bowfin 325  
Diploid Grass Carp 325  
Gar 325  
Green Sturgeon 325  
Ide 325  
Piranhas 325  
Round Goby 326  
Rudd 325  
Ruffe 326  
Silver Carp 325  
Snakeheads 325  
Walking Catfish 325  
Invasive Species - Insects 327  
Africanized Honey Bee 328  
Apple Ermine Moth 327  
Apple Tortrix 327  
Asian Gypsy Moth 327  
Asian Longhorned Beetle 327  
Banded Elm Bark Beetle 328  
Bean Plataspid (Kudzu Bug) 328  
Bee Mite 328  
Black Currant Gall Mite 328  
Cherry Bark Tortrix 327  
Cherry Ermine Moth 327  
Citrus Longhorned Beetle 327  
Emerald Ash Borer 327  
European Elm Bark Beetle 328  
European Grape Berry Moth 328  
European Grape Vine Moth 327  
European Gypsy Moth 327  
European Paper Wasp 328  
European Woodwasp 327  
Exotic Bark Beetles 328  
False Codling Moth 327  
German Yellowjacket 328  
Glassy-winged Sharpshooter 327  
Grape Phylloxera 327  
Japanese Beetle 327  
Kaphra Beetle 327  
Leek Moth 328  
Light Brown Apple Moth 327  
Marmorated Stink Bug 327  
Mexican Bean Beetle 327  
Pine Shoot Beetle 327  
Pink Hibiscus Mealybug 328  
Plum Curculio 328  
Plum Fruit Moth 328  
Potato Tuber Moth 327  
Potato Tuberworm 328  
Red Imported Fire Ant 327  
Silver Y Moth 327  
Small Hive Beetle 328  
Soybean Aphid 327  
Summer Fruit Tortix 327  
Sunni Bug 328  
Vine Mealybug 327  
Wheat Blossom Midge 328  
Invasive Species - Invasive Mollusks  
(Terrestrial Snails & Slugs) 329,  
330  
Applesnail 330  
Brown Garden Snail 330  
Chinese Mysterysnail 330  
Decollate Snail 330  
Faucet Snail 330  
Giant African Snail 330  
Green or Burrowing Snail 330  
Japanese Mysterysnail 330  
Lactea Snail 330  
Marisa 330  
Maritime Garden Snail 330  
Pulmonate Snail 330  
Quilted Melania 330  
Red-lipped Melania 330  
White Garden Snail 330  
Wrinkled Snail 330  
Invasive Species - Invasive Plants  
Energy Crops 330  
Chinese Silver Grass 330  
Cold Tolerant Eucalyptis 330  
Giant Reed 330  
Kudzu 330  
Purging Nut 330  
Switch Grass 330  
Trap Crops 330, 331  
Black Nightshade 331  
Litchi Tomato 331  
Invasive Species - Mammals 326  
Nutria 327  
Invasive Species - Plant Pathogens &  
Parasitic Nematodes 328  
Apple Proliferation  
Phytoplasma 329  
Asian Soybean Rust 329  
Bacterial Wilt of Alfalfa 329  
Bean Common Mosaic Necrosis  
Virus (strain NL-3 & NL-5) 328  
Black Currant Reversion  
Disease 329  
Black Stem Rust 329  
Brown Rot of Potatoes 329  
Brown Stripe Downy Mildew of  
Corn 329  
Cherry Leaf Roll Virus 329  
Golden Nematode 328  
Java Downy Mildew of Corn 329  
Karnal Bunt 328  
Onion White Rot 329  
Philippine Downy Mildew of  
Corn 329  
Phytophthora blight (nursery  
stock) 328  
Pierces Disease of Grapes 329  
Pine Wilt Nematode 329  
Plum Pox Potyvirus 329  
Potato Late Blight 329  
Potato Mop Top Virus 329  
Potato Ring Rot 329  
Potato Spindle Tuber Viroid 329  
Potato Wart 328  
Powdery Mildew of Hops 329  
Soybean Cyst Nematode 328  
Stewarts Wilt of Corn 329  
Wheat Scab 329  
Wheat Seed Gall Nematode 329  
Wheat Smut 329  
White Pine Blister Rust 329  
Invasive Species - Reptiles 326  
Brahminy Blindsnake 326  
Common Wall Lizard 326  
Italian Wall Lizard 326  
Mediterranean Gecko 326  
Red-eared Slider 326  
Snapping Turtle 326  
Inventory Verification 189  
Duty to Gather & Restrain 189  
Visible Identification 189  
Investigation 971  
Child-Related Factors 972  
Description of Investigation 972

- Investigation & Recommendation 2395  
 Costs 2395  
 Disputed Facts 2395  
 Efforts 2395  
 Other Facts 2395  
 Recommendations 2395  
 Investigation Of Complaints For Personnel Licensing Violations 702  
 Investigation Of CWD 196  
 Identification 196  
 Quarantine 196  
 Investigation Of Petition To Adopt & Report To The Court 980  
 Confidentiality of Information 982  
 Degree of Relationship of the Child to Petitioners 981  
 Evaluation & Recommendation 981  
 Financial Accounting 982  
 Legal Availability of the Child 980  
 Medical Information 981  
 Needs of the Child 981  
 Investigational Allowance for Other Nutrients, Fertilizer 258  
 Investigational Allowances 257  
 Deeming a Fertilizer Deficient 257  
 Examples 259  
 Investigational Allowances for Nitrogen, Phosphate & Potash 257  
 Overall Index Value 258  
 Use of Investigational Allowances 257  
 Investigations Or Inspections 561  
 Investment Adviser Affiliation With Broker-Dealers/Issuers/Agents 669  
 Investment Adviser Brochure Rule 669  
 Investment Adviser Registration -- Application/Renewal 665  
 Annual Renewal 666  
 Applications Prior to Expiration 666  
 Completion of Filing 666  
 Deferral of Effectiveness 666  
 Incomplete Applications 666  
 Initial Application 665  
 Updates & Amendments 666  
 Investment Adviser Representative Registration - Application/ Renewal 666  
 Annual Renewal 667  
 Completion of Filing 667  
 Deferral of Effectiveness 668  
 Dual Registration Exemption 667  
 Incomplete Applications 667  
 Initial Application 666  
 Updates & Amendments 667  
 Invoices & Records 2256  
 Delivery of Documents to Commission 2256  
 Invoices 2256  
 Vouchers 2256  
 Involuntary Placement Of Indian Children 947  
 Extended Family 947  
 Foster Home Approved by Tribe 948  
 Indian Institution 948  
 Licensed Indian Foster Home 948  
 Irrigation Line Check Valve 131  
 Construction 131  
 Labeling of the Check Valve or Valve Assembly 131  
 Location 131  
 Model Certification 131  
 Irrigation Systems 127  
 Domestic Water Supply System Cross-Connected for Chemigation 128  
 Flood, Basin, Furrow, or Border Irrigation 127  
 Sprinkler or Drip Irrigation 127  
 Isolation Area 576  
 Isolation Of EIA Reactors in Quarantine 142  
 Issuance Of An Outfitter License 1808  
 Issuance Of Certificate 818  
 Certificate 818  
 Provisional Certificate 819  
 Temporary Certificate 819  
 Issuance Of Default Order 1986  
 Issuance Of License 1007  
 Denial of Licensure 1007  
 Department Action 1007  
 Incomplete Application 1007  
 Issuance of a Regular License 1007  
 List of Licensed Daycare Facilities 1007  
 Notification of License Renewal 1007  
 Issuance Of Reports & Form Of Practice 31  
 Issuance Of TVC 2198  
 Temporary Vehicle Clearances 2198  
 Issuance Of Vehicle Registration (CAB Card) & License Plate(s) 2198  
 Issuance of Vehicle Registration & License Plate(s) 2198  
 Permanent Identification 2198  
 Issuance Of Vehicle Registration (Cab Card) & License Plate(s) 2198  
 Issuance, Expiration, & Renewal 439  
 Issuer Agent Registration 653  
 Issuing Agency 2211  
 Itemization Of Plant Food Elements Within The Guaranteed Analysis 260  
**J**  
 Jockey Agent 554  
 Jockey License 554  
 Application for License 554  
 First Time Licensed 554  
 Jockey Room 574  
 Joint Hearings 1984  
 Journeyman 401  
 Examination 401  
 Out of State Journeyman Applications 401  
 Qualifications for Journeyman Plumber 401  
 Journeyman Electrician Examination And License 381  
 Examination Requirements 381  
 License Requirements 382  
 Unacceptable Work Experience 382  
 Judges 1478  
 Fees 1478  
 Physical Examination 1479  
 Protests 1478  
 Selection 1478  
 Station of Judges 1478  
 Jury Lists 2200  
**K**  
 Kinds & Scope Of Discovery Listed 1981  
 Kinds of Discovery 1981  
 Rules of Civil Procedure 1981  
 Knockdown Of Combatant, Procedure For Counting  
 Both Combatants Down 1493  
 Combatants Down -- Referee Counting 1493  
 Failure of Opponent to Stay in Farthest Neutral Corner 1493  
 Knockdown 1492  
 Knockdown After Bell has Sounded 1493  
 Knock-Out 1493  
 Three Knockdowns in Same Round 1493  
 Timekeeper 1493  
 Kraft Pulp Mill LVHC & HVLC Gas Venting Notification & Reporting 2552  
**L**  
 Label Format 244  
 Customer Formula Invoice & Tag Requirements 245  
 Label Requirements Of Seeds For Sprouting 233  
 Date 233  
 Germination Percentage 233  
 Lot 233  
 Name 233  
 Percentage 233  
 Labeling Standards 1888  
 Distributed Compounded Drug Product 1888  
 Parenteral Admixture 1888  
 Prepackaged Product 1888  
 Repackaged Drug 1888  
 Standard Prescription Drug 1888  
 Labeling, Storage, & Transportation 794  
 Laboratory Licensing Requirements 155  
 License Application 155  
 License Fee 155

- License Required 155
- License Term 155
- Laboratory Minimum Standards 581
  - Instrumentation for Screening 582
  - Lab Accreditation 582
  - Standards of Detection 582
- Laboratory Quality Assurance 751
  - Chain-of-Custody Procedures 751
  - Maintenance of Records 751
  - Proficiency Testing (PT) 751
  - Required Items for the QA Plan 751
  - The QA Plan 751
- Ladders 761
- Ladders, Recessed Steps, Stairs
  - Requirements 761
- Land Disposal Restrictions 2560
- Land Surface Use Rights & Obligations 1271
  - Damage 1271
  - Disposal of Leased Land 1271
  - Distance from Residence 1271
  - Supervision 1271
  - Use & Occupancy 1271
- Land Use, Surface Rights & Obligations 1285
  - Blowout or Spill 1285
  - Disposal of Leased Lands 1286
  - Entry by Director 1286
  - Fences 1285
  - Other Uses 1286
  - Potable Water Discovery 1285
  - Prevention of Injury or Damage 1285
  - Reclamation 1286
  - Timber Removal 1285
  - Use & Occupancy 1285
- Landfill Disposal Site Fires 2520
- Lands Open 1241
- Landscape Architect-In-Training 1564
  - Prohibitions 1564
  - Qualifications 1564
  - Registration 1564
  - Supervision 1564
  - Termination 1564
- Lapse Date & Time, Filing & Data Entry Procedures 1936
- Lapse Of Basic Certification –
  - Reinstatement 631
    - Exception for Officers Remaining With Agency 631
  - Lapse by Time 631
  - Reinstatement After Eight Years Absence 632
  - Reinstatement After Five Years to Eight Years Absence 631
  - Reinstatement After Three to Five Years Absence 631
- Lapsed License 709
  - Application Under Review by the EMS Bureau 709
  - Failure to Provide Application Information Requested by the EMS Bureau 709
  - Failure to Submit an Application and Renewal Documentation 709
- Reinstatement of an EMS Personnel
  - License Lapsed for More Than Twenty-Four Months 709
  - Reinstatement of Lapsed EMS Personnel License 709
- Lapsed Licenses 451
  - Approval of Petition 451
  - Expedited Licensure 451
  - Extension of Time 451
  - Failure to File 451
  - Filing Deadline 451
- Large Commercial Wildlife Facilities 684
  - Application 684
  - Bond 684
  - Specific Requirements 684
- Lasix Administration 588
  - Dosage 588
  - Reporting 588
  - Time of Treatment 588
  - Witness 588
- Late & Delayed Registration Of
  - Divorce 742
    - Additional Evidence 742
    - Delayed Registration 742
    - Late Registration 742
    - Summary Statement 742
  - Late & Delayed Registration Of Marriage 741
    - Additional Evidence 742
    - Delayed Registration 742
    - Late Registration 741
    - Summary Statement 742
- Late Fees 2001
  - Late Fee Payable 2001
  - Waiver 2001
- Late Or Delayed Registration Of
  - Birth 739
    - Abstraction of Documentary Evidence 740
    - Certification by the State Registrar 741
    - Delayed Registration Following a Legal Change of Status 739
    - Dismissal After One Year 741
    - Documentary Evidence -- Acceptability 740
    - Documentary Evidence -- Requirements 740
    - Facts to be Established for a Delayed Registration of Birth 739
    - Form of Delayed Certificate of Birth 739
    - Late Registration -- Fifteen Days to One Year 739
    - Who May Request the Registration of & Sign a Delayed Certificate of Birth 739
  - Late Or Delayed Registration Of Deaths 741
    - Additional Evidence 741
    - Minimum Evidence Required 741
    - Summary Statement 741
- Late or Denied Renewals 497
- Late Payment 1297
- Late Payments 1261
- Late Payments & Penalties 688
- Law Enforcement Certification Program – General Provisions 640
  - Assessment Visits 640
  - Eligibility 640
  - Expiration & Renewal of Certification 641
  - Initial Assessment 640
  - Permission to Proceed With Approval Process 640
- Law Enforcement Certification Program Approval 640
- Law Enforcement Experience, Military Experience, & College Credits For Purposes Of Higher Certification 622
  - College Credits 623
  - Emergency Communications Officer Experience 622
  - Juvenile Justice Experience 622
  - Law Enforcement Experience 622
  - Military Law Enforcement Service & Education 622
- Law Enforcement Inquiries 2200
- Leak Testing & Replacement Of Sealed Sources 794
- Lease Access Roads 1343
- Lease Adjustments 1261
  - Department Required 1261
  - Lessee Requested 1261
- Lease Application, Fee, & Procedure 1296
  - Application to Lease & Fee 1296
  - Fee 1296
  - Fee Is Required 1296
  - Notification of Approval or Denial 1296
  - Request for Reconsideration 1296
  - Submission of Application to Lease & Fee 1296
- Lease Acquisition Process 1282
  - Acquiring a Lease 1282
  - Auction Conditions 1283
  - Auction Procedure 1283
  - Execution of Lease 1284
  - Lease Information for Auction 1283
  - Lease Provisions 1282
  - Nominating a Tract for Auction 1283
  - Withdrawing a Tract for Auction 1283
- Lease Award Through Auction 1269
- Lease Cancellation 1261
  - Change in Land Use 1261
  - Land Sale 1261
  - Mutual Agreement 1261
  - Non-Compliance 1261
- Lease Modification Or Amendment 1298
  - Encroachment Amendment 1298
  - Modification of Existing

- Lease 1298
- Modification of Interior Facilities 1298
- Lease Rate Determination - Annual Rental 1256
- Leases & Easements 1236
  - Lease or Easement Required 1236
  - Seawalls, Breakwaters, Quays 1236
- Legal 1024
- Legal Authority 22, 40, 47, 49, 51, 62, 72, 79, 104, 109, 134, 153, 179, 198, 212, 220, 243, 265, 279, 305, 315, 343, 355, 361, 364, 376, 397, 414, 432, 437, 445, 448, 450, 468, 479, 496, 516, 522, 526, 539, 548, 559, 566, 578, 591, 597, 609, 644, 687, 690, 692, 702, 716, 727, 745, 755, 774, 780, 788, 796, 803, 812, 860, 914, 916, 935, 992, 1087, 1093, 1124, 1128, 1135, 1154, 1157, 1180, 1217, 1221, 1245, 1250, 1256, 1257, 1267, 1280, 1293, 1301, 1311, 1321, 1360, 1382, 1388, 1399, 1403, 1406, 1409, 1412, 1415, 1458, 1466, 1511, 1527, 1535, 1552, 1563, 1568, 1579, 1585, 1596, 1602, 1624, 1637, 1650, 1663, 1673, 1681, 1696, 1701, 1705, 1710, 1724, 1729, 1743, 1756, 1769, 1796, 1801, 1836, 1841, 1857, 1872, 1898, 1903, 1909, 1920, 1945, 1964, 1992, 1998, 2006, 2016, 2038, 2049, 2059, 2074, 2097, 2119, 2155, 2170, 2180, 2181, 2192, 2198, 2199, 2201, 2214, 2226, 2255, 2258, 2262, 2287, 2289, 2292, 2342, 2345, 2364, 2555, 2565, 2599, 2611, 2746, 2761, 2778, 2796, 2819, 2822, 2834, 2851, 2968
- Legal Authority & References 1923, 1925
- Legal Costs 797
- Legal Opinions 1905
- Legal Requirements For Inter-Country Adoption Services 1050
- Adoptive Home Standards 1051
- Children's Agency, Foreign Government Agreement Review 1051
- Citizenship 1051
- Legal Rights Protection 1050
- Licensing Standard Compliance Requirement 1050
- Legal Weight Limits Maintained On Certain Highways 2221
- Lender Liability 2829
  - Definitions & Operative Provisions 2829
  - General Statement 2829
- Length Of Lease 1260
- Lessee Mailing Address 1258
- Lessee's Records, Right Of Inspection By Department 1274
- Levels Of Discipline 2358
- Levels Of Post Conviction Sexual Offender Polygraph Examiner Certification 2353
  - Associate/Supervised Post Conviction Sexual Offender Polygraph Examiner 2353
  - Senior/Approved Post Conviction Sexual Offender Polygraph Examiner 2353
- Levels Of Psychosexual Evaluator Certification 2349
  - Associate/Supervised Psychosexual Evaluator 2349
  - Provisional/Supervised Psychosexual Evaluator 2349
  - Senior/Approved Psychosexual Evaluator 2349
- Levels Of Risk On The Child Protection Central Registry 961
  - Child Protection Level One 961
  - Child Protection Level Three 962
  - Child Protection Level Two 962
- Levels Of Sexual Offender Treatment Provider Certification 2350
  - Associate/Supervised Sexual Offender Treatment Provider 2350
  - Provisional/Supervised Sexual Offender Treatment Provider 2350
  - Senior/Approved Sexual Offender Treatment Provider 2350
- Liability 1308
  - Additional Fee 1309
  - Contractor Liability 1308
  - Failure to Treat 1308
  - Fees 1308
  - State Liability 1308
- Liability (Indemnity) 1266
- Liability & Indemnity 1299
- Liability Insurance 1278
  - Insurance Certificate Required 1279
  - Liability Insurance Required 1278
  - Special Endorsements 1291
    - Certificate of Insurance 1291
    - Liability Insurance Required 1291
- Liberal Construction 1097, 1946, 1966
- License 105, 2262
  - Additional License Application Information 105
  - License Duration 106
  - License Fee 105
  - License Reinstatement Fee 105
  - Loss of License 105
  - Posting of License 105
  - Return of Suspended or Terminated License 105
- License -- Duration, Bonded Warehouse Rules 68
- License And Registration Application 380
  - Application Fee 381
  - Application Form 380
  - Examination 381
  - Examination & Licensure Approval 381
  - License 381
  - License or Registration Period 381
  - License Application 82
  - License Application & Conditions Of Issuance 65
    - License Application 65
    - Modification 66
  - License Certificates & Cards 536
  - License Displayed 83
  - License Examination Fee 2013
    - Examinations Conducted by Department Staff 2013
    - Examinations Conducted by Non-Department Certified Water Right Examiners 2014
  - License Fees 557, 2335, 2337
  - License Granted Upon Conditions 571
    - Duty 571
    - Investigations 571
  - License Not Transferable 571
  - License Number On Bids 467
  - License Plate Provisions For All License Plates 2201
    - Placement of Proof of Registration Document 2201
    - Plate Numbering & Lettering 2201
  - License Plate Provisions For Restricted Vehicle Plates 2203
  - License Plate Provisions For Special Plates 2207
    - Centennial License Plates 2208
    - Disabled Veteran License Plates 2208
    - Year of Manufacture Plates 2207
  - License Plate Provisions For Special Program & Personalized Plates For Trailers 2207
  - License Plate Provisions For Standard Plates 2202
    - County Designations 2202
    - Designation for Farm Vehicles 2203
    - Designation for Recreational Vehicles 2203
    - Designations for Motor Homes 2203
  - License Production 1804
  - License Renewal -- Filing Deadlines 451
  - License Renewal Continuing Education Requirements 715
  - License Renewal Skills Proficiency Requirements 715
  - License Renewals 82
  - License Required 438
    - Designated License Holder 439
    - License for Branch Office of Manufactured/Mobile Home Retailer 439
    - License for Manufacturers 439
    - License to Engage in Business as Manufactured/Mobile Home Retailer, Manufacturer, or Installer 439

- Minimum Age Requirement 438  
Proof of License 439  
Real Estate Brokers 439  
License Required - Scope Of  
Practice 1538  
Backflow Assembly Tester 1539  
Drinking Water Operator  
Scope 1538  
Operator-in-Training 1539  
Wastewater Operator Scope 1539  
License Required For Commercially-  
Used Weighing Or Measuring  
Instrument Or Device 82  
Annual License 82  
Specific Device 82  
License Requirements 2743  
Licensed Operator Required 2743  
Responsible Charge Operator License  
Requirement 2743  
Shift Operator Requirement 2743  
Substitute Responsible Charge  
Operator License  
Requirement 2743  
Water Operator License  
Requirement 2743  
License Requisite 1129  
License Restrictions 1805  
Limitation 1805  
Qualifications 1805  
Qualified 1805  
Review 1805  
Temporary Employment 1805  
License Suspension & Revocation  
Based On Regulatory Samples 160  
License Reinstatement 160  
License Revocation for Repeated Out  
of Tolerance Test Results 160  
License Suspension 160  
Two (2) Out of Four (4)  
Violation 160  
License Types & Classifications 1537  
Backflow Assembly Tester 1538  
Drinking Water Distribution  
Operator 1537  
Drinking Water Treatment  
Operator 1537  
Drinking Water Very Small System  
Operator 1538  
Wastewater Collection  
Operator 1537  
Wastewater Laboratory  
Analyst 1538  
Wastewater Treatment  
Operator 1537  
Wastewater Very Small System  
Operator 1538  
License Void Without Bond,  
Bonding 2165  
License, Display, Renewals, Duplicates,  
Applications 1129  
Bids Will Bear License  
Number 1129  
Duplicate License 1129  
Forms & Fees 1129  
Posting of License 1129  
Renewal 1129  
Time Period 1129  
Licensed Practical Nurse (LPN) 1443  
Functions 1443  
Standards 1443  
Licensed Registered Nurse (RN) 1441  
Chief Executive Role 1442  
Functions 1441  
Management Role 1443  
Standards of Practice 1441  
Licensed Registered Nurse Functioning  
In Specialty Areas 1443  
Conditions for Licensed Registered  
Nurses Functioning in Specialty  
Practice Areas 1443  
Extended Functions 1443  
Licensed Residential Real Estate  
Appraiser Classification Appraiser  
Qualification Criteria 1687  
Education 1687  
Examination 1688  
Experience 1688  
Licensee's Duties A Wrestling  
Exhibition  
Conduct 1505  
Decision & Appeal 1505  
No Abusive Behavior 1505  
Licensee's Duties At Wrestling  
Exhibition 1505  
Licensees Or Certificate Holders Of  
Other States, Boards, &  
Countries 502  
Business Entity Requirements 504  
Denials or Special  
Examinations 504  
International Engineering Licensure  
Evaluation - Countries or  
Jurisdictions with Board Approved  
Licensure Process 503  
International Engineering Licensure  
Evaluation - Countries or  
Jurisdictions without a Board  
Approved Licensure Process 504  
Interstate Licensure Evaluation 502  
Waiver of Prescriptive Engineering  
Licensure Evaluation for Unique  
International Expertise 504  
Licensees Prohibited From Dealing  
With Persons Whose Licenses Are  
Suspended Or Revoked 1507  
Licenses 1313  
Application Form 1313  
Revocation or Suspension for  
Incompetency 1313  
Licenses Canceled For Failure To  
Renew 1586  
Licenses For Public Utilities &  
Government Entities 2244  
Licenses For Simulcast Operators 544  
License 544  
No Limitation 545  
Responsibilities of Applicant 544  
Restrictions 545  
Simulcast License Application 544  
Licenses Requiring Racing Association  
Signatures 552  
Admissions 552  
Announcer 552  
Clerk of Scales 553  
Clocker 552  
Horsemen's Bookkeeper 553  
Identifier 553  
Jocks Room Custodian 553  
Maintenance 553  
Office Personnel 553  
Outrider 553  
Paddock Judge 553  
Racing Secretary 553  
Stall Superintendent 553  
Starter 553  
Track Superintendent 553  
Valet 553  
Licensing 62, 72, 789, 999, 1466  
Application for License 1466  
Bins Labeled 63  
Insurance Calculations 63  
Loss of License 62, 72  
Posting of License 62, 72  
Responsibilities of the Foster Parent  
or Operator 999  
Responsible for Agency Staff  
Knowledge 999  
Responsible for Knowledge of  
Standards 999  
Return of License 999  
Return of Suspended or Terminated  
License 62, 72  
Sign to be Posted 63  
Suspension Due to Neglect 62  
Licensing & Certification 999  
Licensing & Certification Agency  
Policies & Procedures For Foster  
Homes 1042  
Licensing & License Fees for  
Organizations Conducting Bingo  
Games or Raffles 2335  
Licensing and Registration  
Requirements for Industrial  
Radiography Operations 794  
Licensing Application Format 74  
License -- Application 74  
License Conditions of Issuance 74  
License Modification 74  
Licensing Complaints 443  
Licensing For Advanced Deposit  
Wagering 560  
Licensing Professional Applicators &  
Pesticide Dealers 112  
Certification, Department  
Examinations 114  
Demonstration of Competence 112  
Department Examination  
Procedures 115  
Licensed Professional  
Applicator 117  
Licensing Periods & Recertification,  
Pesticide 116

- Licensing Variances 117
- Licensing Provisions Related To The Indian Child Welfare Act, Foster Homes 1017
- Licensing Qualifications & Definition Of Terms 1637
  - Educational Requirements 1637
- Licensing Requirements 870
  - Administrator 870
  - Change in Corporate Shares 870
  - Current License 870
  - Display of Facility License 870
  - Distinctive Business Name 870
  - Issuance of License 870
  - Licensee Responsibility 870
- Licensure 1705
- Licensure & Operation Of Primary & Contiguous Establishments 1779
  - Businesses Other Than Cosmetological Establishments or Barber Shops 1780
  - Conditions for Issuance 1780
  - Contiguous Establishment License 1779
  - Primary Establishment License 1779
- Licensure & Registration
  - General Requirements 1877
    - Board Forms 1877
    - Cancellation & Registration 1877
    - Exemption 1877
    - Incomplete Applications 1877
    - Late Renewal Application 1877
    - On-Time Annual Renewal Application 1877
    - Parent or Legal Guardian Consent 1878
    - Reinstatement of License or Registration 1877
  - Licensure & Reimbursement of Alternate Care Providers 954
- Licensure By Endorsement 1597
  - Certification of License 1597
  - Continuing Education 1597
  - Credentials 1597
  - Disciplinary Action 1597
  - Examination 1597
  - Practical Experience 1597
  - Residency 1597
- Licensure By Equivalency & Endorsement Licensure 1431
  - Applicants Licensed in Another Nursing Jurisdiction 1432
  - Application by Equivalency 1431
  - Application For Licensure By Endorsement 1432
- Licensure By Examination 1597
  - Examination of Applicants 1597
  - Passing Grade 1597
- Licensure By Written Examination For Graduates Of Medical Schools Located Outside Of The United States & Canada 1389
  - International Medical Graduate 1389
  - International Medical School Requirements 1390
- Licensure History 380, 400
- Licensure Of Dental Specialists 1139
  - Examination 1139
  - Limitation of Practice 1140
  - Requirements for Specialty Licensure 1139
- Licensure Of Members Of The Military, Veterans, And Spouses 704
  - Licensure in Non-REPLICA Member State 704
  - Licensure in REPLICA Member State 704
- Licensure of Radiation Machine Facilities 794
- Licensure Of Radiation Machine Facilities, (Services) - And Associated Healthcare Professionals 794
- Licensure Period & Fees 388
- Licensure Surveys
  - Access & Authority to Entire Facility 872
  - Access to Staff Living Quarters 873
  - Interview Authority 873
  - Written Report of Deficiencies 873
- Lien Filing 2183
  - Date of Lien Filing 2183
  - Lien Assumptions 2184
  - Name Change Only 2183
  - Out-of-State Transfer 2183
  - Taxable Transfer of Ownership 2184
- Lifetime Ownership & Transportation
  - Certificates 532
  - Detain 532
  - Nationwide 532
  - Owner 532
  - Validity 532
- Lighting & Electrical Requirements 763
- Lighting Requirements For Loads
  - Traveling After Dark 2214
  - Standards for Lights on Rear Overhang 2215
- Lighting, Children's Residential Care Facilities 1055
- Limit & Authority 628
- Limitation Of Pre-Loan Engineering Reviews 2842
- Limitation Of Preloan Engineering Reviews 2786
- Limitation On Annual Number Of Raffles 2334
- Limitations 454
  - One License 454
  - Previous License Null & Void 454
  - Total Bid Cost 454
  - Two or More Licensees 455
  - Type 4 License Holder 455
- Limitations On Seconds 1490
  - Excessive Use of Water 1490
- Number of Seconds 1490
- Limited Electrical Contractor License 388
  - Modification to Qualifications 388
  - Qualifications for Limited Electrical Contractor 388
- Limited Experience Requirement 385
  - Limited Electrical Installer 385
  - Limited Electrical Installer Trainee 385
- Limited Licenses
  - Compliance Required 1429
  - Disability Due to Substance Use Disorder or Mental Health Disorder 1428
  - Non-Practicing Status 1427
  - Restricted Status 1428
  - Summary Suspension - Lack of Compliance 1429
- Limits On Bingo Operation's Prize Payout Ratios & Administrative Expenses 2332
  - Applicability 2332
  - Donated Cash Funds Prohibited 2332
  - Donated Merchandise 2332
- Liquor Fund 699
- List Of Notices Of Claim Of Lien (List) 1921
  - Compilation & Distribution 1921
  - Cut-Off 1921
  - Schedule 1921
- Listing Or Delisting Toxic Air Pollutant Increments 2515
- Livestock 1855
- Livestock Auction Sales 533
  - Fee 533
  - General 533
  - Other Groups 533
- Livestock Dealer Bonds 536
  - Bond 536
  - Coverage 536
  - Evidence 536
- Livestock Dealers 200
- Livestock Dealers Duty, Livestock Trader Lot 206
- Livestock Identification Removal 139
- Livestock Quarantine 1266
  - Cooperation 1266
  - Non-Compliance 1266
- Livestock Trader Lot Premises 206
  - Condition 206
  - Feed & Water 206
  - Fences 206
  - Pens 206
  - Restraint System 206
- Livestock Treatment 200, 208
  - Euthanized 200, 209
  - Fed & Watered 200
  - Feed & Water 209
  - Returned 200, 209
  - Load Overhang 2219
- Loading Zone Parking Spaces 2177
- Loan Application & Review 2786,

- 2842
- Application Requirements 2786, 2842
- Determination of Completeness of Application 2788, 2844
- Notification of Incompleteness of Application 2788, 2844
- Reapplication for Loan 2788, 2844
- Submission of Application 2786, 2842
- Loan Closure & Administration 2974
  - Cost Incurred 2975
  - Fund Obligation 2975
  - Loan Note & Security Agreement 2975
  - Loan Securing Documents 2974
  - Servicing & Documentation 2974
- Loan Consolidation 2794
- Loan Fee 2786, 2842
  - Determination of Loan Fee 2786, 2842
  - Effect on Loan Interest Rate 2786, 2842
  - Loan Fee 2786, 2842
  - Payment of Loan Fee 2786, 2842
- Loan Offer & Acceptance 2792, 2848
  - Acceptance Executed as a Contract Agreement 2792, 2848
  - Acceptance of Loan Offer 2792, 2848
  - Estimate of Reasonable Cost 2792, 2848
  - Loan Offer 2792, 2848
  - Terms of Loan Offers 2792, 2848
- Loan Policies 2976
- Local Anesthesia 1144
- Local Registration Officers 729
  - Local Deputy State Registrars 730
  - Qualifications of Local Registrar 729
  - Removal of Local Registrar 729
- Location 513
- Location & Nature of Trust
  - Water 2099
  - Snake River Water Rights Agreement 2099
  - Sources of Public Water Not Trust Water 2100
  - Trust Water Created by State Action 2099
- Location Of Buying Stations 204
- Location Of Documents & Records 794
- Location Of Domestic Cervidae 183
  - Department Action 183
  - Exceptions 183
  - Natural Disasters 184
  - Reindeer 183
- Location Of Drains 772
- Location Of Dressing Rooms 763
- Locked Seclusion 1064
  - Duration 1064
  - Locked Seclusion Log 1064
  - Observation 1064
  - Potentially Harmful Objects 1064
  - Re-Introduction 1064
  - Review 1064
- Locked Seclusion Room Requirements, Children's Residential Care Facilities 1065
- Log Brands 1312
  - Applications 1312
  - Fees 1312
- Logo 44
  - Approval for Use of Logo 45
  - Description of the Idaho Preferred-TM Logo 44
  - Graphic Depiction of the Idaho Preferred-TM Logo 45
- Long-Term Strategy For Regional Haze 2528
  - Enforceable Emission Limitations 2529
  - Interstate Consultation 2529
  - Requirements for Long-Term Strategy 2529
  - Submission of Long-Term Strategy 2528
- Loss Of Tool With Radioactive Material 1347
  - Recovery or Cementing of Tool 1347
  - Reporting 1347
  - Sidetracking 1347
- Lots Tagged Not For Sale -- Removal Thereof, Potatoes 50
- Lottery Contracting Rules 2301
  - Advertising & Promotional Contract 2306
  - Classification of Lottery Contracts 2301
  - Delegation of Purchasing Authority 2302
  - Equal Opportunity/Affirmative Action Contracts 2303
  - General Policy 2301
  - Idaho Preference 2303
  - Investment Contracts 2306
  - Major Procurements 2305
  - Personal Services Contract 2303
  - Prequalification of Annuity Vendors 2306
  - Sensitive Procurements 2305
  - State Central Services Agenda 2303
- Lottery Employee or Employee 2293
- LPN, RN, & APRN License
  - Renewal 1418
  - Date License Lapsed 1419
  - Final Date to Renew 1419
  - Renewal Applications 1418
- Lump Sum Payments Of Registration Fees 2461
  - Agreement 2461
  - Minimum Amount 2461
  - Payment Waiver 2461
- M
- Machines Required To Be Licensed 789
- Mail 1029
- Mailing Address 565
- Main & Semi-Main Events 1479
  - Notice 1479
  - Refunds 1479
  - Substitutions 1479
- Maintaining POST Instructor Certifications & Endorsements 637
  - Lapse of POST Instructor Certification 637
  - Renewal of Canine Instructor Certification 637
  - Renewal of High Liability Endorsement 637
  - Renewal of Master Instructor Certification 637
- Maintaining Separate Lots Of Ginseng 277
- Maintenance 2046
  - Corrosion 2046
  - General 2046
  - Tests 2046
- Maintenance Charges 1369
  - Continued Eligibility 1371
  - Exclusions from Income or Payment for Residential & Domiciliary Care 1370
  - Income Eligibility Limits 1370
  - Leave of Absence or Hospitalization 1371
  - Medicaid Eligibility 1371
  - Nursing Care Charges 1369
  - Payment Schedule 1371
  - Residential & Domiciliary Care Charges 1369
  - Security Deposit 1371
- Maintenance Of Certification 752
- Maintain Required Standard of Quality 752
- Notification of Major Changes 752
- Successful Completion of PT Samples 752
  - Use of Specified Methods 752
- Maintenance Of Pre-Need Trust Account Fees 1573
- Maintenance Of Records 106, 641, 1038
  - Course File 641
  - Instructor File 641
  - Organization of Record 1038
  - Record Confidentiality 1038
  - Record Storage 1038
  - Record Storage for Closed Organizations 1038
  - Student Training File 641
- Maintenance, Children's Residential Care Facilities 1055
- Management Certification 626
  - Certification 627
  - Officers not Certified in Idaho 627
  - Police Chiefs, Agency Administrators 627
  - Position 626



- Training 627
- Management Of Activities With The Potential To Degrade Aquifers 2770
- Other Resource Category
- Aquifers 2770
- Sensitive Resource Category
- Aquifers 2770
- Management Plans 1262
- Federal Plan 1262
- Modification of Plan 1262
- Manager Acting As Second 1472
- Manager's Advances --
- Accounting 1474
- Mandatory & Voluntary
- Certification 614
- Mandatory Certification 614
- Voluntary Certification for Certain Officials 615
- Voluntary Certification for
- Correctional Officers & Adult Probation & Parole Officers Employed Prior to July 1, 2005 614
- Voluntary Certification for Emergency Communications Officers Employed Prior to July 1, 2012 615
- Mandatory Continuing Education For Certified Veterinary Technicians 2265
- Approved courses 2265
- Credit for Attendance 2265
- Education Requirements 2265
- Statement of Purpose 2265
- Mandatory Continuing Veterinary Education 2262
- Approved Courses 2263
- Credit for Attendance 2263
- Education Requirements 2263
- Statement of Purpose 2262
- Mandatory Errors And Omissions Insurance 1904
- Mandatory Reporting Of Abuse, Abandonment, Or Neglect 1010
- Mandatory Visitations 1001
- Manner & Frequency Of Notification 2478
- Manual Exemption 655
- Manufactured Home Buyer's Information & Disclosure Form 444
- Manufactured Homes 429
- Construction & Safety Standards 429
- Fees 429
- Inspections 429
- Manufactured Homes & Modular Buildings 856
- Previously Certified 856
- Use of Manufactured Homes & Modular Buildings 856
- Manufacturer Registration 1883
- Mail Service Pharmacy 1883
- Manufacturer 1883
- Marine Deputy Certification 629
- Absence of Three Years 629
- Appointment by Sheriff 629
- Certified or Commissioned in Another Jurisdiction 629
- Minimum Basic Training 629
- Peace Officer Eligibility 629
- Market Release 209
- Affected Animals 209
- Removal of Animals 209
- Saleyard Release Form 209
- Veterinary Inspection 209
- Marketing Order 49
- Markings Required 361
- Marks On Monument Set 513
- Marriage & Family Therapists 1653
- Graduate Degree 1653
- Practicum 1654
- Supervised Marriage & Family Therapy Experience 1654
- Marriage License Recording Fees 738
- Martial Arts & Mixed Martial Arts (MMA) 1495
- Boxing Gloves 1495
- Licensing Exemption 1495
- Practices, Belt Promotions, & Non-Contact Demonstrations 1495
- Regulation of Marital Arts & MMA 1495
- Use of Official Rules for Art 1495
- Master Certification 626
- Experience 626
- Prior Certification 626
- Training 626
- Master Electrician 382
- Master Instructor Certification 636
- Additional Training or Education 636
- Compliance With Other POST Requirements 637
- Exceptional Ability 637
- Instruction 636
- Maintain Certification 637
- POST Instructor Certification 636
- Recommendation 637
- Materials 355
- Maximum & Minimum License Fee Schedule For Commercially-Used Weighing & Measuring Instruments & Devices 82
- Maximum Contaminant Level Goals & Maximum Residual Disinfection Level Goals 2637
- Maximum Contaminant Level Goals for Disinfection Byproducts 2637
- Maximum Contaminant Level Goals for Inorganic Contaminants 2637
- Maximum Contaminant Level Goals for Microbiological Contaminants 2637
- Maximum Contaminant Level Goals for Organic Contaminants 2637
- Maximum Contaminant Level Goals for Radionuclides 2637
- Maximum Residual Disinfectant Level Goals for Disinfectants 2637
- Maximum Contaminant Levels & Maximum Residual Disinfectant Levels 2633
- Effective Dates 2634
- Maximum Contaminant Levels for Disinfection Byproducts 2634
- Maximum Contaminant Levels for Inorganic Contaminants 2633
- Maximum Contaminant Levels for Microbiological Contaminants 2633
- Maximum Contaminant Levels for Organic Contaminants 2633
- Maximum Contaminant Levels for Radionuclides 2633
- Maximum Contaminant Levels for Turbidity 2633
- Maximum Residual Disinfectant Levels 2634
- Maximum On Hospital In-Patient Payments 785
- Maximum Prizes 2331, 2332, 2334
- Maximum Prize for One Game 2332
- Maximum Prizes for One Session 2332
- Measurement Of Container-Type Commodities, How Expressed 92
- Capacity 93
- General 92
- Measurement Of Gas 1351
- Measurement Of Oil 1350
- Correction for Impurities 1350
- Gravity Determination 1351
- Temperature Correction 1350
- Mechanical Integrity Testing 1348
- Inactive Wells 1348
- Mechanical Integrity Required 1348
- Prior Notification 1348
- Reporting Requirements 1348
- Mechanical Restraint 1065
- Administrator Approval 1065
- Intervention 1065
- Mechanical Restraint Log 1066
- Mechanical Restraint Use as a Last Resort 1065
- Monitoring 1065
- Professional Opinion 1066
- Prohibitions on Mechanical Restraints 1065
- Re-Introduction 1066
- Restraint Type 1065
- Review 1066
- Staff Training 1065
- Used Only Until Child Has Regained Control 1065
- Medicaid Eligibility 785
- Medicaid Exclusion 931
- Medicaid For Children In Alternate Care 953
- Medicaid Services Subject To Copayments 808
- Accessing Emergency Transportation

- Services for Non-Emergency Medical Conditions 808  
Accessing Hospital Emergency Department for Non-Emergency Medical Conditions 808  
Chiropractic Services 809  
Occupational Therapy 809  
Optometric Services 809  
Outpatient Hospital Services 809  
Physical Therapy 809  
Physician Office Visit 809  
Podiatry Services 809  
Speech Therapy 809  
Medical & Dental Care 1028  
Child Injury & Illness 1028  
Dispensing of Medications 1028  
Health Care Services 1028  
Storage of Medication 1028  
Medical & Dental for Children In Out-Of-Home Care 953  
Medical Emergencies 953  
Medical Examination Upon Entering Alternate Care 954  
Medical Fees 1116  
Acceptable Charges For Medical Services Provided By Hospitals And Ambulatory Surgery Centers Under The Idaho Worker's Compensation Law 1119  
Acceptable Charges For Medical Services Provided By Other Providers Under The Idaho Worker's Compensation Law 1120  
Acceptable Charges For Medical Services Provided By Physicians Under The Idaho Worker's Compensation Law 1117  
Acceptable Charges For Medicine Provided By Pharmacies 1120  
Billing And Payment Requirements For Medical Services & Procedures Preliminary To Dispute Resolution 1120  
General Provisions for Medical Fees 1116  
Medical Waste 1523, 1750  
Containers for Non-Sharp, Medical Waste 1523, 1750  
Containers for Sharps 1523, 1750  
Storage Duration 1750  
Waste Disposal 1750  
Medication Limitations 1895  
Chloroquine/Hydroxychloroquine Prescriptions 1896  
Oral Azithromycin Prescriptions 1896  
Medication Policy 846  
Allergies 846  
Alteration of Orders 846  
Assistance with Medication 847  
Evidence of Orders 846  
Following Orders 846  
Self-administration 847  
Training 846  
Medication Report Form 590  
Confidential 590  
Content of Medication Report Form 590  
Signed & Dated 590  
Submission of Medication Report Form 590  
Medication Standards & Requirements Administration of Medications 848  
Medication Storage & Administration 1059, 1080  
Disposal of Unused Medication 1060, 1080  
Documentation 1059, 1080  
Medication Changes 1060, 1080  
Medication Storage & Administration 1059, 1080  
Prescription Medication 1080  
Psychotropic Medication 1059, 1080  
Trained Staff 1059, 1080  
Medications 581  
Location 581  
Taking Samples 581  
Testing 581  
Meeting Of The Board 1585  
Meetings 471, 1565, 1568  
Meetings & Organization 1628  
Meetings 1628  
Voting 1628  
Member Of Household Qualifications & Suitability 1018  
Members Of Organization In Attendance--Training Of Employees 2327  
Memorials & Donations 1385  
Donations & Gifts 1385  
Flowers & Grave Decorations 1385  
Grave Markers 1385  
Plaques, Statues, & Other Memorials 1385  
Menu & Diet Planning 899  
Facilities Licensed for Seventeen Beds or More 900  
Facilities Licensed for Sixteen Beds or Less 900  
Menu 899  
Therapeutic Diets 899  
Mercury Emission Standard For New Or Modified Sources 2421  
Applicability 2422  
Exemptions 2422  
Meters 1352  
General Requirements 1352  
Visibility 1352  
Method Of Application-Examination Of Applicants 1585  
Application 1585  
Application Review 1585  
Exam Content 1585  
Method Of Depopulation 151  
Method Of Judging 1489  
Announcing a Winner 1490  
Majority Opinion 1489  
Scoring by Judges 1489  
Method Of Scaling Forest Products For Commercial Purposes 1315  
Cubic Volume 1315  
Other Scaling Methods 1316  
Scribner Decimal "C" 1315  
Methods Of Euthanasia, Pre-Euthanasia Sedation, & Chemical Capture 2275  
Euthanasia Drugs 2275  
Pre-Euthanasia Sedation Drugs 2275  
Remote Chemical Capture Restraint Drugs 2276  
Methods Of Payment 1927  
Cash 1927  
Checks 1927  
Prepaid Account 1927  
Methods Of Sampling -- General Procedure 220  
Bags 221  
Bulk 220  
Composite Samples 220  
Forwarding & Receipt of Official Samples 221  
Free Flowing Seed 220  
Non-Free Flowing Seed 220  
Packets 221  
Sample 220  
Size of Sample 221  
Methods Of Testing 233  
Methods Of Winning MMA Contest 1503  
Decision 1503  
Inability of Opponent to Continue/Thrown in Towel 1504  
Knockout (KO) 1503  
Referee Stoppage 1503  
Submission 1503  
Technical Knockout (TKO) 1503  
Milk And Cream Procurement And Testing Requirements 155  
Milk Component Testing Devices 156  
Calibration & Checks 156  
Calibration Record Keeping 156  
Calibration Standards 156  
Mine Panel 1217  
Mine Tailings Impoundment Structures Design Criteria 2054  
Abandonment 2057  
Borrowed Fill Embankment 2055  
Cutoff Trenches or Walls 2055  
Embankment Slopes 2054  
Freeboard 2057  
Inspection & Completion Reports 2057  
Outlet Systems 2056  
Records 2057  
Riprap 2056  
Top Width Embankment 2055  
Minimal Sedation 1145  
Patient Safety 1145  
Personnel 1145  
Minimum Attendance

- Requirements 641
- Minimum Balance For The Reclamation Fund 1220
- Minimum Bond 1243
- Minimum Charitable Or Nonprofit Donation 2332
- Minimum Criteria 1211
- Minimum Experience Requirements 384
- Minimum Scope Of Installation Inspection 447
  - Inspection Minimum Requirements 447
  - Scope 447
- Minimum Standards 33, 1574, 2077
  - Casket Not Necessary 1574
  - Concrete Plank Boat Launch Ramps 2078
  - Construction Procedures 2077
  - Culverts & Bridges 2078
  - Delay Before Cremation 1574
  - Drop Structures, Sills & Barbs 2078
  - Dumped Rock Riprap 2078
  - Embalming 1574
  - Piling 2078
  - Pipe Crossings 2078
  - Reasonable Sanitation & Safety Required 1574
  - Reduction of Cremated Remains 1574
  - Removal of Sand & Gravel Deposits 2078
  - Suction Dredges & Non-Powered Sluice Equipment 2078
- Minimum Standards For Service 985
  - Content 985
  - Description of Services Available 985
  - Disclosure of Non-Identifying Information 985
  - Education 985
  - Release of Information 985
- Minimum Standards Of Care 827
  - Daily Living Activities 828
  - Emergency Services 828
  - Medication Management 828
  - Plan of Service 828
  - Resident Rights 828
  - Safe Living Environment 828
  - Supervision 828
  - Supportive Services 828
- Minimum Teaching Standards 1906
- Minimum Training Requirements For Inspectors 446
  - Annual Training or Instruction 446
  - Revocation of Approval 446
- Mining 2774
  - Application of Provisions 2776
  - Application Process 2774
  - Change in Point(s) of Compliance/ Ground Water Monitoring 2776
  - Coordination with Other State or Federal Agencies/Public Notice 2776
  - Ground Water Monitoring & Reporting 2776
  - Limitations 2776
  - Request for Setting Point(s) of Compliance & Standards Applicable to Mining Activities 2774
  - Setting the Point(s) of Compliance 2775
- Mining, Oil Or Gas Exploration Exemption Requirements 655
- Advertising 655
- Legal Opinion for Extractive Industries 655
- Offering Circulars 655
- Quarterly Reports 655
- Minor Permit Modification 2453
  - Criteria 2453
  - EPA & Affected State Notification Procedures 2454
  - Implementation Procedures 2455
  - Minor Permit Modification Application Procedures 2453
  - Permit Shield 2455
- Minors 2327
- Miscellaneous 1237, 2200
  - Dredge & Placer Mining 1238
  - Mineral Leases 1238
  - Other Laws & Rules 1238
  - Water Resources Permit 1237
- Miscellaneous Fees 1127
  - Agent Service of Process 1127
  - Certificate Under Seal 1127
  - Certified Copy 1127
  - Continuing Education 1127
  - Documents Filed 1127
  - Insurer Service of Process 1127
- Miscellaneous Rules For Games Using Non-Electronic Bingo Cards 2328
- Miscellaneous Safety Requirements 1014
  - Animals & Pets 1015
  - Heat Producing Equipment 1014
  - Portable Heating Devices 1015
  - Storage of Hazardous Materials 1015
  - Storage of Weapons, Firearms, & Ammunition 1015
  - Telephone 1014
- Miscellaneous Rules For Games Using Non-Electronic Bingo Cards Autodaubing Features 2329
- Braille Cards 2329
- Card-Minding Devices 2329
- Hard Cards 2328
- Two Part Disposable Cards 2329
- Use of Nonreusable Cards 2329
- Misleading Packages, Weights & Measures 99
- Misrepresentation 361
- Mixtures 2255
- MMA Contest Scoring 1504
  - Method of Judging 1504
  - Primary Scoring
  - Considerations 1504
  - Ten Point Must System 1504
- MMA Equipment 1495
  - Commission Approved Attire 1496
  - Commission Approved MMA Gloves 1496
  - Commission Approved Mouthpiece 1495
  - Prohibited Equipment & Attire 1496
- MMA Event Rounds 1503
  - Length of Rounds 1503
  - Number of Rounds 1503
- Moderate Sedation, General Anesthesia And Deep Sedation 1145
  - ACLS 1146
  - General Requirements 1146
  - Training Requirements 1145
- Modification Of Existing Temporary Permit 1839
- Modification Of Order On Presiding Officer's Own Motion 1990
- Modification, Or Revocation & Reissuance Of IPDES Permits 2925
  - Causes to Modify, or Revoke & Reissue Permits 2925
  - Minor Modifications of Permits 2927
  - Procedures to Modify, or Revoke & Reissue Permits 2925
- Modifying Physical Conditions 2398
- Modular Buildings 427, 435
  - Alternates & Equivalents 427
  - Enforcement & Administration 435
  - Field Technical Service 435
  - Insignia 428, 436
  - Inspections 428, 435
  - Installation Inspection 435
  - Local Enforcement Agencies 435
  - Permits 427
  - Plans 427
  - Reciprocal Agreements 436
- Monitoring 2630
- Monitoring & Analytical Requirements 2634
  - Alternate Analytical Techniques 2635
  - Analytical Methods for Radioactivity 2634
  - Approved Laboratories 2635
  - Disinfection Residuals, Disinfection Byproducts, & Disinfection Byproduct Precursors 2636
  - Initial Monitoring Schedule 2635
  - Inorganic Chemical Sampling & Analytical Requirements 2634
  - Monitoring Frequency & Compliance Requirements for Radioactivity In Community Water Systems 2634
  - Monitoring of Consecutive Water Systems 2636
  - Monitoring Waivers 2634
  - Organic Chemicals, Sampling & Analytical Requirements 2634
  - Total Coliform Sampling &

- Analytical Requirements 2634  
 Turbidity Sampling & Analytical Requirements 2634  
 Monitoring & Reporting Requirements 2955  
 Monitoring Requirements 2955  
 Reporting Monitoring Results 2956  
 Monthly Charges & Allowances 1371  
 Nursing Care 1371  
 Residential & Domiciliary Care 1372  
 Monthly Sampling, Disinfection System 768  
 Moratorium 2114  
 Applications for Permit 2114  
 Permits 2114  
 Mortgage Agreements 1262  
 Mortgage Note Exemption 655  
 Definition "Offered & Sold as a Unit" 655  
 Investment Contract or Profit-Sharing Agreement 655  
 Motions 1951  
 Answers to Motions 1952  
 Form & Contents 1952  
 Oral Argument 1952  
 Prehearing Motions 1952  
 Motions--Defined--Form & Contents--Time For Filing 1971  
 Form & Contents 1971  
 Motions - Defined 1971  
 Other 1971  
 Motor Vehicle Inspection & Maintenance Program 2472  
 Applicability 2472  
 Exemptions 2473  
 Governing Authority 2473  
 Options 2473  
 Purpose 2472  
 Motorized Exploration 1243  
 Movement Of Farm Equipment 296  
 Movement Of Restricted Animals 370  
 Consigned Directly to Approved Destination 371  
 Indelibly Marked 371  
 Individually Identified on Approved Document 371  
 Movement Of Used Farming Equipment 280  
 Clean & Free 280  
 Requirements 280  
 Movement Or Sale Of Animal Products 150  
 Multiple Chapters Licensed Together 2336  
 Multiple Drains 772  
 Multiple Licenses 711  
 Multiple Stacks, Hot-Mix Asphalt Plants 2551  
 Multiple Zone Completions 1333  
 Commingling Production 1333  
 Conditions for Approval 1333  
 Requirements of the Owner or Operator 1333  
 Zone Effectiveness 1333  
 Mutuel Employee 555
- N**
- NAISMA Standards 336  
 NAISMA Weed Free Forage Prohibited Weed List 340  
 Names Of Debtors That Are Organizations 1932  
 No Assumed Business Names 1933  
 Single Field 1932  
 Truncation-Organization Names 1932  
 Names Of Debtors Who Are Individuals 1932  
 Individual Name Fields 1932  
 No Assumed Business Names 1932  
 Titles & Prefixes Before Names 1932  
 Titles & Suffixes After Names 1932  
 Truncation -- Individual Names 1932  
 Names Used By Broker-Dealers & Investment Advisers 669  
 Change of Name 670  
 Unregistered Names 669  
 NASAA Statements Of Policy - Registered Offerings 649  
 National CWD Herd Certification Program Official Identification 185  
 APHIS-Approved Identification Devices 185  
 National Electrical Code Compliance, Children's Residential Care Facilities 1054  
 Necessary Clothing 1028  
 Negotiated Service Agreement 891, 892  
 Net Capital Requirements For Broker-Dealers 665  
 Net Decimal "C" Scale Determination 1316  
 Net Pool Pricing 543  
 Guest Participation in Interstate Common Pools 543  
 Takeout Rates 543  
 Net Weight 2255  
 Neurologic 782  
 Eligible Conditions 782  
 Excluded Conditions 782  
 Spending Limit 782  
 Neutrals 1980  
 New Certificates Of Birth Following Marriage Of Natural Parents 736  
 Common-Law Marriage 736  
 Requirements 736  
 New Dairy Products 178  
 Expiration 178  
 General 178  
 Permits 178  
 New Intermediate Or Large Dams 2065  
 Cutoff Trenches or Walls 2066  
 Drains 2067  
 Embankment Stability 2066  
 Freeboard 2068  
 Gates 2069  
 Impervious Core Material 2067  
 Inspection & Completion Reports 2070  
 Outlet Conduits 2068  
 Outlet Controls 2069  
 Release Capability 2069  
 Reservoir Site 2070  
 Riprap 2068  
 Top Width 2066  
 New Outfitter Or Outfitter License Amendment Application 1807  
 Designated Agent 1808  
 Existing Operating Area 1808  
 Hearing 1808  
 Insurance 1807  
 Name 1807  
 Operating Plan 1807  
 Other Signatures 1807  
 New Practices & Technologies 1929  
 New Sources & New Discharges 2918  
 Criteria for New Source Determination 2918  
 Modification vs. New Source/Discharger 2918  
 New Source Construction 2918  
 New Source vs. New Discharger 2918  
 Newborn Hearing Screening Tests 1713  
 Newborn Transfer Of Care Or Consultation 1751  
 Newborn Consultation Required 1752  
 Newborn Transfer of Care 1751  
 Nitrous Oxide/Oxygen 1144  
 Patient Safety 1144  
 Personnel 1144  
 Required Facilities & Equipment 1144  
 NMP Violations 218  
 No Approval for Casual Exploration Required 1241  
 No Refunds 1455  
 No Restriction On Actual Stack Height 2472  
 Nominations, Vacancies & Terms 687  
 Chair & Vice-Chair 687  
 Nominations 687  
 Terms 687  
 Vacancies 687  
 Non-Approved Medication 589  
 Administration by Owner or Trainer 589  
 Clenbuterol 589  
 Noncommunity water system 2623  
 Noncompliance -- Requirements 107  
 Additional Security Requirements 107  
 Provide an Audited or Reviewed Financial Statement 107  
 Non-Compliance With These

- Rules 919  
Nondiscrimination 1856  
Non-Domestic Pesticides 125  
  Ester Restriction 125  
  Home & Garden Restrictions 125  
Nonmetallic Mineral Processing Plant  
  Fugitive Dust Best Management  
  Practice 2545  
  Generally Applicable  
  Requirements 2545  
  Requirements for Crushers &  
  Grinding Mills 2549  
  Requirements for Paved Public  
  Roadways 2546  
  Requirements for Stockpiles 2550  
  Requirements for Transfer Points,  
  Screening Operations, & Stacks &  
  Vents 2547  
  Requirements for Unpaved Haul  
  Roads 2547  
Non-Permitted Medication 581  
Nonpreemption Of Other  
  Jurisdictions 2519  
Non-Protein Nitrogen 246  
  Labels for Medicated Feeds 247  
  Non-Protein Nitrogen Defined 247  
  Urea 247  
Nonrenewal, Denial, Revocation, Or  
  Suspension Of License 1002  
  Criminal Conviction or Relevant  
  Record 1003  
  Other Misconduct 1003  
Nonresident PIC Registration To  
  Practice Pharmacy Into Idaho 1880  
  Facility License Information 1881  
  Individual License  
  Information 1881  
Non-Steroidal Anti-Inflammatory Drug  
  Administration 586  
Non-Steroidal Anti-Inflammatory Drug  
  Request Form 585  
  Filing 585  
  Name of Drug Requested 585  
  Name of Horse 585  
  Name of Trainer & Veterinarian 585  
  Nature of Injury 585  
  Signature 585  
Non-Steroidal Anti-Inflammatory  
  Drugs 585  
  Exception 585  
  Posted 585  
  Procedures 585  
Nontransient noncommunity water  
  system 2623  
Non-United States Educated  
  Applicants 1656  
Non-Violent Physical  
  Intervention 1039  
  Conditions Limiting Restraint 1039  
  Intervention Documentation 1039  
  Intervention Time Guidelines 1039  
  Intervention Training  
  Requirements 1039  
  Prohibition of Prone Restraints 1039  
  Protection from Harm to Self or  
  Others 1039  
  Subsequent Review 1039  
Not For Profit Debt Securities Notice  
  Filing 654  
  NASAA Statements of Policy or  
  Guidelines 655  
  Notice Information 654  
  Notice Requirements 654  
  Sales & Advertising Literature 655  
  Securities Exempt 654  
  Waiver 655  
  Notice 451, 2395  
  Notice & Record-Keeping Of Estimates  
  Of Ambient Concentrations 2402  
  Estimates of Ambient  
  Concentrations 2403  
  Notice 2402  
  Recordkeeping 2403  
  Notice Filing Requirements For Federal  
  Covered Advisers 668  
  Notice Filing 668  
  Renewal 668  
  Updates & Amendments 668  
  When Deemed Filed 668  
  Notice Of Appeal 1991  
  BOE Appeals 1948  
  BOE Appeal 1948  
  Filing Place 1948  
  Separate Notice 1948  
  Contents 1947  
  Additional Contents 1947  
  Appeal Filed by an Attorney or  
  Representative 1947  
  Basic Contents 1947  
  Change in Address or Phone  
  Number 1948  
  Filing Appeal 1991  
  Filing Deadline 1991  
  STC Appeals 1948  
  Amount in Dispute 1948  
  Attachment 1948  
  Objections 1948  
  Security Deposit 1948  
  Notice Of Bankruptcy 1938  
  Notice Of Death Of Domestic  
  Cervidae 190  
  Notice of Death Of Domestic Cervidae  
  Individual Domestic Cervidae 191  
  Submission of Death  
  Certificates 190  
  Notice Of Federal Tax Lien 1940  
  Filing 1940  
  Mechanics of Search 1940  
  Notice Of Hearing 1982, 2396  
  Notice Of Other Lien In Favor Of A  
  Governmental Body (Nature &  
  Duration) 1941  
  Counties 1941  
  Mechanics of Search 1941  
  State Agencies 1941  
  Notice Of Petition For Declaratory  
  Ruling 1978  
  Notice Of Prehearing Conference 1980  
  Notice Of Proposed Default After  
  Failure To Appear or Respond 1986  
  Notice Of Resident Rights 835  
  Annual Review of Resident  
  Rights 835  
  Documentation of Review 835  
  Resident Rights Notice 835  
  Notice Of Resident Transfer Or  
  Discharge & Notice Of Denial Of An  
  Application For Residency 1372  
  Content of Notice of Transfer or  
  Discharge 1373  
  Form of Notice 1373  
  Notification Deadlines for  
  Domiciliary Care 1373  
  Notification Deadlines for Nursing  
  Care 1373  
  Notification Deadlines for  
  Residential Care 1373  
  Notice Of Residents' Rights 905  
  Inform Residents Orally & in  
  Writing 905  
  Posting of Resident Rights 905  
  Written Description of Rights 905  
  Written Statements 905  
  Notice Of State Tax Lien 1941  
  Filing 1941  
  Mechanics of Search 1941  
  Notice Of Violation 757  
  Notice Requirements For ICWA 945  
  Notice of Pending Proceedings --  
  Who is Notified 945  
  Notice of Pending Proceedings--  
  When Identity or Location of  
  Parent(s), Indian Custodian(s), or  
  Tribe is Unknown 945  
  Rights Under a Notice of Pending  
  Proceedings 945  
  Notices - General 1326  
  Emergency Authorization 1326  
  Publication of Legal Notices 1326  
  Written Authorization  
  Required 1326  
  Notices, Instructions & Reports To  
  Workers 795  
  Notifiable Diseases 145  
  Avian Diseases 145  
  Avian Mycoplasmosis (M. galli-  
  septicum and M. synoviae) 145  
  Fowl Typhoid (Salmonella  
  gallinarum) 145  
  Pullorum Disease (Salmonella  
  pullorum) 145  
  Bovine Diseases 145  
  Hemorrhagic Septicemia (Pasteu-  
  rella multocida) 145  
  Malignant Catarrhal Fever (Sheep  
  Associated) 145  
  Equine Diseases 145  
  Equine Herpesvirus  
  Myeloencephalopathy 145  
  Equine Rhinopneumonitis 145  
  Fish Diseases 145  
  Epizootic Hematopoietic

- Necrosis 145  
 Infectious Hematopoietic  
   Necrosis 145  
   Whirling Disease 145  
 Lagomorph Diseases 145  
 Mixed Species Diseases 145  
 Sheep & Goat Diseases 145  
   Bluetongue 145  
   Caprine Arthritis/Encephalitis  
   (CAE) 145  
   Caseous Lymphadenitis 146  
   Contagious Agalactia (Mycoplasma spp.) 146  
   Enzootic Abortion (Chlamydia psittici) 146  
   Footrot 146  
   Haemonchus Contortus (drug-resistant) 146  
   Johnes Disease 146  
   Maedi-Visna/Ovine Progressive Pneumonia (OPP) 146  
   Ovine Epididymitis (Brucella ovis) 146  
   Toxoplasma Gondii Abortion 146  
   Vibriotic Abortion (Campylobacter fetus) 146  
 Swine Diseases 146  
   Porcine Reproductive and Respiratory Syndrome (PRRS) 146  
   Transmissible Gastroenteritis 146  
 Notification 30  
 Notification Of A Substantiated Incident Of Abuse, Neglect, Or Abandonment, & Related Administrative Review & Contested Case Appeal Rights 963  
   Administrative Review Not Requested 963  
   Administrative Review Requested 963  
   Contested Case Appeal 963  
   Notification of Substantiated Incident 963  
   Reversal of Decision to Substantiate 963  
 Notification Of Broken Seals 138  
 Notification Of Change Of Address, Felony Charges, Or Actions Taken 23  
 Notification Of Discharge 219  
 Notification Of Exposure To Disease 191  
 Notification Of Loss Of Certification Or Licensure 720  
 Notification Of Opening, Closing Or Relocation Of Branch Offices 670  
 Notification Required 291  
 Notification Required, Bond Cancellation 536  
 Notification To Sources 2478  
 Notification To The Licensing Authority No Later Than One Day 1031  
   Change in Administrator 1031  
   Employee Investigated 1031  
   Fire 1031  
   Injured Child 1031  
   Notification To The Licensing Authority, Residential Care Facility 1031  
   Notifications 795  
   Noxious Weed Control 1265  
     Responsibility 1266  
     Weed Control 1265  
   Noxious Weeds 230  
     Prohibited Noxious Weed Seeds -- Table 1 230  
     Restricted Noxious Weed Seeds -- Table 2 232  
     Restricted Noxious Weed Tolerances 232  
   Noxious Weeds - Designations 331  
     Designation of Articles Capable of Disseminating Noxious Weeds 334  
     Statewide Containment Noxious Weed List 333  
     Statewide Control Noxious Weed List 332  
     Statewide EDRR Noxious Weed List 332  
     Statewide PROHIBITED GENERAL Noxious Weed List 331  
   NPE Contract Claims On The Fund 70, 77  
     NPE Clause 70, 77  
     NPE Contract List 77  
     NPE Contract Renewal Period 71, 77  
     PE Contract List 70  
   NPIP Certificates Of Participation 141  
     Inspection Forms 141  
     Records 141  
   NPS Project Approval 1864  
   Number Of Outfitters & Guides Limited 1819  
   Number Of Sessions Per Week 2327  
   Number Selectors 2339  
   Nursery Stock 273  
     Acceptability 273  
     Identity Maintenance 273  
     Location 273  
     Rootstocks 273  
     Seed 273  
     Tagging 273  
   Nursing Education For Registered & Practical Nurses 1444  
     Purpose Of Approval 1444  
       Continued Improvement 1444  
       Eligibility for Licensing Examination 1444  
       Evaluation Criteria 1444  
       Guide for Development 1444  
       Preparation of Graduates 1444  
   Nursing Facility Level Of Care Variance 824  
     Conditions for a Variance 824  
     Revoking a Variance 824  
     Variance Not Transferable 824  
   Nursing Home Administrator Qualifications For License 1696  
   Nursing Home Administrators-In-Training 1580  
     Facility Administrator 1581  
     Nursing Home Administrator-In-Training Requirements 1581  
     Preceptor Certification 1581  
     Supervised Hour Requirements 1581  
     Trainees 1581  
   Nutrient Management 218  
     Designated Poultry CAFOs 218  
     NMP Approval 218  
     NMP Updates or Amendments 218  
   Nutrient Management Plan Retention 218  
   Nutrient Management Records 218  
     Records Retention 218  
     Required Nutrient Management Records 218  
   Nutrition, Children's Residential Care Facilities 1060  
   Nutritional & Sanitary Requirements 1079  
     Cleansing of Hands 1079  
     Fasting 1079  
     Food 1079  
     Menu 1079  
     Special Needs 1079  
  
**O**  
 Objections--Offers Of Proof 1984  
 Obligation To Comply 2420  
   Relaxation of Standards or Restrictions 2420  
   Responsibility to Comply With All Requirements 2420  
 Obligation To Comply, Tier II Operating Permit 2466  
 Obligation To Obtain An IPDES Permit 2866  
   Exclusions from Permit 2867  
   Operator's Duty to Obtain a Permit 2867  
   Permits Under the Clean Water Act Section 405(f) 2867  
   Persons Who Must Obtain a Permit 2866  
 Obtaining & Independently Administering Clinical Nutrition Prescription Drug Products 1521  
   Current Certification in Clinical Nutrition Required 1521  
   Obtain Prescription Drugs Products from the Formulary 1521  
   Only Administer Prescription Drug Products from the Formulary 1521  
   Practice Limited to Chiropractic Physicians with Clinical Nutrition Certification 1521  
   Routes of Administration and Dosing

- of Prescription Drug Products 1521
- Sale, Transfer, or Other Distribution of Prescription Drugs Prohibited 1521
- Obtaining A License For A Company 2159
  - Application Processing 2160
  - Application Requirements 2159
- Obtaining A License For An Individual Driller 2158
  - Application Requirements 2158
  - Examination 2159
  - Experience Requirements 2159
- Obtaining An Operator's Permit 2160
  - Application for Class I Operator's Permit 2160
  - Application for Class II Operator's Permit 2160
  - Operator Drills Only for Licensed Driller or Company 2160
  - Processing an Application for Operator's Permit 2161
  - Written Examination 2160
- Obtaining, Storing, & Disposing Of Formulary Drugs 1749
  - Disposing of Formulary Drugs 1749
  - Obtaining Formulary Drugs 1749
  - Storing Formulary Drugs 1749
- Odometers 2184
  - Exemptions 2184
  - Procedures 2184
- Office – Office Hours – Mailing Address – Street Address 2226
- Office – Office Hours – Mailing Address – Street Address – Internet Website 861
- Office – Office Hours – Mailing Address & Street Address 471, 1965, 2572, 2819
- Office Hours 1926
- Office Hours -- Mailing Address & Street Address 2854
- Office Hours – Mailing Address & Street Address 2600, 2781, 2796
- Office Records 64, 73
  - Daily Position Record 64, 73
  - Electronic Records 65
  - Insurance Documentation 65
  - Receipts & Tickets 65
  - Receipts & Tickets Issued by Warehouseman 65
  - Receipts & Tickets Returned & Cancelled 65
  - Scale Weight Tickets 65, 73
  - Settlement Sheets/Storage Ledgers 73
  - Storage Ledger 65
- Offices For Issuance Of Special Permits 2216
  - Cotterell Port of Entry, District Four 2217
  - East Boise Port of Entry, District Three 2216
- Headquarters 2216
  - Huetter Port of Entry, District One 2216
  - Inkom Port of Entry, District Five 2217
  - Lewiston Port of Entry, District Two 2216
  - Sage Junction Port of Entry, District Six 2217
- Official 555
- Official Certificate Requirements 288
- Official CWD Tests 195
  - Official Tests 195
  - Other Scientifically Validated Test 195
- Official Identification 184
  - Identification Assigned 184
  - Progeny 184
  - Reporting of Identification 184
  - Visible Identification 184
- Official Laboratories - Responsibilities & Operating Procedures 155
  - Competency in Testing 155
  - Facility Requirements 156
  - Operating Procedures 156
- Official Livestock Identification
  - Identification Tattoos 139
  - Official Identification Tags 139
  - Official Vaccination Tags 139
  - Trichomoniasis Tags 139
- Official Notice 1956
- Official Notice -- Agency Staff Memoranda 1984
- Official Record 1959
  - Content 1959
  - Cost 1959
  - Verbatim Record 1959
- Official Visible Identification 185
  - Camouflage Patterns 185
  - Color 185
  - Ear Tags 185
  - Size 185
- Officials Of Events 1478
  - Commission Involvement 1478
  - Officials Described 1478
- Officials' Stands 574
- Off-Permit Changes & Notice 2456
  - Criteria 2456
  - Notice Procedure 2456
  - Permit Shield Applicability 2457
- On-Duty Staff Up & Awake During Residents' Sleeping Hours for Facilities Licensed for Sixteen Requirements For Staffing Standards Beds or More 905
- Ongoing Eligibility 951
  - Annual Redetermination 952
  - Child's Age 951
  - Child's Residence 951
  - Department Custody 951
  - Redetermination 952
- On-Line Computer Games 2315
  - Definitions 2315
  - Discharge of State Lottery Upon Payment 2320
- Disclosure 2320
- Distribution of Tickets 2315
- Drawings & End of Sales Prior to Drawings 2317
- On-Line Games -- Authorized -- Director's Authority 2315
- On-Line Games Criteria 2316
- Payment of Prizes 2316
- Payment of Prizes by On-Line Retailers 2319
- Payment of Prizes to Persons Under Eighteen Years of Age 2320
- Prize Rights Unassignable 2320
- Prizes Payable After Death or Disability of Owner 2320
- Retailer Duties 2318
- Retailer Settlement 2319
- Sale of Tickets 2316
- Validation Requirements 2318
- Only One License - Exception 1455
- On-Site Evaluation 748
  - On-Site Audits & Evaluations 748
  - Written Report of Findings from the On-Site Evaluation 749
- On-Site Examination Of Issuers 651
- On-Site Survey -- Additional Surveys 723
- Open Hearings & Closed Deliberations 1956
  - Closed Deliberations 1956
  - Public Hearings 1956
- Open Project Selection Process (OPSP) 1863
  - Availability 1863
  - Generally 1863
  - Requirements 1863
  - Suspension Of OPSP 1863
- Open Water Protection 2228
  - Boats & Houseboats 2228
  - Floathouses 2229
  - Public & Private Marinas 2229
- Opening Sealed Records Of Adoptions 982
  - Motion of an Indian Individual 982
  - Request From the Secretary of the Interior or the Indian Child's Tribe 982
- Operating Area Adjustments 1810
  - Consideration, Territorial Conflict 1810
  - Consideration, Wildlife Harvest 1810
  - Hearing 1810
  - Safety Adjustment 1811
- Operating Criteria For Public Water Systems 2737
  - Chlorination 2740
  - Cross Connection Control - Non-Community Water Systems 2742
  - Cross Connection Control Program - Community Water Systems 2741
  - Fluoridation 2741
  - Ground Water 2739

- Operating Criteria 2740
- Quantity & Pressure Requirements 2737
- Start-up Procedures For Seasonal Systems Subject To Subsections 100.01.a., C., & D. 2742
- Operating Provisions 2295
- Operation & Maintenance Manual 2837
- Operation Of An Account
  - Operator May Refuse Deposits 563
  - Operator May Suspend or Close Account 563
- Operation Plan 2065
  - Alternate Plans 2065
  - Existing Dams 2065
  - New, Reconstructed or Enlarged Dams 2065
- Operations Manual 766
- Operations of the Idaho State Lottery 2292
- Operations Under The Lease 1286
  - Best Practices 1286
  - By-Products 1287
  - Compliance With Rules 1286
  - Designation of Operator 1286
  - Diligence 1287
  - Geothermal Information 1287
  - Legal Representative 1286
  - Loss Through Waste or Failure to Produce 1287
- Opportunity For Public Hearing 2472
- Optional Information 1939
  - Copies of Documents 1939
  - Debtor Name 1939
  - Mode of Delivery 1939
- Optional Offsets For Permits To Construct 2408
- Optional Participation 1219
- Optional Tier I Operating Permit 2427
- Oral Argument 1984
- Orchard Fires 2520
  - Heating Device Emissions 2520
  - Heating Device Opacity 2520
  - Open-Pot Heaters 2520
  - Orchard Clippings 2521
- Order Granting Intervention
  - Necessary 1976
- Order Not Designated 1990
- Order Of Procedure 1983
- Orders Granting Intervention --
  - Opposition 1977
- Orders Resulting From Prehearing Conference 1980
- Organic Nitrogen 261
- Organization 1458, 1536, 1701, 1705, 1729, 1743, 1946
  - Board Members & Duties 1458
  - Election 1946
  - Meetings 1536, 1701, 1729
  - Organization of the Board 1458, 1536, 1701, 1729
  - Power 1946
- Organization & Meetings 1682
  - Meetings 1682
  - Organization of Board 1682
  - Quorum 1682
- Organization & Operations Of The Board 1770
  - Meetings 1770
  - Organization 1770
- Organization And Operations Of The Board 1756
  - Meetings 1756
  - Organization 1756
- Organization Of The Board 1724
- Organization Reports 1326
  - Required Content 1327
  - Updates 1327
- Organizational Chart, Policies & Procedures 1032
- Orientation Training
  - Requirements 906
  - Content for Training 906
  - Number of Hours of Training 906
  - Timeline for Completion of Training 906
- Original Application 1598
- ORP Or HRR Disinfection 767
- Orthopedic 782
  - Eligible Conditions 782
  - Excluded Conditions 782
  - Spending Limits 783
- Other Authorities Remain
  - Applicable 2155
- Other Fees 1455
- Other Idaho Promotion Programs 45
  - Commodity-Specific Promotion Programs 45
  - Ownership of Marks 45
- Other Notices 1931
- Other Notices Of Liens 1940
- Out Of State Licensees
  - Registration Fee 1715
  - Statement of Registration 1715
  - Statement of Time Engaged 1715
- Outfitter Bond or Insurance
  - Cancellation 1811
- Outfitter Business Purchase, License
  - Considerations 1811
  - Notification to Clients 1811
  - Sale of Outfitting Business 1811
- Outfitter License Priority 1811
- Outfitter Renewal 1810
- Outfitter Responsibilities 1806
  - Actions 1806
  - Camps 1806
  - Emergency Provisions 1806
  - General 1806
  - Livestock Facilities 1806
- Outfitter Waiting Lists 1811
  - Length of Time Name Is on Waiting List 1812
- Outfitter Application or Outfitter Amendment Form 1812
- Waiting List 1812
- When an Operating Area Is Relinquished by the
  - Licensee 1812
  - When Available Outfitting Opening Occurs 1812
- Out-Of-Competition Testing 582
  - Conditions for Racing Commission Request 582
  - Horse Selection 582
  - Penalties 583
  - Qualified Horse 582
  - Racing Commission Authority to Request Test 582
  - Refusal to Submit 582
  - Sample Collection & Split Samples 582
- Out-Of-State Ginseng 276
  - Certificate of Origin 276
  - Recordkeeping 276
  - Uncertified Ginseng 276
- Out-Of-State Providers 561
- Out-Of-State-Care 785
- Outsourcing Facility 1895
  - Adverse Event Reports 1895
  - Federal Act Compliance 1895
- Outstanding Leases 1279
- Overflow Gutters 771
  - General Requirements 771
  - Overflow Gutters Connected to the Recirculation System 771
- Overflow Systems 770
- Overhead Wiring 763
- Overnight Use 1849
  - Check Out 1849
  - Length of Stay 1849
  - Occupancy 1849
  - Overnight Use 1849
  - Overnight Use Fees 1849
  - Registration 1849
  - Responsible Party 1849
  - Self Registration 1849
- Overpayment & Underpayment
  - Policies 1928
  - Overpayment 1928
  - Underpayment 1928
- Overpayments 1127
- Overriding Royalty Interests 1276
  - Conformance with Rules 1276
  - Director's Authority 1276
  - Maximum Amount 1276
  - Statements 1276
- Owner & Applicant Responsibility For Claims & Liabilities 2245
- Owner License 555
  - Financial Responsibility 555
  - Lease Agreements 555
  - Multiple Owners 555
  - Supplemental License Fee 555
  - Transfer of Horse Prohibited 555
- Owner's or Operators Duties 1346
- Owners Responsibilities For Well Use & Maintenance 2139
  - Maintain All Other Separation Distances 2139
  - Maintenance 2139
  - New Construction 2139



- Unusable Wells 2139  
 Use 2139  
 Wells Posing a Threat to Human Health and Safety or Causing Contamination of the Ground Water Resource 2139  
 Ownership Of Prizes 2334
- P**
- Packaging & Labeling Rules 84  
 Auxiliary Containers 84  
 Inner Wrappings 84  
 Open Carriers 84  
 Retail Display Containers 84  
 Shipping Containers 84  
 Unpackaged Commodities 84  
 Packing Slips Paper Bingo Card Manufacturers Standards 2338  
 Paper Bingo Card Manufacturers Standards 2338  
 Invoice 2338  
 Labeling 2338  
 Packet Assembly 2338  
 Quality of Paper 2338  
 Random Assignment of Numbers 2338  
 Serial Numbers 2338  
 Parcel Survey 2820  
 Parental Financial Support For Children In Alternate Care 952  
 Financial Arrangements with Parent(s) 952  
 Notice of Parental Responsibility 952  
 Park Capacities 1855  
 Parking Lot Locations 2171  
 Parking Lot Violations 2175  
 Administrative Appeals 2176  
 Driving Violations 2175  
 Other Violations 2176  
 Parking Violations 2175  
 Parking Permit Fees 2174  
 Directors of Executive Branch Departments 2174  
 Elected Officials Parking Permits 2174  
 General Parking Permits 2175  
 Legislators 2175  
 Payment for Parking Permits 2175  
 Replacement Permits 2175  
 Reserved Parking Permits 2174  
 State-Owned Vehicles 2175  
 Parking Permits 2173  
 Parking Permits for Reserved, Legislator, Disabled Employee, Carpool, State-Owned Vehicles & General Parking 2173  
 Temporary Meeting Parking Permits 2174  
 Temporary Monthly Parking Permits 2174  
 Parking Space Allocation 2171  
 Carpool Parking Spaces 2172  
 Disabled Employee Parking Spaces 2172  
 General Parking Spaces 2173  
 Legislators' Parking Spaces 2171  
 Motorcycle Parking Spaces 2173  
 Reserved Parking Spaces 2171  
 State-Owned Vehicles Parking Spaces 2172  
 Visitor Parking Spaces 2173  
 Parking Violations 1845  
 Citations for Violations 1846  
 Designated Campgrounds 1845  
 Designated Overnight Use Area 1845  
 Fee Collection Surcharge 1845  
 Land or Facilities Administered by the Department 1845  
 Participant Clothing, Equipment & Supplies 1080  
 Clothing, Equipment, & Supplies Requirements 1080  
 Denial of Clothing, Equipment, & Supplies 1081  
 Participants Exempt From CoPayment 807  
 Exempt Participants 807  
 Notification of Copayment 808  
 Participants Exempt From Cost-Sharing 804  
 Participation By Taxing Authority 1947  
 Participation Duration & Renewal 41  
 Duration 42  
 Renewing Participation 42  
 Reporting on Use of Logo 42  
 Participation Fees 42  
 Annual Fee 42  
 Participation Categories 42  
 Participation in Multiple Categories 42  
 Pro-Rated Fees 42  
 Participation In Disaster & Emergency Care 1400  
 Participation In The Cost Of Home & Community-Based Waiver Services 809  
 Adjustment of Participation Overpayment or Underpayment Amounts 811  
 Base Participation 810  
 Community Spouse 810  
 Developmentally Disabled Participants 810  
 Excluded Income 810  
 Home & Community Based Services (HCBS) Spouse 810  
 Incurred Medical Expenses 810  
 Personal Needs Allowance 810  
 Recalculation of Participation 811  
 Remainder After Calculation 810  
 Participation Privileges 42  
 Beer 43  
 Listing 42  
 Promotion 42  
 Use of the Idaho Preferred® Logo 42  
 Visibility 42  
 Water 43  
 Particulate Matter -- Existing Equipment Process Weight Limitations 2533  
 Emission Standards -- Table 2534  
 General Restrictions 2533  
 Particulate Matter -- New Equipment Process Weight Limitations 2532  
 Emission Standards -- Table 2533  
 Exemption 2533  
 General Restrictions 2532  
 Particulate Matter -- Other Processes 2534  
 Emission Standards -- Table 2534  
 Other Processes 2534  
 Particulate Matter -- Process Weight Limitations 2532  
 Averaging Period 2532  
 Minimum Allowable Emission 2532  
 Particulate Matter Emission Limitations 2532  
 Test Methods & Procedures 2532  
 Parties & Persons With Similar Interests 1983  
 Parties To Contested Cases Listed 1968  
 Part-Time Juvenile Detention Officer Certification 629  
 Eligibility 629  
 Limitations on Certification & Authority 630  
 Requirements for Certification 629  
 Retaining Certification 629  
 Patient Records 1140  
 Charges & Payments 1141  
 Individual Records 1140  
 Record Retention 1141  
 Patients Records 1590  
 Optometrist Shall Keep a Complete Record of All Patients Examined 1590  
 Prescription Files 1591  
 Storage of Patient Records 1591  
 Payment 1220  
 Acreage Calculation 1220  
 Annual Payments Non-Refundable 1220  
 Assignment 1220  
 Board Approved Payment Schedule 1220  
 Non-Payment Constitutes Lack of Bonding 1220  
 Supplemental Payments 1220  
 Payment For Logging Or Hauling 1313  
 Compliance with Gross Scale Determination 1313  
 Payment For Shelter Care 954  
 Payment Limitations In Adoption, Children's Agencies 1048  
 Payment Of Combatant 1475  
 Manager's Share 1475

- Payment in Full 1475  
Pending Action 1475  
Prior Approval of Commission 1475  
Prior Written Commitments 1475  
Payment Of Expenses, Winnings, &  
Charitable Contributions 2332  
Payment Of Fee To Official Designated  
By Commission 1479  
Payment Of Fees For Permits By Rule  
Registration 2551  
Payment Of Fees For Permits To  
Construct 2426  
Delinquency 2426  
Fee Submittal 2426  
Payment Of Purse 1475  
Alternative Payment 1476  
Non-Payment of Amateurs 1476  
Payment Made 1476  
Reconciliation 1476  
Signatures 1476  
Payment Of Special Permit Fees 2221  
Additional Fees 2222  
Current Schedule of Fees 2222  
Payment of Fees 2221  
Permit Costs 2222  
Refund 2222  
Payment Of Tier I Registration  
Fee 2460  
Fee Payment Date 2460  
Fee Payments Mailing  
Address 2460  
Payment Of Tier II Operating Permit  
Processing Fee 2467  
Delinquency 2467  
Fee Submittal 2467  
Payment To Family Foster Care  
Providers 955  
Clothing 955  
Gifts 955  
School Fees 955  
Payments On Winning Pari-Mutuel  
Wagers 565  
Payments To Providers 785  
Peach, Apricot Trees, Or Any Host 349  
Peer Review Oversight Committee 34  
Peer Review Program Participation 31  
Participation 31  
Practice Privileges 32  
Penalties 558, 590, 2047, 2141  
Enforcement by Director 2047  
Order by Director 2047  
Willful Violations or Failure to  
Comply 2047  
Penalties For Certain Violations 1508  
Penalties For Failure To Collect,  
Account For, Or Remit  
Assessments 70  
Penalties For Failure To Collect,  
Account For, Or Remit Assessments -  
- Other Violations 77  
Penalties For Violations 1844  
Civil Claim 1844  
Violators 1844  
Penalty 289, 296, 301, 758, 2014  
Failure to Submit 2014  
Permits for Which Proof Has Not  
Been Submitted 2014  
Penalty For Late Payment Of Wheat  
Tax 2255  
Additional Penalties 2256  
Interest Penalties 2256  
Percentage Of Gate Receipts To  
Combatant 1475  
Performance Bond Requirements 1167  
Bond Cancellation 1168  
Bond Reduction 1169  
Bond Release 1169  
Bonding Rate 1170  
Correction of Deficiencies 1170  
Federal Bonds Recognized 1170  
Forfeiture 1170  
Form of Performance Bond 1168  
Insufficient Bond 1170  
Submittal of Bond 1167  
Substitute Surety 1169  
Performance Of Work 2244  
Completion of Work 2244  
Work Delayed by Applicant 2244  
Performance Standards 2244  
Perimeter Fence Requirements 187  
Elk & Fallow Deer 188  
Exceptions 188  
Fence Maintenance 188  
Gates 188  
Posts 188  
Reindeer 188  
Wire 188  
Period Before His Next Contest 1494  
Periodic 642  
Periodic Assessment By POST 642  
Assessment 642  
Failure to Comply With  
Standards 642  
Permanent Flow Measuring Device  
Requirement, Conditions of  
Approval 2113  
Permanent Project Signs 1868  
Permanent Register, Residential Care  
Facility 1035  
Permit & Permit Application 2800  
Application for a Small Cyanidation  
Processing Facility & Pilot  
Facility 2804  
Contents of Application 2800  
Exemptions to Fees 2804  
Permit Application 2800  
Permit Application Fees 2804  
Permit Require 2800  
Permit Application 213, 2748  
Application Fee 2750  
Closure Plan 2750  
Construction Plan 2748  
Construction Plans 214  
Contents of Application 213, 2748  
Nutrient Management Plan 215,  
2750  
Other Information 2750  
Permit Application 2748  
Preapplication Conference 2748  
Relevant Information 2748  
Site Characterization 2749  
Permit Application &  
Administration 2242  
Applicant Information 2242  
Application for ICP Permit 2242  
Other Inspections &  
Requirements 2242  
Site Inspection or Waiver When  
Permit Required 2242  
Use of Discretion on Requirements  
by District 2242  
Work Involving Public Right-of-  
Way 2243  
Permit By Rule 2521  
Forms 2521  
General Requirements 2521  
Permit By Rule Requirements, Permit  
Requirements, Nonmetallic Mineral  
Processing Plant Not Subject to CFR  
60, Subpart 000 2544  
Permit By Rule, Dairy Farms 2538  
Exemption 2538  
General Requirement 2538  
Optional Permit by Rule 2538  
Permit Conditions 215, 2756, 2812  
Begin Construction 2757, 2814  
Compliance Required 215, 2756,  
2812  
Construction & Operation of  
Facility 2756  
Construction Commencement 216  
Construction, Operation, &  
Maintenance of the Facility 215  
Discharge Response 2813  
Entry & Access 215, 2756, 2813  
Financial Capability 2756  
Information to be Provided 215  
Notifications 2812  
Permanent Closure 2814  
Permit Renewal 216, 2757  
Provide Information 2756, 2812  
Record Plans & Specifications 2812  
Reporting 215, 2757, 2813  
Specific Permit Conditions 216  
Temporary or Seasonal Closure  
Plans 2813  
Permit Conditions For Specific  
Categories 2942  
Concentrated Animal Feeding  
Operations (CAFOs) 2943  
Existing Manufacturing,  
Commercial, Mining, &  
Silvicultural Dischargers 2942  
Municipal Separate Storm Sewer  
Systems 2943  
Publicly Owned Treatment  
Works 2942  
Storm Water Dischargers 2943  
Permit Fee & Plan Review Fee 757  
Permit Fee Schedule 398  
Additional Fees 400  
Miscellaneous 399

- New Residential 398
- No Permit 400
- Other Installations Including
  - Industrial and Commercial 399
- Permit Fees 49
- Permit Modification 216, 2758, 2815
  - Cause for Permit Modification 2815
  - Major Modifications 216, 2758
  - Major Permit Modifications 2816
  - Minor Modifications 216, 2758
  - Minor Permit Modifications 2816
  - Modification at Request of
    - Director 2816
  - Modification at Request of Permittee 2815
  - Modification Procedure 2816
- Permit Prohibitions 2868
  - Anchorage & Navigation Impaired 2868
  - Area Wide Waste Treatment Management Plans 2868
  - Banned Content 2868
  - Clean Water Act Compliance 2868
  - EPA Objection 2868
  - New Sources or New Dischargers 2868
  - Water Quality Requirements 2868
- Permit Requirements 2543
  - Permit by Rule 2543
  - Permit By Rule Eligibility 2543
  - Permit to Construct 2543
  - Tier I Operating Permits 2543
  - Tier II Operating Permits 2543
- Permit Requirements For New & Modified Stationary Sources 2405
  - Emission Standards 2405
  - NAAQS 2405
  - Toxic Air Pollutants 2406
- Permit Requirements For New Major Facilities Or Major Modifications In Attainment Or Unclassifiable Areas 2407
  - Effect on Visibility 2407
  - Exception to Incorporation by Reference of 40 CFR 52.21 2408
- Incorporated Federal Program Requirements 2407
  - Nonmajor Requirements 2408
- Permit Requirements For New Major Facilities Or Major Modifications In Nonattainment Areas 2406
  - Additional Requirements 2406
  - Compliance Status 2406
  - Effect On Visibility 2407
  - LAER 2406
  - Required offsets 2406
- Incorporated Federal Program Requirements 2406
  - Nonmajor Requirements 2407
- Permit Requirements For Tier II Sources 2463
  - Emission Standards 2463
  - NAAQS 2463
- Permit Revocation 2817
  - Cause for Revocation 2817
  - Revocation Hearing 2817
- Permit Revocation Or Stop Work Order 2243
- Permit To Construct Application Fee 2425
  - Exemption Applicability Determinations 2425
  - Name or Ownership Change 2425
  - Typographical Errors 2425
- Permit To Construct Processing Fee 2425
- Permit To Construct Required 2403
- Permit To Drill, Deepen, Or Plug Back 1332
  - Application 1332
  - Fees 1332
  - Permit Denial 1333
  - Permits Required 1332
  - Time Required to Commence Operations 1332
- Permits 368, 397, 424, 432, 757, 1582
  - Annual Permit 424
  - Building Permits 424
  - Certificates of Veterinary Inspection to be Furnished 368
  - Commercial, Industrial and Others 397
  - Examination & Treatment Fees 368
  - Expiration of Permit 398
  - Home Owners 397
  - Inspection Fees 368
  - Issuance of a Temporary Permit Does Not Obligate the Board 1582
  - Plumbing Contractors 397
  - Refunds of Permits 398
  - Request for Permits 368
  - Requirements for Issuance 1582
  - Serial Number 397
  - Transferring a Permit 398
- Permitted Non-Steroidal Anti-Inflammatory Drugs 586
  - Flunixin (Banamine) 586
  - Ketoprofen (Ketofen) 586
  - Mechlofenamic Acid (Arquel) 586
  - Phenylbutazone (Butazoladin) 586
- Permittee Responsible For Injury To Persons Or Property 2223
- Person 2292
- Person Filling More Than One Position 1035
- Personal Care & Hygiene 1028
- Personal Needs Allowance 915
  - Set-Aside Amount 915
  - State Hospital South (SHS) 915
- Personal Needs Allowance, Table 149.06 810
- Personal Possessions, Allowance, & Money Policy 1040
  - Child's Personal Possessions 1040
  - Financial Accounting 1040
  - Signature Required 1040
- Personal Possessions, Allowances, & Money 1028
- Personnel 2290
- Personnel License Renewal 708
  - Declarations of Convictions or Adjudications 708
  - Documentation of Affiliation with EMS Agency 708
  - Documentation of Continuing Education for Level of Licensure Renewal 708
  - Submit Required Licensure Renewal Fees 708
  - Time Frame for Application of Licensure Renewals 708
- Personnel License Transition 707
- Personnel Licensure Required 703
  - Advanced Emergency Medical Technician (AEMT) 703
  - Emergency Medical Responder (EMR) 703
  - Emergency Medical Technician (EMT) 703
  - Paramedic 703
- Personnel Licensure Requirements 703
- Personnel Qualifications 749
  - Analyst or Equivalent Job Title 750
  - Chemistry Technician 750
  - General Supervisor Qualifications 749
  - Supervisor Qualifications by Discipline 749
- Persons Allowed In Ring 1490
- Persons Exempted By Board 1421
  - Employer Application 1422
  - Family Members & Others 1421
  - Non-Resident Nurses 1421
  - Nurse Apprentice 1422
  - Technicians & Technologists 1421
- Persons Exempted From Advanced Practice Registered Nursing License Requirements 1437
  - Advanced Practice Registered Nurses Educated Prior to January 1, 2016 1437
  - Certified Nurse Practitioners Licensed Prior to July 1, 1998 1437
  - Students 1437
- Persons Not Parties -- Interested Persons 1968
- Persons Who May Appeal 1991
- Pest Detection 280
  - Consequences 280
  - Inspection 280
- Pesticide Use On Seed Crop Fields 125
  - Exemption 126
  - Nonfood & Nonfeed Site Conditions 125
- Pesticide-Fertilizer Mix Restrictions 122
- Pesticides & Herbicides 168
- Petition 2395
  - Requested Relief 2395
  - Statement of Facts 2395

- Statement of Reasons 2395  
Petition For Rehearing Or  
  Reconsideration 1430  
  Administrative Procedure 1430  
  Petition for Rehearing or  
  Reconsideration 1430  
Petition for Removal From the Child  
  Protection Central Registry 964  
Petition For Removal Of An  
  Individual's Name From The Child  
  Protection Central Registry 964  
  Appeal of a Denial of Removal From  
  the Child Protection Central  
  Registry 965  
  Criminal History Checks 964  
  Criteria for Granting Petition for  
  Removal From the Child  
  Protection Central Registry 964  
  Granting or Denying Removal From  
  the Child Protection Central  
  Registry 965  
Petition For Removal Of An  
  Individual's Name On The Child  
  Protection Central Registry Prior To  
  October 1, 2007 964  
Petition To Adopt Under The Adoption  
  Of Children Act 980  
  Filing a Petition 980  
  Registration &  
  Acknowledgment 980  
Petition Under The Child Protective  
  Act 965  
Petitioners 1968  
Petitions 450  
Petitions For Declaratory Rulings To Be  
  Decided By Order 1978  
  Content 1978  
  Final Agency Action 1978  
Petitions For Extension Of Time To  
  File 451  
Petitions--Defined--Form &  
  Contents 1970  
  Petitions 1970  
  Pleadings Defined 1970  
Petroleum Products 99  
  Compressed Natural Gas 100  
  Gauge Stick Measurement 99  
  Liquefied Natural Gas 100  
  Liquefied Petroleum 99  
  Maintaining Scales 99  
  Metering System Installation 99  
  Single Meters 99  
Petroleum Underground Storage Tank  
  Database 2609  
  Availability 2609  
  Identification 2609  
  Maintenance 2609  
  Petition 2609  
Pets & Domestic Animals 1024  
Pharmacist Intern Registration 1881  
  Registration Requirements 1881  
  Renewal 1881  
Pharmacist License  
  Reinstatement 1880  
  Additional Requirements 1880  
  Satisfactory Evidence 1880  
Pharmacist License Renewal  
  CPE Requirements 1880  
  ACPE 1880  
  CME 1880  
Pharmacist Licensure By  
  Examination 1879  
  Graduates of foreign Pharmacy  
  Schools 1880  
  Graduates of U.S. Pharmacy  
  Schools 1879  
  Licensure Examinations 1880  
Pharmacist Licensure By  
  Reciprocity 1880  
Pharmacist Prescribing  
  General Requirements 1885  
  Collaboration with Other Health  
  Care Professionals 1885  
  Documentation 1885  
  Education 1885  
  Follow-Up Care Plan 1885  
  Notification 1885  
  Patient Assessment 1885  
  Patient-Prescriber  
  Relationship 1885  
  Prescribing Exemption 1885  
Phenoxy Herbicide Restrictions 125  
  Airflow & Temperature Inversion  
  Indicators 125  
  High Volatile Ester Restrictions 125  
  Low Volatile Ester Restrictions 125  
  Other Spraying Equipment 125  
Phenylketonuria (PKU) 783  
  PKU Patients Under Eighteen Years  
  of Age 783  
Philosophy & Objectives Of  
  Educational Program 1447  
Photo Finish Devices 574  
  Devices Calibrated 575  
  Location 574  
  Posting Photographs 574  
  Print Provided 575  
  Records 575  
Physical & Eye Examination Of  
  Combatants At Time Of Weigh-  
  in 1487  
Physical Examination 1075  
  Medical Special Needs 1076  
  Physical Examination  
  Availability 1076  
  Prior Physical Examination 1075  
  Standard Physical Examination  
  Requirements 1075  
Physical Examination Of  
  Combatant 1467  
  Additional Examination 1467  
  Blood Testing 1467  
  Drug Abuse 1467  
  Examination by Physician 1467  
Physician -- Suitable Place To Examine  
  Contestant 1488  
Physician Panelist For Prelitigation  
  Consideration Of Medical  
  Malpractice Claims 1391  
  Eligibility 1391  
  Excusing Physicians from  
  Serving 1391  
  Penalties for Noncompliance 1391  
  Purpose 1391  
Physician's Determination Of Fitness  
  Of Combatants & Referee,  
  Certification, Report  
  Determination of Physician 1488  
  Physician's Written Report 1488  
  Written Certification 1488  
Physician's Report To Commission  
  After Contest  
  Applies for Medical Aid 1495  
  Injury 1495  
Piling 2085  
  Condition of Pilings 2085  
  Prohibited Materials, Pilings 2085  
  Replacement of Pilings 2085  
  Standards for Pilings 2085  
Pipe Crossings 2085  
  Cofferdam 2085  
  Construction Methods 2085  
  Depth of Line 2085  
  Pipe Joints 2085  
  Revegetation of Disturbed  
  Areas 2085  
  Standards for Pipe Crossings 2085  
Pit Requirements 1339  
  Closure of Pits 1342  
  Condemnation Due to Improper  
  Impoundment 1342  
  Emergency Pits 1342  
  Location 1339  
  Minimum Plans & Specifications for  
  Long Term Pits 1341  
  Minimum Plans & Specifications for  
  Reserve, Well Treatment, & Other  
  Short Term Pits 1340  
  Operating Requirements 1342  
  Pit Sizing Criteria 1340  
  Plans Required 1339  
  Site Preparation 1339  
  Time Limits for Short Term  
  Pits 1341  
Place Of Filing 1926  
Placement Agreement Required  
  Contents, Children's Agencies 1043  
Placement Of Hunting Camps &  
  Leaving Outfitter's Operating Area,  
  Big Game Hunting & Incidental  
  Trapping 1816  
  Camps 1816  
  Hot Pursuit of Bear & Cougar With  
  Hounds & Hot Pursuit  
  Agreements 1816  
  Wolf Trapping Incidental to Big  
  Game Hunts 1816  
Placement Of The Child 977  
  Disclosure 978  
  Factors to be Considered in  
  Determining Suitability of  
  Adoptive Placements 977

- Selection of Adoptive Placement 978
- Placement Supervision - Transfer From Out Of State Private Agency 979
- Placer Or Dredge Exploration Operations 1161
  - Confidentiality 1161
  - Notice 1161
  - One-Half Acre Limit 1161
  - Reclamation Required 1161
- Placer Or Dredge Mining Of Certain Waterbodies Prohibited 1178
  - Mining Withdrawals 1179
  - Prohibited Areas 1179
- Plan Of Service 838
  - Changes to the Plan 839
  - Copy of the Plan 839
  - Core Elements 838
  - Developing the Plan 839
  - Periodic Review 839
  - Resident Choice 839
  - Signature & Approval 838
- Plan Review 424, 432
  - Addenda & Change Orders 425
  - Application Provisions 433
  - Distribution of Approved Copies 433
  - Jurisdiction 424, 432
  - Non-conformance 433
  - Plans Not Required 425, 433
  - Plans Specifications 425
  - Proprietary Information 433
  - Revisions to Approved Modular Building Plans 433
- Plans, Drawings, & Specifications 2050
  - Application for & Receipt of Written Approval 2051
  - Detailing Provisions of Specifications 2052
  - Dimensions of Plans 2051
  - Engineer's Report 2053
  - Filing of Additional Information 2053
  - Inspections, Examinations & Tests 2052
  - Plans 2051
  - Preparation & Submission of Plans 2051
  - Provision Included with Plans 2052
  - Provisions Included with Specifications 2052
  - Rejection of Defective Material 2052
  - Required Information 2052
  - Responsibility of Engineer 2052
  - Scale of Plans & Drawings 2051
  - Specifications 2052
  - Submission of Plans, Drawings & Specification 2050
  - Suspension of Work 2052
- Planting Of Potatoes 349
  - Certification 349
  - Control 349
- Home Gardens 349
  - Seed Potato Crop Management Area 349
- Plastic/Burn 783
  - Eligible Conditions 783
  - Excluded Conditions 783
  - Spending Limit 783
- Plater 555
- Play Using Electronic Bingo Machines 2331
  - Additional Paper Cards 2331
  - Available Devices 2331
  - Loading Electronic Bingo Devices 2331
  - No Player-Owned Devices 2331
  - One Device Per Player 2331
  - Other Requirements 2331
  - Provision of Devices 2331
  - Reserve Devices 2331
  - Use of Devices on Premises 2331
- Pleadings Listed--Miscellaneous 1970
- Plumbing Contractor 402
  - Advertising 403
  - Effective Dates 403
  - Out-of-State Contractor Applications 402
  - Plumbing Contractor's Responsibility 403
  - Previous Revocation 403
  - Qualifications for Plumbing Contractor 402
  - Restrictive Use of Contractor Certificate 402
  - Reviving an Expired License 403
- Podiatric Residency 1596
  - Residency Required for Licensure 1596
  - Submission of Verification of Residency Curriculum 1596
- Police 627
- Policies 2761
  - Categorization of Ground Water 2761
  - Existing & Projected Future Beneficial Uses 2761
  - Ground Water Quality Protection 2761
  - Ground Water Quality Standards 2761
  - Mining 2761
  - Prevention of Ground Water Contamination 2761
- Policies & Procedures 874
- Policies & Procedures For Transitional Living Services, Children's Agencies 1045
- Policies & Procedures, Children's Therapeutic Outdoor Programs 1070
- Policy 914, 1224, 1245, 1251, 1295, 1360, 1836, 2778, 2834
  - Compensation 1837
  - Consent Required 1836
  - Control 1837
- Director May Grant Leases 1295
- Director's Authorization to Issue & Renew Leases 1295
- Director's Discretion 1246
- Discretion 1836
- Easements Required 1245
- Environmental Protection & Navigational or Economic Necessity 1224
- Exercise of State Title 1251
- Existing Easements 1246, 1252
- Existing Permits 1252
- Interest Granted 1246
- Issuing Authority 1836
- Limit of Director's Discretion 1246
- Limitation on Easement Grant 1252
- Minimum Width 1252
- Modifications 1836
- No Encroachments Without Permit 1224
- Other Permits 1251
- Other Permits and Licenses 1295
- Permitting of Existing Encroachments 1224
- Policy of the State of Idaho 1295
- Prior Grants 1246
- Private Moorage at Commercial Marinas 1296
- Purpose Compatible 1837
- Reciprocal Easements 1246
- Recordation 1246
- Regulation of the Beds of Navigable Waters 1251
- Requests or Inquiries Regarding Navigability 1295
- Rights Granted 1295
- Rules Applicable to All Existing & Proposed Uses & Encroachments 1295
- Stream Channel & Encroachment Permits 1251
- Stream Channel Alteration Permit or Encroachment Permit 1295
- Submerged Lands Lease Required Upon Notification 1295
- Term Easement 1246
- Term of Lease, Renewal of Lease 1295
- Waiver of Lease Requirements 1296
- Width of Easement 1246
- Policy Statement 1940
- Policy Statement, UCC Information Management System 1931
- Polychlorinated Biphenyls (PCBS) 2399
  - Prohibition on Burning 2399
  - Prohibition on Sales 2399
- Polyethylene Sheeting 88
  - Bulk 88
  - Count -- Ply 88
  - Fractions 88
  - Packages 88
- Polygraph Examinations 2359
- Pony Person 555

- Portable Electrical Devices 763  
Possession Permits 317  
    Annual Report 318  
    Application for Possession Permits 317  
    Application Process 317  
    Disposition of Non-Permitted Invasive Species 318  
    Duration of Possession Permit 318  
    Grant or Denial of the Permit 318  
    Permit Revocation 318  
POST 612  
Post Conviction Sexual Offender Polygraph Examiner  
    Qualifications 2353  
    Certification Requirements 2353  
    Certified Examiner 2353  
POST Council 613  
    Compensation 613  
    Council Members 613  
    Resignations 613  
POST Credit For In-Service Training 638  
    Course Attendance Roster 639  
    Credit for POST In-Service Training Provided by a Post Certified Instructor in Idaho 638  
    Credit for POST In-Service Training Provided by an Organization or Vendor who is not POST Certified 638  
    Training Outside Idaho 639  
POST Division Administrator 614  
    Administration 614  
    Responsibilities 614  
    Selection 614  
POST Hearing Board 614  
    Discovery 614  
    Members 614  
    Recommended & Final Orders 614  
Post Hearing Provisions For Residential And Domiciliary Care 1380  
    Effect of Petition for Judicial Review 1381  
    No Motions for Reconsideration 1380  
    Public Inspection 1380  
    Service of Decisions and Orders 1380  
POST Instructor Certification 635  
POST Instructor Certification – General Provisions 635  
    Agency Responsibility 635  
    POST Training Credit 635  
Post-Accident Testing 592  
Post-Entry Quarantine Certification 268  
Post-Graduation Self-Evaluation 641  
Posting Of Fields 296  
    Approval by Department 296  
    Posting 296  
Posting Of License & Hours 2327  
Post-Legal Adoption Services 982  
Post-Placement & Post-Finalization Adoption Services, Inter-Country Adoption 1051  
    Adoption Disruption Re-Placement 1052  
    Child Origin Information Access 1052  
    Crisis Counseling 1052  
    Post-Finalization Counseling 1052  
    Post-Placement Reports 1051  
Postponement Of Program 1479  
    Advance Notice 1479  
    Limitations on Postponement 1479  
    No Fault Postponement 1479  
    Prior Approval 1479  
Potatoes For Consumption 351  
Poultry & Rattles 140  
    Release of Live Birds 140  
    Sale of Live Birds or Hatching Eggs 140  
Power Boat Fishing Guide - (Lakes & Reservoirs) 1816  
    Law 1816  
    Maneuver or Pilot 1816  
    Operation 1816  
Power Boat Guide 1814  
    Classified Rivers 1814  
    Lakes & Reservoirs 1814  
    Log 1814  
    Unclassified Rivers & Streams 1814  
Power to Limit Production 1351  
Powers & Duties Of POST Council 613  
    Additional Time to Complete POST Training & Certification 613  
    Assist, Study, Consult & Cooperate 613  
    Certification 613  
    Committees 613  
    Records 613  
    Reimbursement of Instructors 614  
    Rules 613  
    Vice-Chairman 613  
Powers & Duties Of The State Fire Marshal 1128  
    Assistants, Inspectors & Other Employees 1128  
    Fees 1129  
    Licensing Procedures 1128  
    Records 1128  
    Suspension or Revocation of License 1128  
Powers Of The Racing Commission To Review & Audit Records 565  
Practical Experience 1705  
    Dealer-in-Training License 1706  
    Supervised Practical Experience 1705  
Practical Experience In Lieu of Education 1563  
Practice Of Dry Needling 1629  
    Documentation of Training 1629  
    Written Informed Consent 1629  
Practice Of Pharmacy General Approach 1874  
    Education, Training, & Experience 1875  
    Express Prohibition 1875  
    Standard of Care 1875  
Practice Of Social Work 1637  
    Baccalaureate Social Work 1637  
    Clinical Social Work 1638  
    Employment of a Social Worker 1638  
    Master's Social Work 1638  
Practice Outside Of A Licensed Establishment 1789  
    Cleansing 1789  
    Coloring 1789  
    Extensions 1789  
    Hair Styling 1789  
    Makeup Application 1789  
    Nail Services 1789  
    Safety & Disinfection 1789  
    Temporary Hair Removal 1789  
Practice Privileges 26  
    Internet Disclosures 26  
    Substantially Equivalent 26  
Practice Sites 1454  
    Approval by Other Agencies 1454  
    Evaluation by Faculty 1454  
    Faculty Supervision 1454  
    Planned Communication 1454  
    Sufficient Experiences 1454  
    Written Agreements 1454  
Practice Standards 1400  
    Advertise 1400  
    Delegation of Services Agreement 1400  
    Identification 1400  
    Notification of Change or Addition of Supervising or Alternate Supervising Physician 1400  
    Supervising Physician 1400  
Practitioner Controlled Substance Registration 1881  
    DEA Registration 1882  
    State License 1882  
Pre-Adoptive Parent Responsibilities 977  
Pre-Application Process 2869  
    Application Content 2869  
    Application Schedule 2869  
    IPDES Permit Applicability 2869  
Preceptorship Program 1591  
Prehearing Conference 1951  
    Determination Upon Results of Conference 1951  
    Failure to Appear 1951  
    Notice of Prehearing Conference 1951  
    Prehearing Order 1951  
    Subject of Conference 1951  
Prehearing Provisions For Residential And Domiciliary Care 1375  
    Briefing Schedule 1377  
    Discovery 1377  
    Disposition of Case Without a Hearing 1375

- Hearing Record 1376  
Informal Disposition 1377  
Intervention 1376  
Notice of Hearing 1375  
Prehearing Conference 1375  
Rules of Civil Procedure 1377  
Stipulations 1377  
Subpoenas 1376  
Withdrawal of Appeal 1376  
Withdrawal of Attorney or Representative 1376  
Preliminary Orders 1988  
  Contents of Preliminary Order 1988  
  Definition 1988  
Preliminary Procedure At Hearing 1983  
Prelogging Conference & Agreement 1310  
Premature Timber Sale  
  Termination 1156  
  Request 1156  
  Termination Policy 1156  
Premises Requirements 203  
  Condition 203  
  Feed & Water 203  
  Fences 203  
  Pens 203  
  Restraint System 203  
Premiums For Participation In Medicaid  
  Enhanced Plan 806  
  Recomputed Premium Amount 807  
  Workers with Disabilities 806  
Premiums For Participation Under Home Care For Certain Disabled Children (HCCDC) 805  
  Failure to Pay Premium 805  
  Failure to Provide Information 805  
  Family Income Above 150% & Equal to or Less Than 185% of FPG 805  
  Family Income Above 185% of FPG 805  
  Premium Recalculation 806  
  Reduction of Premium for Creditable Health Insurance 805  
  Waiver of Premium 805  
Premiums For Participation Under The State Children's Health Insurance Program (SCHIP) 804  
  Family Income Above 133% of FPG 804  
  Family Income Above 150% of FPG 804  
Premiums For Participation Under The Youth Empowerment Services (YES) Program 806  
  Enforcement of Premiums 806  
  Premium Fee Schedule 806  
  Premium Recalculation 806  
  Waiver of Premium 806  
Prenatal & Postpartum Care 1068  
  Hospital Delivery Required 1068  
  Infant Medical Care Plan 1068  
  Obstetric History 1068  
  Obstetrical Exam 1068  
  Ongoing Medical Care 1068  
  Prenatal & Postnatal Education 1068  
Preparation Of Draft Permit Or Draft Denial 2447  
Preparation Of Proposed Permit Or Proposed Denial 2448  
  Availability 2448  
  Notice to Affected States 2448  
  Timeline 2448  
Preparations To Stop  
  Hemorrhaging 1506  
Prepared Testimony 1985  
Prepared Testimony & Exhibits 1982  
Pre-Permit Construction 2420  
  Permit to Construct Procedures for Pre-Permit Construction 2420  
  Pre-Permit Construction Eligibility 2420  
Pre-Professional Education 1596  
Prescribed Burning 2521  
  Burning Permits or Prescribed Fire Plans 2521  
  Rights-of-Way Fires 2521  
  Smoke Management Programs for Prescribed Burning 2521  
Prescribed Units 86  
  Area Measure -- Dual Quantity Declaration 87  
  Bidimensional Commodities 87  
  Fluid Measure -- Dual Quantity Declaration 87  
  Four Feet, Four Square Feet, Four Pounds, One Gallon, or More 87  
  Length Measure -- Dual Quantity Declaration 87  
  Less Than One Foot, One Square Foot, One Pound, or One Pint 86  
  Weight -- Dual Quantity Declaration 87  
Prescriber Performance Of Pharmacy Functions 1875  
Prescription Delivery  
  Restrictions 1888  
    Acceptable Delivery 1888  
    Pick-up or Return by Authorized Personnel 1888  
Prescription Drug Order  
  Minimum Requirements 1886  
  Date 1886  
  Directions 1886  
  Drug Information 1886  
  Exemptions for Non-Controlled Substances 1887  
  Institutional Drug Order Exemptions 1887  
  Patient's Name 1886  
  Prescriber Information 1886  
  Signature 1886  
  Validity 1886  
    Antedating or Postdating 1886  
    Digital Image Prescriptions 1886  
    Invalid Prescription Drug Orders 1886  
  Prescriber Self-Use 1886  
  Tampering 1886  
Prescription Writing 1401  
Prescriptions For Spectacles & Contact Lenses 1589  
  All Prescriptions for Rigid Contact Lenses 1590  
  All Prescriptions for Soft Contact Lenses 1590  
  Alteration of Prescriptions 1590  
  Expired Contact Lens Prescription 1590  
  Fitting & Dispensing Contact Lenses 1590  
  Prescription for Spectacles 1589  
Prescriptive & Dispensing Authorization For Advanced Practice Registered Nurses 1438  
Expiration of Temporary Prescriptive Authorization 1438  
Initial Authorization 1438  
Prescribing & Dispensing Authorization 1438  
  Temporary Authorization 1438  
Preservation of Public Property 1844  
Presiding Officer 1955  
  Certification by Board 1955  
  Hearing 1955  
  Motions 1955  
  Oath or Affirmation 1955  
  Official Record 1955  
  Other Action 1955  
Presiding Officer(s) 1979  
Pretreatment Standards 2962  
  Department Program in Lieu of a POTW Program 2962  
  Exceptions to Incorporation by Reference 2963  
  Objectives of General Pretreatment Regulations 2962  
  Purpose & Applicability 2962  
  Term Interpretation 2962  
Prevention Of Significant Deterioration (PSD) Increments 2494  
  Exceedances 2494  
  Exclusions 2494  
  Incorporated Federal Program Requirements - Class I, II and III Areas 2494  
Previous Exemption Review  
  Denials 932  
Primary Data Elements 1931  
  Filing Date & Filing Time 1931  
  Identification Numbers 1931  
  Identification of Parties 1932  
  Lapse Indicator 1932  
  Status of Financing Statement 1932  
  Type of Document 1931  
Primary Purpose 591  
Prior Authorization 785  
Priority Lists 519  
  Limitations on Priority Lists 520  
  Priority Lists for Incorporated City Liquor Licenses 519

- Priority Lists Where Licenses are Available 520  
Refusal to Accept Offer of License or Failure to Complete Application for License 520  
Written Notification 519  
Priority Rating System 2839  
Amendment of Priority List 2840  
Priority List 2840  
Priority Rating 2839  
Priority Reevaluation 2840  
Priority Target Date 2840  
Project Bypass 2840  
Purpose 2839  
Rating Forms 2840  
Private Applicator Licensing 111  
Applying for a Private Applicator's License 111  
License Categories 111  
License Recertification 111  
Prize Logs 1312  
Procedure 754, 1248, 1254  
Board Decision 1254  
Contents of Application 1248, 1254  
Decision on Application 1254  
Denial of Application 1254  
Director's Decision 1254  
Engineer Certification 1248, 1254  
Notification of Approval 1249, 1254  
Notification of Denial 1249  
Where to Submit 1254  
Where to Submit Application 1249  
Procedure & Testimony 1955  
Examination of Witness 1956  
Order of Procedure 1955  
Preliminary Procedure 1955  
Presentation of Evidence 1955  
Testimony 1955  
Procedure For Contesting The Accuracy & Completeness Of A Criminal History Record Contained In Agency File 523  
Challenge Accuracy of Records 523  
Correction of Records 523  
Documentation of Erroneous Information 523  
Notification of Fingerprints Not Matched 523  
Procedure For Issuing Permits 2408  
Additional Procedures for Specified Sources 2409  
Establishing a Good Engineering Stack Height 2410  
General Procedures 2408  
Permit to Construct Procedures for Tier I Sources 2410  
Revisions of Permits to Construct 2410  
Transfer of Permits to Construct 2412  
Procedure For Issuing Permits, Tier II Operating Permit 2463  
Availability of Fluid Models & Field Studies 2464  
General Procedures 2463  
Permit Revision or Renewal 2465  
Specific Procedures 2464  
Transfer of Tier II Permit 2465  
Procedure For Obtaining Phytosanitary Certificates 268  
Application Information 268  
Requests for Phytosanitary Certificates 268  
Rush Service 268  
Procedure For Use Of Scorecards 1489  
Delivery of Scorecards to Commission 1489  
Presentation of Scorecards to Press After Contest 1489  
Report of Each Contest 1489  
Scorecards 1489  
Scoring by Judges 1489  
Procedure Governed 1946  
Procedure 1946  
Purpose 1946  
Procedure On Prehearing Motions 1984  
Procedure Upon Finding Of Reasonable Cause 2340  
Procedure Upon Lapse 1935  
Procedure Upon Refusal 1930  
Procedure When Combatant Is Knocked Out 1494  
Procedures & Duties 1458  
Meetings 1458  
Voting 1458  
Procedures & Requirements For Permits Establishing A Facility Emissions Cap 2399  
Procedures & Requirements For Permits To Construct 2403  
Procedures & Requirements For Tier I Operating Permits 2427  
Procedures & Requirements For Tier II Operating Permits 2461  
Procedures Following A Positive Chemical Analysis 593  
After Evaluation 593  
First Positive Test 593  
Second Violation 594  
Third Violation 594  
Procedures Following The Adoptive Placement 979  
Procedures For Categorizing Or Recategorizing An Aquifer 2770  
Criteria for Aquifer Categories 2771  
Petition Process 2772  
Preliminary Department Review 2772  
Procedures For Certification Of Forage Cubes/Pellets/Compressed Forage/Straw Bales 341  
Application 341  
Documentation 342  
Equipment 341  
Purging 341  
Validity 341  
Procedures For Decision-Making (State Procedures For RCRA Or HWMA Permit Applications) 2560  
Procedures For Issuing Permits Establishing A Facility Emissions Cap  
FEC Termination 2402  
General Procedures 2401  
Renewal 2401  
Reopening the FEC 2401  
Procedures For Licensing Suspension, Revocation Or Nonrenewal 442  
Procedures For Review & Decision Upon An Application 1165  
Adverse Weather 1165  
Amended Applications 1166  
Decision on Application 1165  
Interagency Comment 1165  
Permit Conditions 1166  
Permit Denial Authority 1165  
Permit Offering 1166  
Public Hearings 1165  
Reclamation Obligations 1166  
Stream Alteration Permits 1165  
Water Clarification 1165  
Procedures For Review & Decision Upon An Application For A Reclamation Plan Or Permanent Closure Plan 1192  
Agency Notification & Comments 1192  
Decision on Cyanidation Facility Permanent Closure Plans 1193  
Decision on Reclamation Plans 1193  
Monitoring Data 1194  
Return of Application 1192  
Procedures For Review & Decision Upon An Application To Perform Surface Mining, Reclamation, & Ore Processing Using Cyanide  
Appeal of Final Order 1195  
Denial of an Application 1194  
Permanent Closure Plan Approval 1194  
Public Hearing 1195  
Referral to Board 1195  
Proceeding On The Project 1864  
Proceedings Governed 1966  
Processing 1840  
Notification 1840  
Receipt of Application 1840  
Time 1840  
Processing Application For A Driller's License Or Operator's Permit 2161  
Driller's License or Operator's Permit Issued With Conditions or Denial of License or Operator's Permit 2161  
Incomplete Application 2161  
Issuance of License 2161  
Issuance of Operator's Permits 2161  
Processing Application To Renew License Or Operator's Permit 2162  
Compliance History 2163



- Condition or Denial of an Application for Renewal 2163
- Processing Applications for Renewal 2162
- Regulatory Compliance Required for Renewals 2162
- Renewal of Expired Licenses or Operator's Permits 2163
- Reuse of Identification Numbers 2163
- Processing Applications For Permit & Reprocessing Permits 2103
- Additional Information Requirements 2106
- Burden of Proof 2105
- General 2103
- Protests, Intervention, Hearings & Appeals 2105
- Public Notice Requirement 2104
- Processing Fees 1837
  - Assignment or Renewal 1837
  - Issuance or Modification 1837
- Processing Of Applications For All Other Types Of
  - Encroachments 1234
  - Decision After Hearing 1235
  - Decision Where No Hearing 1235
  - Encroachments Not in Aid of Navigation 1234
  - Factors in Decision 1235
  - Hearing 1235
  - Hearing Participants 1235
  - Judicial Review 1235
  - Nonnavigational, Community & Commercial Navigational Encroachments 1234
  - Notifications 1234
  - Written Comments or Objections 1235
- Processing Of Applications For Single-Family & Two-Family Navigational Encroachments Within Line Of Navigability 1233
  - Decision Following a Hearing 1234
  - Disposition Without Hearing 1234
  - Hearings 1234
  - Judicial Review 1234
  - Notification of Adjacent Littoral Owners 1233
  - Single-Family & Two-Family Navigational Encroachments 1233
  - Unusual Circumstances 1233
  - Written Objections 1233
- Procurement & Administration Of
  - Approved Drugs 2276
  - Administration of Approved Drugs 2276
  - Controlled Substance Registration 2276
  - DEA Registration 2276
  - Purchase of Approved Drugs 2276
- Producer & Miscellaneous Licensing Fees 1126
  - Examination Fees 1126
  - Fingerprint Processing 1126
  - License Renewal 1126
  - Original License Application 1126
- Producing From Different Pools Through The Same Casing String 1352
- Product Qualification 42
  - Apicultural Products 44
  - Authority of Determination 42
  - Beef & Beef Products 43
  - Exceptions 44
  - Forest Products 44
  - Game Meat 44
  - General Product Qualifications 43
  - Lamb & Lamb Products 43
  - Nursery Stock 43
  - Pork & Pork Products 44
  - Potatoes 43
  - Poultry & Poultry Products 44
  - Wine 43
- Product Registration 256
  - Alteration From Original State 256
  - Brand Name 256
  - Registering -- Altered Fertilizers 256
  - Registration 256
  - Sale of Fertilizer 256
- Production 1350
  - Production Districts 238
    - District I 238
    - District II 238
  - Production Reports 1350
    - Annual Production Report 1350
    - Required Content 1350
- Production Requests Or Written Interrogatories & Requests For Admission 1981
- Professional Education 1596
- Professional Engineer Licensure For Faculty Applicants 506
- Program Description, Children's Agencies 1042
- Program Eligibility 783
- Program Exclusions 785
  - Excluded Conditions, Services & Items 785
  - Individual Consideration 787
- Program For Charity 1477
  - Application 1477
  - Certified, Itemized Statement 1477
- Program Objectives 2970
  - Achieving Program Objectives 2971
  - Objectives 2970
- Program Policy 2970
  - Administration 2970
  - Equal Opportunity 2970
  - Filing Applications 2970
  - Use of Loan Money in Conjunction with State or Federal Programs 2970
- Program Statement 1047
  - Delineation of Expenses 1047
  - Description of Services Available 1047
  - Eligibility 1047
- Program Statement For Transitional Living Services, Children's Agencies 1045
- Program Summary, Children's Therapeutic Outdoor Programs 1084
- Progress Reports 979
  - Initial & Subsequent Reports 979
  - Monthly Foster Care Payments -- Pre-Adoptive Placement 980
- Prohibited Discharges 219
- Prohibited Printed Material 568
  - Copies 568
  - Publishers 568
- Prohibited Sale Or Occupancy Notice 427
- Prohibition Of Contributions In Adoptions, Children's Agencies 1048
- Prohibition Of Simulcast Signal 546
- Prohibition Of Staff Adoptions, Children's Agencies 1048
- Prohibition On Possession, Importation, Shipping Or Transportation Of Invasive Species 316
- Possession or Transportation 316
- Releasing 316
  - Transporting An Infested Article 316
  - Transporting From An Infested Environment 316
- Project Amendments, Cost Increases & Time Extensions 1866
  - Amendments 1866
  - Basis for Cost Increase 1867
  - Condemnation 1867
  - Cost Increases on Acquisition Projects 1866
  - Cost Increases on Development Projects 1866
  - Extensions of Time 1867
- Project Contract 1865
- Project Scope & Funding 2785, 2841
  - Combination Step Funding 2841
  - Funding for Reserve Capacity 2842
  - Nonpoint Source Implementation Funding 2785
  - Project Step Funding 2841
  - Requirements for Awarding a Loan 2841
  - Wastewater Treatment Facility Funding 2785
- Project Time Limitations 1859
- Prominence & Placement -- Consumer Packages 90
  - Calculation of Area of Principal Display Panel for Purposes of Type Size 91
  - Color Contrast 90
  - Free Area 90
  - General 90
  - Location 90

- Minimum Height of Numbers & Letters 91  
Minimum Height of Numbers & Letters - Table 1 91  
Numbers and Letters -- Proportion 91  
Parallel Quantity Declaration 90  
Style of Type or Lettering, Consumer Packages 90  
Prominence & Placement -- Nonconsumer Packages General 91  
Promote & Advertise 561  
Promoter's Advances To Combatant Or Manager Or Occurrence Of Debt On His Behalf 1475  
Promoter's Advances To Combatant Or Manager Or Occurrence Of Debt On His Behalf  
Any Indebtedness Restricted 1475  
Restrictions 1475  
Proof Of Education Required 440  
Continuing Education Course 440  
Satisfactory Proof for Initial Application Submission 440  
Satisfactory Proof for License Renewal 440  
Proof Of Hardship 2396  
Proof Of Registration For New, Replacement, Or Reissued License Plates 2202  
Issuance of Manually Completed Temporary Registrations When Automated System is Unavailable 2202  
Placement of Proof of Registration Document 2202  
Proof of Registration Document 2202  
Proof Of Service 1973  
Proposed Officials 572  
Hardship 572  
Protection Of Horses 589  
Protections & Safeguards For Children & Families 942  
Active Efforts 943  
ASFA Placement Preferences 945  
Compelling Reasons 944  
Compliance with Requirements of the Multiethnic Placement Act of 1994 (MEPA) as Amended by the Interethnic Adoption Provisions (IEP) of 1996 944  
Family Decision-Making & Plan Development 944  
ICWA Placement Preferences 943  
Least Restrictive Setting 943  
Legal Requirements for Indian Children 943  
Notification of Change in Placement 943  
Notification of Change in Visitation 943  
Notification of Right to Participate and Appeal 943  
Qualified Expert Witness-- ICWA 943  
Reasonable Efforts 942  
Visitation for Child's Parent(s) or Legal Guardian(s) 943  
Protective Orders 1982  
Protestants 1968  
Protests--Defined--Form & Contents 1971  
Form & Contents 1971  
Protests - Defined 1971  
Provisional Licensure 1138, 1412  
Active Practice 1138  
Current Licensure 1138  
Evidence 1138  
Provisional License 1138, 1412  
Provisional License Dietitian/Monitor Affidavit 1412  
Provisional Permit 1759  
Duration & Renewal 1759  
General 1759  
Provisional Permits 1717  
Provisions For Contested Cases 1374  
Hearing Rights 1374  
Inapplicability of Idaho Rules of Administrative Procedure of the Attorney General 1374  
Requesting a Hearing for Nursing Care 1374  
Requesting a Hearing for Residential & Domiciliary Care 1374  
Provisions For Former Prisoner Of War (POW) License Plates 2210  
Certified Documentation 2210  
Eligible Person 2210  
Provisions For Legislative License Plates 2208  
Numbering Assignment List 2208  
Option to Apply 2208  
Plate Availability 2208  
Provisions For Personalized License Plates 2208  
Acceptability of Plates  
Message 2209  
Credits 2209  
Expired Plates 2210  
Issue of Personalized Plates 2208  
Lack of Current Plates 2209  
Message Preferences 2210  
Recalled Plates 2210  
Renewing Plates 2209  
Special Characters or Marks 2208  
Specific Requests 2209  
Transfer of Plates 2209  
Unexpired Fees 2210  
Provisions For Sample Plates 2210  
Penalties 2211  
Personalized Sample Plates 2211  
Plate Size 2211  
Provisions For Special License Plate Program Prequalification & Application Procedures 2206  
Annual Report 2207  
Appeals 2207  
Special License Plate Approved by the Legislature 2206  
Special License Plate Prequalification 2206  
Special License Plate Program Application Approval 2207  
Special Plate Requirements 2206  
Submission to the Legislature 2207  
Provisions For Wrecker Plates 2206  
Acquisition/Renewal of Wrecker Plates 2206  
Numbering of Plates 2206  
Possession of Registration 2206  
Purpose 2206  
Renewal of Plates 2206  
Use of Plates 2206  
Provisions Governing Specific Activities & Conditions 2398  
Provisions Of Tickets Without Charge Or At Reduced Rates 1481  
Admission Criteria 1481  
Duties Required 1481  
Fees 1481  
No Fees 1481  
Optional Charges 1481  
Without Charge 1481  
Pseudorabies  
Procedures For Control & Eradication 146  
Laboratories 146  
Quarantines 147  
Supervision 147  
Pseudorabies Vaccine 147  
Psychosexual Evaluations 2359  
Adult Psychosexual Evaluations 2359  
Client Participation 2359  
Juvenile Psychosexual Evaluations 2359  
Testing 2359  
Public & Confidential Information 1215  
BMPs 1215  
Information Subject to Disclosure 1215  
Use by Board 1215  
Public Behavior 1846  
Alcohol 1846  
Day Use 1846  
Fires 1846  
Fireworks 1846  
Littering 1846  
Noise 1846  
Non-traditional Recreational Activities 1847  
Personal Safety, Firearms 1847  
Pets 1846  
Protection of Historical, Cultural & Natural Resources 1847  
Protection of Wildlife 1846  
Quiet Hours 1846  
Resisting & Obstructing a Park Employee 1846

- Smoking 1846
- Trespass 1846
- Public Behavior In The Cemetery 1385
  - Alcohol 1386
  - Animals 1386
  - Littering 1385
  - Motor Vehicles 1386
  - Photographs 1386
  - Preservation of Cemetery Property 1385
  - Public Ceremonies & Gatherings 1386
  - Recreation & Entertainment 1386
- Public Comment 1327
- Public Consultation Procedures, Proactive Public Involvement In Transportation Plans & TIPs 2490
- Public Health District Inspection 1055
  - Drinking Water Systems 1055
  - Food Safety & Sanitation Standards 1055
- Public Hearing 1196
  - Call for a Hearing 1196
  - Consideration of Hearing Record 1197
  - Consolidation 1197
  - Hearing Officer 1197
  - Location 1197
  - Notice of Hearing 1197
  - Publication of Notice 1197
- Public Hearing For Permit
  - Application 1167
  - Basis for Hearing 1167
  - Description of Effects 1167
  - Hearing for Water Degradation 1167
  - Hearing Notice 1167
  - Hearing Officer 1167
  - Public Hearings 1167
  - Public Notice 1167
  - Site of Hearing 1167
- Public Involvement In Permit Procedures 2810
  - Participation by Idaho Department of Lands 2811
  - Public Comment(s), Public Comment Period, & Public Meetings 2811
  - Public Notice Information 2811
  - Public Notice of Permit Actions 2811
  - Serving the Public Notice 2811
- Public Key Cryptography 1974
  - Approved Certification Authority 1976
  - Electronic Signature Must Meet ISO X.509 Standards 1976
  - Electronic Signature to Be Unique 1975
  - Signature Capable of Verification 1976
  - Terminology 1974
- Public Livestock Market Charter 209
- Public Livestock Market Minimum Sale Requirement 209
- Public Notice & Hearing 1242
  - Petition for Hearing 1242
  - Public Hearing 1242
  - Publication of Notice 1242
- Public Notices, Comments & Hearings 2447
  - Content of the Notice 2448
  - Generally 2447
  - Giving Notice 2447
  - Public Comment Package 2447
  - Public Comment Procedures 2448
- Public Notification 2524
  - Designation of Burn Days 2524
  - E-Mail Update Service 2525
  - Posting on Website 2524
- Public Notification & Comment 2912
  - Public Comment 2914
  - Public Notification 2912
  - Response to Comments 2915
- Public Notification, Air Quality 2477
- Public Outreach 2475
- Public Park & School Development Projects 1861
- Public Records Act Compliance 109, 471, 2346
- Public Records Services 1928
  - Bulk Copies of Documents 1928
  - Data from the Information Management System 1928
  - Direct On-Line Services 1928
  - Individually Identified Documents 1928
- Public Statements 507
  - Actions in Regard to Other Registrants or Certificate Holders 507
  - Opinions Based on Adequate Knowledge 507
  - Reports, Statements or Testimony 507
  - Statements Regarding Public Policy 507
- Public Witnesses 1977
- Pulling Outside Strings Of Casing 1347
- Purchase, Expiration, Display & Placement of MVEF & Passport Stickers 1843
  - Annual Motor Vehicle Entrance Fee 1843
  - Annual Motor Vehicle Entrance Fee Replacement 1843
  - Daily MVEF 1843
  - Idaho State Parks Passport 1843
  - Idaho State Parks Passport Replacement 1844
- Purchaser Requirements 1304
  - Duty of Initial Purchaser 1304
  - Initial Purchaser 1304
- Purpose & General Provisions 1159
  - Compliance with Other Law 1160
  - General Provisions 1159
  - Policy 1159
  - Purpose 1159
- Purpose Of Firm Registration & Peer Review 31
- Purposes Of Prehearing Conferences 1980
- Purse Money 573
  - Breeder's Awards 573
  - Release 573
  - Weekly Remittance 573
- Q**
- Qualification, Examination & Appointment Of Certified Water Right Examiner 2008
- Consideration 2008
- Denial 2009
- Examinations 2009
- Expiration 2009
- Information 2008
- Ingress or Egress Authority 2009
- Liability 2009
- Money Received 2009
- Reconsideration 2009
- Refusal or Revocation 2009
- Reports 2009
- Qualifications For Administrator License 1696
  - Coursework 1696
  - Education & Experience 1696
  - Examination 1696
  - Good Moral Character 1696
- Qualifications For Advanced Practice Registered Nurse 1435
  - Completion of Advanced Practice Registered Nurse Program 1435
  - Current Licensure 1435
  - National Certification 1435
- Qualifications For All Licenses Or Certificates For Individuals 1771
  - Age 1771
  - Education 1771
  - Good Moral Character 1772
- Qualifications For Associate Marriage & Family Therapist 1652
- Graduate Degree 1652
- Practicum 1653
- Qualifications For Audiologist Licensure 1711
  - Examination 1711
  - Experience 1711
  - Graduate Program Requirement 1711
- Qualifications For Certification Of Prescriptive Authority 1618
  - Holds a License to Practice Psychology 1618
  - Holds Provisional Certification 1618
  - Supervision 1618
- Qualifications For Contractors License 1129
  - Examination, Education or Experience 1129
  - Owner, Officer or Manager 1129
- Qualifications For Hearing Aid Dealer

- & Fitter Licensure 1714
- Education Requirement 1714
- Qualifications For Licensure 1743
  - Applications 1743
  - Incomplete or Stalled Applications 1743
  - Qualifications 1743
- Qualifications For Licensure By
  - Endorsement 1431
  - Current Practice Experience 1431
  - Graduation Required 1431
  - License from Another Nursing Jurisdiction 1431
  - Licensing Examination 1431
  - Minimum Requirements 1431
- Qualifications For Licensure By Endorsement -- Members Of The Military, Veterans, And Spouses 705
- Authorization for Release of Information 705
- Criminal History & Background Check 705
- Declaration of Previous Applications & Licensures 705
- Graduation Required 705
- License from Another Jurisdiction 705
- Licensing Examination 705
- Military, Veteran, or Spouse 705
- Provide Current Affiliation with EMS Agency 705
- Submit Required Licensure Fee 705
- Valid Identification 705
- Qualifications For Licensure By Examination 1430
  - In-State 1430
  - Out-of-State 1430
  - Practical Nurse Equivalency Requirement 1431
  - Time Limit for Writing Examinations 1431
- Qualifications For Licensure Of Graduates Of Schools Of Nursing Located Outside The United States, Its Territories, Or Commonwealths 1432
- Education Credentials 1432
- Examination/Re-Examination 1432
- License 1432
- Qualifications 1432
- Qualifications For Licensure Or Certification 1673
- Requirements for Licensure 1673
- Qualifications For Makeup Artist Certificate 1775
- Additional Education/Training 1776
- Documentation of Education/ Training 1776
- Education/Training 1775
- General 1775
- Qualifications For Original Barber License 1772
- Education 1772
- Examination 1772
- General 1772
- Qualifications For Original Barber Or Barber-stylist Instructor License 1776
- Education and Experience 1776
- Examination 1777
- Licensure 1776
- Single License Required to Practice & Instruct 1777
- Qualifications For Original Barber-Stylist License 1772
- Education 1772
- Examination 1773
- General 1772
- Qualifications For Original Cosmetologist License 1773
- Education 1773
- Examination 1774
- General 1773
- Qualifications For Original Cosmetology Instructor License 1777
- Education or Equivalent 1777
- Experience 1777
- General 1777
- Licensure 1777
- Single License Required to Practice & Instruct 1777
- Qualifications For Original Electrologist License 1774
- Education 1774
- Examination 1774
- General 1774
- Qualifications For Original Esthetician License 1774
- Education 1774
- Examination 1774
- General 1774
- Qualifications For Original Haircutter License 1774
- Education 1775
- General 1775
- Qualifications For Original Nail Technician License 1775
- Education 1775
- Examination 1775
- General 1775
- Qualifications For Professional Counselor Licensure 1650
- Graduate Program 1650
- Supervised Experience Requirement 1651
- Qualifications For Provisional Certification Of Prescriptive Authority 1615
- Clinical Experience 1615
- Doctoral Degree 1615
- Examination 1616
- Master's Degree 1615
- Supervision Agreement 1616
- Qualifications For Sign Language Interpreter Licensure 1714
- Education 1714
- Examination or Certification 1714
- Qualifications For Speech-Language Pathologist Aide Licensure 1714
- Education Program Requirement 1714
- Examination 1714
- Supervision 1714
- Qualifications For Speech-Language Pathologist Assistant Licensure 1714
- Education Program Requirement 1714
- Examination 1714
- Supervision 1714
- Qualifications For Speech-Language Pathologist Licensure 1713
- Examination 1713
- Graduate Program Requirement 1713
- Supervised Experience 1713
- Qualifications Of Applicants For Examination 1459
- Accredited Degree Applicants 1459
- Experience in Lieu of Degree Applicants 1460
- Qualifications Of Regulated Articles For Quarantine Release (Rough Bluegrass) 241
- Analysis Certificate 241
- Planting Seed Stock of Regulated Articles 241
- Quarantine Release Tag 241
- Qualifications To Prescribe For Pediatric Or Geriatric Patients 1617
- Amount of Supervisory Contact 1618
- Credit Toward Certification 1617
- Domains for Supervision 1618
- Number of Patients 1618
- Qualified Applicants & Lessees 1269, 1282
- Qualified Journeyman Electricians 384
- Qualified Pseudorabies-Negative Herds 147
- Quality Assurance 446, 2359
- Division Personnel Training & Certification 447
- Inspected Installations 447
- Inspectors & Programs 447
- Reviews by Division Personnel 447
- Quality Of Services Environment 1032
- Assess Compliance 1032
- Assess Disrupted Placement 1032
- Corrective Action for Non-Compliance. 1032
- Expeditious Correction 1032
- Quality Requirements For Milk For Manufacturing Purposes 164
- Acceptance or Rejection of Milk 165
- Appearance & Odor 164
- Basis 164
- Frequency of Test 165

- Method of Testing 165
  - Retests 165
  - Sediment Content
    - Classification 164
  - Quarantine 370
  - Quarantine Area 149
  - Quarantine Area Bio-Security 150
    - Personnel 150
    - Vehicles & Equipment 150
  - Quarantine Area Security 150
  - Quarantine Area, Subchapter A 279
  - Quarantine Authority 149
  - Quarantine Facility, Cervidae Ranch 188
  - Quarantine Pens 210
    - Cleaning & Disinfection 210
    - Drainage 211
    - Feed & Water 210
    - Fence Construction 211
    - Hard Surface 210
    - Signage 210
  - Quarantine Procedures For An Animal Health Emergency 149
  - Quarantine Release 149
  - Validity of Quarantine 149
  - Written Notice 149
  - Quarantine, Subchapter A 137
    - Acknowledgment of Quarantine 137
    - Disposition of Quarantined Animals 137
    - Hold Order 137
    - Written Notice 137
  - Quarantined Areas 344
  - Quarantines 193
    - Exposed Herds 193
    - Infected Herds 193
    - Validity of Quarantine 193
  - Quarterly Inventory 794
  - Quarterly Road Use Fee
    - Reporting 2193
    - Information Required on the Quarterly Report Form 2193
    - Quarterly Reporting Forms Issued 2193
    - Use of Quarterly Reporting Form 2193
  - Quarterly Road Use Fee Reports For Annual Overweight Permits 2192
- R**
- Rabies 140
    - Discharging Authority 140
    - Reporting 140
  - Racial, Ethnic, & Cultural
    - Considerations, Selection of an Adoptive Placement, Children's Agencies 1049
  - Racing Association License 570
  - Racing Association License
    - Applications 570
  - Racing Association License Fees 570
  - Racing Associations 572
    - General Rules
      - Comfort & Safety 573
    - Conditions of Races 572
    - Credentials 572
    - Fire Regulations Posted 572
    - Horse Ambulance 572
    - Human Emergency Medical Response Vehicle 572
    - Laws & Rules 572
    - Medical Professionals 572
    - Open Market 572
    - Post Notices 573
    - Racing Hours 572
    - Tampering 572
    - Toilets & Other Facilities 572
    - Violators 573
  - Racing Associations Operation 570
    - Additional Information 570
    - Requirements 570
  - Racing Commission 567
    - Association Office 568
    - Visit & Inspection 567
  - Racing Dates 571
  - Radiation Safety Requirements For Industrial Radiographic Operations 794
  - Radionuclides 168
  - Ranch Management Plan 191
    - Mandatory Ranch Management Plan 191
    - Risk Assessment for Ranch Management Plans 191
    - Voluntary Ranch Management Plan 191
  - Random Or Extra Testing 583
  - Rapeseed Growing Outside Cultivated Fields Enforcement & Penalties 239
  - Raw Manufacture Grade Milk Or Cream 163
    - Milk or Cream 164
    - Raw Milk 163
  - Reapplication Following Certification Denial Or Disciplinary Action 2358
    - Denial 2358
    - Restriction 2358
    - Revocation 2358
    - Suspension 2358
    - Withheld Discipline & Probation 2358
  - Reapplication For A License After Previous Denial 1423
    - Request for Review 1423
  - Reasonable & Prudent Parent Standard 1029
    - Reasonable & Prudent Parent Standard Defined 1029
    - Training 1029
  - Reasonable & Prudent Parent Standard For An Organization Providing Services To Children Placed By The Department 1041
  - Reasonable Progress Goals 2528
    - Justification for Reasonable Progress Goals 2528
    - Process for Setting Reasonable Progress Goals 2528
  - Reassessment 642
  - Rebuilt Salvage Vehicles 2187
    - Rebuilt Salvage Vehicle 2187
    - Salvage Vehicle Damaged Out-of-State 2188
    - Salvage Vehicles from Other Jurisdictions 2188
    - Title Application Requirements for Vehicles Defined as Salvage & Rebuilt Salvage Vehicles 2188
  - Receipt & Usage Of Fees 2426, 2551
  - Receipt & Usage Of Fees, Tier II Operating Permit Processing Fee 2467
  - Receipt For Bodies To Be Cremated 1575
    - Contents of Receipt 1575
    - Provide a Receipt 1575
  - Receiving 63
    - Agreements 63
    - Change in Provider 64
    - Electronic Warehouse Receipts 63
    - Every Warehouseman 63
    - Form of Nonnegotiable Warehouse Receipts 63
    - Lost Negotiable Warehouse Receipt 63
  - Recessed Steps 761
  - Reciprocal Licensure 26
    - International Reciprocity 27
    - Interstate Reciprocity 27
  - Reciprocal Recognition of Out-Of-State Radiation Machines 794
    - Addition to Part B, Section B.16 -- New Subsection d 794
    - Modification to Part B, Section B.16.a.iv 794
  - Reciprocity 339, 795, 1692, 2352
    - Submit Statement Verifying Certification/Licensure 1692
  - Recirculation System
    - Cleaning 769
      - Cleaning System 769
      - Integral Vacuum 769
    - Flow Indicator 769
    - Flow Rate 769
    - Sizing 769
    - Strainer 770
    - Thermometers 769
  - Recognition Of EMS Personnel Licensure Interstate Compact (REPLICA) 704
    - Licensed EMS Personnel from a REPLICA Member State 704
  - Recognition Of EMS Personnel Licensure Interstate Compact Agreement (REPLICA) Out-of-State Primary Affiliation 704
  - Recognition Of National Certifying Organizations For Advanced Practice Registered Nursing 1439
  - Recognition Of Registration, Certification Or Licensure From

- Other Jurisdictions 710
  - EMS Personnel Licensed or Certified in Other States 710
  - Limited Recognition in Idaho 711
  - Personnel Licensure Candidate Trained in Other States 711
  - Personnel with NREMT Registration or Current EMS Certification 711
- Recommended Orders 1987
  - Contents of Recommended Orders 1987
  - Definition 1987
- Reconsideration -- Rehearing 1958
  - Answer 1958
  - Consideration 1958
  - Disposition 1958
  - Time for Filing & Service 1958
- Record For Decision 1986
  - Contents of Record 1986
  - Official Record 1986
- Record Keeping 161, 511, 766, 1554
  - Accidents Requiring Professional Medical Treatment 766
  - Amount & Type of Chemicals Used 766
  - Attendance Verification 511
  - Calibration Check Equipment Records 161
  - Clarity Readings 766
  - Disinfectant Levels 766
  - Documented Self-Study 511
  - General Provisions 161
  - Log 511
  - pH Readings 766
  - Record Retention 511
  - Records 511
  - Records Retention - Time Limit 161
- Record Keeping Standards 2272
  - Consent Forms 2273
  - Controlled Substances & Prescription or Legend Drugs 2273
  - Diagnostic Image Identification & Ownership 2273
  - Estimates 2273
  - Medical Records 2272
  - Ownership of Medical Records 2273
  - Postoperative Instructions 2273
  - Return or Disposal of Expired Pharmaceuticals & Biologicals 2275
  - Treatment Records 2273
- Record Management & Reporting Requirements 1029
  - Behavioral Problems 1030
  - Emotional & Psychological Needs 1030
  - Health 1030
  - History of Abuse & Neglect 1030
  - Personal Data 1029
- Record Management, Transitional Living, Children's Agencies 1045
- Record Of Compliance 2243
- Record Of Conference 1980
- Record Requirements, Poultry & Ratites 140
- Record Retention, Residential Care Facility 1038
- Recordation, Issued Permit 1236
- Recording Of Hearings 1986
- Recording, Use & Placement Of Brands 528
  - Brands Acceptable for Recording 528
  - Conflicts Between Brands 529
  - Recording & Use of Brands 528
  - Recording Procedures 528
  - Renewal of Brands 529
  - Transfer of Recorded Brands 529
- Recordkeeping 2348
  - Certificate Holders 2348
  - Maintenance & Inventory Requirements 1889
    - Central Records Storage 1890
    - Drug Distributor Records 1889
    - Electronic Records Storage 1890
    - Inventory Records 1889
    - Prescription Retention 1889
    - Rebuttal Presumption of Violation 1889
  - Records Maintenance & Retention Requirement 1889
  - Violent Sexual Predators 2348
- Recordkeeping & Payment Schedule 70, 77
  - Notice 70, 77
  - Payment Due Dates 70, 77
  - Permanent Record 70, 77
- Records 28, 1677, 1866, 2042
  - Charges 29
  - Confidential Status 2043
  - General 2043
  - Inspection of Records 2043
  - Records to be Filed With the Director 2043
  - Tax Return 28
  - Working Papers Including Audit Documentation Not a Part of the Client's Records 29
- Records - Separate 74
- Records & Reporting 189
  - Emergencies 189
  - Notification 189
  - Records 189
  - Reports 189
- Records Management, Maintenance, Availability To Foster Parent, & Contents 1044
  - Placement Record 1044
  - Record Contents 1044
- Records Of Bodies 1575
  - Content of Record 1575
- Records Of Educational Program 1447
- Records of Leak Testing of Sealed Sources & Devices Containing DU 794
- Records Of Placement 982
- Records Of Prize Disbursements 2333
- Records of Quarterly Inventory 794
- Records Of Tests 166
- Records Of The Certified Adoption Professional 985
- Records Required For Broker-Dealers 665
  - Compliance 665
  - Required Books & Records 665
- Records Required Of Investment Advisers 668
- Records Requirements 119
  - Applicator Records 119
  - Pesticide Dealer Records 120
  - Record Contents 119, 120
- Records Retention 201
- Records To Be Preserved By Issuers 651
  - Form 651
  - Required Records 651
  - Retention Period 651
- Records, Livestock Marketing 211
- Recovery Furnace TRS Monitoring & Recordkeeping 2552
- Recovery Furnace TRS Standard 2552
- Recreation 1029
- Recreation, Physical Exercise, & Leisure Time Activities, Children's Residential Care Facilities 1057
- Recreational & Warming Fires 2520
- Recreational Mining Equipment 1241
- Recruitment Of Adoptive Applicants, Children's Agencies 1048
- Redredging 1231
- Reexaminations 501
- Referee's Instructions To Combatants 1490
- Referees 1478
  - Physical Examination 1478
  - Protests 1478
  - Selection 1478
- Reference To Agency 1966
- Referral To Child Support Services 953
  - Assignment of Child Support 953
  - Collection of Child Support 953
- Refund Applications 2258
  - Assessment Refund 2258
  - Refund Application Form Number 2 2258
- Refunds 1127, 2001, 2195
  - Fees Eligible for Refund 2195
  - Fees Not Eligible for Refunds 2195
  - Request for Refunds 2195
- Refunds of Controlled Hunt Fees 683
  - Refunds 683
- Refunds To Nonresidents 682
  - Department Error 682
  - Partial Refund 682
  - Refund 682
- Refusal Errors 1931
- Refusal To Issue License 550, 571
  - Age 551
  - Community Support 571
  - Competition 571

- Conduct 551
- Convicted 550
- Deny or Revoke 551
- Drug Probation 551
- Ejection 551
- Felony Probation 550
- Misrepresentation 550
- Narcotics 551
- Not Permitted 551
- Ownership 551
- Properly Develop 571
- Reputation 571
- Safety 571
- Unqualified 551
- Violated Rules 551
- Refusal To Test 592
  - Refusal to Supply a Sample 592
  - Subject to Random Testing 592
  - Suspended from Racing for Refusal to Test 592
- Regional Haze Rules 2528
- Regional TSE Committees --
  - Organization & Responsibilities 719
- Registered Interns 1656
  - Designation of Intern Status 1656
  - Expiration 1656
  - Requirements for Registration 1656
  - Supervision 1656
- Registered Trainee Real Estate Appraiser 1685
  - Continuing Education 1686
  - Qualification 1685
  - Renewal & Reinstatement 1686
  - Scope & Practice 1686
- Registered Trainee Supervisors 1686
  - Registered Trainee Supervisor Requirements 1686
- Registration & Collection Of Fees 251
- Registration & Fees 244
  - Product Registration Fee 244
  - Product Registration Fee Exemption 244
- Registration & Licensing Requirements For Use Of The LPC 117
  - Registration 117
  - Use of the LPC (Compound 1080) 117
- Registration & Registration Fees 2458
- Registration By Supervising & Directing Physicians 1396
  - Notification 1397
  - Registration & Renewal 1397
- Registration Examination 1460
  - Grading 1461
  - Passing (ARE) 1461
  - When Taken 1461
- Registration Fee 2460
  - Fee-for-Service 2460
  - Radionuclide Registration Fee 2460
  - Tier I Annual Fee 2459
- Registration Fee For Permit By Rule 2551
- Registration For Out Of State Licensees 1715
- Registration For Permit By Rule 2522
  - Applicant Information 2522
  - Date of Burning 2522
  - Location of Property 2522
  - Plot Plan 2522
  - Preventive Measures 2522
  - Type, Acreage & Fuel Characteristics of Crop Residue Proposed to be Burned 2522
- Registration For Permit By Rule, Nonmetallic Mineral Processing Plant 2544
  - Registration Information 2544
  - Registration Process 2544
- Registration for Permit by Rule, Sections 760 Through 764 2538
  - Exemption from Registration Fee 2538
  - Inspection 2538
  - Registration Due Date 2538
  - Registration Information 2538
  - Registration Process 2538
- Registration Information 2458
  - Facility Emission Units 2458
  - Facility Information 2458
  - Owner/Operator Information 2458
  - Pollutant Registration 2458
  - Radionuclide Registration 2459
- Registration Of Approved Materials 356
  - Department Not Liable 356
  - Effect of Registration 356
  - Initial & Annual Inspection Fees 357
  - Registration 356
  - Registration Fees 357
  - Revocation of Registration 357
  - Seal for Registered Branded Materials 357
- Registration Of Births 735
  - Certifier's Signature 735
  - Signature of Certifier 735
  - Signature of the Informant 735
- Registration Of Buyers, Commission Merchants, & Selling Agents -- Subscription To A PML 1916
  - Change of Name or Address 1917
  - Copy of Rules 1917
  - Duration 1917
  - Form 1916
  - Initial Distribution 1917
  - Initial Subscription 1917
  - Other Subscription 1917
  - Period of Subscription 1917
  - Right to Subscribe - Number 1917
  - Special Subscription 1917
- Registration Of Deaths & Stillbirths 737
  - Acceptance of Incomplete Death Certificate 737
  - Signatures Required on Death Certificates 738
  - Signatures Required on Stillbirth Certificates 738
- Registration Of Debt Securities 649
  - Department May Establish Standards 649
  - Standards To Be Disclosed 649
  - Suitability 649
- Registration Of Foundlings 735
  - Form of Certificate 735
  - Responsibility for Filing 736
- Registration Of Post-Secondary Educational Institutions 485
- Registration Of Postsecondary Educational Institutions 485
  - Application 486
  - Deadline for Registration 486
  - Delegation 485
  - Idaho Presence 485
  - Information Required 486
  - Institutions Exempt from Registration 486
  - Institutions That Must Register 486
  - Registration Fees 486
  - Registration Requirement 485
- Registration Of Proprietary Schools 487
  - Application 488
  - Deadline for Registration 489
  - Delegation 487
  - Exemptions from Registration 488
  - Idaho Presence 487
  - Information Required 489
  - Registration Fees 488
  - Registration Requirement 487
- Registration Of Servicemen & Service Agencies For Commercial Weighing & Measuring Devices 101
  - Certificate of Registration 102
  - Placed in Service Report 102
  - Policy 101
  - Privileges of a Voluntary Registrant 102
  - Publication of Lists of Registered Servicemen & Registered Service Agencies 102
  - Reciprocity 102
  - Revocation of Certificate of Registration 102
  - Standards & Testing Equipment 102
  - Voluntary Registration 102
- Registration Or Exemption Of "Blind Pool" Offerings Prohibited 656
- Registration Procedures & Requirements For Portable Equipment 2469
  - Compliance With Rules & Regulations 2469
  - Registration Requirements 2469
- Registration Statement 1669
  - Date of Filing 1669
  - Failure to Timely File 1669
  - Other Business Locations 1669
  - Statement 1669
- Registration System For Adult Adoptees 736
  - Completion of Match 737

- Fees 737  
Notification 737  
Registration Time 737  
Release of Information 737  
Search for “the Other Birth Parent” 736  
Siblings of Adult Adoptee 737  
Registration, Recordkeeping, & Reporting Requirements 2517  
Recordkeeping Requirements 2517  
Registration 2517  
Reporting Requirements 2518  
Registrations -- Notice Of Intended Idaho Broker -- Dealer Or Agent 650  
Regulated Area, Subchapter F 289  
Onions 289  
Potatoes 289  
Regulated Areas - Apple Maggot 283  
Infested Areas - Outside Of Idaho 283  
Infested Areas - Within Idaho 283  
Non-Infested Areas - Within Idaho 283  
Regulated Areas - Cherry Fruit Fly 285  
Canyon County, Idaho 285  
Gem County, Idaho 285  
Regulated Areas, Subchapter H 297  
Xiphinema Index 298  
Regulated Articles 240, 307, 348  
Any Host 348  
Equipment 348  
Green Peach Aphid Hosts 348  
Irish Potato 348  
Regulated Articles, Subchapter A 279  
Machinery 279  
Plant Material 279  
Regulated Articles, Subchapter C 283  
Apple Maggot 283  
Cherry Fruit Fly 283  
Regulated Articles, Subchapter E 288  
Regulated Bee Diseases 251  
Regulated Commodities, Subchapter H 297  
Regulated Disease, Subchapter J 301  
Regulated Pest - Bacterial Ring Rot 352  
Regulated Pest, Subchapter B 281  
Regulated Pest, Subchapter D 286  
Regulated Pest, Subchapter I 299  
Regulated Pest, Subchapter K 302  
Regulated Pests  
Grapevine Corky Bark Disease 297  
Regulated Pests (Non-Phaseolus Only) 307  
Asian Soybean Rust 307  
Soil 307  
Soybean Cyst Nematode 307  
Regulated Pests (Phaseolus & Non-Phaseolus) 306  
Anthracnose 306  
Bacterial Wilt 306  
Brown Spot 306  
Common Blight 306  
Halo Blight 307  
Regulated Pests, Subchapter A 279  
Hop Stunt Viroid 279  
Iarvirus Species 279  
Powdery Mildew 279  
Verticillium Wilt 279  
Regulated Pests, Subchapter C 283  
Apple Maggot 283  
Cherry Fruit Fly 283  
Regulated Pests, Subchapter E 288  
Regulated Pests, Subchapter G 292  
Diseases 292  
Insects 292  
Noxious Weeds 292  
Regulated Pests, Subchapter H 297  
European Grapevine Moth 298  
Glassy-Winged Sharpshooter 298  
Grape Phylloxera 297  
Grapevine Fanleaf Virus 297  
Grapevine Leaf Roll - Associated Viruses 297  
Pierces Disease 297  
Red Blotch Virus 297  
Vine Mealybug 298  
Regulated Product, Subchapter Gs  
Mentha Production Equipment 293  
Regulated Products 275  
Regulated Products & Related Equipment 251  
Regulated Products, Subchapter B 281  
Regulated Products, Subchapter F 289  
Cull Onions 289  
Cull Potatoes 289  
Regulated Products, Subchapter G 293  
Mentha 293  
Regulated Products, Subchapter J 301  
Regulatory Authority (RA) 747  
Regulatory Compliance - Inspections & Records Review 159  
Regulatory Framework 153  
Regulatory Samples 159  
Outliers 159  
Regulatory Sample Results 159  
Regulatory Sample Tolerances 159  
Sample Set 159  
Rehabilitation Components 1606  
Additional Requirements 1606  
Educational Programs 1606  
Options in Devising Rehabilitation Program 1606  
Reidentification Of Domestic Cervidae 185  
Inventory Evaluation 185  
Permanent Identification 185  
Records 185  
Reproduction of Original Tattoo 185  
Supervision 185  
Reimbursement In The Home Of A Relative 957  
Reinspection 757  
Reinstatement (Non-Discipline) 1421  
Reinstatement After Discipline 1421  
Appearance Before Board 1421  
Application for Reinstatement After Revocation 1421  
Submission of Application Materials 1421  
Reinstatement And Re-Entry 31  
Reinstatement Of A Lapsed EMS Personnel License 709  
Authorization for Release of Information 709  
Competency Certification 710  
Criminal History & Background Check for Reinstatement of Lapsed License 710  
Declaration of Previous Applications & Licensures 709  
Documentation of Continuing Education for Lapsed License Reinstatement 710  
Expiration Date of a Reinstated License 710  
Provide Current Affiliation with EMS Agency 710  
Submit Required Licensure Fee for Reinstatement 710  
Valid Identification for Reinstatement of Lapsed License 710  
Reinstatement Of Advanced Practice Registered Nurse License 1437  
Current Registered Nurse License 1437  
Evidence of Certification 1437  
Fee 1437  
Reinstatement Of License 1675  
Reissuance Of Cancelled Clinical Nutrition Certification 1520  
Reissuance 1520  
Reissuance Of Certificates 497  
Rejected & Returned Claims 2005  
Refiled Claims 2005  
Rejected Claims 2005  
Rejected Milk 166  
Release Reporting Requirements 2604  
Information to be Reported 2604  
Release Causes 2605  
Release Sources 2604  
Requirements 2605  
Relevant Records Resulting In A Conditional Denial 930  
Employees of Providers or Contractors 930  
Individuals Licensed or Certified by the Department or a Department Employee 930  
Underlying Facts & Circumstances 930  
Relicensing (Formerly Temporary Agent Transfer (TAT) System) 664  
Relicensing Agents 665  
Relicensing Investment Adviser Representatives 665  
Temporary License Expiration 665  
Religious & Cultural Practices 1029  
Religious & Culture Policy 1040



- Organizations That Accept Only Private Placements 1040  
 Organizations That Accept State Placements 1040  
 Relinquishment 1839  
 Remediation Standards 2827  
   Establishment of Remediation Standards 2828  
   Voluntary Remediation Work Plan Must Achieve Health-Based & Environmental Remediation Standards 2828  
 Remedies For Failure To Comply 33  
 Removal Of A Child From A Prospective Adoptive Home 982  
 Removal Of Dead Body Or Fetus From Place Of Death Or Stillbirth 742  
   Notify the Coroner 743  
   Obtain Assurance That Death Is from Natural Causes 742  
   Receive Permission to Remove the Dead Body or Fetus 743  
 Removal Of Orders & Notices 427  
 Removal of Orders & Notices Prohibited 434  
 Removal Of Sand & Gravel Deposits 2084  
   Buffer Zone 2084  
   Disturbing Natural Appearance of Area 2084  
   Movement of Equipment 2084  
   Removal Below Water Surface 2084  
   Removal of Sand & Gravel 2084  
 Removal Or Defacing Of Stencils 361  
 Removal Requirements 206  
   Approved Feedlots 206  
   Livestock Markets 206  
   Slaughter 206  
 Renewal 1839  
 Renewal & Reinstatement Fees  
   Reinstatement Fee 1455  
 Renewal Of Advanced Practice Registered Nurse License 1436  
   Current Registered Nurse License 1436  
   Evidence of Certification 1437  
   Evidence of Continuing Education 1437  
   Exemption From Requirements 1437  
   Hours of Practice 1437  
   Peer Review Process 1437  
 Renewal of Certificate 819  
   Desk Review 819  
   Home Inspection 819  
   Validity of Existing Certificate 820  
 Renewal Of IPDES Permits 2923  
   Effluent Limits & Water Quality Standards 2925  
   Final Clean Water Act Section 301(b)(1)(C) or 303 Effluent Limits 2924  
   Final Clean Water Act Section 402(a)(1)(B) Effluent Limits 2924  
   Interim Effluent Limits 2924  
   Renewal Of License 1730, 1744  
   Application for Renewal 1730  
   Complete Practice Data 1744  
   Continuing Education Verification 1745  
   Current Cardiopulmonary Resuscitation Certification 1745  
   Reinstatement 1730  
   Renewal Of License - Continuing Education 1606  
   Renewal Of Standard & Specialty Licenses 1315  
   Option to a Check Scale for Specialty License Renewal 1315  
   Option to a Check Scale for Standard License Renewal 1315  
   To Renew a License by the Expiration Date 1315  
   To Renew a License More Than Two Years After the Expiration Date 1315  
   To Renew a License Within Two Years After The Expiration Date 1315  
   Renewal Of TSE Designation 720  
   Renewal Or Expiration Of License 1759, 1782  
   Reinstatement 1760  
   Renewal 1760  
   Renewal Or Reinstatement Of License 1547  
   Backflow Assembly Testers 1547  
   Expiration Date 1547  
   Operator-in-Training License 1547  
   Reinstatement 1547  
   Wastewater Land Application License 1547  
 Rental 1260, 1296  
   Nonstandard Rental Rates 1297  
   Rental Due Date 1261  
   Rental Rates 1260  
   Special Uses 1260  
   Standardized Rental Rates 1297  
 Rental & Royalty & Late Payments 1242  
   Deduction of Royalty 1243  
   Late Payments 1243  
   Minimum Annual Rental 1242  
   Minimum Annual Royalty 1242  
   Royalty Schedule 1243  
 Rental Notices 1279  
 Rentals 1269  
   Advance Annual Rental 1269  
   Amount 1269  
 Reopening For Cause 2457  
   Criteria 2457  
   Procedures for Reopenings 2457  
 Repayment Of Loan 2975  
   First Payment 2976  
   Repayment of the Loan 2975  
   Repayment Schedule 2975  
 Repeated Noncompliance 857  
 REPLICA Expiration 708  
 Report Of Completion Of Offering 650  
   Completion Statement 650  
   Signatures 650  
 Report Of Disease 579  
 Report Of Funds 570  
 Report To Commission Of Solicitation To Conduct Contest Fraudulently 1506  
 Report To Court - Voluntary Termination 971  
 Report To The Court - Involuntary Termination 972  
   Absent Parent 973  
   Allegations 973  
   Compliance with the Indian Child Welfare Act 973  
   Efforts to Maintain Family 973  
   Family Circumstances 973  
   Investigation 973  
   Medical Information 973  
   Planning 973  
   Termination of Parent-Child Relationship 973  
 Reportable Accidents 766  
 Reporting Abuse, Neglect, Or Abandonment Health & Welfare Employees 958  
   Ministers 957  
 Reporting Foster Home Changes 1030  
   Additional Licensing Application 1030  
   Admission or Release From Facilities 1030  
   Arrests, Citations, Withheld Judgements or Criminal Convictions 1030  
   Change of Residence 1030  
   Counseling, Treatment or Therapy 1030  
   Employment 1030  
   Illness, Injury, or Death 1030  
   Parole & Probation 1030  
 Reporting Of BRR 352  
   Contents 352  
   Mandatory Reporting 352  
   Methods of Reporting 352  
 Reporting Of Child Abuse, Neglect, & Abandonment 1038  
 Reporting Requirements 323, 836, 1890  
   Abuse, Neglect, or Exploitation 836  
   Additional Criminal Convictions 836  
   Contents 323  
   Critical Incidents 836  
   Discharge of a Resident 837  
   Discovery 323  
   Drug Distributor Monthly Reports 1890  
   Hold Harmless 323  
   Individual & Outlet Information Changes 1890

- Methods of Reporting 323  
Notice of Investigations 836  
Report of Fire 836  
Reporting of Funds Managed by the  
  Provider for a Deceased  
  Resident 837  
Serious Physical Injury or  
  Death 836  
Theft or Loss of Controlled  
  Substances 1890  
Reporting System, Reporting Abuse,  
  Abandonment Or Neglect 958  
Reporting To The Board 33  
  Firm Registration Form 33  
  Peer Review Documentation 33  
Reporting, Notification, & Distribution  
  Of Laboratory Results 750  
  Notification of High Contaminant  
  Levels 750  
  Notification of Positive  
  Microbiological Results 750  
  Submission of Test Results in  
  Approved Format 750  
Reporting, Public Notification,  
  Recordkeeping 2636  
  Public Notification of Drinking  
  Water Violations 2636  
  Record Maintenance 2636  
  Reporting & Record Keeping  
  Requirements for the Disinfectants  
  & Disinfectant Byproducts  
  Rule 2636  
  Reporting & Record Keeping  
  Requirements for the Revised  
  Total Coliform Rule 2636  
  Reporting & Recordkeeping  
  Requirements for the Interim  
  Enhanced Surface Water  
  Treatment Rule 2636  
  Reporting for Unregulated  
  Contaminant Monitoring  
  Results 2636  
  Reporting Requirements 2636  
Reports Involving Indian Children 959  
Reports Involving Military Families,  
  Reporting Abuse, Abandonment Or  
  Neglect 959  
Representation & Practice Before The  
  Board 1946  
  Authorized Attorneys 1946  
  Corporations 1946  
  Limited Liability Company  
  (LLC) 1946  
  Natural Persons 1946  
  Partnerships, Joint Ventures &  
  Trusts 1946  
  Public Officers 1946  
Representation Of Parties At  
  Hearing 1969  
  Appearances &  
  Representation 1969  
  Representatives 1969  
Request for Approval 1333  
Request For Approval Of  
  Qualification 1674  
  Course Review 1674  
  Individual Qualification 1674  
Request For Change In Certification  
  Level 2352  
  Request to Advance in Level of  
  Certification 2352  
  Request to Change to a Less  
  Independent Level of  
  Certification 2352  
Request For Conditional Waiver 2352  
Request For Information, Notices Of  
  Claim Of Lien 1921  
Request For Permit 49  
Request For Placement On Inactive  
  Status 2356  
Request For Reconsideration For  
  Adoption Assistance 990  
  Adoption Assistance  
  Agreement 990  
  Eligibility Determination 990  
Request For Transcript 1960  
Requested Check Scale 1318  
  Cost of a Requested Check  
  Scale 1318  
  Submission of Request 1318  
Requests For Information 1918, 1923  
  Content 1923  
  Form 1923  
Required Information For Youth At  
  Service Termination, Transitional  
  Living, Children's Agencies 1046  
Required Inspections 400, 477  
  Final Inspection Tags 400  
  Ground Work Inspection Tags 400  
  Inspection Tags 477  
  Inspection Tags for Unacceptable  
  Plumbing 400  
  Request for Division Inspection 477  
  Rough-In Inspection Tags 400  
Required Number Of Ambulances,  
  Notice To Ambulance Service &  
  Hospital 1482  
Promoter Requirements 1483  
Required Number of  
  Ambulances 1482  
Required Ongoing Training 822  
  Content of Training 822  
  Documentation of Training 822  
  Initial Provider Training 822  
  Type of Training 822  
Required Participants 1218  
Required Staff Ratios 1053  
  Emergency Staff Access 1053  
  Medical Emergency 1053  
  Service Worker or Social Worker  
  Ratios 1053  
  Staff-Child Ratio-Daytime 1053  
  Staff-Child Ratio-Sleeping  
  Hours 1053  
  Supervisor-Staff Ratio 1053  
Required Standard Application Form &  
  Required Information 2429  
  Additional Information 2432  
Alternative Operating  
  Scenarios 2430  
Applicable Requirements 2430  
Compliance Certifications 2430  
Compliance Plans 2431  
Emissions 2429  
General Information for the  
  Facility 2429  
General Requirements 2429  
Other Requirements 2430  
Proposed Determinations of  
  Nonapplicability 2430  
Specific Information for Each  
  Emissions Unit 2429  
Trading Scenarios 2431  
Requirement For BLS 1137  
Requirement for Production  
  Testing 1333  
Requirement To Obtain Tier I Operating  
  Permit 2427  
  Exceptions 2427  
  Prohibition 2427  
Requirements 271, 509, 2472  
  Active Participation in Technical or  
  Professional Organizations 510  
  Application 271  
  Attending Qualifying Seminars 510  
  Authoring Published Papers, Articles,  
  or Books 510  
  Diseased Plants 272  
  Documented Self Study 510  
  Filing Date 271  
  Grafting 271  
  Inspection 271  
  Membership in Technical or  
  Professional Organizations 510  
  Mentoring, Teaching or  
  Instructing 510  
  Nematode Sampling 271  
  Participation 271  
  Patents 510  
  Presentations to Technical,  
  Professional or Civic  
  Organizations 510  
  Registration 271  
  Responsibility 271  
  Successful Completion of College  
  Credits 509  
  Successful Completion of Continuing  
  Education Units 509  
  Successful Completion of Other  
  Courses 510  
Requirements -- Specific Consumer  
  Commodities, Packages,  
  Containers 91  
  Aerosols & Similar Pressurized  
  Containers 92  
  Combination Packages 92  
  Cylindrical Containers 92  
  Display Card Package 91  
  Eggs 92  
  Multi-Unit Packages 92  
  Variety Packages 92  
Requirements - Uncertified Seed

- Potatoes 354
  - Disease Content 354
  - Grown by the Farmer 354
  - Laboratory Tested and/or Grown Out 354
  - Laboratory Testing 354
  - No More Than One Generation 354
  - Planting 354
  - Sampling 354
  - Testing By Designated Agencies 354
- Requirements For A Backflow
  - Assembly Tester License 1542
  - Education 1542
  - Examination 1542
  - Experience 1542
- Requirements For A Class I Operator License 1541
  - Education 1541
  - Examination 1541
  - Experience 1541
- Requirements For A Class II Operator License 1541
  - Education 1541
  - Examination 1541
  - Experience 1541
- Requirements For A Class III Operator License 1541
  - Education 1541
  - Examination 1542
  - Experience 1541
- Requirements For A Class IV Operator License 1542
  - Education 1542
  - Examination 1542
  - Experience 1542
- Requirements For A Facility Administrator 878
  - Ability to Reach Administrator or Designee 880
  - Administrator Notification 879
  - Administrator Responsibility 879
  - Administrator's Designee 880
  - Availability of Administrator 879
  - Corrective Action 879
  - Identify & Monitor Patterns 879
  - Investigation within Thirty Days 879
  - Lapse of Administrator 879
  - Minimum Age of Personnel 880
  - Notification of Adult Protection & Law Enforcement 879
  - Notification of Licensing Agency within One Business Day 879
  - Notification to Licensing Agency 880
  - Procedures for Investigations 879
  - Representation of Residents 879
  - Resident Protection 879
  - Responsibility for Acceptable Admissions 879
  - Sexual Offender 879
  - Written Response to Complaint within Thirty Days 879
- Requirements For A Lagoon Operator License 1542
  - Education 1542
  - Examination 1542
  - Experience 1542
- Requirements For A Very Small Wastewater System License 1540
  - Education 1540
  - Examination 1540
  - Experience 1540
- Requirements For A Very Small Water System License 1540
  - Education 1540
  - Examination 1540
  - Experience 1540
- Requirements For A Wastewater Land Application License 1542
  - Education 1542
  - Examination 1542
  - Experience 1542
  - Other 1542
- Requirements For Additional Physical Standards 886
  - Fire District 886
  - Medical Accessibility 886
  - Roads 886
- Requirements For Admission
  - Agreements 880
  - Advance Directive 882
  - Billing Practices, Notices, & Procedures for Payments & Refunds 881
  - Contested Charges 882
  - Emergency Transfers 881
  - Initial Resident Assessment & Care Plan 880
  - Medication Responsibilities 881
  - Notification of Liability Insurance Coverage 881
  - Notification of Payee Requirements 882
  - Resident Belongings Responsibility 881
  - Resident Permission to Transfer Information 881
  - Resident Personal Fund Responsibilities 881
  - Resident Responsibilities 881
  - Restrictions on Choice of Care or Service Providers 881
  - Smoking Policy 882
  - Staffing 881
  - Transition to Publicly-Funded Program 882
  - Written Agreement 880
- Requirements For Admission Agreements For Private-Pay Residents
  - Services, Supports, & Rates 880
- Requirements For All Brassica Seeds To Be Planted In Idaho 238
  - Exemptions 239
  - Requirements 238
- Requirements For Alternative Emission Limits (Bubbles) 2467
  - Actual Emissions 2467
  - Actual HAP/TAP Emissions 2467
  - Applicable Requirement Prohibition 2467
  - Compliance Schedule Extension 2468
  - Emission Reductions 2467
  - EPA Approval 2468
  - Fugitive Dust Trades 2468
  - Trade Requirements 2467
- Requirements For Banking Emission Reduction Credits (ERC's) 2469
  - Requirements For Banking Emission Reduction Credits (ERC's) Adjustment by Department 2469
  - Application to Bank an ERC 2469
  - Banking Period 2469
  - Certificate of Ownership 2469
  - Proportional Discounts 2469
  - Public Registry 2469
  - Transfer of Ownership 2469
- Requirements For Basic Certification 617
  - Agency Employment 617
  - Application 618
  - Aptitude Test 618
  - Background Investigation 617
  - Code of Ethics/Standards of Conduct 618
  - Mental Readiness Assessment 618
  - Physical Readiness Assessment 618
  - Time for Completing Basic Training
    - Academy or Alternative Training, Field Training & Probationary Period 619
- Requirements For Bingo Game Operations Using Electronic Bingo Machines 2330
  - Connections to Site System 2330
  - Erasing Numbers 2330
  - Identification Number 2330
  - Malfunctioning Electronic Bingo Machines 2330
  - Maximum Number of Faces 2330
  - Players Cannot Choose Numbers 2330
  - Printouts 2330
  - Receipts 2331
- Requirements For Building Construction & Physical Standards 883
  - Approval 884
  - Call System 886
  - Construction Changes 883
  - Dietary Standards 886
  - Dining, Recreation, Shower, Bathing & Living Space 885
  - Heating, Ventilation, & Air-Conditioning (HVAC) 885
  - Lighting 884
  - Plans & Specifications 883
  - Plumbing 885
  - Resident Sleeping Rooms 885

- Secure Environment 886
- Toilets & Bathrooms 884
- Ventilation 885
- Walls & Floor Surfaces 884
- Requirements For Canine Instructor Certification 636
  - Additional Requirements for Patrol Canine Instructor Certification 636
  - Application 636
  - Canine Instructor School 636
  - Canine Training 636
  - Certification & Service in Specific Discipline 636
  - Recommendation 636
  - Requirements for Maintaining Certification 636
- Requirements for Certification of Drinking Water Laboratories 747
- Requirements For Class I Restricted Water Or Wastewater License 1541
  - Education 1541
  - Examination 1541
  - Experience 1541
  - Restricted License Upgrade 1541
- Requirements For Clinical Nutrition Certification 1517
  - Accredited Institution and Program Requirement 1519
  - Audit of Compliance with Clinical Nutrition Certification and Recertification Requirements 1519
  - Didactic Education Requirement 1518
  - General 1517
  - Practicum Requirement 1518
  - Requirement to Maintain Supporting Documentation 1519
- Requirements For Collections 2196
- Requirements For Custody 669
- Requirements For Donation To Charity -- Limitation On Expenses 2334
- Requirements for Drinking Water Laboratories to Maintain, Downgrade, or Revoke Certification 752
- Requirements For Emergency Actions And Fire Drills 898
  - Fire Watch 898
  - Report of Fire 898
- Requirements For Emission Reduction Credit 2408, 2468
  - Allowable Emissions 2468
  - Emission Rate Calculation 2468
  - Imposed Reductions 2468
  - Mobile Sources 2468
  - Permit Issuance 2468
  - Timing of Emission Reduction 2468
- Requirements For Environmental Sanitation 886
  - Garbage & Refuse Disposal 887
  - Housekeeping Services & Maintenance Services 888
  - Insect & Rodent Control 887
  - Linen & Laundry Facilities & Services 887
  - Sewage Disposal 887
  - Toxic Chemicals 888
  - Water Supply 886
- Requirements For Facility Records 892
  - Additional Resident Records 894
  - Admission Records 893
  - As Worked Schedules 895
  - Behavior Documentation 894
  - Dietary Records 895
  - Discharge Records 894
  - Electronic Records 892
  - Fire & Life Safety Records 895
  - Hourly Adult Care Documentation 894
  - Paper Records 892
  - Personnel Records 895
  - Record Confidentiality 892
  - Records for Water Supply 895
  - Resident Admission & Discharge Register 894
  - Residential Care Records 892
- Requirements For Fire And Life Safety Standards 896
- Requirements For Food & Nutritional Care Services 899
- Requirements For Furnishings, Equipment, Supplies, & Basic Services 898
  - Basic Services 898
  - Basic Supplies 899
  - Common Shared Furnishings 898
  - Personal Supplies 899
  - Resident Bed 898
  - Resident Sleeping Room Furnishings 898
  - Resident Supplies & Furnishings 899
  - Resident Telephone Privacy 898
- Requirements For High Liability Instructor Endorsement 635
  - Application 635
  - Completion of a High Liability Instructor School 635
  - Continuing Training Requirements 636
  - Instruction Pending Endorsement 636
  - Multiple Endorsements 635
- Requirements for HVAC Specialty Apprentice 474
- Requirements For Infection Control 896
  - Reporting of Individual with an Infectious Disease 896
  - Staff with an Infectious Disease 896
  - Standard Precautions 896
- Requirements For Initial Certified Public Accountant Licensure Education 25
  - Examination on Code of Professional Conduct 26
  - Experience 26
  - Initial License Application Fee 26
- Requirements For Instructors Of Law Enforcement Subjects 635
  - Additional Requirements 635
  - Experience & Certification 635
  - Instructor Development Course 635
- Requirements For License As A Promoter 1469
  - Provide Waivers 1469
  - Requirements 1469
- Requirements For License As Ring Official 1472
  - Equivalent Qualifications 1472
  - Other Functions 1473
  - Qualifications 1472
  - Ring Officials Determination 1473
  - Validity of Licenses 1473
- Requirements For Licensing Authorized Emissions Technicians 2474
  - Applications for License 2474
  - Requirements for Issuance of an Emissions Technician License 2474
  - Revocation of Emissions Technician License 2474
- Requirements For Licensing Authorized Inspection Stations Or Retest Stations 2473
  - Applications for License 2473
  - Approval Procedure 2474
  - General 2473
  - Requirements for Licensed Inspection Stations 2473
  - Requirements for Licensed Retest Stations 2474
  - Revocation of Inspection Station or Retest Station License 2474
- Requirements For Licensure 1137, 1399, 1628, 1683
  - Application 1628
  - Education 1683
  - Examination 1629, 1685
  - Experience 1684
- Requirements For Licensure By Endorsement 1725, 1758, 1778
  - General 1725
  - General Requirements 1778
  - Has Not Been Convicted of a Drug Offense 1759
  - Has Not Been Disciplined 1759
  - Hold a Current License and Have Experience 1778
  - Holds a Current License 1725, 1758
  - Is of Good Moral Character 1759
- Requirements For Licensure Of A Simulcast Facility 540
- Requirements For Maintaining Idaho Worker's Compensation Claims Files 1104
  - Access Card Payments 1106
  - Audits 1109
  - Checks & Drafts 1108

- Claim Files 1104  
Compensation Payments -  
    Generally 1105  
Copies of Checks 1108  
Correspondence 1105  
Date Stamp 1105  
Electronic Transfer Payments 1105  
Idaho Office 1104  
Non-Compliance 1109  
Notice & Claim 1105  
Prompt Claim Servicing 1109  
Requirements For Medication 889  
    Controlled Substances 890  
    Discontinued & Expired  
        Prescriptions 889  
    Medication Distribution System 889  
    Psychotropic or Behavior Modifying  
        Medication 890  
Requirements For Mint Rootstock To  
    Be Planted In Idaho 293  
    Commercial Production Area 293  
    Restricted Area as Defined in Section  
        100.02 293  
Requirements For Notice Of Claim Of  
    Lien 1920  
    Form 1920  
    Supplement 1920  
Requirements For Nursing  
    Services 888  
    Licensed Nurse 888  
    Licensed Professional Nurse  
        (RN) 888  
Requirements For Operator-In-Training  
    License 1540  
    Education 1540  
    Examination 1540  
Requirements For Organizations  
    Conducting Raffles 2334  
Requirements For Original  
    Licensure 1724, 1757  
    Applicant Bears the Burden 1725  
    Certification 1725  
    Consideration of Factors &  
        Evidence 1724  
    Education 1725  
    General 1724, 1757  
    Interview 1725  
Requirements For Planting Bean Seed  
    In Idaho (Non-Phaseolus) 310  
    Contaminated Seeds 311  
    Idaho Origin Seed to Be  
        Replanted 310  
    Imported Seed From Other Than  
        Malheur County, Oregon 310  
    Malheur County, Oregon Grown  
        Seed 310  
    Tags 311  
    True Identity of Seed Lots 311  
Requirements For Planting Bean Seed  
    In Idaho (Phaseolus) 308  
    Contaminated Seeds 309  
    Idaho Grown Seed 308  
    Idaho Grown Seeds Shipped West of  
        the Continental Divide in the  
        Contiguous United States, except  
        Malheur County, Oregon, or to a  
        Foreign Country and  
        Returned 309  
    Imported Seed Grown East of the  
        Continental Divide in the  
        Contiguous United States or of  
        Foreign Origin 309  
    Imported Seed Grown West of the  
        Continental Divide in the  
        Contiguous United States 308  
    Irrigation 309  
    Malheur County, Oregon Grown  
        Seed 308  
    Tags 309  
    True Identity of Seed Lots 309  
Requirements For Provisional  
    License 1725  
    General 1725  
    Supervision 1725  
Requirements For Reinstatement Of  
    Suspended Or Revoked Vehicle  
    Registration 2196  
    Revocation 2196  
    Suspension 2196  
Requirements For Residents'  
    Rights 901  
Requirements For Residents' Rights  
    Access & Visitation Rights 902  
    Access by Advocates &  
        Representatives 904  
    Access by Protection & Advocacy  
        System 904  
    Access by the Long Term Care  
        Ombudsman 904  
    Advanced Directives 904  
    Citizenship Rights 904  
    Confidentiality 903  
    Control & Receipt of Health-Related  
        Services 903  
    Employment 903  
    Examination of Survey Results 904  
    Fee Changes 904  
    Freedom from Abuse, Neglect, &  
        Restraints 903  
    Freedom of Religion 903  
    Grievances 903  
    Humane Care & Environment 901  
    Management of Personal Funds 902  
    Participation in Other Activities 903  
    Participation in Resident & Family  
        Groups 903  
    Personal Funds 902  
    Personal Possessions 902  
    Privacy 901  
    Resident Records 901  
    Transfer or Discharge 904  
Requirements For Simulcast Facilities  
    Applications for Licenses 540  
    Daily Simulcast License Fees 540  
    General 540  
    Review & Approve 541  
Requirements For Staffing  
    Standards 905  
Detached Buildings or Units 905  
Personal Management 905  
Sufficient Personnel 905  
Requirements For Supervised  
    Practice 1613  
    Amount of Supervisory  
        Contact 1613  
    Duration & Setting of Supervised  
        Practice 1613  
    Evaluation & Accreditation of  
        Supervised Practice 1613  
    Qualifications of Supervisors 1613  
    Unacceptable Supervision 1613  
Requirements For Termination Of  
    Admission Agreement 882  
    Conditions for Termination of the  
        Admission Agreement 882  
    Facility Responsibility During  
        Resident Discharge 882  
    Receipt of Appeal 883  
    Resident's Appeal of Involuntary  
        Discharge 882  
    Written Notice of Discharge 882  
Requirements For The Licensed  
    Registered Nursing Assessment 888  
    Current Medication Orders &  
        Treatment Orders 888  
    Progress of Previous  
        Recommendations 889  
    Recommendations 888  
    Resident & Facility Staff  
        Education 889  
    Resident Health Status 888  
    Resident Medications &  
        Therapies 888  
    Self-Administered Medication 889  
Requirements For Training Of Facility  
    Personnel 905  
Requirements For Wastewater  
    Laboratory Analyst License 1543  
    Class I 1543  
    Class II 1543  
    Class III 1543  
    Class IV 1543  
Requirements For Water Quality  
    Protection 2754, 2804  
    Animal Waste Management System  
        Design Criteria 2754  
    Cap & Cover Criteria 2806  
    Cyanidation Facilities Siting &  
        Preparation 2804  
    Discharges 2754  
    Employee Education Program 2809  
    Land Application 2808  
    Minimum Plans & Specifications for  
        Impoundment, Leach Pads & Other  
        Facilities Designed to Contain  
        Process Water 2805  
    Monitoring Wells Siting &  
        Construction Plans 2808  
    Operation & Maintenance  
        Plans 2807  
    Plumbing & Conveyance  
        Criteria 2807

- Process Buildings, Process Chemical Storage Containment Areas & General Facility Criteria 2806  
Process Water Storage Sizing Criteria 2805  
Spill Contingency Plan 2754  
Stockpile Areas 2754  
Temporary or Seasonal Closure 2809  
Water Quality Monitoring 2754  
Water Quality Monitoring & Reporting 2807  
Requirements To Be Considered "Exceptional" Under Section 54-1223(2), Idaho Code 505  
Activities Which the Board Believes are Exceptional 505  
Activities Which the Board Believes are Ordinary 505  
Waiver of the Fundamentals of Engineering Examination 505  
Written Request for Exceptional Designation 506  
Requirements To Practice Dry Needling 1629  
Course Approval 1629  
Course Completion 1629  
Length of Course 1629  
Proficiency Assessment 1629  
Safety Training 1629  
Requirements To Protect Residents From Abuse 901  
Requirements To Protect Residents From Exploitation 901  
Requirements To Protect Residents From Inadequate Care 901  
Requirements To Protect Residents From Neglect 901  
Research Protections For Persons Served, Residential Care Facility 1032  
Reserve Mud Tanks 1346  
Reserve Peace Officer Certification 628  
Absence of Three Years 628  
Eligibility 628  
Limitation on Certification 628  
Peace or Reserve Officers Certified In Another State, Commissioned by the Federal Government, or Graduates of a Basic Police Academy 628  
Reserve Officer Training 628  
Retaining Certification 628  
Supervision 628  
Residence Outside The State Of Idaho 562  
Residence, Program Eligibility 783  
Resident and Intern Registration 1397  
Registration Certificate 1397  
Resident Funds & Financial Records 843  
Managing Resident Funds 844  
Resident Funds Policy 843  
Resident Records 842  
Admission Records 842  
Maintenance of Resident Records 843  
Ongoing Resident Records 843  
Resident Rights Policy 832  
Access to Resident 833  
Advance Notice 834  
Basic Needs Allowance 833  
Freedom From Harm 833  
Grievance 834  
Health Services 834  
Humane Care 832  
Other Rights 834  
Privacy 832  
Resident Funds 833  
Respectful Treatment 832  
Resident Trainee 1568  
Eligibility to Be Licensed 1569  
Interruption in Training 1569  
Resident Trainee Applicants to Qualify 1569  
Sponsoring Mortician 1568  
Training Requirements 1568  
Residential Care Facilities  
Payment 957  
Referral 957  
Residential Solid Waste Disposal  
Fires 2520  
Fires Allowed 2520  
Fires Exempt 2520  
Resolving Conflicts 2490  
Conflict Resolution at the Level of IDEQ & ITD Headquarters 2490  
Conflict Resolution at the Level of IDEQ Regions & ITD Districts 2490  
Process for Conflict Resolution at the Governors Level 2490  
Respondents 1968  
Response Priorities 958  
Disclosure of Information to Professionals 958  
Notification of the Person Who Made the Referral 958  
Priority I 958  
Priority II 958  
Priority III 958  
Response To Complaint 1319  
Consideration of Complaint 1319  
Response 1319  
Responsibilities 2971  
Commission 2971  
District 2971  
Responsibility Of Issuing Authority 2215  
Permit Issuance 2216  
Primary Concerns 2216  
Responsibility Of Permanent & Condition Defects, Potatoes 50  
Responsibility Of Permittee 2217  
Basic Limitations Shall Not Be Exceeded 2218  
Certification Load Is Non-Reducible 2217  
Delaying Movement 2218  
General Responsibilities 2217  
Hazardous Travel Conditions Restrictions 2218  
Permit to Be Carried in Vehicle 2217  
Responsibility To The Public 506  
Obligation to Affected Landowners 507  
Obligation to Communicate  
Discovery of Discrepancy 506  
Obligation to Comply With Rules of Continuing Professional Development 507  
Primary Obligation 506  
Professional Judgment 506  
Standard of Care 506  
Responsibility, Inspection, & Confidentiality Of Records 1575  
Confidentiality of Records 1575  
Inspection of Records 1575  
Responsibility for Record 1575  
Restraint Facilities 211  
Restricted Licenses 1427  
Following Disciplinary Action 1427  
Restricting Standards To Tablestock Grades, Potatoes 50  
Restriction Of High-Risk Animals 370  
Restriction On The Use Of Infected Potatoes 353  
Restriction On Title 1866  
Restrictions 238, 300, 303, 344  
Certificate of Origin 300  
Certificate of Treatment 300  
Denial of Approval 301  
District I 238  
District II 238  
Exemptions 344  
Movement From a Non-Quarantined Area 344  
Movement From a Quarantined Area 344  
Other Restrictions 344  
Privately Owned House Plants 301  
Seed Potatoes 344  
Restrictions - Apple Maggot 284  
Apples Exposed to Controlled Atmosphere Storage 284  
Certification Required 284  
Infested or Damaged Regulated Articles 285  
Regulatory & Control Measures 284  
Repacked Regulated Articles 284  
Reshipments in Original Containers 284  
Shipments From Cold Storage 284  
Solid Frozen Fruits Exempt 284  
Restrictions - Cherry Fruit Fly 285  
Additional Spraying  
Responsibilities 286  
Chemical Treatments 286  
Emergence 286  
Failure to Treat 286

- Treatments Required 286
- Restrictions & Exemptions 287
  - Exemptions 287
  - Restrictions 287
- Restrictions Governing Shipments 288
- Restrictions Of Wagering 579
- Restrictions On Animals From Areas Or States Affected By Emergency Diseases 150
- Restrictions On Applicability & Nontransfer 1001
  - Change in Ownership, Operator, or Location 1001
  - Issued License 1001
  - Nontransferable 1001
- Restrictions On Import 279
- Restrictions To Protect Pollinators 123
  - Bee Restrictions 123
  - Green Pea Exception 123
  - Other Exceptions 124
- Restrictions, Subchapter K
  - Apples Exposed to Controlled Atmosphere (CA) Storage Admissible Under Certificate 303
  - Certification Required 303
  - Repacked Commodities Admissible from Area Under Quarantine If Certified Grown Outside Thereof 303
  - Reshipments in Original Containers from Area Under Quarantine of Commodities Grown Outside Thereof 303
  - Shipments from Cold Storage at Thirty-Two Degrees Fahrenheit (32° F), Zero Degrees Celsius (0° C) 303
  - Soil or Growing Media When Certified 304
  - Solid Frozen Fruits Exempt 303
- Resuming Count On Boxer 1493
- Retail Cosmetics Dealer License 1780
  - Cessation of Operation 1781
  - Change in Ownership or Location 1781
  - Requirements 1781
- Retail Stores 693
  - Admission to State Store 694
  - Audits 694
  - Customer Refunds & Exchanges 694
  - Disabled Customers 694
  - Distressed Liquor 694
  - Hours & Days of Operation 694
  - Prices 694
  - Site Location 693
  - Site Selection Criteria 693
- Retail Thermal Styling Equipment
  - Dealer Registration 1781
  - Cessation of Operation 1781
  - Change in Ownership or Location 1781
  - Requirements 1781
  - Training 1781
- Retaining Portion Of Purse Pending Determination Of Whether Penalty With Be Charged 1476
- Retention Of Certificates 1976
- Retention Of Documents Relating To Peer Reviews 33
- Return Of Commodity Due To Failure 70, 78
  - Fungible Commodity 78
  - Identifiable Commodity 78
  - Shortfall in Commodity Distribution 78
- Return of Commodity Due To Failure Fungible Commodity 70
  - Identifiable Commodity 70
  - Shortfall in Commodity Distribution 70
- Revenue Feasibility Studies 1862
- Review & Audit Of CPE Reports 30
- Review & Modification Of Support Orders 797
  - Adjustment 798
  - After the Review 797
  - Notice 797
  - Review 797
- Review By Commission 1508
  - Later Review 1508
  - Penalties General 1508
- Review Of Interlocutory Orders 1987
- Review Of Rules 1979
- Reviews & Hearings 946
- Revisions To Permits Establishing A Facility Emissions Cap 2402
  - Criteria 2402
  - Permit Revision Application Procedures 2402
  - Permit Revisions 2402
- Revisit & Relicense 1002
- Revocation & Suspension 725
  - Notification & Appeal 726
  - Revocation 725
  - Suspension 726
- Revocation Of Approved Buying Station Status 202
  - Inability to Trace Animals 202
  - Owner Request 202
- Recordkeeping Requirements 202
  - Regulation Changes 202
  - Violations 202
- Revocation Of Approved Status 206
  - Dealer Request 207
  - Inability to Trace Animals 207
  - Recordkeeping Requirements 207
  - Regulation Changes 207
  - Violations 207
- Revocation Of Permit For Non-Compliance With The Limitations Or Provisions Of The Permit 2223
  - Disqualification of Permits 2223
  - Disqualification Periods 2223
  - Penalties 2223
  - Permit Revocation Process 2223
- Revocation Of Registration 2196
- Revocation, Suspension, & Non-Renewal Of License 1131
  - Causes for Revocation, Suspension, or Refusal to Renew License 1131
  - Eligibility to Reapply After Revocation 1131
  - Length of Suspension 1131
- Revoking A Waiver Or Variance 823
  - Causes for Revocation 823
  - Time Frame to Comply 824
  - Written Notice 824
- Right Of Entry 426, 434
- Right To Sell 859
- Rights Of Parties & Of Agency Staff 1968
- Rights To Discovery Reciprocal 1981
- Risk Of Injury 1492
- River, Lake & Reservoir Power & Float Outfitter Limits 1819
  - Licensable Waters -- River Sections BL1 Through Salmon River -- Table, Outfitters & Guides 1819
  - Licensable Waters -- Salmon River Through Snake River -- Table 1822
  - Licensable Waters -- Snake River Through Teton River -- Table 1824
  - Other -- Table 1829
- Other Lakes & Reservoirs 1830
- Riverbed Mineral Lease 1242
  - Approval Required Before Operations 1242
  - Bonding 1242
  - Limitations on Suction Dredges 1242
  - Simultaneous Filings 1242
- Role Of Filing Officer 1929
  - Duties & Responsibilities 1929
  - What the Filing Officer Does Not Do 1929
- Room, Utilities & Meals 829
  - Bathroom 829
  - Bed 829
  - Common Areas 829
  - Electricity 829
  - Heating and Cooling 829
  - Housekeeping Service 829
  - Meals 830
  - Monitoring or Communication System 829
  - Secure Storage 829
  - Sewer 829
  - Sleeping Room 829
  - Supplies 829
  - Telephone 830
  - Trash 829
  - Water 829
- Rough Bluegrass Quarantine - Inspections 241
  - Infested Seed Stock 241
- Rough Bluegrass Quarantine Restrictions 240
- Rough Bluegrass Regulated Area 240

- Routing Of Hazardous Waste Shipments 2562  
Director's Conditions 2563  
Transporting 2562
- Royalties  
Royalty Payments 1269
- Royalties 1269, 1284  
By-Product Testing 1270  
Calculation of Value 1270  
Commingling 1270  
Due Date 1270  
Measurement 1270  
Oil, Gas, & Natural Gas Plant Liquids  
Royalty Calculation & Reporting 1284  
Overriding Royalty 1285  
Royalty Not Reduced 1284  
Royalty Payments 1284  
Utilization of Geothermal Resources 1270
- Rule For National Type  
Evaluation 103  
Application 103  
Certificate of Conformance 103  
Participating Laboratory 103
- Rule Governing 72-212(5)  
Exemptions 1097  
Approval by Commission 1097  
Effective Date 1097  
Exemption Effective 1097  
Exemptions 1097  
Form 1097  
IC53 Form 1097
- Rule Governing Approval Of Attorneys  
Fees 1115  
Charges Presumed Reasonable 1115  
Disclosure Statement 1116  
Procedure if Fees Are Determined Not to Be Reasonable 1116  
Purpose 1115  
Statement of Charging Lien 1115
- Rule Governing Change Of Status  
Notice To Claimants 1114  
By Whom Given 1115  
Copies of Notice 1115  
Form of Notice 1115  
Medical Reports 1115  
Notice of Change of Status 1114
- Rule Governing Compensation For Disability Due To Loss Of Teeth 1111  
Compensation for Disability 1111  
Prima Facie Evidence 1111
- Rule Governing Computation Of Average Weekly Wage 1110  
Amounts Paid over Base Rate 1110  
Examples Not Exclusive 1111  
Fringe Benefits 1110  
Premium Pay 1111
- Rule Governing Conversion Of Impairment Ratings To "Whole Man" Standard 1111  
Averaging Multiple Ratings 1111  
Converting Single Rating of Body Part to Whole Person Rating 1111  
Correcting Manifest Injustice 1111
- Rule Governing Premium Tax  
Computation For Self-insured Employers 1103  
Experience Modification 1104  
Payroll Reports 1104
- Rule Governing Protection & Disclosure Of Rehabilitation Division Records 1112  
Request for Disclosure 1112  
Requests from Other Agencies 1113
- Rule Governing Reimbursement For Travel Expenses 1112  
Commercial Transportation 1112  
Frequency of Requests 1112  
Mileage Rate 1112  
Request for Reimbursement 1112
- Rule Governing Reporting Indemnity And Medical Payments And Making Payment Of Industrial Special Indemnity Fund Assessment 1110  
Adjustment for Overpayments or Underpayments 1110  
Estimating Indemnity Payments for Entities That Fail to Report Timely 1110  
Filing 1110  
Form 1110  
Penalty for Late Filing 1110  
Report Required When No Indemnity Paid 1110
- Rule Governing Reports Of Attorney Costs & Fees In Litigated Cases 1113
- Rule Governing The Collection Of Premium Tax On Worker's Compensation Insurance Policies 1103  
Procedure for Submitting Premium Tax Forms 1103
- Rule Prohibiting Use Of Sick Leave Or Other Alternative Compensation 1109  
Election of Sick Leave or Alternative Compensation Prohibited 1110  
Employee Not Required to Take Sick Leave in Lieu of Compensation 1109
- Ruled Off 568  
Admittance to Grounds 568  
Persons Ruled Off a Track Ineligible 568
- Rules & Forms 2337
- Rules & Laws Of The State 1266
- Rules Applied To Search Requests 1939  
Initials 1939  
Names Searched On 1939  
No Limit on Number of Search Matches 1939  
Not Case Sensitive 1939  
Punctuation 1939  
Spaces 1939
- The Disregarded 1939  
Words & Abbreviations at the End of a Name 1939
- Rules Apply To Out Of State Buyers 536  
Applicability 536  
Application 536
- Rules Defining Gross Incompetence 1588  
Disciplinary Action or Sanctions 1589  
Displaying Gross Ignorance or Demonstrating Gross Inefficiency 1589  
Employment of Techniques or Methods of Practice 1588  
Failing to Perform Tests & Record Findings 1589  
Failure to Advise Patient of Possible Danger When a Lens Not Meeting Impact Resistance Standards of F.D.A. 1589  
Failure to Meet Prevailing Standards 1588  
Failure to Meet Prevailing Standards in the Referral of Any Patient Who is Suffering From Any Apparent or Suspected Pathological Condition 1588  
Failure to Provide Follow-Up Care 1589  
Failure to Release Prescription 1589  
Failure to Verify the Specifications of All Lenses 1589  
Illegal Prescription Sale, Administration, Distribution, or Use of Drugs 1589  
Sanitary Office 1589  
Sufficient Training or Education 1589  
Using Pharmaceutical Agents 1589
- Rules for Administration of the Idaho Resource Conservation & Rangeland Development Program 2970
- Rules for Allocation of Funds to Conservation Districts 2976
- Rules For Control Of Fluoride Emissions 2536
- Rules For Control Of Fugitive Dust 2527
- Rules For Control Of Hot-Mix Asphalt Plants 2551
- Rules For Control Of Incinerators 2541
- Rules For Control Of Kraft Pulp Mills 2551
- Rules For Control Of Odors 2541
- Rules For Control Of Open Burning 2518
- Rules For Control Of Rendering Plants 2552
- Rules For Cosmetology Schools Approved To Teach Electrology 1783



- Cessation of School 1784  
 Change in Ownership or Location 1784  
 Clinical Work 1784  
 Curriculum 1784  
 Faculty or Instructors 1784  
 Premises 1783  
 Required Equipment 1783  
 Student Records To be Maintained by the School 1784  
 Student Supplies 1784  
 Rules For Sulfur Content Of Fuels 2535  
     Alternative 2536  
     ASTM 2535  
     ASTM Grade 2 2536  
     Coal 2536  
     Definitions 2535  
     Distillate Fuel Oil 2535, 2536  
     Residual Fuel Oil 2535  
     Residual Fuel Oils 2535  
 Rules For The Control Of Ammonia From Dairy Farms 2537  
 Rules For The Control Of Nonmetallic Mineral Processing Plants 2542  
 Rules Governing Continuing Requirements To Underwrite Insurance Or Self-Insure 1099  
     Insurance Carriers 1099  
     Self-Insured Employers 1101  
 Rules Governing License Plates For Governmental Agencies & Taxing Districts 2211  
 Rules Governing Planting Of Regulated Articles (Annual Bluegrass) 240  
     Analysis Certificate 240  
     Tags 240  
 Rules Governing Planting Of Regulated Articles (Annual Bluegrass)) Requirements 240  
 Rules Governing Qualifications To Write Insurance Or Self-Insure 1097  
     Insurance Carriers 1097  
     Self-Insured Employers 1098  
 Rules Governing Shipments 281, 298  
     Admittance into Idaho 298  
     Allium Exemption 281  
     Authority of Director 281  
     Cleaning Machinery, Tools & Equipment 281  
     Designated Counties 281  
     Exemptions 281  
     Machinery, Tools & Equipment 281  
     Marking Contents 298  
     Shipment for Planting Purposes 281  
     Shipment Notification 298  
     Vegetative Propagative Material 281  
 Rules Of Evidence 1957  
     Documentary Evidence 1957  
     Evidence, Admissibility & Evaluation 1957  
     Evidentiary Rulings 1957  
     Failure to Produce Evidence -- Adverse Inference 1957  
     Objections 1957  
     Offer of Proof 1957  
     Post-Hearing Evidence 1957  
     Prepared Testimony 1957  
     Rules Of Evidence -- Evaluation Of Evidence 1984  
     Rules Of Professional Responsibility 1565  
     Rules of Professional Responsibility 1565  
     Violation of the Rules of Professional Responsibility 1565  
     Rules Regarding The Registration Of Fertilizers Containing Plant Nutrients In Addition To Nitrogen, Phosphate, & Potash 253  
     Exemptions 254  
     Labeling 254  
     Other Plant Nutrients 253  
     Rulings At Hearings 1984
- S**
- Safe Haven Exemption For Parents Of Certain Abandoned Infant 965  
 Safety 1077  
     Environmental Hazards 1077  
     First Aid Kit 1077  
 Safety & Disinfection For Establishments & Schools 1791  
     Instrument Cleaning 1791  
     Instrument Disinfection or Sterilization 1791  
     Licenses & Classification Cards 1792  
     Makeup Services 1791  
     Nail Services 1791  
     Premises 1791  
     Restroom Facilities 1792  
     Safety 1792  
     Water Supply & Hand Washing 1792  
     Waxes & Waxing Services 1791  
 Safety & Disinfection For Retail Cosmetics Dealer Facilities & Makeover Or Glamour Photography Businesses 1792  
     Brushes & Implements 1793  
     Cake, Loose or Liquid Makeup 1792  
     Displays 1793  
     First-aid Kit 1793  
     Licenses & Classification Card 1793  
     Makeup Pencils 1793  
     Mascara 1793  
     Water Supply & Restroom Facilities 1793  
 Safety & Disinfection For Retail Thermal Styling Dealer Facilities 1793  
     Cleaning, Disinfection, & Storage 1793  
     First-aid Kit 1793  
     Registration & Classification Card 1793  
     Safety Inspection Requirements For Permitted Vehicles And/Or Loads 2214  
     Drivers 2214  
     Exemption 2214  
     Inspections 2214  
     Inspectors 2214  
     Motor Carriers 2214  
     Sale & Assignment - Required Documentation 1256  
     Assignments 1256  
     Documentation of Sale 1256  
     Sale & Labeling Of Gasoline Which Contains Oxygenates 100  
     Documentation for Dispenser Labeling Purposes 100  
     Fuel Specifications for Gasoline & Gasoline-Oxygenate Blends 100  
     Oxygenates Content Labels 100  
     Pump Labeling Requirements 100  
     Sale Of Diseased Or Exposed Animals Not Allowed 150  
     Sale Or Rental Of Water Rights From The Board's Water Supply Bank 1995  
     Sale Or Rental Of Water Rights From The Board's Water Supply Bank Approval 1995  
     Authorized to Rent 1995  
     Board Review 1995  
     Consideration 1995  
     General 1995  
     Notice 1995  
     Order of Consideration 1995  
     Sale, Rent, Lease Or Occupancy Of A Unit Bearing Such Order Or Notice 427  
     Sample Integrity 158  
     Samples For Official Regulatory Tests 137  
     Accredited Veterinarians 137  
     Persons Approved by the Administrator 137  
     State or Federal Animal Health Officials 137  
     Sampling & Analysis 253, 264  
     Sanctions For Failure To Obey Order Compelling Discovery 1982  
     Sanitary Conditions 211  
     Sanitary Restriction Administration 2820  
     Subdivisions or Plats Proposing Individual & Subsurface Sewage Disposal System Discharge to Subsurface Administration 2820  
     Subdivisions or Plats Proposing Other Than Individual & Subsurface Sewage Disposal System Discharge to Subsurface 2820  
     Sanitary Surveys For Public Water

- Systems Using Ground Water 2643  
  Consultation with the  
    Department 2644  
  Frequency 2643  
  Report 2643  
  Response Required 2644  
  Significant Deficiencies 2643  
  Violation 2644  
Sanitary Surveys For Systems Using  
  Surface Water Or Ground Water  
  Under The Direct Influence Of  
  Surface Water 2642  
  Consultation with the  
    Department 2643  
  Frequency 2642  
  Report 2642  
  Response Required 2642  
  Violation 2643  
Sanitation 1482  
  Reporting 1482  
  Sanitary Conditions 1482  
Sanitation & Storage 58  
  Adequate Lavatory & Toilet  
  Accommodations Shall be  
  Provided 58  
  Case & Carton Storage 59  
  Cases & Packing Materials 59  
  Clean Clothing 59  
  Distributors or Dealers 59  
  Egg Handling & Transport 59  
  Grading & Packing Rooms 58  
  Grading Room 58  
  Pesticides, Insecticides &  
  Rodenticides 59  
  Pre-Wetting or Soaking 58  
  Rest Period 58  
  Sanitary Conditions 59  
  Thermometers 58  
  Trash 58  
  Wash Water 58  
  Wash Water Temperature 58  
  Washing & Rinsing Compound 58  
  Weighing & Grading Equipment 58  
Sanitation, Buying Stations 203  
Sanitation, Livestock Trader Lot 206  
Scabies, Sheep & Goats Entering  
  Idaho 368  
Scale Tickets, Commodity Dealer's 75  
Scale Weight Tickets 105  
  Custom Scale Requirement 105  
  Numerical Order Requirement 105  
  Pre-Numbered Scale Tickets 105  
Schedule Of Fees 699  
  Cost Reimbursement 699  
  Maximum Fee for Annual Supplier  
  Representative Permit 699  
  Maximum Fee for Samples 699  
Schedule Of Fees & Charges 278  
  Certificate of Origin Form 278  
  Hourly Rate 278  
  Overtime Rate 278  
  Registration 278  
Schedule Of Fees For The Idaho State  
  Brand Board 534  
  Due & Payable 534  
  Fees 534  
Scheduling Of The Peer Review 32  
  Currently Enrolled 32  
  Dissolutions or Separations 32  
  Extensions 32  
  Frequency 32  
  Just Cause 32  
  Mergers or Combinations 32  
  Multi-State Practices 32  
  New Firms 32  
  Report Issuance 32  
  Review Year 32  
Scion-Blocks 272  
  Acceptability 272  
  Location 272  
Scope 793  
Scope & Practice Standards 1750  
  Conditions for Which a Licensed  
  Midwife May Not Provide  
  Care 1750  
  Conditions for Which a Licensed  
  Midwife May Not Provide Care  
  without Health Care Provider  
  Involvement 1750  
  Conditions for which a Licensed  
  Midwife must Facilitate Hospital  
  Transfer 1751  
  Conditions for which a Licensed  
  Midwife must Recommend  
  Physician Involvement 1750  
  NACPM Scope & Practice  
  Standards 1750  
Scope Of Appeal In Ad Valorem  
  Case 1958  
Scope Of Authority Of Hearing  
  Officers 1978  
  Limitation 1979  
  Scope of Authority 1979  
Scope Of Practice 1399, 1406, 1598,  
  1698, 1763, 1789  
  Advanced Surgical Procedures 1598  
  Competence 1598  
  Identification 1406  
  Limitations of Scope of  
  Practice 1406  
  Referral by Directing  
  Physician 1406  
  Scope 1399  
Scrapie Infected Flock 366  
Scrapie Program Standards, Scrapie  
  Flock Certification, Scrapie Control  
  & Eradication 369  
Scrapie Source Flock 366  
Scrapie-Positive Animal 366  
Seal, Signature, Date 513  
Seals 497  
  Official Seal of Board 497  
  Seal for Professional Engineer/Land  
  Surveyor 497  
  Standard Seals for Engineers & Land  
  Surveyors 497  
Search Request Delivery 1927  
Search Requests 1938  
  Fee 1939  
  Name Searched 1938  
  Requesting Party 1939  
Search Requests & Reports 1938  
Search Responses 1939  
  Certification Date 1940  
  Copies 1940  
  Filing Officer 1940  
  History of Financing  
  Statement 1940  
  Identification of Initial Financing  
  Statements 1940  
  Name Searched 1940  
  Report Date 1940  
Searches 1061, 1081  
  Body Cavity Searches are  
  Prohibited 1062, 1082  
  Pat Down Searches 1061, 1081  
  Strip Searches are Prohibited 1061,  
  1082  
Second Notice Action -- Non-  
  Compliance, Potatoes 50  
Secondary MCLS 2649  
  Definitions 2649  
  Monitoring 2650  
  Purpose 2649  
  Secondary Maximum Contaminant  
  Levels 2649  
Section 502(B)(10) Changes & Certain  
  Emission Trades 2455  
  Criteria 2455  
  Notice Procedures 2456  
  Permit Shield 2456  
Securing & Enforcing Medical  
  Support 797  
  Enforcement 797  
  Petition 797  
Securities Exemptions, Opinions, & No-  
  Action Letters 644  
Security 576  
  Daily Reports 577  
  Escort Guests 576  
  List of Security Personnel 577  
  Passes 576  
  Prevent Access 576  
  Restricted Areas 576  
Security & Irregularities 25  
Sedation Permit Renewal 1148  
  Permit Renewal 1148  
  Reinstatement 1148  
Seed & Farm Labor Liens 1942  
  Mechanics of Filing 1942  
  Mechanics of Search 1942  
Seed Dealers License Fees 236  
  Exemptions 237  
  In-State Seed Dealers License  
  Fees 237  
  Out-of-State Seed Dealers License  
  Fee 237  
Seed Disposition Notification 350  
Seed Potato Crop Management  
  Areas 345  
  Almo Valley Bridge Seed Potato  
  Crop Management Area 346

- Caribou & Franklin County Seed  
Potato Crop Management  
Area 345
- Fremont Seed Potato Crop  
Management Area 345
- Hog Hollow Seed Potato Crop  
Management Area 347
- Little Camas Ranch Seed Potato Crop  
Management Area 346
- Lost River Seed Potato Crop  
Management Area 345
- Picabo Seed Potato Crop  
Management Area 346
- Ririe Reservoir Seed Potato Crop  
Management Area 346
- Teton & Portions of Madison County  
Seed Potato Crop Management  
Area 345
- Seed-Blocks 272  
Acceptability 272  
Location 272
- Selection 641, 685  
Class Six Applicants 685  
Fish & Game Violations 685  
Low Numbered Vendors 685  
Minimum Sales Volume 685  
Number of Existing Vendors in  
Area 685  
Performance Record 685  
Permanence & Accessibility 685  
Surety Bond 685  
Unsettled Debts 685
- Selection Of An Adoptive  
Placement 1049
- Self-Administration Of  
Medication 847  
Approval 847  
Change in Condition 847  
Evaluation 847  
Safeguarding Medication 847
- Self-Certification 46
- Self-Supervision Prohibited, Children's  
Agencies 1042
- Selling Or Shipping Of Ginseng --  
Certificates 276  
Export 276  
Final Retail Sales 277  
Forms 277  
Idaho Certificate of Origin 277  
Out-of-State Issued Certificates 277  
Wild Ginseng Certificates 277
- Senior Status 1658  
Continuing Education 1658  
Request for Senior Status 1658
- Separate Bank Account & Limitations  
On Use 2332  
Disbursements Use of Funds 2332  
Establishment of Account 2332
- Separation Of High Diving Boards 762  
Separation Of Low Diving Boards 762
- Separators 1352  
Service By Agency 1966  
Service Components 1045  
Activities 1045
- Aftercare 1046  
Counseling 1045  
Legal 1045  
Medical Care 1045  
Planning 1045  
Skills 1045  
Training 1045
- Service Evidence 1131  
Conformance to Standards 1132  
Submission of Plans 1131
- Service Of Documents 1949  
Proof of Service 1950  
Service 1949
- Service On Parties & Other  
Persons 1973
- Service On Representatives Of Parties  
& Other Persons 1969
- Service Plans 1037  
Initial Service Plan 1037  
Updated Service Plan 1037
- Service Plans & Participants, Children's  
Agencies 1045
- Service Sink, Children's Residential  
Care Facilities 1055
- Service Tag 1132  
Control Valve Not Electrically  
Supervised 1132  
Electrically Supervised Control  
Valve 1132  
Form 1132
- Service Testing Fees - Miscellaneous  
Fees 236
- Service Testing Fees -- Purity,  
Germination & Tetrazolium  
Fees 233
- Service Testing Fees - Special  
Tests 235
- Service Worker Available, Children's  
Residential Maternity Care 1068
- Service Worker Or Social  
Worker 1034
- Service Worker Position &  
Qualifications 1042  
Qualification 1042  
Training 1042
- Service Worker Supervisor  
Position 1041  
Bachelor's Degree Provision 1041  
Master's Degree Provision 1041
- Service Worker Supervisor  
Qualifications 1052  
Bachelor's Degree 1052  
Master's Degree 1052
- Services For Adoptive  
Applicants 1048  
Counseling 1048  
Legal Assessment 1048  
Orientation 1048  
Preparation for Placement 1048  
Selections and Services for a Specific  
Child 1048  
Suitability Criteria 1048  
Termination of Services 1048
- Services For Adoptive Parents 1049
- Adoption Finalization  
Assistance 1049  
Disclosure of Non-Identifying Child  
Information 1049  
Post-Finalization Services 1049  
Post-Placement Services 1049  
Provision of Resources 1049  
Specific Training 1049
- Services For Child's Birth Parents,  
Children's Agencies,  
Adoption 1047
- Services For Children As The Primary  
Consideration 1047
- Services To Be Provided In  
Adoptions 966  
Adoption Assistance 966  
Compliance With Multi-Ethnic  
Adoption Provisions & Interethnic  
Adoption Provisions 966  
Period of Support Supervision 966  
Post Adoption Services 967  
Preparation for Placement 966  
Pre-Placement Child/Family  
Assessment 966  
Pre-Placement Home Study 966  
Response to Inquiries 966  
Technical Assistance 966
- Settlement Not Binding 1985
- Seven Days To Challenge Proposed  
Default Order 1986
- Sewage & Waste Disposal  
Political Subdivisions 2227  
Prohibited Conditions 2227
- Sewage Disposal On The Rathdrum  
Prairie In Kootenai County,  
Idaho 2227  
Definitions 2227  
Scope 2227  
Subsurface Sewage Disposal  
Systems 2228  
Title 2227
- Sewage Sludge 2963  
Applicability 2964  
Exceptions to Incorporation by  
Reference 2964  
Purpose 2963  
Term Interpretation 2964
- Sewer System 764
- Sexual Offender Treatment 2360
- Sexual Offender Treatment Provider  
Qualifications 2349  
Certification Requirements 2350  
Certified Sexual Offender Treatment  
Provider 2349
- Sheep & Goat State Entrance  
Requirements 367  
Brucella Ovis 367  
Entrance Requirements 367
- Sheep Assessments 372  
Assessment as Resident Sheep 372  
Costs of Collection 372  
Migratory Sheep 372  
Payment of Assessment 372  
Shelter Care Admission & Plans 1037

- Shelter Care in Excess of Thirty Days 1037  
Shelter Care More Than Sixty Days 1038  
Shipments, From Area Under Quarantine 301  
Shipping Permit Number 250  
  Accompaniment 250  
  Application Deadline 250  
  Changes 250  
  Fees 250  
  No Other Statements 251  
  Permit Number 250  
  Reissue Application 250  
Shipping Records 75  
  Amount & Type 75  
  Buyer & Destination 75  
  Date 75  
  Identification Number 75  
  Name & Address 75  
Short-Term Care & Supervision 845  
  Alternate Caregiver 845  
  Incidental Supervision 846  
  Substitute Caregiver 845  
Showers 763  
  Fixtures 764  
  Scald Prevention 764  
  Showers 764  
  Soap 764  
  Water Temperature 764  
Side Walls 759  
Sign Requirements For Vehicles  
  Combinations Inclusive Of Load 2215  
Signage 203  
  Color 204  
  Location 204  
  Wording 203  
Signature Requirements 2864  
  Certification 2865  
  Electronic Reporting 2865  
  Electronic Signatures 2865  
  New Authorization 2865  
  Permit Applications & Notices of Intent 2864  
  Reports & Other Information Submitted 2864  
Significant Permit Modification 2452  
  Criteria 2452  
  Implementation Procedures 2453  
  Permit Shield 2453  
  Significant Permit Modification Application Procedures 2452  
Significant Permit Modification Application Procedures 2452  
Simulcast Purse Money Collection & Distribution 545  
  Deposit into Appropriate Account 545  
  Designated Purse Monies 545  
  Dual Signature Insured Account 545  
  Sanctions 545  
Single Draft Vehicle Weighing 103  
  Coupled Combination 103  
  Vehicle 103  
Singular & Plural Forms 1926  
Site Requirements For Certified Family Homes 856  
  Accessible Road 856  
  Accessible to Services 856  
  Emergency Medical Services 856  
  Fire District 856  
  House Number 856  
Siting Requirements 2629  
Six Month Reviews For Children In Alternate Care Placement 946  
  Considerations in Six Month Review 946  
  Members of Six Month Review Panel 946  
  Notice of Six Month Review 946  
  Procedure in the Six Month Review 946  
  Recommendations & Conclusions of Six-Month Review Panel 946  
Size & Composition Of Leasable Tract 1243  
  Construction Materials 1243  
  One Mile Limitation 1243  
Size Of A Leasable Tract 1271  
  Navigable Water Courses 1271  
  Surface Area 1271  
Size Of Samples 268  
Skiing, Non-hazardous & Hazardous Terrain Outfitter, Designated Agent, Ski Guide & Ski Guide Trainee 1814  
  Applications 1814  
  Designations & Qualifications for Outfitters, Designated Agents, Guides & Trainees 1815  
  Field Supervisor 1815  
  Level I Ski Guide (Non-Hazardous Terrain) 1815  
  Level II Ski Guide (Hazardous Terrain) 1815  
  Outfitters 1815  
  Outfitters Plan of Operation 1815  
  Ski Guide Trainee 1815  
Skills & Training 1073  
  Skills 1074  
  Training 1074  
Skimmers  
  Capacity 771  
  Piping 771  
  Total Capacity 771  
Equalizers 771  
  Equalizer Valve & Line 771  
  Inlet to the Equalizer Line 771  
  Location 772  
  Requirement 771  
  Minimum Requirements 771  
  Standard Requirements 771  
Slaughtering Of Diseased Animals 138  
  Authorized by Law 138  
  Not Authorized by Law 138  
Sleep, Children's Residential Care Facilities 1057  
Sleeping Rooms 1056  
  Restrictions 1056  
  Size 1056  
  Window Space 1056  
Sliding Fee Schedule For Children's Mental Health, Adult Mental Health, & Substance Use Disorders Services 1089  
Sliding Scale, Family's Percentage Of Financial Participation 784  
Slope Of Decks & Walkways 760  
Slope Of Floor  
  Deep Area 759  
  Shallow Area 759  
Slowly Released Plant Nutrients 256  
  Additional Products May be Added to List of Slow Release Nutrients 257  
  Methods 257  
  Slow Release 256  
  Slow Release Properties 256  
Small Dam Design Criteria 2072  
  Approval Required 2072  
  Design & Construction of Small Dams 2072  
  Notification Prior to Construction 2072  
  Notification upon Completion of Construction 2073  
Smoke & Carbon Monoxide Detecting Devices 1023  
  Carbon Monoxide Detecting Devices 1023  
  Smoke Detecting Devices 1023  
Smoking Requirements 878  
  Combustible Supplies & Flammable Items 878  
  Designated Smoking Areas 878  
  Smoking in Bed 878  
  Unsupervised Smoking 878  
Snowmobiling 1830  
  Emergency Equipment 1830  
  Groomed Trails 1830  
  Non-Groomed Trails 1830  
  Reduction in Guide Ratios 1830  
Snowmobiling Guide 1816  
  Avalanche 1816  
  Hypothermia 1816  
  Mechanics 1816  
  Snowmobiling Techniques 1816  
Social Work Supervisor  
  Registration 1640  
  Registration 1640  
  Renewal 1640  
  Requirements for Registration 1640  
Social Worker Or Service Worker Responsibilities, Children's Agencies 1042  
Social Worker Position & Qualifications, Children's Agencies 1041  
Soil Amendment & Plant Amendment Labels 262  
  Content or Guaranteed Analysis

- Exemptions 262
- Microbiological Product 263
- Ninety-Five Percent Rule 263
- Nutrient Claims & the Use of the Term Fertilizer 263
- Other Ingredients 264
- Precautionary Statements 264
- Warning or Caution Statements 264
- Soil Amendment & Plant Amendment Registration 262
  - Alteration from Original State 262
  - Exemptions from Registration 262
  - Product Registration 262
  - Sale of Soil Amendment or Plant Amendment 262
- Solicitation Of Work 508
  - Assignment on Which Others are Employed 508
  - Commissions 508
  - Contingency Fee Contracts 509
  - Representation of Qualifications 508
  - Selection on the Basis of Qualifications 509
- Solid Waste Management Facility Classification 2573
  - BRC Facilities 2573
  - General & Site Specific Classification Process 2574
  - Site Specific Classification 2574
    - Tier I Facilities 2573
    - Tier II Facility 2573
    - Tier III Facility 2573
    - Wood or Mill Yard Debris Facilities 2573
- Somatic Cell Count 166
  - Level of Somatic Cells 166
  - Procedures 166
- Source Density 2399
- Sources 1522
- Special Agreements 2200
  - Agreements for Services 2200
  - Right to Receive Information Subject to Idaho Code 2200
- Special Allowances For Emergency & Critical Service Vehicles 2221
- Special Conditions 1838
- Special Exemptions 282
- Special Permit Fees Costs To Be Borne By Permittee 2221
- Special Permit Policy During Spring Breakup 2220
  - Suspended Weight Limits 2220
  - Weight Restrictions 2220
- Special Permits 280, 286
  - Application 280
  - Conditions 280
- Special Practice(s) Approval For Loans 2973
  - Special Practice Approval 2973
  - Special Practice Requests 2973
- Special Promotional Activities 45
  - Activities 45
  - Fees 45
- Special Provisions Covered In A Petition To Change Or Add Types Of Construction 451
- Special Regulations 2636
  - Monitoring Requirements for Unregulated Contaminants 2636
  - Prohibition on Use of Lead Pipes, Solder, and Flux 2637
  - Special Monitoring for Corrosively Characteristics 2637
  - Special Monitoring for Sodium 2636
- Special Requests 47
  - Additional Charges 47
  - Customized Certificates 47
- Special Service 250
- Special Situations 312
- Specialized Training For Psychosexual Evaluators & Sexual Offender Treatment Providers 2351
  - Assessment, Treatment, & Management of Adult Or Juvenile Sex Offenders 2351
  - Deviant Sexual Arousal & Interests 2351
  - Offending Behavior 2351
  - Sexually Abusive Behavior 2351
  - Specific Risk Assessment Tools 2351
- Specialty Constructed Vehicles 2187
  - Engine Changes 2187
  - Specialty Constructed Vehicle Examples 2187
  - Title Application Requirements 2187
- Specialty Advertising 1140
  - Disclaimer 1140
  - Recognized Specialty License 1140
  - Unrecognized Specialty 1140
- Specialty License 1314
  - General 1314
  - Procedure to Obtain Specialty License 1314
  - Regulations Governing Use of Specialty License 1314
- Specialty Plumbing Licenses 405
  - Applications for Specialty Licenses 405
  - Examinations for Specialty Licenses 405
  - Fees 405
  - Minimum Experience Requirements 405
  - Mobile Home Set-Up or Installers 405
  - Qualified Journeyman Plumbers 405
- Specific Emergency Episode Abatement Plans For Point Sources 2480
- Specific Permit Conditions 2757
  - Basis for Specific Permit Conditions 2757
  - Compliance Schedules 2758
  - Limitations to Operation 2758
- Monitoring Requirements 2758
- Specific Requirements for Radiographic Personnel Performing Industrial Radiography 795
- Specimens 583
  - Container 583
  - Delivery to Approved Laboratory 583
  - Identity 583
  - Number & Date 583
- Speculation In Tickets Prohibited 1481
  - Exchange 1482
  - No Other Price 1481
  - Prevent Speculation 1481
  - Removal & Possession of Stub 1482
  - Tickets for Readmission 1482
- Speed Restrictions 2220
- Spending 783
- Sponsor Commitment 1866
- Sponsor's Matching Share 1859
- Spot Burn, Baled Agricultural Residue Burn, & Propane Flaming Permits 2525
  - Applicability 2525
  - General Provisions 2525
  - Propane Flaming Permit 2525
  - Recordkeeping 2525
  - Spot & Baled Agricultural Residue Burn Permit 2525
- Sprayed on Fireproofing, 07800 460
- Spreading of Human Ashes 1855
- Spring Breakup Season Type Of Load Restrictions 2220
- Stable Name Change 556
  - Cancellation 556
  - Name Change 556
- Stable Name License 555
  - Changes of Ownership 556
  - Trainer 556
- Stable Names Prohibited 556
  - Distinguishable 556
  - Misleading 556
  - One Name 556
  - Real Name 556
  - Registered 556
- Stack Heights & Dispersion Techniques 2470
- Staff & Other Individual Record Requirements 1007
  - Certification 1008
  - Legal Name 1008
  - Phone Number 1008
  - Proof of Age 1008
  - Record of Hours 1008
  - Record of Training 1008
  - Results of Juvenile Justice Records 1008
  - Verification of Criminal History & Background Check Clearance 1008
- Staff Health Requirements, Children's Therapeutic Outdoor Programs 1073
- Staff Qualifications For Children's

- Therapeutic Outdoor Programs 1071  
 Chief Administrator 1072  
 Field Director 1072  
 Field Staff 1073  
 Intern 1073  
 Program Consultants 1073  
 Senior Field Staff 1072  
 Volunteers 1073  
 Staff Ratios & Group Size 1074  
 Interns & Volunteers 1075  
 Staffing Ratio 1074  
 Staff Ratios Required, Non-Accredited Children's Residential Schools 1069  
 Staff Recruitment, Hiring, Supervision, Training, Evaluation, Promotion & Discipline 1034  
 Job Descriptions 1034  
 Personnel Records 1034  
 Staff Training Requirements 876  
 Behavior Management for Residents 877  
 Facility Operations, Inspections, Maintenance, and Testing 877  
 Hazardous Materials 877  
 Intervention Procedures to Ensure Safety of Residents and Staff 877  
 Mechanical Equipment 877  
 Response of Staff to Accidents, Incidents, or Allegations of Abuse, Neglect, or Exploitation of Residents 876  
 Staff Training, Children's Residential Care Facilities 1053  
 Staff Use Of Alcohol Or Controlled Substances Prohibited 1075  
 Staff Workloads 1042  
 Caseload Limitations 1042  
 Supervisor to Staff Ratio 1042  
 Stage 1 Vapor Collection 2515  
 Stage 2 Disinfection Byproducts Requirements 2648  
 Stages, Atmospheric Stagnation/ Degraded Air Quality 2475  
 Stage 1 - Air Pollution Forecast & Caution 2475  
 Stage 2 - Alert 2476  
 Stage 3 - Warning 2476  
 Stage 4 - Emergency 2476  
 Stairs 761  
 Stakeholder Involvement 1547  
 Standard Conditions 1837  
 Cancellation 1838  
 Compliance with Laws 1838  
 Construction, Operation & Maintenance 1837  
 Hold Harmless 1838  
 Land & Water Conservation Fund 1838  
 Permits Not Exclusive 1838  
 Removal of Facilities 1838  
 Term Limited 1837  
 Utilities 1837  
 Wetlands 1838  
 Withdrawal for Park Use 1838  
 Standard Contents Of Permits  
 Establishing A Facility Emissions Cap 2400  
 Duration 2401  
 Emission Limitations & Standards 2400  
 Monitoring 2401  
 Recordkeeping 2401  
 Reporting 2401  
 Standard Contents Of Tier I Operating Permits 2439  
 Alternative Operating Scenarios 2440  
 Authority for & Form of Terms & Conditions 2439  
 Compliance Schedule & Progress Reports 2441  
 Emission Limitations & Standards 2439  
 General Requirements 2443  
 Monitoring 2440  
 Other Specific Requirements 2443  
 Periodic Compliance Certifications 2442  
 Permit Conditions Regarding Acid Rain Allowances 2442  
 Permit Duration 2443  
 Recordkeeping 2440  
 Reporting 2441  
 Terms or Conditions for Applicable Requirements 2439  
 Testing 2441  
 Trading Scenarios 2440  
 Standard Exempt Plate Designators 2211  
 Standard License 1314  
 General 1314  
 Procedure to Obtain Standard License 1314  
 Regulations Governing Use of Standard License 1314  
 Standard License Examination 1314  
 Practical Examination 1314  
 Written Examination 1314  
 Standard Permit Applications 2427  
 Standard Processing Of Tier I Operating Permit Applications 2446  
 Standards 642  
 Standards - Treatment Of Hazards 1304  
 Purpose 1304  
 Reduction of Total Hazard Points 1304  
 Standards Applicable To Generators Of Hazardous Waste 2559  
 Generator Emergency Notification 2559  
 Incorporation by Reference 2559  
 Standards Applicable To Transporters Of Hazardous Waste 2559  
 Standards For Bulk Milk Haulers 172  
 Adulteration 172  
 Authorization 172  
 Permit Revocation 172  
 Permits 172  
 Standards For Butter 174  
 Grading 174  
 Quality Standards 174, 175  
 Standards For Daycare 1004  
 Daycare Standards 1004  
 Minimum Age of Applicant 1004  
 Standards For Daycare 1004  
 Standards For Foster Homes 1017  
 Standards for Foster Homes 1017  
 Standards for Lights on Oversize Vehicles or Loads, or Both 2214  
 Standards For Minor & Existing Sources, Fuel Burning Equipment -- Particulate Matter 2531  
 Standards For New Sources, Fuel Burning Equipment -- Particulate Matter 2531  
 Standards For Non-Use 1809  
 Definitions 1809  
 Examples of Acceptable Use 1809  
 Non-Use During a Sale 1810  
 Process 1809  
 Required Records 1810  
 Requirement 1809  
 Waiver of Compliance 1810  
 Standards For Owners & Operators Of Hazardous Waste Facilities Operating Under A Standardized Permit 2561  
 Standards For Owners & Operators Of Hazardous Waste Treatment, Storage & Disposal Facilities 2559  
 Standards For Professional Conduct & Client Relations 2354  
 General Considerations for Certified Evaluators & Certified Treatment Providers 2354  
 General Considerations for Certified Post Conviction Sexual Offender Polygraph Examiners 2354  
 Standards For Solo Experiences In Children's Therapeutic Outdoor Programs 1084  
 Emergency Procedures 1085  
 Check In 1086  
 Communication 1085  
 Instruction 1085  
 Participant Response 1085  
 Plan 1084  
 Ability 1084  
 Back Up Plan 1084  
 Individual Solo Plan 1084  
 Preparation 1084  
 Responsible Staff 1085  
 Solo Sites 1085  
 Hazardous Conditions 1085  
 Mapping & Site Coordinates 1085  
 Pre-Site Investigation 1085  
 Supplies 1085  
 Supervision 1085  
 Assigned Staff 1085  
 Observation 1085

- Standards For The Management Of Specific Hazardous Wastes & Specific Types Of Hazardous Waste Facilities 2560
- Standards For The Management Of Used Oil 2560
- Incorporation by Reference. 2560
- Used Oil as a Dust Suppressant 2560
- Standards For Universal Waste Management 2561
- Standards For Whey Butter 174
- Basis for Determining the Acceptability of Whey Butter 174
- Enforcement 175
- Explanation of Terms with Respect to Flavor, Intensity, and Characteristics 176
- Specifications for Acceptability of Whey Butter 174
- Table I -- Classification of Flavor Characteristics 175
- Table II -- Characteristics and Disratings in Body, Color, and Salt 175
- Whey Butter Label Requirements 174
- With Respect to Body 177
- With Respect to Color 177
- With Respect to Salt 178
- Standards Of Conduct 1425
- Classification 1425
- License 1425
- Practice 1425
- Professional Responsibility 1426
- Violations 1425
- Standards Of Conduct & Practice 1668
- Advertisements 1668
- General Conditions 1668
- Office Standards 1668
- Patient Record 1669
- Sanitation 1668
- Standards Of Conduct For Basic Training Academy Students 619
- Notice 619
- Prohibited Conduct 619
- Required Behavior 619
- Standards Of Identity, Labeling, & Quality Standards For Ice Cream & Frozen Dairy Products & Desserts 173
- Definitions 173
- Labeling 173
- Licensed Manufacturers 173
- Quality Standards 173
- Violations 173
- Standards Of Practice 1763, 2271
- Anesthesia Standards 2272
- Dispense and Distribute in Good Faith 2272
- Immunization 2272
- Practice Procedures 2271
- Relationship 2272
- Standards Of Practice For Advanced Practice Registered Nursing 1434
- Certified Nurse Practitioner 1435
- Certified Nurse-Midwife 1435
- Certified Registered Nurse Anesthetist 1435
- Clinical Nurse Specialist 1435
- Core Standards for All Roles of Advanced Practice Registered Nursing 1434
- Documentation of Specialization 1435
- Purpose 1434
- Standards Of Practice For Prescriptive Authority 1618
- Disagreement between Prescribing Psychologist & Licensed Medical Provider 1620
- Disaster Areas 1620
- Emergencies 1620
- Initial Collaboration with Licensed Medical Provider 1619
- Licensed Medical Provider 1618
- Ongoing Collaboration with Licensed Medical Provider 1619
- Prescriptions 1620
- Prohibited Agreements with Licensed Medical Providers 1620
- Release of Information 1619
- Standards of Practice for Telehealth 1559
- Determining Type of Evaluation 1559
- Supervision of Occupational Therapy Assistant 1560
- Standards Of Professional Conduct For EMS Personnel 702
- Confidentiality 703
- Conflict of Interest 703
- Cooperation & Participation 703
- Ethical Responsibility 703
- Integrity 703
- Knowledge & Proficiency 702
- Method of Treatment 702
- Professionalism 703
- Respect for the Patient 703
- Standards Of The Ethical Practice Of Podiatry 1599
- Standing 8 Count In MMA Contest 1502
- Starting Gate 575
- Backup Equipment 575
- Training Hours 575
- Startup, Shutdown & Scheduled Maintenance Requirements 2390
- Amendments to Procedures 2391
- Excess Emissions Procedures 2391
- Filing of Excess Emissions Procedures 2392
- General Provisions 2390
- Startup, Shutdown, Scheduled Maintenance, Safety Measures, Upset & Breakdown 2389
- State & Federal Seals 138
- Persons Designated by the Administrator 138
- State or Federal Animal Health Officials 138
- State Animal Health Official 367
- State Stores Solicitation & Promotional Presentations 699
- State Veterinarian License 556
- State-Funded Guardianship Assistance Eligibility, Requirement, & Benefits 969
- Eligibility for State-Funded Guardianship Assistance 969
- Limitations on State-Funded Guardianship Assistance 970
- Medicaid Benefits Under State-Funded Guardianship Assistance 970
- Nonrecurring Expenses 970
- Statement 2395
- Statement Of Public Policy & Code Of Professional Conduct 1644
- Bartering 1647
- Business Relationships 1647
- Competent Practice for Social Workers 1646
- Dual Relationships 1647
- The Advertising Rules for Social Workers 1646
- The Social Worker's Conduct & Comportment as a Social Worker 1645
- The Social Worker's Ethical Responsibility to Clients 1644
- Statewide Bond 1243
- Statutory Inspection, Examination, Investigation, Etc. -- Contrasted With Other Discovery 1982
- Stay Of Orders 1990
- Stays Of Contested Permit Conditions 2936
- Permittee Responsibilities 2936
- Stays 2936
- Stays Based on Cross Effects 2936
- STEMI (Heart Attack) Designation Centers 719
- Sterile Preparation 1892
- Application 1892
- Compounder Responsibilities 1893
- Documentation Requirements 1894
- Dosage Forms Requiring Sterility 1893
- Environmental Controls 1893
- Sterile Preparation Equipment 1893
- Steward License 556
- Stipulations 1956, 1983
- Stock Exchange Listed Securities 655
- The American Stock Exchange 656
- The Chicago Board Options Exchange 656
- The Chicago Stock Exchange 656
- The NASDAQ/Global Market & Global Select Market 656
- The New York Stock Exchange 656
- Tier I of the Pacific Stock Exchange 656

- Tier I of the Philadelphia Stock Exchange 656  
Stool-Beds 272  
  Acceptability 272  
  Location 272  
Stop Work Orders 427  
Stopping Of Contest  
  Injury To Boxer 1492  
  One-Sided Contest 1492  
Stopping The Contest  
  Contestant Not Honestly Competing 1492  
Storage & Shipment Of Split Samples 584  
  Secured 584  
  Transfer of Samples 584  
Storage Of Pesticide Containers 124  
  Disposal 124  
  Exceptions 124  
  Protecting Humans & Environment 124  
  Storage by Professional Applicators or Pesticide Dealers 124  
Storage Of Poisonous & Toxic Materials, Children's Residential Care Facilities 1056  
Storage Of Potatoes 350  
  Potatoes Produced Outside Seed Potato Crop Management Areas 350  
  Potatoes Produced Within Seed Potato Crop Management Areas 350  
Store Conversions 697  
Stroke Designation Centers 719  
Students, Educational Program 1451  
Stumpage & Interest Payment 1155  
Subcontracting 748  
  Availability of all Subcontracting Laboratory Records 748  
  Availability of the Report from the Subcontracting Laboratory 748  
  Identification Requirements for Subcontracting Laboratory 748  
  List of Subcontractors 748  
Subject to Review or Audit 573  
Subleasing 1262  
Submerged Fill Requirements 2516  
  Installed After November 9, 2006 2516  
  Installed On or Before November 9, 2006 2516  
Submission Of Application 923  
Submission Of EMS Personnel Licensure Application & Documentation 709  
  Early Submission for License Renewal 709  
  EMS Personnel License Expiration Date Falls on a Non-Work Day 709  
Submission Of Fingerprints 923  
  Department Fingerprinting Locations 924  
  Submission of Reprints 924  
  Submitting Fingerprints by Mail 924  
Submission Of FROI & SROI 1113  
  EDI Reporting 1113  
  Filing Considered Authorization 1113  
  Filing Not an Admission 1113  
  Purpose 1113  
  Report Form & Content for Parties Exempt from EDI Requirements 1113  
  Retaining Claims Files 1113  
  Timely Response Requirement 1114  
  Trading Partner Agreements 1113  
Submission Of Medical Reports From Providers 1111  
  Forfeiture of Payment 1112  
  Procedure 1111  
  Report Form & Content 1112  
  Timely Response Requirement 1112  
Submission Of Plans & Specifications 756  
  Construction Compliance Certificate 756  
  Plans 756  
  Stability 756  
Subpoena 1959  
  Fees 1960  
  Issuance of Subpoena 1959  
  Motion Contents & Timing 1959  
  Motion to Quash 1960  
  Service 1960  
Subpoenas 1981  
Subscription Agreement 650  
Subsequent Evaluations 1021  
  Family Functioning 1021  
  Other Circumstances 1021  
  Reasonable Access 1021  
  Update Information 1021  
  Written Plan of Correction 1021  
Substitute Care Placement & Children's Agency Notification 1026  
  Notification to Agency 1026  
  Substitute Care 1026  
Substitution Of Representative 1947  
Substitution Of Representative-- Withdrawal Of Representative 1969  
Substitutions 1543  
  Equivalency Policy 1544  
  Substituting Education for Experience 1543  
  Substituting Experience for Education 1544  
  Substituting Experience for Experience 1544  
Subsurface Sewage Disposal System Installer's Registration Permit 2820  
Suction Dredges & Non-Powered Sluice Equipment 2084  
  Limitation of Mining Sites 2085  
  Mechanized Equipment Prohibited Below High Water Mark 2084  
  Operating Permit 2084  
  Operation of Dredge 2084  
  Permit Required for Non-Powered Operation -- More Than Five People 2084  
  Permit Required for Non-Powered Operation -- More Than Thirty-Three Percent of Stream Width 2084  
  Standards for Suction Dredges 2084  
Sufficiency Of Claims 2001  
  Further Information 2005  
  Single Claim 2001  
  State Law Claim Form -- Insufficient Claims, Waivers 2005  
  State Law Claim Form -- Minimum Requirements 2002  
Sufficient Financial Resources, Residential Care Facility 1033  
Sufficient Recreational Space, Children's Residential Care Facilities 1056  
Suggestion For Or Inquiry About Settlements 1985  
Suicide Prevention Plan, Residential Care Facility 1039  
Summaries Of Payments 1114  
  Approval 1114  
  Change in Status of Employer 1114 Form 1114  
  Summaries Requirement 1114  
Summary Of Idaho Consumer Grades For Shell Eggs 55  
  Grades for Shell Eggs -- Table 1 55  
  Lot Average Tolerance 58  
  Quality of Dirty or Broken Shell Eggs -- Table 5 57  
  Summary of Standards for Quality of Individual Shell Eggs 56  
  Tolerance for Individual Case or Carton Within a Lot -- Table 2 56  
  Weight Classes 57  
Supervised Practice Of Provisional Certification Holder 1617  
  Amount of Supervisory Contact 1617  
  Domains for Supervision 1617  
  Hours of Supervision 1617  
  Number of Patients 1617  
Supervising Physicians Of Medical Personnel 1394  
  Definitions 1394  
  Duties & Responsibilities of Supervising Physicians 1395  
Supervising Veterinarians 2266  
  A Supervising Veterinarian Shall 2266  
  Limitations on Supervising Veterinarians 2267  
  Statement of Purpose 2266  
Supervision 766, 1050, 1552, 1626, 1638, 1763  
  Documentation of Adjustment 1050  
  Generally Applicable Supervision Requirements 1638



- Limited Permit Holders 1552  
Occupational Therapy Aides 1552  
Occupational Therapy Assistants 1552  
Out-of-State Supervised Experience 1640  
Procedures & Interventions Performed by Physical Therapist 1626  
Pursuing Licensure As Clinical Social Worker 1639  
Pursuing Licensure As Independent Practitioners 1639  
Results of Assessment 1050  
Special Needs Adoption 1050  
Students 1553  
Supervision of a Physical Therapist Assistants 1626  
Supervision Of Clinical Work 1763  
Supervision of Fieldwork 1763  
Supervision of Physical Therapy & Physical Therapist Assistant Students 1627  
Supervision of Supportive Personnel 1627  
Supervision Ratios 1627  
Supervision Requirements 1553  
Supervision & Support 1046  
    Contact Documentation 1046  
    Monthly Contact 1046  
    Plan of Supervision 1046  
    Twenty-Four Hour Agency Telephone Access 1046  
    Written Contract & Reviews 1046  
Supervision By Responsible Managing Employee 447  
Supervision Of Agents, Investment Adviser Representatives & Employees 676  
    Broker-Dealer Procedures 676  
    Investment Adviser Procedures 676  
    Supervision Required 676  
    Written Compliance Procedure 676  
Supervision Of Domestic Cervidae Program 186  
Supervision Of Recreational Activity 1059  
    Cardiopulmonary Resuscitation (CPR) & First Aid 1059  
    Instruction 1059  
    Rescue Equipment 1059  
    Safety Equipment 1059  
    Staff Coverage 1059  
Supervision of Respiratory Care 1410  
Supervision Of Trainees 1677  
Supervisor Certification 626  
    Certification 626  
    Position 626  
    Training 626  
Supervisor Requirements 1655  
Supervisory Review - Certain Priority I & II Cases, Response Priorities Abuse, Abandonment Or Neglect 959  
Supplemental Grants 2784  
    Accrued Interest on Loans With Supplemental Grants 2785  
    Costs in Excess of Financial Ability 2784  
    Projects Not Funded by Loans 2784  
Supplemental or Subsequent Report of Injury 1096  
Supplementary Declarations 89  
    Metric System Declarations 89  
    Qualification of Declaration Prohibited 89  
    Supplementary Quantity Declarations 89  
Suppliers 697  
    Advertising 699  
    Contact With Licensees 699  
    Delisting 698  
    Facility Visitations 698  
    Liquor Displays 699  
    Liquor Shipments 698  
    New Listings 698  
    Price Quotations 697  
    Product Returns 698  
    Promotional Samples 698  
    Resident Supplier Representatives 698  
    Samples 698  
    Supplier Representative Permits 698  
    Title to Liquor, Wines & Related Products 698  
    Violations 699  
    Warranties 697  
Support Agreement For Voluntary Placements 953  
Support In Court-Ordered Placement 953  
Support Personnel  
    Audiology 1711  
        Audiology Support Personnel – Pre-Service and In-Service Instruction 1713  
        Audiology Support Personnel – Roles – Restrictions 1712  
        Supervising Audiologist – Responsibilities – Restrictions 1711  
Surety Bond Or Other Security 1476  
    Requirement 1477  
    Sum Due 1477  
    Total Sum 1477  
    Various Locations 1477  
Surface Reclamation 1356  
    Compacted Areas 1357  
    General Clean Up 1356  
    Reclamation Under a Surface Use Agreement 1358  
    Regrading 1357  
    Revegetation 1357  
    Road Removal 1357  
    Timing of Reclamation 1356  
    Topsoiling 1357  
Surrender - Relinquishment 1288  
    Effective Date 1288  
    Partial Surrender 1288  
    Procedure 1288  
Surrender Of Parking Permit 2177  
    Cancellation of Automatic Payroll Deduction 2177  
    Surrender of Permit 2177  
Surrender, Termination, Expiration Of Lease 1277  
    Continuing Obligations 1277  
    Equipment Removal 1278  
    Failure to Pay Rental or Royalty 1277  
    Procedure 1277  
    Surrender After Termination 1278  
    Termination for Cause 1278  
Surveillance For CWD 194  
    Domestic Cervidae Ranch Surveillance 194  
    Slaughter Surveillance 194  
Surveyor's Certificate 512  
Suspension & Revocation Of Instructor Certification Or Endorsement 637  
Suspension & Revocation Of Licenses Additional 1507  
    Cancellation of Contract Rights 1508  
    Comply With Suspensions 1507  
    Continuation 1508  
    Dishonest Methods 1507  
    Specific Actions 1507  
    Temporary Suspension 1507  
Suspension For Circumstances Beyond Control Of Foster Parent Or Operator 1002  
Suspension Of A License -- Debts In Connection With Training 1506  
Suspension Of Licensee For Medical Reason 1488  
    Medical Suspension - Thirty Days 1488  
    Not Fit for Competition or Officiating 1488  
Suspension Of MMA Contest For Unforeseen Reasons  
    Suspicious Circumstances 1502  
    Unforeseen Reasons 1502  
Suspension Of Registration 2196  
    Failure to Comply 2196  
    Non-Filing by the Registrant 2196  
Suspension Or Revocation For Infractions 1002  
Suspension Or Revocation Of License 2338  
Suspension Or Revocation Of License-- Civil & Criminal Penalties 2337  
Suspension Or Revocation Of Parking Privileges 2177  
    Delinquent Payment 2177  
    Parking Privileges Suspension 2177  
    Reactivating a Suspended Permit 2177  
    Towing & Impounding 2177  
Suspension Or Termination Of Loan Contracts 2849  
    Causes 2849

- Determination 2850  
 Notice 2850  
 Reinstatement of Suspended Loan 2850  
 Reinstatement of Terminated Loan 2850  
 Suspension or Termination of Loan Contracts 2794  
 Causes 2794  
 Determination 2794  
 Notice 2794  
 Reinstatement of Suspended Loan 2794  
 Reinstatement of Terminated Loan 2794  
 Suspension, Revocation Or Denial Of License 2340  
 Suspension, Revocation Or Restriction Of Sedation Permit 1148  
 Suspension, Revocation, or Denial of A License 2340  
 Swimming Pool, Pond, Or Other Body Of Water 1057  
 Access by Children Five Years of Age & Under 1058  
 Irrigation Canals or Similar Body of Water 1058  
 Other Water Safety Precautions 1058  
 Pools, Hot Tubs, Ponds, & Other Bodies of Water 1058  
 Staff Person with Lifesaving or Lifeguard Certificate 1058  
 Swine Cleaning & Disinfection 147  
 System Eligibility 2834  
 Assistance to Ensure Compliance 2835  
 Eligible Systems 2834  
 Systems Not Eligible 2834
- T**
- TABLE II - Hazard Characteristics and Offset Slash Load Maximum<sup>20</sup> Points 1305  
 Tables 2743  
 Table 1 - Minimum Distances From a Public Water System Well 2743  
 Table 2 - Well Casing Standards for Public Water System Wells 2744  
 Tagging, Identity, & Records 274  
 Identity 274  
 Official Certification Tags 274  
 Records 274  
 Taking Of Appearances -- Participation By Agency Staff 1969  
 Tampering 2389  
 Tank Batteries 1352  
 Containment Requirements 1352  
 Tax & Late Payment Penalty 2287  
 Levy & Rate of Tax 2287  
 Minimum Levy 2287  
 Opt Out Alternative 2287  
 Payment of Tax 2287  
 Taxes 1279, 1292
- Technical Memorandums For Tier I Operating Permits 2447  
 Memorandum for Draft Permit 2447  
 Release of Memorandum 2447  
 Revised Memorandum for Proposed Permit 2447  
 Technical Mountaineering/Rock Climbing 1830  
 Technical Mountaineering/Rock Climbing Guide 1816  
 Technical Registration Certified Technician Registration 1881  
 Technical Review 1862  
 Technical Waivers Or Modifications 773  
 Director Waiver 773  
 Waiver Requirements 773  
 Technicalities Of Form 467  
 Technician Registration 1881  
 Registration Requirements 1881  
 Technicians/Technologists 1444  
 Functions 1444  
 Supervision 1444  
 Telehealth Services 1149  
 Additional Requirements 1149  
 Informed Consent 1149  
 Licensure & Location 1149  
 Standard of Care 1149  
 Telephone 1025  
 Telepractice Of Sign Language Interpreting 1715  
 Telepsychology 1613  
 Assessment 1615  
 Definitions 1613  
 General 1614  
 Informed Consent 1614  
 Initial Contact 1614  
 Interjurisdictional Practice 1615  
 Security & Confidentiality 1614  
 Temporary Certification 2264  
 Certification Requirements 2265  
 Responsibility 2265  
 Temporary Installations Connected Prior To Inspection 377  
 Temporary Licensure 1418, 1759  
 Applicants from Other Countries 1418  
 Applicants Not in Active Practice 1418  
 Duration 1759  
 Fee 1418  
 General 1759  
 Issued at Discretion of Board 1418  
 Temporary Licensure by Examination 1418  
 Temporary Licensure by Interstate Endorsement 1418  
 Unsuccessful Examination Candidates 1418  
 Temporary Licenses 1598, 1605  
 Temporary Licensure -- Advanced Practice Registered Nurse 1436  
 Applicants Awaiting Initial Certification Examination Results 1436  
 Applicants Holding a Temporary Registered Nursing License 1436  
 Applicants Whose Certification Has Lapsed 1436  
 Applicants Without Required Practice Hours 1436  
 Application Processing 1436  
 Term of Temporary License 1436  
 Temporary Permit 1313, 1798  
 Eligibility 1798  
 General 1313  
 Permit 1799  
 Procedure to Obtain Temporary Permit 1313  
 Regulations Governing Use of Temporary Permit 1313  
 Temporary Permits 1236  
 Applicability 1236  
 Bonding 1236  
 Fee 1236  
 Permit Term 1236  
 Processing 1236  
 Temporary Practice 1692  
 Assignments & Length of Time Permit Will be Issued 1692  
 Proof of Current Certification or Licensure 1692  
 Requirements for Issuance 1692  
 Temporary Practice Permits 1516  
 Only One Permit May Be Issued 1516  
 Supervision Required 1516  
 Validity of Temporary Permits 1516  
 Temporary Re-Placement After Disruption 982  
 Temporary Suspension & Revocation Of Permits 757  
 Cause 757  
 Reissue 758  
 Revocation 758  
 Suspension 757  
 Temporary Suspension Of Posted Weight & Speed Restrictions 2221  
 Temporary Waiver of Spring Breakup 2221  
 Why Required 2221  
 Term 641, 1269  
 Diligence in Utilization 1269  
 Lease Term 1269  
 Yearly Reporting 1269  
 Term Of Easement 1253  
 Federally Licensed Facilities 1253  
 Permanent Uses 1253  
 Term Easements 1253  
 Term of Permit 1332  
 Termination 1934  
 Status of Financing Statement 1934  
 Status of Parties 1934  
 Termination - Cancellation Of Lease 1288  
 Cause 1288  
 Equipment Removal 1289

- Other Wells 1289  
Surrender After Termination 1289  
Termination Of A Contest Due To A Fair Blow In MMA Contest 1505  
Termination Of A Permit 1175  
Completion of Reclamations 1175  
Involuntary Termination 1176  
Termination Of A Plan 1214  
Terminate a Permanent Closure Plan 1214  
Terminate Upon Request of the Operator 1214  
Termination Of IPDES Permits 2928  
Cause to Terminate Permits 2929  
Expedited Termination Process for Terminated or Eliminated Discharge 2929  
Request to Terminate or Termination Initiated by the Department 2928  
Tentative Permit Termination 2929  
Termination of Parent-Child Relationship 971  
Termination Of Transitional Living Services, Children's Agencies 1046  
Terms & Definitions, IDAPA 16.02.08, Vital Statistics Rules 727  
Assistant Local Registrar 727  
Attendant At Birth or Stillbirth 727  
Birth Out of Wedlock 727  
Confidential Registry 727  
Current Registration 727  
Delayed Registration 727  
Department 727  
Director 727  
Expedited Certified Copy 727  
Local Deputy State Registrar 727  
Local Registrar 727  
Mortician or Funeral Director 727  
Nurse Midwife 727  
Putative Father 727  
Registration District 727  
Relatives of Deceased Qualified Adult Adoptees 728  
Relatives of Deceased Qualified Birth Parents 728  
Terms Descriptive Of Shell 52  
Abnormal (B Quality) 52  
Clean 52  
Dirty 52  
Practically Normal (AA or A Quality) 52  
Terms Descriptive Of The Air Cell 52  
Bubbly Air Cell 52  
Depth of Air Cell 52  
Free Air Cell 52  
Terms Descriptive Of The White 52  
Blood Spots or Meat Spots 53  
Bloody White 53  
Clear 52  
Firm (AA Quality) 52  
Reasonably Firm (A Quality) 52  
Weak & Watery (B Quality) 53  
Terms Descriptive Of The Yolk 53  
Blood Due to Germ Development 53  
Clearly Visible Germ Development (B Quality) 53  
Enlarged & Flattened (B Quality) 53  
Outline Fairly Well Defined (A Quality) 53  
Outline Plainly Visible (B Quality) 53  
Outline Slightly Defined (AA Quality) 53  
Practically Free From Defects (AA or A Quality) 53  
Serious Defects (B Quality) 53  
Terms Of Certification For Adoption Professionals 983  
Decertification 985  
Denial of Recertification 984  
Lapse of Certification 984  
Limits of Certification 983  
Recertification 984  
Types of Certification 983  
Test Area 576  
Test Methods & Procedures 2396  
General Requirements 2397  
Observation of Tests by Department Staff 2398  
Reporting Requirements 2398  
Test Requirements 2397  
Test Results Review Criteria 2398  
Test Methods & Procedures, Fuel Burning Equipment -- Particulate Matter 2532  
Test Procedure Requirements 2474  
Test Standards 2475  
Testimony Under Oath 1983  
Testing 582, 592  
Examination 582  
Random Testing 592  
Reasonable Suspicion 592  
Specimens 582  
Testing 582  
Testing & Monitoring Requirements 2516  
Alternative Testing 2517  
Testing 2516  
Testing Expense 594  
Testing Facilities 581  
Testing For BRR 353  
Compliance With Certification Standards 353  
Seed Potatoes to Be Exported Tested 353  
Testing Methods, Domestic Cervidae 193  
Testing Period & Credit 24  
Testing Procedure 592  
Accordance with Established Procedures 592  
Retesting 593  
Testing Procedures 274  
Testing Split Samples 584  
Lab's Willingness to Test 584  
Shipping & Testing Fees 584  
Split Sample Test Results 584  
Submission of Testing Request 584  
Unforeseen Circumstances 584  
Testing, Treatment, Quarantine, Or Disposal Required 193  
Textile Products, Threads, & Yarns 93  
Exemption -- Variety Textile Packages 94  
Sewing Threads, Handicraft Threads, & Yarns 94  
Textiles 93  
Textiles -- Variations from Declared Dimensions 94  
Wearing Apparel 93  
The Adoptive Placement 979  
The Bunker Hill Superfund Site 2235, 2236, 2237  
The Division's Mailing Address 440  
The International Fuel Gas Code, 2018 Edition 468  
Third Party Agreements 1808  
Booking Agent 1809  
Employed 1808  
Other Activities 1808  
Third Party Laboratories 156  
Third Party Payments In Excess Of CSHP Limits 785  
Tickets 1480  
Inventory 1480  
Notification 1480  
Removal & Retention After Match, Destruction 1482  
Removal 1482  
Tickets Limited To Seating Capacity Of Arena 1480  
Tier I Operating Permit Content 2439  
Tier I Operating Permit Renewal 2450  
Expiration & Renewal Application Shield 2450  
Renewal Procedures 2450  
Tier I Operating Permits For Tier I Portable Sources 2446  
Contents of Tier I Operating Permits for Portable Tier I Sources 2446  
Issuance of Tier I Operating Permits for Portable Tier I Sources 2446  
Phase II Sources 2446  
Tier II & Tier III Application & Plan Review & Approval 2596  
Application Review 2596  
Application Submittal 2596  
Application Valid for Two Years 2597  
Preapplication Conference 2596  
Tier II Operating Permit 2461  
Multiple Tier II Operating Permits 2462  
Optional Tier II Operating Permits 2461  
Required Tier II Operating Permits 2462  
Tier II Operating Permits Establishing a Facility Emissions Cap 2462

- Tier II Operating Permits Required by the Department 2462
- Tier II Operating Permit Processing Fee 2466
- Tier II Operating Permit Processing Fee 2466
- Tier II Operating Permit Processing Fee Not Required 2466
- Timber Sale Auctions 1155
- Requirements 1155
- Requirements for Bidding 1155
- Timber Sale Cancellation 1156
- Timber Sales 1155
- Time Between Contests 1468
- Forty-Five Days 1468
- Four Days 1468
- Fourteen Days 1468
- Seven Days 1468
- Twenty-One Days 1468
- Time For Board Determination 1320
- Time Frame For Personnel Licensure After Successful Completion Of Education Course 704
- Complete Standardized Examination 704
- Standardized Examination Not Completed 704
- Time Frame For Submitting Application & Fingerprints 924
- Availability to Provide Services 924
- Incomplete Application 924
- No Extension of Time Frame 924
- Unavailability to Provide Services 924
- Time Limit 1930
- Time Limit For Appraisal 151
- Time Limit For Depopulation 151
- Time line for processing a permit application 2818
- Time Of Examinations 1568
- Time Of Payment Of Hop Assessment Levy 361
- Timely Application 2427
- Changes to Tier I Operating Permits 2429
- Earlier Dates During Initial Period 2428
- Original Tier I Operating Permits 2428
- Renewals of Tier I Operating Permits 2428
- Timely Filing Of Petitions To Intervene 1977
- Time-Out 1062, 1083
- Children Six Years of Age or Older 1063
- Children Under Six Years of Age 1063
- Documentation 1063, 1083
- Duration 1083
- Observation 1083
- Observations 1063
- Prohibited Locations 1063
- Re-Introduction to the Group 1063
- Reintroduction to the Group 1083
- Review 1063, 1083
- Use 1062, 1083
- Title 450, 727, 1279, 2555
- Title & Scope 22, 40, 47, 49, 51, 62, 72, 79, 104, 109, 134, 153, 179, 198, 212, 220, 243, 265, 279, 305, 315, 343, 355, 361, 364, 397, 414, 432, 437, 445, 448, 468, 479, 496, 516, 522, 526, 539, 548, 559, 566, 578, 591, 597, 609, 644, 687, 690, 692, 702, 745, 780, 788, 803, 914, 1087, 1093, 1124, 1128, 1135, 1154, 1157, 1180, 1217, 1221, 1240, 1245, 1250, 1256, 1257, 1267, 1280, 1293, 1301, 1311, 1321, 1360, 1382, 1388, 1399, 1403, 1406, 1409, 1412, 1415, 1458, 1466, 1511, 1527, 1552, 1563, 1568, 1579, 1585, 1596, 1602, 1624, 1637, 1650, 1663, 1673, 1681, 1696, 1701, 1705, 1710, 1724, 1729, 1743, 1756, 1769, 1796, 1801, 1836, 1841, 1857, 1872, 1898, 1903, 1909, 1920, 1925, 1945, 1964, 1992, 1998, 2006, 2016, 2038, 2049, 2059, 2074, 2097, 2119, 2155, 2170, 2180, 2181, 2192, 2198, 2199, 2201, 2214, 2226, 2255, 2258, 2262, 2287, 2289, 2292, 2342, 2345, 2364, 2565, 2599, 2611, 2746, 2761, 2778, 2819, 2822, 2834, 2851, 2968
- Applicability 1180
- Examination Requirements 2006
- Rule Coverage 2016
- Rules 2006
- Scope 2016, 2565
- Solid Waste Management Facilities Not Regulated Under These Rules 2566
- Title 2016, 2565
- Variance of Methods 2016
- Wastes Not Regulated Under These Rules 2565
- Title And Scope 376, 1535
- Title Application Requirements For Replica, Street Rods, Replica Street Rods, And Assembled Vehicles 2189
- Applicant Must Provide Proof of Ownership 2189
- Inspection by a Motor Vehicle Investigator 2189
- Model Year 2189
- Title Branding 2185
- Brand Disclosure 2185
- Branding Time Frame 2185
- Brands Removed 2185
- Title IV-E Eligibility 950
- “Removal From” and “Living With” Requirements 950
- AFDC Eligibility 950
- Agency with Placement Care and Responsibility 951
- Child in Foster Care or Childcare Institution 951
- Child’s Age 951
- Child’s Citizenship Status 951
- Child’s Residence 950
- Compliance with Safety Requirements 951
- Judicial Determination 950
- Physical or Constructive Removal of the Child 950
- Title Opinions 1905
- Title XIX Foster Child 952
- Title, Scope & Intent 2796
- Title, Scope & Policy 916
- Title, Scope, & Exceptions 812
- Title, Scope, & Goal 796, 935
- Title, Scope, & Intent 716, 755
- Title, Scope, & Investigations Trace Back Investigations 353
- Title, Scope, & Policy 774
- Title, Scope, & Responsibilities 860
- Title, Scope, Policy, Purpose, Exceptions, & Exemptions To Licensing 992
- Toilets 763
- Total Compliance 2396
- Totalizer Or Other Approved Equipment Required 547
- Toxic Air Pollutants Carcinogenic Increments 2512
- Toxic Air Pollutants Non-Carcinogenic Increments 2494
- Trace Back Investigation, Sampling, & Testing 352
- Mutual Cooperation 353
- Testing Positive for Cms 353
- Trace Back & Investigation 352
- Track Security License 556
- Tracking Requirements In Games Using Paper Bingo Cards 2327
- Bingo Paper -- for Whom Required 2327
- Designation of Bingo Paper Color for Games 2327
- Documentation for Bingo Paper 2328
- Late Players When Bingo Paper Used 2327
- Tracking by Bingo Paper Packet 2327
- Tracking by Game for Bingo Paper 2327
- Trader Lot Records Retention 205
- Trader Lots, Cattle Subject To Quarantine 206
- Trainer License 556
- Trainer Present 583
- Present During Testing 583
- Refusal 583
- Tag Signed 583
- Training Fires 2520
- Training Requirements 2605
- Operator Designation 2605
- Requirements 2605
- Training 2606
- Unattended Sites 2606

- Training Requirements For Facilities  
Admitting Residents With Diagnosis  
Of Dementia, Mental Illness,  
Developmental Disability, Or  
Traumatic Brain Injury (TBI) 906  
Dementia 906  
Developmental Disability 907  
Mental Illness 907  
Traumatic Brain Injury 907  
Training, Children's Agencies 1043  
Transfer & Discharge Of Residents  
Discharge or Transfer During  
Absence 1367  
Emergency Discharge or  
Transfer 1367  
General Discharge or Transfer 1367  
Transfer And Discharge Of  
Residents 1367  
Transfer Of Alcoholic Beverage  
Licenses 518  
Authorization to Transfer &  
Assignment of Privilege to  
Renew 518  
Death or Incapacity of Licensee 518  
Expiration of Licenses 519  
Maintenance of Keg Receipts 519  
Product Replacement & Credit 519  
Temporary Permits 519  
Transfer of License Subject to  
Sanctions 518  
Transfer Of Approved Plans 1208  
Permanent Closure Plans 1208  
Reclamation Plans 1208  
Transfer Of Drilling Permits 1339  
During Drilling or After  
Completion 1339  
Prior to Drilling Well 1339  
Terms for Acceptance of  
Transfer 1339  
Transfer Of IPDES Permits 2928  
Automatic Transfers 2928  
Transfers by Modification 2928  
Transfer Of Permits 216, 1166, 2759,  
2816  
Basis for Permit Denial 2817  
Decision 2817  
Permit Obligations 2759  
Transfer Application 217, 2759  
Transfer Application Review 217  
Transfer Approval 2759  
Transfer Denial 2759  
Transfer of Permits Allowed 2816  
Transfer Of Resident 859  
Immediate Jeopardy 859  
Violation of Resident's Rights 859  
Violation of Rules 859  
Transient noncommunity public water  
system 2623  
Transit Inspection, Animal  
Industry 138  
Transitional Living Placement 1046  
Basis 1046  
Essential Services 1046  
Living Arrangements 1046  
Self-Care 1046  
Youths Need for Supervision 1046  
Transmittal Of Certificates & Local  
Records -- Reports 730  
Expedited Certified Copies of  
Certificates of Death or  
Stillbirth 730  
Transmittal of Certificates of  
Birth 730  
Transmittal of Certificates of Death &  
Stillbirth 730  
Transmittal Of Criminal History  
Records 523  
Transportation 1024  
Legal Requirements for Transporting  
Children 1024  
Prohibitions of Foster Child  
Transportation 1025  
Reliable Transportation 1025  
Transportation Conformity 2480  
Transportation Of Brassica Seeds Into &  
Throughout Idaho 239  
Transportation Of Children In  
Restraints Prohibited, Children's  
Residential Care Facilities 1068  
Transportation Of Livestock 532  
In-State 533  
Out-of-State 532  
Transportation Of Potatoes 350  
In Transit 351  
Responsibilities 350  
Transporting Children 1060, 1083  
Proper Seating of Children &  
Adults 1061, 1084  
Vehicle 1060, 1083  
Trap Crop Invasive Species  
Permits 321  
Annual Report 322  
Application for Trap Crop Invasive  
Species Permits 321  
Application Process 322  
Disposition of Non-Permitted  
Invasive Species 322  
Duration of Trap Crop Invasive  
Species Permit 322  
Grant or Denial of the Trap Crop  
Invasive Species Permit 322  
Permit Revocation 322  
Trapper Education 681  
Exemption 681  
Fee 681  
Mandatory Trapper Education  
Program 681  
Trauma Designation Centers 719  
Treatment Foster Care 956  
Availability 956  
Continuing Education 956  
Payment 956  
Payment to Contractors 956  
Qualifications 956  
Treatment Plan 956  
Treatment Of Articles 335  
Duty 335  
Treatment 335  
Treatment Restrictions 580  
Treatment Services, Program-Eligible  
Clients 781  
Treatment Techniques 2652  
General Requirements 2652  
Treatment Techniques for  
Acrylamide and  
Epichlorohydrin 2652  
Trespass 1262  
Civil Action by Lessee 1262  
Continuing Trespass 1263  
Loss or Waste 1262  
Trespass Claims 1263  
Trial Grounds 311  
Detection of Regulated Pest 312  
General Trial Ground  
Requirements 311  
Trial Ground Restrictions &  
Inspection Procedures 311  
Trial Ground Subdivisions 311  
Truckers 2255  
Trust Funds, Commodity Dealers  
Rules 77  
Trusts, UCC Information Management  
System 1933  
Truth, Accuracy & Completeness Of  
Documents 2389  
TSE Council 718  
TSE Council -- Responsibilities &  
Duties 718  
TSE Designation -- Length Of  
Designation 720  
TSE On-Site Survey 722  
TSE On-Site Survey -- General  
Requirements 722  
Communication Between Surveyors  
& Facilities 722  
Facility Notification to TSE Council  
of Potential Conflict of  
Interest 723  
Notification of Decision for Conflict  
of Interest 723  
Notification to Applicant of Survey  
Team Members 723  
Survey Team Member Notification of  
Potential Conflict of Interest 722  
Survey Team Member  
Requirements 722  
TSE On-Site Survey -- Survey Team  
Composition 723  
TSE Regions 718  
TSE Regions -- Realignment Of  
Region 719  
Copies of Request for  
Realignment 719  
Requesting Entity 719  
TSE Decision for Realignment 719  
Tuberculosis 194  
Change of Ownership 194  
Rules & UM&R 194  
Tuberculosis Screening, Residential  
Care Facility 1035  
Type 4-Specialty Construction  
Categories 455

- Acoustical Treatment, 09500 461  
Alarm Systems, 13850 463  
Aquatic Recreational Equipment,  
13165 463  
Asphalt Maintenance & Repair, Seal  
Coating, Crack Sealing & Chip  
Sealing, 02785 457  
Asphalt Paving, 02740 457  
Athletic & Recreational Surfaces,  
02790 457  
Blasting, 02319 456  
Boiler & Steam Fitting, 15510 464  
Bridge Crossings & Box Culverts,  
02855 458  
Bridge Expansion Joints & Repair,  
05830 459  
Bridges & Structures, 02850 458  
Building Cleaning & Maintenance,  
18600 465  
Carpentry, Framing & Remodeling,  
06100 460  
Cathodic Protection, 13110 462  
Caulking & Joint Sealants,  
07920 460  
Chemical Cleaning & Masonry  
Restoration, 04900 459  
Chimney Repair, 15550 464  
Circular Prestressed Concrete Storage  
Tanks (Liquid & Bulk),  
13201 463  
Climbing Wall Structures &  
Products, 11485 462  
Cold Milling, Rumble Strip Milling,  
Asphalt Reclaiming & Pavement  
Surface Grinding, 02965 458  
Communication, 16700 464  
Concrete Demolition, Concrete  
Sawing & Cutting, Core Drilling,  
Joint Sealing & Hydrocutting,  
03900 459  
Concrete Grouting, 03600 459  
Concrete Reinforcing Rebar  
Installation, 03200 458  
Concrete, 03300 458  
Construction Zone Traffic Control,  
01550 455  
Craning & Erection, 01542 455  
Crushing, 02720 457  
Demolition, 02220 455  
Develop Gas & Oil Wells,  
18300 465  
Dewatering & Subsurface Drainage,  
02240 456  
Docks - Log & Wood Structures,  
06139 460  
Doors, Gates, Specialty Doors &  
Activating Devices, 08100 460  
Dredging, 02325 456  
Drilled Piers, Pile Driving, Caisson  
Drilling, Geopier & Helical Piers,  
02450 456  
Drilling, 02210 455  
Drywall, 09250 461  
Dust Control, Dust Abatement &  
Dust Oiling, 02312 456  
Earth Retention Systems, Mechanical  
Stabilized Earth Walls & Retaining  
Walls, 02260 456  
Electrical Specialty Contractor as  
Defined by Electrical Bureau,  
16800  
Elevator, Dumbwaiter, Escalator or  
Moving-Walk Electrical 465  
Irrigation Sprinkler Electrical 465  
Limited Energy Electrical License  
(low voltage) 465  
Manufacturing or Assembling  
Equipment 465  
Refrigeration, Heating & Air Con-  
ditioning Electrical  
Installer 465  
Sign Electrical 465  
Well Driller & Water Pump Install-  
er Electrical 465  
Electrical, 16000 465  
Elevators, Lifts & Hoists, 14200 463  
Engineering, 01107 455  
Environmental Remediation,  
Restoration & Soil Stabilization,  
02195 455  
Excavation & Grading, 02310 456  
Excavation, Removal & Handling of  
Hazardous Material, 02110 455  
Fencing, 02820 457  
Finish Carpentry & Millwork,  
06200 460  
Fire Extinguisher & Fire Suppression  
Systems, 13970 463  
Fire Suppression Systems (Wet &  
Dry-Pipe Sprinklers), 13930 463  
Floor Covering & Carpeting,  
09680 461  
Flooring, 09600 461  
Golf Course Construction,  
18100 465  
Guardrails & Safety Barriers,  
02840 458  
Gypcrete, 03500 459  
Hauling, 02318 456  
Hazardous Material Remediation,  
13280 463  
Heating, Ventilation, & Air  
Conditioning (HVAC),  
15700 464  
Horizontal & Directional Earth  
Boring, Trenching & Tunneling,  
02404 456  
Installation of Communication  
Towers, 02580 457  
Installation of School Playground  
Equipment, 02880 458  
Institutional Equipment, 10150 462  
Instrumentation & Controls,  
13800 463  
Landscape Maintenance, 02935 458  
Landscaping, Seeding & Mulching,  
02900 458  
Lath & Plaster, 09200 461  
Limited Electrical Contractor as  
Defined by Electrical Bureau,  
16800 464  
Log & Heavy Timber Construction,  
06130 460  
Logging, 02231 456  
Masonry, 04000 459  
Membrane Liners for Ponds &  
Reservoirs, 02660 457  
Non-Electrical Signs, 10445 462  
Nonstructural Restoration After Fire  
or Flood, 18400 465  
Ornamental Metals, 05700 459  
Painting & Decorating, 09900 461  
Pest Control, Sterilization &  
Herbicide Applications,  
02937 458  
Petroleum & Vehicle Service  
Equipment, Installation & Repair,  
11140 462  
Pipe Fitter & Process Piping,  
15100 464  
Pipeline Cleaning, Sealing, Lining &  
Bursting, 02955 458  
Plumbing, 15400 464  
Post-Tensioned Concrete Structures  
or Structural Members,  
03380 459  
Pre-Engineered Building Kits,  
13125 463  
Prefabricated Equipment &  
Furnishings, 12011 462  
Pre-Manufactured Components &  
Modular Structures, 13121 463  
Pressure Grouting & Slab Jacking,  
03650 459  
Radon Mitigation, 13290 463  
Raised Access Flooring, 10270 462  
Refrigeration, 15600 464  
Removal of Underground Storage  
Tanks, 02115 455  
Roadway Cleaning, Sweeping &  
Mowing, 18800 465  
Rock Trenching, 02317 456  
Rockfall Mitigation & High Scaling,  
02270 456  
Roofing & Siding, 07400 460  
Sand Blasting, 09950 462  
Scaffolding & Shoring, 01541 455  
Sheet Metal Flashings, Roof  
Specialties & Accessories,  
07700 460  
Siding & Decking, 07450 460  
Site Clearing, 02230 455  
Slope Stabilization, Hydroseeding,  
Hydromulching, Native Plant  
Revegetation for Erosion Control,  
02910 458  
Slurry Walls, 02265 456  
Snow Removal, 18700 465  
Specially Placed Concrete, Concrete  
Pumping & Shotcreting,  
03370 459  
Specialty Coatings, 09960 462

- Specialty Machinery & Equipment  
Installation & Servicing,  
11001 462  
Sprinkler & Irrigation Systems,  
02810 457  
Steel Fabrication, Erection &  
Installation, 05100 459  
Steel Stud Framing, 09110 461  
Structural Moving, 02990 458  
Stucco & Exterior Insulation Finish  
Systems (EIFS), 07240 460  
Swimming Pools & Spas,  
13150 463  
Temporary Erosion & Sediment  
Controls, 01570 455  
Testing & Balancing of Systems,  
15950 464  
Thermal Insulation, 07200 460  
Tile & Terrazzo, 09300 461  
Traffic Marking & Striping,  
02761 457  
Traffic Signs & Signals, 02890 458  
Tree Removal & Trimming,  
02232 456  
Underwater Installation & Diving,  
18200 465  
Utilities, 02500 457  
Water/Wastewater & Chemical  
Treatment, 11200 462  
Waterproofing & Dampproofing,  
07100 460  
Welding, 05090 459  
Well Drilling, 02520 457  
Window, Wall Coverings, Drapes &  
Blinds, 12490 462  
Windows, Glass & Glazing,  
08500 461  
Types & Amounts Of Assistance 988  
Monthly Cash Payment 989  
Nonrecurring Adoption  
Reimbursement 988  
Title XIX -- Medicaid Coverage 989  
Title XX -- Social Services 989  
Types Of Available Parking 2171  
Types Of Certification 748  
Certified 748  
Interim Certification 748  
Not Certified 748  
Provisionally Certified 748  
Reciprocity 748  
Types Of Daycare Licenses 1004  
Daycare Center License 1004  
Family Daycare Home 1004  
Group Daycare Facility 1004  
Types Of Official Identification 184  
Electronic Identification 184  
Freeze Brands 184  
Official HASCO Brass Lamb  
Tag 184  
Official ISDA Cervidae Program  
Eartag 184  
Official NAEBA Eartag 184  
Official USDA Eartag 184  
Other Identification 184  
Ranch Specific Unique Bangle or  
Lamb Tags 184  
Tattoo 184
- U**
- UCC Document Delivery 1926  
Courier Delivery, at the Filing  
Office's Street Address 1926  
Facsimile Delivery to the Filing  
Office's Facsimile Filing  
Telephone Number 1927  
Personal Delivery, at the Filing  
Office's Street Address 1926  
Postal Service Delivery to the Filing  
Office's Mailing Address 1927  
UCC Information Management  
System 1931  
Unattended Vending Machines 101  
Units of Measurement 101  
Vending Machine Displays 101  
Unauthorized Absences -- Residential &  
Domiciliary Care 1368  
Readmission Requirements 1368  
Unauthorized Absences  
Prohibited 1368  
Yearly Maximum 1368  
Unauthorized Absences, Residential  
Care Facility 1031  
Unconditional Denial 926  
Appeal of an Unconditional  
Denial 927  
Challenge of Department's  
Unconditional Denial 927  
Issuance of an Unconditional  
Denial 927  
No Exemption Review 927  
Reasons for an Unconditional  
Denial 926  
Undercover Plate Display 2212  
Undercover Plate Status 2212  
Emission Testing of Undercover  
Vehicles 2212  
Expiration of Plates 2212  
Reissue of Plates 2212  
Transfer of Plates 2212  
Underwater Lighting 763  
Unfair Practices, Duties Of Referees  
Deducting Points 1491  
Enforcing the Rules 1491  
Warnings 1491  
Uniform Assessment  
Requirements 837  
Provider Responsibility for Private-  
Pay Residents 837  
Results of Assessment 838  
State Responsibility for Publicly  
Funded Residents 837  
Uniform Standards Of Professional  
Appraisal Practice/Code Of  
Ethics 1693  
Unique Identifier Number (UIN) 1910  
Social Security Numbers & Tax  
Identification Numbers 1910  
UIN System 1910  
Unit Or Cooperative Plans Of  
Development Or Operation 1276,  
1290  
Collective Bond 1290  
Contents 1276, 1290  
Continuation of Lease 1277  
Evidence of Agreement 1277, 1291  
IDWR Approval 1276  
Interested Parties 1290  
Lease Modification 1276, 1291  
Rentals 1291  
Segregation Prohibited 1291  
Term 1277  
Unit Plan 1276, 1290  
Units 510  
Universal Precautions, Children's  
Residential Care Facilities 1060  
Unlawful Practices, Commodity  
Dealer's 78  
Unlocked Seclusion 1063  
Children Under Six Years of  
Age 1063  
Documentation 1064  
Re-Introduction 1064  
Restrictions on Seclusion 1063  
Review 1064  
Staff Supervision 1063  
Supervisory Approval 1063  
Time Needed 1063  
Use of Unlocked Seclusion 1063  
Unprofessional And Unethical  
Conduct 1726  
Unprofessional Conduct 1149, 1644,  
1752, 1790, 1876, 2270  
Abandonment of Patients 1150  
Advertising 1151  
Altering Records 1150  
Apprentices 1790  
Association with Illegal  
Practitioners 2270  
Association with Others 2270  
Compliance with Dental Hygienist  
Professional Standards 1151  
Compliance with Dentist Professional  
Standards 1151  
Consent 1150  
Delegating Duties 1150  
Discipline 1752  
Discipline in Other States 1150  
Disclosure 1151  
Disease Transmission  
Prevention 1790  
Diversion of Drug Products &  
Devices 1876  
Dividing Fees 1150  
Double-Dipping 1790  
Excessive Provision of Controlled  
Substances 1876  
Exclusive Arrangements 1876  
Exploiting Patients 1151  
Failure to Confer 1876  
Failure to Cooperate with  
Authorities 1151  
Failure to Counsel or Offer

- Counseling 1876
  - Failure to Follow Board Order 1877
  - Failure to Provide Records to a Patient or Patient's Legal Guardian 1151
  - Failure to Report 1876
  - False Testimony 2270
  - Fraud 1150
  - Gross Ignorance, Incompetence or Inefficiency 2270
  - Harassment 1150
  - Improper Supervision 2270
  - Inspections & Investigations 1790
  - Lack of Fitness 1876
  - Legal Compliance 1151
  - Mental or Physical Condition 1150
  - Misrepresentation 1151
  - Office Conditions 1150
  - On-Duty Intoxication or Impairment 1876
  - Patient Management 1151
  - Practice Outside Scope of Training 1790
  - Prescriber Incentives 1876
  - Prescription Drug Order Noncompliance 1876
  - Prescription Drugs 1150
  - Scope of Practice 1150
  - Sexual Misconduct 1151
  - Single-Use or Porous Items 1790
  - Standard of Care 1877
  - Standards of Conduct 1752
  - Substandard, Misbranded, or Adulterated Products 1876
  - Supervision 1151
  - Unauthorized Treatment 1151
  - Unethical Conduct 1876
  - Unlawful Possession or Use of Drugs 1876
  - Unlawful Practice 1150
  - Unlicensed Practice 1150
  - Unnecessary Services or Products 1877
  - Unsanitary Methods or Procedures 2270
  - Use of False Information 1877
  - Use of Intoxicants 1150
  - Use of MMA 1790
  - Use of Roll-on Wax 1790
  - Use of Skin Cutting Instruments 1790
  - Use of UV Sterilizers 1790
  - Unusable Pesticides Collection & Disposal 126
  - Unusual Incident Notification 1030
    - Death 1030
    - Illness 1030
    - Law Enforcement Authorities 1031
    - Missing 1030
    - Removal of Child 1031
    - Suicide 1030
  - Unusual Incident Policy, Children's Agencies 1044
  - Update Of Records 1770
  - Updating Criminal History & Background Checks 932
    - Department Discretion 933
    - Employer Discretion 933
    - New Criminal History & Background Check 932
    - Use of Criminal History Check Within Three Years of Completion 933
  - Upset, Breakdown & Safety Requirements 2392
    - Amendments to Procedures 2393
    - Discretionary Reduction or Cessation Provisions 2392
    - Excess Emissions Minimization & Notification 2392
    - Excess Emissions Procedures 2393
    - Filing of Excess Emissions Procedures 2393
    - Routine Maintenance & Repairs 2392
  - Urine Samples 587
    - Lasix 587
    - Phenlybutazone 587
  - Use Of An Architect's Seal 1462
  - Use Of Controlled Substances 591
  - Use Of Earthen Reservoirs 1347
  - Use Of Formulary Drugs 1747
  - Use Of Guidance 2633
  - Use Of Manufacturers' Installation Instructions 445
  - Use of Motor Vehicles 1844
    - Commercial Motor Vehicle 1845
    - Compliance with Posted Regulatory Signs 1845
    - Obedience to Traffic Direction 1845
    - Official Use 1845
    - Overdriving Road Conditions & Speeding Prohibited 1845
    - Restrictions 1845
    - Safety Helmets 1845
    - Snowmobile Operation Limited 1845
    - Use of Parking Spaces for Persons With a Disability 1845
  - Use Of NCEES Model CPC Standard 512
  - Use Of Non-Centralized Treatment Devices 2650
    - Criteria & Procedures for Public Water Systems Using Point of Entry Devices 2650
    - Point of Use (POU) Treatment Devices 2650
    - Use of Bottled Water 2652
  - Use Of Other Anesthesia Personnel 1148
    - Advertising 1148
    - Facility, Equipment, Drugs, & Personnel Requirements 1148
    - Patient's Condition Monitored Until Discharge 1148
    - Use of Services of a Qualified Sedation Provider 1148
  - Use Of Titles, Abbreviations, & Designations For The Practice Of Nursing 1439
    - Licensed Practical Nurse Title 1440
    - Registered Nurse Title 1440
    - Title for Graduates 1439
    - Titles for Advanced Practice Registered Nurses 1439
  - Use Of Tobacco Products, Alcohol, & Illegal Drugs Prohibited, Children's Residential Care Facilities 1060
  - Use, Facility, Or Structure Modification 1253
  - User Access Fees 601
    - Billing & Payment 602
    - ILETS Network User Access Fees 601
    - Payment of Fees Required 601
    - Sanctions for Delinquency 602
    - Usage Fee 601
  - User Agency Sanctions 606
    - Class of Sanctions 606
    - Effective Date of Sanctions 606
    - Form of Sanctions 606
    - Objective of Sanctions 606
    - Reinstatement 606
    - Review of Violations 606
  - User Fees, Charges & Income 1868
    - Nonrecreational User Fees 1868
    - User Fees 1868
  - User Responsibilities 602
    - Background Checks of Terminal Operators Required 602
    - Hit Confirmation 602
    - Minimum Training 602
    - Record Validation 602
    - Terminal Agency Coordinators 602
    - User Agreement 602
  - Utilization Logs 794
  - Utilization Of Vaccination In Animal Health Emergencies 149
- V**
- Vaccinated Swine 147
  - Vacuum Pumps Prohibited 1347
  - Vacuum Relief Valve Or Combination Air & Vacuum Relief Valve 132
    - Location 132
    - Orifice Size 132
  - Valid Veterinarian/Client/Patient Relationship 2269
    - Availability 2269
    - Medical Knowledge 2269
    - Responsibility 2269
  - Validity & Duration Of Permits 2815
  - Valuation Of Improvements 1264
    - Applicant Review of Department Improvement Credit Valuation 1264
    - Duties of the Independent Third Party 1264
    - Failure to File a Timely Notice of Objection 1264
    - Notice of Objection 1264



- Notification of Final Improvement Value 1264
- Selection of an Independent Third Party 1264
- Vapor Balance Requirements 2516
  - Inspection 2516
  - Loading 2516
  - Maintenance 2516
  - Repair 2516
- Variable Fees 2000
  - Claims Including Storage 2001
  - Exceptions 2001
  - General 2000
  - Multiple Purpose Claims 2001
  - Per Acre Fee 2000
  - Per CFS Fee 2000
  - Per Kilowatt Fee 2000
- Variance Applications For TSD
  - Facilities Or Sites 2562
  - Applicant to Bear Costs 2562
  - Application Contents & Standard of Review 2562
  - Director's Decision 2562
  - Public Hearings 2562
  - Public Information 2562
- Variance To The Two Resident Limit 824
  - Additional Training 825
  - Annual Home Inspection 826
  - Application for Variance 824
  - Fire Drill Frequency 826
  - Other Employment 825
  - Reassessment of Variance 825
  - Shared Sleeping Rooms 826
  - Variance Nontransferable 825
- Variances 133, 869, 2958
  - Continuing Temporary Variance 869
  - Decision to Grant a Variance 869
  - Expedited Variance Procedures & Time Extensions 2960
  - Permit Variance Decision Process 2960
  - Revocation of Variance 869
  - Special Procedures for Decisions on Thermal Variances 2961
  - Temporary Variance 869
  - Variance Requests by non-POTWs 2958
  - Variance Requests by POTWs 2960
  - Written Request 869
- Variations To Be Allowed 98
  - Magnitude of Permitted Variations 99
  - Packaging Variations 98
- Vehicle Dealer License Plates
  - Formats 2203
  - Designation for Dealer Plates 2203
  - Designation for Manufacturers Plates 2203
- Vehicle Dealer License Plates Restrictions 2203
  - Penalties 2204
  - Restrictions 2203
- Vehicle Dealer Loaner Plates 2204
  - Fees 2205
  - Identification Card 2204
  - Letter of Authorization 2205
  - Numbering 2204
  - Surrender of Plates 2204
  - User Fee 2205
  - Vehicle Log 2204
  - Vehicle Use Donation for Civic & Charitable Events 2205
- Vehicle Dealer Transporter Registration & Plate 2205
  - Numbering of Plates 2205
  - Penalties 2206
  - Possession of Registration 2205
  - Purpose 2205
  - Renewal of Plates 2205
  - Use of Plates 2205
  - Violations 2205
- Vehicle Identification Number (VIN)
  - Inspections 2184
  - Authorized Inspectors 2184
  - VIN Inspections Required 2185
- Vehicle Titling 2211
  - For Exempt Registration & License Plates 2211
  - Undercover Vehicle Titling 2211
- Vendor's License Required 2337
- Vendors & Vendors' Licenses & Fees – Approved Gaming Devices 2337
- Ventilation 763
- Venturi 111
- Venues Of Continuing Education For Personnel Licensure Renewal 714
  - Agency Medical Director-Approved Self-Study or Directed Study 714
  - Author or Co-Author an EMS-Related Article in a Nationally Recognized Publication 714
  - Case Reviews & Grand Rounds 714
  - Distributed Education 714
  - Evaluator at a State or National Psychomotor Exam 715
  - Journal Article Review with an Evaluation Instrument 714
  - Nationally Recognized Courses 714
  - Refresher Programs 714
  - Regional & National Conferences 714
  - Simulation Training 715
  - Structured Classroom Sessions 714
  - Teaching Continuing Education Topics 714
- Verbal Requests For Information 1924
  - Attempts to Respond 1924
  - SOS Responsibility 1924
  - Time Computation 1924
  - Written Confirmation 1924
- Verification Of Data Entry, Filing & Data Entry Procedures 1937
- Vet Assistant License 557
- Veterinarian License 557
- Veterinary Technician Certification -- Renewal 2267
- Viability By TZ% 233
  - Bitterbrush 233
  - Indian Ricegrass 233
  - Sagebrush 233
  - Saltbush 233
  - Winterfat 233
- Videotaping System 575
  - Location 575
  - Monitors 575
  - Objection 575
  - Oval Track 575
  - Stewards 575
  - Straight Course 575
  - Videotape Copy 575
  - Videotapes Maintained 575
- Violation 46
- Violation & Enforcement 2247
  - Liability of Violator 2247
  - Other Action 2247
  - Successive Days in Violation 2247
  - Violation of Rules 2247
- Violations 219, 288, 373, 590, 793, 2597, 2759, 2817
  - Detected 590
  - Discharge 219
  - Discharges 2759, 2817
  - Failure to Comply 219, 2597, 2759, 2817
  - Falsification of Statements & Records 219, 2597, 2759, 2817
  - First Violation 590
  - Incoming Shipments 288
  - Not Detected 590
  - Penalties 2597, 2759
  - Permit Revocation 2759
  - Second Violation 590
  - Third Violation 590
- Violations - Penalties 1238
  - Cease & Desist Order 1238
  - Injunctions, Damages 1238
  - Mitigation, Restoration 1239
  - Noncompliance Resolution 1238
  - Notice of Noncompliance/Proposed Permit Revocation 1238
  - Revocation of Lake Encroachment Permits 1239
  - Violations 1238
- Violations, Formal Notification & Enforcement 2022
  - Additional 2022
  - Enforcement 2022
  - Formal Notification 2022
  - Violations 2022
- Visible Emissions 2526
  - Applicability 2526
  - Exception 2526
  - Exemptions 2526
  - Standards for Exempted Sources 2526
  - Test Methods & Procedures 2526
- Visitation & Access 1010
  - Denied or Limited Visitation Rights by Court Order 1010
  - Department Access 1010

- Visitation Rights 1010
  - Visitation Policy, Residential Care Facility 1039
  - Voluntary Closure Of The Home 821
    - Closure Date 822
    - Date of Notification 821
    - Discharge Plans 822
    - Provider's Certificate 821
  - Voluntary Consent 971
  - Voluntary Inspection Of Weighing & Measuring Instruments & Devices, Fees 83
  - Voluntary Noxious Weed Free Forage & Straw Certification Program 337
    - Application for Certification 338
    - Cancellation for Failure to Comply 340
    - Certification Fees 340
    - Certification Program 337
    - Certification Standards 339
    - Certification Training 337
    - Certifying Authority 337
    - Copy of Inspections & a List of Approved Inspectors 339
    - Enforcement & Cancellation 340
    - Field Inspection Procedures 338
    - Misuse of Transit Certificate & Certification Markings 340
    - Post-Certification & Distribution Requirements 339
    - Purpose 337
  - Voluntary Posting 339
  - Voluntary Program 41
  - Voluntary Remediation
    - Agreements 2824
    - Contents of Agreement 2824
    - Effect of Termination of Agreement 2825
    - Enforceability of Agreement 2825
    - Negotiation of Voluntary Remediation Agreement 2824
    - Oversight Costs 2825
    - Reasons for Which a Person May Terminate a Voluntary Remediation Agreement 2825
    - Reimbursement of Costs Included in Agreement 2824
  - Voluntary Remediation Work Plan 2825
    - Contents of Voluntary Remediation Work Plan 2825
    - Information Supporting the Voluntary Remediation Work Plan 2826
    - Modification to an Approved Voluntary Remediation Work Plan That Requires Additional Public Notice & Comment 2827
    - Review and Evaluation of Work Plan 2827
    - Submittal of Proposed Voluntary Remediation Work Plan 2825
  - Voluntary Termination 971
  - Voluntary Termination Of Parental Rights To An Indian Child 971
    - Explanation of Consent 971
    - Interpretation If Necessary 971
  - Voluntary Transfer or Discharge 1367
  - Volunteer Dental Hygiene Services 1138
    - Dental Hygiene Services Performed 1138
    - Extended Access Oral Health Care Setting 1138
    - Volunteer Time Limit 1138
    - Volunteers 1138
  - Volunteer Supervision 1035
- W**
- Wagers In Excess Of Account Balance 564
  - Waiver 915
  - Waiver By Administrator 670
  - Waiver Of Fees 757, 779, 2820
    - Determination of Good Cause 757
    - Duration Of Waiver 757
    - Limitations 757
  - Waiver of Fees
    - Determination of Good Cause 2820
    - Duration of Waiver 2820
    - Limitations 2821
  - Waiver Of Limitations For Emergency Movements 2219
    - Economic Emergencies 2219
    - Emergencies Endangering the Public Health, Safety, or Welfare Including but Not Limited to Fire, Flood, or Earthquake 2219
    - Emergency Movement of Implements of Husbandry 2219
    - Military Emergency Affecting National Security 2219
  - Waiver Of Requirements & Amendment Of Integrated Priority List 2794
    - Affordability Criteria Exceeded 2795
    - Availability of Federal Funds 2795
    - Conditions for Waiver 2794
    - Health Hazard 2795
    - Pollution 2795
    - Water Contamination 2795
  - Waiver Of Retroactivity 1860
    - Generally 1860
    - Limitations 1860
    - NPS Waiver Required 1860
  - Waiver Of Rules 2177
  - Waiver Of Titling Requirements 2191
    - Inheritance 2191
    - Law Enforcement Agencies 2191
    - Purpose 2191
  - Waivers 724, 822, 2475, 2850
    - Affordability Criteria Exceeded 2850
    - Availability of Federal Funds 2850
    - Conditions for Waiver 2850
    - Financial Hardship 2475
    - Granting a Waiver 724
  - Health Hazard 2850
  - Notice Distribution 724
  - Notification & Appeal 725
  - Post Notice 724
  - Public Service Vehicles Operating Less than 1,000 Miles Per Year 2475
  - Special Conditions 823
  - Waiver Application 724
  - Waiver Application Distribution 724
  - Waiver Application Review 724
  - Waiver Application Submission 724
  - Waiver Conditions 724
  - Waiver Not Transferable 823
  - Waiver Renewal 724
  - Waiver Revocation 725
  - Written Request 822
  - Waivers Or Variances 1875
    - Criteria 1875
    - Emergency Rulemaking Authority 1875
    - Emergency Waiver 1875
  - Wall Inlets 770
    - General Inlet Requirements 770
    - Wall Inlet Requirements 770
  - Warehouse Receipts 104
    - Date of Delivery 104
    - Kind of Seed Crop 104
    - Lot Identification 105
    - Name & Address of Seed Buyer 104
    - Name of Producer 104
    - Weight of Seed Crop Delivered 105
  - Warehouseman Responsibilities 66
    - Rights & Duties of Warehouse Licensees -- Unlawful Practices 67
    - Warehouse Receipts -- Quality 66
  - Warehouses To Be Kept Clean 66
  - Warning Before Start Of Round 1490
  - Warning Or Caution Statements 254
    - Containing Boron 254
    - Containing Molybdenum 254
    - Examples 254
    - Other Fertilizer Products 254
  - Wash 58
  - Waste Prevention, Drilling & Production Obligations 1273
    - Additional Requirements 1273
    - Diligence 1273
    - Prevention of Waste Through Reinjection 1273
    - Unused Wells 1274
  - Waste 1273
  - Waste Storage & Containment Facilities 217
    - Additional Ground Water Protection Requirements 217
    - All Substances Entering Wastewater Storage & Containment Facilities 217
    - Waste & Wastewater System Maintenance 217
    - Waste Storage 217

- Wastewater Storage & Containment Facilities 217
- Wastewater Grandparent Provision 1545
- Grandparent License 1545
- License Requirements 1545
- Wastewater System Classification Limitations 1545
- Water Front, Children's Residential Care Facilities 1059
- Water Measurement 2012
- Measurement Terminology 2012
- Measurements 2013
- Method 2013
- Rate of Diversion 2013
- Unacceptable Measurements 2013
- Water Pump Plumbing Specialty License 406
- Applications for Specialty Licenses 407
- Examinations for Specialty Licenses 407
- Fees 407
- Minimum Experience Requirements 407
- Qualified Apprentice Plumbers 407
- Qualified Journeyman Plumbers 407
- Scope of Work Permitted 407
- Special Grandfathering Provision 407
- Water Quality Control 2227
- Water Quality Standards 767
- Water Requirements 1078
- Aerial Water Drops 1078
- Electrolyte Replacement 1079
- Water 1078
- Water Caches 1078
- Water for Cooling 1078
- Water From a Natural Source 1079
- Water Rights 1274, 1287
- Potable Water Discovery 1274
- Water Supply 764
- Water System, Cervidae Ranch 188
- Waterfront Areas 1849
- Compliance with Laws 1849
- Ramps & Docks 1849
- Restricted Areas 1849
- Restrictions on Designated Beaches 1849
- Swimming 1849
- Weapons 1365
- Weed Control Fires 2520
- Weigh-In, Examination Of Boxer May Be Ordered By The Commission 1487
- Weighing In Of Combatants 1487
- Attendance by Media 1487
- Attendees & Scales Used at Weigh-In 1487
- Attire 1487
- Security 1487
- Weight Categories – Mixed Martial Arts 1502
- Weight Limits Based On Tire Sizes 2220
- Weights & Classes Of Combatants 1485
- Classes & Weights 1485
- Exceeding Weight Allowances 1486
- Weigh-Ins on Day of Contest 1486
- Well Activity & Reclamation 1353
- Well Completion/Recompletion Report & Well Report 1350
- Well Directional Control 1348
- Angular Deviation & Directional Survey 1349
- Application for Exceptions 1349
- Controlled Directional Drilling 1349
- Copy of Application to Offset Operators 1349
- Department Action 1349
- General Restrictions 1349
- Well Plugging 1354
- Notice of Intention to Abandon Well 1354
- Plugged Intervals 1355
- Plugging Dry Holes 1355
- Plugging of Wells 1355
- Plugging Required 1354
- Subsequent Report of Abandonment 1356
- Wells Used for Fresh Water (Cold Water 212 Degrees Fahrenheit) 1356
- Well Site Operations 1343
- Fencing 1343
- Storage 1343
- Trash 1343
- Vegetation 1343
- Well Sites 1343
- Well Sites & Drilling 1343
- Well Treatments 1333
- Application Denial 1335
- Application Required 1333
- Fresh Water Protections for Well Treatments 1336
- Inspections 1335
- Master Drilling/Treatment Plans 1335
- Reporting Requirements 1335
- Time Limit 1335
- Wheat Delivered On Account Or Exchanged For Other Wheat 2255
- Wheat Tax Return Form 2255
- Form 2255
- Procedures 2255
- Wheat Under Commodity Credit Corporation Loans 2256
- Payee 2256
- Tax 2256
- Wheelchair Access 1025
- When A Boxer Shall Be Deemed Down 1494
- Feet Off Floor 1494
- Hanging Over Ropes 1494
- When Combatant Falls From Ring
- During Round 1494
- Combatant Knocked or Falls from Ring Platform 1494
- Combatant to Neutral Corner 1494
- Penalty 1494
- Stalling Outside Ropes 1494
- When Discovery Authorized 1981
- Wholesaler Licensure & Registration 1882
- VAWD Accreditation 1883
- Wholesaler Licensure 1882
- Wholesaler Registration 1883
- Width Limitation On Two Lane Road 2220
- Width Of Decks & Walkways 760
- Pool Deck 760
- Spa 760
- Wild Cervidae 186
- Duty of Ranch Owner 186
- Failure to Notify The Administrator 186
- Idaho Department of Fish & Game 186
- Notification Of Administrator 186
- Wild Ungulate Cooperative Herd Plan 186
- Wines 699
- Winter Recreation Programs 1849
- Winter Access Program 1849
- Winter Recreational Parking Permits 1850
- Withdrawal 1955
- Withdrawal Of Agent Of Issuer Registration 662
- Agent of Issuer 662
- Pending Revocation or Suspension 662
- Withdrawal Of Application 924
- Withdrawal Of Approval Of Programs 446
- Division Withdrawal 446
- Re-Approval 446
- Withdrawal Of Broker -- Dealer & Agent Registration 661
- Agents 662
- Application Withdrawal 661
- Broker-Dealer 662
- Withdrawal Of Investment Adviser & Investment Adviser Representative Registration 668
- Application Withdrawal 668
- Investment Adviser 668
- Investment Adviser Representative 668
- Withdrawal Of Lands 1282
- Withdrawal Of Parties 1969
- Withdrawal/Abandonment Of A Registration Statement 649
- Abandoned Applications Not Reinstated 650
- Abandonment 650
- Time Limit 650
- Withdrawal 649
- Withholding Formal Discipline &

Probation 2358  
Work Proceeding Without Permit Or  
Approval 426  
Work, Children's Residential Care  
Facilities 1057  
Wrestlers -- Physical  
Examination 1505  
Wrestling  
Disqualification For Dangerous  
Tactics 1505  
Professionalism 1505  
Restrictions 1505  
Special License Is Required For A  
Contest 1505  
Written Alternate Care Plan 950  
Written Bylaws, Residential Care  
Facility 1032  
Written Contracts 1720  
Cancellation & Refund 1721  
Contract Form 1720  
Dealer Cancellation 1721  
Written Interpretation 780  
Written Interpretations 109, 212, 803,  
860, 1093, 2364, 2567, 2599, 2746,  
2761, 2778, 2796, 2819, 2822, 2834,  
2854  
EDI Guide and Tables 1093  
EDI Implementation Guide 1093  
Written Policies & Procedures -  
Adoption, Children's  
Agencies 1047  
Written Statement Of Suitability For  
Licensure 1555, 1716, 1758, 1778  
Applicant Bears the Burden 1556,  
1716, 1758  
Consideration of Factors &  
Evidence 1555, 1758  
Consideration of Factors and  
Evidence 1716  
Interview 1556, 1716, 1758  
Written Statement Of Suitability For  
Licensure Or Certification  
Applicant Bears the Burden 1778  
Consideration of Factors &  
Evidence 1778  
Interview 1778  
Written Statement Of Suitability For  
Licensure Or Permit 1796  
Applicant Bears the Burden 1797  
Consideration of Factors &  
Evidence 1796  
Interview 1797

**Y**

Yearly Reporting 1297  
Annual Report 1297  
Failure to Provide 1297